

QST

August 1958

50 Cents

55c in Canada

devoted entirely to

amateur radio



Now "Top-of-the-Hill" Performance with the only

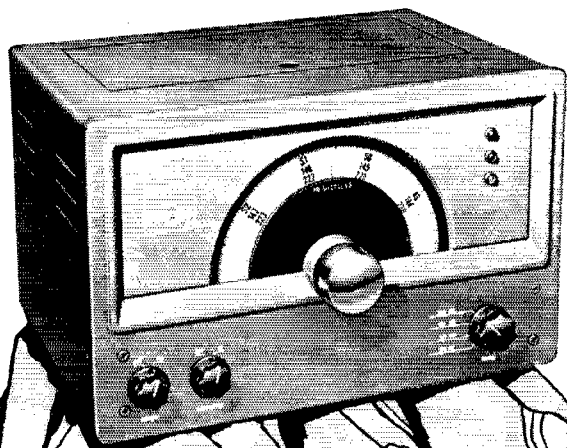

Tunable VHF CONVERTER

for the serious VHF man

RME/VHF 126

Radio amateurs designed and built this versatile VHF converter. Specifically designed to extend the range of any communications receiver through the 6, 2 and 1 $\frac{1}{4}$ meter amateur bands.

The VHF 126 is an independent receiver

with its own power supply utilizing the low-frequency IF stages and audio of your present receiver. Simple to install, it requires no circuit modification to select either VHF or standard communication ranges.

Here's Why You get "Top-of-the-Hill" Performance

- Extends effective usefulness of any receiver to 225 megacycles
- Performance equals that of costly astronomy receivers
- Dual Conversion eliminates images
- Dual-speed tuning: 1 to 1,75 to 1
- Heavy, steel cabinet
- Complete shielding reduces spurious radiation below FCC requirements

Range: 48.4 to 54.2 MC; 143.4 to 149.2 MC; 219.4 to 225.2 MC.

Noise Figure: 50 MC—2.5 db; 144 MC—4.0 db; 220 MC—6.0 db.

Calibration: Direct, MC subdivided in 100 KC divisions.

Panel Controls: Antenna changeover switch, band selector, tuning control, line switch.

Dimensions: 16 $\frac{1}{2}$ " wide, 10" deep, 10" high.

Weight: 32 pounds.

**YOURS NOW FOR THE FINEST VHF
RECEPTION. \$239, Amateur Net!**

GET THE FACTS about RME equipment—built by Hams, for Hams. Write Dept. Q88 for Bulletin 244. See your RME-Electro-Voice Dealer.

RME

DIVISION OF

ElectroVoice

RADIO MANUFACTURING ENGINEERS, Inc.

Division of Electro-Voice, Inc., Buchanan, Michigan

New!

hallicrafters

"2 and 6"



Also available—
A. C.—only model

SR-34
two and six meter
transmitter/receiver

World's first complete two and six meter radio station... features transistorized, built-in power supply

COMPLETE SPECIFICATIONS

General description: The SR-34 is designed for either AM or CW and combines, for the first time in one compact package, the complete functions of a two and six meter radio station. It operates on 115-V. A.C., 6-V. D.C., or 12 V. D.C. and features a highly efficient transistorized power supply for the 6 and 12 volt operation.

Exclusive features: The perfect unit for short-range portable, fixed or mobile communication, the SR-34 meets—and exceeds—F.C.D.A. matching-fund specifications. The crystal sockets and transmitter tuning controls are concealed behind a panel which may be sealed to prevent tampering. Instantaneous selection of desired voltage possible and also "crossbanding" between the two and six meter bands. The specially designed cover has mounting clips for two-band antenna, owner's microphone, and cords.

Both receiver and transmitter may be used for C.W.; key jack and adjustable B.F.O. are provided. Drip-proof case is specially designed for safe outdoor use.

The transmitter is crystal-controlled; up to four crystals may be switch-selected. A fifth position on this switch permits external V.F.O. operation. Band selection also is front-panel controlled.

The receiver is a double conversion superhetero-

dyne, having a quartz crystal controlled second oscillator. This offers outstanding selectivity and high image rejection. Highest stability is obtained through separate oscillator and R.F. sections for each band.

All receiver functions provided—S-meter B.F.O., ANL, etc. Sensitivities average 1 microvolt on both bands. Transistorized power supply eliminates noisy, erratic operation encountered with vibrator-type power supplies.

Front Panel Controls: *Receiver:* Band Selector (49-54 mc., 143.5 to 148.2 mc.); Main Tuning; Sensitivity; Audio Volume; B.F.O. Pitch; Squelch Level; Headphone Jack. *Transmitter:* Function Switch (P.A., Rec., Cal., AM, CW); Power On/Off; Band Switch; Crystal Selector and V.F.O.; Oscillator Tuning; Doubler Tuning; Tripler Tuning; Final Tuning; Final Loading; Meter Switch.

Power output: 6 to 7½ watts on 2 meter, and 7 to 10 watts on 6 meter AM or CW, 100% mod. negative peak clipping. *Rear Apron:* Speech input level control; key jack; P.A. speaker terminals; mic. selector (high Z or carbon); mic. input; A.C. and D.C. fuses; power plug.

Available with convenient terms from your Radio Parts Distributor.

Export Sales: International Operations—Raytheon Manufacturing Co.—Waltham, Massachusetts

The new ideas in communications
are born at ...



In our 25th year of service

hallicrafters

Chicago 24, Illinois

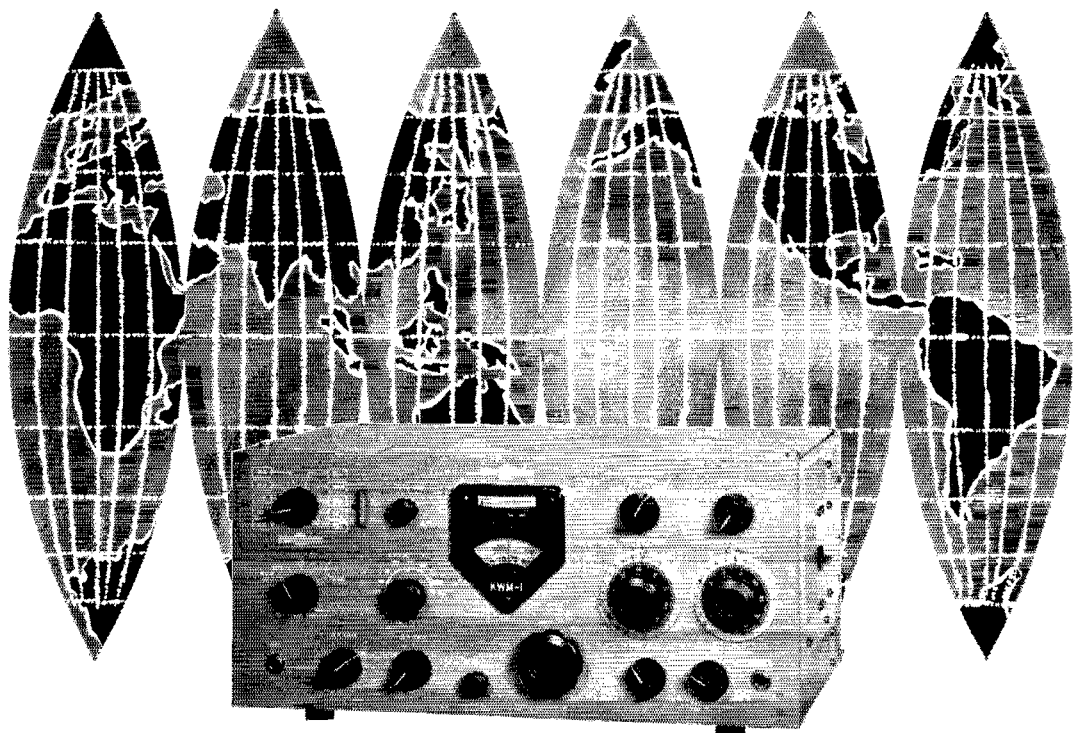

Collins **KWM-1**

Favorite of DXpeditions

The versatility of the KWM-1 mobile/fixed SSB Transceiver has made it the natural choice of the amateur operator on the move. It is the most compact traveling companion available, yet it runs 175 watts input* on SSB. Besides hundreds in operation from cars (and even light airplanes) all over the United States, the KWM-1 is fast gaining an impressive reputation with amateurs who take the transceiver with them overseas. Representative of areas visited with the KWM-1 are Africa, the South Pacific, Europe, South America, Canada, Greenland, Alaska, the Arctic, English Channel islands, Saint Andres Island, the Dominican Republic, Saint Martin Island and Anguilla.

The KWM-1 is also scheduled for expeditions to Galapagos, Barbados and the Boy Scout Jamboree in New Zealand and for a round-the-world cruise.

*P.E.P.



PUBLISHED MONTHLY, AS ITS OFFICIAL ORGAN, BY THE AMERICAN RADIO RELAY LEAGUE, INC., WEST HARTFORD, CONN., U. S. A.; OFFICIAL ORGAN OF THE INTERNATIONAL AMATEUR RADIO UNION

STAFF

- A. L. BUDLONG, W1BUD
Editor
- RICHARD L. BALDWIN, WIKE
Managing Editor
- GEORGE GRAMMER, W1DF
Technical Editor
- DONALD H. MIX, W1TS
BYRON GOODMAN, W1DX
Assistant Technical Editors
- EDWARD P. TILTON, W1HDQ
V.H.F. Editor
- LEWIS G. MCCOY, WIICP
E. LAIRD CAMPBELL, W1CUT
Technical Assistants
- ROD NEWKIRK, W9BRD
Contributing Editor, DX
- ELEANOR WILSON, W1QON
Contributing Editor, YLs
- NANCY A. ACKERMAN
Production Assistant
-
- LORENTZ A. MORROW, W1VIG
Advertising Manager
- EDGAR D. COLLINS
Advertising Assistant
- Chris Dunkle and Associates
740 S. Western Ave.
Los Angeles 5
California Representative
-
- DAVID H. HOUGHTON
Circulation Manager
- J. A. MOSKEY, W1MY
Assistant Circulation Manager

OFFICES

39 La Salle Road
West Hartford 7, Connecticut
TEL: ADams 6-2535 TWX:HF 88

Subscription rate in United States and Possessions, \$4.00 per year, postpaid; \$4.25 in the Dominion of Canada, \$5.00 in all other countries. Single copies, 50 cents. Foreign remittances should be by international postal or express money order or bank draft negotiable in the U. S. and for an equivalent amount in U. S. funds.

Entered as second-class matter May 29, 1919, at the post office at Hartford, Connecticut, under the Act of March 3, 1879. Acceptance for mailing at special rate of postage provided for in section 1102 Act of October 3, 1917, authorized September 9, 1922. Additional entry at Concord, N. H., authorized February 21, 1929, under the Act of February 28, 1925.

Copyright 1958 by the American Radio Relay League, Inc. Title registered at U. S. Patent Office, international copyright secured. All rights reserved. *Quedan reservados todos los derechos.* Printed in U. S. A.

INDEXED BY

- Applied Science and Technology Index
- Library of Congress Catalog Card No.: 21-9421

— CONTENTS —

TECHNICAL —

- A Narrow-Band Image Transmission System — Part I
Copthorne MacDonald, W4ZII/2 11
- Keeping Equipment Cool.....*Ronald L. Ives* 18
- Filtering and Shielding the Station Receiver
David T. Geiser, WA2ANU 27
- New Apparatus:
 - Slug-Tuned Coil Forms..... 29
 - Safe Tower for a City Lot...*Lewis H. Abraham, W6FHR* 30
 - An All-Purpose 813 Amplifier
R. A. Thomason, W4SUD 35
 - A Directional Coupler for 144 Mc..... 38
 - Another Peek at PRP...*Mason P. Southworth, W1VLH* 42
- Recent Equipment:
 - The Viking Courier..... 45
 - The Hammarlund HQ-110..... 46

BEGINNER —

- 80-Meter Loading Without Harmonics
Lewis G. McCoy, WIICP 24

MOBILE —

- Mobile Converter — No B Plus
William E. LaFarra, WSZCC 16

OPERATING —

- Results of Armed Forces Day 1958..... 49
- 1958 Novice Roundup Results..... 50
- 1957 Phone SS Corrections..... 52

GENERAL —

- National Convention..... 56
- Hams Across the Sea.....*Arthur Lubach, W2DPP* 57

- "It Seems to Us..."..... 9
- Coming Conventions..... 10
- ARRL Maritime Provinces Convention..... 10
- Hamfest Calendar..... 10
- Our Cover..... 10
- ARRL QSL Bureau..... 23
- Quist Quiz..... 26
- Silent Keys..... 52
- Happenings of the Month..... 53
- Correspondence from Members 60
- Hints and Kinks..... 62
- How's DX?..... 65
- YL News and Views..... 70
- In QST 25 Years Ago..... 72
- The World Above 50 Mc..... 73
- Operating News..... 76
- With the AREC..... 78
- Station Activities..... 84
- Index to Advertisers..... 158

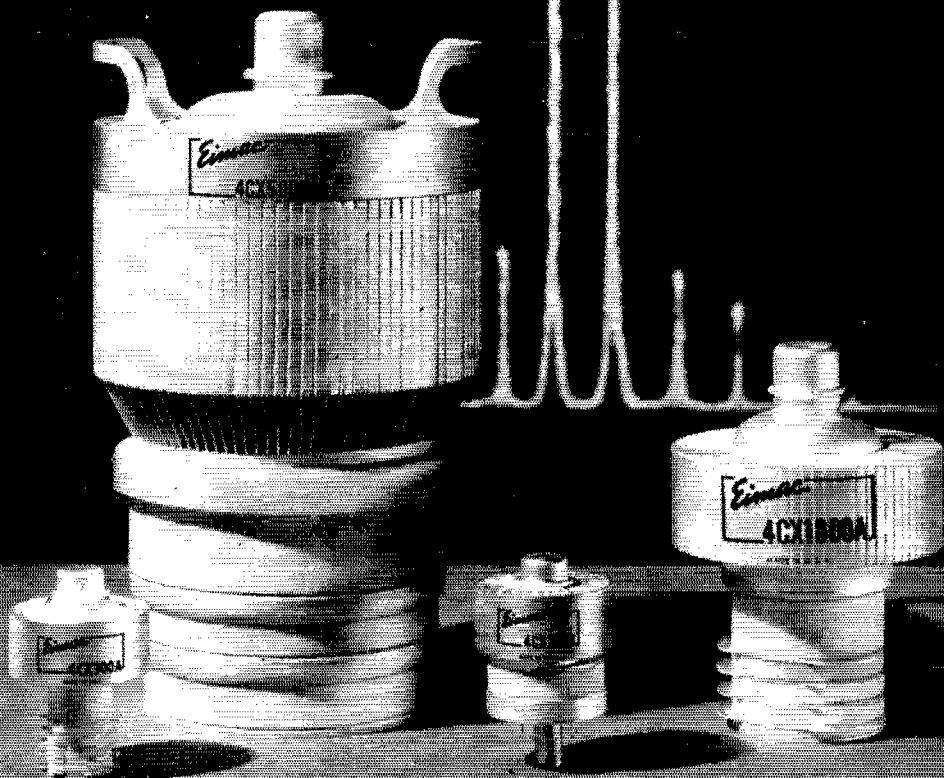

The Ideal Approach to SSB ... Eimac Ceramic Tetrodes for Class AB₁

Generating a clean SSB signal is one thing ... amplifying it to the desired power level without distorting or broadening it is another. A modern class AB₁ final amplifier designed around an Eimac ceramic-metal tetrode is the ideal answer to the problem. Three of the four Eimac ceramic tubes shown above — the 4CX250B, the 4CX300A and the new 4CX1000A — are ideal for amateur radio application. All four offer the high power gain, low distortion and superior linear performance that is needed for class AB₁ operation. Each has performance-proved reserve ability to handle the high peak powers encountered in SSB operation. Efficient integral-finned anode cooler and Eimac Air System

Sockets keep blower requirements at a minimum and allow compact equipment design. And all four incorporate the many advantages of Eimac ceramic-metal design, which assures compact, rugged, high performance tubes.

The reliability and performance that make Eimac ceramic tubes the choice for government and commercial transmitters can be yours in a compact, SSB tabletop kilowatt or a deluxe mobile rig. Eimac ceramic tetrodes simplify design and give more watt-hours per dollar.

For a copy of Application Bulletin #9 "Single Sideband" write our Amateur Services Department

EITEL-McCULLOUGH, INC.
SAN BRUNO · CALIFORNIA

Eimac First with ceramic tubes that can take it



CLASS AB₁ SSB OPERATION

	4CX250B	4CX300A	4CX1000A	4CX5000A
Plate Voltage	2000 v	2500 v	3000 v	7500 v
Driving Power	0 w	0 w	0 w	0 w
Peak Envelope Power	325 w	400 w	1680 w	11,000 w

There's a PR for every Service!

AMATEUR

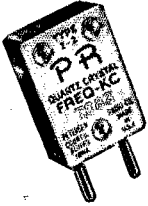

40, 80 and 160 Meters, PR Type Z-2

Rugged. Low drift, fundamental oscillators. High activity and power output. Stands up under maximum crystal currents. Stable, long-lasting, permanently sealed; ± 500 cycles.....\$2.95 Net

20 Meters, PR Type Z-3

Third overtone oscillator. Low drift. High activity. Can be keyed in most circuits. Fine for doubling to 10 and 11 meters or "straight through" 20 meter operation; ± 500 cycles.....\$3.95 Net

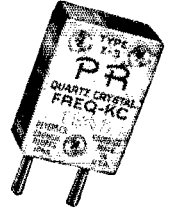

24 to 27 Mc., PR Type Z-9A



Third overtone; multiplies into either 2-meter or 6-meter band; hermetically sealed; calibrated 24 to 27 mc., ± 3 kc.; .050" pins.

\$4.95 Net

50 to 54 Mc., PR Type Z-9A



Third overtone; for operating directly in 6-meter band; hermetically sealed; calibrated 50 to 54 mc., ± 15 kc.; .050" pins.

\$6.95 Net

SPECIAL TYPES

Commercial Crystals available from 100 Kc. to 70 Mc. Prices on request.

Type Z-1, AIRCRAFT

3023.5 Kc., .005%.....\$3.45 Net

Type Z-1, MARS and CAP

Official assigned transmitter frequencies in the range. Calibrated to .005%. 1600 to 10000 Kc. \$3.45 Net

Type Z-6A

FREQUENCY STANDARD

To determine band-edge. To keep the VFO and receiver properly calibrated.

100 Kc. \$6.95 Net



PR PRINTED OSCILLATOR KIT

Has many uses—

- As 100 Kc. Marker
- As 1000 Kc. Marker for Check Points up to 54 Mc.
- As Foundation Circuit for Low Frequency SSB Crystals

Assembled in minutes. Kit contains everything but 6BA6 oscillator tube and crystal.

Each \$4.50 Net

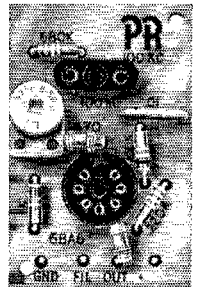

Type 2XP

Suitable for converters, experimental, etc. Same holder dimensions as Type Z-2.

1600 to 12000 Kc. (Fund.) ± 5 Kc. . . . \$3.45 Net

12001 to 25000 Kc. (3d Mode) ± 10 Kc. . . . \$4.45 Net

VHF Type Z-9R, Aircraft



For Lear, Narco and similar equipment operating in the 121 Mc. region, requiring crystals in 30 Mc. range.

Each \$4.95 Net

Type Z-9A RADIO CONTROLLED OBJECTS

27.255 Mc., .04% . . . \$3.95 Net



Type Z-1

TV Marker Crystals

Channels 2 through 13 \$6.45 Net

3100 Kc. . . \$2.95 Net

4100 Kc. . . \$2.95 Net

4.5 Mc. Intercarrier, .01% . . . 2.95 Net

5.0 Mc. Sig. Generator, .01% 2.95 Net

10.7 Mc. FM, IF, .01% . . . 2.95 Net

ALL PR CRYSTALS ARE UNCONDITIONALLY GUARANTEED. ORDER FROM YOUR JOBBER.

PETERSEN RADIO COMPANY, INC.

2800 W. BROADWAY • COUNCIL BLUFFS, IOWA

EXPORT SALES: Royal National Corporation, 250 W. 57th Street, New York 19, N. Y., U. S. A.

Section Communications Managers of the ARRL Communications Department

Reports Invited. All amateurs, especially League members, are invited to report station activities on the first of each month (for preceding month) directly to the SCM, the administrative ARRL official elected by members in each Section. Radio club reports are also desired by SCMs for inclusion in QST. ARRL Field Organization station appointments are available in the areas shown to qualified League members. These include ORS, OES, OPS, OO and OBS. SCMs also desire applications for SEC, EC, RM and PAM where vacancies exist. All amateurs in the United States and Canada are invited to join the Amateur Radio Emergency Corps (ask for Form 7).

CENTRAL DIVISION			
Eastern Pennsylvania Maryland-Delaware-D. C. Southern New Jersey Western New York Western Pennsylvania*	W3JNO W3OCR K2BG K2HUK W3ULN	Richard B. Mesirov Louis F. Croneberger Herbert C. Brooks Charles T. Hansen Anthony J. Mrozka	1472 W. Indian Creek Dr. 9904 Gardiner Ave. 800 Lincoln Ave. 211 Rosemont Drive 475-5th St.
Illinois Indiana Wisconsin	W9PRN W9TQC W9KQB	Edmond A. Metzger Arthur G. Evans George Woita	1520 South 4th St. 823 North Bosart 2103 South 9 St.
North Dakota* South Dakota Minnesota	W0VCL W0FLP W0KLG	Arnold L. Oehlens Les Price Robert Nelson	203 Seventh St. Custer State Park P. O. Box 425
Arkansas Louisiana Mississippi Tennessee	W5ZVY W5FMO W5EHH W4UIO	Olmon M. Golings Thomas L. Morgavi John Adrian Houston, sr. R. W. Ingraham	P. O. Box 207 3409 Bellvue St. 114 North First Ave. 105 West Park Drive
Kentucky Michigan Ohio	W4KKW W8RAE W8AL	Albert M. Barnes Thomas G. Mitchell Wilson E. Weckel	830 Third Ave. 409 Liberty 2118 Tuscarawas St., W.
Eastern New York N. Y. C. & Long Island Northern New Jersey	W2EFU W2TUK W2VQR	George W. Tracy Harry J. Dannels Lloyd H. Manamon	1138 North Country Club Drive 139 East Zoranne Drive 709 Seventh Ave.
Iowa Kansas Missouri Nebraska	W0BLK W0ICV W0GEP W0BXP	Russell B. Marquis Earl N. Johnston Oshorne R. McKeraghan Charles E. McNeel	807 North Fifth Ave. 1100 Crest Drive 15 Sandingham Lane Route 3, RFD
Connecticut Maine Eastern Massachusetts Western Massachusetts New Hampshire Rhode Island Vermont	W1FVQ W1LKP W1ALP W1HKV W1AJJ W1VXC W1OAK	Victor L. Crawford John Fearon Frank L. Baker, jr. Oshorne R. McKeraghan John Arthur Knapp Mrs. June R. Barkott Mrs. Ann L. Chandler	RFD 5, Stadleigh Rough Rd. RFD 1 91 Atlantic St. 22 Muttet St. 15 North State St. 172 Ferris Ave. RFD 2
Alaska Idaho Montana Oregon Washington	KL7DZ W7RKL W7NPV/WX1 W7JDX W7PGY	Eugene N. Herato Rev. Francis A. Peterson Vernon L. Phillips Hubert R. McNally Robert B. Thurston	P. O. Box 1893 Box 542 Box 971 11908 S.E. Madison St. 7700-31st Ave., N.E.
Hawaii Nevada Santa Clara Valley East Bay San Francisco Sacramento Valley San Joaquin Valley	KH6AED W7LIV W6TAM W60IV W60PI K6CFF W6JPU	Samuel H. Lewbel Albert R. Clin G. Donald Eberlein B. W. Southwell Fred H. Laubscher LeVaughn Shipley Ralph Saroyan	P. O. Box 3564 P. O. Box 14 P. O. Box 372 200 South Seventh St. 655 Wakerobin Lane 3005 Maison Way 6204E. Townsend Ave.
North Carolina South Carolina Virginia West Virginia	W4RRH W4GOV W4KX W8PQQ	B. Riley Fowler Dr. J. O. Dunlap John Carl Morgau Albert H. Hix	Box 143 P. O. Box 447 c/o Radio Station WFVA, Box 209 1013 Belmont St.
Colorado Utah New Mexico Wyoming	W0DML W7QWH E5DAA W7PSO	B. Eugene Spoonmore Thomas H. Miller Allan S. Hargett James A. Masterson	224 Carille Ave. 1420 E. 3045 St. 1001 Birch Lane 851 Bon Ave.
Alabama Eastern Florida Western Florida Georgia West Indies (Cuba-P.R.-V.I.)	W4HKK W4KGJ W4RKH W4CFI KP4DJ	Clarke A. Simms, jr. John F. Porter Frank M. Butler, jr. William F. Kennedy William Werner	16 Rosemary Rd Box 7295, Ludlum Branch 28 South Elliott Rd. 1683 Fairway Hill Drive, S.E. 563 Ramon Lovet
Canal Zone	KZ5WA	P. A. White	Box 82
Los Angeles Arizona San Diego Santa Barbara	W6TOB W6TDF W6LRU K6CVR	Albert P. Hill Jr. Cameron A. Allen Don Stansifer Robert A. Hemke	861 No. Millard Ave. 1020 East Maryland Ave. 4427 Pescadero 728 W. Mission
Northern Texas Oklahoma Southern Texas	W5BNG W5PEC W5QEM	L. L. Harjin Richard L. Hawkins Roy K. Eggleston	4515 Calmont 1408 Bell Ave. 1109 Vernon Drive
Maritime Ontario Quebec	VE1WB VE4NG VE2DR	D. E. Weeks Richard W. Roberts C. W. Skarstedt	R.R. 3 170 Norton Ave. 62 St. Johns Rd.
Alberta British Columbia Yukon Manitoba Saskatchewan	VE6VM VE7JT VE4FE VE5LU	Gordon W. Hollingshead Peter M. McIntyre James A. Elliott Lionel O'Byrne	108 Hudson Rd. 981 West 26th Ave. 190 Oaklea Blvd.
			Philadelphia 31 Silver Spring, Md. Palmyra Buffalo 26 Donora
			Springfield Indianapolis Manitowoc
			Devils Lake Hermosa Dassel
			Osecoja Cleveland Kingsport
			Dayton Buchanan Canton 8
			Schenectady Farmingdale, L. I. Asbury Park
			Marshalltown Topeka Ferguson 21 North Platte
			Danbury Wells Beach North Quiney 71 Easthampton Concord Rumford 16 Barre
			Anchorage St. Anthony Harlowton Portland 16 Seattle 15
			Honolulu Keno Los Gatos Dixon San Rafael Sacramento 25 Fresno
			Morgantown Rock Hill Fredericksburg Forest Hills, Charleston 4
			Pueblo Salt Lake City Carlsbad Casper
			Montgomery Miami 55 Fort Walton Beach Atlanta 17 Urb. Truman Rio Piedras, P. R. Camboa
			Rialto Phoenix San Diego 7 Santa Barbara
			Fort Worth 7 Lawton Corpus Christi
			St. Stephen, N. B. Willowdale, Toronto, Ont. Pointe Claire, Montreal 33, P. Q. Calgary, Alta. Vancouver, B. C.
			St. James, Winnipeg 12 Rowatt

*Official appointed to act temporarily in the absence of a regular official.

HERE'S HOW WE SOLVED IT!!!

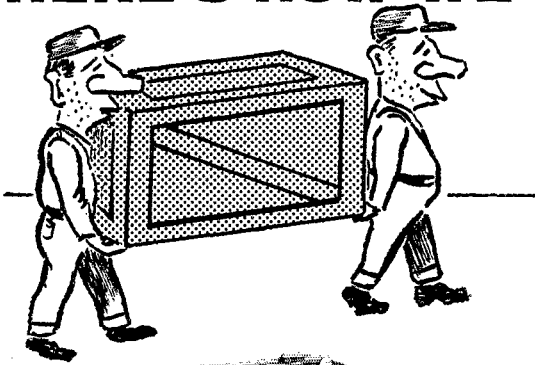

After we design and produce and test a piece of operational equipment like that shown we hit a common problem —

Usually the equipment is wrapped in cellophane which in turn is encased in a vapor proof bag with a dessicant (high class word for moisture prevention). Then it may go into another carton, and then into a case made of 3/4" lumber. Now this packing is heavy (sometimes more than the equipment) and takes a lot of space.

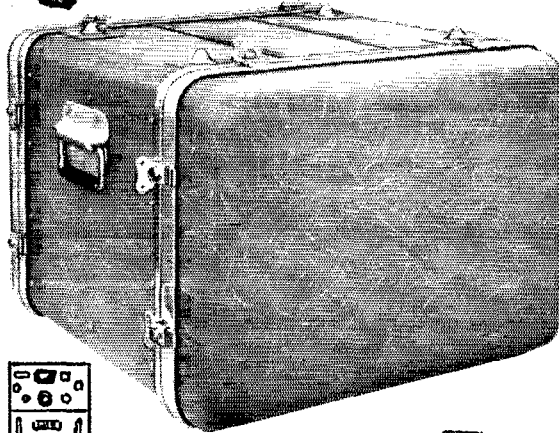

So we've come up with these cases... They're moisture proof... moulded of fiberglass, which has tremendous impact strength but is quite light.

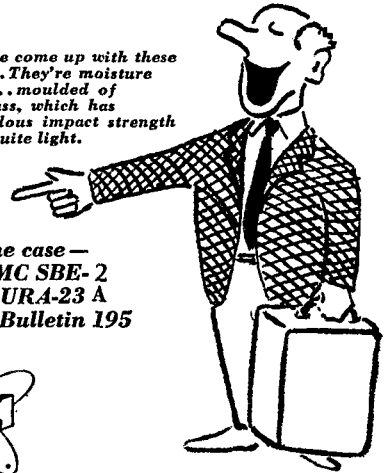

In the case —
the TMC SBE-2
AN/URA-23 A
Request Bulletin 195

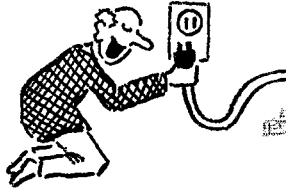
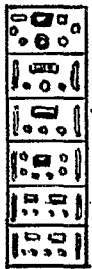

All you have to do is take off the covers and plug it in.

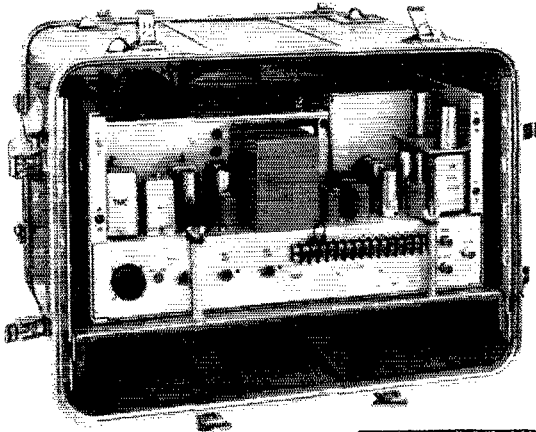
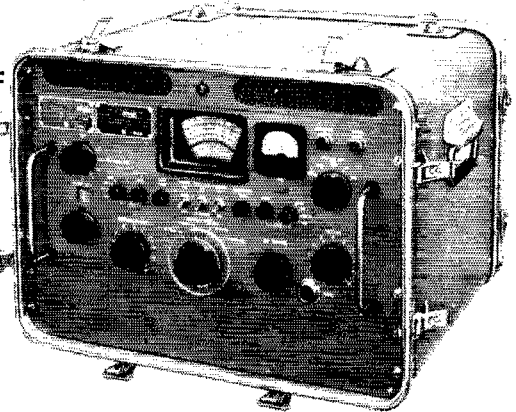

Also when unpacked it requires more handling and unpacking with heavy tools, so we've come up with these cases... They're moisture proof... moulded of fiberglass, which has tremendous impact strength but is quite light. When the equipment arrives all you have to do is take off the covers and plug it in. Simple, huh? Dimples on the top permit stacking a number of units one on top of the other.

Bulletin 217 has the story but call us for the full possibilities of TOC.

The TECHNICAL MATERIEL CORPORATION

IN CANADA
TMC Canada Ltd., Ottawa, Ontario

Main Office MAMARONECK
NEW YORK

THE AMERICAN RADIO RELAY LEAGUE, INC.,

is a noncommercial association of radio amateurs, bonded for the promotion of interest in amateur radio communication and experimentation, for the relaying of messages by radio, for the advancement of the radio art and of the public welfare, for the representation of the radio amateur in legislative matters, and for the maintenance of fraternalism and a high standard of conduct.

It is an incorporated association without capital stock, chartered under the laws of Connecticut. Its affairs are governed by a Board of Directors, elected every two years by the general membership. The officers are elected or appointed by the Directors. The League is noncommercial and no one commercially engaged in the manufacture, sale or rental of radio apparatus is eligible to membership on its board.

"Of, by and for the amateur," it numbers within its ranks practically every worth-while amateur in the nation and has a history of glorious achievement as the standard-bearer in amateur affairs.

Inquiries regarding membership are solicited. A bona fide interest in amateur radio is the only essential qualification; ownership of a transmitting station and knowledge of the code are not prerequisite, although full voting membership is granted only to licensed amateurs.

All general correspondence should be addressed to the administrative headquarters at West Hartford, Connecticut.



Past Presidents

HIRAM PERCY MAXIM, W1AW, 1914-1936
EUGENE C. WOODRUFF, W8CMP, 1936-1940
GEORGE W. BAILEY, W2KH, 1940-1952

Officers

President GOODWIN L. DOSLAND, WØTSN
Moorhead, Minnesota

First Vice-President WAYLAND M. GROVES, W5NW
P.O. Box 586, Odessa, Texas

Vice-President FRANCIS E. HANDY, W1BDI
38 La Salle Road, West Hartford, Connecticut

Vice-President PERCY C. NOBLE, W1BYR
37 Broad St., Westfield, Massachusetts

Secretary A. L. BUDLONG, W1BUD
38 La Salle Road, West Hartford, Connecticut

Treasurer DAVID H. HOUGHTON
38 La Salle Road, West Hartford, Connecticut

.

General Manager A. L. BUDLONG, W1BUD

Communications Manager FRANCIS E. HANDY, W1BDI

Technical Director GEORGE GRAMMER, W1DF

Assistant General Manager JOHN HUNTON, W1LVQ

Assistant Secretary PERRY F. WILLIAMS, W1UED
38 La Salle Road, West Hartford, Connecticut

.

General Counsel PAUL M. SEGAL
816 Connecticut Ave., Washington 6, D. C.

DIRECTORS

Canada

ALEX REID, VE2BE
240 Logan Ave., St. Lambert, P. Q.
Vice-Director: William E. Savage, VE6EO
833 10th St. N., Lethbridge, Alta.

Atlantic Division

GILBERT L. CROSSLEY, W3YA
Dept. of E. E., Penna. State University
State College, Pa.
Vice-Director: Charles O. Badgett, W3LVF
725 Garden Road, Glenside, Pa.

Central Division

JOHN G. DOYLE, W9GPI
4331 N. Wildwood Ave., Milwaukee 11, Wis.
Vice-Director: George E. Keth, W9QLZ
RFD 2, Box 22-A, Utica, Ill.

Dakota Division

ALFRED M. GOWAN, W8PHR
1012 South Willow Ave., Sioux Falls, S. D.
Vice-Director: Charles G. Compton, W8BUO
1011 Fairmount Ave., St. Paul 5, Minn.

Delta Division

VICTOR CANFIELD, W5BSR
Box 965, Lake Charles, La.
Vice-Director: Sanford B. DeHart, W4RRV
227 S. Purdue Ave., Oak Ridge, Tenn.

Great Lakes Division

JOHN H. BRABB, W8SPF
708 Ford Bldg., Detroit 26, Mich.
Vice-Director: Dana E. Cartwright, W8UPB
2979 Observatory Ave., Cincinnati 8, Ohio

Hudson Division

GEORGE V. COOKE, JR., W2OBV
3 Daisy Lane
Commack, L. I., N. Y.
Vice-Director: Lloyd H. Manamon, W2VQR
709 Seventh Ave., Asbury Park, N. J.

Midwest Division

ROBERT W. DENNISTON, W8NWX
Box 631, Newton, Iowa
Vice-Director: Sumner H. Foster, W8GQJ
2315 Linden Dr., S.E., Cedar Rapids, Iowa

New England Division

MILTON E. CHAFFEE, W1EFW
53 Homesdale Ave., Southington, Conn.
Vice-Director: Frank L. Baker, Jr., W1ALP
91 Atlantic St., N. Quincy 71, Mass.

Northwestern Division

R. REX ROBERTS, W7CPY
837 Park Hill Drive, Billings, Mont.
Vice-Director: Howard S. Pyle, W7OE
3434 74th Ave., S.E., Mercer Island, Wash.

Pacific Division

HARRY M. ENGWICHT, W6HC
770 Chapman, San Jose 26, Calif.
Vice-Director: Ronald G. Martin, W6ZF
4212 Berrendo Drive, Sacramento 25, Calif.

Roanoke Division

F. LANIER ANDERSON, JR., W4MWH
428 Maple Lane, Danville, Va.
Vice-Director: Thomas H. Wood, W4ANK
1702 N. Rhett Ave., North Charleston, S. C.

Rocky Mountain Division

CLAUDE M. MAER, JR., WØIC
740 Lafayette St., Denver, Colo.
Vice-Director: Carl L. Smith, WØBWJ
1070 Locust St., Denver 20, Colo.

Southeastern Division

JAMES P. BORN, JR., W4ZD
25 First Ave., N.E., Atlanta, Ga.
Vice-Director: Thomas M. Moss, W4HYW
P.O. Box 644, Municipal Airport Branch,
Atlanta, Ga.

Southwestern Division

WALTER R. JOOS, W6EKM
1315 N. Overhill Drive, Inglewood 3, Calif.
Vice-Director: Virgil Talbot, W6GTE
9226 Alexander Ave., South Gate, Calif.

West Gulf Division

GRADY A. PAYNE, W5ETA
5103 Linden St., Bellare, Texas
Vice-Director: Carl C. Drumeller, W5EHC
5821 N.W. 58th St., Oklahoma City 12, Okla.

"It Seems to Us..."

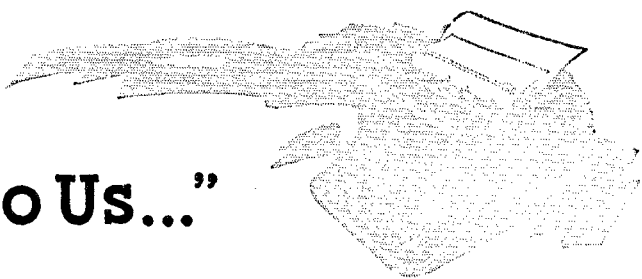

LEAGUE ELECTIONS

Seventy thousand radio amateurs — that's how many of us there are in the ARRL — gathered in one place certainly would make a joyful noise, with QRM worse than 75 meters on a winter night. Clearly it would be impossible to run our affairs on a membership-meeting basis; we are spread from Hawaii to Halifax, from Jacksonville to Juneau. Yet every one of us has a part in the management of our organization through the democratic process of nomination and election of representatives to serve on the ARRL Board of Directors. The Full Members in each of the League's sixteen divisions choose a director every two years to represent them in the determination of policy and the overall direction of the League.

To ensure that some experienced men are present at each Board meeting, and to lessen confusion at election time, the elections are staggered; half of the divisions elect in even years, the other half in odd years. This year the Central, Hudson, New England, Northwestern, Roanoke, Rocky Mountain, Southwestern, and West Gulf Divisions speak up. Details on the nominating procedures are in the "Happenings of the Month" column, on page 53.

Particularly since each director now represents an average of over four thousand members, these men should be the best available, men fully familiar with amateur radio, and enjoying the confidence of the majority in their division. They should be mature men of ability and stature, for they direct the affairs of an organization whose budget runs well over a million dollars per year.

It is up to members to ensure that good men are nominated, before the deadline of September 20th. Don't assume that someone else will send in a petition for the candidate of your choice; it has happened that good men have failed of nomination because of a "Let George do it" attitude. It is also wise to file the petition as soon as possible, too. Sometimes less than ten of the signers can be located in the membership file, thus making the nomination invalid; in the middle of September it's rather late to start another petition and get it to West Hartford by the deadline.

Each director has the responsibility of keeping himself aware of League affairs in his division, and of learning the needs and desires of his constituents, through personal contact, club visits, hamfest QSOs and letters. A proposal you make in a note to your director may

well result in an action at the annual Board of Directors meeting, and if the other fifteen divisions concur, an idea of yours may result in some significant change in the amateur structure. Therefore it is important that you take part in the choosing of this director, and in keeping him informed.

Once more we would like to emphasize that you, the 70,000 voting members, are the League. Basically, you decide policy; you recommend changes in regulations; you keep the League's organizational structure up-to-date; and you oversee the total work of the League — all through your own division director. It's true that the routine business, technical and operational matters are handled by a professional staff of more than sixty, but only in accordance with the wishes and directives of the Board of Directors, who in turn derive all their authority directly from you, the members.

Summing up, for the League to continue as a strong democratic organization, and its leadership in amateur affairs, all of its members must be concerned about its government. Nominate your candidate, then, and when the ballot comes, early in October, be sure to vote.

NATIONAL COVENTION

Breathes there a ham with receiver so dead (and stack of *QST*'s so unread) he hasn't heard something about the 10th ARRL National Convention in Washington, D. C.? Impossible! But if this brief article reaches such a person, we urge him to drag out *QST* for April, June and July and feast his imagination on the program outlined on pages 60, 63, and 66 respectively. The rest of you, already scheming to attend, can get further inspiration from the new dope on page 56 of the present issue.

Fourteen Washington-area clubs, bound together in the Foundation of Radio Amateur Clubs, have been toiling strenuously to make the August 15-17 affair the most memorable ever. There are sideband, traffic, YLRL, DX, military, v.h.f., technical, and ARRL meetings for the hams; cruises, fashion shows and luncheons for the wives; parties, dances, floor shows, tours and the grand banquet for everybody.

Not only will all the ingredients of a first-class ham convention be present, but the city itself is fascinating to visitors, and the sponsors have arranged tours to practically every corner of it. Raid the piggy-bank, pack the suitcase, grab the XYL and we'll see you in Washington!

COMING A.R.R.L. CONVENTIONS

- August 15-17 — ARRL National Convention, Washington, D. C.
August 30-September 1 — Maritime Provinces, Truro, N. S.
September 20-21 — Dakota Division, Sioux Falls, S. D.
September 28 — New England Division, Providence, R. I.
October 4-5 — Midwest Division, Des Moines, Iowa
October 10-12 — Southwestern Division, San Diego, Calif.
October 11 — Hudson Division, Albany, N. Y.
October 18 — Ontario Province, Hamilton, Ontario

A.R.R.L. MARITIME PROVINCES CONVENTION

Truro, N. S.—Aug. 30-Sept. 1

Truro Area Amateur Radio Operators cordially invite all ham brasspounders, rag chowers and others to attend the ARRL Maritime Provinces Convention at the Canadian Legion Hall in the hub town of Truro, N. S., over the Labor Day week end, Aug. 30 through Sept. 1. The convention registration will open at noon Saturday followed by a motor parade through the town late in the afternoon. The official opening banquet Saturday evening will start an evening of speeches and social competitive activity. A chicken barbecue will be held at the formal closing of the Convention Monday noon, Sept. 1.

Registration fee of \$5.00 will include all banquets and hamfest participation but all must be made in advance. Banquet reservations cannot be guaranteed unless registration is received not later than August 20. Accommodation reservations and hamfest registrations may be made through the Secretary, Carl Crowell, VE1TT, P. O. Box 164, Truro, N. S.



Alabama — The North Alabama Hamfest Association will hold its annual hamfest at Spring Park, Tusculumbia, on Sunday, August 24. For further info, contact Howard G. King, W4ZUP, Box 306, Florence.

Georgia — The Confederate Signal Corps will hold a hamfest on the Southeastern Fair Grounds at Lakewood Park in Atlanta on August 17. Plenty of activities and prizes. Registration is \$1.00, plus barbecue ticket of \$1.50. For further info contact Virgil D. Baker, jr., K4CFN, 115 Womack Ave., East Point.

Illinois — The Hamfesters Radio Club is holding its 24th annual picnic at Santa Fe Park, 9100 South Wolf Road, on Sunday, August 10. From the east, take Route 4A (Archer Ave.) to 87th St. in Willow Springs, and turn west to the grove. From the west, take Route 66 to 79th St., then east to Wolf Rd. The park has modern facilities, parking, tables, shade. There will be radio displays and lectures, food and refreshments, events and prizes. Swap

tables. Advance donation \$1.00, or \$1.50 at the gate. For further info or for tickets, write to R. R. Balfour, W9PBM, 8213 Kingston Ave., Chicago 17.

Illinois — The Egyptian St. Louis Hambores and Picnic will be held on Sunday, August 24, at the Egyptian Club grounds just across the Mississippi river from North St. Louis on Highway 66. Signs will mark the spot, and the frequencies 50, 56 Mc., 29,640 kc., and 3940 kc. will be monitored for mobiles, "Diver" Delps, W9QMG, will entertain the children, while W0QDF will take care of the adults. Sidebanders will hold their annual Tri-state meeting at 2 p.m. Contests and prizes. Food and drinks on the grounds. No admission charge. For further info, write W. H. Guhman, W0WPS, 317 No. Meramec Ave., Clayton 5, Mo.

Indiana — The Big Bull Hamfest will be held at Highland Park, Kokomo, on Sunday, August 10, from 10 a.m. to 4 p.m. Bring the family and the picnic basket. Lots of playground and table space. Contests and prizes for all. Registration \$1.00. For further info, contact W. Jerry Smiley, W9DKR, 1826 W. Madison St., Kokomo.

Indiana — The Tri-State Amateur Radio Society will hold its annual hamfest on Sunday, August 24, at Baurer's Grove, Evansville. Games, contests and prizes. You can bring your own lunch, or make reservations for food. Drinks available on the grounds. Mobiles check in on 75, 10 or 6 meters. Advance registration is \$2.00, or \$2.50 at the gate. For further info write Wilbur Weising, W9OV, 719 North Main St., Evansville.

Iowa — The Central Iowa VHF Club is sponsoring a family picnic at Lake Ahquabi State Park, just south of Indianola, on Sunday, August 17. Potluck dinner. Drinks will be furnished. Prizes. W8SMJ δ will be on 50 Mc. to talk in mobiles. Swap and sell tables. For further info contact Jim Cessna, W8SMJ, Indianola.

Kansas — The Kansas-Nebraska Radio Club will sponsor its annual hamfest on Sunday, August 24, at the National Guard Armory in Concordia. This is an all-day affair, with a picnic dinner at noon and games and prizes in the afternoon. For further info contact A. B. Reeves, W0JEO, 1108 Hillside Drive, Concordia.

Louisiana — The Cenla Amateur Radio Club is sponsoring a hamfest on August 31 in Alexandria, but we have no other details.

Michigan — The annual picnic of the Saginaw Valley Amateur Radio Ass'n will be held Sunday, August 3, at Ojibway Island Park in Saginaw. No advance registration. For further info contact Max W. Thomas, W8SXY, 116 No. Michigan Ave., Saginaw.

Michigan — There will be a hamfest and picnic on Sunday, August 3, at Allegan County Park. Bring your own lunch. For further details contact Harold J. Fausnaugh, W8JUU, RFD 2, Lawrence.

Minnesota — The Saint Cloud Minnesota Radio Club will hold its annual picnic hamfest on Sunday, August 10. Registration will start at 1000 at Wilson Park on the east bank of the Mississippi. Mobile field strength contest, hidden transmitter hunt on ten and seventy-five, oldest and youngest hams present, games and prizes. Huge shelter house in case of rain. Bring your own lunch — free coffee provided. Playground, swings, slides and swimming. Registration of \$1.00 per call includes the family. For further info, contact Bob Molitor, W0RVO, 315 7th Ave. N., St. Cloud, Minn.

Mississippi — The Biloxi Amateur Radio Club will hold a hamfest on 23-24 August, at the Community House

(Continued on page 34)

OUR COVER

The mysteries of this month's cover will soon be revealed if you will proceed directly to the facing page and start in McDonald's article on an image transmission system. Part II of this two-part series will be along next month.

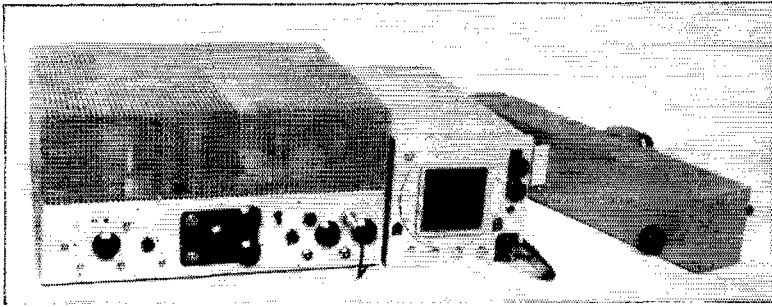

A New Narrow-Band Image Transmission System

In Two Parts

Part I—Principles of Slow Scan Picture Reproduction

BY COPTHORNE MACDONALD * W4ZII/2

FOR THE past twenty years or so the conventional wide-band TV system and various mechanical-scanning facsimile systems have been the only common methods of transmitting images by electrical means. Recently, however, another method has been used to transmit images over wire lines. This method involves using television type pick-up and reproduction devices with slow scanning rates to produce narrow bandwidth video signals.

The Bell Telephone Laboratories' "Picture-Phone" system uses a live pick-up camera to

*49 St. Mary's Place, Nutley, N. J.

Above: These three units contain all the specialized picture transmitting and receiving equipment, ready to be connected to an ordinary phone transmitter and communications receiver. The shielded chassis at the left contains the sync, sweep, power supply, and receiver amplifier circuits. The detector, low-pass filter and 5-inch cathode-ray tube for receiving are in the center unit. At the far right is the light-tight box containing the flying-spot scanner. The modulator chassis is mounted on the rear of the scanner unit.

In this cathode-ray picture transmission system, facsimile communication becomes possible without moving parts. By thus eliminating the precision mechanical scanners and reproducers used in ordinary facsimile, picture transmission and reception by amateur stations is made immediately practicable. The final record picture is easily made by photographing the receiving cathode-ray tube display, or the composite video and sync signal can be recorded on magnetic tape with any home-type recorder, for playback at any subsequent time.

The system takes no greater band width than voice communication, and the signal can be transmitted and received with any equipment suitable for phone work.

generate the video signal, a magnetic storage drum to freeze the action, and special "Iatron" image-storing cathode-ray tubes to reproduce the image. A 60-line picture, 40 lines wide, is scanned once every 2 seconds and can be sent over ordinary phone lines.

Dage Electronics developed a system for use with "high-fidelity" phone lines which are flat from 60 c.p.s. to 5000 c.p.s. or higher. Both these systems employ expensive components and, consequently, have not been widely used.

Upon reading about these "wired" systems the writer became intrigued with the possibility of utilizing the slow-scan principle for image transmission by radio. In September, 1957, he started the design and construction of a low-cost slow-scan system which is especially adapted to the transmission characteristics of amateur phone equipment. This work was undertaken as a personal project in an independent problem course at the University of Kentucky.

Briefly, the system uses a cathode-ray tube flying-spot scanner to develop a 120-line picture, scanned once every 6 seconds, from a slide em-

bodying an inexpensive photographic negative. The video output of the scanner amplitude-modulates a 2000-c.p.s. carrier, resulting in an audio-frequency signal consisting of the 2000-c.p.s. carrier and video side bands extending both ways in frequency to 1000 and 3000 c.p.s. This signal is then fed to the radio transmitter's modulator. At the receiving end, the audio-frequency output of the communications receiver is processed and the picture is presented on the screen of a low-cost electrostatically-deflected cathode-ray tube with a long-persistence P7 phosphor.

The system can be used with almost any amateur phone transmitter and receiver with no changes necessary in the regular station equipment. The slow-scan unit merely plugs into the transmitter mike jack and receiver headphone jack. Air tests on the 11-meter band indicate that conditions and equipment which give good phone transmission, with a reasonably good signal-to-noise ratio, will also transmit satisfactory pictures. The actual type of modulation used in the transmitter seems to be relatively unimportant so long as the audio output of the receiver is a reasonably good replica of the input to the transmitter modulator. Plate modulated a.m. was used in all the tests made so far with good results, as the pictures show. Eleven-meter s.s.b. was non-existent in the Lexington area during the testing period, but this mode of transmission should be quite satisfactory, and the required frequency accuracy of the reinserted carrier should actually be less than for phone reception. N.f.m., with limiter stages in the receiver, could be used to reduce the effects of fading on picture transmission.

While the system presents a less detailed image than conventional facsimile it is adequate for many purposes, and the system is superior to existing facsimile in certain other respects. For one thing, the transmission time is a few seconds

instead of minutes. This increases flexibility of operation by permitting rather rapid alternation of voice and picture transmission over the same circuit. This would, of course, be of vital importance in emergency work where all transmissions must be kept short. Also, by presenting ten scans every minute instead of one every few minutes, it should be possible to dodge the intermittent interference so prevalent on the ham bands. Also, the slow-scan system uses inexpensive and readily-available components, and if cost is not a factor a live-pickup Vidicon camera could easily be added to the system. The slow scanning rate, of course, requires that all images be still, but this should not be too great a disadvantage with the type of material which the ham is likely to transmit.

The System

The important system characteristics are listed below:

Number of lines: 120

Aspect ratio: 1:1 (square picture shape)

Vertical repetition rate: 6 seconds

Horizontal frequency: 20 c.p.s.

Modulation: Amplitude-modulated 2000-c.p.s. subcarrier. (White level, 0-20 per cent of maximum amplitude; black level, 50 per cent to 75 per cent of maximum; sync level, maximum amplitude.)

Pass band required: 1000-3000 c.p.s.

Synchronization: Maximum-amplitude carrier bursts coinciding with retrace periods. (Approximately 0.015 second for vertical pulse and 0.0015 second for horizontal.)

Many possible combinations of sweep times, aspect ratios, and audio carrier frequencies were studied in an attempt to find the most suitable combination. The maximum possible vertical sweep time is limited to about 6 seconds because the brightness of the P7 phosphor on the receiver cathode-ray tube face decays too rapidly to

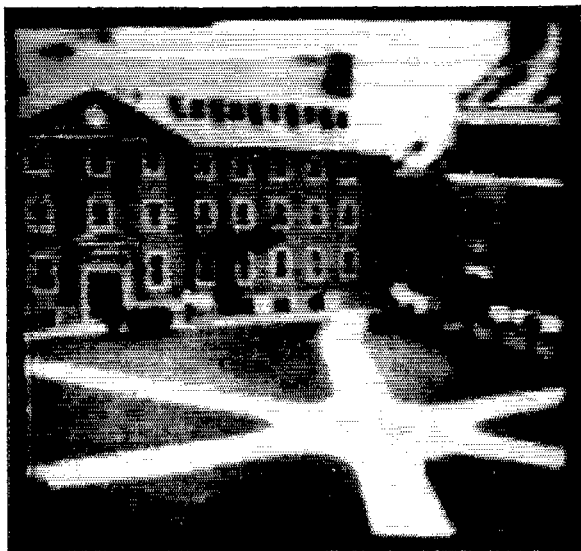

This picture shows the kind of resolution that can be obtained with the 120-line scanning system described here. Taken off the monitor during transmission.

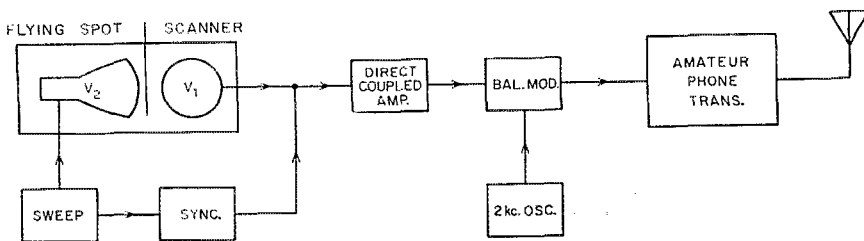

PICTURE TRANSMISSION

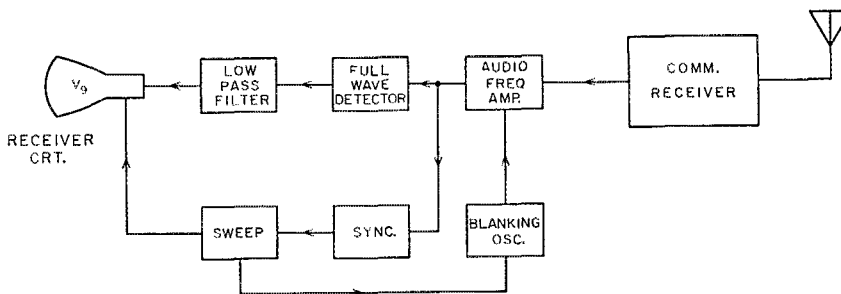

PICTURE RECEPTION

Fig. 1—The separate transmitting and receiving setups are shown in this block diagram.

retain bright picture detail much longer than this. The 1:1 aspect ratio is a picture shape which makes efficient use of a round cathode-ray tube screen, and does not favor the viewing of horizontal objects as the usual 4:3 aspect ratio does. The band-width requirements of the flying-spot scanner video output are d.c. to approximately 1000 c.p.s. The 2000-c.p.s. subcarrier frequency was chosen because it permits the upper video side band to fall within the 300-3000-c.p.s. pass band considered representative of current amateur practice, and provides at least two cycles of carrier for each cycle of modulating frequency.

Modulation polarity was selected to make low level represent white and high level represent black, for two reasons. First, the synchronizing pulses, being at the infrablack level, will blank the cathode-ray tube retrace if the receiver retrace and sync trigger time is less than the duration of the sync pulse. Second, strong noise pulses appear black rather than bright white as they would if high amplitude represented white.

Simple rectangular pulses lasting the duration of the retrace period permit synchronization of the receiver sweep oscillators. Since the vertical pulse is only about one-third the length of a scanning line, it is completed well before the next horizontal sync pulse starts. This avoids the need for serrating the vertical sync pulse to prevent upsetting the horizontal sweep, as is necessary when the pulse is over one line in length.

The picture transmitting and receiving circuits were combined in a single unit with common power supply and sweep circuits, in order to keep the cost as low as possible. As shown in the block diagram of Fig. 2, send-receive switches make

the appropriate sync connections and, on "transmit," also feed the output signal into the video receiver to permit the outgoing picture to be monitored on the receiver cathode-ray tube (V_9). The simplified block diagrams in Fig. 1 represent the circuit connections on "transmit" and on "receive." These diagrams, along with the details of the Fig. 2 block diagram, will be explained in the discussion to follow. Actual circuitry and mechanical details will be described in Part II of this article.

Picture Transmission

The flying-spot scanner consists of a light-tight aluminum box with a 908-A cathode-ray tube (V_2) mounted at one end. The tube faces the other end where a 931-A photomultiplier tube (V_1) is mounted so that light from the cathode-ray tube will strike it. A slit in the side of the box directly in front of the cathode-ray tube allows insertion of a slide, which consists of a size 120 or 620 photographic negative mounted on a 3 × 5-inch cardboard frame. The slide is held in position in front of the cathode-ray tube edges in such a way that the transparent portion of the slide is in intimate contact with the glass face of the 908-A cathode-ray tube. Thus any light which appears on the surface of the 908-A passes through the photographic negative before it strikes the photocathode of the photomultiplier tube, some 8 inches away.

In operation, a small bright spot on the cathode-ray tube face is caused to sweep across the tube in raster fashion by the horizontal and vertical sweep voltages. The 908-A is a 3-inch electrostatically deflected tube with a P5 very-

short-persistence screen, whose brightness decays to 1 per cent of its original value in 35 microseconds. The spot, therefore, remains a spot at the sweep frequencies used and does not leave a "tail" of undecayed brightness behind it as it sweeps across the tube. The spot faintly illuminates the cathode of the 931-A photomultiplier, and the intensity of the illumination is inversely proportional to the photographic density of the negative at a point directly in front of the spot. The small photocathode current is amplified approximately 40,000 times by the secondary-emission action of the dynodes. The voltage across the multiplier anode load resistor is, then, a video signal whose instantaneous amplitude follows the variations in picture brightness as the negative is scanned.

Plate-coupled 6SN7 multivibrators are the heart of the sweep and sync generation circuits. The 20-c.p.s. horizontal multivibrator (V_{17}) is synchronized with the 60-cycle power line, not only as a convenience in keeping its frequency constant, but to insure that any hum in the video will result only in variations in picture shading, not diagonal hum patterns. The vertical multivibrator (V_{14}), with a period of about 6 seconds, is triggered by the horizontal oscillator

during a horizontal retrace period. This insures that the vertical retrace will always occur at the beginning of a line, which is necessary for proper positioning of the vertical sync pulse.

Sweep capacitors, charged during retrace periods from $B+$, are discharged during retrace periods by current from the multivibrators, channeled through isolating diodes (V_{15}). The saw-toothed voltage developed across each capacitor is coupled directly to the grid of its associated sweep amplifier, half a 6SN7 (V_{16}). One of the horizontal and one of the vertical deflection electrodes of the 908-A are internally tied to the tube's anode which is returned to a positive centering potential. The other deflection electrodes are connected to the V_{16} plates, putting the varying saw-toothed plate potential directly on the deflection electrodes.

The rectangular pulses developed by the multivibrators during the retrace periods are combined in a dual-diode tube (V_{12}) to form a composite sync signal. This signal is coupled to the photomultiplier load resistor where it is added to the video signal. The grid of a d.c. amplifier (V_{3A} — triode half of a 6U8) is also connected to this point. Since the sync pulses drive the triode beyond cutoff, the output voltage

Fig. 2—Complete block diagram, showing transmit receive switching and stage functions.

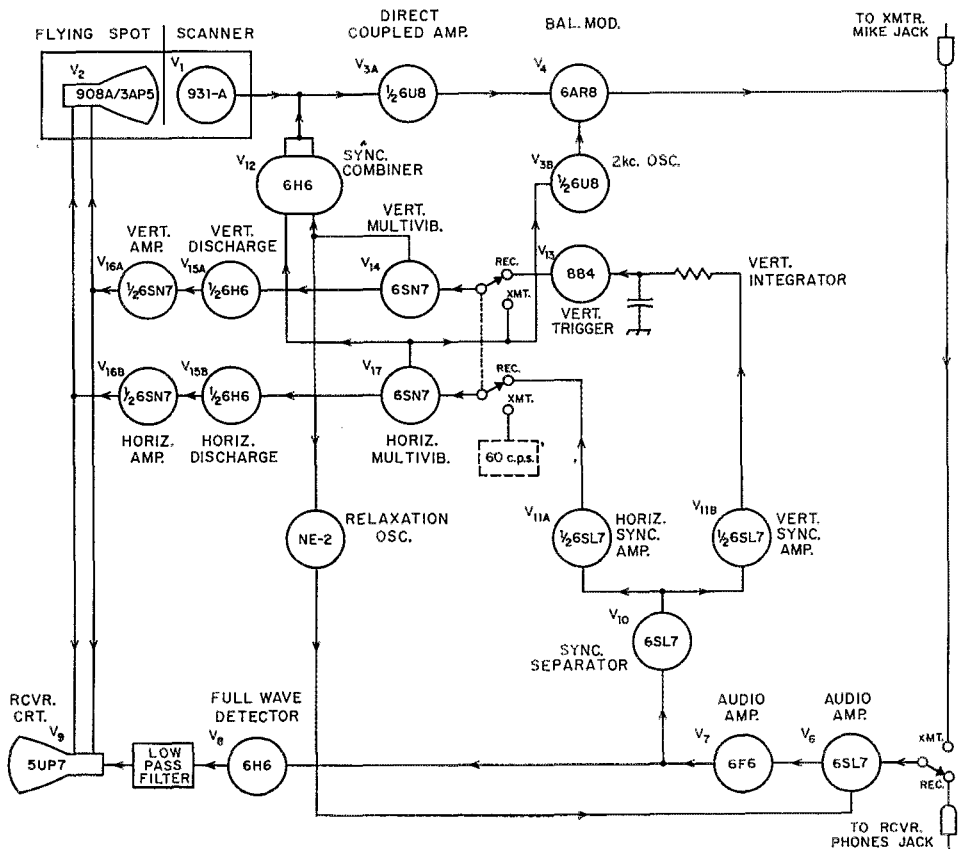

consists of video during the sweep period and of sync pulses, clipped to constant amplitude, during the retrace periods. The ratio of sync level to video level is controlled by the cathode-ray tube's brightness control, increased brightness raising the video level and reducing the ratio.

Since the video signal at this point has important components from d.c. to 1000 c.p.s., it is evident that it cannot be applied directly to the ordinary transmitter modulator which attenuates frequencies below about 300 c.p.s. To surmount this difficulty, the video is directly coupled to the control grid of a 6AR8 sheet-beam tube used as a balanced modulator (V_4). This tube can be thought of as a miniature beam tetrode with two plates and two deflection electrodes. In operation, the 2000-c.p.s. output of a synchronized electron-coupled Hartley oscillator (V_{3B} —pentode half of the 6U8) is applied in push-pull to the deflection electrodes in the 6AR8. This causes the electron beam to be deflected back and forth from one plate to the other at the 2000-c.p.s. rate. The beam current is controlled by the grid voltage and is therefore proportional to the level of the video signal. The output is taken from the plates through a push-pull transformer. The balanced push-pull connection prevents the original 0- to 1000-c.p.s. video signal from appearing in the output, the only output being the 2000-c.p.s. carrier and its side bands. This output may be connected directly to the transmitter modulator. It should be noted here that, although the image source is a photographic negative, signal polarities have been handled so that the transmitted image is positive—that is, clear negative is black level, dense area is white.

Picture Reception

A three-stage audio-frequency amplifier, using a 6SL7 (V_6) and a 6F6 (V_7), amplifies the signal from the communications receiver (or directly from the video generator) to a peak level of about 100 volts. This signal is coupled through an isolation transformer to a full-wave diode detector (V_8). The output of the detector is fed to the grid of the 5UP7 cathode-ray tube through a low-pass filter which passes 0-1000 c.p.s. without attenuation or excessive nonlinear phase shift, but which effectively removes the ripple.

The 100-volt signal is also applied to an i.f. type full-wave triode sync separator (V_{10}) which separates the sync pulses from the composite sync and video signal. These pulses (actually a series of short pulses; one for each alternation of the 2000-c.p.s. carrier) are amplified by the two halves of a 6SL7 (V_{11}), one output going to synchronize the horizontal multivibrator, the other to an RC integrating circuit. The vertical pulse is approximately 10 times as long as the horizontal pulse, and the higher integrator output voltage, when driven by a vertical pulse, is sufficient to separate the vertical from the horizontal.

In conventional TV the vertical oscillator is brought into sync by changing the oscillator

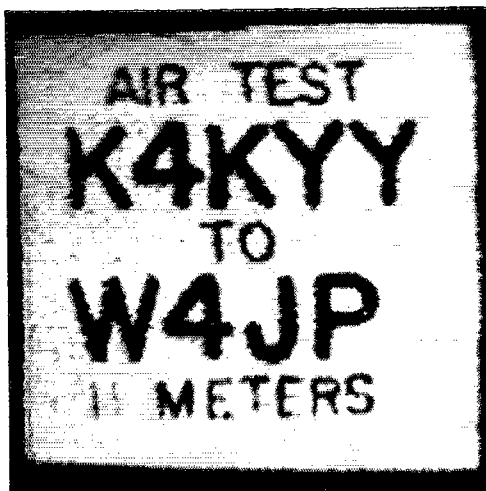

Test picture transmitted by radio over a 7-mile path. The signal-to-noise ratio (peak sync pulse amplitude to peak noise, 12 db.) was in the range where "snow" is evident in the picture.

frequency slightly. This could be a lengthy process with an oscillator that makes only one sweep every six seconds. To solve this problem the integrated vertical sync pulse is used to fire an 884 gas triode (V_{13}). The 884 plate is directly connected to one of the vertical multivibrator plates, providing positive triggering action during almost any part of the vertical sweep period.

Since the retrace times on receive are the same as on transmit, and since an appreciable time is required for vertical sync pulse integration, blanking of the receiver cathode-ray tube is not assured. To insure blanking, a neon-bulb relaxation oscillator, fired by the vertical multivibrator plate voltage during retrace, is coupled to the receiver audio amplifier. The burst of tone signal from the oscillator is amplified, detected, and fed to the cathode-ray tube where the voltage extinguishes the beam for the entire retrace period.

Tests

Since the transmitting and receiving circuits use the same power supplies, sweep oscillators, and sweep amplifiers, it was impossible to have the actual picture transmitter located at one point and the picture receiver at another. In order to conduct tests, therefore, it was necessary to tape record the audio-frequency picture signal. While even the home-type recorders have adequate frequency response, some of the less expensive machines have appreciable "wow" or other forms of instantaneous speed variation which cause a slight skewing of lines in the picture. The effect is most noticeable when viewing an image containing vertical lines, and appears slight in an image of a face.

Incidentally, tape recordings could be a big help in getting started with this mode of trans-

(Continued on page 140)

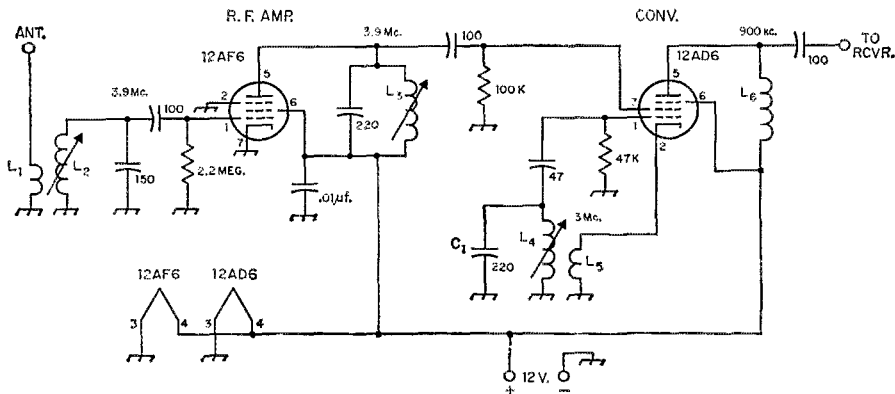

Fig. 1—Circuit of the 12-volt converter. Unless indicated otherwise, capacitances are in $\mu\text{uf.}$; all resistors are $\frac{1}{2}$ watt and values are in ohms. C_1 should be silver mica; all other capacitors may be mica or ceramic.

L_1, L_5 —10 turns No. 28 enam., wound over ground end of associated coil.

L_2, L_3, L_4 —32 turns No. 28 enam., close-wound on $\frac{3}{8}$ -inch iron-slug form (CTC LS-3 form).

L_6 —10-mh. r.f. choke.

WITH THE development of transistor auto radios, many hams have found to their sorrow that their standard converters will not work, since these receivers have no vibrators or transformers. A closer look will disclose, however, that the usual "transistor" radio actually employs a combination of transistors and tubes. The tubes in some of these receivers are of the conventional type, but in most cases tubes of the newer series that operate directly from a 12-volt battery are used.

A trial was made using these tubes in a 75-

meter converter, and it was found that they performed very satisfactorily. To keep the system simple, it was decided to use the b.c. receiver as a tunable i.f. so that it would not be necessary to provide for tuning the converter. The converter could be preadjusted and mounted in an out-of-the-way place in the car. No connections to the car receiver are required other than to plug the output of the converter into the antenna jack of the car receiver. The unit can be built using all new parts for less than ten dollars and a small utility box will house all of the components as shown in the photographs.

The circuit is shown in Fig. 1. A 12AF6 r.f. amplifier feeds a 12AD6 pentagrid converter. The tuning of all circuits is fixed. The high-frequency oscillator operates at 3000 kc. About the only critical component is the oscillator padder C_1 . This should be a silver-mica unit to keep frequency drift to a minimum.

Adjustment of the slug of L_4 will determine where the band comes in on the broadcast dial. I've got mine adjusted so that a 3800-kc. signal comes in at 800 on the dial, a 3000-kc. signal at 900 kc. and so forth. Then reading signal frequency is merely a matter of adding 3000 to the dial reading.

Tuning of the converter is best done at night when there are plenty of signals on the air to work with. The mobile antenna should have been previously tuned to resonance. With the b.c. receiver tuned to 800 kc., adjust the slug of the oscillator coil L_4 . At least a few of the stronger signals in the 75-meter band should be heard. If none is heard, the oscillator is in all probability not functioning. Reversing the connections to the tickler winding L_5 should make the circuit oscillate. If a high-resistance voltmeter is handy, a negative-voltage reading of 5 or 6 volts from Pin 1 of the 12AD6 to ground should indicate

* P. O. Box 43, McGehee, Arkansas.

Mobile Converter —No B Plus

Many of the newer cars are equipped with transistor radio receivers having no B supply that can be used to power a mobile converter. W5ZCC solves the difficulty with a simple fixed-tuned converter using 12-volt tubes.

75-Meter Unit for Transistor Car Receivers

BY WILLIAM E. LaFARRA,* W5ZCC

The 12-volt converter is assembled in a 3 × 4 × 5-inch aluminum box. The 12AF6 is to the left and the 12AD6 converter tube to the right. The shielded lead to the right goes to the broadcast antenna jack.

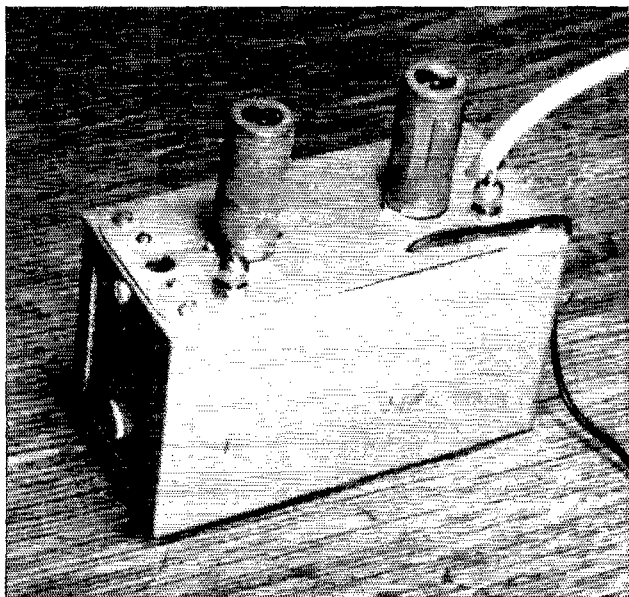

proper operation of the oscillator.

Once the oscillator is working, it is a relatively simple matter to move the incoming signals up or down to the desired spot in the b.c. band by adjusting L_4 . Relatively weak signals should be used while adjusting the slugs of L_2 and L_3 for maximum strength. If you have waited until night, you should hear several out-of-town signals coming through. These signals should preferably be around 3900 kc. (900 kc. on the car radio). Peaking the converter up on 3900 kc. should

provide complete coverage of the 75-meter phone band. However, if most of the operation is to be around some particular frequency, adjustment of the slugs on a weak signal there will give peak performance on that frequency.

After a final adjustment, the sensitivity was compared with that of a commercial converter and the comparison was very favorable. Filament current constitutes practically all of the drain from the battery, since the plate current of the 12-volt tubes is in microamperes. The filament drain is 150 ma. per tube. This converter and our transistor radio combined draw a total current of less than one ampere, which is a very desirable feature for mobiling.

If you are interested in a more elaborate converter of this type, I refer you to a previous article in *QST* for September, 1956.¹ For my purposes, the simpler 75-meter converter described here was entirely adequate since this is the popular band in this area. However, this type of converter could be made for any other single band desired.

¹ Chambers, "Something New in High-Frequency Mobile Converters," *QST* September, 1956.



Inside view of the 12-volt converter. L_4 is in the upper left-hand corner with L_3 below it. L_3 (above) and L_1, L_2 (below) are to the right. The antenna connector at the right-hand end is a b.c. antenna input jack.

Strays

What's in a name? W6BES tells us that W3DUZ lives on Lux Lane.

The annual field day of the Radio Society of

Bermuda will be held on August 9 and 10. The VP9s will be competing for the Phillips Challenge Cup, and hope that all hands will be watching for them on phone and c.w., 10, 15 and 20 meters.

Keeping Equipment Cool

Heat Disposal in Low- and Medium-Powered Electronic Assemblies

BY RONALD L. IVES*

There was a time when the problem of eliminating excess heat in amateur equipment was rarely given any consideration. Layouts were generous with space, enclosures were rare, and operation was intermittent enough so that high operating temperatures were only occasionally responsible for component failures. Not so today, what with the necessity for good shielding. As this article shows, there is a great deal more to effective heat disposal than simply adding a fan.

WHenever the power input to an electronic device exceeds the power output, the "lost energy" must be disposed of somehow, usually as heat. As no electronic device is 100 per cent efficient, the problem of heat disposal is always with us.

Most engineering texts on heat disposal are too involved and theoretical to be of much use in solving practical problems. The majority of practical works, of which there are many, give rather good empirical data for installations involving kilowatts and megawatts, but are strangely silent regarding the problem of keeping an assembly 17 by 8 by 10 inches, with an internal dissipation of 55 watts, at a temperature below 180 degrees F.

Practical heat disposal may be divided very roughly into four broad categories, which are somewhat interrelated and overlapping. Any improvement in one category will usually result in some improvement in at least one of the others. These categories are:

- 1) Over-all heat reduction.
- 2) Localized heat reduction.
- 3) Localized thermal stabilization.
- 4) Heat exclusion.

The primary aim in over-all heat reduction is

*251 Lincoln Ave., Palo Alto, Calif.

to make an assembly that will run cooler. To have a minimum of heating in any assembly, keep the power input to a minimum, and use the most efficient circuits possible. Don't overload any component, for the heat output of most electrical devices increases faster than the useful power output after the optimum operating point is passed.

Electrical Efficiency

Use of efficient components suggests employment of selenium or silicon power rectifiers in place of tubes; *LC* rather than *RC* filters; semiconductor diodes in place of thermionic diodes; minimum-drain bleeder resistors; low-drain voltage regulators; capacitative, rather than resistive, a.c. voltage dividers; and even use of high-voltage filaments in some cases. Operation of tubes at minimum practicable voltages (such as 150 in place of 300) reduces not only heat production but also power-supply requirements.

To cite only one way in which heat production can be reduced in an electronic assembly, let us take the case of a power supply using a 5U4 rectifier. Heat production here will be 15 watts from the filament, up to 4 watts plate loss, and a minimum of 1 watt core and copper loss in the transformer — totaling about 20 watts. If we sub-

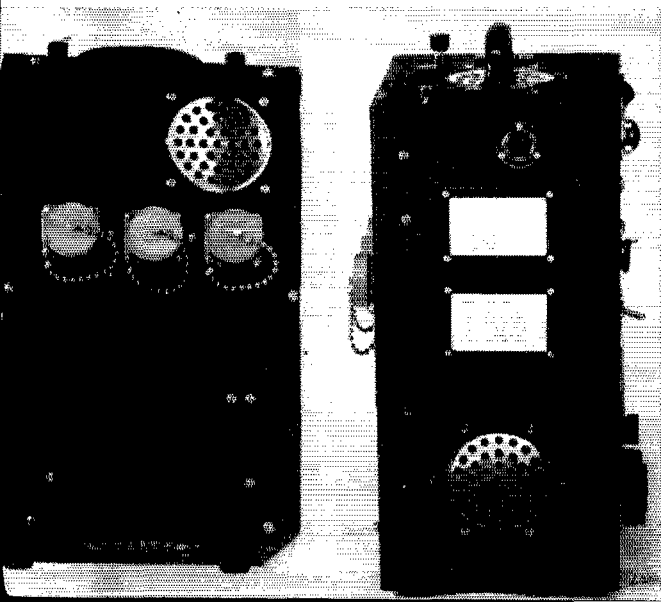

Fig. 1—Air vents to permit convective cooling of a monitor receiver.

QST for

Fig. 2—Vents in small electronic device to facilitate convectional cooling. A similar vent is provided in the chassis shelf, inside the case, to provide an "open" air channel.

stitute selenium rectifiers, heat production will promptly drop to about 5 watts, because we have eliminated the filament heat from the assembly entirely. Selenium rectifiers are both bulky and costly, particularly in the higher voltage ranges, but produce much less heat in operation than a thermionic rectifier. If we now replace the selenium rectifiers by silicon rectifiers in appropriate voltage range, the four watts of plate loss produced in the original 5U4, or its equivalent produced in the selenium rectifiers, drops to about 0.5 watt, because of the very low voltage drop in silicon rectifiers. We have also raised the output voltage of the rectifier-filter system for the same reason, and the total heat production from the power rectifier and transformer is now in the neighborhood of 1.5 watts, or about 7 per cent of what it was at first.

Chassis

Use of a conductive chassis, with as large a surface area as possible, will facilitate equalization of internal heat and rapid cooling by conduction — aided by convection in most instances — as well as by radiation, which occurs at the surfaces of all components and over all parts of the chassis. Most rapid conduction will occur with a copper chassis, but steel, which also furnishes magnetic shielding and mechanical rigidity, is usually the optimum material. Aluminum, although a fairly good conductor of heat, has somewhat unhappy mechanical properties for many applications.

Use of chassis brackets not only increases mechanical strength but also adds to the surface area of the chassis, facilitating cooling by radiation and convection, *provided* there is a conductive bond between the chassis and the end brackets. In general, if the bond between chassis and brackets is a good electrical conductor it will be a good thermal conductor also.

Air Vents

Last, but by no means least, adequate vents for convectional air circulation, and hence convectional cooling, must be provided. If an electronic assembly is completely boxed in so that convection cooling does not take place or is sharply restricted, cooling will occur only by heat conduction to the enclosure, and thence by radiation from it. As the thermal conductive path to the enclosure may be of high resistance, and since the trapped air between the assembly and the enclosure is a poor conductor of heat, the assembly will tend to operate at a very high equilibrium temperature.

If adequate paths for convective cooling are provided, as by inlet and outlet vents with an

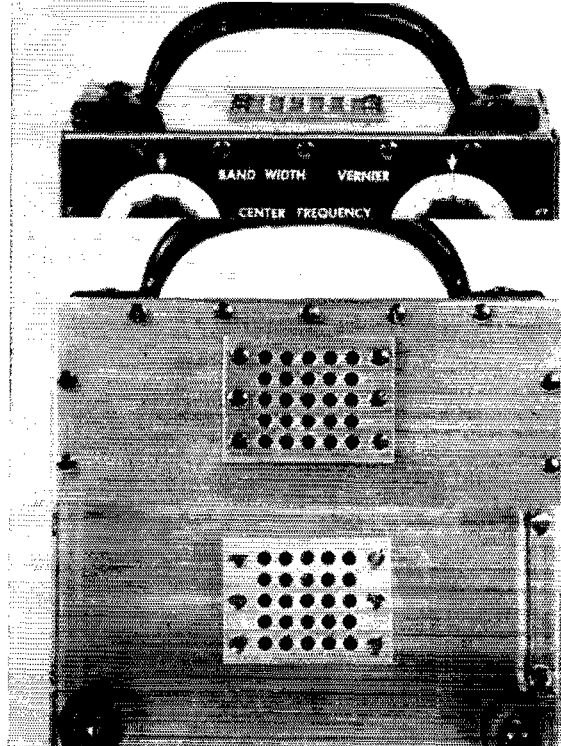

uninterrupted air path between, convective cooling will take place automatically, appreciably lowering the equilibrium temperature.

Arrangement of air vents in a medium power assembly — a 10-tube, six-band monitor receiver which consumes 65 watts — is shown in Fig. 1. Upper-level vents permit heated and expanded air to escape, lower vents allow cooler air from the environment to enter. Rubber feet on the case bottom keep the bottom vent unobstructed. It is important that both top and bottom vents be provided. If the lower vents are omitted convection will not take place, because there is no inlet for cooler "replacement" air. Remember that a chimney will not draw if the stove draft is closed!

Venting arrangements for a smaller assembly, dissipating only about six watts but somewhat temperature sensitive, are shown in Fig. 2. A similar vent is provided in the chassis itself, to permit "through" air circulation.

Vent apertures should also be provided in the tops of chassis and other "inverted box" structures to prevent entrapment of heated air. Unless these are provided, localized "hot spots" may occur under the chassis, leading to seemingly mysterious failures of components even though the entire assembly operates at an average temperature far below the maximum for the specific items.

Local Heat Reduction

Localized heat reduction is desirable or necessary in most electronic assemblies because some components will operate indefinitely at relatively high temperatures but others will fail promptly

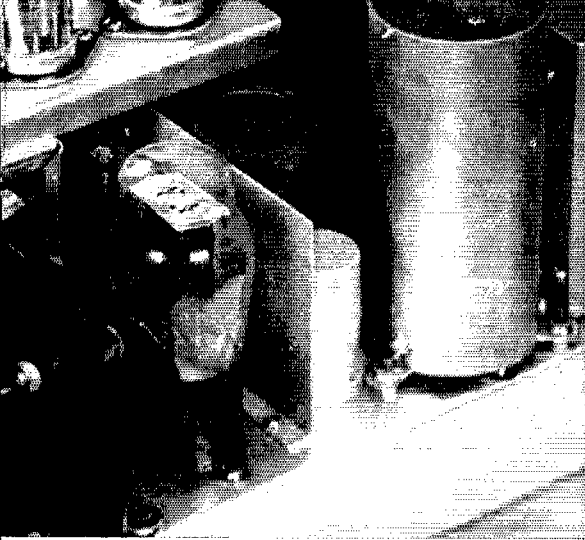
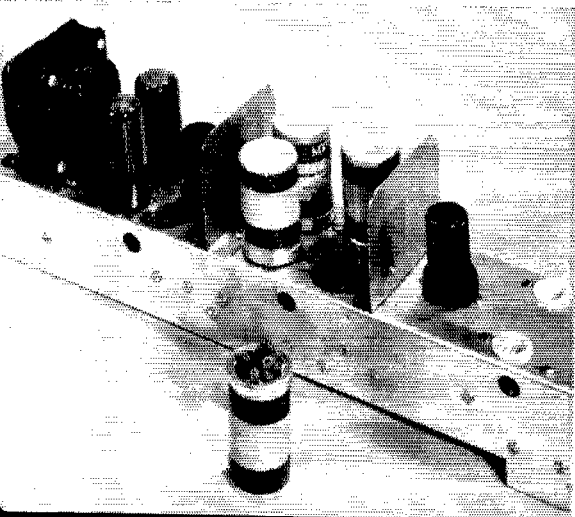

Fig. 3—Thermal shielding in a pulse amplifier.

if heated to much lesser values. For example, ceramic-insulated fixed resistors will operate satisfactorily above the melting point of soft solder, while tube bases come loose at about 150 degrees C.; and electrolytic capacitors, in general, imitate Vesuvius at temperatures somewhat below 90 degrees C.

The general method of localized heat reduction is to prevent heat from normal "stoves" from reaching temperature-sensitive components. This is accomplished by use of heat baffles, guided convection, and insulation. One example of thermal shielding, to prevent cooking of dry electrolytic capacitors by tube heat, is shown in Fig. 3. Here, a high-power pulse amplifier tube, which dissipates considerable power, is surrounded by a tubular shield. This reflects back much radiant heat and acts as a chimney to expedite convective cooling. Note that the bottom of the cylindrical shield is open so it will "draw." Between the power rectifier, at left, and the capacitors is a vertical plane baffle which

Fig. 4—Use of heat baffles and chassis vents to lower capacitor temperatures and keep internal chassis temperature down.



reflects back heat from the rectifier and guides local convections up both its surfaces. As these baffles function principally as reflectors, their surfaces should be bright. Without these heat baffles capacitor life was measurable in hours of operation, and not many hours at that. With the baffles in place, the operating life of the capacitors was extended to years, so that the equipment became obsolete before they failed.

Another installation using baffles to reflect heat away from a capacitor bank, along with chassis vents to keep internal temperatures within reasonable limits, is shown in Fig. 4. Socket mounting of the capacitors here insulates them against heat conducted along the chassis surface.

Temperatures of many components, such as resistors, can be lowered by use of oversize components. If a 1-watt resistor is electrically necessary and the assembly runs hot, substitution of a 2-watt resistor will sometimes be helpful. This lower temperature is not due to lower dissipation. If the resistor dissipates one watt, it will do so regardless of its nameplate rating, but a higher-rated resistor is physically larger and has a larger radiating surface, so its equilibrium temperature will tend to be lower.

Mounting of tubular elements, such as resistors, with through bolts and massive brackets will facilitate conduction of heat from the component to the chassis. Again, this will not reduce the amount of heat produced, but will conduct it away from the source more rapidly, lowering the equilibrium temperature.

Rectifiers

Selenium rectifiers in most amateur and some commercial equipment are operated somewhere between maximum recommended current and the "stink point." In addition, they are commonly stuck in an unvented corner of the chassis — creating, so far as the rectifier is concerned, a sort of autocrematorium, as in Fig. 5, lower left.

Much of this trouble can be eliminated by use of adequately sized rectifiers, or even oversized rectifiers (more radiating area for the wattage to be dissipated): and by mounting them above chassis, as in Fig. 5, upper left and right. Use of a through bolt and heat conductive bracket will be found helpful in eliminating unwanted heat. A pair of small selenium rectifiers mounted in this manner is shown in Fig. 5, lower right.

Perhaps the most satisfactory mounting for the smaller selenium rectifiers is by bracketing them over a relatively large chassis hole, as in Fig. 6. Here convective cooling is at a maximum, conduction cooling is facilitated by the center bolt and brackets, and wiring to the lugs is made easy since they project below the chassis top even though the body of the rectifier is above it.

Power Tubes

By use of suitably vented sockets, a large

power tube can be made to drive convections that will ventilate a large part of an electronic assembly. By mounting a standard socket in a vented sunk assembly, as in Fig. 7, air from under the chassis will be sucked out and upward by the convection about the power tube, *provided* a cool air inlet is also present under the chassis. This particular vented sunk assembly, heavily chromium plated and quite "professional looking," is found in most plumbing shops where it is usually called a sink strainer.

Careful arrangement of components will often remove most of the problems of heat disposal without the use of complicated or costly special devices. One example of this is shown in Fig. 8, where the major heat producers, the power rectifiers (A) are surrounded by the transformers and chokes of the power supply, which are substantially heat-immune. A heat baffle (B) is placed between the audio power tubes and the nearest electrolytic capacitor, to prevent cooking it. Capacitors are protected against heat from the two adjacent 12AU7s by wide spacing (C). Convectional cooling of both the chassis shown and of chassis above and below it is assisted by leaving the speaker well (D) open at both top and bottom.

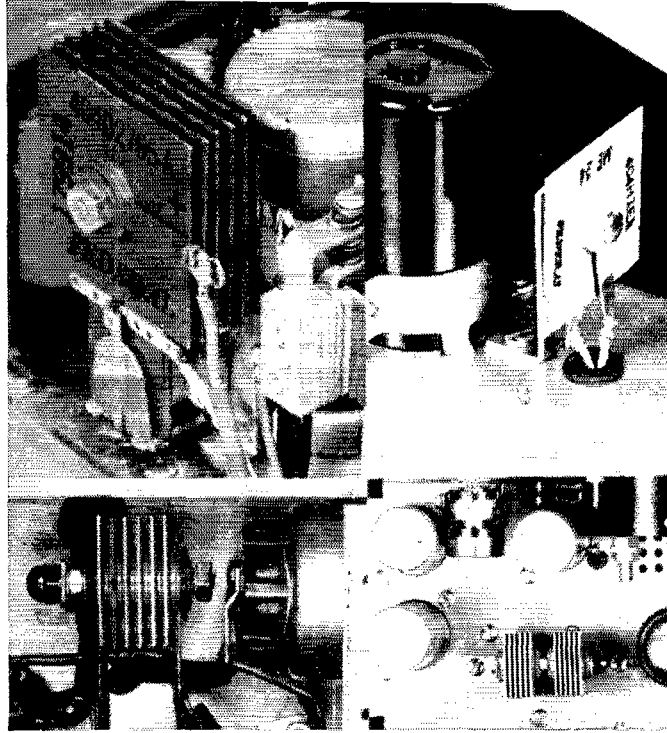

Fig. 5—Selenium rectifier mountings.

Thermal Stabilization

Localized thermal stabilization is necessary or desirable when frequency is controlled by heat-sensitive components, which includes almost all components except zero temperature coefficient crystals. One of the best methods yet developed involves the use of insulated compartments with the temperature controlled thermostatically. This is substantially a crystal oven, for which many adequate designs are known.

Additional thermal stabilization can be provided by mounting the temperature-sensitive device on or in a block of some substance with great thermal mass, such as an iron or brass block. If the temperature-control device, such as a thermostat, is mounted on the surface of this block and the thermally sensitive equipment (such as a crystal) within it, internal temperature variations can be held to a very small fraction of those at the thermostat.

By use of "thermal ballast," plus shielded and insulated containers, plus a sensitive thermostat or series of them, the temperature at the critical point can be held constant to any accuracy desired (except 100 per cent!) and stabilities of plus or minus 0.01 degree C. are rather easily attained.

Where lesser temperature stability is needed, as in most amateur and commercial equipment, thermal stabilization is commonly obtained and maintained by leaving the equipment turned on at all times. If the installation as a whole is fairly massive, rather gratifying thermal stability can be attained in this manner.

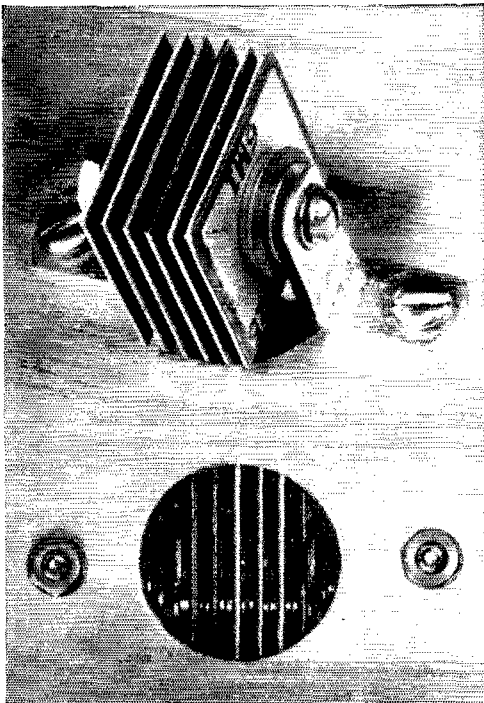

Fig. 6—Recommended mounting for selenium rectifiers.



Fig. 7—Vented sunk socket mounting for power rectifier.

Isolation

Thermal isolation of a heat-producing component, so that its heat will not affect adjacent components and so that the heat produced by adjacent components has little effect on its equilibrium temperature, is attained by use of basal insulation and concentric lateral shields, vented to facilitate convection, as in Fig. 9. At the extreme left is the entire shield assembly.

To its right is the outer "chimney," vented to allow influx of cooler air at the bottom. Next is the tube, mounted in an elevated and insulated socket, to reduce conduction of heat to and from the main chassis. At extreme right is the tube shield, an entirely conventional component.

Tests with nested shields of this type show that, for a tube dissipating about five watts, the spacing between the tube shield and the outer chimney must be at least $\frac{1}{8}$ inch, and full convectional cooling does not take place until the spacing is about $\frac{1}{4}$ inch. All other factors remaining the same, tube temperature changes with this type of shielding are slightly less than one fifth the changes without the shielding. An additional concentric shield improves the thermal stability only by a factor of about 1.5, and a fourth shield causes such a small improvement that it might well be omitted.

Fans

Both localized and general cooling can be facilitated by use of fans, although the improvement that they can bring about is not always as great as is commonly believed. Fan motors, particularly the midget shaded-pole jobs that are quite popular, produce considerable heat themselves. Only if the fan removes more watts of heat than it produces will its use lead to improved cooling.

Placement of fans and proper direction of their air flow is quite important. A very small fan directed to aid convection may be a very effective cooler, but the same fan opposing convection may be less useful than no fan at all. Also, for any given installation, there is an optimum rate of air flow. Up to this point, increasing the air flow increases the cooling in almost any direct ratio. Beyond this point, doubling the air flow may only increase the cooling 20 per cent. In very general terms, subject to many exceptions, optimum cooling is to be expected when the air in a chassis enclosure is changed from five to ten times a minutes.

Small fans are best driven by shaded-pole induction motors; larger fans by capacitor start and run induction motors. Brush-type universal motors are not recommended for use around communications equipment, as very extensive shielding and isolation are needed to keep the brush noise out of receiving equipment. Where relatively large amounts of heat must be dissipated, as in high-power transmitters, it is com-

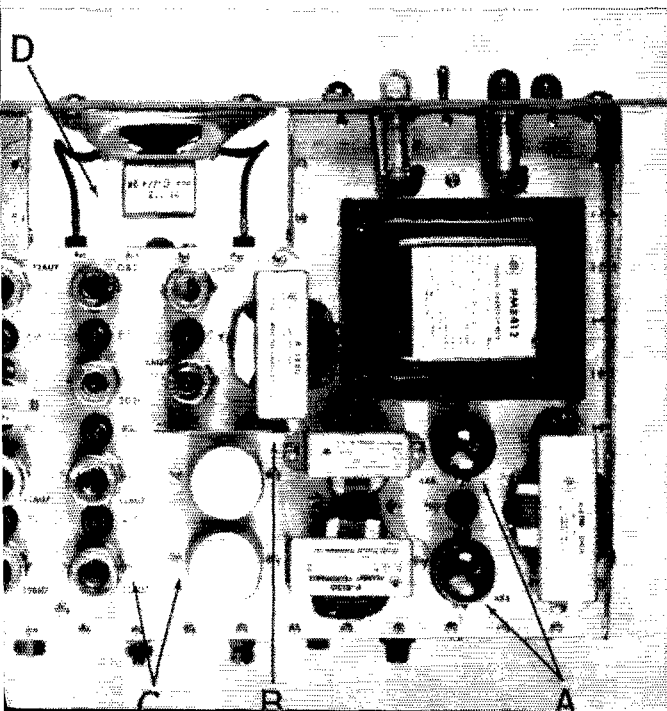
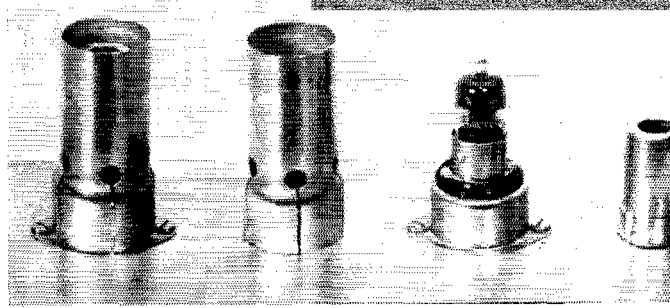

Fig. 8—Component arrangement to minimize heat disposal problems.

Fig. 9—Thermal isolation of a heat-producing element.



monly desirable to mount the fan motors outside the chassis enclosure, and also out of the air stream, so that fan-motor heat is not carried through the electronic assembly. Centrifugal fans are ideal for this specific application.

In considering all heat disposal problems, both economics and good sense should limit our efforts to getting rid of *harmful* heat. Little or nothing is gained by running equipment at 5 degrees above ambient when all components are substantially immortal at 25 degrees above ambient. Improvement of performance and service life will result from keeping the over-all equilibrium temperature somewhat below the maximum rating for the components used, and frequency stability will be improved by minimizing changes in the equilibrium temperatures of the frequency-determining components. Further heat reduction is usually supererogatory, like measuring bricks with a micrometer, and gives little useful return for the effort expended.

General rules for heat control can be summarized as follows:

- 1) For minimum heating of a given assembly, keep power input at a minimum.
- 2) Use components and circuitry of maximum electrical efficiency. All input energy that does not appear at the output is dissipated as heat.

- 3) Arrange components and circuitry for minimum heat at critical points. Wherever possible, isolate heat-sensitive components from heat sources by interposing a heat-immune component. Remember that radiant heat follows the inverse square law; that heat conduction is substantially a linear phenomenon; and that heated convective air rises.

- 4) Arrange extra heat conductors, vents, baffles and cooling fans to compensate, insofar as possible, for remaining uncorrected thermal conditions.

- 5) Apply *Occam's Razor* to each and every planned layout and circuit. This useful logical tool can be paraphrased into the question, "Is this the simplest arrangement that will perform the requisite function?"

- 6) Build and test.

- 7) Make necessary corrections in installation.

Acknowledgment

The writer is indebted to Mr. James P. Welsh of Cornell Aeronautical Laboratory, and to Dr. Stuart W. Grinnell of Stanford University, for helpful discussions of thermodynamic problems related to heat control and disposal; and to Mr. John Bethel of Palo Alto, Calif., for skilled photographic work.

A.R.R.L. QSL BUREAU

The function of the ARRL QSL Bureau system is to facilitate delivery to amateurs in the United States, its possessions, and Canada of those QSL cards which arrive from amateur stations in other parts of the world. Its operation is made possible by volunteer managers in each W, K and VE call area. All you have to do is send your QSL manager (see list below) a stamped self-addressed envelope about 4¼ by 9½ inches in size, with your name and address in the usual place on the front of the envelope and your call printed in capital letters in the upper left-hand corner.

- W1, K1 — G. L. DeGrenier, W1GKK, 109 Gallup St., North Adams, Mass.
- W2, K2 — North Jersey DX Association, Box 55, Arlington, New Jersey.
- W3, K3 — Jesse Bieberman, W3KT, P.O. Box 400, Bala-Cynwyd, Pa.
- W4, K4 — Thomas M. Moss, W4HYW, Box 644, Municipal Airport Branch, Atlanta, Ga.
- W5, K5 — Robert Stark, W5OLG, P.O. Box 261, Grapevine, Texas.
- W6, K6 — Horace R. Greer, W6TI, 414 Fairmount St., Oakland, Calif.

- W7, K7 — Salem Amateur Radio Club, P.O. Box 61, Salem, Oregon.
- W8, K8 — Walter E. Musgrave, W8NGW, 1245 E. 187th St., Cleveland 10, Ohio.
- W9, K9 — J. F. Oberg, W9DSO, 2601 Gordon Drive, Flossmoor, Ill.
- W0, K0 — Alva A. Smith, W0DMA, 238 East Main St., Caledonia, Minn.
- VE1 — L. F. Fader, VE1FQ, 125 Henry St., Halifax, N. S.
- VE2 — George C. Goode, VE2YA, 188 Lakeview Ave., Pointe Claire, Montreal 33, Que.
- VE3 — Leslie A. Whetham, VE3QE, 32 Sylvia Crescent, Hamilton, Ont.
- VE4 — Len Cuff, VE4LC, 236 Rutland St., James, Man.
- VE5 — Fred Ward VE5OP, 899 Connaught Ave., Moose Jaw, Sask.
- VE6 — W. R. Savage, VE6EO, 833 10th St. N., North Lethbridge, Atla.
- VE7 — H. R. Hough, VE7HR, 1684 Freeman Rd., Victoria, B. C.
- VE8 — W. L. Geary, VE8SAW, Box 534, Whitehorse, Y. T.
- VO1 — Ernest Ash, VO1AA, P.O. Box 8, St. Johns, Newf.
- VO2 — Douglas B. Riteer, Dept. of Transport, Goose Bay, Labrador.
- KP4 — E. W. Mayer, KP4KD, Box 1061, San Juan, P. R.
- KH6 — Andy H. Fuchikami, KH6BA, 2543 Namauu Dr., Honolulu, T. H.
- KL7 — KL7CP, 310-10th Ave., Anchorage, Alaska.
- KZ5 — Catherine Howe, KZ5KA, Box 407, Balboa, C. Z.

80-Meter

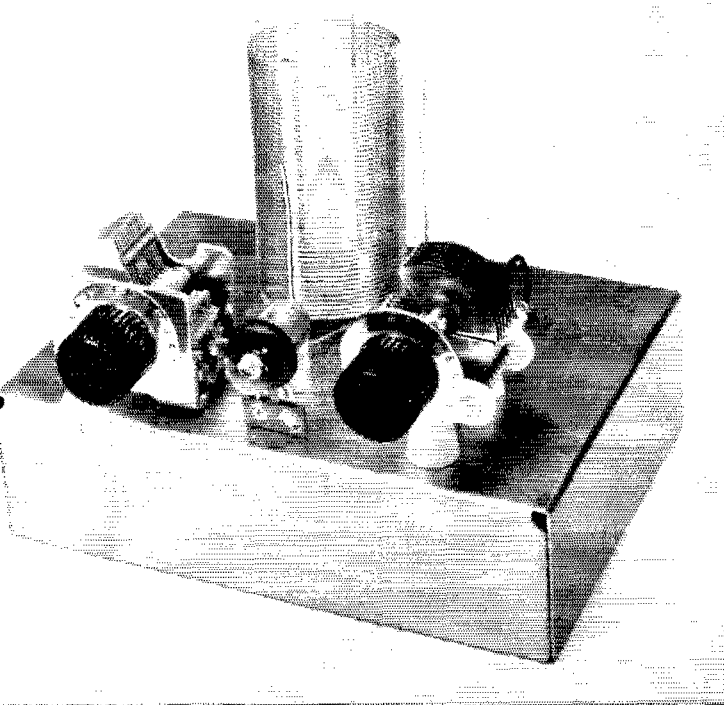

An 80-meter antenna coupler like this is easy to build and tune, and assures that the transmitter can be loaded fully and that harmonic radiation is suppressed.

The neon bulb between the two capacitors serves as a tuning indicator; it is coupled to the coil through the capacitance between the coil and the upright length of wire. Phono jacks mounted 4 inches apart at the rear of the chassis are used for input and output connections. The lefthand capacitor, C_1 , is mounted directly on the chassis, but C_2 , at the right, is supported by small ceramic insulators.

RECENTLY at a radio club the author asked how many of the Novices present had received "QSL cards" for harmonics from the FCC. Of those present, approximately half had been cited by the FCC! All of the notices were for second harmonics of 80-meter operation. The unhappy part of the situation is that simple preventive measures would have kept the harmonics from being radiated. Before we discuss methods for preventing harmonic radiation let's first see what a harmonic is and how it can cause trouble.

HARMONICS, Harmonics, Harmonics

When you key your transmitter on, say, 3725 kc., you want all your output power to be on that one frequency. Unfortunately, life isn't that simple. Transmitters have the nasty habit of generating additional signals at integral multiples of the fundamental. These signals are called "harmonics." If the fundamental is 3725 kc., there will also be a weaker signal at 7450 kc., a

still weaker one at 11,175 kc., another at 14,900 kc., and so on up. As a Novice you may not know all of the amateur band frequency limits but, take our word for it, the harmonics just listed do not fall in any amateur band. It is bad enough to cause unnecessary interference to fellow amateurs, but you can be sure the commercial services take a very dim view of amateur interference to their signals. The transmitter is determined to generate harmonics, but the harmonics will generally not be radiated if we can keep them from reaching the antenna.

The first step in cleaning up a harmonic problem is to find out how bad the harmonic is. This can be determined quickly with the help of a neighboring ham by having him listen at the harmonic frequency. He should be at least a couple of miles away from you, otherwise your fundamental signal may overload his receiver. An overloaded receiver can generate harmonics and "birdies" in itself. This would, of course, lead to false conclusions by your friend.

If you find that your friend can copy a harmonic of your fundamental, you must do something to eliminate the harmonic, no matter how weak it is. Otherwise, it will be just a matter of time before you receive an official notice from the FCC.

Possibly you don't have any amateurs living nearby who can check your signal. In that case there is another way to determine if harmonics are reaching your antenna. Build yourself a simple absorption-type wavemeter. The one described in July *QST*¹ is sensitive enough for checking harmonics.

To use the wavemeter to see if harmonics are

¹ McCoy, "A Novice Band Checker," *QST*, July, 1958

If you're using a coax fed antenna, be it dipole, trap, or vertical, here is an antenna coupler that will work in coax line. This gadget will help you load your transmitter and even more important, keep your 80-meter second harmonic at home where it won't earn you FCC notices!

Loading Without Harmonics

Keeping Spurious Signals From Being Radiated

BY LEWIS G. McCOY,* WIICP

getting to the antenna the instrument should be coupled to the output lead in the transmitter (or to the feed line if Twin-lead or open-wire feeders are used). Then tune the wavemeter through the harmonic frequencies. If even a trace of harmonic shows it must be suppressed.

The wavemeter will also show if your transmitter is tuned to the correct band. It is possible with many transmitters to tune them up on the wrong frequency. If you want to tune up on 3725 kc. but actually end up on 7450 kc., it is just as bad if not worse than having a harmonic. That's why it is a good idea to have a wavemeter to check the tuning of your rig.

One way to reduce harmonics to a point where they should no longer be a problem is to install an antenna coupler in the feedline. Fig. 1 is the circuit diagram for a coupler to be used with coax feedlines. Most transmitters these days are designed to be worked into coax lines. Unfortunately, if you go direct from the transmitter to the antenna without benefit of a coupler (or filter), it is quite easy to end up with an appreciable amount of harmonic being radiated. The coupler described here, when installed in the coax line near the rig and correctly adjusted, will provide adequate harmonic attenuation. Some transmitters have no means for adjusting the coupling or loading of the final amplifier. Another advantage in using this coupler is that it will provide such an adjustment.

Making the Coupler

The coupler shown here is mounted on a 2 X 5 X 7-inch aluminum chassis. Two phono jacks mounted on the back of the chassis are used for J_1 and J_2 . The leads from the jacks are brought up to the top of the chassis through two holes in the chassis top. Rubber grommets are used in the holes to provide further insulation for the wires.

*Technical Assistant, QST.

Both variable capacitors, C_1 and C_2 are mounted on top of the chassis. Standoff insulators are used for mounting C_2 because this capacitor must be insulated from the chassis. The coil L_1 is made from a length of Miniductor stock by unwinding fifteen turns from one end and a single turn from the other. When the fifteen turns are unwound, four polystyrene support bars approximately one inch long remain. The coil is mounted on the chassis by cementing the ends of the bars to the chassis with Duco cement. Let the cement dry overnight and the coil will be firmly mounted on the chassis.

An NE-21 neon bulb, mounted permanently on the coupler chassis, is used for an output indicator. A $\frac{1}{2}$ -inch diameter grommet is slipped over the glass bulb and a piece of stiff wire is wrapped around the grommet. The wire is soldered to a standard terminal tie-point mounted on the chassis between the two variable capacitors. A $2\frac{1}{2}$ -inch length of hookup wire is soldered to the base tip of the neon bulb. This short length of wire serves as a capacitive pickup, C_3 , to the coil.

The Antenna System

A sketch of a Novice installation using the coupler described here is shown in Fig. 2. The diagram also includes the dimensions of an 80-meter dipole for the Novice band.

The coupler can be installed anywhere in the station but it is usually more convenient to mount it near the transmitter. An antenna change-over relay or switch can be installed at the transmitter or in the coax line between the rig and the coupler.

In order to "get out" well the antenna should be mounted as high above ground and as clear of surrounding objects as possible. The antenna will still work if it isn't mounted high and clear but don't expect to get as good results. Some

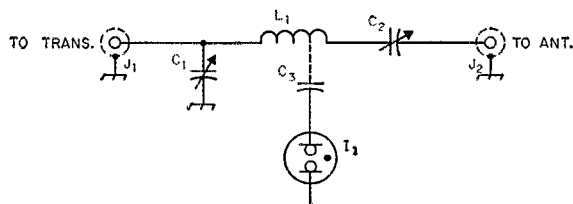

Fig. 1—The circuit for the simple coupler for coax feedlines.

C_1 —400- μf . variable capacitor, broadcast replacement type (Allied No. 61H009).

C_2 —100- μf . variable capacitor (Hammarlund MC-100-M, Bud 1855).

C_3 —See text.

I_1 —NE-21 neon bulb.

J_1, J_2 —Phono type jacks.

L_1 —48 turns of No. 18, 16 turns per inch, $1\frac{3}{4}$ -inch diam. (B & W 3023) Miniductor.

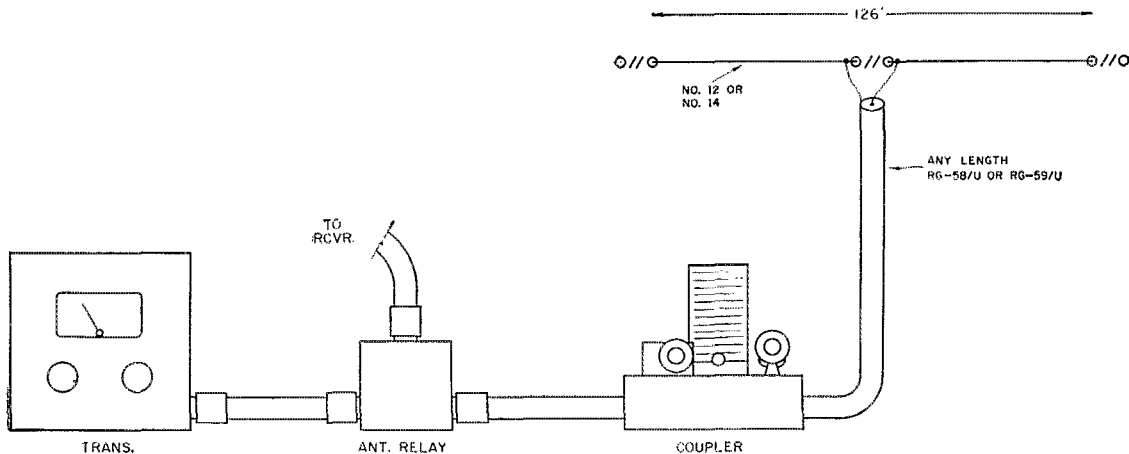

Fig. 2—This drawing shows an antenna system for operation in the 3.7- to 3.75-Mc. Novice band. Either RG-58/U or RG-59/U coaxial cable can be used to connect the different units together. To use the same antenna for receiving, an antenna changeover relay can be installed as shown or, if desired, it can be mounted inside the transmitter.

amateurs don't have the necessary space to put up an antenna 126 feet long. In such a case the ends of the antenna can be bent down or to one side to fit a shorter run.

The feedline can be any convenient length, and one of the advantages of coax is that it can be run along metal rain gutters, through pipes, and even under ground without upsetting the electrical characteristics of the line. However, if possible, it should be perpendicular to the antenna for the first 50 feet or so from the antenna.

Adjusting the Coupler

There is nothing complicated about adjusting the coupler, assuming the feedline and antenna are reasonably well matched, but certain precautions should be observed to obtain maximum harmonic attenuation. Turn C_1 to maximum capacity (plates fully meshed) and leave it set at that position. Now turn on your rig and tune it up normally, dipping the final to resonance. Next, tune C_2 for maximum brilliance of the neon bulb. If the bulb doesn't light move the pickup wire closer to L_1 ; if the light seems too bright move the wire away or make it shorter.

You may find that there are two settings of C_2 that will cause the bulb to light. One will be near maximum capacity and the other near or at minimum capacity. It is *very important* to use the setting of C_2 nearest maximum capacity (plates fully meshed) as this is correct tuning for 80 meters. A tuning indication near minimum occurs when the antenna coupler is tuned to the second harmonic and this is exactly what you do not want to do.

To increase the loading of the amplifier stage in the transmitter decrease the capacity of C_1 . Once you have obtained the recommended plate current reading, with the amplifier tuned for a dip, the transmitter is adjusted.

Some amateurs have antenna systems using 300-ohm Twin-Lead for a feed line. The usual custom with this type of installation is to come out of the transmitter with coax to a set of balun

coils and then use 300-ohm line to the antenna. Unfortunately, balun coils do not provide harmonic attenuation so such a system can get you into trouble. The coupler described here can be installed in the coax line between the transmitter and balun and will give you the protection you need.

We have discussed only the problem of 80-meter harmonics since, as pointed out earlier, they are responsible for the majority of FCC tickets to Novices. However, the same techniques outlined here can be used on the other bands. For additional information on antenna couplers and harmonics the reader should refer to *The Radio Amateur's Handbook*, or to the articles listed below:

McCoy, "The Evils of Multiband Antenna Systems — And the Cure," *QST*, Mar., 1957.

McCoy, "Eliminating 80-Meter Novice Harmonics," *QST*, Mar., 1956.

Wood, "What About Low Frequency Harmonics?" *QST*, August, 1955.



This month's short lesson in logic is submitted by Louis Frenzel, Jr., W5TOM.

A "black box" has ten binding posts mounted on it. An ohmmeter measurement between *any* pair of terminals indicates 2 ohms resistance. Question: What is inside the black box?

— . . . —

Numbering the capacitors of last month's problem from 1 to 23, the answer to the problem is to disconnect No. 7 and No. 11. This leaves a block of .006 μf . (Nos. 1 through 6) a single .001 (No. 7), a block of .003 μf . (Nos. 8, 9 and 10), a single (No. 11) and a block of .012 μf . (Nos. 12 through 23). Any capacitance from .001 to .023 μf . can be made from various combinations of these in parallel.

justed for greatest selectivity. Other very undesirable results of transmitter signal leaking into the receiver are overloading of the first stage, shortening the life of the tube nearest the antenna, and occasionally burning out of the first tuned circuit. Similarly, overload of the first grid will cause pulses of grid current to flow, generating transmitter harmonics in the receiver for transmission to nearby television receivers. This will occur even if the receiver send-receive switch cuts off the plate and screen voltages of the first tube, for only the cathode and control grid of the first (or other) stages are involved in this type of harmonic generation. If the transmitter signal can be kept out of the receiver, none of these troubles will occur.

Modern receivers are all potential transmitters. This is a characteristic of superheterodyne receivers, for this type includes an oscillator whose output frequency has a fixed difference with a desired incoming signal. All oscillators have some harmonic output, and if the receiver oscillator is not sufficiently shielded and filtered (like a good ham transmitter), it may radiate enough harmonic power to interfere with television receivers. Harmonic radiation is not a fault of just amateur receivers, for most old-timers remember how whole sections of the 160-meter band were made unusable by fundamental and harmonic radiation from a.c.-d.c. broadcast receivers.

Curing one of these troubles will usually cure the other, for the filtering and shielding necessary to prevent the transmitter signal from entering the receiver will also effectively block receiver oscillator harmonics attempting to leave the receiver.

Extra advantages result from receiver filtering and shielding that is effective enough to make the receiver antenna connection the only r.f. path into or out of the receiver. Antenna line filters become effective against strong unwanted stations. The receiver is always left in receive position¹ with improved receiver stability. A transmission-line t.r. switch² has a chance to be really effective, and even an antenna duplexing bridge can be used.³

Working Over the HQ-129X

Three local hams had TVI trouble with their communications receivers (all nationally-known, factory-built) and I wanted to try antenna duplexing bridge experiments. As my receiver had already been torn into for other modifications, it was selected for the full treatment. Many of the modifications incorporated will not be necessary with other receivers of even the same model, but severe test conditions were set up so that every possible type of signal leakage would occur.

The receiver was tested with a shielded resistor dummy antenna, the resistor matching the input impedance as determined by diode noise genera-

tor measurement.⁴ The transmitter was loaded into the station antenna for the initial tests. Later, when the pickup had been substantially reduced, the transmitter output was fed into an unshielded series-resonant combination of capacitor, inductor, and resistor (Q of about 11) near the receiver.

The HQ-129X had been modified earlier for use of a low-noise single-ended converter stage,⁵ so it is not possible to tell how much pickup the unshielded grid lead of the original 6K8 converter would have had. It is probable there would have been a great deal.

The greatest signal pickup was by the VR-105/OC3 voltage regulator tube used to stabilize the voltage on the oscillator plate and the r.f. converter, and i.f. amplifier screens. It was necessary to shield this tube. An almost equal source of leakage was the 6SS7 r.f. amplifier, because the metal envelope does not provide sufficient shielding against pickup. The shield covering the voltage regulator tube also was extended to cover this r.f. amplifier tube. There is no reason why commercially-available individual shields would not be satisfactory if shimmed with aluminum foil or similar material.

The writer used 1/4-inch-mesh hardware cloth for shielding wherever convenience was not unduly impaired, but recommends the commercial shields when trade-in value is a factor.

The next prominent cause of leakage was the antenna terminal strip. This strip was removed and replaced by an SO-239 coaxial connector soldered in a copper plate which in turn was soldered to the chassis.

⁴ Goodman, "How Sensitive Is Your Receiver?", *QST*, September, 1947.

⁵ Santangelo, "Second Guessing The Experts On The HX-129X," *CQ*, April, 1952.

The Shielding Story in S-Meter Readings

	<i>Before</i>	<i>After</i>
Receiver connected to shielded dummy, transmitter on regular antenna	Meter	pegged
Shield over VR105/OC3	Pegged	S9
Shield over 6SS7 r.f. amp.	S9	S8
Antenna coax connector installed	S8	S5
Power-line filter installed	S5	S4
Change to transmitter output into dummy antenna near receiver		S9
Rear holes in tuning capacitor frame plugged up	S9	S6
Rear bearings of tuning capacitor covered	S6	S4
Slot in tuning-capacitor shield covered	S4	S2
Shield over bottom of chassis	S2	Less than S1
Leads to meter, pilot lamps and headphones bypassed		Inaudible

¹ In the HQ-129X, the send-receive switch controls the r.f., mixer, and first i.f. plate supplies.

² The Wright t.r. switch and many others.

³ Fessenden, U. S. Patent 1,170,969 and others.

Power-line filters (Sprague Hypass) were next installed in a Bud Mini-Box mounted against the chassis. In the position shown in the photograph the box readily slides through the rear cutout of the receiver cabinet.

The tuning capacitor assembly was the next leaky item. Punched holes in the rear frame were plugged with nuts, bolts, and washers. The slot in the tuning capacitor shield that formerly was used for passing the grid lead to the 6K8 converter was closed by bolting on a metal plate, and the rear bearings of both capacitors were covered with two layers of aluminum foil. The foil was fastened in place with Duco Cement, the centers of the foil layers being insulated from each other and the bearing screw by small pieces of Scotch tape, as shown in Fig. 1.

Hardware cloth was tacked with solder to the bottom lip of the chassis at one-inch intervals to form a bottom shield. The pilot light, "S" meter, and headphone leads were bypassed with 0.001- μ f. ceramic capacitors where the leads entered the chassis. It was not necessary to bypass the loudspeaker leads additionally, though this might be necessary in other cases. It likewise may be desirable to bypass the "RELAY" (send-receive) terminals, but the writer has no information since these connections were not used and did not require bypassing.

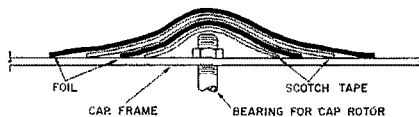
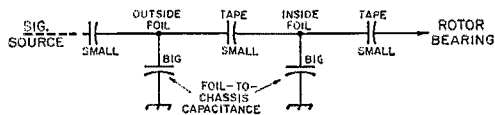
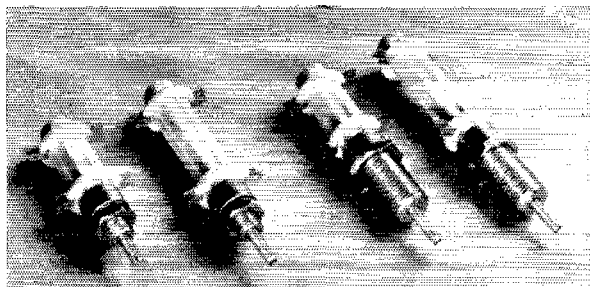

Fig. 1—Method of using foil and Scotch tape to shield the rear bearing of the tuning capacitor. This avoids the necessity for drilling to attach a shield or for soldering the shield to the capacitor frame. The two layers of foil are insulated from each other. Their edges may make contact with the capacitor frame but if not the foil pieces act like a two-section attenuator having the equivalent circuit shown at the top.

Altogether, the above measures permitted the writer to be sure that the *only* signal path to the receiver was through the coaxial connector—where an antenna relay, t.r. box, or duplexing bridge can control the receiver input.

• New Apparatus

Slug-Tuned Coil Forms



A NUMBER of features are incorporated in the slug-tuned ceramic coil forms (type number prefix CSA) recently introduced by Waters Manufacturing, Inc., Wayland, Mass. The winding areas are ribbed, a convenience for running leads to terminals. Insulating rings cemented on the forms at the ends of the winding space are equipped with two double soldering lugs each, so that four terminals are provided for either two separate windings or for a tapped single winding. The double-lug feature permits soldering a coil lead to one part of the lug while the connection to the external circuit is made to the other part. As shown by the photograph, two types of mounting bushings are available, one a standard-length

screw type and the other a "deep-well" type which allows the slug to be retracted farther than normal, thus increasing the possible inductance-adjustment range.

In either the standard or retractable bushing types there are three form diameters— $\frac{1}{4}$, $\frac{3}{8}$, and $\frac{1}{2}$ inch—and each diameter is available in three winding lengths, $\frac{5}{8}$, $\frac{7}{8}$, and $1\frac{1}{8}$ inches. There are also four types of slugs—three varieties of iron to cover the frequency range from audio to above 250 Mc., and brass. The ends of the forms are circular so that two forms can be stacked end to end (a collar is available to slip over the ends to complete the assembly) to form a transformer with separate slug tuning of both coils.

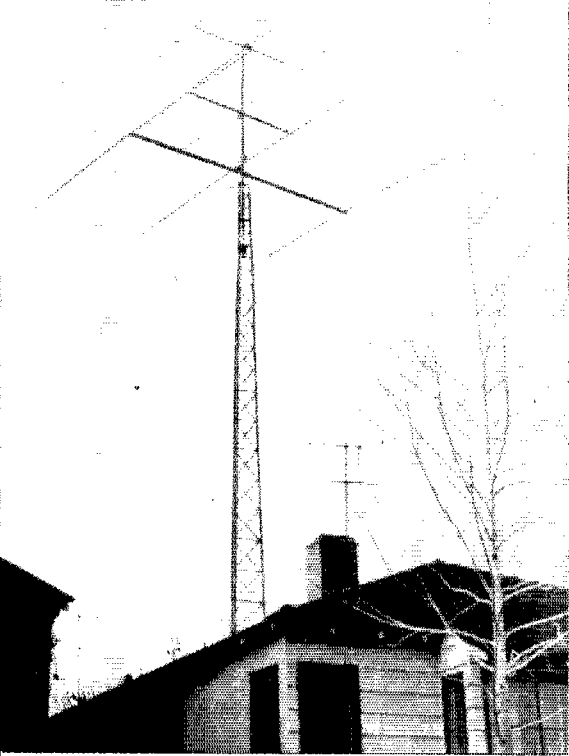

W6FHR's welded tower. The tower is 60 feet high and is broken into six 10-ft. sections. A 15-ft. rotating mast extension supports the 10- and 15-meter beams above the 20-meter array.

Safe Tower for a City Lot

*Welded Sections in a
Self-Supporting Sixty Footer*

BY LEWIS H. ABRAHAM,* W6FHR

FOR YEARS I have owned a multiband transmitter but have operated only a single-band antenna. This wasn't too confining when sunspot activity was low. But then the m.u.f. began to move up. My pole was capable of handling a 15-meter beam over the old reliable 20, so up it went. I had no other choice. Living in the city on the usual 50-ft. lot, the only room I had for expansion was up.

Soon 10 meters turned hot too, and I had to face the fact that if I wanted an additional beam on my Christmas tree I would have to start from the roots up. I had pushed the old pole as far as it would go. For a thousand reasons I couldn't abandon either 15 or 20 meters. Thus the seed was sown for a new support.

Having experimented with various antenna arrangements and finding, to paraphrase the song, "You Gotta Have Height," I set about examining ways and means of gaining a little more altitude at the same time I took on 10-meter capability. Two requirements were obvious immediately. The tower had to comply with building codes, and it had to be self-supporting with full-size three-element 10-, 15- and 20-meter beams.

As a first step, I began to explore available towers for amateur use. For one reason or another, none of these met the requirements. One or two commercial towers designed for nonamateur use were available if one were willing to part with about one kilobuck. Even so, these required too much room because of their base dimensions. Some of the other less expensive towers would not pass the Los Angeles Building Department requirements without extensive modification. These requirements aren't the toughest in the country.

Safe Construction

While not wishing to belabor the point too much, the importance of approval by local building and safety authorities cannot be over-emphasized. The job of these departments is to assure the safety of the buildings occupied by you and your neighbors. While some of the restrictions may seem severe or arbitrary, they are a result of long years of experience that have involved some pretty sad cases. The average amateur is not capable of judging the integrity of a structure.

*11339 Gladwin St., Los Angeles 49, Calif.

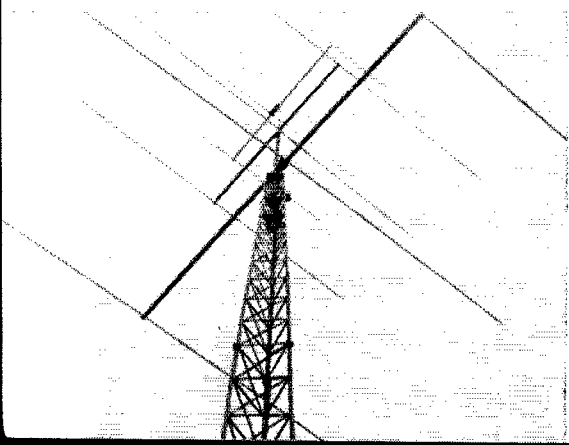

Upper section of the tower. The lowermost triangular plate supports the prop-pitch motor; the upper two are fitted with bearings.

QST for

A typical welded joint. The ends of the diagonal members are flattened to fit into the corners.

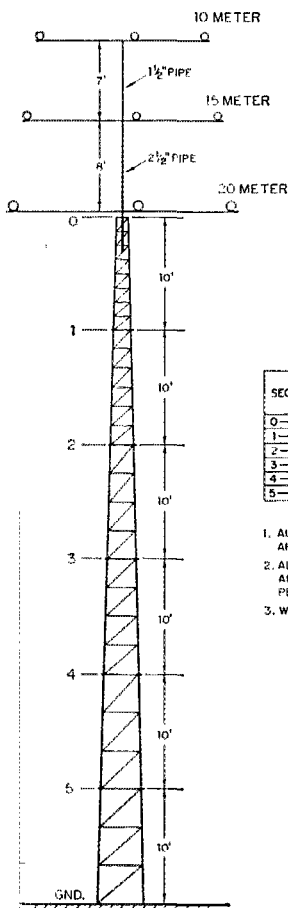
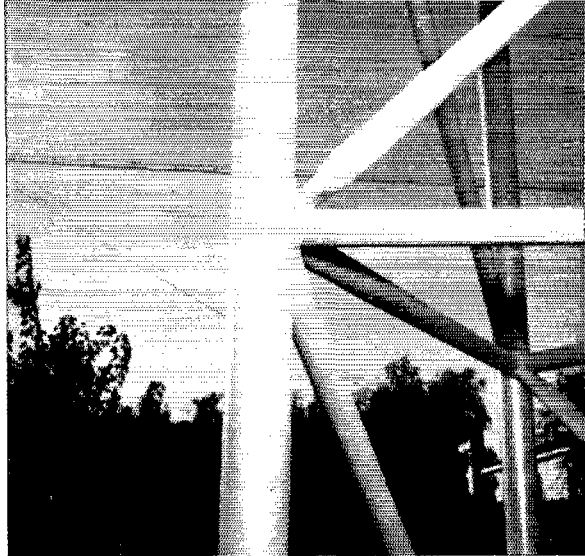

SECTION	VERTICAL MEMBER SIZE	BRACING SIZE	BOLTS AT JOINT
0-1	1"	3/8"	2-1/2" DIA.
1-2	1 1/4"	1/2"	3-1/2" DIA.
2-3	1 1/2"	3/4"	4-1/2" DIA.
3-4	2"	1"	3-5/8" DIA.
4-5	2 1/2"	1"	3-3/4" DIA.
5-GND.	2 1/2"	1 1/4"	2-1" DIA.

1. ALL PIPE SIZES SHOWN ARE STANDARD IRON PIPE SIZES.
2. ALL JOINTS COMPLETELY WELDED AROUND PERIPHERY, COMPLETE PENETRATION.
3. WELD FILLETS 3/16".

Fig. 1—Essential dimensions of the 60-ft. tower plus 15-ft. rotating mast. This sketch shows the actual number of crossbraces used in each side of each 10-ft. section.

Only one weak member can bring a tower crashing to the ground. The author knows of several such incidents. In one, the family dog was killed. It might have been a member of the family or a neighbor instead.

An approved structure, properly maintained, usually will be safe. Building-department approval can be insurance as well as assurance. If an unapproved structure causes property damage, or injury, you have little legal status and may be considered negligent—a very vulnerable position in the eyes of a court of law. Unless an "Act of God" is clearly involved, it is pretty hard to prove that somebody hasn't been negligent when a structure collapses.

Although I had built three towers previously, each time vowing, "Never again!" the prospects of working all hands with increased height goaded me on. Once again I forgot my old scars and let my enthusiasm prevail. Thus began the dream of Number Four. Armed with a copy of the Building and Safety Code, a well-oiled slide rule, and reams of paper, I set about the design of an edifice to rival all save Babel. This was to be my last tower—the ultimate.

From previous tests¹, 7 to 8 ft. seemed to be a satisfactory vertical spacing between beams. Wanting the lowest antenna at about 60 ft., this put the 10-meter beam at a height of around 75 ft. Thus the height was settled.

Constructional Details

Because of space problems, only a 4-ft. square could be allocated for the base. To use readily-available structural steel shapes would mean that the tower would have to be square in cross section. Tapering would add to the difficulty of construction, although tapering is very desirable from aesthetic considerations. Bolting the members together would mean drilling about 400 holes. This prospect almost scuttled the project before it was started. Upon consulting a local welder, it appeared that welding the members together

¹Orr, *Beam Antenna Handbook*.

would offer no particular difficulties, although it would take the job out of the do-it-yourself class.

Once having decided on this method of assembly, other possibilities appeared. The tower could be made of pipe, instead of angle stock, and the cost of welding could be at least partially offset by using a triangular rather than square cross section. Tapering would present no special problem. The final design is shown in Fig. 1.

In order to facilitate transportation from the welder to the station site and to permit erection without the need for a crane, the tower was designed to break into six 10-ft. sections. The three vertical members or legs of each section terminate at both ends in joining plates or flanges. These provide a means for bolting the sections together. The flanges are drilled for joining bolts according to the chart of Fig. 1. It is important, of course, that pairs of flanges that will be bolted together when the tower is assembled be accurately matched as to bolt-hole pattern. This can be done most easily by clamping the mating pairs of flanges together and drilling the bolt holes and pipe-hole centers simultaneously through the two flanges. After the vertical pipes have been cut to the lengths of 10 ft., the flanges are welded onto the ends, keeping the surfaces of the flanges accurately at right angles to the axis of the pipe, and the pipe centered on the flange.

When the three legs of a section have been prepared, jigs of plywood sheet are drilled and bolted to the ends to hold the legs in the correct position with the proper taper. The horizontal spacing between legs in each section is 6 inches less at the top than at the bottom. Since the top jig of any section becomes the bottom jig for the next section above, proper orientation of the bolt holes is assured.

When the jigs have been bolted firmly in place, the cross bracing can be cut to fit and welded in place. Fig. 1 shows the number of cross braces required for each section. The horizontal members are added first, and then the diagonals. Fig. 2

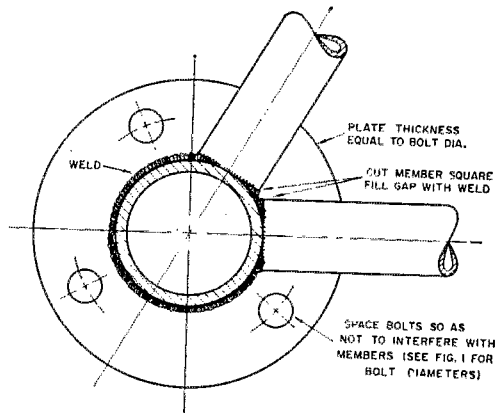

Fig. 2—Detail sketch showing how section assembly flanges and crossbraces are welded to the vertical pipe legs. The flanges are of ordinary low-carbon steel. The outside diameter should be equal to the outside diameter of the largest vertical pipe at the joint, plus six times the diameter of the bolt used at the joint (see chart of Fig. 1). Ample wrench clearance will be provided if the center line of the bolt circle is laid out midway between the pipe and outer edge.

shows a typical joint between a leg and two horizontal members. The ends of the horizontal members are not saddled to fit the pipe legs, but are cut square and the gaps are filled with weld. The diagonals are also cut square, but the ends are flattened somewhat to fit in the corner formed by the vertical and horizontal members, as shown in the detail photograph.

After assembly, each section should be given a coat of primer and one or two coats of paint. Dull grey makes a neat-looking installation.

Mast Support

Three triangular steel plates are welded into the top section of the tower. The first is at the top, the second is at the third horizontal brace from the top (3 ft. 9 inches), and the third plate is at the fifth horizontal brace (6 ft. 3 inches from the top). The bottom plate supports a prop-pitch motor, while the other two are fitted with bearings for the mast that carries the antennas. The bearings are of the plain sleeve type made of $3\frac{1}{4}$ -inch o.d. \times $\frac{5}{16}$ -inch wall mechanical tubing cut to a length of about 2 inches and welded to the triangular plates. A snug fit at these bearings is desirable to minimize vibration. (Standard pipe diameters are usually inside dimensions.) While ball bearings or other low-friction-type bearings are often considered, they are not very weather-proof, and since they are precision devices they are easily jammed, causing considerable difficulty. For the small amount of usage these crude bearings receive, they are quite adequate and only an occasional greasing is necessary. As a matter of fact, mine have not been greased in over a year and they are still working perfectly.

The rotating mast is made up of two sections

Worm's-eye view of the welded tower, showing the joining flanges.

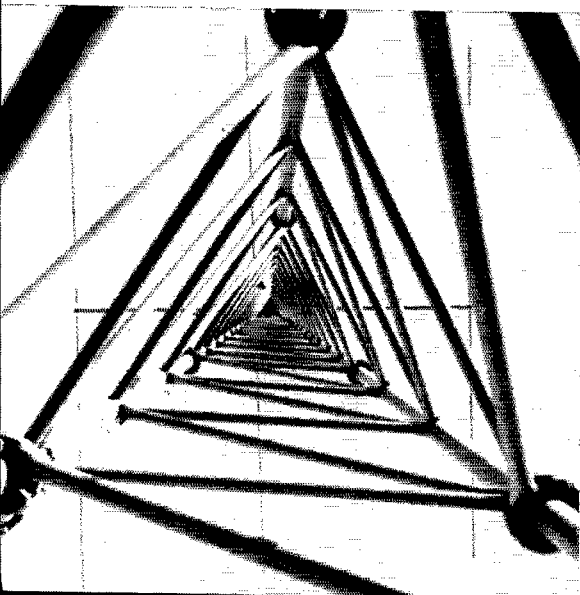

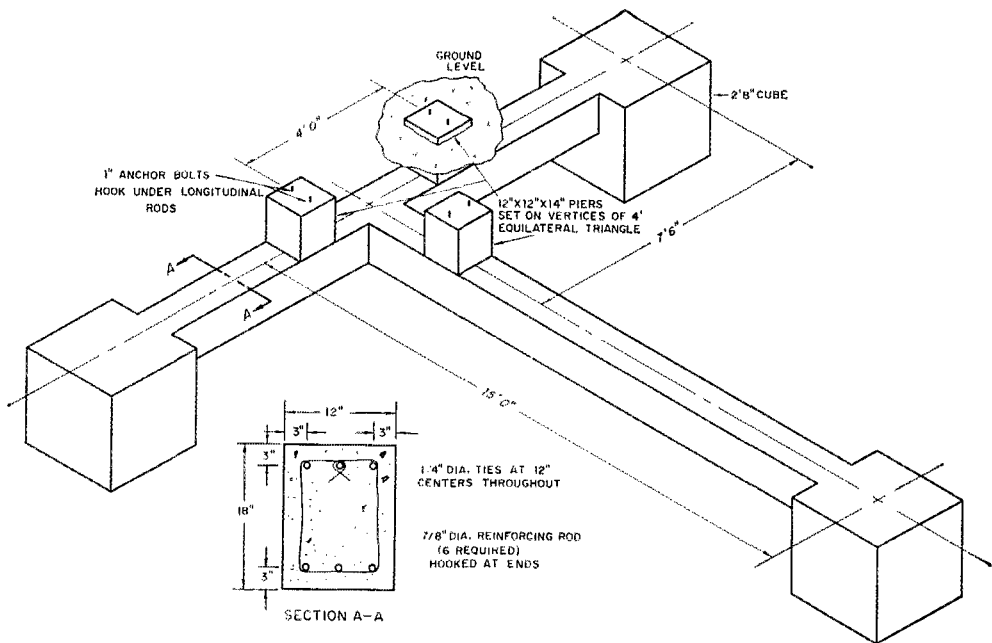

Fig. 3—Details of the concrete foundation. The unit is buried at such a depth that only the tops of the piers appear above the surface of the ground. The asymmetrical pattern is easier to construct than one having three equally spaced legs and may be placed closer to a building or other boundary.

of pipe. The lower section is of 2½-inch pipe and is approximately 15 ft. long. The top section is of 1½-inch pipe and is about 8 ft. long. In joining the two sections together, pieces of welding rod are used as centering spacers and then the two sections are welded together.

Foundation

In checking the design requirements for a conventional foundation, the specifications turned out to be an underground structure worthy of any Pharaoh. They called for a block of concrete 5 ft. square and 10 ft. deep. This hole would have attracted all of the swimming-pool salesmen in town. Discarding this monstrosity, the unconventional design shown in Fig. 3 was devised. This any Sunday contractor can handle. It involves some reinforcing steel, but this is small cost compared to moving about 30 tons of dirt, much of which would have to be passed up from the bottom of the hole with a bucket. This T-shaped design requires only 4 cubic yards of concrete and, buried a foot under the lawn, the foundation is completely invisible except for the three small piers on which the tower is mounted.

It is not necessary to use wood forms for the concrete, except for the piers, if the excavation is made with reasonable care. The excavation itself may serve as the form. The cross-sectional detail of Fig. 3 shows how the reinforcing rods are arranged. These reinforcing rods extend into the cubes and their ends are bent into hook shape. The rods are bonded together every 12 inches with ¼-inch tie wire. The ties wrap around the group of six rods and their ends are anchored

by bending them around the upper central rod. Smaller wire should be used to bind the tie wire to the reinforcing rods where they intersect. The complete foundation, with the possible exception of the cubes, should be poured at the same time; that is, before the concrete starts to set, since dry concrete and wet concrete do not cohere.

Assembling the Tower

The bottom section of the tower weighs about 300 lbs., while the top section weighs approximately half of this. Nevertheless two men (admittedly with some experience) had no trouble in assembling the tower and mounting the antennas in a single week end. The base section was first pushed up by hand and bolted to the foundation. A pipe gin pole with a short boom welded to the top end served as a support for a block and tackle. (See Fig. 4.) The gin pole was clamped about half way up on the base section, and the next section was hoisted into place and bolted fast. With each succeeding section, the gin pole was moved up a section on the tower and the above process repeated. The horizontal members of the tower are used for climbing and yet they are spaced wide enough at the bottom to discourage children from attempting it.

Feed and Adjustment

The antennas were cut to formula dimensions and the resonances checked reasonably close to the calculated figures. Little interaction between antennas was noticed. Gamma match is used on all three arrays. The reactance tuning capacitors of the 20- and 15-meter beams are accessible from

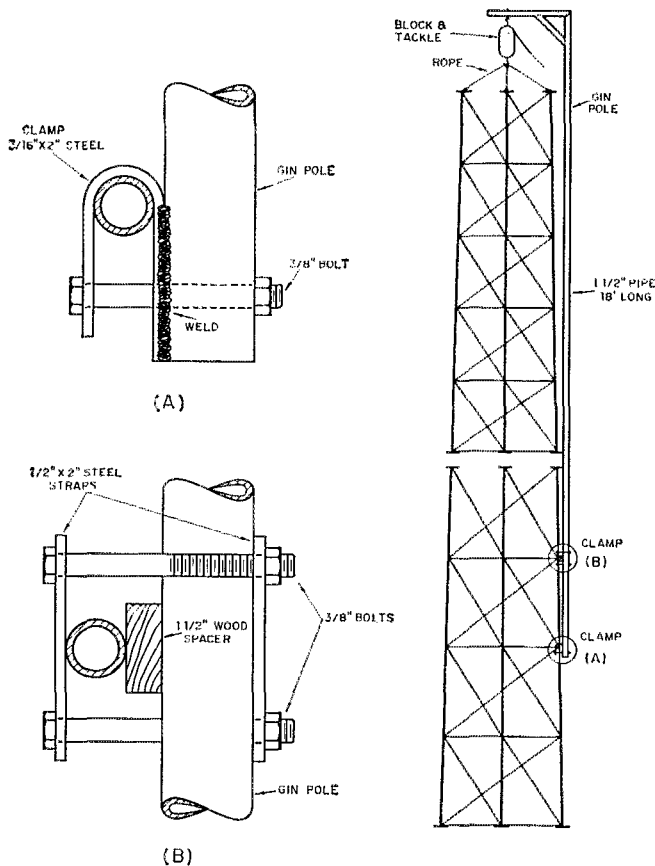

Fig. 4—Method used to assemble the tower. The bottom end of the gin pole is clamped to the bracing members as shown in details A and B. The gin pole is moved up on the tower as sections are added.

all three arrays. The reactance tuning capacitors of the 20- and 15-meter beams are accessible from the top of the tower. To adjust the capacitor on the 10-meter beam, a small 1 r.p.m. motor originally designed to turn a barbecue spit was used. It worked perfectly. A single 52-ohm coax line is used to feed the antennas. Relays at the top of the tower switch the line from one to another.

To those who are interested in cost, the pipe amounted to \$225. Welding required about 40 man hours. While this is not an inexpensive installation, it is cheaper than a comparable manufactured tower. Furthermore, it is exactly what I wanted and I have the assurance that it will stay up—and it's legal. All in all, it was worth the effort. Besides—this is my last tower!

Hamfest Calendar

(Continued from page 10)

in Biloxi. Open house, swap table, bingo and dancing on the twenty-third. Hidden transmitter hunt, mobile rig judging, speakers on the twenty-fourth. Registration is \$1.00. Write to the Biloxi ARC, P.O. Box 1574, Biloxi.

New Jersey—The Central New Jersey VHF Society will hold a hamfest on Sunday, August 24, at Voorhees State Park, Route 513, off Route 69 near Clinton. There will be fixed stations on two and six meters to talk mobiles in. Bring the family and enjoy a good old-fashioned outing. Donations \$1.00 per call. Games and prizes for the children. Facilities for outdoor cooking. Rain date is Sept. 7. Contact Richard Plue, 311 Fairview Ave., Dunellen, N. J.

Pennsylvania—The Third Annual Picnic of the Pack Rats will be held on Sunday, August 10, at Fort Washington State Park, Flourtown. \$1.00 per family. Contact Francis D. Brick, W3SAO, 829 W. Fishers Ave., Philadelphia 41.

Pennsylvania—The third annual ham picnic of the four York County radio clubs will be held at Atland's Ranch, one mile south of U. S. Route 30. 10 miles west of York, on Sunday, August 24. Registration begins at 10:30 a.m. Basket lunch with free soda for the family. Auction, games and prizes. Eastern Pa. phone net meeting is scheduled. Mobile talk-ins on 50.55 Mc., 145.62 Mc., 29.5 Mc., and on 75 meters. Swimming facilities available. Picnic will be held rain or shine. Transportation from nearby York Airport will be arranged if requested in advance. Tickets \$1.00 in advance or \$1.25 at the gate, per ham, including

guests. For further info and tickets, write John Zett, W3FLD, 2740 Grandview Ave., York.

Tennessee—An all-day hamfest will be sponsored by the Frye Amateur Radio Club of Chattanooga on Sunday, August 3, at Warner Park. Plenty of prizes. Total Registration is \$1.00, plus an optional \$1.25 for meal.

Texas—The Central Texas Amateur Radio Club and the XYL Club of Waco are holding their third annual family-style picnic-hamfest on Sunday, August 31, at the Cameron Park Club House. The program begins at 10 A.M. Registration is \$1.50. Transmitter hunts on 75-, 10- and 6 meters. Bring your lunch, or eat at local restaurants. Write to Robert K. Jefferies, W5W1Y, P.O. Box 1032, Waco.

Virginia—The Eighth Annual Hamfest of the Shenandoah Valley Amateur Radio Club and the Blue Ridge YL Club will be held Sunday, August 3, at the Diekey Ridge picnic area, on the Skyline Drive. The picnic area is about four miles south of the Front Royal entrance to the drive. Registration begins at 10 A.M. Registration is \$1.00 total, plus an optional \$1.25 for meal only. Swap tables. Mars meeting. Mobiles check in on 29.2 Mc. or 3835 kc.

West Virginia—The Black Diamond Amateur Radio Club is sponsoring a picnic at Bass Lake Park in Hinton on Sunday, August 31. There is no fee or registration charge.

Alberta—The Northern Alberta Radio Club will sponsor a hamfest in Edmonton on Saturday, August 23 and 24. Banquet, picnic and special events. For further info contact the Northern Alberta RC, Box 163, Edmonton.

British Columbia—The British Columbia DX Club will host Pacific Northwest DXers at its annual convention August 23-24 at the Hotel Grosvenor in Vancouver. Speakers, demonstrations, XYLs welcome. Contact Vic Waters, VE7ALR, 3692 Quessuel Drive, Vancouver 8.

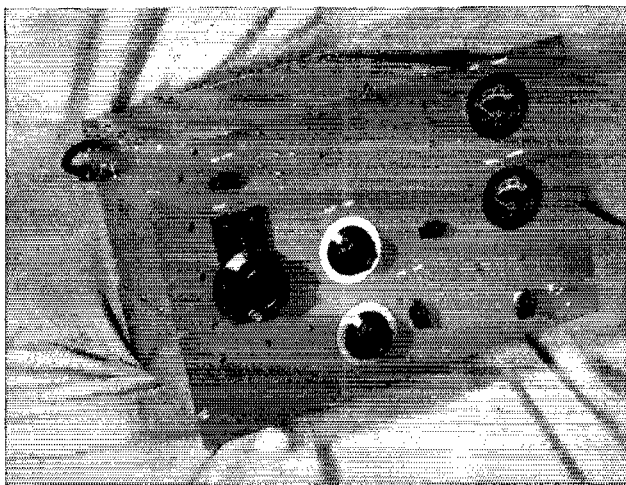

W4SUD's all-purpose 813 amplifier. The output-capacitor switch (coarse loading) is above the turns counter for the variable inductor. Dials near the center are for the plate tank capacitor C_4 (above) and the grid tank capacitor C_1 (below). To the right of the dials are the controls for the plate padder switch S_3 (above) and the grid band switch S_1 (below). The toggle switch below the meters is the mode switch S_4 with the meter switch S_5 to the left. Ventilating holes are drilled in the cover in the area above the tube. The output connector is on the left-hand wall of the shielding box.

An All-Purpose 813 Amplifier

Flexible Unit for C.W., A.M., or S.S.B.

BY R. A. THOMASON,* W4SUD

IN THESE DAYS, the well-equipped amateur, be he traffic man, DXer or rag chewer, must be prepared for c.w., conventional a.m. and s.s.b. In the 813 amplifier shown in the photographs, provision has been made for convenient changing from one mode to another as well as to any of the bands from 80 through 10 meters.

The circuit is shown in Fig. 1. A turret-type grid circuit is used and the output circuit is a pi network designed to work into coax cable. The inductor is the rotary-type variable. Provision for neutralizing is included. R_1 is a parasitic suppressor.

For Class C c.w. or phone operation, S_4 is open. The 90 volts of fixed bias, furnished by a small bias supply and regulated by the VR90, is augmented by a drop of about 50 volts across the grid-leak resistor R_2 at a normal grid current of 15 ma. This brings the total bias to 140 volts. With S_4 closed, the grid leak is short-circuited and the 90 volts of fixed bias alone remains for AB_2 s.s.b. operation. (The author also prefers AB_2 for c.w. operation because it preserves the keying characteristics of the exciter better than with Class C operation.) R_3 should be adjusted so that the VR90 just ignites with no excitation.

Screen voltage is regulated at 750 volts by a string of five 0A2s for s.s.b. operation. When the grid drive is increased for Class C operation, the

*626 Eastwood Drive, Owensboro, Kentucky.

screen current increases, increasing the drop across the screen resistor R_5 , and the screen voltage falls to 400. The regulators then lose control and the amplifier is ready for plate-screen modulation.

The screen is protected against excessive input, should the load or plate voltage be removed, by the overload relay K_1 . The tripping point is set at 40 ma. by the variable shunt resistor R_4 . One meter, M_1 measures cathode current, while the other meter, M_2 , may be switched to read either grid current or screen current.

Forced-air ventilation is always advisable for a medium- or high-power amplifier if it is buttoned up tight to suppress TVI. A surplus 100 c.f.m. blower does the job more than adequately.

Construction

The amplifier is built on a $13 \times 17 \times 4$ -inch aluminum chassis fastened to a standard $12\frac{3}{4} \times 19$ -inch rack panel. The r.f. output portion is enclosed in a $12\frac{1}{2} \times 13 \times 8\frac{1}{2}$ -inch box made of aluminum angle and sheet. The VR tubes, relay, blower and meters are mounted external to the box.

The grid tank-circuit components are mounted underneath the chassis and are shielded with a $5 \times 7 \times 3$ -inch aluminum box. A standard chassis of these dimensions might be substituted. The bias and filament transformers are in a second

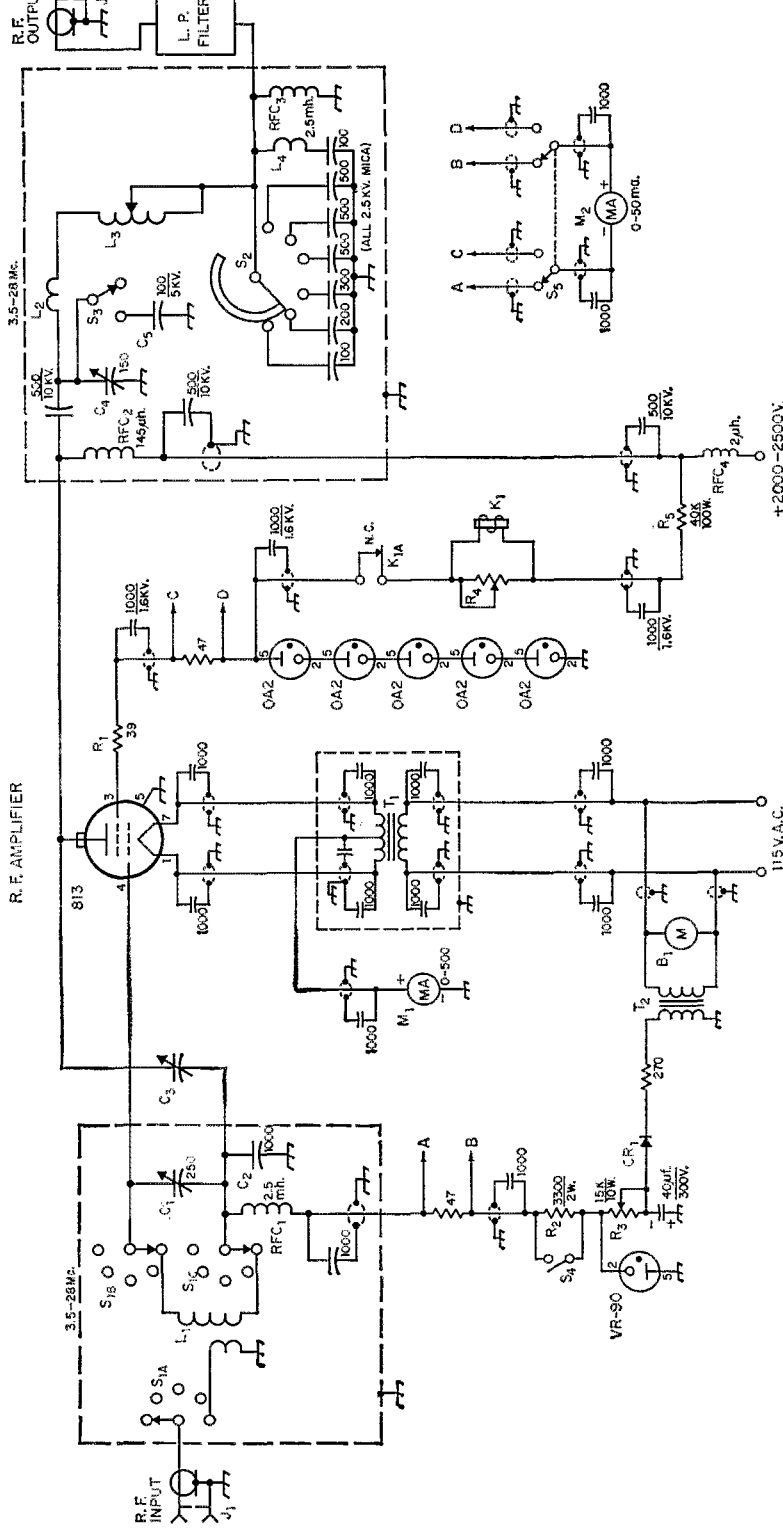
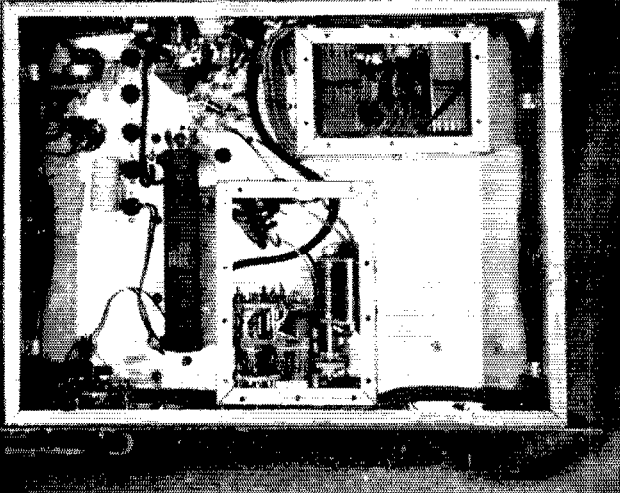

Fig. 1—Circuit of the all-purpose 813 amplifier. Unless otherwise designated, capacitances are in μmf . Capacitors marked with polarity are electrolytic. Other capacitors not listed below should be ceramic. Resistances are in ohms.

- B₁—Ventilating blower, 100 c.f.m. (surplus).
- C₁—250- μmf . variable (Hammarlund MC-250-M).
- C₂—1000- μmf . mica.
- C₃—Neutralizing capacitor, 10 μmf . maximum (Johnson 159-250).
- C₄—150- μmf . 6000-volt variable (Johnson 153-12).
- C₅—100- μmf . 5000-volt fixed capacitor (surplus vacuum, Amperex VC-100, or two 200- μmf . 5000-volt micas in series).
- CR₁—130-volt 50-ma. selenium rectifier.
- J₁, J₂—Coaxial receptacle (SO-239).
- K₁—Screen overload relay, 2500 ohms, 7 ma. (Potter & Brumfield KCP5).
- L₁—3.5 Mc.—32 turns No. 20, 1-inch diam., 2 inches long.
- L₂—5-turn link (B&W 3015 or Airdux 816).
- L₃—7 Mc.—18 turns No. 20, 3/4-inch diam., 1 1/4 inches long.
- L₄—14 Mc.—10 turns No. 18, 3/2-inch diam., 1 1/4 inches long.
- L₅—21 Mc.—7 turns No. 18, 3/2-inch diam., 7/8 inch long.
- L₆—28 Mc.—5 turns No. 18, 3/2-inch diam., 5/8 inch long.
- L₇—1-turn link (B&W 3006 or Airdux 508).
- L₈—3 turns 3/16-inch copper tubing, 1-inch diam., 1 3/4 inches long.
- L₉—15- μh . variable inductor (B&W 3852).
- L₁₀—See text.
- M₁, M₂—3 1/2-inch d.c. milliammeter.
- R₁—39 ohms, 1/2-watt carbon.
- R₂—3300 ohms, 2 watts.
- R₃—15,000 ohms, 1-inch with slider.
- R₄—2000-ohm 4-watt variable resistor (Mallory M2MPK).
- RFC₁, RFC₂—2.5-mh. r.f. choke (National R-50 or similar).
- RFC₃—Plate r.f. choke (National R-175-A).
- RFC₄—V.h.f. choke (National R-60).
- S₁—Rotary switch: 3 wafers, 3 poles, 11 positions per pole, 5 positions used (Centralab PA-O wafers, PA-301 index).
- S₂—Rotary switch: single pole, 10 positions, progressively shorting, 6 positions used (Centralab PA-2042).
- S₃—Rotary switch: s.p.s.t., ceramic (antenna link switch from BC-375 tuning unit, or Communications Products Model 65).
- S₄—S.p.s.t. toggle switch.
- S₅—D.p.d.t. rotary switch (Centralab 1405).
- T₁—Filament transformer: 10 volts, 5 amp. (Thoradson 21F18).
- T₂—Bias transformer: 120 volts, 50 ma.; 6.3 volts, 2 amp., filament winding not used; could be used for pilot light (Merit P-3045).



Bottom view of the all-purpose 813 amplifier. The grid tank-circuit components within dashed lines in Fig. 1 are enclosed in the box at lower center. Input links are wound over ground ends of grid coils. Filament and bias transformers are in the second box. The large resistor to the left of the grid box is the screen resistor. The variable resistor in the upper left-hand corner is the relay shunt R_4 . The selenium bias rectifier is fastened against the left-hand wall of the chassis.

box measuring 6 by 3 by 3 inches. This type of construction, together with the use of shielded wire for all power circuits, was followed to reduce TVI to a minimum. Each wire was bypassed at both ends with 0.001- μ f. ceramic disk capacitors. L_4 can be adjusted to series resonate with the 600- μ f. capacitor at the frequency of the most troublesome channel. A Bud low-pass filter completes the TVI-treatment. As a result, the amplifier is completely free of TVI on all channels even in this fringe area.

Adjustment

In the pi network, the output capacitors are fixed. However, the adjustment of the network is similar to that of the more conventional arrangement using a variable portion of the output capacitance. The only difference is that the "fine" loading adjustment is done with the variable inductor.

The inductor is fitted with a Groth turns

counter, making it easy to return to the proper setting for each band. Until the settings for each band have been found, S_2 should be turned so that all of the output capacitance is in circuit. The inductor should be set near maximum for 80, and approximately half maximum for 40. On the higher-frequency bands, the inductor should be set so that the circuit resonates with the tank capacitor near minimum capacitance. Loading should increase as the output capacitance is decreased. A change in output capacitance will require a readjustment of C_4 for resonance. When the loading is near the desired point, final adjustment can be made by altering the inductance slightly.

A 20-A or similar exciter is well suited as a driver for this amplifier on all modes. The 813 runs cool at 500 watts input on a.m. and c.w. and at 1000 watts p.e.p. on s.s.b. I believe it is a good compromise between the full legal limit and low cost.

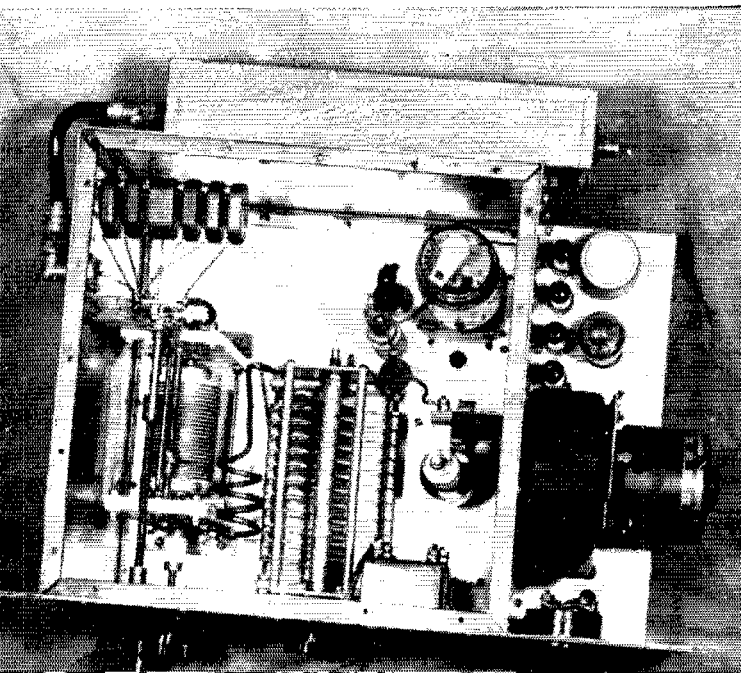

This view shows the placement of components on the chassis. The 813 socket is mounted on spacers over a large clearance hole in the chassis. The several mica output capacitors are assembled in a stack on a threaded rod fastened to the left-hand wall of the shielding box. The neutralizing capacitor and the 80-meter plate padds are to the right of the tank capacitor. To the right of the box are the five 0A2s (the front one hidden), the screen overload relay and the VR90, the blower and meters.

A Directional Coupler for 144 Mc.

Reliable S.W.R. Measurement at Low Cost

WITH MORE and more antennas being fed with coax, a reliable means of measuring standing-wave ratio and power in the transmission line is a must if we are to achieve optimum antenna and loading adjustment. This is particularly true at 50 Mc. and higher, yet few of the devices that can be bought or built for these purposes are reliable for v.h.f. service. V.h.f. men who want to be sure that their equipment is working in tip-top order will be interested in the experience of W3GKP reported below.

For some time Bill had been unhappy about the state of the amateur art as regards standing-wave indicators for v.h.f. use. Most of the circuits in the *Handbook* and other amateur literature are not well suited for use above 30 or 54 Mc. He did not try any of the lumped-constant circuits involving reactive components or potentiometers, because of pessimism regarding the outcome.

Lumped circuits using only resistors, as in the bridge shown in Figs. 21-36, 21-33 and 21-35 in the '56, '57 and '58 editions of the *Handbook* respectively, can be used at 144 Mc., provided the equipment is built with more attention to v.h.f. requirements than is shown in the *Handbook* examples. For several years W3GKP used such a bridge, built by and on "permanent loan" from W3GZQ. In this the standard R_n is built into a coaxial plug and connected into circuit by a connector of the same type as is used for the unknown. The W3GZQ version is symmetrical electrically and mechanically, and it works much better at 144 Mc. than a 75-ohm model copied from the *Handbook*.

The standard supplied with it consists of a 47-ohm $\frac{1}{2}$ -watt resistor filed to 51 ohms, mounted in a PL-259A plug with the shortest possible leads. As a check W3GKP made another standard, selecting a resistor that matched the original at d.c. and mounting it in the same manner. When these are checked against each other on the bridge, a detectable but negligible reading is obtained. With the aid of laboratory equipment Bill then compared both standards with a General Radio 874-WM 50-ohm termination. With either standard a negligible reading was obtained, demonstrating the worth of the bridge as a device for adjusting antennas. But something that could be driven by the transmitter, and left in the circuit at all times, was desired. This led to an investigation of the directional coupler shown symbolically in Fig. 1.

As seen at A, a directional coupler is a 4-terminal device having the property that most of the power introduced at Arm 1 is delivered to Arm 2, except for a small sample that is delivered to Arm 4. There is no output from Arm 3, unless power is introduced at or reflected from Arms 2 or 4. Such devices can be constructed using

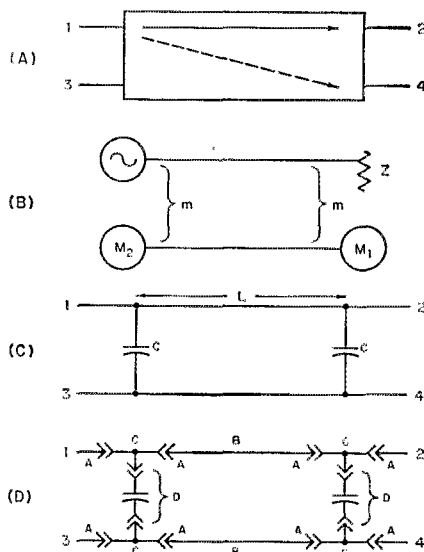

Fig. 1—Development of the 144-Mc. directional coupler. Basic idea of the bridge is shown at A. Mutual coupling, m , between main and side lines, limits directivity (B). Maximum directivity in bridge made of coaxial lines (C) is obtained by introducing coupling capacitances at points so that L is $\frac{1}{4}$ wavelength. Bridge made up from standard coaxial fittings is shown schematically at D.

lumped circuit elements, coaxial cable, waveguide, or combinations of these.

A coaxial version might appear as shown at B, which is intended to portray only the inner conductors. Most of the power flows down the main line to the load, Z . A small portion is coupled by m to the side line, and meter M_1 gives a reading proportional to the power flowing toward the load. If the main line is terminated properly by Z , M_2 will read zero; otherwise it will give a reading proportional to the power reflected by Z . If the generator is a transmitter and Z is an antenna, the ratio of the power readings at M_1 and M_2 is a measure of the standing-wave ratio, and the difference between the power readings is proportional to the power delivered to the antenna. It should be mentioned that this happy state of affairs results only when Arms 3 and 4 are terminated in matched impedances. This places some special requirements on the indicating devices, M_1 and M_2 .

The ratio of power delivered to Arm 2 to that delivered to Arm 4 is termed the coupling. Due to unavoidable variations in the construction of the device, some power may be delivered to Arm 3, even when Arm 2 is properly matched. The ratio of the power to Arm 4 to that to Arm 3, when Arms 2 and 3 are matched, is termed the

directivity. Both the coupling and the directivity may be expressed in decibels. Ideally the directivity should be infinite. Reverting to 1B, the coupling, m , between the main and side lines may be effected at two or more discrete points or distributed over some distance. In addition, it may be inductive, capacitive, resistive, or combinations of these.

Fig. 1-C shows a directional coupler made of coaxial cables, coupled by capacitors, C . If the distance L between coupling points is $\frac{1}{4}$ wavelength, and the capacitors are equal, the coupler should perform as described. Fig. 1-D shows a fairly practical form, which can be constructed using standard fittings. In this sketch, A are PL259 plugs, B lengths of RG-8/U cable, C M-358 T fittings, and D modified PL-258 junctions.

The PL-258 junctions (he used Amphenol 83-1J) were modified to form a capacitive rather than a direct connection. Examination of one of these will show that its innards are retained by a spring C-ring at one end. If a hacksaw cut is made into the body opposite the gap in the ring, in the plane of the longitudinal axis and at about 45 degrees to the transverse axis, the ring will pop out intact when encountered by the saw blade. The insides can be poured out neatly. If the cut is made into the opening of the C ring, its removal can be effected with a scriber. Parts are the C-ring, two insulating beads and a double female contact. The contact has two flanges near the center, which prevent it from falling out through the holes in the beads. W3GKP cut the contact in half between the flanges, filed the rough ends until he had a smooth flat surface extending over the entire area of the flange, and cemented the two contact pieces back together, with a bit of insulation between.

The smoothing can be done nicely by chucking the contact in a drill press and bringing it down on a flat file. The insulation used was transparent plastic 1/16 inch thick, cut from the lid of a small

parts box. This was coated with GC cement, and the assembly clamped lightly in a vise to assure a uniform film thickness. After it dried, the plastic was filed down even with the metal, and the whole assembly coated with cement. It was found that this would stand having a plug inserted, but not removed, so when it is finished the T-fittings should be attached and left on.

On the first attempt W3GKP used RG-8/U cables having a tip-to-tip length of $12\frac{3}{4}$ inches when completed. These gave maximum directivity at 121 Mc. The next attempt to hit 144 Mc. was made with cables $10\frac{5}{8}$ inches long. For testing, Arm 1 was driven with a General Radio 1021 generator, the attenuator of which was adjusted to a suitable level and left fixed. The output from each of the other arms was measured with the following GR equipment: an 874 20-db. pad for matching, an 874-MR mixer, a 1216 i.f. amplifier, and 1215 oscillator. Relative output was read from the i.f., which is calibrated. The unused arms were terminated in 874-WM 50-ohm loads. Fig. 2 shows how the coupling and directivity varied with frequency.

This looked like a usable device. With a coupling of 33 db., 1 kilowatt at 144 Mc. in the main line would result in $\frac{1}{2}$ watt in the side line, indicating that the device should be usable with amateur power levels with a simple terminating resistor. Lower coupling might be useful for low-power operation. While best directivity was obtained at or slightly below the low end, it looked good enough over the entire 144-148-Mc. range.

The computed relationship between s.w.r. and apparent directivity for an ideal coupler is shown in Fig. 3. Judging from this, a directivity of 20 db. would result in an s.w.r. error of 1.2:1. By shooting for a null it should be possible to adjust an antenna system to less than 1.5:1. The points indicated by X's in Fig. 3 show the directivity measured for various standing-wave ratios. The 2:1 point was obtained by paralleling two 874-

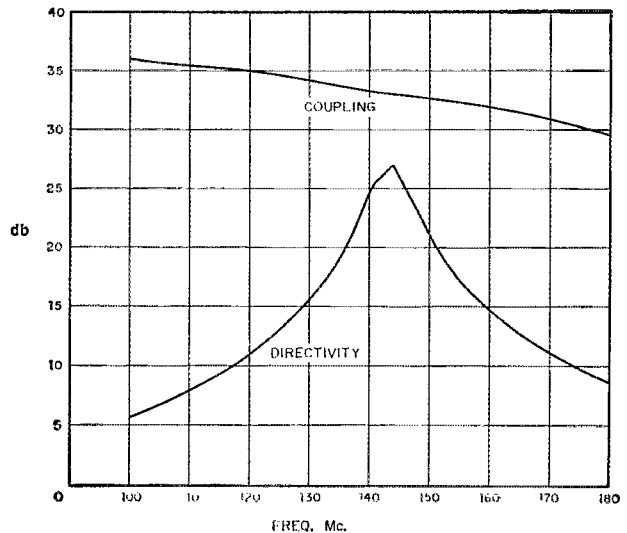

Fig. 2—Coupling and directivity of the 144-Mc. bridge, as measured with laboratory-type equipment by W3GKP.

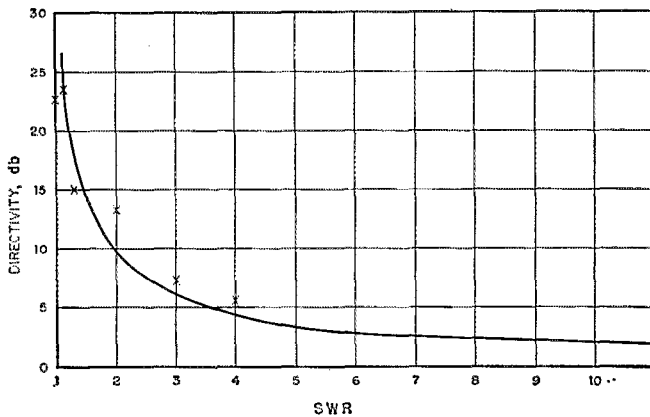

Fig. 3—Computed relationship between s.w.r. and apparent directivity in an ideal coupler. Points indicated by X show measured directivity.

WM units on an 874-T fitting. Ratios of 3:1 and 4:1 were obtained by shunting this with the home-made standards. A single 874-WM was used for 1:1. For 1.2 and 1.25, an open- and short-circuited 874 10-db. pad was used. A plot of the same points, in different form, is shown in Fig. 4, along with the open- and short-circuit points, both of which read well under 1 db. The solid curve is intended to show the variation expected, and it looks as if the coupler favors something under 50 ohms.

The standard resistors used with W3GZQ's bridge were checked, and it was found that his read about 17 db. and Bill's about 22 db. At this point the pin in the plug came loose and broke the resistor lead, so another had to be made. Using the coupler, quite a few resistors were tried. Nominal 47-ohm resistors were consistently better than 33- or 56-ohm units. Most 47-ohm resistors read 20 db. or better.¹ It was found that the match could be improved by surrounding the resistor with a shield connected to the ground terminal. Using this procedure, another standard was made which read 26.5 db., which is as good as the coupler. A further check was made with Arm 2 loaded with a Bird wattmeter, a reasonably good termination over the range from 30 to 500 Mc. The directivity was similar to the curve of Fig. 2.

The next step was to construct a voltmeter

which would present the proper termination to the side line. The best arrangement evolved to date is shown in Fig. 5. The 500- μ mf. silver-mica capacitor is the smallest physically made by Elmenco. The resistor is selected for best match. Final adjustment was made with the 1N34A crystal diode loaded with the meter, by dressing the 800- μ mf. disk ceramic toward or away from the hot end of the rectifier. Two of these were made which, when checked on Arm 2 of the coupler, showed directivities of 28 and 23 db. Since Arm 4 is more critical than Arm 3, the 28-db. unit is used at Arm 4.

Figuring that the diode should have a constant load on it, Bill made up some constant-resistance pads for full-scale ranges of 200, 500 and 1000 microamperes, in addition to the basic 100-microampere range. These were put together in a hurry from standard resistors, and no attempt was made to get the loss just right. The coupler was then driven with the 144-Mc. transmitter, and terminated in the Bird wattmeter. The diode terminating units were attached to Arms 3 and 4.

¹ Presumably the impedance of the main line is lowered by the coupling capacitors to the point where it works best at 46 ohms or so. This may explain the good luck with 47-ohm resistors. If true, this is an argument for looser coupling, or possibly for use of higher-impedance coax in the main line section. It would not be too difficult to experiment with hand-made coaxial sections having impedances between about 55 and 60 ohms.

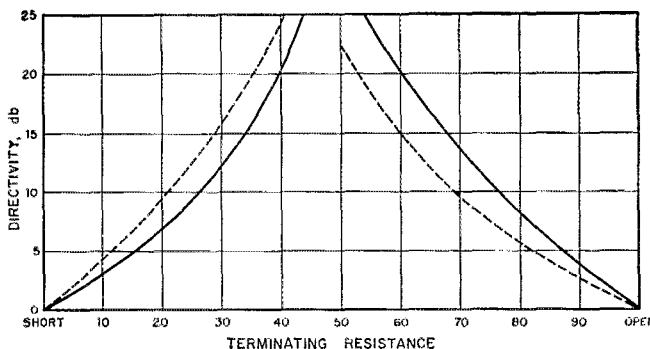

Fig. 4—Directivity for various terminations. Solid line shows expected variation.

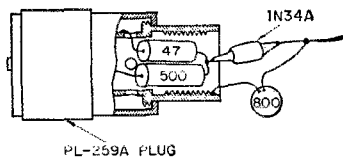
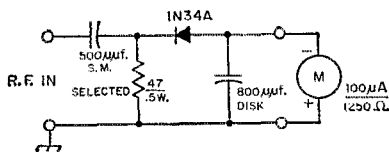

Fig. 5—Schematic diagram and mechanical arrangement of voltmeter.

The power was varied, and the forward diode was calibrated. Arms 1 and 2 were reversed to calibrate the reverse diode, the resulting curve leaving something to be desired. A step at about 20 watts was due to a change in scale on the wattmeter, and other steps showed up as a result of lack of agreement between the microammeter pads.

Subsequently a proper switch box was made, containing the 100-microampere meter and a

group of pads, giving 100, 200, 500, 1000, 2000 and 5000 microamperes full scale. These present constant resistances to both diodes, and are constructed with selected resistors. Duplicate positions are provided for "forward" and "reverse." This was calibrated against the Bird wattmeter, taking care to eliminate the step at 20 watts, by reference to the manufacturer's calibration sheet for this particular meter. Fig. 6 is the result.

When the transmitter was fed through the coupler into the station antenna, there resulted currents of 330 microamperes (38 watts) forward, and 30 microamperes (1 watt) reverse, for an indicated directivity of 16 db., and an s.w.r. of 1.35:1. Using the forward-power indication, adjustments were made on the 829B amplifier, which brought the output from 38 watts up to 55, with an input of 120 watts.

The coupler has been left in the line continuously since it was completed some months ago, and Bill says that he wouldn't know how to get along without it. In rainy weather, for example, when a diode voltmeter on the transmission line gives abnormally high or low readings, the directional coupler indicates only slightly increased forward and reverse power. The net power to the line remains unchanged.

—E.P.T.

Fig. 6—Forward and reverse calibrations of the final form of the directional coupler.

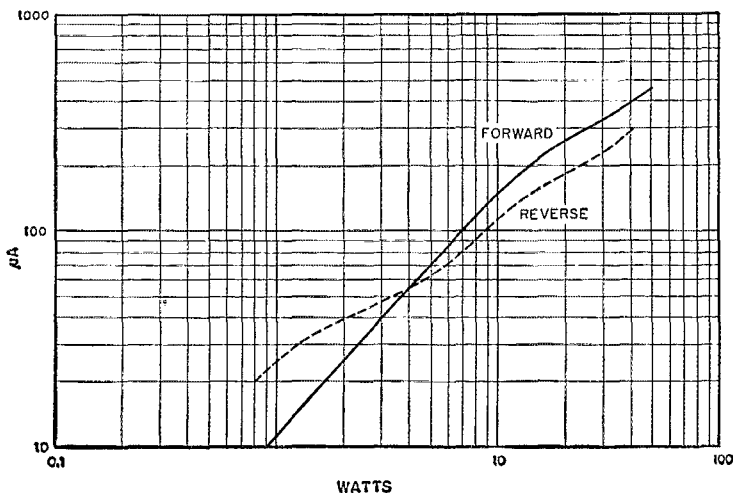

Strays

If you didn't hear the signals from the various earth satellites put up last year and early this year and want to know what they sounded like, there is an interesting recording now available from Taben Recordings, Box 224E, Ardmore, Pa. Prepared by Tom Benham, W3DD, of Haverford College, the recording not only has samples of signals from the first five successful satellites but has a running commentary by Prof. Benham on

the characteristics of the "birds" and interpretation of the transmissions. The price is \$3.95 for either a 4-inch reel of magnetic tape (2 tracks) or a 10-inch LP disk.

.....

We have new claimants for the longest QSO of record. K4MVF and K4THQ talked on six meters for 30 hours and 30 minutes.



REMEMBER the ARRL-IGY Propagation Research Project?¹ You may not have seen very much about it lately in the pages of *QST*, but this doesn't mean that nothing's been going on. Far from it! PRP's hard core of some 550 amateur observers representing nearly 50 countries has been sending in semimonthly v.h.f.

activity reports — many of them ever since we kicked off on January 1, 1957 — in a way that is a real credit to the ham tradition.

No matter what the propagation conditions — bad, calling for a discouraging string of negative reports, or good, meaning long lists of calls worked and heard — we have been able to count on reporting that is both regular and enthusiastic. In fact, we get the impression that some observers blame themselves somehow whenever conditions aren't all that they might be and the log is a short one! Sickness doesn't usually keep PRPers from their appointed task, either, whether it be the sort of sudden "cold" which has kept many a v.h.f. man home from work when the band was wide open, or even a stay in the hospital. Equipped with a portable ham setup by friends, K8CIC kept up his reporting while in the latter situation. One note on his log said he wasn't "too sure about some of these times as was under ether!"

The chief task of PRP observers, of course, is to supply us with reports of the ionospheric DX which they work and hear on the bands above 50 Mc. This information, after some processing, is fed to the International Geophysical Year data centers, and will be available to scientists in all the IGY countries. In addition to these worked and heard reports, we are collecting "negative" reports. These are just what the name implies — reports of the specific times when the reporter

* ARRL-IGY Project Supervisor.

¹ Southworth, "The ARRL-IGY Propagation Research Project," *QST*, Sept., 1956.

² Southworth, "PRP — A Progress Report," *QST*, Apr., 1957.

Another Peek at PRP

ARRL's IGY Propagation Research Project in High Gear

BY
MASON P. SOUTHWORTH,* W1V1LH

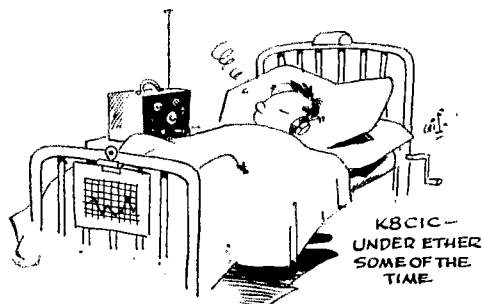

was active but observed nothing. Then, too, there are several stations that have been making continuous or "beacon" transmissions for the benefit of other hams. W5FHS, working with a group of hams all employed by the United Gas Corporation of Shreveport, La., went so far as to obtain permission to use company property to put a 24-hour-per-day, unattended beacon on the six-meter band. Fifty-Mc. enthusiasts owe this group a special debt for their continuing efforts to keep this signal on the air. WIREZ and W4FJ have contributed notably in scheduled 144-Mc. transmissions, and there are many others who are helping whenever they can.

Data Processing

Things haven't stood still at PRP Headquarters, either. For one thing, all that we talked about in the future tense a year ago can now be put in the present or past. Report evaluation, coding, and transcription — the first operations performed on the incoming logs — are well in hand and up to date. (At least they're up to 1½ months behind the present, which is about as close as overseas mail deliveries allow. For this reason, "now" at the PRP office is usually about 45 days ago.) During evaluation, each individual item on each report is examined for propagation type and accuracy as far as possible. The entries surviving this check (those listing ionospheric propagation plus the "nil" and beacon reports) are transcribed onto special forms. In this step, many of the data are coded, and all are arranged in a systematic form suitable for punched card presentation.

Before punching any cards, two more items of information are added to the sheets for each heard and worked report. These are the latitude and longitude coordinates of both stations. It has turned out that to keep track of the geographical locations of essentially all the v.h.f. hams in the world has been quite a project in its own right. Mrs. Jane DeFranco, who handles the PRP coordinate file, is convinced that amateurs are nomadic mountain goats who wander from one hilltop to another! A second problem has to do with stations which can't be located in our atlas collection or on any of our charts; what's the most polite way to write to a fellow and tell him he isn't on the map? In any event, our coordinate file has provided a fine testimonial to the widespread interest in v.h.f. Not only is it bigger

than we expected, but it's still growing.

Now at last we're ready to make some punched cards. This is handled by a handy-dandy little IBM machine with Mrs. Hazel Horan at the controls. Each worked, heard, negative and beacon report rates a card of its own, each one listing all the pertinent information such as date, beginning and ending times, calls and coordinates of the stations, antenna bearings, signal report, type of propagation and type of report. As you might imagine, these cards run to quite a volume, reaching as high as 30,000 per month during the sporadic-E season. All must, of course, be verified as well as punched.

After each month's cards are complete, we sort them out according to report and propagation type and put them into chronological order. This isn't quite the job it sounds, because we have a sorting machine that runs cards through at the rate of 650 each minute. Another job done at this point is to examine all the "worked" cards and pair up those that report the same contact (where both stations are PRP observers). This not only cuts down duplication in the results, but lends further confirmation to the doubly reported items.

Now the cards are ready for a trip to Boston, Mass., where the Air Force Cambridge Research Center puts them through its digital computer. The station coordinates already on the cards are used here to compute the distance between stations and sometimes the coordinates of the path midpoint. These items go into spaces reserved for them on the original cards, as well as onto a new duplicate card deck which is prepared. Another machine takes one of these card decks and automatically makes up a listing of all the information it contains. It is these listings which, at present, are being sent to the IGY world-wide data exchange centers.

Results

The question "What have you learned from all this?" is sometimes asked, and it is a little hard to answer without seeming to hedge. Actually, the IGY is primarily a period of data collection and reduction, not one of detailed study. The time for this will be the years to come . . . quite a few of the years to come, judging by all the information now being gathered. So we don't feel too bad about saying that this is the way it is in



our case. Like the IGY projects in other fields, we're concentrating on collecting and processing.

What does PRP hope to achieve eventually? In brief, our aim is to (a) document v.h.f. amateur observations in a (b) manner which lends itself to scientific study. We feel that (a) and (b) are equally important. Gathering the data is obviously necessary, and this is where the hundreds of PRP observers come in, but putting what you gather into a useful form (and one which *will* be used) is also vital. Therein lies the reason for the use of modern punched-card tabulating techniques with a card layout designed to permit the extraction of a maximum amount of data. We aim to make PRP data not only available, but available in a form which will insure its use. Our extremely detailed records of auroral and sporadic-E openings, for example, can readily be checked and compared with the data taken by other IGY projects. Our F_2 skip m.u.f. observations can and will provide some very interesting correlations with the predicted values and those measured at the (relatively speaking) handful of professional observation points.

A good deal of emphasis has been placed on transequatorial scatter propagation. Not only did "TE" start the powers that be thinking about sponsoring an amateur program such as ours, but this mode shows promise of being one of the most interesting and controversial things in the propagation field. Prior to early 1957, everyone thought of TE as being something unique to Central and South America. After all, it was there that all of the long, north-south evening contacts had been made. Since then, however, PRP with the help of its observers has demonstrated that TE works just as well between Africa and southern Europe and Australia and Japan. The latter path has even been termed "monotonously consistent" by one observer. Comparison of data for these various parts of the world should be of great help in solving the TE riddle, especially since the only professional IGY stations studying this phenomenon are in South America. There also may be some connection between TE and the very long distance contacts such as Japan to South America. This is the impression one gets from scanning the PRP logs during such openings. Later and further study will be most interesting here, also.

The three NBS-CRPL beacon stations³

³ Bowles and Cohen, "N.B.S. Equatorial Region V.H.F. Scatter Research Program for the IGY." *QST*, Aug., 1957.

(CESAE, OA3AAE and OA3AAF) have certainly done their part to make PRP reports interesting. These stations have been audible at times and in places (particularly in the U. S.) which are at some variance with South American amateur results. Furthermore, the many ways in which they are received (strong and steady, weak and steady, weak and fluttering, alternately fluttering and steady) add spice to the puzzle. Here again we have much to learn, and PRP data can and will expedite that learning.

Observers Still Needed

One nice thing about PRP observing is that it doesn't interfere with your operating habits. Log sheets are provided on which to report, and they act as guides to insure our getting the required information. Beyond this, you are free to follow your inclinations. If working stations is your goal, we certainly want those worked reports. If you just like to listen, we are glad to receive all the heard reports you can supply. If you seldom hear anything (which we hope isn't the case) we'd like your negative reports. In fact, even if you don't like to listen, let alone operate (why are you a ham, then?), you could run a beacon station for us!

For these reasons and others, only a very few stations have dropped out of PRP once they actually began to report. We must admit, however, that the number of reporting stations has been something of a disappointment compared with the amount of v.h.f. activity today. While there are enough fellows actively participating to do an adequate job, all right, there might well be more. A goodly number have been content to receive our monthly *PRP News* for free and let their more enthusiastic brethren do the reporting. This doesn't seem quite fair, so a warning has gone out that stations never heard from will be dropped from our mailing list. This in turn will make room for new — and, we hope, more active — PRPers during the final months of the IGY. There's time left, by the way, to earn one of our handsome PRP Consistent Reporting Award certificates!

How about you? If you're on v.h.f. and willing to help out PRP we'll be more than happy to send you our monthly *News*. Even more important, you'll be doing something for the IGY and for amateur radio. Our address is: ARRL-IGY PRP, 530 Silas Deane Highway, Wethersfield, Connecticut, U. S. A. Why not send us your name right now?

Strays

GB3ENT will be on the air on August 4, operating from the annual Show and Sports exhibition which is arranged as a part of the August Bank Holiday. Special QSLs will be issued.

— . . . —
On about the second of June a Collins 75A-3

receiver, serial number 193, was stolen from the ham shack of the MIT Radio Society in Cambridge, Mass. The receiver was badly in need of repair. Any information on this receiver should be addressed to Harold G. Fritz, Secretary, MIT Radio Society, Cambridge, Mass.

• Recent Equipment—

The Viking Courier

THE Viking Courier is an r.f. amplifier using a pair of neutralized 811-As, and covering a continuous frequency range of 3.5 through 30 Mc. in four overlapping segments. The package, which includes power supply, measures only 15 inches wide, $11\frac{5}{16}$ inches deep and 9 inches high. Its 58 lbs. however, tells you that it must be out of the low-power class. A c.w. man or sidebander can push the input to 500 watts (p.e.p. on s.s.b.). Anyone having a flea-power a.m. rig can boost his carrier output to 65 or 75 watts using the Courier as an a.m. linear.

Circuit

The grid circuit is a conventional balanced-tank arrangement using a split-stator tuning capacitor. A double-gang rotary switch (the only band switch in the unit) shorts turns at both ends of the tank coil to reach the higher frequencies. Since the two 811-As are in parallel across one half of the tank circuit, a small fixed capacitance is connected across the other half to compensate for the input capacitance of the tubes. A single coupling link coil serves for all bands.

In the pi-network output circuit, the tank (input) capacitor and rotary variable inductor are ganged to a single control. The tuning range is continuous: thus no switching. The loading (output) capacitance is supplied by a 700- μ mf. variable capacitor and a bank of fixed capacitors that may be switched in parallel with the variable to total a capacitance of over 4000 μ mf. This network will feed loads ranging from 18 to 600 ohms on 3.5 Mc. if the s.w.r. does not exceed 3 to 1. At 7 Mc. and higher, the range increases to cover

load resistances from 20 to 2000 ohms.

It is apparent that the designers have gone to considerable care to assure parasitic-free operation. There are v.h.f. suppressors in each of the plate leads, each of the grid leads and one in the plate side of the neutralizing-capacitor lead. A resistor across the grid-circuit r.f. choke takes care of low-frequency parasites.

Power Supply

The high-voltage supply uses a pair of 866-As and delivers approximately 1500 volts at 350 ma. The input choke of the single-section filter is connected between the plate-transformer center tap and ground, placing it in the negative side of the output. The filter capacitance is made up of five 80- μ f. 450-volt electrolytics in series.

A low-voltage winding on the filament transformer and a selenium rectifier supply about 95 volts of fixed bias. A rotary switch selects the proper biasing system for Class B or Class C operation. The same switch also transfers the meter to show either grid current or cathode current. This is accomplished in four switch positions — two for Class B and two for Class C.

Those who have operated r.f. amplifiers not biased to plate-current cut-off are familiar with the noise that such amplifiers generate in break-in operation with plate voltage applied continuously. This noise is apt to be bothersome when a t.r. switch is used. The problem is overcome in the Courier by an arrangement that permits applying cut-off bias to the amplifier during stand-by periods. This is accomplished through two terminals at the rear of the transmitter.

The Viking Courier is a compact package. The power supply is to the right and the r.f. section to the left. The rotary inductor is below the tank capacitor (right), and a ventilating fan is below the variable output capacitor (left). The separate 10-meter coil can be seen between the two 811-As in the foreground. The small coils around resistors in the plate leads and the larger one near the neutralizing capacitor are parasitic suppressors.

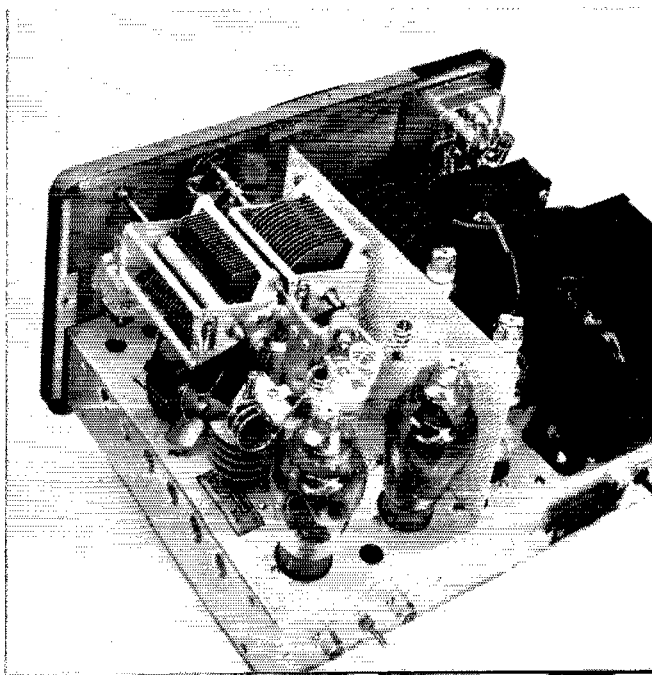

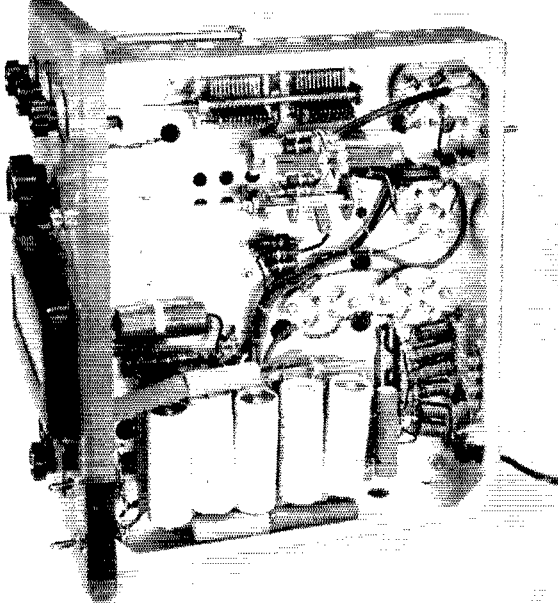

Bottom view of the Courier. The grid tank capacitor, coil and switch are at the top, filter capacitors at the bottom. The coils in the lower right-hand corner are in the TVI filters.

The biasing arrangement is shown in Fig. 1. With Terminals A and B shorted, and S_1 (a pole of the mode-meter switch) closed, the d.c. grid return is grounded for zero-bias Class B operation. When the short is removed from Terminals A and B during stand-by periods, the full 95 volts from the bias supply is applied to the grids, cutting off plate current completely. A switch may be used to short the terminals, or it may be done with a relay tied in with the transmit-receive control system. Cutting off plate current during stand-by periods also increases tube life.

For Class C e.w. operation, A and B are shorted permanently and S_1 is opened. This inserts the grid leak R_1 . Also, the voltage divider consisting of R_1 and R_2 applies 10 to 14 volts of bias which is sufficient to cut off plate current when the key is open.

As in some of the other Johnson transmitting units, terminals are provided for connecting a remote switch to control the high-voltage supply, and to operate an external antenna relay simul-

taneously with the plate power switch.

All power wiring is shielded and all power leads that leave the chassis, including leads to the meter and panel lamps, are fitted with v.h.f. TVI filters. The complete unit is shielded by the standard Johnson one-piece perforated metal cabinet, and the seam between the cabinet and panel is sealed with electronic weatherstripping. A small fan that comes on with the filament and bias supplies keeps the unit at comfortable temperature.

Driver Requirements

Class C e.w. operation requires a driver delivering about 50 watts. At some sacrifice in output, the Courier can also be operated as a Class B e.w. amplifier with a driving power of 25 to 30 watts. However, when this is done, break-in operation may not be too convenient, since it may be necessary to provide for opening Terminals A and B, Fig. 1 (or for turning off the high-voltage supply) during stand-by periods. This noise may not be a serious factor if a separate receiving antenna, or an antenna relay, rather than a t.r. switch, is used. A p.e.p. driving power of 15 to 20 watts is required for s.s.b. operation.

The instruction manual is quite complete in details of operation of the Courier with various driving units, particularly for the lower-power units in the Johnson line. There is also a good section on neutralizing triodes. — *D. H. M.*

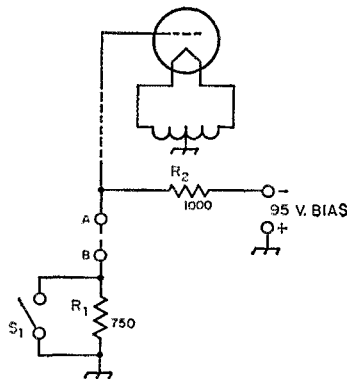

Fig. 1—Essentials of the Courier biasing system discussed in the text. A and B are terminals at the rear of the unit. S_1 is part of the mode-meter switch. R_1 is the grid leak used in Class C e.w. operation.

The Hammarlund HQ-110

COMMUNICATIONS receivers are not all alike. One of the newer models with its full share of innovations is the Hammarlund HQ-110. Second item in the all-new Hammarlund line that began with the HQ-100,¹ the 110 is an amateur-band double-conversion job in the medium-price range.

¹"The Hammarlund HQ-100"—Recent Equipment, Jan. 1957, QST.

It has calibrated tuning ranges for 160, 80, 40, 20, 15, 10 and 6 meters.

After the first quick look, one's reaction is likely to be "What is a ham-hands-only receiver doing with two dials?" And even after you've operated the 110 for a few hours, you're likely to reach for that right-hand knob for bandspread tuning. But it isn't a tuning knob, old man —

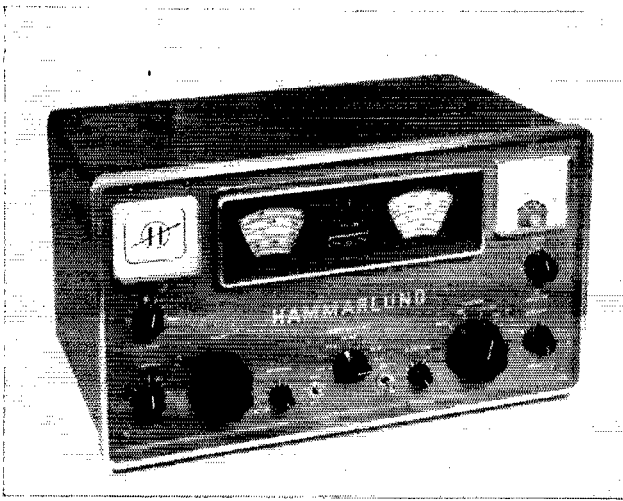

The Hammarlund HQ-110 is probably the first amateur-bands-only receiver to be equipped with two dials. Reasons are given in the text.

it's the function switch. Even though there are two dial windows, all the tuning is done with the knob on the left side of bandswitch.

Those two dials require a bit more discussion. The tuning capacitor is turned through a smooth-running friction-drive dial (left side of the panel) which is calibrated for the 160-, 80-, 40-, and 20-meter bands. Now, to that other window. In back of it is another dial, cable-driven from the first one. This second dial has calibrated ranges for 15, 10 and 6, plus a 0-100 logging scale. This rather neat trick results in dial readability far exceeding that obtainable with any simple single dial having 8 scales.

Each division on the 160-meter scale indicates 2 kc. On 80, 40, 10 and 15 each represents 5 kc. The 10-meter range has 20 kc. per dial marking, and the 50-Mc. range 50 kc. Because the spacing

of the marks is considerable, and the dial is easily read, the frequency can be read much closer than the above increments would indicate. Accurate frequency logging is made possible through the use of the built-in 100-kc. crystal calibrator and movable cross-hairs on both dials. These are manipulated by means of a "calibration set" knob in the middle of the recessed portion of the panel containing the dial openings.

Receiver controls are conveniently arranged, though they take some getting used to. Reading from upper left down around the U arrangement, they are c.w. pitch, antenna trimmer, tuning, sensitivity, manual-a.v.c. (toggle switch), band-switch, limiter on-off (toggle switch), audio gain, function switch, and *Q*-multiplier selectivity and frequency controls. The S-meter is at the upper right. In the corresponding spot at the left side

Interior view of the 110. Switched coils in the r.f. portion of the receiver occupy the center of the chassis, with the tuning capacitor at the right. Black discs above the dials bear against the celluloid dial scales and keep them spaced a constant distance from the dial windows. Rear wall has socket for remote control of the transmitter.

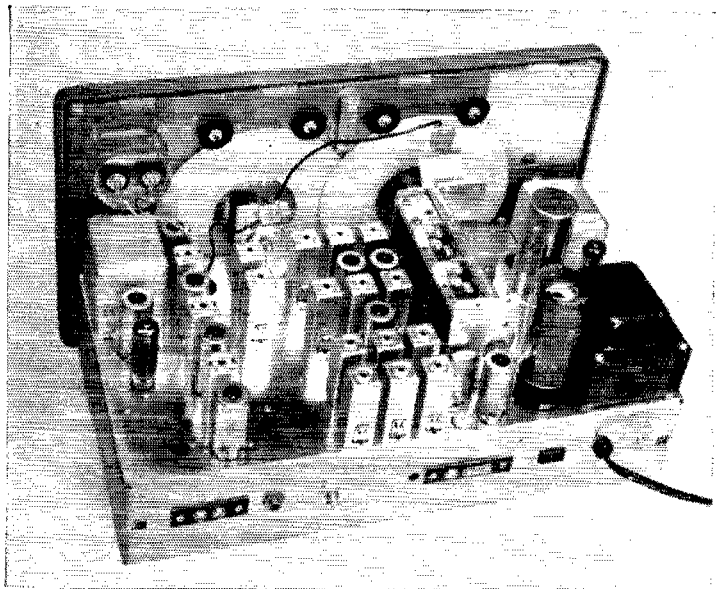

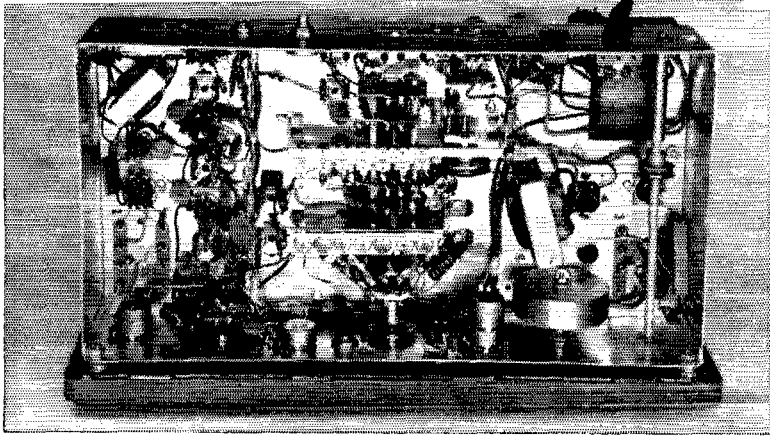

Bottom view of the receiver. Large flywheel, lower right, helps to give the tuning dial a smooth "feel." Oscillator trimmers, lower center, are slug-type plastic variety, for high stability. All coils except for the 50-Mc. range are in individual shield cans mounted topside.

is a space for an electric clock and timer, an extra-cost accessory not included in the receiver tested. We understand that nearly all purchasers either get the clock-equipped model, or eventually order the conversion kit available to take care of buyers who were economy-minded at first and turned down the clock feature. The function switch has positions for send, receive, c.w. — s.s.b. and calibrate. The on-off switch is on the sensitivity control rather than on the audio gain, where one normally looks for it.

The HQ-110 features a die-cast aluminum panel which lends a feeling of solidity to what is in reality a very light receiver. That light weight, incidentally, is welcome for Field Day and V.H.F. Party trips to choice locations. So is the over-all power consumption of only 80 watts. And anyone who has fussed with the innumerable screws that hold some receivers inside their cabinets will take kindly to the arrangement for getting at the 110. Just two screws, both on the back, need be removed to slip the perforated housing off, for tube changes and other servicing.

Though we do not ordinarily attempt to evaluate the performance of equipment described in

these pages, we know one question everyone will ask about the HQ-110, so we will attempt to answer it fairly. "How does it work on 6?"

As might be expected, the r.f. gain is lower on 50 Mc. than on other bands. The S-meter readings are bound to be low on that account. But you can hear noise from the antenna, and side-by-side tests with converter-receiver combinations having much more gain show that just about any phone signal that can be heard on the hot combination can be heard on the 110 alone. Only your next-door neighbor will read S9 on the meter, but you'll hear the weak ones he's working, if your antenna system is as good as his.

With double conversion on all bands from 7 Mc. up, the HQ-110 is free of image troubles, and its dial mechanism allows reasonably comfortable tuning right up through the 50-Mc. band. Appreciable hum modulation shows on 6, probably the result of the hot-cathode oscillator circuit, and therefore subject to variation from one 6BE6 to another. This makes the 110 something less than ideal as a weak-signal c.w. receiver, but its stability, both mechanical and electrical, is adequate for 50-Mc. operation.

— E. P. T.

Strays

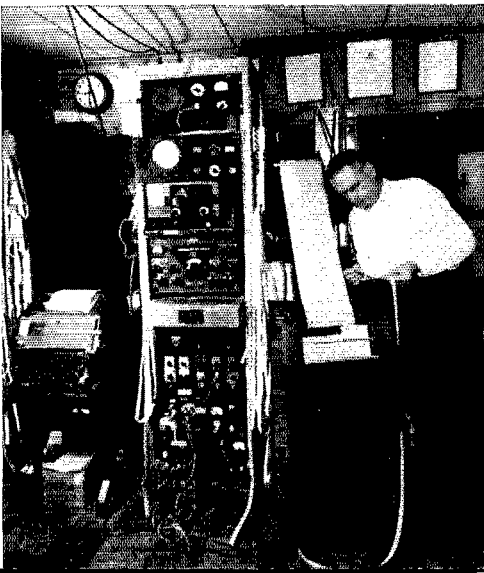

Last month we reported that WØBP had Worked All States using radioteletype. This month we show you a picture of WØBP and some of his equipment. Top to bottom in the rack are audio panel and speaker, a high-speed tuning indicator, a Johnson Navigator modified for f.s.k., and a Collins 75A-4. Down below that are various control, switching and patching arrangements. At the left is a model 15 page printer, while at the right is a model 28. Out of sight to the left in this same room is another rack containing S-76 and BC-779 receivers, a panadapter, power supplies, terminal units, etc. Over in the transmitter room, separated from the operating room by a glass partition, there are three separate kilowatt rigs. And one of WØBP's antennas is a version of a "vertical fan" described by him in QST way back in November, 1920. One of his antenna grounding switches is a Wireless Specialty dating back to 1914.

QST for

Results of Armed Forces Day 1958

CERTIFICATES of Merit have been mailed to two hundred and seventy-eight contestants in recognition of making perfect copy of the Secretary of Defense's International Morse Code message to radio amateurs on Armed Forces Day 1958. The message was transmitted at 25 w.p.m. by military stations on 17 May 1958. Certificate winners of the c.w. message are as follows:

K1AWM, K1BBK, K1BDD, W1BCS, W1BDI, K1CUE, W1DWO, W1GHZ, W1IKE, W1KDQ, W1MCG, W1MEG, W1MIX, K1RRD, W1SDO, W1SMU, W1TEC, W1WPR, W1WTJ, W1ZR, W2BXW, W2CCD, W2CKF, K2CQP, K2CXO, W2DRV, W2GVU, W2HX, W2JCF, W2JCA, W2JOA, W2KLD, W2KSL, K2KUC, W2KW, W2LRW, W2NNK, W2NUI, W2NVB, W2PF, W2PVO, K2QEK, K2RAR, K2RRH, K2SOX, W2VPH, W2WH, W2WNW, W2ZMK, K3ACJ, W3ADE, W3BFF, W3BKE, W3CA, W3DWP, W3ECP, W3EJQ, W3ELI, W3GQC, W3HCE, W3JBP, W3JH, W3JZG, W3LQV, W3LXQ, W3LXU, W3LYN, W3QCB, W3WHK, W3WLO, W3ZNK, W4BCT, W4BIH, K4BLF, W4CMV, W4CQI, W4FJ, K4FEQ, W4GSP, K4HOE, K4IVZ, K4JKR, W4JUQ, W4BRG, W4LYV, W4NHT, W4ODA, W4OXX, W4PMR, K4PSE, K4TDR, W4USA, W4VHX, W4WV, W5ANR, W5ARK, K5CSA, W5DIW, K5DMR, W5EGD, W5EGK, W5GKV, W5HDX, W5HFN, W5HKP, K5HPV, W5JET, W5JPC, K5JGZ, K5LAP, K5LTK, K5MBK, W5MFX, K5MMO, W5NDV, K5OEA, W5PCL, W5PYU, W5SPZ, W5SYE, AA5USA, K5WBA, W5YOK, W6AAB, W6ANX, W6AWP, W6AXV, W6CBF, W6CBX, K6CHR, K6CVZ, KN6DBL, W6DTY, K6DYX, K6EA, K6ESO, K6EWY, K6EXX, W6EYY, W6FAH, K6FP, W6FHI, W6FYN, W6FYW, K6GZ, W6HSA, W6HUF, K6JFY, W6KF, W6KG, K6LDO, K6LLU, K6MTB, W6MYT, W6NCL, K6NRK, K6OHM, W6OWP, W6OZ, K6PWO, K6PXJ, W6PYN, K6PWO, W6QIE, W6QIL, W6RDK, W6THQ, K6VCT, K6VJV, K6VTK, W6WPI, W6YCF, W6ZPX, A7CZY, W7EBS, W7ETO, W7EYX, W7FLX, W7JU, W7KOK, W7LBK, W7LFA, W7LJW, W7MPZ, W7MTY, W7OEB, W7VI, K8AIR, W8BWK, W8CKW, W8DAE, K8DEY, W8HS, W8HZA, W8JVV, W8JQA, K8KLC, W8LEX, W8LFX, K8NAI, W8NEM, W8QLJ, W8TZO, W9ABH, W9CVZ, W9IDO, W9JAM, W9JFG, K9KMT, W9LBV, W9LRV, W9NOE, W9RNR, W9ARO, W9ECE, W9FDJ, W9GKK, W9HIC, W9JHY, KN9LZJ, WN9OJQ, W9PDN, W9PXH, W9QVA, W9TUT, KP4DJ, KP4KD, KH6BLT, KH6FX, KH6UK. Allen, B.B.; Barlog, E.J.; Booth, D.G.; Borneman, U.; Borum, R.J.; Bradley, F.; Cadwell, R.G.; Camm, J.E.; Cohen, B.; Danell, D.; Dennis, H.P.; Dunn, J.A.; Gamboa, H.M.; Greenhalgh, B.N.; Hammond, C.; Harbin, C.L.; Harrell, W.; Heisler, D.E.; Henry, C.R.; Hill, A.E.; Hinkle, W.F.; Holum, G.O.; Hughes, R.S.; Hutton, W.L.; Jarrell, G.W.; Johnson, G.M.; Kauffman, E.; Knight, L.E.; Long, W.; McAdams,

F.; Nehlsen, H.W.; Nelson, E.K.; Norman M.L.; Petrowski, J.; Powell, C.A.; Reding, P.G.; Ripkin, S.; Rogers, D.E.; Saxon, H.; Shryack, L.A.; Simpson, W.G.; Spivey, F.V.; Taylor, T.; Van Hise, C.A.; Wagner, J.E.; Weeks, L.E.; Weiler, F.W.J.; West, L.; USMC Trng Ctr, Zanesville, Ohio; Hilton, G.M.; Harton, D.L.; Galloway, W.E.

Military to Amateur Contacts

Operating on military frequencies AIR, NSS, and WAR worked amateurs in the 80-, 40-, 20- and 15-meter bands, using c.w., a.m., s.s.b., and RTTY. The three military stations made a total of 1407 contacts. Reports from outlying military stations participating in the Novice phase of this test have not been received and are not included in the above total.

Radioteletypewriter Receiving Competition

The radioteletypewriter receiving competition featured a message from the Secretary of Defense transmitted at sixty words per minute. A total of one hundred and forty contestants received a certificate of merit for perfect copy. RTTY winners of certificate of merit are as follows:

W1BDI, W1DNK, W1MCG, W1OUG, W1UHE, K1WAR, W1ZXA, W2ANB, W2ATQ, K2CQP, K2CXO, K2EW, K2HHH, W2ICA, W2JAV, W2KLD, W2LRW, W2ORX, W2PAU, W2RUI, K2VAM, W2WBX, K3ACJ, K3DUI, W3MHD, W3PYW, K3WPL, W3WTW, W4AIY, W4AWM, A4EHU, W4FJ, K4HIA, K4IVZ, W4JUQ, K4PSE, W4OYG, W4RRH, W4TOY, K5BSS, W5FEM, KZ5FW, W5GMM, W5GNE, W5JBW, K5NAN, K5NAZ, K5OEA, W5RMQ, W5SQB, W5SYE, W5TVG, W5TYI, W5ZMK, W6AEE, W6ANX, W6ASJ, W6AXV, W6BIK, W6CBF, W6CBX, K6CHR, K6CHU, W6CG, W6CQI/6, W6DOU, W6FHI, W6FLW, W6FYM, W6FZC, K6GB, W6ILW, W6IJZ, W6JCK, K6JPR, W6LFF, W6LX, K6MTB, W6MTJ, K6NRK, W6NRM, K6NRR, W6PGP/8, W6SCQ, K6SNA, W6SXG, W6UJX, K6USN, K6WGB, W6YNS, W6ZVV, W7BEG, W7CBE, W7CCB, W7CSC, W7DDY, W7JHC, W7KQK, W7LPM, W7MEV, W7PQJ, K7WCV, W8AIR, W8CKW, W8CRY, W8DOO, W8AYT, W8JLV, K8KLC, W8KVV, W8LEX, W8PFE, W8QMI, K9AFE, W9CWH, W9GRW, W9NOE, W9PUD, W9PVN, K9AKG, W9HFU, K9XNM, W9HZR, W9IQC, W9JHS, W9LFI, W9LFH, W9USN, W9YKZ, KP4KD, Goodman, D.J.; Cobb, E.R.; Johnson, G.; Rood, O.; Thomas, C.; Sanzaro, R.; Ungari, J.A.; PMS&T Worcester Polytec.

The military departments are pleased with the continued increase in participation in these tests and appreciate the interest shown by the amateurs participating. Congratulations to all winners of the Secretary of Defense Certificates and it is hoped that next year's participants will exceed the present record.

The 1958 Novice Roundup Results

BY RONNIE GANN,* W1FGF

CONFUCIOUS SAY: 前年多努力在前年多努力 (Man who do not believe '58 Novice Roundup best yet, better should join honorable ancestors than to pound brass.) I'm speaking of course, about Max Confucious, WN1QST. He owns a delicatessen here on LaSalle Road.

Anyway, Max was right. A real crazy scene was dug by all. Logs were submitted from over 85% of the participating sections with a few of the contestants racking up 10,000 points or better. In there pitching for the DXers were KG4AS, WL7CEE and WH6CJJ. It seems most of the boys favored 80 and 40 meters, although 15 was the scene of some pretty bloody battles, too!

Interest reigned high among Non-Novices this year, and apparently some got a bit overzealous. A few scooted up into the Novice band with their half-gallons and caused a bit of QRM, not to mention shattered ear drums! So to all up-and-coming Novices reading this. . . . "We apologize, and promise to watch ourselves next year."

Tyro Topics . . .

"Working the NR was just about the most fun I have had. Most of the fellows were very helpful." — KN8GJD . . . "My greatest thrill of the contest was when a call to a CQ was received from W1AW. Thanks a million for the contests that are sponsored by the League." — KN8GPC . . . "Sure enjoyed the contest, tnx for a lot of fun!" — KN8HGT . . . "Thot SS was fun, but this NR sure had that beat! Many tnx to U fer giving the rock-bound Novices a chance each year to show wat they can do." — KN2ZIS . . .

* Communications Assistant.

Champ Greets Champ: K6SXA, last year's national high scorer, congratulates this year's top man, KN6ZBV (seated) is real happy about the whole deal . . . and he should be! Whipping out 22,995 beautiful points with 315 QSOs, and being top man in the nation, Dave certainly made the most of his Globe Chief 90, NC-300 and 3 element beam. Sac Valley adds another fine operator to its amateur ranks.



—YOUR FORTY-HOUR TIME LIMIT IS UP, TRIGGER

"Please excuse all my mistakes." — KN2EKM . . . "Anybody who can stick out 40 hours of this is NUTS!" — KN8LTB . . . "I'd like to thank the Generals who consistently slowed down for us. It sure helped a lot. Still think the League should give a TWEHDC award. (To Whom Everything Happens During Contest)." — KN1CRB . . . "Please send me complete instructions on Husband Recapturing!" — WN7HXE.

Our Turn, Now . . .

"Helllp" — W1FGF . . . "Have received about 100 QSL cards stating I was their first Maryland QSO, and they're still coming in!" — W3MSR . . . "Most of the Novices I heard on in the contest were hang-up good operators." — W0JHY/5 . . . "Just loads of fun. Wish I could get that Utah station's address." (C'mon WN7JBV) — K2APG . . . "Just keep up the good work of helping the Novices and we'll have scads of good operators." — K5IID . . . "I was surprised at the number of Novices in there that could handle a fast bug." — K2UZJ . . . "Seems like the Novice operators get better each year." — W4OMT . . . "Vy nice NR as usual. Made 68 people happy with another multiplier . . . now comes the QSL cards!" — Y02VA . . . "Think we'll have a swell bunch of operators hitting the big contests before long." — K8BPX . . . "Boy, I really enjoyed this one!" — K6RFT.

A look at the call-area leaders will show a lot of hard work and nose-to-the-grindstone brasspounding by these people. A standing ovation, men.

KN1CEC 11,514-187	KN6ZBV 22,995-315
WN2DYC 12,720-215	WN7HXE 10,560-182
KN3AHQ 10,824-246	KN8GSS 15,848-273
KN4OKZ 20,590-345	KN9IND 15,984-276
KN5KYR 17,748-306	KN0KLB 0900-150

WH6CJJ 1891-61

With the large number of logs submitted, only 14 participants racked up 10,000 points or better. Listed below in descending order are their calls and scores:

KN6ZBV 22,995	KN1CEC 11,514
KN4OKZ 20,590	KN4OUTZ 11,368
KN5KYR 17,748	KN3AHQ 10,824
KN9IND 15,984	WN7HXE 10,560
KN8GSS 15,848	KN5JPS 10,400
KN9JLR 14,310	KN1CAU 10,300
WN2DYC 12,720	KN4PPX 10,229
KN8HKB 12,220	WN2RFS 10,100
	KN5JPB 10,094

Nice goin' fellas!

There were well over 250 logs submitted from Novice participants alone, not counting the non-competing stack. The continuous rise in contest operating by the Novice has been, in a word, "fantabulous," and we can well predict record-smashing participation next year. You non-Novices did us proud again this year, in giving up your time to help pull the new fellas up through the ranks. Here's how things shaped up. Calls are listed alphabetically.

W1AMY 130, W1AW 1925, W1BDI 650, W1DGL 266, W1FGF 340, W1HV 572, W1JFL 150, W1KGY 451, W1KVG 135, W1KYM 2059, W1NJJ 360, W2BVE 100, W2CVW 36, W2EWZ 990, W2FEB 1484, W2ILL 900,

W2RJJ 1296, W2UAL 18, W3ARK 8160, W3FHR 4320, W3GEU 156, W3MDO 1716, W3NISR 24,567, W3SEB 1178, W4KFC 4620, W4OMW 1496, W4UOW 3492, W5FCX 232, W5JHY/5 140, W7PKF 1058, W7YQA 221, W7ZVY 66, W8BAIX 6512, W8CWE 2187, W9LNQ 7682, W9YT¹ 368, W9YYG 1103, W9VFE 275, K1AYW 360, K1BAZ 1460, K1BEB 5740, K1CBI 314, K2APG 1500, K2ITZ 175, K2IYC 360, K2PTS 4012, K2PTU 528, K2TBU 2600, K2UBW 105, K2UCF 494, K2UTV 2116, K2UZJ 152, K2VNS 290, K4CFE 2607, K4IFX 533, K4JOS 585, K4MIOF 2280 K4QPJ 30, K5BQS 4026, K5EJC 5000, K5ESW 1518, K5GFC 3024, K5GHP 260, K5IID 1152, K6DJC 7592, K6KZY 135, K6PUB 1080, K6RFT 407, K6SXA 351, K8BPX 170, K8BXT 9486, K8EJL 1500, K8GUV 49, K8HFO 1144, K9AUE 4720, K9AWV 96, K9DWK 3922, K9HCP 2070, K9CQA 20, K9EKR 1536, K9GIC 2184, K9GVS 288, K9GVE 110, K9IDV 280, K9JOQ¹ 150, KL7CDF 2914, VE2AJD 616, VE3DDU 555, VE3DNR 221, VO2NA 1496.

SCORES:

Scores are grouped by ARRL Divisions and Sections. The operator of the station listed first in each section is award winner for that section. Example of listings: KN4OKZ 20,590-345-58-36, or, final score 20,500, number of stations 345, number of sections 58, total operating time 36 hours.

ATLANTIC DIVISION

Eastern Pennsylvania

KN3ALL... 7488-183-36-40
KN3BK... 2068-84-22-20
KN3AEJ... 1491-56-21-18
KN3ALS... 848-38-16- -
KN3BTC... 560-30-14-11
KN3CZ... 1465-21-15-5
KN3BPL... 924-39-7-10
KN3BIE... 217-16-7-4
KN3DAO... 80-10-8-2
KN3ASH... 19-12-4- -

Mid-Del.-D. C.

WN3MNE... 2997-111-27-14
KN3AZH... 2828-101-28-32
WN3MEO... 203-19-7-10

Southern New Jersey

KN2KCR... 2940-140-21- -

Western New York

KN2DTW... 4998-119-42-34
WN2TPV... 2914-69-41-18
KN2LWG... 1232-41-22-16
KN2DLY... 1104-48-23-18
KN2JIZ... 966-59-14-12
KN2AOQ... 752-32-16-7
KN2EAB... 308-16-1-4
WN2TKG... 80-10-8-10
KN2CSE... 12-6-2-12

Western Pennsylvania

KN3AHQ... 10,824-246-44-38
KN3HDM... 6435-150-39-38
KN3BZY... 1656-72-23-13
KN3BTC... 836-38-22-17
KN3CZ... 176-34-14-11
KN3AUE... 286-22-13-14
KN3CFE... 162-18-9-14

CENTRAL DIVISION

Illinois

KN9IND... 15,984-276-54-39
KN9JLR... 14,310-270-53-40
KN9TSP... 6820-140-44-23
KN9JDU... 5852-118-44-40
KN9HRC... 3360-86-35-30
KN9HIT... 2627-71-37-25
KN9IWS... 2100-60-30-15
KN9JOO... 1932-54-28-23
KN9JDF... 1421-49-29-11
KN9KFP... 936-42-18-24
KN9JLZ... 836-29-19-18
KN9LIG... 714-27-17-20
KN9TEK... 544-48-8-14

Indiana

KN9KQV... 7040-160-44-29
KN9IGP... 2208-138-16-20
KN9JQH... 1200-60-20-17
KN9JWH... 611-47-13-18

Wisconsin

KN9LEK... 5285-151-35-35
KN9JTG... 3520-88-40-31

Running 70 watts input to his homebrew rig, KN4OKZ slammed out a big 20,590 points to win laurels for the Virginia Section and place second nationally. He's following right in his Pop's footsteps too, for Ken's dad is W4KFC, a well-known contest man in the realm of Hamdom.

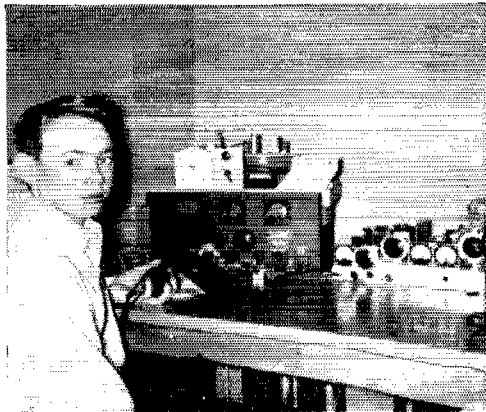

WN7HXE. Three children, an understanding OM, five cats, fourteen hands, a heap of patience, 10,560 points and top banana for the Washington Section. What a gall! FB, Della.

DAKOTA DIVISION

North Dakota
KN0MIK... 448-22-14-24
KN0MBN... 96-6-8-9

South Dakota
KN0MRN... 6192-129-48-24

KN8GJD... 5487-162-31-29
KN8GPC... 1316-96-41-83
KN8HFQ... 3640-89-35- -
KN8GSE... 2250-65-30-14
KN8GMK... 1007-53-19- -
KN8HGM... 380-55-16-21
KN8HWM... 741-47-13-20
KN8IFF... 555-37-15-14
KN8ESY... 180-15-12-3
KN8HCE... 152-9-8-9
KN8HLR... 48-8-6- -
KN8EXP... 39-3-3-1

...I DON'T GIVE A HOOT ABOUT THE NOVICE ROUNDUP!

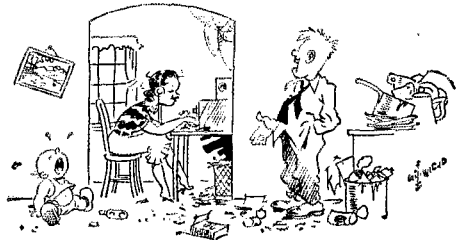

Minnesota
KN0KEE... 2520-72-35-13
KN0LQF... 1848-56-33-12
KN0LBA... 24-6-4-1

DELTA DIVISION

Arkansas
KN5JPB... 10,094-191-49-19
KN5JYW... 2142-63-34-9
KN5KIZ... 570-30-19-4

Louisiana
KN5MPM... 9200-200-46-39
KN5KMV... 8684-157-52-13
KN5LRQ... 6720-145-42-24
KN5MQM... 3185-91-35-19

Mississippi
KN5KGF... 8183-167-49-19

Tennessee
KN4RSY... 390-26-15-9

GREAT LAKES DIVISION

Kentucky
KN4PPK... 3572-79-38-27
KN4QCM... 799-47-17-5

Michigan
KN8GSS... 15,848-273-56-40
KN8EET... 9280-145-58-37
KN8FPZ... 7296-173-38-24
KN8HJS... 6762-151-42-39

Ohio
KN8HKB... 12,220-235-52-29
KN8EJZ... 8850-167-50-39
KN8GWK... 5632-113-44-31
KN8HTK... 5148-151-31-31
KN8HGT... 5115-150-31-30
KN8GUV... 4212-108-39- -
KN8IAZ... 1025-41-25-16
KN8HWH... 940-32-20- -
KN8IAS... 816-48-17-9
KN8EIL... 602-43-14-10
KN8GNG... 306-24-9-9
KN8GZL... 16-4-4-1
KN8GVO... 8-3-2-4

HUDSON DIVISION

Eastern New York
WN2LNU... 3852-107-36- -
WN2LDU... 400-25-16-7

N. Y. C.-L. I.
WN2DYC... 12,720-215-53-35
WN2GRG... 8400-190-42-22
WN2MSZ... 2646-83-27-15
KN2DAL... 2380-109-20-33
KN2ZIS... 3075-83-25-37
WN2KYY... 1120-36-20-25
WN2HQN... 1056-41-16-10
WN2JMP... 1007-53-19-28
WN2HPT... 369-36-19-15
WN2ETH... 210-15-7-3
WN2HLL... 154-14-11-9
WN2STM... 9-3-3-1

Northern New Jersey
WN2RFS... 10,100-202-50- -
KN2ZDZ... 9000-165-50-38

(Continued on page 150)

1957 PHONE SWEEPSTAKES RESULTS CORRECTION AND RECAP

Contest fans are aware that Sweepstakes certifications are issued on a "local" basis, i.e., to club and ARRL Section winners. Yet editorial mention is often made of new contact and scoring records, licensing area leaders, or the country's "top ten."

In our portrayal of the phone SS in June *QST*, section winners were correctly identified. But in working on Minnesota leader WØEDX's score, we overlooked a mathematical error that inflated the actual tally as not intended by either Al or our checking department. To those who wrote, to WØEDX, and to all others concerned, we extend our sincere apologies for the slip.

By way of reconstructing, then, we find Los Angeles winner K6EVR pacing the crowd with 170,520 points. Californians long have had a penchant for monopolizing the voice portion of the SS and 1957, it seems, was no exception. In fact, Sixes now have registered the top A-3 total in nine of the twelve postwar SS's.



Meet K6EVR, top phone scorer in the 1957 Sweepstakes. Although first licensed in 1954, 19-year-old Ronald has rolled up some impressive tallies in the SS, the Novice Roundup and DX Tests, and is DXCC-210.

An all-time high of 22 amateurs posted above 100,000 points under a scoring system that has remained basically unchanged for years. Following K6EVR came Connecticut's W1YWU with 156,366 points, while the 152,643 points of Mississippian W5DQK captured show position nationally. The fourth-ranking score of 147,864 came from East Bay's W6PQW, all of whose 815 QSOs were made on ten meters with 90 watts input. Other six-digit men were: W7BSW 133,152, K6BWD 129,384, W2VCZ 124,830, WØEDX

(whose contact total of 854 was tops) 124,611, W6BSY 121,800, W8AJW 121,764, W7CAF 121,440, W5MYI 121,095, W5VU 108,570, W9OHO 106,812, W6IIM 106,128, W7BJV 105,216, WØVQC 105,053, W3MSK 104,244, K2BHP 102,900, W7CBP 102,837, W1FZ 102,711, W7BLX 100,022.

— — — — —
The 25th ARRL Sweepstakes is set for November 8-9 and 15-16. QRV?

— — — — —
As ships dock at Stateside ports, foreign entries resulting from the 1958 ARRL International DX Competition continue to pour in. Besides those shown in July *QST*, c.w. scores ranging from 100 to above 400 thousand are claimed by CR6AI, HA8WS, JA1VX, JA3AB, KC4USB, OE1RZ, OE3RE, OE6HV, VK2APK, VK2GW, ZL3OB and ZP9AY. DXers reporting from 50,000 up to 100,000 points include DJ3KR, HA5DH, I1BLF, OE3VP, OK1AEH, VK5MY, VK9NK, ZE6JX, ZL1MT and ZS6AJO. Final standings coming up!

Silent Keys

It is with deep regret that we record the passing of these amateurs:

W1AQU, Wilbur H. Roberts, Lowell, Mass.
W2AYK, Lionel Samuel, Pelham Manor, N. Y.
K2DSD, Dante D. Petretti, Tujunga, Calif.
K2IRC, William T. Emmons, Eatontown, N. J.
W2ZL, George J. Eitz, Avon, N. J.
KN3AZT, Fred E. Lotz, Wilkinsburg, Pa.
W3CLV, Hervey E. Heller, Baltimore, Md.
W3HVK, Robert J. Phelps, Phoenixville, Pa.
W3YXE, Merle H. Sexton, Union City, Pa.
W5AEP, Thomas A. Black, El Paso, Texas
K6GEA, Lester B. Eaton, Glendale, Calif.
W7OHS, Gilbert I. Noble, Richland, Wash.
W7TES, Reno W. Diedrich, Bellevue, Wash.
W9ADS, Arthur L. Bennett, Indianapolis, Ind.
K9HDY, Harry M. Blackburn, Bedford, Ind.
W9ZJJ, Paul A. Townsend, Evansville, Ind.
WØDJY, Cecil E. Leonard, Belle Plaine, Iowa
VE3BCW, F. Manley Haines, Willowdale, Ontario
VE3QO, Walter H. Colton, Oshawa, Ontario
VE8AC, E. A. Kirk, Dawson, Y. T., Canada
EA4BH, Luis S. Garcia Viguera, Madrid, Spain
G5UX, George A. Hume, London, England
KL7PC, Sigurd Hopstad, Bethel, Alaska
VK5BY, D. R. Whithurn, Fullarton Estate, S. Australia

IS YOURS ON FILE WITH YOUR QSL MGR?

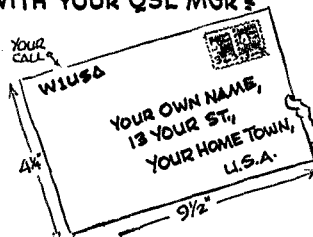

(See page 23)



Election Notice

14-Mc. Phone Expansion Proposed

V.H.F. C.W. Segments Proposed

ELECTION NOTICE

To All Full Members of the American Radio Relay League Residing in the Central, Hudson, New England, Northwestern, Roanoke, Rocky Mountain, Southwestern and West Gulf Divisions:

An election is about to be held in each of the above-mentioned divisions to choose both a director and a vice-director for the 1959-1960 term. These elections constitute an important part of the machinery of self-government of ARRL. They provide the constitutional opportunity for members to put the direction of their association in the hands of representatives of their own choosing. The election procedures are specified in the By-Laws. A copy of the Articles of Association and By-Laws will be mailed to any member upon request.

Nomination is by petition, which must reach the Headquarters by noon of September 20th. Nominating petitions are hereby solicited. Ten or more Full Members of the League residing in any one of the above-named divisions may join in nominating any eligible Full Member residing in that division as a candidate for director therefrom, or as a candidate for vice-director therefrom. No person may simultaneously be a candidate for both offices; if petitions are received naming the same candidate for both offices, his nomination will be deemed for director only and his nomination for vice-director will be void. Inasmuch as all the powers of the director are transferred to the vice-director in the event of the director's resignation or death or inability to perform his duties, it is of as great importance to name a candidate for vice-director as it is for director. The following form for nomination is suggested:

Executive Committee

The American Radio Relay League
West Hartford 7, Conn.

We, the undersigned Full Members of the ARRL residing in the Division, hereby nominate of as a candidate for director; and we also nominate of as a candidate for vice-director; from this division for the 1959-1960 term.
(Signatures and addresses)

The signers must be Full Members in good standing. The nominee must be a Full Member and the holder of an amateur license, and must have been a member of the League for a continuous term of at least four years at the time of his election. No person is eligible who is commercially engaged in the manufacture, sale or rental of radio apparatus capable of being used in radio communications, or is commercially engaged in the publication of radio literature in-

tended in whole or in part for consumption by radio amateurs.

All such petitions must be filed at the headquarters office of the League in West Hartford, Conn., by noon EDST of the 20th day of September, 1958. There is no limit to the number of petitions that may be filed on behalf of a given candidate but no member shall append his signature to more than one petition for the office of director and one petition for the office of vice-director. To be valid, a petition must have the signature of at least ten Full Members in good standing; that is to say, ten or more Full Members must join in executing a single document; a candidate is not nominated by one petition bearing six valid signatures and another bearing four. Petitioners are urged to have an ample number of signatures, since nominators are occasionally found not to be Full Members in good standing. It is not necessary that a petition name candidates both for director and for vice-director but members are urged to interest themselves equally in the two offices.

League members are classified as Full Members and Associate Members. Only those possessing Full Membership may nominate candidates or stand as candidates; members holding Associate Membership are not eligible to either function.

Voting by ballots mailed to each Full Member will take place between October 1st and November 20th, except that if on September 20th only one eligible candidate has been nominated, he will be declared elected.

Present directors and vice-directors for these divisions are as follows: *Central:* John G. Doyle, W9GPI, and George E. Keith, W9QLZ. *Hudson:* George V. Cooke, jr., W2OBU, and Lloyd H. Manamon, W2VQR. *New England:* Milton E. Chaffee, W1EFW, and Frank L. Baker, jr., W1ALP. *Northwestern:* R. Rex Roberts, W7CPY, and Howard S. Pyle, W7OE. *Roanoke:* P. Lanier Anderson, jr., W4MWH, and Thomas H. Wood, W4ANK. *Rocky Mountain:* Claude M. Maer, jr., W0IC, and Carl L. Smith, W0BWJ. *Southwestern:* Walter R. Joos, W6EKM, and Virgil Talbott, W6GTE. *West Gulf:* Grady A. Payne, W5ETA, and Carl C. Drumeller, W5EHC.

Full Members are urged to take the initiative and to file nominating petitions immediately.

For the Board of Directors:

A. L. BUDLONG
Secretary

July 1, 1958

14-MC. PHONE EXPANSION PROPOSED

In 1956 the League requested the Federal Communications Commission to amend the amateur rules to provide that holders of the Amateur Extra or Advanced Class license might use voice emission in 14,300-14,350 kc. FCC has not as yet acted on our request. Responsive to a decision of the Board of Directors, an amended petition has now been filed which would delete the license restriction and therefore presently consists of a straightforward request to make the 20-meter voice band 14,200-14,350 kc. The text follows:

FEDERAL COMMUNICATIONS COMMISSION

Amendment of Sections 12.23 and 12.111 (d) of the rules and regulations

Amendment of petition

On September 27, 1956, the American Radio Relay League, Inc., filed with the Commission a petition seeking amendment of sections 12.23 and 12.111 (d) of Part 12, Rules Governing Amateur Radio, concerning the expansion of the 14-mc. radiotelephony subband. The Commission has not as yet acted on the petition.

The petition requested the expansion of the 14-mc. radiotelephony subband so that it would become 14,200-14,350 kc., and presented arguments in support thereof.

The petition also included the request that the use of the proposed new radiotelephony segment 14,300-14,350 kc. be limited to holders of the Advanced or Amateur Extra Class grades of license.

As directed by its Board of Directors, the League now amends its petition by withdrawing the proposal for a restriction to certain classes of amateur license. The amended petition, therefore, seeks only the expansion of the 14-mc. radiotelephony subband so that it will read 14,200-14,350 kc.

THE AMERICAN RADIO RELAY LEAGUE, INC.

BY PAUL M. SEGAL
Its general counsel

A. L. BUDLONG
General Manager
May 21, 1958

V.H.F. C.W. SEGMENTS PROPOSED

Responsive to a decision of the Board of Directors, the League has filed with FCC a petition for amendment of the amateur rules to provide exclusive c.w. segments of 100 kc. at the low ends of the 50- and 144-Mc. bands. In accord with ARRL's request for preferential attention, the Commission promptly issued a notice of proposed rule making to accomplish the changes, with a date of August 29 by which comment may be filed. The text of both the League's request and the Commission's notice follows:

FEDERAL COMMUNICATIONS COMMISSION

Amendment of paragraphs 12.111 (h) and 12.111 (i) of the rules and regulations; limitation to A-1 emission of the lower 100 kilocycles in the 50- and 144-mc. amateur frequency bands

Petition for rule making

Pursuant to § 4 (d) of the Administrative Procedure Act and § 1.702 of the Commission's Rules and Regulations. The American Radio Relay League, Inc., requests that paragraphs 12.111 (h) and (i) of the Commission's Rules and Regulations be amended to provide for only A-1 emission in the lower 100 kilocycles of each the 50- and 144-mc. amateur bands.

This request is filed pursuant to decisions of the Board of Directors of the League at its meeting in May, 1958. As the Commission is aware, the ARRL Board of Directors is composed of sixteen amateurs nominated and elected by some 70,000 licensed amateurs to represent them in the formulation of League policy.

I. The contributions of the amateur radio service to

knowledge of propagation characteristics in the v.h.f. portion of the spectrum are a matter of record. The most recent examples are the two-way 144-mc. communication between California and Hawaii in July, 1957, and innumerable instances of intercontinental two-way communication in the 50-mc. band during the past year. Additionally, nearly 1,000 amateurs are enrolled in an intensive project, as part of the International Geophysical Year program, to gather further data on propagation phenomena.

2. The principal raw material for such studies, and therefore for contributions to the art, comes from long-distance amateur contacts. It is well established that, watt for watt, A-1 emission is a far more effective medium for marginal work over great distances than A-3 emission. It is also well known that a weak, distant c.w. signal is obliterated by voice signals from local amateur stations. It is more to the credit of the amateurs who, under the handicap of local voice interference, have accomplished the distance records on c.w. so far obtained.

3. The League believes that such experimental long-distance attempts at communication should be provided every opportunity for success, and therefore proposes the establishment of exclusive c.w. segments of 100 kc. each at the low end of the 50- and the 144-mc. amateur bands.

4. In the case of the 50-mc. band, there is technical justification for selection of the low end for the exclusive c.w. segment. For example, in F-2 layer work, such as is now going on widely as the result of the current solar activity peak, and (although not quite to the same extent), in sporadic-E propagation, the lower the frequency the better the chance of making distant contacts. In the case of the 144-mc. band, the location of a proposed c.w. segment is not subject to the same technical justification, and our selection of the low end is purely a matter of consistency with other amateur band suballocations.

5. The League's proposal does not derive from the usual considerations applying to suballocation between types of emission on the lower-frequency amateur bands. It stems from a need to provide experimentally-inclined amateurs the proper tools with which to accomplish successfully the studies they are undertaking, particularly in connection with the IGY. If anything, the exclusive c.w. segments proposed should benefit voice operators as well, for they will provide space where foreign voice stations may be received without local A-3 interference.

6. The League requests that preferential attention be given its petition and hopes that immediate and favorable action will be forthcoming from the Commission in order that, if adopted, the new rules will become effective for as much as possible of the balance of the International Geophysical Year, which ends December 31, 1958.

THE AMERICAN RADIO RELAY LEAGUE, INC.

BY PAUL M. SEGAL
Its general counsel

A. L. BUDLONG
General Manager
May 21, 1958

Before the
FEDERAL COMMUNICATIONS COMMISSION
Washington 25, D. C.

In the Matter of

Amendments of Section 12.111 of the Commission's Rules, Amateur Radio Service, to provide that only A1 emission may be used in the lower 100 kilocycles of the 50 and 144 Mc amateur bands.

Docket No. 12485

Leading Mexican amateurs and officials of the Liga Mexicana de Radio Experimentadores at their 26th national convention at Mexico City in May: Lt. Colonel Mariano Yustis C., XE1BX, administrative manager; Juan Lobo y Lobo, XE1A-XF1A, well-known DXer; Ing. Manuel Medina, XE1N, who this year retired after many distinguished years as society president; General (retired) Alberto Najera, XE1H, newly elected president of LMRE.

QST for

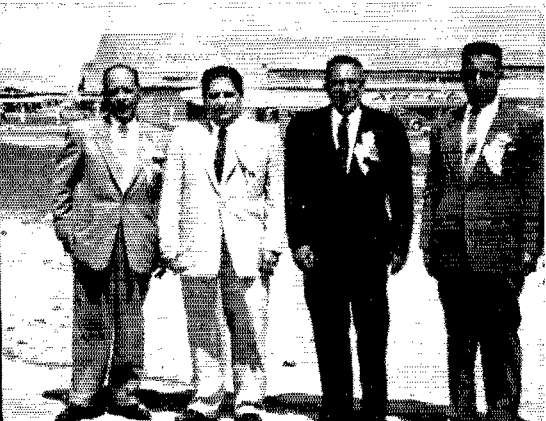

Notice of Proposed Rule Making

1. Notice is hereby given of proposed rule making in the above entitled matter.

2. The Commission has received a petition filed by the American Radio Relay League, Inc., to amend Sections 12.111(h) and 12.111(i) of the Amateur Radio Service Rules to provide that only A1 emission may be used in the lower 100 kc of the 50 to 54 and 144 to 148 Mc amateur bands.

3. The Rules now provide for the use of A1, A2, A3, and A4 emissions and narrow band frequency or phase modulation for radiotelephony in the pertinent portion of the 50 to 54 Mc. band. In the 144 to 148 Mc. band the Rules now provide for the use of A0, A1, A2, A3, and A4 emission and special emission for frequency modulation.

4. In support of the request petitioner states that the contributions of amateurs to the general knowledge of v.h.f. propagation characteristics are a matter of record; that nearly 1,000 amateurs are enrolled in an intensive project as part of the International Geophysical Year program to gather further data on propagation phenomena; that long-distance amateur contacts contribute to such knowledge and that A1 emission is a more effective medium for long-distance communication than is A3; and that such long-distance communication attempts should be given every opportunity for success. Petitioner further states:

The League's proposal . . . stems from a need to provide experimentally-inclined amateurs the proper tools with which to accomplish successfully the studies they are undertaking, particularly in connection with the IGY.

Petitioner, in justification of its selection of the lower 100 kc of the involved bands for exclusive use of A1 emission, states:

In the case of the 50-mc. band, there is technical justification for selection of the low end for the exclusive c.w. segment. For example, in F-2 layer work, such as is now going on widely as the result of the current solar activity peak, and (although not quite to the same extent), in sporadic-E propagation, the lower the frequency the better the chance of making distant contacts. In the case of the 144-mc. band, the location of a proposed c.w. segment is not subject to the same technical justification, and our selection of the low end is purely a matter of consistency with other amateur band suballocations.

5. The sought amendments would result in the removal from other than A1 emission of only two and one-half percent of each of the amateur bands in question and would therefore not appear to materially affect the present usage of these bands. Furthermore, the proposal is generally consistent with the availability, from a historical standpoint, of all bands for A1 emission and only some bands for other types of emission.

6. Accordingly, the Commission proposes to amend Sections 12.111 (h) and 12.111(i) as set forth in the Appendix hereto.

7. Authority for the amendments herein proposed is contained in Section 4(i) and 303 of the Communications Act of 1934, as amended.

8. Any interested person who is of the opinion that the proposed amendments should not be adopted or should not be adopted in the form set forth herein, and any person desiring to support this proposal may file with the Commission on or before Aug. 29, 1958, a written statement or brief setting forth his comments. Replies to such comments may be filed within 10 days from the last date for filing original comments. No additional comments may be filed unless (1) specifically requested by the Commission, or (2) good cause for the filing of such additional comments is established. The Commission will consider all such comments prior to taking final action in this matter, and if comments are submitted warranting oral argument, notice of the time and place of such oral argument will be given.

9. In accordance with the provisions of Section 1.54 of the Commission's Rules, an original and 14 copies of all statements, briefs, or comments filed shall be furnished the Commission.

FEDERAL COMMUNICATIONS COMMISSION
MARY JANE MORRIS
Secretary

Released: June 13, 1958

APPENDIX

IT IS PROPOSED TO AMEND SECTION 12.111 AS FOLLOWS:

1. Amend Section 12.111(h) to read as follows:
(h) 50.0 to 54.0 Mc. using type A1 emission, 50.1 to 54.0 Mc. using types A2, A3, and A4 emissions and narrow band frequency or phase modulation for radiotelephony, 51.0 to 54.0 Mc. using type A0 emission, and on frequencies 52.5 to 54.0 Mc. special emission for frequency modulation (radiotelephone transmissions and radiotelegraph transmissions employing carrier shift or other frequency modulation techniques).
2. Amend Section 12.111(i) to read as follows:
(i) 144.0 to 148.0 Mc. using type A1 emission, 144.1 to 148.0 Mc. using types A0, A2, A3, and A4 emissions and special emission for frequency modulation (radiotelephone transmissions and radiotelegraph transmissions employing carrier shift or other frequency modulation techniques).

LOUISVILLE EXAMS

FCC has, effective August 1, added Louisville, Kentucky, to those cities where its traveling engineers conduct examinations four times yearly. The next examinations in Louisville will be some time in August and November, details available from the Chicago district office (826 U. S. Courthouse). Henceforth, the Conditional Class examination will not be available to applicants residing within 75 miles of that city.

RADIOASTRONOMY

In 1956 FCC solicited comments from interested parties on a petition from radioastronomy groups to restrict radio operation in certain bands in order to prevent possible interference to scientific efforts to receive signals from outer space. Frequencies in our 50- and 5650-Mc. bands were among those throughout the spectrum where such protection was sought. The League's comment at that time (p. 54, November 1956 *QST*) was to the effect that no rules changes were required, and any interference problem could be handled as an individual matter on a cooperative basis.

FCC has now issued a further notice of proposed rule making which provides in effect that, with a few exceptions, future applicants for radio facilities within a designated area around the proposed national radioastronomy observatory at Green Bank, W. Va., will have to clear such applications through radioastronomy authorities. One of the exceptions is the amateur service. FCC says, "Because of the variable frequencies on which they operate, their intermittent use and their low power, amateur stations have also been excluded . . . (from the proposed requirements)."

21-KMC. FILING

Responsive to an FCC proposal, and in accord with instructions of the Board, the League has filed a brief statement with the Commission indicating concurrence with the idea of shifting our 21,000-Mc. band so that it would be 22,000-23,000 Mc.



Congratulations to VE1BZ, newly appointed Lieutenant Governor of Prince Edward Island.

Late National Convention News

PROGRAM details for the 10th ARRL National Convention in Washington, D. C., August 15-17, 1958, are nearing completion at press time and we publish below the names of chairmen, masters of ceremonies, speakers and subjects at the various technical and operating sessions and meal functions. See page 66 of July *QST* for a general outline of the overall program.

Military Luncheon — Saturday — Master of Ceremonies will be George W. Bailey, W2KH, past president of ARRL, and secretary of IRE. Military pays tribute to amateur radio. Awards will be made by Army Signal Corps, Air Force and Navy to amateurs who have made outstanding contributions to the military. Awards will also be made at this luncheon for the three best exhibits. In attendance will be a galaxy of brass and you will see more stars than you can from a Sputnik!

DX Luncheon — Sunday — Vic Clark, W4KFC, of the DX committee announces a get-together of the DX gang with Leonard Chertok, W3GRF, as luncheon chairman. Guest speakers Bob White, W1WPO, DXCC Awards, ARRL, Bill Leonard, W2SKE, and Don Chesser, W4KVX.

ARRL Luncheon — Sunday — Master of ceremonies Paul A. Smith, W4ZZA, office of the Secretary of Defense, will introduce your League officials. Here's your opportunity to get acquainted with the boys from Headquarters.

Buffet Dinner Dance — ARRL Atlantic Division Director, Gil Crossley, W3YA, will serve as master of ceremonies, and ARRL President Goodwin L. Dosland, W8TSN, will extend a brief welcome at this, the first social function of the convention. This is a Friday get-together for cocktails out-of-doors, then dining and dancing in Washington's largest ballroom — 11 piece orchestra — the chance to get together to meet everybody — bring the NYL — stag or drag.

RTTY Dinner — After the party Saturday, the RTTY boys have their own private dinner and then break up for the free entertainment for all. Frank White, W3PYW, will introduce RTTY guests.

Single Sideband Dinner — One of the biggest attractions is the s.s.b. get-together Saturday night. You don't have to be a sidebander to attend. Ladies invited. Those attending this dinner will not have to leave the room for the free floor show that follows. Master of ceremonies will be the popular Lt. Gen. Francis W. Griswold, KØDWC. Guest speaker will be Rev. Father Daniel Linehan, S.J., W1HWK, Geophysical Laboratories, Boston College.

Hiram Percy Maxim Memorial Banquet — Herbert Hoover, Jr., K6EV, will act as master of ceremonies for the banquet honoring the founder of the League, W1AW, one of the all-time great amateurs. Fred Schnell, W4CF, former ARRL traffic manager, who knew Mr. Maxim personally, will give an interesting résumé of his life in ham radio. Other head table guests will be hamdom's best known figures. We are keeping the name of our famous guest speaker a secret — Washington protocol. The annual ARRL Merit Award will be made by Goodwin L. Dosland, W8TSN, ARRL President, Grand Climax of the Convention!

Entertainment — On Saturday night there will be a floor show with many well known top entertainers, supported by an 11-piece orchestra. Free for all registrants.

QCWA — A get-together after the Friday night buffet, for coffee-and. Anyone in ham radio 25 years or longer may attend. Chairman "Mac" Williams, W3ER, announces that short talks will be made by John DiBlasi, W2FX, QCWA national president; Ralph G. Barber, W2MI, QCWA National secretary; Fred W. Huff, W2AMB, QCWA national treasurer; Granville Klink, jr., W3AFV, chairman, Washington chapter QCWA.

Wouff-Hong Initiation — Famous amateur radio secret fraternity again meets to initiate. Admission by secret word, your Wouff-Hong certificate, or small fee. A fine cast will enact the ceremony at the stroke of midnight Saturday.

Military Session — Robert McCormick, W3YAG, chairman. Moderator, Col. E. S. Van Duesen, W3ECP. The office of the secretary of defense has authorized the participation and support of his office and the services in the convention. An official military session of all Air Force and Army MARS members with Naval Reservists will be held in the auditorium of the Pentagon. Transportation by military busses. Welcoming address will be given by an official of the office of the Secretary of Defense. Program will be presented by top officials of the services. Forum will follow official presentations.

Technical Session — Carl Brown, W3LUL, chairman, and G. M. Thynell, W3TCU, co-chairman. "The Grounded Grid 4-1000A Amplifier," by Rex Bassett, W4QS, Bassett Industries; "Single Sideband" by Fritz Franke, Hallcrafters; "Application of a Small High Perveance Tetrode" by W. B. Hall, RCA; "Receiver Design" by Frank Roberts, WLJVG, National Co.

Novice Session — Ivan H. Loucks, W3GD, chairman. "Outfitting the Novice Station" by Lewis G. McCoy, W1-ICP, technical department, *QST*; "Increasing Your Code Proficiency" by John A. Morrissey, W4HEL, Capital Radio Engineering Institute; "Operating Procedures, Good and Bad" by Karl R. Medrow, W3MCG, Naval Research Laboratories.

V. H. F. Session — Riek Emerson, W3OJU, committee chairman, has appointed Sam Harris, W1FZJ, session chairman. "The World Above 50 Megacycles", a color film produced by Antique Wireless Association, ARRL affiliate, narrated by Henry Blodgett, W2UTR; "E-layer Observations for International Geophysical Year, 1957-1958" by Harry Wilson, EI2W; "W1MHL/1 Contest Operation" by Robert P. Rafause, W1RUD.

V. H. F. Forum — An open forum Saturday evening with Edward P. Tilton, W1HDQ, V.H.F. Editor, *QST*, as moderator. There will be discussion of v.h.f. topics by prominent v.h.f. men. A v.h.f. award as well as awards for best designed amateur v.h.f. gear.

Mobile Session — Jim Roberts, W3YAR, IBM, chairman. "Mobile Emergency", a mobile unit display, will be described by Clinton R. Spencer, jr., W3QQH, Phil-Mont Mobile Radio Club; "Mobile Antenna Problems" by Rex Bassett, W4QS, Bassett Industries; "Mobile Communications" by Gay Millus, W4NJF, Cmdr., USN. Andy Anderson, W3NL, editor of *Auto-Call*, will also address the session.

TVI Session — Nate Coffey, W3OBR, chairman. "TVI — Past, Present and Future" by Philip Rand; "Cooperation by 800 TVI Committees and the FCC" by Frank Kratokavil, FCC. Session followed by an open forum headed by Warren McDorman, W3KAN, past president Washington TVI Committee.

RACES Session — Cecil Harrison, W3PG, chairman. Walt C. Lockhart, jr., W3PWB, co-chairman. "The Place of the AREC in RACES" by George Hart, W1NJM ARRL National Emergency Coordinator; "RACES Communication for Region II" by Austin Sparks, communication officer, Civil Defense Region II; "RACES — Antennas and Their Use" by John Barolet, antenna engineer USN; "New York State RACES Communication VHF Teletype" by Vincent Kenny, W2BGO, N. Y. State Civil Defense. Other speakers from FCDA headquarters.

YLRL Session — Elizabeth Zandonini, W3CDQ, chairman, Irene Akers, W3RXJ, co-chairman. "YL Activities" by Eleanor Wilson, W1QON, YL Editor *QST*. "YLRL and You" by Claire Barton, W4TVT; "YLRL Contest" by Kay Anderson, W4BLR, of YLRL's of Richmond. Betty Frederick, W3PVI, past president of YLRL will also address the session.

SSB Session — Sam Newman, W3HN, chairman. "Systems Aspects of the modern SSB Amateur Station" by John Hunt, Collins Radio; "Application of Transistors to SSB" by Tom Stuart, WØREP, Hallicrafters Co.; "The Amateur's Ideal SSB Receiver" by Stuart Seeley, W2ZE, RCA; "Carrier Suppression-Transmission Techniques" by Walter A. Zarris, E. F. Johnson Co.; "Mobile SSB" by Werner Brack, Pldico Electronics; "Ceramic Tube Application SSB" by Ray Rinaudo, Eimac.

Antenna Session — Chester Buchanan, W3DZZ, NRL, chairman. "Stacking of Arrays" by Mike Ercolino, Telrex; "Mobile Antennas" by Rex Bassett, W4QS, Bassett Industries; "Multiband Antennas Using Lump Constant Traps" by Andrew A. Andros, WØLTE, Hy-Gain; "Multiband Antennas Using Linear Traps" by Dr. Leo C. Haughawout, W6FTU, Gonset.

Contest Session — Don McClellon, W3EIS, NRL, chairman. Various phases of contest operation will be discussed by Phil Simmons, W1ZDP, assistant communications manager, ARRL; Larry LeKashman, W9IOP, Electro-Voice; Don Chesser, W4KVX; Harry Miller, WØCDP. An open forum will follow the session.

RTTY Session — Frank C. White, W3PYW, chairman. "Good Keying Practices Employing Local Loops for Teletype Signal Generation" by Philip Catona, W2JAV; "Net Operations and Working DX on Radio Teletype" by Boyd Phelps, WØBP; "Useful Features Needed in Radio Teletype Converters for Amateur Radio Use" by Frank C. White, W3PYW.

DX Session — Vic Clark, W4KFC, CAA, chairman. "The New Story of DX" by Bruce L. Kelley, W2ICE, "The Why of DXCC Countries" by Bob White, W1WPO, DXCC Awards, ARRL; "Navassa Island Expedition" by Wayne Green, W2NSD, Colonel Lloyd Colvin, W6KG, will also address the session. An open forum will follow.

Communication Session — Leo Young, W3WV, Chairman, Edgar Lindauer, W3UE, co-chairman, John Morgan, W4KX, SCM of Virginia will act as moderator, "History and Background of ARRL Communications" by Ed Handy, W1BDI, Vice President and Communications Manager, ARRL; "Message to All SCMs" by Lou Cronberger, W3UCR, SCM Md.-D.C.; "Regional Net Operation" by Ed-

gar Lindauer, W3UE; "National Traffic System and Organization" by George Hart, WINJM, NTS manager, ARRL.

FCC Session — John Gore, W3PRL, chairman. "Part 12 of Rules and Regulations" by William Grenfell, W4GF, Chief, Amateur Radio Service Section, FCC; "Monitoring Problems and Official Observer Participation" by Irv Weston, Chief, Monitoring Division, Field Bureau, FCC.

Public Relations Session — Pierre Portmann, W3RGX, chairman. "Future of Amateur Radio" by George Bailey, W2KH, ARRL Past President and Secretary IRE; "The Amateurs' Need for Public Relations" by Gilbert Crossley, W3YA, ARRL Director; "Getting Publicity for Your Club and Amateur Radio" by John Huntoon, W1LVQ, ARRL Assistant General Manager. There will be additional speakers from the Department of State and the office of the Secretary of Defense.

ARRL Forum — Col. Edwin Van Deusen, W3ECP, chairman. Gilbert Crossley, W3YA, ARRL Director, will serve as moderator. This forum is the focal point of the entire convention. It is here that handom tells the ARRL, its national organization, what's on its mind. Recommendations developed at the individual sessions will be presented to the League for discussion. The session will include a dramatic presentation "The Collapse of Time" by J. Lewis Powell, office of the Assistant Secretary of Defense. ARRL president Goodwin L. Dosland, WØTSN, will speak on "The ARRL and the Amateur." A. I. Budlong, W1BUD, Secretary and General Manager of the League, will address the session on "The 1959 International Radio Conference and the Amateur."

Get your registration in now — \$5 up to August 1, \$7.50 thereafter. Reserve also for such meal functions as you wish to include — the July *QST* story lists the various luncheons and dinners, with the before-and-after August 1 prices.

Headquarters for convention activities is the Sheraton-Park Hotel, completely air-conditioned. Again, see July *QST* for details. Bring the ladies — see page 55 of July *QST* for that special program.

Hams Across the Sea

BY ARTHUR S. LUKACH,* W2DPP

FOR years I was an armchair traveler. With a copy of the *National Geographic Magazine* and a map of the world in front of me I would soar away on a flying carpet to the four corners of the earth and relive some of the scenes seen in its magic pages. More recently I started to collect international plane timetables and became intrigued by the short time required to reach far-away places. Gradually the pressure increased until one night I spread a map on the table, turned to the XYL and said, "Let's take a trip." I knew before I spoke that the answer would be, "When do we start?"

At this point I would like to make a frank statement — as much as I enjoy traveling, I like ham radio more. The thought of not being able to operate the rig for a period of five or six weeks had a dampening effect on my otherwise exuberant spirit. Then up spoke the XYL again

* 295 Fifth Ave., New York 16, N. Y.

and said, "I suppose you'll spend all your time visiting your DX friends." That chance remark is the reason for this article.

Time compresses quickly when you leave Idlewild Airport in New York bound for Vienna. I had hardly unpacked at the famous old Sacher Hotel when the phone rang and a voice said, "Hello, Arthur, this is OE1FT." Incidentally, you have no idea what a wonderful feeling it is to hear someone call you by your first name in a strange city.

We made an appointment for the following day at which time I had the pleasure of visiting Franz, inspected his station and talked shop. Fortunately the weekly meeting of the Vienna Radio Club took place the following evening. Their quarters consist of two rooms located on the ground floor of a neat-appearing building. The front room facing the street had a plate glass show-window on the inside of which were posted

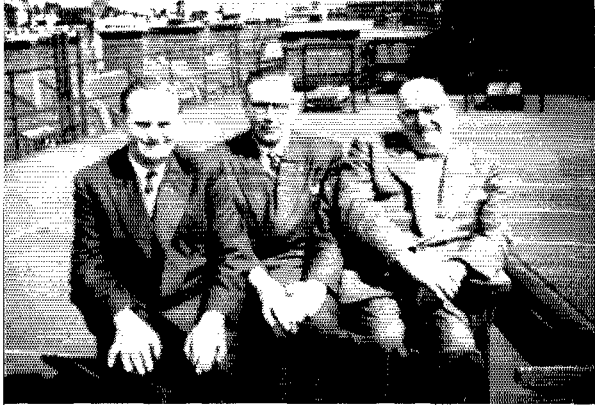

Left to right—G2AHL, G2MI and G6CL, of the Radio Society of Great Britain.

a number of rare QSL cards. A full-time secretary, OE3WB, is the oldest member in the club and a licensed ham since 1926.

What with my poor German and the fact that a number of those present spoke English fairly well, we were able to converse without too much difficulty. When OE1ER, who owns a very modern electrical supply store, heard that a W2 ham was at the club, he insisted that I visit him the following day. His station was very complete and up-to-date. Subsequently I called on OE1PC who is a teacher at one of the local high schools. From there I had no difficulty in contacting the States. It is interesting to note that all of the amateurs I visited lived in apartment houses. Central heating is a rarity and most of the rooms had their own stoves — either coal or oil.

The following observations apply not only to OE hams but also to those visited in the countries described below. All of them were troubled with BCI and some TVI. I say some TVI because TV sets were still too costly for the average family. Because of this interference problem, a number of the amateurs have taken to narrow band f.m. or do not operate their transmitters until late at night. It seemed that more of them transmitted on 28 and 21 Mc. than on 14. Beam antennas were very rare — most of the rigs I saw used either dipoles or ground planes. The receivers were either of the army surplus type (a number of them of German manufacture) which had been converted to the amateur frequencies or of the home-made variety. I saw no receivers of American make and was told that they were far too expensive, what with the initial cost plus a high duty. While on the subject of receivers, I was, of course, asked what I used. When I said a Collins 75A-4, I was looked at with great awe and I had the feeling that they thought I was a millionaire on a holiday! I hastened to inform them that a large number of hams in the United States were also using them. None of those that I met on my trip were operating single sideband. The power line voltage in most of the cities was 220 and there were numerous complaints about the voltage drop, particularly during the evening hours.

My next stop was Salzburg, Austria, which is a short distance by train from Vienna. This is a small, very ancient and picturesque city noted for its annual music festival and as the home of Mozart. I had been advised that if I did nothing

else, I must contact Hans Wieder, OE2HW. Dutifully, I dialed his number from my hotel room. As the dial tone stopped, a voice said, "Welcome to Austria. This is OE2HW." Since I had not said a word, I assume this was his standard salutation. He said he would call for me in half an hour and escort me to his apartment.

One of the interesting things about ham radio is the fact that you never have the slightest idea what your contact looks like. Hans was 62, white hair, tall and full of enthusiasm. In fact, his enthusiasm for amateur radio had overflowed into his family, and both his daughter, Inge, and his son-in-law, Karl, were also hams. Retired now, he has two other hobbies, mountain climbing and photography. He was truly one of the OE oldtimers, licensed since 1927.

The following night, the NYL and I were invited to attend a meeting of the Salzburg Amateur Radio group, which was held in the beer stube of a small hotel. When I asked why they happened to choose this particular room, the answer was, "One of our members owns the hotel." A wonderful spirit seemed to pervade the group, which was exemplified by an incident that took place while I was there. I noticed that a collection was being taken, and when I asked the purpose, I was told that a Yugoslavia ham had informed one of the members over the air that his daughter had been stricken with polio and he had no funds to pay for her medical treatment.

From Salzburg to Munich, in Germany, the route led through the heart of the Bavarian Alps — a thrilling panorama of snow-covered peaks and broad green valleys. Munich, the capital of Bavaria, is a large and bustling metropolis which still shows some signs of Allied bombing. It is also the headquarters of the very active DARC, the Deutscher Amateur Radio Club, which claims almost 9,000 members. I was fortunate in being able to meet DL3JE, their very able vice-president, who is also head of the Air Traffic Control School at the Munich Airport and DL3TJ, an instructor in the same institution. After visiting the latter at his apartment and making a number of contacts to the States, we embarked on an extensive sightseeing tour. Our first stop was at the famous Siemens & Halske Electric Museum. This concern would correspond roughly to our General Electric Company. The next morning I was shown through the school at the airport and then spent an hour in the traffic control tower. It is interesting to note that English is the universal language used on the Continent in all contacts between ground and planes. The following day we drove out into the suburbs to visit a famous abbey noted for the wonderful beer that is brewed by the brothers. I need hardly add their reputation was well deserved.

When it was time to depart, DL3TJ and 3JE were at the airport to say goodbye. They pinned

a DARC badge on my lapel and waved a fond farewell as the plane taxied to the runway.

The advantage of traveling by air in Europe is that different countries are only hours apart. From Munich to London the time was four hours. I had heard so much about the Radio Society of Great Britain and particularly Arthur Milne, G2MI, that it was pleasant to contact him by phone. He suggested that I meet him in front of a well-known church a few doors removed from their headquarters. When I asked how I would recognize him he said, "It should not be too difficult — I am 6 feet 2 inches in height."

The RSGB rooms occupy the entire top floor of an office building at 28 Little Russell Street in the Bloomsbury section of London, close to the British Museum. There I had the pleasure of meeting G6CL, their secretary, and G2AHL, his able deputy. We went to the roof for a wonderful view of the city, and thereafter talked about ham radio in our respective countries. Their organization has close to 10,000 members, and their patron is none other than H.R.H. the Duke of Edinburgh. I glanced through a number of copies of their very excellent monthly magazine and before I left joined RSGB as a regular member.

From London I headed north to the land of windmills, canals, tulips, and bicycles. I had become very friendly with PA0RL over the air, and he was the first person I looked up after my arrival. From him I learned that there were about 115 active amateurs in Amsterdam, most of whom were members of RCA — the Radio Club of Amsterdam. As far as I could learn, only a very few were on s.s.b., the balance working n.b.f.m., a.m. and c.w. Although there is only one television channel in operation, the matter of TVI continued to plague the group.

I visited PA0JD, one of the first licensed hams in Amsterdam. While there I contacted PA0YJ and PA0QK. After I had given the former my call, he came back with "Hello, W2DAY PAX PAX, you are the first W2 I have ever worked without QRM, hi!" On one day PA0JD, myself and the two NYLs took a trip to Volendam and the Isle of Marken where the men still wear the familiar wooden shoes and baggy trousers and the women's colorful costumes are all identical.

Over the years I have had many contacts in Denmark, and I looked forward with great anticipation to my visit in Copenhagen. I also wanted to find out whether it was really true that in this country the women smoked cigars! I found out soon enough. At a restaurant on my very first night, the adjacent table was occupied by a middle-aged couple. When they finished their coffee, the lady opened her bag, took out a large cigar, her husband lit it for her and she puffed away contentedly.

There are approximately 1,700 amateurs in Denmark, of which about 800 live in Copenhagen or the general vicinity. Not all of this group is

active at the present time. I had the pleasure of visiting OZ4H, the QSL manager for Denmark. He lived in an apartment with his wife, sister and mother, the latter a delightful elderly lady of 72. After coffee had been served and remembering what I had seen the previous night, I offered her a cigar. She accepted it, smelled the tobacco, lit it, puffed for a few minutes and said, "Sehr gut." Then her daughter and I followed. I asked OZ4H how many cigars his mother smoked. "Too many" was his reply — "10 or 12 a day!"

In talking to amateurs in the various cities, I found that they were keenly interested in radio developments in our country and asked innumerable questions about our latest receivers and transmitters. In Germany, the DARC even went so far as to translate and mimeograph some of the more important articles from the pages of *QST*. But as they remarked, often 12 months elapsed before they were received by the local chapters. With a very few exceptions, none of the hams I spoke to subscribed to *QST* and I soon discovered the reason. The wages received in Europe are a very small fraction of those obtained in the United States, and the subscription price of \$5.00 loomed as a large sum. When I told them that in the future I would see that they received all of my old copies, the looks of appreciation were so heart-warming that I decided upon my return to make a plea to all the readers of *QST* to do the same thing. The cost of mailing from this country is very low — I have already sent 10 copies in unsealed envelopes marked "Printed Matter" and in no case has the postage exceeded 10¢. I was told repeatedly since ours is a technical magazine, old copies are just as welcome as the latest issues. Let us all resolve to put some of our good DX friends on our mailing list and strengthen still further the wonderful bonds we now enjoy with those across the sea.

I cannot begin to describe the grand feeling in being able to meet face-to-face for the first time persons who heretofore were simply a distinctive voice or the sender of the coded word. The easy introduction, the use of first names and our great common interest, all created the atmosphere of old friendships of many years' standing. Ours is indeed a unique and wonderful hobby and I came away with the thought that perhaps in our own small way, we amateurs were making a very worthwhile contribution to international understanding and good will — both of which are so vitally important in the troubled world of today.



This is DL3TJ, of the Deutscher Amateur Radio Club.



Correspondence From Members -

The publishers of *QST* assume no responsibility for statements made herein by correspondents.

NOVICES

Presque Isle, Maine

Editor, *QST*:

In the June issue of *QST* K2VBL turns thumbs down on Novices and classes them as a nuisance. I for one would like to be marked as regarding this as a very short attitude. I will agree that the 15-meter band is too wide, that the QRM on novice bands is terrific and that Novices (and Generals) get out of hand and band at times, but please don't forget that we all had to learn sometime. I will defy the man who says he can learn all from the book without experience.

I was studying diligently for my General ticket in my spare time and recently decided to pick up a Novice ticket to get on a little earlier. Since my ticket I have had many enjoyable hours on the air and have learned more about theory from actual experience than from many hours of study.

As an employee in the electrical power industry in a supervisory capacity for the past 13 years, I see the dire need for more young men to become electrically-minded. The spark and initiative they need comes from just such a medium as the Novice ticket. Don't forget that a percentage of these youngsters will become our fine electronic experts and technicians of the future. I also find that all Novices are not youngsters. I think that to discourage Novices is to chop at part of the foundation of a strong organization and to help weaken the technical strength of our nation for the future. . . .

— M. S. Mosher, KN1GNB

160-64 27th Avenue
Flushing 58, New York

Editor, *QST*:

K2VBL's letter came as close to my thoughts as any I've ever seen in your magazine (but then again, I know you hold back from print many good letters because they dare disagree with your policy) and was quite surprised you printed it. I am dead-set against your pampering of the Technician Class licensees. These guys are "eating too high off the hog" for no justifiable reason. And they are enjoying this state of affairs through the efforts of the League.

The Novice matter can be cleared very simply by remembering that they are *only* Novices, and as such should concern themselves with attaining 13 w.p.m. rather than WAC and DXCC. Take away 15 meters from them and get them back to 80 and 40 meters; they'll get that 13-per much faster then, with the incentive (a forgotten word these days in ham radio) of DX laying just above 13 per.

— Al P. La Plata, K2DDK

10504 Holly Drive
Everett, Washington

Editor, *QST*:

When the Novice Class license was first proposed, I was one of those who opposed the idea. Now that we have had the Novice with us for several years, I feel that my opposition was mere prejudice with no facts to support it. The presence of hundreds of top-notch operators who have come up through the Novice ranks is ample proof that my attitude was unreasonable. I wish to apologize to all Novices, past, present and future.

It is evident from letters recently published in *QST* that there are those who would like to see further restrictions placed on Novice operation, particularly in the 21-Mc. band. This is undesirable because this is the band that offers reasonable assurance of DX contacts to the Novice licensee. These letters also cite certain bad operating practices ob-

served on the Novice bands. Because the average Novice is unable to receive International Morse at the normal speeds found on the General bands, it is evident that these habits must have been acquired by listening on the various phone bands.

It is not for us to propose restrictions or to criticize, but rather to offer a helping hand and by example assist these newcomers to become the type of operator that will bring credit to the amateur fraternity — the type of operator that we all wish we could become.

— Robert C. Olin, W7ALU

868 E. 7th Street
Brooklyn 30, New York

Editor, *QST*:

I don't see what all these Generals are griping about. I will admit that there is quite a bit of un-understandable hash on the air due to inexperienced Novices and that the Novice test is so simple that most any darn fool can pass it but there are many Generals that are just as much at fault when it comes to causing QRM. If these Generals would just show some courtesy and knowledge of operating procedure, about half of this junk on the air would be cleared up. . . .

— Kim Boriskin, KN2MGS

Box 262
Matador, Texas

Editor, *QST*:

Just a good word in favor of the Novice. Some of these so-called nuisances will one day be electronics engineers. All they need is some place to stir up their interest, and what better place is there than in amateur radio as a Novice?

Sure, the Novice will make some mistakes, but haven't we all at one time or another?

— O. W. Killingsworth, W5ZUQ

531 Ocean Avenue
New London, Conn.

Editor, *QST*:

One has to start somewhere in the game of ham radio and I say that the Novice license is the best first rung on the ladder to General and above. I'm an ex-Novice myself and I am absolutely certain that I could never have passed the General test without the practical experience gained as a WN. K2VBL mentions the harmonics, chirps, and break-break. Just how does he know for certain that the Novice is specifically responsible for the last malpractice on the bands? He cites no proof whatsoever. Besides, an ex-WN/KN has to learn from someone . . . could be an oldtimer, General or Extra Class? Who knows? . . .

— Tracy Levy, Jr., K1GZO

R.F.D. #1
Stony Point, N. C.

Editor, *QST*:

Since when should a 10-year-old boy be prevented from getting an amateur license because of age? I have heard many adults using the terms break-break-break. Some of the Generals on the air are more child-like than a lot of 10 year olds I know. The way for the General to stop these terms is for them to help these new amateurs instead of criticizing and writing *QST* with these foolish criticisms. . . .

As for the "Video Rangers," they will drop out when their licenses run out. If these "Video Rangers" were shown the correct operating tactics we would have a greater percent of hams sticking with amateur radio. Instead of

criticizing their TVI from improperly built rigs, the Generals should take time out and help and show them the correct procedure. In order to enjoy ham radio in the future the Novices must be given help instead of discouragement.

— Charles Blair, KN4RSR

— — — — —

San Antonio, Texas

Editor, QST:

Whatever hobby, profession, sport, or club you find, if you do not bring in new blood and expand the group it will wither up and eventually die. Amateur radio is the same way. This is the purpose of the Novice class license — to train people to be good General class hams. In the matter of youthfulness, let me say that we know several hams under 21 who can send and receive faster code than many of the oldsters. . . .

— David K. Ferry, K5H1F
— Joe Hester, KN5QJR

— — — — —

1122 North Cole Road
Boise, Idaho

Editor, QST:

Although I don't think the Novice should be done away with, I believe some changes should be made to discourage the "Video Rangers." Here are a couple of them: (1) raise the code speed from 5 to say 10 w.p.m. to encourage listening around the bands, which in turn should give the prospective Novice an inkling of how to operate and promote the idea that there are other letters in the alphabet besides CQ CQ CQ de KN7XXX, etc. (2) I believe the written exam should be stiffer so as to teach Mr. Prospective Novice how to keep his 6L6 from radiating on every band except his own.

— Bob Wilcox, W7FTK

— — — — —

Box 55
Carlinville, Illinois

Editor, QST:

Perhaps there are more Novices who believe that they are licensed so they can work rare DX only on 15 meters. Perhaps you, as such an influential organization, should write me and tell me what happened to the old idea that I had that the Novice license was granted for people to get their code speed up by ratchewing, not so they could develop keys that are stuck sending CQ DX. Perhaps you should publish your answer, as I am sure that there are many more Generals like myself who are entertaining this notion as I am.

— G. Huff, K9AUB

— — — — —

9 Cross Avenue
Methuen, Mass.

Editor, QST:

. . . Is it possible for a person to make the marked distinction between a General and a Technician class license and say that the Technician is a mistake, when the only difference is several w.p.m. in speed? Is it likely that the Novice with his few-kilocycle band gives such tortuous treatment to the General with his band-sweeping v.f.o.? Calling the Novice tortuous, has K2VBL ever considered the hold General licensee who with his mighty multi-hundred-watt transmitter slams down on the Novice band, drowning out our mere 75-watt maximum? The Novice and Technician have, in my opinion, inducted many of the young generation (true particularly in my case) to take an active interest in the field of amateur radio. . . .

— Felix J. Gollucci, Jr., KN1EKT
— Felix J. Gollucci, Sr., K1GQJ

— — — — —

135 Gibson Road
Bristol, Rhode Island

Editor, QST:

Evidently K2VBL has never been a member of a model airplane club and seen the warped, wrinkled and non-flying models turned out by the Novices in model aircraft building, and seen master model builders put aside their exact scale model to teach the Novice just how to open a tube of glue, explain just what is dihedral, how to do this and how to that until the meeting was over and the master

builder had not improved his model, but he had improved a Novice.

If the chirps are bothering you, get the call, correspond with the offending Novice and offer to solve his problem. If you hear disturbing harmonics, again follow the above suggestion; the letter you receive in return profusely thanking you for taking time to assist a member of the proletariat will make up for a solid week of chirps.

. . . One Novice (in our club) has constructed a binary computer; another has been awarded a full scholarship; the club vice president is a Novice/Technician; so are the activities manager; the club paper's editor and the public information officer — and the club membership is predominantly General Class! . . . — Nelson G. Beals, W1MUZ

— — — — —

906 West Sugar Street
Mt. Vernon, Ohio

Editor, QST:

In regards to persons yelling "break, break," I noticed a great influx of that type of individual back in '53 when the hitherto "restricted" bands were thrown open to all classes of licenses much too soon for anyone who took their Novice exam to have qualified for their General — so I feel he should have qualified his statement.

About doubling the number of hams in the U. S. — good! The military services recognize the value of the hams as do private industry and a lot of people in the electronics field have their tickets to thank as a stepping-stone to a wide-open field. Also due to the large number of hams our Government is the only one in the world that backs us up to the hilt and the more amateurs on the air the stronger front we present when commercial and foreign interests try to take our bands from us. . . . — A. A. Watts, W8OPU

— — — — —

East Beach Road, R. D. 1
Bradford, Rhode Island

Editor, QST:

. . . The real culprit is the chap who long since has received his General and continues to act like a Novice, sending 5 w.p.m., clicks and squawks, holding his key down, emitting lengthy CQs on a busy frequency, etc. Some never seem to learn either to operate properly or to adjust their rigs to emit a legal signal.

These are the birds that should be expelled from the fold, not the true enthusiastic Novice.

The answer is to tighten up in the General exams and let the Novice have his practice band until he really and truly qualifies. . . . — Bob Sweeney, W1FEQ

— — — — —

5371 Montgomery Avenue
Philadelphia 31, Penna.

Editor, QST:

. . . I'm 15 years old and I've been a ham since 13. I learned many things as a ham that I wouldn't learn in school 'til 11th grade, in both science and math. I am a normal teenager, like rock-and-roll, parties, dances, cars, etc. I feel that I have learned very much from ham radio. All that and enjoyment, too. But, about the Novice, that's just a starting point. Many of today's best operators and contest winners once held WN/KN tickets.

I'll allow the fact that many Novices are poor operators. But, many Generals (maybe even you or I) are also poor operators.

Hams are known for fair play. But, Mr. K2VBL, you're not giving the Novice even a half-fair chance. If you really believe what you wrote, that's your privilege, and I think that no one could change your opinion of the Novice. But, as a favor to today's and tomorrow's Novices, give them a fair shake and don't try to convince other hams that Novices shouldn't be. . . . — Bill Axelrod, K3DDW

THE HBR-14, AGAIN

RFD 1, Box 78-2
Atwater, California

Editor, QST:

There are thousands of hams in this country and probably most of them have something they would like to say or

(Continued on page 148)



Hints and Kinks

For the Experimenters



INEXPENSIVE AND RUGGED MECHANICAL CONSTRUCTION FOR CUBICAL QUAD ANTENNAS

THE CONSTRUCTIONAL details shown in Fig. 1 provide for the most simple, rugged and inexpensive cubical quad design that we have found. The method uses standard parts, completely eliminates welding and makes less difficult the job of attaching element supports to the boom.

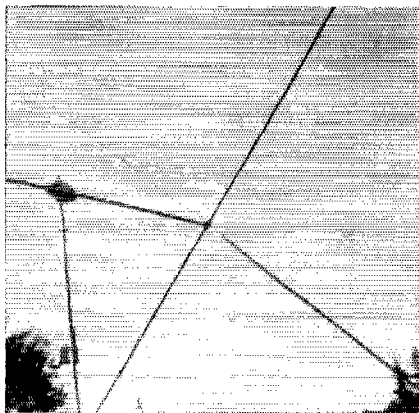

Fig. 1—VE3VU uses readily available "KEE" clamps and simple homemade bushings to mount the bamboo spreaders for his cubical quad antenna. Construction requires no welding or special machine work and cost is kept to a minimum. Method of construction may be applied to either single-band or multiband quads.

Readily available "KEE" clamps of the type used in making pipe frameworks were obtained at a cost of \$1.72 each. These clamps have four 1½-inch diameter openings spaced 90 degrees apart and another 1½-inch opening through the other axis, thus providing mounting holes for the antenna supports as well as a socket into which the boom may be slipped. Aluminum tubing, 1½ inches in diameter, was used for the boom and 8-inch lengths of this same material were used in assembling the bamboo supports. Each section of pipe is firmly locked in place by tightening up on the Allenhead screw already included for that purpose.

Plastic resin is used to pack the space in between the bamboo rods and the short aluminum supports. After the resin had set sufficiently to withstand drilling, each arm of the assembly was drilled (through the aluminum, the resin and the bamboo) to accommodate a bolt which adds mechanical strength to the junction.

Electrical details of the antenna are standard and require no additional description at this time.

However, the fact that the installation has withstood 80-miles-per-hour winds is of interest. Although ours is a single-band affair (14 Mc.), it is obvious that supports for additional antennas could be easily mounted merely by slipping some more "KEE" clamps along the boom.

—Frank Kehoc, VE3VU

SPLICING 300-OHM LINE: AN ADDITIONAL HINT

I HAVE had excellent results splicing 300-ohm transmission line by extending the system described by W9BPS on page 53 of *QST* for January, 1958. The method used here assures a strong, weatherproof joint and makes use of some ordinary kitchen-type wax paper and an electric flatiron. The XYL may immediately say "No dice," but you may guarantee her that the surface of the iron will not be damaged. The steps to be followed in making the joint are as follows:

- 1) Proceed through B (Fig. 4) of W9BPS's instructions.
- 2) Strip wire from scrap pieces of 300-ohm Twin-Lead, leaving only the insulation.
- 3) Cut insulation into 2- or 3-inch lengths.
- 4) Place one piece of insulation on each side of the spliced area and cover with a fold of wax paper (double thickness) as shown in A of the accompanying sketch, Fig. 2.
- 5) Apply heat—medium setting of the flatiron will do—to the wax paper until the insulation becomes molten.
- 6) Remove heat, allow insulation to cool and set, discard wax paper, and trim joint as illustrated in B of Fig. 2.

—Denzil O. Cooper, WØTXP

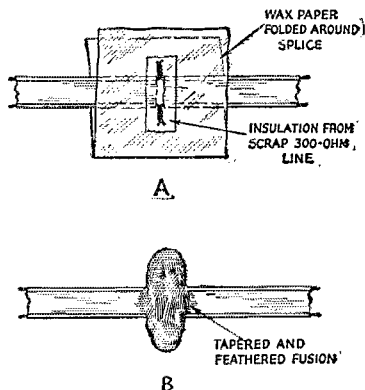

Fig. 2—(A) Sketch showing how WØTXP prepares a spliced 300-ohm line before applying heat with a flatiron. (B) The sturdy, weatherproof joint after excess insulation has been trimmed away.

REMOTELY-CONTROLLED COAXIAL SWITCH

ANYONE who has to jump up to manipulate coaxial connectors each time the band of operation is changed may have given thought to the installation of a remotely controlled coaxial switch. These same operators may be interested in the homemade affair illustrated in the accompanying photograph, Fig. 3. It is simply a B & W type 550A coaxial switch coupled to a Lcdex solenoid-activated slave switch.

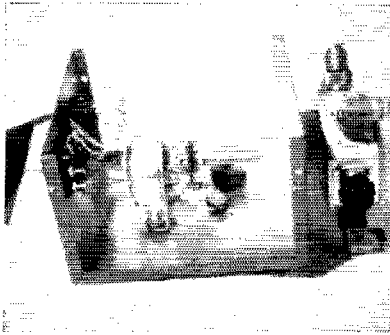

Fig. 3—The cover has been removed in this view of the remotely controlled coaxial switch. The coaxial switch is mounted on the right wall of the U-shaped structure and the electrically operated solenoid is bolted to the inside bottom surface. A terminal block for control wires is at the left.

The Lcdex is a 12-position pulse-operated solenoid operated from 115 volts a.c. It comes mounted on a base complete with line cord, selenium-rectifier power supply and a 12-position rotary control switch. The master or control switch may be remotely located with respect to the solenoid and is connected to the latter through a five-wire cable. The slave switch automatically follows the control switch regardless of which way it is rotated.

The 12-position switch has a 30-degree index while the B & W switch has five positions (plus one for the input cable) with 60-degree indexing. By coupling the two switches together and moving the master control switch two positions at a time, the B & W coaxial unit will switch five different antennas or, at the sixth step, completely disconnect all antennas.

The stop on the B & W switch must be removed because this switch may be required to rotate through a full 360 degrees depending on which way the remote control switch is turned. The solenoid shaft may be coupled to the switch more readily if the rear wafer, which is not needed, is removed so that the rear shaft guide may be moved forward toward the front of the assembly. A standard $\frac{1}{4}$ -inch solid shaft coupler may be used to gang the two switches.

If the unit is to be mounted outside near the antennas, it is advisable to use a weatherproof housing around the solenoid switch. Of course, with the assembly located adjacent to the antennas, it is necessary to use only one coaxial

feedline between the shack and the antenna farm. Short lengths of coax may be run between the coaxial switch and the individual antennas.

— Russell Wellner, W9QNO

FIXED-STATION OPERATION WITH A MOBILE ANTENNA

WE RECENTLY moved into a new home and although the main equipment was set up and ready to go, I lacked time to work on a permanent antenna installation. Casting about for a temporary radiator, I spotted the family bus adorned with a 40-meter mobile antenna. A high- Q loading coil is used with the antenna, and reports with my 12-watt mobile rig had been pretty good. So why not hook the fixed-station transmitter to the mobile antenna?

A 25-foot length of coaxial cable was run from the shack to the car in the driveway. The mobile rig was, of course, disconnected from the antenna and a straight adapter connector (PL-258) used to couple between the coax cables running from the fixed-station rig and to the whip.

The home station runs about 70 watts for voice-modulated operation and reports are nearly as good with the mobile antenna as with the regular antenna used at the previous location. Obviously, there is some operating inconvenience caused by connecting and disconnecting the coax each time you want to operate fixed-station, but the idea does provide a suitable answer for temporary operation and it may solve the problem when a landlord absolutely forbids even No. 37 wire strung around the premises. Naturally, one should avoid slamming the car door on the coaxial extension.

One final word of caution: Don't drive off before disconnecting the coax! It is reportedly very hard on a transmitter to be dragged down the street at the end of a 25-foot length of cable!

— Richard F. Van Winkle, W6TKA

ANOTHER METHOD OF INSTALLING "PROXOS"

THE "Proxos" proximity relay switch described in *QST* for March, 1957, appears to have great merit as a neat and clean way to turn on automatically the oscillator or v.f.o. of almost any transmitter. Perhaps, though, it would be convenient to replace the "feeler" wire with a small metal plate, the plate being located near the knob (or paddle) of the key. When the fingers are moved to the knob, "Proxos" would switch on the oscillator, while the key would control the buffer in the usual manner. When the fingers are moved away from the knob, the oscillator would switch off.

It is estimated the oscillator would normally start about $\frac{1}{2}$ second before the first transmitted character and hang on about $\frac{1}{2}$ second after the last, but, of course, this would depend entirely on how fast the fingers were moved in the region around the sensitive plate.

— W. A. Monahan, jr., W6GTR

SNAP-ON CABLE CLAMPS

Ordinary snap rings such as used with punched loose-leaf note paper make ideal clamps for securing coaxial line and multiwire conductors. They may also be used as a substitute for lacing cord or other binding in the construction of a multiwire cable. Cables or wires held by the clamps may be easily moved or serviced merely by opening the rings, performing the necessary operation, reinserting the conductor/conductors and snapping the rings closed. Small screw eyes may be used to fasten the rings to wooden surfaces.

The snap rings are available in a variety of sizes and can be obtained quite inexpensively from stationery supply stores.

— William A. Cline, W2DMU

RG-8/U IN THE GAMMA-MATCH CAPACITOR

AMATEURS WHO contemplate installation of a gamma match may be interested in construction which uses RG-8/U coaxial cable as the inner or variable element for the gamma capacitor. The mechanical details are not difficult to duplicate and the assembly may be easily adjusted and waterproofed.

Details of the capacitor are shown in Fig. 4. The fixed section of the capacitor is an appropriate length of aluminum tubing having an inside diameter that will fit snugly over RG-8/U after the latter has been wrapped with good quality tape and then coated with plastic spray. Dimension A controls the length of the gamma rod, and the capacitance is determined by dimension B; the capacitance will increase as B is made longer.

One inch of the outer jacket must be removed from the input end of the coaxial element (Section C) in order that a copper band for feedline termination may be soldered in place. Be careful not to damage the shield braid when the insulation is being removed because the copper feedline terminal must be soldered to the exposed shield. After the coaxial section has been prepared and then inserted in the aluminum tubing, adjust at D for a spacing that will prevent shorting between the shield braid and the aluminum tubing.

The inner conductor of the coaxial feedline is terminated at the copper terminal provided and the shield for the line is attached to the boom. The coax line should be taped or clamped to the boom to relieve strain at the termination points. Coarse adjustment of the capacitance is made by varying the length of dimension B. Start with

more than enough coax encased in the tubing and then clip off short pieces as adjustments and measurements proceed. Fine adjustment may be made by loosening the clamp at the outer end of the gamma bar and then sliding the bar back and forth over the coaxial element.

After the assembly has been adjusted for proper performance, it may be waterproofed by plugging the open end of the gamma bar with an ordinary cork and then coating the entire unit with plastic spray.

— Wm. J. Engle, jr., W3KKO

"UMBRELLA FOR TWO;" NOVEL GROUND-PLANE ANTENNA FOR 144 MC.

IHAD wanted to build a cheap-and-easy ground-plane antenna ever since the two-meter craze hit the Beaver Valley Gang. However, it took some activity on the part of local canines to get me started. After they had torn the XYL's umbrella to shreds, they left me with the prettiest set of ready-made two-meter radials you ever saw!

Paint was scraped from the inside ends of the ribs and these thoroughly cleaned areas were bonded together (soldered) with a length of flexible shield braid. A hole to accommodate the vertical section of the antenna was drilled in the top of the umbrella assembly. A 20-inch length of brazing rod fed with coaxial cable was used as the radiator.

One of the nice features is that I can still open and close the umbrella for convenient installation and transit. Furthermore, you don't have to be a drinking man to get the materials!

— Rollyn W. McMahon, W3ECQ

TIME SIGNALS ON THE GONSET SUPER 6

Some operators may not be aware that the Gonset Super 6 converter may be used for receiving time signals transmitted by WWV and CHU (Ottawa, Ontario, Canada).

The 7335-ke. signal from CHU may be received by adjusting the converter for 40-meter operation and then tuning just above the high end of the band. Transmissions at 14.67 and 15 Mc. from CHU and WWV, may be picked up with the converter switched to 20 meters.

The 14- and 15-Mc. signals are easy to find if you keep your eyes on the 10-meter dial scale while tuning. CHU's signal will appear with the pointer set at 29.3, and the 15-Mc. signal from WWV will show up at 29.7.

— Dr. Julian E. Greenbaum, W1LIG

Fig. 4—Sketch showing the details of W3KKO's gamma matching section. The gamma capacitor is made from a length of aluminum tubing and a section of RG-8/U coaxial cable. Although the inner conductor of the coaxial cable is not used, it need not be removed.

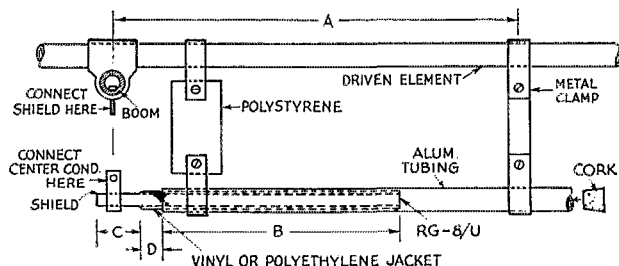



CONDUCTED BY ROD NEWKIRK,* W9BRD

Whew!

Warm, eh? Or are you a KL7? This is a good month to pass up polemics and grind out something innocuous for the file. It's time for our photofiscal triennial, anyway, the presentation of snapshot statistics calculated to allay such queries as "Where did I see that picture of FD4BD?" So, picking up where we last left off (August 1955 QST) we add three more years to your DX family album directory:

1955

July: OZ2KR, I1ER, CT1CO, OE5AH, YK1AA, 3V8AS, EA9DF. *August:* SM2YP, VP8AQ, KC0ZB, CR7DK, CX2CF. *September:* F3BR, CR9AH, JA1ATF, VR3A, Aland OH1s NK PI RX SS ST, SV group, HB1HT & Co. *October:* 4X4FV, SU1IC, LX1AO, FK8AH, VS5CT. *November:* OA5G, HR group, HB9 group, VS2DW, EA0AC. *December:* PX1EX crew, SU1AS, DL3BJ, PA6JA, HZ1AB.

1956

January: JA6AO, MP9AL, KR6LJ, HP1EH, 4X4BL, HA55B & friends. *February:* HB9KB & 3A2s, VP1EK, FD4BD, KX6AF, OQ5BI. *March:* KG4 group, OK1CX, IS1EHM, VU2SX, DU1FC, YN1RA. *April:* VP8AZ, HR1MO, OA9AL. *May:* YN1KK, JA1CV, OQ5BI, VK5ZR, E1 Field Day, Z63JL. *June:* FB8BR, OD5BS, JA1CV. *July:* AP2RH, H18FR, KR6QC, OY7ML, XZ2KN. *August:* HCW, LU5DC, SP5KAB, CT1NT. *September:* VQ5GC, JA1s AGU AEA, ZM6AS, FM7WN, EI5C & staff. *October:* F9MS, KA2NY, ZD3A, VP5DX, ZS5MP, DJ2LK, 487MR, Aland OH1s RT ST SU, ZB2s T & R, HC1ARE. *November:* VS1CZ, ZL2GX, HB1CZ/vs, ZP9AY, FL8AB, SP3PL, ZD4 hamfest, VS6 clubbers. *December:* SM8KV/LA/P, 487PT, WL7BUS, KG1s AG AX.

1957

January: HB1CM/HE, 3A2BH with HE9RDX, HK3AB, AP2U, UA3EG, VR2AK, ET2US. *February:* PY2CK with W1FH, ex-VR3D & Pacific friends, SM5KP with Gs 2MI 2PL 3HLS 4ZU, CR5SP, 487GE, VQ5EK. *March:* UR2-KAA, ZD9AE, YO3RD, CR9AH with W2APF. *April:* M1B, MD5s ADZ AMO DNG, SP6BZ, CR7BS, VS2EF, CN8JX. *May:* BV1US, UA1AB, H18SKE, HS1MQ, EA6-AM. *June:* UA9KAD, YO3GM, DL4ZC's DXCC², HH2Y, XW8AC, Warsaw CCIR meet. *July:* XZ2AD, OH3AA (OH3OD), KW6CA, DL9AU, FK8AS. *August:* CR7s DQ LU, IT1ZGY, UP2AS, OA7I, RAEM, IS1ZTG, SMI-BJA. *September:* HS1A, I5FL, M1H, T19CR, LZ1KPZ, CR4AD. *October:* OH2s IK KQ on Alands, VE3AHU/SU, I5REX, HB9EU, SP5HH, HK7LX. *November:* HZ1AB, 4X4CJ, TF3KG, W6AM, OA5G, XZ2TH. *December:* HB1CZ/vs, PJ2AX, YO2KAC, HR2WC, LX2GH.

1958

January: LX1DC, FE8AE, DU6IV, GC2RS, EA6AF, VR2BC, SP1DC. *February:* HB1CZ/vs, UR2AO, OQ5HP, HL2AM, W4LUV's DXCC², OH1s RX ST & Co. on Alands, JT1AA, W6AM. *March:* FR7ZC, ZELJUM, FQ8AP, VQ3GC, 4X4DK, SU1IC, UO8AA. *April:* PX1YR, LU3ZS, VU2EJ, UA3BJ, OA4FM, FK8 PY ZS6 SVI groups, OY1R. *May:* FL8AC, VP8BS, W6GPB's DXCC², W1BB, LZ2KSB. *June:* TF2WCC, VE8AT, PY1CK10 (PY7SC), UA1DG.

Zooks! how time flies. Another fast pictorial DXCC for your "How's" picture gallery and

*4822 West Berteau Avenue, Chicago 41, Ill.

here are the guys, gals and groups responsible:

W1s BB BDI FH HDQ ICP NS QON QPN TS VG WPO WPR YYM ZDP, W2s BIQ BVS GKP IWP MUM OIIF, K2s BKU BSM IXD KHZ LHW OAH TCD, W3s BQA GHS GLE VKD, W4s CBQ HYW KFC LHT SET TFB ZMC, W5s ALA BRY RS, W6s AM ITH KG KQY MUR YY ZEN ZZ, K6s DV TJK, W7s ADS DJU PHO, W8s DAW DLZ HCW NBK OHV, W9s ABA EU FDX MQR RHI WHM, W0s QGI UQV VFM YFE; AP2RH, CN8MM, CR6AI, DU8s 1CE 78V, HE9RDX, I1FT, KC6AA, LX1AI, OK1s JX MB, SV0WO, UC2AF; Milwaukee Radio Amateurs' Club, West Gulf DX Club; William Rice and S. S. Lawrence.

A special salaam to W1s ICP VG WPO, W3s GHS VKD, W6YY, K6DV, W7PHO, W8DLZ and W9WHM, each responsible for three or more productions. Applause, too, for the dozens of loyal contributors whose proffered pix didn't quite make the team.

Factors in the selection of "How's" photos include reproduction quality, fame of station or operator, DX and ham atmosphere, general topicality, and make-up balance. Their appearance is an important part of our all-out effort to maximize enjoyment of amateur radio through heightening your DXperience. Got some likely prospects for publication? Send 'em along!

What:

Our shimmering summer DX world awaits the marketing of nonstick watercooled headsets and truly nonskid knobs. Meanwhile the season's soaring temperatures and sagging prop conditions continue to drive DROMs to the mountains and the shore. Luckily, however, enough persistent perspirers do remain at their dials to keep your "How's" Bandwagon rolling at a smart clip through thick and thin. Pull up some shade, a julep and a breeze, and help us winnow the mail. . . .

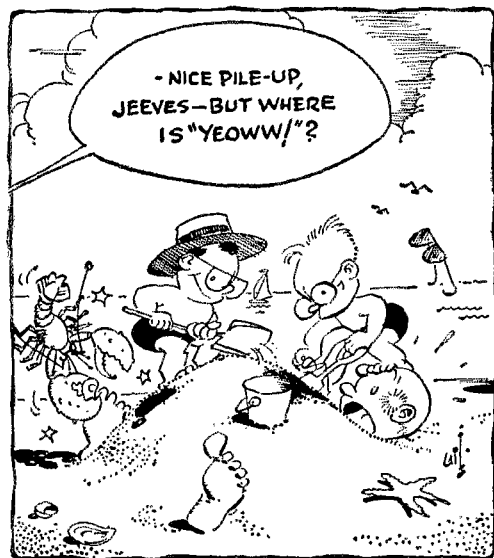

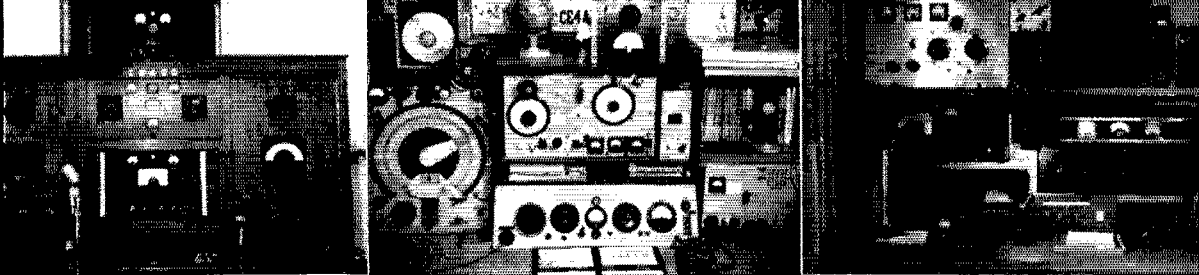

The operating positions of 9G1BQ, DL3TG and VQ4KPB, left to right, are interesting arrangements thoroughly worked by North Americans. The 9G1BQ console houses c.w., a.m. and s.s.b. gear for several bands, 14 Mc. preferred, including SX-24 and Eddystone receivers. DL3TG's layout (photo courtesy W7DJU) is an excellent example of European home-brew precision and utility. VQ4KPB's outfit hits 10 through 40 meters with a 30-watt 807 final modulated by 807s, the receiver an AR-88.

20 c.w., habitat of the decidedly DXotic interests W1s AZW BFK CTW MBX TS TUW, K1CBB, W2HML, K2s KAT LAK QXG RQC (56/40), UPD (127), UYG, W3LOS (61/35), W4s SMU TVQ, K4s HXF (151/129), IEX JOS RJM, W5QMJ, K5s IID (48/25), IZM (65/28), K1Z, W6s AAI JQB KG RLP (205/185), ZZ, K6s ALH (55/37), SHJ SXA THZ TXA (135/103), W7DJU/GYR, W8s BMM CSK IBX JGU (212), K8EGX, W9DAJY, K0DQI, KA8AF and VE7CQ with this arresting array: AP2AD, CE9AK (14,030 kc.), 2 GMT, CN2AQ, CN8s BK (60) 7, EM GU HW (40) 22, CRs 4AH (83) 4, 6A1 6CK (25) 3, 7CI 7DQ (60) 4, 9AH (49), 10AA, CT2BO (21) 1, DM2s ADL AELJ AIG AJB AOH, DUAs IDR 61V 78V (92), EA8 6AW (70) 2, 8BF 8CP 9AP (5) 1, 9BM (70) 21, ET3PRS (60), F9VQ, FC (66), FA8TT (60) 6, FB8s XX (12), ZZ, FF8BX, FK8AS (13), FL8AC, FO8AP (49), FY7YI (48) 1, GCs 2FZC (30) 6, 3AAE (93) 2, GD3FBS (10) 6, HA8 1KSA 5AM 5DH 5KBP 5KBR 5KFR 8CZ SWZ, HB4FE (40) 6 just Switzerland, HC1s LE MD 4, HE9LAC (51) 22, HK0AI of San Andres, HL8 18K (3) 16, IUS (4) 15, 2AJ (80), 9KR, HP5CC, HR2FG, HS1s C (20), E, ISLV 21, IS1MIM (32), IT1s AGA TAI (50) 7, JAs in all call areas save Nos. 6 and 9, JT1s AA (57), YJ, JA8 2ILQ, KG6 (80) 6, 4AQL KG6 4QLY KG6 6TSQ, KG6 (30) 5, KA8 2FEC 2MS 2BS 7FH 7TB 8KW 8RA, KB6BJ (81), KC4s USB (80) 7, UH8 UKS (28) 15, KC6s JC (17), ZD (40) 13-16, KG6s AAY (87), PAE (91), NAA, KM6BK, KP6AL, KR6s CI FH QW RY SS, KV4AA (80) 20-22, KW6CE, KX6s AF BP (18), BT, LA2JE/P, LZ1s KBA (61), KN8 KSP (118) 10, OA4s MB (38), FT, OQ5s CP EH, OR4VN of Belgium's antarctic effort, OX3s DL (31), UD (15, 69), PJ8 2ME of Sint Maarten, 3AB 5CB, one PX1AA (30) of doubtful pedigree, PZ1s AP (30), AR, RAEM of Moscow, SM1BVQ (69) 2 of WGSAs desirability, SM8AQT, LA P (50) 21 way up north, SP8 2AP 3PH 4JF etc., ST2AR (77), SV8 18K 6WB 6WE (324) 5, 6WP, TF5TP (58), TGM9R, T1s 1WS/mmm 2PZ, UA9s CM JF, KCA KCC (110), KCK (97) 2, KOH (58) 2, KYB 6I, Antarctica's UAIKAB and UAIKAE/4/7 outposts, UA0s LJ JA JB JD JF JK JZ KAR on Dickson isle, KCQ KIC, KP2 KJA KJA KJF KJW KKB KKC KKD KQB KSE KUA LB LE LI, UBSs AQ BB BO FO KIA ND UF UV VU VV, UC2s AA AQ AT AU (16), AX BL CB KAR, AU, UD6s AM (16) 0, BG, DD (120) 1, K8K, UF6s AF (125) 1, FB (27), UO8s AK AT (70) 1, KAA, UP2s AA AT AW (62) 3, UO2s AH (40) 4, AJ (20) 7, AK (10) 6, AN BA, UR2s AN (70) 7, AO BV, VE8s AF AT FO NH PB, VK9s AD (30) 6, NT (40) 13, RR (70) 8 of Papua, XK (20) 11, VR0KT, VP8 1BS 2LS 2SI (35) 2, 3AD 3YG (58) 12, 5BH 5BL 5RS 22-0, 6PJ (58), 7BT (1) 1, 7NAI 8HR (57) 4, VO3s CF HD, VO8s AJC AQ ASR, one VR5AZ, VS8 1FZ (46) 12-13, 1GX 2DW (29) 2FK 6DK (20), 6DZ 6EC (20), 9AJ 9AP, VU2s AJ RM (71), W8 1RHO/KG6 4WHF/KG6 6BKL/KG6 6OWY KW6, XEs 1H 1YF 3BL, XQ8AG (80) 17, XW8AI (77) 10, XZ2TH 11, Yo8 2BM 3CD (4) 21, 3GK 3ZA (19), 6XU (50) 8, Y8IO (20) 3, YV5GO, ZCs 3AC 4RF 5AL, ZDs 2CKH 6DT (54), 7SA (80) 12, ZEs 1JV 5JU, ZKs 1AK (39) 2, 1BS (109) 4, 2AD 3-4, antarctic-based ZL5s AC of Camp Hallett, AD and AE of Scott, ZS8 2MI (20) 14 of Marion isle, 3B (68) 6, 4S7ZE, 4X4s CK JO, 5As 2TY (6), 4TC 5TH and 9K2AQ (76) 2, enough targets to take one's mine off heat and humidity!

20 phone keeps K2s QXG* UPD YFE, W6s OBH RLP YY, K6s SHJ TXA, W8s IBX JGU (now 100 on A3), KML and HK7LX well entertained, asterisks denoting sideband users: BV1s TC US, CR6AU, GT3AF (140), EA6AR, FF8AP (170), FG7XE, FK8AU (170), HK7LX (175), HL9s KR KS (140) 6-15, KT, JA1CG, KA2KM, KC4USH*, KG6s AAY (250), AGY AHU (230) 14, FAE*, KR6JN, KX6s BT BX (220) 6-15, CE (210) 7, PJ2AN, SP7FI (160), SV6s FR WB WE* (324) of Rhodes, WN, UAs ICC (130), 6LA, VK9s BS CP (180) of T.N.G., YT, YK6s KT (190), TC, VP8 2BA 3VN, VS8 IHX 2BS 2DW (170) 15, 2FR, 4JT* (304) 10, 5JL (97),

6AZ* (300) 10-11, 61J 9AJ, VU2RX, WHHXI, KW6 (240) 14, XE1WX, XW8AI (160), YN1AP* (305), YV5ABD, ZD1FG, ZK1BS* (305) 13 and ZS2MI. Some of these were hooked c.w.-to-phone style by W8 2HML 8BAX, K8 4IEC and 5IID. . . . K2QXG's protest should be heeded by sideband DX: "S.s.b. boys run on for hours without identifying themselves. Not worth the time and effort to find out who they are, so I'm back to c.w. this month." Come, come, now — at least every ten minutes, gang.

15 c.w. rides out the season's propagational vicissitudes in fine form with W1s CTW (113 on 21-Ac. c.w. 148 total), MBX, K1CBB, W2s JBL OQH, K2s LAK PPT RQC UPD YFE, W4SMU, K4s IEX LAY (60 on 15), MOF PHY RX, W5KLB, K5s IID IZM K1Z, W6ZZ, K6s SXA (145), TXA, W7QNI, W8s CSK YGR, K8EGX, K9GSG, W9QGI, K0JZW, KG1CK, VE7CQ and KP4KD (124 on 15 c.w., 228 total) collecting delectables like CE2AT, CN8s AB EE (30) 22, FM LC, CR8s 6AI (32), 7LU (40), CTs 1TT 3AB, CXs 1FB 2FD 9AM, DMs 2ACN 17, 2AEH 2AHM 3KDA, EA9AP (71), ELIK (80), FA8RJ 20, FB8XX (85) 11, FE8AI (48), FF8s AJ (39), HZ, FM7WT (23) 0, FO8AP (5), GCs 2FZC (55), 8DO, GD3FXN (50), HA8 3MA 5BI 25, 5DH (40) 17, 8CG, HC1s AGI LE, HK1FF (52), IS1CXF (60), IT1s AGA 18, AL JAs 3AB 3CS 15, 5DF 6PA 8GA, KA2YA 6, KB6BJ 11, KC4USB (28), KG6s 4AS 6FAE (72), KM6s AX 19, BK, KP6AL (48), KW6AB, KX6GQ (10) 22, LJ2F (94), LZ1KNE (60), OA4s AK AS BP, OD5s BZ (48), LX, OYs 1R 7ML 5, PJ2s AF AL 20, BA CJ (65), ME, PZ1AO, SP8 1JV 1KAA 2BE 2GS 6NF 7HX 23, 8CP 9AC 9CS, 9JA 9QS, SV6s WP (10), WY (70), TF3AB, TI2s LA (30) 22, RO (39), UAs 1BU 1KBB 2KAW (98), 3BF 3FG (40) 18, 3HI 22, 4KCE 4NB 6KDE 6KTB 9CM 23, 6GF 6KIA, UB5s CI CL CCB UW, UC2s AA AX (30) 20, CB, UF6FB, UH8JE, UJ8AF, UO5AA (18), UO2s AE mmm AN, UR2s BU (20), 2KAA, VP8 5NY of Turks, 6JR 6NG 7NG (12), 9DU 13, 9IVM, VO8s 2AB (41), 2AC 4KPB (4) 22, 4RF, VR3A, VS9AO, WH6CIZ, WL7CCJ, WP4AIQ, XEs 1YF 17, 2FA, YO3AQ, YV5BJ, ZEs DC DS DZ (30) 20, GUH, ZC4s IP (86), RF (22), ZE2JS (85), ZPs 5HK (70) 22, 9AY (15), 4X4s AC 17 and IV (15).

15 phone finds favor in the receivers of W1MBX, K1CBB, W2s LKW OQH, K2s KAT LAK UPD* UYG TFE, W4SMU, K4s IEX MOF PHY RXQ (87/41), W5KLB, K5s IID IZM K1Z, W6ZZ, K6s 1CS SXA TXA, W8s IBX (114/97), KML, K8EGX, K9s GSG ISP and K0JZW, mainly thanks to GE3RC, CN2BK, CN8s AB FA FV HW JC JS MM, GP1AM, GRs 4AI 4AS 5SP of Sao Thome, CT1GE, DU1GF, EA8 6AR 6AY 9EL, ET2US, FO8AK, FO8HG, GD3UR, HC8 1PJ 2KU 5MT, HL5RL, HI8GA, HK8 1EQ 3QV 4DF 5RZ 5ED 0AI* (443), HH9KT, HP3RL, HR8 3VM 8SM, HS1E, IT1CDS, JT1AA (90) 2, KAs 2ML 2RB 7TB, K6s 1DL 15, 1BE 4AL 4AQ* 6AGY, KM6s AX BK, KR6s CP RB, KX6s AF BT, OAs 4CS 4IGY 4V 5N, OE1s FF HE, OO5RT, OX3DL, SV0WS, TF2s WCW* WCY, TG9s AD AL MB (73), TI2s AAL HP* LA and YL PP, VKs 9AD and 9RH of Norfolk isle, VK6s KT and TO of Macquarie, VP8 1BS 2LB (75), 4TE* (448), 5BH* 5FH 6WS 6ZX, VS2s DW EV FR, VS90 (330) 22-23, XE1DT, XQ8AG, YN1s CJ FS (240) 3, MF, YS1s LA MS (240), ZA1AB, ZB1s DC RT, ZB2Z, ZP5MN, 4X4FV, 5As 4TH 4TM 4TZ 5TC and 5TY, asterisks signifying s.s.b. endeavor.

15 Novice news, or lack thereof, reflects the ebb of the m.u.f. WN6YKS, KN8s ICN2Z (six continents worked now), 1GUX 2HIY (25 worked), 5LZA 9KXM and 8LTB (109/50) nevertheless prevailed upon Pegasus for CN8LC, CT1s IQ TT, CX5CE, DM2AEH, EI5D, HI8BE, JA8s 1VX 4JU, JT1AA (132) 10-11, KA2YA, KG6s 1CK 4AS, OK1MB, SP6EG, TF2WCY, UA9s CR JF, UC2AV 3, VK5s LG QR, VQ4FK, WH6CQG, WL7CEJ, UO3VV, ZE1JY and ZL3OB. . . . KN0LTB, leading known Novice DXCC possibility, takes his General exam and keeps plugging for needed QSLs. "I think many Novices can learn from th-

success that KNs 4RID 5LMJ 5LZO 8GHG and others have had that a good antenna is half the battle. The other half? A resolution to quit calling CQs and listen once in a while!" Tony, on behalf of all the WN/KN gang, praises the many DX stations who patiently patronize 15-meter beginners. K6DV echoes likewise.

10 phone features fleeting DX openings and present pickings are slim. K1CBB, K2YFE, W4YQB (123/114 on 28-Mc. phone), W5KLB, K5KIT, W6ZZ, K8CFU, K9s G8G and ISF keep the ball rolling with CN8IV, G05CN, CP1AM, CR6s AI CA (420), CR7DK (420), FM7WT, HC5MT, HK7LX (470), KC4USW*, KH6s CHU SP SY UC, KX6BY, KZ5IF, OA4IGY some 20 miles from Lima on Sput-watch, PZ1AE, T12RLA, VKs 3ATN 6KW, VPs 2LB 3HAG 5CB 6KM 9HH, VQ2AV, VS9AP (470), ZDs 2LNWW 7SA 8JP, ZE2JK (460), ZSs 4F and 6AJH. . . . K8EGX keeps ten c.w. in the running with multiband specialist VP2SI.

40 c.w. suffers from static in its attic but W2s HMJ JBL, W3MQY, K4EX, K5IZM, K6DV, W7DJU, K8EGX and VE3BOH (ex-VE8OW) stick it out for such as CT2AI (30) 0, DM2AVN, FG2XA (20) 3, HA1VP, JA5 1AEA 1AFW 1ON 1PS 6MFE 1 7IL 7JA, K86BJ, LZ2KSB, Fernando de Noronha's PY7SC (9) 0, SP9KF, VE8PB, VPs 2SI 4, 7NG, YS2AF, YU1HKL and bona fide ZA1KC (15) 23. Eleven years of concentrated 7-megacycling produced 107 countries confirmed at W3MQY. Bob's main route to DXCC. . . . KN7s CAD and DBV give the 40-meter Novice slant, nailing VK3XB (149) 9-11. KN7CAD also bagged JA1BXS, and K6DV learns that more JAs are beginning to chase Yank Novices, transmitting just below the 7150-ke. mark. . . . K4MOF hears KZ5RD and VP7BO pursued on 7-Mc. phone, S.W. C. V. Edwards, still stationed in British Guiana, logged VPs 2GT 2GV 3EFG 3HAG 3IG 3VN 3YG 4MM 4TF 6HR 6KM, CT1IC, OA4GR, plus Statesiders K9KJD W4LX, W5s BBN KKT LFE RF, W6QUU and others on phone. . . . Eighty? Only K8EGX with VP2SI.

Where:

Europe — Rhodes DX scholars at SV0WB accept QSL inquiries only pertaining to contacts dating after November, 1957. W4BYD confirms their address as USCG Courier, WAGR-110, APO 223, New York, N. Y. An additional DM bureau is mentioned by WGDXC's *DX Bulletin*: Box 37, Strausberg 1, D.D.R. But, so far as we know, the regular Halle bureau is best yet. . . . Y03FN assures W9TKV he QSLs "200 per cent" but insists that cards be sent direct to the address following. Nino's 60-watt three-stager and dipole are regularly workable on 7000-7020 kc., 0300-0600 GMT. . . . "Niko of ZA1KC QSL'd direct, much to my surprise, even before I sent my own card." This from fortunate W3MQY who raised Niko on 40 c.w. Incidentally, ZA1KB specifies the same mail QTH. . . . As a rule ILEB ships a registered batch of QSLs Stateside once each month to confirm all new W/K contacts. "Conditions now down for U. S. QSOs — only sporadic openings on 15, few signals at all on 10. . . . W1TUW relays word from LA5HE, QSL sidekick for LA2JE/P of Svalbard: "Occasionally I receive QSLs by air for LA2JE/P contacts not included in my log extracts. These I check with Odd on my next schedule. In such cases the gang must be patient." . . . Yes, *never* give up! W1B1H, assisted by RAEM, secured a UAIKEC Franz Josef Land pastebord after a nine-year visit.

Africa — "OQ51G will be off the air for about a year while I'm in the States on furlough. I'm up to date on commitments for all cards received prior to the 1958 DX Test and will finish the job beginning in July. I hope to return to the Congo in mid-'59; meanwhile, QSL inquiries will be

answered from California." Marlowe's current QTH follows: . . . From ZD7SA QSL expeditor CN8GU via W1ZDP: . . . return to the States around August, at that time CN8JX probably will take over for Bob. The boys should submit standard-size s.a.s. envelopes when forwarding their confirmations. QSLing for ZD7SA and myself is quite a chore, believe me — mailed out 250 cards today."

Oceania — "ZK1AK appreciates IRCs from all who expect direct replies," declares K9DQI. . . . Volunteers W7PHO: "VRIC is mailing me his logs and I'll handle his QSL situation from here." Favor Bill with the usual s.a.s.c. courtesy, gang. . . . In WIA's *American Radio* we note that VK8EJ's bureau handled some 45,000 QSLs during the twelvemonth ending February 1958, about 12 per cent over the preceding year.

Asia — A2U, now inactive for undefined reasons, advises WGDXCers he will gladly entertain QSL inquiries regarding his past activity. . . . From the all-caps mill of KR0RY: "I QSL 100 per cent, via bureaus only, including each initial phone and c.w. contact and each different operator worked at club stations. Right now I'm at QSL No. 1650 after operating here since September 1, 1956. I'll QRT around mid-February of next year but my home QTH at W7LQN will remain good indefinitely. . . . KA2AL dismantled for Stateside return in June and expects to become a Texas Five shortly. Bob will accept QSL inquiries via his K9ATM home address. . . . We have QSL'd 100 per cent so far, with the exception of the 1958 ARRL Test, and we still need several states for WAS," chorus W7NIO and K4BTE, ex-members of K39ME. . . . "The KA7AS boys — Ron, Bill, Baker and Dan — are all back in the States now and KA7FT, myself, has been transferred to the KA7 area. I have all logs for both stations and will accept correspondence concerning overdue QSLs." Frank's new address follows: From ex-Y13AA (G3JFT/GW3JFT): "So far as we know Y13AA has QSL'd all stations worked. If any deserving party still has not received a card, reply to me with full QSO particulars."

South America — "I am having PJ5AB cards printed for shipment to the numerous stations I worked while in Aruba," assures W90FO. . . . VP6PJ, according to W6PLG, deems one VP4AR a privateer. . . . W3GHS, aiding the KC4USB QSL cause, informs: "All cards received here for KC4USB will be answered as soon as Steve returns with his logs around January, 1959." . . . W6OUN, contrary to some erroneous advices, never has filed HK9AI loggery. Bill relates, "HE0AI QSLs still go to Isla de San Andres via the Republic of Colombia. IRCs are appreciated but not necessary and all replies are forwarded via bureaus." HK9AI's sister and QSL manager pleads for patient understanding because "It's very difficult to be the only active HK9."

Hereabouts — W4RQR, Caribbean s.s.b. ambassador of good will, informs us of his new address: 5804 Accomac St., Springfield, Va. Bob is hospitable to QSL inquiries concerning early-'58 sideband activity at VPs 4TF 5AB 5B1 5RS 6LT, FG7XE and FM7WT. . . . Bear in mind the desirability of s.a.s.c. when accepting W8VDJ's VP2DA QSL assistance, urges WGDXC. . . . Abetted by W6TNS, KG1CK launched an assault on his QSL backlog in June. . . . W7QNI believes it cannot be overemphasized that overseas stations often appreciate W/K QSLs as much as we savor theirs. It's a poor reflection on the state of the art's ethics when any European must work several stations in a given state before a WAS-clinching pastebord finally appears. August 10th through 16th is International QSY Week, you know. Let's clear all debts, now — and stick with that overlovin' GAIT club. W1s CTW, LLF TS TUV WFO ZDF, W2s BUI HMJ, K2UPD, W3s MQY VKD, W4TVQ, K4s HXF IEX RXQ, W5ERY, W6s APT AM JQB KG RLP YY, K6s ALH ICS,

The lure of high adventure led K6BAZ to a position with the Scripps Institute of Oceanography at the age of 18. After preliminary voyaging in Alaskan waters Doug headed for IGY doings in the south Pacific aboard *Spencer F. Baird* in October of last year, accompanied by a Viking I, SX-99 and a cache of spare parts. Exciting months that followed saw stops at Fakarava, Tahiti, Rapa (shoreline at center), Chile, Peru and Easter Island. As CE0AG on Easter, K6BAZ piled up some 700 QSOs in three short days. K6GKU supplied valuable assistance at home base and routed most QSLs through bureaus. K6BAZ weds this month and then is off to sea again, this time to India.

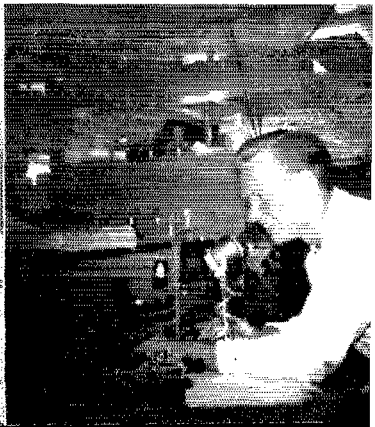
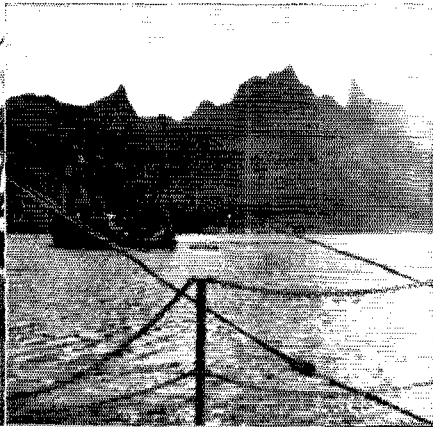

W7s AMM QNI, W8s BMX CSK, K8HFO, W9s DMY
 DRS IRH NN TKV, W9QGI, K8DQI, DL4s XC YK,
 E19Y, DeRidder DX Club, Motor City Radio Club,
 Newark News Radio Club, Northern California DX Club,
 Southern California DX Club and West Gulf DX Club
 direct your attention to these postal possibilities:

BVIUSC, Maj. M. S. Arbogast, Army Sec. SFAAT, Unit
 5, U. S. Army Elem. MAAG, Taiwan, APO 63, San
 Francisco, Calif.
 CN8HA, Lt. Comdr. G. E. Olson, SC USN, Navy No. 214,
 Box 8, FPO, New York, N. Y.
 DL4ADI, J. Bensier, 176th Sig. Co. (Rep.), APO 46, New
 York, N. Y.
 ex-DL4DM, SFC C. S. Self, Aviation & Meteorological
 Det. 5, AEPG, Ft. Huachuca, Ariz.
 ex-DL4FF, Capt. H. Z. Kakklikian, Hq. 16th Sig. Bn., Ft.
 Huachuca, Ariz.
 DL4HD, M. Dorworth, 229th Sig. Co. (Spt.), APO 46, New
 York, N. Y.
 ex-DL4RE, Maj. H. M. McDonald, Post Signal Officer, Ft.
 Hood, Texas
 ex-DL4UI, CWO C. Thomas, Sig. Section, Ft. Harrison,
 Ind.
 DL4USA, Hq. 160th Sig. Gp., APO 46, New York, N. Y.
 DM3KPN, P. O. Box 145, Werdau, Germany (D.D.R.)
 EA7FM, Box 479, Seville, Spain
 EA8CP, Box 215, Santa Cruz de Tenerife, Canary Islands
 ET2TO, H. T. Orr, 821 26th Ave. N.E., Minneapolis 18,
 Minn.
 ex-F7CG, Maj. F. Ivey, Hq. 6th Army Sig. Section, Pro-
 sidio of San Francisco, Calif.
 FO8AP, Michel Bruu, Papeete, Tahiti
 FY7YI, Paul Canavy, Cayenne, French Guiana
 HH5RL, Roland Lamy, Le Borgne, Haiti
 HS1E, USA CAN Stn., APO 74, Box B, San Francisco,
 Calif.
 K4AOL/KG6, M. Sgt. W. Willis, 27th Comm. Sqdn., Box
 163, APO 334, San Francisco, Calif.
 ex-KA2AL (to K9ALM)
 KA4AS (to KA4PT/KA7)
 ex-KA4-S-7EB, Lt. E. A. Bates, U. S. Army Elem. NSA,
 Ft. Meade, Md.
 KA4PT/KA7, F. A. Treadwell, U. S. Army Sig. Research
 Unit No. 3, APO 929, San Francisco, Calif.
 K6GZD (via W3ZJU)
 KR6HP (to K2LEQ)
 KR6JL (to W5ORH)
 KR6JR, J. R. Hunt, 1962nd AACs Sqdn., Box 231, APO
 239, San Francisco, Calif.
 KX6CH (via K6GMQ)
 LB9OE, R. Hansen, Halal Shipping Ltd., Camp Aden,
 Aden
 MP4RCJ, S. J. Sabo, jr., 38 E. Munson Ave., Dover, N. J.
 OA4BW/8 (to OA4BW)
 OK3AB, Gajana 7, Bratislava, Czechoslovakia
 OQ5DG, M. H. Schaffner, 6443 E. Eberle, Lakewood, Calif.
 PJ5AB (to W9QFO)
 PY3AFO, N. C. Rockett, Arroio Grande, Rio G. do Sul,
 Brazil
 SP5AA, E. Pokropek, Box 40, Warsaw 12, Poland
 TG9MB (via TG9AG)
 TG9AA (via TG9MG)
 UA4KAB, Box 158, Stalingrad, U.S.S.R.
 VK2AYY/LH (to VK2AYY)
 VK4AL, E. Brown, Clontarf Beach P. O., Redcliffe, Queens-
 land, Australia
 ex-VK9JF (via VS1FJ)
 VK9RR, R. Hooper, Box 56, Port Moresby, P. T.
 VK0KT (W. Ks via W2SSC)
 VP2AB, J. Brown, jr., P. O. Box 19, St. John's, Antigua
 VP2DA (via W8VDJ)
 VP5CB, MCB 7, FPO, New York, N. Y.
 VP5RD, Box 21, Kingston 5, Jamaica
 VP7BT (via VP7ND)
 VP8CR, L. W. Barclay, 67 Oakleigh Park Dr., Leigh-on-
 Sea, Essex, England

VP8CV, P. O. Box 188, Port Stanley, Falkland Islands
 VP8DF, P. O. Box 195, Port Stanley, Falkland Islands
 VO2FC, V. P. Cotton, P. O. Box 17, Broken Hill, No.
 Rhodesia
 VR1C (via W7PHO)
 VR4JB, P. O. Box 49, Honiara, Guadalcanal, Br. Solomons
 VS9O (via R8GB)
 XE1RM, J. A. Romero, Box 726, Guadalajara, Jal., Mexico
 XE0DOT (to W6ATO)
 ex-XW8AG, R. Maspmiby, 9 rue Ornaud-Bernard, Tou-
 louse (H.-G.), France
 ex-YI3AA (to G3JFT)
 YO3FN, N. Oneci, P. O. Box 11, Bucharest, Roumania
 YV0AB (via KV4AA)
 ZA1KC, Box 42, Tirana, Albania
 ZB1RT, FASRON Special 201, Navy 240, Box 14, FPO,
 New York, N. Y.
 ZD1EO, E. Owen, c/o Army P. O., Freetown, Sierra Leone
 ZD1FG, A. Torrie, UNESCO, T. A. Mission, Teachers
 College, Hjala, Sierra Leone
 ZD8JP (via R8GB)
 ZL1ARB/nm, *HMS Rotuiti*, GPO, Auckland, N. Z.
 ZL2GH, B. E. Atewell, 785 Childers Rd., Gisborne, N. Z.
 ZP5HZ, c/o U. S. Embassy, Asuncion, Paraguay
 ZP5TQ, c/o U. S. Embassy, Asuncion, Paraguay
 ZS1O, J. F. Lategan, Box 17, Stellenbosch, C.P., So. Africa
 ZA2CF (via R8GB)
 3V8BX, Box 303, Tunis, Tunisia

Whence:

Oceania — Further notes on K6BAZ's Polynesian pat-
 rol: "On November 10th we stopped at Finkarava atoll,
 roughly 16°S and 146°W. There I traded cigarettes, cloth-
 ing and fishhooks for the use of a grass radio shack. I was
 set up in two hours, knocking off numerous W/Ks on 10 and
 15 meters. Two days later we headed for Tahiti, truly the
 Jewel of the South Pacific, where I found the island's mains
 carrying 250-volt d.c. My 750-watt 110-volt a.c. putt-putt
 was worth its weight in pearls! Then it was back to the ship
 for more maritime-mobile QSOs while en route Rapa. Here it
 was impossible to land gear, so I operated aboard the
Baird. Some 25 days later, after stops in Chile and Peru,
 we anchored off Easter. The many caves on the island are
 sacred to the natives so I settled for a tumbledown shanty
 for my CE9AG ham shack and QSO'd one station after
 another, 15 to 17 hours per day, for the next three days —
 busy! Then, homeward bound. . . . Cocos correspond-
 ence from W3VKD has VK9JF dismantling in favor of
 probable VS2JF work. "Mike will leave his rig behind but
 it is not known if his replacement is interested in hamming.
 Meanwhile, VK9LE will be active on 23 Mc." . . .
 VR1C's return to the air was facilitated by a rig and v.f.o.
 courtesy W6GFP, says W7PHO. . . . W9IRI finds
 that KM6BJ formerly signed KH6ASG. . . . "Other
 duties, a term in the hospital, power-supply troubles and
 the oppressive QSL burden have limited the activity of
 PW8AA," informs W8KML. . . . KB6BJ (W3PZW)
 refuses to WZDP: "DXing is good out here. This morning
 I went up to No. 89 with VP7BT and a possibly phony
 HB1." Hi! . . . W6YY finds Macquarie adequately
 represented by VK0s KT and TC on 14 and 21 Mc., phone
 and c.w. . . . K1CBR discovers that Kent county,
 R. I., is at high premium for VKs and ZLs in search of
 WANE certifications. . . . Check with ZL1s APM
 or TB for data on the Auckland Branch (NZART) Certificate
 newly available world wide. Briefly, the deal calls for con-
 tacts with 15 or more Auckland NZART members but,
 "No QSLs need be sent with applications if a confirmation
 is held by each Auckland station. If the applicant has not
 received a QSL we will endeavor to obtain one for him.
 Special stickers for 'all phone,' 'all c.w.," and for each addi-
 tional five stations will be supplied." Candidate ZL1s in-
 clude BC CE DH DD GH GI GX HL IG LB LT LZ MQ
 MT of QR RV TB TL UP UR VA VZ WE WEAZ ACI
 ACP ADA AFI AFO AFW APZ AHZ AIV AKU AMM
 APL and APM.

Amateurs of the Ukraine, in mid-1955, took the lead in dissolving a four-year Russian embargo on outside-the-Curtain QSOs. Two representative operators in the region are UB5TV (left) and OM Tura of club-collective station UB5KDK. UB5TV's Dnepropetrovsk station—exciter, final amplifier and HRO, left to right—is widely worked on several bands. (Photos via W7DJU and W6YY)



Asia — Ex-Y13AA departs the restive Middle East and laments: "Tried for almost a year to get back on the air in Iraq but was informed that no more licenses will be issued. They also declare that the country's post office no longer will handle literature dealing with amateur radio." Meanwhile unorthodox HND9A continues activity on 20. Garry's next assignment may be North Africa where he hopes to concentrate on s.s.b. . . . UAØJF assures W6KG there is no Wrangel Island hamming at present. UAØKSI rumors notwithstanding. . . . K4SCW (ex-114ACI-K116AVO) sailed an LCU from Rotterdam to Turkey where he will linger for a while. Dick has gear along but hamming authorization is doubtful. K4SCW, a ham since 1932, has his XYL enthused as K4TGI (ex-W5UGD-K116AWL). . . . Pleasantry from W6YY: "VS1JF tells me he is going to the Maldives for a six-month RAF tour in the near future." . . . XW8AJ chases Mississippi Fives for WAS purposes according to WGDXC, and W6YY finds neighbor XW8AJ also collecting States around 14,023 kc. . . . KR6RY, except for rebuilding spruces and typhoon sessions, has operated almost daily on 20 since September, 1956. George has an ARC-5 on 3.5 Mc. driving a DX-35 which pushes a grounded-grid 813 final at 400 watts. His receivers are a BC-1004 and an R-45, the antenna a 30-ft.-high ground-plane, and some new 10- and 15-meter radiators are on the drawing board. . . . Near-by KR6JR uses his old W5DKK layout, a 10-B exciter driving linear 813s in push-pull on c.w. and sideband, with telling effect. . . . Regarding the Shizuka-A certification mentioned on page 91, May QST, W7DJU specifies SARC candidates JA2s AP BP BY CQ DK DW FR GH HE JW JZ KB MZ NH RW SG TE TH UJ WB XZ YB and ZV. . . . Not even an attractive prefix will turn the tide when the fates refuse to smile. HK7LX sighs, "I called BV1US every morning for a full month but he didn't come back. Still hoping!" . . . Notes on Yanks in Japan: "Practically all American forces now have been withdrawn from the KA4 area," writes KA4FT/KA7. "It probably will be four or five months before I can get quarters on my new base to get on the air as a KA7. We no longer can obtain licenses to operate from private rentals." . . . From KA9ME (K4BTE) and W7NIO, proprietors: "We've been lucky with our DX-35 on 20 c.w. for the past four months, working some 55 countries and 38 United States. Operating here is loads of fun but the local Siberian QRM is fierce. We'll have a BC-610 soon and are erecting a four-wavelength Vee. Look for us around 14,030 kc." . . . Ex-KA4-5-7EB now returns to K3CJW. . . . KA2AL (K9ALM) terminates his APO 994 activities with a DX score of 127/109, plus phone WAC and WAS certifications. "Will miss those FB VK/ZL chin-waggin' I enjoyed in Japan!" Bob expects to try DX life as K9ALM/5 for a spell. . . . West Gulf DX Club gleanings from the Orient: XV5A, concluding his U.S.A. visit, plans to try a KWM-1 in Laos. No fun being rare DX when you're on the ITU-FCC taboo list! . . . CR9AH is outfitting CR8AC with a BC-342. . . . VS90's Oman agenda stresses 21, 330-kc. phone operation with a kilowatt around 1800 GMT. . . . VS1FJ hopes to interest Indian nationals on the Nicobar Islands in amateur radio. . . . VS1HX is mulling over Spratleys Islands DXpeditionary possibilities. . . . HKARTS outfits CR9AL's return to CT1BH.

Africa — From Eritrea, ex-DL4FF-KZ5TO communicates: "I'm on the air here as ET2TO and expect to be active during one month in every six." Tom inquires as to the ethics of "broadside" DX QSOs; i.e., a DX station's calling CQ, scanning the band, logging all answers, answering with reports in chain-fashion; then repeating the process with another batch, etc. Offhand this would seem a DXpeditionary way to handle pile-ups. But, as we all know so well, many an overanxious DX chaser calls rare DX merely because he hears others calling, banking on being able to tune in the rarity, or trusting that a prompter will nudge him if he scores. Page 46, February 1948 QST, warns: "Cards from stations known to practise such a business are very likely to bounce when turned in for awards." Have those RSTs acknowledged! . . . From W6YY's DX news bureau: "VQ8AQR, now VQ8AQ back on Mauritius, leaves only VQ8ASR on Rodriguez." John is shipping Chagos operative VQ8AJC a new v.f.o. to eliminate his present Rate 4 drift. . . . CN8GU, when not tied up with ZD7SA QSL matters, fattens a strapping 194/92 DX tally amassed in five short Moroccan months. Ray tells W1BII that ZD7SA expects to remain on St. Helena "for a long time." . . . Via W6RLP: "ZD1FG has his new 100-watt'er from England and will be back on the air when he receives a shipment of tubes from me for use in his prewar-style HRO. He'll be quite busy but expects to find time for some 20-meter phone and c.w. activity." . . . WGDXC DX detectives find that F2BR is none other than ex-FB8BR.

Europe — LA5HE writes W1TUW cheerily: "There will be two hams on Svalbard next year — LA2GD and a professional operator who has no ham ticket as yet." LA6CF aims for Bear at the same time. . . . WITYQ has the current HY1CN schedule as 0600-0640 GMT daily except Thursdays and Sundays, mainly 20 phone. . . . W3GHS, a winner in the Munich EYMA 800th-anniversary competition, journeyed with XYL W3NL to Bavaria's beverage



CE2DZ becomes the first South American to join our exclusive "DXCC 2" society, following in the footsteps of DL4ZC (W6KG), WALVV and W6GPB (see p. 59, April 1957 QST). Alfredo's 100-plus QSLs from ARRL DX Century Club members in as many countries include souvenirs from WØMCF/CT1, CE7AA, CM9AA, CN8MI, CP5EX, CRs 6AI 7BC, CTs 1JS 3AN, CX1FY, DL7AA, DU7SV, EAs 1BC 6AF 8BC 9AF 9AB, EI4X, ET2AB, FB8S, FA8IH, FE8AB, FF8AG, FG7XA, G6ZO, GC4II, GI4RY, GM3SM, GW3ZV, HA4SA, HB9J, HC2KJ, HP1BR, HZ1HZ, I1AV, IS1AHK, JA6AD, KGs 4AF 6AB1, KH6IJ, KL7PI, KP4CC, KR6SC, KS4AI, KY4AA, KZ5CP, LA7Y, LU7CD, LX1AS, MP4BBE, OA4AK, OE3VP, OH2RY, OK1FF, ON4-FQ, OQ5RA, OX3MG, OZ3FL, PAØGN, PKs 4DA 6HA, PY1AJ, SM5LL, ST2NG, SV1RX, TA3AA, TF3EA, TI2TG, UA9DN, UC2AA, VE7GI, VK2DI, VPs 2LU 6CDI 7NM 9BM, VQs 2GW 3HJP 4EI 8CB, VR2BZ, VSs 1GX 6AE 7NG, VU2JP, W6AM, Y13BZL, YO2BU, YU3EU, YV5AE, ZB1AJX, ZC4IF, ZDs 2DCP 6BX 9AA, ZE2JN, ZK2AA, ZL2GX, ZsS 2X 3K, 4X4RE and 9S4AA. Any other DXCC 2 qualifiers out there?

center in late July as guests of the management. Prosit, Fritz und frau! . . . W1GKK finds W4SSG among those officiating at SVØWB DX festivities on Rhodes. . . . Rather rare Russian areas noted workable by W1TS: UA3KGA, Orel; UA3YR, Bryansk; UA3KUA, Murmansk; UA6WA, Malahykala, Dagestan; and UAØKIA, Magadan, Okhotsk. . . . EI9Y, qualifying for DXCC-190 at W1WPO's DXCC desk, reports that a session of influenza and a sprained ankle complicated his rebuilding projects. Jim will use a Geloso v.f.o. to push a 5763 driving parallel 6146s. "Must continue to depend on my ground-plane — no room for beam types here." . . . SP4JF's 180-watt 6146s and long-wire antenna beat a loud tattoo on 20 where KE4AJ finds Tad ever ready to chew the rag. SP4JF works at a BC station in Bialystok and is the most active DXer in Poland's rarest call area. . . . While visiting in Spain WØELA was grieved to learn of the passing of EA4BH-EA9DD. Luis's son Alberto now studies radio with a view toward perpetuating his father's call on DX bands. WØELA further learned that ex-EA9DC holds out somewhere in the Canaries. . . . W1FII, another visitor to Spain, headed back toward Rhode Island via France, Italy, Austria, Switzerland, Liechtenstein, Germany and other stops. Marty encountered 10-meter man CX8BM in Madrid and heard that EA9s not located in Ceuta or Melilla may become CN9s. . . . A W8FAZ translation of Russia's Radio specifies these requirements for Master of Amateur Radio Sport, Short Waves: "Take first or second place in DOSAAF SSSR championship or in unionwide and international competitions; twice in three years take third place in the same tests; establish a new unionwide record; conduct two-way radio contacts with amateur stations of fifteen union republics in three hours, and 100 oblasts in 12 hours; conduct 300 two-way radio contacts with not less than 100 different contestants in 12 hours; uncover two hidden transmitters operating in the 80-meter band and located not less than four kilometers from the starting place in a time of not more than 60 minutes." Numerous subordinate titles requiring lesser communications skills also are available. . . . W3RPG offers mimeographed copies of OH2YV's AHC specifications (see p. 76, April QST), asking only for s.a.s.e. or just stamps to cover mailing. . . . W1CTW advises that ex-AG2AF now leaves the National Co. in favor of France. . . . DM3KPN drops over to Lychen now and then with a portable rig to help make the rare "C" district available to WADM hunters. This month he may do it again, according to W9DRS's correspondence. You'll find only two resident "C" DMs in (Continued on page 146)

YL News and Views

CONDUCTED BY ELEANOR WILSON*, W1QON

YL Certificates and How to Obtain Them

Interest of both YLs and OMs in awards and certificates issued by YL clubs and nets continues to grow. In an article which appeared in July, 1957, *QST*, Phil Simmons, W1ZDP, listed 60 certificates and awards issued by various clubs and groups which are available to all amateurs. The information which follows here is concerned with certificates available to YLs and OMs which are issued by YL clubs only.

Space limitations preclude giving complete rules for each certificate, but sufficient information is given to help you trace details on the particular ones which may appeal to you.

YLRL Awards

The best known YL awards are those issued by the Young Ladies Radio League — namely, YL-WAS, YL-WAC, and the YL Century Certificate. A few months ago the YLRL augmented the popular three with the addition of the DX-YL award. Complete rules for the YLCC, YL-

*YL Editor, *QST*. Please send all news notes to W1QON's home address: 318 Fisher St., Walpole, Mass.



Interested in amateur awards, Susi Liebig, DJ2YL, of Braunschweig, Germany, has for a starter collection DXCC, WAC, DUF, WASM, S6S, and a certificate from Paraguay. In the last ARRL DX contest, Susi worked more than 300 W and VE stations. She has been operating since 1953, primarily DXing on 10, 15, and 20.

WAS, and YL-WAC awards may be found in the YL column for September 1957, with the detailed rules for the DX-YL award announced for the first time in the May 1958 column.

YL Century Certificate — The YLRL requires proof of contact with 100 licensed YL operators anywhere in the world. All contacts must be made from the same QTH or within a 25 mile radius. Endorsements are issued for confirmed contacts with each additional 25 YLs. Award custodian is Katherine Johnson, W4SGD, Box 666, Fuquay Springs, No. Carolina.

YL Worked All States — Proof of contact with a licensed YL operator in each of the 48 states is required. This award parallels the ARRL's WAS. QSLs should be sent to Grace Ryden, W9GME 2054 No. Lincoln Ave., Chicago 14, Ill.

YL Worked All Continents — Proof of contact with a YL in each of the six continents should be sent to Barbara Houston, KØLYV, 1385 Northview Drive, Marion, Iowa.

DX-YL Award — Issued to YLs only. A YL who contacts 25 other licensed women operators outside of her own country on or after April 1, 1958, is eligible. A copy of the log of contacts should be sent to Kay Anderson, W4BLR, 5210 Raleigh Road, Richmond 23, Va. QSLs not necessary. Stickers issued for each 10 additional contacts.

Unless specifically stated otherwise, the YLRL awards (excepting the DX-YL award) and all of the certificates that follow are issued to all amateurs, YL and OM.

Club Certificates

East:

RIYL Certificate (Rhode Island YL Club) — Contact any ten YLs in Rhode Island. Send confirming QSLs to Ruth Sherman, W1WED, 128 Massasoit Drive, Warwick, R. I.

Penn-Jersey YL Club Certificate — issued to U. S. hams for contacts with 10 club members. Foreign stations must work only 5 members. Send list of stations worked with name, date, time, and band to Carolyn Currens, W3GTC, P. O. Box 523, Norristown, Pennsylvania.

Georgia Peach YL Certificate — Contact 10 members of the Georgia Peaches YLRC. Send proof of contact to Peggy Butterfield, K4KKR, 2203 Terry Mill Rd., Atlanta, Ga.

Floridora YL Certificate — Contact 10 club members (not during net time). QSLs should be sent to Shirley Hill, W4WPD, P.O. Box 11185, Produce Station, Tampa, Fla.

Mid-West:

LARK Certificate (Ladies Amateur Radio Klub of Chicago) — Contact 10 LARKs (resident, non-resident, or honorary members). Send list of contacts, dates made, and frequencies used to Gladys Jones, W9MYC, 4232 Hampton Ave., Western Springs, Ill.

HAWK Certificate is issued by the new Hoosier Amateur Radio Klub of Indiana to any amateur who works 10 members. Cross-band operation or contacts made during nets not valid. Send QSLs to Adah Elliott, W9RTH, 721 Centennial St., Seymour, Ind.

TYLRUN Certificate — The Texas YL Round-Up Net offers its YL-OM certificate to any YL or OM who confirms contacts with 25 full members of the net. Contacts made during regular net meetings will not count. QSLs should be sent to Helen Douglas, W5LGY, 1501 Monroe St., Commerce, Texas. Stickers given for additional 25 contacts.

YL-OM 10CC Certificate — offered by the Texas YL Round-Up Net to YLs only. YLs must contact 1000 different licensed male operators. QSLs not necessary — send a list of the 1000 contacts, verified in writing by three licensed amateurs, to Lyn Ohlson, W5RYX, 7614 Maxwell Ave., Dallas 17, Texas.

GAYLARK Certificate — A brand new certificate offered

by the Gulf Area YLARKlub. Send log data of contact with six GAYLARKs to Phyllis Riblet, W5CXM, 8902 Ilona Lane, Houston 25, Texas. Contacts with members valid after 1-28-58. Include 10¢ for handling.

West;

Chirp-tificate is offered by the Camellia Capital Chirps YL Club of Sacramento, Calif., upon confirmation of contact with six club members. Send application to Wanda Gluck, W6ENK, 7317 Walnut Rd., Fair Oaks, Calif.

Lads N' Lassies Certificate — The Los Angeles YLRC offers this certificate (one of the oldest of the YL club certificates) to any amateur upon proof of contact with 10 members of the club. Send QSLs to Gilda Shoblo, W6KER, 3715 Liberty Blvd., South Gate, Calif.

Others:

WAYL (Worked All YL) — The South African Woman's Radio Club offers this certificate to any amateur who has worked YLs in ZS, ZI, CR, VQ, and OQ lands since July 1, 1952. Amateurs outside the mentioned countries need only 10 QSLs for confirmation. Stickers are issued for additional 20 and 50 confirmations. Send QSLs to Mrs. Margery Snyman, ZS1RM, P. O. Box 80, Strand, Cape Province, Union of South Africa.

Triple K (Key Keen Klub) is a new certificate issued by the South African Woman's Radio Club to YLs only (anywhere in world) for c.w. contacts. Proof is required of 100 contacts using International Morse Code. A certificate with one sticker lettered "K" will be issued if the log submitted is in order. Two additional "Ks" will be issued for additional 500 and 1000 c.w. contacts. Apply to WAYL Custodian ZS1RM.

PARKA Certificate issued by the Polar Amateur Radio Klub of Alaska. Submit proof of contact with seven members of PARKA (cross band contacts not accepted) to Geraldine Nichols, KL7ALZ, Box 4017, Spenard, Alaska.

Grandmothers' Certificate — a new certificate issued to any amateur who contacts 10 or more YLs who are grandmothers or great grandmothers. Send list of stations worked, frequencies, and dates to Mary Meyer, W9RUJ, 16520 Patricia Lane, Brookfield, Wisconsin. (All YLs who are grandmothers are invited to register with W9RUJ — no dues.)

SWOOP (Suffering Wives of Operators' Protectorate) — The San Francisco YLRC sponsors this organization designed to make XYLs feel welcome at hamfests and conventions. SWOOP certificates for distribution to XYLs at such events may be obtained from Esther Given, W6BDE, P. O. Box 84, Montara, Calif.

Many of the clubs require that postage for the return of QSLs to the applicant be included when application for an award is made. Write to the custodians listed with the individual certificates for more detailed information.

National Convention Coming Up

August 15, 16, and 17 are the fast approaching big dates for the ARRL Tenth National Convention in Washington, D. C. There is still time to make plans to attend the affair, if you hurry. Pre-registration prices terminate Aug. 1.

Chairman of the YL Program, John DeBardleben, W3CN, and his committee of Washington Area YLRC members have planned a program which they feel should well please all of the YLs and XYLs who attend. Events for the ladies include special breakfasts, luncheons, teas, and dinner-dances, a wide choice of sightseeing tours (one to the White House), bridge parties, two fashion shows, one American and one Chinese, and a non-radio hobby exhibit. For licensed YLs there will be a special YLRL Forum with several guest speakers, and undoubtedly they will want to take in many of the general amateur sessions.

A nursery for small children will be available at the Sheraton-Park Hotel, scene of the Convention. YLs will operate amateur stations set up at the nursery and at Ladies Headquarters to expedite locating possible lost harmonics and friends.

One lucky lady conventionnaire will go home with a mink scarf!

The general registration fee for ladies is \$7.50 (\$5.00 before Aug. 1). Checks should be made payable to the Federation of Radio Amateur Clubs, Inc. and mailed to P. O. Box 3726, Washington 7, D. C. Fees for tours, special breakfasts, luncheons, etc. may be paid upon registering in person at the hotel.

CU there!

August 1958

Mrs. Floy B. Norman, K5LOV, of Gallup, N. Mexico, reaped some nice publicity for ham radio recently when articles appeared in N. Mex. newspapers publicizing the schedules she keeps daily with her son W5CIN in Farmington. A member of MARS, Mrs. Norman works in the Bureau of Indian Affairs in Gallup.



The President of the new Hoosier ARK, Adah Elliott, W9RTH, welcomes YLs to club membership. An affiliate of the Indiana Radio Club Council and the YLRL, the HAWKS meet three times annually with dues at \$2.50 for Indiana YLs and \$2.00 for out-of-staters. Formerly WØRTH, Adah has been on c.w. since 1941. She's EC for Seymour, Indiana.



Dorie Silva, ex W7VYG of Oregon, is now K6UZA of Paradise (Calif.). The XYL of W6VXC, Dorie is Secretary of the Camellia Capital Chirps YL Club of Sacramento. She operates on several bands from her garage shack.





Left: A YL's dream come true—working DX on the beautiful tropical isle of Samoa. Stateside operators will recognize KS6AF as Evelyn Scott, ex W6NZP, now K6KGM, of Long Beach, Calif. Under the shade of coconut palms at Pago Pago, Evelyn worked 15 and 20 meters at every opportunity before moving on to more DXing from New Guinea and Australia. Right: Estelle Black, KN5MTF, of Dallas, spends all spare minutes on 40 c.w.—7.196 Mc. to be exact. Since becoming a Novice, Estelle has worked 40 states but wonders how she's done it, for she definitely prefers long ragchews to quickie QSOs. A member of WHOOT (Dallas YL club), Estelle's daughter is K5EGB and son-in-law is W5WKH.

KEEPING UP WITH THE GIRLS

Three more YLs were added to the DXCC roster in May, according to WIWPO of Hdqtrs. Chata, W1RLQ, Dora, K4CYF, and Dena, W5DRI, made the grade. . . . New officers of the South African Woman's Radio Club are Pres. and Editress ZS6YL; V.P. ZS6AIL; Secy. ZS6GH; Asst. Editress ZS6KK; Contests and Awards ZS1RM. . . . Some So. African YLs heard regularly on DX bands are ZS4HZ, ZS5s AD, BP, FN, GJ, and ZS6VI, Votie, a new YL who is sightless. . . . Fifty-five YLs registered at the Oregon Amateur Radio Convention held in Salem, Oregon, on May 3 and 4. Forty-one at the YL luncheon heard YLRL President, Beth Taylor, W7NJS, give a history of the club and an account of present and proposed activities. . . . Wanda, K6ENK, takes over editor duties of *YLRL Harmonics* from Betty, W9STR. . . . Helen, W1HOY, lacks only New Mexico and Idaho for WAS on 6 meters. . . . There are about 60 YLs in DL land, according to a check by DJITE, Christie. . . . Martha Edwards, ex W6QYL, is now OD5CH in Lebanon. . . . While studying nursing in Illinois, Jeanne, W8UVV/9, keeps skeds with her mother Wave, W8FPT, in Michigan. . . . The only active YL in Poland is SP5YL. Sophia, age 23, is studying engineering in Warsaw and has been active on 15 and 20

New officers of the Chicago YLRL are (left to right) Secy-Treasurer, Peggy, K9GUB; Pres. Lillian, K9JVL; and V. Pres. Charlene, K9CMZ. K9JVL also replaces June, K9CQF, as editor of the club paper *Queen's Key*. Members have their own club station, W9DEQ, at the Gompers Park Field House, 4222 West Foster Ave., Chicago.



meters since May 1957. . . . ZS6KK, Marie, won both the phone and c.w. trophies in the South African Radio League Contest. . . . The Camellia Capital Chirps are preparing a cookbook of recipes submitted by YLs the world over. . . . CE4EV, Harriet, is returning to the States after four years "temporary residence" in Chile. . . . K2CUQ, Evelyn, is active in the N.Y.S. CD Radiological Information Net. . . . We regret to report the passing of Manila Beebe, W7JWC, the XYL of W7IGM. Manila was licensed in 1946 and had many friends around the world.

K6POG relates that K6PGO, K6OPG, and K6POG are all YLS and that both K6OPG and K6PGO are "Mary."



August, 1933

. . . Technical articles: A Simple 1750-Kc. Auxiliary Transmitter, New Pentagrid Tubes and Coil-Switching in the Amateur-Band Superhet, "Five-and-Ten" Oscillator-Amplifiers Transmitters, The Tool-Box 56-Mc. Transceiver, Modernizing the Long-Wave Receiver, Automatic Overload Protection and Push Button Control, and several pages of ideas for the experimenter.

. . . Operating Information: Ten-Meter Band Hot!, Amateur Radio at a Century of Progress (World's Fair), More on the new QSL Bureau system, descriptions of various amateur stations, IARU News, the Communications Department pages and Station Activities. Calls Heard, incidentally, showed that a number of the signals being heard on 28 Mc. were actually harmonics from 14-Mc. stations.

. . . New regulations were announced, with most changes effective Oct. 1. Phone privileges were extended, and pure d.c. required on 14 Mc. and below. Amateur mobile authorized on aircraft only, on 56 and 400 Mc. only. Class A, B and C licenses introduced, license term to be three years.

. . . Also of interest are the number of advertisers of 25 years ago that are still with us. Among them; reading from page 1 of the 1933 issue: Hammarlund, National, Candler, Port Arthur College, Walter Ashe and Collins Radio.

QST for



CONDUCTED BY EDWARD P. TILTON,* WHDQ

ELSEWHERE in this issue will be found the full text of the ARRL petition to FCC for 100-ke. segments at the low end of the 50- and 144-Mc. bands for c.w. emission only. Also reproduced in its entirety is the *FCC Notice of Proposed Rule Making*, Docket 12485, which starts the legal machinery moving toward the establishment of these exclusive c.w. subbands.

As might be expected, opposition to this proposal has developed in some quarters, but we wonder if those who object to the idea of the c.w. segments understand fully the reasons for the ARRL request. If you are one of the objectors, please turn to "Happenings of the Month" in this issue, and read the ARRL petition and the FCC notice carefully. From these it should be obvious that this is no rehash of the old phone-c.w. argument. Narrow slices of our two most-used v.h.f. bands were not asked for in order to provide more territory for c.w. men. Though it is to be hoped that the subbands will result in more use of c.w. on 6 and 2, that is not the main objective in asking for them.

The principal reason for the c.w. segments is to make it possible for serious v.h.f. operators to do a more effective job in weak-signal communication. It is well known that c.w. has a tremendous advantage over phone in weak-signal work. So great is this advantage that a 10-watt c.w. station can work over as great a distance as a 500-watt a.m. phone. Surely we should do everything possible to take full advantage of this superiority. The catch is that to make c.w. pay off it must be free of competition from voice on the same or closely-adjacent frequencies. This is why we have exclusive c.w. segments in all our lower bands.

Why should we be so concerned with weak-signal communication? Every occupant of our v.h.f. bands should understand that he is using spectrum space that is subject to heavy pressure from other services. The day may come when we can make a good case for retention of our v.h.f. bands only if we can show that we have made the best possible use of them. The record of amateur radio in this respect is one in which we can all take pride. It shows that nearly all forms of long-distance propagation in the v.h.f. range were discovered and first exploited by amateurs. The worth of amateur radio data for scientific studies is widely recognized, but we cannot sit back and rest on our laurels forever. Our record in the future should be equally good. It can be, for there is much left for us to do.

* V.H.F. Editor, QST.

There are still many unknown or little-understood angles in the v.h.f. propagation picture, and amateur observations can be of real value in



1 W6ZJB	11 W2IDZ	21 K6EDX	31 K0GQG
2 W6BJV	12 W1ILL	22 W5SFV	32 W7FFE
3 W6CJS	13 W6DZM	23 W6ORE	33 W6PPP
4 W5AJG	14 W6HVW	24 W9ALU	34 W6BJI
5 W9ZHL	15 W6WKB	25 W8C8M	35 W2MEU
6 W9OCA	16 W6SMJ	26 W6MVG	36 W1CLS
7 W6OB	17 W6CGW	27 W6CNM	37 W6PUZ
8 W6INI	18 W7ERA	28 W1VNH	38 W7ILL
9 WHDQ	19 W3OJU	29 W6OLY	39 W6DDX
10 W5MJD	20 W6TMI	30 W7HEA	40 W6DO

W1FOS	47	W4BHK	42	W7JPA	44	W6ZTW	47
W1CGY	46	W4FNR	42	W7JRC	44	K3JJA	47
W1LSN	46	W4AKX	42	W7BOC	42	W0BL	46
W1AEP	46	W4RFK	42	W7EIV	41	W0JOL	46
W1SUZ	46	K4DNG	41	W7CAM	40	W0USQ	45
W1RFU	45	W40XC	41	W7MKW	10	W0FKY	45
W1ELP	44	W4ZBQ	41	W7UFB	35	W0QVZ	45
W1KHL	44	K4GYZ	41	W7QDJ	34	K6AKJ	44
W1LGE	43					W0FPZ	44
W1FZ	43					W0YJF	44
W1FVZ	41	W5VY	48	W8WPD	47	W0URQ	44
W1LKO	40	W4LPQ	47	W8NOH	47	W0BTG	43
W1CLH	40	W5BNQ	46	W8OJN	46	K0GKR	43
		W5HXZ	45	W8SQU	46	W0JHS	43
		W5VY	45	W8HXT	46	W0PI	43
		K5HVA	44	W8NQD	45	K0DXS	43
W2RGV	47	W5FSC	45	W8UZ	45	W0WNU	42
K2JNS	46	W5ONS	45	W8RFW	45	K0CLJ	41
W2AMJ	46	W5JLY	45	W8LPD	44	W0PKD	41
W2BYM	46	W5ML	44	W8HJR	44		
W2FHJ	46	W5FXN	43	K8ACC	44	VE3AET	47
K2CBA	45	W5JMF	42	W8ESC	42	VE7CN	44
W2SHV	45	W5CVW	41	K8CIC	42	VE1EF	42
K2AXQ	43	W5FAL	41	W8EVH	42	VE3AB	37
K2ITQ	43	W5HEZ	41	W8YLS	41	KL7AUV	36
K2ITP	43	W5BXA	41	W8INQ	40	ELZ	35
K2L7W	41	K5ABW	40			VE3BX	33
W2ORA	40	K5CYK	40			VE3BHQ	32
K2VIX	40					VE1QY	32
						VE1PQ	31
W3TIF	47	W6WNN	48	W9BRN	48	VE2AOM	31
W3KKN	45	W6UXN	48	W9ZHB	48	VE3DHR	31
W3KMY	45	W6BAZ	48	W9QTV	47	VE4HS	30
W3RUE	44	K6JCA	47	W9RQM	47	SM7ZN	29
W3NKM	41	W6JKN	46	W9QKM	47	CO2ZX	27
W3MQU	41	W6ANN	45	W9JFP	47	XE1GE	27
W3MXW	41	W6NDP	45	W9D5P	46	VE1WL	28
W30TC	41	W6ABN	45	W9AAG	46	PZ1AE	26
W3PFH	40	K6GTC	44	W8UFA	45	ZS9G	25
W3LFC	40	K6RNQ	43	W9UHS	43	SM6ANR	23
		W6GCG	43	W9MHP	43	SM6BTT	23
		K6HYI	43	W95WH	43	VE1ZR	23
W4AZC	47	W6NIT	42	W9KLR	43	VE3OJ	22
W4EQM	47	W61WS	41	K9EID	43	CO6WW	21
W4UCH	47	W6CAN	40	W9MFP	42	LA9T	20
W4UMF	47	K6ERG	40	W9JCI	42	LA7Y	18
W4FBH	46	W6BWG	40	W95WH	41	KH6UK	17
K4DJO	46			W9EPT	41	VQ2PL	16
W4EQR	46			W9IMG	41	JA1AUH	16
W4LNG	45	W7BQX	47			LU9MA	16
W4CPZ	45	W7DYD	47			JA8BU	14
W4FLW	45	W7INX	47	W8QIN	47	Z62JV	12
W4MS	44	W7YJE	46	W8NFM	47	W0TKX	12
K4HOB	44	W7ACD	46	W8KYF	47	JA1AAT	12
W4QN	44	W7FDJ	46				

future propagation studies. The ARRL IGY Propagation Research Project is currently providing a great reservoir of amateur communication data for this purpose, but we can do our best work only if we are able to exploit weak-signal possibilities to the fullest extent. This means consistent and widespread use of c.w. during marginal conditions.

Anyone who has attempted DX work on 50 Mc. recently knows that band occupancy has reached a point where the low edge (the most useful spot in the band for observing the beginning and ending times of openings, and their geographical distribution) is nearly always jammed with strong phone signals. How many more West Coast 50-Mc. men could have worked into Europe last winter, had not the signals of EI2W, CT1CO, and the LAs and SMs and other Europeans not been smeared by Ws crowding the low edge of the band on phone? How much oftener could Easterners have worked into Hawaii, had it not been for the mass of phone QRM on the signals of KH6NS and KH6UK? Might not many other American areas have worked into Japan, Australia or New Zealand, except that Ws were so busy working each other on voice, mostly in the first 100 kc.?

If we were concerned merely with open-hand conditions, the problem would not be so serious, for the percentage of time that our bands are open for DX is certainly small. Effective use of the c.w. segments need not wait for either 6 or 2 to be open. One of the most intriguing possibilities of our v.h.f. bands lies in the utilization of the various forms of scatter. These are available at any time or season. Tropospheric scatter is good for distances of 300 to 500 miles at any time, on both 6 and 2, if optimum c.w. techniques are employed. Ionospheric scatter is a practical matter for well-equipped 50-Mc. stations, and it works around the clock and calendar, over distances of 600 to 1200 miles. Meteor scatter is a c.w. operator's game, on either 50 or 144 Mc., but more so on the higher frequency. Moonbounce, if we are ever to get to it, is a c.w. proposition.

In all forms of band openings c.w. gets through first, and works longer, than voice. The fellow who gives up on either F_2 or sporadic-E skip when phone ceases to be readable misses the best part of the fun. The v.h.f. man who struggles in an attempt to copy the garbled voice of a distant station during an aurora is cutting himself off from the best that this weird form of communication has to offer. Yet all these marginal forms of communication can be done effectively on c.w. only on channels that are free of phone QRM.

We should have had such channels throughout the history of v.h.f. endeavor. It is of extreme importance that we have them now. There must be far more work in the world above 50 Mc. than chewing the rag and collecting QSL cards. We should lose no opportunity to build up the record of amateur accomplishment in our v.h.f. bands, as we may someday need it sorely in our continuing battle to maintain our rights to segments of the spectrum above 50 Mc. If narrow slices

of both bands for the exclusive use of c.w. will help the cause along, they are a small price, indeed, to pay.

2-METER STANDINGS

U. S.			U. S.		
States	Areas	Miles	States	Areas	Miles
WIREZ.....	28	8 1080	W5NLE.....	3	3 520
W1AZK.....	23	7 1205	W5FEK.....	8	2 580
W1KCS.....	22	7 1150	W5WY.....	7	3 1200
W1RFU.....	22	7 1120			
W1OAX.....	22	6 800	W6NLZ.....	9	3 2540
W1AJR.....	21	7 1130	W6DNG.....	9	3 1030
W1FZJ.....	21	6 1120	W6WSQ.....	8	4 1380
W1HDD.....	20	6 1020	W6AJF.....	5	2 640
W1MNM.....	19	6 800	W6RRZ.....	4	2 360
W1EZY.....	18	6 750	W6EJA.....	4	3 1330
W1UIZ.....	17	6 890	W6ZLI.....	3	2 1400
W1AFO.....	17	6 920	W6BAZ.....	3	2 400
W1ZJQ.....	17	6 800	W6MMU.....	3	2 388
W1PHR.....	16	6 780	W6ORS.....	2	2 365
W1BCN.....	16	5 850	W6LSB.....	2	2 360
W1KHL.....	16	5 540			
W2NLY.....	34	8 1390	W7VMP.....	11	5 1280
W2CXY.....	34	8 1200	W7LEB.....	6	3 1020
W2ORI.....	34	8 1200	W7JRC.....	3	3 1040
W2AZL.....	28	8 1050	W7LHL.....	4	2 1050
K2AQJ.....	27	7 950	W7JJP.....	4	2 900
K2IEJ.....	27	7 1060	W7JUN.....	4	2 353
W2BLV.....	23	7 1020	W7YZU.....	3	2 240
K2HOD.....	23	7 950			
W2DWJ.....	23	6 720	W8KAY.....	36	8 1020
W2OPQ.....	22	7 1050	W8WAX.....	36	8 1200
W2SMX.....	22	6 905	W8LOP.....	31	8 1060
W2AMJ.....	22	6 960	W8RMH.....	31	8 1000
K2CEH.....	21	8 910	W8PT.....	31	8 985
K2IKJ.....	21	6 925	W88VI.....	30	8 1080
W2CBB.....	21	6 800	W88FG.....	30	8 100
W2LWI.....	20	6 700	W88LW.....	28	8 680
W2AOC.....	20	6 770	W88RW.....	27	7 850
W2PAU.....	20	6 880	W8BAV.....	26	8 950
W2RXG.....	20	6 700	W8JVV.....	25	8 940
W2UTH.....	19	7 880	W81LC.....	25	8 800
W2AZP.....	19	7 650	W8LPD.....	25	8 750
W2RGV.....	19	6 720	W88LD.....	25	8 720
W2LHI.....	18	7 620	W8LCY.....	21	7 610
W2ALG.....	18	6 910	W8NOH.....	19	7 660
W2SHT.....	16	6 650	W8CZV.....	17	7 970
W2PCQ.....	16	5 650	W8RWW.....	17	7 630
W3RUE.....	30	8 950	W9KLR.....	38	8 1160
W3GKP.....	29	8 1020	W9WOK.....	32	8 1050
W3GCT.....	28	8 740	W9GAB.....	29	9 1075
W3TDF.....	27	8 850	W9AAG.....	30	8 900
W3SGA.....	26	6 550	W9ZHL.....	29	8 830
W3IBH.....	23	7 650	W9RLM.....	27	8 850
W3FPI.....	21	8 —	W9UCH.....	27	8 750
W3KCA.....	21	7 —	W9FVJ.....	26	8 860
W3LNA.....	20	7 720	W9BQC.....	26	8 820
W3LGD.....	20	7 —	W9ZHL.....	25	8 760
W3KWL.....	19	7 740	W9ELX.....	24	7 725
W3NKM.....	19	8 660	W9BVP.....	23	7 1000
W3BNC.....	18	7 750	W9VED.....	22	7 960
			W9KPS.....	22	7 690
W4BJQ.....	35	8 1140	W9MUD.....	19	6 840
W4HHK.....	35	9 1280	W9LFL.....	19	6 —
W4AO.....	29	8 1100	K9AGP.....	18	8 725
W4LTU.....	27	8 1160	W9ALU.....	18	7 800
W4UMF.....	27	8 1110	W9JGA.....	18	6 720
W4MKJ.....	24	8 725	W9MBL.....	17	6 660
W4JCY.....	22	6 660	W9DDG.....	16	6 700
W4QRM.....	21	8 900	W9JYJ.....	16	7 560
W4DWU.....	20	6 675	W9LEE.....	16	6 780
W4OLK.....	19	6 820	W9DSP.....	15	6 760
W4TLV.....	18	7 1000			
W4JFV.....	18	7 850	W0IHD.....	27	7 890
W4IKZ.....	18	6 720	W0GUD.....	25	7 1065
W4VLA.....	17	7 825	W0SAJ.....	24	8 1175
W4WNH.....	17	7 750	K9DOK.....	22	8 920
K4EUB.....	17	6 660	W0BFL.....	21	6 1060
W4AIB.....	16	7 720	W0INR.....	21	6 830
W4CLY.....	15	5 720	W0TCC.....	21	8 —
W2BHS/4.....	14	7 650	W0RUF.....	19	7 700
W4ZBU.....	14	5 800	W0UOP.....	18	6 660
W4TR.....	14	5 720	W0ONQ.....	16	6 1000
W4SOP.....	13	5 680	W0BQK.....	16	7 925
W4CPZ.....	12	5 850	W0ZJB.....	15	5 1200
W4MDA.....	11	5 660	W0USG.....	14	6 750
W4KCC.....	11	5 860	W0IFS.....	14	5 —
W4KCC.....	10	4 860	W0OAC.....	14	5 725
W4LNG.....	10	4 800	W0RIG.....	14	5 600
W4GIS.....	9	2 335	W0MVG.....	13	5 700
			W0TFJ.....	13	4 —
W5RCL.....	33	9 1215	W0IC.....	4	2 950
W5DFU.....	25	9 1300			
W5AJG.....	25	8 1280	VE3DIR.....	26	8 925
W5LW.....	18	8 1150	VE3AIB.....	26	7 910
W5LPG.....	16	6 1000	VE3BQN.....	17	7 790
W5VKH.....	15	5 720	VE3DQR.....	16	7 820
W5MMW.....	14	5 700	VE3AQG.....	16	7 800
W5MLT.....	14	4 760	VE3BPK.....	13	6 510
W5PZ.....	13	5 1255	VE2AOK.....	12	5 550
W5KTD.....	13	5 900	VE2APP.....	12	5 550
W5FSC.....	12	5 1390	VE2AOK.....	12	5 550
W5ABN.....	12	5 780	VE2YQ.....	11	4 900
W5QNL.....	10	5 1400	VE2YJ.....	11	4 365
W5CVW.....	10	5 1180	VE2YJ.....	11	4 365
W5SWV.....	10	3 600	KH6UK.....	1	2 2540

Members of the Spartanburg (S. C.) Amateur Radio Club, with some of the 6-meter portable stations built recently as a club project. Equipment was used effectively in connection with the Peach Blossom Golf Tournament. Self-contained and operated from small dry batteries, they could be deployed anywhere on the course to supply a constant flow of information far more effectively than the 75-meter mobiles formerly used.

Front row, l to r: K4HDX, K4LML, K4INO, K4MYR, W4NTO. Back row: K4QZ4, K4BEW, Don Deakin, and K4LEL.



Here and There

Here's a really weird one that happened May 25. W5LFM, San Antonio, Texas, tells us that W5KRH and K5HVC worked JA1US and heard JA1OW on 50 Mc. from just before to a few minutes after midnight! Signals were weak, with rapid fading that is characteristic of transequatorial scatter. Their beams were aimed west, whereas the direct path of Japan would be northwest. The character of the signals suggests the TE mode, and inasmuch as Japanese stations have had considerable success with what might be called transequatorial backscatter, it would appear that something of this sort was responsible for these W5-JA contacts. This is typical of the kind of observations that make amateur radio data so valuable for propagation studies. One thing we can be sure of: just about anything can happen on 50 Mc., and if you are consistently active, and wide awake in the process, it can happen to you!

On 144 Mc. the big news in June was a tremendous tropospheric opening early in the month. W9GAB, Beloit, Wis., calls it the best for north-south work in his experience, bringing in Arkansas, Mississippi, Louisiana, Texas, Tennessee and West Virginia. W8BAX, Columbus, Ohio, reports Kansas, Minnesota and Nebraska worked June 3. It swung to the East June 4 and 5. W1RFU, Wilbraham, Mass., heard stations as far west as Wisconsin June 4, W9SMJ, Indianola, Iowa, picked up Maryland and West Virginia. K8AXU was operating from a 4000-foot elevation near Elkins, W. Va., for this one, the night of June 3, and he gave out many first contacts with his state. Among them was W0INI, Pleasant Hill, Mo.

W3GKP, Spencerville, Md., heard his first Ws before 1930 EST. W9GGH, Kenosha, Wis., was heard on s.s.b., 87, shortly after. W9WOK, Barrington, Ill., was heard at 2000 on voice, saying that the band was open for 350 (!) miles in all directions. He was worked on c.w. at 2004. W9SMJ was raised at 2045, for a new state for both, followed by K0EMQ, Cedar Rapids, at 2102. The next hour was spent in digging for new ones, and in sending QSTs regarding stations and frequencies. W0RUF, Ste. Genevieve, Mo., was heard 87 on voice at 2300. In the midst of a CQ he faded down too weak to read, and the next two hours were spent in frantic attempts to get him on c.w. Finally W0RUF heard W2CXY on c.w., and he changed over, working W2CXY, W4AO and W3GKP, in that order. Bill finally getting him for No. 29 at 0127. The following evening conditions were somewhat similar, but the opening did not extend so far south or west. K0EMQ and W0BFB, both in Iowas, were worked, but the band was full of Ws and 9s, mainly, through 2300 EST, when W3GKP called it a night.

W5KTD, Shreveport, La., began hearing DX from the north around 2130 CST June 3. He worked W9AAG, Woodhull, Ill., at 2135, W9WOK at 2158, W8PT, Benton Harbor, Mich., at 2205, W9REM, Downers Grove, Ill., at 2240, and K0EMQ, at 2314. All were worked on c.w., with signals running about 569, with little fading.

K2GQI, Matawan, N. J., reports W0BFB and W0RUF worked at 2330 and 0105 EST, respectively, for states No. 26 and 27. W1OAX, Coventry, Conn., spent a lot of time looking for Ws, but heard none. His best DX was W9NVK, Racine, Wis., worked at 0042 on the 5th, near the end of the 2-day session.

W8PT pushed his states total up to 31 with W5JWL, Gurdon, Ark., and W5KTD worked, beginning at 2205 EST on June 3. Also worked were W5LPG, Holly Springs, Miss., W9VMN, Leon, Iowa, K0EMQ, W0UFP, Hutchinson, Kan., who used a 522 at 15 watts input, W0RUF, and W6EMS, Omaha, Neb. Jack heard 7 call areas in this one night, missing only W1, 6 and 7!

Almost lost in the noise connected with the best opening on 144 Mc. thus far in 1958 was the fact that early June was also the occasion of the first of the major daylight meteor showers, the June Perseids. Only results reported to date are successful skeeds kept by W9GAB, Beloit, Wis., with W7-JRG, Billings, Mont., K4EUS, Chester, Va., and W1MINN, Orange, Vt. These put W9GAB into the select circle of 2-meter men having 9 call areas worked.

The life of a sideband enthusiast on the v.h.f. bands is no bed of roses. Take it from W5KPZ and K5BEL, who have been using s.s.b. on 50 Mc. for some months now. Both have made a few contacts, local and DX, but they find it discouraging that so few fellows recognize the signal for what it is, or make any effort to tune it in properly. K5BEL says that his contacts with W7MAH and K4EYE on 2-way s.s.b. have demonstrated the value of sideband for getting through under marginal conditions. W5KPZ and K5BEL make a practice of giving long calls when on s.s.b., so that anyone would who like to work them will have ample time to tune the signal in. They ask that you be on the watch for them, when 6 is open to the Dallas area.

Your conductor can vouch for the effectiveness of the s.s.b. at W7MAH, Reno, Nev. He was heard often during the F2 season, and we occasionally tuned him in just to listen to the difference between his signal and that of the a.m. stations. When W7MAH went off, you could crank up the gain and hear a mass of heterodynes on the same channel, but when his s.s.b. rig was on there was nothing else audible on the frequency.

Quite a few d.s.b. signals are heard these days on 6, but a true evaluation of any of these has not yet been received. We hear K1ACD, Orange, Conn., giving his a work-out frequently, but Jay says he, too, is having trouble finding anyone who will tune him in.

The densely populated area around Toronto has been good v.h.f. country for many years, but the coverage enjoyed by these VE3s has been largely confined to the area between the Great Lakes and across into adjacent U. S. call areas. Recently there has been growing interest in working up to the northeast, to Ottawa and Montreal. VE3BQN, Toronto, has been getting into Montreal regularly since he put his pair of 4X150As on 144 Mc., though hearing the VE2s has been another matter. To further this work, VE3BQN is keeping nightly schedules with VE2FF and other interested parties in that direction. He transmits nightly in a northeasterly direction at 1900 local time for 5 minutes, and then listens for a like period at 1905. His frequency is 144.217 Mc.

August Events

August is a big month for the v.h.f. fraternity. First, there's the National Convention in Washington, D. C., Aug. 15-17. The National Capital V.H.F. Society, as part of the Foundation of Amateur Radio Clubs, Inc., has charge of the v.h.f. program. Rick Emerson, W3OJU, promises that v.h.f. men will find plenty to interest them. See you there!

About the time you read this, v.h.f. men all over the Middle West will be taking off for Turkey Run State Park, (Continued on page 142)



Operating News



F. E. HANDY, WIBDI, Communications Mgr.
GEORGE HART, WINJM, Natl. Emerg. Coordinator
PHIL SIMMONS, W1ZDF, Asst. Comm. Mgr., C.W.

ROBERT L. WHITE, WIWPO, DXCC Awards
LILLIAN M. SALTER, W1ZJE, Administrative Aide
ELLEN WHITE, W1YYM, Asst. Comm. Mgr., Phone

Cogent Quotes. Every so often in the flow of operating reports and letters across the desk, comments pop up that seem significant even beyond the correspondence considered by itself. This month we propose to share a few of these comments with our readers to consider each and make of it what you may.

"Let's have a personal program for monitoring one's own signal. Most fellows surely wouldn't put out rotten signals if they knew how they sounded." — Stan, W6ADB.

For those who question what is *real* DX, let them realize that any country you haven't worked is DX for you.

W8KBL suggests more v.h.f. listening with the b.f.o. on. This locates carriers you can work, often DX, if you use a little c.w. W8KBL also says, "You stand a better chance of gaining code proficiency when you actually use it in your operating."

W9HOV in *Ham-Gab*: When they run out of contests, they will have a contest for those who have been in 25-or-more contests.

Listen much, transmit on the air no more than necessary. "I counted one ham CQing 23 times with his call but thrice. Such operating wastes time; those disgusted pass on to someone else."

W0UOL in *Midwest Relay* reviews some controversial aspects in the origins of the word "ham" and in conclusion: "Everyone knows ham radio as slang for the radio experimenter and operator. Let us look to the future, be proud of our name, and strive through our radio efforts to make it more esteemed to the public."

"I like the BPL card better than any other piece of wall paper I have." — K4KNP.

FCC Reports More Amateur Operator License Suspensions. Additional Public Information releases of the Federal Communications Commission provide details on current license suspensions. In connection with FCC actions taken the pertinent regulations may well rate review by other amateurs to avoid more citations and penalties.

We should also mention that during June three amateurs, additional to those listed, submitted their Conditional Class licenses for cancellation rather than appear for personal examination as they had been requested to do by the Commission under the provisions of Sec. 12.45(a) of the amateur rules.

FCC ordered (May 13, 1958) that the Novice Class amateur operator license of Steve S. Sampson, San Francisco, California, be suspended until July 22, 1958, his license to be returned to the offices of FCC at Washington for the period of his suspension, *it appearing that the licensee* on numerous occasions and particularly on Jan. 7, 1958, operated his station WN6QOR in the 3.5 and 7 Mc. bands

using A-3 emission contrary to the terms of his license, in violation of Sec. 12.23 and 12.28 of FCC rules, *it further appearing that said licensee* (1) sent call signs not assigned by proper authority to his station, in violation of Sec. 12.158 of FCC rules, and (2) that while engaged in operating on Jan. 7 he did not have in his possession, or posted in his radio station, his amateur radio operator and station licenses, a violation of Sec. 12.25 and 12.68 of FCC rules.

FCC ordered (May 22, 1958) that the Technical Class amateur operator license of Harvey J. Beaudry, Jr., Oakland, California, be suspended for a period of three months *it appearing that the licensee* on various occasions between July 31, '57 when his Novice Class license KN9ELS expired and Nov. 14, '57 when he was granted a Technical Class amateur license, operated an unlicensed radio station in the 3.5-4 Mc. band using A-3 emission and the self-assigned call K9ELS/G, violating Sec. 301 and 318 of the Communications Act, *it further appearing* (1) that after receiving Technician Class license K9ELS, he operated on various occasions using A-3 on the 3.5-4 Mc. band contrary to the license terms, violating Sec. 12.23 and 12.28 of FCC rules and (2) that he failed to keep a complete and proper log, violating Sec. 12.136 and (3) that he operated at a fixed location other than that authorized in his station license, a violation of Sec. 12.64 and 12.93, FCC rules.

FCC ordered (May 22, '58) that the Technician Class amateur operator license of Gary B. Jones be suspended for a period of three months, *it appearing that the licensee* on various occasions June 9, '57 to July 17, '57 operated an unlicensed radio station in the 3.5-4 and 7-7.3 Mc. bands using A-3 emission and the self-assigned call W6EBU, a violation of Sec. 301 and 318 of the Communications Act. *It further appearing* (1) that after obtaining Technician Class license W6QDJ he on various occasions operated A-3 in the 3.5 and 7 Mc. bands contrary to his license terms in violation of Sec. 12.23 and 12.28 FCC rules and (2) that he operated his amateur station at a fixed location different from that authorized in the station license, violating Sec. 12.64 and 12.93 FCC rules.

FCC ordered (May 16, '58) that the Technician Class amateur operator license of John L. McPherson, Jackson, Miss., be suspended until Oct. 22, 1961 (3½ years) his amateur operator license (of K6UXD) to be turned in to the FCC, *it appearing* (1) that FCC issued to B. L. Pedersen, San Fernando, Calif. a Novice Class operator-station license KN6UXC and Technician Class license K6UXC and *it further appearing* (1) that these licenses were issued by FCC on the basis of information and statements in the application and certifications which were false and (2) that B. L. Pedersen did not execute and file with FCC the applications, nor take the code examination Sept. 13, '56 as certified and (3) that John L. McPherson did on Sept. 13, '56 and other occasions, participate in arrangements wherein by fraudulent means, in violation of Sec. 12.162, the above-mentioned licenses were issued.

FCC ordered (May 22, '58) that the Technician Class amateur operator license of Harold W. Casto, Mountain View, Cal., be suspended for a period of three months, his license returnable to FCC for the period of the suspension, *it appearing that the licensee* during the period July 7 to July 18, '57 operated an unlicensed radio station, using A-3 in the 3.5 and 7 Mc. bands and the self-assigned call sign K6CQA, a violation of Sec. 301 and 318 of the Communications Act and *it further appearing* (1) that after obtaining Technician Class license W6QCU he operated his station using A-3 in the 3.5 and 7 Mc. bands contrary to this

license, violating Sec. 12.23 and 12.28 FCC rules and (2) that he operated his amateur station at a fixed location other than that authorized in his station license, violating Sec. 12.64 and 12.93.

— F. E. H.

BRASS POUNDERS LEAGUE

Winners of RPL Certificates for May traffic:

Call	Orig.	Recd.	Rel.	Del.	Total
W2KEB.....	301	1785	1348	343	3777
W3CUL.....	203	1091	1224	147	2665
W6IAB.....	49	1259	1054	205	2567
W7BA.....	14	1016	986	29	2045
W0SCA.....	36	920	903	4	1863
W8UPL.....	25	681	615	62	1383
W3CPI.....	6	654	614	40	1314
W9CNY.....	6	645	624	21	1296
W0PZO.....	2	652	657	3	1294
W4PL.....	14	624	596	19	1253
W5RCE.....	12	572	513	59	1156
W9DO.....	18	535	506	47	1106
W9NEZ.....	244	407	0	405	1056
W1UEQ.....	669	139	90	44	942
W0LQG.....	32	463	421	26	942
W0LCX.....	30	452	423	29	934
W0OHL.....	2	465	457	8	932
W0BDR.....	5	494	401	19	919
W6GYH.....	259	312	288	6	865
K6HLR.....	55	386	308	75	822
W0IA.....	42	379	366	5	792
K2PHE.....	336	232	191	1	760
W7PGY.....	38	361	313	42	754
K9GDF.....	97	326	275	46	744
W0BLI.....	1	367	364	1	733
W9GAE.....	3	333	332	4	672
K5EPA.....	14	314	300	7	635
W6ZJB.....	183	271	121	40	615
K0CLS.....	92	269	226	15	602
W6GOY.....	349	120	49	76	594
W1YRC.....	19	282	257	28	586
W0BPF.....	3	291	287	4	585
W1EMG.....	2	290	284	23	579
K4RLG.....	33	262	223	39	557
W0TOL.....	54	286	204	9	553
K6CK.....	3	266	150	116	535
W5PFI.....	12	252	240	28	532
W4QDY.....	209	167	118	36	530
W0KQ.....	58	236	209	97	520
W4TWM.....	8	256	237	19	520
W4WQT.....	256	4	256	4	520
K9GDQ.....	31	245	204	40	520
K2NIL.....	46	243	206	21	516
K4ONQ.....	17	249	235	12	513
F4DSN.....	31	240	233	7	511
K4SJI.....	32	263	195	19	509

Late Reports:

W0PZ (Apr.).....	6	791	754	14	1565
W7AFP (Apr.).....	16	463	463	0	942
W0IA (Apr.).....	28	325	322	2	677

More-Than-One-Operator Stations

Call	Orig.	Recd.	Rel.	Del.	Total
K8MCA.....	145	541	563	10	1259

BPL for 100 or more originations-plus-deliveries

K6CZ.....	276	W4SEJ.....	119	K0LNQ.....	104
K1BCS.....	249	W9PCQ.....	119	W0VPO.....	104
W5ZTN.....	149	K2AW.....	114	W1VRE.....	103
K2UTY.....	142	K4AVU.....	110	W1EAE.....	102
W2BVE.....	136	K4HQK.....	110	W6YDK.....	102
K2RKL.....	130	W9ETM.....	109	W1CMM.....	101
W8CWE.....	130	K6YBV.....	107	K9JCF.....	101
K4KBT.....	127	W0QVN.....	106	Late Report:	
R6IDV.....	124	W4PFD.....	105	K9GDQ (Apr.).....	134
W8WGU.....	122	K2VIX.....	104		

More-Than-One-Operator Stations

KGIDT.....	249	K2HHJ/2.....	153	K4OSQ.....	101
		W1AW.....	133		

BPL medallions (see Aug. 1954 QST, p. 64) have been awarded to the following amateurs since last month's listing: W1BTV, W1FYF, K2SLL, K4SJI, W5DWB, K5MZS, K6YBV, K9GCN, K9MMZ, W0SCT.

The BPL is open to all amateurs in the United States, Canada, Cuba, and U. S. possessions who report to their SCM a message total of 500 or more, or 100 or more originations plus deliveries for any calendar month. All messages must be handled on amateur frequencies within 48 hours of receipt, in standard ARRL form.

RTTY NOTES

The East Coast RTTY Net meets with W1BGW as NCS, 3:20 p.m. EDT each Wednesday. Before the net opens 15 seconds of "mark" are sent by the NCS with request for all stations to zero beat the net frequency.

Weekly meetings of the Forty RTTY Net are at 2 p.m. CDT Sundays, 7140 kc. Stations are called in order, any messages to be indicated on responding. After roll call traffic exchanges are directed by NCS W0BP. Bulletins of

amateur interest and a round-table ragchew follow. A score of stations are active in each of these nets. Several licensing areas report into the 7-Mc. TTY net. W0BP has reminded netters to note times and frequencies of section nets that operate daily in the ARRL National Traffic System to permit free transfer of any traffic in and out of the RTTY net. Members in the far west can report in on 21,090 kc.

The Twin City "RATS" have elected W0HZR the "Quick Brown Fox," W0AUS "Lazy Dog" and W0LFT "RY" for the year. The group welcomes visitors at meetings, which will be held on each second Monday starting in September.

Tests have been conducted from W0BP using 850 cycles compared with narrow shifts. A surprising number of operators using straddle-tuned receivers, mark and space half the total shift each side of their 2550-cycle filter midpoint, report satisfactory printing. Further shift-reduction runs are planned. 170 cycles, one-fifth the customary f.s.k., is the most popular narrow shift when stability problems are considered.

Early contacts by KR6GF were with KR6JL and W0BP. A new radio-letter amateur radio RTTY service came about from a KL7OOT-W0BP relay of long-tape punchings (Model 19 on 14.32 Mc.) and from 400 miles inside the Arctic Circle.

W9BQC/9 put on a fine demonstration at the Starved Rock, Illinois Hamfest, and W9s ROQ QKE SPT GLR WMR were on deck there for the Sunday Net. Speaking of demonstrations, an excellent RTTY showing was made by W6PHS/6 at the Pacific Division Convention at Fresno in early June. W6CQI/6 was on from Palo Alto, with W6MXJ and K6OUR of San Francisco, W6ASJ of Piedmont, and W6VPC on from Oakland. Lots of visitor traffic was handled and that for San Francisco and Oakland was relayed on the 147.29-Mc. channel. The Northern California Amateur Radio Teletype Society, with over 80 members, now has distributed over 300 Model 26's. The Society's history and progress were recounted in a bulletin by President W6VVF, sent to the conventioners. W6s CBF FYM MTJ NRM CKQ, K6ZLB and others helped make the W6PHS/6 work a success.

VK3KF has been active Monday, Wednesday and Thursday on 21,090 kc., using a borrowed Model 15 and a tachometer to get the speed down around 368 o.p.m. W6KUY/MM aboard the SS Pacific Transport worked RTTY all the way across, docking at Yokohama June 14. KR6AK often works the gang starting at 0300 GMT, 21,080 kc.

The first two-way RTTY QSO between U.S.A. and Australia was recorded May 24 when VK3KF, with 100 watts on 21,083 kc., worked W6CG. He had worked KR6AK the previous day. The second and third contacts went to K6OWQ and W8GIG.

W3PYW and others in the Washington area have big plans in connection with the National Convention. All RTTY operators present are urged to get together at the RTTY dinner the evening of August 16.

NATIONAL CALLING AND EMERGENCY FREQUENCIES (Kc.)

3550	3875	7100	7250
14,050	14,225	21,050	21,400
28,100	29,640	50,550	145,350

Training Aids Notes

Our Training Aids section announces the availability of a new film Coded F-35 and titled "Get the Idea." This movie is another product of the Phil-Mont Mobile Radio Club, whose other production, "Every Single Minute," is also available to ARRL affiliated clubs.

"Get the Idea" presents some good basic conceptions on phone operating procedure, both commercial and amateur. We're certain affiliated club groups viewing this motion picture will find it very enjoyable and beneficial. It has sound, is black and white and runs approximately 17 minutes.



Now that we're getting plenty of material for this column (thanks, fellows!), we can start looking it over and getting a little choosy about what we use and when we use it. That's what happens, you know. When you get prosperous, you get particular.

The working informal policy we have used is to give highest priority to reports of amateur participation in actual communications emergencies. When the emergency is widespread and amateur participation extensive, and illustrative material is available, we often are able to submit an up-front feature article on it. Reports on drills and special non-emergency activities come second, but when you include a usable picture it "ups" the priority to the extent that we may use the picture with a suitable caption. Other material, such as new ideas for organization, progress reports, reports of meetings or gatherings, take a third priority rating as a general rule.

In all material, we have to insist on using editorial prerogative in consonance with the space we have available. This space problem is a critical one. Some issues of *QST* have more space available than others, so occasionally we have to cut something out, or add something, depending on whether we have more or less space. We deplore interference from the simple mechanics of magazine editing, but this is a very practical problem and we have to deal with it.

You may think that it is very easy to draw the line between emergencies and non-emergencies, but this is not the case. It is sometimes very hard to determine whether an activity can be classified as emergency or not, and becomes harder every day as more and varied material is received. In recent and subsequent issues you will come across some typical examples. In one issue we had an emergency in which a boy was stung by a bee at a fair in which amateurs were helping out with communications. In another we had the rescue of a dog from a snowbound house. There have been plenty of examples of amateurs assisting in getting medicines for sick people, of assisting in searches for lost people, of locating missing persons, and even of collecting money for various causes, both good and questionable; also, of AREC or RACES groups alerted against the possibility of a communications emergency that never materialized. We remember one case where amateurs mobilized to assist a maritime mobile thought to be in distress in a storm until nearly the whole 75-meter band was in an uproar, only to discover later that the boat had never been in distress at all. His rig just hadn't been working. Was this an emergency? We thought not, but others argued very strongly that it was.

What we ought to do is formulate for ourselves a policy definition on just what constitutes a communications emergency, and then stick to it. This is hard to do, and often seems unfair. From a detached standpoint, a communications emergency would seem to be one in which normal (commercial) means of communication are not available or are overloaded, and in which amateurs provide communications facilities on a temporary basis until normal service can be restored or until the emergency is over, whichever is sooner. Two things are requisite: an emergency situation and a lack of communications. If either is lacking, it is not a communication emergency and does not deserve to be treated as such.

Such a policy may seem unfair when a group is alerted for a pending emergency and loses time and sleep in monitoring and preparing, only to have no communications emergency develop, while another group is not called into action until a communications emergency exists, then does a sloppy, makeshift, haphazard job of communications. The latter group has performed in a communications emergency, the former has not — but which group deserves the greatest credit?

As often as not, the information submitted is incomplete, inconclusive and incomprehensible. We don't require you to be journalists, but we do need all the facts: when, where, what, how and who? We're not interested in details of the emergency situation, except to know what it was; what we want to know about is what the *amateurs* did. And if what

they did could have been accomplished just as well (or better) by commercial means (even if it does cost some money!), then it just wasn't really a communications emergency. This doesn't mean you shouldn't report it, only that it will take a lower priority in this column than those activities that qualify as communications emergencies.

Now that we are getting considerable material, we are going to get a little tougher about this distinction. We'll open up another category: the non-communications emergency. That is, the emergency in which amateurs participated by communicating, but in which their services weren't really required by the situation. If it isn't clear from the material you send in, we'll just assume that their services were *not* required. This should get us into a lot of interesting arguments, because we cannot engage in extensive inquiring correspondence on these subjects. We hope you'll make it clear, one way or the other, and that you'll check your reports to see that the five one-word interrogatives above are answered.

— * * * * *

The University of Connecticut Emergency Net had a good workout on April 21 when it was called upon to assist in a forest fire near the Mansfield Hollow Conservation Dam Basin. Two-meter portables were used to maintain communications with Storrs, $4\frac{1}{2}$ miles north, W1s DHP and YWU handled the two portables on the scene. Several other operators, with their stations, stood by to help if needed. — W1DHP, OPS Connecticut.

— * * * * *

On May 3, AREC and RACES members in the Belleville, Ill., area, responded to a tornado alert. Mobiles were manned by W9s TWT UOR QDM RQR NXY BA and K9BTR. Radio Officer W9BA activated the Communications Center, assisted by Alternate RO W9RQR and by W9s JMY RSZ, KN9s LDN MHR. Out-of-town contact was effected by W9EVN and W9END when the twister struck Collinsville. Although damage was slight, there was need for emergency communications facilities. The communications center, serving Belleville, East St. Louis and St. Clair County operated under the call of K9KHN. — W9BA, EC St. Clair Co., Ill.

— * * * * *

A severe wind and rain storm along the South Shore of Nova Scotia on Apr. 2 disrupted communications facilities and brought the AREC into action. VE1ABJ and VE1LB handled train dispatch orders between Bridgewater and Middleton. Fifty-four messages were handled between Middleton and Lunenburg for Canadian National Telegraph and six to other points, through a hookup that included VE1s KE MA and VN. VE1DW handled Yarmouth traffic while VE1ADH looked after Halifax traffic. The operation was continuous from 1245 AST until 2130 AST at which time commercial communications were restored. — VE1A1, EC Western Nova Scotia.

— * * * * *

After a very heavy rainfall on May 9, Nonconah Creek in Memphis overflowed, disrupting communications. The Red Cross requested aid from the amateurs, and in a matter of minutes mobiles W4BAQ, K4CTA and W4WTJ were on the scene. W4EM was set up at headquarters and with K4KQM maintained communication with all units. A mobile was assigned to the fire station at Willow Road, which was used as boat headquarters, and one mobile was assigned to the CAP rescue unit. Other mobiles taking part were W4s JMB ADM CLQ WTI WBK YMG, K4s JSF LZR PPZ RGB UEB PYH VYL ASK EQX and BOM. Fixed stations included W4s JMB FRB, K4s EJU and GPZ.

— * * * * *

On May 23 at 1930, the Long Beach, Calif., Civil Defense Net was called upon to patrol the Signal Hill oil fire area. The fire department requested that the mobiles, operating on 29.4 Mc., patrol the Signal Hill area to keep out spectators, report any small fires, supply road blocks with material and communication and place in custody all vehicles which ran or avoided road blocks or in any other way endangered their lives or those of other personnel on the hill. Participating stations were W6s KQJ ROJ ZVD, K6s CBN HAZ IPJ KYH PFM QBZ and YFG. — K6KYH and W6RUC, EC Long Beach, Calif.

— * * * * *

On June 4, W9JFS, hearing about the tornadoes in Wisconsin, contacted W9SAA in West Bend, Wis., to obtain further information for the Salvation Army, which he then gave to W9ZAD in Milwaukee for delivery to Salvation

Army headquarters at that point. Via amateur radio, contact was also maintained between Milwaukee, Chippewa Falls (Wis.) and Davenport (Iowa), also through W9JFS.

On June 4, K6VDG heard K6YVB calling "CQ Emergency" on 6 meters. On answering the call, K6VDG was told that there was a car accident on the Hollywood Freeway and a lady was badly injured. Even while this information was being passed along, K6ZGK called the police and told them where to go. — K6VDG.

The St. Paul, Minn., Mobile Radio Club was able to offer some valuable assistance during the extensive tornado activity in Wisconsin on June 5th and 6th. While K0GVX operated Red Cross headquarters station W0DKI in St. Paul, W0s PDN EZV GUS and HKF operated mobile in the disaster area, maintaining contact with W0DKI via W9FYS in River Falls, Wis. Much traffic was passed, both of an emergency and personal nature. EC W0PDN gives us the following additional list of amateurs who took part: W0s IPN EXC THY, K0s HUA GCN.

On June 7, K5EOI and K5CHK assisted in obtaining a special antitoxin needed to save the life of an Air Force technical sergeant bitten by a coral snake. Information that the serum was needed came from W5JHS, and before long amateurs from Florida to Texas were calling their hospitals in an effort to obtain it. The needed medicine was finally located in New Orleans and flown by Navy jet to Eglin Air Force Base, Florida, in time to save the sergeant's life.

Members of the Midwest V.H.F. Association (St. Louis area) were alerted for a number of tornadoes in April and May, but no emergency communication resulted. Nevertheless, the turnout for these alerts was always good; these fellows are ready, and we feel sorry for any tornado that dares show its ugly funnel around St. Louis. Operation, including most of the alerting, is all conducted on six meters. Such alerts (the real thing, not drills) were called on April 5 (26 participating), May 3 (29 participating), May 4 and May 31.

On March 18 W0IRM, while driving to work, noticed a large dump truck on fire. He called K0BFS on the six meter net, who notified the fire department by landline. Once the firemen arrived at the fire scene, K0BFS provided communication between them and the chief in Mounds, for a very impressive demonstration of amateur radio emergency facilities.

On April 19, 200 explorer scouts and senior girl scouts participated in the largest scout-c.d. drill ever conducted in the state of Illinois. The problem was a simulated atomic explosion in Waukegan, and scouts were dispatched on search and rescue missions. Each search party was equipped with hand-carried portables, plus mobiles on two and ten meters. Four amateurs and a number of restricted permit-holders took part.

The El Paso (Texas) 10-Meter Emergency Net mustered 35 members on a moment's notice in a simulated emergency test on April 28, spotting portable and mobile stations all over the city. K5DHL, net control, had established his own portable station at the control point within 45 minutes after the drill was called, and other portables were set up at strategic points. Messages from field stations to the mayor, the chief of police, officials of the fire department, Civil Air Patrol, CAA, newspapers, military reserve units and the Red Cross, said: "We are taking this opportunity to acquaint the City of El Paso with the fact that we are available with our 20 mobile units, five portable units and 30 fixed stations which are capable of keeping the city in constant communication day or night with any or all parts of the United States." Amateurs of the group canceled engagements, skipped dinner, got up from sickbeds and otherwise inconvenienced themselves to make the test a success.

A school evacuation drill was the problem of 22 mobile units of the Pueblo, Colo., Amateur Radio Association on April 30. In addition to manning the control center, amateurs ranged far and wide to report on traffic tieups, transportation shortages and other problems. The drill was not an unqualified success from an over-all standpoint, but the



The SWANI Radio Club of Woodstock, Ill., maintains an active RACES group and AREC organization under the direction of W9KMN (standing in picture) in full cooperation with both civil defense and Red Cross. Seated is K9DZF, SWANI club publicity director, at the controls of his rig.

communications facilities provided by the amateurs were exemplary.

Cleveland is not especially noted for its serious emergencies, but nevertheless the Cuyahoga County AREC organization, under EC W8AEU, is one of the most active and efficient units in the country. Not only that, but each activity is fully reported. Here are a few of the highlights in recent months: On April 1, a demonstration for the boy scouts in which six amateurs participated. On April 16, a practice run for the severe weather network in which 88 stations took part in 34 communities on nine different networks on 2, 6 and 10 meters. On April 16, a fund drive of the American Cancer Society supported by 14 AREC mobiles and a portable station, all on 6 meters; 23 amateurs took part in this one.

On May 1 it was a parade celebrating Loyalty Day, in which the AREC supplied communications using 6 mobiles on 10 meters spread throughout the parade. A hand-carried unit was located in the lead car and later transferred to the reviewing stand, enabling the mayor to keep tabs on progress. Another such unit was at an elevated observation post to keep officials informed on parade quality. A fixed station stood by to furnish telephone communication in case of emergency, and this station was not idle. Thirteen AREC members participated in this one.

On May 30, another parade honored the National Guard. Nine amateurs took part using four mobiles, a hand-carried portable and a fixed station. And finally, on June 7, fourteen AREC members provided communications for a sports-car race, using nine mobiles, three hand-carried portables and one portable rig. Although temporary telephone lines were used, the AREC units were useful as back-up and in reporting from positions where telephones were not available.

Maybe the above will give some of our ECs who are trying to keep their AREC units active something to think about.

While on a recent visit to New Mexico for the purpose of attending the Rocky Mountain Division ARRL Convention, it was our pleasure to observe some of the finest net operation we have ever heard in amateur circles. This was executed by the Caravan Club members who were set up at Santa Fe and on all approaches thereto to guide incoming conventioners to the convention headquarters. Nothing particularly unique in this alone, although we must comment that it was exceptionally well executed and might well be a more common practice. What impressed us was the procedure used by the members of the Caravan Club in communication with each other. Although we cannot give any details at the moment (not enough room), in essence the procedure is clipped and to the point, leaving out all nonsense, wasted words and unnecessary transmissions. Procedural breaks and signals are used and observed by all;

but this did not prevent extension of courtesy to outside stations who broke in or to visiting mobiles not familiar with the procedure. The important aspect of this type of operation is less the details than the mien, which impelled even outside stations to make their transmissions short and to the point. We wish more amateur nets sounded like this.

We received 25 April SEC reports, representing 6689 AREC members. This is an increase of three reports and about 500 AREC members over April of last year. What's more, five of the SECs reporting for April were from sections not previously reported in 1958: Western N. Y., N. C., E. Pa., Vt. and B. C. Other sections reporting for April: Md.-Del.-D.C., Conn., NYC-L.I., Ga., Santa Barbara, Tenn., E. Bay, Mont., Colo., Nev., N. M., Ala., San Joaquin Valley, E. Fla., Wis., N. Texas, S. Texas, Santa Clara Valley, Mich., Maritime.

RACES News

The May, 1958, issue of "The Monitor," a monthly paper published out of Dallas, Texas by W5RYP and W5ZYA, contains an interesting item on the Dallas RACES plan.



This plan is comprehensive but still in proposal stages, but it is interesting and encouraging to know that the Dallas gang and some other Texas cities are starting the ball rolling even though there is as yet no coordinating state plan in existence. We wish the Dallas gang success in getting the plan approved to give greater stature to the state of Texas in the RACES program.

So far, RACES is one thing Texas is not biggest in.

Among the agencies asked to participate in the filming of the USO-Armed Forces Religious Emphasis Day in Philadelphia on April 20 was the Philadelphia Civil Defense Council, which was asked to provide mobile radio communications for the roving camera crews of the United States Army Pictorial Service. A RACES mobile was assigned to the director of the movie and other mobiles were dispatched as needed to points needing coverage. Although not a RACES drill as such, the activity was good practice and represented a real situation rather than a paper drill. The first mobile checked in at 0900 and the last checked out at 1815. Frequencies on the Phil-Mont Mobile Radio Club were used on ten meters, and that of the Mobile Sixers Radio Club on six meters. About ten RACES mobiles took part. — W3PST, RO Philadelphia, Pa.

On May 1, W0DCW was designated to organize communications coverage for a C.D. drill involving the evacuation of school children from Jefferson County, Colo., to Glenwood Springs, 130 miles away, and return the next day. The main problem was to keep the children in contact with their parents. K0DCW set up control on forty meter phone and three mobiles accompanied the convoy to Glenwood Springs. Several fixed stations at each end and along the route also assisted in maintaining contact between the control station and the convoy mobiles. About 10 amateurs participated. Everyone proclaimed the operation a great success.

The Peoria (Ill.) Civil Defense Director called K9YDY, net manager of the 12 County Support Area Net at 1855 on May 5, asking that he alert as many stations as possible in 45 minutes for a practice alert. At 1902 K9ESP was contacted and the ball started rolling until by 1940 twenty-four stations had reported in and seven mobiles were ready to roll anywhere needed. This drill was a complete surprise to everybody, so the showing of 24 out of 52 stations on the roster was considered a good one.

CALIFORNIA FLOOD EMERGENCY

Scattered reports indicate amateur operation during the floods of early April in California was quite extensive. There is more to come (we hope), but here's what we have so far.

The Turlock Amateur Radio Club and the Stanislaus County RACES organization set up an emergency control station at a school west of Turlock, using the call W6BXN and two-meter equipment. Operation started on April 5 and around-the-clock watches were maintained for several days. The first day private cars were used, but later the National Guard supplied jeeps and drivers. Services performed included communications connected with obtaining information for plotting the edge of the inundated area, measuring check points for the rise or fall of the water, helping people get transportation to leave the area, and many others.

In Redwood City, the South County Amateur Radio Society was asked to activate the control center and have mobiles patrol the Redwood City area, reporting flooded areas, washed out roads, blocked creeks, downed electric and telephone lines and hazards to life and property. The control center was activated at 1415, April 2. A mobile was dispatched to the home of K6TWH, who was instructed to activate the Red Cross station, K6OTR. This station broadcast an appeal to all amateurs for mobile equipment, and very shortly units began checking in. Communications links were established between police, fire, Red Cross and other services. Amateur radio operators from throughout the area called the NCS, offering their assistance and reporting flooding conditions in their areas. Several mobiles from other areas assisted, a total of 9 mobiles and 15 relay stations participating in the operation. Stations were released and net control closed operation at 0045, April 3. The county CD Director called the amateurs "the heart of our communications system." The following amateurs participated: W6s TYC, VQV AFV, K6s IEE MPN DZR RZF VIN QAX TKF HEG TWH LHV OEJ BXXN UWM JTC TLD TNM, WN6WVG. — K6IEE, RO, Redwood City, Calif.

In East Contra Costa County, a state of emergency was declared on April 2. K6ILH and W6AIL called the AREC in for assistance. W6OHR, K6JAV and W6KLM, all mobile, made checks of the flood areas and reported to headquarters any high waters or floods that were not properly posted on the highways. Other amateurs who served as relief operators at the c.w. communications office included W6s QEN DEX, K6s KRF ZPB IMV AQ KYT and IRB. K6AXV stood by on 50 Mc. until midnight to receive traffic for his area. County officers estimated that amateurs increased the efficiency of communications operation by at least 25%, largely due to the jamming of facilities at the county offices by incoming calls. Other amateurs who participated: W6s LKE HOF PIR LGW FAR IHR RVC EPI KTF CGS FKX, WN6UFG, K6s AXV PIL POU OGU JAY RPY TPO ZWJ. — W6LGV, EC East Contra Costa County, Calif.

In Menlo Park, the e.d. net control station, K6YQT, came on the air at 2000, April 2. A mobile was kept near the banks of the creek and continuing reports were sent into the city as to the height of flood waters. This operation was handled on six meters by K6s MMT SVK KEV and GDH. At the same time a 2-meter link was established with W6WWJ, the Redwood City base station and with K6OTR, the Red Cross station. City officials expressed their satisfaction and gratification with the efficiency of the operation. — K6GDH, Asst. EC, Menlo Park, Calif.

From W6KZF's "Short-Ray-Vues" in Mission Trail Net's "Blazer," we have information of services performed during the emergency by that group; At 2141, April 2, W6NTU advised W6CXO that three people had called to him for help across a raging stream. W6CXO (W6JWF operating) telephoned the Alameda County Sheriff's Office, which dispatched rescue units. These units approached from a direction that would make rescue impossible, this despite W6NTU's warnings that they could not make it through flood conditions; so, after coming within three miles of the victims, the sheriff's office advised that they were sending a helicopter at dawn. Since the condition of the victims appeared to be bad (two elderly ladies and one elderly man), broadcast stations in San Francisco and San Jose broadcast bulletins all night, at W6NTU's request, giving encouragement to the victims in case they had a radio turned on. Just when things looked bad, W6NTU came on with the information that a vehicle had arrived across stream and was picking up the victims, and at 0330 set out for Liver-

NATIONAL RTTY CALLING AND WORKING FREQUENCIES

3620 kc. 7140 kc.

These frequencies are employed throughout the United States by amateurs using radioteletype.

more, after asking for an escort. The following other net members participated in the emergency: W6s RHA ZLO JCU KZF and KGOSX.

Another emergency handled by the Mission Trail Net had to do with several missing buses, two trains and a number of private cars, all stalled by a rock slide on Highway 50 west of Echo Summit. K6M1DA took information from W6TXR. W6JCU acted as liaison and relay for several hours. As a result of this effort, the Highway Patrol cruised the highway on both sides of the slide and got all buses and private cars to safety. Other amateurs working in this emergency were W6s KZF UW EPG USO, K6s SXX JIM YBV LCF KLO, W7s CML TQE, K7AGE/m.

TRAFFIC TOPICS

Experiencing some difficulty in obtaining new traffic "blood" for our nets by conventional means, we have embarked on a more literal and scientific approach. In the dark recesses of a certain nameless medical laboratory, Dr. H. R. Messej, W1QTC, has been researching on a project designed to bring more traffic converts into the amateur ranks. The exact details are top secret, shrouded in mystery, but we can tell you that by both fair means and foul (mostly the latter) he has acquired a supply of blood from some of the more active traffic men and has already developed a serum. When injected into guinea pigs, the effect is encouraging: their front paws twitch as though trying to operate keys, their eyes go blank (i.e., radiogram blank), and they squeak in a manner highly reminiscent of a 75-meter phone net. The effect wears off after a certain length of time, after which re-injection is necessary for continuation. The good doctor is now looking around for human volunteers among the amateur ranks, but all approached so far have turned livid at the thought of such a fate.

Eventually, we are confident that the experiments will prove to be successful and the serum, which we call "traffic juice," will be available for distribution to the field, free of charge, of course. We hope to have supplies of it, along with the means for administering it surreptitiously, available for our agents at meetings of DX, RTTY, s.s.b. and YLRL groups at conventions and hamfests. Meanwhile, W1QTC will work on a new method of oral consumption such as in scotch or bourbon, to assure widespread assimilation by amateurs nationwide.

August 1 is the date that all nets in our present registry are placed behind the "discontinued" tab. They are then restored to the active part of the file only as they are re-registered. Get a copy of CD-85 so you can be assured of a place in the first QST net listing (November QST) and in the annual net directory issued about the first of December. However, this year we want to give fair warning that social and ragchew nets with no other purpose will *not* be registered.

Net reports. The Early Bird Transcontinental Net reports 31 sessions and 716 messages handled. Transcontinental Phone Net handled 5426 messages in May, broken down as follows: 1st Call Area, 2167; Second Call Area, 2382; 4th, 8th, 9th and 9th Call Areas, 877. The Interstate Single Sideband Net conducted 31 sessions, handled 721 messages, averaging 52 stations per session, and 1560 check-ins; three emergency sessions were held. The North Texas Oklahoma Traffic Net had 31 sessions, handled 361 messages in 834 check-ins.

National Traffic System. Seems as though we operators who work in The System ought to set the example for other traffic men. Recently we have noticed many NTS operators, most of whom certainly know better, using procedure not recommended by ARRL, or leaving out things which *are* recommended by the League. Minor things, mostly, and usually a result of habit rather than ignorance — such as leaving out or otherwise neglecting the "check" of a message, omitting the AA separation between the parts of the address or the AR at the end of the message on c.w., or using the word "SIG" before the signature. Many messages come through in non-standard form, mostly as a result of incorrect MARS refiling, and remain in that form because no one takes the trouble of changing it to amateur form along the way. Remember, it is wrong to change the content of a message, but desirable to correct its form. These things have all been covered in this section of QST in the past. Naturally, you have a right to agree or disagree and



Here's W0TOL, manager of the NTS Tenth Regional Net, at his neat and business-like operating position in Manhattan, Kans. "D", in addition to being TEN Manager, is NCS on QKN (Kans. C.W. Net) and Central Area Net. He's ORS, of course, and has been an amateur since 1926. Ex-calls include W9BYY and W9AII.

use the procedure you think best; but you are perpetrating a disservice both to yourself and The System if you ignore the facets of logic on which most of our procedure is based. Trouble is simply that so many traffic men are stubborn individualists and they'll b'god keep right on using the procedure they are used to. We don't suppose we'll ever change this, but we do hope that our newer traffic men (those inoculated with "traffic juice") will study up on procedure as recommended by the League and use this rather than imitating incorrect procedure as practiced by some of the old timers.

May reports:

Net	Ses- sions	Traffic	Rate	Aver- age	Represen- tation (%)
EAN.....	25	1246	.909	49.8	96.7
CAN.....	31	1335	.807	43.1	100.0
PAN.....	31	1269	.530	40.9	90.3
IRN.....	27	471	.370	17.4	88.4 ¹
2RN.....	54	556	.357	10.3	99.3
3RN.....	44	281	.319	6.4	86.4
4RN.....	52	485	.243	9.3	52.7
RN5.....	54	772	.408	14.2	84.4
RNG.....	20	495	.568	24.8	59.6 ¹
8RN.....	47	119	.162	2.5	86.5
TEN.....	93	978	.381	10.5	54.7
ECN.....	16	54	.196	3.3	70.8 ¹
Sections ²	972	7365		7.6	
TCC (Eastern)	64 ³	227			
TCC (Central)	62 ³	1225			
TCC (Pacific)	107 ³	957			
Summary.....	1466	17835	EAN	10.5	CAN
Record.....	1466	18192	.909	22.1	100.0

¹ Regional net representation based on one session per day. Others are based on two or more sessions.

² Section nets reporting: WVN (W. Va.); QMN (Mich.); QKN & QKS (Kans.); AENP Morning, AENP & AENB (Ala.); CWX (Colo.); CN & CPN (Conn.); FMTN, Gator & FN (Fla.); MSPN Noon, MSPN Evening & MSN (Minn.); WSN (Wash.); KSB, KPN & KYN (Ky.); S. Dak. 75 & S. Dak. 40; Iowa 75; TLCN (Iowa); MDD (Md.-Del.-D.C.); GSPN (N. H.); ILN (Ill.); SCN (S. C.); SCN (Calif.).

³ TCC functions reported, not counted as net sessions.

The Rocky Mountain Net is shortly to become the Twelfth Regional Net of NTS; this was decided upon during a recent personal visit to the region. The new regional net, most of which will be backed out of the present Sixth NTS Region, will consist, tentatively, of the states of New Mexico, Colorado, Utah, Arizona and Wyoming. We hope by the time you read this the new RN will be in full official operation, complete with manager, who has not at this writing been officially appointed. We suspect that the new RN will have a pretty rough go of it in the beginning, particularly starting as it is during the summer, and therefore urge all concerned to assist this region in becoming a solid part of NTS in full status. This means that it must have a

full complement of section representatives, net control stations and area net liaisons. NTS is expanding; it's up to you fellows in the Southern Rockies to get behind this movement and show that sparse ability is not necessarily proportional to sparse population.

W9DO has honored the following with hard-earned area net (CAN) certificates: W4RCM/5, K4ONQ, W5RCF, W7s MAK ZYK, W0s KJZ LGG DDT TOL GXQ LCX. PAN has tried operating on 7060 kc. to get away from QRN and short-range propagation, but it isn't working out too well; W6PLG is taking over as acting manager while K6DYX travels during June and July. W2BZJ has received his 2RN certificate. W3LXU, the 13-year-old Western Pa. iron man, is handling representation from that section single-handed, in addition to 3RN NCS and Eastern Area TCC assignments. W4SHJ is still working on Canal

The TCC roster: Central Area (W0BDR, Dir.)—W9CXY, W0s LCX BDR SCA LGG, Pacific Area (W6BPT, Dir.)—W5DWB, W0s EOT ADB PLG BPT VZT HC UTV, K6s DYX EWY HLR GES GID, W7GMC, W0s KQD WMK.

ELECTION NOTICE

(To all ARRL members residing in the Sections listed below.)

You are hereby notified that an election for Section Communications Manager is about to be held in your respective Section. The notice supersedes previous notices.

Nominating petitions are solicited. The signatures of five or more ARRL full members of the Section concerned, in good standing, are required on each petition. No member shall sign more than one petition.

Each candidate for Section Communications Manager must have been a licensed amateur for at least two years and similarly a full member of the League for at least one continuous year immediately prior to his nomination.

Petitions must be in West Hartford, Conn., on or before noon on the closing dates specified. In cases where no valid nominating petitions were received in response to previous notices, the closing dates are set ahead to the dates given herewith. The complete name, address, and station call of the candidate should be included with the petition. It is advisable that eight or ten full-member signatures be obtained, since on checking names against Headquarters files, with no time to return invalid petitions for additions, a petition may be found invalid by reason of expiring memberships, individual signers uncertain or ignorant of their membership status, etc.

The following nomination form is suggested. (Signers will please add city and street addresses to facilitate checking membership.)

Communications Manager, ARRL, [place and date]
38 La Salle Road, West Hartford, Conn.

We, the undersigned full members of the
..... ARRL Section of the
Division, hereby nominate,
as candidate the Section Communications Manager for this
Section for the next two-year term of office.

Elections will take place immediately after the closing dates specified for receipt of nominating petitions. The ballots mailed from Headquarters to full members will list in alphabetical sequence the names of all eligible candidates.

You are urged to take the initiative and file nominating petitions immediately. This is your opportunity to put the man of your choice in office.

— F. E. Handy, Communications Manager

Section	Closing Date	SCM	Term Ends
Yukon*	Aug. 11, 1958	W. R. Williamson	Mar. 17, 1949
West Indies	Aug. 11, 1958	William Werner	Aug. 10, 1958
Idaho	Aug. 11, 1958	Rev. Francis A. Peterson	Oct. 10, 1958
Vermont	Aug. 11, 1958	Mrs. Ann L. Chandler	Oct. 10, 1958
Nevada	Aug. 11, 1958	Albert R. Chin	Oct. 10, 1958
Santa Clara Valley	Aug. 11, 1958	G. Donald Eberlein	Oct. 15, 1958
Rhode Island	Aug. 11, 1958	Mrs. June R. Burkett	Oct. 15, 1958
Arkansas	Aug. 11, 1958	Ulmon M. Goings	Oct. 15, 1958
New Hampshire	Aug. 11, 1958	John Arthur Knapp	Oct. 26, 1958
Kansas	Aug. 11, 1958	Earl N. Johnston	Oct. 29, 1958
North Dakota	Aug. 11, 1958	Rev. Casper F. Bonifas	Resigned
Western Massachusetts	Sept. 10, 1958	Osborne R. McKeraghan	Nov. 10, 1958
Southern Texas	Oct. 10, 1958	Roy K. Eggleston	Dec. 10, 1958

* In Canadian Sections nominating petitions for Section Managers must be addressed to Canadian Director Alex Reid, 169 Logan Ave., St. Lambert, Quebec. To be valid, petitions must be filed with him on or before closing dates named.

ELECTION RESULTS

Valid petitions nominating a single candidate as Section Manager were filed by members in the following Sections, completing their election in accordance with regular League policy, each term of office starting on the date given.

Santa Barbara	Robert A. Hemke, K6CVR	May 9, 1958
Eastern Massachusetts	Frank L. Baker, jr., W1A1P	June 15, 1958
Western New York	Charles T. Hansen, K2HUK	Aug. 10, 1958
Northern Texas	L. L. Harbin, W5BNG	Aug. 10, 1958

A.R.R.L. ACTIVITIES CALENDAR

- July 26-27: CD QSO Party (phone)
- Aug. 6: CP Qualifying Run — W6OWP
- Aug. 20: CP Qualifying Run — W1AW
- Sept. 4: CP Qualifying Run — W6OWP
- Sept. 17: Frequency Measuring Test
- Sept. 18: CP Qualifying Run — W1AW
- Sept. 20-21: V.H.F. QSO Party
- Oct. 1: CP Qualifying Run — W6OWP
- Oct. 11-12: Simulated Emergency Test
- Oct. 17: CP Qualifying Run — W1AW
- Oct. 18-19: CD QSO Party (c.w.)
- Oct. 25-26: CD QSO Party (phone)
- Nov. 8-9, 15-16: Sweepstakes Contest

OTHER ACTIVITIES

The following lists date, name, and sponsor. Details will be presented in future issues of QST.

Sept. 6-7: LABRE DX Contest (c.w.), LABRE.

Sept. 6-7: Virginia Free-for-All QSO Party, W1KX.

Sept. 13-14: LABRE DX Contest (phone), LABRE.

Sept. 27-28: VE/W Contest, Montreal Amateur Radio Club.

Oct. 4-5: VK/ZL DX Contest (phone), NZART.

Oct. 11-12: VK/ZL DX Contest (c.w.), NZART.

Oct. 11-12: Pan American Contest (phone), Radio Club Peruano.

Oct. 18-19: Pan American Contest (c.w.), Radio Club Peruano.

Nov. 22-23: 21/28 Mc. Telephony Contest, RSCB.

Zone and West Indies representation on 4RN. RN5 certificates have been issued to W4s CJW PVG YRO and W5GX. K6SXA is handling RNG during W6CMA's temporary absence, ECN is making contact with its Maritime section on 40 meters for the summer.

Transcontinental Corps. W3WG reported by telegram, so we have no roster this month for the Eastern Area. W0BDR submitted his usual detailed report despite a recent illness. Pacific Area TCC positions are all filled except for one on Saturday and two on Sunday. K6HLR has received his TCC certificate.

May reports:

Area	Func-tions	% Successful	Traffic	Out-of-Net Traffic
Eastern.....	64	96.9	1579	227
Central.....	62	96.8	1972	1225
Pacific.....	107	96.3	1883	957
Summary.....	233	96.6	5434	2409

W1AW OPERATING NOTE

The W1AW summer schedule, as shown on page 80 of last month's QST, is still in effect. See that issue for full information on when and where to look for the ARRL Headquarters station.

CODE PROFICIENCY PROGRAM

Twice each month special transmissions are made to enable you to qualify for the ARRL Code Proficiency Certificate. The next qualifying run from W1AW will be made on August 20 at 2130 Eastern Daylight Saving Time. Identical texts will be sent simultaneously by automatic transmitters on 3555, 7080, 14,100, 21,010, 28,060, 50,900 and 145,600 kc. The next qualifying run from W6OWP only will be transmitted on August 6 at 2100 PDST on 3590 and 7128 kc.

Any person can apply. Neither ARRL membership nor an amateur license is required. Send copies of all qualifying runs to ARRL for grading, stating the call of the station you copied. If you qualify at one of the six speeds transmitted, 10 through 35 w.p.m., you will receive a certificate. If your initial qualification is for a speed below 35 w.p.m., you may try later for endorsement stickers.

Code-practice transmissions are made from W1AW each evening at 2130 EDST. Approximately 10 minutes' practice is given at each speed. Reference to texts used on several

of the transmissions are given below. These make it possible to check your copy. For practice purposes, the order of words in each line of QST text sometimes is reversed. To improve your fist, hook up your own key and audio oscillator and attempt to send in step with W1AW.

- Date* Subject of Practice Text from June QST
 Aug. 4: *Let's Go Microwave*, p. 11
 Aug. 12: *The Versatile S.W.R. Indicator*, p. 15
 Aug. 13: *Crystals Where You Want Them*, p. 19
 Aug. 19: *A Transistorized Grid-Dip Meter*, p. 31
 Aug. 21: *A Weather-Resistant Quad*, p. 42
 Aug. 26: *Board Meeting Highlights*, p. 64A
 Aug. 29: *So You Know Your Field Day Rules*, p. 68

DXCC NOTES

Announcement is hereby made of the addition to the ARRL Countries List of Clatham Islands. These islands are located in the South Pacific Ocean approximately 420 miles east of New Zealand. Addition is made by virtue of point 2 as explained in the May 1955 QST, page 68.

DXCC credit will be given starting October 1, 1958 for creditable confirmations dated on or after November 15, 1945. This is to permit foreign amateurs to start receiving credits at the same time as those in the U.S.A. Confirmations received prior to October 1, 1958 for this country will be returned without credit.

DX CENTURY CLUB AWARDS

HONOR ROLL					
W6AM 279 W8HGW 277 W1FH 277 KV4AA 275 ZL2GX 275 W9NDA 274 PY2GR 274 W3GHD 274 W8BRA 273 W6ENV 273 W6SYG 273 W8NBK 272	W6MX 272 W6DZZ 272 W6RW 272 W2AGW 271 W8JNN 271 W2HUQ 271 W4ASG 271 G2PL 269 W8JNJ 269 W3KT 269 W1ME 268	W7AMX 268 W6OUQ 268 W6TS 268 W2BXA 268 W9YFV 268 W3BES 268 W8ABJ 268 W6GFE 268 W8KIA 267 ZL1HY 267 W6T 267 W6ADP 267	ON4NC 217 W2DEC 214 W1LZE 210 W1TY 210 K6EVR 210 W9EU 210 W6KEK 200 G8KS 200 IZFD 200 W7LOP 197 W6NUU 193 F3FA 193 W4THZ 191 W7KKT 191 F19Y 191 W2IRV 190 W2YTH 190 W3HLX 190 W3WGR 190 W6CG 190 K6BNL 190 K9IV 190 OK1CX 190 W2EQS 187 W3NCF 186 W9DYG 182 W4BYU 181 CN8X 181 DL3FM 181 W3SOH 180 W6LTX 180 F8EJ 180 W4GRP 176 ILAL 173 VE3P 173 W8MWL 172	ZL4BO 171 DL1YA 170 HP1BB 170 W5GNG 168 W9BJJ 164 ZL1AJU 163 W1HCW 162 W4CKB 161 K4LPW 161 FA1AB 161 W9OJD 161 W1LQ 160 W2OTC 160 W3GEN 160 W9HQF 160 ON4GC 160 W7QON 158 W2ROM 157 W8WFB 155 K2CWR 153 W8TUO 153 K1LPIV 153 W3WSE 152 G2RNV 151 W1WAL 150 W4UKA 150 K9AGB 150 KP4YT 150 SM8KY 150 W3BY 148 K4LNM 147 W5QVZ 146 VE5JV 146 K5ADQ 143 W0DRP 143 W9YBK 143 G3GIQ 143	SM6VY 143 VE1NI 143 W4QT 141 K6LGP 141 W2YNA 140 W1FH 140 W0OJV 140 W3RBW 133 K4JOU 133 W8LQA 133 W4BFR 133 W5DNE 131 ET38 131 K2CF 130 W5BQJ 128 K2JGQ 127 W1AF 121 W1OFS 121 W5BLA 121 W1ACB 120 W1HWH 120 W100A 120 W2AWH 120 W4OMW 120 W9LSV 120 W9MUJ 120 W9YFD 120 VE2YT 120 W8LVC 118 W4LW 116 W0DEL 114 W9PIO 114 W0RZU 113 W1YXD 113 T6GAZ 112 PA0KE 111 W5DA 110
Radiotelephone					
PY2GK 273 W8GZ 266 VQ4RR 264 Z86J 263	W1FH 262 W8HGW 262 W8FB 256 W3JNN 256 CN8MM 256	W9RBI 256 W8ABJ 253 CN2CO 252 W9NDA 251			

From May 1, 1958 to June 1, 1958 DXCC certificates and endorsements based on postwar contacts with 100-or-more countries have been issued by the ARRL Communications Department to the amateurs listed below.

NEW MEMBERS

W6CYV 250 W9YCR 179 W8AJH 153 W8AB 144 W9WBL 129 W8RSW 124 W5KLB 119 Z84MG 115 W6CHL 113 W9ONB 113 W5CRK 111 CT1GE 111 W9TJG 110 IJ3J 110 W3MJY 109 W7OCL 109 K4PDV 108 F9IF 108 G4LX 108	XZ2TH 108 W8DDK 107 VK7CH 107 K8ATZ 106 W9LQF 106 KA2AL 106 G13JM 106 W1KYK 105 K2VFR 105 W9CMQ 105 OH1O 105 VK3CN 105 VS1FJ 105 Z84PB 105 W1BPW 104 W8DUU 104 W9DAO 104 K1L7BH 104	K6GLC 103 W9RCQ 103 W9SOA 103 VE8Z 103 ZL1CH 103 W3IPO 102 W5ZWR 102 W9GHE 102 W4HZZ 101 W6HOH 101 W8QP 101 W3KA 100 W4RKB 100 W5EGB 100 K6CHR 100 K6GSL 100 K6TXA 100 W8VVD 100 W8VZ 100
Radiotelephone		
W8HGA 120 OK1MB 116 ZL4BO 116 W1YCX 114 W3GEN 114 W1UQW 110 W8HOY 110 W5BQJ 106 VE5JV 106	W1YJH 105 W8RNB 105 W3ROA 103 W4LVA 102 W9U7C 103 3A2BF 103 W2CCO 102 W8UPN 102	W0VBQ 102 DL6PC 102 LU9DM 102 W1KBS 101 W9ICF 101 KA2AL 101 W4RVL 100 W5WN 100 ZL4IG 100

ENDORSEMENTS

W9HUZ 261 CN8MM 261 G8ZO 260 W5JUF 259 W0DAE 259 W2QHH 258 W4DQH 255 W8KML 252 W1YJH 251 W6LDD 250 ON4AU 250	K2GPO 247 W8TMA 245 W8MPW 244 W7GXA 241 W3DRD 241 W9QVZ 240 W4LYV 238 W4LVY 237 W3OP 233 W5BZT 233 W8QJR 232	W0NTA 231 W9NTC 231 W4GXN 230 W6KEY 227 W6KZL 225 CO2BL 222 W9WFM 221 G3AAE 221 K2CFR 220 W5NV 219 W2ZGB 218
--	--	--

Radiotelephone			
W8BKP 232 W8QJR 230 K8HGR 230 W6VFM 224 W5JUF 215 CO2BK 213 9K2AZ 200 W9JJF 196 W2WY 194 W4DQH 189 W9SX 184 W1GOU 180 W3HLX 180 W0VSK 180 CX3AA 173 W5YD 170 W5PQA 169	W6AED 169 CE3DY 164 W6YJW 162 F9DJ 161 F8XP 161 W7EAP 160 ON4PJ 160 ON4YL 160 TGBAD 160 W2XYL 152 F1CQ 152 W1LSE 152 W8ZET 151 W8TMA 150 W5GNG 147 W1LTF 141 W8CQL 141	W0ZSZ 141 I1RC 137 W1FPH 136 K5FRU 132 W3DRD 132 W4GRP 131 DL1WP 130 K6EVR 127 W3B1W 124 VE1NH 122 W1OFS 116 W5URW 120 K0ACC 116 W1YXD 113 W9BAE 112 W5WQJ 110 W7SPK 110	
W/VE/VO Call Area and Continental Leaders			
W4TMM 261 W0ELA 256 VE1PQ 192 VE2WW 210 VE3QD 210	VE4XO 118 VE5QZ 147 VE5RU 147 VE6NX 200	VE7ZM 242 VE7AW 195 VO6EP 190 Z86V 265 4X4DK 255	
Radiotelephone			
W2BXA 215 W4FA 220 W5BGP 228 W7HTB 199 W0AIW 233	VE1CR 120 VE2WV 167 VE3QA 195 VE4RP 102 VE5RU 143	VE6NX 112 VE7AM 206 G2PL 242 4X4DK 245 ZL1HY 246	

• All operating amateurs are invited to report to the SCM on the first of each month, covering station activities for the preceding month. Radio Club news is also desired by SCMs for inclusion in these columns. The addresses of all SCMs will be found on page 6.

ATLANTIC DIVISION

EASTERN PENNSYLVANIA—SCM, Richard B. Meshrov, W3INQ—SEC: DVB. PAM: TEJ. RM: PDJ. PPN meets Mon. through Fri. on 3850 kc. at 1800. E. Pa. Net meets Mon. through Fri. on 3610 kc. New appointments: K3AEP as EC for Juniata Co., PVY as EC for Carbon Co., K3ANS as OPS. The Mt. Airy V.H.F. Club was host to QST's v.h.f. editor, IHDQ, at its May 27 meeting. KN3CTC qualified at 20 w.p.m. GQC nabbed a Utah QSL for WAS after 22 years of trying and his jr. operator dropped the "N" from his call and now is K3ALS. K3BED has a 110-watt a.m. rig on 220 Mc. using p.p. 8025s. AMC left for Utah on May 30 for an extended trip to Utah. PDJ has a 10-meter mobile in his Volkswagen, Phila. Co. EC, VSD, reports that c.d., AREC and RACES drills on 2 meters Wed. at 2000 need more operators. Contact him for information. ACH is in Panama on business. FYR received WAS and is now on 75 meters with a long-wire and an old Viking II. FCI has a two-element 20-meter beam and was elected president of his high school student council. New officers of the Anthracite Wireless Assn. are KJJ, pres.; IGH, vice-pres.; ZRQ, secy.-treas. YUW spends most of his time chasing DX and is going mobile after graduation. The Lehigh Valley ARC has received its former call, W3OI. New officers of the Oxford Circle RC (Phila.) are: K3ALU, pres.; K3CTS, vice-pres.; K3BHX, secy.; K3ALL, treas. The average age in the club is 14! The Frankford RC entertained the Potomac Valley RC (Washington, D. C., Area) at their annual joint meeting on May 18. Before a dinner for about 100, trips were made to the antenna farms of ALB and DHM. OP was the first Pennsylvania recipient of the Worked All Connecticut Award. The Quakertown ARC school finished with 13 Novices on the way. BUR reports that he has bugs in his KWS-1. HNK figures that more power would triple his traffic total. New officers of the North Penn. ARC: YWV, pres.; PNL, vice-pres.; GTC, secy.; JLI, treas. K3ASH means that 50 watts on 40-meter phone leaves much to be desired. IUU worked NSS and WAR on Armed Forces Day. CMN had his operating curtailed when his club took back its Viking II. ELI was QRT but is back in action. AREC activity is picking up, but we still are shy ECs for many counties. Contact DVB or JNQ if you are interested. Traffic: W3CHL 2665, WHK 304, TEJ 270, PDJ 87, HNK 78, ZRQ 78, BFF 61, K3ALD 56, W3CMN 52, NF 44, IVS 40, AMC 39, PCI 23, K3ANS 20, W3ILD 15, WQL 12, NQB 10, BNR 8, EPL 7, ADE 6, FCI 6, UIU 4, ELI 4, PVY 4, BES 3, BUR 3, QIZ 3, LHA 2, YUW 2.

MARYLAND-DELAWARE-DISTRICT OF COLUMBIA—SCM, Louis T. Cronberger, W3UCR—Asst. SCM for Delaware: Ray de Courcelle, 3DQZ. SEC: CXG. Section Nets: MDD, 3650 M-S 1915 P-S; MEPN, MWF 1830, SS 1300 EDST; DELEN, 3905 Sat, 1830 EDST. On May 14 the SCM and SEC were guest speakers at the HCARA. CXG spoke on "State RACES Operation and SEC Activities." UCR spoke on "Section Activities and ARRL Appointments by the SCM." The RCARA was host for the first quarterly meeting of the Foundation of Radio Amateur Clubs on May 9. ZM, of the FCC, was the guest speaker and Al spoke on the "1959 ITU Conference." FCL showed the slides of his 10,000-mile trip around the U. S. at the May 2 WRC meeting. 4ZAI spoke on "Energy Transfer from Rig to Antenna" at the WRC May 16 meeting. Officers elected were CN, pres.; 4ZM, vice-pres.; Pete Oliva, corr. secy.; CDQ, rec. secy.; and K3AKB, treas. New officers of the NRRLARC are CMX, pres.; PBW, vice-pres.; and RBW, act. mgr.; DHQ was reelected secy. The RCARA had films of "The Battle of Italy, WW II," presented by QFS at the May 23 meeting.

The WMRC and the Phillmont MRC had their annual "Midway Philly Meet" at Havre de Grace on May 18 with over 100 in attendance. EIS, of Beltsville, has been judged winner of the "Frederic A. Leonard, W3AZG Memorial Trophy," awarded to the highest scoring entrant during the 1957 ARRL Sweepstakes. This award is open only to Atlantic Division participants and will be presented at the ARRL National Convention to be held in Washington Aug. 15-17. WLO was winner of the Delaware QSO Party, with QVQ the runner-up. NNAI is the new NCM for the MEPN. PY1BHW was a visitor to the stacks of CDQ and BKE/TSC. KN3DRW is now on 40 and 15 meters with a Viking I and an HQ-100. TSC had the top YL score for the third call area in the YL/OA Contest, with JWM the runner-up. Babe has been licensed only a little over a year. Congratulations, girls. JVZ was operated on at the Washington Co. Hospital. W5HQN, ex-AFY, was a visitor at LZY's. GVL is to study at the U. of Pa. and BFW at M.I.T. in the fall. BFW and his band are making a boat trip to Europe, including a tour of Germany and France. JPU is a new General Class licensee and KN3DRK a new Novice in the Hagerstown Area. KN3s CVZ and DYW are on 2 meters nightly, confusing all who work them from the same Washington QTH. K3CAV now is General Class. K3BUV now is representing Hartford Co. in the MDD. The 10th ARRL National Convention plans are progressing according to schedule. A complete radio (ham) communications system within the convention plus a mobile "talk-in-service," which will be in operation from noon Thurs., Aug. 14, through 1830 Sun., Aug. 17, will be provided. The following frequencies will be used at K3CSH: 3.820, 3.835, 7.250, 14.225 (a.m./s.s.b.), 29.640, 50.4 and 145.32 Mc. It would be appreciated if the Washington Area stations unable to attend the convention would monitor the above, to be of assistance if required, through Mon. noon. Station activity reports should reach the SCM by the 5th of each month for the preceding month. We would like to hear from all areas of the section and would be pleased to receive meeting notices, bulletins, etc., from club secretaries. CU at the ARRL NATIONAL CONVENTION AUG. 15-17, in Washington, D. C. Traffic: (May) W3UE 268, NNM 197, PQ 118, K3WBJ 90, W3WV 73, COK 54, ECP 39, QCW 36, TN 33, CN 31, CQX 22, EAX 13, LGS 7, UCR 5, OYX 4. (Apr.) W3WSE 4.

SOUTHERN NEW JERSEY—SCM, Herbert C. Brooks, K2BG—SEC: W2YRW, PAM: W2ZL. RMs: W2YRW, W2HDW and W2ZL. New appointees: W2BZJ, Pennington, as RM, K2QOS, Trenton, has a new beam on 6 meters. W2ZL, chief operator at State Hq., reports Operation Alert 1958 the best exercise this year. Operators at Hq. were W2SUG, W2BZJ, W2ISZ, W2ZL, K2DSL, K2CLD and W3BCJ. K2SOW, a 14-year-old Princeton ORS, has just passed the Extra 1st-class exam. K2QOS advises that a new club is being formed in the Trenton Area—the Penn Jersey V.H.F. Club. NJN held 31 sessions and handled 293 messages. K2CPR now has 3-band DXCC (7.14 and 21 Mc.). K2HHJ and K2JKA have been appointed Asst. ECs by K2SOL. Gloucester Co. EC, W2RG is confined in the Copper Hospital, Camden, after having had a heart attack. K2JKA, K2SOL, K2PQD and K2HHJ set up a rig at Camp Roosevelt and originated 149 messages. The SJRA has set Sept. 7 as its picnic date. K2UQD is picnic chairman. W2LBX and W2OSD have set up a RACES station in Delaware Twp. Merchantville High School has an active school station with many supporting operators. W2YRW has received the "Early Bird Net" certificate for his consistent activities. W2ADA, Burlington Co. Radio Club program chairman, has been providing many interesting and instructive programs. The club meets the 1st Fri. in Moorestown, K2VQH, K2ZIO, K2ZOM, K2UFF and W2MEO have signed in the Camden County RACES. Traffic: K2EWR 280, W2HDW 234, W2RG 185, K2HHJ 2 159, K2JGU 154, W2BZJ 87, W2ZL 37, K2SOL 17, K2QOS 14, K2SOW 12, K2CPR 4, K2SOX 4.

WESTERN NEW YORK—SCM, Charles T. Hansen, K2HEK—SEC: W2PPY, V.H.F. PAM: W2LXE. RMs: W2RUF and W2ZRC. The NYS c.w. meets on 3615 kc. at 1800. ESS on 3590 kc. at 1800. NYSPTEN on 3925 kc. at 1800. NYS C.D. on 3509.5 and 3993 kc. at 0900 Sun.. TCPN 2nd Call Area on 3970 kc. at 1900. SRPN on 3980 kc. at 1000. LSN on 3970 kc. at 1600. The New York State Phone Net Picnic will be held Aug. 9 at Green Lakes State Park near Syracuse. Contact W2IEP for details. W2SSC made WAZ, W2VRG and K2GUG outfoxed the
 (Continued on page 90)

THE HORSEPOWER RACE

IN THE past several years a change has developed in the manner in which various manufacturers specify the power ratings of their amateur transmitters. The old method, which is largely outdated, specified the DC Power input to the final amplifier. The new trend, caused primarily by the growing movement towards SSB operation, seems to lean toward rating equipment in peak envelope power, commonly referred to as P.E.P. Some manufacturers specify P.E.P. input, while others specify P.E.P. output. At any rate, this change produces a certain degree of confusion in the amateur's mind when he begins to compare the relative merits of various commercially built amateur transmitters or linear amplifiers.

TO ILLUSTRATE various forms this confusion may take, let us consider two examples. One transmitter, which on meter peaks indicates 625 to 650 watts, is rated by the manufacturer at 1000 watts P.E.P. input. The second rig indicates 1000 watts input on the meter, and is rated by its manufacturer at 2000 watts P.E.P. input. As illustrated by this example, one manufacturer considers P.E.P. to be approximately 1.5 times as great as D.C. input, while the other uses a factor of 2 to 1. Obviously, this difference in yard sticks can make it difficult for the amateur to determine how loudly a transmitter will talk.

BASICALLY, it should be readily apparent to each of us that the most important consideration, when discussing power, is how much *output* we get before generating excessive distortion. For example, an amplifier with 1000 watts DC input, which is 50% efficient, gives us 500 watts to the antenna; while a rig which is 66 $\frac{2}{3}$ % efficient can produce the same signal *output* with only 750 watts DC input. It would seem, therefore, that the premium should be on efficiency, rather than on meter input, much of which is burned up in the form of plate dissipation.

MOREOVER, it seems to us, that since 1000 watts is the maximum indicated power input the amateur can utilize, any talk in excess of this figure, regardless of how the input power is stated, has little or no meaning.

IN LINE with the thinking outlined above, we at Hallicrafters have chosen not to add to the confusion by rating our new HT-33A linear amplifier in P.E.P. input. We do state that this final runs conservatively at the maximum legal limit of 1000 watts DC input. Moreover, and this is the important point, the HT-33A can deliver *more output to the antenna*, no matter how it is measured, than any other commercially manufactured amateur linear amplifier now on the market. In addition, it does this with third and fifth order distortion products down in excess of 30 db. It is the feeling at Hallicrafters that this is the type of information today's amateur demands.

— TOM STUART WØREP

Buel Bailey Jr. W. J. Halcyon W9AC for hallicrafters

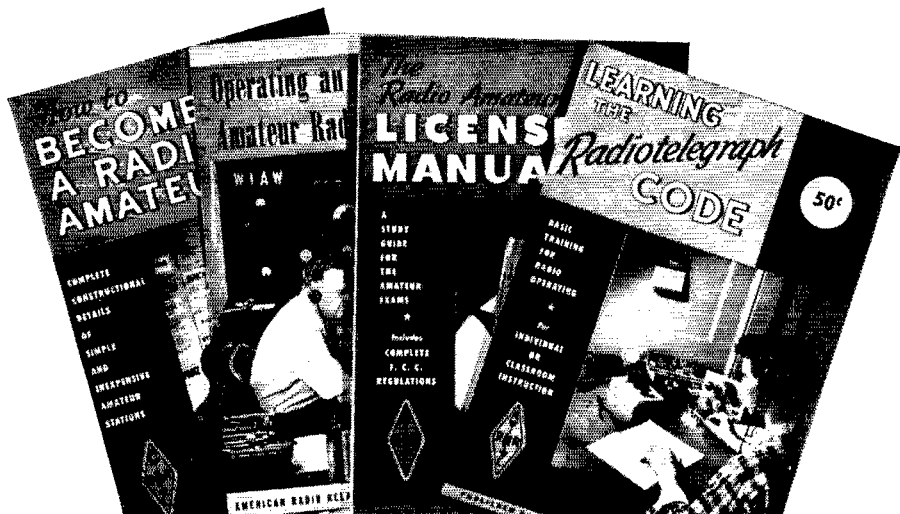

Gateway to Amateur Radio!

- ★ HOW TO BECOME A RADIO AMATEUR
- ★ THE RADIO AMATEUR'S LICENSE MANUAL
- ★ LEARNING THE RADIO TELEGRAPH CODE
- ★ OPERATING AN AMATEUR RADIO STATION

Anyone starting out in amateur radio will find these publications a necessary part of his reading and studying for the coveted amateur radio operator's ticket. Written in clear, concise language, they help point the way for the beginner. Tried and proven by thousands upon thousands of amateurs, these ARRL publications are truly the "Gateway to Amateur Radio."

\$1.50

POSTPAID

The American Radio Relay League, Inc.—West Hartford, Connecticut

NEW FOR VHF!

VIKING "6N2 VFO"

Here's good news for VHF operators: the Viking "6N2 VFO"—exceptionally stable, compact, and packed with outstanding new features! Designed to replace 8 to 9 mc. crystals in frequency multiplying 6 and 2 meter transmitters, including types using overtone oscillators, the Viking "6N2 VFO" provides rock-solid output for operation on any frequency in the 6 and 2 meter bands. Unit is temperature-compensated and voltage-regulated for minimum drift and high stability. "6N2 VFO" is housed in an attractive, extra heavy, shock-proof aluminum cabinet. Plexiglas dial is calibrated from 144 to 148 mc., 50 to 51.5 mc., 51.5 to 53 mc., and 53 to 54 mc. for maximum bandspread. Dial is edge-lighted for high visibility—10 to 1 vernier tuning gives you positive frequency control. The Viking "6N2 VFO" is available completely wired and tested or as an easy-to-assemble kit, complete with tubes and calibrated dial.



Cat. No. 240-133-1 Kit..... Amateur Net **\$34.95**
 240-133-2 Wired and tested... Amateur Net \$54.95

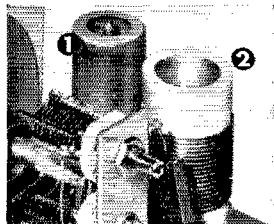

1. Shielded 6BH6 Series Tuned Oscillator Tube.
2. Rigid Ceramic Insulated Inductor.

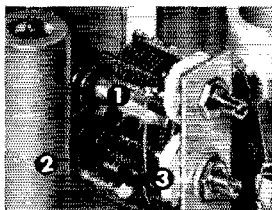

1. Heavy Duty, Double Spaced Tuning Capacitor.
2. OA2 Voltage Regulator Tube.
3. Ceramic Insulated Air Dielectric Trimmers.

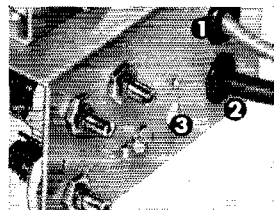

1. Power Cable, complete with Octal Plug.
2. Coaxial RF Output Cable with 1/2" Spaced Crystal plug.
3. Adjustable Output Tuning.

VIKING "6N2" TRANSMITTER

This compact VHF transmitter punches your signal out with 150 watts CW and 100 watts phone input. Instant band-switching 6 and 2 meters. Completely shielded and TVI suppressed, the "6N2" may be used with the Viking "Ranger," Viking I, Viking II, or similar power supply/modulator combinations. Operates by crystal control or external VFO with 8-9 output. With tubes, less crystals, key, and microphone.

Cat. No. 240-201-1 Kit..... Amateur Net \$129.50
 Cat. No. 240-201-2 Wired..... Amateur Net \$169.50

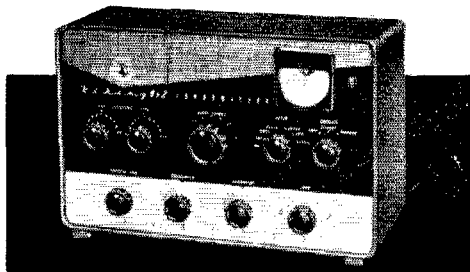

E. F. Johnson Company

2822 Second Avenue Southwest • Waseca, Minnesota

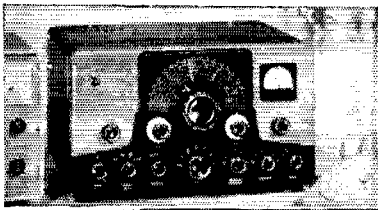

VIKING "RANGER" TRANSMITTER/EXCITER

Superbly engineered . . . delivers solid audio punch! This popular 75 watt CW or 65 watt phone transmitter also serves as an RF/audio exciter for high power equipment. Built-in VFO or crystal control—instant bandswitching 160 through 10 meters. 6146 final amplifier—wide range pi-network output. Timed sequence keying. TVI suppressed. With tubes, less crystals.

Cat. No. 240-161-1 . . . Kit Amateur Net \$229.50
 Cat. No. 240-161-2 . . . Wired and tested Amateur Net \$329.50

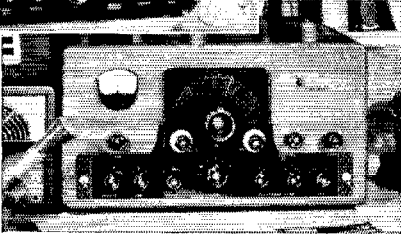

VIKING "VALIANT" TRANSMITTER

Here's effective power, wide flexibility, and many unique operating features combined in a compact desk-top transmitter! 275 watts input CW and SSB (P.E.P. with auxiliary SSB exciter) and 200 watts phone. Instant bandswitching 160 through 10 meters—built-in VFO or crystal control. Final amplifier utilizes three 6146 tubes in parallel—wide range pi-network output. Silver-plated final amplifier inductor—built-in low pass audio filter—low level audio clipping. With tubes, less crystals.

Cat. No. 240-104-1 . . . Kit Amateur Net \$349.50
 Cat. No. 240-104-2 . . . Wired and tested Amateur Net \$439.50

for flexibility and performance



Full 2000 watts SSB*—1000 watts CW and AM! VIKING "KILOWATT" AMPLIFIER

Here's the finest power amplifier ever designed for the amateur service! A sparkling concept of contemporary transmitter design and engineering craftsmanship, the Viking "Kilowatt" is the only amplifier that gives your signal the authority of maximum legal power in all modes. Class C final amplifier operation provides plate circuit efficiencies in excess of 70% with unequalled broadcast-type high level amplitude modulation. Two 4-400A tetrodes in parallel, bridge neutralized—wide range pi-network. Pedestal contains the complete unit. Excitation requirements: 30 watts RF and 10 watts audio for AM; 2.5 watts peak for SSB. With tubes.

Cat. No. 240-1000 . . . Wired and tested Amateur Net \$1595.00
 Matching accessory desk top, back and three drawer pedestal.
 Cat. No. 251-101-1 FOB Corry, Pa. \$132.00

VIKING "PACEMAKER" TRANSMITTER/EXCITER

An outstanding power bargain when used as a transmitter or exciter! 90 watts SSB P.E.P. and CW input . . . 35 watts AM. Unique circuitry uses only 1 mixer for improved spurious signal rejection greater than 50 db. Balanced range audio. Highly stable built-in VFO gives complete coverage of bands without crystal switching or re-tuning. Instant bandswitching 80, 40, 20, 15 and 10 meters. VOX and anti-trip circuits. Wide range pi-network output. Effectively TVI suppressed. With tubes and crystals.

Cat. No. 240-301-2 . . . Wired Amateur Net \$495.00

*The F.C.C. permits a maximum of one kilowatt average power input for the amateur service. In SSB operation under normal conditions this results in peak envelope power inputs of 2000 watts or more depending upon individual voice characteristics.



VIKING "NAVIGATOR" TRANSMITTER/EXCITER

More than a novice transmitter—also serves as a flexible VFO-Exciter delivering enough RF power to excite most high powered amplifiers on CW and AM! 40 watts CW input—6146 final amplifier tube—wide range pi-network output. Built-in VFO or crystal control—bandswitching 160 through 10 meters. Timed sequence keying. TVI suppressed and filtered. Complete with tubes, less crystals.

Cat. No. 240-126-1..Kit..... Amateur Net \$149.50
 Cat. No. 240-126-2..Wired and tested..... Amateur Net \$199.50

VIKING "ADVENTURER" TRANSMITTER

Perfect for the novice or experienced amateur! 50 watts CW input—instant bandswitching 80 through 10 meters. Crystal or external VFO control. Rugged 807 final amplifier tube—wide range pi-network output. Clean, crisp keying. TVI suppressed. Complete with tubes, less crystals.

Cat. No. 240-181-1..Kit..... Amateur Net \$54.95

SPEECH AMPLIFIER/SCREEN MODULATOR

Designed to provide phone operation for the "Adventurer". High gain—use with crystal or dynamic microphones. With tubes.

Cat. No. 250-40..Kit..... Amateur Net \$12.25

—you can't beat a Viking!

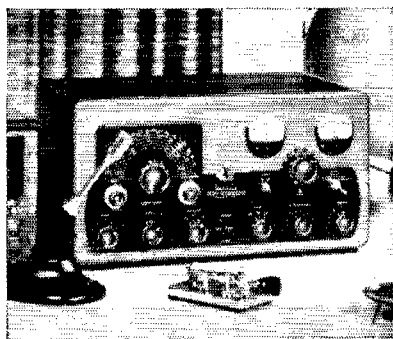

More than one-half kilowatt of power and operating convenience!

VIKING "FIVE HUNDRED" TRANSMITTER

Rated 600 watts CW input . . . 500 watts phone and SSB (P.E.P. with auxiliary SSB exciter)—instant bandswitching 80 through 10 meters! Compact RF unit designed for desk-top operation—power supply/modulator unit may be placed in any convenient location. All exciter stages ganged to VFO tuning. High gain push-to-talk audio system. Operates by crystal control or highly stable, built-in VFO. Class C 4-400A final amplifier provides plate circuit efficiencies in excess of 70% with unequalled broadcast-type high level amplitude modulation. Wide range pi-network output circuit with silver-plated final tank coil will load virtually any antenna system. Low level audio clipping—effectively TVI suppressed and filtered. Complete with tubes, less crystals.

Cat. No. 240-500-1..Kit..... Amateur Net \$749.50
 240-500-2..Wired..... \$949.50

Dollar-for-dollar and feature-for-feature . . . Viking amateur transmitters are your best buy!

The Viking amateur equipment line offers you a complete choice of power ratings, types of emission and operating features in a wide range of prices. Compare Viking quality and performance—you'll soon see why Viking transmitters are "first choice" among the nation's amateurs.

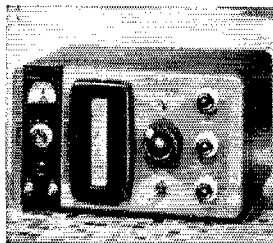

VIKING "COURIER" AMPLIFIER

This power-packed Class B linear amplifier is rated 500 watts P.E.P. input with aux. SSB exciter—500 watts CW and 200 watts AM! Continuous coverage 3.5 to 30 mcs. May be driven by the Viking "Ranger", "Pacemaker" or other unit of comparable output. Drive requirements: 5 to 35 watts. Employs two 811A triodes in parallel—wide range pi-network output. Fully TVI suppressed. Complete with tubes.

Cat. No. 240-352-1..Kit..... Amateur Net \$244.50
 240-352-2..Wired..... \$289.50



VIKING "THUNDERBOLT" AMPLIFIER

Rated at 2000 watts P.E.P.* input SSB; 1000 watts CW; 800 watts AM linear! Continuous coverage 3.5 to 30 mcs.—instant bandswitching. May be driven by the Viking "Ranger", "Pacemaker" or other unit of comparable output. Drive requirements: approx. 10 watts Class AB₂ linear, 20 watts Class C continuous wave. Employs two 4-400A tetrodes in parallel, bridge neutralized—wide range pi-network output. With tubes.

Cat. No. 240-353-1..Kit..... Amateur Net \$524.50
 240-353-2..Wired..... \$589.50



E.F. Johnson Company

2815 SECOND AVENUE S. W. • WASECA, MINNESOTA

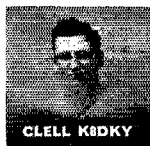

CLELL K8DKY



DAR K8ADS



DICK K8BMJ



DOUG K8GNA



AL W8HTX



REX K8GND



FRED K8GMV



ERNIE W8VFN



WAYNE W8YRW



FRANK W8WUN



AL K8BLI

All of these licensed radio amateurs make important contributions to the Heath line of fine ham kits. In a sense, they are your personal representatives within the company, because their design ideas and performance preferences reflect not only their own "on-the-air" experiences, but those of the amateur fraternity with which they are in constant contact. With this kind of representation in Benton Harbor, you can continue to rely on high-performance Heathkit amateur radio equipment designed by hams, for hams!

HEATH *hams work to bring you*



CHUCK K8CJI



ROGER MACE (W8MWZ)
SENIOR HAM ENGINEER
HEATH COMPANY

HEATHKIT 50-WATT CW TRANSMITTER KIT

MODEL DX-20

\$35.95

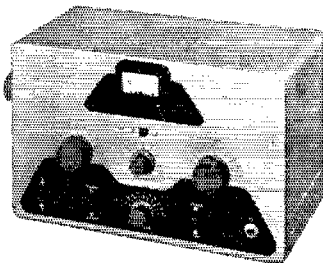

If high efficiency at low cost in a CW transmitter interests you, you should be using a DX-20! It employs a single 6DQ6A tube in the final Amplifier stage for plate power input of 50 watts. The oscillator stage is a 6CL6, and the rectifier is a 5U4GB. Single-knob band-switching is featured to cover 80, 40, 20, 15, 11 and 10 meters, and a pi network output circuit matches antenna impedances between 50 and 1000 ohms to reduce harmonic output. Designed for the novice as well as the advanced class CW operator. The transmitter is actually fun to build, even for a beginner, with complete step-by-step instructions and pictorial diagrams. All the parts are top-quality and well rated for their application. "Potted" transformers, copper-plated chassis, and ceramic switch insulation are typical. Mechanical and electrical construction is such that TVI problems are minimized. If you desire a good clean CW signal, this is the transmitter for you! Shpg. Wt. 19 lbs.

HEATHKIT "APACHE" HAM TRANSMITTER KIT

- Newly Designed VFO—Provision For S.S.B. Adapter
- Modern Styling—Rotating Slide Rule Dial

MODEL
TX-1

\$229.⁵⁰

Shipped motor freight unless otherwise specified. \$50.00 deposit required on C.O.D. orders.

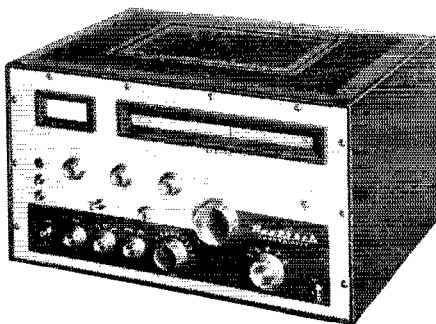

Fresh out of the Heath Company laboratories, the brand-new "Apache" model TX-1 Ham Transmitter features modern styling and is designed as a handsome companion to the also-new Heathkit "Mohawk" receiver. The "Apache" is a high quality transmitter operating with 150 watt phone input and 180 watt CW input. In addition to CW and phone operation, the "Apache" features built-in switch selected circuitry providing for single-sideband transmission through the use of a plug-in external single-sideband adapter. These Heathkit adapters will be available in the near future. A compact, stable and completely redesigned VFO provides low drift frequency control necessary for single-sideband transmission. An easy-to-read slide rule type illuminated rotating VFO dial with vernier tuning provides ample bandwidth and precise frequency setting. Simple band-switching control allows flip-of-the-wrist selection of the amateur bands on 80, 40, 20, 15 and 10 meters (11 M with crystal control). The "Apache" features adjustable low level speech clipping and a low distortion modulator stage employing two of the new 6CA7/EL-34 tubes in push-pull class AB operation. Time sequence keying is provided for "chirpless" break-in CW operation.

The final amplifier is completely enclosed in a perforated aluminum shielding for greater TVI protection and transmitter stability. Cabinet comes completely preassembled with top hatch for convenient access without taking chassis out of cabinet. Die-cast aluminum knobs and front panel escutcheons add to the attractive styling of the transmitter. Pi network output coupling matches antenna impedances between 50 and 72 ohms. Incorporates all the refinements necessary with many "plus" features for effective and dependable communications. Shpg. Wt. 115 lbs.

...top quality at lowest prices!

HEATHKIT "MOHAWK" HAM RECEIVER KIT

- All Critical Circuits Prewired and Aligned
- Crystal Controlled Oscillators for Drift-Free Reception

MODEL
RX-1

\$274.⁹⁵

Shipped motor freight unless otherwise specified. \$50.00 deposit required on C.O.D. orders.



Outstanding results can be expected with the new "Mohawk" receiver which is designed to combine all the necessary functions required in a high quality communications receiver. A perfect companion for the Heathkit "Apache" transmitter, the "Mohawk" features the same wide-band slide rule type vernier tuning and covers all of the amateur bands from 160 through 10 meters on seven bands with an extra band calibrated to cover 6 and 2 meters using a converter. External receiver powered accommodations are available for these converters which will be available in Heathkits soon. The "Mohawk" is specially designed for single-sideband reception with crystal controlled oscillators for upper and lower sideband selection. A completely preassembled, wired and aligned front end assures ease of assembly. All critical wiring is done for you insuring top performance. This 15-tube receiver features double conversion with IF's at 1682 kc and 50 kc. Five selectivity positions from 5 kc to 500 CPS. A

bridged T-notch filter is employed for maximum heterodyne rejection. Complete accuracy is obtained with the use of a built-in 100 kc crystal calibrator and the set features 10 db signal-to-noise ratio at less than 1 microvolt input. S-meter and many other fine features built-in for top-notch signal reception. Shpg. Wt. 90 lbs.

HEATH COMPANY

A Subsidiary of Daystrom, Inc.

BENTON HARBOR 9,
MICH.

HEATHKIT PHONE & CW TRANSMITTER KIT

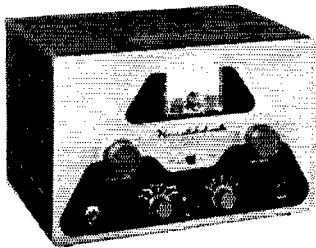

MODEL
DX-40

\$64⁹⁵.

The DX-40 incorporates the same high quality and stability as the DX-100, but is a lower powered rig for crystal operation, or for use with an external VFO. Plate power input is 75 watts on CW, permitting the novice to utilize maximum power. An efficient, control-carrier modulator for phone operation peaks up to 60-watts, so that the rig has tremendous appeal to the general class operator also. Single-knob switching covers 80, 40, 20, 15, 11 and 10 meters. Pi network output coupling makes for easy antenna loading, and pi network interstage coupling between the buffer and final amplifier improves stability and attenuates harmonics. A line filter is incorporated for power line isolation. The efficient oscillator and buffer circuits provide adequate drive to the 6146 final amplifier from 80 to 10 meters, even with an 80-meter crystal. A drive control adjustment is provided, and the function switch incorporates an extra "tune" position so that the buffer stage can be pretuned before the final is switched on. A switch selects any of three crystals, or a jack for external VFO. High quality D'Arsonval meter for tuning. Shpg. Wt. 26 lbs.

HEATHKIT DX-100 PHONE & CW TRANSMITTER KIT

MODEL
DX-100

\$189⁵⁰.

Shipped motor freight unless otherwise specified. \$50.00 deposit required on C.O.D. orders.

You get more for your transmitter dollar when you decide on a DX-100 for your ham shack! Recognized as a leader in its power class, the DX-100 offers such features as a built-in VFO, built-in modulator, TVI suppression, pi network output coupling to match a variety of antenna impedances from 50 to 600 ohms, pi network interstage coupling, and high quality materials throughout. Copper plated 16-gauge steel chassis, ceramic switch contacts, etc., are typical of the kind of parts you get, in assembling this fine rig. The DX-100 covers 160, 80, 40, 20, 15, 11 and 10 meters with a single band-switch, and with VFO or crystal operation on all bands. RF output is in excess of 100 watts on phone and 120 watts on CW, with a pair of 6146 tubes in parallel for the final amplifier, modulated by a pair of 1625 tubes in parallel. VFO tuning dial and panel meter are both illuminated for easy reading, even under subdued lighting conditions. Attractive front panel and



case styling is completely functional, for operating convenience. Designed exclusively for easy step-by-step assembly. No other transmitter in this power class combines high quality and real economy so effectively. Here is a transmitter that you will be proud to own. Time payments are available! Shpg. Wt. 107 lbs.

more fine ham gear from the pioneer



HEATHKIT GRID DIP METER KIT

A Grid Dip Meter is basically an RF Oscillator used to determine the frequency of other Oscillators, or tuned circuits. Numerous other applications such as pretuning, neutralization, locating parasitics, correcting TVI, adjusting antennas, designing new coils, etc. Features continuous frequency coverage from 2 MC to 250 MC, with a complete set of prewound coils, and a 500 ua panel meter. Has sensitivity control and a phone jack for listening to the "Zero-Beat". It will also double as an absorption-type wave meter. Shpg. Wt. 4 lbs.

MODEL GD-1B

Low frequency coil kit: two extra plug-in coils extend frequency coverage down to 350 KC.
Shpg. Wt. 1 lb. No. 341-A \$3.00

\$21⁹⁵.

HEATH COMPANY

A Subsidiary of Daystrom, Inc.

**BENTON HARBOR 9,
MICHIGAN**

HEATHKIT ALL-BAND COMMUNICATIONS-TYPE RECEIVER KIT

Ideal for the short wave listener or beginning amateur, this Receiver covers 550 KC through 30 MC in four bands. It provides good sensitivity and selectivity, combined with fine image rejection. Amateur bands are clearly marked on the illuminated dial scale. Features transformer type—power supply—electrical band spread—antenna trimmer—separate RF and AF gain controls—noise limiter—internal 5½" speaker—head phone jack and AGC. Has built-in BFO for CW reception. An accessory power socket is also provided for connecting the Heathkit model QF-1 Q Multiplier. Will supply 250 VDC at 15 ma **MODEL AR-3** and 12.6 VAC at 300 ma. Shpg. Wt. 12 lbs. Cabinet: Fabric covered cabinet with aluminum panel as shown part 91-15A. Shpg. Wt. 5 lbs. **\$29.95**

HEATHKIT ELECTRONIC VOICE CONTROL KIT

Here is a new and exciting kit that will add greatly to your enjoyment in the ham shack. Allows you to switch from Receiver to Transmitter merely by talking into your microphone. Lets you operate "break-in" with an ordinary AM transmitter. A terminal strip is provided for Receiver and speaker connections and also for a 117 volt antenna relay. Unit is adjustable to all conditions by sensitivity and gain controls provided. Easy to build with complete instructions provided. Requires no transmitter or Receiver alterations to operate. **MODEL VX-1** Shpg. Wt. 5 lbs. **\$23.95**

HEATHKIT "Q" MULTIPLIER KIT

This fine Q Multiplier is a worthwhile addition to any communications, or Broadcast Receiver. It provides additional selectivity for separating signals, or will reject one signal and eliminate a heterodyne. Functions with any AM Receiver having an IF frequency between 450 and 460 KC that is not AC-DC type. Operates from your Receiver power supply, and requires only 6.3 VAC at 300 ma (or 12.6 VAC at 150 ma), and 150 to 250 VDC at 2 ma. Simple to connect with cable and plugs supplied. **MODEL QF-1** Effective Q of approximately 4000 for sharp "peak" or "null". A tremendous help on crowded phone or CW bands. Shpg. Wt. 3 lbs. **\$9.95**

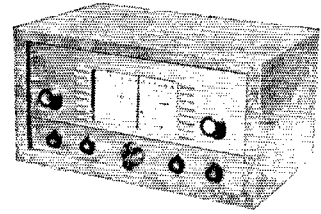

ALL-BAND RECEIVER

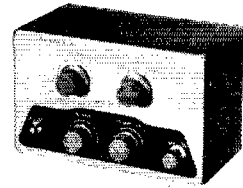

ELECTRONIC VOICE CONTROL

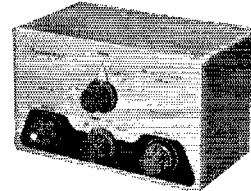

"Q" MULTIPLIER

NOTE: \$10.65 WHEN ORDERED WITH AR-3 BECAUSE OF EXCISE TAX.

...in do-it-yourself electronics!

HEATHKIT "AUTOMATIC" CONELRAD ALARM KIT

Designed to give instant warning whenever a monitored station goes off the air, the CA-1 automatically cuts the AC power to your transmitter, and lights a red indicator. Works with any radio receiver; AC-DC—transformer operated—battery powered, so long as the receiver has AVC. A manual "reset" button is provided to reactivate the transmitter. Incorporates a heavy-duty 6-ampere relay, a thyratron tube, and its own built-in power supply. A neon lamp shows that the alarm is working. **MODEL CA-1** Simple to install and connect with complete instructions provided for assembly and operation. Shpg. Wt. 4 lbs. **\$13.95**

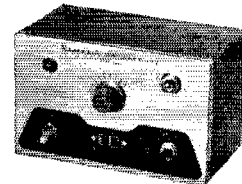

"AUTOMATIC" CONELRAD ALARM

HEATHKIT VARIABLE FREQUENCY OSCILLATOR KIT

Enjoy the convenience and flexibility of VFO operation by obtaining this fine variable frequency oscillator. It covers 160-80-40-20-15-11 and 10 meters with three basic oscillator frequencies. Better than 10 volt average RF output on fundamentals. Requires 250 volts DC at 15 to 20 ma, and 6.3 VAC at 0.45 a, available on most transmitters. It features voltage regulation for frequency stability, and has illuminated frequency dial. VFO operation allows you to move out from under interference and select the portion of the band you want to use without having to be tied down to only 2 or 3 frequencies through the use of crystals. "Zero in" on the other fellows signal and return his CQ on his own frequency! Shpg. Wt. 7 lbs.

MODEL VF-1

\$19.50

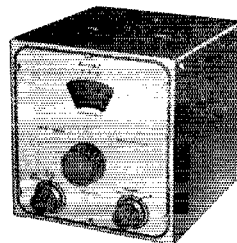

VARIABLE FREQUENCY OSCILLATOR

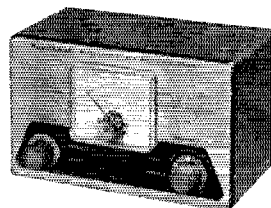

REFLECTED POWER METER

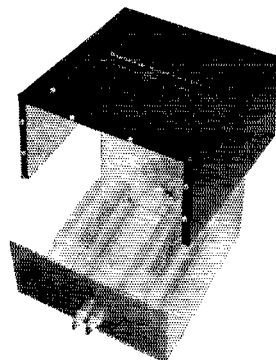

BALUN COIL

HEATHKIT REFLECTED POWER METER KIT

A necessity in every well equipped ham shack, the model AM-2 lets you check the match of the antenna transmission system, by measuring the forward and reflected power or standing wave ratio. Handles up to one kilowatt of energy on all bands from 160 to 2 meters, and may be left in the antenna system feed line at all times. Input and output impedances for 50 or 75 ohm lines. No external power required for operation. Meter indicates percentage forward and reflected power, and standing wave ratio from 1:1 to 6:1. Shpg. Wt. 3 lbs.

MODEL AM-2

\$15.95

HEATHKIT BALUN COIL KIT

This convenient transmitter accessory has the capability of matching unbalanced coax lines, used on most modern transmitters, to balanced lines of either 75 or 300 ohms impedance. Design of the bifilar wound Balun Coils will enable transmitters with unbalanced output to operate into balanced transmission line, such as used with dipoles, folded dipoles or any balanced antenna system. Can be used with transmitters and Receivers without adjustment over the frequency range of 80 through 10 meters. Will handle power inputs up to 200 watts. Shpg. Wt. 4 lbs.

MODEL B-1

\$8.95

save 1/2 or more . . . with **HEATHKITS**



**FREE
1958
Catalog**

Send for this Free Informative catalog listing our entire line of kits, with complete schematics and specifications.

Rush Free 1958 catalog.

HEATH COMPANY

BENTON HARBOR 9, MICH.

a subsidiary of Daystrom, Inc.



name _____

address _____

city & state _____

QUAN.	ITEM	MODEL NO.	PRICE

\$_____ enclosed. Parcel post, include postage—express orders are sent shipping charges collect. All prices quoted are Net F.O.B. Benton Harbor, Mich. and apply to Continental U.S. and Possessions only. All prices and specifications subject to change without notice.

Miniaturization



for work

...for play

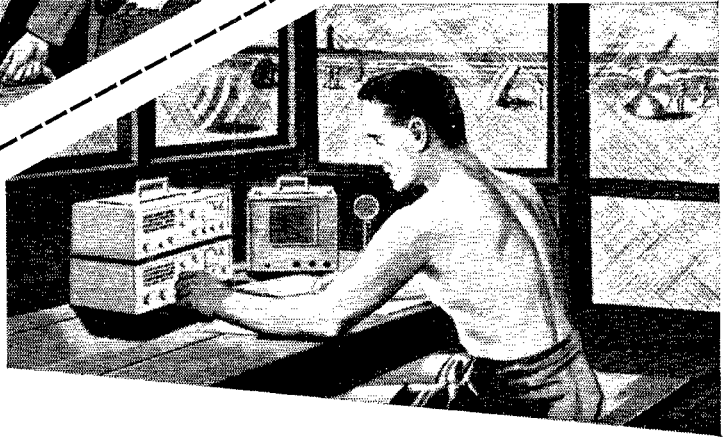

Electronic engineering and research have made possible totally new techniques in miniaturization—the art of getting the most into the least amount of space. Mallory has helped pioneer this field.

With miniaturization comes the necessity of getting maximum reliability into compact assemblies—not only for dependable performance, but because these compact assemblies don't always lend themselves to easy maintenance.

Instruments—that new receiver—a personal BC portable—or civil defense gear—may be an example of how mini-

aturization can deliver more performance in less space.

Whether you buy or build equipment—for work or for play—you can count on the contributions Mallory has made to the state of the art. Tiny Mallory TT, TAP, TAW and TNT capacitors—miniature Mallory-developed Mercury Batteries—special transistor-taper controls—and many other developments assure maximum dependability for a weekend of rag chews, relaxation or emergency communications.

See your Mallory Distributor for all your component needs.

P. R. MALLORY & CO. Inc.
P.O. Box 1558
INDIANAPOLIS 6, INDIANA

P. R. MALLORY & CO. Inc.
MALLORY

Station Activities

(Continued from page 84)

Erie County c.d. by hiding a 2-meter Gonsert in a boat and pretending to be fishermen. K2PVN and K2YKB were the only winners. The NYSPTEN announces new certificate rules via PVL (1) 21 call-ins, 7 during each of 3 months, (2) Minimum of 10 pieces of formal traffic, (3) Three month traffic reports to the SCM, (4) Double check by net secretary. This will insure that only capable traffic men and faithful net members get certificates. We regret to report the death of W2AQS. K2KIR will go to M.I.T. in the fall. W2PTD received a card from JTIAA. W2EUP reports that he and W2ATC set up a station at the U. of B. Engineering School Open House to handle traffic. W2EUP received his WAS and he won the c.w. contest at the RARA Hamfest. The RARA Hamfest was the best yet, with over 450 in attendance. WIDX was among the main speakers. W2EMW got YLCC and worked 2 new ones for 224. K2UNR has a new Tri-Band beam to hunt DX. The Willimantic Jay-Cees gave K2UZI the W-Conn. award. K2GUJ worked 7 new states on 6 meters during May. W2LXE has his kw. on 2 meters and worked Iowa for a new state. The Syracuse V.H.F. Club reports feverish contest activity. K2SN and W2HSG would like reports of Novice activity in the Syracuse Area for their column in the *RAGS Review*. K2LHK, K2VWX and K2MLT helped KN2HPL get on 40-meter c.w. by donating an Adventurer, an NC-101X and an antenna. KN2HPL is blind and anyone wishing to help get him on 6 meters should contact K2MLT. W2QYT reports c.d. activity using 15 mobiles for the Memorial Day Parade. The AWA received a nice letter of praise from ARRL regarding its fine club shows. K2TQC has been appointed ORS. K2SIL made RPT. Traffic: (May) K2-SIL 516, K2IYP 379, W2RUF 373, K2RYH 149, K2UNR 116, K2GWN 94, W2ZRC 85, K2RTN 78, K2IBX 74, K2GQU 53, W2BKC 52, K2OE 52, K2MFS/2 47, K2UZI 47, W2DSS 34, K2BBJ 32, W2FEB 28, W2RUT 25, W2-RQP 21, K2UNZ 20, W2QCT 12, W2EUP 11, K2QDT 11, K2CUQ 5, W2EMW 5, K2HUK 5, W2MTA 1. (Apr.) W2ZRC 131, K2KJZ 36, K2BBJ 24, K2LGJ 7, K2RIR 6, K2TVF 5, W2EMW 4.

WESTERN PENNSYLVANIA—Acting SCM, Anthony J. Mroczka, W3UHN—SEC: OMA, RMs: GEG and NUG, PAMs: AER and TOC. The WPA Traffic Net meets Mon. through Fri. at 1900 EST on 3585 kc. A new ORS is WRE. Winners in the Pennsylvania QSO Party in the order listed: YOZ, GYP, EPL, DQN and out-of-state winner 4APM. The Breeze-Shooters Picnic at North Park was a huge success. The McKean Radio Club has purchased a large commercial trailer and leased some land for a club-house location. JWZ pledged Delta Chi Fraternity at Lehigh. QCN is repairing 2-meter audio and 1.6 monitor equipment. WIQ is considering taking a rest from traffic-handling. BZR graduated from high school and nursed a case of poison ivy after felling trees at the Coke Center RC. K3DUI will be coming home from the Navy soon. EIS is adjudged the winner of the "Frederic A. Leonard, W3AZG" Memorial Award Trophy donated by GJY to 1957 SS entrants in the Atlantic Division. The next Memorial Award Trophy for the coming 1958 Sweepstakes donated by GJY will honor the late Raymond R. Rosenberg. NCJ, BSF now runs a kw. with a home-brewed linear amplifier. The Etna RC now is a full-fledged ARRL affiliate. DER can be heard on 14-Mc. c.w. with a Globe Scout borrowed from ETP. K3BPE is studying hard for his General Class license. GJY is building a new final using the new RCA-7094. The Shaler High School ARC is affiliated with ARRL now. KTM's son received the call KN3DPB. NKM has worked WAZ plus 215 countries with 183 confirmed for DXCC. BEX has 96 confirmed and is waiting patiently for four more confirmations to make DXCC. UEN is home from the hospital and doing well. UEJ has a new Communicator III. New calls around Washington County are KN3DMJ, KN3DHJ and K3DXV. The Weinels Area RC is conducting code classes for Novices. BSO is taking a navigation course given by the U. S. Power Squadron. IAIM was hospitalized. Up Erie way: New officers of the Radio Association of Erie are PBB, pres.; NFM, vice-pres.; K3CLC, secy.; JOQ, treas.; KNQ and KLD, directors. We regret to record the passing of YXE. K3BOQ passed his General Class exam. The 6-meter group assisted the Erie Exchange Club in the collection of funds for the Retarded Children. ALD, stationed in Iceland, has his new call, TF2WCZ. RFX was the main speaker at the ATA's June meeting and spoke on Sports Cars. Traffic: W3LXU 482, WIQ 153, BZR 78, UHN 12, TOC 8, WRE 7, KUN 4.

CENTRAL DIVISION

ILLINOIS—SCM, Edmond A. Metzger, W9PRN—Asst. SCM: Grace V. Ryden, 9GME. SEC: HOA, RM: MAK. PAM: RYU. EC Cook County: HPG. Section
(Continued on page 98)

FIELD ENGINEERING with a Future!



Edward K. Doherr, W1EEE, Assistant Manager
Government Services Division

Resourceful field engineer—now Raytheon executive

Ed Doherr's imagination and quick action probably saved the life of the Air Force pilot in the story at right.

Today, as a Raytheon executive, Ed (W1EEE) still keeps in touch with the activities of Raytheon field engineers in remote parts of the world with the help of a potent kw heard almost nightly on the low end of twenty.

Field engineering experience has helped many Raytheon engineers to become executives. As activities are expanded, field engineers have the opportunity to qualify for new key positions.

Requirements: field experience plus an EE degree or the equivalent in practical experience with air or ground radar, missiles, microwave or sonar. Benefits: attractive salary, relocation assistance, insurance, educational programs, etc.

Interviews in most U. S. cities and overseas. Please write G. E. Dodge for details. No obligation.

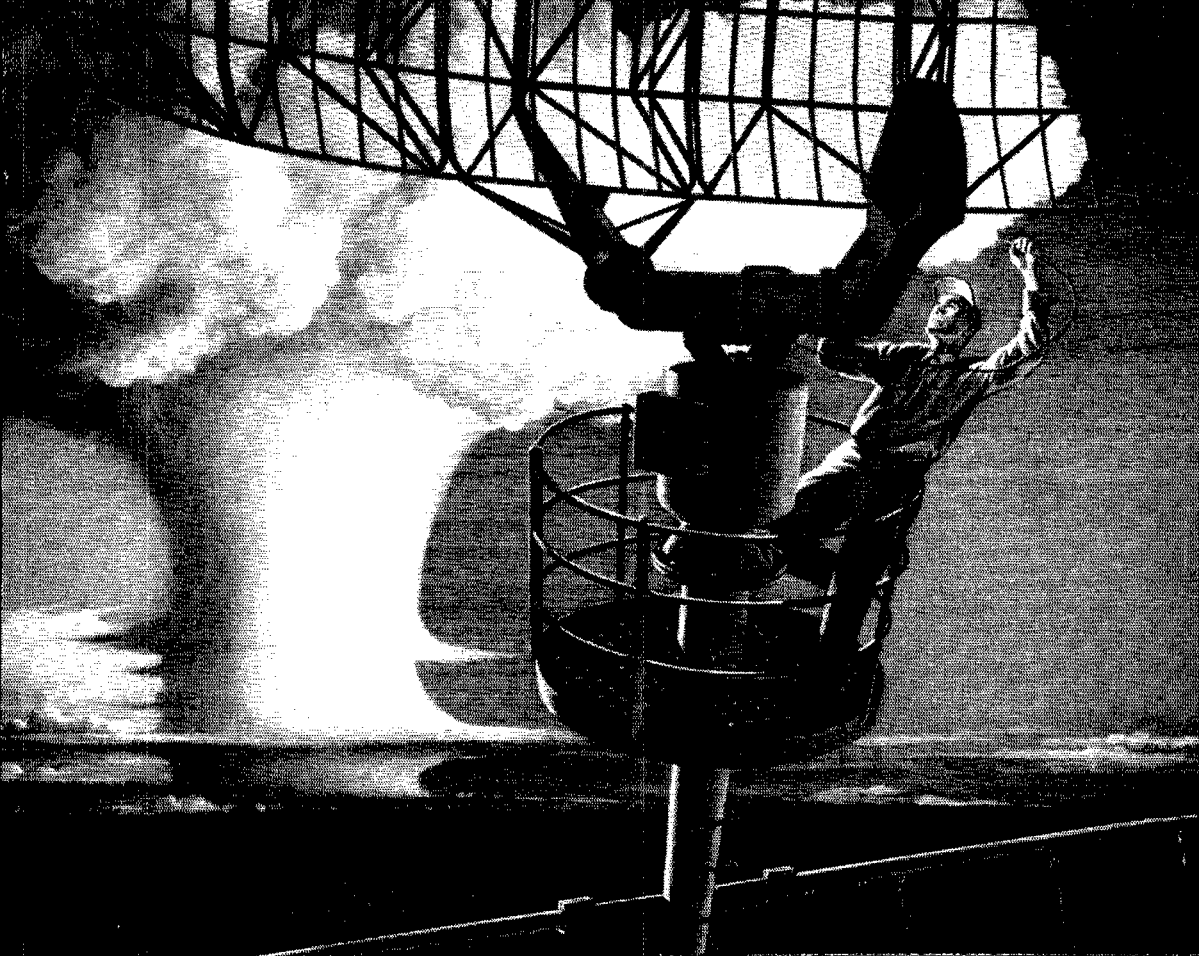

ZERO PLUS 3

The story of the coat hanger that saved a jet pilot

It happened during an H-bomb test near Eniwetok.

Air Force planes had to be at exact altitudes and distances before shot time. A special radar system permitted personnel of the command ship to identify each aircraft and check its position on the radar scopes.

The shot went off as planned, but when the shock wave hit the ship, it knocked out the special radar antenna high on the mast.

The Raytheon Field Engineer* on board went into action. He quickly fashioned an emergency antenna from a metal coat hanger, climbed the mast,

and taped the antenna in place.

With the system working again, it was discovered that one pilot was flying in the reverse direction—out to sea. An Air Force officer reported that the prompt restoration of the special radar undoubtedly made it possible to save this pilot and his plane.

Raytheon Field Engineers work with the Armed Forces to keep electronic equipment in top operating condition. Their skills are another reason why Raytheon has earned its reputation for "Excellence in Electronics".

**Edward K. Doherr, WIEEE; now Asst. Mgr., Government Services Div.*



Excellence in Electronics

RAYTHEON MANUFACTURING COMPANY
Government Services Division, Waltham 54, Mass.

SEE AD ON OPPOSITE PAGE

**Before you buy ANY
HAM EQUIPMENT
.... GET
Henry's DEAL**

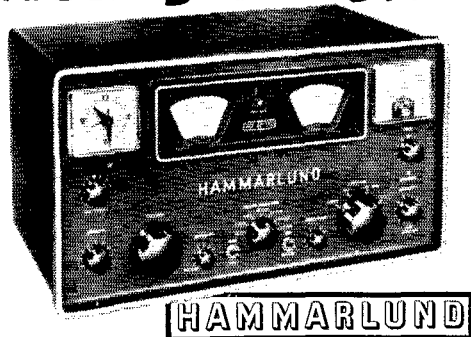

**HQ110 • 20 monthly payment \$11.30.
\$22.90 down. CASH PRIZE \$229.00.**
Designed all the way with the amateur
in mind. Smart, modern receiver packed
with all the features an amateur wants.
Clock timer \$10.00 extra.

**HENRY HAS THESE HAMMARLUND ITEMS
IN STOCK FOR IMMEDIATE SHIPMENT**

- HQ160 RECEIVER.....\$379.00
- HQ100 RECEIVER..... 169.00
- MATCHING SPEAKER..... 14.95
- CLOCK TIMER..... 10.00

**Complete stock of all transmitters, re-
ceivers, antennas, rotators, towers,
parts, accessories, equipment. Henry
has ALL the new equipment first.**

PRICES SUBJECT TO CHANGE
TRADE — CASH — TERMS
WRITE, WIRE, PHONE HENRY NOW

**Henry
Radio
Stores**

Phone 395
Butler 1, Missouri

GRanite 7-6701

11240 West Olympic Blvd. Los Angeles 64

*Send
for
Free
Catalog*

Nets; ILN, 3515 kc., Mon. through Sat. at 7 P.M. The Hamsters Radio Club station (Chicago) has now been assigned the call W9AA. Cy Reed, past-president, had requested that this be done and the club accepted it in his honor. The ILN wants more down-state stations to check into the net. What say, gang? K9LFU's XYL is sweating out her Technician Class exam and in the meantime is planning lace curtains for the OM's shack. FDL's XYL gets a new piano when her General Class ticket arrives. K9GUA is sporting a new dual band quad, DRN is on s.s.b. on 2 meters, BON has a new mobile rig. K9IDJ is now General Class getting ready for DX-chasing. BA has been appointed RO for the combined Belleville, East St. Louis and St. Clair County C. D. Communications Center, 5ZWR is now K9MHW. TZN reports that because of a torn hand ligament his traffic total is not up to par. New Novices heard in the Chicago Area are KN9s MDE, MDF, MDL, MDM and MKA. A new DXCC members is ICF with 100 QSLs on 10-meter phone. MAX reports that the ILN in 29 sessions handled 313 messages, and CSW states the North Central Phone Net total was 590. CZB became the proud father of a daughter on May 6. The SWANI Club has resumed its popular transmitter hunts. By the time this report is printed the Springfield and Sangamon County RACES program will be in full force with 6-meter Communicators. The May 5 Practice Alert saw many RACES organizations operating en masse and from all reports the results were gratifying. There were too many letters received by your SCM to make a listing of their operations. The Joliet Ham Club has a new 600-watt transmitter and at a cost of only \$42.00. New appointments: K9ISP and K9JIN as OOs; K9ERH and K9GDQ as ORSS. ILVQ spoke at the May 23 Hamsters (Chicago) meeting. The League's Board approved the application of the St. Clair Amateur Radio Club, Inc., and also the Ottawa Radio Club, Inc., as duly affiliated societies. The downstate gang was active with the tornado that struck near Belleville on May 3. ESD received his WAZ by receiving JT1AA's QSL. Mr. and Mrs. Carl Mosley (of the ham that bears his name) were guests of the Hillsboro Radio Club during the regular May meeting. UQT is back on the air with a lot of power and says that the signal reports are great. NIU and NGG are celebrating their 25th year of hamming. Congratulations, fellows. K9HZG soon will be leaving for the land of the WAs. K9JVL, K9CMZ and K9GUB are the new officers of the Chicago Young Ladies Radio League, Inc. KN9JLD, NCS of the Regional Novice Net, is in need of members in the northern part of the State, and also is asking each member to get two new members to help enlarge the net roster. K9QL and WYP have gone mobile on 6 meters with home-brew transmitters. Traffic: (May) W9DO 1106, K9GDQ 520, ERH 389, W9MAK 341, FAW 253, PCQ 151, CSW 69, K9ISP 48, W9TZN 16, K9MHW 14, W9BA 9, SKR 6, NN 4, PRN 3, FDL 1. (Apr.) K9GDQ 374, KN9JLD 29, K9GSR 2, W9ICF 1. (Mar.) K9GSR 3.

INDIANA—SCM, Arthur G. Evans, W9TQC—Asst. SCM; Seth Lew Baker, 9NTA, SEC; CMT, PAMs; BKJ KOY, SWD and UXK. RMs: DGA, JOZ and TT. K9DGO was appointed OPS and OBS. QWI is a new OBS. The Martinsville ARC, elected ZSK, pres.; K9JKJ vice-pres.; and JVN, secy.-treas. The Old Post ARC of Vincennes elected GZT, pres.; DAN, vice-pres.; K9HIO, treas.; and GCQ, secy. The TARS Hamfest will be held Aug. 24 at Bauer's Grove near Evansville. Governor Harold Handley proclaimed June 22 through 28 as Amateur Radio Week in Indiana. The Deland ARA is now an ARRL affiliated club. The Central Indiana Mobile RC provided communications for the Sports Car Races by stationing units at the starting line and at each turn. KLR worked Maine via meteor scatter for state No. 38 on 2 meters. BUQ has organized a club and started code classes for the boys at the YMCA in Indianapolis. K9HIO hooked Wyoming to round out WAS. Two new Generals in Porter Co. are K9GFR and ISA. EQO has been transferred so he and XYL JYO will be moving to New Albany. K9IXD is on 6 meters with a new Gonset III. K9ELE has a DX100-B on the air. MHP is on 75 meters with a BC-459. GJS is putting up a trap antenna. K9AUE rebuilt his final and can now run 190 watts on c.w. HXR received the Czechoslovakian 868 DX Award.
(Continued on pag 102)

J O W E R S

ALL THE WAY IT'S E-Z WAY!

See Page 120
ELECTRONIC SUPPLY 61 N.E. 9th Street
Miami, Fla.
Tel. 7-2511

Bob Henry,
WØARA
Butler, Mo.



100% SATISFACTION
or Your Money Back at end of 10 day Trial

Ted Henry,
W6UOU
Los Angeles



**NOW, HENRY DARES TO GIVE YOU THE
ABOVE GUARANTEE . . . Try any receiver or transmitter for 10
days. If you are not perfectly satisfied, return it and all you pay are
shipping costs.**

Collins
KWM-1 Mobile Transceiver

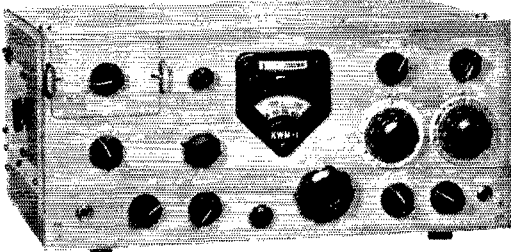

First SSB Mobile Transceiver ever offered. 14-30 mc. 175 watt PEP input. Use for mobile or fixed station without modification. Frequency stability comparable to KWS-1 and 75A-4. Break-in- CW using VOX circuits — side tone CW monitor. Self adjusting ALC. Mechanical Filter sideband generation. Complete TVI filtering. Pi-L output network. 6 1/4" H x 14" W x 10" D. Available in limited quantity.

KWM-1 Net Price\$820.00
75A-4 Net Price, complete with Gear Reduction Tuning
Knob, 3.1 kc Mechanical Filter, and tubes\$695.00
KWS-1 Net Price\$2,095.00

Complete stock of all transmitters, receivers, antennas, rotators, towers, parts, accessories, equipment. Henry has ALL the new equipment first.

PRICES SUBJECT TO CHANGE

Trade • Cash • Terms

Write, wire, phone or visit either store today.

Butler 1, Missouri
Phone 395



Henry Radio Stores

Granite 7-6701



11240 West Olympic Blvd. Los Angeles 64

TOP TRADE-INS

We try to top all offers. Your trade-in makes down payment. Write for our offer.

EASY TERMS

90 days open account or 10% down—up to 20 months. We finance. Payment within 90 days cancels all interest. Write for details.

A-1 RECONDITIONED APPARATUS

Nearly all makes and models—Big Savings—Ten day trial—90 day warranty. 90-day full trade back on new apparatus. Write for bulletin.

**PERSONAL SERVICE
FAST DELIVERY**

Your inquiries and orders handled same day. Write, phone or wire us.

Send for
FREE
Catalog

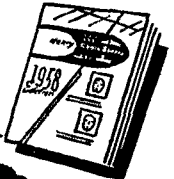

Bob Henry,
WØARA
Butler, Mo.

Ted Henry,
W6UOU
Los Angeles



World's Largest Distributors of Short Wave Receivers

10% PRICE SLASH!



"I am now using the Gotham V80 vertical antenna with only 55 watts, and I am getting fantastic reports from all over the world". VP1SD

ALL-BAND VERTICAL ANTENNAS

GOTHAM'S sensational new vertical antennas give unsurpassed multi-band performance. Each antenna can be assembled in

less than two minutes, and requires no special tools or electronic equipment. In the V160, resonance in the 160, 80, 75, and 40 meter bands is secured through use of the proper portion of the loading coil. Yet, when the coil is eliminated or bypassed, the V160 will operate on 20, 15, 10 and 6 meters! The same idea applies to our V80 and V40 multi-band verticals. No guy wires needed; rugged, occupies little space, proven and tested.

Simple design and superior materials give all-band operation, and effective, omni-directional radiation. Gotham verticals are rugged, with low initial cost and no maintenance. Guaranteed Gotham quality at low Gotham prices. Perfect for the novice with five watts or the expert with a kilowatt.

I USE MY GOTHAM ALL BAND VERTICAL ON 6, 10, 15 AND 20

ME TOO, TOM-AND LAST NIGHT I SWITCHED TO 40, 80, AND NO. WORKED SOME REAL DX!



QUALITY MATERIAL

Brand new mill stock aluminum alloy tubing with Aluminite finish for protection against corrosion. Loading coils made by Barker & Williamson.

ALL-BAND OPERATION

Switch from one band to another. Operate anywhere from 6 to 160 meters. Work the DX on whatever band is open.

EASY ASSEMBLY

Less than two minutes is all you need to put your vertical together. No special tools or electronic equipment required. Full instructions given.

SIMPLE INSTALLATION

Goes almost anywhere. On the ground, on the roof, or outside your window.

AMAZING PERFORMANCE

Hundreds of reports of exceptional DX operation on both low and high power. You will work wonders with a Gotham vertical.

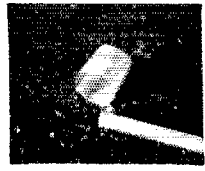
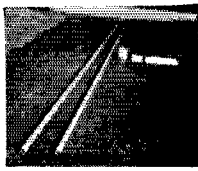

PROVEN DESIGN

Over a thousand Gotham verticals are on the air—working the world and proving the superiority of Gotham design.

AND THE PRICE IS RIGHT!

10% PRICE SLASH!

TAKE 10% WHEN ORDERING

Airmail Order Today — We Ship Tomorrow

GOTHAM Dept. QST
1805 PURDY AVE., MIAMI BEACH, FLA.

Enclosed find check or money-order for:

- V40 vertical for 40, 20, 15, 10, 6 meters..... \$14.95
- V80 vertical for 80, 75, 40, 20, 15, 10, 6 meters..... \$16.95
- V160 vertical for 160, 80, 75, 40, 20, 15, 10, 6 meters..... \$18.95

Name.....

Address.....

City.....Zone.....State.....

"I worked LU3ZS on Half Moon Island in Antarctica on Dec. 26 at 21150 Kc. I was using my Gotham V80 vertical antenna and only 35 watts." KN5GLI

HOW TO ORDER. Send check or money order directly to Gotham or visit your local distributor. Immediate shipment by Railway Express, charges collect. Foreign orders accepted.



GOTHAM 1805 PURDY AVENUE
MIAMI BEACH 39, FLA.

10% PRICE SLASH!

HI JIM, HEARD YOU WORKING THAT DX STATION. HOW DO YOU DO IT ON THE LOW POWER YOU RUN?



EASY BILL. I'VE GOT A GOTHAM BEAM. I'M WORKING STATIONS I NEVER HEARD BEFORE. DX IS A CINCH NOW.



THAT SETTLES IT, JIM. I'M GOING TO GET A GOTHAM BEAM TOO. ARE THEY EASY TO INSTALL AND OPERATE?



VERY EASY BILL, AND THEY'RE FOOL-PROOF AND TROUBLE-FREE. LICKS YOUR NOISE AND WRY PROBLEM TOO. MY GOTHAM BEAM IS THE BEST INVESTMENT I EVER MADE.



YOU COULD WORK WONDERS IF YOU HAD A GOTHAM BEAM!

PUT AMERICA BACK TO WORK! 10% PRICE SLASH! TAKE 10% OFF WHEN ORDERING

Study these specifications—compare them—and you too will agree, along with thousands of hams, that GOTHAM beams are of the best!

TYPE OF BEAM. All Gotham beams are of the full half-wave plumber's delight type; i.e., all metal and grounded at the center. No wood, tuning stubs, baluns, coils, or any other devices are used.

MORE DX CONTACTS

GAIN. Gotham beams give the maximum gain obtainable. Our 2-element beams give a power gain of four (equivalent to 6 db.); our 3-element beams give a power gain of seven (8.1 db.); and our 4-element beams give a power gain of nine (9.6 db.)

THOUSANDS IN DAILY USE

MATCHING. Matching of the transmission line to the beam is extremely simple and quick. No electronic equipment or measuring devices are required.

ALCOA QUALITY ALUMINUM

ASSEMBLY AND INSTALLATION. No special tools are required for assembly and installation. Entire job can be done by one man in less than an hour. Full instructions are included with each beam.

CONSISTENT PERFORMANCE

MAST. Any Gotham beam can be mounted on a simple pipe mast. Diameter of the pipe should be between 3/4" and 1 1/8".

YOU WILL WORK THE WORLD

STANDARD AND DELUXE BEAMS. Standard beams in the 6, 10 and 15 meter bands use 3/8" and 3/4" tubing elements; the deluxe models for these bands use 7/8" and 1". In 20 meter beams, the standard has a single boom, while the deluxe uses twin booms.

TRIBANDER BEAMS

- 6-10-15 TRIBANDER.....\$39.95
- 10-15-20 TRIBANDER..... 49.95

Do not confuse these full-size tribander beams with so-called midgits. The Tribander has individually fed (52 or 72 ohm coax) elements and is not frequency sensitive, nor does it have baluns, coils, traps, or other devices intended to take the place of aluminum tubing. The way to work multi-band and get gain is to use a Gotham Tribander Beam.

TWO BANDER BEAMS

- 6-10 TWO BANDER.....\$29.95
- 10-15 TWO BANDER..... 34.95
- 10-20 TWO BANDER..... 36.95
- 15-20 TWO BANDER..... 38.95

Each Two Bander has twin 12' booms, and full-size half-wave elements. 7/8" and 1" aluminum alloy tubing, all castings and fittings are supplied. Assembly is easy.

Airmail Order Today — We Ship Tomorrow
GOTHAM Dept. QST
1805 PURDY AVE., MIAMI BEACH, FLA.

Enclosed find check or money-order for:

- TWO BANDER BEAMS**
- 6-10 TWO BANDER..... \$29.95
 - 10-15 TWO BANDER..... 34.95
 - 10-20 TWO BANDER..... 36.95
 - 15-20 TWO BANDER..... 38.95

- TRIBANDER**
- 6-10-15 \$39.95 10-15-20 \$49.95

- 2 METER BEAMS**
- Deluxe 6-Element 9.95 12-El 16.95
- 6 METER BEAMS**
- Std. 3-El Gamma match 12.95 T match 14.95
 - Deluxe 3-El Gamma match 21.95 T match 24.95
 - Std. 4-El Gamma match 16.95 T match 19.95
 - Deluxe 4-El Gamma match 25.95 T match 28.95

- 10 METER BEAMS**
- Std. 2-El Gamma match 11.95 T match 14.95
 - Deluxe 2-El Gamma match 18.95 T match 21.95
 - Std. 3-El Gamma match 16.95 T match 18.95
 - Deluxe 3-El Gamma match 22.95 T match 25.95
 - Std. 4-El Gamma match 21.95 T match 24.95
 - Deluxe 4-El Gamma match 27.95 T match 30.95

- 15 METER BEAMS**
- Std. 2-El Gamma match 19.95 T match 22.95
 - Deluxe 2-El Gamma match 29.95 T match 32.95
 - Std. 3-El Gamma match 26.95 T match 29.95
 - Deluxe 3-El Gamma match 36.95 T match 39.95

- 20 METER BEAMS**
- Std. 2-El Gamma match 21.95 T match 24.95
 - Deluxe 2-El Gamma match 31.95 T match 34.95
 - Std. 3-El Gamma match 34.95 T match 37.95
 - Deluxe 3-El Gamma match 46.95 T match 49.95

(Note: Gamma-match beams use 52 or 72 ohm coax. T-match beams use 300 ohm line.)

NEW! RUGGEDIZED HI-GAIN 6, 10, 15 METER BEAMS

Each has a TWIN boom, extra heavy beam mount castings, extra hardware and everything needed. Guaranteed high gain, simple installation and all-weather resistant. For 52, 72 or 300 ohm transmission line. Specify which transmission line you will use.

- Beam #R6 (6 Meters, 4-El).....\$38.95
- Beam #R10 (10 Meters, 4-El)..... 40.95
- Beam #R15 (15 Meters, 3-El)..... 49.95



Name.....
 Address.....
 City.....Zone.....State.....

HARRISON HAS IT!

100 FOOT VERTICAL ANTENNA (OR BEAM MAST) IN YOUR CAR TRUNK!

Just the thing for vacation or field day portable — but rugged enough for year 'round dependable service in the worst weather!

Heavy duty Signal Corps AB-85 portable antenna sections, at a fraction of their original cost. Each 3 feet long, 1 1/2" diameter, with 1/8" thick wall. Made of highest tensile strength light-weight aluminum alloy. Only 34 ounces. Bonded olive drab finish. Precision telescoping joints 6 inches long give sturdy rigidity. Four heavy internal spring fingers insure positive contact.

A cinch to run up, a sec-

tion at a time — and just as easy to take down! 40 section, 100 foot vertical radiators are giving excellent service in commercial installations. (For a rugged high Q vertical, use an insulated base and "Glas-Line" or nylon guys, or wire guys broken with egg strain insulators). 18 sections, guyed every 15 feet, have been holding a heavy Telrex full sized 20 meter beam 45 feet up in 75 MPH winds for more than a year!

Signal Corps AB-85 Mast Sections.
Brand new, in original sealed wrapping.
(Add \$1 per order for packing)

Be sure to order enough sections, now. You might want to go higher, later, and you'll never see a mast bargain like this again! Use some for guy anchor stakes.

ONLY
\$1.25
EACH

ACCESSORIES

- | | | |
|--|--|-----------|
| Flat guy rings 4 for 88c | Guy wire clamps | 6 for 98c |
| Floating guy rings... 96c | Egg strain insulators | 7 for 98c |
| Roller bearing guy rings. | Rotary screw earth anchors (Deadman) | \$4.35 |
| For easy rotation of mast and beam \$2.97 | Universal mounting base. For flat, sloping or peak | \$1.45 |
| Timbales for guys | Insulator for base. Heavy ceramic, glazed, 5/4" high | 49c |
| 12 for 49c | (Or, use a Coke bottle) | |
| Glas-Line, per 100 feet | | |
| \$2.89 | | |
| Heavy 7x17 high tensile strength aluminum guy wire. Per.100 feet | | \$2.63 |

C-D-R BEAM ROTATORS.

- Complete with direction indicating control unit:
New, heavy-duty HAM-M model—\$99.50
(Special 8 wire cable—\$6.25 per 100')
Standard heavy automatic model, FB for VHF arrays, up to 15-20 mini and loaded beams. AR-22—\$31.17
(4 wire cable—\$3.25 per 100')

"HAM HEADQUARTERS, USA"

has all the best antennas (beams, verticals, multi-bands, mobiles, etc.), towers, accessories, measuring equipment — everything you need to put out a better signal!

Come on in, or order by mail for fast service (\$3 minimum, please)

HARRISON

Ham Headquarters Since 1925
225 GREENWICH STREET
NEW YORK 7, N.Y.

PHONE ORDERS - BARCLAY 7-7777
LONG ISLAND - 144-24 Hillside Ave., Jamaica

FJT is back on the air after getting up a 120 ft center-fed antenna at his new home in Princeton. SWD reports IFN evening traffic as 270 and morning 159. JOZ reports QIN traffic as 187. RFN traffic, as reported by TTT, is 71. K0DGO has volunteered to help collect reports and promote liaison between the various 6-meter nets. He would like reports from all net controls on 6 meters. ETM and NZZ made BPL Traffic: (May) W9NZZ 1056, ZYK 417, K9EOJ 217, W9VAY 199, JOZ 197, ETM 177, JT 175, SWD 95, K9AXT 82, W9TCQ 80, EHZ 72, BKJ 64, FJR 58, RTH 51, WID 51, CDW 44, CC 42, K0EOI 38, W9EJW 36, BUQ 34, BDG 30, K9GGB 28, W9GJS 26, SNO 25, DOK 24, QYO 24, K9DGO 23, W9CVZ 21, AMY 19, K9AOM 18, W9TQX 17, HUF 16, IMU 16, YXX 14, VNY 13, K9IXD 12, W9HRW 11, ZSV 10, WAU 9, ENU 8, MHP 8, NTR 8, WHL 8, NTA 7, STC 7, DGA 6, PQZ 6, QR 6, K9DWK 5, BSU 4, W9MLF 3, CYZ 2, K9GSV 2 (Apr.) W9SYM 10, K9DCX 8, W9NTR 8, ZYU 8, K9BXF 7, HIC 5.

WISCONSIN—SCM, George Woida, W9KQB—SEC: YQH. FAMS: NRP and AJU. RMs: K9AEQ and W9EFC. New appointees: LJC, KKM, FMD, K9BCE and K9ANY as EGs; NLJ as GRs; K9ELT as OBS. CXY is now TCC for PAN. K9CJW has WAS. BEN certificates went to K9DTK and K9ERO; WIN certificates to GYA and K9LNX. DYG's DX now is at 184/197. Fred is the new WIN NCS and a member of 91NN. MWQ has a new HQ-160. SAA is busy with the BEN and slow-speed nets. Nine daily kicks keep K9GDF busy with traffic. GFL is getting his kids building a DX-100. K9CEF is happy with his Wausau Hamfest prize, an 8X-100. K9GSC has a new LA-1 linear amplifier. New Oshkosh Club officers are KKK, pres.; IDTM/9, vice-pres.; DTV, secy.-treas. Watch for NLI/8 in North Dakota during the next SS Contest. ADM is building an amateur TV station. K9CMW has a vertical working on all bands. K9IQO made several Texas contacts on 50 Mc. The WVRA station now has a BC-612 and a BC-610. K9GAJ is working southern states on 6 meter. V.H.F. Net operators put on a successful v.h.f. demonstration at the high school at Fond du Lac. The Milwaukee Club's new officers are JDX, pres.; MOT and RKP, vice-pres.; QYW, secy. CUV, treas. QYW has DXCC. The Southeast C.D. Reception Area station, headed by RO NRP at Watertown, handled 95 pieces of traffic during the May 6 and 7 Alert. Operators were WAQ, LUB, PJT, K9s DEZ, GJC, DID, GWG and BVS. The club at the Milwaukee Bay View High School has affiliated with ARRL. VCH, ex-KA4AS, has a new DX-100 and an HQ-110 with an 820-B on 6 meters. The following supplied communications for Sharon, Wis., when storms knocked out the power: LST, HGE, DOW, YTV, K9s CTY, AQB, KKH, BKW, EGR, BOD and LOC. K9BSW demonstrated his 27-tube receiver at the Madison Club meeting. Traffic: (May) W9CXY 1296, K9GDF 744, ELT 309, W9DYG 60, SAA 46, K9B 34, K9DTK 31, AEQ 29, W9FXA 21, VHP 16, GFL 14, NRP 10, RTP/9 10, VCH 9, K9CJL 8, W9RMF/9 7, K9IQO 5, W9MVO 5, K9GSC 4, CEF 3, W9GIL 2, SIZ 2. (Apr.) K9AEQ 65.

DAKOTA DIVISION

NORTH DAKOTA—Acting SCM, Arnold L. Oehlsen, W0YCL—HVA and PHC did a stellar job as net controls for RACES participation in Operation Alert 1958. KLP has moved to Bismarck for the summer. K9ICZ is going into the Army in July. The Jamestown Amateur Radio Club has a club project building 6-meter transceivers. Three of the Jamestown group used these transceivers for local communications for Operation Alert. These were K9CNC, K9GRM and AZV. Another member of the club, K9EOZ, worked Oklahoma City on his 6-meter transceiver using a ground-plane antenna. K9GRM is a new net control on the 75-Meter Phone Net. K9OLM is a new Novice in Jamestown. K9PZN and K9PZO (OM and XYL) are new hams in Devils Lake. Traffic: (May) K9CNC 66, W0YCL 44, K9EAB 17, W0KXZ 5. (Mar.) K9AJW 1.

SOUTH DAKOTA—SCM, Les Price, W0FLP—The following was sent in by SCT: The Prairie Dog ARC operated its emergency trunk at Centerville during the 75th Jubilee with the call OJY. Operators were SCT, K9GDS, K9EWJ, K9BQL, YIM and K9MDF with ZVV, MIMQ and son, K9CFX. EWH, the XYL of K9EWJ, LXD, K9JOK and WUU assisting. Nets reports: 75-Meter Net—35 sessions (ZLB 7, GWA 2, EXX 2, YVF 3, SCT 16, K9CRD 2, DHA 1); QNI 741, high 29, low 10, average 21.17; QTC 82, high 9, low 0, average 2.34; informals 72, high 6, low 0, average 2.05. SD 40-Meter Net—25 sessions (NNX 3, EXX 1, SCT 1, K9LXF 20); QNI 415, high 24, low 7, average 16.6; informals 40, high 5, low 0, average 1.6. K5EEV visited SCT and K9EWJ in May. FVJ is using a kw. transmitter 5FEV has for sale. JOZ is on the air mobile for the summer. LMB was home for Memorial week end from 7-Land. SCT is operating 2 meters with a dual ten-ement beam. 6N2 and S-102. K9PRZ, living with brother-in-law HVY, is

(Continued on page 104)

HARRISON

is headquarters for HAMMARLUND



HC-10

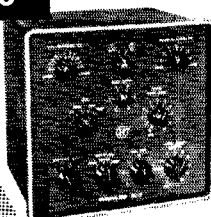

- high stability
- well engineered
- advanced features
- highest standards of quality
- amazingly low prices!

Harrison is the best place to get this sparkling new receiving equipment by one of the oldest and best manufacturers.

Excellent performance at lowest price! Covers .54 to 30 MC, with calibrated bandspread of Ham bands. Has Q multiplier, Auto-response, etc. It's yours for only \$14 a month with down payment of \$25 and low carrying cost.

With control clock, add only \$10.
Matching speaker — \$14.95.
Crystal calibrator — \$15.95.

Write For Free Booklet — Listening in on the World at Large with the Hammarlund HQ-100.

The STAR PERFORMER that has everything. Covers frequency range of 540 KCS to 31 MCS. Dual conversion with calibrated Ham bandspread. Built in notch filter. Q Multiplier. Crystal calibrator. This receiver, reflecting Hammarlund's finest engineering design and production skills, can be yours today for only \$36 down and \$27 a month. Matching speaker—\$14.95.

FOR QUICKEST DELIVERY —

send me your order right now! A deposit of only \$5 will start fast action. If you have a trade-in, tell me about it so I can give you the very highest allowance. Mention the approximate terms you would like, and give employment and credit references.

Prompt, safe shipment to most anywhere in the world, or, you can "Come and get it!" and take it safely home with you.

AT LAST

HARRISON TOWER CENTER

—Complete Tower Information—
Your tower problems are given individual consideration by our experts. Another real advantage in obtaining all your requirements from "Ham Headquarters, U.S.A."

HARRISON

Ham Headquarters Since 1925

225 GREENWICH STREET
NEW YORK 7, N. Y.

PHONE ORDERS—BARCLAY 7-7777
LONG ISLAND—144-24 Hillside Ave., Jamaica



Want to turn your present receiver into the sharpest, slickest, SSB/CW, AM/MCW job, one which can hold its own with the very best of them? Just plug this new HC-10 Converter into the 450 to 500 KC IF output tube socket, and connect your speaker!

It has T-slot filter, vernier passband tuning, noise limiter/squelch, linear product detector, stable BFO, adjustable decay AVC, IF amplifier, internal power supply, etc., to add every modern feature to your receiver. Uses 10 tubes.

TRY ONE, and you'll be convinced! It's well worth the \$149 investment. Especially when you can get it for only \$27.56 down, and 12 monthly payment of \$11, which includes all carrying cost.

HQ-100



HQ-110



Designed with the Amateur in mind! Dual conversion on 6, 10, 15, 20 and 40. Separate linear detector for SSB. 2nd conversion crystal controlled. Crystal calibrator. Q Multiplier. Top Ham Value! You can be enjoying this FB new receiver while paying only \$19 a month.

Even less, if you trade in and down payment is more than \$25 and the low carrying cost!

With control clock, \$10 more.
Matching speaker — \$14.95.

HQ-160



HQ-170

COMING!

The outstanding receiver designed to meet ALL the requirements of modern SSB reception in performance, tuning techniques, and dependability. For earliest delivery place your order with Harrison now!



FROM TRIAD

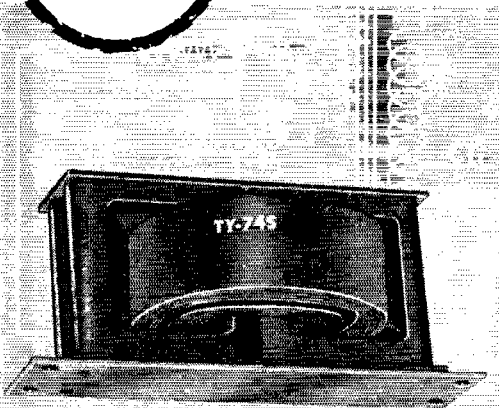

Type No.	*D.C. Volts Output	D.C. Ma.	Max. Watts	Net Price
TY-68S	250	65	16½	\$ 8.34
TY-69S	300	100	30	10.56
TY-70S	325	150	48½	11.40
TY-71S	375	200	75	12.30
TY-74S	600	200	120	15.00

*Center tap output winding provides half voltage at full rated current, high side full voltage at half current.

POWER TRANSFORMERS FOR 12-VOLT TRANSISTOR POWER SUPPLIES

Center tapped output windings are provided so that two simultaneous voltages may be used, if the total power in output watts is not exceeded. Especially designed for mobile transistorized power supplies, these new transformers permit an efficiency of 80 to 85% in the entire power supply.



Available now from your Triad Distributor. Ask him for special bulletin giving schematic and specifications or write direct to Triad for this information.



TRIAD TRANSFORMER CORP.
4055 REDWOOD AVE. | 812 E. STATE STREET
VENICE, CALIFORNIA | HUNTINGTON, INDIANA

A SUBSIDIARY OF LITTON INDUSTRIES

only a few miles from PRZ, leading DXer, in Aberdeen. K6MHF is newly-licensed. The Signal Hill ARC met with DQK in April and with CTD in May. RACES Hq. reports 17½ hours operation May 6 and 7 with 156 messages cleared. Operators were ZLB, IEL, HVY and K6ESP. Traffic: W8SCT 326, DVB 81, OJY/6 79, K6LXF 41, BAIQ 32, DUR 23, W0DKJ 12, K6IAW 8, EWJ 7, CWJ 6, DYR 6, KLR 5, LXH 5, W6NNX 4, FJZ 3, WUU 1.

MINNESOTA—SCM, Robert M. Nelson, W6KLG—Asst. SCM: Bob Schoening, 8TKX. Operation Alert '58 was quiet successful in Minnesota, reports PBY, chief for RACES. The State Headquarters Control Station was set up at Mankato this year. Messages pertaining to the simulated "bomb drop" were handled, using the 2-, 6-, 10-, 75- and 80-meter bands. Much was learned but more drills are needed to keep up the interest in the RACES program. K6DUO, OES, is constructing a 40-element beam for 6 meters. He will be running 200 watts s.s.b. soon and wants 8-meter schedules with stations to the east, preferably in the Chicago Area. HP made WAS with "RTTY No. 1" endorsement on it. He is an NCS and is active on the 40- and 20-meter RTTY nets. K6GQU has left for service with the Navy. K6MGT is back in Minnesota, after graduating from radio school at Kansas City, Mo. K6IDV and K6JCF made BPL—again! K6-KYK and KN6ORK are NCSs on MJN for the summer months. K6DIA and K6IDV, who both have been doing a swell job as net control, have summer jobs. New officers of the Hector Area Radio Club are BILA, pres.; NUI, vice-pres.; K6DHY, secy. Meetings are held the 1st Fri. of each month at Stewart. We still are in need of more Official Observers who will send out cooperative notices and report them monthly via the SCM office. If you think you qualify and are interested, please contact your SCM. Meeting at 0645 CST, 7225 kc. Mon.-Sat., the State Side net control is K6GYS, Crookston. Open for traffic the net tunes the whole Novice band. Traffic: (May) W6KLG 304, K6IDV 261, GCN 201, W6BP 134, RQJ 122, K6JCF 113, W6PET 53, OPX 45, JRD 35, OJK 33, K6EPT 32, W6JIG 31, K6ISV 27, KYK 27, W6QVR 27, ALW 25, KN6ORK 24, K6GVX 20, W6KJZ 20, FGP 19, ENZ 18, WMA 17, UMX 15, K6AEE 14, W6BUO 13, K6LZD 13, W6QVQ 13, IRJ 12, TCK 12, MBD 11, WCD 11, K6GQU 9, KN6MLJ 7, OBM 7, W6YHR 6, K6ELJC 5, W6UCV 5, LST 4, K6GKI 2. (Apr.) W6KJZ 27.

DELTA DIVISION

ARKANSAS—SCM, Ulmon M. Goings, W5ZZY—SEC: K5CIR, PAM: DYL, RM: SZJ. It looks as if K5FJA is due our congratulations for having made BPL twice in a row. We are glad to welcome DAG back to the section. Mac has been living in Texas and we missed his traffic-handling while he was gone. GUE is back in Arkansas. Tom was working /# while in college at Rolla, Mo. BYJ will be operating from W4-Land during the summer while away at college. WSM has returned from W6-Land where he visited ham friends. A new ham in Little Rock is KN5QVR. Congratulations, Wilma. The club in Osceola elected K5HOL, pres.; HFQ vice-pres.; K5KMK secy.; GWB treas.; DUV act. mgr. The club now has a civil defense trailer van to be outfitted for emergency work. We would like to remind all League Officials in Arkansas to look at your appointment certificates and send them in for endorsements if they are about due. Let us not forget to support the local traffic and emergency nets. We notice there are several of the larger towns that have no representation in the various nets that are established. Traffic: K5FPA 635, W5BYJ 149, SZJ 141, K5IPS 26, W5WSM 10.

LOUISIANA—SCM, Thomas J. Morgavi, W5FMO—K5MMP has been appointed EC for the Shreveport-Bossier City Area. The Caravan Club of Louisiana elected KQS, caravan master; KAT, asst. caravan master; K5MMP, secy.-treas., and GZT, program chairman. K5FSW has been appointed as OO. K5JJY reports that the radio club at Jesuit High has nine licensed operators and four beginners. K5GPB is on 2 meters with 15 watts. CFZ continues to roll up FB totals in messages handled. He lost a transformer in his DX-100 but kept skeds with a stand-by Eldico TR-75 rig. VAR reports that an informal picnic was held at Fontainebleau Park recently. Among those present were DP, K5BES, NUH, ADU, K5DAC, K5DVQ, AZM and their XYLS and harmonics. An eight-week code class sponsored by the YMCA and operated by the Jefferson Amateur Radio Club, is about completed. MIXQ is active on MARS. CAN, LAN and RN5. Incidentally, MIXQ sometimes acts as net control for LAN and that net is looking for c.w. outlets over the State. The net meets each night at 6:30 CST on 3615 kc. K5AGJ transmits Official Bulletins on that frequency before the net meets. The Conla Amateur Radio Club plans a hamfest for Aug. 31. K5EFS has been appointed Alexandria Area EC. SUM is fixing marine and mobile equipment in the vicinity of Morgan City. SPZ was back in New Orleans (Continued on page 106)

for the final proof of operating excellence . . . compare on the air!

THESE GREAT SERIES OF

Hy-gain trap tribanders

the FULL-SIZE trap tribanders

the NEW mini-tribanders

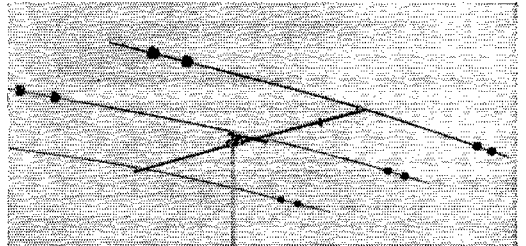
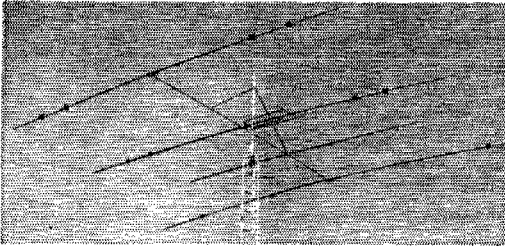

99⁷⁵

the 3-element trap tribander

The 3-Element Tribander shown above is now considered as the standard of performance in the field of amateur communications. F/B Ratio: approx. 25 db. Forward gain: 8 db. average.

69⁵⁰

the 2-element trap tribander

For use in limited space when top quality transmission is desired on 10, 15 & 20M. Single transmission line. F/B Ratio: approx. 18 db. Forward gain: 5.8 db. average.

495⁰⁰

the 5-element trap tribander

The finest, highest gain, rotatable array available. Heavy duty construction. Uses 36", 2x31" rectangular aluminum boom. F/B Ratio: approx. 25 db. Forward gain: 12 db. average.

69⁹⁵

the 3-element mini-tribander

Extremely lightweight, only 39.8 lbs. Turning radius: 13'10", installable almost anywhere, yet boasting many features of the full-size line. Hy-gain top quality performance guaranteed.

49⁹⁵

the 2-element mini-tribander

Practically a featherweight; — only 33.8 lbs., easily one-man installed in the shortest possible time and nearly anywhere. Turning radius: 12'11". Top features at minimum cost.

Here's the smallest practical size constant with efficient operation, to which the trap tribanders may be reduced. Install in the smallest city lots. Light weight & rotatable by most TV rotators. Factory pre-tuned, with dimensions given for quick, easy assembly in a matter of minutes.

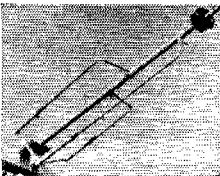

Perfect 1:1 SWR is made possible by the new, pre-calibrated Triaxial Gamma Match System with coaxially formed reactance cancelling capacitor built in. Exceptional band width maintains low SWR over entire band. Coax connector for 52 ohm feed line included. Gamma rod and capacitor section calibrated for exact setting over each band. No external baluns, antenna tuners or matching networks needed.



The automatic switch action of the Insu-Traps is employed in both series of tribanders. They act as insulators at their resonating frequencies, but allow radio energies of other frequencies to pass, isolating various sections of the antennas. Mechanically and electrically stable, the traps are hermetically sealed at the factory in polyethylene cover and cap, completely weatherproof. Hi-Q coils wound on styron form. Guaranteed for the life of the beam. The Mini-Tribander Traps are specially weight-designed for wind loading efficiency.



Split insulated dipole feed with coaxial choke results in SWR of less than 2:1 on all bands. No adjustments needed; simply attach 52 ohm feedline to dipole terminals. Heavy 12 ga. hot dipped galvanized steel channel and polyethylene insulated U-bolts support Hy-gain's driven element. Compare this construction with the flimsy supports using self-tapping metal screws.

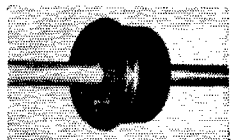

LEO: PLEASE RUSH YOUR FREE CATALOG AND COMPLETE INFORMATION ON THE ENTIRE HY-GAIN LINE!

I WOULD ALSO LIKE A LATE RECONDITIONED EQPT. LIST

WORLD'S MOST PERSONALIZED ELECTRONIC SUPPLY HOUSE

World Radio LABORATORIES
PH. 2-0277

3415 W BROADWAY COUNCIL BLUFFS IOWA

Name:

Address:

City and State:

Your
BEAM DESERVES
A K.T.V.
TOWER

UNEXCELLED
FOR STRENGTH
& STABILITY --

GUARANTEED
TO WITHSTAND
80 MPH WINDS

GET YOURS
NOW FROM
DeMambo

ASK ABOUT OTHER KTV TOWERS —
CATALOG ON REQUEST

DeMambo
RADIO SUPPLY COMPANY, INC.

1095 Commonwealth Avenue, Boston 15, Mass.

Worcester, Mass. Providence, R. I. Manchester, N. H.
Lawrence, Mass. Keene, N. H. Brockton, Mass.

All with TELETYPE CONNECTION TO MAIN STORE
BETTER STILL, COME IN — PLENTY OF PARKING SPACE



on a two-week vacation from Ft. Worth. Some of the calls you might hear on Sun. mornings around 3950 kc. are GAD, JHK, K5MDV, VSQ, QHP, K5CVK, JGV and even PAIO. K5GGW heard W6, W1, W2, W7 and W8 on 6 meters May 25. Traffic: W5CEZ 445, K5AGJ 155, W5MXQ 111, VAW 6.

MISSISSIPPI—SCM, John Adrian Houston, sr., W5EHI—The Biloxi ARC held a picnic on the beach in Biloxi Fri. night May 9. Lighting was provided by the gasoline-powered generator furnished by the club president, SPX. New members are DZZ, RZP, USK, VTI, YEN, W2KOA/5 and Michael Lehman, 12, not yet licensed. The Biloxi ARC operated two stations from the V.A. center on Armed Forces Day. The equipment was furnished by UOO, SPX, KN5LGB and KN5PBX. The stations operated under the calls UOO/5 and SPX/5 and handled 130 messages. Others assisting were AFD, TDU, ISV, RWV, TRF and ex-QYX. The Biloxi ARC will hold a hamfest Aug. 23 and 24. First prize is a DX-100; second, a 17-in. TV set; third a magnetic tape recorder; and many other prizes. For information contact John F. Jackson, 2307 Miller St., Biloxi. K5IHQ is the new net mgr. for MIBEN. NRU is the new secretary. The net time has been changed to 7 p.m. CST. The Cleveland ARC is looking forward to a large turnout at the hamfest. Traffic: W5FPI 532, K51UE 10, MFY 6, W5NRU 6.

TENNESSEE—SCM, R. W. Ingraham, W4UO—SEC: RRV, PAMs: ZZ, UOT, PAH and VQE, RM: NHT. Welcome to DTL, who is back in Tennessee again and on the air from McMinnville. Congratulations to BPL winners PL, 5RCF, WQT and K4ONQ. WQT earned his hard way with 250 origination in eleven hours. Welcome to new Kingsport hams K4VKA, KN4VOS, VVM and VVN. Kingsport is making plans for its usual PB picnic Aug. 10. TDZ reports that he is building a kilowatt final for 6 and 2 meters. K4ONQ has a new "beautiful" CAN certificate. Congratulations to new ORS K4LPW; also to new ECs BXP, CXY, LQE and K4MYL. CXY is putting up a nice trophy for participation in the Oak Ridge RACES drills on emergency power. Look for the Tennessee Nets: C.w.—3635 kc. at 2000 EST; Phone—3980 kc. at 0645 EST and 0645 1900 CST; S.S.B.—3980 kc. at 1900 EST; Six Meter—50.5 Mc. at 2000 EST (Fri.). Traffic: W4PJ, 1253, W5RCF 1156, W4VQT 520, K4ONQ 513, LTA 102, LLB 97, W4VJ 63, NHT 48, CXY 15, UTO 44, RRV 34, UVL 32, K4LPW 24, W4PAH 21, GFL 19, JVM 15, K4KJC 15, W4VQE 9, TDZ 4, UVU 2.

GREAT LAKES DIVISION

KENTUCKY—SCM, Albert M. Barnes, W4KKW—SEC: JSH, RM: K4AIS, PAMs: SUD, OGY, K4ECJ and LOA. The Dix Dam Picnic is now history. I enjoyed meeting so many friends, new and old. The communications system is a "Buck Rogers" dream. Everything is used from controlled-carrier via the high lines to half-microwaves for local post-to-post use. KPN cleared 218 messages in May for an average of 7 per session. High session was on May 18 with 21 cleared. K4MMW, the NCS and also manager of the morning KPN, reports daily morning operation now is at 0730 CST. K4YN cleared 390 in 58 sessions, averaging 6.73 per session. High meeting was on May 17 when K4KIO, the NCS, cleared 25 in 73 minutes. Ky. Sideband Net (KSN) is parking along Mon. through Fri. on 3975 kc. at 2000 CST. K4ECJ is PAM for the sidewinders. K4LOA, U.H.F. PAM, reports excellent progress in organizing KY6 for state-wide e.d. emergency work. K4SBZ is a new Junction City ham. K4NPJ is using a Gonset III. K4HTO is putting up a 4-ft. vertical for his dad, JUI. We are sorry to hear of the death of NRI's mother. New OPSs: K4QHZ and K4PGII. New ORSs: K4MYM and K4PNA. The Maysville, Ky., Radio Club holds code and theory classes every Thurs. K4AIS has a new Dow key. BAZ worked K4IBK, a former KYN member. K4JOP has a new 10-meter antenna. K4KIN is on a two-month's cruise in the Pacific. NUQ works into the Bible Study Net on 3855 kc. at 0600 CST. KKG is going s.s.b. Traffic: W4SUD 352, K4AIS 316, W4KKW 180, OGY 124, RPF 96, K4MMW 77, KIO 76, W4HOJ 75, K4WBG 73, W4BAZ 60, K4JOP 58, LIQ 54, MHM 47, CSH 42, KIN 37, W4JSH 34, K4C 32, W4CDA 32, K4KIS 26, PNA 26, W4NUQ 15, KKG 13, K4QHZ 10, W4NGN 6, SZB 5, K4HOE 4, W4JUI 2.

MICHIGAN—SCM, Thomas G. Mitchell, W8RAE—SEC: YAN. Despite the season slump in news and general activity, our traffic total for May is greater than for April. Perhaps this is like the lull before the storm since every organization and individual seemed to be highly keyed up for Field Day. May BPL certificates were issued to CWE and WGU. The increase in AREC activity noted in this report last month is continuing, according to YAN. The Downriver Radio Club (Wyandott) has elected GUM as president and ARH as record-

(Continued on page 108)

NEW SSB

GSB-100 TRANSMITTER



Introducing Gonset's big SSB value, the GSB-100.

Completely self-contained with highly stable VFO and power supply, for operation on amateur 80, 40, 20, 15, 11 and 10 meter bands.

Amateur Net \$439.50

- Power input of 100 watts P.E.P.
- Operates on SSB with selectable sidebands.
- Operates also on AM, phase modulation or CW. Keying characteristics are excellent.
- Transmits both sidebands when on AM . . . avoids thereby, distortion present when carrier-and-one-sideband signals, at high modulation percentages, are received on conventional AM receiver.
- Frequency control is by fixed quartz crystal and exceptionally stable VFO*. Precise tuning is assured by dial assembly having gear ratio of 100:1.

- New Gonset FILTER-PHASING network gives excellent sideband rejection—quartz crystal band-elimination filter gives more than 60 db carrier suppression, avoids entirely all critical carrier balancing.
- Frequency coverage is full 600 kcs. over all amateur bands, 80 through 10 meters.
- Excellent voice operated control system (VOX). Biasing voltage is available for cut-off of external linear amplifier when receiving.

GSB-100 Transmitter Model #3233

*11 meters and CW portion of 10 meter band covered by separate crystals not supplied.

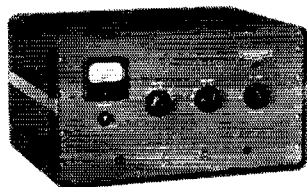

SSB LINEAR AMPLIFIER

New grounded grid linear amplifier is rated at 1000 watts peak input power. It is designed to operate with GSB-100, or similar SSB transmitters supplying 75-100 watts peak power drive. Amplifier is self-contained, includes power supply, pi-network output, antenna changeover relay. Provides bandswitched operation on 80, 40, 20, 15, 11 and 10 meters. Attractively styled. Same size cabinet and general appearance as GSB-100 Transmitter.

Model #3262

See them at booths #3 and #4, ARRL 10th National Amateur Radio Convention, Sheraton Park Hotel, Washington, D. C., August 15, 16 and 17



GONSET

DIVISION OF YOUNG SPRING & WIRE CORPORATION
801 SOUTH MAIN STREET BURBANK, CALIF.

CRAMPED FOR SPACE?

get a
**MOSLEY
TRAPMASTER
MODEL V-3
VERTICAL**
for 10-15-20M

Rated to a full KW—
with ease

- Low SWR
- Automatic Band-switching
- Weatherproof Traps
- No Tuning or Adjusting
- 61ST6 Aluminum
- Weight 4 pounds

COMPLETE—ONLY
\$22.95

ONLY
11' 6"
HIGH

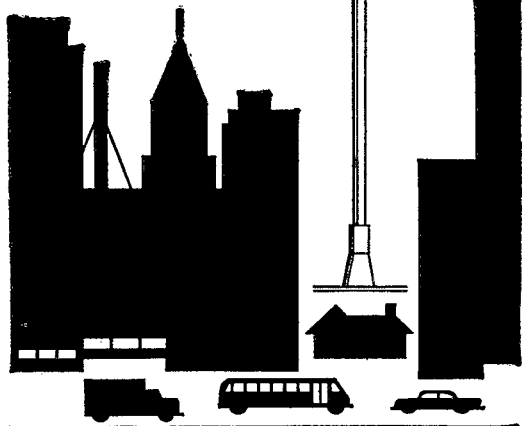
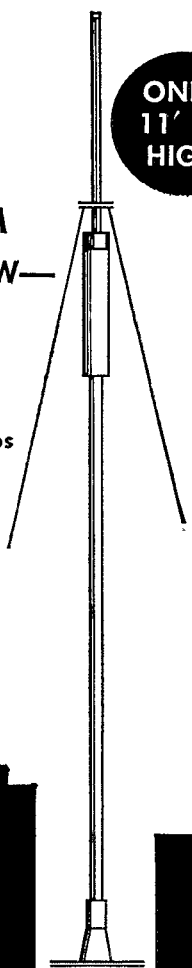

Mosley Electronics, Inc.

8622 ST. CHARLES ROCK ROAD
ST. LOUIS 14, MISSOURI

ing secy. HKT is chasing DX on 15 meters with a new ground-plane and his DX-40. FX has been investigating the subject of VT bleeders and is not too sold on their merits. UCN is off to Hawaii without even a hint as to why or how long, but it is an FB place to be heading for. The Niles ARC received high praise for its installation of an operating amateur station as part of the Tri-County Council Scout-O-Rama held in Berrien Springs last month. The station operated as DUS/8 on 20-meter s.s.b. and received an official message from the Chief Scout Executive to the participating organizations and scouts. This message was relayed over the p.a. system for all to hear. Much interest in our hobby was evidenced by the crowds around the booth at all times. Next month's report will be short because of my vacation. I will hold traffic totals for the following report. Traffic: (May) W8WGU 462, CWE 146, FWQ 118, K8NAW 90, W8DJN 77, NOH 60, FX 57, K8ADD 39, W8WGX 36, VYG 30, K8AXL 27, W8FSZ 18, Q1X 17, AUD 16, IZS 16, FDO 15, DSE 12, HKT 12, RHD 7, SCW 5, CRUI 4, EGI 3, WVL 3, TIC 2. (Apr.) K8NAW 155, W8NOH 103, QHO 83, FDO 27, IZS 10, RHD 4.

OHIO—SCM, Wilson E. Weckel, W8AL—Asst. SCM; J. C. Erickson, 8DAE. SEC: OPB. RM: DAE. PAMS: HPP, HUX and HZJ. K8DEY has a three-band cubical quad. K8CAG joined the Marines. The Tusco RC worked with broadcast station WJER in getting primary election returns from 119 precincts in Tuscarawas County and did a very good job. Those who took part were BIM, EUK, GAC, GUP, HQ, JHJ, MEL, NYQ, SBM, STR, WFE, WJF, K8s GLD, JOR and JPA. New Knucklehead certificates were issued to DBF, DIM, QDC, QMH, K8s GHD, JPA and JSZ. STR made WAS. KN8KPH moved to West Virginia. I wish that I had had the announcement sooner of the Hocking Valley RC Annual Basket Picnic, which was held July 13 at Lake Burr Oak State Park six miles north of Glouster off Ohio route 13. The Clermont County ARC's 1958 officers are PAZ, pres.; K8JTZ, vice-pres.; OWP, rec. secy.; IGE, corr. secy.; QLG, trans.; ZRL, trustee; and WYS. RACES. BPM moved to New York. The Massillon ARC heard Mr. Dushnow speak on Philosophy of Science. FSM and his XYL spent two weeks in Honduras visiting with HR2HA, HR1BB and he showed the club slides and movies of his trip. The South East ARC's 1958 officers are CPC, pres.; JUK, vice-pres.-treas.; and SLR, secy. EL, RJJ and K8CSS made DXCC. The Cleveland Area Council of ARC's 6- and 10-meter ground-wave contest winners are as follows: AJH for 10 and PJC for 6 meters. K8JHZ is on 6 meters. JHI moved to Cleveland from KL7-Land. BVN was in Florida. The Cuyahoga County AREC furnished communications for handling the Loyalty Day Parade, with AEU, AJH, AVU, DGR, FAG, INW, LVM, NZI, PZR, TFW, VFU and K8AAG taking part. This organization did the same thing during Cleveland's Memorial Day Parade, with AEU, CPF, DGR, LHX, PZR, VFU, WLH, K8s AAG and ABA taking part. KN8s JOR, JOX and JPA are new hams, while K8s HED and HTT dropped the "N." Dayton ARA's *R-F Carrier* tells us that KTM gave a talk on antenna's common errors and pitfalls and K8AST spoke on his "Little Giant" antenna. NHW, K8s GAK, GFU and KDW are on 6 meters. GHX, INQ, LPD, MGJ, K8s AEW, AOH, BLS, BOW, CBD and GNJ are on 220 Mc. Ohio Valley ARA's *Ether Waves* informs us that OPA vacationed on the West Coast. DAE is using an SX-96 and a Viking Valiant now. UPH made BPL with over a thousand again. YGR received cards from ZD3 and SV8. The Van Wert ARC's 1958 officers are DHG, pres.; OWC, vice-pres.; BDC, treas.; OWD, secy.; and SGX, act. mgr. The Columbus ARA's *Carascope* informs us that GZ explained the Windom antenna with formulas. A new appointee is K8BIZ as EC. With that tornado striking in Wisconsin, it brings to mind that we still need ECs for the following counties: Ashland, Brown, Carroll, Champaign, Clinton, Coshocton, Defiance, Delaware, Erie, Gallia, Hancock, Hardin, Holmes, Huron, Marion, Medina, Mercer, Monroe, Morrow, Noble, Paulding, Portage, Preble, Putnam, Sandusky, Scioto, Union, Vinton, Warren and Williams. Let us be prepared for such a disaster if it should strike here in Ohio. If interested, write to D. E. Cartwright, UPB, 2979 Observatory Rd., Cincinnati 8, Ohio, or to me. Traffic: W8UPH 1383, QLJ 210, DAE 132, HXB 74, K8HXP 70, W8CTZ 60, YGR 50, K8DDG 48, W8LT 45, AAU 32, K8CZJ 30, W8GD 27, WYS 26, AL 24, IBX 21, RO 18, LMB 16, PLQ 16, SJQ 16, DSQ 14, STR 14, K8GCY 13, W8HJ 10, WTO 8, K8EJL 6, W8FFK 6, QIE 4, K8EVT 3, W8THW 3, LGR 2, STF 2, K8GPI 1, HEJ 1, W8TDB 1.

HUDSON DIVISION

EASTERN NEW YORK—SCM, George W. Tracy.
(Continued on page 110)

International's

NEW 1958

Catalog!

**NOW AVAILABLE
Precision
CRYSTALS**
and

**Electronic
EQUIPMENT**

Send for your **FREE** copy . . . Today!



**Ask About the NEW
FCV-2 CONVERTER**



Model 50

6 Meters

Model 144

2 Meters

**and other
PRINTED CIRCUIT UNITS**

- **T-12 12-Watt Transmitter**
3500-4000 KC 7000-7300 KC
- **VFA-1 Cascode Pre-amplifier**
For 2 Meters or 6 Meters
- **IFA-10 IF Amplifier**
For Use Between Converter and Receiver.
- **FO-1 Printed Circuit Oscillator**
For Generating Spot Frequencies with Guaranteed
Tolerance from 200 KC to 60 MC.
- **FO-1L 100KC Oscillator**
For Band Edge Calibration and
Frequency Standard Use.
- **FMV-1 10 KC Multivibrator**
Used with FO-1L Oscillator
- **FO-6 Oscillator and Buffer Assembly**
- **C-12 Alignment Oscillator**
12 Most Used Frequencies Instantly Available,
200 KC to 60 MC.

**ONE DAY
Processing!**

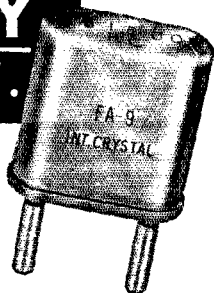

**FA-9
CRYSTALS**

For **AMATEURS—
EXPERIMENTERS** 1500 KC to 50 MC

Wire mounted, plated crystals for use by amateurs and experimenters where tolerances of .01% are permissible and wide range temperatures are not encountered.

CIRCUIT: Designed to operate into a load capacitance of 32 mmf on the fundamental between 1500 KC and 15 MC. Designed to operate at anti-resonance on 3rd overtone modes into grid circuit without additional capacitance load. 5th overtone crystals designed to operate at series resonance. (Write for recommended circuits)

Prices

Pin Diameter .093*
Pin Spacing .486

(FA-9 Fits Same Socket as FT-243)

FREQUENCY RANGE	TOLERANCE	PRICE
1500-1799 KC	.01%	\$ 4.50
1800-1999 KC	.01%	4.00
2000-9999 KC	.01%	3.00
10000-15000 KC	.01%	4.00
Overtone Crystals—3rd Overtone Operation		
15 MC-29.99 MC	.01%	\$ 3.00
30 MC-54 MC	.01%	4.00
Overtone Crystals—5th Overtone Operation		
55 MC-75	.01%	4.50
76 MC-90 MC	.01%	6.50

**PRECISION CRYSTALS
COMMERCIAL USE**

**F-6 SERIES
1500 KC—50 MC**

NOTE: The FA units will not necessarily have the correct correlation for Commercial use.
For commercial applications, the F-6 type unit should be used. Write for details!

One Day Service! Specify exact frequency and crystal will be calibrated to .01% or better of this frequency, when operated in the specified operating circuit.

International Crystal Mfg. Co. Inc.

18 N. LEE

PHONE RE 6-3741

OKLAHOMA CITY, OKLAHOMA

LOW POWER AND CRAMPED FOR SPACE?

ONLY
11' 9"
HIGH

**MOSLEY
TRAPMASTER
MODEL V-3 JUNIOR
VERTICAL
FOR 10-15-20M
will get you out**

Rated to 300W

- Low SWR
- Automatic Band-switching
- Weatherproof Traps
- No Tuning or Adjusting
- 61ST6 Aluminum
- Weight 2 pounds

**COMPLETE—ONLY
\$17.95**

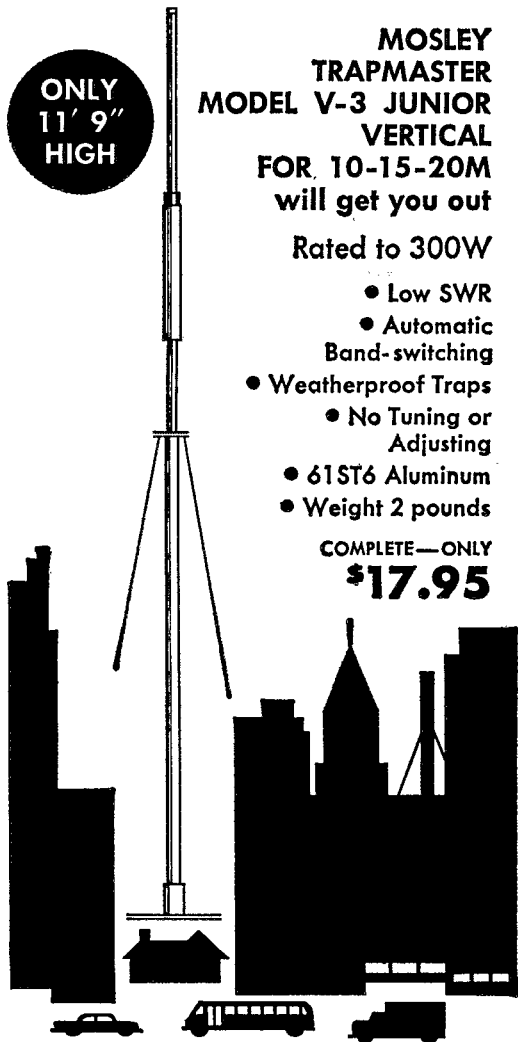

Mosley Electronics, Inc.

**8622 ST. CHARLES ROCK ROAD
ST. LOUIS 14, MISSOURI**

110

W2EFU—SEC; W2KGC. RM: W2PHX. PAMs: W2JG and W2NOC. Section nets: NYS on 3615 kc. at 1900; NYSPTEN on 3925 kc. at 1800; 1PN on 3970 kc. at 1530; ESS on 3590 kc. at 2100; ENY (emerg.) on 29,490 and 145.35 Mc. Fri. at 2100; MHT (Novice) on 3716 kc. Sat. at 1300. We welcome the Port Jervis C/D Club as a new affiliate. Congrats to our scholarship winners—K2HQJ national merit, W2LET to R.P.I., and W2YCZ to C.B.A. in Albany. Among those who recently turned General are K2BIO, W2FOI, W2ROI, W2YDD, W2VDI, W2YDP and W2TGN. New appointments: K2ZAU as OO and K2VTW as OBS. Endorsements: W2PHX as ORS. New officers of the Ulster County Mike and Key Club include W2YOK, pres.; K2BCU, vice-pres.; K2YFA, secy.; W2ZBH, treas.; W2PGE, W2BCU and W2VHZ, directors. Nice to hear W2BTY made DXCC on 20-meter phone. W2VP, with a new DX-100, has moved to Milton, N. Y. W2SZ, as area control station for Area IV C.D. RACES, operated three rigs during the two days of Operation Alert. Although the Albany and Poughkeepsie AREC groups were ready, the N.Y.C.-Albany Outboard races were cancelled. The Schenectady Club held its annual dinner at the Locomotive Club on June 2. Look for a copy of the new Albany Club paper, *B Plus*, a fine job. The club's April meeting featured color TV. All roads will lead to Albany on Oct. 11 for the Hudson Division Convention. The chairman is W2GM, who will send you program and ticket information. K2ZAU reports that the Pelham H.S. Club station, K2OXR, will be in operation this fall. W2AZO worked 45 states and 25 countries since receiving his ticket last October. Traffic: (May) K2UTV 238, K2YFD 159, K2UYK 130, W2PHX 128, W2ATA 127, W2EFD 123, K2LKI 114, K2YJL 111, K2SSB 45, K2VCZ 38, K2YZI 30, K2EJV 26, K2HJX 24, K2HNW 20, K2QJL 19, W2SZ 18, K2OKZ 11. (Apr.) W2GTC 10, K2EJV 8, K2VCZ 8, K2SQV 2.

NEW YORK CITY AND LONG ISLAND—SCM, Harry J. Dannals, W2TUK—SEC: W2ADO. RM: W2OBW. V.H.F. PAM: K2EQH. Section nets: NLI, 3630 kc. nightly at 1930 EDST and Sat. and Sun. at 1915 EDST; NYC-LIPN, 3908 kc. Mon. through Sat. from 1730 to 1830 EDST; NYC-LI AREC, 3908 kc. Sun. at 1730 EDST; V.H.F. Traffic Net, 145.8 Mc. Mon., Wed. and Fri. at 2000 EDST. BPL cards go to W2KEB and K2PHF, K2QBW, K2RKL and K2VIX, the latter four on originations plus deliveries. K2RKL and K2VIX became the first v.h.f. operators to make BPL in this section. Congratulations to Bob and Frank. W2OBW reports that the NYC-LIPN continues to average a 25-station membership per session. W2AEE handled communications for a cup regatta on the Harlem River. New officers of the Oyster Bay HSRC are K2HVV, pres.; K2ZAZ, vice-pres.; KN2PNZ, secy.; and KN2QFJ, treas. K2SFS completed his modified 2EWL s.s.h. exciter. K2BH returned to New England to IQGU after ably assisting the NLI Net during his stay here. It is with deepest regret that W2CLC and ex-W2MIX (late K4RF) are reported as members of Silent Keys. W2LGG is rigging up an S-2OR for portable work. W2AOD reports continued activity on 432 Mc. with new stations joining every month. New officers of the Wantagh RC are W2DUS, pres.; W2KJQ, vice-pres.; and K2CCM, secy. K2AED completed a final for d.s.b. K2KRH is now mobile on 10 meters and runs 150 watts on 2 meters at the home station. New officers of the Garden City HSRC. K2VST, are K2TZS, pres.; K2TZQ, vice-pres.; and Diane Meyer, secy.-treas. K2DIX is signing K4JXJ from Florida. K2MEM received his WANJ certificate. KN2MIG would like to know if anyone is interested in joining him on 40 meters for a ragchewing net. New officers of the Bronx HS of Science ARC are K2PRF, pres.; K2IAD, vice-pres.; W2KQX, secy.; and K2QBW, act. mgr. The Eastern Suffolk RC, K2YVA, is sponsoring a 2-meter club project. The newly-affiliated Woodlawn RC announces the following officers: K2VTL, pres.; K2KQH, secy.; J. Lipsig, treas.; and K2JRE, act. mgr. New members are invited. K2VWF is off to W6-Land. A trap antenna is in use at KN2LGL. KN2SDN and KN2SDM make a new husband-and-wife team. W2RDD has a quad on 14 Mc. W2EW is active on the v.h.f. net with his antennas 55 feet in the air. K2RBS is enjoying 50-Mc. work with the local net. New officers of the NYC are K2EOF, pres.; K2ABA, vice-pres.; W2ATT, secy.; and W2OWL, treas. New officers of the Brooklyn Polytechnic Institute RC. W2BXX, are K2YUX, pres.; K2PUM, vice-pres.; K2YAE, secy.; and K2ZIR, treas. K2AZT installed a discone for 144 Mc. W2JYN has joined the 6-meter mobile gang. New officers of the Fordham RC are K2CON, pres.; K2JBK, vice-pres.; W2KQX, rec. secy.; K2BRK, corr. secy.; K2SOQ, treas. K2MYR, act. mgr.; W2HVC and K2BRK, directors; and J. Kujala, sgt. at arms. K2DCJ became the son-in-law of W2DUS. Hope you are enjoying your summer. See you from the mobile. Traffic: (May) W2KEB 3777, K2PHF 760, K2QBW 441, W2VDT 406, K2RKL 384.

(Continued on page 112)

A Clean Sweep in Every Class!



HAMMARLUND

Established 1910



HQ-170

TRIPLE CONVERSION SSB AMATEUR RECEIVER

All the best features of the finest SSB converters, plus the best features of the finest amateur receivers wrapped up in a single, outstanding receiver. Covers the 6, 10, 15, 20, 40, 80 and 160 meter amateur bands. Separate vernier tuning. Dual and triple conversion 17-tube superheterodyne. Adjustable 60 db notch filter. IF passband tuning. Adjustable AVC.

\$359^{00*}

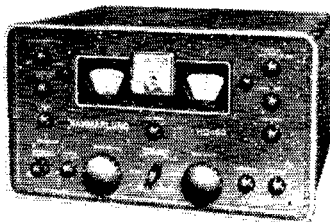

HQ-160

GENERAL COVERAGE

Compares with receivers costing hundreds of dollars more! Dual conversion. 540 KCS to 31 MCS. SSB. Q-multiplier. Electrical bandspread. Separate stabilized BFO. Crystal-controlled 2nd IF. Crystal calibrator. Adjustable 60 db notch filter. 13-tube superheterodyne.

\$379⁰⁰



HQ-110

AMATEUR RECEIVER

Dual conversion, 12-tube superheterodyne. Full coverage of 6, 10, 15, 20, 40, 80 and 160 meter amateur bands. Built-in crystal calibrator. Q-multiplier. Separate linear detector for SSB and CW. Separate stabilized BFO. Crystal-controlled 2nd conversion oscillator. The set that revolutionized the amateur receiver market!

\$249^{00*}



HQ-100

GENERAL COVERAGE

The hottest, fastest-selling general coverage receiver on the market! Continuous tuning from 540 KCS to 30 MCS. Electrical bandspread tuning. Q multiplier for continuously variable selectivity. 10-tube superheterodyne with automatic noise limiter.

\$189^{00*}

*Telechron clock-timer, \$10 extra.

Write For Complete Details...

HAMMARLUND MANUFACTURING COMPANY, INC.

460 West 34th Street, New York 1, N. Y.

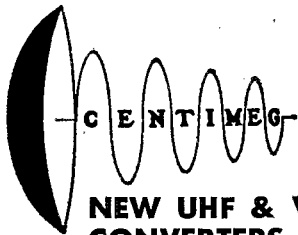

NEW UHF & VHF CONVERTERS

The latest development in converters brilliantly engineered to give you high sensitivity and extra low noise ratio. They're terrific!

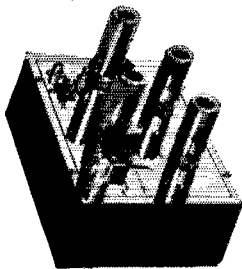

432 MC.

NF. 5 db. Sensitivity: 1/2 uv. Will give 10 db. or better signal-to-noise ratio. Mod. 400 cps. 30%. Image rejection — 40 db. or better. With 14-18 mc. IF output \$69.50

220 MC.

NF. 5 db. Sensitivity: 1/2 uv. 30% mod. 400 cps. Will give 10 db. signal to noise ratio. Image rejection — 50 db. or better. With 14-18 mc. IF output... \$69.50

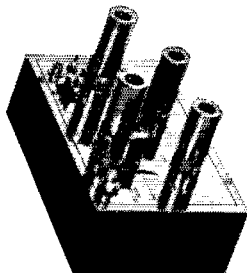

144 MC.

NF. 4 db. Sensitivity: 1/2 uv. 30% mod. 400 cps. Will give 10 db. signal-to-noise ratio. Image rejection — 50 db. or better. With 14-18 mc. IF output..... \$69.50

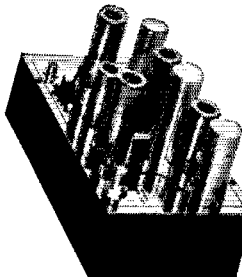

All prices FOB Inglewood, Calif. California Residents add 4%. VISIT "THE ATTIC"—YOUR WEST COAST HAM HAVEN!

universal distributors inc.

4642 W. Century Blvd., Inglewood 2, Calif.
ORchard 4-5740 • ORegon 8-5509

K2VIX 129, W2OME 64, K2SSE 60, W2DUS 53, K2TNAI 49, W2AEE 48, K2HVV 43, K2SFS 33, K2BH 28, K2DQC 23, W2YC 22, W2UGF 19, W2TUK 17, W2JGV 15, K2EQH 14, W2IU 12, W2LKG 12, W2OBW 12, W2PF 12, K2RJO 11, W2JBQ 10, K2MEM 10, W2EW 4. (Apr.) W2AEE 18, K2MYW 14.

NORTHERN NEW JERSEY—SCM, Lloyd H. Manamon, W2VQR—SEC: W2IIN, PAM: W2VDE, V.H.F. PAM: K2KVR. RMs: W2BRC, W2NKD and W2CGG. New ORS appointees are K2VAB and W2YBC. W2GRD has been appointed OO. In looking over the records it is hard to believe that our latest ORS appointment went to K2VAB, age 11. Tex also is quite a traffic man and reports regularly into NJN. K2OBJ has a new GPR-30. K2QYI is installing new full break-in facilities. W2ANG, W2BRC and K2EB have been doing a fine job assisting the staff at Kessler Institute, a research organization in occupational therapy, by interesting the patients in ham radio. Other amateurs assisting in this very worthy project are W2MIU, W2HDD, K2YBC, W2AGJ and W2UKQ. K2AGJ is the spark plug of the group and is a YL, as are K2YBC and W2UKQ. The New Jersey Six-Meter Traffic Net report shows that 39 different stations checked into the net during the month of May. K2VNL was acting net mgr. for May. K2TML has been on the sick list but is fully recovered now. We are very sorry to have to report the death of W2ZL. He will be missed by all of us. George was one of the real old-timers in the section. KN2BRT exhibited an amateur station at the Rumson High School Science Show and won first prize for the exhibit. K2KVF now is General Class. K2VNL is working on a new 6-meter rig. K2GVU and K2USA were visited by WHFDQ recently. K2PIM has a Mosley vertical antenna. W2ZVW worked at W1EIA on Field Day. The Ocean County ARA has issued its second news bulletin under the watchful eyes of W2CFB. The bulletin contains some very good technical articles as well as worthy news items of club members. K2DDM is civil defense officer in Sayreville. The headquarters has some new RACES equipment and activity is picking up. K2MFX is on 10 meters regularly. John has deserted his first love, 6 meters. W2CVW is on 2 meters with a new Gonset III. New calls in the Avenel Radio Club are KN2TZX and KN2TGZ. W2BVE made BPL this month for the first time. K2DHE, Monmouth County RACES officer, held a meeting of County RACES personnel in Freehold during the last week in May. The meeting was well attended. The MARS station at Ft. Monmouth has been completely rebuilt under the guidance of W2GVU. Traffic: W2BVE 417, W2ZVW 160, W2RXL 83, K2VAB 73, W2RZO 59, K2MDS 58, K2QYI 51, W2BRC 47, W2MLW 42, W2KFR 41, W2EWZ 29, K2ZHK 29, W2OXL 25, W2DRV 24, W2CVW 16, W2IUC 15, W2TOD 14, W2GRD 11, K2YBC 9, W2EBG 8, WN2RFS 8, K2BWX 6, W2CFB 5, W2CJX 4, K2VNL 4, K2YWG 4, W2OPB 3, W2GVU 2, K2JTU 2, W2NIX 2.

MIDWEST DIVISION

IOWA—SCM, Russell B. Marquis, W0BDR—NWX directed the Jasper County Emergency Net during a three-day emergency following a windstorm at Rock Creek Lake. Six mobiles and 19 fixed stations participated. The TLCN held its annual party in Marshalltown May 23 with 32 attending. LGG was chosen manager for her 3rd term. The Iowa 75-Meter Phone Net will hold its annual picnic at Clear Lake Aug. 17. K0APS received an ORS appointment and CLS renewed his. K0KAQ and K0CK are now General Class. They and GBB are using the new family Tri-Band beam. KPI has a new 75A-4 and a Pacemaker. The Story County Club handled communications for the Iowa State Veishia Parade. The IDM Net has changed its title to Iowa District Midwest Net because of net expansion. QJF, WLR and K0CLI made another expedition down the Cedar River from Waterloo to Cedar Rapids on rafts with a kw. s.s.b. rig. QVN, with the assistance of AUL, SEG and others, directed Operation Alert for the State. QVN made BPL on originations and deliveries during the operation. The Burlington Club operated its club station, K0LDN, during the

(Continued on page 114)

J O W E R S

ALL THE WAY IT'S E-Z WAY!

See Page 120

ADIRONDACK RADIO SUPPLY

185 W. Main
Amsterdam
New York

For Every Ham Requirement . . .

the complete



. . . More

"Workable

line

Watts" per Dollar!

540w. AM & CW. 700w. max. on DSB or SSB (P.E.P.) Input

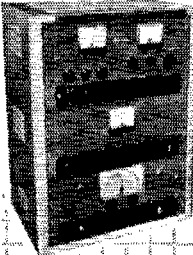

Globe King 500C

Completely Bandswitching 10-160M

W/T: \$795.00

Relay-controlled built-in antenna relay! VFO: commercial type; compression circuit. Separate power supply for modulator. Time sequence keying.

350w CW, 275 AM, 450w SSB (P.E.P.) Input

Globe Champion 300A



W/T: \$495.00
Kit: \$389.00

Bandswitching 10-160. Built-in VFO, Pi-Net output, 145-760 ohms; push for talk; antenna changeover; relay; time sequence keying; compression circuit. Kit with preassembled VFO.

Plate Modulated . . . **Globe Scout 680A**



W/T: \$119.95
Kit: \$99.95
65w CW, 50w AM

Self-contained, bandswitching, 6-80M, with built-in power supply. Hi-Netic 10-80M link-coupled, or 6M. High level modulation. Forward Look.

90w CW for 10-160M **Globe Chief 90A**



W/T: \$74.50
Kit: \$59.95

Forward Look cabinet, bandswitching Xmitter! Built-in power supply, Pi-Net. Provisions for external VFO.

bandswitching 5 & 2M Xmitter **Globe Hi-Bander**

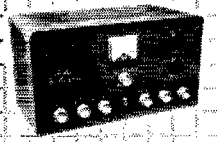

6M: CW, 70w
60w AM
2M:
60w CW, 50w AM

W/T: \$139.95 Kit: \$119.95

Regulated screen supply; 4-stage RF section allowing straight through operation. Good harmonic and TVI suppression. RF Stages metered. Reserve power for accessories! Provisions for mobile use. 52-72 ohm coax output. Forward Look.

100w PEP DSB Input, Suppressed Carrier 40w AM, 50w CW

Sidebender DSB-100



W/T: \$139.95
Kit: \$119.95

Complete transmitter, bandswitching 80-10M. Min. 35db carrier suppression. 3-stage RF section, pi-net; speech clipping. Inverse neg. feedback. Ceramic switches throughout. Narrow bandwidth. Forward Look.

Globe's VOX Model 10

For voice operated control, with extra contacts for auxiliary circuits. Plug in socket at rear of DSB Xmitter. Adaptable for other Xmitters.

W/T: \$24.95

Kit: \$19.95

VFO 755A

160-10 Meters



W/T: \$59.95
Kit: \$49.95

For 10-180M; output on 40 & 160M. Vernier drive with shock absorbing features. Self-contained, well-filtered power supply with voltage regulation.

VFO 6-2



W/T: \$59.95
Kit: \$49.95

Perfect zero heat. Built-in power supply with voltage regulation. Drives 6 & 2M Xmitters. Temp. compensated. Ideal for Hi-Bander. Sideband stability.

Model 666 for 6M, w/t only, \$49.95

Power Attenuator PA-1

Use with Xmitters up to 70w input; for swamping drive to linear amplifiers. Three power reduction positions. Coax input and output. W/T: \$10.95



Antenna Tuner with VSWR Bridge

Globe Matcher Sr.



W/T: \$79.50
Kit: \$69.50

Shielded Cabinet

For Xmitter. with final RF input up to 600w, 80-10M. Fixed link coupling in output. Coax input, 2-wire balanced output. Monitor SWR between Tuner and Xmitter.

Globe Matcher Jr., AT-3

For input to Xmitter. of 100w CW, 75w fone or less. Substantial harmonic attenuation. Unbalanced output. Self contained.

W/T: \$15.95 Kit: \$11.95

Grounded Grid, Class B or C

Globe Linear LA-1

W/T: \$124.50 Kit: \$99.50

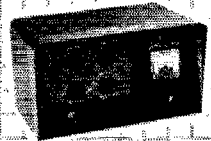

Complete! with well-filtered power supply, 200w input AM (Class B); 300w PEP or 420 PEP input Class-B linear; SSB or DSB; 300w Class C for CW; Pi-Net; 80-10M; 52 ohm Pi-Link coupled on 6M. Extensively TVI-protected.

Versatile Modulator **Plate Modulator UM-1**



Modulates RF inputs up to 100w.

W/T: \$49.95
Kit (less tubes): \$32.50

Class A or AB₁ modulator, driver for higher power modulator; PA Amplifier. Matches output impedances 500-20,000 ohms. Carbon or crystal mike usable. Perforated steel cover \$3.00 extra! Supplies 10-45w audio output ideal for use with Chief.

Controlled Carrier Type **Screen Modulator Kit**



Ideal for use with Globe Chief. Permitted radio-telephone operation at small cost. Self-contained. Concise instructions, printed circuits, etc. supplied.

Kit: \$11.95

6 Meter Converter

Compact, stable, crystal converter for receiver's tuning output frequencies 10-14mc. Cascade RE stage, bands pass coupling, sideband input and output, high sensitivity. Crystal for 10-14mc output supplied.

W/T: \$27.50 Kit: \$19.95

Code Oscillator Kit

Transistor and printed circuit assembly, Code Practice Oscillator! Screw terminal input for key; standard phone tip output jack. Completed with batteries. Kit: \$4.95

Peak Limiting Pre-Amplifier **Speech Booster FCL-1**

W/T: \$24.95 Kit: \$15.95



Perfect for Scout, Hi-Bander & other Xmitters. Clips and filters speech frequencies as preset amplitude. Response: 300-3500 cycles. Increases modulation intensity.



See These At Your Favorite Distributor

FORMERLY **WRL Electronics**

AMATEUR RADIO EQUIPMENT

We're dealing on HAMMARLUND

Stan Burghardt
WØBJV



Here's your opportunity to make a "top deal" on one of these fine Hammarlund receivers! We're loaded with a complete stock on all items, and trading high on every deal. Check the features on these Hammarlund units — then check Burghardt's for highest trade-ins, low down payments, and easy terms that will fit your budget!

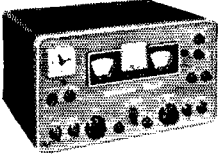

HQ-170 — Hammarlund's great new communications receiver that combines the most desirable features of the best amateur receivers with the finest of SSB/CW and AM/MCW converters. Just a few of its many outstanding features: 17-tube superheterodyne, dual and triple conversion, 6-10-15-20-40-80-160 meter bands, separate vernier tuning, 60 db adjustable notch filter, 100 KCS crystal calibrator, selectable upper, lower or both sidebands, fast attack AVC — plus much more.....\$359.00 NET

er with 14 tuned circuits in the IF — crystal controlled 2nd conversion. Electrical bandspreader — Q-Multiplier — adjustable notch filter up to 60 db attenuation. No finer value in communication receivers.....\$379.00 NET

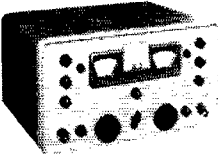

HQ-160 — Tops in performance, tuning and dependability! Covers continuously the frequency range of 540 KCS to 31 MCS. 13-tube dual conversion superheterodyne receiver with 14 tuned circuits in the IF — crystal controlled 2nd conversion. Electrical bandspreader — Q-Multiplier — adjustable notch filter up to 60 db attenuation. No finer value in communication receivers.....\$379.00 NET

HQ-110 — Every feature you want — at the right price. Full coverage 6-10-15-20-40-80-160 meters. Dual conversion 12-tube superheterodyne. Separate stabilized BFO — separate linear detector for SSB and CW. Q-Multiplier. Crystal calibrator. Auto-response.....\$249.00 NET

HQ-100 — An outstanding general coverage receiver at a popular price. 540 KCS to 30 MCS — electrical band spread — Q-Multiplier — auto-response. 10-tube superheterodyne circuit. Voltage-regulated and temperature-compensated for high stability.....\$189.00 NET

MATCHING ACCESSORIES

TELECHRON CLOCK-TIMER — Combination clock and automatic timer. Meet pre-arranged schedules with a warmed-up receiver. Space for clock-timer provided in front panel of receivers. \$10.00 NET

MATCHING SPEAKER — Extended range. 8-watt capacity. Housed in attractive metal cabinet, 9 5/8" high, 9 5/8" wide, 7" deep.....\$14.95 NET

Phone 5749

Write today for your free copy of Burghardt's newest catalog!

Burghardt
RADIO SUPPLY

P.O. Box 746,
Watertown, So. Dakota

Alert. KØBLJ has a new Courier transmitter. Traffic: (May) WØSCA 1863, PZO 1204, LGG 942, LCX 934, BDR 919, KØCLS 602, WØBPJ 585, CZ 460, QVN 170, WVF 145, QVA 112, LJV 4, KØAPS 57, BLJ 51, WØNTB 40, IUY 34, KØAPL 33, WAD 33, WØSLC 32, NCS 30, NYX 29, VQX 25, KØGXC 24, WØMEL 16, UTD 12, KØGOQ 10, INR 10, BPE 9, EXN 9, WØYI 9, KØHBD 8, WØREM 7, PTL 6, CGL 5, FMZ 5, UHO 5, KØIGU 4, BRE 3, WØFDM 3, COD 2, KØHFF 2, WØHNE 2. (Apr.) WØPZO 1565, KØAAH 2.

KANSAS—SCM, Earl N. Johnston. WØICV—SEC: PAH. PAM: LEW. V.H.F. PAM: ZJB. RM: QGG. There was a large turnout for the Christy Memorial Picnic held at Lake Shawnee, Topeka. This will be an annual event sponsored by the KVRC at the same place and same time each year. The JARS is sponsoring a 24-hour watch on 29.6 Mc. for emergencies. A good many RACES groups participated in the 1958 Operation Alert, which was the most successful ever held. Some organizations had equipment failures which bring out the need for practice alerts more often than once a year. All who participated are to be congratulated. I know the c.d. officials deeply appreciate your participation. HAJ was honored with a certificate for his splendid work with the CKRC. Barney has moved to Kansas City. The Mike and Key ARC of Parsons has applied for a club station license, with KØIRI as trustee. KØJVQ has a new Knight VFO. KØKMZ is a new station in Parsons. KØGOP has moved to Parsons. VGE (LOW's daughter) had a nice write-up in the *Omaha World Herald* May 11 for her work in the 1957 blizzard. Yours truly will be mobilizing in Western Canada when you read this, operating 10, 15 and 20 meters, c.w.-a.m. and s.s.b. with an AF67, a PMR-6 and a KWM-1. Traffic: (May) WØOHJ 932, BLI 733, TOL 553, FNS 336, UOL 112, IFR 103. SAF 91, KØBXF 83, IZMI 70, HVG 59, IRL 43, WØSYZ 39, ORB 37, TTG 30, ABJ 27, QQQ 24, KØAWO 19, GZP 10, WØHL 6, LEW 5. (Apr.) WØLJZ 8.

MISSOURI—SCM, James W. Hoover. WØGEP—Net reports: MEN—13 sessions; QNI 426, QTC 173; NCS, DWX, OMM, OHC and KØIZM, MON—34 sessions; QNI 282, QTC 237; NCS, OUD, GBJ and RTW. EBE is seriously ill and hospitalized in Springfield. KØHY has a new mobile installation with an AF-67 and a Super 6. EXN is vacationing and working regular schedules from his mobile with NUE, who can be heard quite readily with his new KWS-1. VVU will be in California for the next few months and will keep in touch with the Missouri gang via 20-meter c.w. After 35 years of other amateur radio activities, BUL set up to work DX and has been enjoying the new experience. Congratulations to the Heart of America Radio Club for the fine *Kansas City Area Amateur Call Book* which has just been published and distributed. Thirty-three stations participated in an unofficial storm warning net Apr. 23 on 3885 kc. KØJAD gathered observations for the Weather Bureau in Columbia. Bad weather stimulated another session on May 31 with 13 stations participating. Some traffic was handled for the Columbia Ground Observer Corps when their commercial power was lost. The St. Louis 6-meter gang has participated in 5 tornado alerts since Apr. 5. Mobiles are dispatched to points surrounding the St. Louis Area and observations are reported to the Ground Observer Corps Filter Center. *The VHF QSO*, publication of the Midwest V.H.F. Association, has detailed reports in the May and June issues. Traffic: (May) WØCPI 1314, GAR 672, KØLNQ 375, WØGBJ 212, VPQ 155, OUD 112, KIK 94, BVL 70, RTW 61, KØHHG 57, LWX 50, WØOVV 33, KNØONK 27, WØOMM 21, YKC 14, KNØLZG 13, WØVYJ 12, VJD 10, BUL 8, CRK 7, HUI 5, KØIHY 5, DEQ 4, WØEBE 3. (Apr.) WØKIK 79, OMM 34, KNØOQF 22, WØVPQ 22, KA 12, HUI 11, BUL 7, KNØLRG 6, WØVFP 6.

NEBRASKA—SCM, Charles E. McNeel, WØEXP—The Nebraska 75-Meter Emergency Phone Net meets on 3983 kc. daily at 1230 CST and MAO reports QNI 476, QTC 57, with 87 stations on roll call. The Western Nebraska Phone Net, reported by NIK as NCS, meets daily on 3850 kc. at 0730 MST with QNI 625 and QTC 88. The Morning 75-Meter Phone Net reports QNI 589 and QTC 137. New members are MAO, KØGWK, YCY, KØLFF, BOQ and PUT. KPA, NME, YVY, KØJFD, KØEYV, SSR, OVW, GEQ and EXP were in attendance at a farewell dinner in Great Bend, Kans., for WWR, who is moving to Texas and will be on 75 meters soon from his new location, Sutherland is now 100 per cent s.s.b. with all three stations active. About forty amateurs attended the picnic held June 1 at Chadron State Park and all reported a fine time. JJJ, our SEC, attended a club meeting in No. Platte and gave an interesting talk on c.d. and RACES. Traffic: WØMAO 160, DDT 142, KØDGW 119, BFD 96, WØOKO 58, ZIF 56, NIK 51, KØLJV 47, BRQ 30, WØPUT 29, KØKUA 28, HKI 22, WØQKR 17, BOQ 16, KØECA 16, WØZOU 16, LXS 13, KØBRS 12, KJP

(Continued on page 116)

HEAVY DUTY MOBILE BASE MOUNTS

NEW!

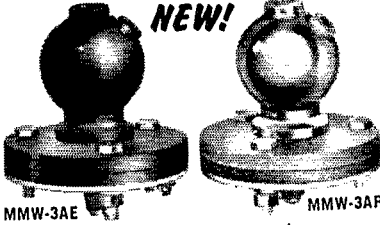

MMW-3AE MMW-3APS

Engineered for Greater Performance
The last word in modern design for strength and service in universal swivel bases. Easy installation, mounts watertight on any surface. With template. Positive locking, any position. Ebony Finish \$6.95 Polished Finish \$7.95
Ebony Finish, S. S. Hardware \$8.95
Polished Finish, S. S. Hardware..... \$9.25

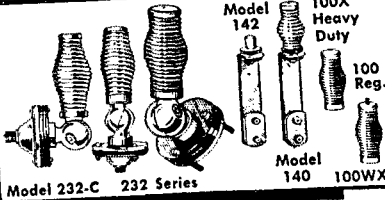

Model 232-C 232 Series Model 142 100X Heavy Duty Model 140 100WX

NEW MULTI-BAND ANTENNA COILS

New Plug-In type coils for the Ham, designed to operate with a standard 3' base section and standard 5' whip

THE ARISTOCRAT

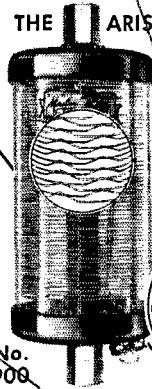

No. 900

10-15-20-40-75 METERS

THE VICTORY



No. 999
10-15-20 METERS

- Rigidly tested & engineered—found to have "Q" of 525
- Handles 500 Watts input
- Operates into a 52-ohm cable
- Positive contact—noise-free, trouble-free operation
- Weather-sealed
- Factory pre-tuned—no adjustments needed

YOUR CHOICE
Amateur Net
\$14.95

Now! 2 New Coils... just plug in and presto! your coil is ready for operation on the desired band! No switches, no sliding contacts, no loose connections. Built and pre-factory tested in Master Mobile's own laboratories.

Leaders in the Design and Manufacturing of Mobile Communication Equipment & Antennas

NEW! from Master Mobile

NEW HEAVY DUTY MOBILE SPRINGS

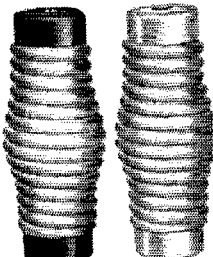

MMW-7 MMW-7SS

PROTECTS YOUR MOBILE ANTENNA

Heavy duty flexible mounting spring mounts on the base and holds the antenna. Special flexible "give" spring prevents sharp impacts and breakage. Lockwashers included.

MMW-7 Cad. plated, black painted ends \$4.50
MMW-7HC Heavy Cad. plated—Extra Protection \$5.50
MMW-7SS Deluxe Stain. Steel..... \$8.95

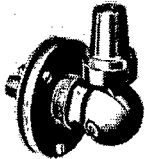

No. 321 BODY MOUNT

Swivel base body mount, less spring. Specially constructed diagonal ball joint for maximum strength. Amateur Net **\$7.95**

NEW! SLIM-JIM ALL-BAND BASE LOADING ANTENNA COIL

FOR 10 11 12 15 20 40 80 METERS

No. B-1080

Positive action, just slide whip in or out to loading point and lock nut into position. **\$17.95**



96" WHIP

SIZE 1 3/4" x 19"

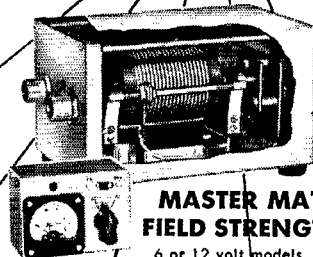

MASTER MATCHER & FIELD STRENGTH METER
6 or 12 volt models **\$24.95**

Automatically tunes the entire band from the drivers seat!

BUMPER MOUNTS WITH NEW X-HEAVY DUTY CHAINS

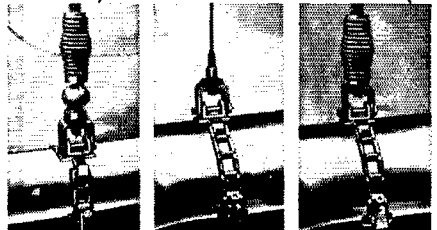

No.444 \$17.80 No.445 \$7.95 No.446 \$13.45

EMERGENCY • COMMERCIAL • AMATEURS



Master Mobile Mounts, Inc.

1306 BOND STREET • LOS ANGELES 15, CALIF.

AT LEADING RADIO JOBBERS EVERYWHERE

**BEFORE YOU
BUY OR TRADE**

See

Ward

W2FEU



COLLINS 75A-4 This SSB Receiver offers all the proven Collins features — excellent image rejection through double conversion, precise dial calibration and high stability of Collins VFO and crystal controlled first injection oscillator, and the ideal selectivity of Collins Mechanical Filter in the IF strip. Net Price\$695.00

COLLINS KWS-1
Companion transmitter to the 75A-4. Unmatched performance in minimum space for a kilowatt. Extremely accurate 70E VFO, Pi-L output network and Mechanical Filter. Net price\$2,095.00.

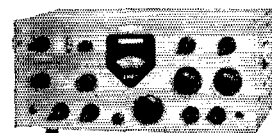
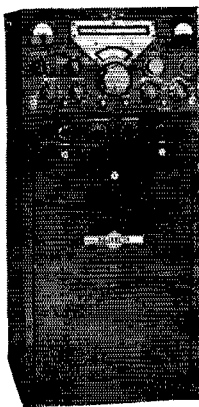

COLLINS KWM-1
The first mobile SSB transmitter in the Amateur field — 175 watts PEP, 14-30 mc. Fixed station use without modification. Net price\$820.00

**Time Payments Arranged at Low Cost
Through Our Local Bank on Purchases
of \$100.00 Net and Over**

**Write, Wire or Call
Ward, W2FEU
At**

ADIRONDACK RADIO SUPPLY

185-191 W. Main St., Amsterdam, N. Y.
Tel. Victor 2-8350
Ward J. Hinkle, Owner

12, W6VEA 12, VZJ 12, K8LEQ 10, W8LJO 9, KDW 8, URC 6, AFG 4, OCU 4, WZR 3.

NEW ENGLAND DIVISION

CONNECTICUT—SCM, Victor L. Crawford, WITYQ —SEC: EOR, RM: KYQ, PAMs: YBH and FHP. Traffic Nets: CPN, Mon.-Sat. 1800, Sun. 1000 on 3880 kc.; CN, Mon.-Sat. 1845 and 2130 on 3640 kc.; CVN, Mon., Wed. and Fri. 2030 on 145.98 Mc.; CTN, Sun. 0900 on 3640 kc. AW and YBH made BPL, RM KYQ reports that CN handled 421 messages, including 133 on the second session, during 27 sessions with an average of 12 stations per session. High QNI goes to AW, GVK and KYQ. KIAJJ is trying for a 40-meter WAS. KIBEB made WAC on phone. The CQRC held four meetings on 2 meters with an average attendance of 10. KNIBMM dropped the "N." FYF was off the air three weeks with transmitter trouble. DHP has 32 states toward WAS. MWB has a new amplifier using 810s, KNIDMA, KNICYU and KNIEJB passed the General Class exam. V.H.F. PAM FHP advises that CVN handled 27 messages during 13 sessions with an average attendance of 9. High QNI was FHP 11, FPF 10, KNIDZI and KIBME 9. FRN has 45 states confirmed on 6 meters. He needs New Hampshire, Vermont and Maine for WAS. RLD attended IBM school at Endicott, N. Y. EJH is busy gardening. PAM YBH reports that CPN handled 281 messages during 31 sessions with an average daily attendance of 28. QNI honors go to PAV, DHP, TVU and YBH 30, KIBEB 28, KIBEN 27, ZQO 26, VOH 25. YOL has a new 50-ft. tower. KUO is busy with a new jr. operator. The Newington Lunch Club celebrated its first anniversary and changed its name to the Propagation and Gastro-nomical Society of Newington. It meets at the Nutmegger House the 1st and 3rd Wed. of the month at noon. New stations on CPN are HAT and KNM. New appointments: GNS as EC for Bristol, MWB as ORS, KIDLML as OPS, KIBEB as OO. Appointments renewed: PFG and NQO as ECs; YBH as PAM; EBW, ECH and FHP as OPSs; ACR, ECH and TYQ as ORSs. Reports received: OES from KIBML, KICKZ, FVV, KLK, MWB, VWP and ZTT; OO from KIAJJ, MWB, RAN and VW. Traffic: (May) WIKYQ 453, YBH 391, EFW 388, AW 365, KIAQB 319, BEN 284, WITYQ 177, GVK 134, KIBEB 106, WIULY 86, DHP 85, BDI 80, MWB 64, FYF 61, KLK 58, FHP 50, KIDLML 49, WILV 49, QJMI 41, VY 23, LXV 18, KAM 16, RFJ 16, MDB 14, KIAQE 12, WIEJH 11, ECH 10, AVS 7, OBR 5, KNIDZI 4, KIBML 2. (Apr.) W1EXO 3.

MAINE—SCM, John Fenron, WILKP—SEC: QJA, PAM: VYA, V.H.F. PAM: JAIN, RM: EFR, TKE and AI sent in OPS certificates for endorsement. JAS flew to Detroit May 23 for a regional meeting of the CAP and gave a talk on communications. GHS has a 1st-class commercial phone ticket. TJO is back from Oklahoma. UOT is tops for Maine in the SS. Waterville hams have organized a new radio club which meets every Tue, at the YMCA. Officers are KIBBJ, pres.; KIDAP, vice-pres.; KIDTK, secy.-treas.; and AKR, tech. advisor. KIHHC, a new ham in Princeton, is active on 75-meter phone. EOP is working many VEs on 2 meters. TJB is now married and living at Green Lake. BPM has 46 states confirmed for 10-meter WAS. KNIHKE is a new Novice in Belfast. FVE is operating portable in Brattleboro, Vt. GPY is now on 75-meter phone from Biddeford. RJE is working mobile in Orono, TEPG is back from Idaho, working for the Dept. of State Inland Fisheries and Game. KIAET, BXU, and HGN joined the AREC. Ex-AQW is now KIAHS. FVE was issued a PTN certificate. SGH and PTN will continue through the summer months. KIAWQ is operating mobile from Biddeford. Kittery hams meet each Tue. at the QTH of WHI, DNA, EBJ, EXD, EIO, WAS, JVU, UOT, GHV, GHS, PLN, KIADY and yours truly enjoyed the fine hamfest at Concord. BBS and KIADY attended the YL luncheon in Boston. KNIDIM and GVD are new members of the Bangor AREC. Traffic: (May) WILKP 238, CEV 86, GPY 48, HYD 47, EFR 42, KIBXI/1 39, WITGW 37, UDD 37, KIAKO 36, WIOQA 22, KIDVN 20, WIBX 18, FNU 17, JMN 14, KIBYE 13, BAY 11, WILWO 11, OTQ 10, IZK 9, RJE 7, LHA 5, TKE 4, FVE 3, UOT 3, KIANM 2. (Apr.) W1FVE 2.

(Continued on page 118)

J O W E R S

ALL THE WAY IT'S E-Z WAY!

See Page 120

WISCONSIN DISTRIBUTORS—FOND DU LAC

MILWAUKEE

AMATEUR ELECTRONIC SUPPLY

PENTA BEAM PENTODES

for higher power and better linearity at lower plate voltages

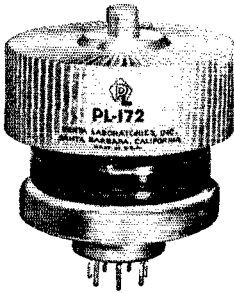

PL-172



PL-177A



PL-6549



PL-175

Here are four tubes for linear amplifier service—higher power output at lower plate voltages with minimum distortion. The PL-6549 and its zero-suppressor-voltage version, the PL-177A, are for 50- to 200-watt peak output service. The PL-172, a 1000-watt type, features the exclusive Penta vane-type suppressor grid which makes possible extra efficiency and linearity. The new PL-175, a 400-watt tube, also has the vane-type suppressor grid, and gives 25 to 30 per cent more output in Class AB₁ linear amplifiers than tetrodes with similar ratings.



RATINGS

Type	FILAMENT		Max. Plate Dissipation (Watts)	USEFUL OUTPUT* CLASS AB ₁ LINEAR AMPLIFIER PLATE VOLTAGE IN VOLTS				
	Voltage (Volts)	Current (Amps)		1000	1500	2000	2500	3000
PL-6549	6.0	3.3	75	96W	140W	210W	—	—
PL-177A	6.0	3.3	75	96W	140W	210W	—	—
PL-175	5.0	14.5	400	—	—	470W	605W	710W
PL-172	6.0	7.8	1000	—	—	1020W	1280W	1540W

*Actual power output delivered to load from typical amplifier.

ASK FOR A FREE COPY of "Transmitting Tubes for Linear Amplifier Service." This nine-page bulletin discusses linear amplifier tube requirements in detail. Graphs, characteristic curves, oscillograph linearity patterns and data show why Penta's exclusive beam pentode designs outperform four-element tubes.



PENTA Laboratories 312 North Nopal Street, Santa Barbara, Calif.

**Order Your New
SIDEBANDER
DSB-100 Today!**

Stan Burghardt
WØBJV



**A Complete Transmitter
for 3 MODE AM - CW
OPERATION from**

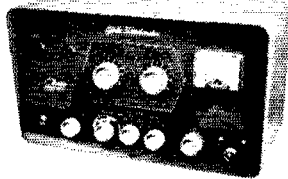

**Sidebander
DSB-100**
Kit: \$11995 W/T: \$13995

Bandswitching 10-80M; 100W PEP DSB Input
Suppressed Carrier; 40w AM Fone; 50w CW

Barefoot or **PUKEY**-back, the Sidebander can be used simply with your present AM equipment, using standard crystals and regular VFO. Even more power when used with the King or Champ. Exclusive automatic balancing and floating grid circuit holds carrier suppression to 35db or better. Continuous band coverage 3-9mc and 12-30mc. Three stage 1st section allows straight through operation for max. efficiency. Internal tone generator facilitates tuning. Pi-Net 52-300 ohms. Speech clipping and filtering assures powerful communication punch and narrow band width. Provisions for antenna relay control. New Forward Look.

VOX

Designed for the DSB-100, the Globe VOX plugs into socket at rear of Xmtr. Extra contacts for aux. circuits. W/T: \$24.95 Kit: \$19.95

QT-10

Plugs directly into VOX unit. Wired & tested only. \$9.95

VFO 755A

Kit: \$49.95 W/T: \$59.95

Covers 10-160M; output on 40 & 160M. Improved vernier dial drive. 13:1 tuning ratio. Temperature compensated. Stability fine for sideband. Highest output any VFO on market.

GROUNDING-GRID

Linear Amplifier LA-1

Complete with well-filtered power supply, operates Class B or C, with grounded-grid Final. 200 watts input operated AM Class B. 300 watts DC input, or 420 PEP input, Class B linear SSB or DSB. Requires 15 watts RF driving power. 300 watts class C for CW (18 watts driving power). Pi Net output circuit covers 80-10M bands, matches loads 30-150 ohms. 52 ohm Pi Link coupled output on 6M. Extensively bypassed, filtered and shielded for TVI.



Wired & Tested:
\$124.50
Kit: \$99.50

Globe Matcher Sr

ANTENNA TUNER AT-4

Built-in VSWR Bridge constantly in circuit. For any Xmtr. with final RF input up to 600 watts, 80-10M. Fixed link coupling in output circuit. Coax input, 2-wire balanced output. Special calibrated meter for monitoring actual SWR. RF shielding cabinet.



Wired & Tested: \$79.50
Kit: \$69.50

Send for Catalog of the Complete Globe Electronics Line and Your Free Copy of Burghardt's Newest Catalog.



Phone 5749

P. O. Box 746,

Watertown, So. Dakota

EASTERN MASSACHUSETTS—SCM, Frank L. Baker, jr., W1ALP—New appointments: CWR Newburyport, YWB Norfolk, SCR and QJB Sector 1-D as ECs; KIAGS and BCR as OBSS. Appointments endorsed: WNP Concord, HLQ Stow, DOF Revere, MB Scituate, QGJ Woburn, VYS Weston, KEK Lynnfield as ECs; KBS as OBS, DOF and QGJ as OPSS, AYG as OO, KICFF is on 6 meters. KNIEKQ, Norwood, is on 40 meters. On 2 meters: KICOF, ABR, GVF, KNIEKM and WINX. AJU/6 is in San Diego, Calif. ALP has another grandson. Quite a gang from this section attended the Concord Convention. MIX was second in the New Hampshire C.W. Party. KIBUF is in the hospital. EPE is feeling much better. KIAGS will have a Tri-Band beam. NJL has a new T-R switch and is working DX. ETH is on 15 meters some. K1DGG is Alt. N. C. for the 6-Meter Crossband Net. KICMS has a Ranger and a 6N2. DIY is making repairs to the rig. KIBEZ, KIBVD and ATK are now General Class. QPU is Asst. EC to DBY. Most every c.d. group was active during Operation Alert 1958. The Framingham Club's new officers are IZA, pres.; FRR, vice-pres.; K1BTF, secy.; ZWJ, treas.; QVK, act. mgr. MEG has a 500-watt job. KIDEY has a DX-100. New officers of the Bedford Radio Club are AQE, pres.; QJB, vice-pres.; WNP, secy.; EIQ, treas. EMG went fishing. MX has a three-band 20-10-meter beam. The Federation of Eastern Mass. Clubs held a meeting. KTJ has a store in Reading now. ALP spoke at the Sharon Radio Club. The club's officers are IAE, pres.; LOS, vice-pres.; DSZ, secy.; KICNX, treas. GHZ is active on 40 meters. K1AZF visited him and worked WIAZF. DOF reports a club in Revere. KIBCR has a Viking I and a Super Skyrider on all bands. KNIGTN is new in Beverly. The Chelmsford ARA is now affiliated with ARRL. QRA held a meeting and AAT showed some early radio gear. MX's *Sparks & Arcs* is quite a newsy paper. New Novices in Middleboro: KNIGUX, GNS, GXV, HCC and GSW, Lakeville. The T-9 Club met at WNK's and elected IBF, pres.; RCA, vice-pres.; JPS, secy.; ISX, treas. KICXG is in Methuen. The Barnstable Radio Club has a nice paper, *Barnstable Oscillator*. BGW has been endorsed as OO. RCJ and ZEN are going to the Augusta Hamfest. COL and group were on during the Alert. Area 1 Radio Comm. met at Sector 1-E with CWZ, SPL, QVK, JZQ, VYI, DWY, ALP and QQL present. KNU is Radio Officer for Lawrence. DLY is Deputy R.O. for Winthrop. The ladies took over for their last c.d. drill down there. 6-meter news came from THO. KICCI is in Brockton. AHB has a new QTH. FWQ is converting mobile to 12 volts. Active mobiles at 7 A.M.: LLY, ENS, ION, M1K, KCO, K1ALA and DZZ. Newly-active are EUT, GEK, JGR, KYE, LHM, LUT, NQU, ZBJ, Kis AJS, AML, ANL, ATO, BEX, BIH, BWU, CDD, CTK, DDY, DIT, DPK, DKT, DNL, DWA, DZU, EGP EGS and GGL. HZP was busy with many things but ham radio. EAE and EMG made BPL Traffic: (May) WIEMG 579, AWA 317, EAE 279, FJJ 177, QPU 124, MIX 111, K1EUF 110, W1GHZ 104, UKO 85, AUG 72, LMZ 60, EPE 53, KIAGS 40, W1HGN 38, KIDGI 33, WIZEN 28, NJL 20, IBE 19, UE 15, LMO 14, ATX 12, BYL 8, KIDGG 8, W1WU 6, AHP 4, SGO 4, KICMS 3, WIDTH 2, ALP 1. (Apr.) W1QPU 136, NJL 124, WAW 20, ION 12, ETH 9, NTK 9, K1EAV 6, W1JBD 4. (Mar.) W1ETH 1.

WESTERN MASSACHUSETTS—SCM, Osborne R. McKeraghan, W1HRW—RM: BVR, PAM: MNG. The West Mass. C.W. Net meets on 3560 kc. Mon. through Sat. at 1900 EST. The Mass. Phone Net meets on 3870 kc. at 1800 EST. BVR has been reappointed RM and ORS. EKO is now an OO Class 1. OSK is a new ORS. The Hampden County Assn. held its annual banquet and business meeting June 7 in Wilbraham. New officers are WFL, pres.; QWJ, vice-pres.; STR, secy., and LRE, treas. The Annual Gabfest of the Central Mass. Assn. was held May 25 in Worcester. New calls heard in the area are KNIHFI in Lee, K1DRE in Leverett and K1HNG in Pelham. EKO has made DXCC. EKO and YQA report that the new radio club formed in the Brookfields is named the Podunk Radio Club. CLO is the president and the name comes from an old-time name of a section of the Brookfields. A radio club has been formed at Commerce High School in Worcester. SPF, EC for the Worcester Area, again is heading up the Emergency Storm Warning Net, which is proposed to make severe storm information available, through amateur radio, to the Worcester Weather Bureau, which has jurisdiction over Worcester, Hampshire and Franklin Counties. Frequencies set up for this net are 51 Mc., 29.2 Mc. and 3900 kc. BVR enjoys operating a new DX-40 strictly for phone he says. UEQ has become a regular in the BPL column. AGM reports his 15-meter vertical is back again and he is going after some of that DX. OSK is working on a new antenna to help put a stronger signal on WAIN Traffic: (May) W1UEQ 942, ZPB 115, BVR 89, TAY 85, OSK 51, DGL 22, HRV 8, AGM 6, KGJ 5, EKO 1. (Apr.) W1TAY 63.

(Continued on page 120)

Transistor Power Supplies* and Components

* Complete Units

D SERIES (Standard)

Continuous operation at 30 watts. Selective taps at 200, 250 and 300 volts; intermediate voltage at 1/2 selective taps. Both voltages can be drawn simultaneously if total power does not exceed continuous ratings. Positive or negative ground operation. Input and output filtering included except for intermediate tap.

Size: 4 3/4" x 3 1/4" x 1 1/8" Wt.: 10 oz. 6- or 12-V Input: **\$39.95** 24-V Input: **\$61.95**

DA SERIES

Continuous operation at 45 watts. 450 volts and 225 volts simultaneous if total power does not exceed continuous ratings. Intermittent duty to 90 watts, 450 volts at 150 MA; 225 volts at 100 MA (5 min. on, 20 min. off). Positive or negative ground operation. Input (primary voltage) filtering; partial high voltage filtering provided.

Size: 4 3/4" x 3 1/4" x 1 1/8" Wt.: 14 oz. 12-V Input: **\$57.50** 24-V Input: **\$79.50**

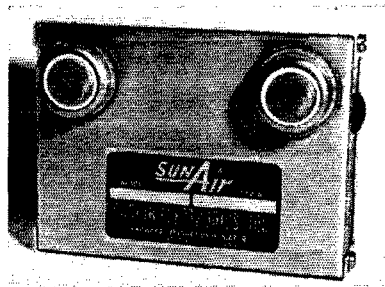

Toroid Transformers for Transistor Power Supply Application

H SERIES

H-6-450-1 Input: 6-VDC. Output: 450-VAC center tapped... 450 and 225 VDC from bridge rectifier... 45 watts.

H-14-450-12 Input: 12/14-VDC. Output: 450-VAC center tapped... 450 and 225-VDC from bridge rectifier... 55 watts.

H-28-450-15 Input: 24/28-VDC. Output: 450-VAC center tapped... 450 and 225-VDC from bridge rectifier... 65 watts.

H-6-100-125-150-D Input: 6-VDC. Output: Voltage doubler configuration. Secondary tapped for either 100, 125 or 150-VAC. DC Output: 200, 250 or 300-V at 100 MA.

H-12-100-125-150-D Input: 12/14-VDC. Output: Voltage doubler configuration. Secondary tapped for either 100, 125 or 150-VAC. DC Output: 200, 250 or 300-V at 125 MA.

H-24-100-125-150-D Input: 24/28-VDC. Output: Voltage doubler configuration. Secondary tapped for either 100, 125 or 150-VAC. DC Output: 200, 250 or 300-V at 150 MA.

Without Encapsulation (2 ozs.). 1-10 units: **\$16.00 ea.**

With Encapsulation (3 ozs.). 1-10 units: **\$18.50 ea.**

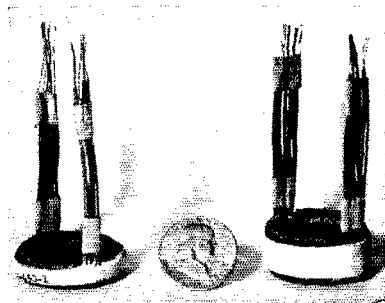

HD SERIES - 2000 CPS

HD-14-225-300-2-D Input: 12/14-VDC. Output: Voltage doubler configuration. Secondary tapped for either 225 or 300-VAC. DC Output: 450 or 600-V at 200 MA.

HD-28-225-300-2-D Input: 24/28-VDC. Output: Voltage doubler configuration. Secondary tapped for either 225 or 300-VAC. DC Output: 450 or 600-V at 200 MA.

Without Encapsulation (3 1/2 ozs.). 1-10 units: **\$18.50 ea.**

With Encapsulation (4 1/2 ozs.). 1-10 units: **\$21.50 ea.**

HDS SERIES - 2000 CPS

HDS-14-225-300-3-D Input: 12/14-VDC. Output: Voltage doubler configuration. Secondary tapped for either 225 or 300-VAC. DC Output: 450 or 600-V at 300 MA.

HDS-28-225-300-3-D Input: 24/28-VDC. Output: Voltage doubler configuration. Secondary tapped for either 225 or 300-VAC. DC Output: 450 or 600-V at 300 MA.

Without Encapsulation (3 1/2 ozs.). 1-10 units: **\$21.50 ea.**

With Encapsulation (4 1/2 ozs.). 1-10 units: **\$24.50 ea.**

400 CYCLE SERIES

14-115-1.5-400 Input: 12/14-VDC. Output: 115-V at 1.5 amp.

24-115-1.5-400 Input: 24/28-VDC. Output: 115-V at 1.5 amp.
Dim: 3" dia. x 1" thick. Without Encapsulation (12 ozs.).
With Encapsulation (16 ozs.). Per Unit: **\$76.00.**

Matched Pair HD Transformers:

12/14-V operation—**\$11.00 per pr.**

24/28-V operation—**\$21.00 per pr.**

OEM Prices on Request

All fully performance tested, 100% guaranteed. Manufactured by makers of world-famous SUNAIR H.F. Aviation Transceivers.

SUNAIR ELECTRONICS, INC.

Broward County International Airport
Fort Lauderdale, Florida, U.S.A.

SUNAIR
ELECTRONICS, INC.

WE'VE GOT "QSHT"*

World famous "Wonder Post" exclusively E-Z Way

- Crank up or down - 1 minute!
- Tilts over for easy access to beam!
- Rotor mounts inside tower with thrust bearing above.
- Brute steel in attractive design!
- 30 types from which to choose!
- No material lost in moving ... no guys, no concrete!

TOWERS ARE OUR BUSINESS
... from conception
through erection!

*"QUICK, STURDY,
HAM TOWERS"

E-Z TERMS
up to 12 months

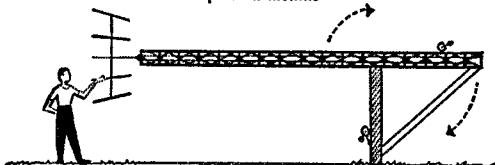

SEND FOR FREE CATALOGUE

Dept. HQ, E-Z Way Towers
P. O. Box 5491, Tampa, Florida
Send me your FREE catalogue on the following towers:

- Broadcast Television
 Ham Radio Two-Way Communication

I am interested in a tower ft. high.
I will use a antenna.
(State type and model)

Type of Rotor
Name
Address
City State

E-Z WAY TOWERS, INC.
P. O. BOX 5491 - TAMPA, FLA.

NEW HAMPSHIRE—SCM, John A. Knapp, W1AJJ—SEC: BXU, RMs: CRW and COC, PAM: CDX, V.H.F. PAM: TA. Congrats are in order to the Hamfest Committees of the Concord Brasspounders, Inc. OC, for the most successful State ARRL Convention held in May, with special emphasis on the "Old Crow" supper and ROWH initiation, headed up by JNC. ARR is now in Texas with the USAF. CNX and AIJ are new members of the QCWA. KNIDWK has dropped the "N." PFI is doing FB with 200 watts to an 813. In the new gear dept.: VAU has a GPR-90 and a Cusherait tri-band vertical; MSX has a Viking II. KICLE is on with a DX-100. RKA has a new mobile rig on 10 meters. RVQ is now an OO (Class III and IV) and an OPS. Ex-LXB is now K4VMC in Florida. ONX has added a modulator to his 300-watt rig and is on phone after many years of c.w. only. Thanks to YCZ, Coos Radio Club president, for an FB report of news items. Best wishes to the new Twin City Radio Club, West Lebanon. RFP is club president. Traffic: (May) K1BCS 416, W1HKA 165, QGU 55, ENM 53, MTX 42, CDX 18, YMJ 18, K1BOO 16, W1KVG 12, MOI 12, YHI 10, EVN 9, IIQ 8, CUE 3. (Apr.) W1EVN 10, YHI 10, FZ 8.

RHODE ISLAND—SCM, Mrs. June R. Burkett, W1VXC—SEC: PAZ. PAMs: KCS and YRC. RMs: BBN and BTV. Although this first item has had much local publicity, it bears repeating here because of its general interest. A bill, authorizing the Registrar of Motor Vehicles to issue call letter license plates to amateurs, was passed by the 1958 R. I. General Assembly and Senate and signed by the Governor on May 16. Rhode Island has become the 40th state to receive the plates, which will be available by October of this year. The Providence Radio Association will sponsor an ARRL New England Division Convention on Sept. 28 from 9 A.M. to 10 P.M. at Rhodes-on-the-Pawtuxet. More details later. Speakers at a dinner given by the Roger Williams V.H.F. Society on May 15 at the Meshanticut Green were Mr. Hallenstein, engineer-in-charge FCC Boston, KCS, OLO and VXC. K1BWX, club president, acted as toastmaster. The La Salle Academy High School Radio Assn. is now affiliated with ARRL. YRC and CMH made BPL in May. New Generals at BVARC are K1EBL and K1DVA. Traffic: W1YRC 586, CMH 172, DDD 170, HKN 104, TXL 44, WED 5.

VERMONT—SCM, Mrs. Ann L. Chandler, W1OAK—SEC: EIB. RM: BNV. PAM: ZYZ. Traffic nets: VTN, Mon., Wed. and Fri. on 3520 kc. at 1830 (summer schedule); VTPN, Sun. on 3860 kc. at 0900; GMIN, Mon.-Sat. on 3855 kc. at 1700. Net manager ZYZ reports fine net participation on both VTPN and GMIN. Route Manager BNV reports VTN is on Mon., Wed. and Fri. to Sept. 15, when the 6-day regular schedule will be resumed. New ECs are K1BGC for Washington and GQJ for Caledonia Counties. EIB reports continued organizing work in the AREC throughout the State. New Novices are KN1s HDB in South Barre and HNS in Barre. K1BGC operated 6-meter mobile in Northfield with the National Guard during inspection. K1CUS and FMK have a new jr. operator. JEV passed the General Class exam at the Concord Hamfest. KIAUE is back from UVM operating 10-meter mobile. UET is back in the State and reported ill. Traffic: W1OAK 174, KJG 60, EIB 29, ZYZ 28, VSA 21, ELJ 17, K1BGC 16, BSU 15, BOL 12, CYY 12, W1ZJL 8, KIAUE 4.

NORTHWESTERN DIVISION

ALASKA—SCM, Eugene N. Berato, KL7DZ—MA/ALZ is the first KL7 to work VK via RTTY and is VK3KF's third RTTY contact, the only RTTY contact made into VK-Land. CRE, ex-W8FGB, now is on 40 through 10 meters c.w. and phone. BYA reports that the Sitka Radio Club should be organized soon. New arrivals in Sitka are CFR, CPH, ENC and BAP. BUS rebuilt a TBX-6 for portable use. New appointments: AH, CDG and AUV as OESs. CDF reports the following new calls on the Arctic Circle: CFS, CFT, CFV, CHA, CHM, CQL and CAV. Armed Forces Day had good ham coverage. DG participated in Kodiak with a new HQ-110C. The Anchorage AARC represented c.d. at Fort Rich with the new club trailer. EARS also had a fine display. BUF is on c.w. and s.s.b. with a 20-A and GG 813. MD is active on 40 meters. AGU is sporting a new Thunderbolt. CDQ, BVY's son, passed his General Class exam. The XYL PARKA Club held its annual election with BVQ, pres.; BLL, vice-pres.; CCP, treas.; CFJ, secy. Traffic: KL7BJD 200, CDF 81, BYA 39, MD 34, AUV 19, CEJ 7, DG 1.

IDAHO—SCM, Rev. Francis A. Peterson, W7RKI—Get in your nominations for the new SCM, one who can give more time to the job. Glad to hear that VQC is recovering from his accident. His XYL is helping him with the traffic. The Boise Club had a nice hamfest in June. Keep up the good work on the c.d. and FARM Nets in spite of summer QRN. Send in your RACES and

(Continued on page 122)

HARVEY Stocks the New CESCO REFLECTOMETERS

Now! with new dual scale all clear meter calibrated in SWR and relative power.

A quality instrument employing mutual inductance and capacity coupling between linear conductors for continuous measurement of standing waves on transmission lines. Suitable for frequency range from 3 to 200 megacycles. For continuous line insertion at power from 25 to 1000 watts. Will work satisfactorily on power input of 10 watts at 7 mcs. and up. Will work on 5 watts output 100 mcs and up. Line insertion power loss less than 1 DB at 30 mcs.

FEATURES:

- Uses sensitive 0-100 microamp meter calibrated in SWR
- Has relative power scale
- For continuous transmission line insertion
- Power to 1000 watts and over
- Prevents false loading from antenna tuner, match box, PI network etc.
- SWR observed immediately at all times without adjustment of Reflectometer
- Power output indicator
- Makes possible increased radiated power by reduction of line reflection
- Simplifies adjustment of antenna match
- No balancing adjustments, no reversing
- Each unit accurately hand calibrated and perfectly balanced
- Frequency tested from 3 to 200 mcs.

MODEL CM-52
For 52 ohm coaxial cable
MODEL CM-75
For 75 ohm coaxial cable

Contains phasing unit, loading control and reversing toggle switch, equipped with SO-239 at each end for inserting into feedline. Ideal unit for inserting in feedline at antenna for visual readings while making antenna adjustments. Housed in an aluminum box, Hammertone finish. Has all features as specified.

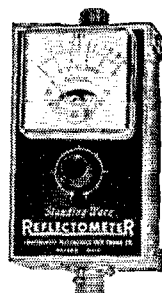

Amateur and Industrial net

\$29.95

DUAL UNITS MODELS CM-52-2 AND CM-75-2



Identical electrically to models CM-52 and CM-75 and has all features except in two units for remote control. Supplied with ten feet of cable and plug wired to control and indicator unit. Standard finish Dove Grey.

Amateur and Industrial Net
Phase and control unit

\$34.95



SPECIAL CONTROL PANEL

For Collins Speaker Grill or Built-In Installations

Special panel containing meter, control, reversing switch and with ten feet of cable and plug. For use with CM-52-2 or CM-75-2 phase units. Standard finish control panel and phase unit Machine Grey.

Amateur and Industrial Net
Phase unit and Control Panel



\$34.95

MINIBRIDGE MODEL CL-52-72

A resistive type unit for observing line standing waves when adjusting antenna match. For use with either 52, 72 or 75 ohm coaxial line. Designed for use with small amounts of RF excitation or Grid Dip Meter. Requires the use of an external indicator such as 0-100 Microamp meter.



Amateur and Industrial Net

\$12.95

We're Generous on Trade-Ins
If You Want to Talk SWAPS and DEALS
write... or call **W2DIO**

NOTE: Prices Net, F.O.B., N.Y.C.
Subject to change without notice.

HARVEY is known the world over, wherever Hams operate, as a reliable source for Ham Equipment. All orders shipped same day received.



Harvey RADIO CO., INC.

103 W. 43rd St., New York 36, N.Y. • JUdson 2-1500

Established 1927

NOW! 6 METERS* ADDED TO THE Hy-gain

MULTIBAND TRAP ANTENNAS!

Shown here are two of the great new hy-gain trap verticals, the 14-AV (for 10-40M), roof mounted, and the 18-AV (for 10-80M), side mounted, each using the sensational Insu-Traps to isolate the various sections of the verticals. 14-AV develops 1/4-wave resonance. 18-AV develops 1/4-wave resonance on 40-80M; 3/4-wave resonance on the 10, 15 & 20 M bands. Each uses new Capacity Hat principle to increase radiating efficiency, and new nylon base insulator for self-support. Less than 2:1 SWR on all bands, single 52 ohm feed line. Combination Guy Wire and Radial Mount Kit available for 14-AV for rooftop mounting. 18-AV comes complete with side-mount bracket fixtures and nylon guring kit, all parts completely weather-treated.

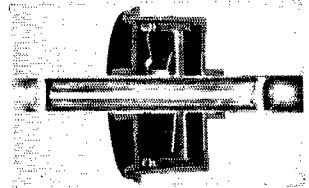

Heart of the hy-gain trap antennas, the Insu-Trap makes possible for the first time a really efficient multi-band antenna system. It acts as an insulator at its resonant frequencies, but allows radio energies of other frequencies to pass freely. This automatic switch action isolates various sections of the verticals to make them the proper length for each band. Completely mechanically and electrically stable, the entire trap circuit is enclosed in a carbon activated polyethylene cover and cap. Traps are effective over the entire band. Completely weather-proof and air tight. Guaranteed for the life of the antenna. Traps will handle 1 KW.



Nylon base assembly makes possible the self-support of the Trap Verticals. Cast aluminum mounting bracket is adjustable for various sizes of masts, with weather protected internal coaxial fitting. All electrical connections are factory sealed. Entire unit completely weather-sealed.

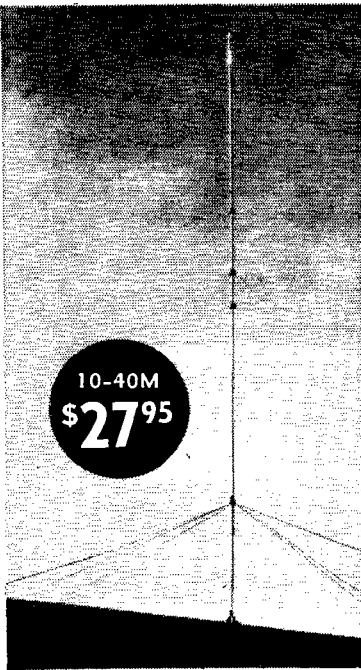

10-40M
\$27⁹⁵

Model LC-80 loading coil for 80M operation of the 14-AV. \$2.00 ham net

Also available (not shown), is the model 26-AV vertical for the 2 and 6 meter bands, complete with new decoupling sleeve and ground plane. Overall height and length of ground plane: 5 ft. . . . and the model 12-AV Trap Vertical (for 10, 15 & 20M), using the Insu-Trap principle to isolate sections and develop 1/4-wave resonance. Combination Guy Wire and Radial Mounting Kit available for rooftop mounting the 12-AV.

Model 26-AV (2-6M) — \$16.95
max. ht. 6 1/4'

Model 12-AV (10, 15 20M) — \$19.95
max. ht. 14'

Model 14-AV (10-40M) — \$27.95
max. ht. 22 1/2'

Model 18-AV (10-80M) — \$69.50
max. ht. 44'

12-AV Mounting Kit — \$8.95

14-AV Mounting Kit — \$9.95

*Available as accessory, specially designed decoupling stub adds 6 meter operation with low SWR to Models 12, 14 or 18-AV. Order Model 6MK: \$4.95 ham net.



10-80M
\$69⁵⁰

Write for Brochure on the Complete Hy-Gain Line Today!

World Radio Laboratories

3415 WEST BROADWAY • PHONE 2-0277 • COUNCIL BLUFFS, IOWA

"The House the Hams Built!"

ONLY 10% DOWN PAYMENT • MONTHLY BUDGET TERMS
PERSONALIZED SERVICE • TOP TRADE-INS • LEADING LINES
CONTINUALLY IN STOCK • GUARANTEED SATISFACTION

NOW... FULL FIDELITY FM RECEPTION FROM YOUR CAR!



A NEW DIMENSION
IN LISTENING PLEASURE!



FM CONVERTER

Now!... smooth, static-free reception... the nation's finest music... "living room" listening pleasure—while driving!

QUALITY RECEPTION...

Converter covers standard 88 to 108 mc. FM band, operates with present car radio* and antenna. Brings you all the well-known advantages possible only with FM... virtually constant program level without severe fading or signal drop-out and a minimum of static or man-made noise even when near power lines.

EASY-TO-OPERATE...

No fussy tuning!... merely locate desired signal on the dial, a unique "locking" circuit then positively and correctly tunes the FM station to the point of fullest fidelity. Switch on Converter restores auto set to conventional AM reception, if desired.

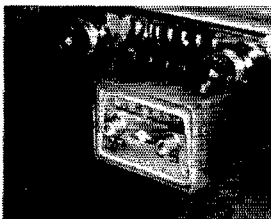

Model # 3239 84.50

See the Gonset FM Converter at booths 3 and 4, ARRL 10th National Amateur Radio Convention, Sheraton Park Hotel, Washington, D. C., August 15, 16 and 17.

GONSET
Burbank, Calif.

DIVISION OF
YOUNG SPRING & WIRE
CORPORATION.

49. AIB 42, GJS 37, NWP 35, USO 33, CTO 24, CZY 22, LVB 13, EKQ 12, EVW 3, JEY 1. (Apr.) W7LVB 54, BXH 25.

PACIFIC DIVISION

NEVADA—SCM, Albert R. Chin, W7JLV—SEC: JU, VIU received the first VA-JF certificate awarded to a Nevada ham and is working such real DX as FB8ZZ, KC4AF, BV1US and VS4JT. YNO now is married and living in Newport, R. I., awaiting his W/K1 call. JU is keeping all "Smokepuff" skeds with negative results and still is keeping his weekly skeds to Southern California and Tucson. YRY now is breaking in his Hy-Gain 10-80-meter automatic vertical. New officers of the NARA are MAH, pres.; PC, vice-pres.; K7DEF, secy.-treas.; K7ANK, sgt. at arms; TQE, BYR and JLV, board of directors; CX, trustee. New calls in the Reno Area are K7DEF and K7DEG. K7AGZ dropped the "N." ARRL Public Service Awards were issued to PC, AZF and ZVN for their part in the Reno Gas Explosion and disaster of Feb. '57. SNARC Achievement Certificates went to GVB (No. 60) and AGE (No. 61) for working 25 Nevada stations. SCM elections for Nevada are around the corner. Start boosting your favorite candidate.

SANTA CLARA VALLEY—SCM, G. Donald Eberlein, W8YHM—SEC: W6NVO. RMs: W6QMO and W6ZRJ. Endorsements: W6CBX as OO Class I, W6NMY as EC. A section net certificate was issued to K6SRC. W6MMG's ORS and OO appointments were renewed. W6WNI's ORS appointment was renewed. It is reported that W6MXW passed away May 29 of a heart attack. K6HGV got tangled up with 2500 volts but is able to tell about it. K6DHO was elected vice-president of the Mt. View Radio Club. Bob also worked a CN8 for his WAC. K6VJI is back on the air after an illness using a DX-100 on 40 meters and 3.8 Mc. feeding a vertical. W6WNI has his kw. final going; he made 420 contacts in 86 sections in the CD Party. K6BBD, finding his code speed had dropped, is now working on c.w. trying to get his speed back. W6AIT is QRL with garden work so is not QNI the net much. W6DEF is looking for more traffic to originate from his station. K6CQM has traded in his 32V-3 on the Ranger Thunderbolt Combo and with a 40-20-15-meter beam on a 50-ft. tower should be going great guns again. W6QMO reports that the 6-meter division of the NCN has folded from lack of activity. K6GID is building a DSD rig for 3.8 Mc. VE2ACF/W6's basement was flooded but Tom did not lose the records of the San Mateo Radio Club. W6AQR now has his 5th harmonic. W6USE is a new member of the PAARA. Traffic: (May) K6DYX 435, K6GZ 394, W6BPT 328, W6PLG 273, W6QMO 259, W6RSY 226, K6GID 170, W6VZT 152, W6YHM 103, K6DHO 102, K6PQH 78, W6YBY 78, W6OH 73, W6AIT 50, W6DEF 42, W6PON 36, K6HGV 12, W6AMG 9, K6VJI 6, W6XS 3, K6CQM 2, K6YKG 2. (Apr.) K6PQH 25, K6LSG 4.

EAST BAY—SCM, B. W. Southwell, W6OJW—SEC: W6CAN, ECS: W6LGW, W6ZZF, W6IUZ, K6EDN and W6JNW. K6LGN is plugging along on 7-Mc. c.w. K6DMI is acting EC of the Richmond Area. K6ESZ operated 75-meter mobile during the RARC Annual Economy Run. W6ASJ has a snappy 2-meter MARS RTTY net operating. W6CBF is flying instead of hamming now that the winter rains are over. W6ITH has left FST-Land for home. K6SRD made his 100 contacts confirmed on 6 meters for a certificate. K6QHC has a new Lyso all-band v.f.o. rig and made 144,594 points in the April 'CD Party. The CCRC met at HARC on May 7. The EBRC heard an FB talk on "Test Equipment Uses in Amateur Radio" at its May meeting. W6WLL moved to Marysville the Sacramento Valley section. K6DMW is a new ORS in Albany and checks into NCN nightly. W2JTP visited W6CQK, W6VPC and W6ASJ still are putting out bulletins on 3.9- and 144-Mc. RTTY. OHR won the MDARC hidden transmitter hunt. K6QKD is a new General Class licensee and is looking for an all-band 150-watt rig. K6SCF is on 75-meter mobile with a home-brew rig, and is leaving for a six-weeks visit to JA/KA-Land. K6RAMD is portable/7 in Oregon on 6 meters until August. KN6-SRU, a new Novice, is Sheriff of Contra Costa County. K6QXY is active on u.h.f. from 6 meters to infinity, and is looking for klystrons and cavities. K6JPR is working on 420-Mc. RTTY for a u.h.f. link to Latayette. K6LRF is president of the Luney Trade-Tech. Radio Club. K6OCF is on 6 meters with a Gooney Bird. See your EC and sign up in the AREC. K6KYT has gone to the Worlds Fair in Belgium for Aerojet-General Nuclearies. The NCN 6-Meter Net has been discontinued because of lack of activity. W6AIT put out an FB booklet on NCN history. W6LGW and W6PIR operated portable in Lake County during the East Bay V.H.F. Sweepstakes. W6-AFF and W6AFN are new Novices in Berkeley. K6DMI will be mobile in New Mexico and Texas during July and August. K6LGN, the school station, will be QRT because of school vacation. K6OSO received an RN6 certificate. K6QHC has a new rotor for his 21-Mc. beam and has

(Continued on page 126)

ARROW...Hamdom's One Stop Shop

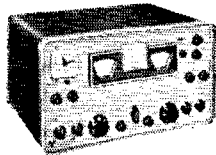

Hammarlund Model HQ-170 Triple Conversion Receiver

The HQ-170 is "hot". It offers the amateur a practically endless combination of tuning techniques whereby optimum reception of SSB/CW and AM/MCW may be achieved. Using vernier tuning, adjustable bandwidth, and the basic, precision front-end of the HQ-170, the user has full control over SSB signals as well as adjacent, or co-channel signals. Provides 10 db signal-to-noise ratio at 1.5 μ V AM or approximately .5 μ V CW, or better depending on bandwidth. The front-end provides tuning of the 6, 10, 15, 20, 40, 80 and 160 meter amateur bands. Designed for use with a single wire flat top, a folded dipole, or doublet antenna. Separate antenna terminals are provided for 6-meter reception.

Amateur Net (Less clock)..... \$359.00
Amateur Net (With clock)..... \$369.00



Tecraft Converters

Widely accepted by Hams, CAP & CD everywhere where top quality performance and highest quality is a must. Built with a wide choice of I.F. output frequencies... to suit the tuning range of the receiver. Please specify I.F. frequency required. Shpg. wt. 5 lbs.

CC-50 50-54 mc-6 meters.....\$44.95
CC-108 108 mc-Satellite Track \$44.95
CC-144 144-148 mc-2 meters.....\$44.95



Tecraft Transmitters

For 220, 144 or 50 Mc.

Hi-Level Plate Modulation. Hi-Impedance Mike. Provisions for Metering All Stages. Tuned Antenna Output System to 52/72 Ohm Line. RF Output Indicator. Power Requirement 6.3 V. AC at 250 ma. Tubes: 6AU6 osc.; 5763 Buf/Dbler; 6360 Buf/Mult; 6360 final amp.; 12AX7 speech amp. & driver; 2-6AQ5 modulators. Power Input to Final, 20 Watts. Complete with tubes, crystal & plugs.....\$59.95
Matching Power Supply.....\$39.95

TS-13 Handsets



Push-to-talk butterfly switch. Handy units for use in mobile, CD units, ham use, etc. Complete with rubber covered cable and plugs. Shpg. wt. 3 lbs.

Amateur Net \$4.95

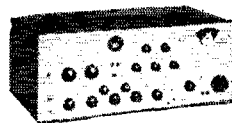
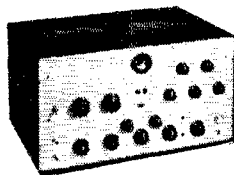

Lakeshore Phasemaster Models II-A and II-B

Band Switching: 160, 80, 40, 20, 15 and 10 meters. 65 watts PEP output from 6146 power amplifier giving sufficient power to drive nearly all types of linear amplifiers including grounded grid finals. SSB or DSB: Suppressed carrier, narrow band phase modulation or break in CW. Voice control and anti-trip circuits built in. Talk-on-frequency or Zero beat. Pi-Network Output: Matches 50-600 ohms impedance coax or balanced antenna output connectors. Voltage regulation of VFO, 9 mc oscillator and 6146 screen. Low pass filter in audio section gives speech cut-off of 40 db at 3800 cps. Temperature compensation in critical 9 mc circuits for improved stability. Novice or CW operation on 160, .80 and 40 meters with direct frequency crystals.

*Built-in VFO - 100:1 precision dial tuning, anti-backlash gears, no string or cable drives. Frequency stability and reset accuracy better than 100 cycles. Completely independent of Exciter section. Built in regulated power supply. Individual AC power switch allows VFO to be left on if desired.

*Applies to Model II-B only.

Amateur Net Model II-A..... \$329.50

Amateur Net Model II-B..... \$459.00

Sub-Miniature 0-200 Microampere Meter



A high quality instrument made to rigid U.S. Govt. Specs. by International Inst. Co. (Model 100). Only 1" in diameter. Ideal for limited space applications & transistorized circuits. A natural for the transistorized grid dip oscillator. Described in June '58 QST.

Amateur Net \$3.95 ea. 2 for \$7.50

2" round 0-500 microamperes. Bakelite case. Made by G.E. and DeJur.

Amateur Net \$2.95 ea. 2 for \$5.50

Weston 2" 0-4 amp RF meter Model 507. A giveaway at \$2.95 ea. 2 for \$5.50



6 Volt Dynamotor

Rated output: 425 volts DC at 375 ma. High efficiency, compact. 4" diameter, 7 1/2" long. Shpg. wt. 13 lbs. Worth 2 to 3 times this low price.....\$12.95

12 Volt Dynamotor

Rated output: 625 volts DC at 225 ma. High efficiency; compact; no battery strain; latest design. Brand new, recent military production. 5" diameter, 9" long. Shpg. wt. 16 lbs. Worth two to three times this low price.....\$13.95

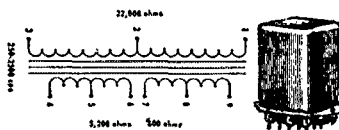

Versatile Miniature Transformer

Same as used in W2EWL SSB Rig - March '56 QST. 3 sets of CT windings for a combination of impedances: 600 ohms, 5200 ohms, 22,000 ohms. (By using the center taps the impedances are quartered). The ideal transformer for a SSB transmitter. Other uses: interstage, transistor, high impedance choke, line to grid or plate, etc. Size only 2" h. x 3/4" w. x 3/4" d. Brand new. Fully shielded.

Amateur Net, each.....\$1.39
3 for \$3.49 10 for \$10.75



"Wonder Bar" 10 Meter Antenna

As featured in Nov. 1956 QST. Complete with B&W 3013 Miniductor. Only 8 ft. long for 10 meters.

Amateur Net.....\$7.85

MAIL ORDERS PROMPTLY PROCESSED SAME DAY SHIPMENT FROM STOCK

TO SAVE C.O.D. CHARGES, PLEASE INCLUDE SUFFICIENT POST-AGE WITH YOUR ORDER. ANY EXTRA MONEY WILL BE RETURNED.

ALL PRICES F.O.B. N. Y. C.

Arrow's Export Dept. Ships To All Parts Of The World!

Prices Subject To Change Without Notice.

ARROW ELECTRONICS, INC.

65 Cortlandt St., New York 7, N. Y. • DIgby 9-3790
525 Jericho Turnpike, Mineola, N. Y. • PIONEER 6-8686

GAIN? MILES AHEAD!

-in these new



STATIONMASTER® ADVANCED DESIGN ANTENNAS

- 5.8 Db Gain
- 1.5:1 Maximum VSWR
- Light weight
- Low wind resistance
- Potted in Fiberglass
- 144-175 MC Cat. No. 200-509
- 450-470 MC Cat. No. 201-509
- Cut to exact frequency

CATALOG
457 —

Write today on
your company
letterhead for
a copy.

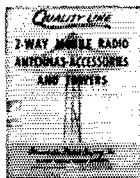

*Communication
Products Company, Inc.*

Main Office and Plant

MARLBORO, NEW JERSEY
Phone FReehold 8-1880
TWX — FREEHOLD N J 843

Pacific Coast Branch:
3043 Rosslyn St., Los Angeles 65, Cal.
Phone — CHapman 5-1144
TWX — GLENDALE CAL 2177

Southeastern Branch:
1709 Prudential Bldg., Jacksonville 7, Fla.
Phone — EXbrook 8-8011
TWX — JK 46

THE **QUALITY LINE**
BEST ENGINEERED — BEST MANUFACTURED

109 countries worked and 57 confirmed. K6GK has a new 20-ft. vertical. W6TI has 260 countries confirmed. Keep the reports coming in and please try to get them to me by the 5th of the month. Traffic: (May) K6GK 535, K6DAMW 142, K6OSO 59, W6JOH 21, K6DMI 10, KN6-JKY 9, K6QHC 6, K6OCF 4, (Apr.) W6ASJ 58, K6QHC 14, K6DMI 9, W6CBF 5, K6ESZ 2.

SAN FRANCISCO—SCM, Fred H. Laubscher, W6OPL—WINJM was the honored guest at a dinner at the famous Fisherman's Wharf June 4. After the dinner date he spoke to the representatives of the Central California Radio Council; a special meeting took place at the National Red Cross Bldg. in San Francisco. W6AJF held the club members' interest with his talk on antennas at the monthly San Francisco Radio Club meeting. K6BJ is in the Oak Knoll Hospital, Oakland, Calif. John had a heart attack recently and was told to take things easy. It seems one just can't keep a good man down and he insisted on dropping into the business office each day so, the doctor decided to put John in the hospital for a complete rest. Latest reports have it that he is getting along nicely. W6ZSE, of Eureka, is in the U. S. Public Health Hospital, 15th & Lake Sts. in San Francisco. He had surgery of a serious nature but reports that he is feeling fine again. The Tri-County Section is very active on the net. W6SLX sends in a new call—KN6ULE. Other new calls from K6ERC lists KN6TPX and two Conditionals, W6NNA and K6VDG. W6GQY tells us that he will be slacking down on traffic because of other commitments but will bounce back full of pep in the fall. W6YC reports that he received No. 23 certificate award from the Hunters Club. Contacts: K6VJV is liaison for RN6 ns of June 2 and thereafter on Mondays. He is able to handle 30 words per minute. W6GQA says he handled no traffic in May but was busy building things. Congratulations to W6EJY, who was married on May 4 to Shirley Phillips. The couple have moved to Marin County so they still reside in the San Francisco section. K6ANP says that Operation Alert was a huge success. For the first time in the history of the San Francisco Civil Defense program all warden communications units reported 100 per cent. K6ANP, EC of San Francisco, was net control station. The Mayor of San Francisco, the Chief of Police, the Chief of the Fire Dept. and Admiral Cook all visited the station and stayed to see how the amateurs put through messages. They were well pleased with the results. Traffic was handled through the Mission Trail Net, the American Legion Net and the Northern Calif. Net. Amateurs who stood by the warden stations were K6LNX, K6LCP, K6AES, W6GHI, K6EJV, K6KTP, K6MZN, K6OHL, W6OST, W6UDV, and W6GHY. W6OPL and W6GGC acted as home station from GGC's QTH. Coverage was had by amateurs in Marin, Sonoma, Mendocino, Alameda, San Mateo, Santa Cruz, Santa Clara and San Benito Counties. Lenny wishes to express his deep appreciation to all who gave him so much cooperation on the Alert. The RTTY group held a meeting and dinner at Millbrae, Calif., on May 23 with a very good turnout. ZLIUB was guest speaker for the evening. Traffic: W6GQY 594, K6VJV 61, W6GGC 26.

SACRAMENTO VALLEY—SCM, LeVaughn Shipley, K6CFE—Hearty congratulations to the Tehama County Radio Club in Red Bluff, affiliated with the League 100 per cent! K6VYV has been working (laboring) back East. So many of us have complained about Delaware for WAS that Steve spent May 6 and 7 in Baltimore trying to accommodate us. Seems he could work Los Angeles, Honolulu and Seattle but not Sacramento. Our vice-director, W6ZF, transmits ARRL Pacific Division News Bulletins on 3540 kc. at 8 p.m. on the 2nd and 4th Mon. of each month. W6QYX really is logging 'em in—in the woods of Shasta County, that is (pine and fir logs). Your SCM had a most enjoyable time recently at the Sacramento Junior College discussing amateur radio. The college has applied for a license and has the nucleus of an FB radio club. Good luck to W6OOR and his boys. It is often said that Fre-no knows how. Take it from one who attended the Pacific Division Convention—Fresno does know how. Arrangements were well handled, the daytime program interesting, the displays informative, the entertainment and dance superb. Prizes were numerous and most desirable. The v.h.f. and RTTY demonstrations were exceptionally good, the traffic gang was well represented and their forums also were good. The XYL won a VTVM. Traffic: K6YBV 376, W6ODV 45, W6ZF 7.

SAN JOAQUIN VALLEY—SCM, Ralph Saroyan, W6JPU—The ARRL Pacific Division Convention was held in Fresno June 7-8 with over 500 in attendance. W6BJI won a Morrow receiver. K6QPE won the NC-109. W6PGU got a B&W final coil. K6EDX won the WRL DBS-100. K6MDX is working on projects. W6CF is working on antennas. The 10-2-meter mobile units helped with the Parade Memorial Day in Turlock. K6RLX is going to tour the U. S. this summer. K6GOX is using a

(Continued on page 128)

Your Ham Headquarters — WASHINGTON to FLORIDA

SPECIALIZING IN THE BEST AT EASY TERMS
HIGH TRADES AND LOW DOWN PAYMENTS
WRITE FOR DETAILS OF OUR TIME PAYMENT PLAN

GO MOBILE FIRST CLASS

with the

Collins

KWM-1

mobile

fixed SSB

transceiver

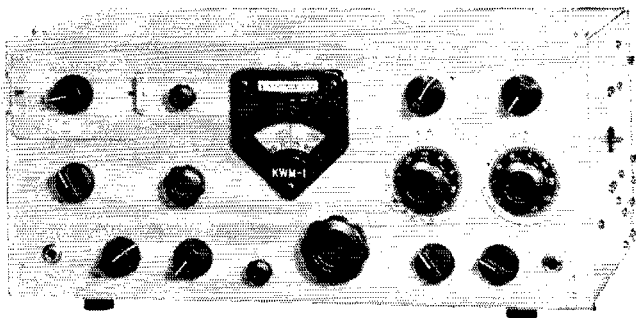

Component and accessory features of the Collins KWM-1 Mobile/Fixed Transceiver make it one of the finest mobile rigs available—and excellent for fixed use, too. The KWM-1 has 175 watts PEP input on SSB, and 160 watts on CW. Receiver/transmitter tuned to same frequency so you don't have to zero in. Covers amateur bands between 1.4–30 mc in 100 kc segments with 10 segments. A DX Conversion Adapter, interchanges with normal crystal box and provides seven transmitting frequencies within the band. It also allows reception over a 100 kc band in or out of the band. Another interchangeable crystal box provides Novice operation of the KWM-1. Switching is easy with crystal switch, automatic antenna switching control and logging scales on PA Load and Tune controls. Front panel meter acts as an S-meter on receive and as the tuning meter on transmit.

The Collins KWM-1 Transceiver is the most compact unit available for mobile operation with anywhere near the power—the only one available for SSB.

Remember, you go mobile first class with the Collins KWM-1 Mobile/Fixed Transceiver.

Mobile or fixed, the KWM-1 measures only 6 1/4" high, 14" wide and 10" deep. Electronic Supply's price is just **\$820.**

Collins 75A-4 SSB Receiver and KWS-1 Transmitter also available for immediate delivery.

Collins accessories available include:

516F-1 60 cycle 110 (or 115) vac Power Supply for fixed or portable operation.....**\$136.00**

516E-1 12 vac Power Supply completely transistorized....**\$262.00**

312B-1 Speaker in Cabinet.....**\$25.00**

312B-2 Speaker Console having 5" X 7" speaker and directional RF wattmeter.....**\$185.00**

Mobile Mounting Tray for snap-in installation which automatically connects power, speaker and antenna.....**\$86.00**

10% DOWN • HIGH TRADES • UP TO 24 MONTHS TO PAY

For all amateur and industrial requirements, write or call. We carry all brands in stock

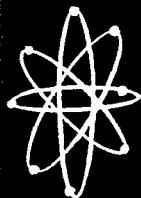

E

LECTRONIC SUPPLY

61 N.E. 9th STREET • MIAMI 32, FLA. • Phone FRanklin 7-2511

LECTRONIC SUPPLY

909 MORNINGSIDE DRIVE • MELBOURNE, FLA. • Phone 1735

LECTRONIC WHOLESALERS, INC.

2345 SHERMAN AVE., N.W. • WASHINGTON 1, D.C. • Phone HUDson 3-5200

Have A Look At . . .

THE SELF-SUPPORTING

SPAULDING

Globe Spire TOWER!

Match these Features:

- ★ Self-supporting up to 32, 40 and 48 ft.; may be extended to 150 ft. with proper guying.
- ★ Structural design offers exceptional strength; reduces torsional twist; X-brace, bridge-type construction guarantees added strength.
- ★ Base area over three times that of usual towers (19½" min.)—decreases stress and allows greater stability.
- ★ Combination of U Channel Beaded Type leg material plus wide base mean added strength and durability. Approximately 35% stronger than tubular leg design.
- ★ Heavy commercial galvanize coating means extra long life. Construction allows easy painting both inside and outside legs at later date.
- ★ Complete riveted construction with aircraft rivets of extreme high tensile strength far surpasses normal, weld-type construction.
- ★ Easy to erect; — the higher you go the lighter the sections. Rotator and RotoBrake easily installed. Built-in thrust bearing and rotor mounting plate.
- ★ Self-supporting and handsomely styled.
- ★ Anchor base type spire eliminates use of concrete; allows relocation of tower if desired.

CONCRETE MOUNTED GLOBE SPIRES

Include Bearing Plate, Rotor Plate and three 4 ft. stubs for mounting in concrete.

32 ft.—Cat. No. 69A091	\$ 49.95
40 ft.—Cat. No. 69A092	68.75
48 ft.—Cat. No. 69A093	99.50
RotoBrake Mounting Plate (Cat. No. 69A097).....	1.65

ANCHOR BASE MOUNTED GLOBE SPIRES

Include Anchor Base, Bearing Plate, and Rotor Plate.

32 ft.—Cat. No. 69A094	\$ 71.50
40 ft.—Cat. No. 69A095	91.95
48 ft.—Cat. No. 69A096	129.95
RotoBrake Mounting Plate (Cat. No. 69A097).....	1.65

Only 10% Down - Easy Terms

Write for Complete Info and Accessory List to

EXCLUSIVE DISTRIBUTOR

WORLD RADIO LABORATORIES

3415 W. Broadway Council Bluffs, Iowa
PHONE 2-0277

Gonset linear on 6 meters, K8IEG, K6BGO and K6HHI helped in the c.d. drill in Coalinga with good results. The Pleasant Valley ARC held Field Day near a swimming pool on top of Kettleman Hills, using one c.w. and one phone rig. The Sanger Radio Club boasts 8 members with Ray Hauck as president and meets the 1st Tue. of each month. K6GMY moved from Stockton to Fresno. W6-ANZ is active and is bothered by key clicks. WV6ABP is the newest Novice in town. KN6VLY is the XYL of K6AHQ. The FCC inspector gave tests at the convention and had 26 customers. W6UBK won a TR switch at the convention. W6QON is heard back on 75-meter mobile. The club 8-meter project is coming along nicely. W6NKZ has a new Cadillac and is installing a 75-meter mobile in it. W6IFE and his XYL were seen at the Fresno Convention. W6JPU had his car broken into and lost a Handset and would have lost the converter if W6PSQ hadn't stepped in. The would-be souvenir hunters got away. Traffic: W6ADB 150, W6EBL 12, K6RLX 11, K6EJT 9, W6ARE 8, W6JPU 4, W6EUH 3.

ROANOKE DIVISION

NORTH CAROLINA—SCM, B. Riley Fowler, W4RRH—SEC: HUL, PAM; DRC, V.H.F. PAM; ACY. Just a reminder for all official appointees: You should submit an activity report to either the SCM or the SEC each month. ECs report to the SEC, all others to the SCM. Congratulations to PCN, elected net manager of the North Carolina Net (c.w. 3599.5 kc.). I would like to remind all net members to inquire of your net managers or secretary as to the requirements for net certificates. They are available upon request of your net official through the SCM. 'Tis interesting to note that of the 2200 amateurs in the section only 110 belong to state nets (less than one-half of one per cent). You should do something about this condition. We have c.w. nets, phone nets, Army MARS, Air Force MARS and a teletype net. Take your pick—North Carolina has it. W6NI/4 has moved from the State and now is operating from Virginia. UJR is the new Radio Officer for Cleveland County. It is very hard to use 2 meters here in the mountains, but we keep trying. Maybe one of these days it will work out. Traffic: W4GXR 271, DSO 145, RRRH 71, BAW 54, ZWF 4.

SOUTH CAROLINA—SCM, Dr. J. O. Dunlap, W4GQV—SEC: K4PJE, PAM; YOS, RM; AKC, K4OZC passed the General Class exam and is active on 15 meters. K4QZA has a new DX-100 to celebrate the dropping of the "N" in his call. K4QVN has departed for Hawaii and K4RSW will leave for Germany in August. K4RLX is sporting a 10-meter beam and is firing up s.s.b. K4GJP is building a new quad. K4POP is mobile in his Jeepster. K4GJP and K4PQJ have accumulated new gear. K4GZ and MYY have been busy relaying messages from the Boy Scouts Campore to parents. K4GMY and DXK both have new XLS and K4DFW has a new jr. operator. K4ASA made an illustrated lecture on mobile operation to the Dreher ARC which also received the call K4VLU. K4UNP is a National Honor Society member at Dreher High and goes to Clemson next fall. K4CIY is the new EC for Conway and ZRH is the new EC for Charleston and Beaufort Counties. YOS is monitoring the nets and working portable from his summer job in Virginia. HMG reports there are now 65 s.s.b. stations on 75 meters in the State. Don't forget Pawley Island's Hamfest Sept. 5 and 6 and the Rock Hill Hamfest in October. Subscribe to the bulletin *Seabird* and keep up with all activities in the State. Traffic: (May) W4PED 298, K4AVU 218, W4AKC 185, K4GAT 148, BVX 112, HQK 110, W4CHD 41. (Apr.) K4GAT 161, W4DAW 55.

VIRGINIA—SCM, John Carl Morgan, W4KX—VSN has merged with VN until September, according to LW. ZPE reports that the Virginia 2-Meter Net still is alive and lively, and K4EUS says there's somebody on 145.35 Mc. every night at 2000. The Arlington Co. AREC Net now is active alternate Fri. at 2000 local time. K4EYE reports frequent AREC/RACES drills in the Bristol Area. The Tidewater Mobile Club again is furnishing communications for the Annual Intl. Cup Boat Regatta, this year to be held at Elizabeth City, N. C. IA is leaving Virginia and is off the air. EV will be sorely missed on VN and MW. Welcome to 6KRN, now chief engineer at WAFC in Staunton. The collegians now are back at their home QTHs. CXQ again is in the NCS harness on VN. UHG operated 74 at Hampden Sydney. VQZ is staying at M.I.T. where he plans 71 operation on 2 meters. School work QRMed the activity of APM, PVA, K4PEJ and K4DSD. K4JKK says summer WX is good for his lawn-mower repair business but is hard on hamming. K4QER now is General Class, but lets OM K4QES have free run of the rig during VN/4RN times at least! K4AET complains that the early morning nets on daylight time have him dragging! Your SCM plans to be on hand at the National Convention in Washington, and hopes to see most of the Virginia gang there. Tentative plans are

(Continued on page 130)

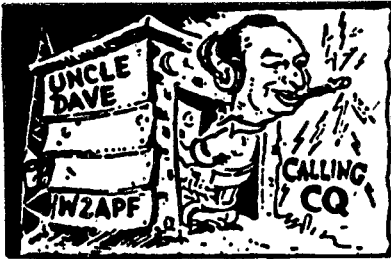

FORT ORANGE

Radio Distributing Co. INC

904 BROADWAY ALBANY 4 N Y U S A
AMATEUR HEADQUARTERS

CALL ALBANY 5-1594

Cable Address "Uncledave"

NITES 77-5891

This summer heat has us down, so our prices come down, too. Tell us your special needs.

GUD USED GEAR

Collins 32V3, very nice ...	\$550.00
Deltronic 144 2 meter trans-supply, gud condition ...	74.50
Elmac A54H, less power ceiver + w. slightly used	99.50
Globe Scout 65A 60 watts CW, very gud condition ..	79.95
Heath AT-1 30 watts CW ..	24.95
Johnson Viking mobile xint.	75.00
Hallcrafters SX28A w/spr.	100.00
Hallcrafters S38D, like new	39.95
Hallcrafters S40, take away	50.00
Hallcrafters SX71 w/spkr.	125.00
Hallcrafters S94 30-50 Mc.	42.50
Heath AR-3, with cabinet..	24.95
National HRO5 complete ..	125.00
National HRO50T1 complete	375.00
National HRO60 complete..	495.00
National NC173 o. k.	138.50
National NC183D xint.	295.00
National NC300	329.00

SEND FOR COMPLETE LIST

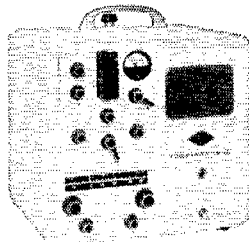

New GONSET Communicator III

- 2 or 6 meters
- 6 vbc, 12 vdc and 115 vac—all 3, 1 vibrator
- Push to talk
- Adjustable squelch
- Xmtr tunable circuits have panel knobs
- New 6L6GB modulator tube for heavier modulation
- Panel meter switches to excitor or RF output and use as revr. "S" meter.
- Holders for 6 xtals.

\$269.50

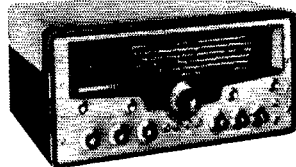

HALLCRAFTERS SX101
Complete coverage 160 thru 10 meters. Exclusive upper/lower sb selection Tee Notch filter. **\$395** less spkr.



COLLINS 75A4

Passband tuning; double conversion; precise dial calibration; AVC for ssb; mechanical filter in IF strip. **\$695** less spkr.

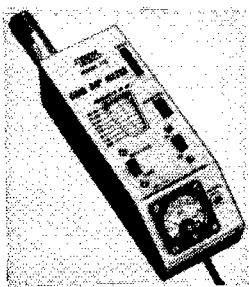

GRID DIP METER

The EICO Model 710 Grid Dip Meter is an instrument of excellent versatility and usefulness for servicemen, as well as amateurs and experimenters. Supplied with complete set of coils for entire band coverage.
Kit 29.95 Wired 49.95

NEW, NEW . . . EICO HAM EQUIPMENT

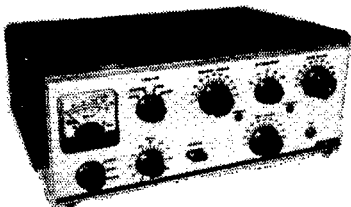

CW TRANSMITTER

The EICO Model 720 is a very "clean" 90 watt CW, 80 through 10 mtr. bandswitching transmitter, 6146 final amplifier for full 90 watts cw input. Wide range, high efficiency variable pitch PI-network for matching a wide variety of antennas for 50 to 1000 ohms. One knob bandswitching—no coils to change.
Kit \$79.95 Wired \$119.95

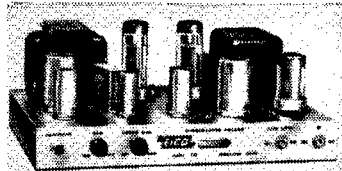

HIGH LEVEL CLASS B Universal Modulator

The EICO Model 730 is a high level class B universal modulator for phone operation, capable of delivering 50 watts of undistorted audio signal, more than enough to modulate 100% the EICO 720 transmitter at full input. The 730 can be used to modulate any transmitter having an RF input up to 100 watts.
Kit \$49.95 Wired \$79.95
Model E-5 Cover—\$4.50

Write Uncledave
W2APF
with your needs
and problems.

FREE! CONELRAD CHARTS
NEW CATALOGUE

WE SPECIALIZE IN FOREIGN TRADE

TIME PAYMENTS
18 Months to pay, life
insurance at no extra cost
24 HR. SERVICE
on stock items

for BIG savings

build your linear amplifier from LA-400-C KIT

Easy to assemble. Operates on 75 thru 10 meters. Has TVI suppression; meter circuit for RF voltage input, plate current. RF amps output; low Z input, 400-watt P.E.P. input with only 20 watts drive; pi-net, output; four Mod. 1625 Tetrodes. Especially effective for SSB; also AM, PM, CW signals. Complete with power supply, tubes. Only.....\$149.95
 LA-400-B, same as above, wired & tested. \$199.95
 Also, Modified 1625 Tetrodes.....each, \$3.75



V-F-O-MATIC



Model 8020 plugs into 75A-2, -3, -4, Collins receivers; needs no changes or adjustments, Collins VFO controls freq. for both transmitter and receiver. For all SSB phasing type exciters using 9mc mixer freqs. Automatically zeroes in Xmtr to exact freq. received. Operates upper and lower SB on 75 and 20 meters. Complete with power supply. only \$129.95
 Model 8010 for KWS-1 75 thru 15. only \$179.95

Model 8010 for KWS-1 75 thru 15. only \$179.95

RF CHOKES

Hi Power Model 160-6 has max. rating of 5000 volts DC at 2.5 amps. Inductance 162 uh at 1 kc. Designed to operate on all amateur bands, 160 thru 6 meters. Each.....\$3.50
 Chokes custom designed to your requirements also available.



See your distributor or write:

P & H ELECTRONICS, INC.

424 Columbia, Lafayette, Ind.

in the works for another "Virginia Free-For-All" to be held in September. Traffic: (May) K4ELG 557, W4QDY 530, APM 425, K4KNP 349, AET 251, QES 192, W4SHJ 186, BZE 68, K4JKK 68, W4IT 62, YVG 47, K4EZZL 32, MEV 31, W4KX 28, 1A 18, K4DPX 17, PTG 15, DSD 13, IIP 12, W4CXQ 9, K4ECD 5, W4LW 4, BRF 1. (Apr.) K4EZZL 36, PEJ 15, W4UHG 5, AAD 4.

WEST VIRGINIA—SCM, Albert H. Hix, W8PQQ—Asst. SCM Festus R. Greathouse; SPZT, SEC: KXD. PAM: FGL, V.H.F. PAM: K8AON, RM: W8GBF, HZA PBO and VYR. The V.H.F. Weather Net did a fine job of handling emergency traffic during the period of high water on Big Sandy River. HZA was in the hospital with a back injury. K8EAB has a DX-100. Winners of the W. Va. QSO Party were JCK first and GNZ second. New officers of the Tri-State Club are AFB, pres.; EEJ, vice-pres.; ELS, secy.; BDD, treas.; and FNI, prop. mgr. The Clarksburg Radio Club operates station TPW. MIP is not too active because of illness. FUM is doing a fine job as Cappel County EC. CRM is on 75-meter phone. K8CQN and JNF have been working good 6-meter DX. New officers of the V.H.F. Weatherbird Club are K8CYW, pres.; K8ARF, vice-pres.; and K8HRO, secy.-treas. The club meets the 3rd Sun. of each month at East High School in Huntington. FNI received a certificate for the highest West Va. score in the recent YVRL Contest. YBN has moved to Kentucky. K8DUO is on phone with a DX-100. K8DJT and his XYL, K8GXQ, are now in Waco, Texas. K8HLR is active in the V.H.F. Net. 1EQ has a new Gonset III on 6 meters. BIT has his General Class ticket. K8KKU got his Tech. Class ticket. KN8JSY is the XYL of WHQ. Traffic: W8FNI 242, HID 81, VYR 59, CNB 47, BWK 35, CSG/KLI 14, FNT/8 4, HRO 4.

ROCKY MOUNTAIN DIVISION

COLORADO—SCM, B. Eugene Spoonmore, W8DML —SEC: NIT. PAMs: CXW and IJR. OOs: OTR and RRV. New ECs: K8DXF and DQN. New OBS: K8BTU. New OES: K8DIQ. New QTH: K8COI, Dillon instead of Leadville, UPS, KTX, K8KZY and Ben's son David worked over the LCARC power plant. K8AYK made a trip back to Council Bluffs. ZFM has worked 20 states on 6 meters. *The El Paso Radio Club News* states that K8GBS and the club have FCC Novice and Technician Class exams for those wishing to take them. ZJO gave a talk to the Western Slope Radio Club, according to the *RF Carrier*. IQV has a new DX-40. There were 450-plus copies of the May issue of the *Roundtable* mailed, according to BWJ, advertising manager. K8DCW wishes to express, on behalf of the Jefferson County Evacuation Communications Net, a great deal of thanks for the fine cooperation of all amateurs in maintaining 7230 kc. as a clear channel for its May e.d. drill. K8EVG reports that SZII and K8JFO are new members of the LCL-YL Net. New 6-meter stations are K8IVC, JGW, OKO and OKP. WMK is running 750 watts with a pair of 813s, a nice weapon against summer QRN. K8GUY is using DX-35 and NC-48. TVR urns a Gonset transmitter and receiver mobile. Traffic: (May) W8IA 782, KQD 530, K8DXF 189, DCW 122, KZL 100, DCC 79, W8DQN 68, K8EVG 37, W8QOT//33, VLS 31, K8WZ 27, W8CBI 17, NIT 15, ENA 10, RRV 8. (Apr.) W8IA 677, WMK 372, NVU 51, K8GUY 11.

UTAH—SCM, Thomas H. Miller, W7QWH—Asst. SCM: Col. John H. Sampson, jr., 70CX. SEC: FSC. RM: UTM. PAM: BBN, V.H.F. PAM: SP, OCX attended graduation exercises at the United States Military Academy at West Point. His son was one of the graduates. The UARC (Salt Lake) is building the "Club-saver" 2-meter portable transceiver which was described in *QST* as a club project. ZKL now has a DX-100 and should be working all bands soon. The Beehive Net members had an outing at Saratoga Resort. LQE, the former SCM, is back in Utah and should be here until August. KN7DOV recently received his license. EII has a new Globe Chief 90A. JQU has been appointed ORS. Send your monthly reports to the SCM. Join the AREC. Traffic: W7OCX 26, QWH 3.

NEW MEXICO—SCM, Allan S. Hargett, K5DAA—SEC: CIN, PAM: ZU, V.H.F. PAM: FPB, RM: DWB. The New Mexico Breakfast Club meets Mon. through Sat. on 7272 kc. at 0700. The NMEPN meets Sun. on 3838 kc. at 0730 and Tue. and Thurs. at 1600 on 3838 kc. The RMN meets Mon. through Fri. on 3570 kc. at 1900. Please try to check in on these nets. K5KBJ, Roswell, received his sheepskin from State College in Ag. and was voted the only cowboy ham. ZU and his XYL, of Roswell, left in June for Alaska via the Alcan Highway. K5IQL, Roswell, mobiled to California on 6 meters. K5ONT visited in Roswell on the way to Hobbs to see how MARS operated from BIH's QTH. On May 23 Albuquerque mobiles spent 5½ hours helping the sheriff's department search for a 13-year-old girl lost in the mountains. LFH recently gave a talk to clubs on satellite tracking, with the assistance of K5IVR. This year's alert went very well in Albuquerque. Santa Fe, Los Alamos

(Continued on page 132)

Make
RADIO PRODUCT SALES, INC. *your*
IN LOS ANGELES



* *A New*
Star *
 * *Performer*



A quality-communications receiver offering all the advantages

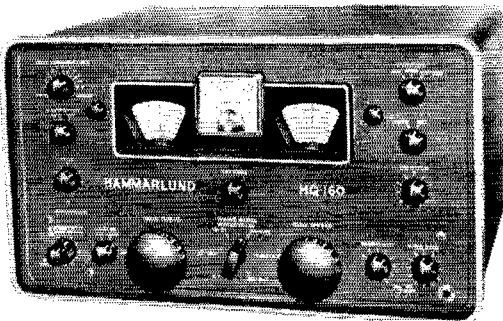

of receivers costing hundreds of dollars more, PLUS several all-new features for better performance. Biggest value ever for amateur and short-wave listener alike.

SPECIFICATIONS: General Coverage: 540 KCS to 31 MCS continuous tuning. • 5 KCS dial markings up to 10 MCS, and 10 KCS markings above 10 MCS. • 13-tube, dual conversion, superheterodyne with automatic noise limiter. • 14 tuned circuits in IF. Crystal controlled 2nd oscillator. • 60 db slot filter. Adjustable plus/minus 5 kc of center frequency. Adjustable depth. • Q-multiplier: Peak and frequency controls. • Separate linear detector for CW and SSB. • Separate, adjustable B.F.O. marked for upper and lower sidebands. • Electrical bandspread. Improved dial readability. • Built-in crystal calibrator (100 KCS). • Dial resets on both dials. • S-meter for easy tuning and read-out of signal strength. • Exclusive Auto-Response for optimum listening.

Price: Only \$379.00

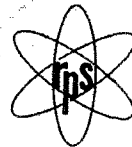

Mail Orders Invited * HAM HEADQUARTERS

**RADIO
 PRODUCT SALES, INC.**



1501 SOUTH HILL STREET • LOS ANGELES 15, CALIFORNIA

LOCATION
 In the easy to get to heart of Los Angeles. Close to all freeways.

COMPLETE STOCKS
 of all the top lines.

HAM SHACK
 operate it before you buy.

LIBERAL TRADES
 on your present equipment.

LONG TERMS
 make it easy to buy.

STORE HOURS
 Mon. thru Thurs.
 8:30 to 5 P.M.
 Friday
 8:30 to 9 P.M.

NEW!

BUD HILOR CHOKES

- Carry more current for any given inductance without increase in size
- Provide higher current and lower inductance
- Lower in cost than any other chokes with comparable features



PIE WOUND CHOKES

Strap or Wire Lead

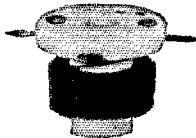

LATTICE WOUND CHOKES

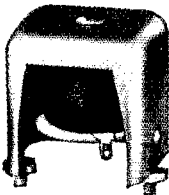

IRON CORE CHOKES

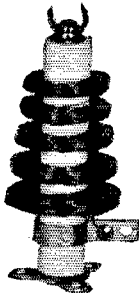

TRANSMITTING CHOKES

• Here's a new line of R.F. chokes engineered to provide superior performance in any circuit for which they are applicable. Employing enamel covered wire, precision wound on special machinery, they can carry more current for any given inductance. Each type is manufactured in a variety of sizes to meet almost any requirement.

See these new chokes at your distributors, check their specifications and current ratings, then compare their prices with other chokes. You'll agree they are the best buy on the market.



BUD RADIO, CORP.

2118 East 55th Street
Dept. Q Cleveland 3, Ohio

and Roswell. Different sections of the rest of New Mexico were on stand-by basis. Traffic: (May) K5GYZ 24, DAB 17, GFC 15, W5VC 5, GD 4, ZU 3, K5DAA 2, KBJ/5 2. (Apr.) K5GFC 14.

WYOMING—SCM, James A. Masterson, W7PSO—SEC: MNW, RM: BHH. The Pony Express Net meets Sun. at 0830 on 3920 kc. with AMU and MWS alternating as NCS. The YO Net meets Mon., Wed. and Fri. at 1830 on 3610 kc. with BHH, DXV and NMW alternating as NCS. Congratulations to the Sheridan gang on a well-planned hamfest. New officers of the Casper Amateur Radio Club are LKQ, pres.; BHH, vice-pres.; and NNX, secy.-treas. QPV has a new KWS-1 and a 75A-4. More than 20 Sheridan hams are constructing 2-meter rigs for emergency communications. ZHN is chairman of the construction project and the receiver was designed by LRU. Stations participating in the recent c.d. exercise included YVW, MNW, AUL, EUZ, YJG, AYU, DW, AEC, HCA, YWY, 5DDG/7 and LKQ. YVW is now on 2 meters. BZC has moved to a new QTH. Traffic: W7AXG 41, DXV 24, BHH 6.

SOUTHEASTERN DIVISION

ALABAMA—SCM, Clarke A. Simms, jr., W4HKK—SEC: EBD, PAMs: DGH and K4BTO, RM: RLG. Congratulations to PVG and OKQ, new ORSS, and to K4KBT for making BPL. K4PFM has made WAC. WAS and has 60 countries confirmed in one year while handling over 400 messages and taking his turn as NCS of AENP. BWG continues code classes for the Jasper vicinity. Welcome to KN4YBF, the son of CEF and TZU, located in Ider and Ft. Payne, respectively. Every licensed operator in Dekalb County has joined the AREC. Wish we had more 100 per cent counties. In fact, wish all counties had an AREC program. If your county is not yet active, please inquire for details to get organized. Write to S. D. Christian, EBD, 8436 No. 7th Ave., Birmingham, Ala. K4ANB now is working 15 meters with a new beam up 50 ft. K4KJD had a nice birthday surprise June 8 when a large group from over the State dropped in with several pieces of new equipment for his station. Traffic: W4RLG 492, K4KBT 176, KJD 142, PFM 134, W4YRO 103, KIX 84, PVG 49, MI 34, K4AOZ 32, JDA 30, W4CRY 18, CIU 17, CEF 13, K4PHH 12, W4RNX 10, IPF 9, K4KAK 9, W4RTQ 8, WAZ 7, K4ANB 6, W4HKK 3, K4MQH 2, W4ZSH 1.

EASTERN FLORIDA—SCM, John P. Porter, W4KGGJ—SEC: IYT, RM: K4SJH, PAM: TAS. With band conditions changing for the worse on 80 meters the Florida Net (FN-CW) will change from 3675 to 7105 kc. for the summer and fall months. The net will maintain its regular time, 1900 EST Mon. through Sat. and liaison to the 4RN, BJI, Polk County EC, has accepted the post of chairman of Red Cross Radio Communications. K4CIT is operating amateur TV in the Daytona Beach Area. The Jacksonville Amateur Radio Society is sponsoring on-the-air code practice sessions Mon. and Fri. at 2000 EST on 3675 kc. RNS has qualified for her WAC certificate. LJM has a new Communicator III, COZ as a v.h.f. converter for his NC-300. IYT and yours truly made the Silver Springs Hamfest and had a wonderful time. PFX has a new DX-100. The Manatee Amateur Radio Club now has a new club room, thanks to the local Police Dept. at Bradenton. The Miami Springs Radio Club set up a complete station at the Governors' Conference in the Americana Hotel and handled 129 messages. The Dade County C.D. Communications Department graduated more than 50 new amateurs from the class completed in June. A new class will start for both Novices and Generals in September. The hurricane season is here, fellows, so let's get our emergency equipment in good shape. Contact your local EC for information on how you can help out. The AREC is for every ham whether a member of the League or not. Don't forget, *Florida Skip* has been out for a year now so send in your renewals. Traffic: W4IWM 520, K4DSN 511, SJH 509, KDN 225, ILB 200, LCF 187, AKQ 153, OSQ 129, RBJ 113, W4TAS 91, K4AHW 90, COO 76, BLM 69, W4IYT 69, K4EXN 62, BNE 53, AEE 48, MEU 44, BR 33, W4LDM 33, K4ODS 30, W4FF 25, BWR 23, DVR 23, K4JZ 17, W4SIZ 15, K4IWT 11, MTP 11, SLR 11, W4BJI 10, KZT 6.

WESTERN FLORIDA—SCM, Frank M. Butler, Jr., W4RKH—SEC: PQW, RMs: AXP and BVE. Among the Western Florida hams attending the Mobile Hamfest were PQW, DDD, SOI, OOW, MFY, RKH, GSK, CUC, 5HRY, IDX and SZIL. Okaloosa County RACES participated in Operations Alert May 6-7. Among those active were JFL, MFY, SJT, JUA, FEJ, BZW, RKH, BPJ, BVE, CUC, GSK, UBR and UXW. Pensacola, Ft. Walton and Panama City hams furnished communications for a boat cruise of about 60 boats May 31-June 1. Those heard were DDD, PIQ, IVD, OOW and QOQ in Pensy.; MFY, SMM, RKH, BPJ, GSK, SJT, JUA and 5HRY in Ft. Walton; QVL in Seagrave Beach; and COR and HQG in Panama City. OLD is back on with a new Globe

(Continued on page 134)

SAVE 33¹/₃ - 50% on LAFAYETTE KEYS and AMATEUR EQUIPMENT

NEW! SEMI-AUTOMATIC "BUG" SUPER SPEED TELEGRAPH KEY

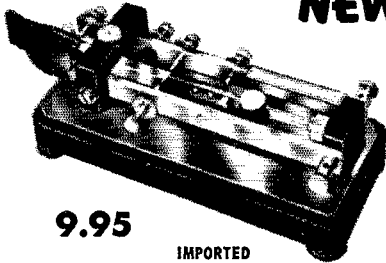

9.95

IMPORTED

Fully the equal of keys selling at almost twice the price! 7 adjustments for speed and comfort, so important in developing the right timing when using a "bug". Heavily weighted with solid steel block in base. Speed adjustable 10 wpm to as high as desired. 1/8" silver contacts; weight scale for reproducible speed settings. A real bargain for radio amateurs and professional CW operators! 6 7/8" long x 3" wide x 2 1/4" high, exclusive of knobs and feet. Shpg. wt., 3 1/2 lbs.

MS-435 Semi-Automatic "Bug" Net 9.95

NEW! CODE PRACTICE SET

Economical and practical code practice key and buzzer unit for learning code. Telegraph key chrome and nickel plated with both adjustable spring tension and contact clearance. The high frequency buzzer has frequency adjustment with locknut to keep tone constant. Screw type pin jack terminals for headphone connection. Works with inexpensive 1 1/2 volt battery. Heavy black molded phenolic base and buzzer housing. Base 6 3/4" x 2 3/4" x 1 3/4", overall length 8 1/2". Shpg. wt., 2 lbs.

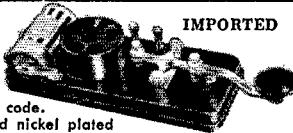

IMPORTED

BATTERY Burgess 213
MS-369 Stethoscope Headset 1.69

MS-438 Code Practice Set (less battery) . 1.95

NEW! Miniature Panel Meters

- D'ARSONVAL MOVEMENTS
- JEWELLED BEARINGS
- ONLY 1-9/16" SQUARE FACES
- ACCURACY 2% OF FULL SCALE



IMPORTED

UNUSUALLY LOW-PRICED FOR SUCH EXCELLENT QUALITY



IMPORTED

Ruggedly built miniature panel meters having zero adjustment screws, silvered dials, black numerals and clear glass fronts. Shpg. wt., 8 oz.

"S" METER — Standard "ham" signal strength indicator. A 0-1 ma dc meter calibrated in S units from 0-9. Scale terminals in +10 and +30 db calibrations and also fully calibrated linearly 0-5 and 0-10.

TM-11 S Meter Net \$3.95

VU METER — Volume level indicator calibrated in standard — 20 to +3 VU and 0-100% ranges. Indicates output level with complex audio wave-forms. Standard VU meter damping.

TM-10 VU Meter Net \$3.95

0-1 DC MILLIAMMETER — Calibrated in .05 mg divisions on a linear scale.

TM-400 Net \$3.75

0-50 DC MICROAMMETER — Calibrated in 1µa divisions on a linear scale.

TM-20 Net \$4.95

0-150 AC VOLTMETER — Rectifier type, 1000 ohms/volt.

TM-300 Net \$3.75

0-15 DC VOLTMETER 1000 ohms/volt

TM-100 Net \$3.75

0-200 DC VOLTMETER 1000 ohms/volt, linear scale

TM-101 Net \$3.75

NEW MINIATURE HIGH SENSITIVITY MULTITESTER

20,000 OHMS PER VOLT DC — 10,000 OHMS PER VOLT AC

A terrific buy in a hand-held, compact, light, accurate, completely wired instrument. Has a 36 µA movement, 1% precision resistors and simple selector switch with calibration markings protected against wear. Scales: Volts DC and AC; 0-5-25, 100, 500, 1000; Ohms: 0-6K-600K-60 Meg; DC Current; 0-50 µA- 5-50-500 MA; Decibels — 20 to +64 in 5 ranges. Size 4 3/8" x 2 3/8" x 1 1/4". Shpg. wt., 1 lb. Complete with batteries and test leads. Imported to save you money.

AR-660 Miniature Meter..... Net 22.50

IMPORTED

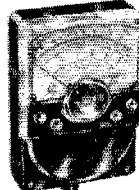

CLEAR PLASTIC FACE COVER

NEW! LAFAYETTE "BRASS-POUNDER'S" KEY

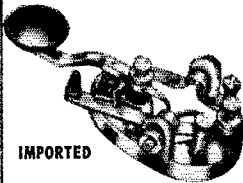

IMPORTED

- With Ball-Bearing Pivots
 - Solid Polished-Brass Base
- A better quality precision-made key designed for hard usage. Polished brass base; spring tension and contact clearance adjustments; 3/16" silver contacts. Base 3" x 2"; overall size 5" long x 2 3/4" wide x 1-1/16" high. Shpg. wt., 1 1/2 lbs.

MS-428 Telegraph Key Net 1.95

SAVE ON NEW! TELEGRAPH KEY

LAFAYETTE SPECIAL



79c

IMPORTED

Economical and practical code practice key. Solid, heavily chrome and nickel plated metal parts, molded phenolic base. Adjustable spring tension and adjustable contact clearance. A real buy! Base 3 1/4" long x 1-13/16" wide. Overall length 5"; height 1 3/4". Shpg. wt., 12 oz.

MS-319 Telegraph Key Net .79

NEW! high frequency CODE PRACTICE BUZZER

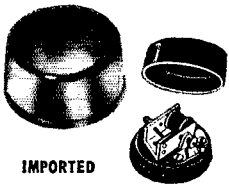

IMPORTED

Reg. Value 2.50
Adjustable frequency buzzer ideal for individual or group code practice. Black molded phenolic housing — Works with 1 1/2 volt battery. Screw adjustment for changing tone. 1 7/8" diam. x 1-1/16" high. Shpg. wt., 6 ozs.

MS-436 Buzzer Net .79

Lafayette Radio

DEPT VH

165-08 Liberty Ave.
JAMAICA 33; N. Y.

Include postage with order.

100 SIXTH AVE., NEW YORK, N. Y.
BOSTON, MASS., 110 Federal St.
PLAINFIELD, N. J., 139 West 2nd St.
NEWARK, N. J., 24 Central Ave.
BRONX, N. Y., 542 E. Fordham Rd.

from



FORMERLY WRL Electronics

A Complete Transmitter with

3 MODE OPERATION

AM - CW
SIDE BAND



\$11995 \$13995

Kit: Wired & Tested

Bandswitching 10-80M, 100w (PEP) DSB input, suppressed carrier, 40w AM; 50w CW

Sidebander DSB-100

Barefoot or piggy-back, this unique sideband Xmtr. can be used simply with your present AM equipment, using standard crystals and regular VFO. Exclusive automatic balancing and floating grid circuit holds carrier suppression to 35 db or better. Continuous band coverage 3-9mc and 12-30mc. Three stage RF section allows straight through operation for max. efficiency. Internal tone generator facilitates tuning. Pi-Net 52-300 ohms. Speech clipping & filtering assures powerful communication punch and narrow band width. Provisions for Antenna Relay Control. Ceramic switches throughout. Forward Look.

VOX Designed for the DSB-100, the Globe VOX plugs into socket at rear of Xmtr. Extra contacts for aux. circuits. W/T: \$24.95 Kit: \$19.95

QT-10 Plugs directly into VOX unit. Wired & tested only. \$9.95

Globe's VFO755A

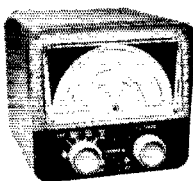

Ideal for use with the Sidebander, the 755A is well-filtered and self-contained. Covers 10-160M, with output on 40 & 160M. Improved vernier dial drive with shock absorption. 13:1 tuning ratio. Voltage regulation. Approx. 50V RF output. Will drive oscillator stage of any Xmtr. on market; plugs into Xtal. socket. Temp. compensated for stability for SSB or DSB. Calibrate switch for zero beating. New. Forward Look.

W/T: \$59.95
Kit: \$49.95

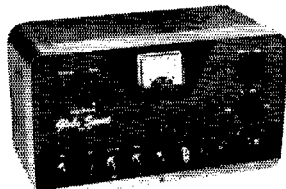

Globe Scout 680A

6-80M Transmitter
65w CW; 50w AM

W/T: Kit:
\$11995 \$9995

Plate Modulated

The Scout Xmtr., housed in the Forward Look cabinet, TVI-shielded, is bandswitching 6-80M, with built-in power supply. High level modulation maintained. Pi-Net output on 10-80M; Link-Coupled on 6M, matching into low impedance beams. New type, wide view shielded meter. Kit complete with all parts, tubes, pre-punched chassis & detailed instructions.



Power Booster PB-1

For All 680 Series Scouts

The PB-1 allows straight through operation on 6M; 50% more power output, \$21.95 while attenuating harmonics and further. Kit: \$14.95 suppressing TVI.

SEE THE COMPLETE GLOBE ELECTRONICS LINE

In Chicago, its

Green Mill Radio Supply

145 West 11th - Chicago, Illinois

TRADE-INS • BUDGET PAYMENTS
COMPLETE STORE OF AMATEUR EQPT.

Scout in P. C. APE reports the 2-meter C.D. Net in Tallahassee is going strong. New officers of the Eglin Radio Club are SM1M, pres.; MFY, vice-pres.; RKH, secy.-treas.; BFJ, act. mgr.; K9KPU, editor, PIQ and QCY. are now Gen. Chas. in Pensacola. K4OPS has moved to Pensy from Tallahassee and is on with a DX-40 and a trap vertical. FLI reports only 2 openings on 6 meters in May. FAA keeps getting the DX with a new Vilking 300. Traffic: W4BYE 21.

GEORGIA—SCM, William F. Kennedy, W4CFJ—SEC.; K4AUM, PAMs: LXE and ACH. RM; PIM. GCEN meets on 8995 kc. at 1830 EST Tues. and Thurs., 0800 Sun.; ATLCW on 7150 kc. 2100 EST Sun.; GSN Mon. through Sat. at 1900 EST on 3995 kc., PIM as NC; the 75-Meter Mobile Phone Net each Sun. at 1330 EST on 3995 kc., U/H as NC; Atl. Ten-Meter Phone Net each Sun. at 2200 EST on 29.6 Mc., VHW as NC; GTAN each Sat. at 1000 EST on 7290 kc., K4ORR as NC; GPYL Net each Thurs. on 7260 kc. at 0900 EST, K4HF as NC. The GPYL has K4GCK, K4CYV, K4HSC/4, KN4TYE and K4UCB as new members. Three Georgia Peaches won prizes at the very successful Atlanta Hamfest. On May 18 the South Georgia Rag Chewers had a fine picnic at Thomasville, Ga. K4LBC moved into his new shack and the same day high winds destroyed his antenna. K4SDL has dropped her "N." K4DWF graduated from GMA. FGH has a "Thunderbolt" on the air. BXV was the nation's southernmost ham for a few minutes while he was in Key West, Fla. K4CZQ's No. 2 girl was born May 29. ISS finished modification of the BC-625. The Albany Radio Club enjoyed a nice weiner roast at Chelaw Park this month. K4LEM worked all Government stations on Armed Forces Day. The Georgia Tech. IRE Chapter's officers are VZR, pres.; HBO, vice-pres.; TKG, secy. K4ANZ won an HQ-160 at the Atlanta Hamfest. Traffic: K4MCL 283, LVE 277, W4ETD 163, K4OQY 154, FCJ 101, C7Q 85, K2P 66, W4ZWT 47, K4KIV 37, HOU 28, LEM 22, W4BXV 14, K4APC 5, W4IPV 2.

CANAL ZONE—SCM, P. A. White, KZ5WA—The annual Canal Zone Civil Defense Practice Alert was conducted May 6. VR, EP/M, QA/M and KJ/M provided communications on 28.9 Mc. RU, RM, BG and JJ operated portable transmitters on 28.9 Mc. to provide walkie-talkie links to field units in the Emergency Net, which fired up to aid the Control Point Commanders and the Civil Defense Director, Mr. Phil Dade. W3ACH, here on business, maintains schedules on 15 meters back home through HG, W3RIH and W3GXR. RM is Stateside on business for the Panama Canal Company. HO and WZ have new Mosley 1r-band beams up. CN will have a new Phasemaster 1L S.S.B. exciter and high-powered final. BB has a fine collection of c.w. DX QSL cards gathered mostly on 20 meters since he arrived here. EL is on vacation in Puerto Rico and the U. S. New stations in the Canal Zone are RD and LLN. New operator licensees are Kenneth Schroeder and Hoss L. Orbach. Traffic: KZ5HA 90, JS 90, HO 70, VR 34, EL 27, WA 15, BB 12.

SOUTHWESTERN DIVISION

LOS ANGELES—SCM, Albert F. Hill, jr., W6JQB—SEC.; W6LIP, RMs: W6BHG and K6HLR. PAMs: W6ORS and K6BWD. BPL was earned this month by K6MCA, W6GYH, K6HLR and W6ZJB. Congrats! K6KYJ is getting the rig working again on 80 and 40 meters. K6MKG is the new EC for the Barstow-Victorville Area. New officers of the San Gabriel Valley Radio Club are W6SRE, pres.; W6UXV, 1st vice-pres.; W6GMC, 2nd vice-pres.; W6BUK, secy.; K6OON, treas. K6PLW is back on the air both at home and mobile. K6IYJ picked up a new one. F8R, K6OQD received a Public Service Award. Congrats. Jean! K6DDO and W6QL worked hard and completed WAZ. Nice going, fellows! K6QMK is putting up a new eight-element beam on 8 meters. K6QPG and W6PHO are doing bang-up jobs as OG working on those harmonics. K6EA is working as relief "Sparks" on the SS *Catalina*. Congrats to the Ramona Radio Club, which received a "Certificate of Award for Community Service," in connection with the 1958 Community Chest Campaign. K6HSQ has moved into the Los Angeles section from Texas, where he was W5DAO. Wha' happen to W6CAN? Support your section nets—on c.w., the Southern California Net at 1930 PDT on 3600 kc.; on phone, the Southern California 6 Net on 50.4 Mc. at 1900 PDT. Traffic: (May) K6MCA 1259, W6GYH 865, K6HLR 822, W6ZJB 615, K6OZJ 407, W6BHG 262, K6PQM 211, K6KZY 209, K6JQB 192, K6HVC 138, W6HLY 78, K6OQD 57, K6QMK 44, W6JQB 35, K6GCC 34, W6RUK 25, W6VSH 20, W6USY 18, K6GUZ 12, K6COP 7, W6CIS 6, K6IYJ 5, W6SRE 5. (Apr.) W6VSH 8.

ARIZONA—SCM, Cameron A. Allen, W7OIF—SEC.; YWF, PAM CSN, 3895 kc.; NYT, Look for SUI, Phoenix, on 420-Mc. TV. When in Yuma County remember they monitor 3885 kc., the frequency used by the Yuma County

(Continued on page 136)

PLYTUBULAR CONSTRUCTION

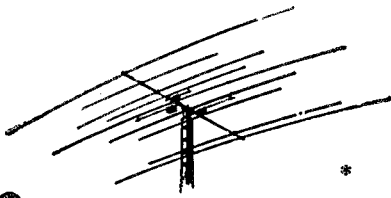

*Sooner or later
you too will switch to*
TENNALAB
for The Dean of Beams

AIR IS THE BEST INSULATOR

- No Traps, Coils, Baluns or Gadgets
- No Inefficient Single Line Feed.
- No Insulators at Points of High Voltage.
- No High SWR—Even at Band Edge.
- No Element Tuning—All Fixed and Full Size.
- No Excessive Weight—Only 67 lbs.*
- No Ungrounded Elements Exposed to Lightning.
- No "Special Method" Ratings.
- No Plastic to Support or Insulate Elements.
- No "Headaches".

THE 9L-101520RG IS A BETTER BEAM ON 10, 15 AND 20 THAN THE AVERAGE STACKING OF THREE SEPARATE SINGLE BAND BEAMS HAVING 8 DB GAIN AND 24 DB F/B. ALL THREE TUNERS REACHABLE FROM THE TOWER FOR UNITY MATCHING.



PLYTUBULAR CONSTRUCTION IS A PROCESS OF FABRICATING MULTI-PLY ALUMINUM BOOMS AND ELEMENTS, PERMITTING SMALLER DIAMETERS FOR GREATER STRENGTH AND LESS ICE LOADING, WIND LOADING, VIBRATION AND TORQUE.

*Investigate
before you
Invest!*

CATALOG NO.	BANDS	AMATEUR NET
9L-101520RG*	10-15-20	\$217.50
6L-1015RG	10-15	105.00
6L-1020RG	10-20	157.50
6L-1520RG	15-20	165.00

ALSO A COMPLETE LINE OF SINGLE BAND BEAMS FOR AMATEUR AND COMMERCIAL USE.

2 METER CORNER REFLECTORS AND YAGIS AVAILABLE SOON
SEE YOUR DISTRIBUTOR OR WRITE—

TENNALAB - QUINCY, ILL.

It's Here! From the House of "Surprise" Trade-Ins

NEW FREE CATALOG

of EVERYTHING in RADIO, TELEVISION and ELECTRONICS for
Amateurs • Schools • Industry • Experimenters • Technicians

144 Pages—"THE TREASURE CHEST OF VALUES"

Features today's best buys! Enables you to select the new, big name communication equipment of your choice at amazing savings! Here's how: Tell us what used, factory-built communication or test equipment* you have to trade. Back will come our "Surprise" trade-in offer. So act now!

*Manufactured since 1945

For the "Surprise" of your Life
Get your FREE Copy Today

**USE HANDY
COUPON**

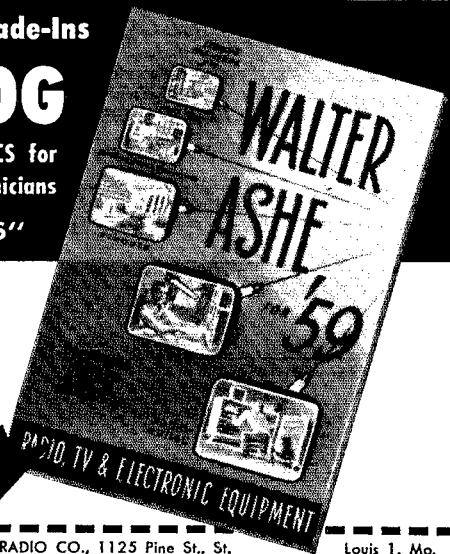

Walter Ashe
RADIO CO.
 1125 PINE ST., ST. LOUIS 1, MO.

WALTER ASHE RADIO CO., 1125 Pine St., St. Louis 1, Mo.

IN OUR 37TH YEAR Q-8-58

Rush New Catalog

Send latest lists of guaranteed Used Equipment

Rush "Surprise" Trade-in offer on my _____

For _____ (show make and model of new equipment desired)

Name _____

Address _____

City _____ Zone _____ State _____

NEW CATALOG

from the NEW RADIO SHACK



RADIO SHACK'S NEW MAIL ORDER HEADQUARTERS

80,000 Sq. Ft. Plant—Features conveyor belt order picking, comprehensive inventory . . . in depth . . . plus electronic order processing guarantees speediest service to any part of the country or overseas!

1959 RADIO SHACK CATALOG!

232 Pages FULL of Vital Listings for:

- Schools — Labs
- Hobbyists
- High Fidelity
- Experimenters
- Servicemen
- Amateurs

EXPANSION SALE!

ONE MONTH ONLY



ARCHER HI-FI

\$1.09

CRYSTAL EARPHONES

Magnificent headset is light as a feather. Weighs less than one ounce, yet outperforms more costly cumbersome units. 60 to 15,000 cps, 70 KΩ imp.
Order No. R-8241D\$1.09

DUAL XTAL EARPHONES

As above with the addition of an extra crystal unit.
Order No. R-7010D\$1.89

Radio Shack Corp. Dept. 8D

730 Commonwealth Avenue, Boston 17, Mass.

Send R-8241D Headsets @ \$1.09 ea.

Send R-7010D Headsets @ \$1.89 ea.

Please send Free Catalog.

Name _____

Address _____

City _____ Zone _____ State _____

Stores: 167 Washington St., Boston, Mass.
230 Crown St., New Haven, Conn.

Net. The *Desert-Rabbit* is published each month by the Yuma County Radio Club. Its editor is CIX; asst. editor KN7DHI; production IPA. 9PMV.7 is a new call in Yuma. K7BDD is sporting a new HQ-160. May 30-31 and June 1 the big Montezuma Well Hamfest was held with the usual large turnout. W5- and W6-Lands were well represented as in the past. This is the last year that this get-together will be held at Montezuma Well. Next year it will be put on by the Prescott Radio Club at a new location. Traffic: W7OIF 24, CAF 6.

SAN DIEGO—SCM, Don Stansifer, W6LRU—W6IAB, at Camp Pendleton, made a traffic count for May of 2567 with only one operator, the highest single-operator count ever made in this section. W6SRQ enjoyed a vacation in New England and visited ARRL Headquarters while he was there. K6RQM has a new three-element beam on 21 Mc. K6EQL has a new tri-band quad operating. KN6IYK sends in a nice traffic report, with 4 net affiliations in the 2-meter band, from Anaheim. The June meeting of the San Diego DX Club was held at the home of W6KYG in Poway. W6CDF is back in town after a trip with the Navy in the Pacific. The Helix Club held Field Day in the Laguna Mountains at an elevation of over 6000 feet. W6OME flew to Annapolis to see his son graduate from the Naval Academy. K6IIR graduated from Pt. Louna High School and plans to attend Cal. Tech. W6JWS lost the "N" in his license. He is building a Heathkit Apache. W6AKY recently celebrated his 81st birthday. W6LRU vacationed in the High Sierras for two weeks with his father. W6MIT was inducted into the Army on June 30. W6RAN becomes the 10th member of the San Diego DX Club to work 200 countries. K6BPI received an ARRL special award for work done when a small child was lost in the desert area last January. New Novices at Dana Junior High are KN6UKQ, KN6UNS and W6ABA. Traffic: W6IAB 2567, W6EOT 411, W6YDK 308, KN6IYK 115, W6KVB 25, K6EQL 13.

WEST GULF DIVISION

NORTHERN TEXAS—SCM, Ray A. Thacker, W5TFP—Asst. SCM: E. C. Pool, 5-NFO, SEC.: BNG. PAMs: K5AEX and IWQ. RM: ACK. New appointees are ONL and ONQ as OOs, PVT and ONQ as OBSs, K5DNQ as ORS. ONL is new to this area from St. Louis. K5s EVU and EVS recently were honored during Armed Forces Day by Dyess Air Force Base in Abilene for the very commendable job of traffic-handling and services rendered. K5DNQ, working away at the ZLs on 15 meters with the tremendous power of three watts, actually made a QSO! HTH reports things are as usual with the Amarillo boys. LR is now a proud OM! His XYL has the call KN5QFA. AAU advises there are 15 stations on 6 meters in the Denton Area. GVS reports from Midland a new Novice call, KN5QPK; also that GBQ is the new EC and that ODH is back on the air after a hospital session. PXV is new to the Dallas Area from Nebraska. GY sure is doing a bang-up job of traffic-handling on c.w. KN5POP reports eighty contacts in fourteen states so far. NFO, our assistant, suggests that we need more OBSs in the Panhandle-South Plains Area. If interested, contact either of us and we will put you to work!! The Dumas ARC is now an ARRL Affiliated club! Have you "browsed" through the FCC regulations lately? Traffic: W5GY 255, BKH 250, SMK 192, BOO 111, K5HTH 58, PXV 36, ILL 27, EMR 21, W5AYX 20, K5DNQ 18, ACD 16, BZH 16, W5RVI 12.

OKLAHOMA—SCM, Richard L. Hawkins, W5FEC—SEC: LXH. PAMs: K5INC and MFX. RM: JXM. The new PAM for 7.2 Mc. is K5INC. A new OPS is GOL. K5EGS is being transferred out of the State. IWL won first place in the SS Phone Contest for Oklahoma for the third consecutive year. The Bartlesville Club received favorable comments from the public on a display in a downtown window featuring amateur radio. The Bartlesville TVI committee has been doing an FB job. 4RCM/5 has left for KL7-Land. PWN now has a refrigerated air-conditioned hamshack. The Sooner Nooner Net had 663 check-ins, 110 messages handled and 27 sessions. KCG is now on 50 Mc. K5BKF resigned as secy. of the OCARC TKC was on two weeks Naval Reserve duty. EHC's station was struck by lightning. HXT has a new vertical. Skip and noise are disrupting the nets, making it doubly important that good operating procedures and techniques be used. Oklahoma Hams of the Month: IWL and K5BNQ for their good operating and general hard work on behalf of amateur radio. Traffic: W4RCM/5 170, W5KY 67, MGK 50, K5INC 44, EGS 41, W5CCK 34, FKL 29, FEC 28, QBX 24, VLV 24, MFX 23, K5CBA 18, DJA 17, W5GOL 15, ERI 14, PNG 12, BBA 10, EHC 9, IER 9, IWL 9, K5BNQ 2.

SOUTHERN TEXAS—SCM, Roy K. Eggleston, W5QEM—SEC: QKF, RM: FCX, PAM: ZIN. It is with deep regret that we record MRY and CVE as Silent
(Continued on page 138)

QUICK QUIZ

The ANSWERS?

You'll find them all in . . .

- Q. What are the procedures to be followed in renewing an amateur station and operator license?
- Q. How do U.S. amateurs obtain authorization to operate in Canada?
- Q. Who may operate an amateur radio station?
- Q. What are the requirements for portable and mobile operation?

Complete FCC and International Rules and Regulations governing amateur radio . . . detailed explanations on amateur licensing covered in separate chapters . . . and, of course, separate study guides for all amateur operator examinations. . . .

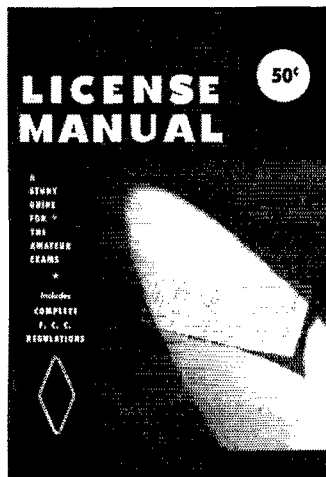

THE AMERICAN RADIO RELAY LEAGUE

West Hartford 7, Connecticut

*50 cents
postpaid*

CHECK YOUR QSLS

WITH **DXERAMA** ✓

Second Edition

So Many Hams Have DX Operating Awards Earned **AND DO NOT KNOW IT!**

Nearly 50 DX Awards with up-to-date rules and regulations as offered by Ham Radio Organizations in all six continents; fully spread in log form, well indexed, 8½" x 11", 72 pages. Compiled by W3AXT.

\$1.60 U.S.A. & Possessions

\$1.85 Foreign

Order from your Distributor or direct from

DXERAMA 1101 Farmingdale Rd., Lancaster, Penna.

EASY TO LEARN CODE

It is easy and pleasant to learn or increase speed the modern way — with an **Instructograph Code Teacher**. Excellent for the beginner or advanced student. A quick, practical and dependable method. Available tapes from beginner's alphabet to typical messages on all subjects. Speed range 5 to 40 WPM. Always ready, no QRM, beats having someone send to you.

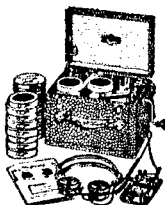

ENDORSED BY THOUSANDS!

The **Instructograph Code Teacher** literally takes the place of an operator-instructor and enables anyone to learn and master code without further assistance. Thousands of successful operators have "acquired the code" with the **Instructograph System**. Write today for full particulars and convenient rental plans.

INSTRUCTOGRAPH COMPANY

4709 SHERIDAN ROAD CHICAGO 40, ILLINOIS

MOSLEY TRAPMASTER

Model TA-33
for 10, 15 and 20

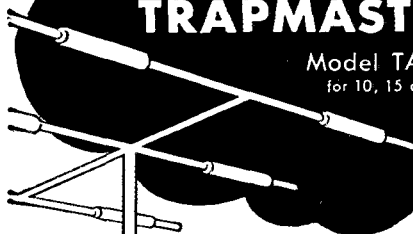

Aluminum Elements AND Boom

STRONG!

No boom braces needed!
No noticeable sag!

Mosley Electronics, Inc.

8622 St. Charles Rock Road • St. Louis 14, Mo.



FORMERLY WR1 Electronics

presents . . . the

Sidebander DSB-100

Kit: \$11995
W/T: \$13995

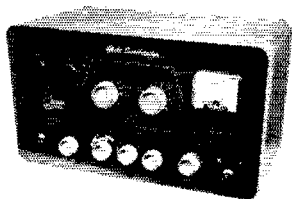

A Complete Transmitter for 3 MODE OPERATION AM - CW SIDEBAND

40w AM; 50w CW
100w P.E.P. DSB
Input, Suppressed
Carrier

Barefoot or piggy-back, this unique sideband transmitter can be used simply with your present AM equipment, using standard crystals and regular VFO. Exclusive automatic balancing and floating grid circuit holds carrier suppression to 35db or better. Continuous band coverage 3-9mc and 12-30mc. Three stage RF section allows straight through operation for max. efficiency. Internal tone generator facilitates tuning. Pi-Net 52-300 ohms. Speech clipping and filtering assures powerful communication punch and narrow band width. Provisions for Antenna Relay Control. Ample power reserve for external accessories at socket on chassis rear apron. Forward Look.

VOX

Designed for the DSB-100, the Globe VOX plugs into socket at rear of Xmtr. Extra contacts for aux. circuits.

W/T: \$24.95 Kit: \$19.95

QT-10

Plugs directly into VOX unit. Wired & tested only. \$9.95

Hand in Hand with Globe's New

VFO 755A

SUCCESSOR TO THE 755

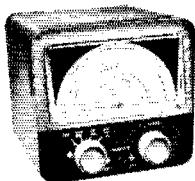

Ideally used with the Sidebander, the 755A is well-filtered and self-contained in the new Forward Look Cabinet. Covers 10-160M. with output on 40 & 160M. Improved vernier dial drive with shock absorption. 13:1 tuning ratio. Voltage regulation. Approx. 50V RF output; will drive oscillator stage of any Xmtr. on the market; plugs directly into Xtal socket. Temp. compensated for stability for SSB or DSB. Calibrate switch for zero beating.

Kit: \$4995 W/T: \$5995

SEE THE COMPLETE GLOBE ELECTRONICS LINE AT

Rogers Radio Company

"HAM HEADQUARTERS FOR THE ROCKY MOUNTAIN EMPIRE"

1648 WAZEE

DENVER, COLO.

PHONE TABOR 5141-42

10% Down; Up to 18 mos. to Pay

Keys. They will be missed by their many friends. K5LIU made 130 contacts in 43 sections in the April CD Party. She has moved to a new QTH at La Marque where she will have more room for antennas. EBY and family have moved to San Diego, Calif. RPH and his XYL are moving back to Corpus Christi after serving in the Air Force in Little Rock, Ark. TEL greeted friends in South Texas while on furlough from the Canal Zone. BOY is operating as XE0BOY while vacationing in Mexico. The STS C.W. Net is meeting with the NTX during bad band conditions for the summer. K5BYV was heard mobiling in Corpus Christi while on vacation. K5CPA is a recent graduate from Roy Miller High School. K5PEQ is the new activities manager for the Baytown Amateur Radio Club. K5BJU has a new Thunderbolt. BOY also is burning up the airways with a new Thunderbolt. LRQ and family are vacationing in North Texas. K5OQN worked 70 stations on 6 meters May 25. He worked 180 stations in 22 states during May. Congratulations to ZIN on making BPL for the second month. The 7200 Net had 43 sessions, with 1172 stations and 742 messages. EDG sent 10 ARRL bulletins in May on c.w. How about some news as things are getting dull because of vacations. Traffic: W5UMY 241, ZIN 217, FCX 214, EGD 199, K5BYV 174, W5NXX 30, QLT 7.

CANADIAN DIVISION

MARITIME—SCM, D. E. Weeks, VE1WB—Asst. SCM; Aaron Solomon, 10C. SEC: AEB, PQ is the second to make the WAZ Honor Roll for the Maritimes, not PZ as originally reported. New calls include PB, AET and VO2EB. OD has moved from Oromocto to Sydney. OC recently vacationed in the VE7 district. Aaron reports that he was able to arrange schedules with ELIH for direct handling of emergency information. VJ, ex-VE0NE, has been posted to Churchill, Man. Newly-elected officers of the FRAC are LS, pres.; OQ, vice-pres.; VU, secy.-treas. ES now has a DX-40. DX addicts are reminded that they should keep in touch with FQ if they expect to receive those rare cards. Brit has many awaiting delivery. A stamped self-addressed envelope forwarded to him will do the trick. OM and WL have a 6-meter circuit set up with ABV on Sable Island. Don't forget the Convention to be held at Truro during the Labor Day week end. Please assist the Truro Club by registering in advance. See you there. Traffic: VE1VN 66, ABJ 32, OM 22, GM 16, AAR 12, VO2NA 9, VE1AEB 6.

ONTARIO—SCM, Richard W. Roberts, VE3NG—My sincere thanks to all who so kindly helped to reelect me as SCM. By the time you read this you will have had a wonderful time on Field Day. Some of our clubs were absent from Field Day this year because the date conflicted with that of the North Bay Hamfest. Our National Holiday also fell on that week end. KM has returned from W6-Land; he also visited the Sault Ste. Marie Club. The Hamilton ARC is going great guns with plans for the ARRL Ontario Convention to be held Oct. 18. RE is in good health again. More than 50 mobiles are active on 75 meters in the Metro Toronto Area. The Quinte ARC has its club transmitter on the air with the call BSQ. The St. Clair Valley ARC has an FB program lined up for the balance of '58. Movies are on loan from the U. S. Army. The Nortown ARC elected BQT, pres.; HB, vice-pres.; EGW, rec. secy.; BOF, corr. secy.; KA, treas. VE80W/VE3BOH has returned from the Arctic. The St. Thomas Civil Defense group visited the Sarua Club recently. The Ottawa ARC held a successful dinner June 6. CJ heads the Ontario Amateur Radio Federation (or TVI). The secretary is DAR. DSX visited AJR at Leamington. Traffic: (May) VE3UCX 256, BUR 129, NG 94, DPO 88, AUU 70, EII 66, DTB 59, BJV 57, BZB 39, KM 38, AML 37, EAM 24, EAU 22, AOE 13, AES 12, DEX 9, DH 6, SG 6, DLC 5, CE 4, ELC 4, AVS 3. (Apr.) VE3SG 2.

QUEBEC—SCM, C. W. Skarstedt, VE2DR—APR snagged HH70G on 75-meter phone. He also received appointment as Sherbrooke Area EC. AHK, AGI and AOL are consistent mobiles on 75 meters. VE is planning to go to 2 meters. JA is back on 75 meters. S.s.b. notes: JS has a fine signal using a KWS-1. AN is on with 100 watts. IQ is using home-brew. BG is active. QA is proud of WAC using 20A. WV is the first VE2 to apply for a WAZ certificate. YU led all VEs in the RSGB Phone Contest. GE is rebuilding to reduce the big local signal from YA. The South Shore Club arranged a fine evening to celebrate BG's 50-year ham anniversary. APO at Terrebonne, is a newcomer. AIL hopes to join APC for a Volkswagen trip to Washington, D. C. AWR, at Rawdon, is hooking DX on 80-meter c.w. ABE and NP discuss astronomy during weekly skeds. AWK expects to take a 2-month vacation to Edmuntson, N. B. AZS likes the new AR-88 for DX. Traffic men are bemoaning the poor 80-meter early evening conditions and c.w. men may move to 7 Mc. AAR also held the experimental call

(Continued on page 140)

3 COGENT REASONS WHY YOU SHOULD USE THE NEW DELUXE TECRAFT 1 1/4, 2 and 6 METER CONVERTERS

1 OUTSTANDING PERFORMANCE

Finest engineering — best design techniques — years of experience — all assure you of Tecraft's superior performance.

2 BEST DOLLAR VALUE

Critical comparison of technical features, constructional details, wiring and components reveals Tecraft is your best buy!

3 THE ULTIMATE IN HIGH SENSITIVITY

Proved on every communication band from 50 through 220 mc.

- SPECIFICATIONS**
- 1/10 uv input will provide an output signal at least 6 db above noise.
 - More than 30 db overall gain.
 - Adjustable RF gain to minimize cross modulation.
 - A series tuned trap in antenna input circuit limits I.F. Feedthru. Rejection ratio better than 10000:1.
 - .005% crystals provide maximum calibration accuracy.
 - Extensive shielding and L/C-R/C isolation of power wiring prevents coupling to local RF fields and interference therefrom.

CRYSTAL CONTROLLED CASCODE CONVERTERS FOR AMATEUR, COMMERCIAL AND SPECIAL FREQUENCY APPLICATIONS — USE WITH ANY COMMUNICATIONS RECEIVER.

A Tecraft converter, connected to the antenna terminals of such a receiver, provides the finest reception and control of VHF signals. The resulting system is ideal from the point of view of **LOW NOISE, EXTREME SENSITIVITY, HIGH GAIN AND MAXIMUM STABILITY.** Virtually any receiver may be used, since Tecraft Converters are built with a wide choice of I.F. output frequencies — to suit the tuning range of the receiver.

FEATURES

- Sufficient output to operate several receivers simultaneously.
- Exceedingly low noise figure.
- High signal to noise ratio.
- Freedom from spurious responses.
- Minimum cross modulations
- Maximum rejection of IF feed through.

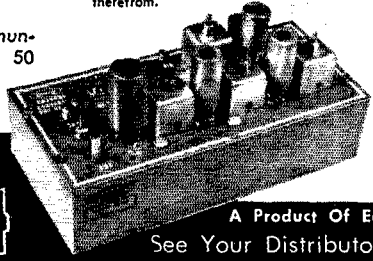

\$44.95

A Product Of Equipment Crafters
See Your Distributor Or Write Us

TRACK THE EARTH SATELLITE!
(Transmission on 108 mc)
Use Model CC 108
\$44.95
Specify if output frequency required.



BOX 116 RIVER EDGE, N. J. COLfax 2-0159

REFLECT-O-MATCH SWR INSTRUMENTATION



A VALUABLE INSTRUMENT, FIXED OR MOBILE!

You furnish simply-constructed indicator. Instructions for indicator and operation included. Economical. Calibrated and guaranteed. Original design by Lewis McCoy, QST, February 1957. See at distributors or write for information to: **\$8.95**

Instructions for indicator and operation included. Economical. Calibrated and guaranteed. Original design by Lewis McCoy, QST, February 1957. See at distributors or write for information to:

D. MOORE CO. 1236 Virginia Ave. Redwood City, Calif.

NEW series 7000 sub-miniature rotary switch

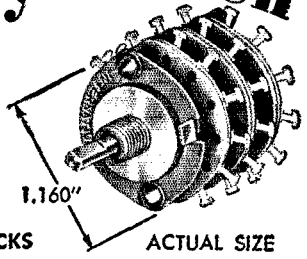

OFFERING UP TO TWELVE POSITIONS PER DECK AND THREE DECKS

Maximum versatility, 1 to 3 decks, wide range of contact arrangements. Specially impregnated glass melamine wafer. Solder type lugs. Positive indexing.

Write FOR ENGINEERING DATA SHEETS ON ROTARY SWITCH AND:

- 1 1/2" Ruggedized Meters; 1" and 1 1/2" Panel Meters; 1 1/2" VU, Db and Illuminated Meters; Miniature Multitesters; and Side Indicators.



international instruments, inc.
P.O. BOX 2954, NEW HAVEN 15, CONN.
Cable "INTERINST"

announcing the **Cubex 3-BAND CUBICAL QUAD**

- EQUALS 3 EL w.s. BEAM
- 8 db GAIN.....24 db FBR
- TV ROTOR HANDLES
- ONLY 16.8" wide - NO STUBS

Dual-band 15-20 \$44.95
Dual-band 10-15 \$34.95
factory prices — f.o.b. arcadia, cal.

— write for brochure 'dx' —

CUBEX CO. 3322 TONIA AVENUE ALTADENA, CALIFORNIA

15 20 10 only \$49.95

Perfect 1:1 SWR

with the NEW **hy-gain**

monobanders

GAMMAXIAL Gamma Match System!



Now a feature of all three monobanders, the new, pre-calibrated (GAMMAXIAL) Gamma Match assembly with coaxially formed reactance cancelling capacitor built-in, makes possible for the first time a perfect 1:1 SWR. Coax connector for 52 ohm feed included. Developed by hy-gain's engineering staff and used exclusively in the hy-gain monobanders.

10M - 3 ELEMENTS



18 lbs.
Boom Length: 104"
Longest Element: 17'10"

\$2495

15M - 3 ELEMENTS

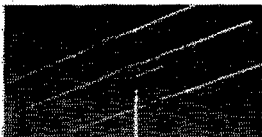

30 lbs.
Boom Length: 142"
Longest Element: 23'10"

\$3495

20M - 3 ELEMENTS



48 lbs.
Boom Length: 212"
Longest Element: 35'9"

\$5995

Carefully engineered, incorporating the latest design principles for top performance, the hy-gain monobanders are factory pre-tuned and pre-matched. Complete with easy-to-follow instructions for assembly, these booms sold with 1 year guarantee. Features include large diameter elements and ruggedly built Boom/Mast clamps. Booms hot dipped galvanized steel for max. strength with minimum wind resistance. Elements 6061T6 alloy. Extremely simple to put up and into operation.

Average Gain: 8½ db. Average F/B Ratio: 24 db.

SEE THE COMPLETE HY-GAIN LINE . . .

Buy it from "THACH", WØQV
at the

Overton Electric Co., Inc.

522 JACKSON ST. • TOPEKA, KANSAS

PHONE

CE 3-3261

VE9JZ and could operate on 152-174 Mc. with F-3 emission. ATL reports success with the DX forecasting project—87 per cent accurate. APC expects to join the 2-meter gang with an eight-element beam and rotor. NV and AIO do a great deal of careful listening for rare 20-meter DX which pays dividends. VA took time off from QSL Bureau chores to build a very fine exciter. U. reported erroneously last month as moving to VE3, remains in the VE2 district. Traffic: VE2DR 91, EC 29, APR 11, YF 6.

ALBERTA—SCM, Gordon W. Hollingshead, VE6VAI—PAM: OD. Circle Aug. 23 and 24, the dates of the Edmonton Hamfest, which it is promised will be the best ever. Your attendance is a must. 2-meter activity in Calgary is due for a big increase. PQ and his construction group are completing their gear. AX has been appointed EC for the Calgary district. The RTTY demonstration by JZ, EN and HMI on C.D. Exercise Group II, was a big success. MJ now is mobile on 75 meters. Traffic: VE6HM 226, OD 17, TT 8, MJ 5, BL 2, VM 2.

BRITISH COLUMBIA—SCM, Peter M. McIntyre, VE7JT—Hope you all had a good Field Day and found a good location. TF our Route Manager, and some of his stalwarts are keeping the BCEN (on 3650 kc. at 1830 to 1930 Mon. through Fri.) going along steadily even under poor summer conditions. ALE will have finished his stint as radio operator on the Mt. Fairweather Expedition so lend him your ear for some humorous recounts of the antics. KX worked VE3KF for the first VK/VE RTTY contact during May. TF is looking for members for 3650 kc. It has been proposed that the BCARA Open Forum be held in Nanaimo Aug. 9 and 10. More information can be had from ALE, the BCARA secy or the Nanaimo gang whose newsy paper adds spice to anyone's reading. However, the editor, AIB, says he is running out of spice. We hear there will be a DX Club Convention in Vancouver during August. If you want any information perhaps it can be obtained from ALR. It could be that it is by invitation only or I have not had any information about it as yet. Hearty congrats to TF on getting his A-1 Operator certificate. Traffic: (May) KG1DT 335, VE7TF 86, ALY 31, AAF 16, AEC 12, (Apr.) KG1DT 235.

MANITOBA—SCM, James A. Elliott, VE4IF—The May c.d. exercise was quite successful with several of the local hams participating. K6SMR, ex-VE4AIY, 4RX would like VE4 contacts on 20-, 15- and 10-meter phone and c.w. JW has found out the secrets of the DX-40. The Dauphin gang is preparing for the hamfest to be held Aug. 30 and 31. Get your reservations in soon to XP. This is the BIG EVENT of the year. Let's swamp them, gang! We wonder what effect the "Great Mortant," 2AHZ has had on the northern tribes? Have been wondering what Four Pussy Willows is growing in his "rock" garden. Glad to hear that XW will be flying again soon. JQ has been working into the net with his mobile. According to TJ, 20 meters is the best DX band these days. Old-timers who have held tickets for 25 years or more and who are interested in joining the North West Old Timers Association, please contact your SCM. Traffic: VE4GE 17, QD 14, JY 10, AY 9, KN 9, AN 8, IF 6, RB 6, JW 4, IW 1.

Image Transmission

(Continued from page 15)

mission. For instance, a club could build a picture transmission unit as a club project, and this could be used to make recordings of the members' slides. Armed with recordings of the pictures he wished to transmit, the individual ham would then only have to build receiving equipment.

Local air tests were made over 1-mile and 7-mile distances on the 11-meter band, under a variety of transmission conditions. K4KYY played the video tape through his plate-modulated a.m. rig, and the signal was received on the NC-300 at W4JP, the University of Kentucky's station. These tests yielded information about the signal-to-noise ratio required for faithful picture reproduction. The figure of interest is the ratio of the sync pulse amplitude of the receiver output signal to the receiver peak noise output when receiving the unmodulated r.f. carrier. When this ratio was greater than about 26 db., the received picture quality was equivalent to

(Continued on page 142)

BANDMASTER Z-MATCH

EVERYTHING YOU'VE EVER WANTED IN AN ANTENNA COUPLER

4 INSTRUMENTS IN ONE UNIT

1. Antenna Matching Unit
2. Forward-Reflected Power Wattmeter
3. R. F. Wattmeter
4. Dummy Load

The Bandmaster Z-Match Antenna Coupler, featuring the improved M. C. Jones Micro-Match Circuit, is a combination antenna matching device, 50 ohm Dummy Load, R.F. Wattmeter, and Forward-Reflected Power Meter, designed to provide high efficiency antenna matching.

The tuning arrangement covers from 3.5 to 30.0 megacycles, while matching a 50 ohm input to reactive and non-reactive loads from 10 to 2500 ohms without switching coils. The R.F. Wattmeter is in the circuit at all times, and the Dummy Load may be used to tune your transmitter before going on the air, in accordance with F. C. C. regulations. The Micro-Match circuit is built-in, with a panel switch to read Forward or Reflected Power.



ONLY \$89.00

AGAIN AVAILABLE — T-90 BANDMASTER TRANSMITTER AND POWER SUPPLIES AND R-9A DOUBLE CONVERSION RECEIVER.

See your dealer — if he can't supply you, you may order direct from factory.

FREE LITERATURE IS AVAILABLE ON REQUEST.

Harvey-WELLS ELECTRONICS, INC., SOUTHBRIDGE, MASS.

SSB •—• SSB •—• SSB

ORDER the Sensational New

100 V TRANSMITTER

and any other

CENTRAL ELECTRONICS Gear

"The Pioneers of Amateur SSB"

600 L-10-B-20-A-MM-2-etc.

SAVE BIG MONEY; write for Bulletin "Getting Started" and "Stepping Up" in SSB. Give your call letters.

Write W9ADN at

ORGANS & ELECTRONICS, Box 117, Lockport, Ill.

**TAPE RECORDED
CODE INSTRUCTION**

TAPEDCODE®

ONE OF THE FINEST CODE COURSES AVAILABLE
NOVICE TAPE. Complete basic instruction and practice material up to 8 WPM. \$6.50
ADVANCED TAPE. Practice material 9 to 18 WPM. Plain language and coded groups. \$5.50
COMPLETE COURSE. Both above tapes. \$11.00

Ppd. in U. S., Possessions and Canada. — Penna. Residents 3% tax. Dual Track 7" 1200' tape. Recorded at 3 1/4 IPS.

See Your Local Ham Distributor. If he doesn't carry them, order direct and give us his name

TAPEDCODE

BOX 31E, Langhorne, Pa.

30 Years of Hatry HAM Service!

● SEPTEMBER 1928 WE STARTED.

England, France, Iceland, Chile, China, Germany, Australia, Ireland, New Zealand, Japan, Italy, Canada, Alaska, Hawaii, Holland, Belgium—

Broadcast stations, ships at sea, all states, schools, Signal Corps, Army, Navy, Air Corps—

ALL Have Used Our Hartford Services

TODAY—4 Hatry Stores:
Bridgeport—New Haven
Waterbury and

HATRY of HARTFORD

203 Ann St., Hartford 3, Conn.

The ELECT in ELECTRONICS

MOSLEY TRAPMASTER

Model TA-33
for 10, 15 and 20

114 LBS. WIND LOAD

computed in accordance
with sec. TR-116—EIA
Standards (formerly RMA)

Mosley Electronics, Inc.

8622 St. Charles Rock Road • St. Louis 14, Mo.

NOW—faster, easier
ball-bearing drive
for GREENLEE
chassis punches

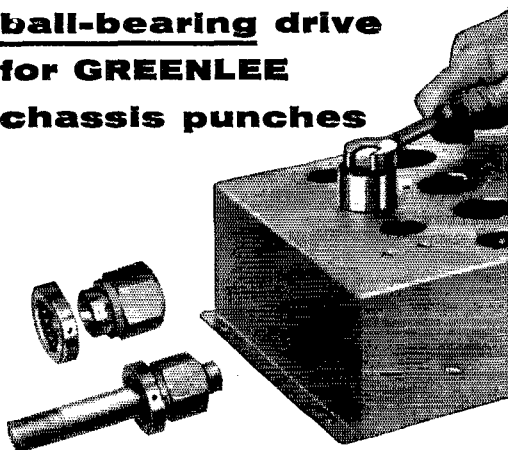

New GREENLEE Ball-Bearing Drive Nuts and Drive Screws reduce friction and make it easier than ever to cut smooth, accurate holes with GREENLEE No. 730 Round Radio Chassis Punches. The new faster drives are available for all round-type GREENLEE Punches sizes 11/16" through 2-25/32". Operate with ordinary wrench for quick socket openings, etc., in metal, Bakelite, or hard rubber.



GREENLEE TOOL CO.
1868 Columbia Avenue
Rockford, Illinois

142

that observed when monitoring transmissions with the picture received fed directly with the outgoing picture signal. With a 20-db. ratio the quality was still good, but with some snow present. When the ratio dropped to about 12 db. the picture contained considerable snow, but call letters could still be distinguished. In all these tests the black level was set at 50 per cent of the sync level.

K4KYY and PJ2AO tried valiantly to make a satisfactory long-distance test, but 11 meters had slipped a little too far into the summer slump for success. Phone signals were only slightly above the noise, and the signal received at W4JP from PJ2AO, who had recorded and played back the signal sent by K4KYY, was well down into the noise. While this test didn't produce conclusive results, the successful operation of conventional a.m. facsimile systems indicates that long distances can be covered if the signal-to-noise ratio is sufficiently high.

The World Above 50 Mc.

(Continued from page 75)

Indiana (near Terre Haute) for the annual Turkey Run V.H.F. Picnic, July 27. See W9ZIL for details.

The Mt. Airy V.H.F. Club of Philadelphia invites you to their Third Annual Picnic, it's Aug. 10, at Fort Washington State Park, Flourtown, Pa.

The Keystone V.H.F. Club is pushing the York area hamfest Aug. 24. They will have 6-meter communication for talking in mobiles. Event is held at Atlands Ranch, off Route 30, about 10 miles south of York, Pa.

V.h.f. activities, including a 6-meter transmitter hunt, will be featured at Cameron Park Club House, Waco, Texas, Aug. 31, when the Central Texas Amateur Radio Club throws its annual hamfest.

Then, of course, there's the Perseids meteor shower, best of them all. Last month we ran some tentative plans in these pages. W6LIT confirms, with no essential change, the schedule printed therein. He will be monitoring 7002 kc. continuously from 2100 MST Aug. 9 on for schedule information. This is a real chance to catch Wyoming and Idaho on 144 Mc. if you get to Don in a hurry.

W7VMP is back in business at Phoenix, Ariz., for the summer, with two of the Fenwick trio still on the job. (W7VMP, himself, is living in California this summer.) Charlie and Bob will keep the Fenwick kilowatt hot on 6 and 2 through the summer, and they are open for Perseids skeds. There is some talk about a trip to the Four Corners (Utah, Colorado, Arizona and New Mexico come together at one spot in the wide-open spaces) area for some 144-Mc. shenanigans.

The World Above 220 Mc.

Throughout all the early days of v.h.f. development, one of the great problems was maintaining activity, so that when you had an opportunity to be on the air you'd find someone to talk with. In most areas we're "over the hump" as far as 6 and 2 are concerned. At least during the times that most hams are free to operate, there is something doing on 50 and 144 Mc. in the more populous areas, though there is still room for improvement.

But on the bands from 220 up we have the age-old problem everywhere, with the possible exception of a few spots where heavy population densities make it possible for the 220-and-up enthusiast to find activity running spontaneously. One way to help the cause along is to set up regular operating schedules for the higher bands. If you can (and will) be on the air at specified times, send us the details of your schedule, and we'll publish it here. The rest is up to you. Remember there's a time lag between the time you write your letter and appearance of the information in these pages — so don't work the schedule for a week or so and then give up. That won't help anyone, including you.

Here's one such 220-Mc. sked. VE3BQN, Toronto, has a go with W3ARW and others in the Scranton area each

(Continued on page 144)

working
**Mobile or Portable
 THIS SUMMER**

Then, your log-keeping needs can be met by the ARRL MINILOG. Convenient, pocket-size, it contains proper headings for all necessary entries. MINILOG will help you comply with FCC regs, provide a lasting record of the many pleasant QSOs you'll enjoy this summer.

Spiral bound, 4" x 6" 30¢
 USA Proper, 35¢ elsewhere

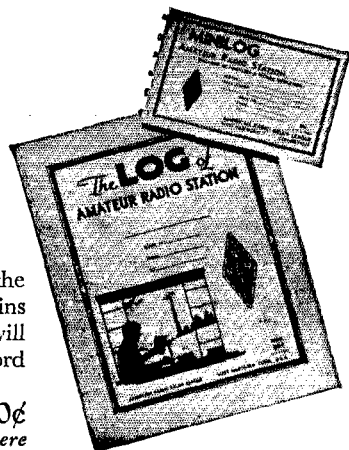

If you prefer more detailed station records, the ARRL Log Book with ruled 8½ x 11 sheets (also spiral bound to lie flat when open), will make record-keeping a pleasure. Useful also for portable or mobile as well as fixed station operation! 50¢

USA Proper, 60¢ elsewhere

These are available in loose-leaf form (punched for 3-ring binders), 100 sheets \$1.00

The AMERICAN RADIO RELAY LEAGUE, INC.
 WEST HARTFORD 7 CONNECTICUT

ELECTRONICS • RADIO • 36 Years of Successful
 RADAR • TELEVISION Training in Electronics
COMMERCIAL RADIO INSTITUTE
 Approved by Maryland Board of Education
 38 West Biddle St. Baltimore 1, Md.
 Write for Free Catalog • Tel. LE 9-3342

PLEASE

WRITE YOUR POSTAL ZONE NUMBER

By including your correct zone number each time you write your address you can speed delivery of your own mail and help cut Post Office costs. The Post Office must do extra work to deliver each letter, parcel and magazine that does not show the correct postal zone number in the address. It will help you—it will help the Post Office—and it will help us. Thanks.

QST

**MOST COMPLETE STOCK
 OF TRIAD IN NEW YORK**

Melville Radio Corporation

Wholesale Distributors of the BEST in Electronics
 FRANK MELVILLE—W2AQC

43 Hamilton Avenue, White Plains, N. Y.
 White Plains 8-6131
 Long Island Stamford, Conn.
 FL 8-9150 DA 5-1911



**"Mags" Magers
 W0JL, President
 A Ham Since 1910**

For the man who demands the best!

**VESTO'S
 Hurricane-Proof*
 Self-Supporting
 TOWER**

A Galvanized Tower that will last a lifetime.
 Ten sizes to choose from! 22 ft. to 100 ft.
 Easy Terms Available

VESTO TOWERS HAVE: No guy wires! No cables! No moving parts!

VESTO TOWERS OFFER YOU:

- 4-leg construction for better balance—greater strength
- Safe, steel ladder from ground to platform near top
- Safety platform with metal railing and trap door (optional)

PLUS VESTO'S NEW Geared Crank-Over Antenna Head

Now! Tilt antenna for easy accessibility! Tilts heaviest antennas! Holds in any position!

*** NO VESTO TOWER HAS EVER BEEN DAMAGED BY HURRICANE**

Easy Payment Plan
 Write for complete
 FREE information

VESTO CO., INC.
 20th & Clay St.
 North Kansas City, Mo.

DAMPP-CHASER®

Reduces frequency drift
Protects your TX, RX, test
or electronic equipment
against moisture damage:

\$4.95
Net

Ends leaky condensers
High voltage arc-overs
And corroded Xformers

The safe, efficient Thermo-Electric Dehumidifier that chases moisture before it strikes. Never needs attention — refills, baking out or emptying.

Model 1E 12 1/2" Long, 8 Watts, 117V
Model 3E 18 1/2" Long, 12 Watts, 117V

Comes complete with clips and instructions. Order longest size that will fit inside chassis. 24" attached cord solders to power SW terminals. Original equipment in Hallcrafters SX-101 and over 12 leading Electronic Organs.

DOUBLE GUARANTEE: Your money back if not satisfied after 30 days trial PLUS 5 Year Factory Guarantee.

AIRMAIL ORDER TODAY — WE SHIP TOMORROW. Postpaid anywhere in the world. Be sure to state models required. Sorry—No C.O.D.'s.

Send \$4.95 each: Check or Money Order to:
DAMPP-CHASER, INC.
P. O. Box 520 Hendersonton, N. C.
Over a decade of manufacturing quality
Electronic Components

DAMPP-CHASER JOBBER INQUIRIES INVITED

FREE COIL BULLETIN

Technical data on coils specified in QST and Handbook. Standard coil series ideal for experimenters and designers.

NORTH HILLS ELECTRIC CO., INC.
402 Sagamore Avenue Mineola, L. I.

DISTRIBUTORS — Harrison Radio Corp., New York, N. Y.
Radio Shack Corp., Boston, Mass.
Zack Radio Supply Co., Palo Alto, Calif.

QSL SPECIAL

\$1.50 per 100 cards—Postpaid U. S. only
(Fla. hams add sales tax).



These cards are printed on glossy stock with red call letters, name and QTH. QSO information, etc., printed in green. All orders mailed within ten days. No C.O.D. Sorry, we cannot make any changes or additions in form or ink at this price. We have only one style. Free sample.

HOBBY PRINT SHOP, P.O. Box 155D, Umatilla, Fla.

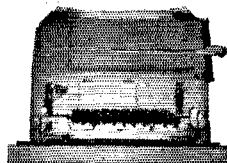

TELETYPE EQUIPMENT

Model 15 Send/Receive Teletype equipped with pulling magnet selectors, series motors. Completely refinished and overhauled and ready to install... \$350.00

Same as above but equipped with synchronous motor. \$375.00

SPARE PARTS AVAILABLE WITH MINIMUM
ORDERS OF.....\$25.00

The machines are available to amateurs only and it is requested that call signs are quoted when ordering.

BROADCAST EQUIPMENT CORP. 130 North 16th Street
Lincoln, Nebraska

Friday and Saturday at 2330 EST. If the attempt fails on 220, they try it on 144. Frequencies: VE3BQN — 220.05 Mc., W3AEW — 220.08 Mc.

W8VCO, Toledo, Ohio, wonders why we don't have more information on 420-Mc. activity in these pages. So do we! All its takes is letters from you fellows who are doing the good work. W8VCO backs up the information from W8JLQ, recently published, with the statement that there is activity in Toledo and Detroit regularly on 432 Mc. He has worked W8s UST RQI JLQ YCR, Toledo, and VOZ, Van Buren, and DX HRC UCT RLT and K8AIY, Detroit. His rig uses a 2C39 tripler driving another as an amplifier, delivering about 12 watts input. This feeds a 16-element array, which will soon be replaced with a 48-element job.

The San Bernardino Microwave Society lost no time in converting from 3300 Mc. to the new band at 3500 to 3700 Mc. Equipment described in W8BCK's article in June QST was modified for the new band at once, and the first 2-way QSO over any distance was made on June 5, by W6IFE/mobile and W6SDE, over a 5-mile circuit. W6IFE used a 2C40 lighthouse oscillator, but W6SDE had the 726A and juice-can polaplexer.

Tests made on the beer-can model show that it can be made to work on the new band, but the new version is less critical to build and adjust, according to W6OYJ. Ed says that they have come across a new can used for a chocolate drink that is just the right size, 2 1/2 inches in diameter and 3 1/4 inches long. Two of these soldered together work nicely with the dimensions given in the article. It may not be necessary to fiddle with the repeller voltage, when this version of the polaplexer is used.

The best distance worked on the new band was upped to 11 miles on June 9, when W6IFE/6, Box Springs, Ala., near Riverside, worked W6RNA, Arlington, New record will be coming up shortly.

OES NOTES

K1BML, Bethlehem, Conn. — Improved mobile coverage on 144 Mc. with folded-dipole halo.

K1CKZ, Norwalk, Conn. — "Converted" DX-20 to 50 Mc. by removing all low-frequency components and installing almost completely new circuit for 50 Mc. Used International Crystal Mfg. Co. FO-6 oscillator, 6C16 buffer and 6DQ6 final amplifier. Shielded wiring and all circuits on one frequency helped TVI situation, making installation of high-pass filters on TV receivers effective in every case.

K2AZT, Baldwin, L. I. — Discone installed for general-purpose work on both 220 and 144 Mc. Working crossband 50-220 with W2SEU and K2IMV.

W4AZC, Birmingham, Ala. — Phase-modulated exciter, crystal-controlled, giving good results on 50 Mc.

Worked 47th state on 50 Mc. June 16: K4AWB/4, Greenville, S. C., 260 miles. This was first time S. C. had been worked from Birmingham area, yet K4AWB/4 worked a total of 14 Alabama stations, including K4SRU, who was running less than 5 watts input. Distances is about 260 miles.

K5DCQ, Irving, Texas — Worked XE1PY and XE1FU on 50 Mc. May 25, and heard KZ5PW May 27. Band open for Es almost daily in May.

K5HTH, Amarillo, Texas — First good Es April 28. DX heard or worked nearly every day thereafter. Season seems better than 1957.

K6QMK, Pacoima, Cal. — Last IUs and ZLs worked in early May. Single-hop sporadic-E good after middle of month. New social and traffic net organized on 50 Mc. May 18, consists of two divisions, for metropolitan and valley areas.

W7EPZ, Billings, Mont. — Addition of K7CML and K7CMU, Miles City, brings Montana's 6-meter population to about a dozen.

W9JIV, Indianapolis, Ind. — Members of Central Indiana Mobile Radio Club used 6 effectively in providing communication for sports car races May 10 and 11.

Skeds with K9GWP and W9ULH on 220 working well. Hearing W8s CSW WRN GHX and IGH on 220 Mc., but no contacts. Heard tone-modulated signal near 220.5 Mc. from 2055 to 2205 CST, traveling from east around to southwest before fading into noise. Signal was frequency-modulated and keyed, as if for telemetering. Any info on this one?

W9LST, Clinton, Wis. — Operation on 50 Mc. paid off in successful emergency work following severe storm May 31. Mobile stations K9s AQB KKH BKW EOR and W9-LYV worked with fixed stations W9HGE W9DOW K9LOC

(Continued on page 146)



Founded in 1909
**RADIO TELEPHONY
 RADIO TELEGRAPHY
 RADAR & TELEVISION**

Courses ranging in length from 7 to 12 months. Dormitory room and board on campus for \$52.00 a month. The college owns KPA-C, 5 KW broadcast station with studios located on campus. New students accepted monthly. If interested in radio training necessary to pass F.C.C. examinations for first-class telephone and second-class telegraph licenses, write for details New: Advanced TV Engineering Course.

PORT ARTHUR COLLEGE **PORT ARTHUR TEXAS**
 Approved for G. I. training

BUY DIRECT FROM-FACTORY **SAVE MIDDLEMAN PROFITS**

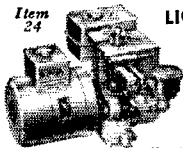

MASTER MECHANIC PORTABLE LIGHT PLANTS, PUSH BUTTON START

AC Plant 700 Watts—115 v. 60 cyc. Powered by a rugged 2.2 hp, easy starting Briggs gas engine. No wiring necessary; just plug in and operate. Plenty of current for receivers, transmitters, antenna motors, emergency lights, etc. which require up to 700 Watts. Ideal for radio amateurs, Civil Defense, trailers and camps. Complete with Voltmeter and built-in winding to charge 6 v. auto batteries. Both engine and generator fully radio shielded. Hams report less hash than on commercial power line.

- Item 24, Wt. 75 lbs. Be prepared if war or storms knock out power lines. **\$143.50**
- 800 Watt Plant (Item 44) same as above but with larger engine and greater capacity. **\$169.95**
- 1200 Watt Plant (Item 45) same as Item 24 but with larger generator and engine—50% greater output. **\$199.50**

We make all sizes up to 25,000 Watts. Write for information. Send 10¢ for Big New Catalog. Free with order. Prices f.o.b. factory. Money back guarantee. Send check or M.O.
Master Mechanic Mfg. Co., Dept. I-88, Burlington, Wis.

NEW! . . . 60-ft. 4-BAND ANTENNA TUNES 40-20-15-10 METERS

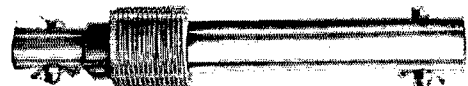

Same Hi-power design except 4 bands in 60 ft. over all. Tested at 10,000 KV RF. Will handle 2 KW of well over-modulated AM. Only coils guaranteed to take a KW on the market.

- Available for immediate delivery**
- 40M-C 4 band KW coils **\$14.95**
 - 40M-A 4 band KW antenna **\$24.50**
 - All antennas have 88 ft. KW twinlead, heavy duty insulators, copperweld wire.
- FIVE BAND ANTENNAS STILL AVAILABLE:**
- HC-F 5 band KW coils **\$19.95**
 - HA-F 5 band KW antenna **\$33.95**
- Improved quarter KW 5 band models:**
- 5 BC-F phone coils; 5BC-C CW coils **\$12.50**
 - 5BA-F phone; 5BA-C CW antennas **\$27.50**
- Postpaid in U.S.A.*

MONEY BACK GUARANTEE
GENERAL CRYSTAL COMPANY, INC.
 372 Wilmot Ave., Burlington, Wis.

PORTABLE POWER PLANTS

Push Button Start—115 V AC (& 12 V DC) Always available. Be prepared with reliable emergency power, designed for use with radio gear, etc. Only unit at these low factory prices fully shielded and filtered for radio, and individually checked by scope. Not surplus, but brand new 4 cycle, easy starting, cast iron cylinder engines, fiber glass insulated generators, and control boxes with voltmeter and controls. Conservatively rated. Just the generator for CD, Field Day, Camping and Boats. Complete line. Fully guaranteed.

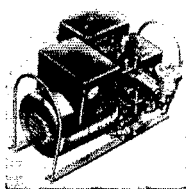

- 700 watt (A712) Shpg. wt. 77 lbs. **\$143.50**
 - 1000 watt (A1012) Shpg. wt. 90 lbs. **\$195.50**
 - 2500 watt (A2512) Shpg. wt. 225 lbs. **\$325.50**
- Sizes to 3500 watts. Dual voltage models, automatic controls, etc., available. Write:

GENERAL ELECTRONIC SERVICE CO.
 P. O. Box 9 ROckwell 3-2425 Burlington, Wisconsin

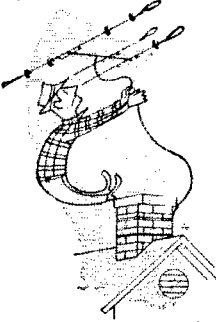

**Tired of formulas and living on ur roof?
 Wanna enjoy ur hobby and live-a-little too?**

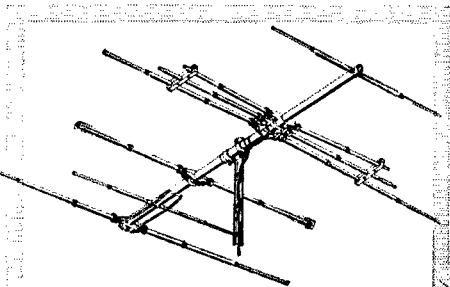

If so, latch onto and install a TELREX Model TB-7E. It's the only no-compromise one-transmission line "Tri-Band"® providing satisfying *top-man-on-the-frequency* results on 3-bands: 3 elements, 7db on 10 meters; 2 elements, 5.5 db on 15 meters; 2 elements, 5.5 db on 20 meters; F/B . . . 22 db on 10, 19 db on 15 and 20; no traps to break down, or tricks and formulas to fiddle with!

How much for TOP PERFORMANCE AND THE FINEST MATERIALS, TOO? ONLY \$158.00 f.o.b. AP.—N.J. Wanna write instead? Complete Teck. info. free!

ASBURY PARK 2, NEW JERSEY
 Telephone: PProspect 5-7252

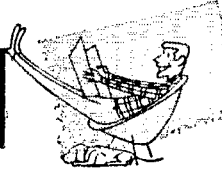

EASY TO INSTALL TELESCOPES CRANK DOWN TO ADJUST

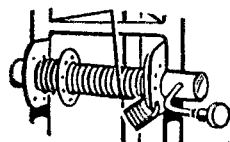

Spring loaded
ratchet winch
can be pulldocked.

VERSATILE

Used by thousands — Hams,
Signal Corps, Civil Defense,
Industry, Mobile Units.
Made of strong, lightweight
3/4" aircraft type tubular steel.

LOW COST

Prices start at **\$40.25**
GALVANIZED TOWERS AVAILABLE
WRITE FOR FREE BROCHURE

QST-8



Tele-Vue TOWERS INC.
701-709 49th ST. SO. ST. PETERSBURG, FLORIDA

CANADIANS! We have large stocks of nationally
advertised Ham parts. Write for Free catalog.

THE CRAWFORD RADIO

VE3YR 119-121 JOHN ST., N. VE3JU
"Geo" HAMILTON, ONT. "Bill"



Groth

TURN COUNT DIAL

Registers Fractions to 99.9 Turns

FOR roller inductances, INDUC-
TORS, fine tuning gear
reducers, vacuum and other multiturn
variable condensers. One hole mounting. Handy
logging space. Case: 2" x 4". Shaft: 1/4" x 3/8". TC
2 has 2 1/2" dial — 1 3/4" knob. TC 3 has 3" dial —
2 1/2" knob. Black bakelite.
TC 2 \$4.20 — TC 3 \$4.75 — Spinner Handle 75c extra
Add 8¢ for Parcel Post

R. W. GROTH MFG. CO.

10009 Franklin Ave. Franklin Pk., Illinois

THE HEART OF THE BEAM

by MACH

- ★ Synchronous motor
driven matching
systems
- ★ Absolute 1-1 SWR
- ★ All final adjustments
made from operating
position
- ★ No tower climbing

One KW Gamma match for 10, 15, 20 meters.
In 6, 12 or 115 volt A.C. \$19.95
400 watt Gamma match for 6, 10, 15 meters \$13.60
Omega matches custom-built on order \$28.40

Mounting brackets extra. All prices Amateur net, plus postage

MACH ELECTRONICS Box 201 Broadacre Court
Danville, Ind.

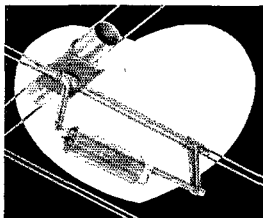

and K9BOD in supplying communication to towns without
telephone service.

K0DUO, St. Paul, Minn. — Would like 6-meter schedules
to east, preferably near Chicago. Will have large array in
operation before Aug. 1. Address: 97 N. Oxford St., Apt. 2.
W0KLQ, Jefferson City, Mo. — Etching several crystals
to get them off the surplus frequencies helped greatly
in making contacts during 50-Mc. openings. See W2IHW's
article in January QST for details.

Putting the DX-40 on 50 Mc.

Many requests are received at ARRL Headquarters for
6-meter conversion information for various commercial
transmitters. Unless someone has done the job, and sends
in a step-by-step procedure that is acceptable, we normally
cannot handle these requests. QST has carried such conversions
for the Viking 1 (Dec., 1952), and the Heathkit
AT-1 (May, 1957). A conversion of the Viking Adventurer
is ready and will appear soon.

Here is the procedure used by W5BRQ, Vicksburg, Miss.,
to put his Heathkit DX-40 on 6. First the 40-meter oscillator
coil was removed and replaced with 10 turns of No. 26
enamel on a National XR-50 form, close-wound. (The XR-
50 is slug-tuned, 3/4-inch diameter.) Next the 10-meter
buffer coil was replaced with 10 turns of No. 16 enamel,
close-wound, 1/2-inch diameter.

The last three turns were then clipped from the 10-
meter section of the final tank coil, at the bottom of the coil
and to the rear of the bottom coil spacer. The three short
ends were soldered together, and to the lead going to the
final-stage tuning capacitor.

The final amplifier plate choke was replaced with an
Ohmite Z-50 (7-ph.) r.f. choke, and an 8.4-Mc. crystal
placed in the crystal socket.

To tune the rig up for 6-meter operation, the oscillator
plate circuit is tuned to the third harmonic of the crystal.
Check this with a grid-dip meter or absorption-type wave-
meter. Adjust the "drive" capacitor for maximum grid
current to the final, about 3 ma. in this instance. Tune the
final amplifier to 50 Mc. in the manner described in the
instruction book. Check with grid-dip or absorption wave-
meter to be sure signal is on the right frequency.

Because of the relatively minor changes involved, the rig
can be put back into service on the lower frequencies with a
minimum of trouble.

How's DX?

(Continued from page 69)

your Call Book DL6ZZ credits DL2RO-G2DC with
much assistance and encouragement in furthering his ham-
ming aspirations, this in a letter via VE3BWY (ex-G6WY)
. . . . So. Calif. DX Club operatives have G3ZY pre-
paring for a 3A2CF foray to occur between the 5th and 17th
of this month, 10, 15 and 20 meters.

South America — Since activating a year ago HK7LX
has rung the WAS bell and has reached 129/104 on the DX
ladder, all via 10- and 20-meter phone. BERTA and WBE
sheepskins also arc applied for. . . . From HK8AI's
sister Iris via W6OUN: "It's impossible for Victor to make
schedules because he never knows when he will be called to
work. He usually is on after 10 A.M. except Tuesdays and
Thursdays, sometimes after 8 P.M. on Sundays."
The Galapagos plans of W0s AGO LUX and WGF (licensed
as HC8s with the same suffixes) go forward apace. Next
month may be it. . . . LU3DAB-LU3ZS, operating as
OA4BW/8, tells W2HMJ of intentions to operate with CP
and ZP credentials. . . . From down south s.w.l. C. V.
Edwards advises that VP3IG is a fresh B.G. candidate who
may be found on 40-meter phone almost any Sunday

. . . . UA1KAE/7 of Russia's antarctic crew gave
78°24'S-86°35'E as a QTH when QSOing W6KG. . . .
A convincer from FL8AC made it 258/241 for diligent
DXcavator CE3DZ. . . . W9OFO made arrangements
to operate as PJ5AB on Aruba in late May and then carried
through nicely. "I set up headquarters at the Basi-Ruti
Hotel and, with the fine cooperation of PJ2AA, I was able
to operate a rig on 20-meter sideband. Unfortunately my
stay in Aruba was short but it was a thrill to be able to have
the fellows wait in line to talk to you!" Through
herculean efforts by PY1CK and friends, Brazil's Trindade
Island was activated for DX-chasers over a four-day stretch
in early June. WIZDP and W6RLP observed PY0NA
busily parrying pile-ups on 10, 15 and 20 meters, mostly 15,
employing phone-to-phone, phone-to-c.w. and c.w.-to-c.w.
techniques. Another Trindade trip may ensue this month or
next — PYS 1HQ 2CK and 7AN are most eager for their
turn. PY0NA scored 800 QSO's with 65 countries.

(Continued on page 148)

In
Indiana...

all
roads
lead to

GRAHAM
Electronics
SUPPLY, INC.

Hoosier Ham Headquarters

102 S. PENNSYLVANIA
INDIANAPOLIS 4



CODE-SENDING-RECEIVING-SPEED

Be a Radio Ham or Commercial Operator. Pass FCC code test in few weeks. Fascinating hobby. Good pay, interesting work in Commercial field. Same system used by radiotelegraph specialists. FREE book explains how Amateurs and Operators learn code and develop amazing skill and speed. Candler System Co., Dept. 4-J, Box 9226, Denver 20, Colo., U.S.A. and 52b, Abingdon Rd., Kensington High St., London W.8, England

XMTRS FOR 160 TO 2 METERS

TECHNICIAN - NOVICE - GENERAL

or Special Freq. 500 KC. to 160 MC.



MOD. 240 WITH MOBILE CONNECTIONS & AC SUPPLY. 1.6 to 30 mc. with Hi-O plug-in coils. For Phone & CW. Novice, General, CAP, Industrial. Complete with 8 x 14 x 8 cabinet; tubes, 40 meter coils & crystal. Wt. 30 lbs. \$79.95.

80, 20, 10 meter coils \$2.91 per band. 160 meter coils \$3.60.

MODEL 130 FOR 120 to 130 WATTS—
NOW \$169.50

MODEL 242 FOR 6 METERS OR 2 METERS—45 WATTS INPUT—6146 FINAL. Complete with mobile connections, A.C. power supply, tubes, xtal. Xtal mike input. Uses 8 mc. xtals or Lettine VFO. Swinging link matches 52—300 ohm antennas. Same cab. as 240. \$89.95.

TECHNICIANS! The 6 meter 242 is your ideal transmitter, designed especially for 6 meters. Check these features. 45 to 50 watts input. Three RF stages with 6146 high efficiency straight-through final. 100% plate modulation with push-pull modulator. High capacity double tuned circuits for maximum TVI suppression.

VFO-\$49.95—ANT. TUNER \$20.00 LESS COILS

Send full amount or \$25 with order—balanced C.O.D.

LETTINE RADIO MFG. CO.

62 Berkeley Street

Valley Stream, New York

I CAN THANK HAM RADIO FOR MY NEW CONVERTIBLE

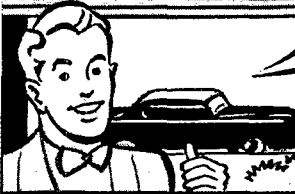

Like most hams, I've been tuning and adjusting transmitters and receivers for years. When a W9 told me about the boom in 2-way commercial and public-safety radio—and of the high income he was earning in mobile-radio maintenance—it seemed a wonderful business for me. So I sent for Lampkin Laboratories' booklet "HOW TO MAKE MONEY IN MOBILE-RADIO MAINTENANCE" and learned about the hourly rates... contract terms... and monthly income in that field. Now I'm in the business—and driving a new convertible! The coupon at the bottom of this ad can lead to the same results for you. Better mail it today—while it's fresh in your mind!

You can start your own mobile-radio maintenance business, too — from your own shack. With Lampkin's mobile maintenance meters you'll need a surprisingly small investment. For your free copy of "HOW TO MAKE MONEY IN MOBILE-RADIO MAINTENANCE" send coupon today!

THE PREFERRED MOBILE-MAINTENANCE METERS



LAMPKIN 105-B
MICROMETER
FREQUENCY METER
Range 0.1 to 175 MC
and up
Price \$220.00 net



LAMPKIN TYPE 205-A
MODULATION METER
Range 25 to 500 MC
Price \$240.00 net



LAMPKIN LABORATORIES, INC.
Mfg. DIVISION, BRADENTON, FLA.

At no obligation to me, please send free booklet.

Name _____
Address _____
City _____ State _____

LAMPKIN LABORATORIES INC., BRADENTON, FLA.

MOSLEY TRAPMASTER

Model TA-33
for 10, 15 and 20

...but

Now! Not Just Rust-Resistant
FULLY RUST-PROOF!

All metal parts of aluminum,
brass or stainless steel—
including screws and U-bolts!—

Owners of earlier TA-33
models can obtain
rust-proofing kits at cost.

Mosley Electronics, Inc.

8622 St. Charles Rock Road • St. Louis 14, Mo.

YOU GET UP TO

50%

SAVINGS

on
Reconditioned
Equipment at

**WORLD
RADIO!**

Here's Just A Sample

RECEIVERS

RME 4350	\$175.00
HQ 129X	159.00
NC 300	319.00
NC 183D	329.00
NC 98	119.00

TRANSMITTERS

Collins KWS-1	\$1,399.00
Johnson KW with desk	1,195.00
Halliferafters HT30 (SSB)	349.00
Collins 30K-1	595.00
Globe King 500	449.00
Globe King 500A	475.00

Communicator II (6M-6 Volt) 179.00

PLUS

Over 800 Items in
Stock • New Listings
Each Month • 10 Day
Free Trial • 90 Day
Factory-New Warranty

WORLD RADIO LABORATORIES QR-8

3415 W. Broadway • Council Bluffs, Iowa

SEND YOUR LATEST
RECONDITIONED EQUIPMENT LIST

NAME: _____

ADDRESS: _____

CITY & STATE: _____

Hereabouts — Just f.y.i., W6KG relays CM8EM's info as to the significance of Cuban prefixes. CM stations hold Class B licenses which limit their phone activity to 7 Mc, whereas COs can use all phone ranges. W4CYY, now recovering from a stairways tumble, reports a lively time and flock of DX hounds on hand at the Charlotte Swapfest in late May. W4RQR checked out 600 a.s.b. contacts as VP5BH's Caymans guest just under the DXCC status-change deadline, K1UYM assisting. Also in May W4RQR played an encore at VP6LT who, says Bob, now is infected with s.s.b. fever and hopes to do a little Caribbean DXpedition on his own. Norway, Paris, Denmark, Naples, Sweden, Poland, Mexico, Peru and China are less than 200 miles apart — in W1APU's native Maine, that is. KP4KD, our nomination for most-active Puerto Rico amateur of all time, assesses: "My DX-station card file, which excludes W. K./VE/KP4 QSLs, has grown to 3884 postwar, a bit large to handle." KP4KD leads W2QHLH 453 to 375 in the most-KP4s-worked race inspired by the WPR certification. W9s KA and NN call your attention to the 6th Annual W9-DXCC Meet and Banquet to be held at Chicago's Hotel Sheraton on the 13th of next month. Check with chairman W9NN regarding advance registration for this famed function. Deadline: August 30th. W1TUW finds W6MHB keeping touch with DX pals as VP7BT on 20 c.w. W8QZR is all set to sign an undisclosed FP8 call from the 19th to 26th inst. on 80 through 10 meters with 65 watts and a multiband doublet. W6JQR, who handled the ARRL Hq. DXCC desk as W1QMI a decade ago, cooks on 20 c.w. with a new DX-100 and Window wire. Al continues a long career of service to ARRL and its membership, now as SCMI, Los Angeles Section. W8BGU yearns for the current whereabouts of HZ1AB operator Ken, vintage January 1948. W6ZZ's W4VKCA requirements are completed by VKØKT. W8JIN maintains his impressive lead in Ohio Valley Amateur Radio Association's hand-countries roster with an esoteric 1360 total. W8s J1W S1D1 and EV follow Jim with 773, 732 and 605 hand-countries, respectively.

Ten Years Ago in "How's DX?" — Our August 1948 prelude deals with the Chicago relocation of Jeeves & Co., and not without some misgivings on the part of our gentleman's gentleman. Eighty meters sloot, north blazets of QRN, but 40-meter stalwarts stalk CT3AB, V6Gg GW LAL and VR2BA. Twenty c.w. is fine for Cs 11C 2HK SLS 8YR 8YCW, EK1GW, ET3a AD AJ, F88AB, FM8AD, FT4AN, Js 2BNR 2COM 6BMC 6KDY, KAs IBT AK, KH6KH, KB6, M13US, NY4JB, PKa LAT 2Kk 6XA, TAlS C AB, VRa 2AZ, VR1 5PL 6AB, W60DD YS, YA3B, Y12AM, ZC1AL, ZC6 and ZD9AA. Cs 1HK 1HY 7HH, ET3AE, HLIAB, J5LQK, Ws 6JIM, C1 and 90ZW, K66 are 14-Mc. radiotelephone desiderata detectable. Ten c.w. is on summer furlough but sporadic 28-Mc. phone openings feature AR8AB, M13ZJ, UB5KAG and V87PS. "Tidbits" reports W60DD heading for F18 regions, W9UXY off to Turkey, K6BDG en route Ponape, and W8SO battling his 2000-QSL TA380 backlog. Photos of ZP8AC and HE1EO keep Jeeves company as he installs an underground diamond.

Correspondence from Members

(Continued from page 61)

describe in *QST*. Please allow me a little space to say hats off to Ted Crosby, W6TC. The many, many hours he must have spent designing the HBR-14 (*QST*, July 1957) were well spent. I know Ted has been swamped with mail, troubles by the bundle, and is perhaps a little discouraged.

The HBR-14 is not a project to be undertaken by the inexperienced builder or casual "kit enthusiast." It is a full-fledged and marvelous receiver. It works at least as well as he claims. I, for one, say thanks for a wonderful job of designing.

Having built the HBR-14 myself, with virtually no trouble, may I say this to prospective builders: Study the schematic and learn how the receiver works. Study the photographs and then follow the original layout as closely as possible. Take your time, be careful, and follow good wiring practices. In corresponding with Ted since completion of my receiver, I've found out that there is a reason for everything from specific component placement to specific component value.

Receiver articles are very rare items these days. It will be a long time before there is another one described that can match the HBR-14. All equipment at K6AOV is home-built; the HBR-14 is at the top of my "proud" list. I say not only hats off to W6TC for an excellent job, but also to ARRL and *QST* for recognizing and publishing it!

— Jack Robinson, K6AOV

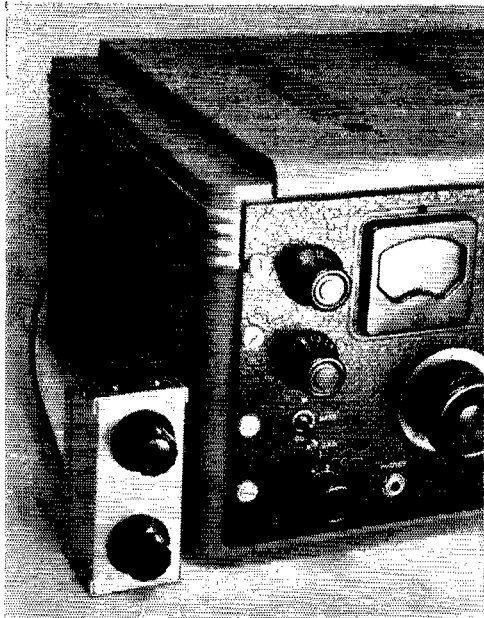

Fig. 5-65—View of the Q multiplier showing its single connecting cable to the receiver. The box can be placed in any convenient spot on or around the receiver.

BEEEN looking for a way to combat QRM? Perhaps this is the answer. The transistorized Q multiplier pictured here is fully described in the 1958 *Radio Amateur's Handbook*. It appears with complete constructional details in the chapter "High-Frequency Receivers." Numerous other receiver accessories are described that may help you to realize better performance from your receiving equipment. And that's not all! The twenty-five chapters of this useful book cover the entire field of amateur radio communications: receivers, transmitters, v.h.f., antennas, mobile, measurements, operating, etc. Get your copy of the big 1958 *Radio Amateur's Handbook* now: 746 pages, over 1350 illustrations, charts, diagrams and tables.

RADIO AMATEUR'S HANDBOOK
\$3.50

\$4.00 U. S. Possessions and Canada, \$4.50 elsewhere
 Buckram-bound edition, \$6.00 everywhere

**THE AMERICAN
 RADIO RELAY LEAGUE, INC.**
 West Hartford 7, Connecticut

UNUSUAL OPPORTUNITY

for inexperienced man who wants on-the-job training in TV transmitter operation. First phone required.

BOX 185, QST

TELETYPE PRINTERS

Models #14, #15, #19, #26. Telewriter Receiving Converter. Perforators, D.C. Power Supplies. Transmitter-Distributors. Polar Relays.

ALLTRONICS-HOWARD CO.

Box 19, Boston 1, Mass.

(Richmond 2-0048)



"SATURN 6"
MOBILEER

- ▶ Horizontally polarized
- ▶ Minimizes flutter and noise
- ▶ Adjusts to your frequency in 6 meter band
- ▶ Feeds with 50-ohm cable
- ▶ Fits standard mounts
- ▶ Ruggedly constructed
- ▶ Weighs under 2 lbs.

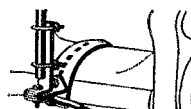

MODEL S-1

"Saturn 6" Antenna

2-pc. adjustable aluminum mast, bracket, universal bumper hitch. No holes to drill. Co-ax feed line not inc. Net.\$16.95

HI-PAR PRODUCTS CO.

Fitchburg, Mass.

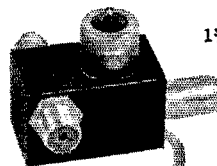

SIZE:
 1 1/2" x 1 1/2"
 x 2 3/4"

with a performance rating never before possible.

DOW-KEY

ANTENNA SWITCH

MODEL DKC-TR

The DKC-TR features a gain of zero db at 60 mc to plus 6 db at 3.5 mc. Can be close-coupled to the transmitter for easy, compact installation with a Dow (DKF-2) connector. Instantaneous recovery, powered from transmitter accessory terminal. Matches 52 and 72 ohm impedance without insertion loss. Handles one KW with ease.

POWER SPECS: B plus 125-150 volts, consumption at 125 volts, 6.2 mls; .450 amps at 6.3 volts; uses 6AH6 tube.

GUARANTEED! Fully backed by factory warranty for unit replacement. **PRICE, \$12.50** (price subject to change without notice).

DOUBLE MALE-CONNECTOR (DKF-2) for mounting relay directly onto output of transmitter. **\$1.45**

See your local electronics dealer or write direct for complete specifications.



DOW KEY CO., INC.
 THIEF RIVER FALLS, MINNESOTA

TVI

GET **W1DBM'S**

New TVI book at your local HAM Supply House

It is a NEW handbook—NOT a collection of old reprints

NOVICES—TECHNICIANS

Includes TVI from 50 Mc. as well as 144 Mc.

The price is only **\$1.75** in USA and **\$2.00** foreign

If your Radio Dealer does not have it, send your check to:

NELSON PUBLISHING CO.
Redding Ridge, Conn.

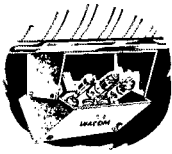

the **WACOM**

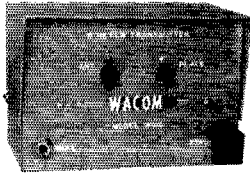

6 3/4" wide
4" high
3 3/4" deep

Fixed or Mobile 6-METER TRANSMITTER

For Information Write:
WACO COMMUNICATIONS, INC.
1213 CLAY • WACO, TEXAS

LEARN CODE!

SPEED UP Your
RECEIVING
with G-C
Automatic Sender

Type S
**\$28.00 Postpaid in
U. S. A.**

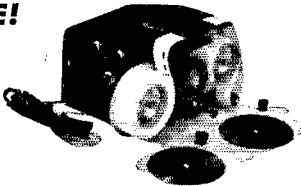

Housed in Aluminum Case, Black Instrument Finished. Small—Compact—Quiet induction type motor. 110 Volts—60 Cycles A.C.

Adjustable speed control, maintains constant speed at any Setting. Complete with ten rolls of double perforated tape. A wide variety of other practice tapes available at 50c per roll.

GARDINER & COMPANY
STRATFORD NEW JERSEY

Novice Roundup Results

(Continued from page 51)

WN2REH...5334-117-42-20
WN2OPE...3876-99-34-38
KN2EKM...2928-122-24-26
WN2EUJ...1980-75-22-32
WN2OQH...1775-56-25-
WN2PZY...1200-48-28-9
KN2ZPD...1082-37-21-2
WN2ZFC...615-41-15-8
WN2GIX...612-26-17-7
WN2KWO...98-14-7-7
KN2GJS...68-34-2-6
KN2DQF...45-15-3-
WN6YLL...2492-74-28-16
WN6TFR...782-26-17-21
WN6NOK...462-22-11-6

San Francisco

KN6BPN...9019-147-54-33
WN6LDE...4328-103-42-2
WN6SNQ...1110-64-13-38

Sacramento Valley

KN6ZBV...22,995-316-73-35

San Joaquin Valley

KN6ZSJ...9000-206-40-38
WN6NQM...8950-164-50-34
WN6UWF...1320-44-30-25

ROANOKE DIVISION

North Carolina

KN4SZW...3948-94-42-17
KN4RID...2272-142-16-27

South Carolina

KN4MUP...7398-137-54-22
KN4RJA...326-15-13-12

Virginia

KN4OKZ...20,590-345-58-36
KN4QER...12,438-219-51-33
KN4SGQ...329-162-44-
KN4RME...7602-166-42-25

West Virginia

KN8EYD...280-18-10-7

ROCKY MOUNTAIN DIVISION

Colorado

KN0KLB...6900-150-46-29
KN9LCR...3492-97-36-21

Utah

KN7AHK...4840-110-44-13
WN7IBO...4032-97-36-38

New Mexico

KN5KYR...17,748-306-58-40
KN5KYU...620-31-20-8

SOUTHEASTERN DIVISION

Alabama

KN4SSB...680-25-17-7

Eastern Florida

KN4PPX...10,229-183-53-37
KN4RNG...660-11-50-40
KN4QOO...6437-157-41-27
KN4PQC...6204-132-47-19
KN4QZJ...1012-44-23-7
KN4RJR...989-43-23-6

Georgia

KN4OUZ...11,368-232-49-29
KN4OCI...7992-196-37-32

West Indies

KG4AS...544-34-16-17

SOUTHWESTERN DIVISION

Los Angeles

WN6RWA...5418-111-43-14
WN6NML...4070-110-37-16
WN6UGU...8471-74-39-32
WN6QCQ...1710-37-30-25
KN6BEP...944-44-16-22
WN6SYM...684-23-18-
WN6QQD...405-27-15-7
KN6KDV...216-6-8-13
WN6OJV...184-40-8-6

Arizona

KN7BHL...3589-82-37-27
KN7BLU...1984-99-16-21

San Diego

WN6WDL...136-17-8-13

Santa Barbara

WN6OUL...3332-78-34-21
WN6DOP...921-38-19-24

WEST GULF DIVISION

Northern Texas

KN5KSI...9310-190-49-17
KN5LKN...218-24-9-7

Oklahoma

KN5JPS...10,400-200-53-35
KN5JQB...3230-85-38-9

Southern Texas

KN5JCC...2112-66-32-18
KN5KFK...288-18-16-11

MIDWEST DIVISION

Iowa

KN0LZJ...3906-116-31-34
KN0KOO...2070-69-30-23
KN0JSZ...1012-36-22-
KN0LUV...936-37-18-6

Kansas

KN0IWK...5720-123-40-25
KN0JGV...2573-68-31-11
KN0LFR...35-7-6-3

Missouri

KN0LTB...6525-145-45-11
KN0JZL...4725-105-45-20
KN0JPJ...3638-92-34-16
KN0MOD...350-25-14-7
KN0LRE...99-11-9-5

Nebraska

KN0MRS...5896-134-44-39
KN0LOK...4847-131-37-23

NEW ENGLAND DIVISION

Connecticut

KN1CEC...11,514-187-57-31
KN1CAK...5720-153-40-26
KN1DCS...5805-125-43-21
KN1BTE...2496-63-32-28
KN1CSH...1440-62-20-34
KN1DYY...656-31-16-34

Maine

KN1BUH...3290-84-35-13
KN1DPM...1584-67-22-24
KN1DWQ...1426-52-23-20
KN1DIK...110-7-6-1

Eastern Massachusetts

KN1DSX...7065-157-45-27
KN1DEX...6424-126-44-24
KN1DZC...6360-134-40-22
KN1DWY1...6248-112-44-26
KN1DQG...3640-121-40-23
KN1DCL...3384-84-36-34
KN1BYV...2850-80-30-25
KN1CRB...921-38-24-18
KN1COV...665-35-19-5
KN1BTP...390-20-13-10
KN1BZJ...10-5-2-4

Western Massachusetts

KN1CAU...10,300-186-50-38
KN1DFC...1980-90-22-33

New Hampshire

KN1CDV...5096-122-38-26
KN1CSJ...2028-63-26-26
KN1CIP...588-39-12-3

Rhode Island

KN1EDW...3192-137-21-40

NORTHWESTERN DIVISION

Alaska

WL7CEE...444-37-12-30

Idaho

KN7BOM...1250-50-25-15

Montana

KN7BCO...2349-87-27-16

Oregon

WN7IYW...7590-150-46-31
KN7BDU...7104-148-45-33

Washington

WN7HXE...10,560-182-55-40
KN7BLN...3696-92-33-20
KN7AKD...3572-84-38-22

PACIFIC DIVISION

Hawaii

WH6CJJ...1891-61-31-16

Santa Clara Valley

WN6YKS...456-23-12-7

East Bay

KN6AB1...7865-143-55-23
WN6OZK...2822-68-34-40

† Multiple operator station

‡ KN1DIYD, opr.

VIBROPLEX

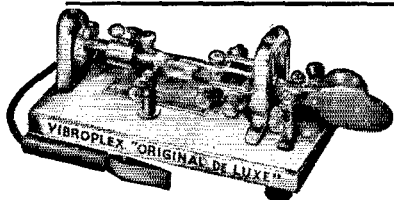

MAKES
SENDING
Twice
AS
Easy

That's because its semi-automatic action actually performs all the work for you — automatically. And that's not all: it gives you freedom from nervous and muscular tension and arm strain, so common to old-fashioned keys. No special skill necessary. Anyone can use it. Even beginners master it in minutes. Precision machined, Vibroplex is built for long life and rough treatment. With patent jewel movement, touch control and other exclusive features, it offers you the easiest and best sending of your life. Over 40 years of daily use on land, sea and in the air proves it. No other key can match this record. What it has done for so many, it will do for you. Take a tip from a user and get your Vibroplex today. At dealers or direct. You'll be glad you did. FREE folder.

Choice of five models, standard or deluxe, priced from \$15.95 to \$29.95. Left-hand models, \$2.50 more. Carrying case, \$6.75.

THE VIBROPLEX CO., INC.

833 Broadway

New York 3, N. Y.



CANADIAN AMATEURS —

We are now manufacturing Amateur and Commercial antennas—Write for free brochure describing our new Beam Antenna series.

LINDSAY ANTENNA & SPECIALTY PRODUCTS Ltd.
"DEPT. CA" LINDSAY, ONTARIO, CANADA

MOSLEY TRAPMASTER

Model TA-33
for 10, 15 and 20

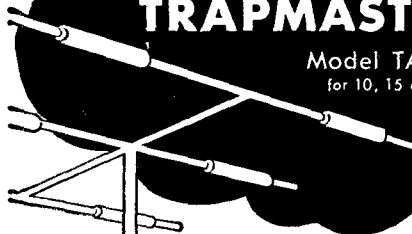

**MATHEMATICAL
FREQUENCY
STABILITY**



Every beam is factory pre-tuned. The especially designed Mosley Traps make any deviation impossible—rain or shine!

Mosley Electronics, Inc.

8622 St. Charles Rock Road • St. Louis 14, Mo.

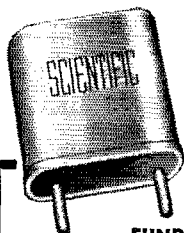

for the best in Crystals . . . and fast service . . .

**BE SPECIFIC—
ORDER . . .**

SCIENTIFIC

- Highest Quality—Hermetically Sealed
- Fast Delivery—One day for small orders
- All Crystal Types—Civilian and Military

WRITE TODAY for your FREE CATALOG

Orders shipped C.O.D. unless money sent with order. Open account only with qualified credit.

FUNDAMENTAL CRYSTALS			
2000	-10.000 KC	.01%	\$2.80
10.001	-15.000 KC	.01%	\$3.90
15.001	-20.000 KC	.01%	\$6.50

THIRD OVERTONE CRYSTALS			
10	-30 MC	.01%	\$2.80
30.001	-60 MC	.01%	\$3.90

FIFTH OVERTONE CRYSTALS			
50	-75 MC	.01%	\$4.50
75.001	-100 MC	.01%	\$6.50

ALL AIRCRAFT VHF 30-60 MC
(TYPE S2 or S10) .005% \$6.50
SPECIAL 100 FC—1 ppm/1° F \$6.95

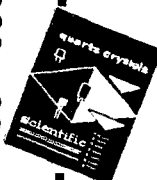

One of the Oldest Manufacturers of Crystals in the U. S.

Scientific
RADIO PRODUCTS, INC.
LOVELAND • COLORADO

SCIENTIFIC RADIO PRODUCTS, INC. Dept. C
Loveland, Colorado

Please send me a copy of FREE catalog, and:
..... crystals. Freq. Price: \$.....
..... crystals. Freq. Price: \$.....
Total \$.....

Name.....
Address.....
City..... State.....

Check Cash M.O. for \$..... enclosed
 Send C.O.D.

Buying... or Trading...

WORLD RADIO'S RECONDITIONING DEPARTMENT

Guarantees You the Most!

SAYS LEO I. MEYERSON, W0GFQ, WORLD RADIO PRESIDENT



A five-man team of trained technicians continually repairs and perfects used equipment. As many as 300 items each month pass through their skilled hands; - tested, double-checked and finally, warranty-tagged.

Over the years, we have built up such a tremendous market for used equipment, that sometimes we even have a waiting list for certain items. Because of this guaranteed market, we can offer you a better price for your trade-in. We want it! We need it! We'll allow more for it! Let us give you our top quotation next time you buy.

If you're in the market for less expensive equipment, send for the current listings on more than 800 items of Reconditioned Equipment. You'll realize up to 50% savings - in addition to a ninety-day warranty, ten day free trial, and a 90-day, 100% return value on trade-in . . . at World Radio Laboratories — "The House the Hams Built!"

"The World's Largest Distributor of Amateur Radio Equipment!"

GUARANTEED SATISFACTION

EASY TERMS

TOP TRADE-INS

PROMPT SHIPMENT

PERSONALIZED SERVICE

LEADING LINES

Make me a trade-in offer for my:

I'm interested in buying:

NAME: _____

ADDRESS: _____

CITY & STATE: _____

WORLD'S MOST PERSONALIZED RADIO SUPPLY HOUSE



3415 W BROADWAY, CO. BLUFFS, IA., Phone 2-0277

HAM-ADS

(1) Advertising shall pertain to radio and shall be of nature of interest to radio amateurs or experimenters in their pursuit of the art.

(2) No display of any character will be accepted, nor can any special typographical arrangement, such as all or part capital letters be used which would tend to make one advertisement stand out from the others. No Box Reply Service can be maintained in these columns nor may commercial type copy be signed solely with amateur call letters.

(3) The Ham-Ad rate is 30¢ per word, except as noted in paragraph (6) below.

(4) Remittance in full must accompany copy, since Ham-Ads are not carried on our books. No cash or contract discount or agency commission will be allowed.

(5) Closing date for Ham-Ads is the 20th of the second month preceding publication date.

(6) A special rate of 7¢ per word will apply to advertising which in our judgment, is obviously non-commercial in nature. Thus, advertising of bona fide surplus equipment owned, used and for sale by an individual or apparatus offered for exchange or advertising inquiring for special equipment, takes the 7¢ rate. Address and signatures are charged for. An attempt to deal in apparatus in quantity for profit, even if by an individual, is commercial and all advertising so classified takes the 30¢ rate. Provisions of paragraphs (1), (2) and (5), apply to all advertising in this column regardless of which rate may apply.

(7) Because error is more easily avoided, it is requested copy, signature and address be printed plainly on one side of paper only. Typewritten copy preferred but handwritten signature must accompany all authorized insertions.

(8) No advertiser may use more than 100 words in any one issue nor more than one ad in one issue.

Having made no investigation of the advertisers in the classified columns except those obviously commercial in character, the publishers of QST are unable to vouch for their integrity or for the grade or character of the products or services advertised.

QUARTZ—Direct importers from Brazil of best quality pure quartz suitable for making piezoelectric crystals. Diamond Drill Carbon Co., 248 Madison Ave., New York City 18.

MOTOROLA used FM communication equipment bought and sold. W5BCO, Ralph Hicks, 204 E. Fairview, Tulsa, Okla.

WANTED: Cash or trade, fixed frequency receivers 28/42 Mc. W9Y1Y, Troy, Ill.

MICHIGAN Hams! Amateur supplies, standard brands. Store hours 0830 to 1730 Monday through Saturday. Roy J. Purchase, W8RP, Purchase Radio Supply, 327 E. Hoover St., Ann Arbor, Michigan, Tel. NOrmandy 8-8262.

WANTED: Early wireless gear, books, magazines, catalogs before 1922. Send description and prices, W6GH, 1010 Monte Dr., Santa Barbara, Calif.

WANTED: All types aircraft & ground transmitters, receivers ART-13, RT/ARCI, R5/ARN7, BC610E, ARN6, BC7883, ARC3, BC342. Highest prices possible paid. Dames, W2KUW, 308 Hickory St., Arlington, Va.

ATTENTION! Mobsellers! Leeco-Neville 6 volt 100 amp. system alternator, regulator & rectifier, \$45.00. Also Leeco-Neville 12-volt 100 amp. system, alternator, regulator & rectifier, \$85.00. Good condition. H. A. Zimmerman Jr., K2PAT, 115 Willow St., Brooklyn 1, N. Y. Ulster 2-3472.

CASH for your gear. We buy as well as sell. Write for cash offer or trade. We stock Elmac, Gosnet, Hallcrafters, Hammarlund, Johnson, Lyseo Master Mobile Remote, National and other ham gear. H & H Electronic Supply, Inc., 506 Kishwaukee St., Rockford, Ill.

WANTED: Receiver R5/ARN-7, MN-62A transceivers, RT18/ARC-1, AN/ARC-3, BC-7887, I-1524, Collins, Bendix equipment, test sets, dynamos, inverters. We pay highest prices. Advise quantity, condition, price in first letter. Aircraft Radio Industries, Inc., 70 East 45th St., New York City. Tel. W2Xington 2-6254.

MULTI-BAND Antenna. 80-40-20-15-10, \$21.95. Patented. Send stamp for information. Latin Radio Laboratories, Owensboro, Ky. SAN FRANCISCO and vicinity. Communication receivers repaired and realigned. Guaranteed work. Factory methods. Special problems inquired, any equipment. Associated Electronics, 55 South P St., Livermore, Calif. W6KFL Skipper.

RECEIVERS: Repaired and aligned by competent engineers, using factory standard instruments. Authorized Factory Service Station for Collins, Hammarlund, Hammarlund, National. Our twenty-first year. Douglas Instrument Laboratory, 176 Norfolk Ave., Boston 19, Mass.

RADIO magazines. Buy, sell or trade. Bob Farmer, Plainview, Texas. TECHNICAL Manuals TM11-273, 120 pages covering BC-312 receivers and BC-191 transmitters, \$2.50. ID-60/APA-10 Pa. adaptor maintenance manuals, \$2.75. Both postpaid in U. S. A. Electronicraft, Bronxville, N. Y.

AMATEUR Paradise Vacation Spot: Livingstone Lodge and Lodge Cabins, Mascoca Lake, Enfield, N. H., gateway to White Mountains. For couples and Family Groups, 100 acres, eleven buildings, Main Dining Lodge, one sandy beach, boats, sport, skiing, Dartmouth golf & tennis, churches, Lusslette Shrine, Fishing, 29th year, 75 and 40 meter rig in Lobby. American plan, \$40 per week up. Children half that. Booklet. Write A. Q. Livingstone, W2QPN.

"PIG-In-A-Poke"? Not it. You visit Ham Headquarters, USA, and pick your choice from the hundreds of "Like-New" bargains in the world-famous Harrison Trade-in Center. Greater values, because tremendous turnover means lower overhead! Terms. Trades. Send us postcard for mouth-watering photograph and price-list. For the best in new and used equipment it pays to come to Ham Headquarters, USA! BCNU, Bill Harrison, W2AVA, 225 Greenwich St., New York City.

QSLs? SWLs? Finest and largest variety samples 25¢ (refunded). Callbooks (latest), \$5.00. "Rus" Sakers, W5DED, P.O. Box 218, Holland, Michigan. Printing press for sale, cheap 8 x 12 C & P. Details on request. (Religious QSL samples, 10¢).

QSLs. Reasonable, 3 Week Delivery. Samples dime (color). Dick K&GJM, Box 294, Temple City, Calif.

QSL-SWLs. High quality. Reasonable prices. Samples. Bob Teachout, W1FSV, 204 Adams St., Rutland, Vt.

QSL-SWLs. 100, \$2.85 up. Samples 10¢. Griffith, W3FSW, 1042 Pine Heights Ave., Baltimore, Md.

QSLs, SWLs, VHF's, XYL-OM's. (Sample assortment approximately 94¢.) Covering designing, planning, printing, arranging, mailing, eye-catching, comic, sedate, fabulous, DX-attracting, photopai, snazzy, unparoled, cards. Rogers K8AAB, 737 Lincoln Ave., St. Paul 5, Minn. Also glamorous, pulsating (Wow!).

QSLs, Taprint, Union, Miss.

QSLs. Plain and fancy samples 10¢. Fred Leyden, W1NZJ, 454 Froctor Ave., Revere 51, Mass.

CREATIVE QSL and SWL Cards. Are you proud of your card? If not let us print your next order. Write for free samples and booklet. Personal attention given to all requests. Bob Wilkins Jr., K8OZMT, Creative Printing, P.O. Box 1064-C, Atascadero, Calif.

QSL-SWL samples free. Bartnoski W2CVE Press, Williamstown, New Jersey.

QSL-SWLs, Samples free. Spicer, 4615 Rosedale, Austin, Texas.

QSL "Brownie," W3CJI, 3110 Lehigh, Allentown, Penna. Samples 10¢ with catalogue, 25¢.

QSL-SWLs, Samples 10¢. Malgo Press, 1937 Glendale Ave. Toledo 14, Ohio.

QSLs, Sharp! 200 one color, glossy, \$4.75 Multi-color samples dime. K9DAS QSL Factory, Edward Green & Sons, 4422 Marquette Dr., Ft. Wayne, Ind.

PHOTOGRAPHIC QSLs—Picture post-card type, your shack, home, mobile, etc. You send photo. 1000, \$12.00. Raum's, 4154 Fifth St., Phila. Penna.

QSL-SWLs, 100, \$2.50. Samples 10¢. QSO file cards, \$1.00 per 100. Rusprint, Box 7507, Kansas City 16, Mo.

QSLs. Newest designs, glossy stock, 2 colors, 100 for \$2.50. Sample brochure free. One week service. Box 671, Hawthorne, California.

QSLs of distinction. Three colors and up. 10¢ brings you samples of distinction. Uncle Fred, Meshoppen, Penna.

QSLs. Twenty exclusive designs in 3 colors. Ruth \$3 for 100 or \$5 for 200 and get surprise of your life. 48 hour service. Satisfaction guaranteed. Constantine Press, Bladensburg, Md.

QSLs. High gloss, 3 colors, samples 10¢ (refunded). K2VOB Press, 62 Midland Boulevard, Mapletown, N. J.

FREE Samples. QSLs-SWLs, Backus, 703 Cumberland St., Richmond, Va.

QSL-SWLs that up returns! Samples 25¢ deductible. Log file cards \$2.00 per 200, \$6.50 per 1000. C. Fritz, 1213 Briargate, Joliet, Ill.

QSLs for economy-minded hams. \$4.65 for 500. Free brochure. K9EUF Print (Charley Vorderberg), 1839 46th St., Rock Island, Ill.

QSLs, 100 for \$3.00, glossy. Samples free. R. A. Larson, 32 Midland Ave., Stamford, Conn.

QSLs, Samples 10¢. SPA Print, Box 181, Hot Springs, Ark.

QSLs. Neat, Attractive. Samples 10¢. Woody's, Box 164, Asher St., Little Rock, Ark.

QSLs—We've printed a million! Samples 10¢. VYS QSLs, 1704 Hale, Ft. Wayne, Ind.

QSLs, Samples, dime. Printer, Corwith, Iowa.

QSLs: 4 colors, 100, \$3.00. Samples 10¢. Dick, W8VXK, 1018 Arthur, Mt. Pleasant, Mich.

QSL Special. See page 144 this issue. Nat Stinnette, W4AYV, Umatilla, Fla.

QSLs: Cartoons, colors, something different. Samples 20¢. Chris, W9PPA, 365 Terra Cotta, Crystal Lake, Ill.

QSLs Samples dime. Sims, 3227 Missouri Ave., St. Louis 18, Mo.

QSLs, samples dime. Eddie W. Scott, W3CSX, Fairplay, Md.

DIFFERENT QSLs. 100 kromekote, \$2.50, plain, \$2.00. Sample free. Grossenbacher, K9EUF, Box 340, Eagle Pass, Texas.

DELUXE QSLs. Petty, W2HAZ, Box 27, Trenton, N. J. Samples 10¢

QSLs for economy-minded hams: \$4.65 for 500. Free brochure. Charley Vorderberg, K9EUF, 1839 46th St., Rock Island, Ill.

QSLs, SWLs, Tackards, glossy, colors, 100, \$2.75 up. Samples 10¢ refunded. W1GKH Press, 27 Liberty St., Danbury, Conn.

QSLs. Personal photo at rig, your design, 5¢ each (includes two sides). Request details. Samples, Free bonus: 100 lettershead with order of 500 cards. Olsen QSL Photoprint, Box 37, Somers Point, N. J.

QSLs. We've printed a million! Samples 10¢. VYS QSLs, 1704 Hale, Ft. Wayne, Indiana.

FREE! 100 "Thingloss" Anglican QSLs. Order 100 "Hevigloss" red, blue, green (black back). Radtoprint, Ojai, Calif.

ANY Photo on stamps, 100 for \$2.00, 200 for \$3.00. Ideal for QSLs. Send photo (returned): K9BDR Enterprises, Mark, Ill.

QSLs, Glossy, Samples 10¢. WIOLU Press, 30 Magoun, Medford, Mass.

YOUR QSL made into a laminated plywood plaque, \$3.00. Satisfaction guaranteed. Solomon, 46 Cornhill, Boston 8, Mass.

HAMFESTERS Radio Club announces its 24th Annual Picnic to be held Sunday, August 10th, 1958, at Santa Fe Park, near Chicago. See July Hamfest Calendar or write W9PBM.

PERSONAL: All hams! Don't forget you have an appointment with me at the stroke of midnight at the ARRL National Convention in Washington, D.C. on 16, 1958. Use to obtain your certificate of the Royal Order of the Wouff Hong. This is the hour and moment of truth. Signed, "The Old Man".

"THE Saga of Telegraphy" LP recording & brochure. Historical. \$3.75. Ralph Graham, W4RJX, Box 3556, Arlington 3, Va.

HAM Licenses, Resident courses, Novice and General classes, 3 evenings weekly, Delehanty Institute, 117 East 11th St., NYC 3, GR 3-6900.

COAXIAL Cable, 63 ohms, 100 ft. \$4.35. Postpaid. Satisfaction guaranteed. Van Dick, Riverlawn Drive, N. J.

416B Owners, brass mounting plate, machined 3/4" — 40 hole, \$2.50. Robert B. Plint, W9YBV, RR #2, P.O. Box 290A, Bridgeport, Ind. VRTCC QSL to W4TAJ with self-addressed envelope.

CALL plates. Deluxe 8" x 1 1/4" black phenolic laminate with engraved white letters. Only \$1.00 p.p. Polished plexiglass base, \$1.00 extra. L. & J. Products Co., P.O. Box 122, Downers Grove, Ill.

BARCO'S in Sandusky, Ohio, for your best deal in Ham Gear. National, Hammarlund, Hallcrafters and WRL Globe transmitters. Hy-Gain and Mosley beams. 1725 Columbus Avenue, Main 5-9864.

KITS assembled, wired and tested promptly. Our charge 20% of kit price. Experienced with all makes ham equipment, test instruments and high fidelity. Partly wired kits same price. Finest checking equipment. Also equipment designed and built, factory standard workmanship. Have kits sent direct to you. Surplus gear converted. (Licensed ham since 1924, Ex W9AXJ). Money back guarantee. K9KJX, L. P. Jackson, 645-A Marshall Ave., St. Louis 19, Mo. Tel. Woodland 2-2048.

MOBILE Batteries, Vita-Plate Special Service Types, 6 and 12 volt for all cars. Used by Police and Fire Departments. Free data. Central Communications, 1340 Ford Rd., Cleveland 24, Ohio (Paul, W8EWF).

S.S.B. Transformers identical and exact as used in W2EWL exciter (see QST March 1956). Brand new for \$4. No C.O.s. please. S. Tucker, W2HLL, 51-10 Little Neck Parkway, Little Neck 62, N. Y.

FOR Sale: Hallcrafters SX-99 with matching speaker. In exc. cond., one year old. Price only \$120. Write Harry Bergman, 88-30 199 St., Hollis 23, L. I., N. Y.

YOU asked for it! A broad band I.F. coupler tuned to 455 Kc for double sideband reception. This unit will plug into the mechanical filter socket of a 75A-4. Only \$12.95 postage prepaid. Busacker's, 1216 West Clay, Houston 19, Texas.

BARGAINS: Send for list of reconditioned receivers and transmitters with new guarantee. 10% down with up to 23 months to pay. In stock, new Collins, Johnson, Hallcrafters, WRL, National, Hammarlund, Gonset, Elmac, Drake, Central Electronics, B&W, Hy-Gain, Mosley and Gotham beams. Shipped on approval. Write Ken, W9ZCN or Glen, W9ZKD, for your best deal. Ken-Elis Radio Supply Co., 428 Central Ave., Ft. Dodge, Iowa.

NEW Mercury outboards and boats. Will take ham gear on trade. Write: Boyd Retter, K9IM0, Boyd's Marine Shop, Clinton, Iowa.

WANTED: Alerat, Airline, Military, Electronics gear — and test equipment. Call Hendix, ARC, Airforce, Narco, BC348, BC610, ARN6, ARN14, ART13, 51R3, MN62A, others. We pay C.O.d. advise price condition. Ritco, Box 185A, Annandale, Va., Phone Jefferson 2-5805.

PITTSBURGH Hamfest: Biggest yet! 21st annual hamfest of the South Hills Brass Poles & Modulators. Sunday, August 3, 1958. South Park Totem Pole Lodge. Contests for young and old. Swap Shop. Pre-registration, \$1.50. Write or call William E. Guthrie, W3LDB, 4949 Roberta Drive, Pittsburgh 36, Pa. \$2.00 at door.

VACATIONS: Modern housekeeping cabins, American plan; ham with my equipment. Lighthouse Lodge on Big McKenzie Lake, Spooner, Wis., Tony, W9HZC.

TWO-WAY Communications, Mobile, Industrial, Aviation. Free catalog, RCE, 520 S. Virginia, Reno, Nev.

MINIATURE 1" meters: Popular ranges available from stock. Free literature. Alco Electronics, Lawrence, Mass.

SELL: Dyna Labs Gaussmeter Model D-79 with instruction book, carrying case, two probes. In new cond., not adaptable our special research model: \$225.00, prepaid for cash. Lampkin Laboratories, Inc. RFD #1, Bradenton, Florida.

KIT wiring. Rates reasonable. Write: John Hjelm, W9DBT, 1782 Portland Ave., St. Paul 4W, Minn.

DX Radio Coop forwards outgoing QSLs, 2¢ each. Callbook, \$5.00, Schematics, 59¢, Sam's Information free with schematic, 500 QSL Cards, \$4.00. Free Flyer. "DX Radio Coop", Box 5938, Kansas City 11, Mo.

OLD QST'S wanted. Need December 1915 and January through July of 1916. Will pay cash or will trade Bound Volumes I (yes, Dec. 1915 thru Nov. 1916), 18 (1934), 19 (1935), 20 (1936), 21 (1937), 23 (1939), 24 (1940), 28 (1944). L. A. Morrow, W1VIG, 99 Bentwood Rd., West Hartford 7, Conn. Phone Adams 2-2073.

CODE Practice tapes, name your speed, \$3.75 each. Bob, W4BJN, 931 Maple Ave., Dayton, Ky.

FOR Sale: National NC-300 receiver, brand new condx. Total use 5 hours; \$255. George Schwartz, W1VDW, 371 Highland St., Newtown, Mass.

PENETROX anti-corrosion beam lubricant (recommended in Bill Cole's "Beam Handbook") \$1.00 postpaid. Chubberson, W6T7Y, 2515 Novato, Palos Verdes Estates, Calif.

FOR Sale: Viking 1L, SX-98, Heath VFO, D-104, B&W Balun coils, W1YOD, Roger Strickland, Portland, Conn. Tel. Diamond 6-5320.

QRG Calibration log book — P.O. Box 123, Boston 1, Mass. 43 perforated "work sheet" 8 1/2 x 11 hand spread dial charts — 26 pages illustrated text. Range: .10 Mc to 30 Mc plus 2 and 6 meter bands. Correct wave length shown every 10 Kc. \$2.00 U.S.A., \$2.50 foreign.

VAN Sickle will trade photographic, boat or radio on new KWS-1 Collins. Gene, W9KJF, 4131 N. Keystone, Indianapolis, Ind.

SMALLEST "Shielded" D'Arsonval meters available. 1" round or rectangular. Standard Ranges available, \$4.95 postpaid. Alco Electronics, Lawrence, Mass.

WANTED: Unused electronic tubes, commercial gear, lab test equipment and components. Will pay cash or swap for choice ham gear, etc. Write for Barry's "Green Sheet", check full of bargains in ham gear, tubes, relay racks, transformers, etc. Barry Electronics Corp., 612 Broadway, New York 12, N. Y.

SSB — Latest diagram, template, 3 xfrms. disc ceramic & mica condensers, coils, 1L thru 17 for "W2EWL Special" (Mar. 1956 QST). \$10.95 postpaid. A Vitale, W2EWL, E. Glen Rd., Denville, N. J.

RUBBER Stamps for Hams, sample impressions, W8DNY, Hamm, 542 North 93, Milwaukee, Wis.

HEATHKIT AT-1 transmitter for sale, \$18. In good shape. Jack Hoffman, KN9LD, Nelson, Nebraska.

QST'S Wanted: All prior to Nov. 1921, Feb., March and July 1922; January 1924; state amount, price and condx. Carl Schardt, W8CTU, 17301 Maplerow Ave., Cleveland 5, Ohio.

WANTED: Coll No. CNA-47159 for my Model RA8-5 National receiver. Loyal R. Parker, Heppner, Oregon.

COLLINS 75A3 rec. Spkr 100 Ka. cal. and product det. in FM socket; 32V3 trans. D104 mike on stand; Bud low-pass filter, spare 4D32 final tube. Equipment used 100 hours, looks brand new. Price: \$725. Macdonald, 140 Rum on Road, Massachusetts, L. I., N. Y.

ELMAC AF-67 transmitter, PMR-7 receiver, and James 6-12-110 volt mobile power supply for sale: \$325. All brand new, never used. Marshall Lincoln, KN9KT, 3583 Forest Grove, Indianapolis 5, Ind.

FOR Sale: National NC-88 in good condition, \$80. Also a Globe Scout 680 in good condition, \$90. John Portner, K9CPS, Route 2, Keup Road, Cedarburg, Wis.

SELL: Meissner 150B phone — c.w. xmtr with signal shifter VFO, in excellent condx. In metal cabinet with tubes, spare condensers, resistors, key, mike. Has 1600 volt power supply 813 final, part 811 mod. and instr manual. Best offer over \$150 buys. H. Kazanowski, W8PSK, 103 Mackin Ave., Lancaster, Penna.

FOR Sale: Gonset Commander Model B with Gonset VFO, perfect worked condx. \$90. Home brew power supply for above, \$12. Heathkit AT-1 transmitter, with built-in modulator, \$25; Heathkit AC-1 antenna coupler, \$7.50; Morrow 5 BR-1 mobile converter, \$30; Instructograph code instructor with 10 tapes, \$25. Will ship on receipt of payment or substantial deposit, if you pay charges. G. H. Wagman, K2EWA, 62 Farms Road Circle, Milltown, N. J.

SX-100 with matching speaker, mint condx. \$135, prefer not to ship. Bud KW low pass filter, \$10; JT-30 mike, \$5; UTC unit, mod. xmtr SW-19 30 W, brand new, \$5. All items P.O.b. Jim Eckenwiler, W8DQN, 1366 Grant St., Akron 1, Ohio.

ATTENTION DX'ers! Sell 57' Aeromotor tower, worked 253 counties, \$195. F.O.b. QTH or delivered Chicago area. W9ABA, 1006 Lake Ave., Wilmette, Ill.

COLLINS 75A4, used 30 hours, brand new condition, Will ship C.O.D. collect, in original packing. Best offer over \$500. Frank Fairchild, 23 Wood Ridge Lane, Sea Cliff, N. Y.

WANTED: Parts for half KW transmitter, K1DVO.

SALE: BC-698, \$8; BC-459, \$8; BC-455, \$7; 80 M ARC-5, \$7; Clamtube modulator, rack and control unit for above (on chassis), \$11; power supply, bridge, rectified 600V-400 Ma. Fullwave rectified 200 Ma. brand new, \$5. All items P.O.b. Jim Eckenwiler, W8DQN, 1366 Grant St., Akron 1, Ohio.

FOR Sale: 2,000 CT 1 A trans. 4X500 with socket, 4X150s, 4-6-65 814s, J. Lewis, K4ULC, 518 E. Gore Ave., Orlando, Fla.

SELL: Precise Model 909 VTVM with bi voltage and RF probes. Factory calibrated Jan. 58, \$34.50. Millen absorb. Freq. meters, 4 units, 1.5 to 40 Mc. New condx. \$115.00. Spokane, Zimmerman, K4HPF, 8109 Maple Fairchild, AFB, Wash.

FOR Sale: DX-100 with modified keying in excellent shape, \$175. Almost new HQ-110 in original carton, \$200. W9GML, A. Verne Roberts, 8520 Porter, Wichita, Kansas.

FOR Sale: Surplus dynamotors, 12 volt. DCC to 400V 200 Ma. New, \$11.00, two for \$20.00, express collect. Ross, RD2, Box 880, Orlando, Fla.

SALE Best offer! BC348Q, 32V3, like new, Navy #FD20080A supply. Eldico TRIVY factory wired (No blown parts but requires changes) VHF 162, DB22A, DB23, Eico 5 in. scope 425; Altronics-Howard telewriter Mod. A, prop pitch motor converted with Harrison conversion selsyn indicator, complete but never used with spare pitch motor, W3CUL, 255 Waverly Rd., Morton, Penna.

WILL Trade brand new Mercury outboard motors, cameras, appliances or TV for good ham equipment. What have you? Blough Miner Co., 7511 Madison St., Forest Park, Ill.

HAVE 416Bs, 417As, 723A/Bs flashlight tubes, pencil triodes, etc. Trade any or all for one or pair of 4X250Bs and sockets. K6ALI, 178 Fulton St., Redwood City, Calif.

SELL 75A2 with Universal Prod. detector, \$325. Misprinted in my first ad. Harry Taubin, W2GCV, 731 Gerard Ave., Bronx 51, N. Y.

WILL TRADE: Busch Pressman 2 1/2 x 3 1/2 Kodak Ekktar f:4.5 101 mm lens. Built in Kalark synchronized range-finder, plus Kalark flash attachment with one film pack adapter and three cut film adapters. Condition good. Also Federal enlarger Mod. 331 with f:6.3 Fedar lens. Needs new base and bellows. Will trade for used radio equipment, up or down. Sammy Kurrell, McGeehe, Ark.

SELL: 10 mtr. mobile complete, cheap; Motorola 69-20 xmtr and pull-out user manual with Motorola 5 band converter and all cables and controls for antenna, mike. Have no more of this type DB22A. Make offer all or part. W9GBS, 6020 N. Neva, Chicago, Ill.

WORKED All States? Mount your QSLs neatly in first QSL Album designed especially to hold your WA8 cards. Heavy leather-textured covers, sturdy wire binding, individual spaces for all 48 states. Cards can be inspected, removed, replaced, \$3.50 postpaid. Call letters in gold for affixing to cover, \$1.00 extra. Hanover Electronics, 126 East 37th St., N. Y. C. or your dealer.

SELL: Holmes Institute (CREI) Course, "Practical Techniques of Supervision & Management", 41 latest lessons, plus 10 extra lessons, all textbooks. Cost new, \$150. First \$55 takes it. W3FEP, 3053 Marmon St., Winston-Salem, N. C.

NC300-Calibrator-Speaker: 20-A factory-wired and 458 VFO-KW linear complete, with all power supplies, commercial components throughout. Best cash offer. Tim Williams, 179 Beach St., Berea, Ohio.

75A-4 Receiver, used ten days, late serial no. #549.50; Pacemaker, new model, in warranty, never used, \$395.50; Drake low-pass filter, \$9.95; Kay Electric mega sweep and mega marker, both, \$259.50. Write W4JSH, 480 Skain Ave., Lexington, Ky.

SELL: Four months old Matchstick, \$97; new HQ-100, \$125; spotless NC125, \$125; need G66B, G77A, Jones, W2AEV, 111 Hillside Rd., Farmingdale, N. Y.

KEYER-Amplifier-Modulator, TC-10 code practice unit. Like new, 20 watts, 110V AC, \$25. Also first class at \$5.00 each: Vibroplex 'Champion bug'; Ward Leonard KW antenna relay, 110V AC, 4" spacing; VEC vest-pocket transistor code practice oscillator; CML 6 meter converter; 304TH's; 6 volt dynamotor, 425 volts at 375 Ma. Shaw Manual antenna rotator, W30PH.

NEW 4X250B and P78315 transformer, \$20 each. Other power supply components. Jim Connor, K0ADL/1, 16 Hartwell, Littleton, Mass.

S-85 Hallcrafters receiver, \$80. Little used. Mark Yurman, 981 Carnegie Ave., Plainfield, N. J.

SELL: AF67—Gonset Super Six—two PE103As—mike—Tri-bander and 75 meter haltpips—Master Mobile and HWM-1 mounts—Write for details. Box 136, Batavia, N. Y.

TRADE OR Sell: Triplett scope, Mod. 3441, new condx. Wanted: 3000 volt 500 Ma. power supply or Tri-band beam, tower & rotator. Anthony J. Gasbarre, 841 Sewanee Pl., Shreveport, La. (K5MNM).

SELL: BC-779 receiver with RME 152A converter, excellent, best offer over \$100. M. Lisansky, 436 Beach 99th St., Arverne 92, N. Y.

CLEANING Shack! Send stamped envelope for free list. W2VMX, 435 Washington Ave., Linden, N. J.

HALLCRAFTERS 8X-100 for sale, top condition, \$190. KN2GID, Sanford 8mil, Hillcrest Road, Warren TWSP, Plainfield, N. J.

FREE Kilowatt station brochure less items sold piecemeal. W3BJI, 1804 Maltravers Road, Glen Burnie, Md.

FOR Sale: NC-300 with spkr, xtal calibrator, 2-meter conv., A-1 condx, \$350; Viking Valiant 3 months old factory-wired A-1 shape, \$450; Johnson Matchbox, \$35, Hy-Gain 3-cel. Tri-band beam, never used or assembled; \$85. Free pick-up deal but will ship— you pay freight. James E. Munroe, Jr., W1JPJ, 73 High Street, No. Attleboro, Mass.

SELL: Globe Scout, 65A, good condition, \$70. Will ship. K0E6G, Oelwein, Iowa.

FOR Sale: S-381, In v. gud shape: \$40. U pay shppg. Woody Demitz, 4533 Pershing, St. Louis, Mo.

ANTENNA: Sell or trade new Hy-Gain 3-element Tribander for two 20-meter Mark heliwhips or similar. K2RVY, Mel Weiner, 8714 Farragut Road, Brooklyn 34, N. Y.

WANTED: Home brew 2-meter transmitter 25-75 watts. Prefer equipment described in ARRL Handbook. John Moffit, Mechanicsville, Iowa.

TRADE: Remington automatic 22 rifle, 8 x 25 French binoculars, value \$47, new, 1500V, 400 Ma power supply, built-in cabinet with switch for 700 v., 1000 v., 1500 v. I need Heath reflector meter, Johnson Matchbox, or any gear to trade. Tom Reed, 3226 Westridge, Houston 25, Texas.

TRADE: New, (2) 829-Fs, (2) 805s, (1) 815, (2) 811-As, (2) 807-Ws, (1) 4-125A, 2 used 4-125As. Want: 75 meter mobile ant., receiver BC-348, BC-342, BC-312, etc. Q multiplier. Earl Stodden, W9SMH, Galena, Ill.

SELL: HT-32 \$530; HT-32 \$625; 75A4, \$625; Drake receiver, \$230; NC18C, \$250; L-W 2-meter SSB, \$60; E-V mobile mike, parts for Mosley VP 15 and 20 meter beams; Mohawk Midget tape recorder. Dr. Lamb, W3VDE 1219 Yardley Rd., Morrisville, Penna. G-E 155 Mc. FM equipment— 60 watt base station, complete \$250; 25 watt mobile unit, \$65, also ARC4 12 volt converted 2 meters, \$30; ARC4 not converted, \$15; APQ9 converted 420 Mc, \$15; BC798 converted, 420 Mc, \$15. W2KZK, 61 E. Depew Ave., Buffalo 14, N. Y.

SELL: Full size Telrex 20 meter beam plus prop pitch motor and pair of 60 cycle selsyn motors, \$95. RAK R receiver, 15 Kc to 600 Kc, \$20. All shipped F.o.b. K2ZVA, Paul Kroll, 3527-203 St., Bayside 61, Queens, L. I., N. Y.

GONSET G66 with universal power supply, \$150; NC125, \$130. Both in excellent condition. Norman A. Weihe, W7HJM, Hingham, Mont.

HALLCRAFTERS HT-30 SSB exciter, \$250; Gonset Model 500V, linear amplifier, \$200. Will sell both together for \$400 cash. Will set up at your QTH in Chicago area. George J. Johnson, W9LQX, 5617 Peck Ave., LaGrange, Ill.

WANTED: Good communications receivers and xmtrs, also mobile equipment. Will swap for HT17, Novice xmtr; Simpson 260 multimeter; Gruen Vert-Thin gold watch, 35 mm camera, many others. Send for list. Martin Schiff, 12 Burbank St., Yonkers, N. Y. Tel. DE 7-2990.

FOR Sale: Like new 400C Globe King with 40 meter coils, WRL VFO 755 and Brute Force filter, \$325; Gonset Tri-Band conv. \$18; excellent Super Six conv., \$30. All for \$350. W9EWU, Herman Nobe, 812A South Church St., Belleville, Ill.

SELL SSB, 10-B exciter; 457 VFC, 4-655, PP linear amplifier, 300 Ma, 2000 volt power supply, \$300; RME VHF 152A 2, 6, 10-11 meters converter, \$50. Clayton C. McFadin, W5MGR, 715 Northwest, MetComb, Miss.

HQ129X receiver, late series, like new with speaker, \$150; DB20 Preselector, \$20; SCR 522 transmitter and receiver, \$20; 1 each 6 volt and 12 volt vibrator for receiver or low power transmitter, \$7.50; TV set, 7 in. suit case type, \$35; 813 tube, \$5. 4X150A tube, new, \$7.50. M. D. Welch, 2637 49th Ave., S.W., Seattle 16, Wash.

GAINS: With New Guarantee: KWS-1 \$1,399.00; Collins 30K-1 \$550.00; Johnson KW and desk like new \$1195.00; 8-72 \$49.50; Hallcrafters HT-30 \$349.00; HT-31 \$299.00; HT-4 with speech amplifier and antenna tuner \$695.00; NC-98 \$119.00; NC18B \$329.00; NC-300 \$319.00; HQ-129X \$159.00; Lyco 600 \$99.00; Elicco 825-100 \$395.00; E-W 61-SB \$195.00; L-W 61-SB-B \$185.00; HW L-1000-A \$295.00; Ranger \$199.50; Phasemaster II \$239.00; Gonset Linears (2M) \$99.00— (6M) \$119.00; Globe King 500 \$425.00; Globe King 500A \$455.00; Communicator II 6 meter \$179.00; Johnson Rotomatic \$125.00. Free trial, terms, write Leo, W0GFR for best deals. World Radio Laboratories, 3415 West Broadway, Council Bluffs, Iowa.

WANT TO buy couple V-70-D tubes. For sale: General Electric transformer 4300 volts, 450 Ma. center tapped, \$20. Latest Meissner Signal Shifter kit, never wired, \$25. W4NER, Box 595, Lancaster, Ky.

FOR Sale: Brand new Telrex 3-element 20 meter beam, Make offer; brand new Johnson Matchstick, Make offer, Johnson Kilowatt amplifier with Hanger. Make offer, W. A. Kuehl, W9EZN, 6647 Kenton Avenue, Lincolnwood, Ill.

SELL Or trade: 500 watt 813 Handbook rig, custom job, exact parts as per article, 250 volt hi-voltage and lo-voltage supplies all in 5 ft. cabinet; 300 watt coupler, spare \$138, \$250 cash or trade. What have you? WILLL, Risley, Brainard Hill Rd., Higganum, Conn. Tel: DI 5-2747.

HQ-129X, matching speaker, built-in crystal calibrator, Q-multiplier. Perfect condition: \$165 delivered. K9CEF, Route 1, Casco, Wisconsin.

SELL: Viking Ranger, HQ-100 receiver, four months old. Both for \$350. WINFY, 166 Henry Law, Dover, N. H.

OLD QSTs for sale. One of few complete files in existence. Issue #1 December 1915 to 1958. Every copy good to excellent condition. Sell single copies or otherwise to highest bidders. Will hold bids 30 days. All inquiries answered. W6SN.

"VOICES of the Satellites" Authentic recordings of radio signals from man's first six satellites with clear explanation of what they mean. A collector's item. Everyone from nine to ninety will be thrilled to meet these space travelers. \$3.95, 5 in. reel or 10 in. LP disk. Taben Recordings, Box 224-B, Ardmore, Penna.

SELL: SX-42 \$150, BC779A, \$125; SX28, \$75. W2HMA, 96 Melrose Ave., Irvington, N. J.

2 METER Transceiver, Abbott TR-4, with spare tubes, \$20 I.o.b. Also 808s, 1616s, Hugh Richards, Jr., Box 631, Ft. Myers, Fla.

TELEX 3-element, 20M, full-size beam. Model 503-A. Best offer. W2ZGB, 178 Colonial Rd., Summit, N. J.

SELL: Telrex 3-el 20 M beam, \$50; new radio tubes, original cartons, cheap; new IRC volume controls; Volumes 1-3 RCA Picto-O-Guides, \$5; Stancor 5x 6V, battery eliminator, \$15. Calvin Evans, 327 W. Spring, LaGrange, Indiana. "W9LTR"

BRAND New, never used: Collins coax relays in sealed bags (as supplied with KW3-1) \$7.50 each; Drake or Amphenol 300 HP filters, \$2; National AM-5 dial, \$1.75; RAK Rt. and Drive, \$2; National Select-O-Ject, \$15; 807s, \$1.50; 809s, \$1.50; 808s, \$2.65. \$1. Slightly used: Bud 100 Kc. freq. calib., \$6. Send check or m.o. for speed. Bob, K2HKP/K2GXJ, 48 Thatcher, Buffalo, 15, N. Y.

HQ-100 revr with clock-timer and manuals, \$149, operating condx and appearance as new. K6VRM, 5641 Dorset Way, Sacramento, Calif.

INVERTER Wanted: 110 volts DC to 110 AC; 250 or more watts continuous. George Farris, K2KNV, 894 Colvin, Kenmore 23, N. Y.

SELL: Viking I with TV suppression and VFO, \$195; Magnatube Twin-Trax tape recorder, professional model with mike, \$100; Elmac 454, \$50. Local sale preferred. William Peet, W3DIY/2, 57 Kings Rd., Little Silver, N. J.

YOUR Call Letters block engraved on the bar and lapel pin set, \$4.95. Individual gift bar or lapel pin, \$2.50 each. Heavily silver-plated, individually gift boxed. An ideal gift. Money back guarantee. Prices include postage and federal tax. Check or money order to Hewlett Sales Co., 1199 East Broadway, Hewlett, L. I., N. Y.

SELL: Gonset Communicator II, 2 meters, 12 volts. Keller, 514 Stevens Rd., Morrisville, Penna.

FOR Sale: Estate of KN1DHR, SX101, \$275; DX-20 with Dow coax relay, \$30. Write WIGLK, 22 Lyman Rd., West Hartford, Conn.

FOR Sale: Reconditioned 55 ft. self-supporting crank-up lift-over E-Z Way tower with telescoping motor shaft, \$175. W1LOP, 71 Hilldale Rd., West Hartford, Conn.

WANTED: B+W 51SB, RME DB28; clean looks and in top working condx. Metropolitan area only. Write W2GYQ, Marc Felt, 50 Prince Lane, Westbury, L. I., N. Y.

CLEANING SHACK: Have hundreds of excellent tubes, resistors, capacitors, fantastically cheap. List free. Richard Light, K2UOY, 640 Riverside Drive, N. Y.

VIKING II, NC-300 for sale. Viking with VFO, time-sequence keying, factory-wired, excellent, \$210. NC-300 with matching speaker, calibrator, like new condx, \$295. Dave Smith, 54 Butler Rd., Scarsdale, N. Y. Tel: SC 3-4083.

DX-100, must sell, late model, new condition, everything A-1. First \$150 takes it. Will ship prepaid. W9DRC, 900 W. Laramie Lane, Milwaukee 17, Wis.

COLLINS KWS-1. In excellent condx, extra pair final tubes; \$1395. Joe Brand, K6OJC, 7926 Coldwater Canyon, North Hollywood, Calif.

SELL: Elmac AF67 xmtr, 12 volt dynamo power supply plus Elmac PS2V AC power supply; PMR6A revr 12 volt supply; Webster Bandspring antenna 12 volt relay, \$300; Sonar VFN 650 exciter, \$20; National NC-183 revr w/speaker, \$125.00; Meissner 150B xmtr. VFO exciter plus home-built 6N7X-807 exciter, needs work done, \$65; Triplett #630 Multitester, \$35; Millen Grid Dip meter #90651, \$45; Jones MicroMatch coupler and indicator, \$25; all in new condx. No shipping, sorry. Pick up deal on what you want. W2PLB, Charles, DI 2-7914, 314 East 52nd St., Brooklyn, N. Y.

FOR Sale: SX-100, R46H matching speaker, both for \$175; complete dual power supply, 400V 250 mls, 180V 200 mls. All on one chassis with panel. Rack or cabinet mounting. Ideal for 300 watt rig. \$50.00. W2MJB.

PENTA 4-400s, \$40; Elmac 4-125s, \$15; and 4-100s, \$35 and 4-65s, \$8; G66B and 3-way power supply, \$180; Gonset Tri-band beams; W0-88 scope, \$115; Model A Slicer, \$50; GPR90-X, \$395; TR switch, \$8. 2 Kw Amertran, Lecco-Neville GV-100A alternator. E. Baker, W8QJR.

COMPLETE Ham station. Viking Ranger, SX-99, Bud low pass filter, Dow antenna relay, crystal mike, cables and connectors, Wonderbar antenna with coils and mounting brackets, 100' coax. Less than one year old. Original cartons, instruction manuals, cash and carry, \$325. Marvin Wallach, K2GZF, 84-25 Elmhurst Ave., Elmhurst, N. Y.

NC-300 or SX-101 wanted. Need not be in operating condx but must be mechanically OK and present good appearance. Will pay \$200. W0ZBJ, 2444 "D" St., Lincoln, Nebr.

FOR Sale: Globe King 500C, new condx. Used only five hours, push-to-talk mike, guaranteed perfect shape. Price, \$600.00. W8CFP, Box 261, Charleston, W. Va.

SELL: KW amplifier, 813s in cabinet, KW modulator, 3000 volt pwr supp, speech amplifier: \$400 takes all 75A4 w/spkr, \$500. Need cash quickly for college. Make any reasonable offer. K5AGI, 1710 Emerson St., Monroe, La.

FOR Sale: HRO-60, callibrator and speaker. W5ONQ.

TRADE New Johnson Viking mobile, mobile VFO, and 12 volt dynamo, all kit form and in factory cartons for DX-100 or Viking Ranger. K4IFP, 1105-47th St. West, Birmingham 8, Ala.

FOR Sale: KW8-1/75A4 in like new condx, complete with instrux manuals and in original cartons. Loaded with extras, such as new style tuning knobs, matching speaker and additional 500 cycle filter for receiver, \$1995.00. W. W. Staats, Ripley, West Virginia.

SELL: 553A A-1 condition, \$50, 20W 40 meter xtal xmtr, \$15. Hb for \$30. K2PCP.

LINEAR Amplifier, pair 803 8, GG, complete shielding, metering, lower plate, spare 803s, \$25; 3 KV power supp, components for above, \$35; 144 Mc Terract conv. 26-30 Mc IF, \$25; 144 Mc RF section, \$29B final, 7" panel, 2 meters, no surplus, \$25; Field Strength meter, battery operated 3.5 thru 144 Mc., \$10; Monitone and 100 Kc standard, a beauty at \$20; Millen freq. meter 130-170 Mc., \$5; vacuum variable, 20-700 μ fd, \$35; Panadapter SP44, \$75; all P.O.-C. Jaray, 215 Main St., Fort Washington, L. I., N. Y.

SELL: 300W rig, June 1954 QST, with scope, varac control, 250 w. mod. in 6 ft. enclosed cabinet, SX71 receiver, in exc. condx, both \$300 cash and carry. PE 103 dynamotor, \$15. A. Heath, 655 Leigh Terr., Westwood, N. J. Sell: 300 QRTs, 1932-1957. Best offer.

SELL HRO-M, \$63; Collins TCS revr, \$32; 40-watt 6-meter xmtr w/modulator, \$48.50; Heath TV sweep generator, \$27.50; 300 watt Eldico e.w. rig w/VFO and pwr supp, \$125; 150-watt mod. w/p.s. \$50; Jackson #636 tube tester, \$22. Will trade, want SX-71, 129X, Preselector, HRO coils. Don Maxwell, 110 Fayette St., Charleston, W. Va.

SELL Collins 32V3 and 75A1, \$600; xmtr separately, \$475. Misc. items, meters, etc. cheap. W6BZU, Peterson, 1830 Clayton Way, Concord, Calif.

SELL: Ronar 12-V MR-3 revr, \$17; Viking Whipload Six loading coil, \$8; Mallory G346R 12-V Vigrapak, \$4. Express collect. W2KDB, Exlit, 2 Rogan Lane, West Islip, N. Y.

FOR Sale: Harvey-Wells xttr TB8-50D, 80 thru 2 meters, \$70; AP8-50 pwr supp, \$20; RME MC-55 converter, 80 thru 10, 6 or 12 volt, \$40; four new 813s, best offer. All equipment guaranteed excellent. Want VFO and revr, 75A2 or NC300, G. Staves, W3JIC, 525 S. Rolling Rd., Baltimore 28, Md.

WANTED: 6-meter Gonset Communicator III. Will trade factory-wired Globe Scout 65A, JT-30 Astaltle mike, 5 x 8 printing press with type, etc. and Col. 45 automatic. KØELK, Herb Whipple, Box 900, Desoto, Mo.

FOR Sale: 1D-X-35 in vy gud condx. Shipped express collect. First \$50 takes it. W5GIF, Box J, Centerville, Miss.

WRL Screen modulator, \$7.00, in exc. condx, w/manual. Jim Wurtz, 2861 Gonzaga, Kitchener, 10, Calif.

(CANADIAN) Set of 8 Marconi manuals, brand new, for first and second class commercial license, cost \$15. Sell for \$10. Never used. V3E6GG, Ernie Crump, 64 Barrie, Galt, Ont., Canada.

FOR Sale or trade for SSB gear; SX42, VHF-152A, 10B with VFO, TBY with 4 volt pwr supp, 3-30 Gonset converter, 10 meter mobile xmtr, with dynamotor. K2POF, 1152 Park Ave., Vineland, N. J.

SALE: SX-101, \$330; HT-32, \$550. Will ship. Units perfect. Used less than 40 hours. Will sell separately or together. Don Goodrum, K4DBH, 2819 Plantation Dr., East Point, Ga.

FOR Sale: BC312N and BC314D receivers with pwr supp; Q multiplier, 100 Kc. freq. std. Sold as one unit: \$50. No shipping, sry. George Reil, W4DQY, 324 Orange St., Gallion, Ohio.

NEW: NC-300 C2 converter (with guarantee), \$30; NC-300 (4 meters), \$300; will deliver up to 100 miles. Larry Kohlman, K2BVC, 330 Beechmont Dr., New Rochelle, N. Y.

WANTED: BC946 revr. front end coils for BC-453, 20 40 MEL, 40 OF8, 40 BVL. Gene Bradley, 706 Oak, Warren, Ohio.

SELL San Francisco Bay Area only, 62 ft. Vestro tower stacked 10 over 20 meter beam selyns, prop pitch motor, best offer. Will answer all inquiries. Tel. LUCerne 1-4035. W6GIB, 8438 Alma Ave., Castro Valley, Calif.

MOBILE Station complete, \$55; Gonset 3-30 Mc. post mount, Lyseo xmtr, Mallory Vigrapak whip, mount, coil, T1, MC, 75 M xtal, and coax 6V. Also Geniac, \$13; Heathkit VFO \$13. Send postag. K2ABY, Bethpage, L. I., N. Y.

SELL: Collins 75A4, \$495; Hallcrafters HT-30 SSB exciter, \$295; HT-31 500 watt linear amplifier, \$195. All in like-new condx with instrux books, W6UGH, 8209 NADA, Downey, Calif.

SX-28 in fine condx, \$125; Heath AT1, 30 watt xmtr, like new, \$20. Rev. Battin, 616 Glenwood, Elgin, Ill.

MUST sell complete SSB station at once: KW8-1, 75A-4 and SC101. Must go together. In a like-new condx. One year old. Price, \$2500. Write or call K5HRJ, Charles Clarke, Box 535, Knox City, Texas.

FOR Sale: 100 Kc-10 Kc. xtal frequency standard as in QST, June 1955: \$25. W9ODT, 528 E. 4th St., Lockport, Ill.

HAVE Three new Eljac 4-250A and two 4-125A. Need NC-300-C1, NC-300-C2 or XCU300. Make offer. W3ZYK, Mechanicsburg, Penna.

WANTED: Coils "AC and AA" for HRO50. Trade complete dark-room outfit for 12 volt Communicator or DX-100. Write for details. K4MEX, Lawrence Smith, Rt. #2, Nevada, Iowa.

SELL: Elmac PMR-8 revr with 6V Vigrapak; BC-453 revr. PE-103, Browning freq. meter. Make an offer! Robert Titterton, W8YBP/4, RFD 1, Box 11-A6 Portsmouth, Va.

SELL: Hallcrafters S-53A with Heath Q-multiplier. Best offer. Bill Goodman, 114 East Wayne Ave., Easton, Pa.

#2V3 excellent condition, \$495. Need Paefelcer and audio amplifier for Johnson kilowatt, also Model B slicer. Lewis West, W9AIO, 3414 W. St. Louis, Wichita 12, Kans.

FOR Sale: Portable mill, pica type, \$25; portable radio, needs batteries, \$5; Timex magnetic recorder, \$20; 2-station intercom, \$10. Postage extra. V. R. Hein, 418 Gregory, Rockford, Ill.

WANT: Good homebrew 2 meter revr and xmtr. Both must be in A-1 shape with pwr supplies and ready to go. Must also be neat-appearing. Xmtr must run at least 40 watts out. Absolutely no junk wanted. N. K. Thompson, W1LWV, 99 Water, Millhooket, Me.

SELL: Globe Scout 850, in perfect condx. Only 16 hours use. To the most reasonable offer. Wilson Routh, RFD #3, Nicholasville, Ky.

FOR Sale: Steel tower, 90 ft. guyed, Jontz mgfd., 10 ft. sections. Will hold any combinations of antenna, in perf. condx; \$75; 3-el. 20M beam, \$25; 4-el 15 meter beam, \$30, aluminum fittings, kramm, mast, 1/2" x 1/2" to install. Parts alone worth twice the price; prop pitch motor selyns and xfrm. \$20; Westinghouse plate xfrm. 2000Vdc after filter 750 ma CCS, perf. condx, steel at \$60; plate xfrm 3000 VDC after filter, 750 Ma CCS, 110 220 pri., brand new, nev. used, \$75; Thord. Multimatch mod. xfrm, 500 watts aud. output, like new w/manual, \$50; 2 factory sealed Elmac 4-250A, \$47.50 each, \$50 taking 1000. First check or m.c. gets any item. All letters ansd. E. H. Smith, W8HMI, RFD #3, Park Paw, Mich.

DX-100: Exc. wiring, very clean, \$180. E. Getchell, Causeway St., Medfield, Mass.

WANTED: Johnson Matchbox (275 watts) K2VNS, Levy, 1075 West Ninth, Brooklyn, N. Y.

ALUMINUM for the Hams who want the best for less. Write for list of angle, channel, plain and perforated sheet, castings, fasteners, beam kits, etc. VHF coil arrays, \$14.20 up. 8X and ten meter beam specials, \$15.95. Dick's W8JDL, Chery Ave., Rte. 1, Tiffin, Ohio. Successor to Radcliff's.

CRYSTALS Alrmailed. Novice, net. general: FT-243. Any kilocycle. 0.1%, 3500 to 8600, \$1.00; thin Gonset, \$1.45; 1700 to 3499, \$1.75; 8601 to 21,500, \$1.95; new crystals. Guaranteed. Marine, C.A.P., Inc. \$3. Write for frequency listings and brochure. Crystals since 1933. C-W crystals, Box 2065G, El Monte, Calif.

HAMMARLUND HQ150, \$175. New set, with factory guarantee. Howard W. Smith, Hiawasseo, Ga.

PLAN Now for ARRL Hudson Division Convention, Albany, N. Y., October 10-12. Watch for announcement.

KW Final parallel 4-250As, vacuum variable, see ARRL Handbook (1957) page 210, 4 ft. tes. to tower. Will ship if knocked down. Fr collect. PE 813 modulator, 600 watt Multimatch xfrm: 6 ft. cabinet, misc. pwr supply parts, etc. K4DGM, 225 Vincent Blvd., Alliance, Ohio.

SELL Transmitter: 10 thru 80 meters, 813 final, KW supply, VFO, \$225. Bob Snicer, 217 Osborn Rd., Albany 5, N. Y.

DX-40 For Sale: new this year, in perfect condx. J. T. Morey, W2HXF, 210 Mountain Ave., Princeton, N. J.

SACRIFICE: Hy-Gain 152T2 2-el. Triband beam, brand new and in original cartons, \$45; Donner 40 ft. crank-up tower, brand new, \$45. S. E. Schwarz, 1726 Shiloh St., Camarillo, Calif.

LOW Mileage 65B Scout, \$69; WRL mod. 755VFO, \$49, with manuals, factory-wired. New Drake KW lo-pass, \$12; new ARC5 7-9.1, \$8; shipped postpaid anywhere in the USA. Fred Krauss, W8SPR, 95 Morris, Salem, Ohio.

SELL: 75A3 32V3 in A-1 condition, like new appearance, reasonable. W2OGE, 6 Clinton, Warwick, N. Y.

SELL: NC-109 revr six months old, \$215; Harvey-Wells xmtr complete band-switching 80 thru 2 meters; pwr supply, AP8-50, \$90. Chicago area. G. H. Duffner, Jr., W9FBM, 8454 So. Dante Ave., Chicago 19, Ill.

BECOME A Radio Amateur. Free information on how to pass Code and Theory FCC examinations. American Electronics, 1203 Bryant Ave., New York 59, N. Y.

SELL KWS1, 75A4 (both with Collins vernier knob), matching deluxe speaker, with 24-hour tumblor clock installed; 2.1, 3.0, 6.0 kc filters; all modifications with two minor exceptions incorporated. Cash package price, \$1,795.00. Used less than two months a year ashore because of shipboard Radio Office position where maritime mobile never permitted. Steve Fox, W2ALZ, 14 Beekman Pl., Glen Rock, N. J.

SELL Meek 60W transmitter, coils, mike, \$35, 20M 3-element Short-beam, \$30, W2GWT, Penn Yan, N. Y.

RECONDITIONED: Shipped on approval with easy terms. Hallcrafters \$40B \$79.00; SX99 \$119.00; SX71 \$149.00; SX36 \$139.00; SX100 \$229.00; SX101 \$299.00; HQ129X \$159.00; HQ100 \$139.00; HQ1140 \$189.00; HQ150; National NC98 \$99.00; HRO50T \$100.00; NC189D \$279.00; NC300 \$279.00; Viking 1 \$129.00; Viking 2 \$199.00; Ranger \$179.00; Vallant; Pacemaker; PMR6A; PMR7A; AR67; Collins 75A1; 75A2; 75A3; 75A4; KWS1. Many other items. Write for list. Henry Radio Co., Butler, Mo.

FOR Sale: Viking II with VFO and NC183, all in good condx, \$295. Estate of W5V LZ, Write Mrs. S. G. Swartz, Rt. 2, Box 34, Lusk Cruces, N. M.

TUBES: Brand New 4D32's \$22.50, 4-125A \$15.00, 4X150A \$12.50, 813 \$7.50, 814 \$3.50, 815 \$1.75, 832A \$4.75, 3E29(R29B) \$6.00, 5894 \$10.00, 446B \$4.50, 5E26 \$2.25, 211 \$1.00, 8414 \$1.00, RK25 \$1.50. ART-13 transmitter, perfect condition \$125.00. VHF 152 converter 10-6-2 meters \$42.00. Stancor 500 watt modulation transformer \$40.00. Superior 126 powerstat 15 amp \$25.00. 1130-0-1130V - 500MA Kenyon \$25.00. 2MFD-3000V all filtered condensers \$6.50. Stancor 250 watt modulation xmr \$18.00. ART-13 modulation transformer, \$8.50. Close circuit T.V. camera \$75.00. New batteries for BC611 \$1.75 pair. All guaranteed. C.O.D.'s OK, Bill Step Waffly, Box 178 Ellenton, Florida.

KITS Wired - 20% of kit price. Transmitters designed, built. Surplus conversions, 6m VFO, new design, with power supply, \$39.50; 1 KW dummy antenna, cabinet, \$5.75; complete 100 watt 6 or 2m phony xmtr with m.c. xtal, power supply, TVI-suppressed, \$99.50; transmitter motor supplies, \$10 up; new! all guaranteed 1 year. Catalog sheets, bargain lists. Graduate engineer (licensed ham since 1924, ex W9AXJ). Money-back guarantee. K9KJX, L. P. Jackson, 645 Marshall St., Louis 19, Mo.

HQ-129X for sale, \$125, plus transportation. P. F. Williams, 25 Denison St., Hartford 5, Conn.

SELLING: 840B, \$60, AT-1, \$17. K5JTP.

FOR Sale: Heathkit electronic voice control, Vy kud. condx, \$21 ppd. W8SWN, Zealand, Mich.

AMATEUR Electronic Supply, Wisconsin's largest ham distributor, has moved to 3832 West Lisbon, Milwaukee. Write for free used equipment lists.

COAXIAL-CABLE - 53 ohms - 100 ft., \$3.95, postpaid. Satisfaction guaranteed. Van Dick, Riverlawn Drive, Wayne, N. J.

W9CVU Gold Cup given for 100th country two-way SSB. QST with W9CVU. Must receive QSL verification of contact to qualify.



6-METER Communicator III (3) with crystals, 2 mikes, ground plane, \$220 (excellent); Gonset 6-meter linear (11) with 10 spare power tubes, as new, \$300; 2000 for \$300. (Money order.) Bob McKnight, K8SEK, 1760 State St., Apt. #15, South Pasadena, Calif.

SELLING FB low power rig, both units new and in perf. operating condition. DX-50, \$50; VE-1, \$16. Postpaid. Money order preferred. Gordon Kittel, K3AIG, 2930 Tlghman St., Allentown, Pa.

SELL: 12V. dynamotor 425V at .375A output \$12; 6V dynamotor 425V at .375A output, \$8, both in excellent condx, no surplus. Like new. LM freq. meter with orig. calibration book, \$55. W6AJ, 8015 Loyola Blvd., Los Angeles, Calif.

ELMAC PMR 6A revr with TNS, \$75; 12v powr supp, \$15; Johnson mobile xmtr, \$70; mobile VFO, \$25; dynamotor with filter, 12v—400V/400 Ma., \$10 or \$170 take all. F.o.b. New York City, Bill Herzog, W2KOO, 3132 104 St., East Elmhurst 69, N. Y.

HOUSECLEANING: KWS-1, several other transmitters, receivers, kits, accessories, Triband beam; tremendous quantity of excellent components. Clearance prices. 6-page list for stamped envelope. W4LDW, 5514 No. 16th, Arlington, Va.

I Am a member. Are you? WILWA.

WANTED: Receivers, transmitters, test equipment, teletype, especially 51J, 75A, 200, BC-348, HC-810 in trade for new S-101, NC-300, HQ-170, Ranger, Valiant, HT-32, Gonset, Relrex, Fisher Hi-Fi, Bell, etc. Write Tom, W1AFN, Alltronics-Howard Co., Box 19, Boston 1, Mass. (Tel. Richmond 2-0048) Stores: 278 Friend St., Boston (near North Station); 60 Spring St., Newport, R. I.

SELL: DX-100. Also build all kits. Write for information, George, K2PGC, 7 Thurston Ave., Trenton, N. J.

ART-13 for sale, with 110 V AC power supply. Make an offer, located West Orange, N. J. F. Metzger, 4105 Black Point Road, Honolulu, 15, T. H.

IMPERATIVE! Must sell: NC-98 with spkr, \$95; WRLAT-3(w/v), \$10; VP-1, \$16.50; Vy modified AT-1 with antenna relay, new meter, 40W inpt., \$31; Cathode modulator, \$6; Everything for \$149.95. All inquiries will be answered. W2JEM/2, Michael Hoodes, Walter, Camp Roosevelt, Sackett Lake, Monticello, N. Y.

FOR Sale or trade: Viking Adventurer xmtr, like new condx, \$40 or will trade for G-meter revr or two meter converter. W4DSO, P. O. Box 444, Morrilton, N. C.

WANTED: Hallicrafters portable receivers models 8-72 and 8-72L, new or used. State condx and price wanted. Grote Reber, P. O. Box 2, Green Bank, W. Va.

FOR Sale: HQ-129X, exc. condx, \$145 less spkr. Will be willing to ship freight collect, also C.o.d. with a 925 deposit. Clyde Lawrence, Box 983, McCall, Idaho.

GONSET Communicator III, a-1 2 meter, E.V. carbon mike, 205KK and Astatic 2008 xtal mike, \$300 value for \$200. Cliff Apple, K8BUG, 3721 Mengel Dr., Kettering 29, Ohio.

HALLICRAFTERS SX-28A w/matching spkr, in gud condx, both in appearance and working order. \$125. Gerst, 2674 W. 25th, Cleveland 13, Ohio.

DX-100, \$160 shipped prepaid. Reason for sale: going on 2 meters where there's lots of room. K9GYA, 1025 Main St., Stevens Point, Wis.

HEATH AR-3 in gud condx, \$20; automatic bug, vy gud condx, \$16. Will be willing to ship. K9KHQ, 102 East 17th, Hutchinson, Kans.

SELL: surplus 3-6 Mc. revr, 115 ac. speaker, \$10; code machine, no tapes, no key, \$5. Wanted: S-53A. Deal on Holiday flash camera, closeup lens, gadget bag? W6NUTJ, 2501 Fremont Dr., Sonoma, Calif.

SX-71 with xtal calibrator, \$140; 75 watt Handbook xmtr, \$35. For complete details write to Don Uber, W1FGW, 132 Woodbridge St., South Hadley, Mass.

SELL: HRO-5, rack cabinet, spkr, p/supp, coils E. F. G. H. J, JA, JB, JC, and JD. In mint condition: \$125. Bob Noon, Rte #2, Coffeyville, Kans.

PIERSON KE-93 wanted. All replies will be answered. Please state whether die-cast panel, power supply, etc. Full info is desired. Eric, VE3DPV, 212 Dublin St., Guelph, Ont., Canada.

S-53A with Heath Q-Multiplier, in excellent condition, \$60. Sorry, can't ship. K2YFM, N. Y. C. Gone after 6 p.m. FO 5-8978.

ELECTRO-VOICE carbon mike #210 KK, never used, \$15. K8HRO, Box 1075, Huntington, W. Va.

RCA 30-45 Mc. 30 watts, outpt. FM mobile xmtr, \$7.95; supplied with tubes but less dynamotor and xtal. Schematic available. Telemobile, Inc. Dynamotors input: 6 volts output 600 v at 155 Ma., \$3; input: 6 v; output 900 volts at 265 Ma., \$5.75. Telemobile, Inc., 60 Grant Ave., Bethpage, N. Y.

CLEANING House! ARR-1 with tubes, \$5; new SCR-522, \$25; BC-1068, \$20; new BC-454, \$7.50; BC-453, \$10; BC-457, \$7.50; BC-455, \$7.50; BC-314 with 110 VAC supp, \$40; BC-620 and BC-659, both with 6/12 VDC supp, \$10 a.; Pair 10-meter walkie-talkies, home built, \$25; Robert Harstad, 933 Fifth St., Eau Claire Wis.

CANADIANS! For sale: xmtr's Heathkit DX-100, Hallicrafters HT-9 revr; Hammarlund HQ-129X. Requested Viking Ranger. VE2OU, P. O. Box 355, Juviere du Loup, Que. P., Canada.

GLOBE Scout 65A, \$75; Heathkit VE-1, \$17 and AC-1, \$10; ARC-4 two meter transmitter, \$50; lo-noise two meter converter, \$30, 150 volt regulated power supply, \$10; two meter walkie-talkie, \$10; Par-Metal cabinet for 8 1/2" panel, \$5.3C24, \$1; 2E26, \$2; various QSTs and Radios, 1930 to 1942, broken runs, about 100 in lot; \$25. Make an offer. Roger Shultz, 33 Valley View Place, Tiffin, Ohio.

FOR Sale: 350-500 W. 6-meter xmtr, commercial cabinet, chassis rack mounted, 304TL final, 829B driver, PP203A, 300W modulator, 5 pwr supplies, \$200 cash, 7-90 Harvey-Wells Bandmaster, Z match and pwr supply, \$200. Cash. Sorry, cannot ship. Wm. E. Barefoot, W3UQJ, 1408 Whitford Ed., York, Pa.

TUCSON Area: For sale one Felrex 3-el. 10-meter beam and TR4 rotator in perfect condx. Best offer over \$50. Almost new Triplett meters, one each 0-500 Ma., 0-25 Ma., \$5 each; several kits and other equipment. Sorry, no shipping. W7PQ, phone MAIN 4-2946.

SALE: Gonset 2-meter VFP Preamp and canvas case for Communicator II, like new, reasonable. Storch, 5 Winfield Terrace, Great Neck, L. I., N. Y.

United We Stand...

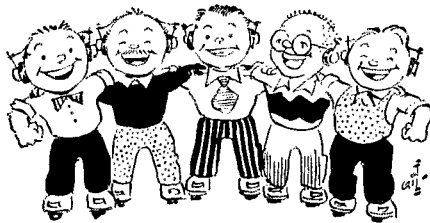

Have You Signed Up
Any New Members
Lately?

As the old greeting-song goes, "The more we stick together, the happier we will be." The more members your League has, the more prestige it enjoys; the more prestige it has, the better it can protect our privileges; the better it protects our privileges, the more fun you and I get out of ham radio. Start your own membership campaign soon.

P.S. Don't forget that additional licensed amateurs residing in the same household with a full member may join the League for only \$1—without having to obtain a subscription to QST.

QST and ARRL Membership \$4
\$4.25 in Canada, \$5 elsewhere

THE AMERICAN RADIO
RELAY LEAGUE, INC.
West Hartford 7, Connecticut

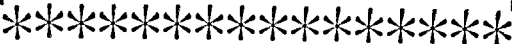

Designed for

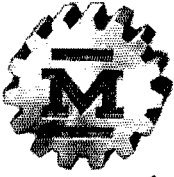

Application



90801

**The No. 90801
EXCITER-TRANSMITTER**

The No. 90801 Exciter-Transmitter is of the most modern design including features and shielding for TVI reduction, band-switching for the 4-7-14-21 and 28 megacycle bands, circuit metering. Conservatively rated for use either as a transmitter or exciter. 5763 oscillator-buffer-multiplier and 6146 power amplifier. 90 watts input for CW. Can be keyed in the oscillator and/or amplifier or by means of keyed external V.F.O. such as the 90711. 67 watts input phone. Rack mounted 3 1/2" panel height.

**JAMES MILLEN
MFG. CO., INC.**

MAIN OFFICE AND FACTORY
**MALDEN
MASSACHUSETTS**



Index of Advertisers

Adirondack Radio Supply	112, 116
Allied Radio Corp.	160
Alltronics-Howard Co.	149
Amateur Electronic Supply	116
American Radio Relay League	
<i>Logbooks</i>	143
<i>License Manual</i>	137
<i>Handbook</i>	149
<i>Gateway</i>	86
<i>Postal Zone Request</i>	143
<i>QST</i>	157
Arrow Electronics, Inc.	125
Ashe Radio Co., Walter	135
Box 185	149
Broadcast Equipment Corp.	144
Bud Radio, Inc.	132
Burghardt Radio Supply	114, 118
Candler System Co.	147
Collins Radio Co.	142
Commercial Radio Institute	142
Communication Products Co., Inc.	146
Crawford Radio, The	146
Cubex Co.	139
Damp-Chaser, Inc.	144
DeMambo Radio Supply Co., Inc.	106
Dow-Key Co., Inc., The	149
D.X.era.m.a.	137
Eitel-McCullough, Inc.	4
Electronic Supply	98, 127
Electro-Voice, Inc. (RME)	Cover II
E-Z Way Towers, Inc.	120
Fort Orange Radio Distributing Co., Inc.	129
Gardner & Co.	150
General Crystal Co., Inc.	145
General Electronic Service	145
Globe Electronics	113
Gonsel Div.	107, 124
Gotham	100, 101
Graham Electronics Supply, Inc.	147
Green Mill Radio Supply	134
Greenlee Tool Co.	142
Groth Mfg. Co., R. W.	146
Hallcrafters Co., The	1, 85
Hammarlund Mfg. Co., Inc.	111
Harrison Radio	102, 103
Harvey Radio Co., Inc.	121
Harvey-Wells Electronics, Inc.	141
Hatry of Hartford	141
Heath Co., The	90-94
Henry Radio Stores	98, 99
Hi-Par Products Co.	149
Hobby Print Shop	144
Instructograph Co., Inc.	137
International Crystal Mfg. Co., Inc.	109
International Instruments, Inc.	139
Johnson Co., E. F.	87, 88, 89
Lafayette Radio	133
Lampkin Labs, Inc.	147
Lettime Radio Mfg. Co.	147
Lindsay Antenna & Specialty Products, Ltd.	151
Mach Electronics	146
Mallory & Co., Inc., P. K.	95
Master Mechanic Mfg. Co.	145
Master Mobile Mounts, Inc.	115
Melville Radio Corp.	143
Millen Mfg. Co., Inc., James	158
Moore Co., D.	139
Mosley Electronics, Inc.	108, 110, 137, 142, 148, 151
National Co., Inc.	Cover
Nelson Publishing Co.	150
North Hills Electric Co., Inc.	144
Organs & Electronics	141
Overton Electric Co., Inc.	140
P & H Electronics, Inc.	130
Penta Labs, Inc.	117
Petersen Radio Co., Inc.	5
Port Arthur College	145
Radio Products Sales, Inc.	131
Radio Shack Corp.	136
Raytheon Mfg. Co.	96, 97
RCA Electron Tube Div.	Cover IV
Rider Publisher, Inc., John F.	159
Rogers Radio Co., Inc.	138
Scientific Radio Products, Inc.	151
Sinair Electronics, Inc.	119
Tapcode	141
Technical Materiel Corp.	7
Tecraft	139
Tele-Vue Towers, Inc.	146
Telrex, Inc.	145
Tennalab	135
Triad Transformer Corp.	104
Universal Distributors, Inc.	112
W. S. Crystals, Inc.	122
Vesto Co., Inc.	143
Vibroplex Co., Inc., The	151
Waco Communications Co.	150
World Radio Labs.	105, 123, 128, 148, 152

it's easy to learn all about

• DIGITAL COMPUTERS •

• TELEVISION •

the Rider 'Picture-Book' Way

It's no mystery why Rider 'picture-book' training courses are the easiest, quickest, most economical way of learning all about electronics. Text is written in down-to-earth English and explanations are thorough enough to satisfy the most critical engineer. Coverage of each subject is completely up-to-date. Fundamentals are presented idea-by-idea, page-by-page, permitting the reader to build his knowledge step-by-step. Specially conceived, easily understood illustrations support the text and make each subject crystal clear. At least one big illustration on each page! Here are two new 'picture-book' courses...

BASICS OF DIGITAL COMPUTERS

by John S. Murphy

catapults you into the exciting digital computer field

If you have a knowledge of the fundamentals of electronics, you can master the basics of digital computers and understand the details of any specific digital computer with this new 3 volume 'picture-book' course. Written by an expert in the computer field, text matter has been tested and proven in the training of computer field engineers and technicians. More than 350 illustrations support the text.

Volume 1 covers the background of computers (development; what a computer is; binary data representation—basis of digital computers; automatic calculation, programming and control).

Volume 2: the components and units (basic building blocks of logical systems; transition from communication electronics to computer electronics; uses of tubes, diodes and magnetic cores; examples combining use of building blocks and elemental circuits).

Volume 3: operation of the computer (major logical systems; storing and transferring data; allied input-output units; magnetic drums and core type of memory; static and dynamic types of registers including shift registers; timing pulses; control; retiming).

Basics of Digital Computers is ideal for training of programming personnel, maintenance men, for introductory training of engineering and technical personnel, for engineering students and for others who wish to broaden their knowledge of this new field.

#196, 3 volumes, soft cover set.....\$6.95

#196-H, cloth bound, all 3 volumes.....\$7.95

BASIC TELEVISION

by Alexander Schure, Ph.D.

Newcomer, or old 'pro' you can learn all about television.

Editors of leading electronic magazines, service technician publications and industrial magazines—the experts—unanimously acclaim BASIC TELEVISION, new five volume Rider 'picture-book' training course, as the easiest possible way of learning all about black and white television. Here are typical comments from prominent magazines:

Electronic Technician, April 1958 "One picture is worth 10,000 words," so you can imagine the information contained in the more than 700 figures included here. Each of these drawings is illustrated in the manner which makes the most difficult concept readily understandable. Text is very clear.

Radio & Television News, May 1958 There is no reason why the student with an elementary radio and electronics background couldn't use this 'course' as a springboard to a career as a service technician in the television field.

Telephony, April 1958 This is undoubtedly the most understandable presentation of the basic theory, operation and circuitry of black and white television ever published.

#198 - 5 volumes, soft covers.....\$10.00 per set

#198-H - cloth bound, 5 vols. in one binding.....\$11.50

Basics of Digital Computers and Basic Television are now available. If you cannot get them where you normally buy your books, you can order them direct.

----- 10-day unconditional money-back guarantee -----



JOHN F. RIDER PUBLISHER, INC. 116 West 14th Street, N.Y. 11, N. Y.

Q-8

I enclose \$..... Please send me:

3 vol. BASICS OF DIGITAL COMPUTERS set (soft cover) \$6.95 Cloth bound edition, \$7.95

5 vol. BASIC TELEVISION set (soft cover) \$10.00 Cloth bound edition, \$11.50

I understand I may return the books in 10 days for refund of full purchase price if not satisfied.

Name.....

Address.....

City..... Zone..... State.....

if it's **NEW-**
ALLIED has it **IN STOCK-FIRST!**

here's what's new:

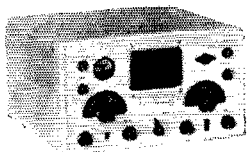

GONSET G-28
 10 Meter Communicator
 Stock No. 835U587....\$299.50

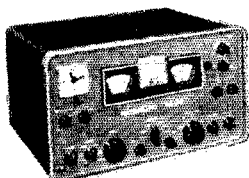

HAMMARLUND HQ-170C
 Dual Conversion Ham Receiver
 Stock No. 92SU347....\$369.00

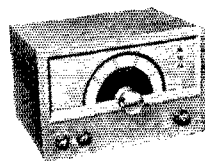

RME VHF 126
 6, 2, 1 1/4 Meter Converter
 Stock No. 83SU598....\$239.00

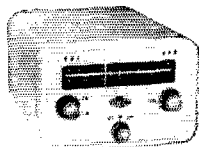

GONSET
 2 and 6 Meter Converter
 Stock No. 835597...\$69.50

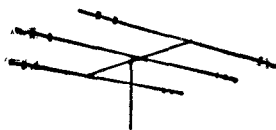

HY-GAIN MINI-TRI BAND BEAMS
 10, 15 and 20 meters
 3-Element No. 92SZ498....\$69.95
 2-Element No. 92SZ499....\$49.95

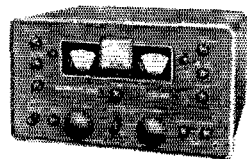

HAMMARLUND HQ-160
 Dual Conversion All-Band Receiver
 Stock No. 94SZ816....\$379.00



get **HIGHEST** trades
 for this new equipment

Try us...write today...describe your equipment, and see what a sweet deal we'll give you on the new gear you want. You'll get a "King-Size" trade-in every time!

easiest terms: Only 10% down, or your trade-in as down payment. Fast, efficient handling...no red tape.

15-day free trial: Order with confidence... 15-day free trial on all receivers and transmitters.



FREE 404-PAGE CATALOG

It's packed with the largest selections of station gear—it's your complete Buying Guide to everything in Electronic equipment and supplies. If you haven't a copy of the 1958 ALLIED catalog, write for it today.

Our 37th Year



ALLIED RADIO

100 N. WESTERN AVE., CHICAGO 80, ILL.

ONLY NATIONALS NC 109 HAS THE NEW MICROTOME FILTER



FEATURING:

- Five degrees of sharp selectivity with variable bandwidth from 50 to 4000 cycles (6 db down).
- Deep, sharp phasing notch capable of phasing within 250 cycles of desired signal.
- Desired signal cannot be phased out on AM.
- Provides up to 10 db more gain at sharpest position — no more losses!

WHY IS THE NC-109 FOR YOU?

National's new NC-109 is the lowest priced general coverage receiver available today with the exclusive new Microtome filter and separate product detector for CW and SSB operation. Covers 540 kc to 40 mc in 4 bands, including broadcast band. Voice, CW or SSB.

Write for complete specifications or see your National distributor today and try the NC-109 — you'll agree it's the finest amateur receiver in its price class.

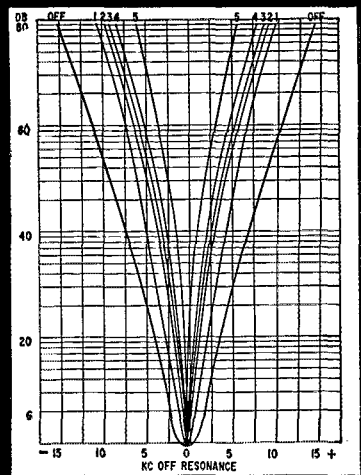

IF SELECTIVITY CHARACTERISTICS

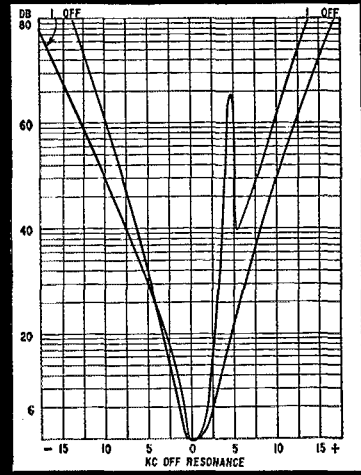

MICROTOME FILTER SELECTIVITY CHARACTERISTICS

* Only \$19.95 down
Up to 20 months to pay at most receiver distributors.
* Suggested price: \$199.95 **
** Prices slightly higher west of Rockies and outside U. S. A.
Eight out of 10 U.S. Navy Ships use National Receivers

tuned to tomorrow
National
since 1914 MALDEN 48, MASS.

BURTON BROWNE, New York

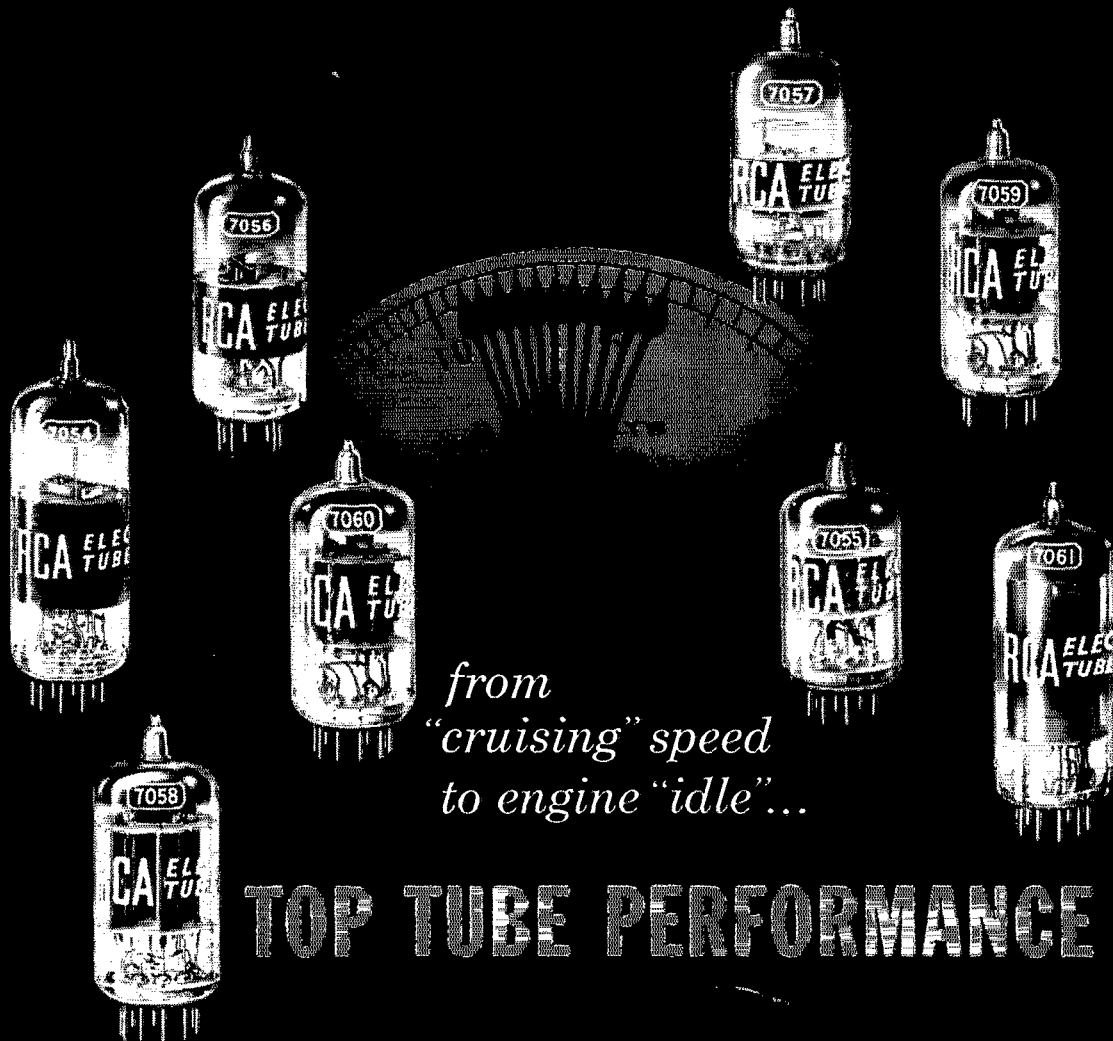

RCA Announces a New, Comprehensive Line of Mobile Communications Tubes for 6-cell Storage-Battery Operation.

AGAIN, RCA is **FIRST**—with a line of communication tubes that insures reliable service in mobile equipment operating with a terminal supply voltage *ranging all the way from 12 to 15 volts (they will take momentary excursions from 11 to 16 volts)!*

Here is a line of tubes for amateur mobile service that can take the extra plate and screen dissipation at “cruising” speeds—and yet deliver satisfactory performance at engine “idle”. In addition, the 13.5-volt heaters are specifically designed and controlled to withstand the frequent “on-off” heater operation normally encountered in mobile use.

Check the list for the types you need. They're available at your RCA Industrial Tube Distributor. Tube technical data is available from RCA Commercial Engineering, Section H-37-M, Harrison, N. J.

NEW RCA 13.5-VOLT MINIATURE TUBES FOR MOBILE COMMUNICATIONS

RCA-7054—Power Pentode. For class C rf power amplifier, oscillator, frequency multiplier, up to 40 Mc. Also for modulator, af power amplifier.

RCA-7055—Twin Diode. For low-current rectifier, detector, speech-clipper.

RCA-7056—Sharp-Cutoff Pentode. For if amplifier and rf amplifier up to 45 Mc.

RCA-7057—Medium-M μ Twin Triode. For rf amplifier in cascode-type circuits up to 200 Mc.

RCA-7058—High-M μ Twin Triode. For phase inverter, resistance-coupled amplifier, if oscillator.

RCA-7059—Medium-M μ Triode-Sharp-Cutoff Pentode. For oscillator-mixer at if frequencies up to 40 Mc. Triode unit also useful for vhf oscillator and, connected as diode, for high-perveance rectifier in noise-squelch circuits.

RCA-7060—Medium-M μ Triode-Power Pentode. Triode useful for reactance modulator; pentode for class C rf power amplifier, and frequency multiplier, up to 40 Mc.

RCA-7061—Beam Power Tube. For af power amplifier.



RADIO CORPORATION OF AMERICA

Electron Tube Division

Harrison, N. J.