

February 1953

40 Cents

45c in Canada

QST

devoted entirely to

amateur

radio



PUBLISHED BY THE AMERICAN RADIO RELAY LEAGUE

What do you want in a MICROPHONE?

Check the features and characteristics for which E-V microphones have become favorites in every field. Then take your choice, and know you can expect performance that is guaranteed by E-V research-engineering. Here are 9 models of today's most complete microphone line.

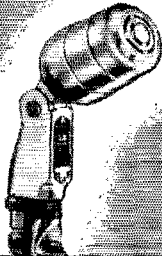

THE BULLHORN
 This microphone is the most popular in the world. It is the standard for all professional recording studios, radio stations, and public address systems. Its unique design provides a wide frequency response and excellent intelligibility. It is available in several models to meet your specific needs.

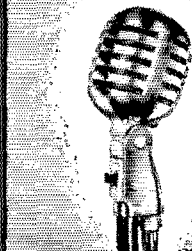

20" MONITOR
 This microphone is designed for use in recording studios and broadcast stations. It features a large, flat, circular grille that provides a wide pickup pattern and excellent sound reproduction. It is available in several models to meet your specific needs.



THE BULLHORN
 This microphone is the most popular in the world. It is the standard for all professional recording studios, radio stations, and public address systems. Its unique design provides a wide frequency response and excellent intelligibility. It is available in several models to meet your specific needs.

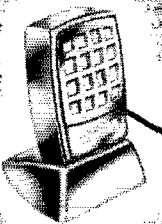

THE BULLHORN
 This microphone is the most popular in the world. It is the standard for all professional recording studios, radio stations, and public address systems. Its unique design provides a wide frequency response and excellent intelligibility. It is available in several models to meet your specific needs.



THE BULLHORN
 This microphone is the most popular in the world. It is the standard for all professional recording studios, radio stations, and public address systems. Its unique design provides a wide frequency response and excellent intelligibility. It is available in several models to meet your specific needs.

THE BULLHORN
 This microphone is the most popular in the world. It is the standard for all professional recording studios, radio stations, and public address systems. Its unique design provides a wide frequency response and excellent intelligibility. It is available in several models to meet your specific needs.



THE BULLHORN
 This microphone is the most popular in the world. It is the standard for all professional recording studios, radio stations, and public address systems. Its unique design provides a wide frequency response and excellent intelligibility. It is available in several models to meet your specific needs.

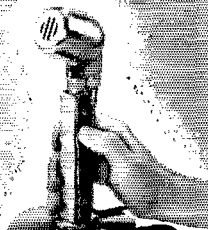

**MICROPHONES • PHONO-CARTRIDGES
 HIGH FIDELITY SPEAKER SYSTEMS
 TV ACCESSORIES • PA PROJECTORS**

See your E-V Distributor or Write for Bulletins

Crystal mikes licensed under Brush patents. E-V Pat. Pend.

Electro-Voice INC.

404 CARROLL STREET • BUCHANAN, MICHIGAN
 Export: 13 East 40th Street, N.Y. 16, U.S.A. Cables: Arlab

*Patent No. 2,350,010

NOVICES! THE GL-807 POWER TUBE IS YOUR



... biggest dollar value
... most versatile performer!



● **Low Price** . . . less than a pair of average receiving types! That's all you pay for this popular General Electric tube with 75-w-input wallop. In fact, the GL-807 gives you *more watts per dollar* than any other power tube!

Jack-of-all-Trades! You can use the GL-807 as oscillator—buffer—doubler, tripler, etc.—or final tube. The tube is fully rated for five types of service, and widely employed in all of them. When you get your regular ham license, and can operate by phone on the standard bands, you will find the GL-807 ready to handle modulator assignments capably.

Beam Power Efficiency! You get *more* output with *less* drive, from beam power tubes like the GL-807. Voltage to the grid can be far lower. You save in circuitry and power requirement.

Start right with economy GL-807's! Design your first rig around this low-priced, versatile, efficient power type! Your G-E tube distributor will be glad to assist you with complete tube information. See him today!
*Tube Department, General Electric Company,
Schenectady 5, New York.*

GL-807

Beam Power Amplifier

Filament voltage	6.3 v
Filament current	0.9 amp
Max CW ratings (ICAS)	
voltage	750 v
current	100 ma
input	75 w
dissipation	30 w
Freq. at max ratings	60 mc

ELECTRONIC TUBES OF ALL TYPES FOR THE RADIO AMATEUR

GENERAL  ELECTRIC

166-1B2

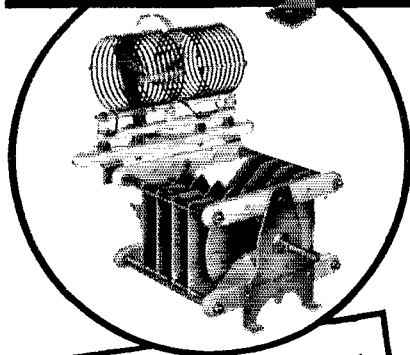
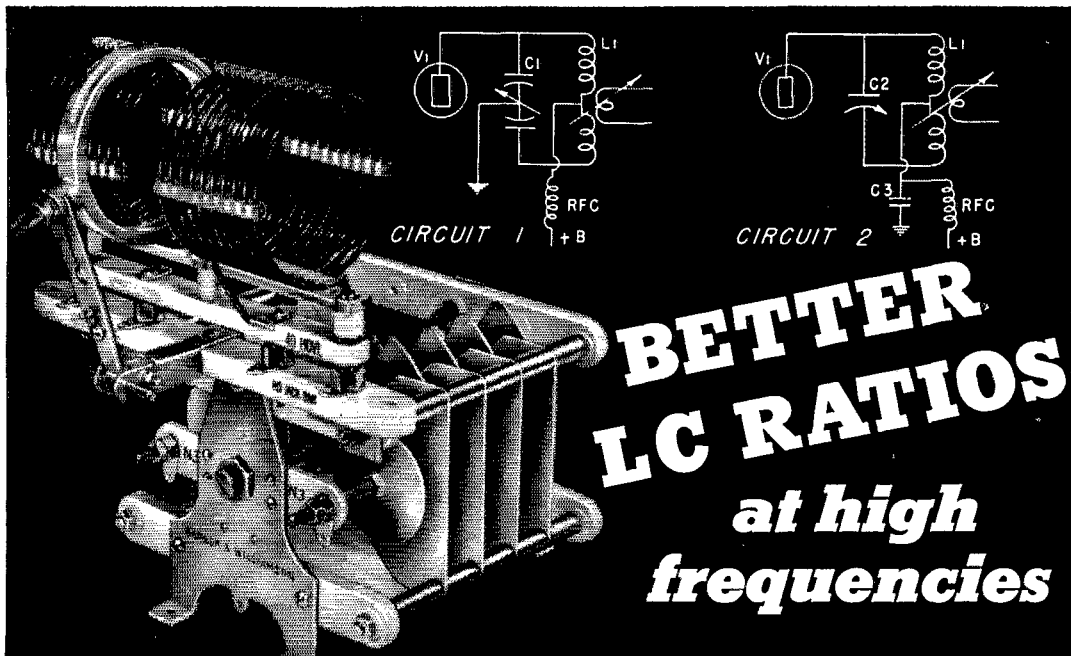

... with beam power tubes

B&W Types CX and JCX Butterfly Variable Capacitors with coils integrally mounted pave the way for increased efficiency in single-ended circuits.

Using B&W capacitors and coils with either fixed or variable center links in a split-circuit arrangement as shown above, effective tube capacity is reduced 75%, while circulating current and coil losses are cut to a minimum. All beam power tubes from an 807 up may be used in this manner with smaller losses, greater output and ease of operation.

Single or twin vacuum condenser mounting brackets are available for low-frequency tuning range extension. Rear end plates have provision for built-in neutralizing capacitors thus keeping grid and plate leads uniformly short. Type CX capacitors are normally supplied with air-gap spacings of .500", .375" or .250". Standard plate thickness is 1/16" but 3/32" plates can be supplied on order.

These popular B&W units are featured by leading distributors. See them today—or write for Catalog and Bulletin 547.

Other features of B&W integral coil-condenser combinations are:

- Greater coupling efficiency.
- Easily mounted Faraday Shielded Links.
- Short R-F paths.
- Simplified conversion to push-pull.
- Compactness with a minimum of leads.

Barker & Williamson, Inc.

237 Fairfield Ave., Upper Darby, Pa.



PUBLISHED, MONTHLY, AS ITS OFFICIAL ORGAN, BY THE AMERICAN RADIO RELAY LEAGUE, INC., AT WEST HARTFORD, CONN., U. S. A.; OFFICIAL ORGAN OF THE INTERNATIONAL AMATEUR RADIO UNION

STAFF

Editorial

A. L. BUDLONG, W1BUD
Editor

HAROLD M. McKEAN, W1CEG
Managing Editor

GEORGE GRAMMER, W1DF
Technical Editor

DONALD H. MIX, W1TS
BYRON GOODMAN, W1DX
Assistant Technical Editors

EDWARD P. TILTON, W1HDQ
V.H.F. Editor

C. VERNON CHAMBERS, W1JEQ
LEWIS G. McCOY, W1ICP
Technical Assistants

ROD NEWKIRK, W1VMW
DX Editor

ELEANOR WILSON, W1QON
YL Editor

ANN B. FURR
Production Assistant

WALTER E. BRADLEY, W1FWH
Technical Information Service

Advertising

LORENTZ A. MORROW, W1VIG
Advertising Manager

EDGAR D. COLLINS
Advertising Assistant

DAVID H. HOUGHTON
Circulation Manager

HAROLD K. ISHAM, W1MFA
Assistant Circulation Manager

OFFICES

38 La Salle Road

West Hartford 7, Connecticut

TEL.: 3-8268 TWX: HF 88

Subscription rate in United States and Possessions, \$4.00 per year, postpaid; \$4.25 in the Dominion of Canada, \$5.00 in all other countries. Single copies, 40 cents. Foreign remittances should be by international postal or express money order or bank draft negotiable in the U. S. and for an equivalent amount in U. S. funds.

Entered as second-class matter May 29, 1919, at the post office at Hartford, Connecticut, under the Act of March 3, 1879. Acceptance for mailing at special rate of postage provided for in section 1102, Act of October 3, 1917, authorized September 9, 1922. Additional entry at Concord, N. H., authorized February 21, 1929, under the Act of February 28, 1925.

Copyright 1953 by the American Radio Relay League, Inc. Title registered at U. S. Patent Office. International copyright secured. All rights reserved. *Quedan reservados todos los derechos.* Printed in U. S. A.

INDEXED BY
INDUSTRIAL ARTS INDEX

-CONTENTS-

TECHNICAL—

The "Ultimatic" — The Key with a Memory <i>John Kaye, W6SRY</i>	11
Structural Details of the Detroit C.D. Portables <i>Gus E. Undy, W8YNC,</i> <i>and Joseph A. Gardella, W8WFA</i>	16
The Clapp Oscillator — and How! <i>Rex Cassey, ZL2IQ</i>	19
Mechanical Bandpass Filters for I.F. Ranges <i>Ben Roberts, W0IEU</i>	22
A Self-Contained VFO Rig <i>Gilbert L. Countryman, W3HH</i>	25
Practical Adjustment of the Gamma Match <i>Warren H. Davis, W6IBD</i>	32
Low-Voltage Filament Supplies... <i>E. J. Gauss, W0EOS</i>	35
Universal-Shunt Milliammeter Design <i>Walter Price, W2ZQY</i>	43
Magnetic Ceramics: Ferrites... <i>F. E. Vinal, W1GXJ</i>	44
Notes on V.H.F. Converter Design <i>John P. Van Duyne, W2MLX,</i> <i>and Kurt E. Treptau, K2CEM</i>	52

NOVICE—

An 80- and 40-Meter Antenna System for the Novice <i>Lewis G. McCoy, W1ICP</i>	29
---	----

OPERATING—

19th Annual ARRL DX Contest.....	10
----------------------------------	----

GENERAL—

Expedition to Brunei <i>Clyde F. Norton, W0ELA, VS5ELA</i>	40
Progress Report on TVI Committees <i>George S. Turner, W3AP</i>	48
"It Seems to Us...".....	9
Our Cover.....	10
Hamfest Calendar.....	10
Silent Keys.....	24
In QST 25 Years Ago.....	31
Happenings of the Month.....	36
YL News and Views.....	47
Military Affiliate Radio System	50
United States Naval Reserve..	50
On the Air with Single Sideband	51
Quist Quiz.....	55
Correspondence from Members.	56
Feed-back.....	57
Hints & Kinks.....	58
How's DX?.....	61
ARRL QSL Bureau.....	64
World Above 80 Mc.....	65
Operating News.....	68
With the AREC.....	70
Station Activities.....	74

"I Read

Welcome Words!

Hear them more often with Hallicrafters

It's true that Hallicrafters equipment lets you hear more. It's equally true that you hear better—and are heard better—when you depend on Hallicrafters equipment. That's why for twenty years Hallicrafters communications equipment has been top favorite with the most critical expert in the world, the American amateur.

You see, these sets are designed and built specifically for the ham operator. They are planned with an amateur's problems, and pocket-book, in mind. They enjoy the best reputation in the world with this critical group of experts. You can *hear* why every night in the year on the air. Just listen!

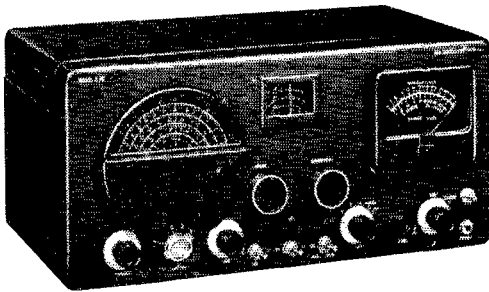

Top Selectivity—Low Price! Model SX76
Dual Conversion Super with 50 kc amplifier for tops in selectivity, 500 kc at 6 db down—3.5 kc at 60 db down. Giant 4-in. "S" meter. 540-1580 kc, 1.72-32 Mc in 4 bands. 1 r-f, 2 conversion, 2 i-f stages. 5 pos. selectivity. Phono input jack. 3 watt output. **\$179.50**

hallicrafters

Chicago 24, Illinois

World's Leading Manufacturer of Precision Radio and Television

You Five..!"

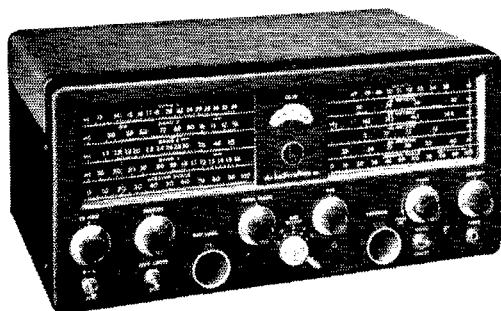
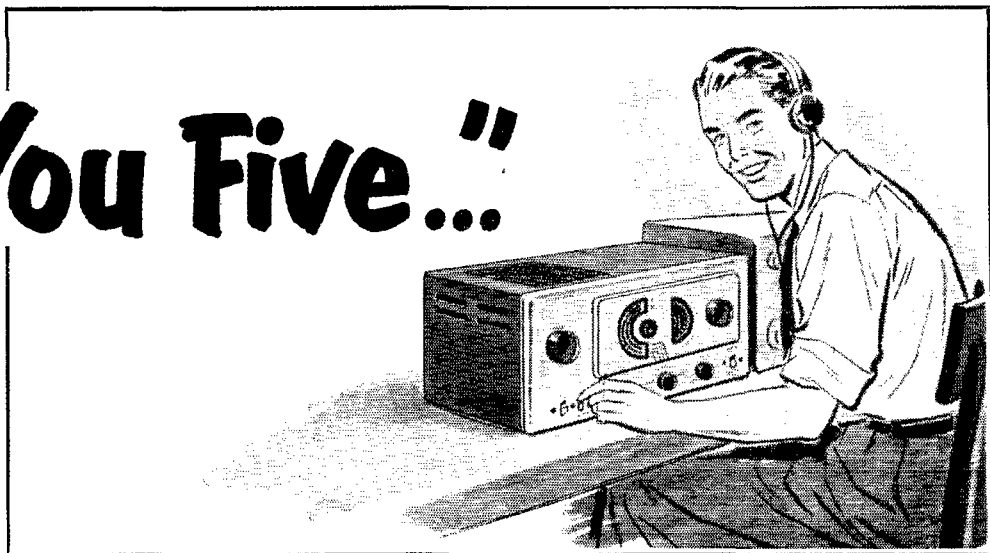

◀ **A Ham's Dream! Model SX71**—Com. Rcvr. especially designed for top ham performance. Double conversion, built-in NBFM limiter stage. 538 kc to 35 Mc, 46-56 Mc in 5 bands. Temp. Comp., voltage reg. 1 r-f, 2 conversion, w i-f stages. Xtal. filter, w-pos. selectivity, 18½" x 8⅞" x 12" deep. Ship. wt. 51 lbs. 115 V. AC, 11 tubes reg. tect. **\$224.50**

TVI Suppressed 100 Watter—Model HT20—Here's the transmitter you've been waiting for! Continuous coverage from 1.7 Mc to 30 Mc. Full band switching, no more plug-in coils; choice of 10 crystals. Shielded, filtered r-f compartment plus low-pass 52 ohm coaxial line output filter cuts anything over 30 Mc. Only **\$449.50**

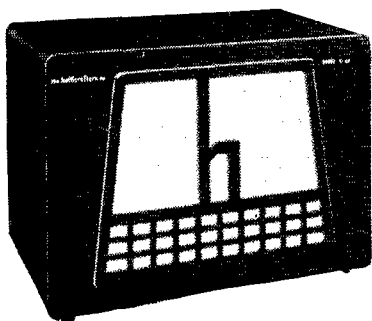

◀ **Matched Speaker, Model R46**—The perfect speaker for SW. Includes transformer of 500/600-ohm input. Voice coil impedance 3.2 ohms. 10" cone. Gives excellent response for either voice or cw. Heavy construction throughout for years of service. Black finish. 15" x 10⅞" x 10⅞" deep. Only **\$19.95**

Section Communications Managers of the ARRL Communications Department

Reports Invited. All amateurs, especially League members, are invited to report station activities on the first of each month (for preceding month) direct to the SCM, the administrative ARRL official elected by members in each Section. Radio Club reports are also desired by SCMs for inclusion in *QST*. All ARRL Field Organization appointments are now available to League members. These include ORS, OES, OPS, OO and OBS. Also, where vacancies exist SCMs desire applications for SEC, EC, RM, and PAM. In addition to station and leadership appointments for Members, *all amateurs* in the United States and Canada are invited to join the Amateur Radio Emergency Corps (ask for Form 7).

ATLANTIC DIVISION				
Eastern Pennsylvania	W3BXE	John H. DuBois	2219 Rhawn St.	Philadelphia 15
Maryland-Delaware-D. C.	WJOMN	James W. John	29 Fawcett St.	Keesington, Md.
Southern New Jersey	W2UCV	Lloyd L. Gainey	Hoffman Ave. & Marlton Pike	Merchantville
Western New York	W2SJV	Edward Graf	81 King St.	Tonawanda
Western Pennsylvania	W3KWL	Ernest J. Hinsky	309 Beechwood Ave.	Parrell
CENTRAL DIVISION				
Illinois	W9KQL	H. F. Lund	3135 S. 5th St.	Springfield
Indiana	W9DGA	Clifford C. McGuyer	1321 South Governor St.	Evansville 13
Wisconsin	W9RQM	Reno W. Goetsch	929 S. 7th Ave.	Wausau
DAKOTA DIVISION				
North Dakota	W0VKP	Eyerett E. Hill	1527 Fifth Ave., So.	Fargo
South Dakota	W0RRR	J. W. Sikorski	1900 South Menlo Ave.	Sioux Falls
Minnesota	W0MXC	Charles M. Bove	1611 1/2 E. Lake St.	Minneapolis 7
DELTA DIVISION				
Arkansas	W5LUX	Fred Ward	520 South Maple St.	Harrison
Louisiana	W5GHH	Robert E. Barr	Box 446	Springhill
Mississippi	W5JHS	Norman R. Feehan	1000 Box 491	Culport
Tennessee	W4CXV/WLG	Mark M. Bowelle	109 Dixie Lane	Oak Ridge
GREAT LAKES DIVISION				
Kentucky	W4TUT	Ivan C. Kelly	415 E. Mt. Vernon St.	Somerset
Michigan	W8HKT	Pabian T. McAllister	920 Price St.	St. Joseph
Ohio	W8AJW	John R. Stringer	2972 Clague Rd.	Cleveland 16
HUDSON DIVISION				
Eastern New York	W2ILL	Stephen J. Neason	704 River St.	Troy
N. Y. C. & Long Island	W2OBU	George V. Cooke	88-31 239th St.	Bellerose 26, L. I.
Northern New Jersey	W2VQR	Lloyd H. Manamon	410 1/2 Fifth Ave.	Asbury Park
MIDWEST DIVISION				
Iowa	W0PPP	William G. Davis	3rd St.	Mitchellville
Kansas	W0KCV	Earl N. Johnston	624 Roosevelt	Lopaka
Missouri	W0GBJ	Clarence L. Arundale	1048 South Jefferson Ave.	Springfield 4
Nebraska	W0CBH	Floyd B. Campbell	203 W. 8th St.	North Platte
NEW ENGLAND DIVISION				
Connecticut	W1HYF	Roger C. Amundsen	RFD 4	Ridgfield
Maine	W1PTL	Orestes R. Brackett	Goodrich St.	Bingham
Eastern Massachusetts	W1ALP	Frank L. Baker, jr.	91 Atlantic St.	North Quincy 71
Western Massachusetts	W1JYH	Roger E. Corey	67 West Allen Ridge Road	Springfield
New Hampshire	W1GMH	Carroll A. Currier	1426 Belmont St.	Manchester
Rhode Island	W1JBB	Merrill D. Randall	22 Annandale Road	Newport
Vermont	W1FPS	Raymond N. Flood	2 Marlboro Ave.	Braintreeboro
NORTHWESTERN DIVISION				
Alaska	KL7NT	Glen Jefferson	938—3rd Ave.	Anchorage
Idaho	W7IWU	Alan K. Ross	2105 Irene St.	Boise
Montana	W7KGY	Edward G. Brown	421 Yellowstone Ave.	Billings
Oregon	W7MQ	J. E. Roden	519 N.W. Ninth	Pendleton
Washington	W7CZY	Laurence Sebring	Route 2, Box 384	Everett
PACIFIC DIVISION				
Hawaii	KH6RU	John K. Sanders	c/o Mackay Radio & Telegraph Co. Inc. Box 2993	Honolulu
Nevada	W7JU	Ray T. Warner	539 Birch St.	Boulder City
Santa Clara Valley	W6LZL	Roy I. Couzin	16615 Englewood Ave.	Los Gatos
East Bay	W6JZ	Ray H. Cornell	929 Curtis St.	Albany 6
San Francisco	W6ATO	R. F. Czekowicz	243 Colon Ave.	San Francisco 12
Sacramento Valley*	W6CKV	Willie van de Kamp	RFD 1, Box 492A	Chico
Sau Joaquin Valley	W6FYM	E. Howard Hale	741 E. Main St.	Turlock
ROANOKE DIVISION				
North Carolina	W4DLX	J. C. Geaston	1832 Logie Ave.	Charlotte
South Carolina	W4ANK	F. Hunter Wood	1702 North Wicket Ave.	North Charleston
Virginia	W4FF	H. Edgar Lindauer	Route 1, Box 431	Annandale
West Virginia	W8MCR	John T. Steele		Hansford
ROCKY MOUNTAIN DIVISION				
Colorado*	W0CDX	Karl Brueggeman	1945 Kearny St.	Denver
Utah	W7UTM	Floyd L. Hinshaw	165 East 4th, North	Bountiful
Wyoming	W7HNI	A. D. Gaddis	P. O. Box 786	Gillette
SOUTHEASTERN DIVISION				
Alabama	W4GJW	Dr. Arthur W. Woods	411 Woodward Bldg.	Birmingham
Eastern Florida	W4FWZ	John W. Hollister	3809 Springfield Blvd.	Jacksonville
Western Florida	W4MS	Edward J. Collins	1003 E. Blount St.	Pensacola
Georgia	W4ZD	James P. Born, jr.	25 First Ave., N.E.	Atlanta
West Indies (Cuba-P.R.-V.I.)	KP4DJ	William Werner	563 Ramon Llovet	Urb. Truman, Rio Piedras, F. R. Margarita, C. Z.
Canal Zone	KZ5NM/W4QBS	Nelson W. Magner	Box 373	
SOUTHWESTERN DIVISION				
Los Angeles	W6FSR	Samuel A. Greenlee	1701 Sepulveda Bldv.	Manhattan Beach
Arizona	W7LVR	Albert Steinbrecher	Maple Road, RFD 5, Box 237	Tucson
San Diego*	W6SWU	Thomas H. Wells	1320 Wilbur St.	San Diego 9
WEST GULF DIVISION				
Northern Texas	W5GF	William J. Gentry	1509 Avenue Q	Lubbock
Oklahoma	W5GVV	Jesse M. Langford	2005 W. Oklahoma Ct.	Enid
Southern Texas	W5JIF	Jr. Charles Fermaglich	618 Medical Arts Bldg.	Houston 2
New Mexico*	W5BIW	Dick Matthias	P. O. Box 548	State College
MARITIME DIVISION				
Maritime	VE1DQ	A. M. Crowell	69 Dublin St.	Halifax, N. S.
ONTARIO DIVISION				
Ontario	VE3IA	G. Eric Parquhar	16 Emerald Crescent	Burlington, Ont.
QUEBEC DIVISION				
Quebec	VE2GL	Gordon A. Lynn	R.R. No. 1	Ste. Genevieve de Pierrefonds, P. Q.
VANALTA DIVISION				
Alberta	VE6MJ	Sydney T. Jones	10706-57th Ave.	Edmonton, Alta.
British Columbia	VE7US	Wilf Moorhouse	324 Regina Ave.	Lulu Island
Yukon				
PRAIRIE DIVISION				
Manitoba*	VE4LC	Leonard E. Cuff	286 Rutland St.	St. James
Saskatchewan	VE5HR	Harold R. Horn	1044 King St.	Saskatoon

* Officials appointed to act temporarily in the absence of a regular official.

QSY WITH PR

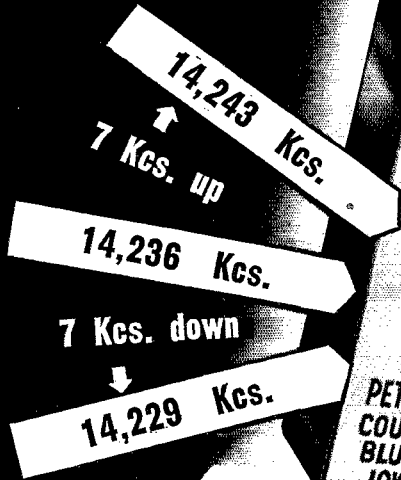

The old refrain on phone bands these days: "Sorry, old man, an S9 plussity-plus from Barbwire, Nebraska, is kicking you all over the place. Can you move a few kay-cees lower?" The answer to that is: "Sure can!" You will enjoy all the advantages of having "your spot" with crystal control, and yet dodge QRM if you buy *three PRs*. Spot your main fre-

quency... get PR CRYSTALS, say 7 kcs. each side of your spot. See your jobber! All PRs are unconditionally guaranteed.

20 METERS, Type Z-3, \$3.75 • 40, 80 AND 160 METERS, Type Z-2, \$2.75

PR Crystals



USE **PR** AND **KNOW** WHERE YOU ARE

PETERSEN RADIO COMPANY, INC.
2800 W. BROADWAY • COUNCIL BLUFFS, IOWA

EXPORT SALES ONLY: Royal National Company, Inc., 75 West Street, New York 6, N. Y., U. S. A.

THE AMERICAN RADIO RELAY LEAGUE, INC.,

is a noncommercial association of radio amateurs, bonded for the promotion of interest in amateur radio communication and experimentation, for the relaying of messages by radio, for the advancement of the radio art and of the public welfare, for the representation of the radio amateur in legislative matters, and for the maintenance of fraternalism and a high standard of conduct.

It is an incorporated association without capital stock, chartered under the laws of Connecticut. Its affairs are governed by a Board of Directors, elected every two years by the general membership. The officers are elected or appointed by the Directors. The League is noncommercial and no one commercially engaged in the manufacture, sale or rental of radio apparatus is eligible to membership on its board.

"Of, by and for the amateur," it numbers within its ranks practically every worth-while amateur in the nation and has a history of glorious achievement as the standard-bearer in amateur affairs.

Inquiries regarding membership are solicited. A bona fide interest in amateur radio is the only essential qualification; ownership of a transmitting station and knowledge of the code are not prerequisite, although full voting membership is granted only to licensed amateurs.

All general correspondence should be addressed to the administrative headquarters at West Hartford, Connecticut.



Past Presidents

HIRAM PERCY MAXIM, W1AW, 1914-1936
EUGENE C. WOODRUFF, W8CMP, 1936-1940
GEORGE W. BAILEY, W2KH, 1940-1952

Officers

President GOODWIN L. DOSLAND, W0TNS
Moorhead, Minn.

First Vice-President WAYLAND M. GROVES, W5NW
P.O. Box 586, Odessa, Texas

Vice-President FRANCIS E. HANDY, W1BDI
38 La Salle Road, West Hartford, Connecticut

Secretary A. L. BUDLONG, W1BUD
38 La Salle Road, West Hartford, Connecticut

Treasurer DAVID H. HOUGHTON
38 La Salle Road, West Hartford, Connecticut

* * * * *

General Counsel PAUL M. SEGAL
816 Connecticut Ave., Washington 6, D.C.

Technical Director GEORGE GRAMMER, W1DF
38 La Salle Road, West Hartford, Connecticut

Technical Consultant PHILIP S. RAND, W1DBM
Route 58, Redding Ridge, Conn.

Assistant Secretaries:
JOHN HUNTOON, W1LVQ JOHN E. CANN, W1RWS
38 La Salle Road, West Hartford, Connecticut

DIRECTORS

Canada

ALEX REID VE2BE
240 Logan Ave., St. Lambert, P. Q.
Vice-Director: William W. Butchart VE6LQ
10740 107 St., Edmonton, Alta.

Atlantic Division

ALFRED C. HECK W3GEG
515 Cedar Ave., Sharon, Pa.
Vice-Director: Charles O. Badgett W3LVF
725 Garden Road, Glenside, Pa.

Central Division

WESLEY E. MARRINER W9AND
844 N. Galena Ave., Dixon 7, Ill.
Vice-Director: Harry M. Matthews W9UQT
Box 1195, Springfield, Ill.

Dakota Division

ALFRED M. GOWAN W0PIR
325 S. Menlo Ave., Sioux Falls, S. D.
Vice-Director:

Delta Division

JAMES W. WATKINS W4FLS
220 N. Howell Ave., Chattanooga, Tenn.
Vice-Director: George S. Acton W5BMM
Plain Dealing, La.

Great Lakes Division

JOHN H. BRAHB W8SPT
417 Ford Bldg., Detroit 26, Mich.
Vice-Director: Harold E. Strleker W8WZ
247 W. 5th St., Marysville, Ohio

Hudson Division

GEORGE V. COOKE, JR. W2OBU
83-31 239 St., Bellerose 26, N. Y.
Vice-Director: Thomas J. Ryan, Jr. W2NKD
1082 Anna St., Elizabeth 4, N. J.

Midwest Division

WILLIAM J. SCHMIDT W9OZN
306 S. Vassar, Wichita, Kansas
Vice-Director: James E. McKim W0MVG
1404 S. Tenth, Salina, Kansas

New England Division

PERCY C. NOBLE W1BVR
87 Broad St., Westfield, Mass.
Vice-Director: Frank L. Baker, Jr. W1ALP
91 Atlantic St., North Quincy 71, Mass.

Northwestern Division

R. REX ROBERTS W7CPY
587 Park Hill Drive, Billings, Mont.
Vice-Director: Karl W. Weingarten W7BG
3219 N. 24th St., Tacoma 7, Wash.

Pacific Division

KENNETH E. HUGHES W6CIS
3105 Crest Haven Drive, Sacramento, Calif.
Vice-Director: Richard F. Chelkowitz W6ATO
243 Colon Ave., San Francisco 12, Calif.

Roanoke Division

P. LANIER ANDERSON, JR. W4MWH
428 Maple Lane, Danville, Va.
Vice-Director: Gus M. Browning W4BPD
135 Broughton St., S. E., Orangeburg, S. C.

Rocky Mountain Division

FRANKLIN K. MATEJKA W0DD
P. O. Box 212, Estes Park, Colo.
Vice-Director: Claude M. Maer, Jr. W0IC
740 Lafayette St., Denver, Colo.

Southeastern Division

LAMAR HILL W4BOL
104 Myrtle, Cochran, Ga.
Vice-Director: Ernest W. Barr W4GOR
911 Rosemary Ave., SW, Atlanta, Ga.

Southwestern Division

JOHN R. GRIGGS W0KW
10412 Don Pico Rd., RED 2, Spring Valley, Calif.
Vice-Director: Walter R. Joos W6FKM
1315 N. Overhill Drive, Inglewood 3, Calif.

West Gulf Division

A. DAVID MIDDLETON W5CA
9 Kay Road, Elzeras, N. M.
Vice-Director: Carl C. Drumeller W5EHC
5824 N.W. 58th St., Oklahoma City 12, Okla.

"It Seems to Us..."

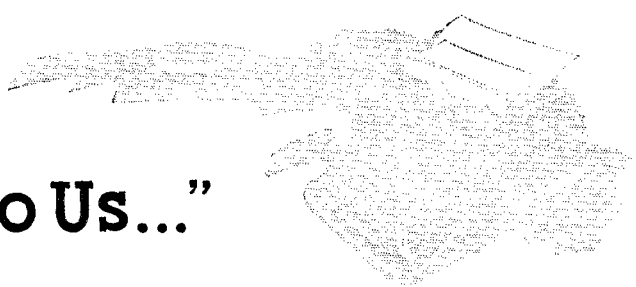

THE DEATH OF CLASS A

Well, the Commission has settled, presumably once and for all, the question of whether special qualifications will continue to be required for operation with voice on certain amateur bands: they won't be. Effective February 18, 1953 (see "Happenings" in this issue for details), any amateur licensee except Novice or Technician may use voice anywhere it is permitted; more specifically, newly in the 3800-4000 and 14,200-14,300 kc. suballocations.

This question has been the subject of debate in amateur circles for years. At one or another of its meetings, the ARRL Board of Directors has devoted much attention to it. There are valid arguments pro and con. But when all was said and done, it always has been the Board's view that a higher license (Class A, or its new name of Advanced Class) with a moderately more difficult examination and some extra privileges was a desirable thing for amateur radio and the Board consistently maintained that view; this was not only long before the Commission injected itself into the matter, but throughout the last several years of FCC's often-conflicting rule-making proposals dealing with privileges and licenses.

The Commission has been far less consistent. Its present action is, rather, an astonishingly complete reversal of views it expressed in a separate matter (Docket 9295) less than four years ago. At that time, as will be recalled, it had "reflected upon the general situation in which the Amateur Radio Service finds itself" and concluded that we needed "a new overall plan or blueprint to provide scope and direction for the immediate and long-range development of the service." Part of its objective was defined as "a program which provides for encouragement for advancing skills in both the communication and technical phases of the art." A study of detailed proposals in the original document provides one inescapable conclusion: the Commission was going all out to force drastically upwards the standards for voice operation. For example, at that time it proposed to establish 6-kc. (and other) bandwidths of emission in our voice suballocations. More significant, it proposed that all Class A holders were to lose their special privileges outright, and every single one of them who wanted to continue 75- and 20-meter voice operation

was to be obliged to go again to an FCC office and take a new Amateur Extra Class examination with a really tough technical written test, and a code speed of 20 w.p.m., so much tougher than Class A as to raise serious question of the ability of any great number of amateurs to qualify. In the League's view, such requirements were wholly unrealistic for the 'phone privileges sought. The League battled both these proposals, and won. For a while the Commission continued to insist, however, that though it would let present holders of Class A keep their privileges, after a certain date all *newcomers* would have to take the tough exam. It was obvious that in the Commission's view, not only should there be a special exam for 'phone (and possible other) privileges, but it should be much tougher than Class A. That view has now, apparently, switched 180 degrees. It is the Commission's final decision in the whole drawn-out subject that no special examination is necessary. (Throughout the entire time the League's position was that Class A should be continued, as it was, as a practical but not discriminatory incentive to improvement of the art.)

Among the arguments, pro and con, in the amateur debate on this subject over the years, we recall such things as the relative knowledge of Class B and C versus Class A licensees, "favored few," TVI problems in the 28-Mc. Class B band, claims of class distinction, and so on. But we think we correctly interpret the Board's view, which has been consistent, when we say that none of these, pro or con, had any major effect on the ARRL decisions. Rather, it was adherence to a view expressed, surprisingly enough, by the Commission itself as one of the purposes of the amateur rules quoted earlier: "encouragement for advancing skills." The Board felt that the stepping-stone principle, the providing of an incentive for personal improvement, was a part of that objective. Even in an isolated case where a ham might memorize the *License Manual* answers, at least he would learn in the process.

On the other hand the Commission apparently now takes the obverse view; at least, its decision completely removes the practical incentive for self-improvement. It seems to us that the effect will be to stagnate the great body of amateur radio at the General Class

level. Don't misunderstand — that's quite a respectable level. But the FCC decision is a step backward from the theory of progressively higher levels which held attraction for most all of us, which gave us the incentive for moderate technical improvement (or at least a refresher), and which is now withdrawn.

We think the Class A license served amateur radio well; we think it still could aid in a desirable objective. However, by Commission action, which we believe the body of amateur radio neither asked for nor wanted, it no longer has that opportunity.

Strays

W3LEZ thinks he's found the ham with the shortest call — WIDIT.

Many TVLs in the Belleville, Ill., area will soon get plenty of real TVL. W9BA reports that a Channel 54 station will go on the air there in May. Its call sign? WTVI!

W8JDC just obtained his ham ticket. His name — Paul E. Newcomer. We'll be watching for another item on him 20 years hence when he joins the Old-Timers' Club! — W1FWH

Add new odd applications for the Pride of Marconi: U.h.f. pack-portables now serve as liaison between main offices and pick-and-shovel crews in larger cemeteries. — W2QPQ

W1THO finally got around to firing up a BC-474A on 75 meters eleven months after purchasing it from W9DSB/1. The first come-back? None other than ex-W9DSB, now W1VSB.

Tape-Respondents International, an association of hobbyists who enjoy exchanging tape recordings — "talking letters" — with fellow recorder enthusiasts throughout the world, seeks to enlarge its membership. Amateurs desiring information about TRI may write Fred Goetz, Secretary, 3488 22nd St., San Francisco, Calif.

Does your high school or junior high school have an amateur radio club? A roster will be compiled of all replies to this item. To be sure your school club is in the first issue, write to Willis C. Brown, Room 3643, U. S. Office of Education, Washington 25, D. C. Give him the following (and any other) information: Name of school, town, state, name of club, name of president, when club meets, number of members, special activities, exhibits and demonstrations. Copies of the list will be available on request when compiled and should help you make schedules with other schools having similar activities. You may apply for a copy merely by sending Mr. Brown the facts about your club.

OUR COVER

An historic milestone in amateur radio — the first use of a transistor for transmitting purposes — is depicted as the designer of the equipment, George M. Rose, K2AH, operates what is probably the lowest-powered rig ever to be used in amateur communication. The complete transmitter (with power supply!) rests on the camera tripod in the foreground. Details on page 65. (Photo by Fred M. Wenzel)

HAMFEST CALENDAR

MICHIGAN — Saturday, February 28th, at the Rowe Hotel, Grand Rapids — the Grand Rapids Amateur Radio Association will hold its annual Midwinter Hamfest. The 3:00 p.m. session will include a Michigan Council of Clubs meeting, traffic net meeting and a "swap and shop" affair. There will be a business meeting in the evening. Phil Rand, W1DBM, ARRL technical consultant, will be the principal speaker and will conduct afternoon and evening demonstrations of practical TVI elimination measures. Accompanying him will be Lewis G. McCoy, W1ICP, of the ARRL Technical Department. Tickets may be obtained by writing the Secretary, Grand Rapids Amateur Radio Association, Box 333, Grand Rapids, Michigan.

Nineteenth Annual ARRL DX Contest

*Phone: Feb. 6th-8th, Feb. 20th-22nd;
C.W.: Mar. 6th-8th, Mar. 20th-22nd

Amateurs everywhere are invited to take part in the 19th Annual ARRL DX Competition. There will be two week-end periods devoted to c.w. participation and two to 'phone. Special certificate awards will be given to the highest-scoring c.w. and 'phone stations for each country and each continental U. S. A. and Canadian ARRL section entered in the contest. Operators outside the U. S. and Canada will attempt to work as many W, K, VE and VO stations as possible. Exchange of serial numbers will be required. Complete rules and details on scoring appear on page 35 of January *QST*.

The contest periods will be divided for c.w. and 'phone as follows: first 'phone period will begin on Feb. 6th at 7:00 p.m. EST and end on Feb. 8th at 7:00 p.m. EST. The second 'phone period will be scheduled during the same hours from Feb. 20th to 22nd. The first c.w. period will begin at 7:00 p.m. EST on Mar. 6th and end at 7:00 p.m. EST Mar. 8th. The second 'phone period will be scheduled during the same hours from March 20th to 22nd.

Though not necessary for entry in the contest, ARRL will supply convenient report forms upon request. If you request report forms from Headquarters, please indicate whether you plan to enter the c.w. section, the 'phone section, or both.

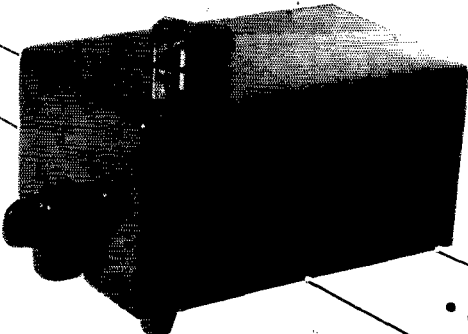

BY JOHN KAYE,*
W6SRV

The "Ultimatic" — The Key with a Memory

Automatic Spacing with a Margin for Manual Error

AN article in *QST* some time ago described an electronic key¹ that sent automatic spaces as well as automatic dots and dashes. The author described it as an "infernal, maddening machine" because it required that the operator "stay with it" all of the time. The continuously-running time base resulted in an uncontrollable "beast" that would wait for no one. If the key were not closed at the instant of a marking pulse the character was lost. However, using the basic idea of a continuously-running time base and adding "memory" to the key transforms the "beast" into a "beauty." Once the key has been closed to select a character, that character is stored and properly transmitted when the "mark" pulse arrives, even if the key is open, or closed on the opposite side. And adding "sequencing" allows the storage of a dot-dash (or dash-dot) series, even if both are stored before the appearance of the first character at the output. Stated simply, with the key set for 10 w.p.m., you can hit a 40-w.p.m. "N" and walk away while the key produces a slow "daah-dit."

In general, the "Ultimatic" key² considers interletter and interword spacings as specific code characters, just as much as the dot and dash. These all-spacing characters are delivered in exact one- and two-cycle durations, just as start-stop autokeys deliver exact one- and two-cycle marking characters. The memories provide tremendous timing leeway at the key for selection of a succeeding character, in some cases as much as three full cycles. The astounding ease of operation due to this leeway cannot be fully appreciated without some knowledge of how the circuits work. The key combines a free-running time base,

a differentiating network, a dot generator, a dash generator that starts the dash for completion by the dot generator, a dot memory, a dash memory, a sequencing circuit, a regulated power supply, a heavy iron base and the front half of an old bug. Shoehorn it all into a 3 × 4 × 6-inch box and you have the Ultimatic, a key that gives Klein output with Lake Erie input. It does everything for the operator but spell and punctuate.

The sketch in Fig. 1 illustrates to some extent the potentialities of the key. The top line shows some possible key-lever positions in sending the word "MICE," and the second line shows the perfect copy that comes from the key. The third line shows the positive and negative pulses of the time base — it can be seen how they line up with the code characters in the output and thus account for its perfection. Note, however, that the

• Here is something that comes as close to being an electronic brain as you are likely to encounter in amateur radio. A big step forward in the automatic-key field, it has the ability to hold a dot or a dash and send it at the proper time, thus eliminating much of the need for perfect rhythm on the part of the operator. As the inventor says, "It gives Kleinschmidt output with Lake Erie input."

The history of the key's development is a story in itself, and one that we have followed with the author for about a year and a half. During that time several versions have been submitted to *QST*, and uncounted more have been devised and tested by the author. The present key is, therefore, a simplification of the original concept and a key that anyone can build and put to use.

* 981 N. 1st St., Banning, Calif.

¹ Herbstreit, "Automatic Spacing of Letters and Words for the Electronic Key," *QST*, April, 1951.

² Pat. pending.

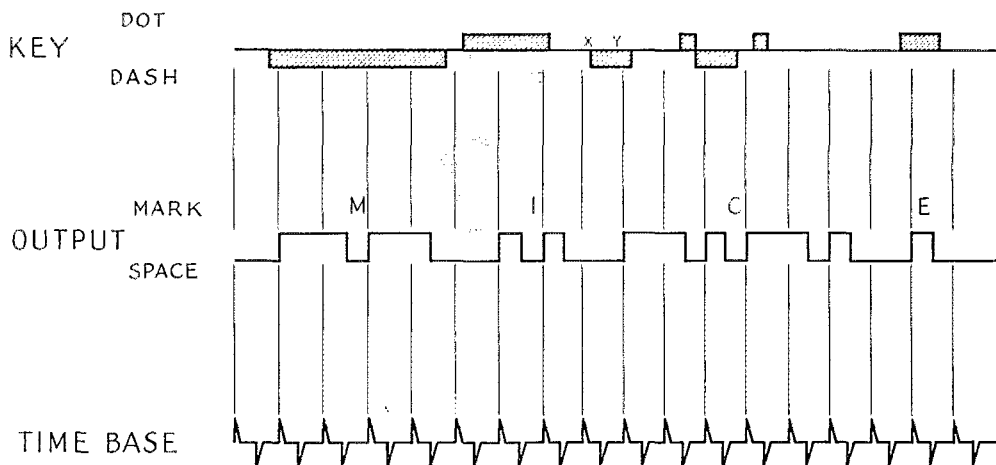

Fig. 1—Some possible key-level positions during the sending of the word "MICE" illustrate how the "Ultimatic" key corrects for operator timing errors.

key takes over from the operator and corrects his timing errors. For example, his poor spacing of the "M" and "I" would normally show up as a poorly-sent "Z," but here the too-short space allowed after the completion of the "M" is corrected to a full letter space by the Ultimatic. Farther along, the first dash of the "C" is made too soon after the "I," but the key corrects for it, as well as for the sloppy spacing within the "C." The "C" also illustrates the memory principle to its fullest capability—notice that the last dot of the "C" is hit while the last dash is just starting, but it shows up correctly in the output.

This particular model was selected for description because it proved to be the simplest to build and the easiest to adjust. Motor-driven cams, capacity-delayed buzzers, squared sinewave and sawtooth oscillators, etc., have been used successfully for the time base. Directly-operated relay integrators, flip-flop triggers, gas triodes, blocked oscillators, transistors—all work equally well as marking generators, memory and sequence circuits. With three more inches on the box, secondary memories fit in, permitting advance storage of a full letter C or umlaut A (· · ·).

General Circuit Data

A hazard was introduced in minimizing this model's bulk and, for safety's sake, the line rectifier and heater string should be operated from an external isolation transformer. Unregulated 140 volts is fed to the relays, while the cathode-coupled multivibrator is run from 108 volts regulated and decoupled to prevent reaction from relay and line surges.

All relays are open in the idle circuit condition, as shown in the schematic in Fig. 2. The back contacts are shown above the relay arms and will be called "B" in the discussion. The contacts made when the relays are closed are drawn below the arms and will be called "C." The figure "6C" would therefore refer to the contact closed when relay K_6 is energized. A constant holding current

of 1.5 ma. flows in all relays via series tubes or resistances. This does not cause operation of the relays, but holds them closed after pull-in by a pulse.

To separate the functions of the various components in the circuit, a tabulation is given below:

Component Summary

Power: $CR1, R_6, R_{27}, R_{28}, C_1, C_9, V_7$.
 Time Base: $V_1, V_2, C_2, C_3, R_2, R_3$ (speed range limiter), R_4 (speed control), R_5 (mark-to-space control).
 Differentiator: $C_4, R_{12}, R_{10}, R_{11}$ (load isolation).
 Dot Generator: $V_4, V_5, R_9, R_{16}, R_{19}, K_1$ (dot output), K_2 (dot memory clearance).
 Dash Generator: $V_3, V_6, R_7, R_8, R_{14}, R_{15}, R_{17}, R_{18}, C_5, R_{13}$ (release delay), K_3 (dash output), K_4 (dash memory clearance).
 Dot Memory: K_7, C_8, R_{25}, R_{26} .
 Dash Memory: K_6, C_7, R_{22}, R_{23} .
 Memory Clearance: C_6, R_{24} .
 Sequence: K_5, R_{20}, R_{21} .

Time Base

The time-base generator is a cathode-coupled multivibrator, which generates rectangular-shaped waves. The on-off ratio can be adjusted by the setting of R_5 —the sketch in Fig. 1 is plotted for a true square-wave ratio. The frequency is set by the adjustment of R_4 . When the square wave output from V_2 is passed through the differentiator circuit C_4R_{12} , only the spikes shown in the third line of Fig. 1 get through, corresponding to the rise and fall of the square wave.

Dot Generation

These alternate positive and negative pulses are applied to the grids of V_4, V_5 and V_6 . When the key is idle, the cathode of V_5 is heavily biased and the pulses have no effect. Ground on the dot bus from the key or dot memory applies 13 volts cut-off bias to the cathode of V_5 from $R_{16}R_{19}$. The first positive pulse at the grid of V_5 then produces a 4-ma. peak pulse through K_1, K_2 and

closes them. The marking output starts at closed $1C$. The 1.5 ma. through R_9 and V_4 holds K_1 and K_2 closed until the following negative pulse cuts off V_4 and releases them. A second dot marking baud cannot be generated until the arrival of the next positive pulse, one baud later. This provides the spacing baud to complete the dot.

Dash Generation

Similarly, V_6 closes K_3K_4 on a positive pulse when the dash bus is grounded at the key or dash memory. Dash output begins at $3C$. K_3 and K_4 hold in via R_{14} and $1B$. The opening of $3B$ lifts ground from the grid of V_3 . When the following negative pulse cuts off V_4 and V_5 , the grid of V_3 is raised to its plate potential via R_8 and R_9 during the pulse. K_1 and K_2 close on the resultant 4-ma. pulse through V_3 to continue the marking output at $1C$. The K_3K_4 holding current is now interrupted at open $1B$. These relays release after C_5 charges. This delay guarantees that $1C$ closes before $3C$ opens. The following positive pulse does nothing except momentarily pulse K_3 and K_4 if the dash bus is grounded. The second negative pulse releases K_1 and K_2 , as in dots.

Dot Memory

While the memory is idle, C_8 discharges across R_{25} . Grounding the key dot contact charges C_8 through K_7 . The 8-ma. peak pulse closes the relay, which then holds in on the 1.5 ma. through R_{25} , R_{26} and $7C$. Ground is maintained on the dot bus at $7C$ independently of the key. When K_2 closes later on for this stored dot, discharged C_6 is applied to the top of K_7 via $2C$, releasing the relay to clear the memory. Steady ground at the key generates successive dots. The resistor R_{24} is more

than a spark suppressor — it also prevents reverse-current hang-up of the relay because of the large capacity of C_6 .

Dash Memory

Similarly, ground at the key dash contact closes K_6 by charging C_7 . Independent ground is maintained on the dash bus at $6C$. The memory is cleared by C_6 via $4C$ and $2B$ when K_4 closes at the start of the stored dash. Contact $2B$ is never open when $4C$ initially closes on a dash. When $2C$ does close after $4C$ has already closed, C_6 has charged up enough so that it does not affect K_7 . Therefore, the action of $2C$ clears only the dot memory, and $4C$ only the dash memory. Steady ground at the key generates successive dashes.

Spacing Characters

A one-cycle interletter spacing is obtained if the new letter is started at the key any time between the two successive positive pulses following the preceding letter's last spacing baud. The key need be merely bumped, not held until the second pulse. The memories hold the character until that second pulse. Interword spacing of two cycles is obtained by starting the new word at the key any time between the second and third positive pulses following the preceding word's last spacing baud. In Fig. 1, the key may be bumped, or held solidly, any time between "x" and "y" to start the "C."

The first two characters of a letter may be stored during the last cycle of the spacing character. The time base thus corrects underspacing at the key, and the memory eliminates the necessity for the manual delay used to get adequate spacing, which usually results in overspacing.

The "Ultimatic" key is built on two sides of a sheet of plastic, and the whole is mounted on an iron plate.

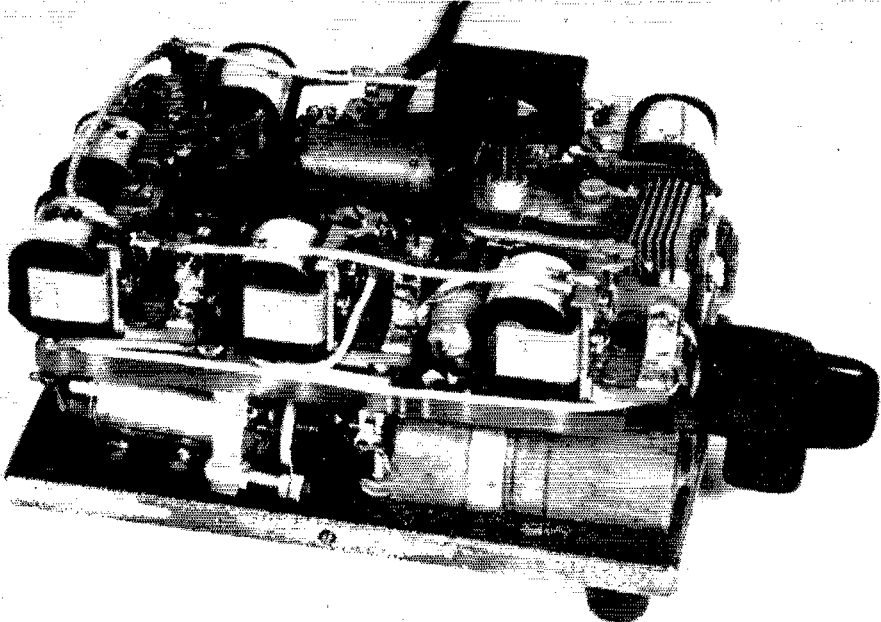

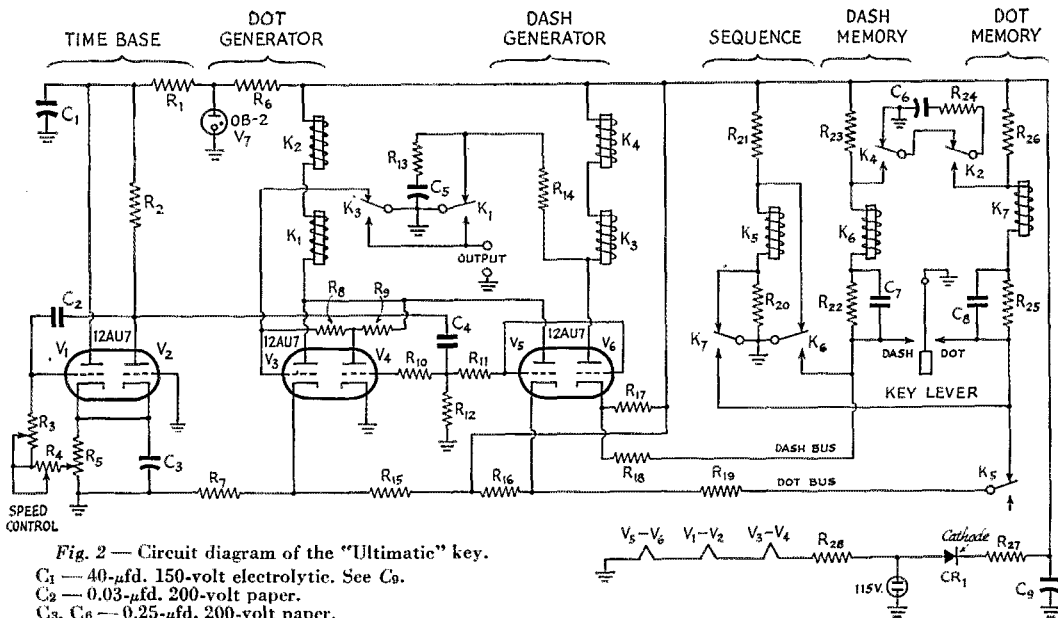

Fig. 2 — Circuit diagram of the "Ultimatic" key.

- C₁ — 40- μ fd. 150-volt electrolytic. See C₉.
- C₂ — 0.03- μ fd. 200-volt paper.
- C₃, C₆ — 0.25- μ fd. 200-volt paper.
- C₄ — 0.01- μ fd. 200-volt paper.
- C₅ — .1- μ fd. 200-volt paper.
- C₇, C₈ — 0.05- μ fd. 200-volt paper.
- C₉ — 120- μ fd. 150-volt electrolytic. (Three 40- μ fd. in parallel. C₁ and C₉ made from two dual 40- μ fd. electrolytics. Sprague 18F178).
- R₁ — 1000 ohms.
- R₂ — 56,000 ohms.
- R₃ — 0.5-megohm volume control.
- R₄ — 4-megohm volume control.
- R₅ — 3000-ohm volume control.
- R₆ — 1800 ohms, 1 watt.
- R₇ — 15,000 ohms.
- R₈ — 3.3 megohms.
- R₉ — 62,000 ohms.
- R₁₀, R₁₁ — 2.2 megohms.
- R₁₂ — 0.15 megohm.
- R₁₃, R₁₈, R₁₉, R₂₄ — 2700 ohms.
- R₁₄, R₂₂, R₂₅ — 82,000 ohms.
- R₁₅, R₁₆, R₁₇ — 27,000 ohms.
- R₂₀ — 75,000 ohms.
- R₂₁ — 18,000 ohms, 2 watts.
- R₂₃, R₂₆ — 8200 ohms.
- R₂₇ — 25 ohms, 1 watt.
- R₂₈ — 530 ohms. 330- and 200-ohm line cords in series.

- CR₁ — 75-ma. selenium rectifier.
 - K₁ through K₇ — 8000-ohm s.p.d.t. relay (Sigma 4F).
- See text for adjustment.
- NOTE: The 12AU7 is the only dual triode that is rated to stand the 140 volts heater-to-cathode when the busses are open.

Accurate overspacing in three- and four-cycle units is available for feeble signal work.

Sequencing

A dot and a dash often are so rapidly stored, in that order, that both busses are grounded before the dot is started by a positive pulse. Subsequent closure of 2C by the dot generator clears the dot memory, but the simultaneous brief closure of 4C by the dash generator does not clear the dash memory because of open 2B. The dash remains in storage until the dot is completed and then appears after the dot's spacing baud. Contact 4C clears the dash memory this time, as 2B is closed.

A problem arises when a dash-dot combination is similarly stored. Ground on both busses would permit operation of the dot generator first, converting the stored dash into a dot to be followed by a dash in reverse order. However, when K₆ stores the dash via the opening of 6B provides 6 ma. to pull in K₅ via still-closed 7B. When 7B opens as the dot goes into storage, the current through K₅ drops to 1.5 ma. for holding. Open 5B removes the memory ground (and key) from the dot bus until the dash has been started first, and the dash memory cleared. Contact 6B then re-

shorts K₅, and the stored dot reappears as ground on the dot bus via 5B. The dot follows the dash in the order keyed.

Returning to the combination dot-dash: 7B opens first (on the dot), so the current through K₅ is only 1.5 ma. when 6B opens (on the dash), and the relay does not close. Ground on the dot bus therefore appears through 5B. As the dot starts and the dot memory clears, 7B closes. K₅ pulls in since 6B is still open on the stored dash. After this instant another dot to follow the dash may be stored for an "R." The "Sequence" would then be holding a dash-dot series.

Timing Leeway at the Key

It is to be noted that once a character has been stored in the memory it appears at the output in the order of selection, independently of the position of the key. A dot can be coming out while the key is being held to dashes, or while the operator is applying a match to his pipe. A stored dash can be transmitted while the operator waits over on the dot side or just relaxes. For the amazement of visiting speed merchants, one can crank the speed down low and demonstrate the maximum full three-cycle interval during which a dot may

be struck off when it follows a dash in a letter. In ordinary sending not much more than one or two bauds of leeway is actually used or needed within a letter, but by taking advantage of three or more bauds of leeway, continuously perfect letter and word spacings come up with no attention whatsoever paid to the spacing.

If Fig. 1 were transmitted as is, it would read ZTR E, and very poorly at that; yet it comes out MICE *a la* Klein, with proper letter and word spacing. Any character can be keyed as late as the positive pulse that would start the character, or as early as right after the pulse that starts a foregoing spacing cycle or like marking character. When it is the second character in a letter, it can be stored as early as right after the pulse that starts the last spacing cycle prior to the letter (after storage of the first character, of course).

Construction

The Ultimatic key works equally well spread all over the work bench or jammed into the same volume occupied by an ordinary bug. The photographs show some of the details. The relays and associated RC components are assembled on top of the notched $\frac{1}{4}$ -inch lucite deck. The four sockets are fastened to the lucite bracket glued to the deck, with most of the time-base and generator components tied to the socket terminals. The power supply components and speed control are mounted on and about the bug frame. R_3 and R_5 are mounted under the frame with shafts projecting through counterbored holes in the

$4 \times 6 \times \frac{3}{8}$ -inch iron base. The deck is then attached to the base on four long pillar bolts and the few interconnecting wires tied down. No tie-point strips are used. Resistor and condenser leads pass through small holes drilled in the plastic and are secured with solder blobs on the far side. Wires are tied to these leads on both sides of the lucite. The entire circuitry could just as well be spread out in the station rack with only the key and speed control leads brought out to the desk.

The cover is $\frac{1}{4}$ - and $\frac{1}{8}$ -inch plastic sheet cemented together and painted with black auto lacquer. The base and rear of the cover are riddled with $\frac{1}{4}$ - and $\frac{1}{8}$ -inch ventilation holes. That weird knob accommodates the radically different reaches and techniques of the author and wife while it plugs up the unavoidable slot in the cover.

Adjustment

The relays are all initially adjusted to close on 2.0 ± 0.1 ma. and to open on 1.0 ± 0.1 ma. These figures are readily met with 0.008-inch armature travel and 20 to 23 grams spring tension when the operated contact is turned in just far enough for reliable contact. With two relays in series in the generators there is a tendency for one relay only to close on the exceedingly short pulse. A slight variation of the armature travel at the back contact on one relay of the string equalizes the relays for simultaneous operation. Use of d.p.d.t. relays such as the 10,000-ohm Potter Brumfield type

(Continued on page 120)

Another view of the key shows the four tubes mounted between the iron and plastic plates.

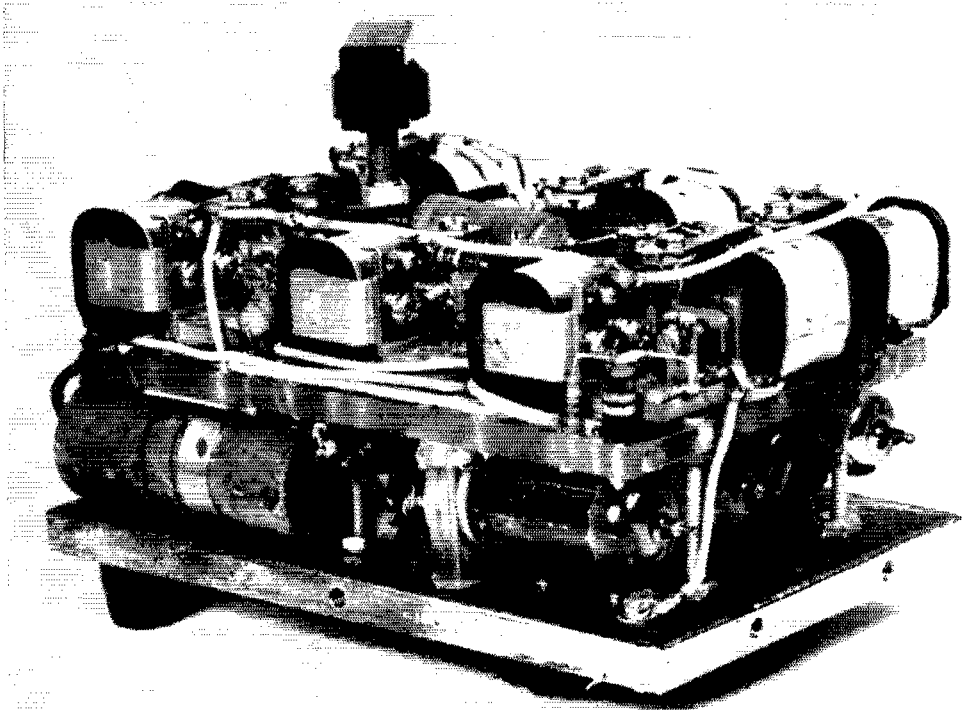

Structural Details of the Detroit C.D. Portables

How-To-Build-It Information on the Result of the Mass-Production Project Described Last Month

BY GUS E. UNDY, W8YNC,* AND JOSEPH A. GARDELLA,** W8WFA

IN a recent issue was told the story of how amateurs in the Detroit area built their own hand-carried portable rigs on a group basis.¹ Many requests have been received for the details of this unit.

The sets in question are complete flea-power stations with separate r.f. sections for transmitting and receiving, not transceivers in the usual sense. Their power amounts to 80 milliwatts output by actual measure at the antenna terminal when using the bottom loaded whip described here. Eighty milliwatts may sound insignificant in a day when kilowatts are the password, but it can provide solid contact between two of these units a mile apart. In tests with fixed stations, DX on the order of five miles has been logged frequently.

The receiver is a 1U4 superregenerative detector preceded by a 1U4 r.f. amplifier to increase gain and reduce detector radiation. The transmitter consists of a crystal-controlled 3V4 oscillator-doubler using a 40-meter crystal. This drives a 3V4 doubling in the final to 29 Mc. The modulator and audio stage also uses a 3V4.

Placement of parts is not too critical if caution is used in preventing long leads and interstage coupling. The layout shown in the photographs seemed to work out best in practice. If parts must be substituted for those in the original design, be sure allowance is made for any difference in physical size. The audio output transformer was specially built for the Detroit group on a production basis. Indi-

vidual constructors will find the UTC O-9 "Ouncer" transformer an excellent substitute.

The slug-tuned circuits are quite broad and are best tuned with the aid of a grid dipper. L_1 is peaked at the 7-Mc. crystal frequency. L_2 is then peaked at the second harmonic of the crystal and L_3 to the output frequency. L_4 in the receiver is also rather broad and can be tuned over approximately half of the 10-meter band. The coil values given will peak up best on the high end of the band. The 100-odd units built here were all tuned up on 29,610 kc., the Detroit civil defense mobile frequency. The unit could be made more flexible by replacing the 5- μ fd. fixed condenser across L_4 with a miniature variable or paddler type. For emergency work, however, it was decided to make the receiver fixed tuned.

The bias battery shown in the photographs was made by cutting up "B" batteries into three-cell units. This would hardly be economical unless the construction was to be on a production quantity. For individual units, bias cells or "Penlite" cells will be more suitable.

A 4-section send-receive switch is used to perform the following functions: Section A — antenna, Section B — earphone on-off, Section C — transmitter or receiver filaments, Section D — modulator filament. It will be noted that Section B could be eliminated by leaving the earphone permanently connected in the circuit, but some of the audio power needed for modulation would be wasted thereby.

Two sections are required for filament switching, in order to be able to cut off the modulator filament when the set is turned off, this tube being common to both transmit and receive positions.

* Chief Engineer, Multi-Products Co., 559 East Ten Mile Road, Hazel Park, Mich.

** Chairman, Inter-County Amateur Radio Emergency Committee, Area I.

¹ "Here's How!" — Detroit," p. 38, Jan., 1953, *QST*.

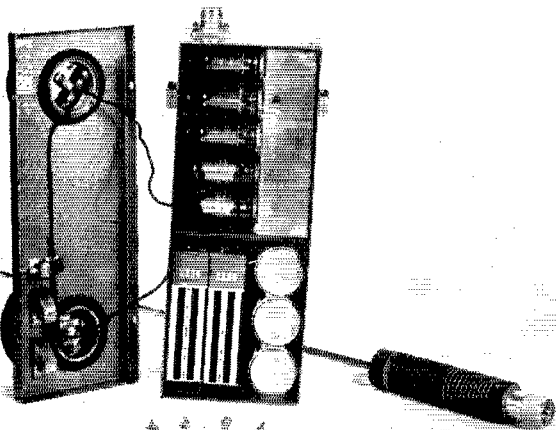

Battery location can readily be seen here. The positive "A" battery terminals contact an insulated copper strip not shown. The "A" batteries are held in place and grounded by the three phosphor-bronze springs on the cover at left. Microphone and earphone connections are also on the cover. The antenna may be removed for storage or to allow the station to be used with full-sized antenna.

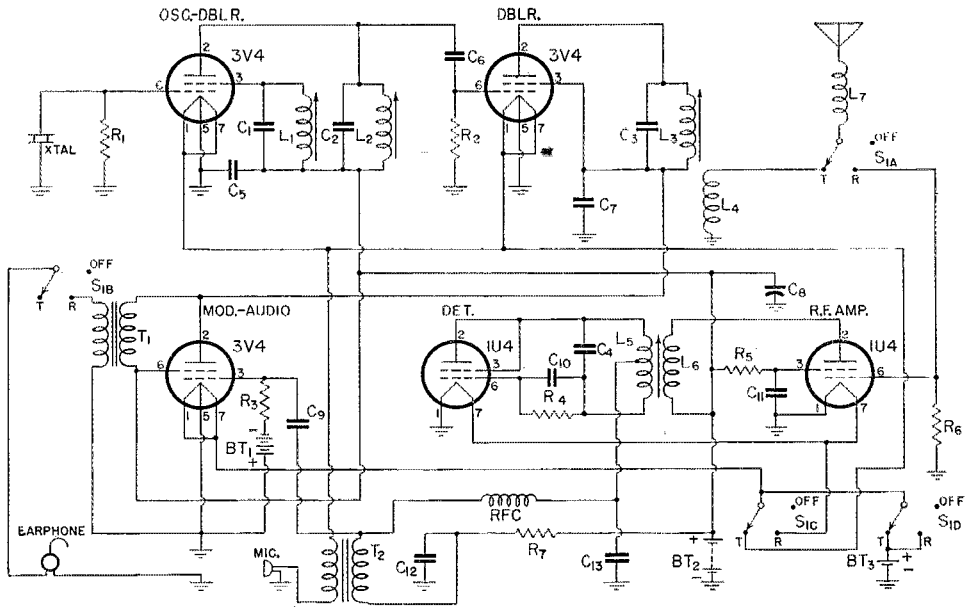
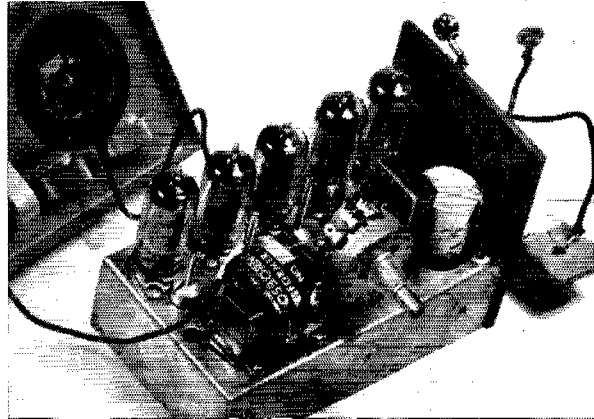
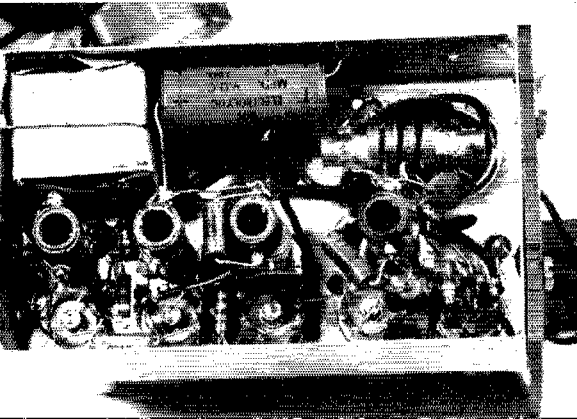

Fig. 1 — Schematic diagram and parts list for the Detroit portable transmitter-receiver.

- C₁, C₄ — 5- μ fd. ceramic.
- C₂, C₃ — 10- μ fd. ceramic.
- C₅, C₉, C₁₂ — 0.01- μ fd. disk ceramic.
- C₆, C₁₀ — 75- μ fd. ceramic.
- C₇, C₁₁ — 0.001- μ fd. disk ceramic.
- C₈ — 12- μ fd. 150-volt electrolytic.
- C₁₃ — 680- μ fd. ceramic.
- R₁ — 0.33 megohm.
- R₂ — 47,000 ohms.
- R₃ — 1 megohm.
- R₄ — 3 megohms.
- R₅, R₆ — 0.1 megohm.
- R₇ — 33,000 ohms.
- All resistors $\frac{1}{2}$ watt.
- L₁ — 48 turns No. 30 s.c.c., jumble-wound.
- L₂ — 26 turns No. 30 s.c.c., close-wound.
- L₃ — 11 turns No. 22 s.c.c., close-wound.
- L₄ — 3 turns No. 22 s.c.c., close-wound, adjacent to cold end of L₃.
- L₅ — 14 turns No. 30 s.c.c., tapped at center, close-wound.
- L₆ — 6 turns No. 30 s.c.c., at grid end of L₅. All coil forms $\frac{3}{8}$ -inch diam., slug-tuned (CTC LS-3, or equiv.).
- L₇ — Antenna loading coil. 13 turns No. 22 enam., spaced 8 turns to an inch on top end of hard fiber form 1-inch diam., 4 inches long.
- BT₁ — 4 $\frac{1}{2}$ -volt bias battery (see text).
- BT₂ — 90-volt "B" battery (2 Burgess XX30 45-volt batteries in series).
- BT₃ — 1 $\frac{1}{2}$ -volt "A" battery (3 flashlight cells in parallel).
- RFC — 2.5-mh. r.f. choke.
- S_{1A}, S_{1B}, S_{1C}, S_{1D} — 4-pole 3-position wafer switch (Mallory 32432-J).
- T₁ — 200-ohm prim. to 0.5-megohm sec., single button to single grid (UTC O-14 "Ouncer").
- T₂ — 10,000-ohm prim. to 50-ohm sec. (UTC O-9 "Ouncer").

Bottom view of the chassis. At upper left is the bias battery described in the text. The coils, left to right, are the final plate, final grid, oscillator plate and detector coil. Sockets along the bottom of the photograph are the final amplifier, oscillator, modulator, detector and the r.f. amplifier, in that order. Note that the construction is compact, yet not overly crowded.

"The works" of the 10-meter portables. The first three tubes from the left are 3V4s, the two on the right 1U4s. The slug-tuning adjustments are along the center of the chassis. On the front left corner is the output transformer, next the off-receiver-transmit switch, the crystal and microphone transformer. At far right, the "B" battery clips and "A" battery positive strip.



The Clapp Oscillator — and How!

An Explanation of the Series-Tuned Colpitts Circuit

BY REX CASSEY,* ZL2IQ

• In this article, ZL2IQ discusses the principles behind the popular Clapp VFO circuit, and applies the theory to practice. A discussion of the "remotely-tuned" Clapp is included.

MANY of the peculiar results obtained with the Clapp oscillator can be explained by a simplified analysis of the circuit, such as the one given below based on the work of Sandeman of the B.B.C.¹ Give it a few minutes' study and you'll be surprised how many improvements you can make on your oscillator!

The basic r.f. circuit for the Clapp oscillator is shown in Fig. 1. The oscillatory circuit consists of the series-tuned circuit L_1C_1 together with its loss resistance R , and the feed-back condensers C_2 and C_3 . The condition where the feed-back energy balances out the losses in the circuit, i.e., the condition for oscillations to occur, is given by

$$R = -g_m X_2 X_3 \quad (\text{see Appendix}), \quad (1)$$

where X_2 and X_3 are the reactances, respectively of C_2 and C_3 .

The condition determining the frequency of oscillation is given by

$$f = \frac{1}{2\pi \sqrt{L_1 C_1} \sqrt{1 + \frac{C_1}{C_2} + \frac{C_1}{C_3}}} \quad (2)$$

(see Appendix).

Just take another look at that formula (2) above. What does it tell you? Sure — the frequency of oscillation; but that's not all by a long shot. It also tells you how to make your oscillator have high stability! Take a good look at that expression under the square-root sign on the right. It includes C_2 and C_3 , the feed-back condensers. The value of the effective capacitance of these two condensers will change as the loading of the oscillator is varied, since they have the effective grid-cathode and plate-cathode capacitance in parallel with them. However, the resultant changes in frequency will be quite small because of the effect of that square-root sign. If we make the tuning capacitance, C_1 , small and the feed-back condensers large, the expression under the square-root sign will be very nearly unity, and the frequency becomes relatively independent of the feed-back condensers and de-

pendent only on the series-tuned circuit, L_1C_1 . Hence, dynamic instability attributable to change in tube capacitance is effectively eliminated.

What else can we find out from that expression under the root sign? One thing is that it can tell us why the oscillator is often called the "series-tuned Colpitts." It will be seen that the expression never quite reaches unity, but is always slightly larger. Putting it another way, the oscillator frequency can never be the same as that of the series-tuned circuit alone, but is always slightly higher. If it were the same as the resonant frequency of the series circuit, we would have merely a pure resistance of value R across the e_1 terminals of Fig. 1. We would not expect the circuit to oscillate in that case. However, at a higher frequency the reactance of the series circuit will be positive and it will look like a small

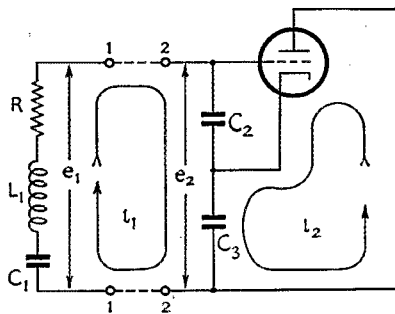

Fig. 1 — Basic Clapp circuit.

inductance across the terminals. This is equivalent to the circuit condition we have in the normal Colpitts! Are the Colpitts and Clapp oscillators the same? No. Thanks to "Cathode Ray" with his reactance-frequency diagrams,² this has been made abundantly clear. Briefly, if we used only an inductance, the inductive reactance across the e_1 terminals would vary very slowly with change in frequency. By using a series circuit, L_1C_1 , however, a small change in frequency causes a large change in the inductive reactance across the terminals and hence an extremely small change in frequency will be sufficient to counteract any change in the phase shift taking place around the feed-back loop. The stability is therefore very much higher than can be obtained with the normal Colpitts — probably at least 100 times more so.

There is one other difference which may be mentioned as a matter of interest. In the Colpitts we generally tune by varying the value of the feed-back condensers, C_2 and C_3 , whereas in the Clapp circuit we vary the "effective" inductance

* 92 Amritsar St., Wellington, N. Z.

¹ E. K. Sandeman, *Radio Engineering*, Vol. I, p. 421, 1947.

² Cathode Ray, "Series or Parallel," *Wireless World*, August, 1952, p. 321.

by altering the series-tuning capacitance. However, the essential difference does not lie in the method used for tuning, but in the method of providing the effective inductance in the oscillatory circuit.

Now take a look at that other formula marked (1) above. What can you deduce from it? Yes, sir, this one's the 64-dollar question. And the answer is that if the value of the expression on the right-hand side is less than the value of R , the circuit just doesn't oscillate. If the right-hand side is greater than R , the circuit will oscillate and the grid current will flow. As grid current increases, the operating g_m falls until the value of the expression on the right-hand side equals R , when stable oscillations result. There's one thing in particular you should notice in that formula. You may have the idea that if you increase the Q of the coil, the efficiency and output of the oscillator will be improved. But take another look at formula (1). It's not the Q of the coil that's the important factor but the value of the loss resistance R . If you put in a coil with a higher inductance and a higher Q , the efficiency won't be improved unless the loss resistance has been lowered in the process.

Now let's look at some of the problems you can solve by this "oscillation formula."

Some of the local gang have been telling you that the Clapp oscillator is just the cat's pajamas for stability, so you decide to build one. You were going to change from xtal to VFO before the Sweepstakes Contest, anyway. Half an hour before the contest starts everything is almost ready. You've checked the tuning range of the series circuit with the grid-dip meter and the range is OK. Fine — you flip the switch — and what happens? It doesn't oscillate. Wow! Better check the plate voltage — where did I put that multimeter? Ah, yes, here it is. Just over 300 volts and the ICAS rating is only 300. Should be getting plenty output. Hmm. Maybe it's a dud tube. There's a new one in the box at the top of the shelf there. Here she is — plug it in and let it warm up a bit. Now flip the switch once more — and what happens? No oscillations. Hmm. This is going to be a job for the soldering iron. It's also a job where a look at that "oscillation formula" can be mighty useful. On the left-hand side of formula (1) we have the loss resistance. We could reduce it in various ways. For example, we could raise the Q of the existing coil by removing the shield can and replacing it with a bigger one. This would result in a lower value of loss resistance, which is what we want. We could prune some turns off the coil, but this would mean that the series-tuning condenser would be bigger, but we have already seen that this may reduce the stability slightly. What about the expression on the right-hand side of the formula? The first part is the g_m of the valve. We've got the correct voltages for the plate (and screen) applied so we can't very well increase it to make g_m bigger. We might be able to use another value of cathode or grid resistor, though. What else have we that can be varied? The only other terms in

the formula are the reactance of the feed-back condensers. We could increase the reactance by putting in smaller values of feed-back condensers, although this would reduce the frequency stability slightly as we have already seen in connection with formula (2). This would be the easiest way to make the circuit oscillate; but the best way

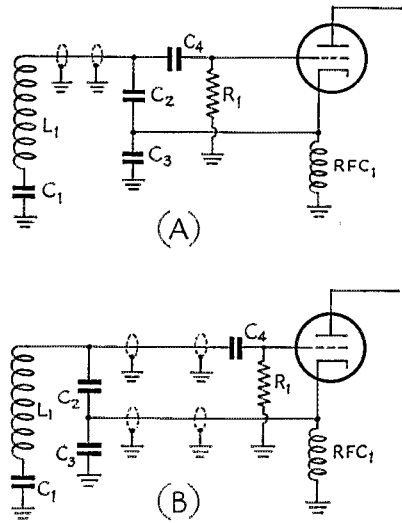

Fig. 2 — Circuits using remote frequency control. In the circuit of (A), a single coax conductor is used between the tuned circuit and the feed-back condensers. In (B), two cables are used between the feed-back condensers and the tube.

would be to reduce the loss resistance in the series-tuned circuit.

You take a look at the clock and find that there's still 10 minutes to go before the contest starts, so you decide to reduce the values of the feed-back condensers. A moment's work with the soldering iron and the job is done. You flip the switch once more, and — bibbety-boppety-boo — it goes!

Nice timing — still 5 minutes to go before the contest starts. You check the setting for the low-frequency end of the band and then swing the dial to check the high frequency end and suddenly "plop" — no oscillation. Down again and it's OK. Up again and it stops. Why? Well, the only term in the oscillation formula which is dependent on frequency is the reactance of the feed-back condensers. At the higher frequency the reactance is lower and the g_m would have to rise to counteract the effect. Another quick change is made. With a lower value of feed-back condenser, everything is OK, and you're off to a flying start in that contest after all. When it's over, you'll have time to think out ways and means of reducing that loss resistance in the tuned circuit so that the value of feed-back condensers can be increased.

One point, which we have not considered so far in our discussions, is the desirability, or otherwise, of using a grid-blocking condenser such as C_4 in Fig. 2. It is certainly not necessary for the

purpose of blocking the high voltage from the grid of the tube; this is effectively done by the series-tuning capacitance, C_1 . Does the inclusion of the grid condenser have any undesirable effect on the operation of the oscillator? The answer can be found by an extension of our simplified analysis of the circuit. In the analysis, we assumed that the grid voltage was equal to $i_1 X_2$. However, if C_4 is included in the circuit, only a portion of the voltage across C_2 will be applied to the grid, since C_4 and the grid-cathode capacitance of the tube now form a voltage-divider network across the feed-back condenser. If the appropriate change is made throughout the analysis, it will be found that the right-hand side of formula (1) is multiplied by a factor of $C_4/(C_4 + C_{ko})$, while the frequency formula (2) remains unchanged. If the grid condenser is very much larger than the grid-cathode capacitance of the tube, its effect may be neglected. However, it must be remembered that under operating conditions, the grid-cathode capacitance may be as much as 30 or 40 times the static value. In the case of a triode, it may be as high as 100 $\mu\text{fd.}$ as a result of the Miller effect, with a 100- $\mu\text{fd.}$ condenser for C_4 , only half the voltage would be applied to the grid. In this case the circuit would not oscillate so readily and it may be necessary to reduce the value of the feed-back condensers to offset the effect, with a resultant loss in stability. In general, we deduce that the grid-blocking condenser is undesirable in the case of a triode, since it reduces the efficiency and stability of the oscillator. In the case of a pentode it has little effect but is still an unnecessary element in the circuit.

Since this dissertation has been prepared as a result of reading a very interesting article by W3ASW in August *QST*,³ it may be of interest to comment on the effects found in the remote-controlled VFO which he described. The appropriate circuits are shown in Fig. 2.

In a description by W9ERN of a somewhat similar arrangement,⁴ it has been pointed out that 70-ohm coaxial cable has a capacitance of about 20 $\mu\text{fd.}$ per foot. Two 10-foot lengths were, in fact, used by W9ERN in place of C_2 and C_3 . In the circuits shown in Fig. 2, each of the lengths of coaxial cable would have a capacitance of about 125 $\mu\text{fd.}$ The effect of this additional capacitance will depend on how it is introduced into the circuit and a number of cases are shown in Fig. 3. The circuit in A shows the normal condition, while those in B, C, and D contain added capacitance. In the normal case A, the effective capacitance which has been placed across the series-tuned circuit is 250 $\mu\text{fd.}$ For the other circuits, this value will be found to have been increased to 313, 375, and 405 $\mu\text{fd.}$, respectively. In the case of B, the values of X_2 and X_3 in our oscillation formula (1) above will have been reduced and the circuit will not os-

illate so readily. The original conditions could be obtained by simply reducing the 500- $\mu\text{fd.}$ condensers to 375 $\mu\text{fd.}$ This is effectively the arrangement used by W9ERN in his oscillator circuit. However, in order to use this arrangement, a grounded-cathode oscillator circuit must be adopted. This does not present any difficulty.

In the case of C, which is equivalent to Fig. 2B, and in the case of D, which is equivalent to Fig. 2A, it will be noticed that the feed-back condensers have been by-passed by the 125- $\mu\text{fd.}$ capacitance of one of the coaxial cables. This results in a portion of the current i_1 , which flows in the oscillator circuit, being ineffective insofar as the production of grid voltage across C_2 is concerned, and hence lowers the efficiency of the oscillator. If we increase the current flowing in

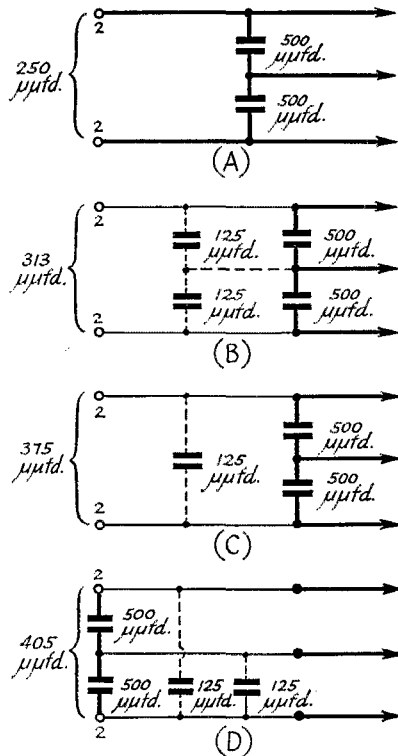

Fig. 3 — The effect of additional cable capacitance across the feed-back condensers will depend upon where the capacitance is introduced, as discussed in the text.

the series-tuned circuit to make up for this by-passing effect, more energy will be lost in the resistance of the series-tuned circuit and this will tend to offset the improvement we may have made. Looked at from another point of view, the effect is similar to that of adding capacitance across a crystal holder, a practice which we know from experience to be undesirable.

Mention has been made by W3ASW of the apparently excessive loss in the coaxial cables when they are inserted between the series-tuned circuit and the feed-back condensers. This may

(Continued on page 122)

³ Long, "Cutting Down VFO Drift," *QST*, August, 1952, p. 20.

⁴ Clemens, "The R.C.O. — A Remote Control Oscillator," *Radio & Television News*, August, 1952, p. 40.

Mechanical Bandpass Filters for I.F. Ranges

An Approach to the Ideal Selectivity Curve

BY BEN ROBERTS,* WØIEU

FOR a good solid QSO in a crowded amateur band, we like to hear just one signal and nothing but that signal. The receiver that will come closest to meeting this requirement must have a selectivity curve with a flat top, straight vertical sides, and a bandwidth only wide enough to pass the desired signal. This is the "ideal" selectivity curve.

Receiver selectivity is usually increased by adding tuned i.f. stages. However, when this method is used to increase selectivity, even to the point where so much sideband power is lost that 'phone signals become unintelligible, the skirts of the selectivity curve may still be broad enough to pass interference from strong signals a few kilocycles away. Crystal-lattice filters¹ offer one approach to the ideal selectivity characteristic, but they are usually expensive and their commercial use has been confined to telephone-company applications.

The Mechanical Filter

An entirely new approach to high selectivity is available through the use of the "mechanical filter," a resonant mechanical device. Shown in the photograph, it consists of three sections: an input transducer, a mechanically-resonant filter section, and an output transducer. The input and output transducers are identical and use magneto-

*% Collins Radio Co., Cedar Rapids, Iowa.

¹ Weaver and Brown, "Crystal Lattice Filters for Transmitting and Receiving," Part I, June, 1951, *QST*.

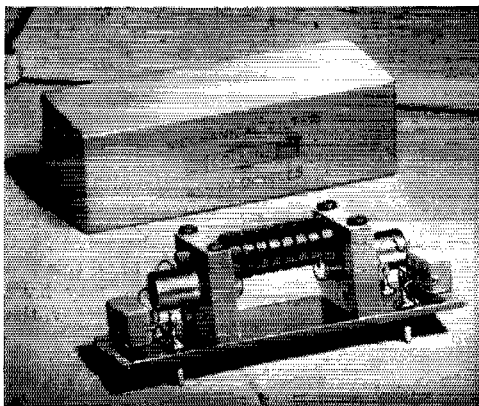

The mechanical filter is shown here removed from its $2\frac{1}{8} \times 1 \times 1\frac{1}{8}$ -inch case. The filter proper consists of the small disks in the center — each one is carefully machined to the correct dimensions to give the proper mechanical resonance.

• If you have been waiting for "something new" in the selectivity department, here it is. By cascading accurately-machined bits of metal, bandpass filters can be built in the i.f. range that approach in performance the straight-sided "ideal," and this article describes their operation and their advantages. Unless you are a genius who has a more practical solution to the problem of crowded bands than the use of higher selectivity, we're sure you will want to know something about this latest development.

striction to convert the electrical signal to mechanical energy and vice versa. Three small metal rods are used to connect together the resonant disks of the filter section. The second disk from each end connects to a transducer by means of a small metal rod, and the two end disks are secured to the transducer housings to serve as supports for the filter section.

Magnetostriction, which makes possible the electrical-to-mechanical and mechanical-to-electrical transformation of energy in the transducers, is a fairly well-known but rarely used phenomenon. When a highly magnetic substance such as nickel is subjected to magnetic flux, the shape and volume of the magnetic substance change. The metal will elongate, twist, or bend. The magnetostrictive transducer used at each end of the mechanical filter consists of a small coil of wire surrounding a nickel core. Application of a 455-kc. signal (or whatever other frequency the filter is designed for) to the input coil causes a magnetostrictive action resulting in a mechanical vibration of the nickel core. This 455-kc. mechanical vibration is transmitted through the interconnecting metal rods to the mechanically-resonant disks of the filter proper. Each disk is mechanically driven by the preceding disk, so that all of the disks vibrate at 455 kc. The last resonant disk drives the core of the output transducer. Here the vibrations of the nickel core are changed by magnetostriction into a varying magnetic field. The output coil intercepts this field and supplies a 455-kc. output voltage.

In order to avoid a frequency-doubling action that would generate a mechanical cycle for each electrical half-cycle, a small magnet in the mounting above each transducer applies a magnetic bias to the nickel transducer core. The elec-

trical pulses then add to or subtract from the magnetism that already exists, causing the filter elements to reproduce the input cycle. There is no movement in the mechanical filter except for the imperceptible vibration of the internal filter elements.

The mechanically-resonant disks of the filter proper have extremely low losses at their resonant frequencies. Each disk has a Q greater than 2000. These high- Q components exhibit characteristics that make possible application of the theory of lossless elements to filter design. A mechanical filter can be constructed for either narrow or broad bandpass without sacrificing its nearly rectangular selectivity curve. The relatively low Q of electrical elements does not permit the design of equivalent electrical filters. Typical characteristics obtainable with mechanical filters are shown in Fig. 1, with the selectivity curve of an i.f. amplifier using nine tuned circuits (electrical elements) shown for comparison. The transmission loss of 23 db. or so through the 3-kc. mechanical filter is made up easily by subsequent amplification by vacuum tubes.

Once the mechanical filter has been constructed, it is enclosed in a hermetically-sealed case and requires no further adjustment. Connections to the input and output transducer coils are brought out of the unit on feed-through insulators whose edges are sealed to the case.

Using the Filter

A receiver using the 3-kc. mechanical filter in its i.f. amplifier handles differently than one with a conventional selectivity characteristic. As the receiver is tuned across the band, signals appear and disappear with more than usual suddenness. The straight-sided selectivity curve makes the band appear less crowded—such a curve is easier to interpose between two signals without responding to either of them.

Using a steep-sided 3-kc. bandwidth for 'phone reception is by no means standard procedure, and it requires a bit of explanation. With a good conventional i.f. curve, like the one obtained from nine turned circuits and shown in Fig. 1, the carrier frequency must be tuned very close to the center of the selectivity curve. This is because the carrier level decreases as the receiver is tuned off. As the signal is moved off the center of the selectivity curve, the carrier level decreases but one of the sidebands does not. This results in too much sideband for the available carrier amplitude and causes the distortion (overmodulation at the detector) that always results when a receiver with a rounded selectivity curve is not tuned "on the nose." The only way to avoid this distortion is to tune the receiver to the carrier rather than to a sideband. This is the conventional way to tune a receiver; however, when we

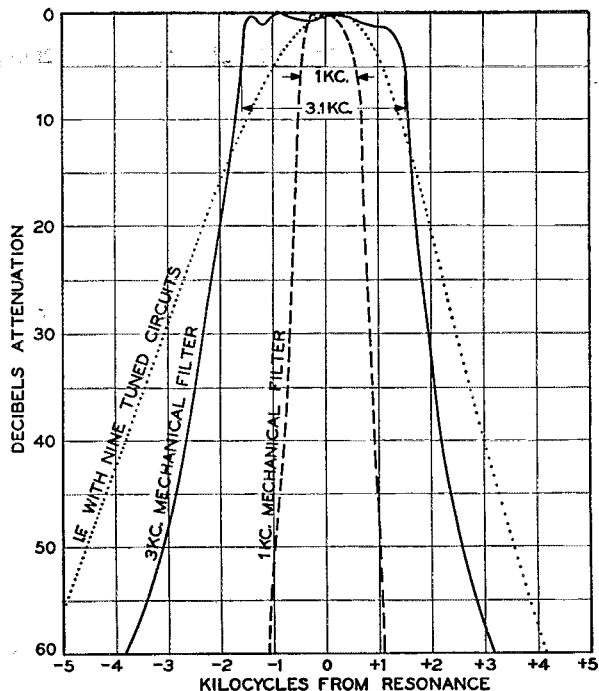
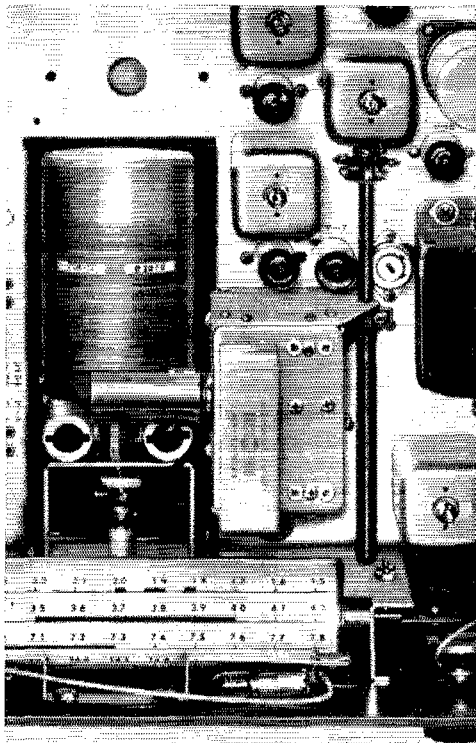

Fig. 1—Selectivity at 455 kc. of two mechanical filters of different bandwidths, shown for comparison with the selectivity obtainable with nine tuned circuits at the same frequency. The narrower "skirts" and the flat "top" of the mechanical filters account for their superior performance in crowded amateur bands.

do this, we are splitting our available bandwidth between two sidebands, although we need to receive only one. Therefore, if a receiver with a conventional i.f. curve has a 3-kc. bandwidth and is tuned to the carrier, as it must be for distortionless reception, it will respond to audio frequencies up to about 1500 cycles—not to 3000 cycles as is sometimes assumed. To accept side frequencies up to 3000 cycles, the carrier must be set off to one side, and distortion will result, except at very low percentages of modulation. But the curve of the mechanical filter has a flat top, and setting the carrier off to one side does not substantially reduce its amplitude with respect to the sideband. By keeping the carrier inside of the flat-topped selectivity curve, we can tune to either sideband without introducing the "overmodulation" type of distortion. Since it is no longer necessary to split the available bandwidth between two sidebands, we can pass a given range of audio frequencies with a passband only half as wide as would be required with a conventional i.f. selectivity curve. Since only one sideband is needed for reception of a signal, setting the carrier at one edge of the passband will still permit us to hear all of the audio frequencies up to 3000 cycles, when the 3-kc. mechanical filter is used.

The 3-kc. filter is excellent for use in reception of s.s.b. signals, when used with a receiver of good



A top view of part of the 75A-3 receiver, showing the mechanical filter mounted to the right of the tuning unit. Sockets are provided for an additional filter section if desired. The shaft along the right-hand side of the filter platform is a double shaft — the outer shaft permits switching between the two filter units, and the inner shaft is the b.f.o. pitch control.

oscillator stability. It has the correct bandwidth for s.s.b. reception, although the 1-ke. filter can be used when conditions require extreme selectivity. Under such conditions, the reinserted carrier (b.f.o.) is set about 300 cycles outside the i.f. passband, allowing an audio range of 300 to 1300 cycles to be received.

The good skirt selectivity of the mechanical filter allows it to reject the carrier and one sideband of an ordinary a.m. signal, thus converting it to a s.s.b. signal in the receiver past the filter. The b.f.o. is then set just outside the filter passband, to coincide with the frequency of the eliminated carrier, for proper detection. This type of s.s.b.-plus-exalted-carrier reception minimizes the effects of selective fading and of certain types of noise. Either the 3- or the 1-ke. filter can be used in this application.

The Filter Applied to the Collins 75A-3 Receiver

The amount of selectivity that is desirable in a communications receiver is a good subject for debate. Most of us like a very selective receiver, but we also want faithful reproduction when 'phone signals are in the clear. Development of the mechanical filter has solved this problem, since to change the selectivity of a receiver using

the filter it is only necessary to cut in a filter of different bandwidth. The new Collins 75A-3 receiver is supplied with a 3-ke. mechanical filter and has plug-in provisions for the optional installation of a 1-ke. filter. The 3-ke. filter is ideally suited for all types of 'phone reception including s.s.b., and for exalted-carrier reception of regular a.m. signals. Even the 1-ke. c.w. filter can be used for 'phone reception, as described above. The crystal filter is retained for phasing out heterodynes.

The mechanical filter is not just an accessory, but is an entirely new development in communications. It shows promise for use in many applications, including the simplification of single-sideband transmitter circuits. Presently, development work is proceeding toward the production of mechanical filters with higher and lower operating frequencies and bandwidths as required for special applications.

Strays

W4GJW, compiling the second edition of his Directory of Physician and Dentist Amateur Radio Operators, invites ham members of those professions to write him requesting applications for listing.

Philco TV receivers of 1951 and 1952 vintage may be de-ITV'd by means of anti-radiation shield kits (Part No. 45-1783) now available. The kits are applicable to sets having the following power and deflection chassis serials: A1, AP1, C1, C2, C3, CP1, CR3, F2 and FR2. No holes need be bored and everything fits snugly; a high-pass filter in the antenna lead at the tuner will clinch the job. — *W1AVY*

Silent Keys

It is with deep regret that we record the passing of these amateurs:

W1AJS, Lee Morehouse, Marbledale, Conn.
 W1KWN, H. W. Featherstone, Berlin, Mass.
 W1QAR, Kenneth L. Sumner, East Hampden, Me.
 W1SZX, Arthur J. Heckbert, Lynn, Mass.
 W1UD, Isaiah Creaser, Springfield, Mass.
 W2AQF, John C. Tredwell, Suffern, N. Y.
 W2MO, Earl G. Ports, Livingston, N. J.
 W2PLU, George F. Herman, Buffalo, N. Y.
 W3IBT, Stephen J. Zubrecky, Silver Spring, Md.
 WN3SLM, Lee S. Effenbein, Erie, Penna.
 W4JYR, Darrell A. Downard, Louisville, Ky.
 ex-4KT, Jesus T. Pinero, San Juan, P. R.
 W51QQ, Dr. John A. Strickland, Alice, Texas
 W5WA, John McArthur, Moss Point, Miss.
 W7EGV, Ruben L. Johnson, Olympia, Wash.
 ex-8AEZ, M. B. West, Lima, Ohio
 W8ML, Frank M. Murphy, Cleveland, Ohio
 W9GA, John Dodman, Chicago, Ill.
 W9MVE, N. Rex Scott, Anderson, Ind.
 WN9QAK, Welby E. Dahlman, New Lenox, Ill.
 W9TFV, Paul R. Clark, Riverdale, Ill.
 WØVDG, Harry C. Young, Sikeston, Mo.
 VE3BA, W. Mitchell, Brantford, Ontario

◆

W3HH's 3-band VFO transmitter. The high-voltage power supply is at the left, and the low-voltage power supply, along with the clamper tube, is in the center behind the VFO box. On top of the VFO box may be seen the screw for adjusting the slug of I_1 . The final tank coils are soldered directly to the tank condenser and the contacts on the bandswitch. The low-pass filter had been removed when this photograph was made, but it fits on the chassis in the right rear corner.

◆

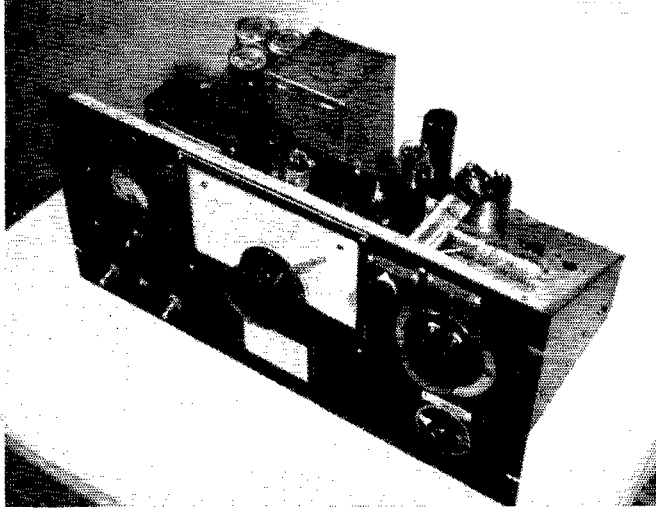

A Self-Contained VFO Rig

50 Watts — 3 Bands in a Single Unit

BY GILBERT L. COUNTRYMAN,* W3HH

• Here is a neat looking bandswitching rig that can be built at a reasonable cost. Furthermore, W3HH has had no trouble from TVI on any of the four channels in use in Washington. Using an 807 or 807W in the final, it delivers an output of 50 watts on 80, 40 or 20 and, with minor modifications, can be operated also at 21 Mc.

IN the November, 1948, issue of *QST* a VFO/crystal exciter was described that did yeoman service for several years.¹ When the rebuilding urge developed sufficiently (aided by the advent of TV and the need for more stability), the chassis, panel, two power supplies and dial were retained. Everything else was stripped clean and a compact unit evolved that fully satisfied the following requirements:

- 1) Bandswitching operation in the c.w. 20-, 40- and 80-meter bands.
- 2) Reasonable output to permit use of the unit as either a transmitter or as a driver for a high-powered final amplifier.
- 3) Stable drift-free VFO control.
- 4) Rack construction to permit inclusion in a relay rack or optional use on the operating table.
- 5) Complete elimination of BCI and TVI.
- 6) Excellent keying characteristics.
- 7) Operating convenience including terminals to permit operation with relay control of the entire station, and frequency setting without putting a signal on the air.

* Capt., USN, BuShips Code 806, Navy Dept., Washington, D. C.

¹ Countryman, "A VFO/Crystal Exciter," *QST*, Nov., 1948, p. 36.

8) Simplicity of circuit for ease of construction adjustment and maintenance.

Considerable time was spent in arriving at a final design that was foolproof and that would include all of the above requirements. The new rig is a job with two power supplies; a Clapp series-tuned VFO, one isolation stage, one buffer-doubler and an 807W or 807 final. The 807W is a ruggedized version of the 807 and is an excellent tube provided either fixed grid bias or clamper-tube screen control is used. Otherwise, its service life appears to be comparatively short. This rig includes a clamp tube which may be a 6V6, 6L6, or 6Y6G. Right now the tube in the socket is an old reliable 6L6. The circuit is shown in Fig. 1.

Complete TVI elimination has been achieved. The unit is constructed on 10 × 17 × 3-inch steel chassis and an 8¾ × 19-inch steel rack panel. The meter, MA_1 , is enclosed in an aluminum shield box; another small aluminum shield box contains the v.h.f. chokes, RFC_7 and RFC_8 , as well as by-pass condensers, C_{27} and C_{28} , in the a.c. input line; and a simple low-pass filter in a third aluminum box is included in the r.f. output lead. An aluminum chassis bottom cover is included. A few ¼-inch holes drilled in it permit ventilation. The sides and back are shielded with a formed sheet of ⅛-inch aluminum 6¼ inches high bolted to the chassis sides and back. Lengths of ½-inch aluminum angle, drilled and tapped, permit a 10 × 17-inch aluminum top to complete the shielding. The top has clusters of ¼-inch ventilation holes drilled over each vacuum tube, and similar holes in the sides and back permit complete ventilation and at the same time keep the r.f. where it belongs.

In the photographs the shielding has been removed for clarity, but the aluminum angle

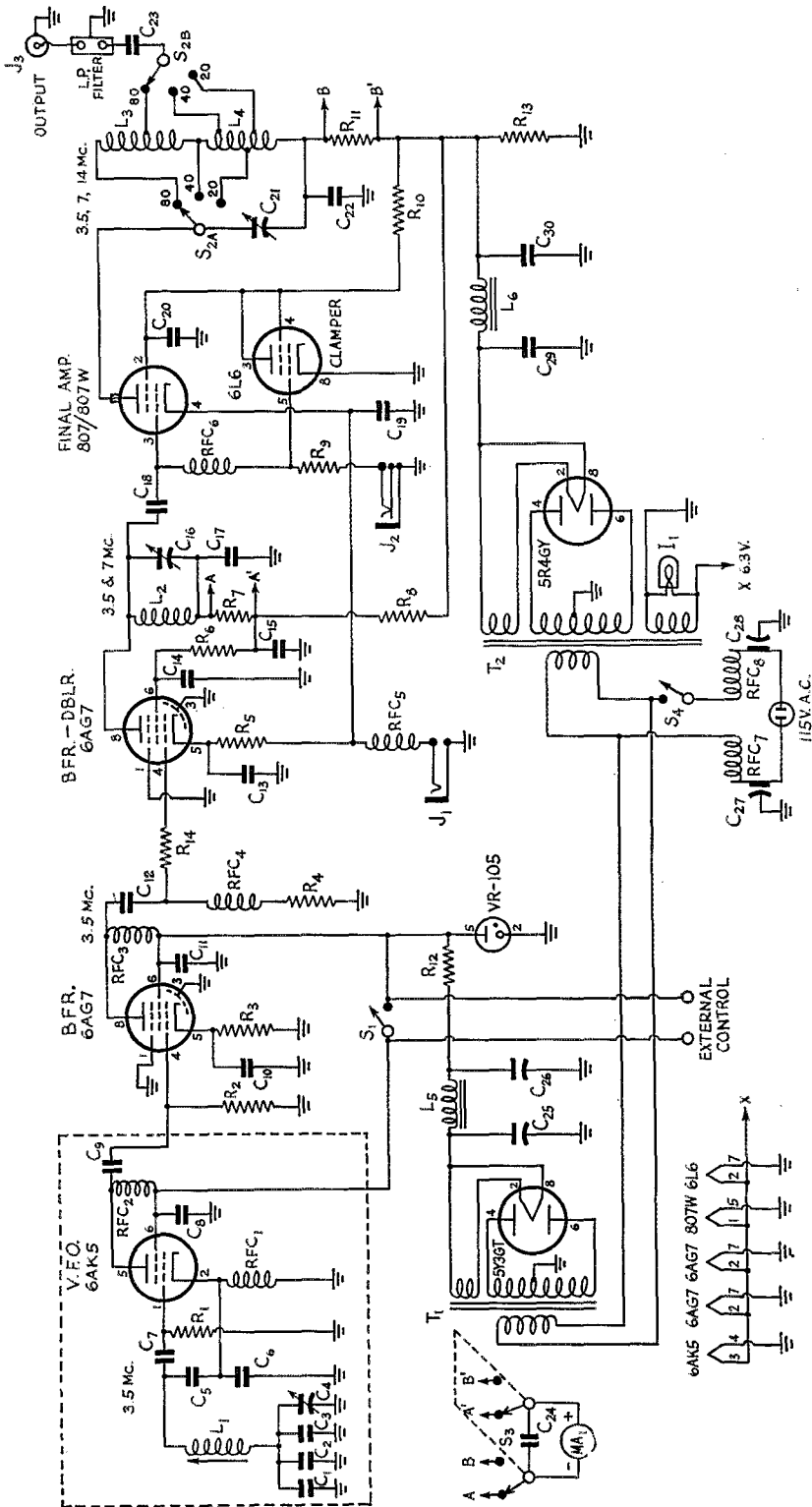

Fig. 1—The circuit of the W3HH transmitter-exciter shows a 6AK5 VFO and 6AG7 isolation stage operating at 3.5 Mc., a 6AG7 buffer-doubler that can be tuned to either 3.5 or 7 Mc. by its tuning condenser, C16, and an 807 final amplifier with coil switching in the output circuit. By doubling frequency in the output stage, 14-Mc. output is obtained. Two power supplies and a metering system are included.

across the panel top, to which the front of the top shield bolts, is in place.

Operation is completely stable on all frequencies without neutralization. When running full-blast beside an RCA television receiver, there is no indication of the signal on Channels 4, 5, 7, or 9, which are the channels in use locally.

Referring to the photographs, across the front, left to right, are the milliammeter with a toggle switch, S_3 , below it to place the meter in the plate circuit of either the buffer or the doubler stage, the National ACN VFO dial, the bandswitch, S_2 , and the final-tank tuning control, C_{21} . Below are the a.c. off-on switch, S_4 , pilot light, I_1 , the VFO switch, S_1 , and the buffer-doubler tuning control, C_{16} . A calibration card on the front panel below the VFO dial shows the settings of the two tuning condensers for the three bands. (The settings are approximate; actually the circuits must be tuned to the dip in the plate meter.) The only other operation necessary when changing bands is to turn the bandswitch to the band desired, as this switch selects the proper number of tank-coil turns and the correct tap for proper loading of the final. On the rear chassis apron are the a.c. line terminals, VFO-control terminals for use if desired, keying jack, J_1 , a jack into which a milliammeter may be plugged to read the grid current of the 807 final, J_2 , and the coaxial r.f. output socket, J_3 .

For use on the operating table, a wooden cabinet was constructed in which the rig with its $8\frac{3}{4} \times 19$ -inch steel rack panel just fits. If desired, the rig can be removed from this cabinet and inserted in the relay rack with the high-powered final and associated components.

Circuit

Let's look over the circuits for a minute. There is nothing unusual about the VFO, which operates in the 80-meter band. A screen-grid tube is used to give a measure of isolation in

addition to the isolation stage. The VFO coil, L_1 , is a National XR60 form, wound full of No. 26 enameled wire. The combination of negative- (C_2) and zero-temperature (C_1 and C_3) compensating condensers shown in the wiring diagram cuts the drift from a cold start down to where it is less than the drift in the receiver used. The VFO is completely enclosed in a separate $3 \times 4 \times 5$ -inch steel box with the leads coming out the bottom and through the $17 \times 10 \times 3$ -inch main chassis. The VFO coil is mounted so that the slug-adjusting screw protrudes from the top of the VFO box, making initial adjustments easy and accurate. The usual care in building a VFO must be taken. Make all wiring short and rigid. You should be able to jar the operating table without causing the slightest change in your note. With the three-plate Hammarlund double-bearing midjet tuning condenser, C_4 , a 180-degree revolution of the dial covers from 3500 to 3800 kc. If you wish to cover the entire band from 3500 to 4000 kc., use a five-plate midjet condenser of the same type. There will, of course, be some sacrifice of bandsread on the 20- and 40-meter bands. If the rig is to be used only on c.w. the stated coverage is to be preferred, because of the better bandsread on 20 and 40.

The isolation stage is self-explanatory from the wiring diagram. A piece of $\frac{1}{4}$ -inch copper gas line was fastened with cable clamps and takes the r.f. output wire from the VFO, where it comes through the chassis, to a point about $\frac{1}{4}$ inch from the grid-socket terminal of the 6AG7 isolation stage.

The VFO and isolation stages are run at 105 volts, regulated, from a separate power supply. A switch, S_1 , in the panel is connected in the high-voltage lead to the VFO and isolation stages. This switch is paralleled by two terminals in the rear chassis apron for connection to a control relay or foot switch if desired. To set the VFO on a received signal, it is only necessary to snap the

- C_1 — 15- μ fd. zero-temp. mica.
- C_2 — 27- μ fd. negative-temp. mica.
- C_3 — 27- μ fd. zero-temp. mica.
- C_4 — 20- μ fd. variable (Hammarlund MC-20-S).
- C_5, C_6 — 0.001- μ fd. silvered mica.
- C_7, C_9 — 100- μ fd. zero-temp. mica.
- $C_8, C_{10}, C_{11}, C_{13}, C_{14}, C_{15}, C_{17}, C_{19}, C_{20}$ — 0.01- μ fd. disk ceramic.
- C_{12}, C_{18} — 100- μ fd. mica.
- C_{16} — 250- μ fd. midjet variable.
- C_{21} — 100- μ fd. variable (Bud CE-2004).
- C_{22} — 0.01- μ fd. 1000-volt mica.
- C_{28} — 0.003- μ fd. 1000-volt mica.
- C_{24} — 0.0047- μ fd. mica.
- C_{25}, C_{26} — 3- μ fd. 450-volt electrolytic.
- C_{27}, C_{28} — 0.1- μ fd. 600-volt coaxial (Sprague).
- C_{29}, C_{30} — 4- μ fd. 600-volt, oil-filled.
- R_1 — 47,000 ohms, $\frac{1}{2}$ watt.
- R_2 — 0.1 megohm, $\frac{1}{2}$ watt.
- R_3, R_5 — 300 ohms, 1 watt.
- R_4 — 47,000 ohms, $\frac{1}{2}$ watt.
- R_6 — 15,000 ohms, 2 watts.
- R_7, R_{11}, R_{14} — 50 ohms, 1 watt.
- R_8 — 20,000 ohms, 25 watts.
- R_9 — 22,000 ohms, $\frac{1}{2}$ watt.
- R_{10} — 25,000 ohms, 25 watts.
- R_{12} — 1500 ohms, 25 watts.
- R_{13} — 0.2 megohm, 50 watts.

- L_1 — National XR60 ceramic threaded 1-inch diam. form with iron slug, wound full of No. 26 wire.
- L_2 — 25 turns, 1-inch diam., $1\frac{1}{2}$ inches long (B & W 3015 Miniductor).
- L_3 — 48 turns, 1-inch diam., 3 inches long, tapped 11 turns from end connected to L_4 (B & W 3015 Miniductor).
- L_4 — 24 turns, 1-inch diam., 3 inches long; tapped 10 turns from "cold" end for S_{2A} ; tapped 5 turns and 13 turns from "cold" end for S_{2B} (B & W 3014 Miniductor).
- L_5 — 12-hy. 50-ma. filter choke.
- L_6 — 12-hy. 200-ma. filter choke.
- I_1 — 6.3-volt dial lamp.
- J_1 — Open-circuit key jack.
- J_2 — Closed-circuit grid-current jack.
- J_3 — Coaxial socket.
- MA_1 — 200 ma.
- $RFC_1, RFC_2, RFC_3, RFC_4, RFC_5$ — 2.5-mh. r.f. choke.
- RFC_6 — 7- μ h. r.f. choke (Ohmite Z-50).
- RFC_7, RFC_8 — 14- μ h. choke (Ohmite Z-20).
- S_1, S_4 — S.p.s.t. toggle switch.
- S_2 — Two-pole 3-position ceramic rotary switch.
- S_3 — D.p.d.t. toggle switch.
- T_1 — Power transformer: 500 v. c.t., 50 ma.; 5 volts, 3 amp.
- T_2 — Power transformer: 1200 v. c.t., 200 ma.; 5 volts, 3 amp.; 6.3 volts, 6 amp.

VFO switch on (or press the foot switch if used) and listen for the note in the receiver as the VFO is tuned. This switch can also be used as a send-receive switch in applications where the unit is used as a transmitter or, if no external relay is used, in those applications where the unit is serving as an exciter.

The buffer-doubler is another 6AG7. The tank coil, L_2 , is a B & W 3015 Miniductor cut down to 25 turns. With the 250- μ fd. midget surplus tuning condenser, C_{16} , it covers both 80 and 40 meters at about 10 degrees and 90 degrees on the dial, respectively. The lead from this tank to the grid of the 807W is also inserted in a short length of copper gas line supported under the chassis by cable clamps.

The buffer-doubler and final are keyed simultaneously. The VFO may be keyed if break-in operation on the same frequency is desired, but the author prefers to let the VFO run and key a later stage or stages, since a keyed oscillator does not readily permit shaping of the waveform. A final high-powered amplifier, if used, should be biased to cut-off. An Ohmite Z-50 choke, RFC_5 , inserted in the keying lead under the chassis, removed the last vestige of a persistent harmonic that fell in TV Channel 5 and was radiated for about 30 feet by the lead from the rig to the key.

A 10- μ fd. electrolytic condenser should be connected across the key terminals for shaping, unless a separate vacuum-tube keyer is used. With a v.t. keyer no additional shaping condenser is necessary. A simple keyer was recently described by the author.²

The milliammeter may be switched to the plate circuits of either the buffer-doubler or the final and is by-passed with a 0.005- μ fd. mica condenser, C_{24} . The jack in the grid circuit of the 807W, J_1 , is located on the rear chassis apron. It is helpful to be able to check the grid current of the final during initial adjustments or when trouble-shooting, but once the rig is in operation no meter is needed.

The clamper tube keeps the 807W on an even keel and its use is recommended. No by-passes in the clamper tube circuit are necessary.

The final tank is made of two B & W one-inch-diameter Miniductors. The 24-turn coil, L_4 , is mounted directly from the tuning-condenser terminal to the bandswitch, parallel to the panel. The 48-turn coil, L_3 , is switched in for 80-meter operation and is mounted from the bandswitch to a ceramic stand-off, at right angles to the other coil. This arrangement reduces the length of the leads to the taps on the coils. Incidentally, tapping a turn of the 48-turn coil is easy if the two adjacent turns are pushed down leaving the turn to be tapped in the clear. At first it was feared that the little Miniductors would heat up at 50 watts but no difficulty of any kind has been experienced. The taps on the coils, as shown in the wiring diagram, permit loading on all three bands to 85 ma. Moving the 20- and 40-meter

output taps one turn, and the 80-meter tap two or three turns toward the "hot" end, increases the loading to 100 ma. This output tends to overdrive the author's 400-watt final, hence the taps are located as shown in the diagram. For use as a transmitter, the taps should be changed to give full fifty watts input, 500 volts at 100 ma. There is no change in the smooth operational characteristics or keying.

Using the clamper tube, key down, the voltage on the screen of the 807W is 240 volts at 13 ma. With key up, the voltage drops to 28 and the current increases to only 22 ma. — well within the limits of the screen-dissipation rating. The plate of the 6AG7 buffer-doubler runs at 220 volts and its screen at 125 volts.

Since the aluminum shielding is perforated, ventilation is no problem. The wooden cabinet has holes drilled in the bottom, sides, and in the top directly over the VFO tube, the 807W and the 5R4GY rectifier. The wooden cabinet is raised slightly from the operating desk by means of four screw-on rubber feet. No excessive heating has been experienced, even over extended periods of operation.

TVI

After the rig has been completed and is operating smoothly, an absorption wavemeter covering the TV bands and using a 1-ma. indicator and crystal rectifier should be used for checking parasitics. A.c. leads and key leads should be checked. Next, use a 50-watt bulb for dummy load and check the output leads. The meter pick-up coil should then be held adjacent to the final tank coils (CAUTION!). Tests must, of course, be made on all three bands. If the slightest indication of harmonics on any TV band shows up, it must be eliminated. A few Ohmite Z-50 or other v.h.f. chokes and some ceramic disk condensers in values from 100 μ fd. to 0.01 μ fd. should be tried in various places until the harmonics disappear. Then check everything again, since the insertion of a choke or by-pass may cause other harmonics to appear. The wiring diagram shows all the measures necessary for complete TVI elimination, although different wiring arrangements may require different treatment in the rig you build. Grounds and by-pass returns from each tube should be made to the same point adjoining the tube on the chassis. A lug attached to one of the screws holding the tube socket is convenient.

A Lyco Model 75 low-pass filter, as used in their Model 600 transmitter, is installed in the r.f. lead from the bandswitch to the coaxial output terminal. The case is only 6 inches long by 1 $\frac{1}{4}$ inches square. It is available separately and is adequate. A simple filter can be easily constructed by following directions contained in the ARRL *Handbook*, if desired.

Some expense may be saved by using surplus transformers, chokes, filter condensers, etc. Only the best by-pass condensers, r.f. chokes and VFO fixed condensers should be used, however.

(Continued on page 184)

² Countryman, "Vacuum-Tube Keying Simplified," *Radio & Television News*, Oct., 1951, p. 51.

An 80- and 40-Meter Antenna System for the Novice

Making Use of Flashlight Bulbs To Show Antenna Loading

BY LEWIS G. McCOY,* WHICP

• A hard job for any newcomer is to decide upon an antenna system and then find an antenna tuner to go with it. The "package deal" presented here gives him the whole works, with an economical approach that is hard to beat.

THE first big adventure confronting almost any newly-licensed amateur is the business of building that all-important first transmitter and putting it into operation. But ask these same newly-licensed amateurs what their most difficult problem is during this period, and nine out of ten will agree that it is knowing when the power is getting into the antenna. Many of them will say that they are not making contacts on the air, although the plate meter shows that the final is drawing current and everything *seems* to be working.

Obviously, some of this can be caused by unfamiliarity with operating techniques, but we aren't going to talk about that phase of amateur radio. One of the purposes of this article is to describe a simple means for insuring that the power from the transmitter is on its way toward the antenna. At the same time we'll tell you about an antenna system you can use on 80 and 40 meters with practically no fuss or bother.

There are a number of different types of antennas that can be made to work on 80 or 40 meters, as the *ARRL Antenna Book* or *Handbook* antenna chapter will testify. And the more types one hears about, the harder it becomes to make any decision about them! To eliminate the necessity for decision, we will describe one particular antenna, with information on two different lengths of feed lines just to take care of varying circumstances. The ultimate performance of any antenna depends on factors such as height above ground, surrounding objects and ground conductivity, to name just a few. But one hasn't very much control over these factors, so the antenna must be planned to fit the location.

The first step in any antenna planning is a study of the location where the antenna will be erected. Look for points on your (and your neighbors') houses to fasten the antenna ends, always keeping in mind that the higher the antenna is, the better it will work. Trees make convenient tie points for antenna ends, and there are recommended methods for suspending antennas from

trees given in the antenna chapter of the *Handbook*. Also given in the *Handbook* are construction details of masts and towers.

Don't be discouraged if it is impossible to put your antenna up 50 or 60 feet in the air. It will still do a fair job of radiating if as low as 20 feet. Many newcomers also feel that an antenna won't work unless it is straight. It will work best when it is run straight but it will still do a fair job of radiating if the ends are dropped down or bent around corners.

In this case we are describing an antenna 67 feet long. The 67 feet is opened at the center and fed with open-wire line. Most of the books on antennas recommend using an antenna 133 feet long for 80 meters. But, while the longer length is preferred, 67 feet will radiate almost as well. What is more important, it will fit many locations better than 133 feet would.

The best feed line for our purposes is "open-wire" line. Open-wire line is made of two wires supported a fixed distance apart by insulated "spacers." Because it is mostly air-insulated, it has low losses. Since the advent of television, several manufacturers produce a low-cost open-wire line that is readily available for less than five cents a foot. This line costs much less than any home-built feeders and saves the work of building your own.

There are two choices of feeder lengths for this antenna system, 33 or 66 feet. If your shack is in

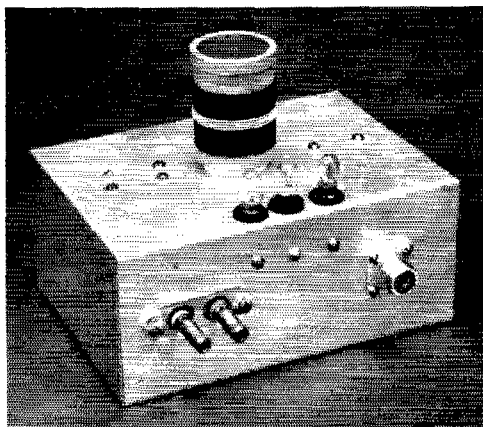

A top view of the antenna coupler for the 80- and 40-meter antenna system. The antenna terminals are on the left and the coax input jack on the right. The light bulbs for indicating feeder current are insulated from the chassis by rubber grommets.

*Technical Assistant, QST.

the attic or close to the antenna, the 33-foot length will be best. For basement locations or longer runs, the 66-foot length will fill the bill. Plan your antenna location so the feeders will end up right at the antenna coupler. Some slack can be taken up by the way in which the feed line is hung between antenna and shack.

Three insulators are needed for the antenna, one for each end and one for the center. There are

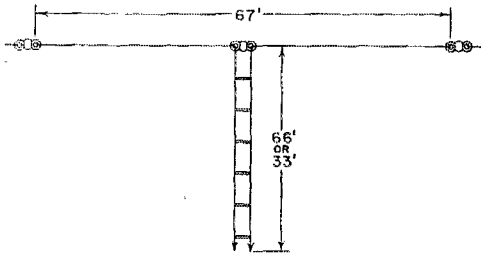

Fig. 1 — The 80- and 40-meter antenna system uses a 67-foot antenna fed at the center by a 33- or 66-foot length of open-wire feed line.

several different types of insulators, such as ceramic, glass and Pyrex, and any of these are suitable. The cheapest kind are the ten-cent store glass type receiving insulators. These will work just as well as the expensive kind. The antenna wire size can be any that is strong enough to support its own weight and that of the feed line. No. 14 or 12 enameled is the most commonly used wire. Stranded copper receiving type is also suitable. "Copperweld" and hard-drawn copper are the strongest.

Two 34-foot lengths of wire are cut for the antenna, allowing the extra 6 inches for the loops

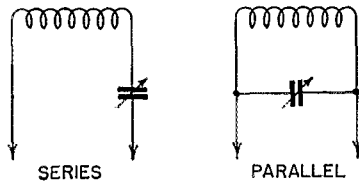

Fig. 2 — The terms "series" and "parallel" are used to describe the connections of the coil and the tuning condenser. The feed line connects at the points shown as arrowheads.

through the insulators. The antenna drawing, Fig. 2, shows the layout of the antenna and feeders. The ends of the antenna are run through the insulators and twisted around themselves. These ends can be soldered for a strong mechanical connection. The center ends of the antenna are cleaned and looped through the center insulator. To insure good mechanical rigidity and electrical contact, the respective feeder wires are also run through the insulator, wound around the antenna wire, and soldered.

The antenna is then raised to its permanent location and the feed line run to the transmitter. The feed line should come away from the antenna at as close to a right angle as possible. There are several approved methods of bringing

the feed line into the shack, and the antenna chapter of the *Handbook* should be studied to choose the best system for your location. Most shacks are near a window, and one simple way of bringing in the feed line is to mount two feed-through insulators in a board held down by the window. For lightning protection, a double-pole double-throw knife switch is mounted where the feeders enter the building. Two of the contacts of the switch are connected by heavy wire to a metal stake driven in the ground. The feeders coming from the antenna are attached to the center switch blades and the feeders to the transmitter to the other two switch contacts. When the antenna is not in use, the switch is thrown to

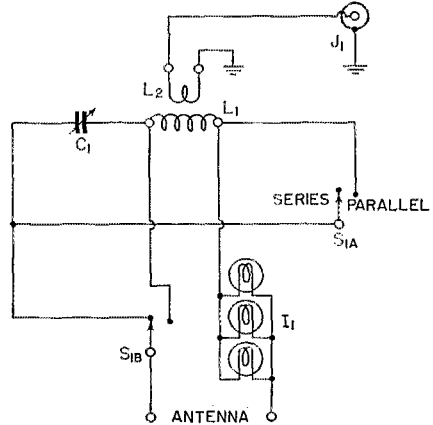

Fig. 3 — Circuit diagram of the antenna coupler to be used with the 80- and 40-meter antenna system.

- C₁ — 200- μ fd. variable (Millen 19200).
- L₁ — 26 turns No. 22 enam., 1½-inch diam., spaced wound (National XR-4 coil form).
- L₂ — 4 turns No. 26 d.c.c. interwound at center of L₁.
- I₁ — Flashlight lamps. See text.
- J₁ — Coaxial input jack (Amphenol 83-1R).
- S₁ — D.p.d.t. wafer switch (CRL C).

the grounded contacts, thus giving positive protection.

An antenna coupler is used to couple the output of the transmitter to the feed line. The antenna coupler shown in Fig. 3 gives either "series" or "parallel" tuning, depending on the position of S₁. The expressions "series-" and "parallel-tuning" describe how the coil and condenser are connected. The end of the feed line at the transmitter looks like a high or low resistance, depending upon the electrical lengths of the feed line and the antenna. Fig. 3 shows both a series and a parallel circuit, the two types of circuits needed for our purposes. A low-resistance load couples easiest with a series-tuned circuit, while a parallel circuit makes it easier to couple a high-resistance load.

If you choose to use 66-foot feeders for your antenna, you will use series tuning on both 80 and 40 meters. It won't be necessary to have the switch in the antenna coupler for this length of feeders. For 33-foot feeders, series tuning is used on 80 meters and parallel tuning on 40.

◆
 Bottom view of the coupler
 showing the placement of parts.
 ◆

The coupler is built on a 7 × 5 × 3-inch aluminum chassis. As can be seen from the photograph of the top, L_1 and L_2 are wound on a plug-in coil form and the socket for L_1 is mounted in the exact center of the chassis. The back view shows the antenna terminals and the coax input jack. Three flashlight lamp sockets are mounted on the chassis and insulated with rubber grommets. The bottom view shows C_1 mounted on an insulated bracket so that both the stator and the rotor are free from ground. An insulated shaft coupling is used to isolate the rotor shaft from the chassis. S_{1A} and S_{1B} , the d.p.d.t. switch, is mounted on the right.

L_1 is wound with No. 22 enameled wire spaced the wire diameter. The easiest method of winding the coil is to first drill two holes for L_1 spaced $1\frac{1}{4}$ inches apart. Two additional holes for L_2 are then drilled $\frac{1}{4}$ inch apart at the center of the L_1 holes. Eleven feet of No. 22 wire is needed for the 26 turns of L_1 . The ends of the wire are scraped clean of enamel and one end is run through a hole in the coil form and soldered into one of the base plugs. The other end of the wire is clamped in a vise or wrapped around a nail in the wall. Pull the wire taut, and then wind the coil while walking toward the anchor point. Maintain tension so that the turns are wound tightly onto the form. The end of the wire is then run into one of the coil base plugs and soldered, keeping the turns as tight as possible. Use soldering paste to insure a good solder job. Another piece of No. 22 wire is wound between the turns of L_1 and then unwound, to give the proper spacing. Then give the coil a coat of dope. After the dope has dried, L_2 is wound on at the center. L_1 has sufficient range to cover both the 80- and 40-meter bands, so this one coil is enough.

Operation

The transmitter is hooked up to the coupler with a piece of 72-ohm coax cable, which can be any length needed for convenient placement of the coupler. For powers up to a few hundred watts, RG-59/U coax cable will work well. A supply of light bulbs is needed for the power indicators in the coupler. Three No. 40, 6- to 8-volt, 150-milliamperere brown-bead, and three No. 48 2-volt, 60-milliamperere pink-bead, will be enough for a start. The three No. 40 bulbs are screwed into the sockets on the coupler and the rig turned on. The coupler and the final of the transmitter are tuned to resonance, as indicated by the bulbs lighting up and the dipping of the amplifier plate meter. If the bulbs fail to light, they should be unscrewed, one at a time, until there is an indication of power going into the feeders. It may be necessary to put in the No. 48 bulbs for indica-

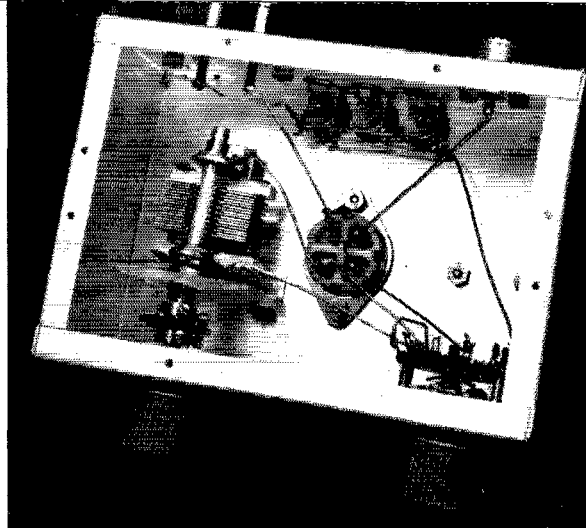

tion, as the less sensitive No. 40 bulbs won't light under some conditions. Once a combination of bulbs is obtained where there is an indication, it is simply a matter of tuning the coupler and rig for maximum brilliance of the bulbs. The brighter the bulbs become, the more power goes to the antenna. A few spare bulbs should be kept on hand for replacement, as a burned-out bulb would leave an open circuit in the feed line.



February 1928

... It is stressed editorially by ARRL Secretary Warner that, although the recent Conference did not bestow the widest privileges desired, here at last is the first concrete official international recognition of our hobby.

... Clark C. Rodimon's "MacMillan and Party in Labrador" gives information on the latest cruise of the *Bowdoin* — the Rawson-MacMillan Field Museum Expedition — with Cliff Himco, 1IK, operating onboard radio gear.

... Ross A. Hull dwells upon the ascendance of international amateur radiotelephone communication as embodied in the propagation possibilities of our newly-opened 20-meter 'phone band.

... In the Experimenters' Section are details on the 5-meter equipment of 9EHT, Lawrence, Kansas, featuring the reflector antenna which has enabled 9EHT to be heard on that band in San Diego, California.

... For the second of their series of articles on the design of filters and filter components, D. E. Replogle and James Millen furnish an analysis of "The Final Capacity in a Two-Section Low-Frequency Filter."

... Neon lamps as convenient indicators for ham work are the subject of an article by F. S. Huddy, 11I-1ZS-7SW, while Ralph B. Mason provides valuable data in "The Shielding Efficiency of Metals."

... Don C. Wallace and QST Technical Editor Robert S. Kruse collaborate to tell of interesting circuits and gear used at 6AM, the former's widely-worked Long Beach, California, station.

... Correspondence reveals mixed reactions regarding Conference decisions . . . 1B1T leads BPL with 503 traffic points . . . WAC certificates issued now total 117 . . . work on the new 10-meter band is eagerly anticipated.

Practical Adjustment of the Gamma Match

Feeding the "Plumber's Delight" with Coax

BY WARREN H. DAVIS,* W6IBD

• Although many articles have been written on the subject of parasitic-beam adjustment, there are still many who are puzzled as to the relative importance of the various factors involved in attaining optimum performance. But no matter how much you have studied the subject, we believe that you will find the experiences of W6IBD, in feeding the plumber's-delight type 3-element beam with coax cable, most interesting.

ARTICLES on antennas are as old as ham radio itself. Therefore, it is not my intention to present anything sensational for the beam I am about to describe, but I would like to state that it works as well as any beam it has ever competed against. I use the word "competed" because there is no other way really to check an antenna if you are a DX man.

The competition in this case was supplied by some of our better known local stations, namely: W6FSJ, 3 elements, 50 feet high; W6ENV, 3 elements, 65 feet high; W6SN, 3 elements, 65 feet high; and W6CYI, 3 elements, 60 feet high. Of these four stations mentioned, two are very active in DX contests and three of them have worked more than 240 countries. They are all very rough in any dogfight.

In the recent DX contest, most of these gentlemen waited for me to finish, then they took their respective turns. Upon occasion I, too, would wait for them, but not too often. Now, considering that we all run about the same power, all live within a fifteen-mile radius, and all think we are the world's best DX operators, the obvious conclusion is that our beams, for all practical purposes, work equally well. Therefore, the only claim that I can make for my beam is that it is the easiest to build, which I consider a prime factor to be considered by any ham.

Feed System

The part of the beam that usually is the worst to build and to make work is the feed system and the matching device or driven element. Two of the above-mentioned rascals use one method of feed system and matching, and the other two use another. W6FSJ and W6CYI use folded dipoles and two pieces of RG-8/U to feed them. W6ENV and W6SN both use split driven elements. W6ENV uses a single piece of RG-8/U to feed his, and W6SN uses a quarter-wave matching section, then 600-ohm line.

* 1054 Broxton, Los Angeles 24, Calif.

Well, I ask you, which is the easiest type of line to feed into the modern well-shielded TVI-free final amplifier? Naturally, anyone in his right mind would choose a single piece of coax. W6ENV, Andy Elsner, took the honors here — that is what *he* uses.

Several months ago when I decided to build this beam, that was what I decided to use. Andy assured me that he had never experienced any trouble with unbalance, and he thought it was great. However, I did not like to think of the reasonably difficult problems of attaching a split driven element to the 2½-inch square aluminum boom that I proudly possessed. Moreover, I did not wish to detune the parasitic elements of my beam to raise the center impedance to meet that of 52-ohm coax, although this in itself will not hurt the operation of a beam if the correct spacing is used. By the way, I am glad I added that last statement; it should get me off the hook for implying that Andy's beam is a mess.

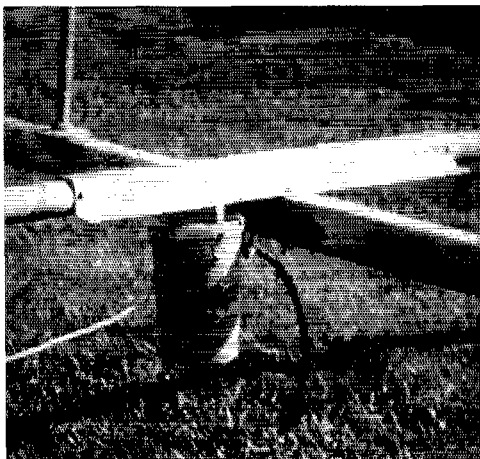

A plastic fruit-juice container makes a good weather protector for the variable condenser.

The next step was to decide what type of match could be used to feed a piece of 52-ohm coax into a plumber's-delight type of beam. A plumber's-delight was decided upon because there was no question in my mind that this was the easiest to build. However, feeding a beam of this type with coax line presents a few problems, such as balanced feed, obtaining a low standing-wave ratio, and the actual mechanics of obtaining these desirable features. There was one other feature that I desired in this beam. It was that the beam must be resonant in the 14-Mc. band. This is not a prime factor for good operation of

the beam itself, although it should be reasonably close to resonance. But it is necessary for a low standing-wave ratio and good coax efficiency.

The obvious choice for my beam was a gamma match. This, with a few refinements, is what I have used. A few articles have appeared on this type of match but they seem to present no details of how they should be tuned, nor do they tell the performance data on a beam using this match, such as what is the bandwidth of the usable standing-wave ratio. When running high power into RG-8/U that has a low-pass filter in it, the s.w.r. should not be over certain limits. Therefore, I decided to run some experiments with a gamma match and see just how good it really was.

Element Spacing

Some months before all of this brain work started, my child bride and myself had rented a house only 300 yards from W6SN. This, in itself, was a mistake, but it was the only habitation available at the time. The house did not come equipped with poles for antennas, but it was owned by a lady who said that I could put up one small pole for my wireless if I would promise to remove it when leaving. This promise was very glibly given and in we moved.

Immediately after this event, my beam was attached to a piece of pipe, and placed in a vent pipe on top of the house where it was approximately 25 feet above the ground, but could still be reached when standing on the roof of the second story. This was, of course, an ideal place to tinker with the beam and its matching device.

If you will refer to the diagram of Fig. 1, you will see that the beam has a 22-foot boom and that the reflector is spaced closer than the director. I do not believe that this is any better than when the reverse is true, as in most beams, but the center impedance of a beam is slightly higher when the director is spaced farther than the reflector. The spacing of this beam is approximately R-0.15 and D-0.2.

In spite of the volumes written on beam spacings, if a beam is resonant in the band where you wish it to work, the director is tuned to a frequency higher than that of the driven element, the reflector is tuned to a lower frequency, and the beam is fed properly, it will in all probability get out as well as any other beam with the same number of elements at the same height, regardless of spacing. However, beams with wider spacing do have a higher impedance and slightly better bandwidth, so I tried to go down the middle of the road so far as boom length goes.

Adjustment of Gamma Match

After erecting the beam on its pipe in the roof, I grounded the braid of the coax to the boom, directly under the center of the driven element and connected the center wire to a piece of aluminum tubing that ran out under the driven element about four feet. The end of this small piece of tubing was then connected to the upper tubing by a brass clamp that could slide back

and forth to vary the point of attachment for the gamma match. The driven element at this point was $2\frac{1}{2}$ inches in diameter and the gamma match was 1 inch in diameter, and spaced approximately 5 inches from the element.

After considerable checking with my trusty coax-line standing-wave indicator in the line,

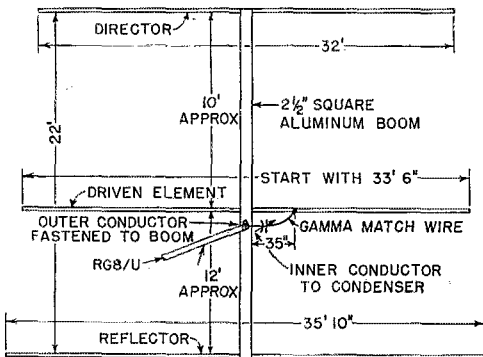

Fig. 1—Sketch of W6IBD's "plumber's-delight" beam antenna with dimensions for the 14-Mc. band. The use of the variable condenser is discussed in the text.

at long last I discovered what others before me had learned—it won't work; that is, the standing-wave ratio cannot be made low enough at the resonant point of the beam. This is probably true because it is very difficult to get the correct ratio of tubing size to spacing between the matching system and the driven element, plus the fact that the point at which the gamma match is attached to the element is critical if there is reactance. And, believe me, there is.

Therefore, the next step was to put a variable capacitor in series with the center wire of the coax and the gamma match. This was better, but not quite as good as I had expected. I could get the standing-wave ratio down quite low, but the beam was resonant outside of the band; and when I changed the length of the driven element of the gamma match to pull the resonant point back into the band, the standing-wave ratio was again kaput. This got to be very tiring, so I tore off the tubing that made up the gamma match and replaced it with a piece of No. 10 wire. This piece of wire merely looped from the capacitor up to the driven element and was attached to a point approximately 35 inches from the center of same. Immediately things began to get better. The s.w.r. was now $2/1$ at 13.5 Mc. and dropped as I approached the center of the band, rising again to about $3/1$ at 14.3 Mc. The piece of wire I used between the condenser and gamma tap was about 33 inches long. The length of this wire has an influence on the tapping point, so if the length is changed, a different tapping point must be used.

By the way, the condenser being used was a 120- μ fd. variable with $1/8$ -inch spacing. This was considered adequate to tune out the reactance of the gamma match and, since it was located at a low-voltage point, the spacing should be enough.

We found we were correct on both accounts.

Once the wire was installed and the s.w.r. found to be as stated above, I decided to make the beam resonant in the middle of the band and to make the s.w.r. as low as possible. Actually, all that I did was to shorten the driven element a bit on each side, then, keeping my eye on the s.w.r. meter, I tuned the capacitor and the needle dropped almost to zero. This was the equivalent of about 1.4/1 s.w.r. A series of measurements was then taken from about 13.5 Mc. to 14.4 Mc. The point of lowest s.w.r. was found to be at 14.150 Mc., and the s.w.r. at this point was as near to 1/1 as anyone could ever hope to get a beam. This is also the resonant point of the beam, and this resonant point is always found at the point of lowest s.w.r., regardless of what the s.w.r. may be.

When checking the bandwidth of the beam, it was learned that it was 2/1 at 13.990 Mc. moving downward to its low point at 14.150 Mc. and then moving upward to 2/1 at 14.450 Mc. The low point, as stated before, was about 1.1 to 1. There is no question that a folded dipole would be better, but think of the extra work involved in construction, to say nothing of the fact that two wires are necessary to feed it.

What about the losses at 2/1 s.w.r.? Well, at 14 Mc., which is where s.w.r. is almost, but not quite, that amount, the loss in the line using 100 feet of RG-8/U is 0.75 db. This I refuse to worry about.

Element Length

The next month was spent in changing the lengths of the various elements to see if I could raise the gain, or perhaps improve the front-to-back ratio. This latter could be done, but the forward gain always remained about the same, so long as the reflector and the director were not detuned too far from the frequency of the driven element. Incidentally, after each adjustment of the elements, it was only necessary to change the length of the driven element slightly one way or the other and to touch up the condenser on the beam, and the antenna would be back in the band with the s.w.r. back to normal.

I also tried moving the point of attachment of the gamma match to the beam back and forth. This would make a difference in the s.w.r. and the resonant point of the beam, but not as much as I had expected. I finally left it at 35 inches.

By this time I was sick and tired of spending half of my waking hours on the roof, so the director was set at 14.3 Mc. and the reflector at 14 Mc. The s.w.r. indicator was inserted in the line about 15 feet from the beam. After checking the s.w.r., the beam was found to be resonant at about 14.3 Mc. I merely lengthened the driven element an inch or so on each side, trimmed up the condenser while watching the meter, and — presto! — we were back in the middle of the band with the previously-mentioned excellent s.w.r.

Feeling that it was necessary to keep our gentle Los Angeles rains off my precious con-

denser, I mounted it upside down in a plastic fruit-juice container that was mounted on the side of the boom just under the driven element. This did the trick; the job was done. The sad part of this entire affair was that after weeks of fooling around with this beam, my final results were the same as the ones I had in the beginning.

Summary

In conclusion, let me say that this match can be attached to any beam that has an unbroken driven element. The director and the reflector should be set by the charts in the ARRL *Handbook*. They may be tuned, if you wish, but it is your time that is being wasted, not mine. The driven element should be set initially for the center of the band by the chart in the *Handbook* and the gamma match, consisting of a condenser and a piece of No. 10 wire, attached to the driven element. This point of attachment is about 35 inches from the center of same. A section of 52-ohm coax, with the s.w.r. indicator inserted in it, should be attached to the beam; the braid is grounded to the center of the boom directly under the center of the driven element, and the center wire of the coax is attached to one side of the capacitor. A VFO should be fed into the coax. Set the frequency in the middle of the band and adjust the capacitor to give the lowest s.w.r. Then, run a series of checks across the band to find the resonant point of the beam. If that point is not where you want it, either lengthen or shorten the driven element. Leave the parasitic elements as they are. If a complete null cannot be obtained, it may be necessary to change the point of attachment on the driven element slightly. This should do it; you are now in business.

The photograph shows how the match and its plastic container looks on my beam. This particular set-up will take a kw. of 'phone and several on c.w.

By the way, in spite of the fact that I had the highest score on 14 Mc. in the Southern California area, I was severely thrashed by W6BAX in Northern California during the last DX contest. Believe me, if Opie would only move south to this land of half-hour European openings I would fix his wagon.

Oh yes, my beam is now on a small pole 57 feet high, and my landlady is really flabbergasted!

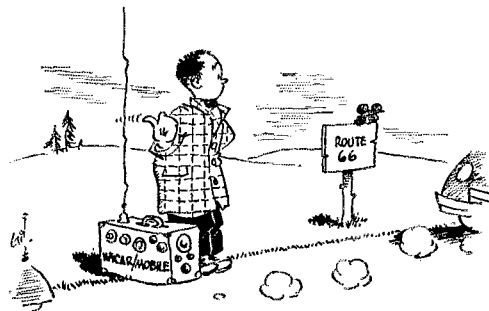

— Suggested by W9YMZ

Low-Voltage Filament Supplies

A D.C. Source for Battery-Tube Filaments

BY E. J. GAUSS,* WØEOS

EXPERIMENTAL work by the ham, with tubes designed for dry-battery operation, often is hampered by the prohibitive cost of the batteries. If such equipment has been built and is ready to test, it is disconcerting to find that the batteries have run down. A trip to the store is then necessary before work can be resumed. Anyone who has serviced or experimented with circuits using filament-type tubes realizes the convenience and saving of some sort of a stable low-voltage supply that can be plugged into the power lines.

Most battery tubes are designed to work at 1.4 volts and a supply capable of providing an ampere should be sufficient for most work, since battery-tube filaments usually take only 50 or 100 ma. This, of course, must be pure d.c. to eliminate hum.

Rectifier

The logical choice of a rectifier to supply a few volts output at about an ampere is the copper-sulfide magnesium type. These units are small in size, and have a break-down potential of 4.0 volts per section. However, most units tend to heal if the damage done by surge voltages is not too severe. Such rectifiers are commercially available as they have found extensive use in commercial battery eliminators and pin-ball machines. The internal resistance is appreciable in the forward direction, and allowance must be made for the voltage drop. A satisfactory design supplying about 2 volts into a filter would consist of a bridge rectifier and a transformer supplying about 3 volts, the rectifier and the filter dropping the output to the desired 1.4 volts. This is shown in Fig. 1.

Transformer

The most satisfactory transformer commercially available for this circuit is a 6.3-volt center-tapped heater transformer. By using only half of the secondary 3.15 volts is obtained. If a more flexible system is desired, a transformer

• Have you ever put off working with one-volt tubes because of the high cost of filament batteries? Here is a unit that can be substituted, thus reserving the batteries for field work only.

should be wound giving steps of 0.2 volt from 2.8 to 3.6. A universal output transformer might be usable with the plate winding going to the power line and the rectifier operating from the speaker winding, although the experimenter should check its voltages before using.

Filter

For the current involved, large values of inductance in the filter become impractical. Therefore, much of the filtering is done by the condensers which are available in values on the order of 2000 μ fd. with a voltage rating of 3 volts, which is adequate. To secure sufficient filtering, a two-section choke-input filter is advised. The choke-input design is preferred, as it gives longer rectifier life. The input choke, L_1 , need have a value of only a few hundredths of a henry. The second-section choke, L_2 , is less important with respect to rectifier life and can be the same as L_1 or even may be replaced by a one-ohm resistor, R_1 . In this case, it may be convenient to use a rheostat to provide a means of adjusting the output voltage.

Choke Construction

The chokes are not difficult to make. Many cheap output transformers and chokes have cores similar to that in Fig. 2A [p. 128]. Almost any core will do; the design given being a minimum size for economy of space. Even a solenoid wound on the core obtained from a burned-out automobile spark coil (Fig. 2B) will work. The required gap in the design of Fig. 2A is made with use of a file card. Such cards have a thickness of about 0.01 inch, while imperfections in the core provide for the additional 0.005 inch. Although

(Continued on page 128)

*Blacker House, California Institute of Technology, Pasadena 4, Calif.

Fig. 1 — Circuit of a 1.4-volt 1-ampere d.c. filament supply.

C_1, C_2 — 2000- μ fd. 3-volt electrolytic.

R_1 — See text.

L_1, L_2 — Filter choke (see text).

S_1 — Power switch.

T_1 — Center-tapped 6.3-volt filament transformer (one half of secondary used).

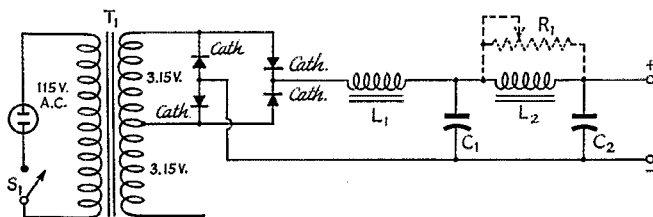

Happenings of the Month

75 AND 20 'PHONE "CLASS A" REQUIREMENTS BEING DROPPED

On December 23rd, in what might be considered a Christmas present for General and Conditional Class licensees, the Federal Communications Commission amended the amateur rules, effective February 18, 1953, to eliminate the requirement of an Advanced or Extra Class license as a condition to operation in 3800-4000 kc. and 14,200-14,300 kc. with voice emission. Thus, on and after February 18th, all amateurs except Novices and Technicians may use voice in those bands.

As of the first of the year the Commission discontinued examinations for the Advanced Class license. Under the regulations as amended all amateur privileges will be equally available to licensees of General, Conditional, Advanced and Amateur Extra classes.

The text of the Commission's release is as follows:

**Before the
FEDERAL COMMUNICATIONS COMMISSION
Washington 25, D. C.**

In the Matter of Amendment to Part 12 with respect to special radiotelephone operating privileges presently granted only to holders of the Advanced and Extra Classes of amateur operator licenses.	}	FCC 52-1632 83737 Docket No. 10173
--	---	---

REPORT AND ORDER

The Commission heretofore, on April 26, 1952, published a Notice of Proposed Rule Making (17 F. R. 3754) to amend existing rules, which provide that only radio amateurs holding an Advanced or Extra class amateur operator license may utilize radiotelephone emissions while operating in the frequency bands 3800-4000 and 14,200-14,300 kc, so that holders of General and Conditional class licenses may likewise utilize radiotelephone emissions in these frequency bands. This operator restriction was imposed, originally, some twenty years ago as a precaution against possible interference to radio services other than amateur and among amateurs, to reduce interference through faulty operation of radiotelephone transmitters by unskilled persons. Written comments concerning the proposed amendments were received from nearly 300 individual amateurs and local amateur clubs and from two national organizations.

Comments in favor of the proposed amendments were to the effect that larger numbers of amateur operators would be available for emergency network operation and civil defense work than are now available should the proposed rules be adopted. The comments also indicated that the need for denying persons, who hold a conditional or general class operator license, the privilege of utilizing radiotelephone emissions in the frequency bands 3800-4000 and 14,200-14,300 kc as an anti-interference measure no longer exists.

Comments in opposition to the proposed rules alleged that elimination of restrictions with respect to classes of operators who may utilize radiotelephone emissions in the frequency bands in question would reduce incentive for amateurs to progress from lower to higher grade licenses and result in over-all lowering of amateur standards of technical knowledge; that the frequency bands in question are already

over-crowded and to permit additional persons to operate in them could be expected to result in use of excessive power and out-of-band operation. Rules, recently put into effect in long range planning, provide for discontinuing the issue of new Advanced class operator licenses after December 31, 1952, thus leaving the Extra class operator license as the next step above the General class license. One comment was that the Commission should nullify these rules and maintain the Advanced class license as a logical step between the General and Extra licenses. Disparity between the requirements for the General and Extra class license was given as a reason for this suggestion. It was further suggested that, in view of certain pending rule-making proceedings (Dockets 10073 and 10188), which contemplate providing additional space for voice operation in the frequency bands 7 and 21 Mc., adoption of the rules proposed in this proceeding is unnecessary.

Proposals in Dockets 10073 and 10188 have not yet been adopted and, if adopted, could not be considered to affect this proceeding except that to provide additional frequency space in the 7 and 21 Mc bands, for voice emission, possibly, would relieve, to some extent, congestion in the frequency bands under consideration.

Study of all the comments received leads to the conclusion that the objections to the new rules are based, largely, upon sentiment and the desire for continuation of personal privilege rather than upon any technical or practical considerations. The suggestion that adoption of these rules would reduce incentive to progress from the General or Conditional to a higher class license (the Extra) is merely conjectural. The Extra Class license signifies that the holder is a pioneer in the field of amateur radio or that he has attained a code speed of at least 20 words a minute and passed an examination in advanced amateur technique, or both. That this in and of itself affords real incentive for obtaining the Extra Class license is evidenced by the fact that over 1,000 Extra Class licenses have been issued since January 1, 1952. Nor is a lowering of over-all amateur technical knowledge expected to result. On the contrary, it is believed that to make the frequency bands 3800-4000 and 14,200-14,300 kc available to all classes of operators, except the Novice and Technician, would encourage increase in technical skill on the part of General and Conditional Class operators desiring to communicate proficiently in these bands. As to the suggestion that the proposed elimination of restrictions would increase congestion in the frequency bands under consideration, the Commission realizes that these bands are already crowded, but the additional man-power which would become available for emergency and for civil defense operation from eliminating operator restrictions as contemplated by these rules would more than compensate for any inconvenience to operators which might result in the frequency bands under consideration. The technical knowledge and skill of the average amateur has been demonstrated to be such that the distinction between classes of operators as a means of reducing the probability of interference resulting from the use of telephony in two bands, for which the distinction was originally imposed, is no longer justified. Also it is believed that the reduction of congestion in particular amateur bands by means of such discrimination is not appropriate.

The proposed amendments may be adopted pursuant to the provisions of Sections 4(i) and 303(b), (1), and (r) of the Communications Act of 1934, as amended.

In view of the foregoing, it is ORDERED, This 23rd day of December 1952, that Sections 12.23(c) and 12.111(a)(2)(ii) and 12.111(a)(4) of Part 12, "Rules Governing Amateur Radio Service", ARE AMENDED to read as follows:

SECTION 12.23(c) General and Conditional Classes.
All authorized amateur privileges.

SECTION 12.111(a)(ii). 3800 to 4000 kc, using type A3 emission and narrow band frequency or

phase modulation for radiotelephony, to those stations located within the continental limits of the United States, the Territories of Alaska and Hawaii, Puerto Rico, the Virgin Islands, and all United States possessions lying west of the Territory of Hawaii to 170° west longitude.

SECTION 12.111(a)(4). 14,000-14,350 kc, using type A1 emission and, on frequencies 14,200 to 14,300 kc, type A3 emission and narrow band frequency or phase modulation for radiotelephony.

IT IS FURTHER ORDERED, That the foregoing amendments shall become effective on the 18th day of February, 1953.

FEDERAL COMMUNICATIONS COMMISSION

T. J. SLOWIE
Secretary

Released: December 29, 1952

40-METER 'PHONE TO BE OPENED

A simultaneous action of the Commission, dated *effective February 20, 1953*, amended the amateur rules to permit voice emission in the frequencies 7200-7300 kc. Either A-3 or narrow-band frequency or phase modulation may be employed. These privileges will be available equally to all amateurs except Novices and Technicians. As on other bands, of course, mobile will be permitted. For the eager beavers, we remind you that on the 20th the amended rule becomes effective at 3:00 A.M. EST, which is midnight on the West Coast.

NOVICE AND F.S.K. PRIVILEGES BEING EXPANDED

Further actions of the Commission two days before Christmas expanded Novices' privileges, opened some low-frequency channels to frequency-shift keying techniques, established standards for teleprinter operation, and clarified call sign identification procedures — all *effective February 20, 1953*.

On and after that date, Novices will be permitted the use of 7175-7200 kc. for radiotelegraphy, type A-1 (c.w.) emission only. The usual requirements of crystal control and 75 watts input apply to this new band also.

Effective the same date, F-1 emission will be authorized in the non-voice portions of our 80-, 40- and 20-meter bands — specifically, 3500-3800, 7000-7200, 14,000-14,200 and 14,300-14,350 kc. This type of emission can be used either for manual keying or for radio teleprinter operation. For RTTY operation, our rules are amended by the addition of some new standards.

The text of the Commission's release is as follows:

Before the
FEDERAL COMMUNICATIONS COMMISSION
Washington 25, D. C.

In the Matter of
Amendment of Part 12, "Rules
Governing Radio Service."

FCC 52-1634
84543
Docket
No. 10073

ORDER

At a session of the Federal Communications Commission held at its offices in Washington, D. C., on the 23rd day of December, 1952;

The Commission having under consideration its Further Notice of Proposed Rule Making in the above entitled matter in which it was proposed to provide for use of radio-

telephone emissions in the 7200-7300 kc segment of the 7 Mc amateur frequency band, to provide for the use of the 7175-7200 kc segment of the 7 Mc amateur frequency band by Novice Class amateur operators, to provide standards for amateur radio teleprinter operation, to provide for the use of F-1 emission in the non-radiotelephone segments of the 3.5, 7 and 14 Mc amateur frequency bands and to provide for readily identifiable transmission of call signs;

IT APPEARING, That in accordance with the requirements of Section 4(a) of the Administrative Procedure Act, general notice of proposed rule making in the above entitled matter, which made provision for the submission of written comments by interested parties, was duly published in the Federal Register on April 26, 1952 (17 F.R. 3754), and that the period provided for the filing of comments has now expired;

IT FURTHER APPEARING, That comments were filed by some 266 individuals, amateur radio clubs and other amateur organizations and that a large majority were in favor of adoption of the proposed amendments, some opposition to the severity of technical and identification requirements proposed for amateur radio teleprinter operation was expressed, clarification of the transmission of call signs requirements was suggested, the American Radio Relay League requested more space for Novice operation than was proposed and the League and several individuals requested that F-1 emission be restricted to a segment of the 7 Mc amateur band only;

IT FURTHER APPEARING, That, in order to facilitate monitoring and to assist the Commission in carrying out its responsibility for the proper enforcement of its rules and regulations, the proposed teleprinter technical and identification requirements cannot be relaxed at this time, and;

IT FURTHER APPEARING, That consideration of providing a larger segment for Novice operation in the 7 Mc amateur frequency band than that proposed preferably should be deferred until such time as experience with Novice operation in the space proposed has indicated the necessity for additional space, and;

IT FURTHER APPEARING, That, in view of the present practice in amateur radioteleprinter operation to concentrate operation on a few frequencies selected, for their own advantage, in a manner least likely to interfere with other modes of amateur operation, the greater latitude of choice of frequency permitted by the amendments as proposed will be the most beneficial to the amateur service as a whole, and;

IT FURTHER APPEARING, That clarification of the proposed requirements for the transmission of call signs as requested is desirable, and;

IT FURTHER APPEARING, That authority for the aforesaid amendments is contained in Section 4(i) and 303(a), (c), (e), and (r) of the Communications Act of 1934, as amended;

IT IS ORDERED, That effective February 20, 1953, Sections 12.23(e)(2), 12.82(a), 12.111(a)(2)(i), 12.111(a)(3) and 12.111(a)(4) ARE amended, and a new Section 12.107 IS added, as set forth in the attached Appendix.

FEDERAL COMMUNICATIONS COMMISSION

T. J. SLOWIE
Secretary
Attachment
Released: December 29, 1952

APPENDIX

PART 12, RULES GOVERNING AMATEUR RADIO SERVICE, IS AMENDED IN THE FOLLOWING PARTICULARS:

1. AMEND SECTION 12.23(e)(2) TO READ AS FOLLOWS:

(2) Only the following frequency bands and types of emission may be used, and the emissions of the transmitter must be crystal-controlled:

(i) 3700 to 3750 kc, radiotelegraphy using only type A-1 emission in accordance with the geographical restrictions set forth in Section 12.111 of this Part.

(ii) 7175 to 7200 kc, radiotelegraphy using only type A-1 emission.

(iii) 26,960 to 27,230 Mc, radiotelegraphy using only type A-1 emission.

(iv) 145 to 147 Mc, radiotelegraphy or radiotelephony using any type of emission except pulsed emission and type B emission.

2. AMEND SECTION 12.82(a) TO READ AS FOLLOWS:

(1) The operator of an amateur station shall transmit the call sign of the station or stations (or may transmit the generally accepted identification of the network) being called or communicated with, or shall identify appropriately any other purpose of a transmission, followed by the authorized call sign of the station transmitting:

(i) at the beginning and end of each single transmission or;

(ii) at the beginning and end of a series of transmissions between stations having established communication, each transmission of which is of less than three minutes duration (the identification at the end of such a series may be omitted when the duration of the entire series is less than three minutes), and;

(iii) at least once every ten minutes or as soon thereafter as possible during a series of transmissions between stations having established communications, and;

(iv) at least once every ten minutes during any single transmission of more than ten minutes duration.

(2) The required identification shall be transmitted on the frequency or frequencies being employed at the time and, in accordance with the type of emission authorized thereon, shall be by either telegraphy using the International Morse Code, or telephony. In addition to the foregoing, when a method of communication other than telephony or telegraphy using the International Morse Code, is being used or attempted, the prescribed identification shall also be transmitted by that method.

3. ADD NEW SECTION 12.107 AS FOLLOWS:

§ 12.107 *Special provisions regarding radio teleprinter transmissions.* The following special conditions shall be observed during the transmission of radio teleprinter signals on authorized frequencies by amateur stations:

(a) A single channel five-unit (start-stop) teleprinter code shall be used which shall correspond to the International Telegraphic Alphabet No. 2 with respect to all letters and numerals (including the slant sign or fraction bar) but special signals may be employed for the remote control of receiving printers, or for other purposes, in "figures" positions not utilized for numerals. In general, this code shall conform as nearly as possible to the teleprinter code or codes in common commercial usage in the United States.

(b) The nominal transmitting speed of the radio teleprinter signal keying equipment shall be adjusted as nearly as possible to the standard speed of 60 words per minute and, in any event, within the range 55 to 65 words per minute.

(c) When frequency-shift keying (type F-1 emission) is utilized, the deviation in frequency from the mark signal to the space signal, or from the space signal to the mark signal, shall be adjusted as nearly as possible to 850 cycles and, in any event, within the range 800 to 900 cycles per second.

(d) When audio-frequency-shift keying (type A-2 or type F-2 emission) is utilized, the highest fundamental modulation audio frequency shall not exceed 3000 cycles per second, and the difference between the modulating audio frequency for the mark signal and that for the space signal shall be adjusted as nearly as possible to 850 cycles and, in any event, within the range 800 to 900 cycles per second.

4. AMEND SECTION 12.111(a)(2)(i) TO READ AS FOLLOWS:

(i) 3500 to 4000 kc, using type A-1 emission and, on frequencies 3500 to 3800 kc, using type F-1 emission, to those stations located within the continental limits of the United States, the Territories of Alaska and Hawaii, Puerto Rico, the Virgin Islands and all United States possessions lying west of the Territory of Hawaii to 170° west longitude.

5. AMEND SECTION 12.111(a)(3) TO READ AS FOLLOWS:

(3) 7000 to 7300 kc, using type A-1 emission and, on frequencies 7000 to 7200 kc, using type F-1 emission and, on frequencies 7200 to 7300 kc, using type A-3 emission or narrow band frequency or phase modulation for radio-telephony.

6. AMEND SECTION 12.111(a)(4) TO READ AS FOLLOWS:

(4) 14,000 to 14,350 kc, using type A-1 emission, 14,000 to 14,200 kc and 14,300 to 14,350 kc using type F-1 emission and on frequencies 14,200 to 14,300 kc, type A-3 emission or narrow band frequency or phase modulation for radio-telephony.

**CALLING FREQUENCIES ABANDONED
— EMERGENCY RULES AMENDED**

As announced briefly in our January issue, the Commission in early December acted in the matter of its Docket 10237, wherein it proposed complex rules for emergency operations, and a channel system for calling and answering purposes. In its final action, FCC completely abandoned its idea for restricted calling bands for amateurs. It adopted the League view also in the matter of emergency operation when it amended our rule § 12.156, effective February 2, 1953, to read almost exactly as the text offered by ARRL as a simplified alternative:

§ 12.156 *Operation in emergencies.* In the event of an emergency disrupting normally available communication facilities in any widespread area or areas, the Commission, in its discretion, may declare that a general state of communications emergency exists, designate the area or areas concerned, and specify the amateur frequency bands, or segment of such bands for use only by amateurs participating in emergency communication within or with such affected area or areas. Amateurs desiring to request the declaration of such a state of emergency should communicate with the Commission's Regional Manager of the area concerned. Whenever such declaration has been made, operation of and with amateur stations in the area concerned shall be only in accordance with the requirements hereinafter set forth, but such requirements shall in no wise affect other normal amateur communications in the affected area when conducted on frequencies not designated for emergency operation.

(a) All transmissions within all designated amateur emergency communication bands other than communications relating directly to relief work, emergency service, or the establishment and maintenance of efficient amateur radio networks for the handling of such communications, shall be suspended. Incidental calling, answering, testing or working (including casual conversation, remarks or messages) not pertinent to constructive handling of the emergency situation shall be prohibited within these bands.

(b) The Commission may designate certain amateur stations to assist in the promulgation of information relating to the declaration of a general state of communications emergency, to monitor the designated amateur emergency communications bands, and to warn noncomplying stations observed to be operating in those bands. Such station, when so designated, may transmit for that purpose on any frequency or frequencies authorized to be used by that station, provided such transmissions do not interfere with essential emergency communications in progress; however, such transmissions shall preferably be made on authorized frequencies immediately adjacent to those segments of the amateur bands being cleared for the emergency. Individual transmissions for the purpose of advising other stations of the existence of the communications emergency shall refer to this section by number (§ 12.156) and shall specify, briefly and concisely, the date of the Commission's declaration, the area and nature of the emergency and the amateur frequency bands or segments of such bands which constitute the amateur emergency communications bands at the time. The designated stations shall not enter into discussions with other stations beyond furnishing essential facts relative to the emergency, or acting as advisors to stations desiring to assist in the emergency, and the operators of such designated stations shall report fully to the Commission the identity of any stations failing to comply, after notice, with any of the pertinent provisions of this section.

(c) The special conditions imposed under the provisions of this section shall cease to apply only after the Commission, or its authorized representative, shall have declared

such general state of communications emergency to be terminated; however, nothing in this paragraph shall be deemed to prevent the Commission from modifying the terms of its declaration from time to time as may be necessary during the period of a communications emergency, or from removing those conditions with respect to any amateur frequency band or segment of such band which no longer appears essential to the conduct of the emergency communications.

SCATTER SOUNDING OKAYED

Just a year ago, W6QYT and W6POH conducted the first of some extremely interesting and productive experiments in measurement of radio transmission paths, their purpose being the instantaneous determination of skip distance. While heralded as an outstanding development in propagation prediction techniques,¹ it prompted the Federal Communications Commission to raise the question of whether the amateur rules permitted the specific type of emission employed, which was a form of pulse. After several exchanges of correspondence between FCC and the amateurs, the League requested an informal meeting with Commission personnel to discuss the problem. Such a meeting was called in early December by Commissioner George Sterling, W3DF, in his Washington office, attended by FCC's Safety & Special Radio Services Bureau Chief White, Public Safety & Amateur Division Chief Rollins, Amateur Service Branch Chief Grenfell, and ARRL's General Manager Budlong and Technical Director Grammer. The meeting was characterized by an evident desire on the part of all concerned to find a method to permit full use of amateur capabilities in advancing propagation techniques and knowledge in such a fashion, but with adequate safeguards to keep non-amateur interests from seizing the opportunity to conduct their investigations under the guise of amateur operation. It was concluded that no change in the amateur rules was necessary or desirable, but that special temporary authority would be granted in instances where the Commission is able to satisfy itself that a proper and useful purpose will be served thereby. Subsequent editions of the ARRL *License Manual* will contain the following editorial footnote:

EDITOR'S NOTE: Adequately-qualified amateurs interested in undertaking, purely as an amateur activity, special technical investigations, such as observation and measurement of propagation phenomena, may apply for special temporary authority to employ types of emission other than those provided for in § 12.111. Requests for such authority should include full details and should be addressed to the Secretary, Federal Communications Commission, Washington 25, D. C.

LEAGUE FILES 50-MC. REQUESTS

In early December the League filed, in accordance with policy established by its Board of Directors, requests with the Federal Communications Commission to amend the amateur rules to provide (1) Novice operation with A-1 or A-3 in 51-53 Mc. for an experimental period of one year, and (2) AØ operation (duplex) in 51-54 Mc. The text follows:

(Continued on page 130)

¹ QST, p. 11, Mar. 1952.

WHAT BANDS AVAILABLE?

Below is a summary of the U. S. amateur bands on which operation is permitted as of February 20th. Readers are cautioned that a number of proposals are now pending before the FCC and that action on those proposals may change this compilation considerably. Changes will, as usual, be announced by WIAW bulletins. Figures are megacycles. AØ means an unmodulated carrier; A1 means c.w. telegraphy; A2 is m.c.w.; A3 is a.m. 'phone; A4 is facsimile; A5 is television; F1 is frequency-shift keying; n.f.m. designates narrow-band frequency- or phase-modulated radiotelephony; and f.m. means frequency modulation, 'phone (including n.f.m.) or telegraphy.

3.500-4.000	— A1
3.500-3.800	— F1
3.800-4.000	— A3 and n.f.m.
7.000-7.300	— A1
7.000-7.200	— F1
7.200-7.300	— A3 and n.f.m.
14.000-14.350	— A1
14.000-14.200	— F1
14.200-14.300	— A3 and n.f.m.
14.300-14.350	— F1
21.000-21.450	— A1
26.960-27.230	— AØ, A1, A2, A3, A4, f.m.
28.000-29.700	— A1
28.500-29.700	— A3 and n.f.m.
29.000-29.700	— f.m.
50-54	— A1, A2, A3, A4, n.f.m.
52.5-54	— f.m.
144-148	} AØ, A1, A2, A3, A4, f.m.
220-225	
420-450 ¹	} AØ, A1, A2, A3, A4, A5, f.m.
1,215-1,300	
2,300- 2,450	
3,300- 3,500	
5,650- 5,925	
10,000- 10,500	} AØ, A1, A2, A3, A4, A5, f.m., pulse
21,000- 22,000	
All above 30,000	

¹ Peak antenna power must not exceed 50 watts.

In addition, A1 and A3 on portions of 1.800-2.000, as follows:

Area	Band, kc.	Power (watts)	
		Day	Night
Minn., Iowa, Mo., Ark., La. and east, including Puerto Rico and Virgin Ids.	1800-1825	500	200
	1875-1900		
N. and S. Dak., Neb., Colo. N. Mex., and west, including Hawaiian Ids.	1900-1925	500*	200*
	1975-2000		
Texas, Okla., Kansas	1800-1825	200	75
	1875-1900		

* Except in State of Washington where daytime power limited to 200 watts and nighttime power to 50 watts.

Novice licensees may use the following frequencies, transmitters to be crystal-controlled and have a maximum power input of 75 watts.

3.700-3.750	A1	26.960-27.230	A1
7.175-7.200	A1	145-147	A1, A3

Technician licenses are permitted all amateur privileges in the bands 220 Mc. and above.

Expedition to Brunei

The Story of VS5ELA

BY CLYDE F. NORTON,* WØELA, VS5ELA

ALMOST every DX man who is seriously interested in his favorite phase of amateur radio activity has at some time or another had a secret desire to be rare DX himself. The thought of having the world calling your station, instead of your station calling the world, possesses a fascination which only a DX man can fully appreciate. It was basically this desire which motivated my actions in planning a radio expedition to a country in which there had been no previous amateur radio operation.

* * *

The story of the VS5ELA operation actually began in the spring of 1951. At that time it appeared probable that I would make a trip to the Orient late in the summer. It then occurred to me that it would be an interesting venture to take a side trip to some country in which there had never been amateur radio activity and to place a station on the air with the objective of giving the DX enthusiasts of the world a new country for their lists. Unfortunately, however, a series of serious delays ensued after elaborate preparations had been made for such a DXcursion in collaboration with Joe Pehoushek, ex-W9EFK and second operator at JA2BQ for some time. Tardy official authorization, airlines schedules changes and other factors conspired to force a postponement of the effort until the following year.

In the spring of 1952 I started planning for a second attempt. In May Joe came to the Mayo Clinic for an operation. Because of the resulting extended absence from his work in Tokyo, he withdrew from participation in the expedition. I immediately contacted Fatty Fung, VS6CG, who had previously indicated an interest in the expedition, and offered him the assignment as second operator. Fung quickly accepted.

Improved equipment was assembled in Minneapolis and was packed in a large wooden box. Upon my arrival in Tokyo on July 12, 1952, I requested that the box be stored in customs in

* 14 Westwood Circle, Ivanhoe Woods, Minneapolis 16, Minn.

• In the entire world very few countries remain in which there has been no amateur activity. One country which until very recently was included in that category is Brunei on the northwest coast of the island of Borneo. Brunei was removed from that position of dubious distinction when VS5ELA came on the air on July 27, 1952.

bond until the time of departure of the next flight to Manila.

Two days later upon my arrival at the airport from the hotel the box could not be found. A search was quickly started, but no information regarding the whereabouts of the missing equipment was obtainable. That evening I was informed that an agent loaded my box erroneously onto a plane for Hong Kong the previous day. It was my intention to fly to Hong Kong that night anyway so I took off in accordance with original plans. Upon arrival I checked carefully with airline and customs representatives but they knew nothing about the missing radio gear.

The predicament was outlined to members of the Hong Kong Radio Club, Pat O'Brien (VS6AE), Bill Musty (VS6BA), and Fatty Fung (VS6CG). As a result, VS6CG volunteered the use of his home station, which included a pair of 807s in the final. Plans were proceeding on this basis when a letter was received from Joe Pehoushek on Monday, July 21st, stating that Joe would meet me in Manila on Wednesday, and that he was bringing the equipment assembled the previous year, and in addition that he was bringing his sixteen-year-old son, Bill. When this letter was received, they had already left Tokyo for Manila so we could not inform them of the changes in plans. Realizing the extreme shortage of space aboard the plane to Labuan as well as the virtual impossibility of obtaining additional transportation and living accommodations in Brunei, Fung then very graciously withdrew.

On July 25th Joe, Bill, and I went to the Manila Airport to board the Cathay Pacific Airways flight to Labuan. The equipment, together with our luggage, weighed nearly three hundred pounds. After considerable delay we learned that the DC-3 airplane would be nearly 700 pounds over gross weight with us aboard, and that some reduction in weight was therefore necessary. It appeared that Bill would have to



WØELA faces the camera with three of the local Dyak dandies.

QST for



The going gets rough as the author bears down amid 14-Mc. pile-ups at the VS5ELA shack.

remain behind. However, at the last minute the captain decided to reduce the gas load, and that change, together with a reduction in cargo, made it possible for all of us to take off. VS6CG, who is a flight radio operator for Cathay had arranged to be working on this flight, and his efforts were instrumental in getting our load on board. (Were these narrow scrapes *never* to end?)

We flew across the South China Sea and landed at Sandakan, British North Borneo. The airport there consists of a grassy landing strip hewn out of the jungle and an open terminal building. After a stop at Jesselton, we departed for Labuan where we retired at the Airport Hotel.

The next morning we arose early. The manager of the Shell Oil Company in Manila had provided me with a letter of introduction to the manager of the British Malayan Petroleum Company on Labuan. Because Labuan is a small island, we had no difficulty in locating the manager with the aid of the local Chief of Police, a jeep and a driver.

The manager informed us that his organization operated a small airplane which would fly to



relief) and in less than one hour we saw the Seria airstrip below us — a grassy runway chopped out of the jungle about two hundred yards from the shore.

We were met by an East Indian with a car who drove us through the oil fields of Seria to the government rest house in Kuala Belait. The Indian told us that there were black snakes eighty feet long in the area. That's more than a full wavelength on twenty meters, even allowing for exaggeration! The driver assured us that these big snakes were non-poisonous, but any resulting feeling of relief faded quickly when he explained that they readily kill human beings by strangulation. On arriving at the rest house, I explained that we had previously requested accommodations. We were informed by a bare-footed Malayan, "no room." Because there are no hotels in Brunei and now no way of leaving the country for at least several days, it was obvious we were in trouble.

I asked the Indian boy to take me to the Chief of Police, who I hoped would have some helpful suggestion to offer but the Chief was not expected to return to Kuala Belait for several days. Without explanation, the boy then took me to the home of one of the natives who, fortunately, spoke English. He informed me that he was the Senator-Inspector, apparently a position of considerable responsibility. He seemed impressed when he learned that our arrangements had been made with the Chief of Police and immediately stated that he would evict two residents of the rest house to provide room for us and wrote out an eviction order which the Indian took back to the place. Unfortunately the two men evicted sat on the steps of the house trying to decide what to do for nearly three hours and we could not risk erecting our antenna. Finally, they left for places unknown and we furiously started unpacking.

Several hours later after hurriedly assembling the complete station we found that it was impossible to load the antenna. It was then after midnight and extremely dark. (We were not very eager to investigate the difficulty at the antenna itself because we were not sure what sort of opposition we might encounter from the animal kingdom!)

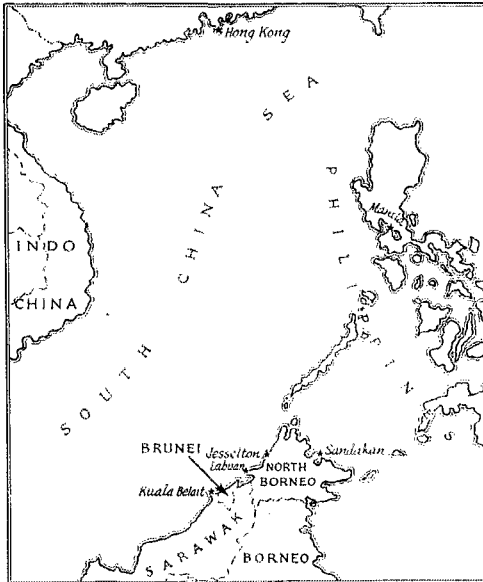

Seria in Brunei at noon, but that it probably had a full load on board. Later, the airport representative belatedly informed us that he thought arrangements had been completed to board us on the flight. We and our baggage were weighed and we learned that we were one hundred pounds too heavy. (*Again* it looked as though Bill would have to remain behind!) However, at the last minute the captain decided that the full load could be boarded. We took off (much to my

Finally I listened across the 14-Mc. band and heard W7GUI say, "I guess he didn't get on the air this morning as haven't heard anyone calling him." Apparently the DX fraternity was really watching for our start of operations! Feeling very much disappointed and even more exhausted, we crawled under our mosquito netting and quickly went to sleep.

The next morning we arose and rushed out to inspect the antenna; we found the trouble immediately. One side of the transmission line had

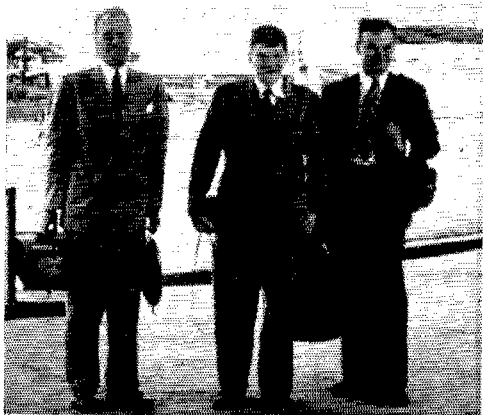

W0ELA, with Bill and Joe Pehoushek at Manila Airport.

been torn off when the line had become snagged in a tree in the darkness. Repairs were made, and the antenna loaded normally. We then concentrated on improving the installation. For example, because a nonstandard type of power outlet was used in the rest house, we smashed a light bulb and soldered wires onto the base in order to obtain power for our equipment.

Finally at 0835 GCT on July 27th, the big moment arrived; I called CQ for the first amateur radio transmission ever made in the country of Brunei! We received a tremendous thrill when we heard an answer to that first CQ; it was VK4QL. Upon signing with him five minutes later, I was surprised to hear W6FSJ call us for the first U.S.A./Brunei QSO in history. The first ten stations worked were VK4QL, W6FSJ, VS6CG, KC6QL, ZL1AH, W6MX, W6LW, W6MEL, W7AMX and ZL2FA. Twenty-five stations were QSOd during the first hour.

Subsequently the tempo was accelerated, and we worked stations at the rate of 45 per hour during peaks. During the best short interval I worked ten stations in six minutes including three in a period of one minute. One of the highlights of the entire expedition for me developed just past midnight of that first night of operation when Ray Weihe, W0CTW, operating W0ELA, called me and I experienced the thrill of working my own station from a distance of nearly 10,000 miles.

Finally at about 1:30 A.M., Brunei time, after working nearly 125 stations, we became so exhausted that we decided to stand by for a few minutes of rest. Bill had been asleep for several hours, and Joe and I climbed under our mosquito netting. I intended to get up again in about fifteen minutes because there still seemed to be hundreds of stations calling VS5ELA; however, I didn't awaken until eight o'clock the next morning.

The next evening we were off the air for an hour and a half during a period of peak conditions as the result of a blown filter condenser. The line voltage normally drifted down from a maximum of about 230 volts to about 150 volts, but superimposed on this general decline in voltage were several unexplainable surges to extremely high values which deflected most of our meters off scale. By moving rapidly it was usually possible to turn off all power before damage was done, but in this case we blew out the main line fuse in the rest house.

Also, because of the tremendous heat and humidity, we continued to lose parts of the transmitter. Even the insulation in the amplifier variable condenser started to break down. The grid meter developed internal arcing and had to be removed. (The heat and humidity were so high that a package of candy mints which I had obtained in Manila deteriorated into a moist powder and could not be eaten.)

The operation of the station was continued for a period of five evenings. Very few signals were heard in the daytime; in general, only Asian stations were worked at that time. In the middle of the afternoon, Australian, New Zealand, and west coast U.S.A. signals usually started coming through, followed in the early evening by central U.S.A. and African stations. When U.S.A. signals faded out at approximately midnight, European stations made their appearance. It wasn't until the fourth night of operation that stations located along the east coast of the U.S.A. were heard. Upon completing a QSO with PY2CK at 1100 GCT on July 30th, I heard W1FH break

(Continued on page 132)

◆
A view at Kuala Belait,
scene of VS5ELA operations.
◆

QST for

Universal-Shunt Milliammeter Design

Simple Multiplier Calculations

BY WALTER PRICE,* W2ZQY

MANY articles have appeared, at various times, describing the construction or the design of the conventional type of multi-range milliammeter. But for some reason, the universal-shunt circuit, which appears in most commercially-designed milliammeters, is neglected in the average home-constructed instrument. Since the universal-shunt milliammeter has some advantage over the conventional type, the necessary data for design of this type is presented in this article.

Two examples of the universal-shunt milliammeter circuit are shown in Fig. 1, the only difference being that a 100- μ a. meter is used in circuit A, while a 1-ma. meter is used at B. In contrast to the individual-shunt-type circuit, the switch contacts are external to the meter circuit and therefore variation in contact resist-

is, of course, principally a matter of physical size and procurability.

It will be found that the greatest dissipation takes place at the lowest-resistance (highest-current) multiplier, R_1 . If this resistor is to be limited to a 1-watt size, its resistance cannot exceed

$$(1) \quad R_1 = \frac{P}{I^2},$$

where P is the power dissipation in watts and I is the maximum current in amperes through resistor. If the highest-current range is to be 500 ma. (0.5 amp.), R_1 should have a value no greater than

$$R_1 = \frac{1}{0.5^2} = 4 \text{ ohms.}$$

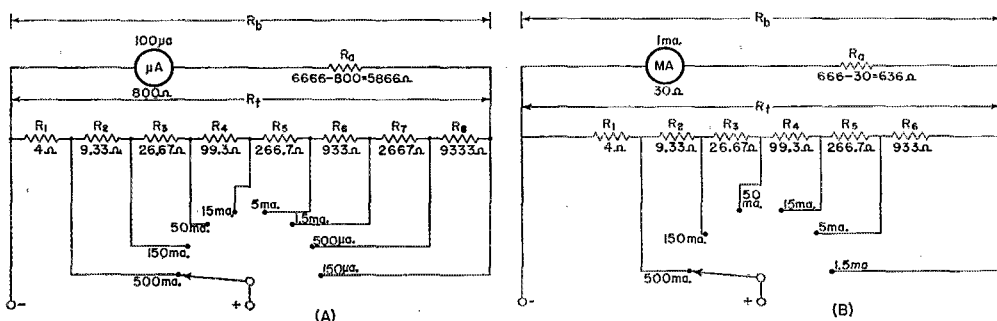

Fig. 1 — Universal-shunt milliammeter circuits, (A) for a 100- μ a. meter, (B) for a 1-ma. meter. As explained in the text, different resistance values may be substituted if found desirable.

ance does not affect the meter reading. In the conventional arrangement, switch-contact resistance may not be a negligible portion of the multiplier-shunt resistance. Another advantage of this circuit, when properly designed, is that there is always some resistance in series with the meter, which offers a measure of protection against accidental burn-out when the meter is switched to the wrong range.

While the changing combinations of series and parallel resistance may look a little complicated on the surface, actually the design of the universal-shunt system is quite simple. For maximum protection to the meter, it is desirable to have as much series resistance, R_a , in the circuit as possible. However, as R_a is increased, the resistance of the multipliers must also be increased. And since the current through the multiplier resistor remains the same regardless of its resistance, the dissipation varies directly with the resistance value. The limitation on dissipation

For the next step, the following formula is used:

$$(2) \quad R_t = R_1 \left(\frac{n_{\max}}{n_{\min}} \right),$$

where R_t is the total multiplier-branch resistance, n_{\max} is the maximum multiplier factor and n_{\min} is the minimum multiplier factor.

For the 100- μ a. meter and multiplier in the example of Fig. 1A, n_{\max} is 5000 for the 500-ma. range and n_{\min} is 1.5 for the 150- μ a. range. Substituting known values in (2),

$$R_t = 4 \left(\frac{5000}{1.5} \right) = 13,333 \text{ ohms.}$$

The meter-branch resistance, R_b , is determined by

$$(3) \quad R_b = R_t (n_{\min} - 1).$$

Substituting values,

$$R_b = 13,333 (1.5 - 1) = 6666 \text{ ohms.}$$

The position of each tap on the multiplier

(Continued on page 134)

* 1988 Madison Ave., New York 35, N. Y.

Magnetic Ceramics: Ferrites

The Latest in Magnetic Materials for R.F.

BY F. E. VINAL,* WIGXJ

THROUGH current advertising items and several articles which have appeared recently, some in electronics journals, it is becoming increasingly evident that an entirely new series of electronic components exists based on the magnetic ceramics or ferrites. These materials, many of whose trade names have been obtained by taking various liberties with the Latin word for iron — *ferrum* — have opened new horizons for the professional design engineer, but they are no less a challenge to amateur ingenuity and the home experimenter.

It is the purpose of this article to introduce magnetic ceramics to the rank and file of the amateur fraternity; from there, one hesitates to predict what may result. No attempt will be made to be fundamental about the source of the magnetic effects. The writer, who is a chemist gone astray, does not follow all of the abstractions which are available on the internal workings of atoms, but friends who are theoretical physicists tell me that quantum mechanics are required to give an adequate explanation of the origin of the magnetic effects in ferrites; further, there are adequate theoretical publications now available dealing with these phenomena in ferrites. Let us see instead what ferrites can mean to those who get their callouses handling the soldering iron.

First, one might ask, "Why ferrites?" Refreshing our memories from what the ham's bible (29th edition, 1952, page 27) has to say about iron-core coils and their properties, we can conclude that where currents run small — as in r.f. or i.f. transformer windings for receivers — it would be very helpful to have high-permeability, low-loss cores. For this purpose, component manufacturers have provided powdered-iron cores which have per-

meabilities of the order of 125. Powdered-iron cores offer great improvement at low and intermediate frequencies, but at the high frequencies losses still plague us and the effective permeability of a powdered-iron slug is far below the true permeability which may be obtained with a closed magnetic circuit (toroidal cores). Now come the ferrites with maximum permeabilities ranging up to 4000 at 1 megacycle and with a loss factor of 0.0003 at that frequency. With further increase in frequency, the path divides at present into high-permeability materials with rapidly increasing losses and lower-loss materials of much lower permeability. The field is an active one and advances are being made daily, so it would be foolish to assume nothing better is forthcoming — but just how soon would be hard to say.

Where the Losses Come From

High permeability and low losses in the r.f. range! How do we get it? Well, first let us borrow a formula from the metallic-iron core designer. From it we can say that the eddy-current losses (which are the principal losses to be considered) for each lamination in the core are dependent upon a number of factors, some of which we can monkey with and some of which we cannot:

$$\left. \begin{array}{l} \text{Eddy current} \\ \text{loss in watts} \\ \text{for each lamination}^1 \end{array} \right\} = \frac{AVB_{\max}^2 d^2 f^2}{R}$$

where $A = \frac{\pi^2}{6}$, a constant

- V = volume of the lamination
- B_{\max} = magnetic flux in the lamination
- d = thickness of the lamination
- f = frequency
- R = specific resistance of the lamination

Frequency and thickness both occur in the

* 31 Silver Hill Road, Weston 93, Mass.

¹ *Magnetic Circuits and Transformers*, M.I.T. Staff, p. 136, J. Wiley and Sons, 1943.

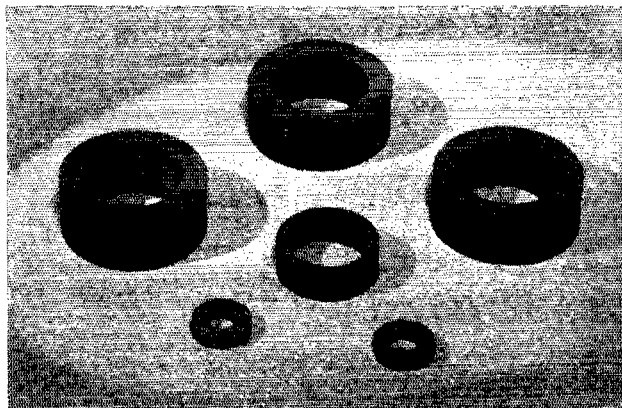

◆
Typical ferrite cores for toroidal inductors. (Photo courtesy Sprague Products Co.)
◆

numerator as the square power and work against you, and volume should be kept as low as possible. You can't help wanting to use high-permeability material at high frequencies but what can you do about the thickness? There is practical limitation to minimum thickness for a single lamination, and to exceed that limit core manufacturers have turned to finely-powdered iron particles. However, these cannot be packed together without insulating them from each other, just as the laminations in a power transformer are coated with a film of shellac. Plastics have been used to coat the powdered-iron particles, but the amount of

• Get acquainted with one of the newer magnetic materials that looks destined to play an important part in the communications field. It is already responsible for some of the high-*Q* coils that have gone into low-frequency "super-selective" i.f. amplifiers.

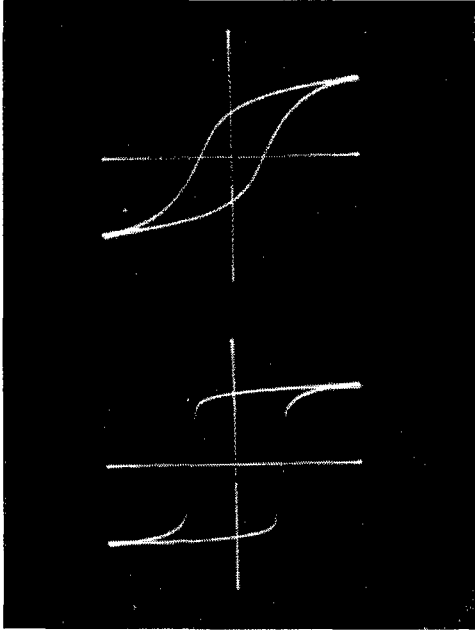

Oscillograms showing the types of hysteresis loops obtained with ferrites. The flattened top and bottom of the lower trace show a type of characteristic that lends itself well to on-off magnetic switching circuits.

plastic necessary to coat completely the surface of each iron particle becomes surprisingly large in these particle size ranges.

To get some idea of the surface area involved, start with a centimeter cube whose surface area is 6 square centimeters. This amount of material, if reshaped, would be approximately equal to one i.f. tuning slug. Cut it first into 8 equal cubes, one-half centimeter on an edge, and the surface area has increased to 12 square centimeters. Continuing to cut, we find that after 1000 cuts the surface area is 60 square centimeters and when the cubes are a millionth of a meter on an edge, the total surface is 60,000 square centimeters or 64.5 square feet. The amount of plastic insulation present in a powdered-iron core is therefore considerable, and its principal effect is to "dilute" the iron and hence lower the overall true permeability to about 125 from a value of 2500, typical for transformer iron. Worse yet, even these small particles develop losses that can,

at high frequencies, become serious or prohibitive. Permeability decreases further because these fine-grained materials have higher coercive force values, and as the area enclosed by the hysteresis loop increases, so do the hysteresis losses. The use of open magnetic circuits (slugs) instead of closed magnetic circuits (toroids) takes away a considerable chunk of the true permeability, so that at 100 Mc. one can expect an effective working permeability of about 5.

Referring back to the formula, the denominator is seen to contain the specific resistance of the core material. For iron (no matter how small the particles may be) this figure is about 0.00001. Dividing an already large numerator by such a figure makes the answer come out extravagantly large, and there is no way to change this materially so long as you are dealing with iron and its alloys; it's just the nature of the beast.

Why Ferrites Are Better

Ferrites, however, are different. The various commercially available types have specific resistance values ranging from 10,000 to 1,000,000,000 ohms per centimeter cube. With this sort of figure in the denominator we no longer care about the thickness, *d*. We can make the core of one solid piece to achieve maximum working permeability and take full advantage of the magnetic properties, at least up to moderate frequencies. Although *V* increases, this is more than offset by high specific resistance values in the denominator.

At present, materials for use at 3 to 5 Mc. are available which have low loss and high permeabilities (700-800). Toroidal coil forms of this material should provide the highest efficiency yet achieved in transformers for this range and perhaps the next 5 or 10 Mc. as well, for although losses increase rapidly with frequency, they don't go out of sight yet. Many problems remain to be solved, but ferrites offer more promise for r.f. cores than any material known.

At the very high frequencies, dielectric losses in ferrites become quite high and we do not yet have the answer to very good cores for use above 10 to 20 Mc.; but, even so, those now available are fully equal to or superior to powdered iron at 100 Mc.

As we go from the very high to the ultrahigh range, oddly enough the dielectric losses largely disappear in the range of 500 Mc. for some of the ferrites. Above that, these materials are rather free of loss up to the range of 12,000 Mc., with the exception of a range around 3000-4000 Mc. where large losses occur from magnetic resonances within the crystal lattice structure of the ma-

terials.² This figure is variable and may be adjusted to lie outside a desired operating range.

What They Are

A few words about the composition and manufacture of ferrites may be of interest. First of all, it has been found that a few simple inorganic chemical compounds, known as ferrites, are magnetic (there are many other ferrites which are not magnetic). The basic ideas are not new, as they are a logical extension and expansion based on the magnetic lodestone whose origin is lost in Chinese antiquity. Hence, one could easily say, "Why didn't I think of that?" Be that as it may, it was not until about 1935 that any systematic studies were undertaken toward the results we now have available. Commercially, the development is entirely a postwar one.

Magnetic ferrites are formed by chemical reaction of one or more oxides of certain metals with a chemically equivalent amount of red oxide of iron. This reaction is usually carried out between the mixed oxide powders at temperatures above 2000° F. The various metal oxides which may be reacted with red oxide of iron are magnesium oxide, black oxide of iron (which results in magnetite or the lodestone), nickel oxide, copper oxide, cobalt oxide, manganese oxide and lithium oxide. These combinations will each give a simple magnetic ferrite. However, complex mixtures of oxides are usually employed, in order to give improved or special properties to the ferrite. Oxides of zinc and cadmium form nonmagnetic ferrites, but are often blended with the magnetic ones to reduce the temperature at which maximum permeability occurs to a value near normal operating temperature.

Once the oxides have been reacted, the ferrite powder thus formed is used to shape the piece or core desired. The usual practice is to mix a little binder with the powdered ferrite and then press the desired piece in steel dies. The piece thus formed will hang together until placed in a furnace for the final hardening or sintering process. During the early stages of this heating, the binder is burned out of the piece and later, at temperatures above 2000° F., the particles sinter or coalesce into a dense, hard, somewhat brittle material, usually dark in color.

Applications and Possibilities

Ferrites have already seen many applications, and new ones are coming up practically daily. Some of the better known applications see them used in recording heads, i.f. transformer cores, magnetic modulators, horizontal sweep output transformer cores for TV, yoke cores for TV, audio transformer cores (fine for the very high audio frequencies), tuning slugs, "built-in" antennas, electronic computer "memory devices," pulse transformer cores, recording tape coatings, etc. One of the most intriguing uses proposed is the microwave gyrator. In this application, a rod of ferrite is inserted axially in a wave-guide where a polarized microwave may be rotated up

² *Bell System Technical Journal*, Vol. 31, pp. 1-31, 1952.

to 90° upon passing through the ferrite in one direction but a reflected wave is rotated 90° again in the same direction and hence it is possible to isolate an oscillator or some other associated device from the rest of the microwave system.²

The limit to which ferrites may be applied is not now known, and it is not possible even to speculate on it because of the continuous march of new ideas as the properties of ferrites are further explored. For instance, it has been found that the shapes of the hysteresis loops of ferrites can be monkeyed with (see photograph) on a practical basis. The two hysteresis loops shown are for specimens prepared by the author, and yet the chemical analysis of both specimens is the same. Fast-switching ferrites suggest magnetic switches which will operate in 1 or 2 microseconds, and many other interesting possibilities. Now it's up to you to try ferrites in your pet circuit or scheme and see what comes of it. Who knows—you might make a million dollars!

EDITOR'S NOTE: Ferrite parts are being produced by General Ceramics & Steatite Corp., Keasbey, N. J.; Stackpole Carbon Co., St. Mary's, Pa.; Ferroxcube Corp. of America, Saugerties, N. Y.; but all current production is of manufacturers' items only. It is expected that Ferroxcube Corp., through its affiliate, the Sprague Products Co., North Adams, Mass., will soon make ferrite parts available through regular distributors.

Strays

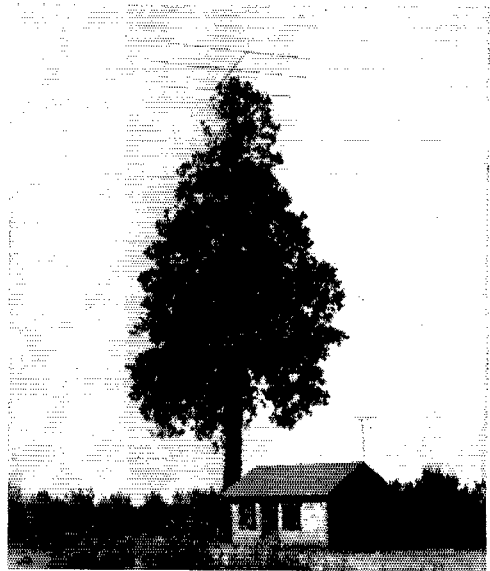

W6WZD didn't grow this handy shrub for the purpose but it fills the bill. His "Tree-Top Beam" is over ninety feet in the air. The prop-pitch motor rotator is concealed in foliage at the 73-foot level. With a pair of 813s hooked to this installation, W6WZD puts out a mean signal on 20-meter 'phone. Not every ham can sit back and watch his antenna grow higher day by day!

YL NEWS and VIEWS



BY ELEANOR WILSON,* W1QON

4th Annual YL-OM Contest

OMs — do you remember the feminine QRM during last year's YL-OM Contest? Why not join the good time this year and give the girls your contacts — there'll be lots looking for you.

And girls, you can help the YLRL officers who work hard to sponsor such an activity as this. Be a self-appointed publicity agent and talk YL-OM Contest over the air, at clubs, and in correspondence. The more publicity, the more participants and the more fun for all! Details:

Starts: February 28th at 6 P.M. EST. **Ends:** March 1st at 12 midnight EST.

Eligibility: All licensed OMs and YLRL members are eligible to compete.

Exchange: QSO number, RS or RST report, state, U. S. possession, VE district (or country).

Scoring: (a) 10 points for each station worked, YL-to-OM or OM-to-YL only, multiplied by number of different states, U. S. possessions, VE districts or countries (except W-VE). (b) Stations and multipliers count once only, regardless of band or mode of operation. (c) For 'phone-only or c.w.-only awards — 10 points for each station worked, YL-to-OM or OM-to-YL only, multiplied by number of different states, U. S. possessions, VE districts or countries (except W-VE). Stations and multipliers count once only regardless of frequency band.

Operating: Any or all bands may be used. On 'phone call "CQ YL-OM contest." On c.w. OMs call "CQ YLRL" and YLs call "CQ OMs." C.w. YLs are encouraged to operate near the net frequencies of 3610, 7040, and 14,150 kc.

Awards: For the highest OM combined score, a cup donated by W8UDA (now held by W1BFT). For the highest YL combined score, a cup donated by W1BFT (now held by W4SGD). For highest OM 'phone-to-'phone only, highest YL 'phone-to-'phone only, highest OM c.w.-to-c.w. only, and highest YL c.w.-to-c.w. only, awards will be made by YLRL. Second- and third-place winners in all categories will receive certificates. The cups are awarded on a yearly basis, with a three-time winner obtaining permanent possession.

Logs: All participants, whether competing for awards or not, are requested to submit logs, to be postmarked not later than March 7, 1953, to Dorothy K. Wickenhiser, W3JSH, 1112 State Avenue, Coraopolis, Pennsylvania.

*YL Editor, QST. Please send all contributions to W1QON's home QTH: 318 Fisher St., Walpole, Mass.

If you have worked Ann Chandler, W1OAK, of Orange, Vermont, you know how good c.w. should sound. An A-1 operator for some time, Ann is ever patient in helping c.w. beginners, and her excellent operating sets a fine example. An RM and member of the VTSS, VTN, and IRN, she spends most of her operating time in nets. Ann's OM is W1MMN.

Announcing: The YL CENTURY CERTIFICATE

1) The YL Century Certificate for confirmed contacts with stations operated by 100 or more different licensed women amateur radio operators is available to all amateurs throughout the world, and is issued by the Young Ladies Radio League at no cost to the applicant upon compliance with these rules.

2) Two-way communication must be established on the authorized amateur bands with stations — mobile or fixed — operated by 100 different licensed women amateurs. Any and all amateur bands may be used.

3) All contacts must be made from the same location. Within a given community, one location may be defined as from places no two of which are more than 25 miles apart.

4) Contacts may be made over any period of years, provided only that all contacts are from the same location as defined in Rule 3.

5) Contacts with YLs anywhere in the world are recognized, provided only that confirmations clearly indicate that the stations contacted were operated by duly licensed women amateur radio operators.

6) One hundred QSL cards, or other written communications from the stations worked confirming the necessary two-way contacts, accompanied by a list of claimed contacts, including the full names of the operators, alphabetically arranged, and the dates and times of contacts, must be submitted by the applicant directly to the YL-CC Custodian. Sufficient postage must be sent with the confirmations to finance their return by first-class mail. The YLRL will not be responsible for any loss or damage to same.

7) Endorsements: Confirmations of contacts, accompanied by alphabetical list, as per Rule 6, from stations operated by additional YLs may be submitted for credit each time 50 additional confirmations are available. Endorsements will be made to the original certificate as applications are approved.

8) Decisions of the YL-CC Custodian regarding interpretation of these rules as here stated or later amended shall be final. All inquiries regarding cards, applications or the certificates should be addressed to her.

NOTE: A Custodian has not yet been appointed, so please hold back your cards and questions until notice of her appointment appears in this column.

Keeping Up with the Girls

Two new nets — W6PJF, Rosemary, is NCS of a Calif. YLRL Net which meets Wednesdays, 9:00 A.M. PST, 3915 kc. 'phone and c.w. W7GLK, Dot, is NC of an 80-meter c.w. net which meets Mondays, 10:45 A.M. PST, 3680 kc. . . . ZS YLs have formed a new club — the South African Women's Radio Club. ZS2AA is Pres., ZS5KG is V.P., and ZS6KK and ZS6GH are Joint Secretaries. . . . W0CCK, Maxine, will soon operate "portable-five" from her new 'Tyler, Texas, QTH. . . . W3JSH worked ZS9I on 7 Mc. from her

(Continued on page 136)



Progress Report on TVI Committees

FCC Sponsorship of Community Interference Committees Pays Dividends

BY GEORGE S. TURNER,* W3AP

• Here's a summary of the first year's experience in FCC sponsorship of local TVI committees. The effectiveness of this program conclusively shows that your community should have one to help lick the interference problems.

IT has been a little over a year since the FCC Field Engineering and Monitoring Bureau directed its Regional Managers to assist in organizing interference committees within their respective regions. The response from amateurs, service men, distributors and other groups has generally been most gratifying. The most recent reports received from the Regional Managers showed a total of 177 established working committees with 30 more being formed or in a proposed status. These do not include MARS operations which have established committees throughout the 4th Air Force. Committees which have not made their existence known to the Regional Manager and established working procedures with him for referral of complaints received by FCC district offices are not included in the above statistics.

The FCC does not in any manner wish to give the impression that this plan of community interference committees was wholly its idea. Most amateur radio clubs since their inception have had such committees. The pioneer work on TVI by the hardworking, courageous amateurs comprising the Dallas Amateur Club TVI Committee was done before the FCC directed its Regional Managers to coordinate committees and to sponsor and assist in forming new committees. The FCC and its predecessor agencies have helped to organize groups outside their own ranks for the old bugaboo of BCI before the advent of TV. Some of you real old-timers may remember "The Chicago Plan" which was developed to solve BCI back in 1920 by a group of Chicago amateurs called together by Supervisor of Radio Charles C. Kolster of the Department of Commerce, Radio Division, who then was in charge of the old 9th radio district. Through Mr. Kolster's efforts upon transfer to Boston, a similar plan was put into effect there. There were many other instances of cooperative effort on the part of the amateur and the regulatory body to eliminate BCI but it would mean digging into musty files or old-timer's memories to recall them.

In this day and age the BCI problem is a very minor one compared to its offspring TVI. The

decision was made in November, 1951, to have the Regional Managers assist in forming and coordinating interference committees outside the Commission because the investigative work load at the FCC district offices had reached such staggering proportions that the reduced staffs could not successfully cope with it. Also, as was later pointed out in an article by the writer in the January, 1952, issue of *QST* and in a guest editorial by Commissioner George E. Sterling in *CQ* magazine for February, 1952, the amateur TVI problem is one which in most instances may best be tackled by amateurs, TV set owners, manufacturers, dealers and servicemen working together to remedy the situation without recourse to the FCC except as a last resort if all other efforts have failed.

It is pleasing to report that the work accomplished by the interference committees has materially lightened the interference investigative work at the FCC district offices. One district office reports that TVI committees operating in the metropolitan area have reduced the FCC office workload to the extent that time can now be given to handling more cases in rural areas. It is also known that this assistance to FCC field offices has also made it possible to handle more of the type of investigations which relate to unauthorized operation and to interference to services other than broadcast and TV from sources other than amateur. Yes, there are many such cases unfortunately; the amateur is by no means the only one who causes radio interference. It is necessary that commercial and military communications be kept free of interference. This is FCC's job both from a rule-enforcement standpoint and to keep communication channels interference free for handling traffic vital for national defense. Therefore, you can understand how the community committees dealing only with TVI and BCI are nevertheless of very real value to the over-all communications picture.

The Regional Managers' last reports show interference committees known to them to be located by region as follows:

Region	Established	Proposed
Central States	30	—
Great Lakes	26	10
Gulf States	18	—
North Atlantic	32	—
North Pacific	8	10
South Atlantic	16	2
South Pacific	44	4
Alaska	2	1
Hawaii	1	3
	177	30

* Chief, Field Engineering and Monitoring Bureau, FCC.

The internal organization of interference committees, their policy in handling complaints, and the types of cases considered, appear to vary from city to city according to local needs, variety of agencies available for liaison, and the level of interest maintained by the committee after original enthusiasm has worn off.

Organization Structure of TVI Committees

There are two basic organizational structures for the amateur group which appear to be in general usage. (1) Where a number of amateur clubs are situated in close proximity in a metropolitan area, the usual approach is to pool individual resources into one unified amateur committee. From its own interference committee, each club provides one or two voting representatives to serve on this amateur steering committee. A chairman directs its numerous activities. All TVI complaints or calls for assistance, are referred, recorded, assigned and ultimately cleared through a committee "coördinator." (2) In more isolated areas, each individual amateur radio club may provide its own committee on a purely local basis.

The following are listed as examples to show the type of representatives usually serving directly with the amateurs on a TVI committee, or in an advisory capacity as a cooperating group: Representatives of broadcast and television stations, local power companies, ARRL, RTMA, NARTB, local airways, police radio, television manufacturers, distributors, service organizations, independent service personnel, the military, Civil Air Patrol and Civilian Defense. A Commission district office representative or the Regional Manager may also serve in an advisory capacity.

Usual Committee Objectives

Each committee will usually be found to outline its own version of the following primary objectives, all of which aim toward a better mutual understanding in relations with the general public, and providing the basis for self-regulation in TVI for the amateur:

(1) To provide assistance for those amateurs who are restricting their amateur radio activities because of TVI or in the fear of TVI. (2) To investigate amateur TVI complaints where the amateur is known or accused. (3) Crusade for a better understanding between all parties concerned with TVI. Integrate this with an educational program for both the general public and TV service personnel. (4) Provide a clearing house for the coördination of the cooperative efforts of all concerned directly or indirectly with TVI.

Committee Policy

First reports indicate only slight divergence from the over-all plan suggested by the FCC Field Engineering and Monitoring Bureau in the writer's January *QST* article. Most committees appear to be gratefully accepting to the fullest extent, direct cooperation, liaison, or mutual

assistance volunteered from all possible sources.

There are a few amateur committees tending to "spell out" policy in definite terms, ostensibly to preclude chances of overwhelming workload. Most committees, however, appear to realize that, in view of the unpredictable nature of TVI, no hard and fast rules should be formulated, and each case must be handled on its own merits.

Results Obtained

In a review of the information available at this time, the following improvements appear to have been effected in varying degrees: (1) Gain in confidence and mutual respect between amateur and complainant. (2) TVI cases are resolved in a cool-headed, cooperative manner. (3) Military Reserve Units (such as MARS) and Civil Defense amateur units are able to maintain continuous operations. (4) Decline in petitions against amateur operations. (5) Reduction in number of interference cases coming to attention of members of Congress and FCC.

One of the reasons for the effectiveness of these committees is the arrangement which the Commission has worked out with major receiver manufacturers to cooperate with the receiver owner through the use of high-pass filters when the interference is due to receiver deficiencies. Although committees by no means act with FCC authority, the liaison they have established with our Regional Managers places them in an ideal position to obtain full cooperation from the manufacturer.

Examples of Committee Effectiveness

The value of Committee handling of TVI investigations can be demonstrated by several examples of previously enraged complainants who, following an unexpected show of sympathetic attention on the part of a local TVI committee, become interested in amateur radio. More than a few amateurs, after prompt and congenial settlement of a TVI problem, now find their neighbor on the way to becoming a member of the amateur fraternity.¹

Many neighbors, having learned the friendly way that television and amateur radio can live side by side, soon take advantage of the message-handling services of the amateur station.

One complainant, whose interference problem had been solved by the installation of a high-pass filter at the television receiver, called upon the amateur to install a switching arrangement for the filter so that amateur's conversations might again be heard when desired.

Committee handling of complaints has resulted in a surprising number of pleased receiver owners who offer to pay for installations of a filter, or for other receiver modifications where indicated. This was an almost unheard of occurrence before the birth of TVI committees.

Most committee members have reason to appreciate the service they are rendering others. For example, in the Washington, D. C., area a considerable number of committee members who

¹ This is not always the ideal solution! — Ed.

(Continued on page 138)



M. A. R. S.



U. S. N. R.



MARS Now in Fifth Year of Operation

The Military Affiliate Radio System observed its fourth anniversary on November 26, 1952, with numerous local and area open houses and demonstrations. Highlights of the System celebration was the transmission of a special anniversary greeting from the then Secretary of Defense, the Honorable Robert A. Lovett. Member stations copying this transmission received the special 8 X 10-inch photo-montage acknowledgement shown below. The text of the message follows:

On behalf of the Department of Defense it is my pleasure to extend congratulations and best wishes to the Military Affiliate Radio System on the occasion of its fourth birthday. As a result of your splendid program you encourage private citizens to become interested in military communications methods and practices. Furthermore, and as a result of your unstinting efforts you assist in the organization and operation of radio nets for morale and training purposes and for possible use by military commands or local civil authorities in the event of disaster or emergency and also during any situation which causes existing official and commercial communications channels to become overloaded or inoperative. The members of MARS are to be commended for their excellent record of public service and I extend them every good wish in their future endeavors.

ROBERT A. LOVETT, *Secretary of Defense*



A reproduction of the acknowledgement earned by MARS member-stations who copied the Secretary's message.

Naval Reserve Visit

During November approximately seventy members of the Dade Radio Club, Miami, Florida, made a tour of the local Naval Reserve Training Center. Cmdr. Frank B. Hoselton, USNR, W4ADP, of the local unit, was in charge of the tour. Electronics equipment was demonstrated and the use of training aids and instruction kits was explained during visits to the electronics laboratory and classrooms.

Forest Fire Emergency

During the November forest fire emergency in the Charleston/Bluefield, West Virginia, areas, a Naval Reserve emergency communications network was activated and prepared to furnish communications. This network consisted of the Fifth Naval District Reserve Master Control Station, Norfolk, Va., and Naval Reserve Training Centers and Electronics Facilities in the West Virginia area. Amateur radio station W4USN at the Reserve Master Control Station, Norfolk, cooperated with W8CLX, the West Virginia Fire Control Station near Charleston, on 3890 kc., in providing assistance on amateur frequencies. Operators at the Reserve control station were: W6BYY/4, Cmdr. E. J. Beall, USNR; J. C. Pulliam, RMC, USNR; W8KQX, G. H. McClelland, RM1, USNR; and W8CLT, J. F. Wheby, RM2, USNR.

Helpful Service

The Eleventh Naval District Reserve Electronics Program now provides a helpful service to amateurs in the San Diego, Calif., area. K6NCB, located at the district headquarters building, maintains a continuous loudspeaker watch on 29.5 Mc. daily from 0800 to 1600 local time Monday through Friday. Local amateurs may contact K6NCB during this period. A directory service is provided for out-of-town amateurs driving into the city with mobile equipment. Operators at K6NCB are W6HYA, Bill Munoz, ET2, USNR; K6DY, Cmdr. J. C. Picken, USNR; W6WOY, Cmdr. B. A. Wambsgans, USNR; and W6PXW, Marvin Fair, ET1, USNR.

Code Practice

Naval Radio Station NAM-1, located on the east coast, sends weekly practice code transmissions, Monday through Friday, for training purposes. These transmissions are made simultaneously on 4205 kc. and 8410 kc. at these times and speeds (w.p.m.): 1000 to 1100, 14; 1100 to 1145, 16; 1300 to 1400, 15; 1400 to 1500, 8; 1500 to 1530, 12; 1530 to 1545, 25; 1545 to 1600, 30; and 1600 to 1615, 35. This code practice is available for use by all amateurs.

Here and There

Anthony J. Gibilaro, RMC, USNR, W4QEL, is licensee, operator and stationkeeper at K4NAY, Naval Reserve Training Center, Portsmouth, Va.

Charles V. McNeil, ETNSA, USNR, W7RFP, the operator at K7NAE, Naval Reserve Training Center, Spokane, Washington, recently made a training cruise on the *USS Gilligan*.

K6NRN, Volunteer Electronics Company 12-8 of Redwood City, Calif., has three active amateur members. They are W6CBX, Cmdr. Norton C. DeWolfe, USNR, commanding officer; W6HXD, Cmdr. Arthur C. Adams, USNR; and W6GWF, Lt. Cmdr. Charles R. Finn, USNR.

The Anderson Radio Club meets the first and third Thursdays at the Naval Reserve Electronics Facility (K4NBV), Anderson, S. C. C. J. Walker, jr., RM1, USNR, W4SSN, is club secretary.

Merrill D. Randall, RMC, USNR, (W1JRB) stationkeeper at K1NRN Naval Reserve Training Center, Newport, R. I., was recently elected as Communications Manager of the ARRL's Rhode Island Section, New England Division.

On the Air with SINGLE SIDEBAND

The newest country to show up on s.s.b. is Switzerland, thanks to HB9HF. W4INL worked him on 20, for the first HB-W s.s.b. QSO. Other single-siders that W4INL scared up include G2IG, KT1DD, VR2CG, G2ALN, KP4HF, KH6-AJH, OE13CC and G3COJ.

The Hamfesters Radio Club is proud of its two active s.s.b. stations, W9KNP and W9DKA, both using phasing rigs. . . . W4GL uses a phasing rig on 20 to drive the final of his Collins KW1. . . . Latest figure on W6 s.s.b. activity is 44 on 80 and 8 on 20, to refute our figures of a few months ago.

Grounded-Grid Linear

With the current interest in grounded-grid linear amplifiers, you will probably be interested to see how W2EAS has his rigged up. Bill uses a pair of 805s, as shown in Fig. 1A, and the heart of the thing is the low-capacity filament transformer, T_1 , that makes it easier to keep the filaments above r.f. ground. The transformer was one that was kicking around in surplus, with about $\frac{1}{2}$ -inch spacing between windings and core. Originally with a 5-volt secondary, it was rewound for 10 volts to keep the 805s happy.

The resistor R_1 has no particular significance except to limit the d.c. voltage appearing at the end of the cable if the link is disconnected. The $4\frac{1}{2}$ -turn link, L_1 , is part of the converted BC-696 driver. Peak plate input to the driver runs around 75 watts. Idling current to the 805s is around 85 ma., kicking to 350 to 400 ma. on peaks. The linear worked right off, after a minor oscillation was killed by the parasitic suppressors in the plate leads, and no neutralizing is required, of course.

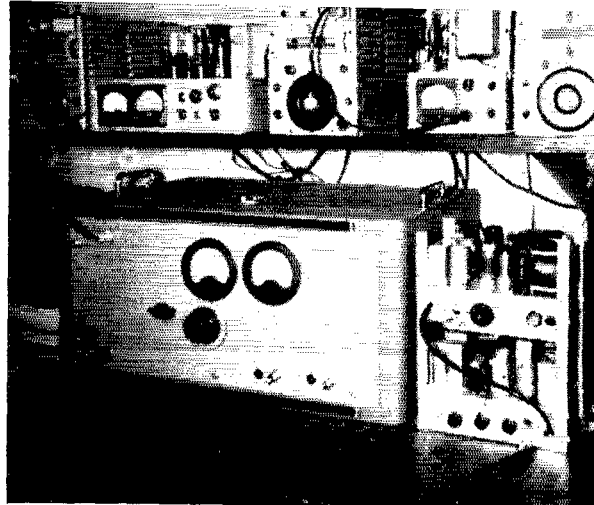
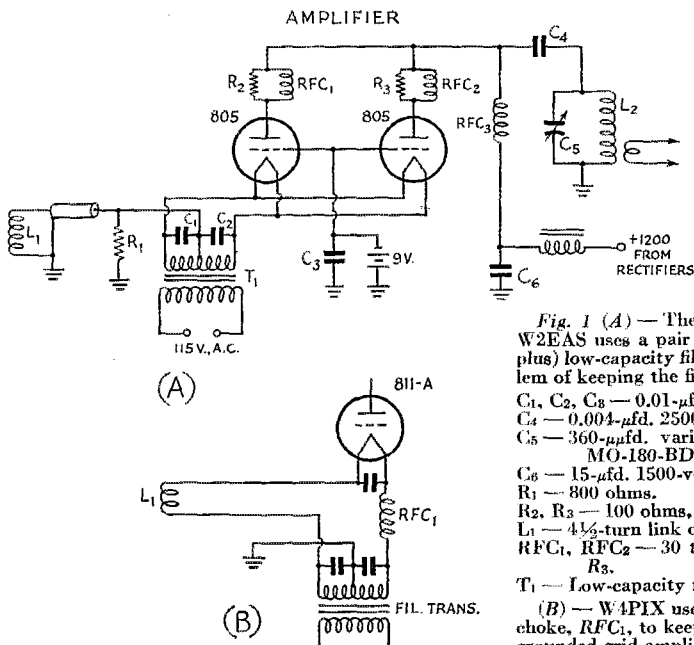

Here is the s.s.b. station of W2EAS. The cabinet in the center houses the parallel-805s grounded-grid final and its 1200-volt power supply. That "open-air" rack to the right of the cabinet is the Weaver-Brown crystal-lattice exciter, complete with power supply and variable-crystal oscillator. The center BC-696 on the shelf was revamped for use as a driver amplifier between the exciter and the final. The other two ARC-5 units are for 40- and 80-meter c.w.

Bill also passes along the sketch of Fig. 1B, which is the way W4PIX runs his grounded-grid 811-A linear final. This method takes a higher-voltage filament transformer, to make up for the drop in the link and the r.f. choke

High-Level Converters

There has been a need in s.s.b. circles for a good high-level converter, to aid in band changing at powers above what the small receiving tubes will handle, and W6EDD has come up with what looks like a neat solution. Shown in Fig. 2 [p. 118], it can be used as a Class A grounded-grid amplifier or as a mixer, depending upon how the plate circuit is tuned. W6EDD has used a 6Y6, 6V6, 6L6 and 6AQ5 in the circuit, all with equally-good results. As an amplifier,

the plate current runs around 15 ma. (at 300 volts), with no variation with signal. As a mixer, the plate current idles at around 15 ma. and kicks to 30 ma. on peaks. It requires less than 1 watt of drive, and its output is sufficient to overload a heavily-loaded 807. The heterodyning signal has no effect on straight-through operation. Norm uses the device straight-through on 75, and a 10.4-Mc. oscillator and a new coil at L_2 put the output on 20 meters.

(Continued on page 118)

Fig. 1 (A) — The grounded-grid linear amplifier at W2EAS uses a pair of 805s in parallel. A special (surplus) low-capacity filament transformer solves the problem of keeping the filaments above ground for r.f.

- C_1, C_2, C_3 — 0.01- μ fd. 600-volt mica.
 - C_4 — 0.004- μ fd. 2500-volt mica.
 - C_5 — 360- μ fd. variable, 0.05-inch spacing (Cardwell MO-180-BD, both halves in parallel).
 - C_6 — 15- μ fd. 1500-volt filter condenser.
 - R_1 — 800 ohms.
 - R_2, R_3 — 100 ohms, 1 watt.
 - L_1 — $4\frac{1}{2}$ -turn link on ARC-5 driver.
 - RFC_1, RFC_2, RFC_3 — 30 turns No. 30 enam., wound on R_2, R_3 .
 - T_1 — Low-capacity filament transformer, surplus.
- (B) — W4PIX uses the excitation link, L_1 , and an r.f. choke, RFC_1 , to keep the filament above ground in his grounded-grid amplifier.

Notes on V.H.F. Converter Design

Some Practical Hints for Improving the Performance of Crystal-Controlled Converters

BY JOHN P. VAN DUYN,* W2MLX, AND KURT E. TREPTAU,** K2CEM

• Crystal-controlled converters are becoming more popular among v.h.f. men every day, but unless they are carefully designed their considerable response to signals outside the intended frequency range may make them something less than an unalloyed blessing. Here the authors describe simple means for reducing spurious responses in v.h.f. converters, while at the same time maintaining uniform high sensitivity across the desired tuning range.

THE basic reason for the use of a converter is to extend the frequency range of a communications receiver to bands where the owner of the receiver wishes to operate. Various forms of v.h.f. converters have been used with amateur receivers for many years, but only recently have they begun to achieve a high state of perfection.

A major drawback of v.h.f. converters in general has been instability in the local oscillator, resulting from mechanical vibration or long-term thermal effects. In order to circumvent this difficulty the use of crystal-controlled injection sources has come into vogue. The higher the frequency the more difficult it is to design a variable-frequency oscillator, so though crystal-controlled converters for all amateur bands have been described, their greatest use has been found on 50 Mc. and higher bands.

The use of crystal control in the converter, though it makes possible a high order of stability, introduces other complications. These revolve around the fact that, with a single injection frequency, the intermediate frequency must be varied to effect a tuning range. The r.f. portion of the converter must thus be broadbanded in some way, so that its gain will be constant across the band for which it is designed, yet it must be made to reject signals on all frequencies outside the desired range insofar as possible.

Some crystal-controlled converters that have been described make use of rather inefficient broadbanding methods. An example is the use of single-tuned coupling circuits damped with shunt resistors to broaden their frequency response, as shown at the top of Fig. 1. This is simple circuitwise, but it produces a passband that is far from the ideal. It achieves broad response at the expense of gain, and the passband

is such that interference from strong signals outside of the desired frequency range is a problem. On the other hand, we have found that use of several double-tuned-overcoupled circuits as shown in the lower portion of Fig. 1, results in an almost ideal flat-topped passband characteristic. High-Q coils of proper form factor, oriented for minimum capacitive coupling between stages, make possible this desirable response without an excessive number of circuits. It is obvious that this technique is going to be effective in reducing the amplitude of adjacent-frequency signals from strong local stations and interference from the unwanted harmonics of the crystal oscillator or doubler stages in the converter. The tendency to cross-modulation from stations located outside the passband is reduced, and higher gain is obtained at the desired frequencies.

Probably even more annoying than the cross-modulation trouble that is found in many crystal-controlled converter designs is their spurious response to signals outside the desired frequency range. It is quite common, in tuning the four-megacycle range covered by the 2-meter band, for example, to find many interfering signals in addition to the desired amateur stations. These may be the sound or video carriers of local television stations, taxicab or other mobile service stations, operating in the frequency range that serves as the intermediate frequency, or unmodulated signals resulting from harmonics of the receiver oscillator. All except those in the last category can be minimized or eliminated completely by employing suitable converter design techniques.

One of the purposes of this article is to describe means of overcoming these weaknesses of crystal-controlled converters for 144 Mc. while at the same time achieving a high order of sensitivity and stability. The 2-meter band is used as an example for several reasons, though the same principles may be applied to other frequencies in the v.h.f. range. Reception at 144 Mc. requires multiplication of the crystal oscillator frequency. A converter for this band is quite susceptible to the spurious response troubles mentioned above because of its location in the spectrum between two high-powered broadcasting services, f.m. and TV, and close to many aircraft and mobile frequencies. In addition, it requires the use of low-noise r.f. amplifier techniques, as the frequency is high enough to make receiver noise one of the major limiting factors in weak-signal reception.

* Consulting Engineer, Teeraft Division, Television Industries, Inc., Hackensack, N. J.

** Chief Engineer, Teeraft.

R.F. Amplifier Circuitry

It is well known that the first r.f. amplifier in a good design controls the sensitivity, or more accurately, the noise figure of the entire system. In the specific design in question it was decided to use one of the new low-noise dual triodes, such as the 6BQ7A, the 6BK7 or 6BZ7. The first r.f. amplifier circuit is the so-called cascode or driven grounded-grid arrangement shown in Fig. 2. This provides high gain, low noise figure, excellent stability and ease of adjustment.

Many variations of this circuit have been devised, and nearly all show complicated neutralizing methods for achieving the lowest possible noise figure. In the case of a circuit to be used only over a narrow band of frequencies (it should be noted that the 2-meter band is actually narrower than a single television channel) fussy neutralizing arrangements can be dispensed with, and a single small coil used to advantage. This inductor is connected between the plate of the first triode section and the cathode of the second, and is designed to be resonant with the input capacitance of the grounded-grid section. This dual-triode circuit has a noise figure under 4 db. above thermal. When it is used with a suitable pentode r.f. amplifier following, the over-all noise figure can be just slightly in excess of 4 db., which is quite good at these frequencies.

Note that a second r.f. amplifier using a pentode (6AK5 or 6CB6) is suggested. If the mixer follows the first r.f. amplifier directly the noise figure will not be as good, and the operating conditions for the mixer become more critical. The intermediate r.f. amplifier also permits the use of more tuned circuits at the signal frequency and hence improves the rejection of adjacent signals and those on the intermediate frequency. In this respect, the additional pentode r.f. stage is superior to the use of an i.f. amplifier stage in the converter as a means of building up the gain. The latter tends to increase difficulties with signal pick-up at the intermediate frequency, whereas the second pentode stage is effective in reducing it. If control of the over-all converter gain is desirable, it can be accom-

plished by means of a cathode-bias gain control in the pentode stage in the same manner as is commonly used in i.f. amplifier stages.

Double-tuned circuits are used between the triode and pentode amplifiers, and between the pentode amplifier and the mixer. This is a very important feature, making possible the highly-desirable over-all response shown in the lower portion of Fig. 1. The coupling circuits can best be aligned by the use of a sweep-frequency generator, but this is not necessary. Entirely satisfactory performance can be obtained by judicious use of a grid-dip meter and a final touch-up using on-the-air signals. The gain of the unit is adequate to give very good performance, even with some mistuning.

Pentode or Triode Mixer?

Triode mixers are commonly used in v.h.f. converter service in preference to pentodes because of their generally lower noise figure. This is an important consideration only when no r.f. stage, or an ineffective stage, is used. The performance of the triode-pentode combination already described is such that the mixer following

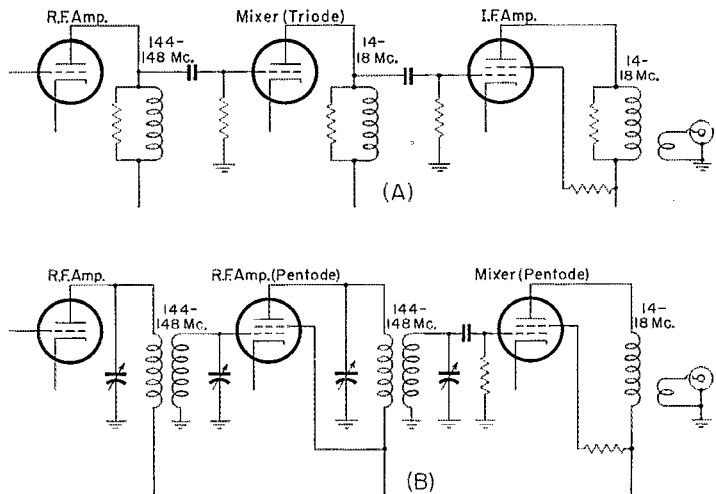
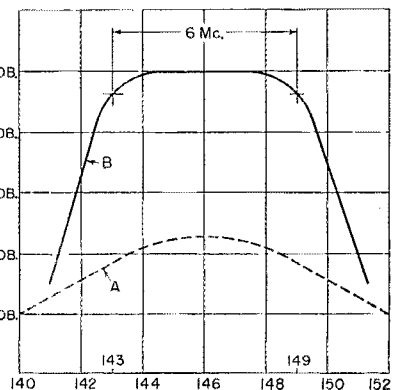

Fig. 1—Basic converter circuits, showing methods of broadbanding. Circuit A has resistive loading resulting in the broad but low-gain response shown by the dotted line in the graph at the right. An i.f. amplifier stage is needed for satisfactory over-all gain.

In B, double-tuned circuits between the r.f. and mixer stages to give the desirable characteristics of Curve B. The first stage, a triode, is followed by a pentode to build up gain. The mixer can be either pentode or triode. Gain is equal to the above, without an i.f. stage, and rejection of unwanted signals is greatly improved.



it has substantially no effect on the noise figure of the system, so the following desirable features of a pentode mixer can be made use of.

Properly designed, the pentode mixer is less susceptible to oscillation trouble than a triode. It affords better isolation between r.f. and i.f., and consequently contributes to the ability of the converter to reject signals on other than the desired frequency range. The better pentodes have higher conversion gain, making an i.f. amplifier following the mixer unnecessary. Pentodes generally require less injection voltage than triodes, making the work of the oscillator-multiplier chain easier.

The design of a mixer to follow an effective r.f.

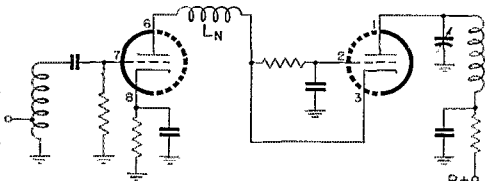

Fig. 2—Modification of the cascode circuit suitable for 2-meter r.f. amplifier service. The coil L_N is resonant at the middle of the band with the input capacitance of the second triode section. Its adjustment is not critical. Suitable tubes are the 6BQ7A, 6BK7 or 6BZ7.

amplifier system is not critical. Generally speaking, the principal consideration is to set up the operating conditions of the pentode so that it draws the lowest plate current consistent with satisfactory output.

Oscillator-Multiplier Consideration

The oscillator portion of the converter uses a crystal operating on its third overtone, permitting selection of the crystal from readily-available frequencies in the 7-to-8-Mc. range. The actual frequency is dependent on the intermediate frequency selected. Choice of the i.f. is a matter for later discussion. The final multiplied output should be 144 to 148 Mc. minus the desired tuning range of the low-frequency receiver. An example is in injection frequency of 130 Mc., allowing the receiver to be tuned from 14 to 18 Mc. to cover the 144-Mc. band. This is achieved by a 7222-ke. crystal operating on its third overtone, which is then multiplied by a factor of 6.

Many other possibilities exist, though this one provides for the use of a low-cost crystal and a simple multiplying chain. It is desirable to keep the frequency multiplication to a minimum, as the more multiplication there is involved the more complex becomes the signal fed into the mixer tube, and consequently the greater the danger of mixing the incoming signals with frequencies other than the desired one, resulting in "birdies" across the band. A typical case develops if high-order harmonics, other than the desired 130 Mc., get into the mixer tube together with the sound or picture carriers of TV Channel 7, which can be very disconcerting if a transmitter is operating on that channel locally. There are many other possibilities, of course, but suffice to say that it is highly desirable to minimize

the presence of other than the desired frequencies at the mixer grid.

Occasionally, it will be found that local interference problems can be solved by suitable choice of multiplier frequencies following the crystal oscillator, selecting these frequencies so that none is higher or lower than a local service by the amount of the intermediate frequency. Normally the stage following the overtone oscillator multiplies the frequency by 2, and another stage runs as a tripler. This sequence is desirable in the presence of a strong TV signal on Channel 7, but there may be other cases where the order of frequency multiplication can be reversed to advantage.

In addition to choice of frequency multiplication according to local conditions, it is important that adequate filtering of unwanted harmonics of the crystal is provided in the plate circuit of the last frequency multiplier. This can be done with undercoupled double-tuned circuits, but in this instance it has been found adequate to use a high-Q plate circuit loosely coupled to the mixer grid by means of an inductive link.

Mechanical Layout

Several desirable objectives can be attained by proper layout of components for a crystal-controlled converter. There are two general approaches to the problem of adequate isolation and reduction of feed-back. One is to build compactly and resort to rather complicated shielding and filtering. Another is to build somewhat larger, in order to provide space for a layout that will achieve the same ends.

Stability, that is, freedom from feed-back, is accomplished in the r.f. portion of the converter by careful positioning of the r.f. inductors, and phasing of the windings for minimum unwanted coupling between stages. Capacitive coupling between r.f. stages is held to a minimum by designing the r.f. inductors so that their hot connections (to plate and grid) occur at opposite ends of the coil structure. Components in the oscillator-multiplier chain are so placed as to prevent strong local fields therein from adversely affecting the performance of the r.f. portion.

Complete shielding from strong external fields is important, as is the prevention of signal pick-up at the intermediate frequency by any portion of the converter circuitry. This is achieved in a very simple manner by building the converter entirely on a metal plate that is then fitted to a chassis or metal-lined box to complete the metal enclosure. Connection from the converter to the communications receiver should be made with coaxial line, the outer conductor of which is connected to the case of the converter and to the receiver shielding. In the case of extremely strong local signals on the intermediate frequency, it may be necessary to add a shielding box around the receiver antenna terminals.

Desirable Receiver Characteristics

The communications receiver with which the converter is used plays an important part in

the over-all performance of the v.h.f. receiving system. Desirable receiver attributes could be stated in general as follows: The receiver should have very good image rejection in the frequency range that is to be used as the i.f. band for the crystal-controlled converter. It should be well-enough shielded to prevent direct pick-up of signals in the i.f. range. The receiver oscillator and beat-frequency oscillator should be stable, if maximum advantage is to be derived from the use of crystal control in the converter. The tuning range that is to serve as the intermediate frequency should have sufficient bandwidth so that signals may be tuned in easily and spotted readily as the receiver is tuned across the i.f. range. Some receivers are deficient in this category, particularly those that have separate bandspread and general-coverage dials.

The local oscillator of the communications receiver should be of low amplitude, be thoroughly shielded and of low harmonic content, and preferably applied to an inner grid of a pentagrid type mixer. When this is done, the oscillator voltage is effectively isolated from the signal input grid voltage by means of the screen. It is especially important that there be no oscillator voltage appearing at the antenna input terminals of the receiver, for such voltages even at very low amplitude will cause "birdies" in the tuning range.

It is not necessary that the receiver be outstandingly sensitive; in fact, it may be desirable to have less than the usual sensitivity, as the converter has quite high gain in its own right.

If the receiver has inadequate image rejection (less than 1000 times) at the frequency chosen for the converter output, repeat signals will appear at twice the receiver i.f. away from the main response. That is, if the communications receiver i.f. is 455 kc., the 2-meter signals will repeat 910 kc. away from the proper frequency. This is a characteristic of the communications receiver, and nothing can be done about it in the converter. In general, it may be said that single-conversion receivers having one r.f. stage or none at all will have inadequate image rejection in the 14- to 18-Mc. region. Single-conversion jobs with two tuned r.f. stages will be much better, but double-conversion receivers with a higher first intermediate frequency are the best of all.

If the converter is to be used with inexpensive receivers having poor image rejection at 14 Mc., better results will be had with a lower converter i.f., such as 7 Mc. Using 14 to 18 Mc. has a special advantage for 144-Mc. converters, however—it allows direct reading of frequency from the receiver tuning dial, 14 Mc. being 144, 15 Mc. 145, etc.

Where energy from the receiver oscillator is radiated through leads to a separate power supply, or as a result of inadequate shielding, harmonics of the oscillator frequency may cause many fast-tuning birdies in the tuning range. The rapid-tuning characteristic identifies them as harmonics, the speed of tuning being related to

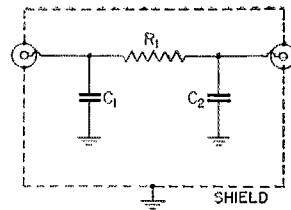

Fig. 3 — Simple low-pass filter for use in keeping receiver oscillator energy from entering the converter through its output cable. C_1 and C_2 are about 20 μfd . R_1 should be 100 to 200 ohms.

the order of the harmonic. One otherwise excellent receiver that is troublesome in this respect may be corrected by the use of shielding over the power supply cable and filtering of the individual leads where they come out of the receiver. A simple low-pass filter such as is shown in Fig. 3 may help in minimizing this trouble in cases of inadequate oscillator shielding. This should be inserted in the line between the converter and the receiver input terminals.

Performance

A typical 144-Mc. converter based on the design thoughts here discussed will have a noise figure of 4 to 5 db., depending on the tubes used. Rejection of spurious signals will be a minimum of 1000 times, and will be that low only on signals around 116 Mc., a little-used frequency that should cause no particular difficulty. Response to signals in the 14- to 18-Mc. range, often troublesome in crystal-controlled designs, is too low to be measured; in other words, in excess of 100,000 times.

The response in the region of the 144-Mc. band, shown in Fig. 1, is essentially flat across the band itself, dropping sharply a short distance from either band edge.

Though the 144-Mc. band is used as an example, the same principles have been applied successfully to bands from 28 to 420 Mc. By suitable attention to minimizing spurious responses, the stability of crystal control and the advantages of broadband design can result in a quality of reception on these bands that is available through no other means.

Quist Quiz

A has just completed a beautiful little converter for 6 and 2 meters, and its measured noise figure is as good as or better than anything the local v.h.f. men can produce. He feeds the output into a surplus radar i.f. amplifier, and claims he now has the finest receiving set-up in the county. **B** won't go along with this, says that a slightly poorer converter working into a good communications receiver would give a better signal-to-noise ratio. Who is right?

(Please turn to page 138 for the answer)



Correspondence From Members -

The Publishers of *QST* assume no responsibility for statements made herein by correspondents.

NEW F.C.C. REGS

821 Rutgers Road
Franklin Sq., N. Y.

Editor, *QST*:

I wish to register a protest against the decision of the FCC to open all bands to permit 'phone operation by General and Conditional licensees.

It shows bad faith indeed to have required additional examination elements to qualify for additional privileges and then to discover that no such privileges are granted. . . .

All in all, surprising thoughtfulness and consideration of the license structure has been shown. I do hope reconsideration is still possible.

— Herbert Greenberg, W2EEJ

@

1212 Gore Blvd.
Lawton, Okla.

Editor, *QST*:

I protest against the new law giving all amateurs the same privileges without working for them. There is no incentive to try for a higher class of license.

— Gilbert Butler, W5OQD

Spencer
Iowa

Editor, *QST*:

. . . In the first place the proposed regulation will completely kill the incentive of obtaining a higher class ticket, because a General Class will have the same advantage and privileges as an Amateur Extra Class.

Our personal solution would be to leave the General and Advanced Class as they are, with the same privileges and restrictions. The new 'phone allocation on 40 meters, and possibly 15 meters in the future, should be given to the Amateur Extra Class with the same restrictions for obtaining that license as are in effect now.

This would give the amateur something to work for, from Novice to Amateur Extra Class, with increasing privileges for each license. . . .

— Dr. D. P. Schmitt, W0GEL

640 Milwood Ave.
Venice, Calif.

Editor, *QST*:

. . . It would appear that the Commission is far too readily swayed by a minority pressure group purporting to represent a large segment of the amateurs concerned. I believe further that they should be brought to realize that it is actually a minority group that is promoting the bulk of these changes that are not desired by the majority of the amateurs. . . .

— Ben F. Myers, W6ROP

770 Davies Ave.
Akron 6, Ohio

Editor, *QST*:

In the past I have restrained myself from making comments on the ill-advised and ill-conceived decisions rendered by the FCC on the amateur's behalf but after the latest edict handed down by the Commission, I feel that further restraint is impossible.

What ideology considers it just to reward equally initiative and lack of initiative? Either this is a new precept aimed at dividing and conquering the largest reserve of communication specialists or else it is cleverly contrived to relieve us of all frequencies below the microwave region.

It appears to me as if a well-planned campaign is rapidly reaching its conclusion unless the amateurs wake up and

demand to be heard in the formulation of these policies as was done before World War II when the amateurs were permitted virtual self-regulation.

Perhaps it is too much to expect to return again to the days when a man was deemed wise enough to govern himself instead of being dictated to by a group of power-mad bureaucrats who consider themselves the only recourse when it comes to making decisions affecting thousands. . . .

— R. K. Bolles, W8DIY

11044 Durland Ave., N.E.
Seattle, Washington

Editor, *QST*:

. . . Based on the storm of protest this has aroused, my letter is undoubtedly one of many ARRL will receive on this subject. I surely hope there will be sufficient to cause the setting aside of action that so many amateurs feel is both unnecessary and ill-advised. . . . The gradual step-up from Novice to B and eventually to A licenses has furnished worthwhile goals for the beginning amateur. This is definitely true in my own case in going from B to A and I have even heard disappointment expressed by amateurs now holding a B license and contemplating on taking the A examination. They who have been working toward it now feel something has been taken from them. . . .

— Lloyd Peck, W7B.1

539 Eastern Dr., Rt. 6
Memphis, Tennessee

Editor, *QST*:

I strongly urge immediate action to keep Generals out of Class A 'phone bands.

— W. Battersworth, W4IYY

1043 Schley Avenue
San Antonio, Texas

Editor, *QST*:

. . . I believe that this action has completely undermined the amateur licensing procedure. If the Commission would have continued issuance of new Advanced Class licenses rather than authorizing Conditional and General Class licenses the additional radiotelephone operating privileges, the stimulation for persons to advance in their studies of radio could have continued and at the same time the number of stations operating with the additional privileges could be limited to a practical amount.

— Albert Jerry Balusek, W6SAII

Morrisville
Vermont

Editor, *QST*:

. . . These bands are in rather tight shape now afternoons and evenings. The increase in QRM ought to be something to see. But how about the increase in transmitters not adjusted for optimum performance? The increase in b.c. and other forms of interference? Will our admiring public stand for it? . . .

Understand also 7200-7300 is to be opened for 'phone. If Class A, I for one approve.

— Gray Jensvold, W1ETE

1428 W. 15th St.
Casper, Wyoming

Editor, *QST*:

. . . There is a swelling tide of resentment against this decree and the FCC will so find in their mail. . . . It serves no good purpose, and it is about the rottenest deal thus far perpetrated against the amateurs. . . . Let all earn alike the right of higher achievement. . . .

— A. F. Pickett, W7GOH

(Continued on page 116)

The attention of old-timers will be drawn to the appearance of several familiar names among the recent ranks of Silent Keys. . . .

A former ARRL Director, M. B. West (ex-SAEZ) pioneered in the field of transmitting theory and practice. His classic discussion on power factor, "Some Whys, and Speculation as to Some Possible Wherefores" (*QST*, Feb., 1921), remains memorable as well as his part in the famous debate on that subject which developed at the first ARRL National Convention, held in Chicago in 1921.

A. L. Groves (ex-3BID) preferred the considerations involved in receiving techniques and his numerous contributions to *QST* during the early Twenties established him as a leading authority of the day.

Enthusiastically active in League affairs, Isaiah "Ike" Creaser, W1UD, joined the roster of *QST* authors in May, 1936, with his provocative description of "The Preselector Antenna."

Frank M. Murphy, W8ML, may easily be remembered for his lucid accounting of the problems met and solved in "The Murphys Build a Mast" (*QST*, May, 1923).

FEED-BACK

In the circuit diagram of the "Tur-Key" on page 19 of the December issue, the connections to the diodes D_1 and D_2 should be reversed in each case. In other words, the cathode connections should go to R_{14} and R_{13} , while the plate connections should go to R_{37} and R_{38} .

In the answer to the December Quist Quiz, the figure 923 should have been 996.

A number of readers have pointed out to us that there is something obviously wrong about the oscillator plate circuit in the 6146 transmitter described in December *QST* ("75 Watts with an 'Economy' Power Supply"). Since it is easier to show a schematic than to describe the changes in words, the correct tank coil wiring is shown in the accompanying drawing, which should replace the

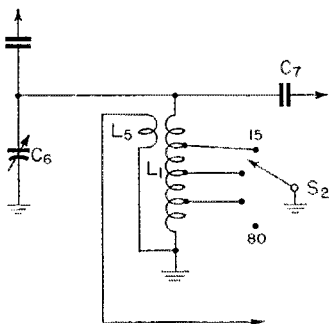

corresponding section in Fig. 1, page 24, December *QST*. Note that the neutralizing link, L_5 , is coupled to the hot end of L_1 , and that S_2 is on an open position for 80-meter operation.

ARRL Appointments:

OFFICIAL BULLETIN STATION

Here's a post in the ARRL field organization that renders a service strictly "of, by and for the amateur." Stations designated as Official Bulletin Stations by SCMs transmit bulletins from ARRL Headquarters containing the "latest and most important news concerning amateur radio." These OBSs receive the bulletins by mail, or where possible copy them directly from the League's headquarters station, W1AW. Through repeated transmissions of these bulletins at different times and in the various bands, reliable and early information concerning regulations, activities and matters of interest to amateurs is provided.

The general qualifications for OBS appointment are: ability to give good local coverage,



BROAD LOCAL
COVERAGE IS NECESSARY

ability to make a minimum of three bulletin transmissions per week, adherence to bulletin transmission schedules agreed upon with the SCM, compliance with certain requirements for reporting OBS activity to the SCM.

The ARRL Official Bulletin program is performing a valuable service to amateurs. Hundreds of OBSs are assisting in this worth-while activity. There's room for additional stations that can give certain types of coverage. Especially needed are those that can give broad local coverage such as can be obtained on the 2- and 6-meter bands. Stations working other bands in some instances are needed to fill vacancies or extend service to bands not already covered. If as a member of the League you can help as OBS, your SCM (address on page 6) will welcome your application. Where there are openings, preference will be given to stations that can provide the greatest number of transmissions and give best signal coverage.

ARE YOU LICENSED?

- When joining the League or renewing your membership, it is important that you show whether you have an amateur license, either station or operator. Please state your call and/or the class of operator license held, that we may verify your classification.



Hints and Kinks

For the Experimenter



SAFE KEYING OF A.C.-D.C. MONITORS

An a.c.-d.c. monitor can be keyed safely and simultaneously with the transmitter if a microswitch is used to activate the monitor circuit. The control arm of the microswitch should be slipped under the regular key knob so that the switch will be actuated when the key is closed. — *E. M. Brownless, VE2APO*

SIMPLE AUDIO LIMITER

An effective noise limiter that can be installed in almost any receiver in a few minutes' time consists of a pair of 1N34A germanium crystals connected across the secondary of the last i.f. transformer. The crystals should be connected in parallel with opposing polarity. Clipping depth for the system is adjusted by the r.f. gain control of the receiver.

I use the system principally as an "ear-saver" on break-in c.w., but it also performs effectively on 'phone signals. One of the nicest features is that it can usually be installed without necessitating the removal of i.f. cans or other components — *Ralph W. Stewart, W6KTR*

IMPROVING THE 14-MC. PATTERN OF 7-MC. ZEPHS

MANY of us have to rely upon a 7-Mc. half-wave Zepp antenna as a general purpose antenna. One disadvantage of this practice is that the radiation at right angles to the line of the antenna is practically nil with the system tuned for 14-Mc. operation.

This disadvantage can be overcome without affecting performance at any other frequency by dropping a 14-Mc. half-wave section from the center of the horizontal flat-top. Connected at this point the new vertical member will have no noticeable effect on the loading at any frequency but will cause the antenna to radiate an omnidirectional vertically polarized signal at 14 Mc., so eliminating the previous gap in the coverage.

It needs to be said that one does not get something for nothing, and that the amount of power radiated at right angles to the modified antenna is subtracted from the power formerly radiated in other directions. — *W. A. Roberts, G2RO*

MANUAL CONTROL OF GENERATOR CHARGING RATE

A SIMPLE method for control of the charging rate of an automobile battery is shown in Fig. 1. The system has three features that should be of interest to the mobile enthusiast: (1) the generator automatically charges at full rate

whenever the transmitter is activated by the push-to-talk switch; (2) the generator charging rate may be manually controlled by the operator; (3) voltage regulator noise is eliminated because the regulator is removed from the circuit when desired.

In Fig. 1, K_1 is a 6-volt relay and S_1 is a s.p.d.t. toggle switch. The relay is installed with the field winding connected in series with the 6-volt lead to the microphone switch and with the normally-open contacts connected between the rotor arm

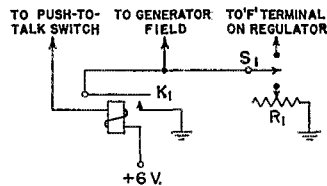

Fig. 1 — This modification of an automobile battery-charging system will eliminate voltage regulator noise and will provide additional charging current when it is needed most — during transmitting periods.

of the s.p.d.t. and ground. When installing the system, the generator lead that connects to the "F" terminal of the regulator is disconnected and then returned to the toggle switch. The remaining contacts of the toggle switch are connected to the "F" terminal of the regulator and to the 4-ohm wire-wound potentiometer, R_1 , respectively. When the switch is in the up position, the charging rate is controlled by the regulator and when the switch is snapped down, the charging rate is controlled by the potentiometer.

Any surplus relay with a 6-volt field can be used as K_1 . The contacts need not be of the heavy-duty variety, because the generator excitation current that flows through them is not of great magnitude. The points of the relay simply ground the generator field lead, thus adjusting the generator for full output for the duration of a transmission. — *L. H. Beckwith, W8OGK*

CARE OF SOLDERING IRONS

WHEN the tip of your soldering iron becomes pitted, instead of filing it smooth, thus wasting copper, draw the copper tip by squeezing it in a vise or with a ball peen hammer. The elongation of the tip not only restores the length, but the cold working will make the tip last longer. Any small irregularities remaining can be smoothed with a few light strokes with a fine file. — *Warren S. Lincoln, W6EYP, ex-W1JFA*

BC-459A CALIBRATION CRYSTAL FOR CONVERTER USE

ANYONE who has the 8000-ke. calibration crystal from a BC-459A transmitter kicking around may be interested to know that it can be put to good use in a crystal-controlled, 10/11-meter converter. When the crystal is operated at the third harmonic in the oscillator section of a converter, the resultant i.f. permits use of the calibration of the main receiver with as simple a correction factor as possible. Complete coverage of the 28-Mc. band is had by tuning the receiver between 4 and 5.7 Mc. and the 11-meter band will be tuned by the receiver range of 2960 to 3230 ke. — *John W. Watson, W7GHB*

POLYSTYRENE MOUNTING BOARDS

A COMMERCIAL appearance can be lent to that new piece of gear by mounting capacitors and resistors in bank form. One quick and easy way of making these assemblies is to lay the components flat on a narrow strip of polystyrene and then curl the wire leads over the edges of the sheet.

If the leads are then heated with a soldering iron — no solder, please — they may be forced down into the polystyrene as the latter melts. After the material has reset, it will maintain a permanent grip on leads of the components. Mounting holes for the finished assembly may be drilled at each end of the strip. — *Roy R. Campbell, W4DFR*

MODIFIED SWITCHING CIRCUIT FOR THE ELMAC TRANSMITTER

As delivered, the 3-band Elmac transmitter does not include a switch for cutting off the audio tube filaments during c.w. operation of the rig. However, the manufacturer does wire the filament circuit so that a control for this purpose may be added. Recently, when this addition to the rig was being considered, it was decided that the new switch could be mounted on the panel just to the right of the power-amplifier on-off switch. Furthermore, it became apparent that a little more input to the amplifier could be obtained by re-routing the high-voltage wiring around the secondary of the modulation transformer whenever the transmitter was switched to the c.w. position.

Section A of Fig. 2 shows part of the original Elmac schematic, and B shows the revamped circuit that uses a d.p.d.t. toggle switch to handle the filament and the high-voltage switching. Notice that S_1 disconnects the secondary of the modulation

transformer when the switch is snapped to the c.w. position, and that it turns on the audio filaments only when set at the 'phone position. Of course, the original filament on-off switch remains in the circuit.

The compactness of the transmitter makes it difficult to do any soldering at the switch terminals after the latter has been mounted on the panel. Therefore, it is advisable to equip the switch terminals with 2-foot wire leaders before the unit is mounted in place. — *William G. Grell, W1DKR*

INEXPENSIVE HIGH-CAPACITANCE VARIABLE

WHEN looking for a truly inexpensive high-capacitance variable condenser, don't overlook the b.c. receiver field. Some of the dual-superhet tuning units offer a capacitance of approximately 400 $\mu\text{fd.}$ per section for a cash outlay of only a dollar or so. Sometimes, you even find these variables on the bargain counter — marked down to 29 cents! — *John J. Schultz, W2EY*

MORE ABOUT THE MONITONE

AFTER a Monitone had been constructed and installed here at W7LGS, considerable difficulty was experienced in obtaining enough rectified voltage to bias the 6J5 to cut-off. The difficulty was eliminated by obtaining bias voltage for the monitor from the grid circuit of the transmitter final amplifier. A lead connected to the junction of the r.f. choke and the bias resistor of the amplifier may be terminated at an insulated jack on the rear of the transmitter chassis, so that the bias line to the Monitone may be a plug-in

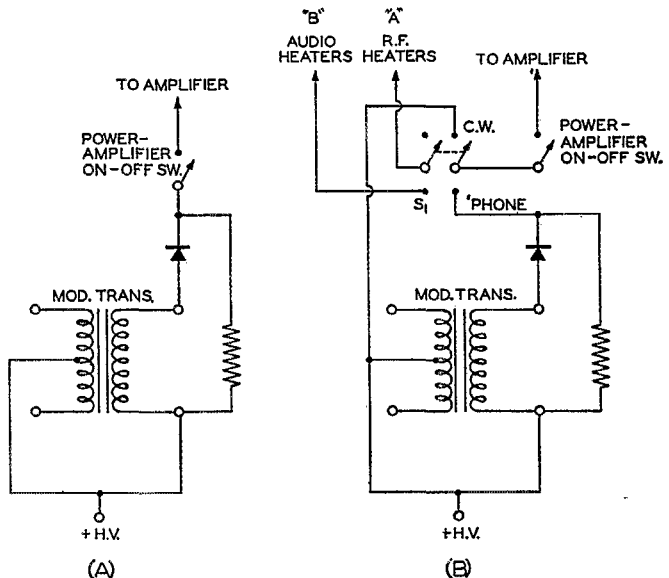

Fig. 2 — A before and after wiring diagram of the filament circuit for the Elmac transmitter. S_1 is a d.p.d.t. toggle switch.

affair. With the bias for the monitor so obtained, it is necessary to remove the input r.f. choke and the crystal diode from the Monitone circuit. Bias from the transmitter is then fed to the junction of the grid resistors for the 6J5 monitor tube.

The above system is, of course, not applicable to transmitters that use fixed bias. In the layout described above, the transmitter uses a 6Y6G protective tube that tames the 829-B final during the keying process. — *Henry A. Heller, W7LGS*

[EDITOR'S NOTE: In instances where inadequate r.f. pick-up for a Monitone is experienced, it is usually possible to remedy the condition by experimenting with the position of the pick-up link with respect to the transmitter antenna tuner or the antenna feed line. This is not intended to imply that W7LGS's stunt is not an exceedingly good one, but the information may be of assistance to those who cannot obtain bias from the transmitter for the Monitone.]

A SIMPLE LACING SUBSTITUTE

SHORT lengths of plastic spaghetti spaced along a group of wires make a good lacing substitute. Slide the spaghetti over the wires prior to fastening or soldering of the cable ends. Many colors and diameters of spaghetti are available so it is nearly always possible to achieve a secure, attractive job. — *Merrill F. Malvern, W2ORG*

SIMPLE FREQUENCY ADJUSTMENT OF MASTERMOUNT ANTENNAS

OWNERS of 3.8-Mc. Mastermount mobile antennas can lower the resonance frequency of their systems by as much as 25 kc., merely by attaching an alligator clip to the bottom of the loading-coil shield can. The clip should be oriented with the jaws pointing up toward the top of the shield, so that the body of the clip will extend down below the can in a line parallel with the lower section of the whip. If a small metal tab is soldered to the body of the clip, it will effect a still greater reduction in the resonance frequency of the antenna. — *Thomas N. Park, W6SYX*

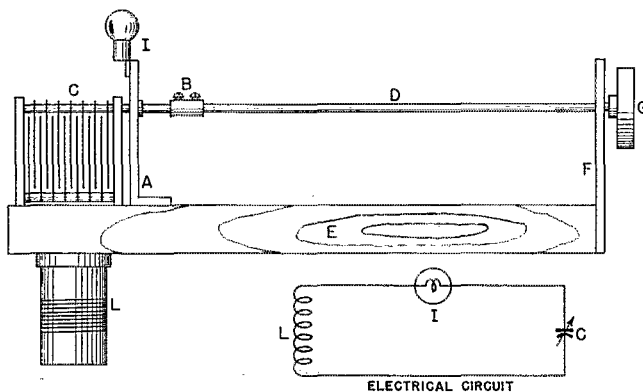

Fig. 3—An absorption-wavemeter layout that protects the operator from accidental high-voltage shock. (A) Right-angle bracket. (B) Shaft coupling. (C) Tuning capacitor. (D) Insulated shaft. (E) 12-inch length of 1-by-2-inch board. (F) Shaft-support plate. (G) Control knob. (I) Dial-lamp assembly. (L) Tank coil.

CHARACTERISTICS OF KRYLON SPRAY

A READILY available acrylic spray carrying the trade name of Krylon seems to be ideally suited for the spraying of coils and other radio components. The characteristics of this material are quite similar to those of polystyrene as shown by the following comparison:

	Polystyrene	Krylon
Dielectric Constant	2.1-2.9	2.8-2.4
Puncture Voltage *	500-2500	400-800

* In volts per mil (0.001 inch).

This crystal-clear liquid spray is easily handled. It is sealed under pressure and requires only a few moments of drying time after being released from the self-exPELLING container. — *Wendall S. Johnson, W2HYL, DL4MK*

[EDITOR'S NOTE: Several other plastic sprays are also available on the market. One of these — a product called Cres-Lite — has been successfully used in the ARRL Headquarters lab to preserve the finish on copper v.h.f. plate lines.]

SUPPORTING FORMLESS COIL WINDINGS

MASKING tape, wound sticky-side up on a temporary form of the correct diameter, will provide a permanent anchorage for windings placed over the tape. After a winding has been completed, it may be covered with a layer of tape for additional reinforcement. Links wound over the primary assembly may be held in place by another layer of tape.

When laying the tape in place make certain to overlap as the length of the temporary form is encircled. If the form is covered with talcum powder before the masking material is wound in place, it will facilitate the removal of the completed inductor from the form. — *Walter L. Petersen, W2JDH*

HIGH-VOLTAGE PROTECTION IN WAVEMETER CONSTRUCTION

AN absorption wavemeter can be a most useful and helpful gadget to have around any ham shack. However, if it is constructed in a metal box and is used near high-voltage circuits, it can be a most dangerous gadget to use.

This peril may be avoided by constructing the meter in a manner which provides adequate insulation and physical separation between the tuned circuit and the control knob of the unit. An ideal example of how this preferred type of construction may be worked out is shown in Fig. 3. Circuit constants for the tuned circuit of the meter can be found in the *Handbook*. If the shaft-support plate, F in Fig. 3, is made large enough, it may be used as the mounting surface for a calibration dial. — *David M. Sanders, W6EGX*

How's DX?

CONDUCTED BY ROD NEWKIRK, *W1VMW

How:

Well, this is *it*, gang. The month, we mean. ARRL's 19th International DX Competition gets under way in a cloud of ionospheric dust!

If you're out to cop a section or country award, consult 1952's October *QST* (results of last year's Test) to get a line on the guys and scores you'll probably have to beat. If it's a new country or two you're after, arm yourselves with the DXCC Countries List and set out to call your shots. In either line of endeavor, or both, we wish you the best of luck!

— * — * —

Jeeves emitted a rich chuckle this month when he hauled an interesting contrib out of the "How's" mailsack and found this postscript appended thereto: "First time I've ever sent anything in and sure feel like a big braggart for doing this."

Bro-ther! It's a good thing this viewpoint isn't widely held or we might just as well skip the prospect of future DX columns — there wouldn't arrive enough printable stuff to make up a miniature Stray.

That goes for most *QST* departments, for that matter. They make up ham radio's historical diary. The furnishing of an account of your individual amateur activities for documentation in this, your ARRL organ, is no more "boastful" than showing a fellow philatelist your mint album or flying your pet model plane at the town hobby meet.

So, would-be contributors, fear not to be considered vaunting by a deluded few if you've ever a notion to slip us a bit of gist for this DX mill. Those who would scoff are kidding themselves with misdirected modesty — the bright lights they thus make off to be hiding under their own bushels may be about the size of birthday candles, anyway.

What:

A few sessions of short skip have made *twenty* sound a lot more jivey. Didn't help DX sigs much but one could at least hear one's competition in the pile-ups. [Is that good? — *Jeeves*.] This list of W9HUZ's c.w. catches makes us wonder why we ever left Illinois: AP2K (14,088), CP1BX (030), CRs 6CZ (038), 7CK (030), 7LU (056), CT3AA (038), DU6CO (042), EA0AD (084), FB8s BB (066), BZ (050), ZZ (048), FK8s AB (034), AI (045), FO8AC (084), FO8s AP (066), AR (050), FY7s YB (022), YX (020), GD3UB (025), HH3L (040), HRIAT (020), IS1CXF (057), KA9AA (076), KR6IT (040), KW6AZ (102), KX6AI (047), LB6XD (018), LU4ZI (058), LZ1KAB (050), MF2AG (100), OE13HL (013), OQ5RA (016), TA3AA (015), TG9AC (106), VPs 2KM (018), 2MD (054), 8AE (054), 8AN (033), 8AP (042), VQs 2JN (045), 2KR (036), 3BM (052), 4CW (024), VR2BZ (034), VU2JG (022), ZB2A (017), ZC4GT (020), ZDs 2DCP (010), 2FFB (080), 4AB (032), 4AE (054), 7A, ZK1BC (064), ZPs 5CL (050), 6CR (020), 9AW (008), ZS3HX (066), 4X4DK (054), 5A2TS (040) and 9S4AX (017). (*Jeeves*, check the attenuation of 1000 miles of coax and

then rent us one of Van's guywires.) W4TO was AP2R's first W. Buck also mentions M13AT, SU1HS, VS9AW, ZSs 7C 7D 9G, 4X4BT, an LZ1 and a TA3 MP4HBK (123), SUSEB (125) and 4UAG (085) swelled W5ASG's collection. Bill prefers the 14-Mc. long skip in the a.m. GD3UB was a welcomed addition at W2TKG and W2AYU. The latter nabbed EA8AW, FF8AN, KV4AQ, TF3ST and 5A3TZ in addition Ex-Novice W4USM tried twenty for KV4AZ (100), TI2CR (002) and VP6EB (030) while W6LW finds VQ2HR holding court in the late p.m. on 14,086 kc. YL W3JSH awaits QSLs from 110 worked countries to elench her DXCC. ZS7F, a CR7 and ZD7A are among Dottie's most recent trophies W4KE tallied a GD3, GC4LI, OQ5CP, TG9RB, YU1AD, ZE3JP, 5A3TU, a TA3 and KN6 to keep his list growing We find FKS8BC (072), OE13RN (037), VU2EK (065), YU1CY (055), ZC4RX (050) and 9S4AR (090) accounted for by W8DLZ W1NLM, of the *Braille Technical Press*, has his DXing time limited by other activities but Jan Mayen's LB6XD was recently worked. Ev found that VP7ND is operated by W6TYF W3MFW got that LB6, too, as well as an LZ1, FB8BE (098), FM7WF (132), JA3AC, VQs 3BU (110) and 4AQ (110). "VQ3BU was on 'phone and we gave him a call on c.w.; he came back right away and then VQ4AQ called both of us." Some guys just live right! FB8BB was No. 213 for W2QHH. Howy added 5A3TY and ZD2HAH (069) for good measure CN8GK (015) was grabbed by W0AIN while W2EEY salted away FP8AP (165) and FY7YC (060) A 112/91 record is possessed by W9IHN after successful encounters with CR5AD (060), FF8s AJ (095), AG (050), VQ4NZK (070) and an EA9. Chuck speaks of chasing IT1TAL. All should bear in mind, however, that Sicily is just a different prefix and not separate from Italy on the Countries List The Northern California DX Club's *DXer* fills us in on CRs 5JB (025), 8AB (105), CT2BO (078), EAs 6AF (010), 0AC (085), F9QV/FC (052), FB8BI (042), FN8AD (050), FR7ZA (020-032), HA5FA (067), IS1CYN (020), KC6QL (118), M13LK (001), MP4s BBD (048), KAE (020), OY3IGO (050), P1J2AD (060), SP6XA (023), ST2GL (023), VQ5AU (020), VRs 2CK (095), 4AE (002), YK1AH (022), ZD9AA (035), ZS2MI (032) and 4X4BN (075).

On *twenty* 'phone, VR4AE (14,140) has been mighty popu-

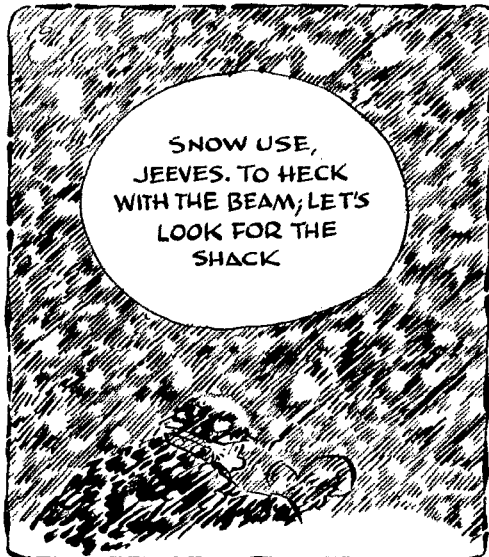

*DX Editor, *QST*.

lar with his 25 watts and folded dipole. FR7ZA and VS9AW are others helping to fatten 'phone totals; ZCSVR (284), likewise "Going is getting very tough due to very short openings," writes W1WQC. Ham finds business tapering off after a fast rise to 70 countries worked on voice. YN1LB (150) was his latest. . . . W5ASG found VS9AW on 14.123 kc. and MP4KAC (135) available. . . . West Gulf DX Club's *DX Bulletin* finds numerous 'phones handy despite rough conditions: CRs 4AD (275), 6AT (170), FB8BA (285), FQ8s AD (150), AG (120), MF2AA (164), M13s AB (150), KE (165), VG (140), OD5AC (150), ST2GL (120), SV5UN (340-380), VQs 2DT (360), 3BU (100), 4AQ (097), 5CY (170), ZS9G (190) and 5A3TX (307). We've been getting quite a few questions re those



Hundreds of W/VE DXers recorded their first Sardinia QSOs through the courtesy of Fausto Ravenna, IS1AHK.

5A2 and 5A3 prefixes now both used for Libya The *Bulletin* reveals that 11HR and IS1AHK were intending some December, 1952, 20-meter 'phone activity as 9A1B in San Marino. Lucky you if you nailed 'em!

Enthusiasm for fifteen is definitely not on the wane. Writes W3AYS: "Twenty-one Mc. sure fun — when it's open. Lots of stuff on and, best of all, they call you!" He backs this up by listing GC4LI, HZ1MY, TA2EFA, TF3SF, VQ4DO and VR2CG as recent victims; ZD9AA and ZK2AA were heard. Beams for 21 Mc. are sprouting throughout the land and the 2-element job at W3AYS brought him up to 44 countries on the band We see that W4COK is now well over sixty countries, W6VX reached 45 and W5GUD's 3-element beam brought back a fast 34 countries on fifteen VE7AIIH rigged up a stacked pair of 3-element 21-Mc. beams and is cleaning up on people like CS3AC, VR2CG, ZE2JV and this quickly worked WAC sextet: KA2OL, VK9GW, VQ2DT, HB9LO, PY3SI and VP9GX TVI haunts W2QHH on fifteen, but Howy rased CT3AV, EA9AP, OA4C, VQ4HJP, ZE3JP and ZS3K (thanks to long TV commercials?) W3MFW reached 49 countries on 21 Mc. and W4KE worked FA9UO, FF8AG, a ZE3 and many others CE3AG (21,035), CP1BX (030), GC3EML (090), KH6ARA (060), VK4FJ (095), VP7NM (031), TI2TG (030), VR2CG (068), ZB1BJ and ZD7A answered W9HUZ. . . . From KP4KD we hear of QSOs with CN8AF, CT3AV, EA9AP, VK3NM,

VP9BG, YU3BC and 4X4RE. VKs and others normally plentiful on other DX bands are uncommon catches right now on 21 Mc.

We'll have a new paragraph headed forty 'phone ere long and it should help out 'phone DX enthusiasts no end in view of spotty doings on twenty. That first 7-Mc. 'phone WAC will look good in any log! Meanwhile, forty c.w. was used by W3JSH for FM7WD (7040), VP8AP (020), VR2CG and ZS9I (040). That VR2CG really gets around on all bands! OT DXer W2DOD (ex-W8DOD) nailed IS1AHK, MP4BAU (011) and ZS9I to reach that coveted 100-countries-on-40 status. Elmer's first 91 were worked with a 60-watt BC-459; he switched to a 400-watt 813 rig for the last few W2QHH made it 96 7-Mc. countries by way of FF8AG (002), OE13RN, YV5DE (020) and ZB2I (039) W4KE did a job on EA8BF, FF8AG, HH2LD, PJ2AD, VK6SA, VP6UN, ZE3JP and 5A3TR while SP9KKR gratified KP4KD. . . . MP4BAU and YJ1AB are good ones at W4TO; W3DLI caught PJ2CE very QRL around 7050 kc. . . . W9HUZ specifies CE3DG (016), CN8AF (041), CR7BC (038), KJ6FAA (040), KT1RF (030), TFs 3MB (011), SV (036), YUs 2CE (050), 3CV (050) and ZD2DCP (010) as good bets for QSOs The DXer has us watching for CR9AH (022), FK8AJ (004), KC6QL (055) and ZCSVS (016-021).

Eighty is obviously enjoying a lull before the DX Test storms. OE13RN (3500-3511) and VR2CG (3511 — there he is again!) made it 95 countries on 3.5 Mc. for W2QHH VK5KO and sundry Europeans kept KP4KD busy while W9HUZ was knocking off VP9BF (3516) and ZD4AB (3504) KH6ARA has been giving east coast Ws a good shot at Oceania — W8YGR and W9AIN were also pleased to catch Pat around 3510 kc. . . . ZB1BJ and FF8AG are new ones lately on 80 and we hear that W8BKP pulled a good one out of the hat — VU2EJ (3550)!

The 160-Meter Transatlantic Tests are up to bat and as we write Europeans are being worked by W5s and W6s. March QST should contain some juicy details!

Where:

"Many QSL cards for Canton [Island] hams are being missent to Canton, China, and are subsequently forwarded from there via surface transportation. It will help to include 'Pacific Oceania' in the addresses for cards destined Canton Island, and underline this part of the address. The complete address for all Canton Island hams: Amateur Radio Station KB6—, (operator's name if available), Canton Island, Pacific Oceania, U. S. Post Office 06-50000." So advises our friend KB6AY (ex-KM6AH-W6ZVJ-W2DBE).

AP2R, Box 151, Karachi, Pakistan

CRKP, Box 192, Lanchow, Manu, China

EA8AF, B. Ruiz Diez, Ing. Manuel Becerra, Las Palmas, Canary Islands

EA8BQ, A. Ramirez, Noria Alta 1, Santa Cruz de Tenerife, Canary Islands

EA9AP, P. O. Box 213, Melilla, Spanish Morocco

EA9AB, Barriada de la Lealtad, Pabellon 1, Ceuta, Spanish Morocco

EA9AT, F. Aragon, Pabellones de la Heras 5, Ceuta, Spanish Morocco

ex-EQ8SAM, Samuel G. Morrison, 509 Weldon Ave., Oakland, Calif.

FD4AD, Box 185, Lome, French Togoland

FQ8AS, (QSL via FQ8AG)

JA3AB, D. Fujimoto, 339 Shinmachi, Shimoda Chiuri, Kamigyo,

Kyoto, Japan

KJ6WU, APO 105, % Postmaster, San Francisco, Calif.

KL7DP, Phil Argell, % CAA, Box 2421, Juneau, Alaska

OA4DW, Box 2916, Lima, Peru

PJ2CE, M. J. Huith, Curacao, Netherlands Antilles

SU1HS, (QSL via W4TO)

TA3AA, A. Kirinich, USN, TUSNG-JAMMAT, APO 206A, %

Postmaster, New York, N. Y.

VE8RD, % Eastern Arctic Patrol RMS, Ottawa, Ontario, Canada

VK1HM (VK6HM), % Department of Civil Aviation, Cocos Islands

VP2LE, Box 170, St. Lucia, Windwards, British West Indies



OE13JR, Salzburg, Austria, works plenty of DX on 14-Mc. 'phone and c.w. Stewart has held the calls W1KJO and W4NCW. Some gat collection, too!

QST for



There are at least 3200 worked countries accounted for in this group photograph of last October's second informal get-together of Massachusetts DXCC members, held at Cambridge. Local line voltages must have been at all-time highs that night!



VQ2HR, Box 199, Livingstone, No. Rhodesia
 VQ2W, Box 249, Chingola, No. Rhodesia
 VS9AW, % RAF, Salalah, Aden
 WP4TP, Calvin S. Scott, Naval Base, Box 53, San Juan, P.R.
 ZC4RS, Roy R. Sullivan, Haraklis, Nicosia, Cyprus
 ZC5VR, Vic Randall, P. O., Sandakan, British North Borneo
 ex-ZM6AK, Normau Wilding, ZL1FT, Aeradio Stn., Kaitia, via
 Awanai P.O., N.Z.
 ZS3N, Gordon, P. O. Box 109, Lederitz, Southwest Africa
 ZS9I, Maun, via Francistown, Bechuanaland (or QSL via SARL)
 5A3TR, (QSL via W6FJB)
 5A3TU, (QSL via W6PCS)

For the preceding QTHs we are indebted to W1s RWS WPO W2CJX, W3s DLI LXE, W4TO, W6s DI LW, W9s CFT HUZ 1HN, G3FEM, KL7PI, KP4KD and NCDXC's DX'er.

Tidbits:

Asia — "Although there *should* be an evening opening here to the States, the 14-Mc. band is useless after 1800 our time so the only chance [for Ws] I have is after breakfast — 1700 to 1900 EST. I find such openings 10 or 12 days per month and manage to contact quite a few of the boys then." So writes KA9AA (W4VE). Fred says there's a chance that KAs will be authorized use of 7 Mc. soon and this should help fill in the 20-meter holes W1WPO (ex-W6YYN) of the DXCC Desk finds that ZC4XP (ex-MD7XP) collected the first DXCC membership ever awarded a Cyprus applicant Remember W2OAA/J8 who was very active just after WW-II from Korea? Harry, who has been W1DJV for several years, now moves to Syracuse where he intends to put W2OAA on the air.

Africa — VQ3KIF notifies us of the passing of VQ4KTB, one of East Africa's pioneer old-timers W9IHN worked VQ4NZK while the latter traveled with an African safari shooting wildlife photography. George was expecting to beat the bush through Tanganyika, Uganda and Zanzibar before calling it a day. Could be some VQ1 QSOs in the making? VQ2HR informed W6LW of a change in mail QTH (see "Where") and we learn that VQ2AB hasn't yet returned from Europe to tackle that QSL backlog.

Oceania — In the case of ZC5VR, everybody was curious about the sudden switch from the regular VS4 prefix for North Borneo. ZC5VR first popped up in last December's "How's" — he and 5VS are all okay although G2MI tells W1WPO that something is awry with the label. Art recalls similar difficulties with VS4H/VS5JH some years ago KB6AX QRT'd in favor of a new CAA assignment at Rock Springs, Wyo. KB6AZ is newly ticketed on Canton and KB6s AO, AQ and AY are quite active. "Ten meters

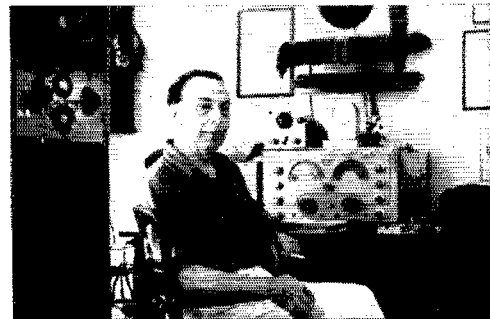

PY1DD blasts out a solid signal from Coffeeland by keeping a 150-watt warm on most DX bands. His receiver is an HRO.

has been showing a little life lately with west coast W stations beginning to put in fair signals for short periods each day. Fifteen meters continues to be rather spotty with little activity noted. KB6AY will be active on ten and fifteen, as well as twenty and forty," writes Fred, KB6AY Yipes — W3DLI's local TV station changed to Channel 2 from TVI-free Channel 3. Walt learned from VK5XK that VK6HM (VK1HM) will operate regularly from the Cocos Islands on a fairly permanent basis. Can anybody in Vermont, Rhode Island and Georgia help VK5XK complete WAS? Arch has a solid 7-Mc. signal when conditions are decent The 75-foot *Congoola*, a two-master bound from Brisbane from the Mediterranean, has VK4OA aboard operating maritime mobile. VK4SG adds that the skipper is an ex-ZL1 VK2YC assures us that VK1s PG and YG have QSL'd 100 per cent via bureaus. Jim's friend Dr. Bob Black, VK2QZ, uses the call VR4AF in different parts of the Solomons. Bob works for the Tropical Medicine Section of Sydney University and has had a little difficulty obtaining cards on order from the printer for his VK2QZ/P/9 operations — patience requested Try the QTH in "Where" if you still are owed a ZM6AK QSL. Norm tells W2CTO he's eager to clean up any backlog outstanding "I had approximately 50 QSL cards stamped and ready to mail when the typhoon struck [Wake Island] on Sept. 16th. As a result I have no record of those amateurs who sent QSLs and requested mine in return," reads a letter from KW6AZ. So, if you haven't chalked up a KW6AZ card for your QSO prior to that date you'll have to reapply. Louis (ex-W8REC-W2LDD-W5LDD) strives to maintain a spotless QSL record and his *Call Book QTH* is all okay.

Europe — Although he knows it has no separate-country status, DL4LQ thought it would be interesting to operate from the island of Helgoland in the North Sea and he gave it a try during December. DL4LQ/P used an 807 at 65 watts, c.w., and 50 watts, 'phone. To Bud's knowledge there never was previous ham activity there. His earlier efforts to try some Leichtenstein and 9S4 DXing bore no fruit. DL4LQ is also looking into the possibility of a small Corsican DXpedition W7MQY, who had no luck in attempts to land a KA2 license, reports that W7MIC is about to get on in France with an F7 call Howy's QRP scores again — W2QHH has captured the first Helvetia-22 sheepskin awarded a non-European amateur Alec of ZB2A writes W1WQC (ex-W9WQC-W9WQC) regarding the trials and tribulations of Gibraltar's ham club. It seems their policy of QSLing three times yearly has brought ZB2A a poor rep in that department and the boys are digging in to do something about it. Use of the following address may get you your overdue ZB2A QSL: 4041733 S.A.C. Allan, Room 114, Signal Block, RAF, Devil's Tower, Gibraltar LB9IC caused W3MZE to do a double-take but Andøy Island turned out to be barely off the Norwegian mainland a *la* Key West.

South America — Cheery news for those awaiting VP8AP confirmations: K2BU has it that 8AP was momentarily expecting delivery of 750 blank pasteboards. This should more than take care of his logjam in that respect W7HYW hears that VP8AP still pursues Nevada, New Mexico and Utah for you-know-what and looks for these states around 1700 MST daily on 14,030 kc. From W9CFT we understand that W9OWK is in Paraguay and hopes to put a ZP call on the air behind a Harvey Wells exhaler. W1OB is another ham heading down that way and Dag may have a chance to give the bands a whirl from the vicinity of Peru From HC2JR via

DX CENTURY CLUB AWARDS

HONOR ROLL

W1FH.....250	WØYXO.....242	W3JTC.....237
W8HGW.....245	W6ENV.....241	W3KT.....236
W6VFR.....244	G2PL.....241	W3CPV.....235
W3BES.....243	W6AM.....238	W6SN.....235
	W3GHD.....237	

RADIOTELEPHONE

W1FH.....223	W1NWO.....204	Z36BW.....197
PY2CK.....221	W8HGW.....202	W6DI.....195
VQ4ERR.....216	W9RBI.....200	W2APU.....194
XE1AC.....213	W1JCX.....200	SM5KP.....194

From November 15, to December 15, 1952, DXCC certificates and endorsements based on postwar contacts with 100-or-more countries have been issued to the amateurs listed below.

NEW MEMBERS

W8CDT.....203	DL1AV.....106	W2HAZ.....100
DL1DX.....120	G1BAXI.....105	W4KR.....100
OZ7SM.....117	G8EFY.....103	DL1HA.....100
DL1FE.....114	W2GVP.....102	VE3XY.....100
	W2HQB.....102	

RADIOTELEPHONE

W4KAE.....117	OZ7SM.....110
PAØJA.....114	KL7AFR.....103

ENDORSEMENTS

FNBS.....221	SM5WJ.....148	ZL4BO.....124
W2DS.....221	GM3CLX.....142	W6RRG.....119
W6DL.....202	SM5DZ.....142	W3LXE.....117
W4NNH.....182	G5LH.....141	CF4AD.....117
W6EAY.....170	W7HXG.....141	W9KA.....113
W1BFT.....153	W1BGW.....140	W4JUJ.....111
VK5RX.....152	VE3QZ.....140	VE1EX.....111
HP1BR.....150	ZS3K.....140	W1KQY.....110
	I1FO.....124	

RADIOTELEPHONE

W3GHD.....170	WØANF.....130	EA4CM.....117
VE3KF.....152	SM5WJ.....123	

W1WPO comes a clarification concerning HC9MM QSLs floating around. HC8MM now operates from a fish refrigeration plant on the island of San Cristobal and uses, in some instances, the HC9MM cards which were previously designated for maritime-mobile operation. Depending on the dates of QSOs, they may be perfectly okay for DXCC.

Hereabouts — A phoney FG7XA fooled the boys for a while during August and September of last year. FG7XA

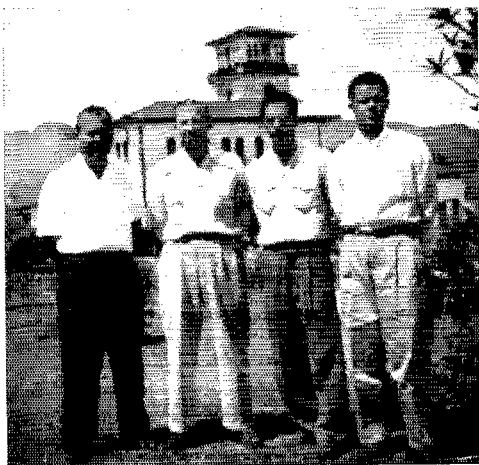

If you've worked Costa Rica, you've undoubtedly worked one or more of these TIs (l. to r.): 2DL, 2BR, 2TY and 2PZ.

does hit the air at times but travels much in the interims. W4LVV, who has an opportunity to keep close tabs on the Guadeloupe situation, has rigged up a 2-element rotary affair after knocking dead over 200 countries with a half-wave vertical If you are long overdue for a KJ6AJ c.w. confirmation, take a closer peep at the log to see if you might have worked CO6AJ instead. It's an easy mistake to make if you have no beam because CO6AJ frequents 14 Mc. in the early mornings and is very QRQ It's an unpleasant task to record here the passing of two well-known DXers, Bob Haskins, W4DRZ, and Jack Dodman, W9GA. Bob, whose big sig will easily be recalled by the prewar gang, was a holder of DXCC when countries were relatively few and far between. Jack was a strong competitor in postwar ARRL DX Competitions and won the award for Illinois in the '48 Test W1WPO notes that KL7AFR's postwar DXCC diploma is the first earned by an Alaskan 'phone W2BBK (FP8AK) speaks of plans for a bigger and better DXpedition to St. Pierre come summer, in conjunction with W3BXE and W2ZBO W9NDA, who sports a large signal in DX 'phone doings, has sprouted a flock of new skyhooks and we understand that OT DXer W2BMX is rolling up his sleeves for the fray once more.

Jeeves just laid aside his slide rule and trig tables after calculating that if all verbiage pertaining to rumored rare-DX expeditions that never pan out was hooked end to end we wouldn't need a boat to get to TI9.

A.R.R.L. QSL BUREAU

The function of the ARRL QSL Bureau system is to facilitate delivery to amateurs in the United States, its possessions, and Canada of those QSL cards which arrive from amateur stations in other parts of the world. Its operation is made possible by volunteer managers in each W, K, and VE call area. All you have to do is send your QSL manager (see list below) a stamped self-addressed envelope about 4¼ by 9¼ inches in size, with your name and address in the usual place on the front of the envelope and your call printed in capital letters in the upper left-hand corner. For a list of overseas bureaus see p. 62, Dec., 1952, QST.

- W1, K1 — J. R. Baker, jr., W1JQJ, Box 232, Ipswich, Mass.
- W2, K2 — H. W. Yannel, W2SN, Lake Ave., Helmetta, N. J.
- W3, K3 — Jesse Bieberman, W3KT, Box 34, Philadelphia 5, Penna.
- W4, K4 — Thomas M. Moss, W4HYW, Box 644, Municipal Airport Branch, Atlanta, Ga.
- W5, K5 — Oren B. Gambill, W5WI, 2514 N. Garrison, Tulsa 6, Okla.
- W6, K6 — Horace R. Greer, W6TL, 414 Fairmount St., Oakland, Calif.
- W7, K7 — Mary Ann Tatro, W7FWR, 513 N. Central, Olympia, Wash.
- W8, K8 — Norman W. Aiken, W8LJS, 701 East 240th St., Euclid 23, Ohio
- W9, K9 — John F. Schneider, W9CFT, 311 W. Ross Ave., Wausau, Wisc.
- WØ, KØ — Alva A. Smith, WØDMA, 238 East Main St., Caledonia, Minn.
- VE1 — L. J. Fader, VE1FQ, 125 Henry St., Halifax, N. S.
- VE2 — Austin A. W. Smith, VE2UW, 6164 Jeanne Mance, Montreal 8, Que.
- VE3 — W. Bert Knowles, VE3QB, Lanark, Ont.
- VE4 — Len Cuff, VE4LC, 286 Rutland St., St. James, Man.
- VE5 — Fred Ward, VE5OP, 899 Connaught Ave., Moose Jaw, Sask.
- VE6 — W. R. Savage, VE6EO, 329 15th St., North Lethbridge, Alta.
- VE7 — H. R. Hough, VE7HR, 1330 Mitchell St., Victoria, B. C.
- VE8 — W. L. Geary, VE8AW, Box 76, Whitehorse, Y. T.
- KP4 — E. W. Mayer, KP4KD, Box 1061, San Juan, P. R.
- KZ5 — P. C. Combs, KZ5PC, Box 407, Balboa, C. Z.
- KH6 — Andy H. Fuchikami, KH6BA, 2543 Namauna Dr., Honolulu, T. H.
- KL7 — Box 73, Douglas, Alaska



CONDUCTED BY E. P. TILTON,* WHDQ

SEEMS like every winter it's the same story. Along about two weeks before Christmas the short skip starts booming in on 10, and finally things get rolling on 6. But not right away, because too many of the gang who work the 50-Mc. band in the summer months take it for granted that it's all over until the following spring when the DX openings dwindle out early in August. Despite all that has been written about sporadic-E skip being a sure thing in December, the few boys who are around for it always express surprise at finding the band open in the winter months.

Not that DX is the end and all of living for the 50-Mc. enthusiast, but a shot of sporadic-E skip is relished by us all now and then. We could have a lot more fun on 6 the year around if more fellows would just keep trying on the band, instead of making it a summertime pursuit only.

And winter isn't so bad for the higher bands, either. To be sure, there isn't an inversion every night, and it is not often possible to equal summer distances even when conditions are at their best, but when there is a good night in the winter signals are steady and strong over extended-local distances in a way that summer seldom produces.

How about the rest of the cold months? January turns up its share of sporadic-E, though it will be largely over by the time this appears in print. February and March are the aurora months. Some of the most pronounced examples of this intriguing form of propagation have occurred then, and there can be good tropospheric conditions any time of the year. You got a shot of v.h.f. enthusiasm during the 6th Annual V.H.F. Sweepstakes early in January—how about sticking with it through the rest of the winter? You'll be in just that much better form for the spring and summer openings if you do.

Using Crystal-Controlled Converters with the 75A Series Receivers

Some time ago, W8NOH, Grand Rapids, Mich., built the 2-meter crystal-controlled converter described in *QST* for September, 1951, and in the 1952 and 1953 editions of the *Handbook*. It was fine so long as Lou kept his general-coverage receiver, but when he acquired a Collins 75A-2 the crystal-controlled converter went back on the shelf. The converter was designed to tune upward from 7 Mc. on the communications receiver, and that meant only 500 kc. of the band could be covered on the 75A-2.

A tunable converter that had seen service prior to construction of the crystal-controlled job was hauled out, but it took only a few minutes' struggling with its wandering oscillator to convince W8NOH that this approach to v.h.f. was no longer for him. Once you've used crystal-controlled reception you're not likely to be satisfied with anything less—but how to do it with the limited tuning range of the new receiver?

*V.H.F. Editor, *QST*.

Ah—how about the two highest ranges on the 75A-2? To cover both 11 and 10 requires movement of the band-switch, but it gives a tuning range of 26 to 30 Mc., the four megacycles needed for 6 or 2. That would require an injection frequency of 118 Mc., which could be reached with the same order of frequency multiplication originally used by changing the crystal frequency to 6555.55 kc. Next, a check of the surplus crystal stock turned up one at 6540. A few swipes on the ground glass moved this to 6556; close enough. No changes other than retuning the circuits of the converter were needed to get oscillation on 19,688, and multiply progressively to 59,004 and 118,008. The discrepancy was within the range of the zero-set adjustment on the 75A-2, so it was possible to read frequencies in the 2 meter band right on the nose!

Next, and last, all that was needed was to remove a few turns from the mixer and i.f. amplifier plate windings so they would resonate at 26 Mc., and Lou was ready to go. Not a birdie in the whole tuning range, stability like on 7 Mc., and a 12-db. improvement in signal-to-noise ratio over that of the wobbly old tunable job. Say—this 2-meter c.w. is really something!

The Transistor Transmitter at K2AH

Last month we reported the first use of a transistor in an amateur transmitter by K2AH, Mountain Lakes, N. J., crediting it as the low-power record for v.h.f. transmission.

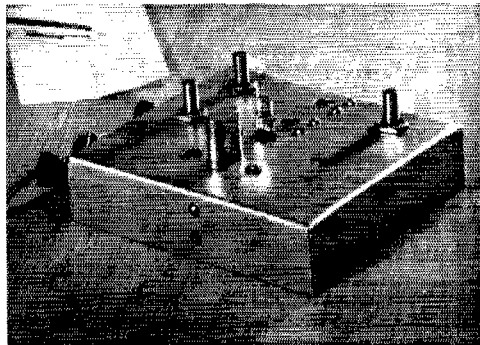

Even though the 2-meter transistor rig at K2AH is an experimental lash-up equipped with pots and trimmers of conventional size, it is still only a medium-sized handful. The transistor is the tiny object at the center of the chassis.

Here are the basic facts, in case you'd like to challenge George's claim to the record.

The transmitter used an experimental RCA transistor connected as an overtone oscillator, working on the 9th overtone of a 16-Mc. fundamental crystal intended for use on its 5th overtone, 80 Mc. The "power supply" was a single 22½-volt hearing aid battery, dropped to 8 volts through a variable resistor. The input was 3 mls, or about 24 milliwatts. Output, difficult to measure at this level, was estimated to be in the vicinity of 50 microwatts!

Only the single transistor was used, and it was keyed for c.w. directly in the oscillator. For the moment, George was unable to find a small enough audio system to modulate the thing safely, though W2UK, 25 miles away, reported the signal strong enough to have been readable on voice. What a portable for the next v.h.f. contest!

Here and There on the V.H.F. Bands

The week before Christmas produced some fine 6-meter DX, including the first double hop reported during winter months. Contacts too numerous to report in detail were

2-METER STANDINGS

Call			Call		
States	Areas	Miles	States	Areas	Miles
W1HDQ	18	6 850	W5ONS	7	2 950
W1IZY	16	6 750	W5SWV	7	2 —
W1RFU	15	7 1150	W5FBT	6	2 500
W1MNF	14	5 600	W5IRP	6	2 410
W1BCN	14	5 580	W5FSC	5	2 500
W1DJK	13	5 520	W5DFU	5	2 275
W1CTW	12	4 500			
W1KLC	12	4 500	W6PJA	3	3 1390
			W6ZL	2	2 1400
W2NLY	22	7 1050	W6WSQ	2	2 1390
W2UK	21	7 1075	W6NLZ	2	2 237
W2QED	18	7 1020	W6CGG	2	2 210
W2AZL	18	7 1050	W6EXH	2	2 193
W2ORL	16	7 830	W6ZEM	1	1 415
W2PAU	16	6 740	W6GGM	1	1 300
W2QNZ	14	5 400	W6YYG	1	1 300
W2SEK	13	6 —			
W2DFV	13	5 350	W8WJC	21	7 775
W2CET	13	5 405	W8BFQ	21	7 775
W2UTH	12	7 880	W8WRN	19	7 670
W2DPB	12	5 500	W8WXV	18	8 1200
W2FHH	12	5 —	W8UKS	18	7 720
W2BVU	12	4 260	W8DX	17	7 675
			W8EP	17	7 —
W3RUE	19	7 760	W8WSE	16	7 830
W3NKM	19	7 660	W8RWW	16	7 500
W3QKI	17	7 820	W8BAX	15	6 655
W3KWL	16	7 720			
W3LNA	16	7 720	W9FVJ	22	7 850
W3FPH	16	7 —	W9EQC	21	8 820
W3GKP	15	6 650	W9BPV	20	7 1000
W3WOW	13	6 600	W9UCH	20	7 750
W3KUX	12	5 575	W9LF	19	—
W3PGV	12	5 —	W9WOK	17	6 600
W3LMC	11	4 400	W9MBI	16	7 660
			W9BOV	15	6 —
W4AO	20	7 950	W9LEE	14	5 780
W4HHK	19	6 710	W9AFT	14	—
W4JFV	18	7 830	W9UIA	12	7 540
W4MKJ	16	7 665	W9GTA	11	5 540
W4OXC	13	7 500	W9JBF	10	5 760
W4JDN	13	6 —	W9DSP	10	3 700
W4IKZ	13	5 650			
W4JFU	13	5 720	W0EMS	21	8 1175
W4CLY	12	5 720	W0GUD	20	7 1065
W4JHC	12	5 720	W0IHD	16	6 725
W4OLK	12	5 720	W0NFM	14	7 660
W4FJ	12	5 700	W0ZJB	12	7 1097
W4UMF	12	5 600	W0INI	12	5 830
W4LRR	5	2 900	W0WGZ	11	5 760
			W0OAC	11	5 725
W5JTI	14	5 670	W0JHS	9	3 —
W5RCL	14	4 790	W0HXY	9	3 —
W5QNL	10	5 1400			
W5CVW	10	2 1180	VE3AIB	17	7 850
W5MWW	9	4 570	VE3DIR	14	7 790
W5AJG	9	3 1260	VE3BPB	12	6 715
W5ML	9	3 700	VE3AQG	11	7 800
W5ERD	8	3 570	VE1QY	11	4 900
W5ABN	8	2 780	VE3DER	10	6 800
W5VX	7	4 —	VE3BOW	8	5 520
W5VY	7	3 1200	VE3QN	7	3 540
W5FEK	7	2 580	VE3TN	7	4 480

made throughout the East and Middle West on the 16th, 18th, 19th, 20th and 21st. The session of Dec. 19th was perhaps the most widespread winter 50-Mc. opening on record, stations having been reported worked in all U. S. call areas.

Some idea of the extent of this one can be gained from the report of W7QAP, Hereford, Ariz. Beginning at 1728 MST, Bud logged W1GJO, and in the next hour, W0ZJB, W0MVG, W5AJG and W8SSQ. At 1828 W1RFU was heard, and almost simultaneously W8GZ, W5SFW and W4FBL—Massachusetts, Ohio, Texas and Florida, all within a space of 10 minutes. Single-hop W5s, 8s and 9s remained in until 2230. W6BWG, San Gabriel, Calif., logged several Texas stations during this period.

W7QAP worked W0ZJB intermittently from 1008 to 1302 the following day, and on the evening of the 21st he was in three-way contact with W5ONS and W4LAW for more than an hour, with signals still strong when they quit at 2015 for lack of more stations to work. W6BWG was hearing W5ONS at the time, but not the others.

Would anybody like to make a transatlantic contact on 144 Mc.? Now wait a minute before you start the horse laugh—remember how most of us would have reacted to the suggestion of a 1000-mile two-way on 144 Mc. a few years ago; yet scores of contacts have been made in the past couple of years over this and greater distances on 2. All the evidence indicates that even the 1400-mile record was not the maximum distance that could have been worked, and practically every haul over 1000 miles has been limited in distance only by lack of activity in two more widely-separated areas.

The first real shot at a transatlantic 2-meter mark will be afforded us next summer as the result of a series of tests to be sponsored by the VHF Research Society of Ireland, according to word received from the president of that group, Harry Wilson, EI2W-EI2B. A 2-meter station will be maintained in constant operation from Mayo on the West Coast of Ireland, from the latter part of July through early August, and liaison with this country will be maintained on 20. Other Irish stations will also participate in the tests, and the cooperation of all American 2-meter operators is requested. The nearest point on the North American Continent is about 1900 miles from Mayo, and the nearest in this country is about 2500 miles, but nothing tried, nothing gained. More details later.

While we are in the international DX department, OQ5LL, Leopoldville, Belgian Congo, writes that his 500-watt 50-Mc. rig is about ready to go. While it is unlikely that much F₂ DX will be workable on 6 for the next few years, the CRPL predictions for next spring show higher F₂ MUF in some localities than was indicated on the predictions for the same period last year. Sporadic-E DX around the African Continent should be possible, and there's no harm in trying for something better, either. Andy will be on 50.010, and he's working this country regularly on 14,110 to 14,120, if you want to talk things over with him. Saturdays at 2000 GCT he skeds W5FXN.

Looks as if we may have credited the wrong fellow with the new 220-Mc. record between W5RCL and the Houston boys. W5FEK says that W5AXY worked W5RCL first, and was followed by W5BDT, so Waldo nominates the two Houston operators as co-holders of the 520-mile record, with AXY having a slight edge in distance.

Until recently, the state of New Mexico was nearly devoid of v.h.f. activity, but now, thanks to the efforts of the Albuquerque V.H.F. Club, things are coming along nicely. W5VWU lists the following as among the more active 2-meter stations in the state: Albuquerque—W5s FJE LQW RFF RQK OLN FAG FPB; Tijeras—W5CA; Santa Fe—W5s NTF and KCW; Los Alamos—W5s TOU BNJ and MYQ. About 20 others get on less frequently. W5s DAI CTG and LQW are on 420.

W5VWU would be glad to keep DX skeds with stations in West Texas or elsewhere. He calls CQ on c.w. each morning at 0630 on 144.1. He has a pair of 4-65As, a 16-element array and a crystal-controlled converter—plus a 7200-foot elevation with a clear shot to the east.

The Albuquerque V.H.F. Club is sponsoring a 144-Mc. activity competition, with points scored according to the distance covered: up to 10 miles, 1 point; 10 to 75, 5 points; 75 to 150 miles, 10 points; and over 150 miles, 25 points. Points may be claimed for contact with a given station only once in any 24-hour period, and all must be two-way on 144 Mc. The contest is open to any New Mexico amateur, and logs should be submitted to W5OLN. A total of 1000 points is needed to qualify for the award.

Did you see that antenna on the cover of the December issue of QST? Well, that wasn't enough for W3RE. Reports are that Robbie now has a 32-element array for 420 on a separate tower, rigged with a hydraulic hoist, so that its height above ground can be varied between 20 and 75 feet. This one should produce some interesting results.

W2QED, Seabrook, N. J., is back on 420 after a serious illness, and is keeping 420 skeds each Thursday night. The morning skeds on 144 Mc. with W1HDQ have been resumed, the present sked time being 0730. Ken says that W3AIR has been experimenting with a dish reflector on 420, and he has found that the best orientation of the array

changes from time to time, even during a single transmission. Sometimes maximum signal has been received several degrees off the true direction, and on occasion tilting the dish as much as 15 degrees upward produces the strongest signal.

In the hope of promoting greater interest in the region around Fitchburg, Mass., the Region 9 Amateur Radio Club is sponsoring a V.H.F. Night to be held at the Elks Club, Fitchburg, Feb. 20th. Invitations are being mailed to all amateurs within a 30-mile radius, and others beyond are welcome. An extensive program is being planned, to include an equipment and parts raffle (bring your salable gear; owner and the club will share in proceeds), snack luncheon at small cost, and other features, including a talk by your present correspondent. There will be no admission charge.

OES Notes

WICTW, Arlington, Mass., reports completion of a Control Center rig for 50 Mc., using a 12AT7 and a 2E26. The method of stabilizing the latter is of interest. The 2E26 stage didn't take off when drive was removed, but neither was it as stable as Cal would like, the reaction on the grid drive when the plate circuit was tuned being excessive. The screen inductance method Cal showed in his article on the CD portable in May, 1952, QST was then tried. A 1/4-inch-diameter coil of 3 1/2 turns between the 2E26 screen and a 470- μ fd. by-pass to ground did the trick. All the cathode pins of the 2E26 socket were grounded, and the turn spacing of the coil adjusted for optimum stability.

Reporting for the Rochester V.H.F. Group, of which he is now Secretary (W2OWF, Chairman, W2QF, Vice-Chairman), W2UAD says that "off-season" activity on 144 Mc. is at an all-time high in the Rochester area. The Finger Lakes Net now includes stations in Greece, Irondequoit, Webster, Chile, Perry, Spencerport, Hilton, Walworth, Auburn, Genesee, East Bloomfield, Newark, Savaanah, Ontario, Bristol Center, and several other towns, and new calls are being added right along. Plans are being made for a long-range v.h.f. contest under Rochester V.H.F. Group sponsorship.

W2UTH, also of Rochester, has gear for 50 Mc. now, but is not having much luck finding stations to work on that band.

W7JRG, Billings, Mont., reports success in his 144-Mc. skeds with W7HNI, Gillette, Wyo. This is a 181-mile path between elevations of 3561 feet and 4338 feet, with two ranges over 5000 feet lying in between.

V.H.F. Net Schedules

Name or Area Served	Frequency	Control	Date and Time
Minute Men (E. Mass.)	51 Mc.	W1IN	Sun. A.M.
N. E. 50-Mc. Net	50-54	W1CLS	Mon. 2000
Worcester, Mass.	50.56	Rotates	Thurs. 1930
E. Mass., N. H.	50-54	W1DJ	Fri. 2030
Arlington, Mass.	53.4	W1VPT	Tues. 2030. Sun. 1000
Swampscott, Mass.	53.44	W1AXA	Tues. 2000
Mass. CD, Region 9	50.5	Rotates	Wed. 1830
Providence, R. I.	144-148	Rotates	Thurs. 2000
Horsetraders (W1, W2)	50-51	W1HDQ	Tues. 1930
N. Y. Area	220-225	?	Sun. 1100
Brookhaven, N. Y.	50.4	W2IVX	Sun. 1000
Poughkeepsie, N. Y.	145.35	W2HZZ	Mon. 2000
N. Y., N. J.	50-54	Rotates	Nightly 2200
Finger Lakes	145.35	Rotates	Fri. 2000
N. Y. Zone 10	145.26	W2TBD	Mon. 2200
Phila. High Freq. Club	147.3	?	Thurs. 2000
Intercity (Phila.)	147.3	?	Mon. 2000
York Road Radio Club	146.6	?	Wed. 1930
R.TTY (Countrywide)	147.96	—	Random
Oak Ridge Em. Net	50.7	W4NDE	Tue. & Fri. 1900
Albuquerque VHF Club	144.138	Rotates	Fri. 1930
2 Meters & Down Club	144-148	W6HKK	Mon. 2000
Chula Vista	144-148	W6MUJ	Thurs. 1930
San Diego	144-148	Rotates	Tues. 1900
Columbus, Ohio	146.34	?	Mon. 2000
Jackson, Mich.	145.6	W8BBY	Wed. 1930
Muncie, Ind.	146.86	W9GSY	Mon. 2000
N. Wis. Radio Club	144-148	Informal	Nightly 2000
144 Megacyclears (St. Louis)	111-118	W9KYF	Tues. 1930



W8ZJB.....48	W4BEN.....35	W8BFQ.....41
W8BJV.....43	W5VY.....48	W8LBH.....39
W8CJS.....43	W5GNY.....48	W8LPD.....37
W5AJG.....48	W5GND.....46	W9ZHB.....48
W9ZHL.....48	W5MJD.....46	W9QUV.....48
W9OCA.....48	W5ONS.....15	W9HGE.....47
W6OB.....48	W5JTI.....14	W9PK.....47
W8INI.....48	W5ML.....43	W9VZP.....47
W1HDQ.....48	W5JLY.....14	W9RQM.....47
	W5JME.....43	W8ALU.....47
W1CLS.....46	W5SFW.....43	W9AUA.....45
W1CGY.....46	W5VV.....42	W9UNS.....45
W1LL.....45	W5FAL.....41	
W1HMS.....43	W5FSC.....41	
W1LSN.....42	W5HLD.....40	W8QIN.....47
W1DJ.....40	W5HEZ.....38	W8DZM.....47
	W8LIU.....37	W8NFM.....47
W2AMJ.....46		W8TKX.....47
W2RLV.....45	W6WNN.....48	W8KYF.....47
W2MEU.....45	W6UXN.....47	W8HVV.....45
W2IDZ.....45	W6ANN.....45	W8MVG.....44
W2FJJ.....44	W6TMI.....45	W8JOL.....44
W2GYY.....40	W6TWS.....41	W8TJF.....44
W2QVH.....38	W6OVK.....40	W8JHS.....43
W2ZUW.....35	W6CCG.....35	W8PKD.....43
		W8IPL.....41
W30JU.....45	W7HEA.....47	
W3NKM.....41	W7ERA.....47	VE3ANY.....42
W3MQU.....39	W7BQX.....47	VE3AET.....38
W3RUE.....37	W7FDJ.....46	VE1QZ.....34
W30TC.....35	W7DYD.....45	VE1QY.....31
W3FPH.....35	W7JRG.....44	U86WW.....21
	W7BOC.....42	XE1GE.....19
W4FBH.....46	W7JPA.....42	
W4EQM.....44	W7FIV.....41	
W4QN.....44	W7CAM.....40	
W4FWH.....42	W7ACD.....40	
W4CPZ.....42		
W4FLW.....42	W8NSS.....36	
W4MS.....40	W8NQD.....45	
W4OXC.....40	W8UZ.....45	
W4FNR.....39	W8YLS.....41	
W4IUJ.....38	W8CMS.....41	
	W8RFW.....41	

Strays

W9ROX needed a nonmetallic alignment tool in a hurry. He quickly manufactured one by filing the end of a plastic drink stirring rod.

If your young son is already fed up with his Christmas-present mechanical construction set, W2FBE recommends that you file the remains in your junk box — many handy gadgets of the mounting and strip variety are usually contained therein.

National Bureau of Standards has under construction a major laboratory at Boulder, Colo., where complete and modern facilities are to be provided for research on radio-wave propagation and other projects. By mid-1954 a staff of some 500 scientific and clerical personnel will be employed on the 210-acre site.



Operating News



F. E. HANDY, WIBDI, Communications Mgr.
R. L. WHITE, W1WPO, Asst. Comm. Mgr., C.W.
GEORGE HART, WINJM, Natl. Emerg. Coördinator

J. A. MOSKEY, WIJMY, Deputy Comm. Mgr.
ELLEN WHITE, W6YYM, Asst. Comm. Mgr., 'Phone
LILLIAN M. SALTER, Administrative Aide

Let's Work Some DX. DX Contest time is here, and ARRL's '53 DX test (Feb. 6th-8th, 20th-22nd—'phone; March 6th-8th, 20th-22nd—c.w.) should be the best ever. Advance notices by airmail to some rare DX points as well as to all foreign amateur societies were sent out in December. All amateurs are cordially invited to get in the swim and have some operating fun and DX, such as the occasion will make possible.

A few pointers to the fellow not regularly looking for DX may be in order. Don't get in there and call indiscriminately. Try to follow practices indicated best in past experience. (1) Listen first for DX stations instead of calling. (You have to hear them before you work them, as a rule!) (2) Make calls *short*; for best results judge carefully the time to start your calls. (3) Call DX only after it signs SK, calls CQ or sends QRZ? (4) Make the reports and power figures correct and true in formulating the serial number exchanges. (5) Follow tuning indications of the DX, such as 20U, 10D or the like, meaning to put your transmitter up 20 or down 10 kc. from the frequency used by the DX, a practice that helps to prevent QRM drowning out the DX completely. HM, LH (high-to-middle, low-to-high) indications are sometimes given to help you know how the DX will tune in looking for you when time for you to transmit.

How one operates has an important bearing on the score; also, it is more important in other ways than *what* the score is since it determines how other amateurs feel about us. Try to avoid the type of operation that jams the frequency of the DX unnecessarily as by calling to no avail when numbers are being sent. Sending frequent or insistent CQs is not generally as productive of DX for Ws as *listening for and calling* the DX at the proper time, using break-in to minimize unnecessary calling. A reputation for sportsmanship and clean operating is more admired than score itself. Avoiding poor practice also avoids the label of being a ruthless and disreputable DXer.

Copies of the ARRL DX Operating Code (Operating Aid No. 5) are available on request. You can send request by letter or radiogram. In the DX test scoring competition is on the basis of true geographical equality, a certificate award for the leader using 'phone and the leader using c.w. in *each one* of the ARRL field organization sections. In the same way, the conditions vary from country to country. It wouldn't be fair to compare a score or results of a fellow in Mexico with one in Peru, for example, so there's a certifi-

cate as always for each country-leader, one for the 'phone period, one for c.w. Use our convenient DX Contest log forms for reporting and be the score large or small, let us know how you make out wherever you are located.

There are bound to be plenty of good surprises and new DX contacts if one puts in some time and chooses his bands of operation carefully. We hope for the best conditions possible. It will not be safe to ignore any band but we caution amateurs who have been off for two or three years that they may have to make a new operating plan. Some of the lower frequency bands may be good while the hours for use of ten and twenty meters will be more limited than before. However it may be, here's luck and best DX in the annual ARRL 'phone and c.w. DX fray.

Off-Frequency Citation Dangers. February and March are always months of heavy activity in FCC monitoring, since these months probably mark the greatest volume of operating by amateurs for the entire year. Official Observers will be active as customary trying to note off-frequency deviations ahead of FCC to warn careless amateurs and help keep us all out of trouble, as well as keep our amateur service reputation for frequency observance high. As in past DX contests, disqualifications will be made this year where contestants are reported by FCC or by two or more Observers for operating out of the assigned amateur frequencies.

Attention is invited by WØIA to improper operation by amateurs on the military (MARS) channels 3497.5 and 6997.5 kc. He wants to caution amateurs that they subject themselves to FCC citation by any attempt to zero-beat stations such as WAR, AIR, A- and AF-authorized MARS as an accidental or deliberate matter. Just a word in time, he says, may help some to avoid spoiling a good amateur record through the FCC citation process.

Civil Defense and Our Future. A recent FCDA successful test (Exercise Nor'easter) won praise for W1LPM, W1RVA and W1TPX. In the course of the test, the operations were made an occasion by some amateurs operating on the 75-meter 'phone band for exercising on-the-air gripes and jibes. Just *how* does name calling and over-the-air griping help our amateur fraternity does someone ask? The obvious answer is that it doesn't. Not only does it NOT help, but it is a two-edged sword that might cut our own throats. The amateur groups serving the public interest are helping to keep the flag high for all amateurs;

more, *not* less, should strive to add something to the stature of their amateur radio. No one has a moral right to decry this work. Constructively inclined amateurs will aid in such AREC/RACES efforts, and monitor the frequencies if it will help in the short time of a test. Interference between individual amateurs and groups of amateurs is a normal that we have learned to work around when busy in our amateur bands. At times we all suffer, but we come out in ability better communicators as a rule. We must bear in mind that RACES is also part of our own amateur service. It is that part of our service that is expected to give us an important operating place should another armed conflict come along; our *big* chance to be an asset under these circumstances.

So let us each take the *long-range* viewpoint. Let's listen (excellent practice at all times!) before we transmit. Surely none of us has an exclusive use or right to one frequency. There's everything to gain in the long run through co-operation. What matter if we move a few kilocycles for a few hours? Let's watch our operation, our language, and the future of amateur radio. It is our *respected* relationships with the public and others, our capabilities and self-training, the especially constructive rather than the wholly casual things we do, which constitute our surest claim on the future.

— F. E. H.

FREQUENCY-MEASURING TEST, FEBRUARY 11TH

All amateurs are invited to try their hand at frequency measuring. WIAW will transmit signals for the purpose of frequency measurement starting at 9:30 P.M. EST (8:30 P.M. PST), Wednesday, February 11th. The signals will consist of dashes interspersed with station identification. These will follow a general message sent to help listeners to locate the signals before the measurement transmission starts. The approximate frequencies used will be 3529, 7286 and 14,096 kc. About 4½ minutes will be allowed for measuring each frequency, with long dashes for measurement starting about 9:36 P.M. It is suggested that frequencies be measured *in the order listed*. Transmissions will be found within 5 or 10 kc. of the suggested frequencies.

At 12:30 A.M. EST, February 12th (9:30 P.M. PST, February 11th), WIAW will transmit a second series of signals for the Frequency Measuring Test. Approximate frequencies used will be 3611, 7210 and 14,034 kc.

Individual reports on results will be sent to all amateurs who take part and submit entries. When the average accuracy reported shows error of less than 71.43 parts per million, or falls between 71.43 and 357.15 parts per million, participants will become eligible for appointment by SCMs as Class I or Class II OOs respectively.

This ARRL Frequency-Measuring Test will be used to aid qualification of ARRL members as Class I and Class II observers. Present observers *not* demonstrating the requisite average accuracy will be reclassified appropriately until they demonstrate the above-stated minimum required accuracy. Class I and Class II OOs must participate in at least two FMTs each year to hold appointments. SCMs (see address, page 6) invite applications for Class III and IV observer posts, good receiving equipment being the main requirement. All observers must make use of the cooperative notices (mail forms provided by ARRL) reporting activity monthly through SCMs, to warrant continued holding of appointment.

Any amateur may submit measurements on one or all frequencies listed above. No entry consisting of a single measurement will be eligible for *QST* listing of *top results*; at least two readings should be submitted to warrant *QST* mention. Listing will be based on over-all *average* accuracy, as compared with readings made by a professional frequency-measuring lab.

HIGH CLAIMED SCORES 1952 SWEEPSTAKES

The Nineteenth ARRL Sweepstakes, held during the week ends of November 15th-16th and 22nd-23rd, was an operating spree that conformed to the best traditions of this well-established annual activity. Stations galore were on the air merrily engaged in swapping contest preambles. Some bands were almost completely taken over by the classic call "CQ SS" and the non-participant was hard put to find anyone willing to engage in routine contacts, which certainly attests to the popularity of the Sweepstakes! Preliminary examination of the huge stacks of entries that have reached Headquarters shows a fine crop of high scores. Leading the field on c.w. was the score of Mel Wardell, W3DGM, 1065 contacts, all 72 sections and a total of 191,700 points, which may turn out to be a new record when the final tallies are made. Right behind Mel was veteran W9IOP, a top entrant in previous Sweepstakes frays as W2IOP and W8IOP, with all sections worked, 1052 contacts, 186,660 points. Another battle-scarred veteran, W3BES, snagged third place with 181,800 points, all sections and 1010 contacts. In the 'phone category, where top honors have been taken for many years by a western contestant, the outstanding entrant was Al Pichitino, W0EDX, who scored 108,972 from contacts with 506 stations and all sections. Westerners W6GZ, 102,666 points, 724 contacts and 71 sections, and W7PUM, 98,255, 465 QSO's, 69 sections, were next in line.

Listed below are the highest claimed scores received. The listings show score, number of contacts, and number of sections worked. All figures are *claimed* by the contestants and are subject to further checking. Final results will appear in an early issue of *QST*.

C.W.

W3DGM	191,700-1065-72	W3KT	121,015-673-72
W9IOP	186,660-1052-72	W1RY	118,260-658-72
W3BES	181,800-1010-72	W5LGG	117,949-665-71
W4KFC	181,100-1048-72	W8OYL	115,500-660-70
W7PGX	169,513-971-71	W8IYE	115,380-641-72
W9RQM	168,840-941-72	W7YG	115,200-635-72
W3CTJ	162,540-903-72	W5QNZ	113,470-809-70
W4BGO	160,470-901-72	W3GRF	112,712-635-71
W3GHM	158,580-881-72	W0MBY	111,860-658-68
W3GAU	157,480-898-72	W8RSP	111,300-643-70
W3EIS	154,080-856-72	W3FQB	111,125-635-70
W7KEV	151,674-861-71	W4HQN	110,970-622-72
W3JTK	147,858-833-71	W0NWX	110,775-635-70
W9ERU	145,650-806-72	W9PNE	109,418-628-69
W6BJU	144,911-1023-71	W0PZO	109,163-624-71
W8WZ	144,000-805-72	W8SMC	108,875-650-67
W7GEB	141,120-786-72	W3EQA	108,009-610-71
W0YCR	139,213-796-70	W6HOC	106,944-606-71
W6EPZ	135,788-765-71	W3LTV*	106,234-602-71
W9WFS	133,559-753-72	W9VUL	106,225-607-70
W8LQA	128,155-727-71	W3AEL	106,087-615-69
W3LVF	127,440-708-72	W4SAT	105,915-615-69
W2GFG	126,463-755-67	W3KDP	105,847-645-66
W3JTC	125,650-718-70	W3ALB	105,300-835-72
W4CC	124,694-703-71	W3CPS	104,725-598-71
W9NII	123,717-697-71	W8CEG	104,363-605-69
W5MCT	122,670-685-72	W8YIN	101,517-590-69
W9YFV	121,500-675-72	W4ESK	100,667-601-67
W2ZSM	121,437-725-67		

'PHONE

W0EDX	108,972-506-72	W2JKH	42,480-240-59
W6GZ	102,666-724-71	W4CYC	42,147-335-63
W7PUM	98,255-465-69	W9RBI	41,580-210-66
W9NDA	91,872-638-72	W8VQD	40,020-290-69
W4PJU	83,283-391-71	W1BFT	38,802-223-58
W6AM	78,120-548-72	W1JEL	38,493-309-63
W3LXE	77,454-361-66	W9HFX*	34,710-270-65
W0PRZ	73,548-350-72	W2SZ	32,860-265-62
W4KZF	71,379-361-66	W5OTH	30,723-274-57
W6CHV	61,620-316-65	W2ICE	29,376-230-64
W9BCF	60,894-433-71	W3KDD	27,872-207-67
W5MYI	51,188-266-65	W9LXY	27,803-170-55
W7HAD	48,564-342-71	W3BET	27,136-257-53
W2NSD	46,242-367-63	W7EYD	25,955-180-58
W4H0W	44,940-321-70	W4NTZ	25,376-210-61

* Multiple-operator station.



During the week of October 19th many forest fires broke out throughout West Virginia, with the most serious ones centered around the Kanawha-Boone-Lincoln county area. Members of the Charleston Radio Club offered radio facilities to the Conservation Commission, and after demonstrating that they were capable they received the bulk of the radio communications job. W8PNR was appointed Chief Radio Officer, and W8PNR/8, with other hams assisting, began to handle emergency traffic from the Charleston Fire Control Center, using the West Virginia Net frequency, 3890 kc., and approximately 40 watts input. W8PNR/8 relayed traffic through mobiles, and later through W8COE/8 set up in the Kanawha State Forest, and W8UEB/8 on Cabin Creek. Ten meters proved inadequate because of the terrain. The entire communications job was shifted to 3890 kc., with c.w. operators standing by on 3570 kc.

Other areas of the state reported in with emergency facilities. The Huntington Radio Club station, W8KEG, was moved to Hamlin; W8FUM/8 reported from Logan; W8EKF, with W4SBI assisting, from Williamson; W8VPO from Beckley; W8FGL from Parkersburg; W8EUS from Summersville; and another group moved in and set up at Madison. Throughout the remainder of the campaign, the Conservation Commission based its entire fire-fighting plans on information sent in twice daily from these stations.

At 2050, October 31st, FCC authorized voluntary clearance of 3890 kc. for the southern one-third of the state of West Virginia. Adverse conditions made it impossible at times for W8CLX to communicate direct with portable and mobile stations near the fire lines, and traffic had to be relayed through points as far away as Connecticut and Missouri, particularly W1OND, W3BHK and W9RNM. Many others assisted in policing the emergency frequency.

By the end of the week the situation had been brought under control enough so that most of the field stations were able to secure, but when strong winds arose and threatened to cause new outbreaks the Conservation Commission requested the amateurs to maintain their watch for at least another 24 hours. On November 7th it was decided that the situation had improved enough to allow the amateurs to secure their facilities, and the emergency frequency was relinquished by FCC. Net Control Stations W8PNR/8 and W8CLX had handled 535 messages, besides much more net in message form. W8CLX showed a total of 93.5 hours of actual transmitting time.

There is no doubt that as a result of this incident ham radio moved ahead 20 years in West Virginia in the eyes of the public. The following stations are known to have participated: W8s AEN AFB AQP BNL BPI BWD CCF CTZ DAR DHX DNN DPF EKB EKF ELJ EMQ EOA ERN ESQ ETF EUZ EVR FGL FMU FUM FUS FYD GEC GIO GIW GQH GRO HNC HRQ HRX HYX IBT JBEI JDF JGL MCR MRV NET OSZ PQQ PLD SDU SHU SKO QHG RFD TIS UEB UUM UYR VAB VPO VPR WYF YGL YJF YPR ZJS ZKK ZAIG; W1OND; W2s MHE ZBY ZQA; W3s BET BHK BRC KSF LSU OKU; W4s BAQ IQQ PSU TBX PSU; W5s BCZ GIC GRC; W9s AOB FVL KGP KXN RNM; W0s IQY CYH IHA GKP. Also, from W4USN were W6BVY/4, W8CLT and W8KOX. — W8YPR, SEC West Va.

On Nov. 3, 1952, the Royal Canadian Mounted Police requested VE7BV to assist in locating a missing small commercial plane near Ocean Falls, B. C. Unable to make contact with Air Service headquarters at Vancouver due to skip conditions, VE7BV called the Oregon Emergency Net on 3840 kc. W7BTF at Portland contacted the plane dispatcher at Vancouver, relayed the needed information to VE7BV, a boat was dispatched and the plane located. No one was hurt. — W7BTF

When calls were made for volunteers to help fight forest fires on October 24th, W9KDV and W9JVN reported to the National Guard and offered their services. An office pa-

trolled the fire-fighting areas in the car of W9KDV and maintained communication with W9JVN at headquarters where helpers were organized and dispatched from National Guard units. These two officers, as well as TV, radio and press releases, expressed sincere appreciation for the service rendered. W9NTA at his fixed station acted for the Martinsville area in maintaining communications to the mobiles.

On Sunday, October 26th, W9VFX, W9KDV, and W9DUD mobiles on 75 maintained communication between fire-fighting headquarters and Martinsville through severest QRM from 1800 to 1930. W9NTA, W9MEU and W9NSWC also assisted. — W9DUD, EC Morgan Co., Ind.

On Sunday, Nov. 9, 1952, at about 0700, at the request of National Guard, Forest Service and Civilian groups, EC W4FVM of Chattanooga sent three mobiles — W4JIE/M, W4SMP/M, and W4FVM — into the forest fire areas in the vicinity of Chattanooga. W4JIE/M worked from Dunlap, Tennessee; W4SMP/M worked from Elder Mountain and W4FVM/M worked from Raccoon Mountain. At all three locations fire-fighting crews of the National Guard and volunteers were working feverishly to extinguish the flames. Base stations were W4QT, Chattanooga; W4IIB of Red Bank; and W4LU of Signal Mountain. Traffic handled pertained to dispatching of crews, supplies and instructions from National Guard Headquarters. About 40 or 50 messages were handled, some verbal. Other stations who assisted the group were W4s PAF HSQ and AEE. Operations were suspended when the rains came around 1600 that day.

When mobiles W4FVM and W4SMP had trouble "getting out" with their mobile whips, a quarter-wave wire clipped to the base of the whip and strung out to a tree or truck body boosted their signal to S9 as far away as Nashville on 3980 kc. — W4AEE, SEC Tenn.

A new section put in its first 1952 appearance in the SEC reporting column in October. We welcome the SEC of Missouri. Fourteen other SECs submitted reports, representing 2672 AREC members. We now have received reports from the SECs of 29 sections in 1952.

NATIONAL CALLING AND EMERGENCY FREQUENCIES

C. W.	'PHONE
7100 kc. (day)	3875 kc.
3550 kc. (night)	14,225 kc.
14,050 kc.	29,640 kc.
28,100 kc.	

During periods of communications emergency these channels will be monitored by stations of the National Emergency Net for personal-inquiry traffic. At other times, these frequencies can be used as general calling frequencies to expedite general traffic movement between amateur stations. Emergency traffic has precedence. After contact has been made the frequency should be vacated immediately to accommodate other callers.

The following are the National Calling and Emergency Frequencies for Canada; c.w. — 3535, 7050, 14,060; 'phone — 3815, 14,160 kc., 28,250 kc.

OPERATION SNOWBOUND

In late November, a surprise snowstorm hit a large area comprising roughly the states of Virginia, Tennessee, Kentucky, and to a lesser extent the immediate surrounding areas; this while the Northeastern States, where one expects such things to happen, were getting off with nothing more calamitous than a drenching rain. The snow was of the wet, heavy, sticky type which clings to things. It stuck to wires which would withstand just so much weight before snapping, or dragging poles down; or it stuck to trees which, when weighted down, would crash across telephone and

power lines. Many localities were completely isolated by the time some 22 inches of the stuff had accumulated.

The most affected section seems to have been Eastern Tennessee where, fortunately, our emergency establishment is at the highest efficiency. By Friday afternoon, Nov. 21st, Kingsport, Knoxville, Johnson City, Morristown, Gatlinburg, Maryville, Jonesboro and others were without a single line to the outside world. Bristol and Oak Ridge had one or two heavily-loaded circuits. Emergency Coördinators of the affected cities called their groups into action.

The first news of the conditions in that part of the state to reach the press originated at Kingsport. W4LNF was in operation on 3980 kc. and contact was established with Nashville through W4AEE. W4PSI was also active in Nashville, clearing Highway Patrol traffic and keeping the SEC informed of conditions. This was the beginning of long hours of work for many of the hams in this area.

The Tennessee Phone and C.W. Nets were activated at 1500 CST, Nov. 21st. On Nov. 22nd, additional c.w. frequencies, 7010 and 7136 kc. were set up. Liaison was maintained with the Tennessee Emergency Net, Kentucky Phone Net, Kentucky C.W. Net and National Emergency Net. Liaison was maintained by W4s CXY AKJ TAV W2BO and W9LZI. Traffic was handled for the Southern Railroad, CAA, AP, UP, Western Union, the telephone company, Army and Forest Service. Amateur radio was also used to summon line crews from other towns, order food for the markets, and to take care of certain urgent private messages.

Stations in the affected cities known to have handled the heavy traffic were (all W4s): Kingsport, EUM JD LNF PHQ; Bristol, IYI ORK; Knoxville, DEK DPI EWR FX FY HEQ RRS TYU ZZ; Johnson City, ANN PMR; Oak Ridge, CXY KMH KUW RRV; Morristown, KKR; and Jonesboro, BQK.

The emergency operation continued on a round-the-clock basis through November 23rd, and on a limited basis through Nov. 24th. The operation was featured over WKPT (AM and FM) on Nov. 27th, thanks to a wire recording made by W4PID in Kingsport. Letters of appreciation and favorable publicity notices abounded. SEC W4AEE, who sent us a fine consolidated report of this emergency in Tennessee, submits the following additional list of amateurs who participated: W4s AFM AGC AQL ATF ATW AVR AY BAQ BDB BFQ BXG BXP CAK CFV CQW CRI CV CVM CYR CSZ CYZ DIX DAL DFR DQH DTI EBD EIV FQK FY HJW HBZ HII HK HSQ IKG IYU IIB IKG IYU JAF JGD JGS JZG KRX KPR LRR LUH LXE LLH MCZ MQV MWH MEM MWR NBY NS NV NJE NAD NQP OGG OQF ODR OAO ONO OLM PAH PFC PFA PFP PGV PGR PL PAF POI PIF PXX PZW QAN QCT QZC QT QFL RLD RFR RTV RSE RPR RKW RHO RYY SMD SGU SSL SNZ SJ STY SSV SPE SUF SAQ SUD SZP TIS TGK TDV TYJ UJH UIO USA UVS VAB VBA VNE VSV VTU WAX WHN WB WLG WQW WRH YID; K4WCL, K4WDF; W1s JCX TJX; W2YY, K2BFI; W3s AHD GRF; W5s IZS MRK PFC WXD, K5FBI; W8s HNC UUM; W9s JAW SBB UCR VXH YWE. Many of these stations operated on emergency power.

Several counties in the southwestern tip of Virginia were also hit hard by the storm; Appalachia, Norton, Big Stone Gap, Ben Hur, Bristol and Hilton were all cut off except for amateur radio. The Virginia Phone Net went into emergency session in the evening of November 21st, with stations all over the state assisting. Fourteen emergency messages

were cleared for the telephone company, Western Union, the L&N Railroad, power company, Highway Department, and state and county police. Operation continued on Saturday with some 40 stations reporting in, and when skip lengthened W1JCX acted as NCS and relayed about 20 messages. SEC W4NAD appealed to FCC for assistance when QRM from stations working in the SS Contest bade fair to smother the emergency net. The Washington monitoring office of FCC responded immediately with a request for voluntary clearance of the segment 3830-3840 kc. The net was secured at midnight, Saturday, but resumed at 0800 Sunday. FCC's emergency order (voluntary) was terminated at 1700, Sunday. SEC W4NAD, in his report, declared his pride in the performance of the Virginia AREC organization in this emergency, and said, "I will put them up against any similar group in the country." The following calls are added to the above list of participants: W4s AJA DXD FV ITA JAQ JHI KAK KMS LLU MAI NBA NHK ONV OSJ RLA RMG SHJ SPE T'BX TOU; K4FCC; W2s SZ MQB/1; W8EFF; W9NDA. EC W4IYL's excellent report from Bristol, which straddles the Tenn.-Va. line, expresses gratification at the performance of the local AREC gang in this, their first postwar emergency.

The Kansas Emergency 75-Meter Phone Net was active in November when about seven inches of snow was blown into terrific drifts. After their regular drill at 1230, several stations maintained watch on the net frequency (3920 kc.). The first message came from W0BAH/M, who was en route from Medford, Okla., to Wichita. He relayed a message from the Oklahoma Highway Patrol to the Kansas Highway Patrol to stop all southbound traffic; W0HS assisted.

About 1700, word was received from W0UCS/M that he was marooned in snowdrifts near Salinas, along with about 100 other cars. W0HS gave this information to Kansas Highway Patrol, who sent out their snowplows. W0MVG of Salina maintained contact with W0UCS/M advising him of the progress of the snowplows and by all means to instruct everybody to stay put. W0BAH/M finally bogged down at Mulvane, a short distance south of Wichita. While all this was going on, the net was busily handling emergency welfare messages, mostly relative to students who had left for home for the holidays. Due to landline failures, such messages were handled for the following areas: Manhattan, Lawrence, Coffeyville, Topeka, Junction City (Kans.) and Lincoln (Nebr.).

In Wichita, Red Cross station W0SOE opened on Nov. 26th, with W0DSY at the controls, and with W0ERB and W0HAJ spelling him, the station was on the air until 0130, November 27th. Two mobiles at a time were kept busy providing communications to food trucks, road-clearing crews and checking on snowbound travelers. Mobiles were W0s AAO BVM CTK LKU WLR and ZKA. W0FJC and W0LEA participated from fixed stations. Wichita operators also participated in the Kansas 75-Meter Phone Net on 3920 kc., notably W0YOS, who had a portable rig on the air and set up a station for the Civil Defense Council; W0AKT, who monitored the frequency all night on the 26th; and W0s YXG, OZN (who also operated mobile), UUS, GHU, BAH (mobile), BVQ, IJV (mobile) and NAS. W0GAV and W9PIK/Ø were active on 160. Harvey County was represented by W0AAJ and W0VTT. Until this storm, says EC W0RC, 1952 had been a very quiet year.

In southeastern Nebraska many towns were completely isolated. W0GTW and W9YMU were active, but W0LAY had trouble with his emergency equipment and vows he will not be caught unprepared again.

Rev. C. Lynn White, W4NBY, was the sole contact with Harlan, Ky., during a part of the snowstorm emergency. His tireless operation gained for him the admiration and respect of his fellow townsmen, and much favorable local publicity. W4NBY is the former Kentucky SCM.



TRAFFIC TOPICS

These days when conditions are so poor on 80 and 40 meters, at least from the standpoint of us traffic men, some of us switch our receivers to the 160-meter band. There, much to our surprise, we hear signals loud and steady from the very areas in which signals are almost entirely washed out on 80. Not only that, but a little more listening reveals that many of these fellows, some on 'phone and some on c.w., are using pretty makeshift equipment with pretty makeshift antennas.

True, there isn't much room on 160 these days, but maybe it or 6 meters is the answer to our late-evening skip problems, problems which are making it increasingly tough to maintain any late-evening traffic schedules. How about some of you pioneering traffickers giving these short-haul bands a whirl? We're going to, as soon as we can throw together some kind of a blooper for 160.

— * * * —

If every net submits a monthly traffic report, and we try to tabulate it in this column, we won't have room for anything else. The tabulation each month of data in NTS nets has attracted similar figures from other nets, and we will attempt to enumerate them separately until they become too numerous. This month we have figures from three transcontinental nets.

The Early Bird Transcontinental Net, operating three times per week on 3845 kc. at (yaww!) 0445 CST, reports a November traffic total of 126 by 24 stations, averaging 10.5 messages per session. W0BVL is manager.

The Transcontinental Phone Net (3970 kc., 1730 EST daily) handled 2447 messages in November, with 30 sessions, an average of 82 messages per session. Thirty-eight stations participated, 26 of them every night. This per W1SJO for Manager W1SS.

On the Transcontinental Relay Net (7042 kc., 0115 EST daily), W3CVE reports 5030 messages handled on 30 November sessions, an average of 168 per session. Nine regular members participated.

— * * * —

National Traffic System. The response to our postcard offer to send complete information on NTS to all ORS on request has been most gratifying. We made this offer specifically to ORS because they, as traffic-handling appointees, should be well informed. But the information is available to *anyone*, appointee or not, and participation in NTS is open to *any* licensed amateur except Novices and Technicians; we haven't figured a way to include them yet.

A few points of NTS policy should be cleared up. Correspondence from certain traffic men indicates some doubt, even an occasional incorrect conviction, on these matters: (1) NTS nets are not "closed" nets. Anyone *with* traffic and the required net savvy for the net into which he is reporting is welcome. Since NTS nets have their normal outlets for all traffic reported in, there is usually no traffic for a casual station who reports in QRU on regional and area nets.

But *everyone* is urged to QNI his own section net, whether QRU or not. (2) The normal routing procedure *can* appear ridiculous in certain isolated instances, like in the case of adjoining sections which fall into different regions and/or different areas. In such cases, an agreed-upon system of direct interchange between those sections is, far from being frowned upon, all to the good. In *most* cases following normal routing procedure is the path of least resistance, requires *one* liaison link instead of several. (3) The NET framework at *section level alone* provides for and urges 72 section nets each meeting ten times a week (twice daily Monday through Friday). Assuming ten stations per net meeting, that's 720 stations. If we have different stations each day of the week, that's 3600 stations, and if we have different stations every session, that's 7800 stations. How, then, can it be said (as it often is) that NTS restricts traffic work to a chosen few? There's room for everyone, and a lot more.

November reports:

Net	Ses- sions	Traffic	High	Low	Aver- age	Most Consistent
EAN	20	650	84	9	32.5	1 RN, 2RN
CAN	13*	448	70	4	24.8	All
PAN	12	206	—	—	17.2	—
1RN	29**	264	25	0	9.1	E. Mass.
2RN	40	362	28	0	9	NJN
3RN	33	251	52	1	7.6	EPa, MDD
4RN	40	270	27	0	6.8	Va.
RN5***	33	201	23	0	6	Tenn.
RN6	53	681	34	1	12.9	BAN
RN7	46	322	24	0	7	Wash.
8RN	33	129	21	0	4	Mich.
9RN	25	386	46	2	15.5	Ind.
TEN	40	797	56	5	19.9	Ia., Minn., Kans., Mo.
TRN	40	78	8	0	1.9	Ont.
QKS	19	79	8	0	4	
(Kans.)						
TLCN	20	304	30	5	15.2	
(Ia.)						

* Out of 20 sessions held

** Out of 40 sessions held

*** Out of 40 sessions scheduled

W8SCW's December EAN Bulletin was a corker, outlining seven points on EAN procedure. EAN NCS, Monday through Friday respectively, are: W3GEG, W4MWH, WINJM, W1CRW and W2ZVW.

CAN certificates have been earned by W4WAX, W5QHL, W9CXY and W0DQL. W9JUJ has been off while moving, with W4AGC and W0BVE holding down the fort.

PAN is operative again, but without a manager. W6ELQ reports that operation is difficult due to QRM from TV sweep oscillators.

W1BVR has only one comment — conditions are terrible!

Latest recipients of hard-earned 4RN certificates are W4PZT, W4TVI and W4UWS.

RN6 is now using PAN for movement of eastbound traffic. Several alternative routes, and overseas routes are also maintained.

W7NH is carrying on as RN7 manager until her replacement can be appointed.

The 8RN gang has decided tentatively to stay on 3530.

W0ITQ took three weeks' vacation, and on returning found TEN in such good shape that he now wonders if he has been holding them back.

W0BVE has been designated an assistant manager of TCC, to sparkplug the central area Transcontinental Corps staff. VE3WY serves a similar function in the Eastern Area. Another assistant is needed in the Pacific Area.

◆

Although W5MRK is resigning as manager of RN5, we want you traffic boys and gals to have a look at him. Forrest did a stellar job during the year and a half he served, and we are sorry to see him go. W5MRK is ORS and holds a 25-w.p.m. code proficiency certificate.

◆

QST for



CODE-PROFICIENCY PROGRAM

Twice each month special transmissions are made to enable you to qualify for the ARRL Code Proficiency Certificate. The next qualifying run from W1AW will be made on February 17th at 2130 EST. Identical texts will be sent simultaneously by automatic transmitters on 1887, 3555, 7130, 14,100, 28,060, 52,000 and 146,000 kc. The next qualifying run from W6OWP only will be transmitted on February 8th at 2100 PST on 3590 and 7248 kc.

Any person may apply; neither ARRL membership nor an amateur license is required. Send copies of all qualifying runs to ARRL for grading, stating the call of the station you copied. If you qualify at one of the six speeds transmitted, 10 through 35 w.p.m., you will receive a certificate. If your initial qualification is for a speed below 35 w.p.m., you may try later for endorsement stickers.

Code-practice transmissions are made from W1AW each evening at 2130 EST. References to texts used on several of the transmissions are given below. These make it possible to check your copy. For practice purposes, the order of words in each line of QST text is reversed during certain of the slow-speed transmissions. To get sending practice, hook up your own key and buzzer and attempt to send in step with W1AW.

Date Subject of Practice Text from Dec. QST
 Feb. 3rd: 75 Watts with an "Economy" Power Supply, p. 23
 Feb. 5th: The Tune-Up Loop, p. 37
 Feb. 11th: A High Powered Amplifier . . . p. 11
 Feb. 13th: The "Tur-Key," p. 18
 Feb. 16th: The Helromon, p. 32
 Feb. 19th: A Bargain (?) Novice Station, p. 15
 Feb. 24th: Carrier Generators for S.S.B. Reception, p. 35
 Feb. 27th: Low-Cost Low-Pass Filters . . . , p. 38

BRASS POUNDERS LEAGUE

Winners of BPL Certificates for November traffic:

Call	Orig.	Recd.	Rel.	Del.	Total
W6IAB	63	3140	3066	34	6303
W3CUL	226	2296	1723	556	4801
W6KYY	163	1983	614	1369	4129
W2BTB	42	1102	1065	37	2246
W4USA	103	990	895	105	2093
W8TQD	4	900	877	19	1800
K47LJ	150	800	689	111	1750
W2ZOL	5	721	700	21	1447
K5WAC	42	643	614	29	1328
W7ONM	28	592	592	0	1272
K5FKF	41	559	524	72	1196
W4PL	12	585	417	66	1080
W7BA	37	451	387	68	943
KR6HW	431	205	158	47	841
W3PZW	27	402	379	23	831
W1CRW	15	393	382	5	795
W6GYH	18	376	257	119	770
W7IOQ	57	357	18	337	769
W2BO	28	320	280	110	738
W0BDR	11	356	344	7	718
W0CPL	9	345	321	23	698
W0QKO	24	311	282	27	644
W0SCA	11	296	294	2	603
K6FAL	223	174	154	19	570
W0XJ	6	270	218	52	546
W8AUJ	8	279	216	29	532
W6IZG	38	46	201	246	531
W4SHJ	270	128	117	18	528
W0QYZ	1	260	258	2	521
W5QHL	31	194	112	182	519
W2RUF	29	247	158	82	516

The following made the BPL for 100 or more originations-plus-deliveries:

K4WBG	289	W4LNF	127	W2EC	102
W9NZZ	167	W1BDI	112	W7HDN	101
W5MN	150	W0YBV	109		

A message total of 500 or more or 100 or more originations-plus-deliveries will put you in line for a place in the BPL. The Brass Pounders League is open to all operators who qualify for this monthly listing.

ELECTION NOTICE

(To all ARRL members residing in the Sections listed below.)

You are hereby notified that an election for Section Communications Manager is about to be held in your respective Sections. This notice supersedes previous notices.

Nominating petitions are solicited. The signatures of five or more ARRL full members of the Section concerned, in good standing, are required on each petition. No member shall sign more than one petition.

Each candidate for Section Communications Manager must have been a licensed amateur for at least two years and similarly a full member of the League for at least one continuous year immediately prior to his nomination.

Petitions must be in West Hartford, Conn., on or before noon on the closing dates specified. In cases where no valid nominating petitions were received in response to previous notices, the closing dates are set ahead to the dates given herewith. The complete name, address, and station call of the candidate should be included with the petition. It is advisable that eight or ten full member signatures be obtained, since on checking names against Headquarters files, with no time to return invalid petitions for additions, a petition may be found invalid by reason of expiring memberships, individual signers uncertain or ignorant of their membership status, etc.

The following nomination form is suggested: (Signers will please add city and street address to facilitate checking membership.)

Communications Manager, ARRL [place and date]
 38 La Salle Road, West Hartford, Conn.

We, the undersigned full members of the
 ARRL Section of the
 Division, hereby nominate
 as candidate for Section Communications Manager for this Section for the next two-year term of office.

Elections will take place immediately after the closing dates specified for receipt of nominating petitions. The ballots mailed from Headquarters to full members will list in alphabetical sequence the names of all eligible candidates.

You are urged to take the initiative and file nominating petitions immediately. This is your opportunity to put the man of your choice in office.

— F. E. Handy, Communications Manager

Section	Closing Date	SCM	Present Term Ends
Los Angeles	Feb. 2, 1953	Samuel A. Greenlee	Apr. 12, 1953
Maine	Feb. 2, 1953	Orestes R. Brackett	Apr. 16, 1953
Santa Barbara	Feb. 2, 1953		
Yukon*	Feb. 16, 1953	W. R. Williamson	Mar. 17, 1949
San Francisco	Feb. 16, 1953	R. F. Czeikowitz	Apr. 14, 1952
West Indies	Feb. 16, 1953	William Werner	Aug. 15, 1952
Colorado	Feb. 16, 1953	M. W. Mitchell	Sept. 15, 1952
Maritime*	Feb. 16, 1953	Arthur M. Crowell	Oct. 16, 1952
Sacramento Valley	Feb. 16, 1953	Ronald G. Martin	Nov. 4, 1952
Hawaii	Feb. 16, 1953	John R. Sanders	Jan. 14, 1953
Oregon	Feb. 16, 1953	J. E. Roden	Mar. 1, 1953
Southern Texas	Feb. 16, 1953	Dr. C. Fergaglich	Apr. 29, 1953
Wisconsin	Mar. 2, 1953	Keno W. Goetsch	May 12, 1953
New Mexico	Mar. 2, 1953	Robert W. Freyman	Resigned
Manitoba*	Mar. 2, 1953	A. W. Morley	Resigned
Iowa	Apr. 1, 1953	William G. Davis	June 16, 1953
South Dakota	Apr. 15, 1953	John W. Sikorski	July 2, 1953
Western Florida	May 15, 1953	Edward J. Collins	July 29, 1953
N.Y.C.-L.L.	May 15, 1953	George V. Cooke, jr.	July 31, 1953
Eastern Florida	May 15, 1953	John W. Hollister	July 31, 1953

* In Canadian Sections nominating petitions for Section Managers must be addressed to Canadian Director Alex Reid, 169 Logan Ave., St. Lambert, Quebec. To be valid such petitions must be filed with him on or before the closing dates named.

ELECTION RESULTS

Valid petitions nominating a single candidate as Section Manager were filed by members in the following Sections, completing their election in accordance with regular League policy, each term of office starting on the date given.

Santa Clara Valley	Roy I. Couzin, W6LZL	Oct. 15, 1952
Saskatchewan	Harold R. Horn, VE5HR	Dec. 15, 1952
Kentucky	Ivan C. Kelly, W4TUF	Jan. 2, 1953
Michigan	Fabian T. McAllister, W8HKT	Feb. 17, 1953

• All operating amateurs are invited to report to the SCM on the first of each month, covering station activities for the preceding month. Radio Club news is also desired by SCMs for inclusion in these columns. The addresses of all SCMs will be found on page 6.

ATLANTIC DIVISION

EASTERN PENNSYLVANIA—SCM, John H. DuBois, W3BXE—SEC: ISE, RMs: AXA, BIP, E. Pa. Nets: 3610 kc. On Dec. 6th, the Northeast RC of Philadelphia enjoyed its second annual banquet at Sunken Gardens. The North Branch ARC of Bloomsburg is now an ARRL affiliated club and the SCM would welcome reports from that area. E. Pa. traffic net now averages 14 members per night. Those interested in starting an E. Pa. phone net should contact PLYE. Tentative plans are for 3915 kc. Mon. through Fri. at 1900 EST, with a liaison station to tie in with E. Pa. c.w. net for complete coverage. PDJ is new NCS for E. Pa. Emergency Net, which meets on 3610 kc. at 2030, Mon. Thanks to ETM, the former NCS, for a job well done. KEW (ex-W9LEZ) now is signing W3LFZ, compliments of FCC. MYL now has 41 states and 4 countries, all with 80 watts on 75-meter mobile. OQG is in the Army and hopes to be on with a KA call soon. EG-3NDZ now is IPEP and is an engineer at WSPR in Springfield, Mass. RFI will be QRT because of enlistment in the USAF. TEC is coralling equipment for 220 and 420 Mc. and would like to hear from others interested in those two bands. All reports indicate that E. Pa. was well represented in Field Day and SS Contests. Traffic: (Nov.) W3CUL 4301, BIP 300, QLZ 109, AXA 70, PDJ 61, ELI 54, RCG 38, AD 28, DUI 25, NOK 25, CDT 20, ADE 19, MLY 16, CHU 7, PVE 6, QEW 3. (Oct.) W3QLI.

MARYLAND-DELAWARE-DISTRICT OF COLUMBIA—SCM, James W. John, W3OMN—Phil Rand gave talks on TVI in Baltimore on Nov. 12th and in Washington on Nov. 20th. More than 800 of the section amateurs at these two lectures were acquainted with solving the technical problems of TVI. An informal dinner party was held by WRC and WTVIC for IDBM and ARRL Division Director GEG before the TVI meeting in Washington. AIR, Frank South, presented an honorary life membership in the Rock Creek Amateur Radio Assn. to IDBM for his work in solving the technical problems of TVI. AFR, DB, FQR, G.A., JE, and OMIN attended FCDA Staff College. Operation of KACES was discussed and the contribution manual of FCDA was masticated. During November the BARC-visited WWV, and LMC spoke on "Two Meter Teletype," "Speech Clipping" was the topic covered at the Nov. 3rd meeting. On Nov. 10th AFR, at the Chesapeake Amateur Radio Club meeting, discussed "Common Carrier, Mobile Radio, Telephone System." UJW covered "Practical Mobile Installation" at the Nov. 24th meeting. The Washington Radio Club held an auction and showed motion pictures at its meetings in November. Club members visited CDQ's station after the Nov. 22nd meeting. LUL discussed modulation at the Nov. 28th meeting of the Rock Creek Amateur Radio Assn. PZW has new 75A-2 receiver and 4-125 final for 80 meters. ONB is restricting operation because of TVI. ECP still is working to complete mobile installation. CVE enjoyed a trip to the Midwest in October. SBP and TZK made Rag Chewers Club with CQB. Traffic: W3PZW 831, QZC 142, COK 91, AKB 76, ONB 66, JE 43, ECP 31, VAA 27, JZY 23, RJA 21, CVE 18, IIC 18, JHW U, NNK 6, LVJ 5, PTZ 4, ONB 2, QZB 2.

SOUTHERN NEW JERSEY—SCM, Lloyd L. Gainey, W2HCV—SEC: K2BG. A mobile emergency net has been formed in the Princeton Area with five units participating. We regret to note the passing of the mother of BAY. Many old-timers in this section knew her very well. ZI returned from a well-earned vacation on the high seas, traveling to the West Indies and South America. ASG flew to France for the Christmas holidays to visit his son in Paris. YT now is pounding brass as second operator aboard the SS *United States*. Congratulations are in order to BLV on dropping the "N." ABQ is operating mobile on 10 meters with a new Lyco transmitter. The SJRA Outstanding Amateur Award for 1952 went to JAV and JRO. It is the first time the award has been given to more than one ham in any one year. The

amateur fraternity can use many more hams of this calibre. PRG gave a demonstration of amateur radio for the Moorestown Friends High School. The FCC is anxious to line up some volunteers in the Atlantic City Area for a local TVI committee. Any hams who can help are requested to contact the SCM. The South Jersey emergency nets gave considerable assistance to the City of Camden at the recent air-raid siren test. Both mobile and fixed stations participated on 2 and 10 meters. Traffic: K2BG 264, W2RC 127, ZI 31, ASG 28, ZQ 7, HAZ 3.

WESTERN NEW YORK—SCM, Edward G. Graf, W2SJV—SEC: UTH, RMs: RUF, COU, PAM: GSS. NYS meets on 3615 kc., 7 and 10 P.M.; on 3980 kc., 6:30 P.M. NYSS meets on 3595 kc., 8 P.M. NYS CD meets on 3509.5 and 3993 kc., 9 A.M. Sun. DRQ is on 80 and 40 meters with 813 final. COU, new OBS, can be heard on 3615 kc. at 1830 on Wed., Fri., and Sat. UTH visited UHI and SJV. ZYQ is in KLI-Land with the USAF. The Finger Lakes 2-Meter Net operates on 145.350 kc. at 8 P.M. Fri., with stations from Rochester, Greece, Irondequoit, Webster, Chili, Perry, East Bloomfield, Newark, Savannah, Ontario, Bristol Center, and several towns in the Finger Lakes region participating. The band is tuned for newcomers after roll call. The Rochester v.L.F. group officers are OWF, chairman; QY, vice-chairman; UAD, secy. New calls on 2 meters in the Rochester Area are ZS-IDWY/2 and QS, IBE now is Advanced Class. Members of KBT were addressed by OZR, of Cornell Labs, on Miniaturization of Radio Equipment and by SKN on Radio Controlled Models. QQ has p.p. 813 on the air designed after a model constructed by Dick Smith, formerly of ARRL, and QSOed VE6NL with VQ2OS at the key. New officers of the Binghamton ARA are UJS, pres.; 5LUU/2, vice-pres.; PWN, treas.; VIQ, secy. Meetings are held the third Fri. of each month. The code speed contest of the club was won by KN2BPD, K2BHP, and PST. A testimonial dinner was held for PUV, ex-8HVO, sponsored by the Batavia ARA, upon the occasion of his retirement as a Morse telegrapher after 39 years with the N.Y.C. RR. He is leaving to make his home in California. KN2CBM is on 80 meters. K2BGC is on 80 and 40 meters. IPC now is General Class and is on 80 and 40 meters with a Viking I and an SX-42. EMW has 10 watts on 80 and 40 meters with an indoor antenna but is active in NYS and worked 151 stations in the SS. NYS 'phone net certificates have been issued to DPR, CFY, JPE, PWN, DHQ, ZHU, and YFZ. CRD was very active in the S.E.T. with a teletype direct to Washington Headquarters of the Red Cross. GSS and RUF report cooperation between NYS 'phone and NYS c.w. has been most gratifying. UTH has been re-appointed SEC. QQ hurt both legs when his pole crashed after being weakened by wood-eating ants but has recovered. Traffic: (Nov.) W2BTB 2246, ZOL 1447, RUF 516, COU 213, OE 70, KEL 65, ZRC 52, DJF 46, JWU 32, EMW 29, SJV 29, RUT 16, RJJ 6, ZHU 6. (Oct.) W2KHA 66, TPN 52, K2DQ 20, W2ZHU 4.

WESTERN PENNSYLVANIA—SCM, Ernest J. Hlinsky, W3KWL—PAM: AER, RMs: GEG, NUG. Among those heard in the Sweepstakes were KUN, LXE, JSEI, GEG, and NCD. LXE reports an SS score of 77,454, CQ DX Contest score of 40,750 on c.w. and 15,444 on 'phone and the October CD Party (c.w.) score as 27,950 points. QN, Erie County EC, reports 27 full AREC members and 4 supporting members active, and 8 mobile units and 4 emergency units participating in 4 test drills for the month. The Erie Radio Assn. now has quarters in the YMCA. Dope has it that MMJ has a grid dipper available for the boys to use. NXX experiments on controlled-carrier modulation. *The Bucktail Hamster*, official publication of the Bucktail Amateur Radio Club, Emporium, again makes its appearance. The McKean County Net invites all Cameron County amateurs to join the net each Sunday at 9 A.M. on 3525 kc. Net members are LQQ as NCS, MBEY, PZF, LPO, and TMA. We understand a Cameron County net operates on 29 Mc. Sunday evenings with LAY, KUN, IIX, NMI, OLB, and DNO among the favorites to check in. TCP is working to become active again. Up Meadeville way, your SCM and Atlantic Division Director GEG, along with NCD, SYZ, and 80AJ, attended the Crawford County ARA's dinner-meeting to talk over plans in forming an efficient civil defense network system. NRU, Crawford County EC, and MIE did a swell job of arranging the affair. BRC, from Van, represented the c.d. boys in Northwestern Pennsylvania and New York State. The Amateur Transmitters Assn. reports via its club publication, *ATA News*, that LFK, one of the country's leading DX operators, gave an interesting talk on "I was DX." We understand AYV and RFX were in the SS Contest. OMA keeps a sky and

(Continued on page 80)

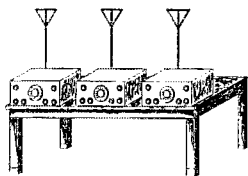

RECENTLY, this page was used for a discussion of receiver Gain and Signal-to-Noise ratio. Noise Figure was not included in this discussion as this parameter of a receiver is not particularly important at frequencies in the H.F. range (3 to 30 mc.) normally covered by the usual communications receiver. The reason for this is that any reasonable antenna attached to the receiver will develop enough noise to mask completely the internal noise developed by even a receiver with only a mediocre noise figure. Of course, as the received frequency is increased this becomes less true. Over most of the VHF range (30 to 300 mc.), Noise Figure becomes important due to the lower amount of noise developed by the smaller antenna. At micro-wave frequencies, Noise Figure becomes all important.

Now suppose that a desired signal is hidden down in the noise somewhere. We know it is there but it is buried too deeply to read. Perhaps it is buried only part of the time as in the case of a badly fading signal. Or perhaps the signal is steady but just too weak to assert itself. What can we do to make it fully readable?

Of course, we may do all we can to the receiver first. The Signal-to-Noise ratio can be improved by sharpening the receiver selectivity and turning down the Tone Control. This can be carried only to the point where it affects the fidelity of the desired signal. The power of the transmitting station may be increased, if possible. Having done all this, suppose we find the signal still is unreadable. Now what?

In the case of the fading signal, a remedy that is used extensively by the commercial interests is Diversity reception. This is based on the idea that the signal cancellation that causes the fading does not occur simultaneously under all conditions or locations of reception. If two receivers are used with two well-separated antennas, the signal may peak at one antenna while it fades at another. By connecting the receiver outputs into a single output unit and providing a means to use the receiver that has the strongest input, the signal can be made fully readable. Usual commercial practice is to use three receivers. In addition to "space" diversity, there is also "polarization" and "frequency" diversity. The latter method requires two or more transmitters. This system, of course, is rather expensive and works very well as long as the fading signal is readable part of the time on each receiver. If the signal is entirely below the noise level at all times, Diversity reception does not work. But there is still a relatively simple method to make the signal readable.

This method is the use of a "beam" or directional array for the antenna system. It can be shown that the signal-to-noise ratio of a receiving system is directly proportional to the gain of the antenna. Assuming that noise is received equally from all directions, thereby excluding man-made noise, it is obvious that a dipole picks up a certain amount of noise over a wide area. If the dipole is replaced by a high-gain array, much less noise will be received in directions "off the beam" but noise "on the beam" will be received more strongly. The net total noise power is about the same as with the dipole but the signal power has increased in direct proportion to the power gain of the array. For example, suppose the antenna gain is 10db. If a signal received by a dipole is 5db below the noise level, switching to the beam should increase it to 5db above the noise level. It is now a perfectly readable signal.

If you still cannot hear the guy by now, better turn off the lights and go to bed. Perhaps conditions will be better tomorrow night.

CAL HADLOCK, W1CTW



COLLINS

Leading Manufacturers

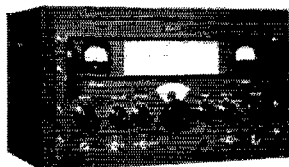

70E-8A Permeability Tuned Oscillator — The versatility, accuracy, stability and voltage coefficient that distinguish good v.f.o. are standard in the 70E-8A. Every component is highest quality — meets strict specifications. 16 turns of the vernier dial cover the linear range of 1600 kc to 2000 kc. Use in exciter or measuring instruments for truly professional performance. You can depend on it to give you long service free from trouble.

32V-3 VFO Transmitter — A controlled bandswitching, gang-tuned amateur transmitter. Rated at 150 watts input on CW, 120 watts phone, this little receiver-size rig has the kick of a kangaroo, and its excellent audio provides extraordinarily good readability. The 32V-3 covers the 80, 40, 20, 15, 11 and 10 meter ham bands. It is thoroughly filtered and shielded to minimize the possibility of TVI.

KW-1 Transmitter — Engineered for maximum power allowed by your license. Its input is a full 1000 watts on phone and CW. The entire transmitter, including power supply, is integrated in attractive cabinet. Complete bandswitching of the exciter, driver and power amplifier by a single control on the front panel. It covers bands 160 through 10. TVI reduction is accomplished by well engineered shielding and filtering. It's as easy to handle as the 32V-3.

AUTHORIZED COLLINS DISTRIBUTORS

ALABAMA

BIRMINGHAM
Ack Radio Supply Co.
2205 Third Ave., N.

ARIZONA

PHOENIX
Radio Parts of Arizona
214 S. 11th St.

TUCSON

Elliott Electronics, Inc.
Box 5081
418 N. Fourth Ave.

ARKANSAS

LITTLE ROCK
Carlton Wholesale Radio

ARKANSAS-TEXAS

TEXARKANA
Lavender Radio Supply
Co., Inc.
520 E. Fourth St.
P. O. Box 596

CALIFORNIA

BURBANK
Valley Electronics
Supply Co.
1302 W. Magnolia Blvd.

LONG BEACH

Scott Radio Supply
266 Alamitos Ave.

LOS ANGELES

Henry Radio
11240 W. Olympic Blvd.
Kierulff & Co.
820-830 W. Olympic
Blvd.
Radio Products Sales,
Inc.
1501 S. Hill St.

OAKLAND

Electric Supply Co.
140 — 11th St. at Madison

SAN DIEGO

Western Radio & TV
Supply Co.
1415 India St.

SAN FRANCISCO

San Francisco Radio &
Supply Co.
1282-1284 Market St.

COLORADO

DENVER
Radio Products Sales Co.
1237 Sixteenth St.

CONNECTICUT

NEW HAVEN
Dale-Connecticut, Inc.
140 Ferry St.

DELAWARE

WILMINGTON
Radio Electric Service Co.
of Pa., Inc.
S.E. Corner Third &
Tatnall Sts.
Wilmington Electrical
Spec. Co., Inc.
405 Delaware Ave.

DISTRICT OF COLUMBIA

WASHINGTON
Electronic Wholesalers,
Inc.
2345 Sherman Ave., N.W.

FLORIDA

JACKSONVILLE
Kinkade Radio Supply
1402 Laura St.

MIAMI

Electronic Supply Co.
61 N.E. 9th St.
Waldner Radio &
Appliance Co.
1809 N.E. 2nd Ave.

TAMPA

Kinkade Radio Supply
402-04 W. Fortune St.

GEORGIA

ATLANTA
Specialty Distributing Co.
425 Peachtree St., N.E.

AUGUSTA

Specialty Distributing Co.
644 Reynolds St.

ILLINOIS

CHICAGO
Allied Radio Corp.
833 W. Jackson Blvd.
Newark Electric Co.
223 W. Madison St.

PEORIA

Klaus Radio & Electric
Co.
707 Main St.

ROCK ISLAND

Tri-City Radio Supply Co.
1919 Fourth Ave.

INDIANA

FT. WAYNE
Ft. Wayne Electronics
Supply, Inc.
223 E. Main St.
INDIANAPOLIS
Graham Electronic
Supply, Inc.
102 S. Pennsylvania St.

LAFAYETTE

Lafayette Radio Supply,
Inc.
627 Main St.

MUNCIE

Muncie Electronics
Supply, Inc.
305 N. Madison

SOUTH BEND

Radio Distributing Co.
432 Carroll St.

IOWA

COUNCIL BLUFFS
World Radio Laborato-
ries, Inc.
744 W. Broadway
DES MOINES
Radio Trade Supply Co.
1224 Grand Ave.

KANSAS

TOPEKA
The Overton Electric Co.,
Inc.
522 Jackson St.

KENTUCKY

LEXINGTON
Radio Equipment Co.
480 Skain Ave.

LOUISVILLE

Universal Radio Supply
Co., Inc.
533 S. Seventh St.

LOUISIANA

NEW ORLEANS
Radio Parts, Inc.
807 Howard Ave.

MARYLAND

BALTIMORE
Kann-Ellert Electronics,
Inc.
9 South Howard St.

MASSACHUSETTS

BOSTON
DeMambro Radio Supply,
Inc.
1111 Commonwealth Ave.
Radio Shack Corp.
167 Washington St.

MICHIGAN

DETROIT
M. N. Duffy & Co.
2040 Grand River Ave., W.

MISSOURI

BUTLER
Henry Radio Co.
211 North Main
KANSAS CITY
Radiolab
1612 Grand Ave.
ST. LOUIS
Walter Ashe Radio Co.
1125 Pine St.

MINNESOTA

DULUTH
Lew Bonn Co.
228 E. Superior St.
Northwest Radio
123 E. First St.

MINNEAPOLIS

Lew Bonn Co.
1211 La Salle Ave.

ST. PAUL

Lew Bonn Co.
141-147 W. Seventh St.
Hall Electric Co.
566 N. Robert St.

NEW HAMPSHIRE

CONCORD
Evans Radio
10 Hills Ave.

NEW JERSEY

ATLANTIC CITY
Radio Electric Service Co.
of Pa., Inc.
452 N. Albany Ave.

CAMDEN

Radio Electric Service Co.
of Pa., Inc.
513-15 Cooper St.

of Amateur Radio Equipment

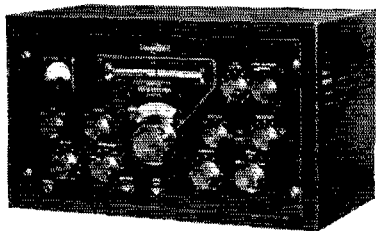

75A-3 Receiver — Makes use of the new Collins mechanical filter which represents an entirely new approach to the attainment of selectivity. The 75A-3 is a double conversion superheterodyne for top performance on the 160, 80, 40, 20, 15, 11 and 10 meter bands. Only the band in use is shown on the slide rule dial — accurately calibrated directly in 1/10 mc. Vernier zero set control is on front panel.

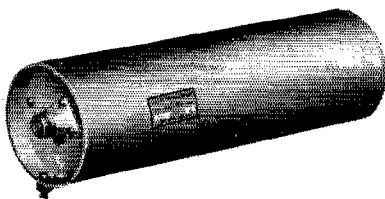

35C-2 Low-Pass Filter — Designed to reduce harmonic radiation. Can be used with any 52-ohm-output transmitter though especially built for use with Collins 32V-3 (left). 35C-2 has coaxial fittings to make installation easy. Provides about 75 db attenuation at television frequencies with an insertion loss of only .18 db. The filter's three sections are individually shielded and the use of low-loss capacitors insures excellent performance under all conditions.

AUTHORIZED COLLINS DISTRIBUTORS

NEW YORK

ALBANY
Ft. Orange Radio Distributing Co., Inc.
642-644 Broadway

AMSTERDAM
Adirondack Radio Supply
P. O. Box 88
32 Guy Park Ave.

JAMAICA
Harrison Radio Corp.
172-31 Hillside Ave.

NEW YORK
Harrison Radio Corp.
225 Greenwich St.
Harvey Radio Co., Inc.
103 W. 43rd St.

NORTH CAROLINA

GREENSBORO
Johannessen Electric Co., Inc.
312-14 N. Eugene St.

OHIO

CINCINNATI
Steinberg's Inc.
633 Walnut St.

CLEVELAND
Radio & Electronic Parts Co.
3235 Prospect Ave.

COLUMBUS
Thompson Radio Supplies
182 E. Long St.

DAYTON
SREPCO, Inc.
314 East Leo St.

SPRINGFIELD
SREPCO, Inc.
119 W. Main St.

TOLEDO
Selectronic Supplies, Inc.
1013 Jefferson Ave.

OKLAHOMA

TULSA
Radio, Inc.

OREGON

EGENE
United Radio Supply Co.
179 W. Eighth St.

PORTLAND
Pacific Stationery
Wholesale Radio Dept.
414 S.W. Second Ave.
United Radio Supply Co.
22 N.W. Ninth Ave.

PENNSYLVANIA

ALLENTOWN
Radio Electric Service Co.
of Pa., Inc.
1042 Hamilton St.

EASTON
Radio Electric Service Co.
of Pa., Inc.
916 Northampton St.

JOHNSTOWN
Cambria Equipment Co.
17 Johns St.

PHILADELPHIA
Radio Electric Service Co.
of Pa., Inc.
3412 Germantown Ave.

Radio Electric Service Co.
of Pa., Inc.
5930 Market St.

Radio Electric Service Co.
of Pa., Inc.
N.W. Corner 7th & Arch Sts.

PITTSBURGH
Cameradio Co.
1211 Penn Ave.
The Tydings Co.
5800 Baum Blvd.

RHODE ISLAND

PROVIDENCE
W. H. Edwards Co.
94 Broadway

SOUTH DAKOTA

ABERDEEN
Burghardt Radio Supply
P. O. Box 342

WATERTOWN
Burghardt Radio Supply
P. O. Box 41

TENNESSEE

CHATTANOOGA
Curle Radio Supply
439 Broad St.
Specialty Distributing Co.
709 Chestnut St.

JACKSON
L. K. Rush Co.
P. O. Box 1418
MEMPHIS
Lavender Radio Supply Co., Inc.
1014-16 Union Ave.
W & W Distributing Co.
639 Madison Ave.

TEXAS

AUSTIN
The Hargis Co.
P. O. Box 716
706 W. 6th St.
CORPUS CHRISTI
Electronic Equipment & Engineering Co.
805 S. Staples St.

DALLAS
Crabtree's Wholesale Radio
2608 Ross Ave.

EL PASO
C. C. McNicols
811 Estrella

HOUSTON
Busacker Electronic Equip. Co.
1721 Waugh Drive

SAN ANTONIO

Amateur Headquarters & Supply
P. O. Box 5086
Beacon Hill Station
TYLER
Lavender Radio Supply Co., Inc.
503 E. Oakwood

UTAH

OGDEN
Iverson Radio Co.
265 — 25th St.

VIRGINIA

NORFOLK
Radio Equipment Co.
821 W. 21st St.

WASHINGTON

EVERETT
Fringe Radio Wholesale Co.
2514 Colby Ave.

SEATTLE
Western Electronic Supply Co.
717 Dexter

SPOKANE
Northwest Electronic Co.
N. 102 Monroe St.

TACOMA
C & G Radio Supply Co.
2502-6 Jefferson Ave.

WISCONSIN

MADISON
Satterfield Radio Supply, Inc.
326 W. Gorham St.

MILWAUKEE
Central Radio Parts Co.
1723 W. Fond du Lac Ave.

For the best in amateur radio, it's . . .

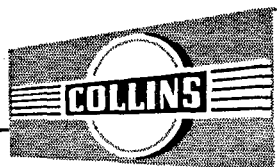

COLLINS RADIO COMPANY, Cedar Rapids, Iowa

11 W. 42nd St., NEW YORK 36

1930 Hi-Line Drive, DALLAS 2

2700 W. Olive Ave., BURBANK

NOW AIR PROVED



ELDICO'S SINGLE SIDEBAND XMTR-XCTR

The Eldico SSB Jr. is patterned after the amazingly effective unit developed by Don Norgaard, W2KUJ, and described in the November-December 1950 G-E Ham News. Now with the advanced improvements incorporated after amateur field tests — it is available immediately in either kit form or completely wired and tested.

Everyone can now enjoy *all* the benefits of single sideband transmission. Tremendous effectiveness of low power; QRM minimized or eliminated entirely; QSB has less effect . . . complete phone contacts with "c. w. reliability." Eldico's SSB Jr. is a complete 6-tube 5 watt single sideband transmitter. Tube complement consists of 12AU7 combination speech amplifier-oscillator; 12AT7 twin-channel amplifier;

6AG7 final; 12AT7 twin-speech pre-amplifier; 6116 bias; 5Y3G rectifier.

Each kit comes complete with all parts, punched chassis, cabinet, tubes, power supply components and full instructions for assembly and operation. Audio phase-shift network comes fully assembled-preadjusted, eliminating necessity for elaborate test equipment. Less difficult to construct and adjust than many conventional transmitters . . . practical SSB at amazingly low cost is now a reality. The Eldico SSB Jr. may be used as a transmitter, as a driver for high-power linear amplifier, or in conjunction with a v.f.o. The transmitter provides -40-db. sideband suppression by using a simplified phasing method which, because of Eldico's laboratory assembled phase-shift network, requires only standard components and no special technical skills. A pre-amplifier is included as an integral part of the Eldico SSB Jr. kit to enable the use of any low-level microphone such as crystal or dynamic.

Listen on the amateur bands for the Eldico SSB Jr., or stop in at your local distributor for a demonstration.

Signals of Distinction

ELDICO
OF NEW YORK
INCORPORATED

YOUR FREE
COPY OF
CATALOG '52-'53
NOW AVAILABLE
AT YOUR
DISTRIBUTOR

44-31 DOUGLASTON PARKWAY, DOUGLASTON, L. I., N. Y. • Bayside 9-8687

BY AMATEURS!!

ACK RADIO SUPPLY CO.
Birmingham 3, Alabama

ALLEN & HURLEY
Trenton, New Jersey

ALLIED RADIO CORP.
Chicago 7, Illinois

ALMO RADIO CO.
Philadelphia 6, Penna.

ALMO RADIO CO.
Atlantic City, N. J.

ALMO RADIO CO.
Wilmington, Delaware

ARROW ELECTRONICS INC.
New York 7, New York

WALTER ASHE RADIO CO.
St. Louis 1, Missouri

GEORGE D. BARBEY CO.
Reading, Penna.

BLUFF CITY DIST. CO.
Memphis 3, Tenn.

CAMERADIO CO.
Pittsburgh 22, Penna.

CONSOLIDATED RADIO CO.
Philadelphia 6, Penna.

CRAWFORD RADIO
Hamilton, Ont., Canada

CURLE RADIO SUPPLY
Chattanooga 2, Tenn.

DE MAMBRO RADIO
Providence, R. I.

DOW RADIO, INC.
Pasadena 4, Calif.

M. N. DUFFY & CO.
Detroit 26, Michigan

W. H. EDWARDS CO.
Providence 3, R. I.

ELECTRIC SUPPLY CO.
Oakland 7, Calif.

THE ELECTRONIC EQUIPMENT CO.
Fort Worth 3, Texas

ELECTRONIC WHOLESALERS INC.
Washington 1, D. C.

EVANS RADIO
Concord,
New Hampshire

FORT ORANGE RADIO DIST. CO.
Albany 7, New York

R. C. & L. F. HALL, INC.
Beaumont, Texas

R. C. & L. F. HALL, INC.
Galveston, Texas

R. C. & L. F. HALL, INC.
Houston 2, Texas

HARRISON RADIO CORP.
New York 7, N. Y.

LOOK AT THESE OUTSTANDING FEATURES OF THE SINGLE SIDEBAND JR.

- Simple enough for the newcomer to Single Sideband Transmission to assemble, sturdy enough for years of trouble free operation.
- Uses the time proven W2KUJ General Electric Ham News audio phase shift network.
- Circuit permits use of any 80 meter crystal for operation anywhere on the 80 meter phone band.
- Fully assembled and pre-adjusted audio phase shift network eliminates necessity for elaborate test equipment.
- Husky internal power supply furnishes all voltages needed.
- The SSB Jr. can be used as a transmitter, as a driver for a High Power Linear Amplifier, or in conjunction with VFO.
- Pre-amplifier is included as integral part to enable the use of any high impedance microphone.
- Furnished in attractive grey crackle finished cabinet size 8 x 14 x 8. Complete (less crystal). Not another bolt or nut to purchase.

SSB JR. complete kit with Instructions \$79.95
Factory wired and tested 129.95

HARRISON RADIO CORP.
Jamaica 3, L. I., N. Y.

HARVEY RADIO CO. INC.
New York 18, N. Y.

HENRY RADIO STORES
Los Angeles 25, Calif.

HENRY RADIO STORES
Butler 1, Missouri

HUDSON RADIO
New York 7, N. Y.

HUDSON RADIO
New York 19, N. Y.

KIERULFF & CO.
Los Angeles 15, Calif.

MONTAGUE RADIO DISTRIBUTORS
Beaumont, Texas

MYTRONIC CORP.
Cincinnati 2, Ohio

NEWARK ELECTRIC CO.
Chicago 6, Illinois

OFFENBACH & REIMUS CO.
San Francisco 2, Calif.

OLSON RADIO WAREHOUSE
Akron 8, Ohio

PURCHASE RADIO SUPPLY
Ann Arbor, Michigan

RADIO, INC.
Tulsa, Oklahoma

RADIO AMATEUR CENTER
Raleigh, N. Carolina

RADIO ELECT. SERV. CO. OF PENNA. INC.
Philadelphia 6, Penna.

RADIO ELECT. SERV. CO. OF PENNA. INC.
Allentown, Penna.

RADIO ELECT. SERV. CO. OF PENNA. INC.
Easton, Penna.

RADIO ELECT. SERV. CO. OF PENNA. INC.
Wilmington 22, Delaware

RADIO ELECT. SERV. CO. OF N. J.
Atlantic City, N. J.

RADIO ELECT. SERV. CO. OF N. J.
Camden, New Jersey

RADIO EQUIPMENT CO.
Lexington, Kentucky

RADIO EQUIPMENT CO.
Norfolk 10, Virginia

RADIO LABORATORIES
Charleston 5, S. C.

RADIO PARTS, INC.
New Orleans 12, La.

RADIO PARTS CO. INC.
Milwaukee 3, Wisconsin

RADIO PRODUCTS SALES
Los Angeles 15, Calif.

RADIO PRODUCTS SALES CO.
Denver 2, Colorado

RADIO PRODUCTS SALES CO.
Seattle, Washington

RADIO SHACK CORP.
Boston 8, Mass.

RADIO TELEVISION RAYTEL S. A.
Mexico, D. F.

RADIO WHOLESALE & SUPPLY CO.
Honolulu 11, Hawaii

RADIO WIRE TELEVISION INC.
New York 13, N. Y.

RADIO WIRE TELEVISION INC.
Boston 10, Mass.

RADIO WIRE TELEVISION INC.
Newark 2, New Jersey

THE RADIO CENTRE
Montreal, Quebec,
Canada

SAN FRANCISCO RADIO & SUPPLY
San Francisco 2, Calif.

SCOTT RADIO SUPPLY
Long Beach 2, Calif.

SREPCO INC.
Dayton 2, Ohio

UNITED RADIO SUPPLY INC.
Portland 9, Oregon

VALLEY ELECTRONIC SUPPLY
Burbank, Calif.

VALLEY RADIO DIST.
Appleton, Wisconsin

WESTERN DISTRIBUTORS
Salina, Kansas

WESTERN RADIO & TELEVISION
San Diego 1, Calif.

WIRELESS RADIO & TELEVISION
Canton, Ohio

YUKON RADIO SUPPLY INC.
Anchorage, Alaska

A rotary turret for best performance

The Super-Pro 600 Receiver has it!

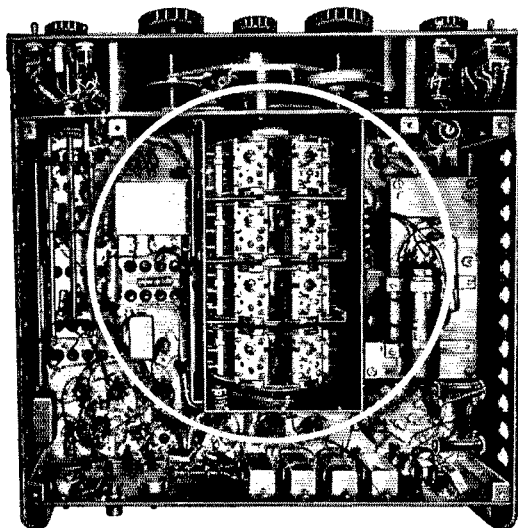

A rotary turret, uniquely incorporated into the "SP-600-JX," makes possible the placement of the coil assemblies of the two RF Amplifier stages, Mixer stage and First Heterodyne Oscillator stage directly adjacent to their respective sections of the four-gang tuning capacitor and the individual tubes.

Coil assemblies are mounted on the turret. Turning the band selector switch to any one of the six frequency bands places the required coils immediately in their correct positions. This arrangement increases receiver stability, provides uniform maximum performance from band to band, and simplifies servicing.

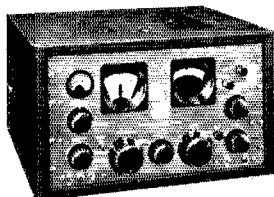

For more details about this magnificent 20-tube receiver write to The Hammarlund Mfg. Co., Inc., Dept. Q, 460 W. 34th St., New York 1, N.Y.

HAMMARLUND

(Continued from page 74)

KP4NY to help father and son keep in touch with one another. JSH can sleep in peace after working an XS9. SUJ and NUG are working hard to combat TVI. The Steel City Amateur Radio Club sends in its FB club bulletin. NWD has his new QTH in Florida. RXT has a sixteen-element 2-meter beam going for club station KWH. UHN and UVD are most consistent on the WPA Net. SYW has passed his General Class exam and now is operating on 10-meter 'phone. The WPA Traffic Net operates Mon. through Fri. at 7 P.M. on 3585 kc. NUG reports that the WPA Net handled 50 messages during November. SYZ, Mercer County RA treasurer, who is handicapped by total blindness, got a swell write-up on his accomplishment in obtaining his General Class ticket. Traffic: (Nov.) W3NCD 119, UHN 75, NRE 59, NUG 39, MIZ 6, AER 3, LXE 2. (Oct.) W3NCD 144, NRE, 12.

CENTRAL DIVISION

ILLINOIS — SCM, H. F. Lund, W9KQL — Section Nets: ILLN (c.w.) 3515 kc.; IEN (phone) 3940 kc. SEC: QLZ. Asst. SEC: HPG. RM: BUK. PAM: UQT. The State c.d. office announces the appointment of HOA as "State C.D. Coordinator of Amateur Radio Activities in Illinois." It is now possible to get your local RACES program in full swing. SRRC again is publishing *Static* under the able editorship of ZEN. The Waukegan and Midway Clubs participated in the full-scale Lake County c.d. drill; local c.d. officials had high praise for results obtained by amateur communications. 4CVO/9 was one of the spark-plugs for the Virginia call license bill — we will need his help here in Illinois, too. IDA is organizing an emergency net for Henry County. Activity also is picking up in Fulton County. A club has been organized with MUL as pres.; BLP, secy.; and AOV in charge of emergency work. OKI made WAS. MTB signs /8 while at college. OKQ works the mobiles now with a new 28-Mc. ground plane antenna. KWN has returned to 40-meter c.w. after curing TVI by working on the TV sets. Another new radio club, York High at Elmhurst, has elected OKI, pres.; OKQ, vice-pres.; and OIJ, secy. OCG succeeded in making the grade for Ad. Cl. ticket. SKR had a good time in the SS. The Starved Rock Club officers for '53 are VOK, pres.; ZEN, veep; and QLZ, secy.-treas. ZMU graduated to Ad. Cl. and will be on 4 Mc. soon. ICF acquired new test equipment as insurance against TVI. VBH is a new Novice in Havana and is quite interested in emergency work. OGY made Gen. Cl. but can operate only when home from college on vacation. Antenna damages from the 80-m.p.h. wind are reported by MBI, OKI, QUC, WFS, and 4CVO/9. CSW has a nice traffic total and is a new ORS. Traffic: W9CSW 356, YIX 92, SXL 71, BUK 65, W4MXU/9 54, W9STZ 52, W6CIW/9 49, W9KQL 45, BGN 38, LXJ 38, OKQ 30, W4CVO/9 29, W9MRQ 20, TBI 20, IDA 15, OKI 13, FRP 5, WFS 3, CTZ 2.

INDIANA — SCM, Clifford C. McGuyer, W9DGA — ZIB reworked his 10-meter beam and put up a new one for 2 meters. RZS is back on after his fire with a 32V-2 transmitter and an HRO-50 receiver. NJR, from Evansville, is a new ORS. MDW is in the Dental Corps in Germany. KLR has built a cascade crystal-controlled converter for 2 meters and an antennascope. YPF moved to Florida. AZJ monitors 147.3 Mc. nightly. WWT is a new OO. BKJ reports IFN traffic as 191. DKR built a Select-O-Ject and likes it very much. YWE has a new daughter. VGD is a new OES. JBQ reports RFN traffic as 78. PPS, OWZ, and RBX are new members of RFN. LZI and TT have 147.3 Mc. f.m. rigs. JBQ has moved to Jeffersonville. SKP works for the Nickle Plate Railroad. EUC reports the New Albany group is becoming more active. DLL is handling Hobart traffic on 80-meter c.w. DHJ built bandswitching VFO for 160, 80, and 40 meters. New EC for Clinton County is SKP. LOZ has rotator on his 70-foot tower now. ELL joined the Silent Keys. The Key and Mike Club of New Albany has 26 members and sponsored a transmitter hunt. DFI gave a talk on his 30 years in amateur radio to the Tri-State Amateur Radio Society and, as usual, was well received. KVE has new grid-dip oscillator. RIT, OBV, QAV, PQR, and TIU received their General Class licenses. FJI works 80-meter c.w. WN9THEV has recovered from a back injury. ULA built the Heathkit 5-inch oscilloscope. RZS is in the 5 and 10 business. MWM enjoyed the SS Contest very much. CWH has moved to New York. UNT received his Advanced Class license. MZE is with the Air Force in Germany. QOS has Viking transmitter and HQ-129 receiver. LOZ is on 2 meters almost every night. SZC has emergency net for Henry County. Sun. at 1330, on 80-meter c.w. OLX schedules PPG and KOY. The SEC, LZI, spoke at the Tri-City meeting (New Castle, Richmond, and Muncie) on the AREC activities. LQE is very active as OBS. DLJ is in the auto parts business. PWB is a member of MARS. DGA is building new TVI-proof rig for 20-meter DX. NJR is a new member of QIN. DLJ reports the Calumet Area Emergency Net on 160 meters is very active. Traffic: (Nov.) W9NZZ 272, YWE 237, BKJ 197, TT 130, FG 74, DHJ 92, FYM 86, WBA 69, JBQ 63, VN 50, DOK 46, PPS 45, HUV 44, KDY 44, NTA 42, QLW 39, DGA 33, LFR 32, YVS 32, MUR 25, OLX 25, QID 19, BDF 17, CMT 6.

(Continued on page 82)

For use in your finest equipment

Variable Capacitors that make the best radio gear better!

More than 30 years of capacitor manufacturing experience has produced "know-how" at Hammarlund that includes thorough understanding of nearly every method of capacitor design and construction. Because of this important background, the company's engineers can select from experience, as well as theoretical factors, the design for each specific capacitor type that fulfills all requirements.

This past experience is responsible for the outstanding features found in Hammarlund capacitors, such as:

1. Plates of brass, and soldered, *not staked*, to their supports to insure perfect contact and prevent loosening.
2. Precision soldering fixtures and assembly jigs used during fabrication to assure uniformity of plate spacing.
3. Rotor and stator assemblies nickel-plated to minimize corrosion.
4. Rotor contact springs of beryllium copper or phosphor bronze, and nickel or silver plated, for positive contact.
5. Insulators of low-loss steatite, impregnated with DC 200 silicone fluid to prevent absorption of moisture.

These are some of the features that make Hammarlund capacitors your choice for use in quality electronic equipment.



If you haven't received your new Hammarlund Capacitor Catalog, write for it today to The Hammarlund Mfg. Co., Inc., Dept. Q, 460 W. 34th St., New York 1, N. Y.

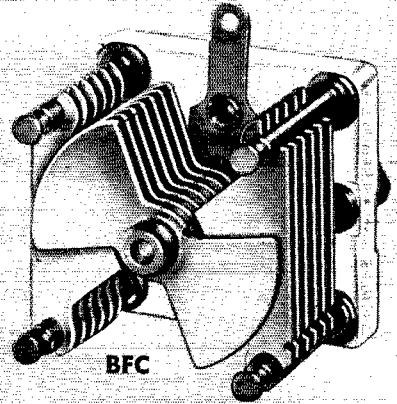

BFC

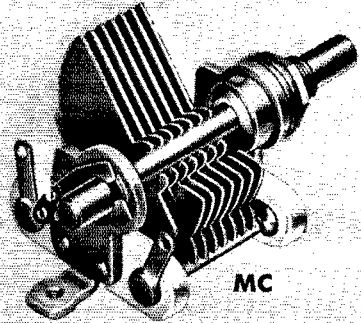

MC

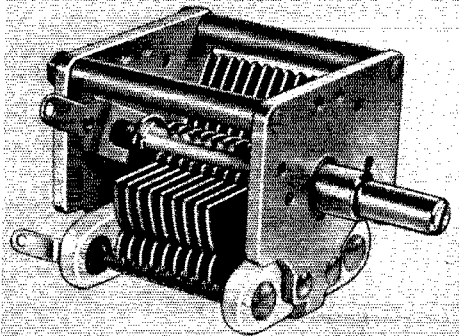

RMC

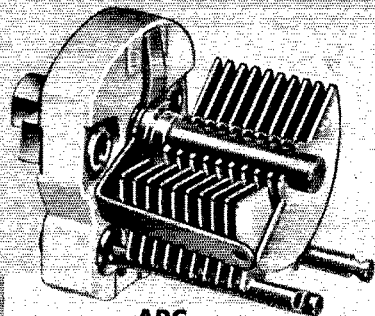

APC

HAMMARLUND

inside this package on your Jobber's shelf...
is the world's toughest transformer

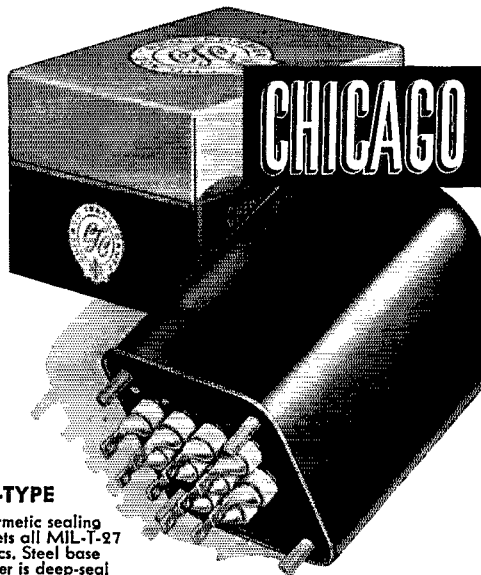

H-TYPE

Hermetic sealing meets all MIL-T-27 specs. Steel base cover is deep-seal soldered into case. Terminals hermetically sealed. Ceramic bushings. Stud-mounted unit.

there's nothing tougher than
CHICAGO'S "Sealed-in-Steel" construction

CHICAGO "New Equipment" transformers (available in 3 mountings) feature one-piece drawn-steel cases—the strongest, toughest, best-looking units you can buy. The one-piece seamless design, enclosing an electronically perfect construction, provides the best possible electrostatic and magnetic shielding, with complete protection against adverse atmospheric conditions. For every application: Power, Bias, Filament, Filter Reactor, Audio, MIL-T-27, Stepdown—ask your electronic parts distributor for CHICAGO "Sealed-in-Steel" Transformers—the world's toughest with that extra margin of dependability.



S-TYPE

Steel base cover fitted with phenolic terminal board. Convenient numbered solder lug terminals. Flange-mounted.



C-TYPE

With 10" color-coded leads brought out through fibre board base cover. Lead ends are stripped and tinned for easy soldering. Flange-mounted.

FREE "New Equipment" Catalog

Get the full details on CHICAGO'S New Equipment Line—covering "Sealed-in-Steel" transformers for every modern circuit application. Write for your free copy of this valuable catalog today, or get it from your distributor.



DKR 6, FSA 6, KLR 2, WN9UQP 2. (Oct.) W9ZIB 19, RZS 5, IZC 4.

WISCONSIN—SCM, Reno W. Goetsch, W9RQM—SEC: OVO, PAM: ESJ, RMs: IQW, SFL, C.W. Net (WIN) meets on 3625 kc. at 7 p.m. daily; slow speed; 6:30 p.m. Mon.—Fri. Phone Net (BEN) meets on 3950 kc. at 6 p.m. daily. State mobile and c.d. frequency: 29,620 kc. CXY is planning a 1/2-wave doublet for 3.5-Mc. operation. After a summer of remodeling, ESJ is getting back to a state of normalcy again. Net certificates (BEN) were issued to ANC, HZS, MWQ, and PZN. 1LRG/9, formerly EC, OHS, and ORS at Bangor, Me., now is located at Middleton, Wis. In addition to traffic, UCR also is on 7 and 14 Mc. chasing DX. LSK has parasitic trouble. Twenty-nine stations checked into the slow-speed WIN net in November, according to an FB report submitted by SFL. With 35 watts, RGI has worked 38 states on 3.5 and 7 Mc. since he was licensed in January. REQ and DSP claim a first in Wisconsin with 6-mile coverage on 438 Mc., A3 with 30 watts to BC645. HEE is 3rd region NCS of the Trans-Wis. 28-Mc. net which meets at 9 p.m. Tues. and Thurs., on 28,648 kc. WN9SDH's 144-Mc. Texas QSO turned out to be a phoney. QZO has converter and antenna going on 144 Mc. FAN is checking twelve-element phased array against dipole and screen reflector for aurora work on 144 Mc. MRAC held an auction of donated radio gear with the proceeds going to help the blind who are interested in ham radio. DSP added a 12A17 r.f. stage for improved signal to noise ratio on 420 Mc. WYRA was represented in the SS by FCF, FZC, HRX, LED, PBA, IUQ, EWM, RQM, JBF, QJB, KJM, and GKO, and a club score of 275,000 points. New appointments: DSP as OES, MSD as EC. Appointment renewals: JBF and LEE as OES, EIZ as ORS. Traffic: W9CXY 156, ESJ 97, W1LRG/9 66, W9UCR 46, SFL 41, PCF 35, DR 32, IQW 32, NRP 29, LSK 25, EIZ 18, ERW 17, VLL 17, RQM 16, CBE 7, OVO 6, IHW 3, IFS 2.

DAKOTA DIVISION

NORTH DAKOTA—SCM, Everett E. Hill, W6VKP—N All North Dakota amateurs are invited to take part in the following nets: (1) 3670 kc., 1830, Mon.—Sat., W6AOX-NCS. (2) 3845 kc., 1800, Mon.—Sat., W6EOZ-NCS. (3) 1920 kc., "No. Dak.," Mon.—Sat., W6IAP. (4) 1980 kc. "Goose River," Sun. only, 0900, W6OEL. Reports here will include all word received from active hams. Be sure to report your activity radiowise to the SCM the first of each month, Support our nets.

SOUTH DAKOTA—SCM, J. W. Sikorski, W0RRN—SEC: GCP, RM: OLB, PAM: UVL. With UVL's acceptance of the appointment South Dakota has, for the first time in years, a PAM. South Dakota, has a superior 'phone net. Much credit goes to Trot for his past activities and your continued cooperation will be appreciated. DTB, Centerville, has purchased HAT's rig, running 300 watts to S13. A new call at Emery is WN0LXP, PAV, Selby, is a newcomer on 160-meter 'phone. CLJ, Vermillion, has joined the 75-mobile gang. CQK is in the TV antenna and service business. KVB has been transferred to Omaha by the telephone company. After talking about it for two years, PHR installed a 45-90 antenna, and after a two-week trial went back to the center-fed on the second day of the SS. UVL and HWS handled press for AP while Pierre was isolated by a sleet storm. Traffic: (Nov.) K0FAL 75, W0OLB 38, PHR 38, EHO 36, WISWX/0 14, W0AEN 10, GCP 6, RRN 2, CSB 1. (Oct.) K0FAL 108.

MINNESOTA—SCM, Charles M. Bove, W0MXC—Asst. SCM: Jean Walter, KYE, SEC: BOL, RMs: DQL and RPT, OPS: UCV and HEO. The Minneapolis Radio Club now holds transmitter hunts the fourth Friday of each month. A v.h.f. steak dinner was held at Anoka. Most of the 2- and 6-meter boys attended, 17 in all. Among the 2-meter equipment on display was ATD's 9-watt etherbuster. GVO now is Advanced Class and soon will be checked into the MSN. On Thanksgiving 52 stations checked into the MSN 'Phone Net. The St. Paul Mobile Corps, affiliated with the Red Cross, now is tying in with the Ramsey County auxiliary police. RA now is on the air with an Elmac. PCV has been reported as missing in action in Korea. He was radio operator on a B-29. ANY now is operating K4FCE. Did you know that CTW was SCM back in 1931? EPJ has moved to Minneapolis. K6EA's XYL received her Novice Class license with the call WN0MFW on their wedding anniversary. JNC did all right for himself in the Sweepstakes. OAZ is back checking into the 'phone net. He is the father of ROR and RQT. UVC is building a new 2-meter converter. CCX is selling communications equipment in South Dakota. BRA now has a 32V-3, which got rid of his TVL. DSF is using the call DL4HM on the highest hill in Western Germany. Art's set-up is a 32V-3 and a 75A-2. He now is Major Monsees. HFY is building a rig using the new 6146. The Red Cross station in St. Paul, DKI, has a new Viking II. The Minneapolis Radio Club has published a vest-pocket call book covering the Twin Cities and suburbs. DYF now is in the Navy. BUO has built a new 'phone patch that really sounds good. WQM has a new SX-71. We would like to see all (Continued on page 84)

CHICAGO TRANSFORMER

DIVISION OF ESSEX WIRE CORPORATION

3501 ADDISON STREET • CHICAGO 18, ILLINOIS



W1FH reports on Eimac 4-250 A's...

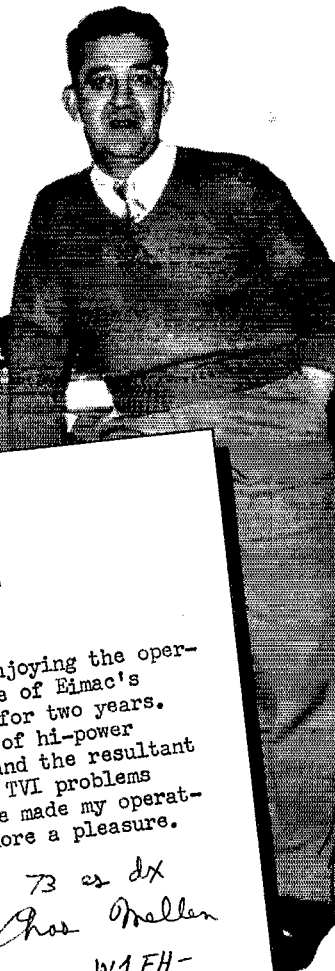

In a recent letter
CHARLES MELLEN
says:

I've been enjoying the operating convenience of Eimac's 4-250A tetrodes for two years. The elimination of hi-power driving stages and the resultant ease with which TVI problems were solved have made my operating that much more a pleasure.

*73 es dx
Chas Mellen
W1FH-*

DX
CENTURY CLUB
AWARDS
Honor Roll
W1FH.....249*
Radiotelephone
W1FH.....222*
* First Place

Eimac
TUBES

EITEL McCULLOUGH, INC.

SAN BRUNO • CALIFORNIA

Export Agents: Frazer & Hansen, 301 Clay St. San Francisco, Calif.



**More Safety...Less Guesswork
When You Use
—PRECISION—
TEST EQUIPMENT**

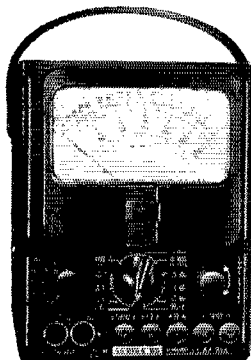

**Stay On The Air
With "PRECISION"
SERIES 85
AC-DC
Circuit Tester
(20,000 Ohms per Volt)
SELF-CONTAINED TO
6000 volts,
60 Megohms,
12 Amperes, + 70DB**

A compact, laboratory type, *high sensitivity* test set indispensable for test and maintenance of modern amateur communications equipment.

20,000 Ohms per Volt D.C. — 1000 Ohms per Volt A.C.

VOLTAGE RANGES: 0-3-12-60-300-1200-6000 A.C. & D.C.

CURRENT RANGES: 0-120 microamps; 0-1.2-12-120-MA;
0-1.2-12 Amps D.C.

RESISTANCE RANGES: 0-6000—600K—6 Meg—60 Megohms.

DECIBEL RANGES: From -26 to +70DB.

Complete with batteries and test leads..... **\$39⁹⁵**

PLUS superior physical features:

- ★ 4½", 50 microamps, Easy Reading Meter.
- ★ Heavy duty bakelite case 5½ x 7½ x 3".
- ★ Deep etched, anodized aluminum panel.
- ★ Recessed 6000 volt safety jacks.
- ★ Only two pin jacks for all standard ranges.

LC-1 LEATHER CARRYING CASE—Custom designed, top-grain cowhide case with tool and test lead compartment. \$9.50
See Series 85 and other famous "Precision" instruments, on display at leading radio parts and ham equipment distributors. Write for latest catalog.

Precision Apparatus Co., Inc.

92-27 Horace Harding Blvd., Elmhurst 13, N. Y.

Novices check into the Minnesota Junior Net every chance you get. Traffic: W8QYZ 521, DGL 338, HEO 176, RXL 101, UCV 74, HFY 68, RQJ 59, DYD 42, TJA 39, MXX 31, MPW 23, CTW 18, KNR 15, BUO 13, GGQ 12, BWM 10, K6EA 6, W0BRA 2, OPA 1.

DELTA DIVISION

ARKANSAS — SCM, Fred Ward, W5LUX — ASO has battery-powered rig for emergencies all ready to go. DRW has code class doing fine. SMIN, at Berryville, is building \$13 rig for 160 meters. We hope it works on 80, too. OKU has been working the traffic nets on 80 meters with a nice signal. FPD renewed his EC appointment for Hot Springs. Not many reports were received this month. None arrived from 26 of our Emergency Coordinators. Fellows, if you hold any appointment we would like to have your report. C.w. net activity has been pretty low, caused partly by bad skip conditions. The slow-speed net failed to get started this year, and OZK needs more stations. Slow-speed operators are welcome to join the Ozark Net. Net racing time is 1900 on 3695 kc. Net Control Stations: DRW, VN, RWJ, MRD, STU, Traffic: W5EA 40, LUX 38, VN 7.

MISSISSIPPI — SCM, Norman B. Fishan, W5JHS — New SEC appointee is YTK/5, Jack Martin, P.O. Box 990, Gulfport. We regret to lose LPL our former SEC, who is being transferred to Oklahoma. 4YTK/5 will be remembered as the father of WN5WCG, Helen Martin, 9 years old, also SKA, SKB, and two other Novices whose calls I do not remember, making six hams in this family. LPL and K5FBB ran up some nice scores in the SS Contest. News from Korea: RUT should be home by now, RMC is counting the days when he will be home, also JFE's time is getting short. We are looking for you back, boys. Note: VQE's traffic report — not bad for an XYL, considering this was all handled direct to KZ5-Land. Skip conditions have been very bad for the Hurricane Net, also the Morning MARS Net. UHU and OGN are checking into the Hurricane Net now. FSS has eliminated all TVI and is heard frequently on 75 meters. Traffic: K5FBB 353, W5JHS 108, RIM 52, VQE 10, PDJ 4.

TENNESSEE — SCM, Mark M. Bowelle, W4CXY — SEC: AEE, RM; AGC, PAM; PFP, Communications emergencies are becoming so commonplace here in Tennessee that the gang just swings into them as if it were all in the day's work. Early in November all of East Tennessee was beset with forest fires and several amateurs aided in fire-fighting work, most notable of which was a group of Chattanooga mobiles that took over between the fighters and their base until rains helped check the fires. Later, on Nov. 21st, a record snow fell in East Tennessee and took out nearly all wire lines, as well as much of the power. Both the c.w. and phone nets swung into action, aided by several out-of-state stations who QSPed because of QSB and took out-going traffic. Just about ALL communication in the area was taken over by amateur radio — R.R. dispatching, W.U., Bell Tel. urgent calls as well as direction of Bell's line crews; even the Forest Service and Highway Patrol, who have their own emergency set-up, had to call on hams for help. SSers raised Cain with the c.w. net but, without exception, scrambled when told we had an emergency. These emergencies bring to life many good traffic men who otherwise are dormant. Our best traffic man, PL, is beset with TVI but RHO now has it licked — he thinks. The Memphis gang has elected new club officers and still is mailing a very FB bulletin. Traffic: W4PL 1080, PFP 475, OGG 205, AGC 188, LNF 154, PMR 148, APC 122, IIB 106, JD 101, WAX 97, HHQ 95, EWR 56, CXY 41, AKJ 29, WQW 14, RHO 12, FHP 6, RMJ 4, FLW 2.

GREAT LAKES DIVISION

KENTUCKY — SCM, I. W. Lyle, jr., W4KKG — K4WBG makes BPL with a nice total. KZF went all out in the SS Contest and raked up a nice score. TAV has a new Viking II. PRT keeps Lexington on the map. MIS has 500 watts on all bands and put in lots of time during the big snow storm emergency. NBY and RRU, of Harlan, did a whale of a job during the emergency. RRT handles NCS of KYB in fine style. ODA visited KJP at Dix Dam. WHC received his Advanced Class ticket. CMT, an old-timer, is being heard from again on the nets. MWX turned in his usual fine report and keeps KYN buzzing. UWA has nice signal and operating style. IIAN now is in Louisville and has his application in for a W4 call. Welcome to Kentucky, Gordon. All amateurs were sorry to learn of the passing of JYR, ex-W9ARU, an old-timer in our game, former SCM and a member of many amateur organizations. Although Darrell has joined the ranks of Silent Keys he will not be forgotten. His pleasant manner and ready willingness to help the beginner was an inspiration to all who knew him. This will be my last report as your SCM. It has been a real pleasure to have served in this capacity and the job has been made easier by the cooperation of the amateurs of Kentucky. Congratulations to our new SCM, Ivan Kelly, TUT, of Somerset. Kelly is ready, willing, and able to do a fine job and all he needs is your cooperation. Let's give it to him, fellows. 73 to all of you and be seeing you around
(Continued on page 88)

MALLORY HAM BULLETIN

Oscillator Switching with the MALLORY 152L 6 Position Switch

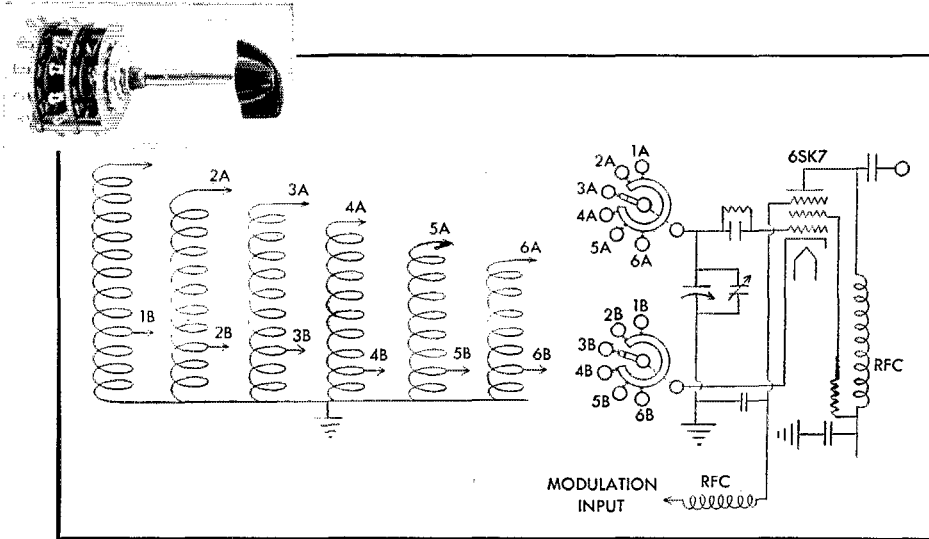

It is surprising how much the sensitivity of the average communication receiver can be improved by the use of a simple variable frequency test oscillator, to "touch up" the I.F. section or to peak the R.F. stages.

An oscillator suitable for most amateur work need not be complicated or difficult to build. It should consist of a reasonably stable circuit similar to the one shown here, and should be roughly calibrated over a range from approximately 400 KC through 30 MC. Some method of modulating its output should be employed, although this is not a necessity if the receiver to be tested is equipped with a carrier level "S" meter.

Bandswitching should be employed for convenience in switching from one range to another. Mallory type 152L is admirably suited for this purpose. It consists of 2 sections and 6 positions. A unique feature of the Mallory 152L switch is its automatic shorting mechanism which shorts out all unused coils, thus eliminating the possibility

of harmonic "suck-out" points. In addition, this switch is equipped with an adjustable "stop" so that any number of positions may be used from 2 through the full 6.

Circuit constants and modulation methods for the suggested oscillator schematic may be found in most of the late Amateur Handbooks. The 152L band switch and other parts may be purchased at your nearest Mallory authorized distributor.

You can rely on Mallory Precision manufacturing to supply you with the most dependable line of: ham band switches, push button switches, controls—rheostats—potentiometers—pads, tubular capacitors, transmitting capacitors, dry electrolytics, dry disc rectifiers, vibrators, and vibrator power supplies—practically every component you need to keep your rig in A-1 condition.

P. R. MALLORY & CO., Inc., INDIANAPOLIS 6, INDIANA

P. R. MALLORY & CO. Inc.
MALLORY

ENGINEERING OPPORTUNITIES AT JOHNSON

We invite QST readers to consider technical employment in the following categories made necessary by an expanding products development program.

COMMUNICATIONS ENGINEERS ... With EE DEGREES

... or equivalent professional experience in the communications field.

MECHANICAL ENGINEERS

... with design experience on small mechanical and electrical parts similar to those used in electronics equipment.

DESIGNER-DRAFTSMEN

... for diversified work on equipment and components.

These openings are the result of steady growth of our company over 30 years. The excellent reputation and wide acceptance of Johnson products have been the result of sound engineering, close control of manufacturing, conservative but progressive management and adequate financial strength. These factors, plus widely diversified lines, lead to job security that is unsurpassed in the industry.

Waseca offers an attractive small city environment, ideal for family life, close to work, to good schools and recreational opportunities in the Land of Ten Thousand Lakes.

If you feel you are qualified and interested in working with a compatible and highly respected group on projects ranging from component items to broadcast and amateur equipment and without the disadvantages of over-specialization and resultant boredom, write to A. M. Pichitino, Chief Engineer. We would appreciate a resume of your education and experience in your first letter together with a recent photo. All responses will, of course, be held in strict confidence.

E. F. JOHNSON COMPANY

210 2nd Avenue, SW

Waseca, Minn.

on the bands. Traffic: K4WBG 373, W4TAV 354, MWX 169, WHC 66, MIS 55, PRT 51, CDA 34, CMT 23, UWA 19, RFI 7, KZF 6.

MICHIGAN—SCM, Norman C. MacPhail, W8DLZ—Asst. SCMs: R. B. Cooper, 8AQA (phone); J. R. Beljan, 8SCW (c.w.); M. C. Wills, 8CPB (Upper Peninsula). SEC: G.J.H. RMs: YKC, ELW, UKV. New appointments: OPS to IKX, FGB, and JYJ; EC (Area 10) to GNS; ORS to SJF. New Officers of the Grand Rapids Club are AQA, pres.; GKT, vice-pres.; IRI, secy.; ZCH, treas.; HJC and DUV, activities directors. FLA reports the Allegan Club again is meeting in the old club house at "Read's Gulch," home of JUQ. ALV has moved to Washington, D. C. RJC and MGQ lost antennas in the recent high wind storm (as did yours truly). New officers of the Cherryland Radio Club are JUY, pres.; JEF, secy. DZX QNIs the QMN from St. Louis, Mo., under his new call, 8IJS. WVJ received his Advanced Class ticket. EGI and SCW got Joe's special "SS antenna" up just 10 minutes before the startin' gun went off. The Berrien Club goes to jail for club meetings now. A new Viking II is all set for AREC work in the local "pokey," according to FGB. SWF mourns the loss of a 250TH. FX says his 31-year-old Marconi antenna is no good for modern-day SS operation. Now he has the DX bug. DAP says the QMN will be in session every Sat. on 3663 kc. starting at 1830 EST. Everyone is welcome. Now that the deer season is over (and everyone home safe and sound) both QMN and BR should show increased attendance. A close look at traffic reports shows Lansing has more active amateurs (per capita) on our traffic nets than any other city or town in Michigan. Congratulations! The GR gang has set the date for the Midwinter Hamfest. It is Feb. 28th at the Rowe Hotel in Grand Rapids, starting time between 2 and 3 p.m. ZZU now is on 7025 kc. as 8ZZU/1 from Searsport, Maine, and is looking for Michigan QSOs any evening at about 8 EST. Traffic: (Nov.) W8RJC 366, NZZ 297, ELW 190, NOH 171, QIX 127, SPF 108, ILP 104, ZLK 100, DAP 80, JYJ 60, SCW 57, WVL 57, IV 55, RTN 49, YKC 46, IKX 44, COW 35, IBB 35, DLZ 27, SJF 25, AQA 19, WNT 19, EGI 16, FGB 16, MGQ 13, TQP 13, SWF 12, HK 10, AUD 9, EEF 9, LLD 8, HKT 7, FX 5. (Oct.) W8RJC 168, YKC 58, QBO 57, GNS 52, UKV 25, IKX 23, IBB 22, SCW 22, SJF 17, WNT 17, AQA 16, AHV 9, FFG 6, HK 4.

OHIO—SCM, John E. Slinger, W8AJW—Asst. SCMs: C. D. Hall, 8PUN, and J. Erickson, 8DAE. SEC: UPB. PAM: PUN. RMs: DAE and PMJ. New appointee is AJH as OBS. According to DAE, NCS of BN, activity is very good. DSX's report shows eight Ohioans reporting regularly into 8RN. LMB has installed a new 75-meter antenna and as a result his traffic is picking up. YGR worked 11 sections during the SS Contest. ISD is moving to Syracuse, N. Y. A new club has been formed in Fremont with about 20 members. HRN is president. LVF, an ex-Signal Co. ps operator, is a newly-licensed amateur in Columbus. Here are a few election results: The Dayton gang elected YCP, pres.; FHJ, vice-pres.; OVG, secy.; and ZSK, treas. New West Park Radios prexy is PM, IWP is secy.-treas., while ZEU and VM were made trustees. In Columbus, EYE became the new CARA pres.; ZCQ, vice-pres.; FYY, secy.; while ABO was made guardian of the funds. Club directors are IJ, QQ, and APF. With a splendid display of courage and stick-to-itiveness HSM made General Class on his sixth try. MBB nailed his initial amateur license and 2nd-class commercial 'phone on the same day. According to *Shack Gossip*, GTV and GDE acquired baby daughters; HFX has a new granddaughter; GIY, a former c.w. stalwart, is on 160-meter 'phone exclusively; and DQR has returned home from Crile Hospital. Emery Lee, FCC Engineer, desires that each community establish a TVI committee and that the address of the secretary of each committee be sent him. The Great Lakes Emergency Net meets on 1880 kc. at 7:30 p.m. (EST) on Tues, Thurs., and Sat. The Ohio 'Phone Net on 3860 kc. is doing quite well according to its originator, CTZ. The Dayton R-F Carrier states that they will conduct a code school after the first of the year if sufficient applications are received; LUZ is ex-G2HLP; new members are ARN and JOB; and ACE has just made Double DXCC. DOG is currently conducting code classes in the Cleveland Area and welcomes new applicants. Springfield's Q-5 informs us that their emergency test run was successful; new committee heads are Program WAU, Interference OG, Educational IRT, Contest JNC, and Emergency DCJ; and EQN has almost completed his WAOC (Worked All Ohio Counties). The QCEN's *Listening Post* relates the GAL soon will receive "Greetings" from Uncle Sam, and that Carly, our de luxe SEC, still is traveling about the section in the interest of the AREC. OVG writes that in view of the 1952 Hamvention being such a pronounced success the Dayton gang is going to sponsor another on March 21st. Columbus' *Carascope* states that IGN is building a new 813 final, 24 mobiles and 6 fixed stations participated in the area's S.E.T.; UPS has moved to Chicago. Traffic: (Nov.) W8FYO 234, DAE 144, UPB 125, CTZ 114, LMB 91, YGR 52, AL 35, RO 34, BN 33, WE 27, EQN 26, AJW 16, QIE 14, UZJ 14, TLW 11, KFB 9, ET 5, BEW 4, MGC 4, PMJ 4, LBH 3, BUM 2. (Oct.) W8KFB 17, TLW 13, ZAU 10, ZJM 2.

(Continued on page 88)

JOHNSON AMATEUR EQUIPMENT

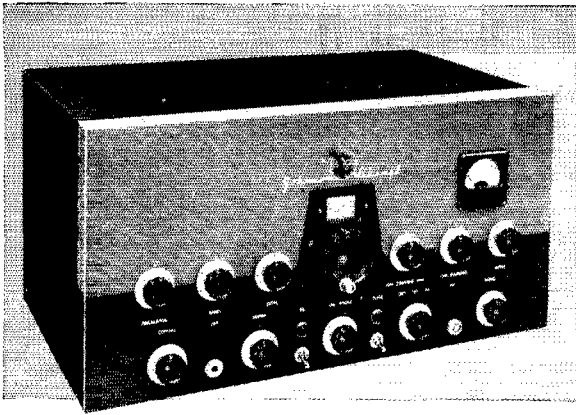

VIKING II TRANSMITTER KIT

The JOHNSON Viking II is an expertly designed transmitter, furnished unassembled, but complete. All amateur bands from 10 to 160 meters, 100 watts phone output, 130 watts CW. Includes all necessary parts, hardware, tubes, wiring harness, cabinet, and step by step instructions.

- TVI Suppressed
- Dual Power Supplies
- Instant Bandswitching
- VFO Input Provision

240-102 Viking II kit with tubes, less crystals, key and mike

AMATEUR NET **\$279⁵⁰**



VIKING VFO KIT

The JOHNSON VFO kit is accurately calibrated for all amateur bands from 10 to 160 meters. Stability is excellent, assured by rigid construction and temperature compensated ceramic padders. Vernier tuning, clean keying, and perfect "break-in" on all bands. Assembly is simple. Kit complete, less tubes.

240-122
VIKING VFO KIT.

AMATEUR NET **\$42⁷⁵**

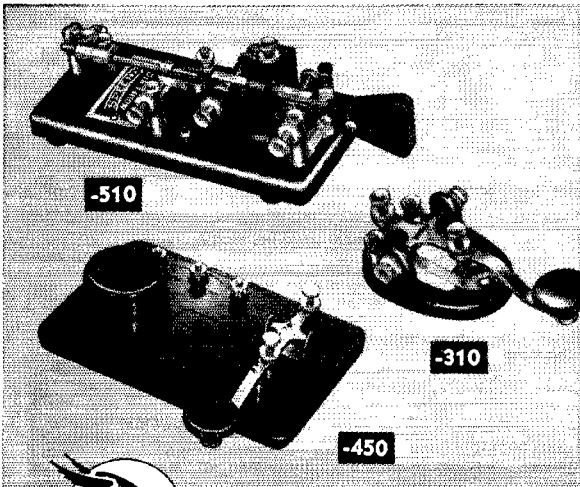

JOHNSON KEYS

SEMI-AUTOMATIC KEY WITH SWITCH

Compact, light model. Circuit closing switch. Die cast base, 6"x2³/₄"x3¹/₄". Black wrinkle enamel finish. 1/4" coin silver contacts. Fully adjustable from eight words per minute to highest rate desired.

Cat. No. 114-510 Net Price \$10.50

STANDARD MODEL KEY

Heavy die cast base. Smooth adjustable bearings. Provision for plugging in semi-automatic keys. 1/4" coin silver contacts. Operates with a light keying touch.

Cat. No. 114-310 Net Price \$3.00

PRACTICE SET

An inexpensive practice set for beginners. Constant frequency buzzer and key mounted on a 4"x6" molded brown Bakelite base. May be used singly or in pairs for code practice.

Cat. No. 114-450 Net Price \$3.60

Complete information on JOHNSON semi-automatic, standard and practice keys included in General Products Catalog 973. Write for your copy today!



E. F. JOHNSON COMPANY

CAPACITORS, INDUCTORS, SOCKETS, INSULATORS, PLUGS, JACKS, DIALS, AND PILOT LIGHTS

210 SECOND AVENUE SOUTHWEST • WASECA, MINNESOTA

FOR FINEST QUALITY

RELIABLE
SUBMINIATURE
TUBES

RELIABLE
MINIATURE
TUBES

GERMANIUM
DIODES

TRANSISTORS

NUCLEONIC
TUBES

RECEIVING AND
PICTURE TUBES

MICROWAVE
TUBES

use

RAYTHEON

Excellence in Electronics

RAYTHEON MFG. CO.

Receiving Tube Division

Newton 58, Massachusetts

HUDSON DIVISION

EASTERN NEW YORK — SCM, Stephen J. Neason, L W2LLI — RMs: TYC, KBT, PAM; IJG, K2CA. FED and AYM are rebuilding and will be on 1.8 Mc, soon. EWO is having trouble with her rig on 1.8 Mc. RVWARS has formed a TVI-BCI committee. LRW will be more active on the nets now that the MARS contest is over. PSH reports that the Ossining officials are very much pleased with his AREC set-up. HEI, recovering from a recent illness, is active from his shack which is located in his bedroom. LEL is en route m/m from Dakar. VP is very active on 10-meter mobile. New officers for SARA are PFTU, pres.; FGL, vice-pres.; YIV, secy.; GRI, treas.; GTC, ACC, and UKL, directors. The following have been awarded Section Net certificates for activity on NYSEPN: TRE, NOC, CFU, MHE, K2CA, and ILL NYSS: APH, HEI, WSS, and DGW. New members of AARA include IGX and JNC. My sincere thanks to those who supported me in the recent election for Director of the Hudson Division. Our best wishes for a successful term go to our new Director and Vice-Director, OBU and NKD. UQW has returned from a three-week Florida vacation and may be heard on 14 Mc. with a full gallon. ITQ is dividing his time between 3.8 and 29 Mc. these days. NYS meets on 3615 kc. Mon.-Sat. at 7 P.M., Mon.-Fri. at 10 P.M.; NYSS on 3595 kc. at 8 P.M. daily; NYSEPN on 3980 kc. at 6:30 P.M. daily and 8:30 A.M. Sun. Please make sure to include a complete break-down of your traffic when sending in your report. YXE has erected a new antenna for operation on 3.8 Mc. Avoid loss of appointment, check your endorsement date now. Many appointments are now available; a note to the SCM will bring full details. Traffic: (Nov.) W2TYC 151, LRW 47, EFU 37, ILI 36, APH 10, HEI 10. (Oct.) W2APH 13.

NEW YORK CITY AND LONG ISLAND — SCM, George V. Cooke, jr., W2OBU — Asst. SCM: Harry Daniels, 2TUK, SEC: KTF, RM: VNJ, PAM: YBT. The New York Radio Club meeting featured the Hon. George E. Sterling, FCC, and was excellently attended by representatives of 22 clubs from the N.Y.C.-L.I. and N.N.J. sections. The committee for the evening was VOU, K2DW, AMB, ZE, and BW and a really fine talk was enjoyed by all. The club announces GKP, NSII, and FBT are chief operators at their Red Cross station. GTE, and seek more operators to maintain an extended schedule. GKP, after many years in flying, fell in a Broadway store and broke his arm. The Nassau Club boasts a membership of 63 and is running a member sweepstakes with special prizes offered to members in various licensed grades. The L.I. unit of the YLRL has all the paperwork for the Braille Technical Press to take care of voluntarily and is bending every effort to help this worthy cause. VNJ, RM for the NLI Traffic Net, which meets at 1930 on 3630 kc. Mon. through Fri., announces that BRAT awards, patterned after the West Coast, will be issued to any amateur in this section who complies with the point score required for by attendance and traffic counts. A teletype station was set up in a New York City store and free messages were solicited for GIs everywhere. BFD, VNJ, EC, BC, AEE, and others handled the traffic to outgoing channels. The North Nassau Club now meets in the Roslyn High School the 2nd and 4th Tues. of each month and invites all amateurs to attend its meetings. Contact GFF for particulars. The Jamaica UIIF Club is building up a 420-Mc. net and asks, "Why not a mobile 420-Mc. net?" BIV, Brooklyn EC, reports 7 c.d. drills and states 30 per cent of his AREC members are emergency powered. DUP, Bronx EC, reports drills in the Bronx are held Mondays on 10 and 2 meters, with 12 mobiles active. In Suffolk County, KNA EC, installation of a control station at Riverhead is going ahead, 6 of the 10 townships there are reporting in, and KNA requests more AREC stations at the far eastern end of the county to get on 2, 6, or 10 meters. ADO is extremely active on TCPN and is building up some nice traffic scores. LGK finally got Class A after 14 years, and asks for QSLs on his ARRL bulletins on 80, 10, and 2. The Lake Success Club has a new mast and gear and now is installing 2-meter rig for c.d. use. WDT has been appointed OBS. IVU received ORS appointment. KN2BPM is a new Novice in Center Moriches. The QCWA Net meets Sundays at 1100-1200 on 3810 kc. PAA (Copiague) worked AOD (Flushing) for best DX on 420 Mc. with sked at 2100 on Tuesdays. Let's get more in for round tables. IVS has new 500-watt rig, antenna, and electronic keyer and is going to town on traffic scores. OJM piled up 119,230 points in the Sweepstakes Contest. Traffic: (Nov.) W2BO 738, VNJ 295, EC 215, ADO 199, LPJ 190, HDK 137, JXM 117, GP 83, IVS 59, OBU 51, OJM 50, LGK 47, ZKJ 47, PF 22, GXG 11, BQM 10, UXY 9, EEE 6, IN 6, IVU 3. (Oct.) W2ADO 274.

NORTHERN NEW JERSEY — SCM, Lloyd H. Manamon, W2VQR — Asst. SCM: D. Reid, 2FMG, SEC: NKD. RMs: WCL and NKD, PAM: CCS. Karitan Valley Radio Club notes: GUZ assisted 4 men in the New Brunswick Area to obtain Novice licenses. Doc himself got Advanced Class ticket, as did COG. K2BCK reports joining the NNJ Net and has received ORS appointment. CUI is busy with nets and traffic activity. YJC reports his brother now is KN2BNK. TPJ, OO, reports 500 Sweepstakes contacts

(Continued on page 90)

Specify *Bliley*... For 22 Years The Foremost Name In Crystals

★ ★ ★

AMATEUR

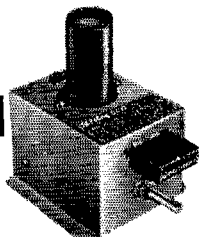

Types AX2 and AX3, designed especially for this service, bring price and precision together in the ham bands. Bliley's packaged oscillator, Model CCO-2A, is a favorite for 2-6-10-11 meter home built rigs. Price and details are given in Bulletin 44.

SHIP-TO-SHORE



Types MC7, SR5 and SR8 are suggested for shipboard dependability. Price and details given in Bulletin 44.

BROADCAST



Types BC46T, MO3B, TC92 are first choice for automatic temperature control in AM, FM and TV transmitters. Consult Bulletin 43 for basic details.

SPECIAL PURPOSE



Types SR10 and MC9 provide wide range frequency choice for TV service, diathermy and citizens band. Request Bulletin 44 for price and description.

COMMUNICATIONS



Type BH6A is the predominant choice for land mobile and airborne applications. Consult Bulletin 43 for basic information.

STANDARD



Types KV3, MC9, SMC100 and MS433 cover reference frequencies from 100 kc through 10.7 mc. Price and "stock tolerances" given in Bulletin 44.

MILITARY



For reference in this broad category, see the "Specification Index for Military Crystal Units" in Bulletin 43.

ULTRASONIC DELAY LINES



Custom built fused quartz delay lines provide high stability and precision time intervals for manipulation of pulsed or pulse modulated signals. Consult Bulletin 45 for technical information.

FREQUENCY STANDARDS



Model BCS-1A is a high stability instrument for precision reference at 100 kc. Ideal choice for research and development laboratories. Descriptive information given in Bulletin 43.



Bliley
CRYSTALS

BLILEY ELECTRIC COMPANY
UNION STATION BUILDING • ERIE, PENNSYLVANIA

*You've been
waiting for it - a*

VFO

for your **Harvey-Wells**
BANDMASTER

NOW IN PRODUCTION

**FULL EFFICIENCY ON ALL BANDS
THIS IS IT**

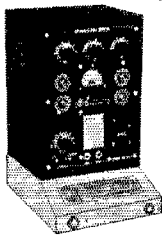

OCCUPIES NO MORE DESK SPACE

**WRITE NOW FOR
DESCRIPTIVE
LITERATURE**

• Ask your own
supply house to
reserve one for you.

PRICE \$47.50

Harvey-Wells ELECTRONICS, INC.
SOUTHBRIDGE, MASSACHUSETTS

EXPORT DEPT., — 13 East 40th Street, New York
CANADIAN DISTRIBUTOR: Canadian Marconi Co.
861 Bay St., Toronto, Ontario

with 64 sections for a score of 80,000. DXD is active in TCPN and MARS daily. JKH is going back on c.w. for a while. Reason? He went to the hospital for a tonsil-removal job. EAS, ORS, has 400 watts input to a pair of 805s Class B linear grounded grid on s.s.b., also 70 watts on c.w. bands. HXP, working 10-meter mobile rig, reports in the AREC on 146.9 Mc. at 8:30 p.m. Tues. ATE, at Westwood, reports plenty of c.d. activity with new equipment and set-ups. New DXCC members: GNQ, EQS, CGJ, and ATE. The Ridgewood ARC had one of its best years. NIY, OO, reports 2 violations logged. GVZ, OO, had 11. TPJ, OO, reports 14 second-harmonic discrepancies. The Garden State ARA's new officers are DME, pres.; K2BX, vice-pres.; FZY, treas.; OPH, program chairman; GUM, chief engineer; Howard Parker, sergeant at arms. CCS, active in TCPN, NJ 75 EN, and Bergen County EN, wants daily 'phone net on 75 meters. CFB skeds DJ, Hornell, N. J., 3566.5 kc. Mon., Wed., and Fri.; NJN c.w. 1900, 3695 kc.; and CDNJ, 1930, Tues., 3505.5 kc. HIA, EC, handles traffic on NJ 75 'phone net and Middlesex County Net. 147.15 Mc. ABL works random skeds with K5FBB where his son, W2ZEP, is stationed. During November and December your SCM represented the N. J. amateurs at Area C.D. meetings called by the Director of Civil Defense in Trenton, Freehold, Toms River, New Brunswick, Bridgeton, Atlantic City, and Camden. VQR had as a visitor, SFT, formerly of No. N. J. and now on the air from Rome, N. Y. NJ State CD C.W. Net has been changed to 7:30 p.m. each Tuesday night on 3505.5 kc. NCS RG: CVF reports successful operation on the part of Bergen County AREC in "Operation Palisades," conducted by Area 1 C.D. Director. The NJ c.d. amateurs volunteered their services for close support by furnishing communications for Military Bomb Disposal teams which were sent out to various industrial sections of the State for the purpose of simulating bomb disposal operations. The following Explosive Ordnance Disposal Squadrons and areas of activity out of Fort Dix were the 42nd Squadron covering Camden, Gloucester, Salem, Cumberland, Atlantic, and Cape May Counties; the 60th EOD Sqdn. covering Mercer, Monmouth, Ocean, and Burlington Counties; the 72nd covering Sussex, Passaic, Bergen, Essex, and Morris Counties; the 143rd covering Hudson, Union, Somerset, Hunterdon, Middlesex, and Warren Counties. The authorized RACES frequencies were used exclusively for these first tests. Trenton Net Control Headquarters for the State was operated by ZI at ZQ. FMG was located at Camp Dix Military Base operations. Area Coordinators directed their traffic nets on 10 and 2 meters in their respective zones throughout the State. KBH reports a fine job being done by the amateurs in Fair Lawn in c.d. work. ZDH reports mobile operation in Dumont c.d. organization. EMX is on the air week ends from the U. of Mass. ENM has returned from a cruise to Bermuda and points south. GUM, enjoying a stay in Phoenix, Ariz., operates on 20 and 40 meters from there. NIE is back on the air after a summer aboard his new cruiser. Traffic: (Nov.) W2DXD 354, CCS 239, CUT 232, EAS 140, NKD 117, K2BCK 62, W2ILN 10, ZDN 7, FMG 6, HIA 6, CFB 5, NIY 2, (Oct.) W2DXD 268. (Sept. and Oct.) W2CCS 360.

MIDWEST DIVISION

IOWA — SCM, William G. Davis, W0PP — The Sioux City Club now has its own station with the call ERG. An auction with a record turnout of 52 was held by the Club to obtain money to buy a Viking. The Club was very active in the SS Contest and expects several members to place right up there in the top bracket. CXN has a new 60-ft. tower. The boys at Sioux City have been having their TVI troubles, being 100 miles from the nearest TV station, but they are resolving these difficulties in fine shape. The Central High School Radio Club is turning out the WNs by the "zillion," it is reported. DSP is the instructor. ATA again is building up his traffic score after being off the air because of illness. A new ham in Burlington is 5PUV/#. DVP has his Advanced Class ticket. W0CGW now is W0CGW. Ex-MVE now is MDU since returning from the Navy. GZ attended a well drilled's convention in Mississippi. According to the new TLCN roster there are 46 active members. YBV makes BPL the hard way, originating 101. SCA and BDR did it with a higher traffic count than ever. SCA has made BPL twelve times consecutively and 24 times since Aug. 1950. PTL now has Advanced Class ticket. The Indians no longer bother BLE. YTA cites a need for more stations on 2 meters. BDR visited at BBZ's after the Director's Omaha meeting. Traffic: W0BDR 718, SCA 603, BVE 216, YBV 142, CZ 112, QVA 100, YTA 89, PZO 77, NYX 32, BBZ 30, BLE 20, BQJ 13, ATA II, DDV 8, SEF 8. **KANSAS** — SCM, Earl N. Johnston, W0ICV — SEC: PAH, RM: KXL, PAM: CIK. The outstanding activity of most Kansas amateurs this month was "Operations Snowbound" Nov. 26th and 27th involving many of our emergency-minded operators who operated efficiently on several bands. Another outstanding activity was the ARRL Midwest Division Convention in Topeka Dec. 6th and 7th which, from reports, was the best in many years. W0B, Colby, reports that a new ham, W0BLOW, is on with 20 watts to a 2E26 and has a new Viking II under construction.

(Continued on page 92)

*Long Life—Low Maintenance
No Comebacks with the*

New 300 OHM TRANSMISSION CABLE by BELDEN

FOR 50 YEARS
*Wrenches for
Industry*

To You,
Belden's Golden Anniversary
Means

—product performance that can come only from a "know-how" that has grown through actual service since the inception of Radio.

—an ability to co-operate in pioneering new wires to meet or anticipate industry's growing needs.

In the years that follow

This Belden Program Is—

— TO BE
CONTINUED

No. 8230

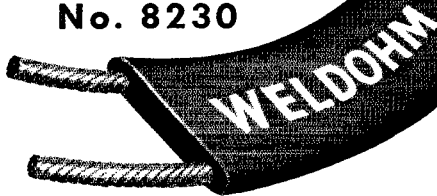

**COPPER-SHEATHED
20-GAUGE**

STRANDED STEEL WIRE

Brown Polyethylene—Resists Weather and Oxidation

The new Belden Weldohm, 300-ohm Transmission Cable is the greatest advancement in television installation since television began.

Reducing TV lead-in conductor breakage to a minimum is easy. The new Belden Weldohm Cable has overcome the breakage point by 162%, that's 1½ times the strength of pure copper wire.

In actual test, Belden Weldohm Cable will withstand 254% more whipping or severe flexing than the average installation of 300-ohm copper lead-in wire.

There is no difference in the electrical characteristics between an all-copper conductor and the Belden Weldohm copper-coated steel wire. The web is 72 mils of 100% virgin polyethylene.

NEW

**FOR U. H. F. INSTALLATION
BELDEN ULTRA-WELDOHM—8235**

**BELDEN MANUFACTURING COMPANY
4621 W. Van Buren Street, Chicago 44, Illinois**

Belden
Radio **WIRE**

180° FLEX TEST

BELDEN 8230 WELDOHM

COPPER

*Result—
254% More
Flex Life*

0 100 200 CYCLES

BREAKING STRENGTH

BELDEN 8230 WELDOHM

COPPER

*Result—
162% More Breaking
Strength*

0 50 100 150 LBS.

GONSET

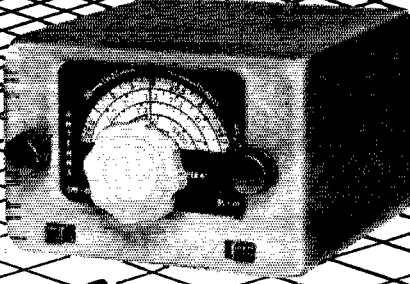

Super Six 40, 75
10, 11, 15, 20

now . . . a
new converter designed to
fully meet all requirements of the exacting
mobile operator. Significant improvements
over previous units include . . . even better
sensitivity and stability . . . the addition
of the 40 meter band with real band-
spread . . . improved bandspread on 20
. . . coverage of the 19 and 49 meter short
wave BC bands for casual listening.

- ▶ Built-in BC trap . . .
- ▶ Easily accessible RF gain switch on rear . . .
- ▶ Separate isolated antenna inputs for converter
and BC set . . .
- ▶ "Zero corrector" oscillator compensator knob
now moved to rear of chassis . . .

Have you noticed that the
"Super Six" and other Gon-
set products designed for
rugged mobile service are
housed in heavy, one-piece
drawn aluminum cases?
Compare this housing
against any other.

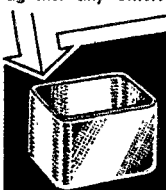

\$52.50

Amateur net

GONSET CO.

801 South Main St.
Burbank, Calif.

VDF is active with a pair of 6146s on 80 and 40 meters and has s.s.b. exciter under construction. CC plans to rebuild his mobile rig. AXZ (the highway patrolman out there) has been transferred to Hayes. WOB holds his skeds with Kansas 75-meter net with 100 watts to a pair of 807s. WN0MIL, YL, reports the following new members of the Field Kindley HS Radio Club: WN0MLJ, N1O, M1I, M1K, M1R, M1P, M1L, M1H, and M1W. YFE is back on all bands with a Viking II and HRO-5TAI receiver and worked 67 sections and made over 50,000 points in the SS Contest. BNU is working 160 meters with his Viking II into a 400-ft. wire. HAW made 10,000 points in his first SS Contest. LFN and CWB are on 10 meters. HJ, of Overland Park, is building 2-meter converter and will be on the air soon. He also is planning on 450-Mc. work with KGG. Traffic: K0FBK 352, W0BLI 143, N1Y 116, W1OQ 58, PAH 46, FDJ 42, FUF 36, WGM 34, YFE 30, ICV 27, LIX 22, BEO 13, VBQ 9, BNU 8, DZR 1.

MISSOURI — SCM, Clarence L. Arundale, W0GBJ — The Central Missouri Radio Club has been organized at Sedalia and is training 8 prospective hams. The operators and engineers at WDAF-TV have organized a club and will operate under the call LII, using BKY's transmitter at present. We regret to report the loss of VDG, who passed away Nov. 16th. He was well known in this area and had been quite active in the Moarky Amateur Radio Club. PTG is planning lots of mobile operation. PXW is on 75 meters with 300 watts. OJC had to return to the hospital again. SPR keeps schedule on 80 meters with his brother. FUZ. RLAI reports from Korea that he will be home in January. LBM is returning from Germany. RMX has a 522 and is going to try 2 meters. BPE and his XYL, CCK, have moved to Tyler, Tex. 5QHO has been released from military service and is operating in Springfield. SOT, who is in the Navy, has a new jr. operator. ISJ now is located in St. Louis. The operators at K0WBD are Joe and Charles. ZLN is running 750 watts to the BC-610. ITX lost his modulation transformer. FXU has received his Adv. CL license. St. Louis Area reports much activity on 40 meters, among new as well as old hams. CPI makes BPL even though time out was taken for a vacation trip to Texas. JXJ makes BPL again. QXO lost some operating time because of a breakdown of his rig, but still made BPL. New AREC members: EPO, KUR, and RLAI. New Notices: WN0KAB and WN0LQC. Thanks for the reports that were sent early so that your SCM could attend the Convention at Topeka. Traffic: (Nov.) W0CPI 698, QXO 644, JXJ 546, CXE 221, BYL 177, GBJ 140, ZLN 134, K0FAY 120, K0WBD 94, W0GAR 61, IQY 41, LF 41, HUI 39, EBE 30, KIK 27, CFL 26, ETW 22, RAM 20, CKQ 13, OUD 13, JJS 10, TGG 10, AZL 8, BUL 8, QALP 8, BKV 7, JEJ 7, PXW 7, PTG 6, NNH 4, CIA 2, (Oct.) W0PXX 7.

NEBRASKA — SCM, Floyd B. Campbell, W0CBH — Welcome to WN0MAO of Lincoln. RYG finally is back on the air after a lot of time off changing the YL to an XYL. VYX and his new 99.99 per cent TVI-proof rig is one of the best in the State. VEC, ASE, and OHP are on QRM-free 2 meters. NSS needs more members (3745 kc.). New hams and old ones also are invited to do something about that rusty c.w. LARC (Lincoln Amateur Radio Club) has been activated and is doing very well with the no-officer plan, using the rotating chairman idea at present. FQB, KDW, and TQD renewed their ORS appointments. ATU is new EC for the North Platte Area. EKP has OBS appointment. EUT renewed appointment as PAM. VYX is the NCS for Nebraska 'Phone Net for 1953 kc. LJO has been appointed RM for the c.w. net. New-comer LRK (North Platte) has new vertical rhombic and is using Elmac. ASI has a new rig and a swell signal. AIN really is having QRM trouble. Congratulations on the new YL, Don, Charlie District, of MARS C.D. Net, is on 4080 kc. Fri. 8 p.m. to 8:30 p.m. EXP is Control Station. Traffic: W0TQD 1800, RYG 143, JDJ 93, FQB 74, VYX 71, KDW 37, SAI 32, CBH 19, ZJF 18, HQQ 16, HWM 12, AIN 11, LJO 10, EGQ 9, QOU 7, THF 7, KDR 4, YSK 4, UVQ 3, VPR 3, DJJ 2, GTW 2, IAY 2, RAM 2, VBJ 1.

NEW ENGLAND DIVISION

CONNECTICUT — SCM, Roger C. Amundsen, W1HYF
C — SEC: LKF. PAM: FOB. RAI: KYQ. CN-3640, CPN-3880, CEN-29,680 kc. BDI makes BPL. The top three in the CN QSO party, sponsored by CWA, were LOP 3600, RFJ 1488, and GVK 1222. Congrats. Glad to welcome the Hamden ARA as an affiliated club. LIG gave a ham broadcast on WNAB. BYB has GP vertical working good. UNG is a new ORS in Westport. CUH had fun in the SS. LY is moving a couple of blocks. LWV had his EC appointment endorsed. The CARA held its annual banquet with a talk by SZL. USF has moved from Fairfield to Stamford. WN1WUB is a new one in Stamford and is a student at Fairfield University. TCX has a jr. operator. TUC is working ten. NOA is amateur radio editor of *Radio and Tele. News*. The SAREC was called out for a simulated test while holding its first annual picnic. The fellows responded like true firehorses. NOF is new radio officer of SAREC although PCZ is still comm. chief. QN gave a talk on pioneering and progress in radio to the SAREC. If this seems full of SAREC
(Continued on page 94)

BUD Condensers

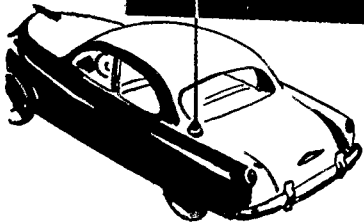

Won't Guarantee
TOPS
in Mobile Operation!

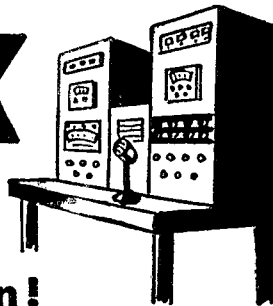

We don't claim that putting BUD Condensers or other BUD products in an inefficient rig will magically improve your results. We do know BUD products will aid in building efficiency. Now that Spring is approaching you will have

more opportunity to enjoy mobile work. You can expect improved performance if you install BUD component parts in your rig.

THREE-GANG TINY MITE CONDENSERS

Hams, Radio Constructors and Experimenters can find many uses for these compact, three-gang condensers. Designed particularly for high frequency use, they are adaptable for use in converters, preselectors and receivers covering the Amateur, Television and F.M. bands. Well

constructed with soldered brass plates and ceramic brackets. Rotor shaft extended $\frac{1}{4}$ " at rear. Height $1\frac{1}{16}$ ". Width $1\frac{1}{16}$ ". Length behind panel $3\frac{3}{4}$ ". Mounting holes $2\frac{3}{16}$ " apart.

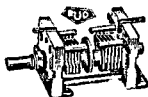

Catalog Number	Cap. Per Section		No. of Plates Per Section	Amateur Net
	Max.	Min.		
LC-1845	11	5	3	\$3.81
LC-1846	17	5	4	4.32
LC-1847	25	6	5	4.71

TINY MITE TUNING CONDENSER SINGLE SECTION

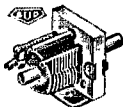

This series of condensers has been designed for applications where space or weight are limiting factors and for tuning of ultra-high frequency circuits. Rigid construction, close fitting bearing, positive rotor contact and Steatite insulation are the outstanding features. Cadmium plated, soldered, brass plates and rods insure high frequency efficiency.

Catalog Number	Max. Cap. MMFD.	Min. Cap. MMFD.	Air Gap	No. of Plates	Amateur Net
LC-1640	8	2.5	.017"	3	\$1.35
LC-1641	15	3	.017"	5	1.47
LC-1642	25	4	.017"	9	1.53
LC-1643	35	5	.017"	13	1.77
LC-1644	50	6	.017"	19	1.86
LC-1645	75	7	.017"	29	2.01
LC-1646	100	9	.017"	37	2.19
LC-1648	10	4	.037"	7	1.50
LC-1649	15	5	.037"	11	1.62
LC-1650	25	5.5	.037"	17	1.92
LC-1651	35	6	.037"	21	2.10
LC-1652*	50	8	.037"	35	2.64
LC-1653	6	3.5	.073"	5	1.59
LC-1654	15	5.5	.073"	15	1.92
LC-1655*	25	9	.073"	27	2.61

* Denotes double bearing.

MINIBOXES



There are thousands of uses for this box, for its design permits installation of more components than in the conventionally designed box of the same size. Made of heavy gauge aluminum of two piece construction. Flange type construction assures adequate shielding. Available in etched aluminum finish and grey ham-merloid finish.

Catalog Numbers		Length	Width	Height	Amateur Net	
Grey	Etched				Grey	Etched
CU-2100	CU-3000	2 $\frac{3}{4}$ "	2 $\frac{1}{4}$ "	1 $\frac{5}{8}$ "	\$.63	\$.57
CU-2101	CU-3001	3 $\frac{1}{2}$ "	2 $\frac{1}{8}$ "	1 $\frac{5}{8}$ "	.63	.57
CU-2102	CU-3002	4 $\frac{1}{2}$ "	2 $\frac{1}{8}$ "	1 $\frac{5}{8}$ "	.66	.60
CU-2103	CU-3003	4"	2 $\frac{1}{4}$ "	2 $\frac{1}{4}$ "	.87	.78
CU-2104	CU-3004	5"	2 $\frac{1}{4}$ "	2 $\frac{1}{4}$ "	.90	.84
CU-2105	CU-3005	5"	4"	3"	.99	.93
CU-2106	CU-3006	5 $\frac{1}{4}$ "	3"	2 $\frac{1}{2}$ "	.96	.90
CU-2107	CU-3007	6"	5"	4"	1.23	1.14
CU-2108	CU-3008	7"	5"	3"	1.38	1.26
CU-2109	CU-3009	8"	6"	3 $\frac{1}{2}$ "	2.01	1.89
CU-2110	CU-3010	10"	6"	3 $\frac{1}{2}$ "	2.49	2.07
CU-2111	CU-3011	12"	7"	4"	2.94	2.64
CU-2112	CU-3012	17"	5"	4"	3.45	3.06
CU-2113	CU-3013	10"	5"	1 $\frac{5}{8}$ "	.99	.93
CU-2114	CU-3014	12"	2 $\frac{1}{2}$ "	2 $\frac{1}{4}$ "	1.35	1.17
CU-2115	CU-3015	4"	2 $\frac{1}{2}$ "	2 $\frac{3}{4}$ "	.84	.78
CU-2116	CU-3016	4 $\frac{1}{4}$ "	2 $\frac{1}{4}$ "	1 $\frac{1}{2}$ "	.87	.81



The Mark of
Perfection

BUD RADIO, Inc.

2118 East 55th Street Cleveland 3, Ohio

TWIN-LEAD folded dipole



Buy the kit and assemble your own HAM ANTENNA

Tested—tried and proven components from which to build your HAM ANTENNA—complete with full instructions for assembly. Build for permanence and performance with quality components.

complete
kit ...

- 2 lengths of #16 copper-clad steel conductor twin-lead—cut to band length.
 - 1 75-foot length of standard 300 ohm twin-lead for lead-in.
 - 1 high strength laminated "T" block.
- Assembly and installation instructions.

Cut to 10, 20, 40 and 80 Meters

We all strive for the best in transmission and reception characteristics—now with the Amphenol Amateur Antenna Kit you are assured of the *BEST*. Designed by electronics engineers for the most efficient service.

amateur net as low as
\$535 for 10 meters

see your **AMPHENOL**
radio parts distributor

AMERICAN PHENOLIC CORPORATION

news it's because they send it in. How about you doing the same? IAR sends a swell report on doings in Farmington. They have WSG for c.d. work. Traffic: WISJO 320, AYC 223, BDI 179, LV 164, AW 127, NJM 127, KYQ 122, RRE 65, CUI 53, FOB 37, HYF 19, LIG 17, KV 15, RFJ 14, BVB 11, QJM 11, JTD 6, ODW 3, UNG 1.

MAINE—SCM, Orestes R. Brackett, W1PTL—SEC: BYK. PAM: OLQ. RM: LKP. The Pine Tree Net operates on 3596 kc. at 1900, Mon. through Fri.; the Sea Gull Net on 3960 kc., Mon. through Fri., at 1750. TWR did a fine job with portable at Lake Moxie while on a hunting trip. LRG/9 sure is putting a nice signal into Maine from Wisconsin. BOK spent some time in the E.M.G. Hospital but is out now and doing much better. Some of his visitors while he was there were PYY and XYL, OLQ, EBJ, DPJ, and KEZ with his XYL. Mary, the XYL of SSK, has passed her Novice Class exam at Boston and should soon be on the air. ACO does an amazing job on 10 meters with only 7 watts. TO has left WFAU to go to work for the State on something connected with communication work. Net certificates have been issued to JIS and DEG. It is with much sorrow that we report the following Silent Keys: CBO, JAA, and QAR. DL4KW called into the Sea Gull Net in a rather odd way; he had PGZ make a tape recording and then Roger played it back at net time. By the way, DL4KW is ex-W1PSK of Auburn, Me. MGR and Irene called at the shack recently and we were surprised and pleased. He is working for QEI in Fairfield repairing TV sets. We know that BDL and party got their deer, thanks to Charlie's swell portable station at LaGrange. Traffic: WILKP 221, OHT 96, BX 83, PTL 22, VV 18, ROC 17, BTY 16, AFT 11, HXQ 11, SEJ 9, SNE 4, SUK 4, EFR, 2, QEK 2.

EASTERN MASSACHUSETTS—SCM, Frank L. Baker, jr., W1ALP—New appointments: As ECs—MEG for Framingham, PAN for Billerica, TWQ for Newbury, WKF for Taunton. Appointments endorsed: As ECs—CQN Norwood, QMJ Norwell, KWD Weymouth, PZ Lynnfield, MD Hingham, MAN Marblehead, MKX Lowell. As RM for 80-meter c.w. band—JCK. As OBS—GDY, MEG, GOU, AAR, QHC. As OPS—GOU, PZ, AAR. As ORS—AAR, QMJ, MEG. Many thanks to all who re-elected me as your New England Division Vice-Director. NLL now is in Weymouth. WN1VIK, 14 years old, has a TBS-50, SSB-M/M is on 28 Mc. on the Boston Light Ship. EGD and UZK are on 144 Mc. GKR and AGC are on 3.5-Mc. c.w. KMW is mobile on 144 Mc. GUF and IIM are on 3.9-Mc. phone. The South Shore Club held an auction with AKY at it again, also a demonstration of Western Union's desk fax system through the efforts of OTZ, and TVI reports by WK. TYA is at Fort Monmouth, N. J. HFX is having trouble with 80-meter rig. LLY is building 150-watt job for 80-meter c.w. TVZ, now Class A, worked 38 sections in the SS. WN1WTK is the call of Sam Townsend, Haverhill, THY is on 28 Mc. The following assisted in the "Ketch Miru Radio Net" to help out with ZKIAN/MM traffic: BB, AVY, BDM-mobile, JAK, TUP, ME, MB, LIB, SIB, LBH, DBE, CPI, BNS, and FW. PXY was Net Control for a radiological net drill from home QTHs. A monthly meeting of Region 5 Comm. was held at Newton with CTW, RM, TQP, ALP, and KTG present. MKX is on 3.9 Mc. MEG says his city will have a rig on for c.d. work from RO. KN2ADA/1 is on 80-meter c.w. in Quincy. LFD's XYL has the call WN1WKK and his son is UBE. LAT's son is WN1WJX. We are sorry to hear that NKW is in the Tewksbury State Hospital. ALP spoke at the Eastern Mass. Club's meeting for BVR, who could not attend. UPO reports that MX has new ground place on 7 Mc. and worked 11 new countries. WU has p.p. 4-1255. New Bedford Emergency Net is on Sun., 8:30 a.m., on 29 Mc. UTH wants to hear from teen-agers about a teen-age net on 7 Mc. Braintree Radio Club, TYN, has old police transmitter for 50 Mc. to work along with Viking on 28 Mc. NUP gets on EMN. RRP has mobile rig on 28 Mc. and is on at KBN on 80-meter c.w. UPZ is on various nets. WLV has General Class license. QP has a Lyco transmitter and gets on 3.9 Mc. mornings. AVY, New Bedford EC, reports that the c.d. group has the call WKM with a TBS-50 on all bands and a large emergency power unit. ONK, OH, HMS, UTE, BLX, AVY, TZU, OMA, JKT, and UID have mobile on 28 Mc. WGN, UID, LAZ, FXB, APN, WU, CTZ, HPH, OQE, PWL, SSS, and QUE are on 28 Mc. ONK arranged a hidden transmitter hunt. South Eastern Mass. ARA will hold election of officers. RYJ, DOX, STA, TUJ, HQO, Sam Townsend, Bill Tift, and Bob Thornton attended Yankee Radio Club auction. RS is working in Connecticut. JCK is working on a get-together for the members of the EMN. WKF is home and active on the air. MAN is the Radio Officer for Region 4 of Mass. C.D. QQL is Radio Officer for Sector 4, Region 4. NBN is Region 4 Control Station. BJN is helping MAN. Region 4 took part in 8-State Federal Civil Defense Drill on Nov. 14th, which simulated atomic bombings of major cities. Traffic was handled between them and Mass. State Control in Framingham, on 80-meter c.w. They also had a highly successful 2-meter net, through the efforts of BJN, consisting of QW, IO, NPJ, CTD, JDF, UVB, QKN, MAN/1, and BJN mobile. The T-9 Radio Club held a Christmas Party at ISX's QTH in Lynn. BB, Winthrop EC, held a get-together

(Continued on page 96)

For faithful tone reproduction... high fidelity at low volume level-use Centralab's COMPENTROL®

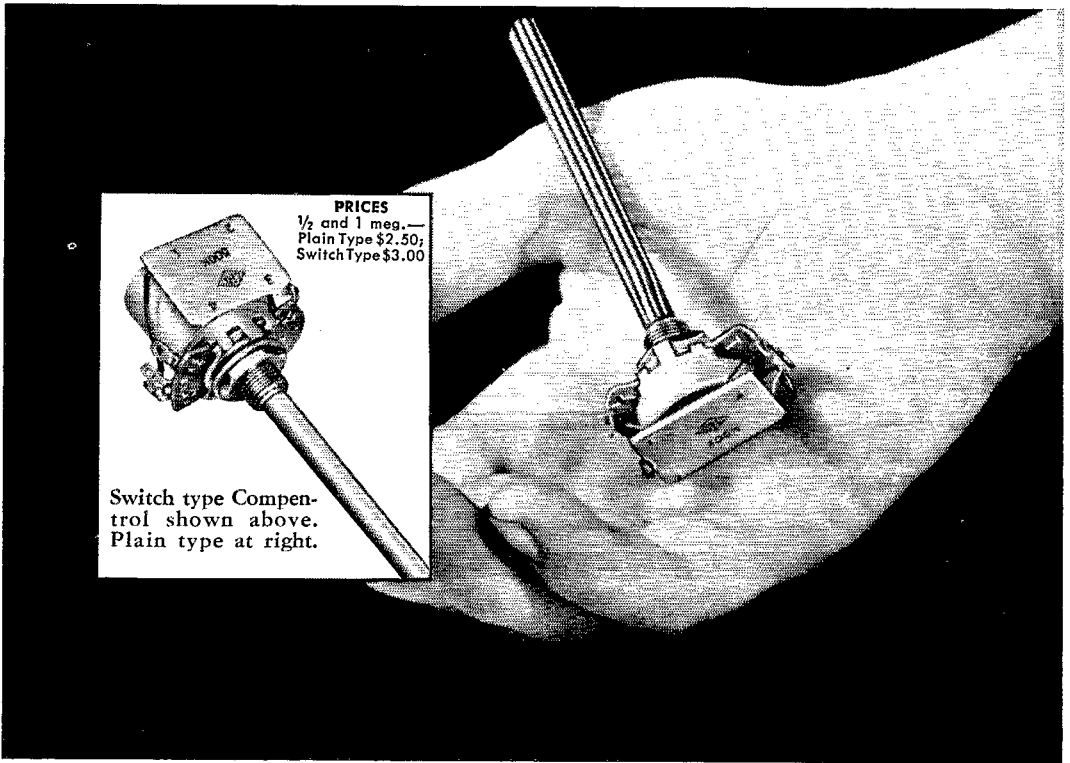

PRICES
 $\frac{1}{2}$ and 1 meg.—
 Plain Type \$2.50;
 Switch Type \$3.00

Switch type Compentrol shown above. Plain type at right.

YOU can build better rigs with the Centralab Compentrol. That's because this combination volume control and Printed Electronic Circuit faithfully reproduces the high-pitched tones of the operatic soprano — or the deep bass notes of the boogie woogie beat — when volume is set at low level.

In fact, Compentrol was especially developed to better reproduce the apparent bass and treble response of radios, audio amplifiers, phonograph combinations and television sets. What's more its low price will please you!

Because of its design CRL's Compentrol needs *no additional amplification*. There is no insertion loss when you use Compentrol.

The Centralab Compentrol is furnished in $\frac{1}{2}$ or 1 meg. — plain or switch types. Switch is SPST, and an insulated switch shield is furnished for a-c shielding. Most amplifiers use a plain type. For complete details, ask your Centralab distributor, or use the coupon.

**Make your Centralab Distributor
 headquarters for
 exact electronic components**

Centralab®

A Division of Globe-Union Inc., Milwaukee 1, Wisconsin
 In Canada, 635 Queen Street East, Toronto, Ontario

Yours for the asking — a 16-page booklet telling the whole Compentrol story. See your distributor or use the coupon.

The Centralab Compentrol is only one of the more than 470 *new* items listed in Centralab's new Catalog 28. Get your copy of this 32-page index to the latest developments in the fast-changing electronic field.



CENTRALAB, A Division of Globe-Union Inc.
 912 E. Keefe Ave., Milwaukee 1, Wisconsin

Please send me my copy of the new Compentrol Booklet as well as Centralab Catalog 28 at once and without charge.

Name.....

Call Letters.....

Address.....

City..... State.....

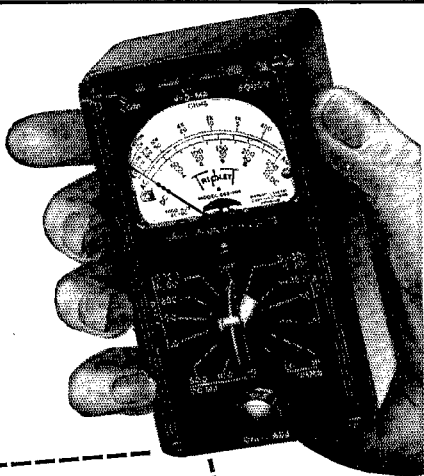

**Mighty
Midget**

of the Service World

Mighty Midget of all the V-O-M's! Slips into your pocket for making spot-analyses of D.C. and A.C. Voltage, Current, and Resistance. Has quick-reading scale, only one switch, 50" leads — alligator clips, banana-type jacks, self-contained snap-in type batteries, and plenty of ranges on the one-knob 14-position switch. Remarkable stability on voltage ranges. Completely insulated molded case. Get yours today! Triplet Electrical Instrument Co. • Bluffton, Ohio, U.S.A.

Model 666-HH Volt-Ohm-Milliammeter

ONLY \$24.50 AT
YOUR DISTRIBUTOR
(Price Subject to Change)

FOR THE MAN WHO TAKES PRIDE IN HIS WORK

Triplet

TRIPLIETT ELECTRICAL INSTRUMENT COMPANY • BLUFFTON, OHIO, U.S.A.

at his QTH for his c.d. group. Among those present were BDU, CMW, PBX, MQB, DPI, QUX, UOC, SBT, HFJ, LVA, WJZ, and DJ, and their C.D. Director, Harold Katz. HFJ has portable rig. DPI demonstrated some real miniature equipment. LVA gave a talk on rectifiers for meter work. The Hingham Radio Club is going to WBZ-TV for a meeting. IBE has a Viking I on the air. UIM has an NC-183. Sorry to have to announce the death of SZX, of Lynn. Traffic: (Nov.) WIEMG 339, MX 205, UE 125, TY 81, JCK 66, WU 51, AVY 38, UTH 22, BY 20, RDV 17, NUP 15, QON 13, LM 12, RRP 8, BGW 4, HWE 4, TQS 3, UPZ 3, ALP 1, WLV 1. (Oct.) WIFTH 21. (Sept.) WIFTH 16.

WESTERN MASSACHUSETTS — SCM, Roger E. Corey, WIJYH — SEC: KUE, RM: BVR, PAM: RDR. WAIN meets on 3560 kc. at 7 p.m. Mon. through Fri.; WAINS (slow speed net) at 8 p.m. Mon., Wed., and Fri. New officers of Quinnebaug Valley Club are PQZ, pres.; BAN, vice-pres.; WNTVR, secy.; ORP, treas.; EES, act. mgr. Southbridge AREC has 7 mobiles and main station on 28 Mc. for emergency work. WN1WEI is a newcomer to the section. Welcome! ULE, SAS, CLU, SPG, ULF, and RLQ hold new Advanced Class tickets. Worcester has 5 YL operators. Let's hear from some of you gals throughout the section. Perhaps a section YL net is in order. The Central Mass. Club has a class of 35 ready to take exams. BVR again leads the section in traffic. EOB, PHU, VBG, BVR, TVJ, YK, MNG, DVW, MVF, TCM, RRR, JYH, CJK, NY, SAS, and TSX took part in the SS. EOB and JYH each missed only one section. CJK, a leading 'phone man, made a good score on c.w.! MUN has new frequency measuring equipment. TVJ has 22 states on 80-meter c.w. and has had 100 per cent attendance on WMN since Sept. 1st. ESA has a new sixteen-element on 144 Mc. KK, DPY, SXJ, and QWJ have joined the ranks of s.s.b. enthusiasts. RRW has a new Viking and is pleased with the lack of TVI. UDK is newly active on 7 Mc., as is OAZ on 50 Mc. ACP, BNO, EHH, GJO, GUI, JTL, IPZ, PRS, OOO, UDK, VBS, VBT, and ODS are active members of the 6-meter Region 9 Civil Defense Net which meets Wed. at 6:30 p.m. EOB has built a 50-ke. i.f. strip which gives him real selectivity and which helped him roll up the highest SS score in the section. KFV has a new HRO and a new, quiet location. MVF, home from the Navy, renewed his ORS appointment. Traffic: WIBVR 91, HRV 49, DVW 44, TVJ 38, EOB 5, JYH 5, SFF 3, HRC 2, MVF 2.

NEW HAMPSHIRE — SCM, Carroll A. Currier, WI-GMH — RM: CRW. Dartmouth College Radio Club is doing a great job on 20 meters with kw. rig. Ten hams are attending college there. The Port City Radio Club has elected the following officers: TTT, pres.; CDX, vice-pres.; Norman S. Freedman, treas.; UEB, secy. The Club has the call WQM. Two new WNH certificates are held by UXS and RBX. CVK now is mobile on 75 meters. WBM has a fine 50-ft. tower up for new sky wires and 10-meter beam. GMH has Viking II. IP now is Advanced Class. BXU has TVIed his Viking I. The Test Exercise went off in fine style Nov. 14th. and APK with IJB, along with those who participated, should be congratulated. UNV has new shack in fine working condition. Many of the old-timers in New Hampshire will miss the voice of BDN, who recently joined the Silent Keys. It is gratifying to note the improvement in the traffic reports that are coming in. One other thing that would be a great help also, is to have some news items sent in to help make this report interesting to you all. GJG has a Viking II. Traffic: (Nov.) WICRW 795, POK 28, QJX 24, GMH 23, FZ 11, CVK 1. (Oct.) WICRW 323, SAL 117. (Sept.) WISAL 33.

RHODE ISLAND — SCM, Merrill D. Randall, WIJBB — SEC: MIJ, RM: BTV, PAM: BFB, BBN reports Bristol is very active with OAM, SJJ, TBY, TST, UDJ, and URA looking for contacts on all bands. A lecture on antennas was given by BCR, ably assisted by Admiral, to members of the NCRG and was enthusiastically received. On a recent trip to New York, K2BXX passed his examination for that call and will be on 10-meter mobile in this section for some time. If you are interested in a section 75-meter 'phone net, get in touch with OIK or TRX and we'll start one. A very pleasant and educational evening was spent with NZR (R.L. RO) and MIJ (SEC). Rhode Island's c.d. plans really are clicking but we still can use the help of your fellows in the various communities! A look at the files indicates that many certificates are in need of endorsement. Send 'em in or see me at your club — I'll be there sooner or later. If any of you fellows are rebuilding, remodeling, rechannelling, or in any way changing your rigs, how about letting me know so I can pass the word along. Club news also is needed. Traffic: W1BBN 54, QYX 51, OIK 22, BTV 21, TGD 18, TRX 5.

VERMONT — SCM, Raymond N. Flood, WIFPS — SEC: JEN, PAM: AXN, RM: OAK, Asst. RM: TAN. Thanks for all the activity reports sent in. Keep 'em coming. UGW works DX on 40 meters when home week ends. AD, TXY, and UJN are active on 6 meters in Bellows Falls. WN1WLG is a new ham in that town. WN1WUN is a new ham in Bradford. He is the father of UFV and grandpappy of UFV. Junior operators are arriving by the wagon load. According to NLO the following have passed around

(Continued on page 98)

**Here's How
CRITICAL
QUALITY
CONTROL
Assures You**

***TYPE ML-6 — RANGE:**
1.4 — 75.0 mc
Supplied per Mil type
CR-18; CR-19; CR-23;
CR-27; CR-28; CR-32;
CR-33; CR-35; CR-36
when specified.

LASTING STABILITY

in *Midland* CRYSTALS

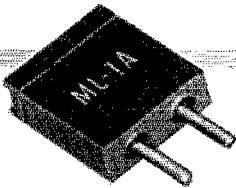

***TYPE ML-1A — RANGE:**
2.0 — 15.0 mc
Supplied per Mil type
CR-1A when specified.

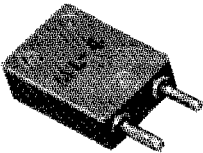

***TYPE ML-4 — RANGE:**
1.0 — 10.0 mc
Supplied per Mil type
CR-5; CR-6; CR-8; CR-
10 when specified.

Midland Quality Control is Midland's own system of making sure you get a crystal that takes the beating of extreme heat without excessive drift. Quality control starts with exacting selection of quartz and extends through every step of processing.

For example, slicing of the crystal is guided by X-ray checks to maintain highest accuracy. Correct angular relationships are strictly maintained. After lapping, X-ray is again used to detect any deviation from precision standards. And finally, after sealing, tests are made again — tests far more punishing than conditions found in actual use.

That's why STABILITY is something you can count on in your Midland crystal — and why Midland quality will give you years of dependable service in every respect.

*Whatever your crystal need,
conventional or highly specialized . . .*

When  It Has to Be **EXACTLY RIGHT . . . Contact**

Midland

MANUFACTURING CO., INC.
3155 Fiberglas Road Kansas City, Kansas

Manufacturer of Quartz Crystals for Electronic Frequency Control

WORLD'S LEADING MAKES

*Always
in Stock at*

HUDSON

RADIO & TELEVISION CORP.

Prompt Delivery on All Types



SYLVANIA
Germanium Crystal
DIODES

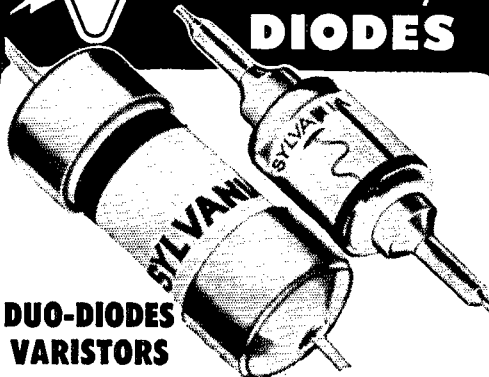

**DUO-DIODES
VARISTORS**

Sylvania Germanium diodes are available in Ceramic or Sealed-In-Glass construction. Designed for efficient dependable service for every type of application in Radio, Television, and Electronics.

They're Compact • Lightweight • Rugged • They have Low Shunt Capacity • No Contact Potential • Require No Heater Supply • No Mounting Hardware • Estimated Life more than 10,000 hours •

Write us your requirements . . . get your copy of the New Hudson Catalog . . .

FREE!

NEW 1953

**HUDSON
CATALOG**

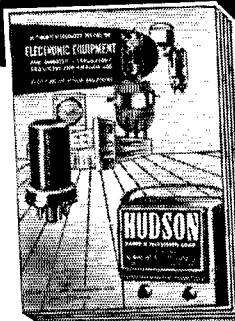

Everything in electronics at your fingertips in this greatest of all 1953 HUDSON CATALOGS! Over 196 pages of everything in Radio, TV, and Industrial Electronics. The World's Finest High Fidelity, Test Equipment, Audio Equipment, and the latest in Ham Gear, etc. The most complete buying guide of its kind INCLUDES the latest JAN CROSS-REFERENCE GUIDE and all types of fully approved JAN type components with interchangeability charts.

Send for your
FREE Catalog today!

One Call for All!

HUDSON
RADIO & TELEVISION CORP.

Write or come in and chat with **BOB GUNDERSON**, W2J10 at our uptown store Thursdays. Downtown Sats.

Uptown (Dept. Q-2)

Downtown

48 WEST 48th ST. • 212 FULTON ST.

New York 36, N. Y. • Circle 6-4060 • New York 7, N. Y.

Open daily until 6 P.M. Thursdays Til 9 P.M.

cigars: QQ, FSV, TBG, MLJ, QVS, VSA, and CUN. GAZ is building a kw. rig. RLS bought a Collins 32V-3 transmitter. BJP is trying to get out with only a 32V-2. QQN has Elmac mobile on 10 and 75 meters. SEL is mobile on 10 meters. UPZ is operating on 10 through 160 meters. VVO (VFO) is on 40 and 80 meters. VJJ, Bennington, joined c.d. RWP worked 42 states in the 8S but no Vt. Traffic: WIRNA 114, OAK 107, NDB 42, FPS 32, IT 14, ELJ 12, TRY 7, VVO 3.

NORTHWESTERN DIVISION

ALASKA—SCM, Glen Jefferson, KL7NT—Civil defense activities, in connection with Operation Warmwind, have given an operational shakedown of c.d. communications in the Anchorage Area. Anchorage suffered a simulated severe bombing and resultant casualties, but military ground forces repulsed the aggressor; all hands have returned to near-normal operations. Efforts of KL7AEE have paid off and the Sourdough Net began operation on 3892 kc. Dec. 8th. Although some details of operation in Southern Alaska are yet to be settled KL7RU, at Ketchikan, will handle traffic between Alaska and the States. Roll call is scheduled every night at 1930 Alaska Standard Time; AEE will act as NCS and alternates will be appointed by Floyd as available and as required. Give this project your assistance, fellows—it is urgently needed in Alaska. Traffic: KL7AOS 10.

IDAHO—SCM, Alan K. Ross, W7IWU—Caldwell: EYR, EC, reports their club has voted to go on 2 meters for local drills. Kuns: A new ham is WN7SPZ. Meridian: MKS puts out Official Bulletins on 3935 kc. from 6:30 to 7:00 p.m. Lewiston: LDZ has appointed OOW as his Assistant EC. Lewiston has a TBS-50, HRO-5, and a 10-kw. gas plant for emergencies. Boise: Gem State Radio Club's new officers are KFB, pres., KJIM, secy.-treas.; and AXY, APK, and BBS, Board of Directors. You fellows interested, and on 160, are reminded of the 160-meter DX tests on Feb. 8th and 22nd. See December QST, pages 64-65. Note that British stations may transmit between 1717 and 1795 kc., with most activity between 1775-1795. Other DX may be found below and above U. S. band segments. Also note that 0500 to 0800 GCT is 10 p.m. to 1 a.m. MST and starts Feb. 7th and 21st for the MST gang. Traffic: W7MKS 22, EMT 16, FIS 11.

MONTANA—SCM, Edward G. Brown, W7KGJ—The Harlo Radio Club now is officially an ARLL affiliated club. The Cathode Ray Radio Club of Great Falls reports some of its new members have taken their Novice Class exams. JRG has his new high-power transmitter on 2 meters with an input of about 700 watts and is consistently heard at Gillette, Wyo., a distance of about 300 miles over mountainous terrain. In a few cases two-way contact has been made with HNI, who has considerably less power in Gillette. JBC, upon hearing of the airplane crash about ten miles east of Billings, took his mobile rig and transmitted an eyewitness report back to Billings which was rebroadcast over one of the local broadcast stations. Ernie gave a very interesting description of the accident. The Billings Club has received from the police department five or six mobile transmitters and receivers to be used in emergency work. The police department is changing to f.m. WN7SCG has new transmitter and is getting a very nice station lined up. RJL has new transmitter with p.p. 807s. MKB is in the Army stationed at San Luis Obispo, Calif., and has been contacting his XYL through KGJ. CT and KGJ are building new Select-O-Jects. Traffic: W7BNU 11, CT 10.

OREGON—SCM, J. E. Roden, W7MIQ—ONM makes BPL again with a total of 1212. HDN also makes BPL on originations plus deliveries, totaling 101. WJ has just recovered from a bad case of pneumonia. PCL has left his job at Ordnance and has been transferred to Germany. GDV has a class of CAP pupils in full swing now and seems to enjoy teaching. EDU reports that Hood River now has nine licensed amateurs and he is in the process of enrolling them all in the AREC. New officers of the Portland Amateur Radio Club are as follows: HVX, pres.; the XYL of CKV, vice-pres.; QJY, secy. MEZ now is on the air with a new 500-watt rig. SO still is busy experimenting with high frequencies. PHM seems to have deserted amateur radio temporarily to do some experimenting on model railroading. SMJ is a new Novice, recently getting his license. Traffic: W7ONM 1212, HDN 136, EUG 107, MQ 10, GDV 9, EDU 1.

WASHINGTON—SCM, Laurence M. Sebring, W7CZY—SEC: BTV. RM: FLX. PAM: NRB. Major Art Monsees, W7SOX, obtained his Old Timers Club certificate, and now is operating from Western Germany with a 32V-3 and 75A-2. OYO is putting up a new antenna. The Clark County Radio Club is holding a hamfest Feb. 14th. AIB spent most of November on a Coast Guard inspection trip. The Mt. Baker Radio Club elected LMU, NSI, KWC, and an outside technician as TVI committee. The Club held a hidden transmitter hunt which proved very successful. PGY has new 75A-2 receiver. FLX gave BA a message from Mukiteo, 20 miles away. Because of skip it was relayed by KA2GU to IOQ, a round trip of 10,000 miles. KZP and JNC are building new all-band VFOs. CO is using 5-watt

(Continued on page 100)

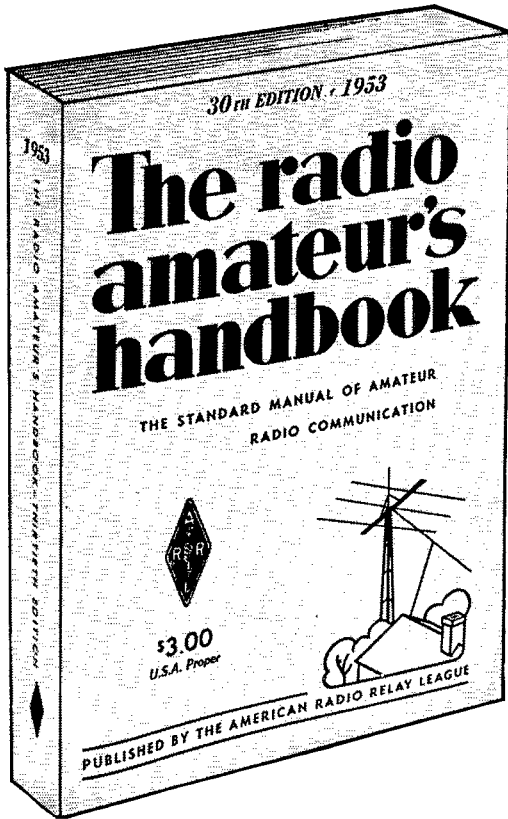

**1953 edition
now ON SALE**

800 pages

700 photos-diagrams

**466 tube base
diagrams**

A complete and comprehensive treatment of radio and electronics from simple to advanced radio theory and technique. A valuable asset, a constant reference source for the bookshelf of every amateur, engineer, experimenter and technician. Theory, construction, application . . . all are covered in this internationally accepted Handbook—plus a complete catalog section featuring leading manufacturers and suppliers of electronic equipment, components and tubes, providing an ideal buying guide for purchasing agents as well as individual users of parts and equipment.

\$3 USA proper

\$3.50 US Possessions and Canada

\$4 Elsewhere

Buckram Bound Edition \$5 Everywhere

The AMERICAN RADIO RELAY LEAGUE, Inc.
WEST HARTFORD 7, CONN.

BA... HAS THE VALUES!

75 AND 80 METER CRYSTALS IN REGULAR FT243 HOLDERS

79c

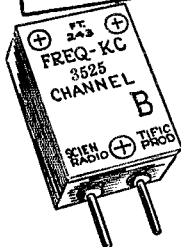

First quality guaranteed active oscillators made to Signal Corps specs... every one brand new and tested! Better get plenty while available... we doubt this lucky buy can be repeated.

Available in following frequencies:
 3525 KC No. 15A1173
 3555 KC No. 15A1174
 3700 KC No. 15A1176
 3735 KC No. 15A1177
 3980 KC No. 15A1178

CHOICE EACH **79c**

You can easily change frequency if necessary by following crystal grinding instructions in any handbook. Assortment of 4 Crystals—Our choice from above.

No. 17B818. Per Asst. **\$2.45**

POWER SUPPLY KIT 110 VOLT FILTERED DC at 40MA

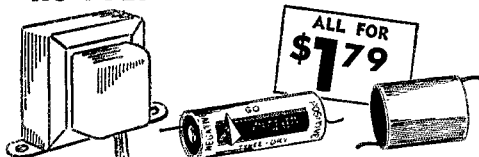

Here at a Big Saving you get Top Quality basic components for a Power Supply with many applications... for Mike or Phono Pre-Amp, Midget Radios or Audio Amplifiers, Photo Cell equip., Garage Door Openers, Code Practice Oscillators, TV Boosters, Test Equipment, etc.

Kit consists of a compact, fully enclosed Power Transformer, pri: 117 V, 60 cycle AC 110 V @ 40 MA. H.V. Sec. and 6.3 V @ 1 amp. for filament. A 35 MA-130 V. Selenium Rectifier and a 16 Mfd-150 V. DC wkg-225 V. peak electrolytic Filter Condenser... both very compact and easy to mount with the tinned wire leads. Wt. 1 1/2 lbs. You Get All Above No. 14B993. PER KIT..... **\$1.79**

HI-SPEED COPE-SAW DRILL-BIT



IT SAWS! IT REAMS!

IT DRILLS!

\$3.75

Drill, saw, ream metal, wood, plastic, etc., with any electric drill. Drills own starting hole—upper part cuts, saws or reams circles, ovals, squares or scrolls. Abrasive resistant high speed steel. Withstands severe continuous use. 1 1/2" dia. x 3 1/2" long. Has two cutting sections. No. 19B270..... **\$3.75**

INCLUDE ALLOWANCE FOR POSTAGE—ALL OVERPAYMENTS WILL BE REFUNDED



FREE! BIG 1953 RADIO CATALOG

See the 148 Page B-A Catalog No. 531 for Many More Values! Write us if you don't have it.

BURSTEIN-APPLEBEE CO.

1012-14 McGEE ST. KANSAS CITY, MO.

mobile with success. JPH now is located in Seattle. MTX is building an all-band TVI-proof rig. OIH, MTX, and HMQ are building 6AG7 VFO. OEB joined MARS and cleaned up TVI with an O.K. from FCC. PXY dropped the "N" from his call. VARC held a card party and a Christmas party, due to the efforts of the auxiliary. LQT, JBH, and LVB are on 144 Mc. PSX reports the formation of the Lake Washington Amateur Radio Club with 30 active members in the Seattle Area. The club station call is BB. Meetings are held the 1st and 3rd Thurs. at the Highland Community Center, Bellevue. Traffic: W7BA 943, 10Q 769, CZX 270, RIX 217, PYV 117, OPO 53, FET 35, ETO 31, FWD 17, MYL 12, NRB 11, AIB 4, BG 4, HNA 4, ZU 4, APS 2.

PACIFIC DIVISION

NEVADA—SCM, Ray T. Warner, W7JU—SEC: HJ. NECs: KOA, LGS, NWU, OXX, TJJ, VO, and ZT. OPS: JUO. Nevada State frequencies: 3660, 7225, and 29,360 kc. Nevada's 1953 "ham" license plates have a green background with copper-colored letters—a welcome change and very pretty. Boulder City's newest Novice is WN7SRJ. KEV, SXD, CX, JU, and BKS were active on c.w. and JUO was active on phone during the last SS Contest. NWU recently was appointed EC for Nye and Esmeralda Counties. ZT is active on 75 meters and MARS whenever his travels don't keep him away from home. Latest rumor has it that TV channel 13 will be in operation in Las Vegas some time in April. News is scarce this month. Why not drop a card to your SCM now? Schedules with eastern amateurs who want Nevada for WAS have clicked 100 per cent. Contact JU for skeds.

SANTA CLARA VALLEY—SCM, Roy I. Couzin, W6LZL—The NPEC recently elected the following: NVO, pres.; MMG, vice-pres.; PCR, secy.; MFW, treas.; MHV, act. mgr.; GXF, liaison officer. The SCCARA elected WGO, pres.; JBE, vice-pres.; QBO, secy.; APV, treas. New board members are LKY, JZU, and HC. Board members carried over are NX and NKP. AEV, our SEC, reports that regular drills are in progress in San Mateo and Santa Clara Counties. A section meeting is being planned for January at the request of the SCM. JTV now is using a vertical antenna with good success. KGR is planning to put up a vertical. YSQ now is active on 14-Mc. phone YHC now is on with a Viking II. GXP, with a new Ford, visited Las Vegas and Death Valley during a recent vacation. WNGEWW and his XYL, ALL, are sporting new Plymouth with a 144-Mc. rig built into the dashboard. QTE is finishing up 829-B final for 144-Mc. net. WMM reports he reworked 14- and 23-Mc. beams and tower and installed new rotor; he also is working on a single sideband exciter. OFJ is keeping on the LSN net in spite of working long hours; he also is planning on more power in the near future. QYR now is using GQ-9 transmitter for bulletins and in SS Contests, and single sideband the rest of the time when not using 11V mobile. YHM reports he still is working on 4E27 final. The Stanford Radio Club was host to the PAARA at a joint meeting recently and Dr. Allen Peterson, POH, gave an interesting talk on Scatter-Sounding. Traffic: W6YHM 118, OFJ 29, MMG 13, WMM 4.

EAST BAY—SCM, Ray H. Cornell, W6JZ—AREC and c.d. work are receiving heavy emphasis these days. The Nov. 23rd, c.d. drill pointed out many weaknesses in the present radio communication system which will be ironed out as soon as possible. It did serve to step up interest among the hams. A meeting of section officers was held at the Oakland Radio Club Nov. 23rd, to attempt to integrate the Section AREC into a closer knit group. The Southern Alameda County c.d. gang has been working over the headquarters station every other Tuesday. The 75-, 10-, 6-, and 2-meter equipment has been getting worked over by EKF, TUN, UZX, and others. These boys are shaping up an FB organization. PXL notes that more 6-meter activity resulted from the Nov. 23rd. drill than has been seen around these parts in years. The East Bay Radio Club has decided to meet the 2nd Fri. of each month. Hams in the Berkeley-EI Cerrito-Albany Area are especially invited to attend. New officers of the Club are VSV, pres.; DNK, vice-pres.; VNH, secy.; RLB, treas. DNK has just completed a Viking II. The big blow brought down his 2-meter beam. Santa Claus brought PAZ a new Viking II. FXX has been loading up a Bay antenna with his 32-V and reports FB results TVI-wise and QSO-wise. NJX was another ham who suffered antenna casualties from the big blow. MSS and EFD recently received their Advanced Class licenses. The Richmond Amateur Radio Club meets in the Red Cross Bldg., the 1st and 3rd Fri. of each month. WTI is getting ready to go on 2 meters. AJF is experimenting with a new design in beam antennas. YFI is building single sideband selector for c.w. QES, MXQ, VSV, and RLB were engaged in an impromptu 2-meter hidden transmitter hunt at midnight. The Berkely police force was very mystified and stopped QES twice. YDP is helping to organize the Boy Scouts Jamboree to be held in Southern California next July. BS is spending a lot of time at the Russian River. SARO members visited the Radiation Lab for the November meeting as the guests of UHM. If your favorite subject is not covered here, why not send me some news? It isn't

(Continued on page 102)

23,698

HOURS of SERVICE

**...and still no change in
Performance Quality!**

That's what Earl F. Lucas, Chief Engineer

WPAT

Paterson, N. J.

says about

Federal's

F-5680

2.5 KW POWER TRIODE

**Here's another record of the long life
and operating stability of Federal Tubes!**

STILL on the job after 23,698 broadcast-hours! That's the record Federal's F-5680 has scored to date for WPAT, popular 5,000-watt station of the North Jersey Broadcasting Company, Inc.

Moreover, says Chief Engineer Lucas, "periodic comparison with our spare tubes shows no performance differences, so I anticipate many more hours of use."

Based on amazing service records of other Federal broadcast tubes, WPAT's F-5680 should be on the job *for years to come!*

Here's *proof* of the solid-rock ruggedness and dependable performance built into *all* Federal tubes by Federal craftsmen—drawing on tube design and production experience dating from the very birth of the industry... *on experience with hundreds of broadcasters!*

Get the facts of longer-life Federal tubes... write to Dept. K-857.

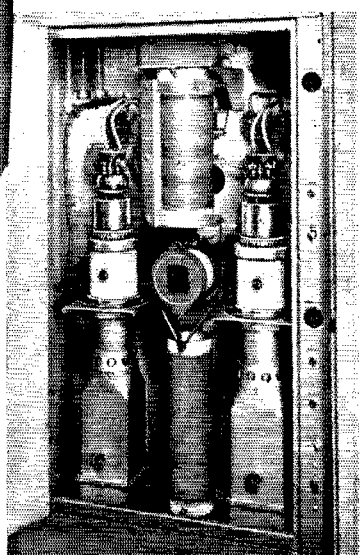
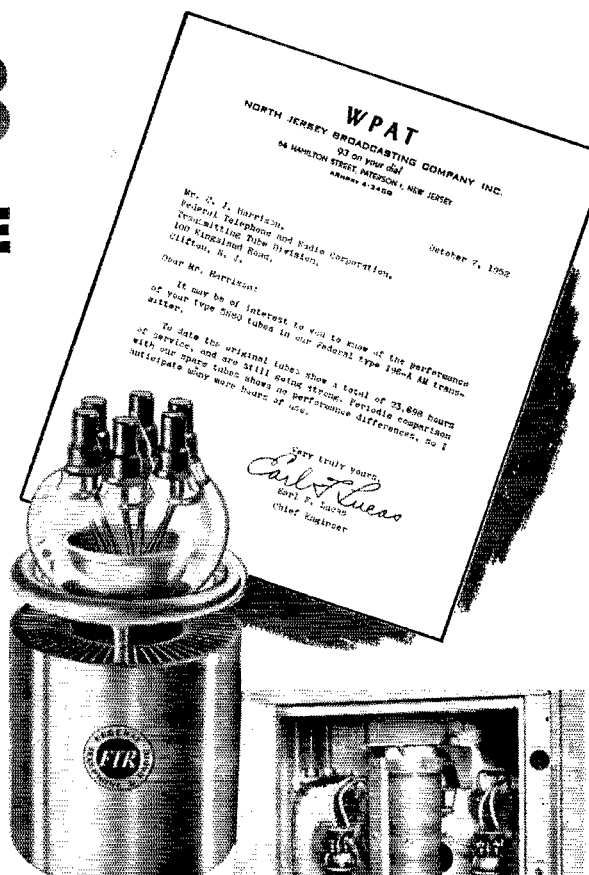

Federal F-5680 Power Triodes—
in WPAT's Federal 196-A AM Transmitter
—providing one of the most powerful signals
in the New York-New Jersey area.

"Federal always has made better tubes"

Federal Telephone and Radio Corporation



VACUUM TUBE DIVISION

100 KINGSLAND ROAD, CLIFTON, NEW JERSEY

In Canada: Federal Electric Manufacturing Company, Ltd., Montreal, P. Q.
Export Distributors: International Standard Electric Corp., 67 Broad St., N. Y.

CONCORD is your BEST BET for HAM VALUES!

NO MORE BATTERY WORRIES!

**35 AMPS WITH ENGINE IDLING 60-80 AMPS CHARGE
WITH 10 VOLT FIL. TRANS. FOR 110V. A. C.**

**LEECE-NEVILLE
A. C.
GENERATING
SYSTEM**

Alternator
only **\$35**
TERRIFIC BUY!

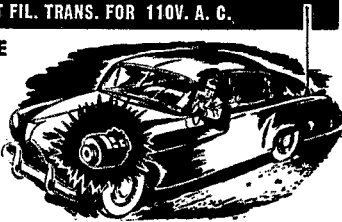

Recently removed from Police cars, these systems are in excellent shape for many years of top performance. Simple wiring and installation on most 1936 to 51 cars. Complete with wiring diagram and instructions. Alternator only.

STANDARD BRANDS

RECEIVING TUBES
60% OFF LIST PRICE!

BRAND NEW — BOXED — GUARANTEED

Type	Net	Type	Net	Type	Net
1B3GT	\$1.02	6BF5	.80	6Y6G	1.00
1HSGT	.68	6B6GG	1.92	7N7	.88
1L4	.84	6BH5	.84	12A7G	.62
1L6	1.06	6BJ6	.84	12A77	.72
1NSGT	.84	6BK6	.60	12AU6	.72
1N7	.84	6BQ6GT	1.16	12AV7	.96
1S5	.76	6C4	.68	12AV6	.62
1T4	.84	6CB6	.84	12AV7	1.16
1T5GT	1.04	6D6	.88	12L7GT	1.00
1X2A	1.06	6FF6	.84	12BA6	.76
3Q5GT	1.00	6FG6T	.66	12BA7	1.00
3L4	.80	6FG	1.24	12BE6	.76
3V4	.80	6H6	.66	12SA7GT	.74
5U4G	.60	6H6GT	.74	12SM7GT	.74
5V4G	.98	6J5	.60	12SL7GT	1.00
5Y3G	.54	6J5GT	.60	12SN7GT	1.00
5Y3GT	.44	6J6	1.00	12SQ7GT	.64
6AR4	.80	6K6GT	.64	19B6GG	2.40
6AG5	.90	6L6G	1.25	19C8	1.28
6AK5	1.66	6L6GA	1.42	25B06GT	1.36
6AK6	.94	6N6	.68	25L6GT	.68
6AL5	.72	6SA7GT	.58	25Z6	.66
6AQ5	.80	6S7	.66	25Z6GT	.54
6AQ6	.76	6S7GT	.74	35A5	.72
6AR5	.64	6SK7GT	.74	35C5	.80
6AS5	.84	6SL7GT	.98	35L6GT	.68
6AT5	.62	6SN7GT	.88	35W4	.50
6AUG	.72	6SQ7GT	.60	35Z5GT	.50
6AU7	.48	6T5	1.16	50B5	.80
6AV6	.62	6V6GT	.80	50C5	.80
6EG	1.28	6W4GT	.68	50L6GT	.68
6BAG	.76	6W6GT	.88	117L7	1.56
6BA7	1.00	6X4	.62	117Z3	.62
6BC5	.80	6X5GT	.62	117Z6GT	1.00
6BE6	.76				

TERRIFIC TRANSMITTING TUBE BUYS!

1625	24¢ each	25T	3.95	805	4.25	814	2.75
1626		35T6	4.50	807	1.75	815	2.75
1629		100TH	8.95	811	2.95	826	.75
		250TH	22.50	813	9.50	866A	1.25
						1619	35

**GET ON OUR SPECIAL
BARGAIN BULLETIN MAILING LIST!**

For our Special Bulletins, listing Red Hot Limited Quantity Buys, write your name and address on postal card, and send it TODAY to Dept. Q-2.

Concord Radio

55 Vesey Street,
New York 7, N. Y.



Phone
DIgby 9-1132

easy to get it any other way, so how about it? RRH is back on the air after a year with no TVI. Traffic: K6FAL 570, W6LPW 213, JOH 86, HXH 32.

SAN FRANCISCO — SCM, R. F. Czeikowitz, W6ATO — Phone JU 7-5561, SEC; NL, Phone PL 5-8457. *Eureka Area:* EC: SLX, A hearty "well done" to the past year's officers of the Humboldt Amateur Radio Club, and congratulations to the newly-elected officers. They are BWV, pres.; FYY, vice-pres.; QCS, treas.; WN6NLL, secy.; and KTV, act. mgr.; while the various chairmen are FYY for T.V.L., LE for B.C.I., KTV for c.d., with SLX and CWR working together on publicity. ZZK is building a c.d. all-band transmitter, and LE is building a new 10-20 beam. EQQ has moved to his new location, and may be reached at Box 204, Cutten, Calif. TEX has just started to work for the telephone company in Eureka. ZSE is using a Command transmitter while building a new rig, and has received his new Hi-Lite three-element close-spaced beam. C.w. men active are WN6PYL, W6BME, JTD, and PKJ. CWR is looking around for a new rig. The Humboldt Amateur Radio Club meets the second and fourth Fri. in the YMCA rooms, rear of Municipal Auditorium, entrance on "E" St., Eureka. *San Francisco Area:* EC: BYS. The San Francisco Naval Shipyard Amateur Radio Club handled the communications for the Northern California Outboard Motor Association regatta on Lake Merced. Two meters was used exclusively and very successfully. Among those operating were CHP/MM (in a rowboat) and mobiles BYS, GQK, LOZ, NGV, WN6s JAA, SCU, and SDN and from the North Peninsula Electronics Club, WN6JES, WGM, of the Vallejo Club, provided and operated for the Mare Island Navy Yard one set of speakers and a p.a. system. Two other p.a. systems were provided and operated by the S.F. Naval Shipyard. The p.a. systems were located at the float, the boathouse, and the far end of the lake, where the viewing public gathered. The new c.d. frequency for S.F. is 145.59, and the Bay Area net frequency is 145.35 Mc. 147.15 Mc. is used as an alternate channel. Excellent coverage was maintained in the c.d. emergency test of Nov. 23rd, which was city-wide. WB gave an excellent talk at the SFR on the new Collins mechanical i.f. system. The Highfrequency Amateur Mobile Society held a successful dinner and dance. The SFR meets the fourth Fri. at 51 Lakeshore Plaza, opposite 34th Ave. and Sloat Blvd. The HAMS meets the second Fri. at 1625 Van Ness Ave. the SFSNYARC meets the first Fri. but, being on a Naval Reservation, only club members are permitted in the Navy Yard. The Shipyard Club is featuring a school for radio theory and one for code. The meeting place and night of the new Cathay Radio Club is as yet unknown. *Marin Area:* EC: KNZ. Tamalpais Club EC: ZUB, KZF, of the Tamalpais Club and of Mission Trail, has been appointed Phone Activities Manager and all 'phone stations are asked to cooperate with Bill, who comes to us from the East Bay section, where he also had the HAM job. The Marin Radio Club meets the second Fri. at the American Legion Hall, Larkspur. The Tamalpais Radio Club meets at 7 Loma Ave., Tiburon, on the third Fri. *Santa Rosa Area:* EC: LOD. The Sonoma County Radio Amateurs meets the first Wed. in the Board of Supervisors room (temporarily), County Court House, Santa Rosa. Traffic: W6ATO 8.

SACRAMENTO VALLEY — Acting SCM, Willie van de Kamp, W6CKV — OPY is going 10-meter mobile. REF now is located in Sacramento. GTG went visiting in W7-Land. HVB moved to Redding. CFU is busy on MARS. FKI has all-band mobile. OMR has opened a radio shop in Mt. Shasta. IOM has a special radio room in the new house. New officers of the Placer Radio Club are GHP, pres.; OUB, secy.-treas. AIS joined the AREC. UNT has turned to 2 meters. MUN is back in Roseville. CMY is in the Navy. TID obtained Extra Class license. DOA is active again. PJV is back from Alaska. JVI has a 3-kw. generator for emergency use. KTF is busy with c.d. Traffic: W6JDN 30, GTG 8.

ROANOKE DIVISION

NORTH CAROLINA — SCM, J. C. Gesslen, W4DLX — Seems like the North Carolina boys have been giving the FCC a workout lately trying to beat that Jan. 1st deadline. New tickets are held by the following: Advanced Class — UJI, Fuquay Springs; NOV, Raleigh; SAJ, Charlotte; SWB, Statesville. General Class — WBU, Sanford; VEO and VGH, Charlotte. Technician Class — WND, Sanford; WMZ, Spring Lake. The Atlantic Net, meeting Tues. and Thurs. at 7:30 p.m. on 1895 kc. have new officers. ETF/4 as NCS, LOA and TSM as alternates; LWU, secy. AKC reports the N.C. Slow-Speed Net is going fine and looking for more prospects at 8:00 p.m. on 3605 kc. New officers of the Mecklenburg Amateur Radio Society of Charlotte are UEG, pres.; GJA, vice-pres.; OQQ, dir.; Ed Kieckler, secy. How about all affiliated clubs notifying the SCM and ARRL of the name and address of your new secretary so we can keep our files up to date? OQS, Kure Beach, and the crew from Wilmington, MDA, MVP, VNK, LWS, NTQ, and YHY, took a jeep and barge trip to Bald Head Island off the Coast. They took along some 10-meter gear and portable beams and did much better with Panama and Argentina than back to Wilmington. OQS also is on 2 meters now so

(Continued on page 104)

THE *New* ELMAC PMR 6-A RECEIVER

Designed by Amateurs... for Amateurs!



PORTABLE MOBILE RECEIVER — 6 BANDS A (AMATEUR COVERAGE)

Here is a complete 10 tube, dual-conversion, communications receiver that packs more performance and value into a six-inch wide cabinet than anything you've ever seen! Engineered and manufactured by the makers of the famous ELMAC, all-band mobile transmitters, the PMR-6A is a six band (INCLUDING BROADCAST) receiver designed for either mobile or fixed station use. You new car buyers will want to include this receiver in the deal. It will be your car radio *supreme* . . . from now on! Compare these specifications and then order your ELMAC PMR-6A from your nearest dealer.

- 6 Bands
 - (1) 600 kc to 2000 kc. (Broadcast and 160 meter band)
 - (2) 3.5 to 4.0 Mc. (75 and 80 meter band)
 - (3) 6.9 to 7.4 Mc. (40 meters)
 - (4) 13.95 to 14.45 Mc. (20 meters)
 - (5) 20.95 to 21.65 Mc. (15 meters)
 - (6) 28 to 29.7 Mc. (10 meters).
- Dual-Conversion eliminates images. 1600 kc first I.F. 455 kc second I.F.
- Ten tuned circuits provide high selectivity.
- Built-in highly effective noise limiter.
- Built-in Beat Frequency Oscillator.
- Full 3½ watts audio output with less than 1 micro-volt signal.
- Tuned R.F. ahead of converter on all bands.
- Voltage regulated to local oscillator, BFO, and second converter.
- Temperature compensated separate oscillator tube for high stability.
- Black back-ground dial gives full vision but does not blind the mobile operator at night.
- AVC "on-off" switch located on front panel.
- Antenna input designed to match 50 ohm coax.
- Power requirements: 6 volts A.C. or D.C. at 3.3 amperes. 250 volts D.C. at 90 milliamperes. Power supplies available for 6 and 12 V.D.C. or 115V. AC.
- Cabinet finished in grey hammertone size 4½" H. x 6" W. x 8½" Deep. Weight: 6½ pounds.
- Uses 10 tubes.
 - 1—6B1G R.F. Amplifier
 - 1—6BE6 First Converter
 - 1—6C4 Local Oscillator
 - 1—6BE6 Second Converter
 - 2—6B1G First and Second I.F. Amplifier
 - 1—6AL5 Detector and Noise Limiter.
 - 1—12AT7 First Audio and B.F.O.
 - 1—6BK5 Audio Output
 - 1—OB2 Voltage Regulator
- Price: \$134.50

From **KL7 to VU**
The SHURE "SONODYNE"
is Being Used by Veteran
Hams for Top-Flight Rigs

The popular "Sonodyne" Multi-Impedance Dynamic Microphone is being used more and more by veteran Hams throughout the world. The "51" Sonodyne is a rugged unit, will give you year-in, year-out brilliant performance under even the most difficult conditions. The "Sonodyne" provides high speech intelligibility, and will faithfully reproduce your natural voice.

The Multi-Impedance switch of the "Sonodyne" gives you your choice of either low, medium or high impedance!

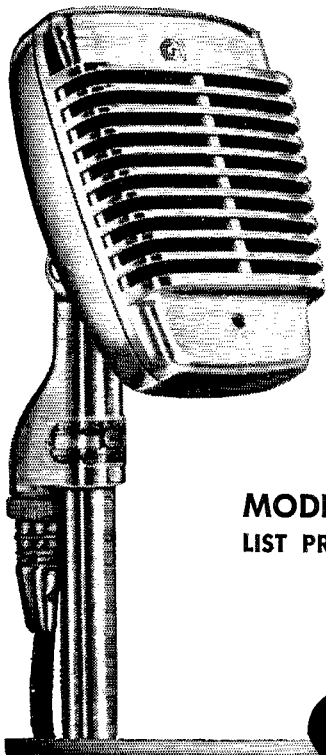

MODEL "51"
LIST PRICE \$45.00

SHURE

SHURE BROTHERS, Inc.

Microphones and Acoustic Devices

225 WEST HURON STREET, CHICAGO 10, ILL.
 CABLE ADDRESS: SHUREMICRO

how about some of you boys Down East giving him some competition? If you do, don't forget to report it to the SCM. Traffic: W4RRH 159, AKC 115, PIC 31, PXE 29, RAZ 24, QDA 20, PEY 17, AJT 14, R8F 14, DLX 10, HUW 9, SGD 8, CAY 7, LWU 5, NYE 2.

SOUTH CAROLINA — SCM, T. Hunter Wood, W4ANK — OHN is on all bands from North Charleston. W4YBJ is a new ham in Gaffney and is operating on 2 meters. CPZ is on 2 and 6 meters nightly and is planning 2-meter high power. W4YLT is a new ham in Mullins. GIT, MPR, EDQ, CPZ, and FFH are active on 75 meters. EDQ and AZT have new TV set. The Anderson Radio Club held a Chartering Supper Dec. 12th and is planning affiliation with the ARRL. W1WB will be in Charleston on Dec. 15th to meet with the Charleston group. An S.C. QSO Party is being planned for early spring. UOQ has his General Class license. W4WKL and W4UVA1 is a father-and-son team at Fort Jackson. OWW has a new Viking. FM enjoys working his 10-watt low power and has ordered 160-meter crystal on Atlantic Net frequency, 1895 kc. The S.C. c.w. net operation now is on 3525 kc. nightly Mon. through Fri. with UNO as Net Manager and QCC, ANK, and UNO as NCS. You are urged to QNI and provide outlet for your community and get in c.w. practice. The Pickens Radio Club has become affiliated with the ARRL. Traffic: W4ANK 127, FM 4.

VIRGINIA — SCM, H. Edgar Lindauer, W4FF — Virginia is very proud of its part in furthering the candidacy of MWH, of Danville, who took office Jan. 1st for a two-year term as Roanoke Division Director. Andy is very active in all phases of our hobby, including both c.w. and 'phone. His participation in all types of operating makes him well qualified to represent us. Andy is assured of this section's full support and cooperation. VFN was alerted for the recent emergency caused by a heavy snow storm that disrupted power and communications lines, isolating many communities in Washington, Lee, and Scott Counties. CAK, CFV, IYI, JGS, KRK, MCZ, and PAH were on the air in a few hours and furnished the only means of communications for their respective areas. The facilities thus established were utilized by the telephone company, Western Union, L&N RR, power company highway dept., state police, and county police. The power company went out of its way to provide emergency power for KRK, who was able to keep going at times when the local police were without power. Forty-four VFN stations assisted in handling traffic. Out-of-state stations very much in the picture included JGX, 2SZ, 2MQB/1, 3HV, 8ETF, and 9NDA. SDK leaves us at the request of Uncle Sam and his duties have been taken over by UHG, who has advanced in less than a year from Novice to RM assignment and is one of Virginia's most active traffic men. TVX continues to QNI from Florida QTH. SHJ is up to his usual capacity of BPL. VFN net certificates were issued to JAU, JZG, LJK, PMF, QEL, TBX, and 3HDV. FV checks into 3 overseas nets and is excellent source for that type of traffic. OVV says there was an error in that XYL statement — it's YL. The Happahannock Valley Radio Club's application for ARRL affiliation has been granted. KMS is secretary-treasurer. Recent appointments are HQN and UHG as RM; ODG and RDG as EC; JAQ and NV as PAM; JAQ, OWV, SB, and YHD as OPS; HQN, NV, and SB as OO; EHB, FOR, LJK, JUJ, MCV, MLE, OWV, SB, SPE, TVI, TVX, UHG, UWS, WBC, and YHD as ORS. Traffic: W4SHJ 528, JOT 405, FV 146, LJK 145, K4FCC 108, W4KRX 104, CFV 86, FOR 82, NV 81, KF 55, UWS 55, UHG 53, SPE 50, KFC 49, JAQ 48, OWV 33, PWX 28, KX 25, K4WAG 20, W4SNH 19, IYI 15, TVX 12, HQN 9, JUJ 7, LK 3. (Oct.) W4PWX 17.

WEST VIRGINIA — SCM, John T. Steele, W8NCR — A copy of the *Princeton Amateur Radio Assn. Bulletin* contains some interesting news. DFC is busy working 10-meter cross-band; IYG has had some nice QSOs with South Africa really going after DX. GGC still is on 80-meter c.w. GCZ sold most of his gear and bought a Viking. YMN still is busy building, YPR, our SEC, was really busy in the recent emergency. HNC now has a new NC-183D. KBU has a new Viking II. GEP is checking into both 'phone and c.w. nets and handling lots of traffic. Where's your report, Ben? A five-member committee has been appointed in Charleston to draw up plans for RACES. It consists of CIX, ETF, DHX, SFJ, and CCF. CCF, as chairman, has been sent to Maryland to attend c.d. school. FUS now is active on MARS frequencies. A new ham in Ritchie County is W8NLLJ. AUJ again made BPL in November. Traffic: W8AUJ 532, FUS 57, DFC 11.

ROCKY MOUNTAIN DIVISION

UTAH — SCM, Floyd L. Hinshaw, W7UTM — The past month has seen skip rear its ugly head — this occasion on CARS Monday night sessions. A California kw. would have had no chance of getting through! SP and IS have done a swell job for Utah Section Net and deserve a great deal of credit for keeping interest up and tempers down. QAG, of Provo, is a new full member in the Amateur Radio Emergency Corps. The Novice net meets at 4 p.m. Tues and Thurs., with W7QVP as NCS. All Novice operators are invited to join for some fine practice in
(Continued on page 106)

**ALLIED
has it!**

**the new RME* MC-55
MOBILE CONVERTER
for 10-11, 15, 20, 40 and 75 meters**

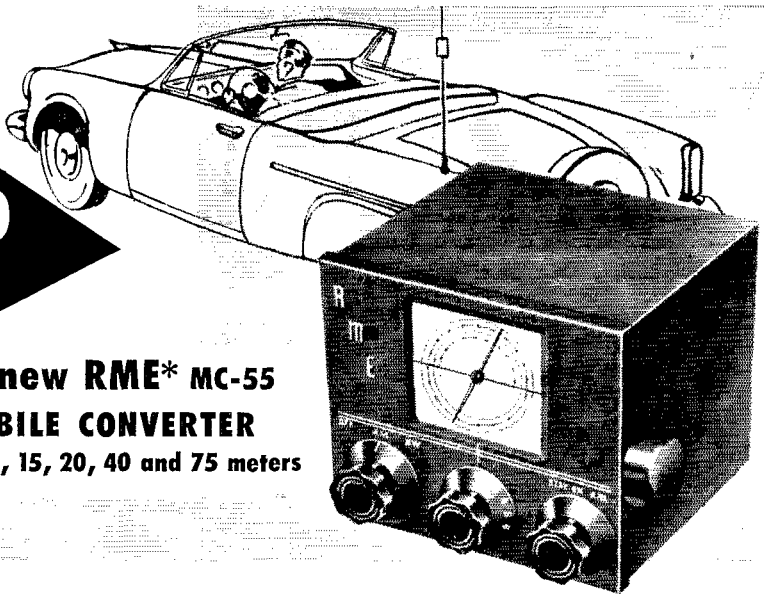

Here's the new mobile converter with FIVE BAND coverage. With the possible opening of 15 and 40 meters for phone operation, the MC-55 is ready to do a fine job on these bands as well as on 10-11, 20 and 75 meters.

MC-55 FEATURES: High Sensitivity—1.25 mv. on all bands; 3-gang tuning with individual slug-tuned coils for each band; built-in noise limiter all ready to plug into car radio, with handy "in-out" switch; separate input connections, with input connector for regular car antenna switched from front control knob;

ratio of 25-to-1 worm gear drive assembly for smooth, solid tuning; all-miniature low-drain tubes; 4 tuned circuits in IF output stage; large edge-lighted dial with clear band calibrations.

The MC-55 is small, compact and rugged (only $5\frac{3}{4} \times 4\frac{1}{8} \times 5\frac{1}{4}$ "). It's easy to mount in any handy location, and the attractive cabinet blends nicely in any car. Complete with all tubes, connecting cables, underdash mounting bracket, and instructions. Shpg. wt., 6 lbs.

**No. 98-032. RME MC-55 Converter.
Amateur Net \$69.50**

RME* MC-53 CONVERTER

Covers 2, 6 and 10-11 meters. Separate coaxial antenna connectors are provided for each range so that individual antennas may be used for top performance. Built-in noise limiter. Requires 200-250 volts DC at 30 ma., and 6.3 volts at .82 amps. In attractive grey case, $5\frac{3}{4} \times 4\frac{1}{8} \times 5\frac{1}{4}$ ". Supplied complete with tubes. Shpg. wt., 6 lbs.

No. 98-031. RME MC-53. Amateur Net. . . \$66.60

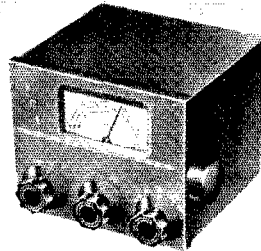

**IN STOCK
AT ALLIED
All Products of**



**Division of Electro-Voice*



FREE 236-Page Catalog

Refer to your 1953 ALLIED Catalog for all of your electronic needs, including complete stocks of station equipment and supplies. Save time, effort and money at dependable ALLIED RADIO... If you haven't a copy of our latest 1953 catalog, write for it today.

ALLIED RADIO

**ALLIED RADIO CORP., Dept. 15-B-3
833 W. Jackson Blvd., Chicago 7, Illinois**

Ship RME Converter Model.

\$ enclosed. Full Payment. Down Payment.
 Send FREE 1953 ALLIED Catalog.

Name.

Address.

City. Zone. State.

Slashed!!!

"TOTE-LITE" PORTABLE LAMPS

An amazing lamp with fluorescent lighting and power-boosting control. Less batteries.....\$4

PHONE HANDSET SPIRAL CORD, NEW

Normal length 23 inches, extends to 6 feet. 3-core rubber covered, complete with connecting lugs.....\$1.45

MARINE SIGNAL LAMPS

Complete with 3 lamps, 4 color filters, power-line, fixtures and case. Less batteries.....\$8.75

ARC-4 VHF TRANSCEIVERS

OK for 2-meter or civil defense, with instructions for AC operation!.....ONLY \$19.95

TU-10 TUNING UNIT

Full of coils, chokes, etc. Complete.....\$3.50

40-METER COIL FORMS, UR-10A

R.F. porcelain coil, mounting-strip, 5 banana plugs. Complete with chart.....\$1

HS-30 HEADSET

Lightweight hearing-aid type. Complete with cable...\$2.25

COAX CABLE

Okonite, RG-29/U. 52 Ohms. In 20-ft. lengths.....\$1

NEW N. ELECT. F-1 TELEPHONE HANDSET

Complete with connecting cord!.....\$8.25

ANTENNA MAST SECTIONS

Set of seven MS49-MS55 in bags (BG-56)...per set \$6.50

ANTENNA MAST INSULATORS

Heavy-duty type 106A.....\$7.50

ARC-5/R-28 RECEIVERS

100-160 MC., 4-channel crystal motor switching! less tubes and dynamotor.....ONLY \$29.50

W.E. NO. 703A 3-PIN CRYSTAL UNITS

Contains 2 crystals, 142,XXX ± MC.

\$2.75 each. Five for \$10.

SLIDE RESISTORS, ADJUSTABLE

150 Ohms, 50 watts; heavy duty type.....\$1.30

DE LUXE RADIO CABINET

Famous make, blue-grey and chrome. 9" H x 16½" L x 10½" W.....\$3.25

STEPDOWN ISOLATION TRANSFORMERS

Input 220-240-V, output 110-120-V.
100-VA.....\$5.00 500-VA.....\$8.50
1000-VA.....\$11.75

GIANT 35-FT. PLYMOLD ANTENNA TOWER MAST

Type AM-223. Complete.....\$49.50

7-HENRY FILTER CHOKE

For receiver and lower-power transmitter supplies...\$1.00

VOLTMETER A.C.

0 to 150. Diameter 2½".....\$3.00

VOLTMETER D.C.

0 to 500. Diameter 3½".....\$3.20

MILLIAMMETER D.C.

0 to 500. Diameter 3½".....\$2.95

NEW SONAR SR-9 Mobile Receiver.....\$72.45
SONAR MB-26 Transmitter.....\$72.45
SONAR SRT-120 100-watt Xmitter \$198.50

ILLUSTRATED SPECIFICATIONS WITH PLEASURE!

Prices F.O.B. Newark, N. J.

Bigelow 2-6666

Telegraph WUX, Newark, N. J.

Always Right With Earl White

RADCOM Engineering Co.

8 LIVINGSTON ST.

NEWARK 3, N. J.

preparing for their General Class exams. Amateurs in this section eligible for Emergency Coördinator appointment (League membership) are urged to send a completed Form 7 and a short note for such appointment to the SCM. Registration in AREC is not dependent on League membership but such membership is desirable. Traffic: W7UTM 136.

SOUTHEASTERN DIVISION

ALABAMA — SCM, Dr. Arthur W. Woods, W4GJW — A KNW regularly answers AENB, AENP, and AENR. PPK is looking for a 4D32 to help him in his search for DX. KIX answers phone and c.w. nets in Alabama and also RN6. AENB handled 120 messages last month, with an average attendance of 8.2 per session. UHA answers AENB, VN, and DON. AENP needs a Huntsville station. AENP meets at 1730 nightly on 3955 kc., AENB meets at 1900 nightly on 3575 kc., and AENR meets Sundays at 1300 and Thursdays at 1900. Traffic: W4KTX 135, UHA 118, KNW 34, PPK 18, GJW 4.

EASTERN FLORIDA — SCM, John W. Hollister, jr., W4FWZ — Hearty congratulations to PJU on being the first recipient of the Hawkins-Kirk-Gordon Post 4185, VFW of Clewiston, Good Citizenship Medal. Many of you will recall reading in this column of the many fine operating feats turned in by PJU for his pleasure and certainly for the betterment of the prestige of amateur radio. Lots of traffic reports came in but very little news. Clewiston: PZT jumped into the traffic gap left by EJU, who has to take more rest periods. Jacksonville: NKC is moving to Birmingham. FRP is using a Viking. FJC's new rig uses a 4-125 driven by a Meissner. RQN is jumping around the bands with a Viking since getting his Advanced Class license. GZJ and other officers did a nice job running the JARS this past year. Ft. Lauderdale: All known mobiles in the county, except one, are AREC members. Does IM top all other ECs on that score? (And thanks for the Honorary membership in BEN). Miami: TYI is TVing. There was plenty SS activity in Miami. The big four were SAT, LUV, LQN, and AEK. Others active were OVZ, TRP, SPK, WGB, IEH, and UJX, plus TRA on 'phone. SAT put his sky wire up 60 feet with a bow and arrow! IEH is busy on his new double-sideband reduced carrier rig. (Who else around the State?) Traffic: W4PZT 360, EFC 325, PJU 252, WS 126, LMT 71, HWA 57, KJ 31, TKD 29, RWM 23, NAK 10, FWZ 9, TRA 8, IM 7, YXK 3, IYB 3.

WESTERN FLORIDA — SCM, Edward J. Collins, W4MS/RE — SEC: PQW, EC: PLE. WN4YRF is the newest ham in the section. VCB made her WAS on 10 in the first six months of operation. 2CKD/M visited UTB. 3NDEK/4 keeps 10 meters hot. MUX keeps 7 Mc. hot. UQZ has a radio club going in the junior high school where he teaches. RZV and SZH are exclusively 75 meters. PQW is rebuilding. FHQ has the Viking II going FB on all bands. SRX, Eglin AFB Club station, is going FB. SWF has Extra Class ticket. JM, NJH, VAQ, and UCY are on 10 meters. NN is c.d. communications officer. KWM keeps 20 meters hot with a kw. MFY has TBS-50 for mobile rig. PLE still is building. RKH has 110-v. supply for mobile rig. SMM is working on audio. SQO keeps things humming at his shack. SSP meets the Alabama Net. SUQ is working on I44-Mc gear. 5QMK/4 has his Advanced Class license. UNV worked a KH6 without an antenna (hmm). UOO now is mobile. UXW is converting equipment. VCR completed audio project. 0JT/B/4 is meeting the Hair Net from Mary Esther. JPD has been active on 10 meters. ART keeps 2 meters going. WN4YFG is now a captain in the USN. MS is meeting MARS skeds.

GEORGIA — SCM, James P. Born, jr., W4ZD — The new officers of the Atlanta Radio Club for 1953 are IPL, pres.; SOV, vice-pres.; RVH, secy.; NWK, treas.; KFL, act. mgr. KFL is the new editor of *The Atlanta Ham*. YMN is a new ham in Dublin. The AREC in Georgia is being completely reorganized and all hams are requested to contact their local EC, SEC, or SCM and take an active part in the emergency preparedness program in their community and state. The following is a list of ECs continued from last month: TOW as EC for Putnam and Jasper Counties; TNW as EC for Catoosa, Walker, and Dade Counties; DND as EC for Clark, Jackson, Madison, Hart, Elbert, and Oglethorpe Counties; IPV as EC for Calhoun, Lee, Dougherty, Stewart, Webster, Quitman, Clayton, Randolph, and Terrell Counties; KIZ as EC for Coffee, Jeff Davis, Appling, Bacon, and Atkinson Counties; KGP as EC for Chatham, Effingham, Bryan, and Liberty Counties; RGC as EC for Baldwin, Hancock, Warren, Glascock, and Washington Counties; GVX as EC for Chatoga, Floyd, Whitfield, Murray, Gordon, and Bartow Counties; OHH as EC for Upson Talbot, Pike, and Lamar Counties; GDW as EC for Carroll and Heard County. SII has returned to the air after ten months in Germany. KWC has joined the merchant marine. Congratulations to USA on the FB traffic total of 2093 for the month of November. WN4VJH is a new ham in Millen. BOC is building a 500-watt final for all bands. Traffic: W4USA 2093, EJC 73, ACH 59, OCG 52, ZD 40, MZO 20, MA 15.

WEST INDIES — SCM, William Werner, KP4DJ — SEC: HZ. HZ is new SEC, while CN takes over as San Juan District EC. ES and OS are new ECs for Ponce and Agua-
(Continued on page 108)

to the **E. E. or PHYSICS GRADUATE**

with experience in

RADAR OR ELECTRONICS

Hughes Research and Development Laboratories, one of the nation's large electronics organizations, is now creating a number of new openings in an important phase of its operation.



Here is what one of these positions offers you:

THE COMPANY

Hughes Research and Development Laboratories is located in Southern California. We are presently engaged in the development of advanced radar devices, electronic computers and guided missiles.

NEW OPENINGS

The positions are for men who will serve as technical advisors to the companies and government agencies purchasing Hughes equipment. Your specific job would be to help insure the successful operation of our equipment in the field.

THE TRAINING

Upon joining our organiza-

tion, you will work in our Laboratories for several months until you are thoroughly familiar with the equipment you will later help the Services to understand and properly employ.

WHERE YOU WORK

After your period of training (at full pay), you may (1) remain with the company Laboratories in Southern California in an instruction or administrative capacity, (2) become the Hughes representative at a company where our equipment is being installed, or (3) be the Hughes representative at a military base in this country—or

overseas (single men only). Compensation is made for traveling and for moving household effects, and married men keep their families with them at all times.

YOUR FUTURE

You will gain all-around experience that will increase your value to the company as it further expands in the field of electronics. The next few years are certain to see a large-scale commercial employment of electronic systems—and your training in the most advanced electronic techniques now will qualify you for even more important positions then.

HOW TO APPLY

If you are under thirty-five years of age, and if you have an E. E. or Physics degree, with some experience in radar or electronics,

write to:

HUGHES

RESEARCH AND DEVELOPMENT LABORATORIES

Engineering Personnel Department

CULVER CITY, LOS ANGELES COUNTY, CALIFORNIA

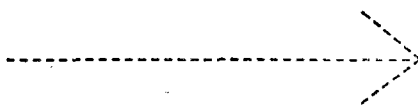

Assurance is required that relocation of the applicant will not cause disruption of an urgent military project.

**Maximum
Performance
Minimum
COST!**



CASE X

CASE A

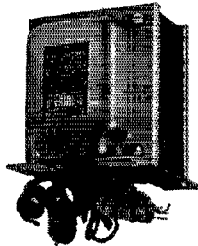

**TRIAD
Amateur
Audio
Components**

Absolute minimum size, without reduction in performance—sturdy featherweight construction—"Climatite" treated for resistance to moisture. That's why Triad Audio Components will get top efficiency from your gear—at low cost! See your jobber for these and other Triad items.

INPUT Transformers, Line or Microphone to Grid

Type No.	Application	Frequency Response	Primary Impedance Ohms	Turn Ratio	List Price
A-1X	Line or single button mike to grid.	300-3000	100	31.4	\$ 2.40
A-3X	Line or d.b. mike to grid.	300-3000	400 C.T.	15.8	2.60
A-5X	Single button mike to p.p. grids—Hi-gain.	300-3000	100	84	3.80

DRIVER Transformers

Type No.	Driver tubes	Output tubes	Frequency Response	Ratio 1/2 Sec. D.C. Ma.	Primary Impedance	List Price
A-81X	30, 1H4, etc.	P.p. 19, 30's, 1J6, etc.	300-3000	2.66:1	15	\$ 2.65
A-83X	6F6, 42, 45, etc.	P.p. 6L6, 6F6, 6V6, 807, etc.	70-7000	1.33:1	40	3.00
A-85X	6F6, 42, 45, etc.	P.p. 6L6, 6F6, 6V6, 807, etc.	50-10000	1.33:1	40	3.50
A-89A	P.p. plates to class B or AB grids—Universal 15 watt.	Any class B or AB tubes. 100-500 watts output.	50-10000	3.1 or 2.2:1	100 per side	6.70
A-91A	P.p. plates to class B or AB grids—Universal 30 watt.	Any class B or AB tubes. 400-1500 watts output.	50-10000	3.1 or 2.2:1	160 per side	14.40

MODULATION Transformers, Tube to RF Load

Type No.	Primary	Frequency Response	Secondary Impedance	Ma.	Audio Watts	List Price
M-1X	10000 C.T. for 19, 1J6, 6N7, 6A6, etc.	300-3000	5000-8000-10000	50	5	\$ 3.80
M-3X	10000 C.T. for 6N7, 6A6, 6F6's, etc.	300-3000	3000-5000-8000	100	20	5.20
M-7A	4250 C.T. for 807's	300-3000	3000-5000-8000	200	60	15.20

WRITE FOR CATALOG TR-52D

**TRIAD
TRANSFORMER MFG CO**

4055 Redwood Ave., Venice, California

dilla Districts, respectively. The 10-meter AREC Net made public note of sympathy on the death of Jesus T. Pinero, ex-4KT, one of the pioneers of amateur radio in Puerto Rico. The Net also sent a message of congratulations to President-elect Eisenhower through PJ and MARS channels. New Novices on 80 meters are TQ and TP. CY switched to 6146s in the final. PW passed Advanced Class exam. MT, Las Piedras, is heard in San Juan on 10 meters when skip is right. RK adds Hawaii and Portugal to his 18 water, and also QSOed W4WKP, an eight-year-old blind amateur in Georgia. PT is building 20-meter QH beam. New AREC members are RK and TC. TO, now General Class, has new 10-meter beam and 500-watt transmitter. DJ increased the length of the 80-meter antenna to 136 feet. WP4SV, Rio Piedras, is on 3735 kc. PW is fussing with 7-Mc. doublet. UW, of FCC, gave exams in KZ5-land. QR, on 75-meter 'phone with 150 watts and speech clipper, made 551 SS QSOs. PJ improved 80-meter antenna. PZ received WPR25 certificate. DV is QRL P.R.A.R.C. Ground Ware. KD is up to 50 countries on 21 Mc. SK lengthened antenna to 136 feet. CN has Commander 75 mobile. KP4AK has been relieving KV4BB at St. Croix. HN wants to hear from anyone who can work him on 144 Mc. Traffic: KP4CP 3, DJ 3, DV 3, ES 2, CY 1, KD 1, PW 1.

CANAL ZONE — SCM, Nelson W. Wagner, KZ5NM — New appointments: RM as SEC, GF as RMI, ML as PAMI, WJ, Diablo Heights, and RT, Coco Solo, as ECs. 2S, 900 kc. now is monitored 7 days a week at 1215 and 1700 EST for incoming traffic. RM completed an all-band exciter for his 4-65As. WJ is building a new 30-Mc. VFO mobile rig. TB is building a de-TVied all-band kilowatt 'phone and c.w. rig using 4-250As. CARC members are building 5-watt 3.5-Mc. c.w. rigs for local use. AP's new QTH is France Field. PH has a new Viking on the air. IA now is using the Monitore as per ARRL *Handbook* and strongly recommends it for working c.w. break-in. This is my first report as your new SCM. Please send in your station activity reports or mail a card with any news, and do call me if I can be of any help. Traffic: KZ5ML 153, DG 31, NM 13, NN 12, RM 6, IA 2.

SOUTHWESTERN DIVISION

LOS ANGELES — SCM, Samuel A. Greenlee, W6ESR — Asst. SCM, Kenneth L. Kime, K5X. RMs: FMG, FYW, GJP, JQB. Section Traffic Nets: LSN, Mon. through Sat. 3600 kc. at 2030. ECN, Mon. through Fri. 3655 kc. at 2030. BPL this month was made by KYV and GYII. Attention all California hams: Time is fast approaching for presentation of our license plate bill to the State Legislature. If you want those plates, write now to your Assemblyman. California is one of the few states not allocating call-letter plates to hams. If it doesn't work this time, it may be your fault! Want further information? Contact PIB, Pat-on-the-back Dept: To Hindon, EUV, for again helping us hams, this time by handling the legal aspects of our license plate deal, and to PIB for sparkplugging the whole deal. VHN is QRL — seems the phone company refused further support for his antennas! Glad that CK and WPF are off the sicklist. AM worked all 72 sections on 'phone in the SS. HKD is going in for power on 2 meters. FMG, RMI, asks "what-saunner with LSN?" The answer, nothing — it's the hottest net on 80. Per NCA: ZEV now is in Burbank, QRT big rig but very mobile; VPD is fully "Collinized" in new QTH; NTR really is DXing with new 60-ft. pole; another DXer is TG on 2 and 20; YH prefers new Viking to kw. Thanks. Tom. BUK has troubles with tank fushing. VCF is NCS of California MARS Net. BLY tells us that CEA has a Viking; DWL is on with Motorola; MJA still is sleeping off the SS Contest; GTL handled Christmas fighting for Whittier. Thanks, Ira, but you didn't mention your all-out activity in c.d. Such modesty! HIF has been bitten by the traffic bug. Ever notice how YBF mentions his town in every transmission? He must own the C of C! CMN just completed a classy new ham shack. The Mission Trail Net is going places under the leadership of HLZ. COZ reports he is back on 10 again; HYS is QRT — tower down; HYO and JMY are back from the Air Force. Gracias, Gene. EBK is on 40 now that the 75-meter antenna fell down. Grin-of-the-month Dept.: What mobile ham dutifully took the li'l woman to church, parked outside, and in a QSO explained that, being a ham, he was going to heaven anyhow — all to the delight of the congregation being S9 via the electric organ. And was Mrs. ZSL embarrassed! DPL reports the teenage net (7250 kc. at 10 Sun.) adds MYD and HJK to roll call; and 6RPN dropped the "N." Thanks to WRT for the report that the YLRC is giving a certificate for 10 members worked since Jan. 1, 1952 (see KER for information) and that LMQ now is Cl. A. KYV now is taking traffic in 1000 lots! PMS and DRI have had 2996 contacts on 75. FYW says MSG is busting 2-meter DX records. Per YCF: OTO says no QRM on 40; new W6 is TML (ex-W7LAQ); ORW and ORI have new Panadaptor; ENR is crowding(?) 250TH with 200 watts; ZRR has two emergency supplies — hand power and gas. LB is going nuts trying to locate frequency of c.w. signals from family stove (atsa hot one!). AREC Notes: Whittier (BLY): CAU is doing a bang-up job as NC. MidCities (DCB): All control stations now are Viking equipped. Long Beach (Continued on page 110)



HENRY RADIO offers YOU:

LOW PRICES: You can't beat my wholesale prices.

FAST SERVICE: You get fast service. I have big stocks of Collins, National, Hallicrafters, Hammarlund, RME, Johnson, Harvey-Wells, Lysco, Gonset, Millen, Morrow, Mallard, Elmac, Master Mobile, Hy-Lite, Babcock, all other receivers, transmitters, parts at lowest prices.

BIG TRADES: I want trade-ins. I trade big. Tell me what you want—what you have to trade. Get my offer. I pay cash for receivers and transmitters too.

TIME PAYMENTS: Get what you want and pay by the month. I give you better terms because I finance all terms myself. Write for details.

SATISFACTION: Try any communications receiver ten days—if you return it your only cost is shipping charges. I want you to be satisfied. Ask any ham about Henry Radio.

PERSONAL ATTENTION: You get personal attention. Bob Henry, WØARA, runs the Butler store. Ted Henry, W6UOU, runs the Los Angeles store. Bob Henry can be reached nearly 24 hours a day, 7 days a week. Write, phone, wire or visit either store. Send us your orders and inquiries. Export inquiries solicited too.

Bob Henry
WØARA

Butler 1, Missouri
Phone: 395

HENRY RADIO STORES

11240 Olympic Blvd.
LOS ANGELES 64
BRadshaw 2-2917

"LARGEST DISTRIBUTORS OF SHORT WAVE RECEIVERS"

for the high-power man!

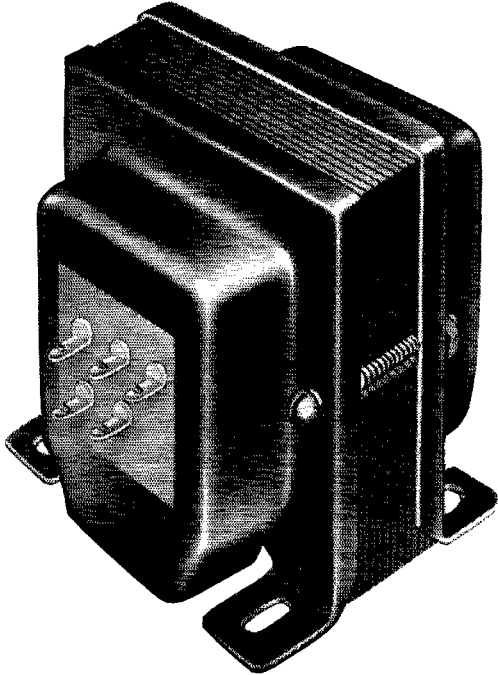

MERIT HIGHPOWER Filament Transformer P-2943

Designed for highpower use in both Amateur and industrial applications.

Specifications: Sec. Volts, 5—Sec. Amp., 30—Insulation Volts, 3000—Center tapped with primary taps for 110-115-120 volts, 60 cycles—Dimensions, 3 7/8 H. x 3-3/16 W. x 4 3/8 D.—DL Mounting . . . Will handle a pair of 250 TH's . . . 4—250 A's . . . 4—125 A's . . . 4—400 A's, etc.

Net Price — \$6.60

Merit Transformer Corporation
4427 North Clark Street
Chicago 40, Illinois



BURTON BROWNE ADVERTISING

(NSX): Beautifully set up on 10 and 2, rotating all members at control stations for familiarity with equipment. All nets are setting up for 2 and working closely with c.d. Traffic: W6KYV 4129, GYH 770, WFT 375, WRT 264, JQP 151, FMG 136, BHG 111, UEN 111, PMS 98, ESR 91, GJP 90, YBF 48, FYW 39, BLY 35, HLL 32, DFI 31, NTN 29, CMN 28, COZ 27, YCF 25, NCA 17, CBO 16, HIF 14, PIB 13, HKD 10, AM 8, GCO 4, NJU 4, YSK 2. Also reporting: EPL, GEB, KQS, and MU.

ARIZONA—SCM, Albert Steinbrecher, W7LVR—Asst. SCMs: Kenneth P. Cole, 7QZH, and Dr. John A. Stewart, 7SX. SEC: OIF. RM: JGZ. Arizona Phone Net: Tues. and Thurs., 7 p.m., 3865 kc. Arizona C.W. Net: Mon., Wed., Fri., 8 p.m., 3515 kc. Phoenix Net: Tues., Thurs., 7 p.m., 29 Mc. Tucson Net: Thurs., 8 p.m., 29 Mc. Arizona YL Net: Wed., 7:30 p.m., 3865 kc. Arizona 6&2 Net: Nightly, 7 p.m. Arizona MARS: Tues., Thurs., 9 p.m., 4025 kc. Arizona Restricted Speed C.W. Net: Mon., Wed., Fri., 8 p.m., 3700 kc., 8–12 w.p.m. Station activities reports and active club information is requested monthly from all hands! Because of the lack of reports this month (November) your SCM is submitting some special data of interest: According to the latest Call Book (Fall Issue), 850 licensees are located in 77 communities in Arizona. Phoenix has 282 and Tucson 274. The top 10 cities: Mesa 23, Prescott 19, Scottsdale 18, Douglas 14, Tempe 14, Morenci 12, Winslow 12, Flagstaff 11. The balance have 10 or less. We have 13 clubs, 29 YLs, and 94 Novices. ARRL members now represent 225 calls, 25 per cent unless we eliminate some removed from the section or dropped out before their 5 year licenses run out! ARRL needs the support of every active amateur in Arizona. I appeal to those members reading this report to urge non-members in your community to join the League. Let us join in a program for an active Arizona section. Help do this for the betterment of our mutual hobby as well as to improve the personal satisfaction in pursuit of our hobby. Your SCM will greatly appreciate hearing from any and all of you regarding your activities and any help which this office can render to you. Traffic: K7FAG 320, W7KOY 196, PLM 102, SX 85, LVR 40, QZH 11, OIF 6.

SAN DIEGO—Acting SCM, Thomas H. Wells, W6EWU—Asst. SCMs: Shelley E. Trotter, 6BAM; Richard E. Huddleston, 6DLN. RM: MUE. SEC: SK. Asst. SECs: WYA, FOP. EC: DEY. Last month's report indicated FOP has been appointed to the post of San Diego EC. This was clarified when Don, our SEC, returned from his vacation. FOP has been designated Don's assistant for 75-meter 'phone and to help coordinate the activities of 75 and 10 meters. The latter now is headed by the capable WYA. November has shown the effects of turkey QRM. An FB report comes from FJH, who says that the November joint meeting of the Palomar and High School Clubs produced a new president, HAW; and with refreshments came an informative talk by Master Sergeant Ray Baumann, of Camp Pendleton. Ray is the very super operator who handles the Oriental Pacific circuit of Macan/4. See his monthly message count and drool with envy. AKY now is sporting a new 75-meter 'phone rig. PYU is selling his beam and moving to 75 meters. We want to know who was the instructor who helped a certain pretty little teenager get her Novice ticket. FJH is having good results in LU-Land on 15 meters. The LSN members held a meeting at the home of the Net Manager, FMG. Get-togethers like this always make for better understanding. Congrats to BAM on working YYN/1 on 21 meters.; also to DYM on getting his new ticket; and to ERZ on receiving a silver cup from the Pan-American tournament in Mexico City. The Point Loma Club is reorganizing. Traffic: W6IAB 6303, IZG 531, FCT 9, CHV 4.

WEST GULF DIVISION

NORTHERN TEXAS—SCM, William J. Gentry, W5GF—SEC: JQD. PAM: IQW. LGY and her mother spent three months in Florida. She took her 60-watt portable rig and was a member of the Florida Phone Net. The Knights of Kiloeyele was bestowed on her. Congratulations and welcome back to Texas. NWF is back from the Navy and is teaching in Odessa. GF is trying to get a 75-meter skywire up in his limited space. Lubbock now has a TV station on the air and the hams spent a week in a TV school. TVI was covered in the school. Dallas hams are having good programs on single sidebands and v.h.f. Traffic: W5QHI 519, BKH 288, PAK 269, VXR 51, SRQ 43, PXI 38, ARK 35, CF 35, LEZ 24, RUM 20, UFP 11, GZU 7, VVY 6, GF 4, ROH 3.

OKLAHOMA—SCM, Jesse M. Langford, W5GVV—SEC: AGM. RM: OQD. PAMs: GZK and ATJ. The end of November found MFX still in the process of rebuilding. SWJ will handle Kansas traffic. JP found time for a vacation in Florida. SCX has rebuilt the receiver for a 522. Lawton and Frederick Clubs are working hard on civil defense. TVG now is on 75-meter 'phone. KY now is in new ham shack. FEC is using a new antenna. WN5YJR and WN5YJQ are new calls in Bethany. ECA has moved to Washington, D. C., and NBX to El Paso. HXT is going to town with a 4-Mc. mobile. VRV is on 144 Mc. WLN is using a vertical antenna on 14 Mc. Oklahoma County AREC participated in the

(Continued on page 118)



HARVEY FIRST TO STOCK... FIRST TO DELIVER

NATIONAL NC-183D RECEIVER

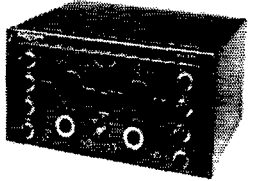

Has everything you want: 3 stages of IF... 15 meter band spread... 6 meter band... dual conversion... 2 stages of RF... broadcast band... push-pull audio output... sharper, narrower IF... sensitivity better than 1.5 microvolts... exclusive full adjustable automatic noise limiter... and many other exclusive features. Finished in smooth gray enamel. Supplied complete with all tubes.

NC-183DT Table Model (with speaker)\$385.50
NFM-83 Narrow Band FM Adaptor 17.95

ELDICO TR-75-TV



TRANSMITTER KIT

This is an ideal unit for the novice. Very simple to assemble. New, revised circuit to

aid in the elimination of TVI. Uses 6L6 oscillator—807 amplifier combination PI-network output. Husky power supply delivers 600 volts to the 807. Complete... including a punched chassis and shielded cabinet. Unbelievably low priced at...
\$64.95

MD-40 modulator kit for above... 49.95
MD-40P as above but with power supply..... 59.95

SUPERIOR POWERSTATS

Smooth, efficient voltage control, 0-135 volts output from 115 volt AC line. Models also for 230 volt input. Write for free literature. Models for table and panel mounting.

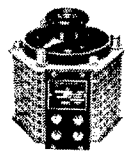

Type 10, 1.25 amps..... \$ 8.50
20, 3 amps..... 12.50
116, 7.5 amps, table mtg..... 23.00
116U, 7.5 amps, panel mtg... 18.00
1126, 15 amps..... 46.00
1156, 45 amps.....118.00

Complete Stock Always On Hand For Immediate Delivery

Complete Line in Stock
CAMBRIDGE THERMIONIC COILS
For Immediate Delivery

NOTE: In view of the rapidly changing market conditions, all prices shown are subject to change without notice and are Net, F. O. B., New York City.

The New HALLICRAFTER



HT-20 Transmitter

A completely TVI-suppressed transmitter with complete bandswitching from 10 to 160 meters. Power output 115 watts CW or 100 watts on phone. TVI radiation is at least 90 db. below output. Has provision for external VFO head, plus many other new features.
Complete with Tubes.....\$449.50

HALLICRAFTER "CIVIL PATROL" S-81 AND S-82

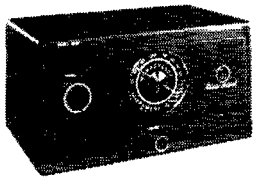

A compact, low-cost, FM receiver covering police, fire, taxi, telephone, railroad, and other industrial frequencies. Ideal for civilian defense and emergency communications. Has built-in PM speaker and phone tip jacks. Operate on 105/125 volts 50/60 cycle AC or DC.

Supplied complete with tubes.
S-81 VHF FM 152-173 mcs.....\$49.50
S-82 HF FM 30-50 mcs..... 49.50

Central Electronics Units Increase Phone Power 8 Times With SINGLE SIDEBAND VIRTUALLY ELIMINATES TVI

MULTIPHASE EXCITER MODEL 10A—Switchable single sideband with or without carrier. Double sideband AM. Phase-Modulated Break-in CW. Output approximately 10 peak watts 160 to 20 meters, reduced on 15 and 10. Voice operated break-in. With coils for one band:
Wired and tested.....\$139.50
Additional Coils per band..... 3.95

SIDEBAND SLICER MODEL A—Receiver adapter. Selectable single sideband reception of SSB, AM, PM and CW. Reduces heterodynes and interference at least 50%. For receiver IF, 450-500 kc.
Wired and tested.....\$69.50

PS-1 PLUG-IN prealigned 90° phase shift network and socket.....\$7.50

The New SONAR Transmitter

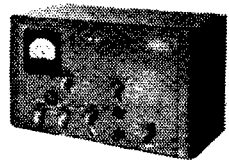

Model SRT-120

For mobile and fixed location operation. Has band-switch for 80, 75, 40, 20, 15, and 10 or 11 meters, plus spare position for any future band. Has provision for two crystals or external VFO head. Final amplifier employs the new Amperex 9903/5894A tube. Power input is 120 watts on CW, and 100 watts on phone. All circuits metered. Power requirements: 600 volts dc at 350 ma, and 6.3 volts at 6.4 A.
Complete with Tubes.....\$198.50
External VFO Head..... 16.50

HARVEY IS YOUR COLLINS HEADQUARTERS

The New 75A-3 Receiver

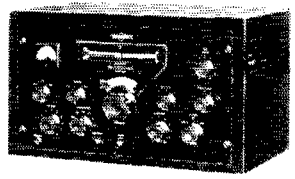

With Mechanical Filter

The familiar Model 75A-2, redesigned and modified to provide for the use of mechanical filters. Supplied with one 3 KC filter, and facilities for one additional. A 2-position front panel switch permits selection of filter desired.

with speaker \$550.00
1 KC Mechanical Filter..... 75.00
COLLINS 75A-2 still continues in popularity.....with speaker 440.00

COLLINS 32V-3 Transmitter

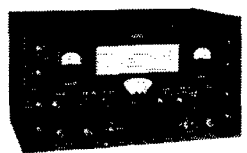

A VFO controlled bandswitching, gang-tuned amateur transmitter. 150 watts input on CW and 120 watts on phone. Covers 80, 40, 20, 15, 11 and 10 meter bands.

Dimensions: 21 1/8" wide, 12-7/16" high, 13 3/8" deep.
Complete with tubes..... \$775.00



Harvey RADIO CO., INC.

103 W. 43rd St., New York 36, N. Y. • LUxemburg 2-1500

CRYSTAL CONTROLLED CONVERTERS

FOR
2, 6, 10-11, 15 or 20
METERS

MODEL
RC-1B

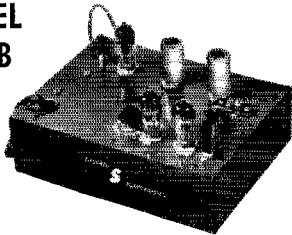

\$45.00
NET

(Complete,
with
power
supply,
crystal
and all
tubes)

Designed for the ultimate in performance on any one amateur band, these converters have been widely accepted and very popular, giving all the benefits of dual conversion at low prices.

FEATURES:

- Tube line-up: 2 band-pass 6BQ7-A grounded grid R.F. stages, 1—6J6 push-push mixer, 1—6BA6 I.F. amplifier, 1—6J6 crystal oscillator-multiplier.
- Built-in transformer type power supply using selenium rectifier.
- Built-in I.F. amplifier, one stage.
- Built-in gain control.
- Output frequency 7-11 Mc. on all but 20 meter model.
- Output frequency 3.5-3.9 Mc. on 20 meter model.
- Available for either 52 ohm or 75 ohm coax or 300 ohm line.
- 18" shielded output cable.
- Ruggedly built—RTMA guarantee.
- 2 1/4" x 6" x 8" overall. Weight 4 lbs.
- Not a kit—completely wired, tested and ready to use.
- More than 500 converters now in use.
- For full information, write Dept. Q-2.

Converter for any one band, complete with built-in power supply, crystal, tubes, output cable and input fitting for 52, 75, or 300 ohm line, \$45. Now available at leading distributors. Specify band and input impedance when ordering.

SYLVAN
S ELECTRONICS
LABORATORIES, INC.
393 NORTH PEARL ST., ALBANY, N. Y.

Oklahoma City Armistice Day parade. CKQ is going whole hog; his home rig now is on the active list and he is thinking about a mobile. AGM is back on the air with 150 watts. RDE is back on the air with the big rig. HXL and NQV now have 70 cm. rigs going. EHC was elected West Gulf Division Vice-Director. OQT is busy with traffic and checking modulation for the gang. The Tulsa Club had a two-page write-up with pictures in the magazine section of the *Tulsa Sunday World*. BDX has new SS exciter. KY and CKQ were heard giving the Kansas gang an assist during their emergency. YMV is a new ham in Lawton. Long skip has been giving the NTO net lots of trouble but, because of the fine work of those who could hear, traffic has been moving along in good shape. Traffic: W5GZK 350, ROZ 123, SWJ 92, QAC 46, GVS 31, PML 30, KY 24, MQI 23, SVR 22, EHC 16, PA 16, GVV 14, QVV 14, OQD 10, ESB 9, RST 8, ADC 7.

SOUTHERN TEXAS—SCM, Dr. Charles Fergaghlich, W5FJF—Your SCM has just returned from a meeting in Austin and Ft. Arthur. Emergency communication was discussed with the emphasis on 2-meter mobile. The Austin Club is going to *standardize* on a 2-meter converter and transmitter. Members are going to mass produce these units for their own use. Port Arthur and Beaumont Area hams will do likewise. I expect to visit other groups soon and institute a similar program. Details can be had from NZE, pres., Austin ARC, or CVD, Austin EC. I wish to thank NZE for the swell lunch for I'XN SYN, NFC, DCS, IIK, DCV, AXV, GPQ, OMP, POL, NZE, CVO, and FJF. DCV discussed the important role of hams in emergency work. My visit to Port Arthur was indeed a pleasure. Thanks to BUZ for arranging this meeting. It was gratifying to see such interest by teen-age hams. Those present were B, Freeman, TPD, PJX, WPV, OWL, VOM, UOQ, WN5WRW, TEH, WRE, PCD, EQK, UTR, WN5YFC, PKY, CCT, QFQ. A new 3710-ke. c.w. net has been formed. UTR is NCS Mon., Wed., Fri., and Sun., 5:30 p.m. CST. All interested are urged to participate. WPL recently got General Class license. WN5WRW is active on 80 meters. VOM is doing FB with 5 watts. TEH has WAS. WN5WYZ worked Rhode Island with 30 watts. Ten-year-old Robert Hearne passed the exam and is the youngest in Beaumont to do so. WN5YFC is 12 years old. WN5WRE is building a new rig. The South East Texas mobile group meets on 3855 kc. Thurs., 7:30 p.m. Active stations: 4SQI/5, QBY, QIO, KWA, RYV, GNX, PKY, SM, and CWS. They are looking for new members. NIY is doing FB on 21 Mc. OYP is interested in c.w. traffic nets and reports in N. Tex. Net, OK. Net, and RN5. BUZ is another active State Guard member. F'XN reports NZE got his DXCC 'phone as well as WAC, WAS, and A-1. OQ5LL is on 20 meters every Sat. Supplying TV sets cuts his time on the air; he reports. A new jr. operator as of Nov. 19th. NIIB reports 430 works like a charm. NIIB, AYU, IGL, HPC, PKJ, QMY, ONS, and AXV are active on 430 Mc. K5WAS had two antennas blown down in November. UMY reports Brazoria County ARC coming along FB. EKO set up portable 10-meter 'phone rig so that VDE could attend over the air. WN5YLP is a new ham in Angleton. SAH says WNATOM now is W5YMB, WIC also is General Class. AQN still is busy rolling pills in Madisonville. Ex-5BME is going up for his new license soon. YK has a new NC-125 and has remodeled the shack to use 80, 40, 10, and 2 meters; his dad is going up for Novice Class test soon. V.H.F. Note: OQ5LL has been active twice daily from Dec. 15th on 50,002 kc. with 500 watts. Listen for him at 1200, 1800, 2100 GMT. Traffic: K5WAC 1328, K5FKF 1196, W5MN 443, QFA 95, UMY 64, OYP 23, F'XN 12, NIY 7.

NEW MEXICO—Acting SCM, Dick Matthias, W5BIW—LDO was Acting NCS for New Mexico 75-Meter Emergency Phone Net while BIW was in Houston during November. Unusually long-skip conditions are curtailing net activities. However, on Dec. 2nd we were able to check in 21 on the roll call and handle a couple of messages before the skip took us out. Traffic: W5NKG 207, ZU 22, JZT 8.

CANADA MARITIME DIVISION

MARITIME—SCM, A. M. Crowell, VE1DQ—SEC: FQ, EC: EK, RM: Om. Newly-elected officers of the HARC are OM, pres.; DG, vice-pres.; CP, secy.; PT, treas.; FQ, bulletin editor. Under the able guidance of these O's we should have a very good year in 1953. Your SCM herewith extends best wishes to all for the New Year. A serious fire in Conerbrook, Newfoundland, saw several of the gang, including YV, HC, and DW, assisting with emergency traffic. Several of the XYL and YL members of the Halifax Ladies Dit and Dah Club recently formed a social group which meets regularly at members' homes, the old L.D.&D. Club being inactive as such. HJ reports activity on all bands, as does ME, who is doing some building with 1625s. FQ continues his northern skeds. PT reports great luck with the new 14-Mc. two-element beam. DB says his best to all. Reports hit an all-time low this month. Traffic: VE1FQ 93, OM 52, JA 26, DB 3.

(Continued on page 114)

Make Your Dollar Go Farther!

The father of our country made a dollar go a long way but *your* dollar will go a longer way when you get a Walter Ashe "Surprise" Trade-In.

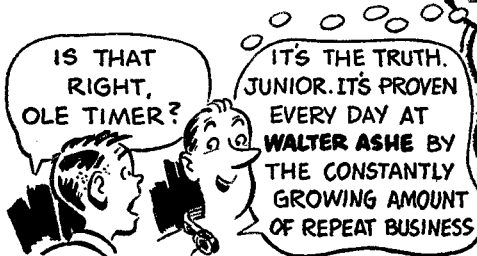

S-t-r-e-t-c-h those dollars and be money ahead by taking advantage of the one and only "Surprise" Trade-In Allowance on your used (factory-built) communication equipment. For fast action use the convenient coupon to tell us what you have to trade and to indicate your choice in new equipment. Don't delay. Get your trade-in deal working today!

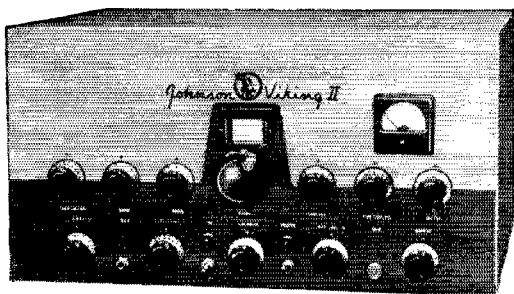

JOHNSON VIKING II TRANSMITTER KIT. Complete with tubes. Shpg. wt. 85 lbs. Only \$279.50
JOHNSON VIKING II Wired and tested. Only \$336.50



NATIONAL HRO-60T
 Less spkr. Shpg. wt. 90 lbs.
 Only \$483.50

Send for your copy today

All prices f. o. b. St. Louis
 Phone CHEstnut 1125

Walter Ashe
RADIO CO.
 1125 PINE ST. • ST. LOUIS 1, MO.

FREE CATALOG!

WALTER ASHE RADIO COMPANY
 1125 Pine St., St. Louis 1, Missouri

Q-53-2

Rush "Surprise" Trade-In offer on my _____
 for _____
 (show make and model number of new equipment desired)
 Send new 1953 catalog.

Name _____

Address _____

City _____ Zone _____ State _____

DX

Announces
a NEW 90° YOKE
for 27" TUBES

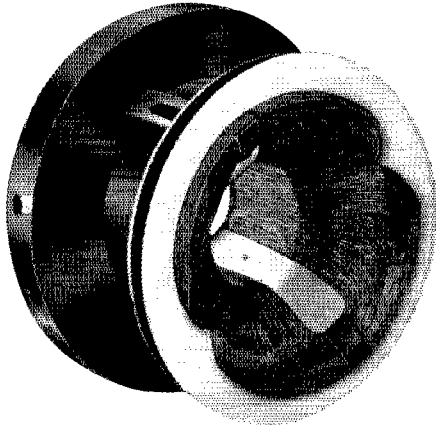

It's Engineered for
TOP PERFORMANCE
... in Production NOW!

This new DX 90° Deflection Yoke has everything a television receiver manufacturer wants . . . a sharp full-screen focus, a minimum of pincushioning, the ultimate in compactness and a price that's downright attractive. Because this yoke has been brilliantly designed for mass production on DX's specialized equipment, it warrants immediate consideration in your 27" receiver plans. Write us today.

DEFLECTION YOKES . . . TOROID COILS . . .

I. F. TRANSFORMERS . . . DISCRIMINATORS . . .

SPEAKERS . . . R. F. COILS . . .

TV TUNERS . . . CRYSTALS

ION TRAPS . . . TRANSFORMERS



DX RADIO PRODUCTS CO.

GENERAL OFFICES: 2300 W. ARMITAGE AVE., CHICAGO 47, ILL.

ONTARIO DIVISION

ONTARIO — SCM, G. Eric Farquhar, VE3IA — It is with deep regret we record the passing of Wes Mitchell, of Brantford. His call, BA, however, is still with us as it was a case in which two brothers were assigned the same identifying signal. Appointments for the month include BSW as OO, EAB as OES, DOC as EC for Fergus. It would be appreciated if holders of ARRL appointments would check the date of their last endorsement. Please let's hear whether reinstatement or cancellation is desired. ATR has been elected manager of OSN. TO moved to London. DFA, DFC, and NG now are Class A. Recent three-letter to two-letter call changes include EAD to GJ, BVC to HE, DBU to HZ. The Ontario Forty Meter Net, now operating on 7285 kc., solicits your traffic for Northern Quebec, Maritimes, and the West Coast. AHO, BJV, and IA were seen roaming among the cattle and horses at the winter fair. Hamilton Club members were treated to a splendid talk and demonstration on "Pulse Techniques in Radar and Television" through the courtesy of RCAF, Clinton. AVS reports four hams-to-be working on tickets. BSW, active on 3.5 and 7 Mc., reports bags of DX. The Mohawk Club now is settled in newly-acquired quarters. AFO with 33-ft. vertical atop a 35-ft. windmill tower, consults Beaufort's scale every time a blow comes up. Good luck to KF, with 31 countries and 5 continents on 21 Mc. to his credit. OW is heard on 21 Mc. Ottawa Club election results are as follows: BFW, pres.; CAX, vice-pres.; LX, secy.; DY, treas. CMW, technical adviser, solicits your problems. The 6-meter gang at Ottawa held an S.E.T., and escorted CSD to the train depot as part of the exercise. Glad to hear IB getting around after being hospitalized. The Ottawa boys set up receiving facilities and helped to make the load lighter for him. Traffic: (Nov.) VE3WY 238, ATR 181, BUR 129, IA 85, EAM 80, DGZ 67, BJV 42, NG 40, EAU 34, KM 33, CP 25, AJR 24, BSF 20, DU 18, DOC 12, DFE 4. (Oct.) VE3NG 30, DQA 4.

QUEBEC DIVISION

QUEBEC — SCM, Gordon A. Lynn, VE2GL — WW has worked 48 countries on 21 Mc. BB and ADK are building new rigs with 813. BK has TVI in his own TV set from his own rig and is running it down but finds time for AREC demonstration from his car with IS and BB and other members of the Lakeshore Emergency group, with portable rig set up in the church hall. BK also has new ground plane erected for 21 Mc. NI is working on 144-Mc. converter. EC reports the St. Maurice Valley gang is doing lots of rag-chewing on the air but that TVI has them all worried, as they are in the outer fringe area! AEM, AGU, AOB, VE, APE, and ZG continue active on 75-meter 'phone in that area. DR took part in the SS Contest and skeds QEN each Sunday. CA reports he still is QRL work but that Phyl is holding the fort with northern skeds and handling considerable traffic. CK specializes on the southern route, handling traffic with the West Indies. AHQ has new Eddystone receiver. SU gave a very interesting and informative talk on TVI and the means of preventing it at the November meeting of the MARC. AMB is conducting slow-speed net, QSS, on 3570 kc. Tues. and Thurs. at 7 p.m. and invites participation. This is of particular interest to beginners and those who wish to improve their code speed. Traffic: VE2AMB 79 CA 65, EC 15, LO 10, DR 8, GL 6, NI 4.

VANALTA DIVISION

BRITISH COLUMBIA — SCM, Wilf Moorhouse, VE7US — Very little written news was received this month from British Columbia hams. Guess that our 1100 amateurs never do anything worth writing about, judging from activity. YM is on 2 meters every night with converter from Feb. '50 QST. DH sends news from Nanaimo concerning VE7s UB, BF, AQS, ASB, AHF, AQB, and SH in that area. AV mobiles 750 miles with 11 watts input. The three B.C. nets are re-registered for another year. All ECs except 7ANK are reissued for 1953 and endorsement has been filed with ARRL in writing by the SEC. TM is rebuilding to remove a bug (TVD). We regret to report the death of GY. A late report was received from YE, EC for his area. AREC is registered with all the agencies and the ECs' names and addresses have been provided. JB is busy in TV. The minutes of the BCARA was received by the SCM. Amateurs are welcome to join c.d. but AREC is a separate group of amateurs. The two will be kept as such, with AREC of, by, and for the amateur. QC reports a traffic total of 139. He is an ORS, OO, and EC. AKI is very QRL. KC sends in a report at last. CX reports added hams in Alberni districts. Parksville Area reports new hams in training. Will all amateurs please note that the 1st of the month is the deadline for monthly reports. The SCM must file his report postmarked not later than the 7th of each month. Traffic: VE7QC 139, DH 25.

PRAIRIE DIVISION

MANITOBA — SCM, A. W. Morley, VE4AM — Acting SCM, Len Cuff, VE4LC. Because of the illness of your SCM I will endeavour to carry on for him this month. We all wish Art a speedy recovery. FD has been endorsed for
(Continued on page 116)

HARRISON

Points the Way to
Increased Selectivity... Better QSO's
with Single Sideband



MILLEN AUDIO PHASE SHIFT NETWORK

Precision, 90-degree differential phase shift unit for use in receiving or transmitting service (see Oct. 1952 QST). ± 1.3 degrees over range of 225 to 2750 cycles. Contains two independent networks, precisely-adjusted and sealed at the factory. No readjustments necessary. A single sideband transmitter using this unit will have 40 db suppression of the unwanted sideband. Completely shielded can is 7/16 x 2 x 4" and mounts like an IF transformer. SSB transmitter with phase shift network is no more difficult to construct and start operating than simple conventional transmitter. With schematic and mounting dimensions. MILLEN No. 75012.....\$7.50

MILLEN No. 75011 SSB PHASING NETWORK. Single unit complete with wired tube circuits. Uses four 12A7's. Less Tubes.....\$38.40

ELDICO SSB TRANSMITTER-EXCITER

Here is practical single sideband at an amazingly low cost! A complete 6-tube, 5-watt SSB transmitter available in wired or kit form. Each kit is complete with all parts, punched chassis, cabinet, tubes, power supply and full instructions for assembly and operation. It's no more difficult to construct and adjust than any simple transmitter because the audio phase-shift network is laboratory assembled and adjusted. The transmitter provides 40 db sideband suppression by using a simplified phasing method which requires only standard components and no special technical skills. Can also be used as a driver for a high power linear amplifier or in conjunction with a VFO. Tubes: 12AU7 speech amplifier-oscillator, 12AT7 twin-channel amplifier, 6AG7 final, 12A77 speech preamplifier, 6H6 bias, and 5Y3GT rectifier.

ELDICO SSB Jr. TRANSMITTER-EXCITER KIT.....\$ 79.95
Same as above factory wired and tested.....\$129.95

Top Professional Gear for Amateurs

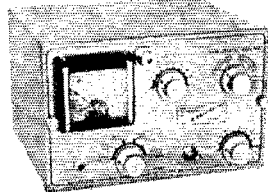

NEW BABCOCK 6-BAND BAND SWITCHING TRANSMITTER

All band changing and frequency changing (including antenna switching) handled by one switch... a "flick of the wrist" selects your band! Input 35-50 watts. Covers all ham bands—80 to 10 meters. Crystals located inside transmitter. Tubes: 6AQ5 oscillator-multiplier, 6146 straight amplifier, 12AU7 PP driver, 2-6AQ5 class AB modulators with automatic speech compression and clipping. Complete metering, even RF output wattage. Push-talk antenna and receiver relay. With tubes, plugs and instruction manual. Excellent for either mobile or home station use. Only 5 x 8 x 7" D. Weight 9 lbs. ORDER NOW!

BABCOCK MT5A TRANSMITTER.....\$99.50
6V. DC Power Supply—P54A.....\$67.50
115V. AC Power Supply—P51B.....\$44.95
LS1 Two-band antenna tuning unit \$15.00

NEW COLLINS 75A-3 RECEIVER

Featuring Sensational New
Collins Mechanical IF Filter

Gives a practically straight-side, flat-topped selectivity curve! Greatly improved signal-to-noise ratio. Plug-in provision for two mechanical filters. 3 kc filter used as standard equipment. 1 kc plug-in unit available as optional accessory for even greater selectivity on CW. Other proven features of 75A-2, such as crystal controlled front-end, highly stable VFO, accurate dial calibration, etc., have been retained. Here's a natural for the single sideband operator!

COLLINS 75A-3. With Speaker....\$550.00
1 kc mechanical filter.....\$ 75.00
8R-1 plug-in crystal calibrator....\$ 25.00
148C-1 plug-in NBFM adapter....\$ 22.50

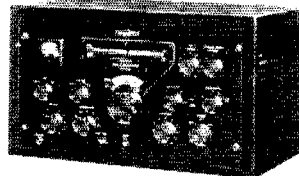

75A-2 OWNERS!

We can have the factory install the new 3 kc mechanical filter in your receiver. The charge is \$125, and also includes minor adjustments and complete realignment. Ask us for details.

HARRISON IS YOUR
AUTHORIZED COLLINS DISTRIBUTOR

Latest COLLINS 32V-3 XMITTER

The most wanted of all medium powered transmitters! With added TVI suppression features. Compact, VFO controlled, gang-tuned unit with complete bandswitching. 150 watts input on CW, 120 watts input on phone. Covers 80, 40, 20, 15, 11 and 10 meter bands. Permeability tuned circuits. Audio distortion less than 8% at 90% modulation with 1000 cps input.
COLLINS 32V-3 TRANSMITTER — With Tubes\$775.00

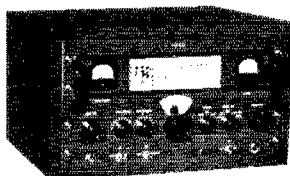

Ham Headquarters Since 1925!



HARRISON

RADIO CORPORATION

225 Greenwich St. • N. Y. 7, N. Y.
Barclay 7-7777

JAMAICA BRANCH: Hillside Ave. at 172nd St.

HARRISON HAS IT!

Complete Stocks...
Fast, Friendly Service
Lowest Prices

FREE! HARRISON HAM-A-LOG

Includes New Gear,
articles, bargains, ham
kinks, etc.
Write today for your
free copy.

LICENSE

MANUAL



typical questions and answers
plus — license data and complete study guides for all amateur exams —

Novice

Technician

Conditional

General

Extra-Class

50¢ postpaid

The American Radio Relay League

West Hartford 7, Conn.

'phone. RB renewed his OO appointment for another year. HL has taken over ORS and has been appointed RML. JQ now is EC for the Minnedosa district. MX will be NCS for Monday evenings. RP has been appointed to represent the Amateur Radio League of Manitoba (Inc.) on the Amateur Committee of the Provincial Civil Defense Communications Committee. JY was presented with a Life Membership in the ARL of M. at its November meeting. TN would appreciate donations of parts for his Boy Scout club which he has recently formed. RT has been promoted and will be leaving shortly for VE3-Land. 1953 officers of the Amateur Radio League of Manitoba are SE, pres.; NI, vice-pres.; DP, secy.; LC, treas. In response to inquiries, a c.w. net will be set up if enough of you make application to the SCM. Also we still can use a few more active stations on the 'phone net. Traffic: VE4HL 102, ER 16, AM 5, JY 3, LC 2.

SASKATCHEWAN — SCM, Harold R. Horn, VE5HR. — Not many reports were received this month, fellows. Please forward news of your doings for this report. Trunk Line "I" made a start and so far has been able to do quite well. TE says a c.w. net is tough to get going and needs members. QL rebuilt his rig and TVied it and says it does wonders for BCI, too. He now runs 325 watts to an 813. FA has a new NC-183D. Our sympathy to IC and his XYL on the passing of her father. SL and RU are heard regularly on 80-meter c.w. 78J is back at home, while EV underwent a serious operation and will be QRT for some time. We all wish you a speedy return. Len. RH has been transferred to Claresholm with a VE6 call. Are you interested in your call for car license plates? If so, let GI know immediately as a brief is being prepared to present to the government. Congratulations to DZ and his XYL, GW, on the new addition to the family. FS received federal nomination for CCF Melfort-Humboldt Constituency. Good luck, Alex. LU is going to try a vertical for 75 meters. It would be a big help if stations watched net frequencies and times and kept the channels clear. Traffic: VE5HR 42, TE 14, QL 7, GO 4, LU 4.

Correspondence

(Continued from page 56)

DISINTEREST

Kellogg Star Rte.
Oakland, Oregon

Editor, *QST*:

I just want to mention how disappointed I was to learn how many hams in the W7 area did not even read the part "It Seems To Us" in *QST* regarding the FCC plans for our bands. At least twenty worked by me never had time, or just didn't notice the item.

— John E. Barrett, W7PXS

SPURIOUS RESPONSES

220 James St.
Scotia 2, N. Y.

Editor, *QST*:

Re the current Quist Quiz . . . with rare exceptions the number of spurious responses present in superheterodyne receivers is astonishing. If f is the r.f. frequency, f_0 the local oscillator, and f_1 the i.f., some of the responses which can be found are

$$\begin{aligned} f_0 \pm f_1 \\ f_0 \pm 2f_1 \\ f_0 \pm 3f_1 \text{ etc.} \\ 2f_0 \pm f_1 \\ 2f_0 \pm 2f_1 \text{ etc.} \\ f \pm nf_0 \pm nf_1 \\ nf \pm nf_0 \pm nf_1 \text{ etc., where } n \text{ is any} \end{aligned}$$

integer.

— R. P. Haviland, W2JDA

REMEMBER?

Wilson Avenue
South Norwalk, Conn.

Editor, *QST*:

Your editorial, "History In The Making," November issue, is about the nicest thing that's happened to me in a long time. And what a flood of memories it recalls! For, despite the depression, that was an exciting era in amateur radio — and *QST* was its chronicle. The "new" regulations of the Federal Radio Commission (pre-FCC) imposing near-impossible transmitter stability requirements had begot ARRL's highly successful Technical Development Program

(Continued on page 118)

**NEW! FOR REMOTE CONTROL!
ROTARY, SOLENOID-OPERATED
6V DC MULTI-CIRCUIT
WAFER SWITCH!**

REG. \$7.25

\$3.95

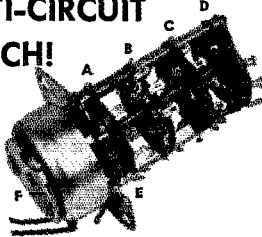

NO NEED TO MOUNT XMTR. UNDER DASH!

Wonder solenoid that obsoletes manual switching. Remote selection of crystals, band changing, audio circuits, antenna switching etc. Solenoid (F) produces a rotary motion (from 6V DC source), transmitting this motion to rotor shaft of 4 gang wafer switch by novel ratchet mechanism, advancing switch. Cam-operated interrupter switch (E) attached to wafer (A) opens when solenoid nears end of stroke, de-energizing solenoid. By combining E and A, either stepping or rotary selective action is achieved. Requires 6V DC @ 10A for .03 seconds. Control wafers: Decks A, B and C are 1 pole 6 pos. Deck D is DPST. Resistance 1/2 ohm DC, 25 degree rotary stroke; 8 lbs./in. torque. Size: 4 1/2 x 2 1/2 x 2 1/2". Shipping weight 1 lb. Pictorial schematic circuits included.

ORDER NO. RE-4519\$3.95



everybody's
going
MOBILE

LOWEST PRICED MOBILE MIKE!

List \$16.50

\$9.70



E-V 208 single button, push-to-talk, high output carbon mike for maximum intelligibility in mobile use. Output: -50 db. Blast-proof, waterproof, shock-resistant. With 5 foot 3 conductor cable. Wt. 3 oz. Order No. Q20-200.

E-V 602 DIFFERENTIAL DYNAMIC

Similar to model 600-D, but close-talking, noise-cancelling differential type. Available in all impedances. 5 ft. cable. Weight 8 oz. Order No. Q20-116\$26.46

E-V 205 DIFFERENTIAL CARBON

Close-talking, noise-cancelling, single button, carbon Mobil-mike. Substantially flat response gives high articulation. Press-to-talk switch. Order No. Q20-130\$20.29

SHURE 101-C CARBON MOBILE MIKE

Push-to-talk, hand-held operation, with mounting bracket. 5' coil-cord. List \$27.50. Order No. Q20-049\$16.17

ASTATIC 10M5 CARBON HAND MIKE

Single button carbon element, moisture and fungus proofed. Press-to-talk DPST(NO) switch. Coil-cord. No. Q20-042\$17.35

NEW MOBILE RADIO HANDBOOK

Latest edition, 184 pages. Order No. Q42-556.....\$2.00

WHEN ORDERING: Please send enough money to cover shipping charges, any overpayment will be promptly returned. COD orders (min. \$4.00) must include 20% down payment.

NOW! CONVENIENT TIME PAYMENT PLAN

10% down, 1 year to pay balance, no interest if account is paid within 60 days. Time pay plan limited to items costing \$45.00 or over.

NEW GONSET "SUPER-SIX" CONVERTER

Replaces Tri-Band. Many added features\$52.50

NEW GONSET SIGNAL SLICER Model 3028

I.F. amplifier increases selectivity to 3.5 kc\$29.95

NEW GONSET CASCADE PREAMPLIFIER

Increases signal-to-noise ratio of 2 meter revrs\$19.95

GONSET 2-METER XMTR-RCVR.

With combination 110V AC and 6V DC power supply. \$189.50

MORROW 6-10-20-40-75 METER CONVERTER

Includes choice of coil for any of above hands.....\$44.05

MALLARD 10-20-75 METER CONVERTER

Covers 27-29.5, 14-14.4 and 8-5.4 megacycles\$52.60

STANCOR ST-203A MOBILE XMTR KIT

Operable from AC or DC power packs, 27-32 mc...\$47.50

ELMAC MOBILE XMTR WITH VFO

VFO or crystal control on 10, 11, 20, 75 meters\$149.00

HARVEY-WELLS BANDMASTER, SR.

Phone or CW. Crystal-VFO-oscillator circuit\$109.37

HARVEY-WELLS BANDMASTER, DELUXE

Similar to above, with built-in pre-amplifier\$134.75

Bandmaster Accessories

DPS-50 Dynamotor6V power supply\$85.75

CMA-50 Mike Pre-amplifier (as in Deluxe)\$21.56

RADIO SHACK

CORPORATION

167 Washington St., Boston 8, Mass.

BECOME A RADIO AMATEUR

LEARN CODE AND THEORY FOR AS LOW AS \$6.95

ECONOMICAL HOME STUDY COURSES PREPARE YOU TO PASS AMATEUR AND COMMERCIAL CODE EXAMS, AND A MATHEUR THEORY EXAMS THE EASY, FAST WAY.

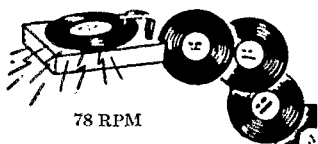

78 RPM

3 "AMECO" COURSES AVAILABLE:

No. 1—NOVICE CODE COURSE. You get and keep 10 recordings (alphabet through 8 W.P.M.). Includes typical F.C.C.-type code exams. Free instruction book on learning how to send and receive code the simplest, fastest way; plus charts to check your receiving accuracy plus an album all for the low price of only \$7.95

No. 2—SENIOR CODE COURSE. You get and keep everything given the Novice Course except that you get 22 recordings (alphabet through 18 W.P.M.), plus typical F. C. C.-type code exams for General class and 2nd class commercial telegraph licenses. All this for only . . . \$12.95

No. 3—COMPLETE RADIO THEORY COURSE. A complete, simplified home study theory course in radio, covering the Novice, Technician, conditional, general, and advanced classes — all under one cover — with nearly four hundred typical F. C. C. type questions to prepare you for license exams. No technical background required. You also get, FREE, one year of consultation and a guide to setting up your ham station. All for the amazingly low price of \$6.95

No. 4—NEW ADVANCED COURSE. Prepares Novice operators for the amateur general class and second class commercial license tests. Contains 12 recordings — (8 through 18 W.P.M.) PLUS the complete code book — PLUS typical FCC code examinations for general and commercial tests. All for only \$6.95

See your dealer. If he does not yet stock Ameco courses, order direct. Free Literature Available. Dept. Q-2

AMERICAN ELECTRONICS CO.
1451 Wilkins Ave., N. Y. 59, N. Y.

Write for information on the NEW
50 Watt AMCO Transmitter!

Founded in 1909

**RADIO TELEPHONY
RADIO TELEGRAPHY
RADAR & TELEVISION**

Courses ranging in length from 7 to 12 months. Dormitory room and board on campus for \$48.00 a month. The college owns KPAC, 5 KW broadcast station with studios located on campus. New students accepted monthly. If interested in radio training necessary to pass F.C.C. examinations for first-class telephone and second-class telegraph licenses, write for details. New: Advanced TV Engineering Course.

PORT ARTHUR COLLEGE PORT ARTHUR TEXAS
Approved for G.I. training

under the late Ross A. Hull's able direction. Receiver audio-frequency selectivity had been a minor product of this program as a sort of auxiliary to remarkably improved transmitter stability, but left unanswered the question, "What's wrong with our c.w. receivers?" (Phone, as a major selectivity problem, was found amenable to the same treatment a little later.) Thus my invention of the variable-selectivity crystal filter and development of the "Single-Signal" receiver of twenty years ago was literally mothered by necessity. The necessity remains and it is, I must admit, especially gratifying to me that the 1932 answer still serves a useful purpose.

Along with the variable-selectivity crystal filter with separate rejection control, the "S.S." receiver also introduced for the first time in a communications receiver electron coupling of the mixer and c.w. beat oscillators, and air-condenser tuned i.f. stages in combination with effective intersectional and over-all shielding. . . .

— James J. Lamb,
Dir. Electronic Research
Remington Rand, Inc.

Single Sideband

(Continued from page 51)

KH6AJH uses a 6AQ5 in the circuit, driving it directly from his balanced modulators, and W6PNT uses an 807 mixer at 500 volts on the plate to drive a 304TTL. W6EPX

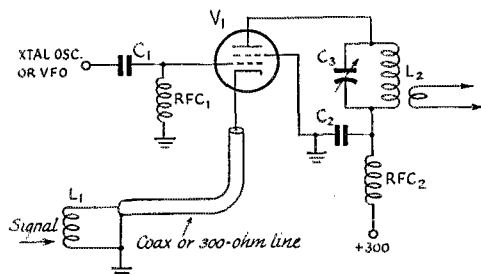

Fig. 2 — This simple high-level mixer/amplifier has been used by W6EDD and others. The heterodyning signal is present at the grid in either amplifier or mixer service — the tuning of the output circuit, L_2C_3 , determines the function.

C_1 — 100 μ fd.

C_2 — 0.001 μ fd.

RFC_1 — 2.5-mh. r.f. choke.

See text for suitable tube types.

uses a 6AQ5 in the circuit in his all-band mobile rig. Successful tubes other than those already mentioned include the 2E26 and the 6AR6.

Dual Oscilloscope Connection

W2NJR points out that it is often desirable to have a 'scope connected to a transmitter (for monitoring) and also

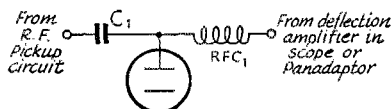

Fig. 3 — W2NJR uses this simple circuit to connect (without switching) the vertical deflection plates of his oscilloscope to the transmitter and receiver.

C_1 — 100 μ fd.

RFC_1 — 2.5-mh. r.f. choke.

have the 'scope available for use with a panoramic adapter or just the audio output of a receiver. He passes along the simple circuit of Fig. 3, which will permit such operation. You don't want any receiver or panoramic-adapter output when the transmitter is on, of course, or the pattern may become a trifle baffling. — B. G.

See NEWARK! For "Up to the Minute" HAM EQUIPMENT

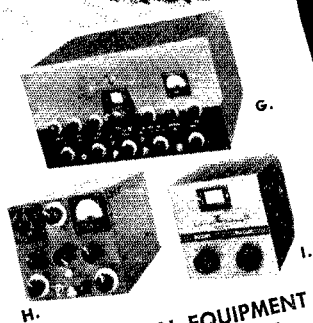

E. F. JOHNSON EQUIPMENT
VIKING II TRANSMITTER KIT
 Fig. G. New version of the Viking I band-switching 100-watt phone/115 watt CW amateur transmitter kit. Incorporates all features of its predecessor plus TVI suppression. Full output is available on the 160, 80, 40, 20, 15 and 11 and 10 meter Amateur bands. With tubes, cabinet, punched chassis, wiring harness, wire hardware and detailed instructions. For 110-120 volts, 50-60 cycles. Shpg. wt., 91 lbs.
279.50
97F455. NET

VIKING MOBILE TRANSMITTER KIT
 Fig. H. Provides up to 60 watts on 75, 20 and 10 meter phone. Complete band-switching, with provision for one additional band, with crystal selector switch, with 4-position for external VFO. Requires 600 volts DC at 200 ma and 6.3 volts at 3.75 amps. Size: 6 7/8" x 7 1/8" x 10 1/8". With cabinet, chassis, parts and instructions. Less tubes. Wt., 16 lbs.
99.50
97F454. NET

VIKING VFO KIT
 Fig. I. Companion unit to famous Johnson Viking II Transmitter Kit. May also be used with similar transmitter. Only two controls; frequency control and bandswitch. Cabinet, 7 1/8" x 6 1/8" x 6 1/8". With all parts, plugs, cables, and instructions; less tubes. 7 lbs.
42.75
97F451. NET

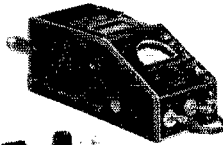

MILLEN 90651 GRID DIP METER
 Fig. A. Accurate measuring instrument using calibrated RF oscillator principle. 2" G.E. meter reads oscillator grid current. Most commonly used to find resonant frequency of non-energized tuned circuits. Other valuable uses include receiver tuned circuit alignment. Range: 1.7 to 300 mc, in 7 overlapping bands; separate plug-in coils for each. Calibrated 270° dial has 7 direct-reading, one universal scale, 7 x 3 1/8" x 3 3/8". For 105-125 volts, 50-60 cycles. With coil rack, 7 coils and tube. Shpg. wt., 3 1/2 lbs.
61.50
97F208. NET



MEISSNER MODEL 2-CW NOVICE TRANSMITTER KIT
 Fig. B. Transmitter kit for the new novice class. Operate as transmitter with folded dipole antenna. 20 to 25 watts input. Terminal strip at rear of chassis for metering plate current. Size: 6 3/4" x 10 1/8" x 7 1/8". With 80 meter coil, punched chassis, all parts and instructions; less crystal and tubes. For 110-120 volts, 60 cycles AC. Wt., 7 1/4 lbs.
24.45
97F602. NET



GONSET AMATEUR EQUIPMENT
3016 "COMMANDER" TRANSMITTER
 Fig. C. Multi-band transmitter covering 1.7 to 54 mc continuous. Power requirements: 300 volts DC at 200-225 ma (phone) and 6.3 volts AC or DC at 3.15 amp. 35 watts input on phone. 50 watts on CW. Provision for all conventional feed lines. Tubes: 6AG7, 6146, 12AT7, 2-6AQ5. With tubes and two high Q final tank coils for 10-11, 15, 20, 40, 75 and 80 meters. Final coils for other frequencies available on special order. 8 lbs.
124.50
97F111. NET



2 Meter Converter
 Fig. D. 2 Meter Converter. For fixed or mobile stations. Super bandwidth has twenty main tuning dial divisions for 144-146 mc as well as 146-148 mc. Output, 1 mc. Tubes: 6CB6, 12AT7, OB2. In gray case, 5 1/8" x 3 1/2" x 5 1/4". Shpg. wt., 5 lbs.
44.50
97F110. NET



Clipper Noise Limiter
 Fig. E. Clipper Noise Limiter. Reduces interference from ignition noise, power leaks, electric razors, etc. Uses a 9000 tube. Mounts in any receiver in which second detector and first audio is in one tube. With instructions and cables. 2 1/4" x 1 1/2". Wt., 2 lbs.
9.24
97F104. NET

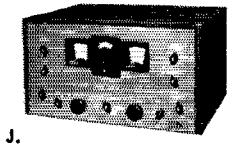

HAMMARLUND HQ-129X POPULAR AMATEUR RECEIVER
 Fig. J. Representative of Hammarlund's precision craftsmanship, the model HQ-129X incorporates many outstanding features, such as high sensitivity, selectivity, and efficiency at high frequencies, plus an excellent automatic noise limiter. Provides continuous frequency coverage from 540 kc to 31 mc in 6 ranges, with calibrated main tuning dial and a special tuning condenser which permits full 310 degrees of bandwidth for each Amateur band—80, 40, 20 and 10 meters. Shpg. wt., 75 lbs.
239.50
97F400. NET

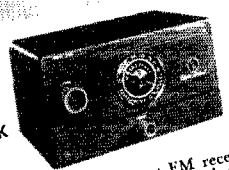

hallicrafters
CIVIL PATROL MODELS S-81 AND S-82
 Fig. K. Compact new FM receivers covering police, fire, taxicab, truck, railroad, and other industrial frequencies. May also be used as stationary receivers or monitors in conjunction with the "Little-Tone" systems. Have illuminated circular dial with main channels marked. Circuit: 12AT7, 2-12BA6, 12AL5, 12SO7 and 30L6GT. Include selenium rectifier, headphone jack, and built-in PM speaker. Black wrinkle-finish steel cabinets, 12 1/8" x 7 1/4". For 105-125 volts, AC or DC. Shpg. wt., 14 lbs.
49.50
98F017. Model S-81. Covers 152-173 mc. NET EACH
98F018. Model S-82. Covers 30-50 mc.

Write to Department T-23

Just Out!
NEWARKS NEW CATALOG NO. 55

FREE!

196 Pages of the Latest Releases in Radio,
 TV, Industrial Electronics and High Fidelity.

NEWARK
 ELECTRIC COMPANY

223 W. MADISON ST. CHICAGO 6, ILL.

ATTENTION MOBILE HAMS

Complete mobile package — nothing else to buy. Outstanding mobile signals use motorola equipment — backed by years of communication equipment experience — World's largest producer of 2-way mobile equipment.

A mobile transmitter with a double feature FM or AM at flip of the switch, the MOTOROLA FMT-30-DMS (27-30 MC.)... **\$130.00**

P-7253 spring base rear — mount antenna **\$23.13**
New Gon-set Tri-Band Spread Converter... **\$47.60**

MOTOROLA P-69-13 or 18-ARS receiver with special noise limiter for use with any converter having 1440-3000 KC..... **\$60.00**

3—30 famous Gon-set converter complete to connect to the P-69-13 or 18-ARS receiver. **\$44.75**
P-327-E Fire wall loud speaker.... **\$7.50**

The above comes complete with all necessary accessories and mounting hardware. Order direct or through the Motorola National Service Organization member in your area.

NOTE: This Receiver and Transmitter is equipment which has been returned from the field, modified and rebuilt for Amateur Service.

For further information write to:
MOTOROLA INC.
Amateur Sales Dept. QST — February
1327 W. Washington Blvd. Chicago 7, Illinois
Attention: Harry Harrison, W9LXX, Tel. Taylor 9-2200 Ext. 161

MORE SIGNALS PER DOLLAR
From Money Invested in an Antenna

Self Supporting
STEEL TOWERS
For Rotary Beams, FM, TV

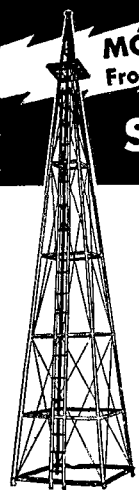

ATTRACTIVE—NO GUY WIRES!

- 4-Post Construction for Greater Strength!
- Galvanized Steel—Will Last A Lifetime
- SAFE—Ladder to Top Platform
- COMPLETE—Ready to Assemble
- Easy to Erect or Move
- Withstands Heaviest Winds

Pay Only 1/3 Down!
12 EASY MONTHLY PAYMENTS
Freight Charges May Be Included in Financing

Width of Base Equal to 1/5 Height

Vesto Towers are available in a wide range of sizes to meet requirements of amateurs and commercial users alike. Note the low prices for these quality lifetime towers: 22'—\$94.75, 28'—\$115.75, 33'—\$135.75, 39'—\$157.75, 44'—\$178.75, 50'—

\$217.75, 61'—\$279.75, 100'—\$1060.00. Towers are shipped to your home knocked down, FOB Kansas City, Mo. 4th class freight. Prices subject to change... so order now! Send check or money order... or write for free information.

WRITE TODAY FOR COMPLETE FREE INFORMATION AND PHOTOGRAPHS

VESTO CO., Inc.
20th and Clay
North Kansas City, Mo.

A.R.R.L. ACTIVITIES CALENDAR

- Feb. 6th-8th: DX Competition (phone)
- Feb. 8th: CP Qualifying Run — W6OWP
- Feb. 11th: Frequency Measuring Test
- Feb. 17th: CP Qualifying Run — W1AW
- Feb. 20th-22nd: DX Competition (phone)
- Mar. 6th-8th: DX Competition (c.w.)
- Mar. 13th: CP Qualifying Run — W6OWP
- Mar. 18th: CP Qualifying Run — W1AW
- Mar. 20th-22nd: DX Competition (c.w.)
- Apr. 3rd: CP Qualifying Run — W6OWP
- Apr. 11th-12th: CD QSO Party (c.w.)
- Apr. 16th: CP Qualifying Run — W1AW
- Apr. 18th-19th: CD QSO Party (phone)
- May 9th: CP Qualifying Run — W6OWP
- May 15th: CP Qualifying Run — W1AW
- June 6th-7th: V.H.F. Contest
- June 7th: CP Qualifying Run — W6OWP
- June 15th: CP Qualifying Run — W1AW

The "Ultimatic"

(Continued from page 16)

LM11 would eliminate this adjustment which, incidentally, is the only one required other than setting up the mark-space ratio and the top speed.

With an ohmmeter connected to the output, R_5 is twisted for midscale reading on dots. It will read $\frac{1}{4}$ scale on dashes. The mark-space ratio holds within 2 per cent from 1 to 75 w.p.m. With 0.001-inch armature travel, the variation is 0.5 per cent, but with such small travel the relay current range is reduced from 1 to 0.25 ma., resulting in unstable operation if the line voltage varies more than ± 10 per cent. With 0.008-inch travel, the circuit is stable from 90 to 140 volts.

A value of 0.27 megohm at R_3 gives a speed range of 4 to 75 w.p.m. when R_5 is set for 50-50 mark-space. R_5 affects the top speed considerably. When a distorted mark-space ratio is set up to compensate for distortion in connected equipment, R_3 must be readjusted for the desired top speed.

Operating the Keyer

A detailed study of Fig. 1, with contemplation of what occurs when the key is closed at times other than those shown in the first line, will greatly help in getting the hang of the Ultimatic. At first, the speed should be set at minimum (or lowered to a fraction of a w.p.m. by shunting C_2 with 0.25 μ f.) and games played on the knob. Rip off a 50-w.p.m. "A" before the dot shows up in the output, or an "N" before the dash appears, and listen to the stuff drag out while you fumble for smokes with the sending hand. Make a "K" by holding the dash side until the output starts, and then add the rest with the quickest flips possible. Convert it to a "C" as soon as you hear the dot, or anytime during the second dash. Make a "Y" by flipping dash-dot and immediately lay on the dashes (all before the first dash starts). The entire letter comes out while the key

(Continued on page 122)

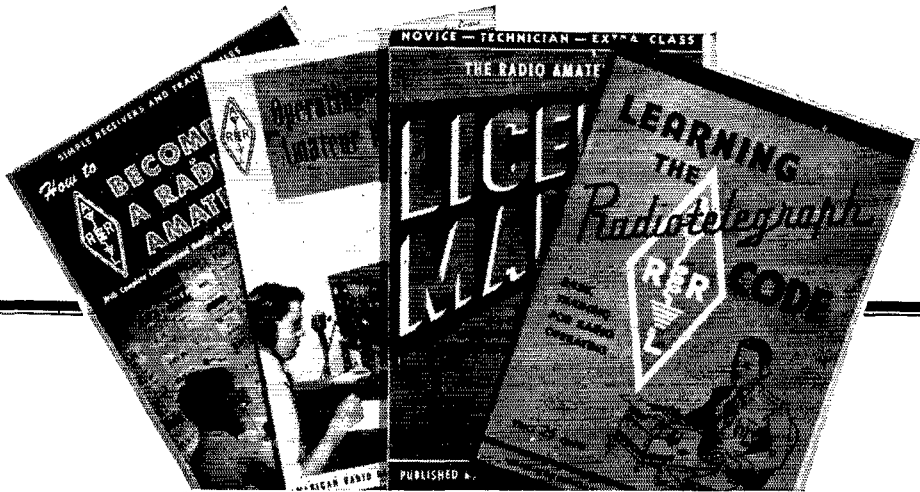

Your Gateway to Amateur Radio!

- ★ HOW TO BECOME A RADIO AMATEUR
- ★ THE RADIO AMATEUR'S LICENSE MANUAL
- ★ LEARNING THE RADIOTELEGRAPH CODE
- ★ OPERATING AN AMATEUR RADIO STATION

Anyone starting out in amateur radio will find these publications a necessary part of his reading and studying for the coveted amateur radio operator's ticket. Written in clear, concise language, they help point the way for the beginner. Tried and proven by thousands upon thousands of amateurs, these ARRL publications are truly the "Gateway to Amateur Radio".

Attractively packaged with a bright yellow band, they make an ideal gift for the newcomer.

Available at your dealer

\$1.25

The American Radio Relay League, Inc.—West Hartford, Connecticut

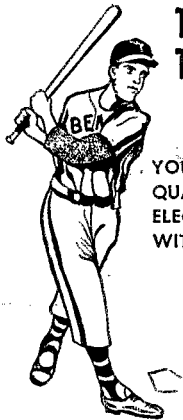

TURN "PRO" WITH THE "BIG" LEAGUE

... And you'll bat 1.000!!

YOUR AMATEUR EXPERIENCE MAY QUALIFY YOU FOR A HIGH-PAYING ELECTRONICS OR RADIO POSITION WITH BENDIX RADIO.

- TECHNICAL WRITERS AND TRAINEES
- COMPONENTS ENGINEERING TRAINEES
- LAB TECHNICIANS

We have openings in excellent positions which carry engineering responsibility. If you have a good background of practical experience, you need not have a degree.

Write, Wire or Phone MR. E. O. COLE Dept. L

Bendix Radio

DIVISION OF BENDIX AVIATION CORPORATION
BALTIMORE-4, MD. Phone: TOWSON 2200

Makers of the World's Finest Electronic Equipment

is held to dashes. Reverse this for an "L." These initial practices will check operation of all the circuits.

Then, with the speed set at 10 to 15 w.p.m., key at various (and varying) speeds. It will be found that the hand can move, on the average, somewhat slower than the output or a great deal faster. As the speed control is slowly advanced there will appear an abrupt point at which the output goes completely to pot. At this speed, determine whether the hand is *averaging* too slow or too fast. A few hours of operation, always just below the break-up speed, will acquaint the fist with the memory leeway effect, and the speed of easy perfect sending will climb and climb. In the meantime, what would ordinarily be drudgery is pure pleasure listening to the beautiful stuff coming out. Practice preferably from written copy.

Thirty-w.p.m. top-speeders have made it to 50 in a couple of weeks,³ with far less concentration than originally. The quality won't be indifferent or just good—it will be perfect. Now we can all sound like WCX.

³ But not without being able to copy 50 in the first place! — Ed.

Clapp Oscillator

(Continued from page 21)

have been a result of the increased current brought about by the by-passing effect of the coaxial cables. In his final circuit arrangement, the majority of the circulating current has been confined to the remote control box by placing the lumped capacitance of the feed-back condensers in that position, so that any losses in the coaxial cables should have been reduced.

In closing, here's hoping I'll be seeing you on 7023 kc. some time. Yes, I'm "rock bound," but not for long (I hope) now that I know where to look for some of the bugs that are going to arise when I build that new Clapp VFO oscillator!

Appendix

Suppose that an r.f. current, i_1 , is flowing around the circuit in the direction shown. The voltage developed across the terminals 1-1, is equal to $i_1 Z_1$, that is,

$$e_1 = i_1 \left[R + j \left(\omega L_1 - \frac{1}{\omega C_1} \right) \right]$$

Consider now the voltage developed across the feed-back condensers across the terminals 2-2. Let the plate current be $i_2 = g_m e_g = g_m (i_1 j X_2)$. The voltage developed across the feed-back condensers will be the sum of the voltages produced by the two currents which are flowing.

$$\begin{aligned} \text{That is, } e_2 &= i_1 (j X_2 + j X_3) + i_2 j X_3 \\ &= i_1 j (X_2 + X_3) - (g_m i_1 X_2) X_3 \\ &= i_1 \left[-g_m X_2 X_3 + j (X_2 + X_3) \right] \end{aligned}$$

If the two voltages we have found above are
(Continued on page 124)

Yours..
FREE!

New,
130-page
Illustrated

TERMINAL'S AUDIO CATALOG

Your complete guide to the
Finest in Audio Equipment!

Write or come in for your
FREE Complimentary Copy!

Visit our Audio Dept.
Open Thurs. eves. till 9 P. M.
Ample Parking Space after 6 P. M.

Terminal Radio Corp.
85 Cortlandt St., New York 7

LOOK STEINBERGS LOOK

IMMEDIATE DELIVERY

Single Sideband Exciter SS-75

"Sideband" is sweeping the country... progressive amateurs are going SSSC by the hundreds... and one night spent in listening to a "sideband" QSO will impress you with the terrific "punch" carried by this method of operation—voice control, fast break-in, no heterodynes, the sharpness of tuning... it really "gets the signal through".

Here's single sideband with all the headaches removed. The SS-75 has been field-tested for over a year and is a complete self-contained, factory aligned single sideband transmitter-exciter, designed for operational ease, reliability of performance, freedom from maintenance problems, ready to transmit a high quality SSSC phone signal alone, or to drive a Class B linear final to 1 KW input.

Check these specifications and you'll see why the SS-75 is now the one piece of equipment that places all the advantages of single sideband at your finger tips:

- ★ Built-in stable VFO, with voltage regulation.
- ★ Carrier injection to receiver antenna terminals... tune in SSSC signals the same as AM, no other gadgets necessary.
- ★ Illuminated VFO tuning dial provides 31 inches of band-spread 3800-4000 KC in 4 bands, with 5 to 1 gear reduction.
- ★ Built-in voice control and receiver disabling circuit. Also provides for break-in CW operation.
- ★ Specially designed crystal filter network for maximum stability and reliability.
- ★ Carrier injection to transmitter available for working single sideband WITH CARRIER, for tune-up adjustments, or CW.

A partial list of enthusiastic SS-75 users includes W1BBA, 1BGA, 1NSP, 4AYF, 4CIM, 4PAV, 8AV, 8FWT, 8GYJ, 8JYU, 8VLV, 8WHE, 9ARK, 9ELK, 9GSE. (Refer to By Goodman's article on page 42 Dec. 1952 QST)



- ★ 10 watt output, with additional 807 socket for up to 100 watt operation with external power supply.
- ★ Handsome grey crackle cabinet, chrome trimmed, 20" x 12" x 12". Complete with 12 tubes, including one 807, operating manual.....\$245.00
- Frequency conversion mixer for 20 meters, rack mtg. 3 1/2" x 19" less power supply..... 45.00
- Frequency conversion mixer for 40-20 meters, rack mtg. 3 1/2" x 19" less power supply..... 75.00

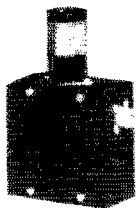

WRIGHT T-R SWITCH

For break-in operation on CW, AM, or SSSC. Use one antenna for transmitting and receiving. It's instantaneous! No moving parts, no power needed to operate. Coax fitting for connections to antenna and receiver. With 75 meter plug-in coil.....\$9.95

Extra coils \$1.75 per band

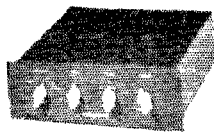

MAYNARD PREAMPLIFIER

Self-powered; 4-position record equalizer plus mike or tuner input; 20 db bass or treble increase or decrease; 3-12AX7, 6X4. Regularly \$62.50.

Limited quantity. \$49.50



PHOSPHOR BRONZE AERIAL

125 ft. of the finest aerial wire obtainable. 42-strand phosphor-bronze with linen center. Will not stretch, very high tensile strength, diameter approximately same as No. 14 copper, very flexible. Excellent for transmitting or receiving antenna, control cable, guy wire. Regular list \$4.95..... 90¢

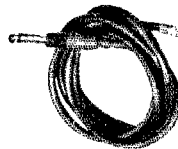

PL-55 PLUG AND CORD

Standard plug with 6 ft. rubber, 2-wire cord with spade lugs..... 85¢

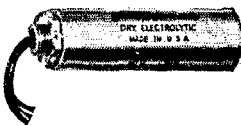

Triple 8 mfd. 450 V. electrolytic upright can condenser, separate negatives, all leads insulated from can. Nationally known mfr. Reg. dealer net \$2.58..... ONLY 59¢

10 for \$5.00



8/8/8 MFD. 500 V. D.C.

Triple 8 mfd. 500 working volt D.C. oil-filled condenser, common negative, solder terminals, hermetically sealed. 5" x 3 3/4" x 2 1/4"..... \$1.95

MINIMUM ORDER \$2.00. Send 20% deposit with COD orders. Please include sufficient postage or instruct us to ship by Express Collect. Overpayment will be refunded by check.

Steinbergs

Phone CHerry 1880

633 WALNUT STREET • CINCINNATI 2, OHIO

Your order will receive my personal attention and will be shipped the same day order is received. We distribute all top-flight amateur lines... let us know what you need.
73, Julie Burnett W8WHE

BUY OF A LIFETIME! TRIED AND PROVEN THE WORLD OVER

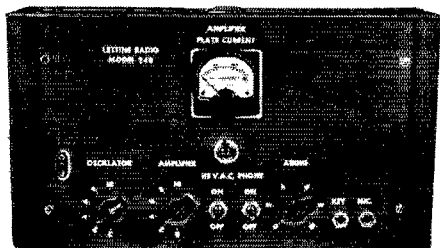

LETITINE MODEL 240 TRANSMITTER WITH MOBILE CONNECTIONS AND A.C. POWER SUPPLY

This outstanding transmitter has been acclaimed a great performer throughout the world. It is excellent for fixed station, portable or mobile operation. Even if you have a transmitter of your own you can't afford to miss this wonderful buy, direct from our factory, ready to operate.

The 240 is a 40 watt Phone-CW rig for 160 to 10 meters, complete with: (8 x 14 x 8) cabinet, self contained A.C. power supply, MOBILE connections, meter, tubes, crystal and coils for 40 meters. Tubes: 6V6 osc., 807 final, 6S17 crystal mike amp., 6N7 phase inverter, 2 6L6's mod., 5U4G rect. Weight 30 lbs. TVI instructions included. 90-day guarantee. Price \$79.95.

\$25 deposit with order — balance C.O.D.
80, 20, 10 meter coils \$2.91 per set. 160 meter coils \$3.60.
Also for CAP, Broadcast, MARS, Marine, State Guard, Novice.

LETITINE RADIO MFG. CO.
62 Berkeley Street Valley Stream, N. Y.

TOWERS by TRYLON

Amateur radio types • Guyed towers for
FM-TV antennas • Vertical radiators • Micro-
wave towers • Commercial communication
towers • Transmission line supports, etc.

Completely fabricated by the most
modern methods by 20-year tower spe-
cialists, Trylon towers offer top value for
any installation—commercial or ama-
teur. Special design and construction
features assure maximum dependability.

Manufactured by
WIND TURBINE COMPANY

WEST - 1143447

HPB-957

124

exactly equal, we have the normal condition for stable oscillations in the circuit. If we equate the two expressions we have found for the voltages and cancel out the term i_1 , since it is common to both sides, we get

$$R + j \left(\omega L_1 - \frac{1}{\omega C_1} \right) = -g_m X_2 X_3 + j(X_2 + X_3).$$

If we equate the real terms in the above expression, we get

$$R = -g_m X_2 X_3. \quad (1)$$

Equating the imaginary terms now,

$$\omega L_1 - \frac{1}{\omega C_1} = \frac{1}{\omega C_2} + \frac{1}{\omega C_3}$$

$$\omega L_1 = \frac{1}{\omega C_1} + \frac{1}{\omega C_2} + \frac{1}{\omega C_3}$$

$$\omega^2 L_1 C_1 = 1 + \frac{C_1}{C_2} + \frac{C_1}{C_3}$$

$$= \frac{1}{2\pi\sqrt{L_1 C_1}} \sqrt{1 + \frac{C_1}{C_2} + \frac{C_1}{C_3}} \quad (2)$$

VFO Rig

(Continued from page 28)

Operation

So far as the antenna is concerned, a coaxial plug may be connected directly to Twin-Lead to a folded dipole; one wire can go to an end-fed Hertz or off-center-fed half-wave antenna; an antenna coupler can be added for feeding a Zepp or the T2FD recently described by the author.³ All varieties of antennas may be used effectively. The author is personally partial to the T2FD, especially since it will radiate on all three of the bands covered by the transmitter.

For operation on 80 meters all stages work straight through. For operation on 40 meters, the VFO frequency is doubled in the 6AG7 buffer-doubler and the 807W operates straight through. For operation on 20 the buffer-doubler remains tuned to 40 and the final 807W doubles to 20 with no apparent loss in output and with no chirp. With c.w. there is no objection to multiplying in the final and the necessity for an additional stage is avoided.

The author does not operate in the 15-meter band but, if output on that band is desired, it may be accomplished in either of two ways. Of course, the band-change switch, S_1 , must be changed to a 4-pole type, and additional taps for the new band brought out. The 807W triples beautifully and, with the VFO on 80, the 6AG7 on 40 and the final tuned to 15, excellent results are obtained. It is also possible to triple in the 6AG7 buffer-doubler and then double in the 807W final. However, this method requires a tap

³ Countryman, "An Experimental All-Band Nondirectional Transmitting Antenna," *QST*, June, 1949, p. 54; Countryman, "Performance of the Terminated Folded Dipole," *CQ*, Nov., 1951, p. 28.

Uncle Dave's Amateur Headquarters!

NATIONALLY ADVERTISED PARTS and ACCESSORIES . . .

Millen grid dip oscillators	\$61.50
Eldico grid dip oscillator kit complete	34.95
Eldico grid dip oscillator kit wired and tested	47.95
Premax three element 10 meter rotary beam	30.00
Hyllite three element 10 meter rotary beam	42.40
Hyllite three element 20 meter rotary beam	64.95
Towers Penn Boiler Thrifttower 30 ft.	28.50
Towers Penn Boiler Thrifttower 40 ft.	33.40
Instructograph code teacher senior model with 10 tapes	24.50
Instructograph code teacher standard model with 5 tapes	17.50
Elmac P5500 ac power supply sec. 6 VDC @ 3 amp 300 V @ 225 ma	39.50
Harvey-Wells APS-50 ac power supply sec. 6 VDC @ 3 amp 325 V @ 225 ma	39.50
Eldico ac power supply sec. 6 VDC 300 VDC @ 200 ma	39.50

Receivers

Hallcrafters S-38C	\$ 49.50
Hallcrafters S-40B	119.95
Hallcrafters S-53A	89.95
Hallcrafters SX-62	299.50
Hallcrafters SX-71	224.50
Hallcrafters SX-73	973.00
Hallcrafters S-76	179.50
Hallcrafters S-77A	119.95
Hallcrafters S-72 portable	109.95
Hallcrafters S-72 longwave portable	119.95
Hallcrafters R46 speaker for Models SX62, SX71, SX73, S76	19.95
Hammarlund HQ-129-X with speaker	254.00
Collins 75A2 with speaker	440.00
Collins 75A3 with speaker	550.00
National HRO-60T with speaker	499.50
National NC-1 83D with speaker	385.50
National NC-125 with speaker	160.50

Bargains

Single button carbon mikes with push-to-talk switch; hand held similar to T-17B (made in England)	\$3.95
J-38 hand transmitting keys	1.29
Sprague Non-inductive (resistors 120 Watt 2500 ohm, 7500 ohm, 10000 ohm, 25000 ohm or 40000 ohm. Each	2.00
.25 mfd. 1000 V condensers either GE 23F158 or 23F47250
15. mfd. 1000 V oil condensers	5.95
10. mfd. 600 V oil condensers	2.25
2. mfd. 1000 V oil condensers	2.95
2. mfd. 2000 V oil condensers	4.25
72 ohm kilowatt twinlead similar to Belden 8210. Per C	5.00
872A tubes	2.65
866A tubes	1.25

Transmitters

Hallcrafters HT-20 less mike or crystal	\$449.50
Eldico TR75 TV wired and tested	94.95
Eldico TR75 TV in kit form	64.95
Eldico TR1 wired and tested	379.95
Eldico TR1 kit form	259.95
EF Johnson Viking I kit with tubes and TVI proof	300.00
EF Johnson Viking II wired and tested	339.50
EF Johnson Viking II kit with tubes	279.50
Elmac A54 low impedance carbon with VFO less mike	139.50
Elmac A54H high impedance crystal with VFO less mike	149.50
Harvey-Wells TBS50C Bandmaster Sr. less mike	111.50
Harvey-Wells TBS50D Bandmaster Deluxe less mike	137.50
Philmore Novice transmitter kit	29.40

Used Equipment

Hallcrafters S-38	\$ 35.00	Collins 75A2 receiver (like new)	\$390.00
Gonset two meter converter (like new)	39.00	Gonset 3-30 converter	29.50
National NC-240D with speaker	215.00	Gonset noise clipper	8.00
Telvar Transmitter 60 Watts phone/CW 10, 20, 40, 80 meter	75.00	RME-70 with DB20 preselector	120.00
Hallcrafters HT-9 transmitter with 40/80/10 meter coils	195.00	HRO-60 with speaker and ABCD coils (like new)	450.00
Harvey-Wells TBS-50A transmitter	80.00	Hallcrafters S-72 (demonstrator—used very little)	107.95
Collins 32V3 transmitter (like new)	700.00	Sonar tri-band receiver (like new)	67.50

Note: Prices Do Not Include Transportation Charges



UNCLE DAVE IS HERE AGAIN W2APF WITH HIS BEST

FORT ORANGE RADIO DISTRIBUTING CO., INC.
904 BROADWAY, ALBANY, NEW YORK, U.S.A.
AMATEUR HEADQUARTERS FOR ALL HAM GEAR



W2APF

DROP US A CARD WITH YOUR NAME-QTH & CALL LETTERS SO WE CAN PLACE YOU ON OUR SPECIAL MAILING LIST... 73.... WATCH OUR AD IN QST

24 HOUR GUARANTEED SERVICE TO ALL AMATEURS

OVER 35 YEARS IN AMATEUR RADIO SERVICE - WITH THE BEST....

Descriptive Catalogue Sheets Sent On Any Items You Request • Send for Our New 1953 Catalogue to Be Out Soon

PRICES DO NOT INCLUDE TRANSPORTATION **LONG DISTANCE PHONE 5-1594**

DOW CO-AX RELAY

FOR 52 OR 72 OHM LINE

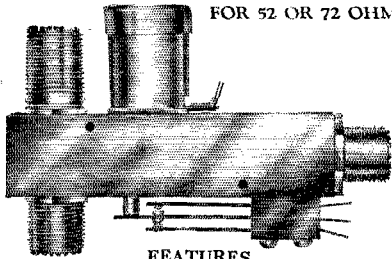

FEATURES

1. Causes negligible change in s.w.r. up to 100 Mc.
2. Handles power up to 1000 watts.
3. Fits standard connectors for co-ax.
4. No chatter. Specially built for "Silent operation".
5. Over-all length $4\frac{1}{2}$ ". Over-all width 3". Note new magnetcover.
6. Externally mounted SPDT switch operated by relay can be used for opening B+ of receiver when transmitting, or for other control purposes. Add to prices below \$1.00.
7. When in transmit position a built-in shorting connector grounds receiver antenna lead. This protects receiver against injury from r.f. and reduces to a minimum the capacity coupling between receiver and relay contacts. Add to prices below, \$1.00.

AC Types (all voltages). Amateur Net. \$10.50
 DC Types (all voltages). Amateur Net. 9.50
 See your distributor, but if he has not yet stocked Dow Co-ax Relays, order now direct from factory. Send check, money order, or will ship C.O.D. Prices are Net, FOB shipping point: Warren, Minn., or Winnipeg and Montreal, Canada.

Dealer Inquiries Invited

THE DOW-KEY CO., INC. Warren Minnesota
 578 Goulding Street
 Winnipeg, Canada

THE DOW-KEY CO. 2310 Wilson Avenue
 Montreal, Canada

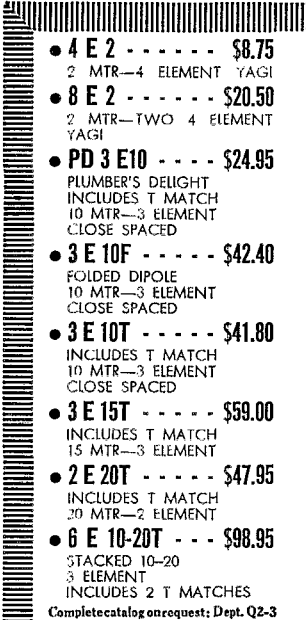

HY-LITE BEAMS
HY-LITE BEAMS
HY-LITE BEAMS
HY-LITE BEAMS
HY-LITE BEAMS
HY-LITE BEAMS

- 4 E 2 \$8.75
2 MTR—4 ELEMENT YAGI
- 8 E 2 \$20.50
2 MTR—TWO 4 ELEMENT YAGI
- PD 3 E10 \$24.95
PLUMBER'S DELIGHT
INCLUDES T MATCH
10 MTR—3 ELEMENT
CLOSE SPACED
- 3 E 10F \$42.40
FOLDED DIPOLE
10 MTR—3 ELEMENT
CLOSE SPACED
- 3 E 10T \$41.80
INCLUDES T MATCH
10 MTR—3 ELEMENT
CLOSE SPACED
- 3 E 15T \$59.00
INCLUDES T MATCH
15 MTR—3 ELEMENT
- 2 E 20T \$47.95
INCLUDES T MATCH
20 MTR—2 ELEMENT
- 6 E 10-20T \$98.95
STACKED 10-20
3 ELEMENT
INCLUDES 2 T MATCHES

Complete catalog on request; Dept. Q2-3

HY-LITE Antennae INC
 Makers of Fine Antennas for AMATEUR · FM · TELEVISION
 241 EAST 137th ST., N. Y. C. 51, N. Y.

on the 6AG7 tank coil to reduce its inductance. Either method is effective.

Because of the low *C* used in the tank circuits, no retuning of the buffer or final is necessary, unless you are going from one end of the band to the other. On 40, for example, you can operate from 7000 to 7150 kc. with no adjustments except tuning the VFO, and the complications of condenser tracking have been avoided.

One final point should be emphasized. Lay out the rig to give the shortest possible leads, and especially keep all by-pass condenser leads at an absolute minimum length.

Want to hear what the rig sounds like? W3HH is on the air close to 7100 kc. nearly every evening around 7 o'clock EST, and Sundays about 9 A.M.

ARRL Appointments:

THE EMERGENCY COÖRDINATOR

If one appointment were to be picked out as the most important of all ARRL/SCM appointments, that would probably be the Emergency Coördinator. The EC is the key man in the Amateur Radio Emergency Corps, the man whose actions and decisions at local level multiplied by 1700 (the total number of ECs at this writing) and leveled down to a basic average, shape the destiny of the Amateur Service's emergency establishment.

The EC is four kinds of people in one person. He is a leader, an organizer, a promoter and an administrator. As a leader, he establishes and

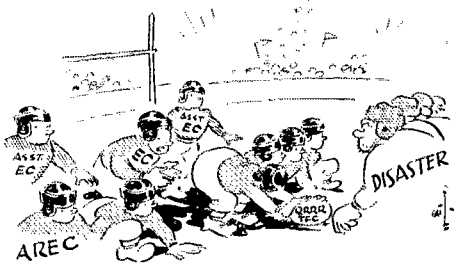

heads up the local AREC facility for public service. As an organizer, he puts into effect a plan of operation by means of which that facility can be most effective. As a promoter he "sells" public officialdom on the immediate value and potential of the amateur's services. And as an administrator he does the necessary paper work to keep his local organization active and interested. He may be a single amateur playing a lone hand in a small community, or he may head up a "team" of hundreds of amateurs in a city of millions.

Now we have civil defense, with many ECs taking on additional responsibilities as Radio Officers for the Radio Amateur Civil Emergency Service, and with a new phase of emergency communications to be considered. We need an EC in every community with an amateur population of one or more. Has one been appointed in your community?

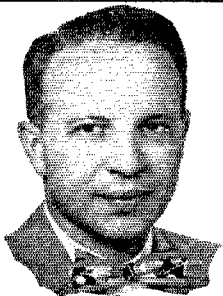

LEO I. MEYERSON W8GFO
CU ON 10-20 & 75 METERS

UNCLE SAM RELYS UPON . . . HAMS PREFER WRL TRANSMITTERS!

That's right fellows. The U.S. Air Force and Signal Corps are buying WRL Globe King and Globe Champion transmitters because they know they can depend upon their accurate, split-second performance.

Also, more and more amateurs prefer the outstanding performance of WRL transmitters—both Phone and CW. Our prices are low, we give personalized service, tailor-made terms, liberal trade-ins, and have complete stocks. We finance our own paper—NO RED TAPE—NO DELAYS. Special attention given to foreign orders. Deal with WRL—"Largest Distributors of Amateur Radio Transmitting Equipment."

NO TVI WITH GLOBE KING!

Says Jerry Armstrong, 2738 N. 49th St., Omaha, Nebr. Here are some excerpts from Jerry's letter:

"I have had my Globe King Transmitter for 2½ years. I get out with it every night despite heavy QRM, and have QSL cards from all over the world showing excellent contacts.

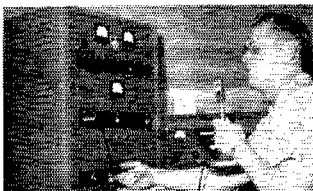

Jerry Armstrong with his Globe King

There are 8 TV sets within a quarter block but no one has trouble with TVI even though I use a ground plane vertical antenna.

Dollar for dollar, I feel that the Globe King is the ham's best buy."

—Signed/ Jerry Armstrong

NEW WRL 400-WATTS Phone-CW GLOBE KING XMTR

Send for complete data sheet

KIT FORM WIRED-TESTED
\$475.00 \$495.00

NEW ENGINEERING TRIUMPH! THE WRL GLOBE SCOUT

(50 WATTS PHONE — CW)

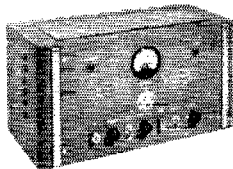

The WRL GLOBE SCOUT is the latest triumph of the WRL engineering staff. It is a beautiful, compact XMTR, completely self-contained, including power supply—8H X 14½W X 8¼D. Contains new 6146 tube in final; covers 160M thru 10M. Metering provided for final grid and

final plate circuits. Complete kit includes all parts, chassis, panel, power supply, cabinet, tubes, meter and one set of coils. Can be used for mobile work with suitable power supply. (Auxiliary socket provided.) An ideal XMTR for the novice or the experienced ham.

GLOBE SCOUT ACCESSORIES

Coil sets available for 160, 80, 40, 20, 15 and 11-10, per each set . . . \$3.00
Crystals 160, 80, or 40M (40M used on 10-20) each . . . \$2.75
Quality crystal microphone and stand . . . \$10.17
Signal R-50 Key . . . \$1.43

KIT FORM
(Incl. all parts
and tubes)
\$89.95

WIRED
(By our
engineers)
\$99.95

WRL 165 WATT GLOBE CHAMPION XMTR

(less
accessories)

KIT-FORM
\$329.50

WIRED
\$349.50

SEND
NOW!
FREE
1953
WRL
CATALOG



160 Meter Crystals

1819-1825 K. C.
1875-1925 K. C.

\$1.50 Ea.

WHILE THEY LAST

80 METER

3615-3619 K. C.
3756-3979 K. C.

40 METER

7064-7095 K. C.
7162-7425 K. C.

5675-6975 K. C.
7425-7999 K. C.

8000-8650 (in 25
K. C. Jumps)

99¢

each
while
they
last

79¢

each
while
they
last

All crystals mounted in FT-243 holders and checked for activity before shipment. Crystals will only be furnished within the range of frequencies shown above. Will furnish as close to desired frequency as possible. When these are gone, no more available.

RADIO REFERENCE MAP

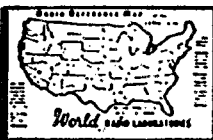

25¢

HANDY
WALL
SIZE

WRITE FOR DETAILED SPECIFICATION EQUIPMENT SHEETS

WRITE
WIRE

PHONE
7795

World
LABORATORIES



Radio
COUNCIL BLUFFS,
IOWA

World Radio Laboratories, Inc.
744 West Broadway
Council Bluffs, Iowa

Q-2

Please send me:

- New Log Book
 Free Catalog
 Radio Map

- Globe Scout Info
 Globe King Info
 Globe Champion Info
 Used Equipment List

Name _____

Address _____

City _____ State _____

Raise Your Phone Power 8 Times with
SINGLE SIDEBAND



HARMONIC TVI VIRTUALLY ELIMINATED

MULTIPHASE EXCITER MODEL 10A Switchable Single Sideband with or without carrier. Double Sideband AM, Phase Mod. Break-in CW. Output approx. 10 peak watts 160 to 20 meters, reduced on 15 & 10. VOICE OPERATED BREAK-IN. With coils for one band. Wired & Tested **\$139.50**. Kit **\$99.50**. Coils **\$3.95**/band.

SIDEBAND SLICER MODEL A Receiver Adapter. Selectable Single Sideband reception of SSB, AM, PM, & CW. Reduces heterodynes & interference at least 50%. Eliminates fading distortion. For receiver IF 450-500kc. Wired & Tested **\$69.50**. Kit **\$47.50**.

PS-1 PLUG-IN prealigned 90° phase shift network & socket **\$7.50**.

Send for Literature

Central Electronics, Inc.

2125 W. Giddings Street Chicago 25, Illinois

PIONEER CHASSIS PUNCHES



Type "CS"
Square Punch
cuts any
Size Larger
Square or
Angular Hole



For mounting IF's, Terminal Strips, Sockets, Plugs, Meters, Controls, Xfrmers, Switches, Panel Lites, Etc.

■ SQUARES		● ROUNDS		Simple Hand Wrench Screw Action		
3/8	\$2.95	1/2	\$1.95			1 1/4
1/2	\$3.25	3/4		1 3/8		
3/4	\$3.50	7/8		1 1/2		
7/8	\$3.85	1		1 3/4		
1	\$3.95	1 1/8	\$2.15	1 3/4	\$2.60	
● KEYED		1 1/4		1 1/2		\$2.95
1 1/4	\$3.50	1 1/2		2 1/4		\$5.65

"AT YOUR FAVORITE DISTRIBUTOR"

PIONEER TOOL CO.
LOS ANGELES 16, CALIFORNIA

Filament Supplies

(Continued from page 36)

the design of Fig. 2A is more efficient than the solenoid of B, it is to be noted that the solenoid may be easier to tuck into some corner of a crowded chassis.

The rectifier and chokes require some cooling, but less than that required by most power-handling resistors. Although almost any arrangement of parts will be satisfactory, it is well to

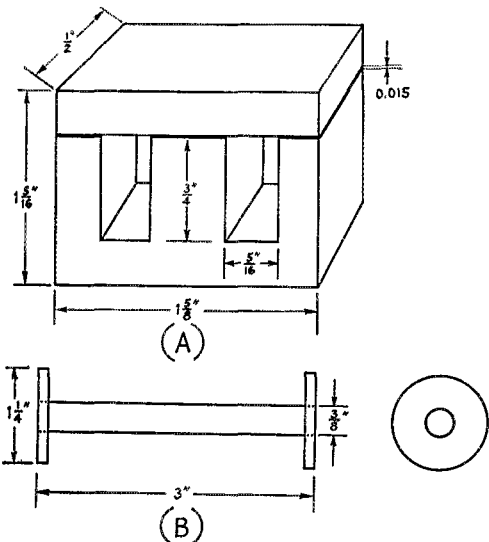

Fig. 2 — Suitable cores for filter chokes.

A — Core from small output transformer or choke. A winding of 100 turns of No. 24 enameled wire should be adequate. B — Core from automobile ignition coil. Wind with 350 turns No. 24 enameled.

remember that battery tubes are somewhat sensitive to the field produced by the transformer. The completed unit should first be tested with a dummy load. Such a load can be made of No. 30 copper wire which has a resistance of 0.1 ohm per foot. Fourteen feet will draw an ampere from a 1.4-volt supply. Any adjustment in voltage can be made preferably by changing transformer taps or the value of R_1 . If two chokes are used, R_1 may be connected in series with the second choke.

The total cost of such a unit should be less than ten dollars and should easily pay for itself in battery savings and convenience.

Strays

The core materials for the i.f. transformers described in "The Ultimate C.W. Receiver" (Sept., 1952, *QST*) are not too easily come by. However, we are informed by author W5FKQ that he has located a limited supply of core materials and shield cans for the 37-kc. units and all the 1700-kc. transformers. If interested, write him at 1447 Fleming Ave., Dallas 16, Texas.

UNBELIEVABLE

Price!

BIG NAME BRAND Hearing Aid

resale \$185.00
price

our price

\$24.50

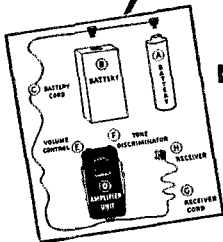

Now Anybody Can Afford One!

Unbelievable! But a fortunate purchase by Lafayette makes available a top-brand hearing aid regularly priced at \$185.00 for only \$24.50. Because of our low price we may not advertise the name but you will recognize the high quality of the manufacturer the moment you see it. Excellent as a spare aid, and a real opportunity if you could not afford one before. Brand new, packed in original manufacturer's jewelled case as illustrated. Supplied with receiver, receiver cord, battery cord and plug (less batteries). Order sample immediately. In lots of 3, \$23.50. Uses Burgess XX30E and 8R batteries at \$1.55 per set.

JOHNSON MOBILE TRANSMITTER KIT

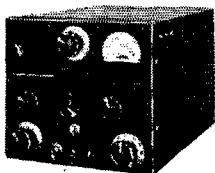

New Johnson mobile transmitter kit, a band-switching 4 band rig, 60 watts input, 100% modulated (30 watts on 300 volt supply) 807 final, microphone input—dynamic, microphone control.

crystal or carbon. Crystal or VFO control. Viking Mobile Transmitter Kit (less tubes) **99.50**

WE CARRY A COMPLETE STOCK OF MASTER MOBILE ANTENNAS

- TYPE AB/W75—Meter Whip— **NET 8.75**
- MODEL M-20—20 Meter load coil for using 75 meter antenna on 20 meters — **NET 3.23**
- MODEL M-40—40 meter loading coil for using 75 meter antenna on 40 meters — **NET 3.23**
- MODEL 100—96S—96" Stainless Steel — **NET 5.14**
- MODEL 92—18" Whip Extension— **NET 3.18**
- MODEL 9—96T—96" Economy Whip— **NET 3.67**

HEADQUARTERS FOR GONSET AMATEUR EQUIPMENT

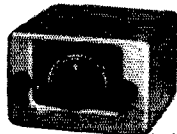
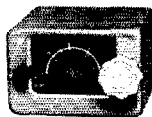
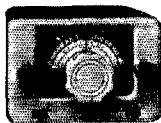

GONSET 2-METER AMATEUR AND C.A.P. CONVERTER For fixed or mobile use on 144-182.2 mc. High stability permits use with auto or home broadcast set. Super-imposition tuning and 1 mc (output) IF doubles band-spread, speeds tuning and avoids images from TV, police and other stations outside 2 meter band. 50 ohm coaxial input. Easily adapted for use with open wire lines or 300 ohm ribbon. High frequency and extended to cover C.A.P. frequency. Requires 135-250 V. DC, 20 MA; 6 V. DC. Draws power from receiver. Tubes: 6CB6, 12AT7, 0B2. Gray case measures 5 1/4 x 3 1/2 x 5 1/4". Supplied with tubes, cables and instructions. Shpg. wt. 4 lbs.

Gonset No. 3008 2 Meter Converter.....NET 44.50

GONSET 3-30 MC SHORT WAVE CONVERTER Continuous coverage from 3-30 mc on three bands. For use in all-band mobile station installations. 1500 kc output. High sensitivity on short whip. 4 tubes. Uses power supply of receiver to which attached. Size: 5 1/4 x 3 1/2 x 5 1/4". Shpg. wt. 4 lbs.

Gonset No. 3002 Converter.....NET 44.75

STEERING POST MOUNTING BRACKET—For installing any Gonset Converter on auto steering post.

Gonset Steering Post Mount 3006.....NET 3.90

Gonset 3008 Tri-Band Converter.....NET 47.60

GONSET MODEL 3017 SINGLE BAND CONVERTERS
Available in 10, 15, 20 and 75 } **NET EACH 39.95**
meter models (specify band) }

The NEW GONSET 2 Meter XMTR-RECEIVER
Complete 2-meter fixed-portable unit..... **NET 189.00**

Lafayette Radio

FAMOUS IN RADIO FOR 32 YEARS

NEW YORK 13, N. Y., 100 Sixth Ave., REctor 2-8600
BOSTON 10, MASS., 110 Federal St., HUBbard 2-7850
NEWARK 2, N. J., 24 Central Ave., MARket 2-1661
PLAINFIELD, N. J., 139 W. 2nd St., PLAINfield 6-4718
BRONX 58, N. Y., 542 E. Fordham Rd., FORDham 7-8813

New Heathkit GRID DIP METER KIT

MODEL GD-1

SHIPPING
WT. 4 LBS.

\$19.50



Complete unit easily held and operated with one hand.



A valuable addition to any ham shack.

The INSTRUMENT FOR HAMS — has numerous transmitter applications such as retuning, neutralization, locating parasitics, correcting TVI, adjusting antennas, design and many others.

Receiver applications include measuring C, L and Q of components — determining RF circuit resonant frequencies, etc.

Covers the 80, 40, 20, 11, 10, 6, 2 and 1 1/2 meter bands. Complete coverage from 2-250 MC.

Easy one hand, one unit operation. Convenient thumb wheel drive of tuning condenser leaves one hand free for making circuit adjustments. No tuning head and meter with connecting cable to worry about. It's compact — case only 2 1/2" wide x 3" high x 7" long.

All plug-in coils (rack included) are wound and calibrated — no coil winding, drilling, punching, forming or painting to do — all fabrication is complete, and the kit goes together smoothly and easily.

The 500 microampere Simpson meter movement and sensitivity control allow operator to set instrument for easy detection of dips on all ranges. Instrument is transformer operated for safety. You'll like the appearance of this kit with its baked enamel panel and crackle finish cabinet.

Please include postage to cover parcel post and insurance for 4 pounds.

HEATH COMPANY
BENTON HARBOR 9,
MICHIGAN

Happenings

(Continued from page 39)

PETITION FOR RULE-MAKING

The following petition is made pursuant to the instructions of the Board of Directors of the American Radio Relay League, Inc. As the Commission is aware, the ARRL Board of Directors is composed of sixteen amateurs nominated and elected by approximately 35,000 licensed amateurs in the United States and possessions, to represent them in the formulation of League policy.

Pursuant to § 4(d) of the Administrative Procedures Act and § 1.702 of the Commission's Rules and Regulations, the American Radio Relay League requests that Part 12 of the Commission's Rules and Regulations be amended in the following respects:

§ 12.111(a)(8) to read as follows:

(8) 50.0 to 54.0 Mc. using types A1, A2, A3 and A4 emission and narrow band frequency or phase modulation for radiotelephony; and on frequencies 52.5 to 54.0 Mc. using special emission for frequency modulation (radio-telephone transmission and radiotelegraph transmissions employing carrier shift or other frequency modulation techniques); and on frequencies 51.0 to 54.0 Mc. using type Aθ emission.

§ 12.23(e)(2)(iii) to read as follows:

(iii) 51.0 to 53.0 Mc., radiotelegraphy or radiotelephony using only type A1 or A3 emission for a period ending

_____ (one year from the effective date of this amendment).

Former subparagraph (iii) to be renumbered as subparagraph (iv).

The effect of the proposal to change § 12.111(a)(8) would be to extend the privilege of using type Aθ emission between 51.0 and 54.0 Mc., thus permitting "duplex" operation.

The effect of the proposal to change § 12.23(e)(2)(iii) would be to permit Novice Class licensee operation on the frequencies 51.0 to 53.0 Mc.

The League makes these requests of the Commission in order to promote more efficient occupancy of the amateur bands. It is believed that greater occupancy of the upper portion of the 50 Mc. band would be promoted by the amendments now suggested, thus relieving congestion elsewhere.

Granting of the League's request for Aθ emission on the 50 Mc. band would increase occupancy on those frequencies. As is well-known, the number of amateurs continues to increase and thus a large number of amateurs are using radiotelephony, creating considerable congestion on the lower frequency 'phone bands. As has been demonstrated by those who operate on the 50 Mc. band consistently, that band is suitable for carrying on many of the contacts that now take place on lower-frequency 'phone assignments. Up to this time, however, few amateurs have been willing to construct additional transmitting and receiving equipment in order to operate in the 50 Mc. band. But if Aθ were permitted, many more amateurs would be attracted to the band in order to operate "duplex." It was largely the duplex aspect of operation on the old 5-meter band in the early 1930s which gave it a tremendous surge of popularity. By permitting type Aθ emission above 51 Mc., no interference would be caused to the bulk of present amateur activity on the 50 Mc. band. It is a natural consequence that if more amateurs were to migrate to the 50 Mc. band for their routine activities, there would be less congestion on the low-frequency amateur 'phone bands.

The League also feels that it would be advantageous to permit Novice operation between the frequencies 51.0 and 53.0 Mc., using both 'phone and c.w. At the present time, Novice amateurs desiring to use radiotelephony are restricted to operation on the frequencies 145 to 147 Mc. It is believed that the 50 Mc. band would hold considerable interest for Novice licensees because the equipment is less costly and easier to build and adjust than is equipment for the 144 Mc. band. Additionally, the Novice would be attracted to 50 Mc. by the greater possibility of DX contacts on that band as compared with 144 Mc. A larger number of operators in the 50 Mc. band would promote occupancy of the v.h.f. and u.h.f. bands and encourage a greater amount of experimentation in the spectrum above 50 Mc.

AMERICAN RADIO RELAY LEAGUE, INC.

A. L. BUDLONG
Its General Manager

By PAUL M. SEGAL
Its General Counsel

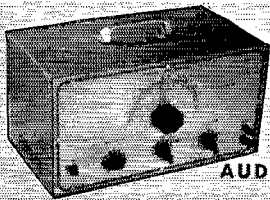

AUDIO GEN. KIT
\$29.50

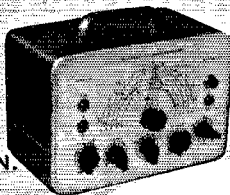

R. F. SIGNAL GEN. KIT
\$19.50

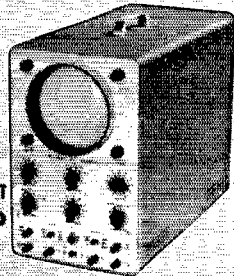

5" SCOPE KIT
\$43.50

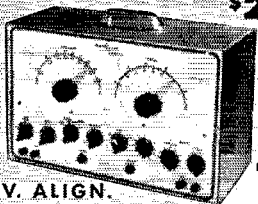

T.V. ALIGN. GEN. KIT
\$39.50

BUILD YOUR OWN *Heathkit* TEST EQUIPMENT

Heathkits are completely engineered instruments supplied unassembled. Every kit goes together smoothly and easily. All drilling, punching, and painting has already been done for you. All parts are furnished and are of highest quality.

Detailed construction manual shows clearly where each wire and part goes and tells exactly how to build the kit. Write for free catalog.

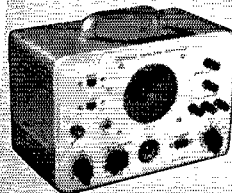

SIGNAL TRACER KIT
\$22.50



VACUUM TUBE VOLTMETER KIT
\$24.50

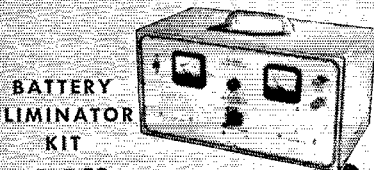

BATTERY ELIMINATOR KIT
\$24.50

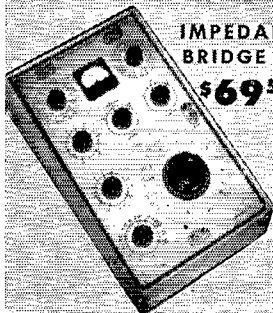

IMPEDANCE BRIDGE KIT
\$69.50

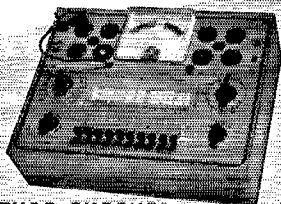

TUBE CHECKER KIT
\$29.50

HEATH COMPANY

BENTON HARBOR 9,
MICHIGAN

EXPORT AGENT
ROCKE INTERNATIONAL CORP.
13 East 40th Street
NEW YORK CITY (16)

GRID DIP METER KIT
\$19.50

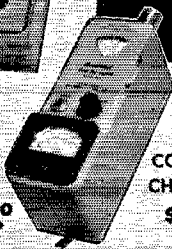

CONDENSER CHECKER KIT
\$19.50

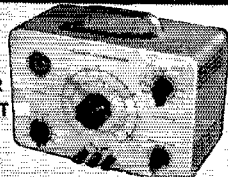

Q-H

5 ELEMENT NON-ROTATING QUICK-HEADING BEAM

DESIGNED BY WIPKW

IN KIT FORM (PARTIALLY FINISHED)
10M-\$55.50 • 15M-\$60.00 • 20M-\$98.50

3 ELEMENT HORIZONTAL ROTATING BEAM KITS

FOLDED DIPOLE MODEL

10M-\$29.00 • 15M-\$38.50

ALUMINUM ALLOY TUBING

CALAMAR

18 RICHARDSON AVE. WAKEFIELD, MASS.

CODE SENDING SPEED RECEIVING SPEED



HAVE SKILL, ACCURACY

SEND and RECEIVE CODE this EASY — FASTER WAY! The CANDLER SYSTEM has developed expert Amateur and Commercial Operators, and Code Speed Champions. In a few weeks you can pass the code examination for license. You can send and receive with amazing skill and speed, without tension. Long hours of practice unnecessary to acquire proficiency. The WAY YOU

LEARN is ALL IMPORTANT! By simple progressive lessons Candler teaches you at home to send and receive as easily as you talk or read — FAST, ACCURATELY. SEND Now For FREE BOOK — explains how fine amateurs and radiotelegraph experts learned code and developed skill and speed.

CANDLER SYSTEM CO.

Dept. 4-B, P. O. Box 928, Denver 1, Colo., U. S. A.
and at 52b, Abingdon Road, Kensington High St., London W. 8, England

NEW Tele-Vue* TOWER

for
RADIO AMATEURS

Crank raises or lowers beam!

NO GUY WIRES

Top 20 ft. section of 40 ft. tower telescopes into lower section—for repairing or changing transmission lines or antenna height. Light but strong aircraft-type welded steel tubing. Hinged at base!
ORDER NOW, OR WRITE FOR ILLUSTRATED DETAILS.

\$68⁹⁵ } From Jobber
Net } or F.O.B. Factory

(Please specify carrier you wish)

TELE-VUE TOWERS, INC., ST. PETERSBURG, FLORIDA
701 — 49th St. South

* (Finest tower made for Television homes)



Expedition to Brunei

(Continued from page 48)

through to start a procession of more than thirty eastern U.S.A. QSOs.

Review of the logbook reveals that 232 contacts, slightly over half of the total number of QSOs, were with W stations. The first station worked in each of the U.S.A. call areas is indicated in the following list: W1FH, W2QKS, W3KKT, W4FU, W5LHP, W6FSJ, W7AMX, W8BRA, W9NDA and WØYXO. In the entire five days nearly 450 contacts were established with stations in nearly fifty countries on all continents.

Incidentally, the food in Kuala Belait was entirely different from anything we had previously experienced. The Malayan cook made such dishes as Singapore curry and Malayan stew, both so highly seasoned as to be incredible insofar as I was concerned. At various times we had doubts in regard to what we were eating. Perhaps Bill discovered a clue when he noticed that there were fewer cats around the rest house when we left than there had been when we arrived. We were, however, able to obtain an orange crush bottled in Singapore which tasted excellent. We consumed gallons of this drink. The net effect of all this was that I lost fifteen pounds during the expeditionary period.

On our last night in Kuala Belait, July 31st, we operated the station until after midnight. Then we dismantled the equipment until about 3:00 A.M. We slept for one hour and forty-five minutes, and then had to arise to pack our luggage and were aboard the launch at 6:00 A.M. We then proceeded to Labuan Island. From 5:00 A.M. until 7:00 P.M., a period of fourteen hours, we had nothing to eat. Needless to say, we were in a state of exhaustion that evening.

The next morning at 6:00 A.M. we took off from Labuan for Manila. Except for the long journey back, that ended the VS5ELA expedition. And that ends the story of the first amateur radio station in Brunei.

* * *

I wish to acknowledge with sincere thanks the assistance given by amateurs in many parts of the world, without which this expedition could not have been such a success.

EaZon

The ideal junction for matching coax to center fed antennae. Patented design permits a natural match when assembled. Extremely low SWR. May be used with RG/8U, 11/U or other cable of similar dimensions. Light weight (4 ozs.). Measured pull exceeds stress for No. 12 steel wire. Use types 3W and 4W for trap or stub junctions in coaxial cable.

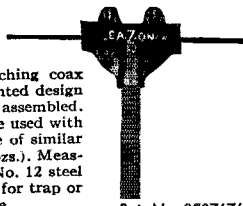

Pat. No. 2587676

Type 3WA (see cut) Antenna Match \$4.60 Net
Type 3W Tee Junction 3.00 Net
Type 4W Cross Junction 3.00 Net

See your dealer or write to

DALLAS C. AKERS CO.

33 Greenwood Ave. East Orange, N. J.

LEARN CODE!

SPEED UP Your
RECEIVING
with G-C

Automatic Sender

Type S

**\$24.00 Postpaid in
U. S. A.**

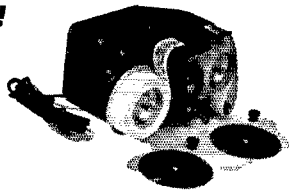

Housed in Aluminum Case Black Instrument Finished. Small—Compact—Quiet induction type motor. 110 Volts—60 Cycle A.C.

Adjustable speed control, maintains constant speed at any Setting. Complete with ten rolls of double perforated tape. A wide variety of other practice tapes available at 50c per roll.

GARDINER & COMPANY

STRATFORD

NEW JERSEY

Answer to QUIST QUIZ on page 55

A is definitely wrong, and B can be right or wrong. Noise figure is a means for comparing "front ends" of receivers without regard for bandwidth—the best with the best noise figure is *potentially* the best weak-signal receiver. But noise is proportional to bandwidth, so any receiver with a bandwidth greater than that required to pass the significant sidebands is noisier than necessary. A radar rf, and video amplifier is unnecessarily broad for audio work. The receiver bandwidth can be restricted at any point throughout its chain of stages, but the rf and audio amplifiers are the most practical points of attack.

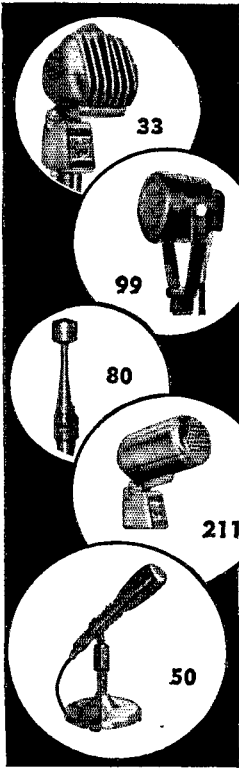

COMPACT – CONVENIENT – CAPABLE THE TURNER 80

This is the new TURNER 80 — a crystal microphone so tiny it hides in the palm of your hand, yet so strikingly designed it is the very picture of symmetry. Weighs less than five ounces, but its high output and unusually fine response characteristics make it a natural for amateur communications, home recording, dictating machines, portable recorders and dozens of other applications. Finished in beautiful satin chrome.

Level: Approximately 58 db below 1 volt/dyne/sq. cm. Response: 80–7000 c.p.s. 7 foot attached single conductor shielded cable. List Price **\$15.95**

In Canada: Canadian Marconi Co., Ltd., Toronto, Ont., & Branches
Export: Ad. Auriema, Inc., 89 Broad St., New York 4, U. S. A.

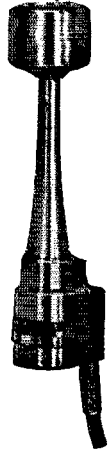

THE TURNER COMPANY

917 17th Street, N. E.

Cedar Rapids, Iowa

Microphones by **TURNER**



In Canada: Canadian Marconi Co., Toronto, Ont., and Branches
Export: Ad. Auriema, Inc., 89 Broad Street, New York 4

The Green Engraver

**ENGRAVES
ROUTS
PROFILES
and MODELS**

Used and endorsed by tool and die, electronic, machine, plastics, radio, electrical and instrument manufacturers. A real money saver.

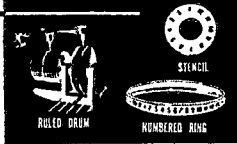

Specify the Green Engraver for precision engraving on metal, plastics, wood, glass, hard rubber etc. . . . engraves panels, name plates, scales, dials, molds, lenses, instruments, instruction plates, directional signs . . . by simple tracing from master. *Routing, profiling and three dimensional modeling indicate its versatility.* Electric etching attachment available.

Special attachments and engineering service available for production work.

FREE: Brochure—yours upon request.



Green Instrument Co.
INCORPORATED

308 PUTNAM AVENUE • CAMBRIDGE • MASS.

Proven Performance

**SONAR's New
LOW-PASS FILTER
MODEL LP-7**



only
16⁵⁰

AMATEUR NET

- 44 mc Cut-off - 52 ohms
- 75 db Harmonic Attenuation
- 1 KW Fully Modulated
- TEFLON Insulation

IMMEDIATE DELIVERY • AT YOUR DEALER
WRITE FOR LITERATURE • Dept.

**SONAR
RADIO CORPORATION**

3050 West 21st St.

Brooklyn 24, N. Y.

It's *QST* in '53 for the best in amateur radio. From the ARRL laboratory and technical staff, from the pens of leading authors in the radio field will come the construction and theory articles YOU want . . . articles to help YOU get the most out of your hobby. Plus diversified, top-notch special interest departments for balance and all around coverage to round out each **BIG** issue. Every member of ARRL gets *QST*. Dues are \$4 per year in the U. S. A., \$4.25 in Canada, \$5 elsewhere.

RADIO COURSES

- RADIO OPERATING
 - RADIO SERVICING
 - CODE
 - FM TELEVISION
- Preparation for Civilian, Maritime, Army and Navy license requirements.
Personal Counselling Services for Veterans
Write for Catalog T.Q.

YMCA

TRADE & TECH. 15 W. 63 St., N. Y. 23
SCHOOL ENdicott 2-8117

IF YOU TELEGRAPH YOU NEED A VIBROPLEX

Semi-Automatic Key

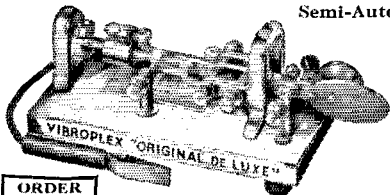

Suits any hand

Choice of five models

ORDER YOURS TODAY!

Twice as EASY as hand sending

Saves the arm, gives a professional performance without arm-tiring effort. Simple to operate. Suits any hand or any style of sending. Vibroplex has a "touch" that lessens arm fatigue and makes sending easier for you. Patented Jewel Movement balance lets you send SMOOTHLY! EASILY! NATURALLY! No other key so easy on the arm. Any old key won't do — get Vibroplex and be sure. Choice of five models, \$12.95 to \$29.95. Left-hand models, one dollar more. ORDER YOURS TODAY! At dealers or direct. FREE catalog.

Headquarters for NEW portables, all models and styles of type. Also, REBUILT standard and portable typewriters with ALL CAPITAL letters and other styles of type. Immediate delivery. Get our prices before you buy!

THE VIBROPLEX CO., INC.

833 Broadway

New York 3, N. Y.



Universal Shunt

(Continued from page 45)

branch in relation to the negative terminal can be found by

$$(4) R = \frac{R_t + R_b}{n} = \frac{13,333 + 6666}{n} = \frac{20,000}{n}$$

where n is the multiplier factor for each tap. This gives the total resistance between the negative terminal and the tap. The value of each section can be determined by simple subtraction.

For the 150-ma. range in Fig. 1, $R = 20,000/1500 = 1333$ ohms. Since R_1 is 4 ohms, $R_2 = 13.33 - 4 = 9.33$ ohms. For the 50-ma. range, $R = 20,000/500 = 40$, and R_3 is then $40 - 13.33 = 26.67$ ohms, etc.

In a practical case, it would probably be found permissible to make the resistance values greater, if desired, because the dissipation requirement of each multiplier resistor drops off rapidly as the multiplier factor, n , decreases. In the above example, R_2 need dissipate less than 0.2 watts, and its value could be increased to 44 ohms before reaching the 1-watt limit. In this case, only the 500-ma. multiplier would need to exceed the 1-watt maximum selected. However, it should be borne in mind that instrument multiplier resistors should be operated well within their maximum rating to maintain accurate calibration.

Following the same procedure, Fig. 1B shows why the circuit is called the universal-shunt type. It will be observed that for the same current ranges, the multiplier resistances stay the same. The only differences between the two circuits are that in B the impossible (500- and 150- μ a.) ranges are omitted and that R_b and R_t are reduced in proportion to the increase in meter scales, i.e., in a ratio of ten to one.

From the foregoing, it is evident that values can be shifted around within a rather wide range, depending upon what is available for R_b , R_t and the multiplier factors desired, provided only that the above relationships are observed.

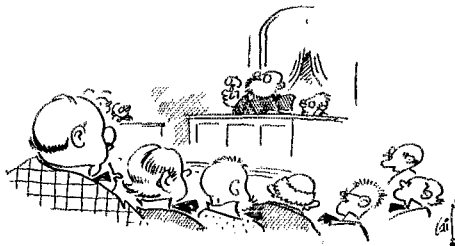

Heads uncovered for Pete P. Piaster,
Who thought he had nothing to fear
From the threat of high-voltage disaster;
Now they're auctioning off all his gear.



MAKE THIS YOUR HOME FOR IMPORTANT WORK UNDER IDEAL CONDITIONS

- TV RECEIVER DESIGN ENGINEERS
- ELECTRONICS ENGINEERS
- FIELD ENGINEERS
- TEST & INSPECTION ENGINEERS
- LAB. TECHNICIANS

NEEDED TO WORK ON: Radar, G.C.A., Mobile Radio, Auto Radio, Airborne Communication & Navigation Equipment, Television, Antennas, Microwave Equipment, Servo Mechanisms, Guided Missiles and Test Equipment Design.

YOU BENEFIT AT BENDIX RADIO:
from high wages, a modern, air-conditioned plant, paid vacations and holidays, group insurance and a good chance for advancement.

Housing immediately available in the beautiful suburban and country areas that surround the Bendix Radio plant.

Write, Wire or phone
MR. E. O. COLE, DEPT. K

Bendix Radio

DIVISION OF BENDIX AVIATION CORPORATION
BALTIMORE-4, MD. Phone: TOWSON 2200

AN/APR-4 COMPONENTS WANTED

In any condition. Also top prices for: ARC-1, ARC-3, APR-1, APR-5A, etc.; TS-34 and other "TS-" and standard Lab Test equipment, especially for the MICROWAVE REGION; ART-13, BC-348, BC-221, LAE, LAF, LAG, and other quality Surplus equipment; also quantity Spares, tubes, plugs and cable.

ENGINEERING ASSOCIATES

434 Patterson Road

Dayton 9, Ohio

RADIO and TELEVISION

Over 30 years N.E. Radio Training Center. Train for all types FCC operators' licenses. Also Radio and Television servicing. FM-AM broadcasting transmitters at school. Send for Catalog Q.

MASS. RADIO SCHOOL

271 Huntington Avenue

Boston 15, Massachusetts

Lic. by Comm. Mass. Dept. Educ.

AIRLINE RADIO

SUPERINTENDENT OF COMMUNICATIONS · OVERSEAS AIRLINE

Pays \$666.66. Free housing. Experienced in trouble-shooting and maintaining ground radio equipment.

RADIO ENGINEER

Communications or government radio transmitting and receiving station experience for Ground Radio field maintenance and trouble-shooting, shop and laboratory procedures. Write Trans World Airlines, Employment Manager, Kansas City 5, Missouri.

ARROW HAS 'EM IN STOCK

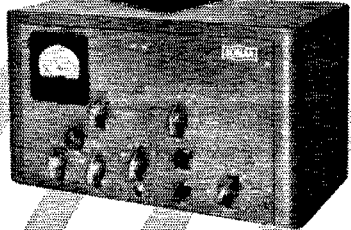

NEW! SONAR SRT-120

ALL BAND TRANSMITTER

Arrow has 'em—the transmitter you've been hearing about. The SRT-120 is All-Band, All-Purpose—delivers 120 watts on CW, 100 watts on Fone. 6-Band Switching—simple as a receiver. Complete TVI suppression. Amprex 9903/5894A final. Complete with 10 tubes, less power supply. 12" W, 21½" H, 8¼" D.
Amateur Net..... **198⁵⁰**

ARROW ELECTRONICS INC.

82 CORTLANDT ST., NEW YORK 7, N. Y., DIGBY 9-4714

NEW LOW-PRICED BETTER ANTENNAS

10 METER DIPOLE.....	\$6.95
6 METER 2 EL-BEAM.....	9.95
10 METER 2 EL-BEAM.....	11.95
6 METER 3 EL-BEAM.....	12.95
10 METER 2 EL-BEAM*.....	12.95
10 METER 3 EL-BEAM.....	16.95
10 METER 3 EL-BEAM*.....	18.95
10 METER 4 EL-BEAM*.....	24.95

* With T match.

Furnished complete, easy and quick to assemble. Instructions and all data included. Strong aluminum castings and tubing, less mast and wire. Made by hams and sold only to hams, no dealers. Literature on request. All antennas adjustable over entire band. ORDER NOW—IMMEDIATE SHIPMENT.

HOW TO ORDER

Remit by check or money order. All shipments sent Railway Express, charges collect. Money back guarantee

GOTHAM HOBBY 107 E. 126 Street
New York 35, N. Y.



It's easy to see why W8ATB, Esther Stuewe, is so well-known on 75, 20, and 10. She spends many hours at her efficient rig handling traffic and participating in the Overseas, Michigan Emergency, Buzzards Roost, and various YLRL nets. During the day she monitors the Michigan Net on 3930, and with a mike in her kitchen and speakers all over the house, including the garage, she has no trouble hearing traffic calls for Flint. Esther is a member of the Flint Emergency Corps and holds OPS, WAS, and WAC certificates. Her OM is W8QBO.

YL News & Views

(Continued from page 47)

110th country. Dottie also had an FB QSO with CR7LU, Lucia. . . From G8ACC, Margaret, comes word that Jean, ex-G3HSQ and ex-VS1YL, is about to operate as DL2YL in Germany. . . After residing temporarily in Virginia, W4LKM, Annette, and OM W4CWW have returned to their permanent home in Ft. Lauderdale, Fla. . . Some new YLs are WN4WXL, Cornelia, Tenn.; 13-year-old WN4WPO, Jeanne, Louisville, Ky.; WN1WJJ, Mary, Weymouth, Mass.; WN1WNT, Evelyn, Braintree, Mass.; and W8LNZ, Joy, of Dayton, Ohio, the daughter of W8FYT, Lillian. . . With the aid of amateur radio, W4WLH, Helen, of Shelbyville, Tenn., and OM W6CF were able to locate missing heirs in California and thereby settle a Tennessee estate. . . The Long Island Unit of YLRL voted to sponsor annually a fund-raising project for W2JIO, Bob Gunderson, and his Braille Technical Press, and to undertake the secretarial work of that organization. . . In two years W4SGD, Katherine, has worked 140 mobile stations in 19 states. . . W0s DBH, Edythe, and KOY, Inga, call into the North Dakota 160-meter net daily. . . In December the Faetu-lant Amateur Radio Club (W4NPT, Naval Air Station, Norfolk, Virginia) set aside usual meeting matters and devoted time to tell nonlicensed women in attendance about the YLs of amateur radio. Substituting for W4LAS, Mabel, a talk was given by the XYL of W4OKL. The YLRL Photograph Album was displayed, and it was felt that the program had probably won new feminine recruits for the hobby.

California YLRL members are considered "very cooperative" by their present YLRL District Chairman, Mildred O'Brien, W6HTS, who has particularly enjoyed meeting them all either personally or by mail. And the girls find Mildred an energetic and ambitious chairman. The XYL of W6HSB and the mother of W6GDO, she operates 75, 20, and 10. She holds WAS (10 meters), RCC, and ARRL Public Service certificates.



Evans RADIO
Service to hams • "YOUR FRIENDLY SUPPLIER"
by hams. Nationally accepted brands of parts, tubes and equipment. Trade-ins and time payments. Write W1BFT.
10 HILLS AVENUE • CONCORD, N. H.



RCA INSTITUTES, INC.

A Service of Radio Corporation of America
350 West 4th St., New York 14, N. Y.

OFFERS COURSES
IN ALL TECHNICAL PHASES OF
RADIO, TELEVISION, ELECTRONICS

Approved for Veterans

Write Dept. ST-53 for Catalog

BEFORE YOU BUY

. . or trade that Collins, Johnson, Hallicrafters or National piece of radio gear be sure to get our prices. Our service cannot be beat. Remember the name—

ADIRONDACK RADIO SUPPLY

32 Guy Park Avenue Amsterdam, N. Y.

Ward J. Hinkle, W2FEU, Owner

Remember also—Our telephone number is 73

Our P. O. Box number is 88

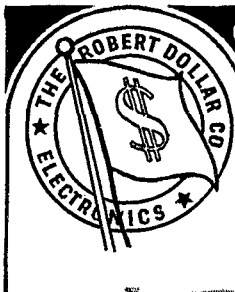

More power for 2 meter mobile!

Introducing the "222" . . . a new two meter transmitter to meet the demand for greater power output and increased range from mobile units. The 222 is capable of power outputs from 5 to 7 watts with a 300 volt power supply yet satisfactory operation, at decreased output, is possible with 200 volt supplies. The output circuit includes a low-loss antenna changeover relay and an adjustable series-tuned, coupling link for operation into 52 ohm co-ax lines. High level plate modulation, (with P-P 6AQ5's) is used.

The basic intent of the overall design has been to produce a highly stable, (Crystal controlled) transmitter and to apply time-tried-and-proven commercial practice to a new and highly worthwhile piece of amateur equipment.

FREQUENCY RANGE: 144-148 mcs. (Also covers adjacent Civil Air Patrol frequencies)

POWER OUTPUT: 5 to 7 watts into 50 ohms. (300 V supply)

TUBE LINEUP: 6X8 Xt1 osc & multiplier, 57G3 multiplier, 2E26 PA, 2-6AQ5 mods.

XTL FREQ. RANGE: 8 to 8.222 kcs, FT-243 holders.

MICROPHONE: F1 type required.

(Complete with tubes but less crystal, microphone, and power supply) **\$89.50** net

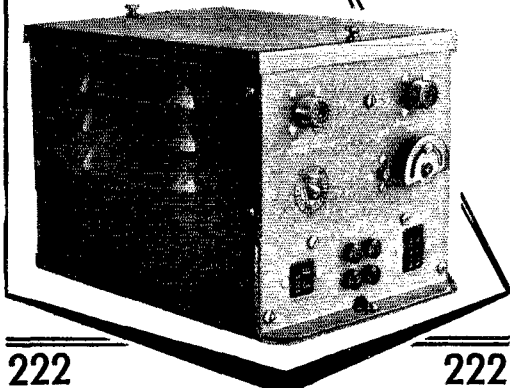

222

222

JOBBER INQUIRIES INVITED

THE ROBERT DOLLAR CO.

50 DRUMM ST. SAN FRANCISCO, CALIF.

COMMUNICATIONS
EQUIPMENT DIVISION

EXPORT AGENTS: M. SIMONS & SON 23 WARREN ST., N. Y. C.

Newly Designed!! EQUIPMENT FOR C-D AND RACES

Frequency range, 1750-1800 kcs.
Transmitters in 30, 100, 250 W output.

Crystal controlled receivers

Mobile Audio Amplifiers
4 and 12 watts output

Write for engineering bulletins

THE ROBERT DOLLAR CO.

Communications Equipment Division

50 DRUMM STREET, SAN FRANCISCO, CALIF.

EASY TO LEARN CODE

It is easy and pleasant to learn or increase speed the modern way — with an **Instructograph Code Teacher**. Excellent for the beginner or advanced student. A quick, practical and dependable method. Available tapes from beginner's alphabet to typical messages on all subjects. Speed range 5 to 40 WPM. Always ready, no QRM, beats having someone send to you.



ENDORSED BY THOUSANDS!

The **Instructograph Code Teacher** literally takes the place of an operator-instructor and enables anyone to learn and master code without further assistance. Thousands of successful operators have "acquired the code" with the **Instructograph System**. Write today for full particulars and convenient rental plans.

INSTRUCTOGRAPH COMPANY

4769 SHERIDAN ROAD, CHICAGO 46, ILLINOIS

STANDARD OF THE WORLD FOR
QUALITY HEADSETS



The Only Personal Part of Any Communication System
for a world of . . .

**LISTENING
COMFORT**



***MONOSET**
(magnetic)

***DYNASET**
(dynamic)

The modern styling, dependability and superior performance of these under-chin TELEX headsets have made old fashioned headphones obsolete. With more highs and lows of both music and speech, they are the delight of radio and TV monitors.

Wearing a lightweight TELEX headset with no pressure on the ears and all background noise blocked out, you're all set for hours of traffic, DX or just plain chewing the rag. You'll never again wear an old fashioned headphone after you try one of the fatigue-free, featherweight TELEX headsets.



***TWINSET**

This lightweight 1.6 oz. TELEX Twinset pipes signal directly into the ear, blocking out background noises and banishing listening fatigue. Magnetic.

*Trade
Mark



For complete information on any of the above headsets, write

TELEX

ELECTRO-ACOUSTIC DIV.
Department 16-F • St. Paul 1, Minn.
In Canada
ATLAS RADIO CORP., Toronto

TELEX
HEARING AT
ITS BEST



NATIONAL

- **P**roven
- **D**ependable
- **Q**uality

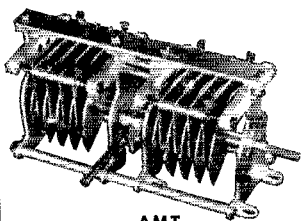

AMT

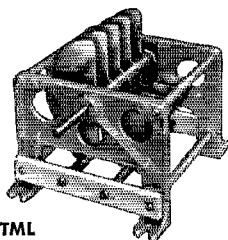

TML

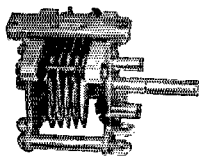

TMK

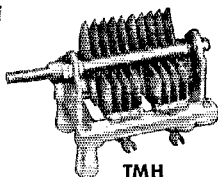

TMH

TRANSMITTING CONDENSERS

National's preferred line of extremely rugged transmitting condensers covers wide voltage and capacity ranges for both low and high power stages. Single and double stator models are available with standard and/or right angle drives. Rigid construction and precision bearings assure permanent alignment. Extra thick plates with rounded and polished edges provide exceptionally high flashover, current and voltage ratings. Write for drawings and specifications.

National



EST.

1914

NATIONAL COMPANY, Inc.
MALDEN, MASSACHUSETTS

TVI Committees Progress Report

(Continued from page 49)

are amateurs have at one time or other asked for the cooperative assistance of their committee in clearing TVI or BCI cases directed against their own stations.

There are humorous aspects to all work connected with human relations. TVI investigations are no exception. The following case histories were submitted by the WTVIC (Washington D. C. Committee):

A complainant adamantly refused to allow an amateur to install a high-pass filter at an affected television receiver, at no cost to the receiver owner, but instead purchased a low-pass filter which he insisted the amateur accept for installation at the transmitter involved. The TVI committee, with the aid of Commission representatives and a manufacturer's agent, resolved this case satisfactorily. The amateur station was found "clean" of objectionable harmonics. Since the low-pass filter was therefore of no use in this case, the complainant, in a friendly gesture, offered the filter for the future use of the committee.

One committee was asked to investigate an interference condition whereby a local television channel was affected by "an awful squealing noise" every Friday evening during telecasting of wrestling matches. It developed that on Friday nights an elderly uncle regularly visited the family reporting the interference. He alone watched the wrestling matches. Investigation proved the "interference" was actually due to weak batteries in a hearing aid used by the uncle, resulting in an oscillating condition within the aid.

Continuing Progress

The interference committee program has been and should continue to be publicized as widely as possible. The articles and editorials which have appeared in radio magazines coupled with the personal and written contacts by ARRL and other amateur organizations as well as by radio clubs and individual amateurs have successfully launched the program and developed it into a nation-wide coordinated effort. Let's keep the program rolling and acquaint everyone concerned with it, including the TV set owners. The Regional Managers and their staffs comprising the Engineers-in-Charge of district offices and other FCC engineering personnel of these offices stand ready to explain the program to new groups and to give all possible assistance. Publicity alone is only the means of lighting the fuse. The problem then resolves itself into plain hard work by committee members. The examples of such tireless work and the results accomplished which have come to the Commission's attention have been extremely encouraging. It is predicted that this cooperative effort will in the years to come reduce TVI to the present minor status of BCI.

WANTED

COMMUNICATION and RADAR PERSONNEL

WHO WANT TO EARN

\$7,000

Per Year, Or
BETTER

PHILCO TECHREP DIVISION

Offers Such Openings

... to men who are qualified by experience or training in the design, maintenance and instruction of Communications, Radar and Sonar Equipment.

FUTURE OPPORTUNITY AND JOB SECURITY

... are more than "sales talk" at Philco. Demands for our electronics installation and service work throughout the entire world have been coming to us with increasing regularity since 1941. This is YOUR best assurance of a future with us.

PLUS — OF COURSE

... the fact that in Civilian Radio and Television, PHILCO has led the industry for 20 years.

COMPENSATION IS TOPSI

Salary, bonus, subsistence up to \$6,500 stateside and \$7,500 foreign; PLUS, hospitalization, group insurance, profit sharing, retirement benefits, merit and faithful service salary increases and paid vacations.

TRAINING PROVIDED

Philco provides all necessary refresher courses and new courses, where required on new equipments, to insure your qualifications before assignment. Pay while training.

WRITE for complete details to

PHILCO TECHREP DIVISION

22ND & LEHIGH AVENUE

PHILADELPHIA 32, PA.

GET INTO ELECTRONICS

You can enter this uncrowded, interesting field. Defense expansion, new developments demand trained specialists. Study all phases radio & electronics theory and practice: TV; FM; broadcasting; servicing; aviation, marine, police radio. 18-month course. Graduates in demand by major companies. H.S. or equivalent required. Begin Jan., March, June, Sept. Campus life. Write for Catalog.

VALPARAISO TECHNICAL INSTITUTE
Dept. TN Valparaiso, Ind.

We Carry a Complete Line of Amateur Equipment including: **National • Hallicrafters • E. F. Johnson Co. • Bud • Barker & Williamson, etc.**

VARIETY ELECTRIC CO., INC.

468-470 Broad Street, Newark 2, New Jersey

XTALS FOR ALL PURPOSES!

LOW FREQ.—FT 241A for SSB, lattice filter, $\frac{1}{2}$ " spc, 54th or 72nd harm channels listed by fund. Fractions omitted.	SCR 522 $\frac{1}{2}$ " sp.	BC-610 2 banana plugs $\frac{1}{2}$ " spc.	FT234- $\frac{1}{2}$ " spc
374 395 418 487 511 400 464	5910	2030 2435	4190 1015 5940 6640
375 396 419 488 514 440 466	6370	2045 2442	5030 1129 5973 6673
377 397 420 490 515 441 468	6450	2105 2532	5485 2045 6273 6706
379 398 422 491 516 442 470	6470	2125 2545	6073 5305 6325 7440
380 401 423 492 518 446 472	6490	2145 2557	6106 5677 6340 7506
381 403 424 493 519 447 474	6522	2165 2571	6140 5706 6373 7506
383 404 425 494 520 450 475	6547	2220 3215	6173 5725 6406 7540
384 405 426 495 522 452 476	6610	2258 3237	6206 5740 6450 7573
385 407 427 496 525 461 477	7350	2280 3250	6273 5760 6473 7606
386 408 431 497 526 462 479	7580	2282 3322	6773 5773 6475 7640
387 409 433 498 530 463 480	7810	2290 3510	6873 5800 6506 7650
388 411 435 503 531		2300 3520	6906 5806 6540 7673
390 412 436 504 533	99¢ ea.	2305 3550	7140 5825 6573 7706
391 413 481 506 537	10 for each	2320 3580	7173 5840 6575 7973
392 414 483 507 538	\$9.00	2360 3945	7740 5850 6600 8240
393 415 484 508		2415	7840 5873 6606 8250
394 416 485 509		2390 3995	7873 5906 6625 8273
	Add 20¢ for each 10 xtals or less for postage and handling	\$1.29 ea.	7906 99¢ each 10 for \$9.00
		49¢ each, 10 for \$4.50	

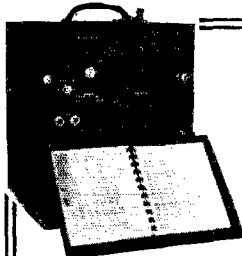

LOOK HERE, FELLOWS!

We will gladly pay the highest possible price for the purchase of any Heterodyne Frequency Meter as illustrated here, including the BC-221, the TS-173, the TS-174, the TS-175, and the TS-323.

Please write, giving complete information on nomenclature and condition to

WESTON LABORATORIES

Weston 93

Massachusetts

Special Purchase FM Radio Chassis

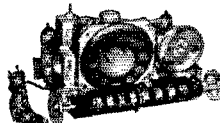

88-108 MC

Complete with 6 tubes. Built-in Antenna and speaker. Product of Famous Radio & TV Manufacturer whose name we promised not to mention. **\$16.95**

Maroon Plastic Cabinet for above\$3.95

SUN RADIO

OF WASHINGTON, D. C.
938 F STREET, N. W. WASH. 4, D. C.

HAM-ADS

(1) Advertising shall pertain to radio and shall be of nature of interest to radio amateurs or experimenters in their pursuit of the art.

(2) No display of any character will be accepted, nor can any special typographical arrangement, such as all or part capital letters be used which would tend to make one advertisement stand out from the others.

(3) The Ham-Ad rate is 30¢ per word, except as noted in paragraph (6) below.

(4) Remittance in full must accompany copy. No cash or contract discount or agency commission will be allowed.

(5) Closing date for Ham-Ads is the 25th of the second month preceding publication date.

(6) A special rate of 7¢ per word will apply to advertising which, in our judgment, is obviously non-commercial in nature and is placed and signed by a member of the American Radio Relay League. Thus, advertising of bona fide surplus equipment owned, used and for sale by an individual or apparatus offered for exchange or advertising inquiring for special equipment, if by a member of the American Radio Relay League take the 7¢ rate. An attempt to deal in apparatus in quantity for profit, even if by an individual, is commercial and all advertising by him takes the 30¢ rate. Provisions of paragraphs (1), (2) and (3), apply to all advertising in this column regardless of which rate may apply.

(7) Because error is more easily avoided, it is requested signature and address be printed plainly.

(8) No advertiser may use more than 100 words in any one issue nor more than one ad in one issue.

Having made no investigation of the advertisers in the classified columns, the publishers of QSL are unable to vouch for their integrity or for the grade or character of the products or services advertised.

QUARTZ --- Direct importers from Brazil of best quality pure quartz suitable for making piezo-electric crystals. Diamond Drill Carbon Co., 719 World Bldg., New York City.

MOTOROLA used communication equipment bought and sold. W5BCO, Ralph Hicks, 204 E. Fairview, Tulsa, Okla.

SUBSCRIPTIONS. Radio publications a specialty. Latest Call Books, \$3.00. Earl Mead, Huntley, Montana. W7LCM.

QSL's-SWL's Meade W6KXL, 1507 Central Avenue, Kansas City, Kans.

QSLs, SWLs, America's Finest! Samples, 10¢. C. Fritz, 1213 Briar-gate, Joliet, Ill.

QSLs: Fluorescent QSLs radiant and glowing with quality-control. QSLs Kromekote three colors and up. Rainbow maps. DX QSLs. Samples rushed. 10¢. Uncle Fred. Box 86, Lynn, Pa.

QSL Samples 10 cents. Minner, WISQF Press, Candia, N. H.

WANTED: Cash or trade, fixed frequency receivers 28-42 Mc. W9YIV, Troy, Ill.

QSLs, SWLs. High quality. Reasonable prices. Samples. Write to Bob Teachout, W1FSV, 204 Adams St., Rutland, Vermont.

WANTED: Marconi multiple tuner, coherer, spark coil, magnetic detector, etc.; DeForest responder, coherer and other early equipment; Marconiographs, Modern Electric; Electrical Experimenter and early Call Books and text books of wireless. Franklin Wingard, Rock Island, Illinois.

MICROWAVE test equipment wanted. Weston Laboratories of Weston 93, Massachusetts, will make you a high cash offer on any microwave test equipment, particularly such numbers as: TS-13, TS-120, TS-45, TS-35, TS-147, etc. To those more interested in trading, we offer any new standard ham item or a combination of cash. Write giving full description for prompt reply.

WANTED: All types of aircraft radios, receivers and transmitters. Absolutely top prices. W2KUU, 308 Hickory St., Arlington, N. J.

WANTED: Top prices paid: Navy selyns 1 DG, 1F, 1CT, 5CT, 5D, 5DG, 5G, 6C, 7C, etc. and BC-348, BC1221, AN/ART-13, AN/ARC-1, AN/ARC-3, RTA-1B, AN/APR-4. Letriconic Research, 719 Arch St., Philadelphia 6, Pa.

WANTED: BC610 or BC610 parts or components. State price and condition by letter. C. Porter, 8545 11th Ave., Silver Spring, Maryland.

WANTED: Summer Camp Counselor to teach radio in Jackson Hole, Wyoming ranch camp, (Boys and girls), maintain radio equipment, keep contact with pack trips. Also able to do other things such as trail cooking, or music, or campfire programs, etc. Single man or married (no children) if wife is nurse or can assist with ranch program. Contact W. S. Wilson, 2619 Oak Knoll Avenue, San Marino, California.

RADIO amateur and commercial license preparation. International Morse code transcribed on magnetic tapes, recording wire and long playing microgroove discs. Disc-A-Method Recording Company, 317 East 48th St., New York, N. Y.

ELECTRONIC blanket controls, useful for remote control purposes or component parts. Contains: plate relay, 6.3 filament transformer, switch, 3 tubes, sockets, resistors, condensers. Complete with cabinet and diagram. \$5.00 postpaid. John Randolph, W4QA, 100 Westwood Place, West Asheville, N. C.

FOR Sale: 118 foot 13 inch triangular steel tower, base insulated, three sets of three guys broken up in 10 ft. insulators. Perfect condition. Two men can take down in two days. In place as is, \$500. Photos on request. W1CPI.

DON'T Fail! Check yourself with a time-tested "Surecheck Test," similar to the F.C.C. tests. Novice, \$1.50, General, \$1.75. Amateur Extra available soon. Amateur Radio Supply, 1013 Seventh Ave., Worthington, Minn.

QSLs? SWLs? America's finest, and the largest variety of superb *goos* QSL State-map? Rainbow-map? Modernistic? Cartoon? samples, 25¢. Rus Sakkers, W8DED, Ham Print Shop, 53 East 7th St., Holland, Mich.

WANTED: Selyns and syncros. Top dollar paid. Write full descriptions to: Box 84, Babson Park 57, Massachusetts.

VOLTOHM Milliammeters, pocket size, AC-DC ranges 750 V 150 V and 15 V; 150 Ma. and 1 megohm, \$2.75. W2OXR. R. Gross, 11 Belmont Terrace, Staten Island 1, N. Y.

4D32 new, \$20; Heath grid dip meter, \$32.50; Heath A8-A 20W, Hi-Fi amplifier, \$49.50; Heath V-6 VTVM, \$39.50; Meck T-60, \$49.50. W5AXL.

SAMPLE conversions, surplus dynamos, \$1.00. Kujampaa, Box 72, Revere, Mass.

WANTED: Navy Selyns, types 1DG, 1F, 1G, 1CT, 5F, 5G, 6G, 7C, etc. Autogyms: AY1, AY10D, AY201, etc. Tubes, test equipment, Signal Corps Equipment. Send Lists. Top prices. Electro, 110 Pearl St., Boston, Mass.

QSLs: Samples free. Big 18 page catalogue, 25¢. "Brownie," W3CJI, 3110 Lehigh, Allentown, Penna.

WANTED: APN, APR, ART-13, DV-17, TRC-2, PE-162, SCR-694, BC-1306, PE-237, GN-58, GN-53, GN-45, SCR-284, BC-654, PE-103, PE-104, BC-221, BC-348, BC-312, BC-342, RA-62, RA-34, BC-611, TCS, test equipment, technical manuals, Pandaport, etc. Arrow Appliance, Box 19, Boston 1, Mass. (Tel. Lynn 8-3100).

SALE: 250 watt phone/c.w. transmitter, 813 final, 811 modulators. Earl Carlsen, W3KUC, 507 Margaret Drive, Silver Spring, Md.

SELL: HRO-50-T-1 receiver with xtal calib., \$299.00 NFM, ABCD AD coils, new, August 1952, \$349.00, ARME 45 399.00 comp. Cheap 183D w/spkr. R. Long, 184 L St., So. Boston, Mass.

BEST offer takes late model Globe King, complete mobile rig includes Motorola P-69-13 rcvr, FMT-30-DMS, AM/FM transmitter, Conset TriBand, cables, control head and mike. E. C. Zamber, 2470 Andrus, Hamtramck, Michigan.

KILOWATT fone xmitter for sale: 833A final, ART-13 exciter, VFO, final Variac controlled, 810 Mod., 20 watt compression speech amplifier, low-pass filter for exciter and final, 30 ft. steel tower, aluminum tubing for 20-meter antenna, drop pitch motor, spare 833A Commercial appearance, \$500.00. Bring a truck. Olney Dearing, W5ERW, 2011 Preston Road, Glenn Burnie, Md.

Q5'er, with plug-in pwr supply, like new, \$20.00; another with plug-in transformer pack, 6 volt conversion, schematics, good condition, \$15.00; Millen R9'er, 10 and 20 meter coils, matching transformer power pack, like new, \$20.00. Walt Bennett, W6WMM, 4515 W. 62nd St., Mission, Kansas.

THINKING of two meters? ARC-3 with six crystals 500 Ma 400 to 500 v power supply, 3 section filter for rack mounting. Runs ARC-3 to 829B, also ARC-3 converter required. Pwr. Will swap for 1951 HRO. W9BBH, E. Blackman, 19 N. Green St., Carpentersville, Ill.

HT18 VFO direct output on all ham bands with or without NBFM modulation, also 3 crystal positions, self-powered new condition: \$75.00. Am interested in Elmac. H. I. Griffiths, 39-82 65th Place, Woodside 77, L. I., N. Y.

NATIONAL HRO-60, brand new, complete with matching speaker, five coils "A", "B", "C", "D" and "F". In original factory cartons. List price, \$524.00. A buy at \$410. Standard 90-Day guarantee. J. W. Siedenfeld, W2TBS, 26 Gibson Park, Washington, N. J.

BEST offer takes National SW3, coils for 160, 80, 40, 20, 5880AR power supply. Also two TR4A transceivers. Ark in excellent cond. W2HWN, M. Kunzman, 723 Hillside Ave., Plainfield, N. J.

COLLINS 32V3 transmitter, like new, in original carton, manual, tags. Submit cash offers. John H. Elder, 15 Churchill Road, Pittsburgh 35, Penna.

SELL: Cabinet, 19 x 19 x 84", steel, grey, rear door, double blowers, \$25.00. RG39/U, new 72 ohm coax, .05 per ft. Pair 250THs, new, \$15.00 each; 12 VT 127, \$2.00 each, Pair RCA 800, \$20.00 each; BC 348L with AC power, \$75.00; Kilowatt chassis, final, modulator, speech, low power and bias, filter power, 15 ampere powerstat exciter, all or part. Want: tape recorder, coil winder, selyns motors, good receiver, Livingstone, 12-01 Ellis Ave., Fair Lawn, N. J.

GONSET TriBand converter, \$30.00; Lysoc 10-meter mobile transmitter, 6AQ5's, \$20.00; Mallory 300 volt 200 mil Vibropack, \$20.00; Hallicrafters S-38B receiver, \$32.00; all like new, use only few hours, BC455, new, converted, \$10.75. W3ELV, c/o Kronenberg's, Inc., Carlisle, Penna.

WANTED: Service manual for BC224. State price. Albert Kaiser, 1331 Dayton Street, Camden 4, N. J.

SELL: 1500 volt 500 Ma. supply, \$35.00; complete 120 watt Class AB 807 modulator and amplifier, \$20.00; good tubes and components. E. O. Johnson, W2ZWA, RD 1, Snowden Lane, Princeton, N. J.

1000 KC marker crystal blanks, unmounted, \$1.00 each. Hundley Crystal Co., 2951 North 36, Kansas City 4, Kansas.

SELL: BC348, completely converted. Write for details. Best offer takes it. W8JNO, 71 Griawold St., Delaware, Ohio.

FOR Sale: TVI proff 750 watts fone/c.w. Nice clean conversion of BC610 with BC614E speech amplifier. External Hunter Cyclometer exciter (similar to Collins 310B). P.P. 4-125A's in final, top condition, \$600.00. H. G. Overeynder, W8KUU, 138 Vernon, Ashland, Ohio.

FOR Sale to highest bid, Collins 32V-1 transmitter and 10-20 RME converter. W4AD, Box 793, Rome, Ga.

WANTED: ART-13 Mod. transformer. For sale: choke 6 HV., 350 Ma., 82 ohm cased, \$4.50. A. Brocato, 1217 N. 33rd St., Birmingham, Ala.

RADIO News, Engineering Edition, 1945-1952 inclusive, in good condition, \$25.00. BC348R receiver, 110 volt AC, \$50.00. Bob Abernethy, W2PQV, 120 Frederick Ave., Babylon, L. I., N. Y.

TRADE: Line Materials Co. 1401 surplus transformer, heavy, 9" cube, in excellent condition; five 115v windings, one bus bar wound; two complete sets MX30 series antenna sections. Need T240, 811As, 100THs, accurate tester, grid dipper, signal generator. Sell: dynamos, (wholesaler) sealed boxes, 425V at 375 Ma., \$20. W9OFU, Macomb, Illinois.

JOHNSON Beam, 2-element, 20 meters, including "T" match and boom, \$35.00. Drake TV300-10HW and TV300-20HW half-wave filters for 300 ohm line, both \$12.50. Two Advance 400 relays, both \$12.50. All perfect condition. WSDA, Young, 4425 Bordeaux, Dallas, Texas.

WANTED: AN/APR-4, APR-5A, ARC-1, ARC-3, ART-13, etc.; TS-12 and other "TS-", particularly Microwave equipment, even salvage; VHF frequency meters and signal generators; quantities of 723A/B, 3C22, etc., tubes; any laboratory equipment. Top cash or swap; rush! Engineering Associates, 434 Patterson Road, Dayton 9, Ohio.

FOR Sale: National 183 receiver, practically new, latest model before 193-D, gunmetal finish, black knobs, with speaker. Excellent buy, \$225.00. F. H. B. W. B.

BEAT TV! One 7" television receiver, \$35.00. One 10", \$50. Excellent as monitor, other uses around shack. W4AF1, Spitz, 1420 South Randolph, Arlington, Virginia.

RADIO formulae, lucidly explained, 28 pp, 30¢, invaluable to hams. Request list ingenious circuits oscillators, receivers, measurement equipment. S E R Company, 543 Lexington St., Waltham, Mass.

COLLINS 32V1, perfect, \$449.95. Welco all-band 50-watt phone xmitter, \$69.95 or trade, plus cash for National or Collins revr. Leroy E. Halsted, W0KUK, 5616 Ammons, Arvada, Colo.

SELL or swap: New York City vicinity preferred. 400 watt phone/cw transmitter in 7 ft. enclosed cabinet, 5 pwr supplies, PP810's, modulators 811's, \$225.00; Meck T-60 transmitter, \$60.00; German 1934 telephones, \$20 for pair; Lyaco 10 in. converter and noise-clipper, \$20.00; RME-99 receiver, \$15.00. Sell each for \$175.00. Viking II. A. E. Kimeldorf, W2KQA, 936 Chancellor Ave., Irvington 11, N. J.

KAAR Engineering Co. FM equipment: FM-176A transmitter, 50 watt, FM-40A receiver, power supply, all in enclosed steel rack; Tunes 152-162 Mcs, cost \$885.00; one new unit, \$300.00; one used, \$175.00. RSA-251M remote control unit for above. New. Cost Sell for \$75.00. Mobile FM-50X transmitter, FM-39X receiver, 30-4 Mcs. Used. Cost \$15.00. Sell each for \$175.00. FM-50X transmitter. New. Cost \$335.00. Will sell for \$150.00. 32 VDC dynamotor power supply, 50 watts. New. Cost \$160.00. Sell: \$50.00. Entire lot plus \$200.00 worth of tubes, antennas, accessories. \$700.00. Thomas Dale, W1TWP, Box 868, Portsmouth, N. H.

RF chokes: Bud, Ohmite, Meissner, etc. values to \$1.25 each; ten assorted myr. coils for \$1.25. Millett 807 tube shields: 4 for \$1.00. National discriminator type 1R, 32.00 each. Aerovox 150µµ silver micas: ten for \$1.00. All new and pp. H. W. Merideth, W5PQA, 3912 Anderson Ave., SE, Albuquerque, N. M.

SELL: Harvey-Wellis IBS-50D xmitter, \$109.00; APS-50 power supply, \$29.00; Hallcrafters S-76 receiver, \$119.00; R-46 speaker, \$11.00. All in excellent condition. Sawicki, W5UKD, 7349 Southway, Houston, Texas.

BIRTH announcements, ham-styled, 25 for \$1.00. Narvestad, Granite Falls, Minnesota.

SELL: AR88, less speaker, with front panel xtal phasing, ART-13 with power supplies. What offers? V6JAZL, 25767 i/s Paterson, RCAF Station, Clinton, Ontario, Canada.

BARGAINS: New and reconditioned Collins, Hallcrafters, National, Hammarlund, Johnson, Arac, Harvey-Wellis, Babcock, Gonsert, Morrow, RME, Millen, Meissner, Lyaco, Worktop, Plyco, others. Reconditioned S38, \$29.00; S40A, \$69.00; S40B, \$79.00; SX43, \$119.00; S-76, \$129.00; SX-71, \$149.00; SX-42, \$199.00; SX-62, \$199.00; SW54, \$35.00; NC57, \$69.00; NC125, NC173, NC183; N1483D, HRO5TAL, HRO7, HRO50T, HRO50T1, HRO60, HQ-129X, SP400X, RME-84, RME-43, VHR152A, HF-10-20, Lyaco 600, Collins 75A1, 75A2, 32V1, Viking transmitter, etc. shipping on approval. Terms. List free. Write to Henry Radcliff, Butler, Mo.

SELL or trade: Wire recorder Webster Model 178-1, with mike and it has a meter for recording level; "new", S/ Supreme oscillograph "new condx". Also new Sylvania tubes in boxes 10-1LA4; 5-1A4P, 25-1LE3, 5-1H6, 5-6T7, 10-65T7, 10-627, 5-12J5; 5-12Z3; 5-12SF5; 5-12Z3; 5-14C5; 5-14S7; 10-2V55, 8-26, 5-27, and 5-34. Don Clark, W4OHG, 105 N.W. Main, Blackfoot, Idaho.

CRYSTALS - Those hard-to-get spot amateur freqs. 1.8 to 7.4 Mc, \$2.50. Pennsylvania Crystal Co., K 2, Knox, Penna.

"SUITCASE Portable", see QST Dec '51; a complete station using 6146 final 600, \$95.00. Also CW/FM 1500 cps. xmitter using 4-65A built-in HT-18 and National all band tank, rack mounting TV1 proof. A steal at \$150.00. C. P. Ross, 1006 Lake Ave., Wilmette, Ill.

WANTED: 2-meter fone rig. Complete with converter and power supply. Will pay cash. All replies will be answered. J. Dugan, Jr., W2CML, 9 Sunset Dr., Clark TWP, P. O. Cranford, N. J.

FOR Sale: "Auto-Lite" automotive generator, 12 VDC, 50 amperes with matching regulator. In excellent condition. \$50.00. New Exide aircraft battery, 28v 63 amps, \$40.00. James W. Craig, Jr., Box 6119, Mather FFB, California.

SELL: Ten meter Workshop beam, C-D rotor, never used, W2KX, 102.50. Also Preato K-8 disc recorder, in good condition, W2KHJ, 13-36 230 Plze, Laurelton 13, L. I. N.

BARGAINS: Extra special: Motorola 6-69 13 mobile receivers, \$29.50. Globe 50 \$275.00. HT-9 \$199.00. LR-50 \$200.00; Lyaco 600, \$109.00; HRO-7 \$199.00; Collins 75A1, \$275.00; HRO-57 \$175.00; SX-71, \$159.00; SX-42, \$189.50; SX-43, \$129.00; HRO-Senior, \$119.50; RME 2-11, \$99.50; RME-45, \$99.00; Meissner EX Shifter, \$59.00; S-40A or SX-16, \$69.50; VHF-152, \$59.00; HF 10-20, \$59.00; Globe Trotter, \$79.50; Meissner Signal Calibrators, \$24.95; MB611 mobile transmitters, \$19.95; 90800 exciter \$29.50; RCA channel \$69.50; XE-10, \$14.95; Gonsert 10-1 converter \$19.95 and many, many others. Large stock of trade-ins. Free trial. Terms financed by Leo, W6GFC. Write for catalog and best deal to World Radio Laboratories, 740-44 W. B'way, Council Bluffs, Iowa.

QSLs by Petty, W2HAZ, 17 Southward, Trenton, N. J. Samples, 10¢.

WANTED: Electro Importing, DeForest, Marconi, Wireless Specialty Apparatus; QST Wireless Age, Electrical Experimenter, Marconigraphs before 1920. Early catalogs, etc. Please describe items in detail and give price wanted. Louis Rizoli, W1AAT, 100 Bay View Ave., Salem, Mass.

PANADAPTOR SP-44 with new 3" tube, \$45.00; Sylvania modulation meter, never used, \$22.00; Premax 75 meter vertical antenna, AL-535 aluminum six-section adjustable 35 ft. 8 inch with loading coil type 1 base insulator, list \$97.50, Will sell for \$39.50. W1PST.

SELL: Latest National 183D, in original carton, \$320.00. W9DHT. Richard Karl, 2836 Leland Ave., Chicago 25, Ill.

WANTED: Service manual, schematic, plug-in meter, control box for AVT-23 aircraft transmitter. If you have any of the above items, please contact me. Leo Braxton, W4RIH, Box 24, Cottdale, Fla.

WANTED: Collins 30-B transmitter. Will pay cash and pick up in metropolitan New York area only. Have 32V-2 or 75A-2 as part trade if desired. Please write W2AEB, 90 Lakewood Ave., Cedar Grove, N. J.

FOR Sale: Collins 310-B-3. In good condition and complete with all coils. Best offer over \$200.00. Fredrick Ostlund, W6PLV, Clyde, Kansas.

GONSET Triband Converter, new factory sealed cartons, guaranteed. Special, \$39.95. Variety Electric Co., Inc. 468-70 Broad St Newark 2, N. J.

QSLs. Stationery, samples. Dime, refunded. Gale, W1BD, Waterford, Conn.

SELL: Teletype equipment, motors, parts. Want: BC-610-E, BC-614-E, APR, APN, ART-13, BC-348, BC-312, RA-62, RA-34, BC-1306, PE-237, GN-58, technical manuals, test equipment. Tom Howard, W1AFN, 46 Mt. Vernon St., Boston 8, Mass. Richmond 2, N. Y.

ANTENNASCOPE, new, unused, commercially built, employing 50 microamp. meter \$22.50. Selection. Used only 2 hours. Like new, \$20.00. BC-187A, Army surplus 80 meter transmitter. New condition, \$20.00. C. H. Scheiffy, M.D., Mayo Clinic, Rochester, Minn. QSLs! Interesting samples, 10¢. Tooker Press, P.O. Box T, Lakehurst, New Jersey.

12 piece drill set, chrome Vanadium Speed steel 1/16" to 1/8" \$3.49; 866A kit, two tubes, sockets and transformer, \$5.49. Sell your surplus tubes and equipment. Free Tabogram. "TAB", 111 Liberty St., New York 6, N. Y.

HARRISON'S QSLs. Samples for stamps, 8001 Piney Branch Road, Silver Spring, Md.

TWO-METER converters, crystal controlled, wired, \$12.00. Transmitters, 15 watts, phone, pre-assembled kits, \$34.50. L.W. Electronic Laboratory, Route 2, Jackson, Mich.

B & W 20TUL coil-base, like new, \$7.00; Instructograph, spring-wind built-in oscilloscope and sprk, 13 tapes, \$25.00; Editors etc. Handbook, new, \$5.00; National TM-H-75D, 350 volt condenser, new, \$5.00; 2-J-37 keys, new, 50¢ ea.; WRL Globe-Trotter, coils for 10-40-80, like new, have orig. container, \$85.00; PE-103 Dynamotor, base & cables, \$30.00 never used, FR 826's with ceramic sockets, \$2.00; TB3, tilt base for National 173, \$2.50; Elincor 2-meter beam, never used, \$6.50. K. Lindberg, W2KLH, 229 Sampson, Jamestown, N. Y.

FOR Sale: 1 Milen 90881 R.F. amplifier 500 watts, pr. of 812A, power supply for same 400 mA 1500 volts; 1 Milen 90800 50 watt transmitter and exciter, matched power supply 90281, all in one cabinet, \$175.00; one BC221M with regulated pwr supply, \$100.00; 1 Sonar XE10, \$20.00; 1 BC348N with separate power supply \$55.00; 1 BC459 and BC696 in a dual rack with power supply, \$60.00. All gear in working order. Will not ship. Must pick up. W3MQS Charles S. Howard, 194-49 115RD, St. Albans 12, New York, N. Y.

QSLs 100 2-colors, 23 & 3 colors, \$3.00 processed same day. Remit with order. CPS Blendenburg, Md.

FOR Sale: HRO-50-T1, purchased Jan. 1952. C. J. Haas, 121 E. 6th, Junction City, Kansas.

QSLs, SWLs. New! See the 1953 line. Samples, 10¢. Almar Printing Service, 602 Barker Building, Omaha, Nebraska.

SELL: 4D32, brand new, never used, \$18.00. W6LUR, 710 Lobos Pacific Grove, Calif.

10 and 15 & 20 meter beams, aluminum tubing, etc. Perforated aluminum sheet for shielding. Radcliff's, Fostoria, Ohio.

LIQUIDATION of complete electronic stock laboratory and testing equipment of highest quality. No war surplus in this stock. Few used items. Electronic gear from smallest to large commercial size. This opportunity is your dream come true. Must hurry. Send ten cents for aerial inventory and reports. Industrial Electric Company, Fallon, Nevada.

SELL: Hammarlund Super-pro SP-400-SX receiver. Excellent condition. Power supply and speaker, \$250.00. Boulder City, Nev. Also sell Collins 23-B transmitter. Complete cool KW, 1.75 Mc to 21 Mc. Bandswitching or autotune. CW and AM phone. New spare tubes included, \$400. Worth more in components. No crating. Bring truck or trailer. Ray Warner, W7JU, 539 Birch St., Boulder City, Nev.

SELL: Hallcrafters SX-42 like new, with special Peerless Hi-Fi output transformer. Operation and maintenance manuals included. Used very little as had other sets. Only \$195.00. Dwight Baum, W6FRB, 1011 Oak Grove Ave., San Maricao, Calif.

TROUBLE obtaining ham parts or equipment? Why not try a parts distributor who specializes in catering specifically to radio amateurs and who employs licensed, active amateurs to serve you? We trade and offer terms. Write Carl, W1BFT at Evans Radio, Concord, N. H.

FOR Sale: HRO50T, like new, in and out in original cartons with coils A,B,C,D. FM adaptor, xtal calibrator and matching speaker. Used very little. \$300.00. C. R. Schmidt, W9LRW, 146 West 5th Ave., Naperville, Ill.

FOR Sale: HT9 Hallcrafters xmitter, including Meissner signal shifter, three 814s, Elicdo TV1 filter, \$200 or make best offer. W9COB, 11606 Yale Ave., Chicago 28, Ill.

SELLING: Temco 100 watt xmitter daily on 75; DM-36 HF converter; Collins 310B3 exciter-xmitter. W2JLL, Box 746, Brooklyn, N. Y.

WANTED: Variometer, Vario-coupler, crystal set or other equipment made in early 1920's by Columbian Radio Corporation of Chicago. Good price paid. Write I. W. Rubin, Allied Radio Corp., 833 W. Jackson Blvd., Chicago 7, Illinois.

COLLINS 310B-1 and HRO7R. New condition, \$200.00 each. N. G. Ray, Rte 3, Box 481, Bothell, Washington.

CABLES: Crystals, Six PE-103 dynamotor cables, two plugs attached, \$2.75 each, W5C-223 transmitter cables, PL149 plug attached, \$2.75 each. Miscellaneous crystals in Marine Frequencies 2000 to 3000 Kilocycle range, for BC-223 and other transmitters, \$4.00 each. Also some 3105 and 6210 kilocycle aircraft crystals, \$4.00 each. W6KEC, 2142 Parkway Dr., El Monte, Calif.

Designed for



Application

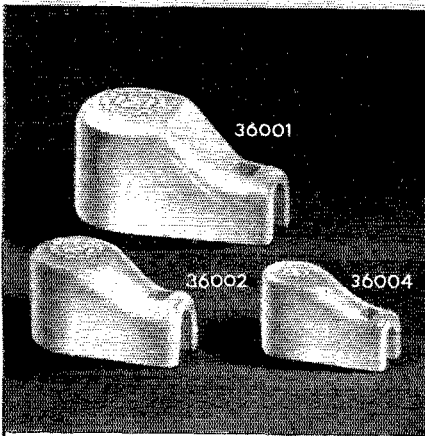

36000 SERIES Ceramic Plate or Grid Caps

A new addition to this series of exclusive Millen "Designed for Application" products is the 36004 for use on tubes with 1/4" diameter contacts. Efficient, compact, easy to use and neat appearing. Soldering lug and contact one-piece. Lug ears annealed and solder dipped to facilitate easy combination "mechanical plus soldered" connection of cable. No. 36001 for 9/16" tube terminals, No. 36002 for 3/8". No. 36004 for 1/4".

JAMES MILLEN MFG. CO., INC.

MAIN OFFICE AND FACTORY

MALDEN
MASSACHUSETTS



Index of Advertisers

Adirondack Radio Supply	136
Akers Co., Dallas	132
Allied Radio Corporation	105
American Electronics Co.	118
American Lava Corporation	144
American Phenolic Corporation	94
American Radio Relay League, Inc.	
<i>Handbook</i>	99
<i>QST</i>	134
<i>License Manual</i>	116
<i>Group Offer</i>	121
Arrow Electronics, Inc.	135
Ashe Radio Company, Walter	113
Barker & Williamson, Inc.	2
Belden Manufacturing Co.	91
Bendix Radio Division	122, 135
Bliley Electric Company	89
Bud Radio, Inc.	93
Burstein-Applebee Co.	100
Calamar	131
Candler System Company	131
Centralab	95
Central Electronics, Inc.	128
Chicago Transformer Co.	82
Collins Radio Institute	76, 77
Concord Radio	102
Dollar Co., The Robert	137
Dow-Key Co., Inc.	126
DX Radio Products	114
Eitel-McCullough, Inc.	83
Eldico of New York, Inc.	78, 79
Electro-Voice, Inc.	Cov. 11
Engineering Associates	135
Evans Radio	136
Federal Telephone & Radio	101
Fort Orange Radio Distrib. Co., Inc.	125
Gardiner & Company	132
General Electric Company	1
Gonset Company, The	92
Gotham Hobby Company	136
Green Instrument Corp.	133
Hallcrafters Co., The	4, 5
Hammarlund Manufacturing Co., Inc.	80, 81
Harrison Radio Corporation	115
Harvey Radio Company	111
Harvey-Wells Electronics, Inc.	99
Heath Company, The	130, 131
Henry Radio Stores	109
Hudson Radio & Television Corp.	98
Hughes Research & Develop. Labs.	107
Hy-Lite Antennae, Inc.	126
Instructograph Company	137
Johnson Company, E. F.	86, 87
Knights Company, The James	143
Lafayette Radio	129
Letrine Radio Manufacturing Co.	124
Mallory & Co., P. R.	85
Masa Radio & Telegraph School	135
Merit Transformer Corporation	110
Miffland Manufacturing Co., Inc.	97
Millen Manufacturing Co., Inc., The James	142
Motorola, Inc.	120
Multi-Products Co.	103
National Co., Inc.	Cov. III, 75
Newark Electric Company	119
Peterson Radio Company	7
Philco (TechRep Div.)	139
Pioneer Tool Company	128
Port Arthur College	118
Precision Apparatus Company	84
Radcom Engineering Company	106
Radio Corporation of America	Cov. IV
Radio Shack Corporation, The	117
Raytheon Manufacturing Co.	88
RCA Institutes, Inc.	136
Shure Brothers	104
Sonar Radio Corporation	133
Steinberg's, Inc.	123
Sun Radio of Washington	139
Sylvan Laboratories	112
Telex, Inc.	137
Tele-Vue Towers, Inc.	132
Terminal Radio Corporation	122
Trans World Airline, Inc.	135
Triad Transformer Mfg. Co.	108
Turner Company, The	133
Valparaiso Technical Institute	139
Variety Electric Co., Inc.	139
Vesto Company, Inc.	120
Vibroplex Co., The	134
Weston Laboratories	139
Wind Turbine Company	124
World Radio Laboratories, Inc.	127
YMCA Trade & Tech. Schools	134

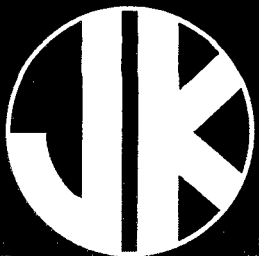

PRODUCTS

Let Ship-to-Shore is Ship Shape

Her decks may be awash but there's fair weather in the radio shack. Despite wind and waves the Captain's message will reach the home port. In fair weather or foul, you'll find JK Crystals rate a Navy "E" for their part in keeping marine communications "ship shape."

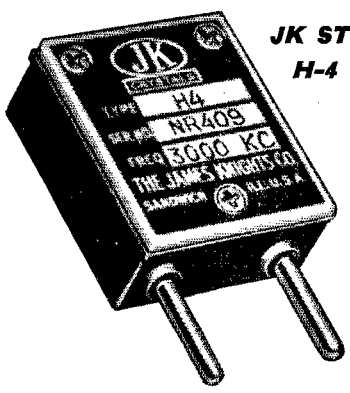

**JK STABILIZED
H-4 CRYSTAL**

CRYSTALS FOR THE CRITICAL

A versatile crystal the JK H-4 is widely used as a replacement crystal in marine and other communications systems. Pressure mounted, dust and water proof, stainless steel electrodes. Frequency range 1800 kc to 15 mc. Military type holder. Another of the many JK Crystals available to serve every need.

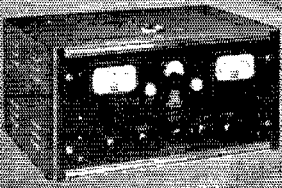

the JK
FB-12

FREQUENCY & MODULATION MONITOR

Monitor any four frequencies anywhere between 25 mc and 175 mc, checking both frequency deviation and amount of modulation. Keeps the "beam" on allocation, guarantees more solid coverage, too!

THE JAMES KNIGHTS COMPANY

SANDWICH ILLINOIS



ALSIMAG[®]

GIVES YOU
THE BEST IN

HF
INSULATION

Custom Made
Technical Ceramics

FOR ELECTRONIC AND ELECTRICAL USES
SOLD ONLY TO MANUFACTURERS

AMERICAN LAVA CORPORATION

CHATTANOOGA 5, TENNESSEE

51ST YEAR OF CERAMIC LEADERSHIP

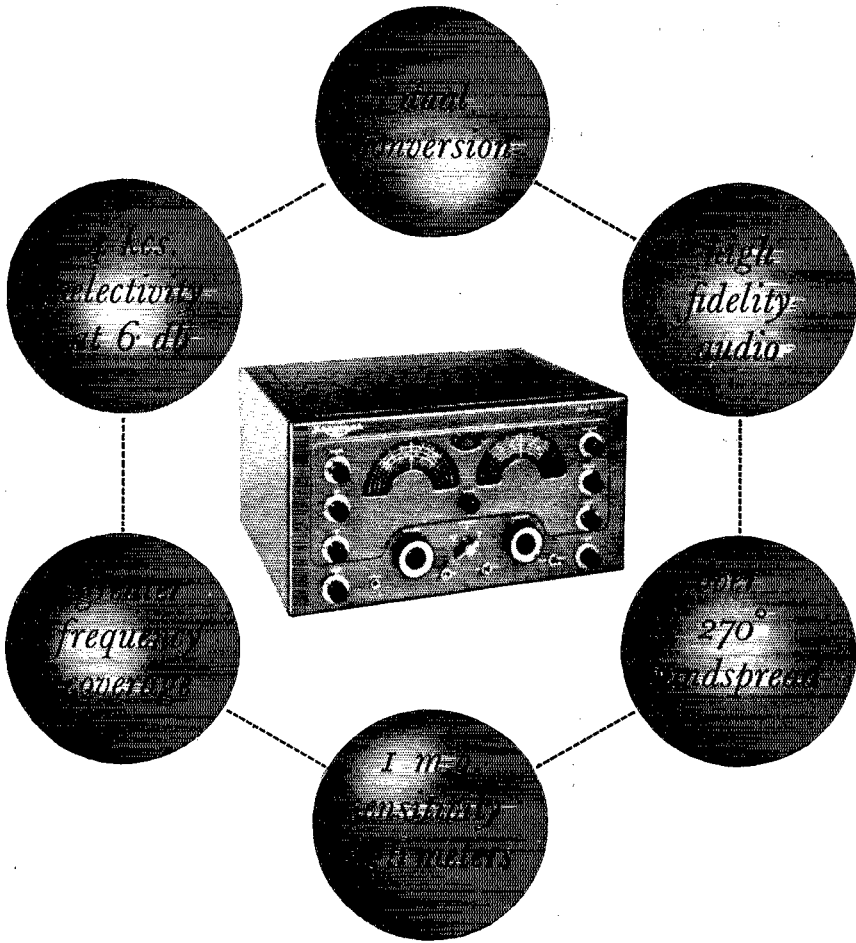

NC-183D

THE ONLY RECEIVER WITH ALL THESE FEATURES FOR LESS THAN \$500!

Dual conversion on the three highest ranges! Twelve tuned circuits (16 on the three high bands)! Excellent separation of phone signals. One microvolt sensitivity on 6 meters! Audio essentially flat to 13,000 c.p.s.! Exceptional coverage — from 540 kcs. to 31 mcs. and 47 mcs. to 55 mcs.! Bandspread scales that are a pleasure to read!

No other receiver selling for less than \$500 can give you all these features!

\$369⁵⁰*

(less speaker)

*slightly higher west of the Rockies

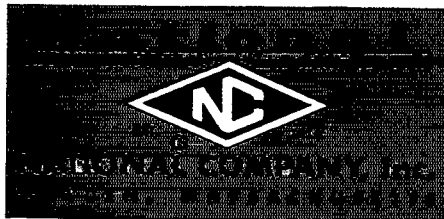

"Ether buster"



...penny pincher

**500 watts input*
...4 watts drive!**

HERE'S a real champion when it comes to circuit simplicity, operating convenience, high power, and economy. For high-power work . . . for full input up to 30 Mc with a 6L6 driver, RCA 813 delivers *more watts per dollar than any other amateur beam power type in its class.*

The low driving power required at the grid of this "ether buster" also allows you to simplify the design of the exciter circuit, thereby making it easier to minimize TVI.

Get an RCA 813 for your new high-power final. Your RCA Distributor carries them in stock.

It's a "power house"
(ICAS ratings) { 500 watts input on CW
 { 400 watts input on phone

*CW rating, ICAS

Suggested user price \$18.00

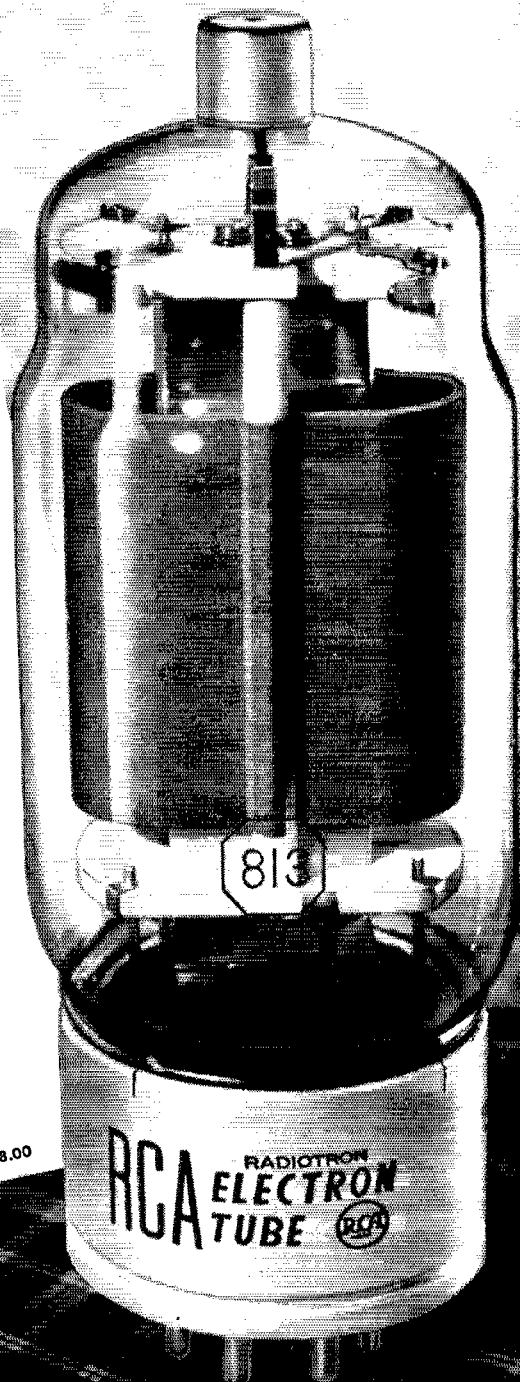

RADIO CORPORATION of AMERICA
ELECTRON TUBES

HARRISON, N. J.