

March, 1948

35 Cents

QST

devoted entirely to

amateur radio

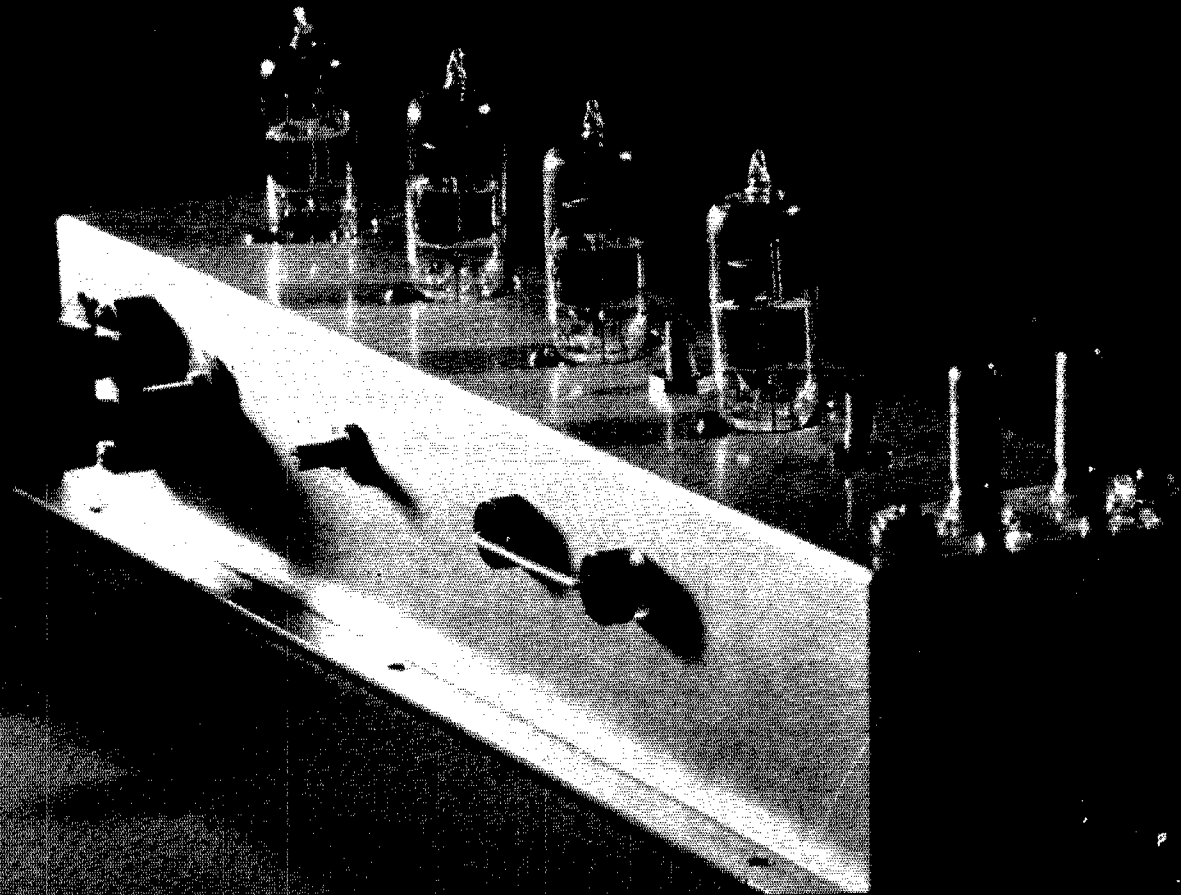

PUBLISHED BY THE AMERICAN RADIO RELAY LEAGUE

NEW!

Commercial Grade Components

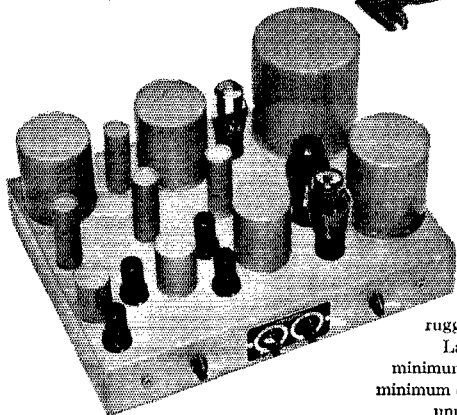
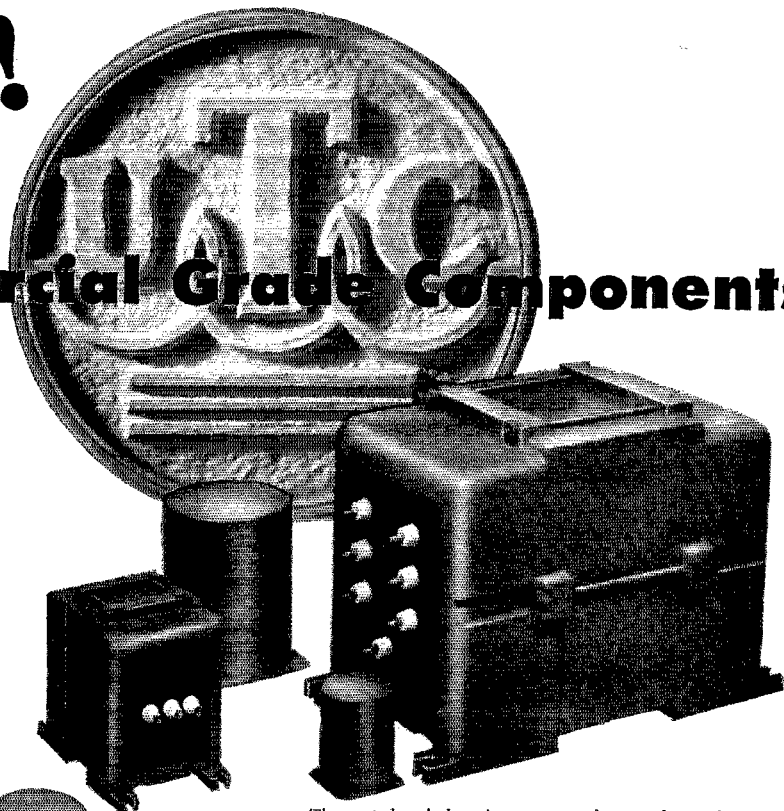

The past decade has shown tremendous strides in the adaptation of electronics to the industrial field. The new UTC Commercial Grade Series of transformers was developed to meet the requirement of this field as well as that of the discriminating amateur and public address man.

CG units are conservatively designed with low temperature rise and good insulation factors to assure dependability in continuous service. All coil structures are vacuum impregnated, and cases are poured with special sealing compounds to assure stability under adverse climatic conditions.

The mechanical construction is rugged. Audio units and power units up to 300 V.A. are housed in heavy drawn steel cases with rugged lugs on moisture-proof bakelite, arranged for chassis mounting.

Large power and audio components employ cast aluminum shells for minimum weight, and support the lamination in vertical position to occupy minimum chassis space. CG units are finished in light grey enamel and result in unusual professional appearance on equipment in which they are used.

The CG line includes audio components for all applications ranging from low level... humbucking... multiple alloy shielded input transformers to 600 watt Varimatch modulation transformers. Power and filament components range up to those required for a 3,000 volt 1 Amp. plate supply.

For full details on this new line, write for catalogue PS-408.

United Transformer Corp.

150 VARICK STREET

NEW YORK 13, N. Y.

EXPORT DIVISION: 13 EAST 40th STREET, NEW YORK 16, N. Y.

CABLES: "ARLAB"

FOR THOSE NEXT TWO BANDS...

235 MC

420 MC

GL-8025-A U-H-F TRIODE
500 mc frequency at max input

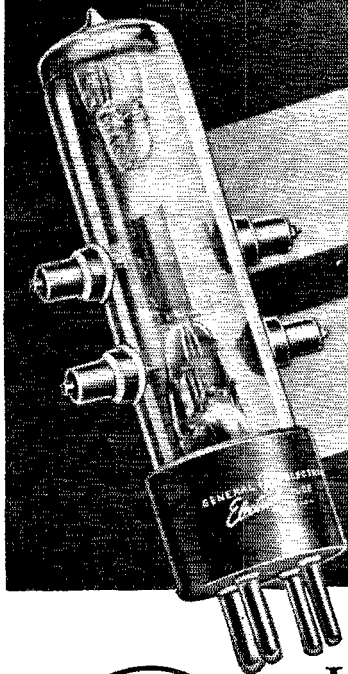

GL-8025-A

ELECTRICAL CHARACTERISTICS

Filament voltage	6.3 v
current	1.92 amp
Interelectrode capacitances:	
grid-plate	3.0 mmfd
grid-filament	2.7 mmfd
plate-filament	0.4 mmfd
Frequency at max ratings	500 mc
Ratings (ICAS) for typical operation	
<i>R-f oscillator, Class C Telegraphy</i>	
Plate voltage	1,000 v
current	50 ma
Grid voltage	-90 v
Power output	35 w

HAMS seldom are satisfied — which of course means radio progress. Now that long-distance contacts are an old story on 6 and 2 meters . . . how about 235 mc (1¼ meters) and 420 mc (¾ meter)? What is needed to get on the air on those bands?

It's clear that your lower-frequency equipment won't serve. A new circuit and new components are called for, with spotlight falling on the power tube.

Type GL-8025-A takes the center of the stage by reason of (1) a frequency range up to 500 mc at max ratings, (2) adequate power—50 w max CW input, (3) advanced

design, especially in features that contribute to low lead inductance, so important in u-h-f work.

Note, for example, the double side leads to plate and grid, extremely short; also the center-tapped filament, by means of which you can cut filament-lead inductance to a minimum.

Inspect this modern u-h-f power triode at your G-E tube distributor's. And get ready for a pleasant surprise when you ask the price, for the GL-8025-A is another G-E top tube value! *Electronics Department, General Electric Company, Schenectady 5, New York.*

March-April issue of Ham News is called the "gadget edition" because it describes a whole group of novel devices to add to your satisfaction as a ham—a miniature volt-ohmmeter, a field-strength meter, and many others. Don't miss this idea-packed issue, which will be available shortly. Ask your G-E tube distributor to reserve a copy for you.

ELECTRONIC TUBES OF ALL TYPES FOR THE RADIO AMATEUR

GENERAL ELECTRIC

161-GA3-8850

"To Work Them . . . You Have To Hear Them"

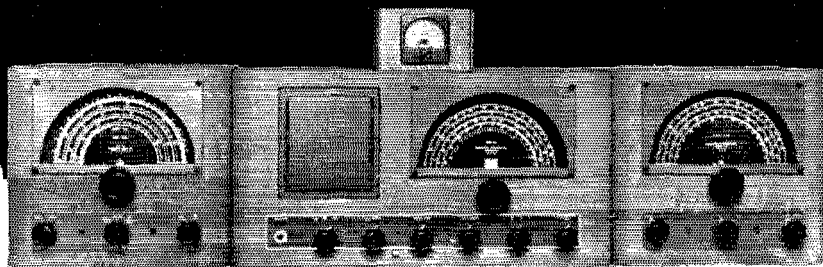

Nothing is any truer than the oft repeated statement that if you can't hear 'em you can't work 'em. By supplying the finest in receiving equipment, RME is helping hams pile up impressive DX records—whether it be on the lower frequencies or on two or six meters.

THE RME 84

For Home, Portable or Mobile Operation

The RME 84, illustrated above, is a quality receiver in the lower price field that will give you the most for your money. It operates from 115 volts, AC, batteries or from the VP-2, a six volt power pack, optional with the RME 84. Also optional, is the CM-1—Carrier Level "S" Meter. The RME 84 outperforms anything in its price class.

VHF-152 CONVERTER

For 2, 6, 10 and 11 Meters

Illustrated at top left is that popular matched instrument that has set scores of new DX records on the high frequencies. It has built in power supply, voltage regulator and temperature stabilized oscillator circuits. There's provision for connection of 4 separate antennae.

DB22 PRESELECTOR

Illustrated at top right is the new DB22 Preselector, with self-contained power supply, and an over-all gain of 30 db throughout its tuning range of .54 to 44 mc. The image ratio is 50 db down with a communications receiver such as the RME 45, or the 84.

THE HF 10-20 CONVERTER

This unit provides outstanding and imageless reception on 10, 11, 15 and 20 meters. Output (i.f. frequency) is 7 mc. Features include provision for separate antenna, band selector switch, self-contained power supply, planetary tuning and high gain. If your receiver tunes only to 18 mc, the HF 10-20 is necessary for reception on 10, 11 and 15 meters, and will provide improved reception on 20 meters.

THE "BOOMERANG" (MB-3)

The new "Boomerang" is a break-in device, a signal monitor, a code practice unit and a tone modulator for MCW. It will follow the fastest bug and provide the best method for rapid and efficient break-in. Because it will help you monitor the band even when sending—your receiver is in operation when the key is up—you can avoid needless QRM. Hams everywhere are finding that the new "Boomerang" improves QSO's 100%. Unit has self-contained power supply. See this marvel at your dealer.

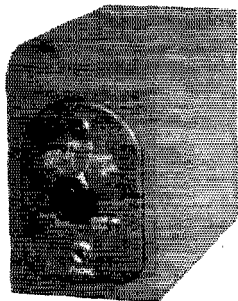

RME

FINE COMMUNICATIONS EQUIPMENT
RADIO MFG. ENGINEERS, INC.
 Peoria 6, Illinois U. S. A.

Illustrated Folders On Request
 Canadian Representative: Measurement
 Engineering Ltd., Arnprior, Ont.



MARCH 1948

VOLUME XXXII • NUMBER 3

PUBLISHED MONTHLY, AS ITS OFFICIAL ORGAN, BY THE AMERICAN RADIO RELAY LEAGUE, INC., AT WEST HARTFORD, CONN., U. S. A.; OFFICIAL ORGAN OF THE INTERNATIONAL AMATEUR RADIO UNION

STAFF

Editorial

KENNETH B. WARNER, W1EH
(Managing Secretary, ARRL)
Editor

HAROLD M. McKEAN, W1CEG
Assistant Editor

GEORGE GRAMMER, W1DF
(Technical Director, ARRL)
Technical Editor

DONALD H. MIX, W1TS
BYRON GOODMAN, W1DX
Assistant Technical Editors

EDWARD P. TILTON, W1HDQ
V.H.F. Editor

RICHARD M. SMITH, W1FX
C. VERNON CHAMBERS, W1JEQ
JOHN W. PADDON, VE3BLZ
Technical Assistants

ROD NEWKIRK, W9BRD/1
DX Editor

WALTER E. BRADLEY, W1FWH
Technical Information Service

Production

RALPH T. BEAUDIN, W1BAW
Superintendent

NANCY A. PRICE
Assistant

Advertising

F. CHEYNEY BEEKLEY, W1GS
LORENTZ A. MORROW, W1VG
EDGAR D. COLLINS

Circulation

DAVID H. HOUGHTON
Circulation Manager

RALPH T. BEAUDIN, W1BAW
Assistant Circulation Manager

OFFICES

38 La Salle Road
West Hartford 7, Connecticut

Subscription rate in United States and Possessions, \$3.00 per year, postpaid; \$3.50 in the Dominion of Canada, \$4.00 in all other countries. Single copies, 35 cents. Foreign remittances should be by international postal or express money order or bank draft negotiable in the U. S. and for an equivalent amount in U. S. funds.

Entered as second-class matter May 29, 1919, at the post office at Hartford, Connecticut, under the Act of March 3, 1879. Acceptance for mailing at special rate of postage provided for in section 1103, Act of October 3, 1917, authorized September 9, 1922. Additional entry at Concord, N. H., authorized February 21, 1929, under the Act of February 28, 1925.

Copyright 1948 by the American Radio Relay League, Inc. Title registered at U. S. Patent Office.

- CONTENTS -

"It Seems to Us . . ." 11
Our Cover 12
500 Watts of Audio from AB1, Harry A. Mandoli, ex-W6HAM, and David H. Atkins, W6VX 13
Coaxial-Line V.H.F. Receivers, Joseph Santangelo, WINXY 20
Happenings of the Month 24
A Single-Control 180-Watt Transmitter, T. A. Benham, W3DD 25
Adjusting the Matching Stub, William L. Smith, W3GKP 31
A Bandpass Converter for 144 Mc., John E. Williams, W2BFD 34
Public Relations for the Amateur 38
United States Naval Reserve 41
Technical Topics
Single-Sideband Power Gain 42
Inductive Coupling to Rotary Beams 43
New Apparatus 44
A Mobile Transmitter-Receiver for Shipboard, William K. Squires, W2PUL 45
Silent Keys 47
Ten Elements; Ten Meters, E. C. S. Leavenworth, W6ZV 48
The World Above 50 Mc. 50
In QST 25 Years Ago This Month 54
I.A.R.U. News 55
Underground Antennas, Paul M. Cornell, W8EFW 56
VE/W Contest 57
Navy Day - 1947 58
No Turrets - Just Tune!, Allen King, jr., W1CJL 59
Improved Break-In Keying, Byron Goodman, W1DX 64
How's DX? 68
'Phone-Band Phunnies, John T. Frye, W9EGV 72
Hamfest Calendar 72
Revised WWV Schedule 72
Hints and Kinks 73
Correspondence from Members 74
Operating News 75
Station Activities 82



\$110.00 Amateur net

What...

HALLICRAFTERS MODEL HT-18 VARIABLE MASTER OSCILLATOR DOES FOR IMPROVED AMATEUR TRANSMISSION

The HT-18 is called by hams who have used it the most efficient, flexible piece of gear to be developed in recent years. Easily added to your present transmitter, it brings it right up to date. Narrow band FM and calibrated 5 band V.F.O. complete in one compact cabinet with all coils and power supply concentrates and simplifies your entire operation. Put your transmitter anywhere, place the neat, highly functional HT-18 on the operating table and you're in action. Narrow band FM quality like you've never heard before. The HT-18 places your signal *anywhere in the band* with excellent stability. Go to your nearest Hallicrafters distributor today for a demonstration and complete technical data on this splendid instrument.

Follow the Gatti Hallicrafters scientific safari to the "Mountains of the Moon" — Hallicrafters sponsored mobile radio equipped expedition now in East Africa, operating regularly via shortwave. See your local distributor for maps, itinerary, and probable schedules.

EASY, PRECISE, FLEXIBLE OPERATION FOR THESE REASONS:

- Converts any good CW transmitter to a high quality phone transmitter.
- Eliminates 90% of broadcast interference.
- Puts your signal *anywhere in the band* with stability comparable to crystal controlled transmitter.
- Gives you direct calibration, direct output on all bands 80, 40, 20, 15, 11, 10.
- Simplifies operation of entire station. Puts both frequency selection and power control at your finger tips. 72 ohm output. Remote power control terminals.

hallicrafters FAMOUS

MODEL

SX-42



**CONTINUOUS
FREQUENCY COVERAGE
FROM 540 kc TO 110 Mc
IN 6 BANDS: AM-FM-CW**
\$275.00 *Amateur net*

Greatest continuous frequency coverage of any communications receiver—from 540 kc to 110 Mc in six bands AM, FM, CW—with exceptionally fine performance on CW. Offers in one superbly engineered, precision instrument a top flight standard and VHF communications receiver; standard, short wave and FM broadcast receiver. Freedom from drift and maximum stability are provided by temperature compensation and the use of a type VR-150 voltage regulator tube. The tremendous frequency range is made possible by the development of a new "split-stator" tuning system and the use of dual intermediate frequency transformers.

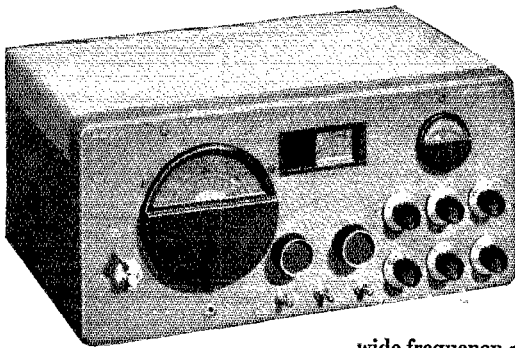

**MODEL
SX-43**

\$169.50 *Amateur net*

**ALL THE ESSENTIAL
AMATEUR FREQUENCIES
FROM 540 kc TO 108 Mc**

The SX-43 provides custom quality, precision engineering, excellent performance and wide frequency range at a medium price. The SX-43 offers continuous coverage from 540 kc to 55 Mc and has an additional band from 88 to 108 Mc. AM reception all bands. CW on four lower bands and FM on frequencies above 44 Mc. In the band 44 to 55 Mc, wide band FM or narrow band AM, just right for narrow band FM reception, is provided.

hallicrafters RADIO

THE HALLICRAFTERS CO., MANUFACTURERS OF RADIO AND ELECTRONIC EQUIPMENT, CHICAGO 24, U. S. A.

Sole Hallicrafters Representative in Canada:
Rogers, Majestic Limited, Toronto-Montreal

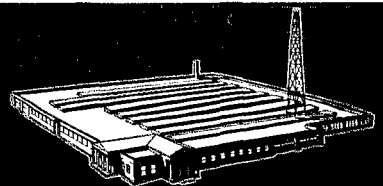

Section Communications Managers of the ARRL Communications Department

Reports Invited. All amateurs, especially League members, are invited to report station activities on the first of each month (for preceding month) direct to the SCM, the administrative ARRL official elected by members in each Section. Radio Club reports are also desired by SCMs for inclusion in QST. All ARRL Field Organization appointments are now available to League members. These include ORS, OES, OPS, OO, and OBS. Also, where vacancies exist SCMs desire applications for SEC, EC, RM, and PAM. In addition to station and leadership appointments for Members, *all amateurs* are invited to join the ARRL Emergency Corps (ask for Form 7).

ATLANTIC DIVISION				
Eastern Pennsylvania	W3BES	Jerry Mathis	623 Crescent Ave.	Glenside Gardens
Maryland-Delaware-D.C.	W3BWT	Eppa W. Darne	132 Tennessee Ave., N.E.	Washington 2, D. C.
Southern New Jersey	W2QXK	G. W. Bill Tunnell	23 Wyoming Ave.	Audubon
Western New York	W2PGT	Harding A. Clark	753 Westmoreland Ave.	Syracuse 10
Western Pennsylvania	W3KWL	Ernest J. Hlinsky	509 Beechwood Ave.	Farrell
CENTRAL DIVISION				
Illinois	W9AND	Wesley E. Marriner	624 College Ave.	Dixon
Indiana	W9SWH	Ted K. Clifton	Route 1, Coldwater Road	Fort Wayne 8
Wisconsin	W9RQM	Reno W. Goetsch	929 S. 7th Ave.	Wausau
DAKOTA DIVISION				
North Dakota	W0GZD	Paul M. Bossoletti	204 Polk St.	Grand Forks
South Dakota	W0NGM	J. S. Foesberg	509 Idaho Ave., S.E.	Huron
Minnesota	W0CWBj	Walter G. Hasskamp	116 3rd Ave., S.W.	Crosby
DELTA DIVISION				
Arkansas	W5TIC	Marshall Riggs	4405 Howell Ave.	Fort Smith
Louisiana	W5TWT	William B. Unruh	Room 313, Jefferson Hotel	Shreveport
Mississippi	W5IGW	Harold Day	Route 2, B. 233	Greenville
Tennessee	W4FLS	James W. Watkins	270 North Howell St.	Chattanooga 4
GREAT LAKES DIVISION				
Kentucky	W4CDA	W. C. Alcock	155 St. Mildred's Court	Danville
Michigan	W8SCW	Joseph R. Beljan, jr.	13959 Tuller Ave.	Detroit
Ohio	W8PNQ	William D. Montgomery	1290 Coolidge Ave.	Cincinnati 30
HUDSON DIVISION				
Eastern New York	W2HZL	Ernest E. George	2044 Lexington Parkway	Schenectady 8
N. Y. C. & Long Island	W2KDC	Charles Ham, jr.	200 Harvard St.	Westbury
Northern New Jersey	W2IIN	John J. Vitale	57 Sayre St.	Elizabeth 3
MIDWEST DIVISION				
Iowa	W0PPP	William G. Davis	3rd St.	Mitchellville
Kansas	W0AWD	William G. Unruh	842 N. Terrace Drive	Wichita 6
Missouri	W0GUD	Mrs. Letha A. Dangerfield	411 Moffet Ave.	Joplin
Nebraska	W0ROK	William T. Gemmer	1708 West 6th St.	North Platte
NEW ENGLAND DIVISION				
Connecticut*	W1VB	Walter L. Glover	Glover Ave.	Newtown
Maine	W1GKJ	F. Norman Davis	RFD 1	Old Orchard Beach
Eastern Massachusetts	W1ALP	Frank L. Baker, jr.	91 Atlantic St.	North Quincy 71
Western Massachusetts	W1AZW	Prentiss M. Bailey	62 Dexter St.	Pittsfield
New Hampshire	W1AQQ	Gilman K. Crowell	15 Academy St.	Concord
Rhode Island	W1BRK	Clayton C. Gordon	70 Columbia Ave., Gaspee	Providence 5
Vermont	W1NDL	Gerald Benedict	23 Foster St.	Montpelier
NORTHWESTERN DIVISION				
Alaska	K7CRF	August G. Hiebert	Box 1540	Anchorage
Idaho	W7IWU	Alan K. Ross	1017 East Jefferson St.	Boise
Montana	W7EQM	Albert Beck	2326 Amherst Ave.	Butte
Oregon	W7HAZ	Raleigh A. Munkres	Box 744	Baker
Washington*	W7ACF	Clifford Cavanaugh	Route 1	Auburn
PACIFIC DIVISION				
Hawaii	KH6EL	John Souza		Wailuku, Maui
Nevada	W7CN	N. Arthur Sowle	Box 2025	Reno
Santa Clara Valley	W6RPT	Roy F. Pinkham	1061 Fremont St.	Santa Clara
East Bay	W6TI	Horace R. Greer	414 Fairmount Ave.	Oakland 11
San Francisco	W6NL	Samuel C. Van Liew	215 Knowles Ave.	Daly City
Sacramento Valley	W6MGC	John R. Kinney	5240 Jay St.	Sacramento 16
Philippines*	KA1CB	Craig B. Kennedy	25 Roosevelt Road	San Francisco, Del Monte
San Joaquin Valley	W6PSQ	James F. Wakefield	2940 Adoline Ave.	Fresno
ROANOKE DIVISION				
North Carolina	W4CYB	W. J. Wortman	6 Duke Power Co.	Charlotte 1
South Carolina	W4BOE/ANG	Ted Ferguson	3422 Rosewood Drive	Columbia 25
Virginia	W4JHK	Walter R. Bullington	1710 Oak Hill Lane, Rt. 1	Richmond 23
West Virginia	W8JM	Donald B. Morris	303 Home St.	Fairmont
ROCKY MOUNTAIN DIVISION				
Colorado	W0QVT	Glen Bond	2550 Kendall	Denver 14
Utah-Wyoming	W7NPU	Alvin M. Phillips	3887 Quincy Ave.	Ogden, Utah
SOUTHEASTERN DIVISION				
Alabama	W4G1W	Dr. Arthur W. Woods	411 Woodward Bldg.	Birmingham
Eastern Florida	W4FWZ	John W. Hollister	3820 Laurie	Jacksonville
Western Florida	W4PAQ	Luther M. Holt	223 W. Romana St.	Pensacola
Georgia	W4HVW	Thomas M. Moss	570 Oak Drive	Hapeville
West Indies (Cuba-P.R.-V.I.)	KP4KD	Everett Mayer	P. O. Box 1061	San Juan 5, P. R.
SOUTHWESTERN DIVISION				
Los Angeles	W61OX	Vincent J. Haggerty	1017 Indio Muerto St.	Santa Barbara
Arizona	W7MLL	Gladden C. Elliott	39 North Melwood	Tucson
San Diego	W6GC	Irvin L. Emig	4852 Marlborough Drive	San Diego
WEST GULF DIVISION				
Northern Texas	W5DAS/MNL	N. C. Settle	5630 McCommas	Dallas
Oklahoma	W5HXI	Bert Weidner	Box 14	Crescent
Southern Texas	W5HIF	Ted Chastain	3037 So. Staples St.	Corpus Christi
New Mexico	W5SMA	Lawrence R. Walsh	P. O. Box 1663	Los Alamos
MARITIME DIVISION				
Maritime (Nfld. & Labr. att.)	VE1DQ	A. M. Crowell	69 Dublin St.	Halifax, N. S.
ONTARIO DIVISION				
Ontario	VE3DU	David S. Hutchinson	90 Wellington Road	London, Ont.
QUEBEC DIVISION				
Quebec	VE2GL	Gordon A. Lynn	c/o Radio Division, Montreal Airport	Montreal, P. Q.
VANALTA DIVISION				
Alberta	VE6LQ	W. W. Butchart	10,740-107 St.	Edmonton, Alta.
British Columbia	VE7WS	W. W. Storey	3915 W. 32nd Ave.	Vancouver
Yukon	VE8AK	W. R. Williamson	Radio Range Sta., D.O.T.	Teatin, V. T.
PRAIRIE DIVISION				
Manitoba	VE4AM	A. W. Morley	26 Lennox St.	St. Vital
Saskatchewan	VE5CO	Norman Thompson	1120 7th Ave., N. W.	Moose Jaw

* Officials appointed to act temporarily in the absence of a regular official.

Jensen

"SECTOR" CABINET

WITH Bass Reflex*

for 8-inch Speakers

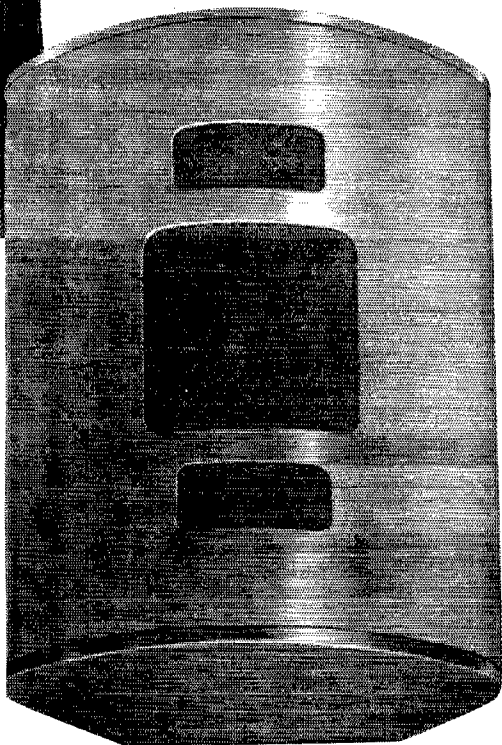
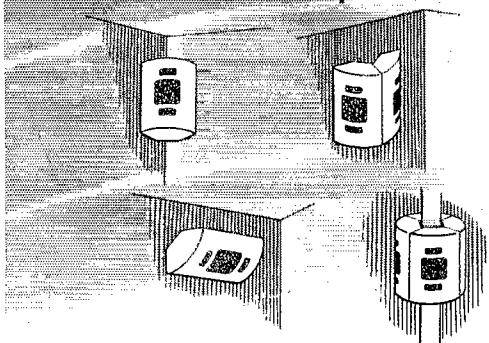

Model H-B1 Sector Cabinet (ST-141) List Price \$22.50

They fit anywhere — in 90-degree corners — flat on walls — or in clusters to give wide-angle distribution. Perfectly adapted for nearly all interior sound installations, because of their economy, small size and, above all, the high quality performance of JENSEN speakers in Bass Reflex enclosures. Use with any JENSEN 8-inch speaker. Model P8-SH is recommended for high fidelity as required by many wired music installations.

Type H Sector Cabinets are built around a frame of solid wood with wood composition replacing the conventional plywood panels.

Finish is brown opaque lacquer although covering colors may be applied on the job if desirable to match environment. Size: Height 22½", width 17¾", depth 8½" Furnished with mounting brackets and screws.

JENSEN MANUFACTURING COMPANY

6611 South Laramie Avenue, Chicago 38

In Canada: Copper Wire Products, Ltd., 11 King St., W., Toronto

* Trade Mark Registered

OTHER Jensen CABINETS

— BASE REFLEX —

PERI-DYNAMIC



IMPERIAL TYPE D
D-151 (15-inch)
D-121 (12-inch)



UTILITY TYPE B
B-131 (15-inch)
B-121 (12-inch)
B-81 (8-inch)

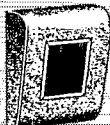

WALL TYPE J
J-61 (6-inch)



Jensen

SPEAKERS

WITH ALNICO 5

Designers and Manufacturers
of Fine Acoustic Equipment

**Speak out...
and be Heard!**

*Overcome Room
Reverberation...
Cut through QRM*

THE CARDAX
CARDIOID CRYSTAL MICROPHONE

**The Only High Level Cardioid Crystal
Microphone with Dual Frequency Response**

You can sit back and relax . . . when you call with the CARDAX. E-V Mechanophase* unidirectivity overcomes room reverberation, permits working at greater distance from microphone. Dual Frequency Response gives you high fidelity for clear channel or rising characteristic for *extra crisp* speech signals that cut through QRM. Brings *more* and *better* QSO's. For DX or Rag-Chewing, there's nothing like it! Smart looking, too! CARDAX, Model 950, lists at \$39.50.

Authorized Distributors Everywhere

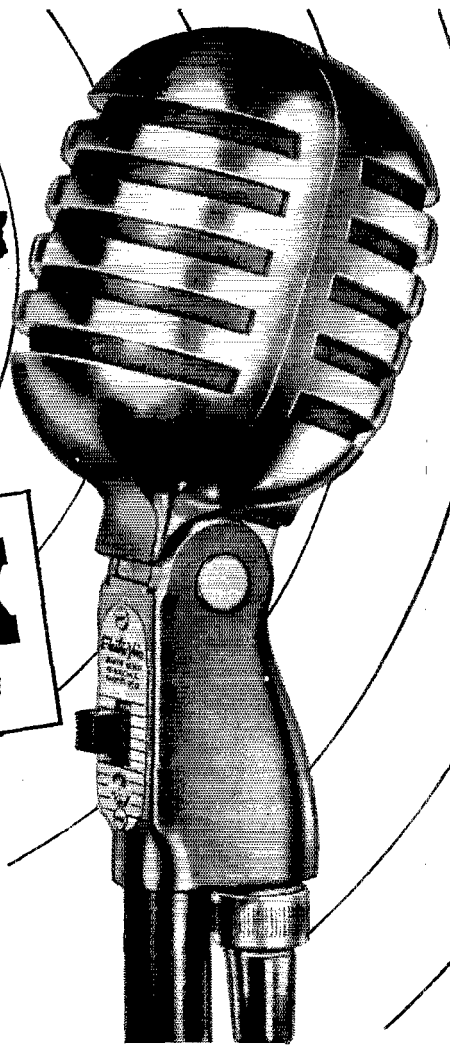

NO FINER CHOICE THAN

Electro-Voice

ELECTRO-VOICE, INC., BUCHANAN, MICH. Export Division: 13 East 40th St., New York 16, N. Y. Cables: Arlab



"Cardyne" Cardioid Dynamic
Models 731 and 726



Crystal—Model 910
Dynamic—Model 610

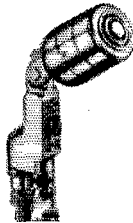

High Fidelity Dynamic
Model 630



"Comet" Crystal Model 902
Dynamic—Model 601



Send for Catalog 101
Get valuable data on
today's most complete
microphone line.

*Patent Pending. Crystal Microphones Licensed under Brush Patents

How to Make Friends

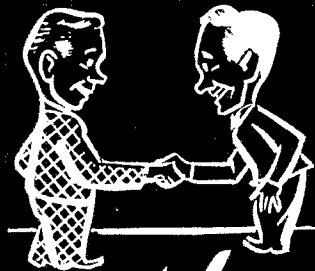

and keep them!

Many a beautiful friendship has been lost to a handful of kilocycles! More and more... under crowded present day band conditions... amateurs are learning IT PAYS TO STAY PUT... with PR Precision CRYSTAL CONTROLS. Yes, PRs pay off... with stable, trouble-free operation on spot frequencies... where you can make

friends and keep them. Whether you operate phone or CW, or both, you will appreciate the fine dependability, high output, economical operation and hair-line accuracy of PR Crystals. They're UNCONDITIONALLY GUARANTEED, and your Jobber can supply you with the EXACT FREQUENCY YOU WANT (Integral kilocycle) WITHIN THE AMATEUR BANDS AT NO EXTRA COST, NO PREMIUM. Insist on genuine PRs!—Petersen Radio Company, Inc., 2800 W. Broadway, Council Bluffs, Iowa. (Telephone 2760)



SINCE 1934

PR Precision CRYSTALS

10 METERS
PR Type Z-5.

Harmonic oscillator. Ideal for "straight through" mobile operation. High activity. Heavy drive without damage in our special circuit\$5.00

20 METERS
PR Type Z-3.

Harmonic oscillator. Low drift. High activity. Can be keyed in most circuits. High power output. Just as stable as fundamental oscillators\$3.75

40 & 80 METERS
PR Type Z-2.

Rugged, low drift fundamental oscillators. High activity and power output with maximum crystal currents. Accurate calibration...\$2.75

THE AMERICAN RADIO RELAY LEAGUE, INC.

is a noncommercial association of radio amateurs, bonded for the promotion of interest in amateur radio communication and experimentation, for the relaying of messages by radio, for the advancement of the radio art and of the public welfare, for the representation of the radio amateur in legislative matters, and for the maintenance of fraternalism and a high standard of conduct.

It is an incorporated association without capital stock, chartered under the laws of Connecticut. Its affairs are governed by a Board of Directors, elected every two years by the general membership. The officers are elected or appointed by the Directors. The League is noncommercial and no one commercially engaged in the manufacture, sale or rental of radio apparatus is eligible to membership on its board.

"Of, by and for the amateur," it numbers within its ranks practically every worth-while amateur in the nation and has a history of glorious achievement as the standard-bearer in amateur affairs.

Inquiries regarding membership are solicited. A bona fide interest in amateur radio is the only essential qualification; ownership of a transmitting station and knowledge of the code are not prerequisite, although full voting membership is granted only to licensed amateurs.

All general correspondence should be addressed to the Secretary at the administrative headquarters at West Hartford, Connecticut.



Past Presidents

HIRAM PERCY MAXIM, W1AW, 1914-1936
EUGENE C. WOODRUFF, W8CMP, 1936-1940

Officers

President GEORGE W. BAILEY, W2KH
Washington, D. C.

Vice-President J. LINCOLN MCCARGAR, W6EY
Oakland, California

Secretary KENNETH B. WARNER, W1EH
West Hartford, Connecticut

Communications Manager FRANCIS E. HANDY, W1BDI
West Hartford, Connecticut

Treasurer DAVID H. HOUGHTON
West Hartford, Connecticut

.....

General Counsel PAUL M. SEGAL
816 Connecticut Ave., Washington 6, D. C.

Assistant Secretaries ARTHUR L. BUDLONG, W1BUD
JOHN HUNTON, W1LVQ, LEROY T. WAGGONER, W1PEK
West Hartford, Connecticut

DIRECTORS

President
GEORGE W. BAILEY, W2KH
921 19th St., N.W., Washington, D. C.

Vice-President
J. LINCOLN MCCARGAR, W6EY
66 Hamilton Place, Oakland 12, Calif.

Canadian General Manager
ALEX REID, VE2BE
240 Logan Ave., St. Lambert, P. Q.
Alternate: Leonard W. Mitchell, VE3AZ
78 Raglan Ave., Toronto, Ont.

Atlantic Division
WALTER BRADLEY MARTIN, W3QV
1033 Arbutha Rd., Abington, Pa.
Alternate: Henry W. Wickenhiser, Jr., W3KWA
1112 State Ave., Coraopolis, Pa.

Central Division
CLYDE C. RICHELIEU, W9ARE
4901 So. 30th St., Milwaukee 14, Wisc.
Alternate: Harold H. Jansen, W9DJQ
3519 California Ave., Alton, Ill.

Dakota Division
GOODWIN L. DOSLAND, W0TSN
Moorhead, Minnesota
Alternate: Robert A. Kimber, W0BLK
Canyon Lake Rd., Rapid City, S. D.

Delta Division
VICTOR CANFIELD, W5BSR
P. O. Box 965, Lake Charles, La.
Alternate: James W. Watkins, W4FLS
220 N. Howell St., Chattanooga, Tenn.

Great Lakes Division
HAROLD C. BIRD, W8DPE
114 Hickory Dr., R. F. D. 2, Pontiac 2, Mich.
Alternate: John H. Brabb, W8SPP
1321 Berkshire Rd., Grosse Pointe Park 30, Mich.

Hudson Division
JOSEPH M. JOHNSTON, W2SOX
427 Lincoln Ave., Avon-by-the-Sea, N. J.
Alternate: Robert A. Kirkman, W2DSY
1910 Oak Drive, West Belmar, N. J.

Midwest Division
LEONARD COLLETT, W0DEA
Civil Aeronautics Administration
Box 776, Joplin, Mo.
Alternate: Alvin G. Keyes, W0KTQ
1201 Merchants Nat'l Bank Bldg., Cedar Rapids, Ia.

New England Division
PERCY C. NOBLE, W1BVR
37 Broad St., Westfield, Mass.
Alternate:

Northwestern Division
HAROLD W. JOHNSTON, W7DXF
2727 Belvidere Ave., Seattle 6, Wash.
Alternate: R. Rex Roberts, W7CFY
110 W. Brennan St., Glendive, Mont.

Pacific Division
WILLIAM A. LADLEY, W6RBQ
200 Naylor St., San Francisco 12, Calif.
Alternate: Kenneth E. Hughes, W6CIS
810 W. Orange Ave., So. San Francisco, Calif.

Roanoke Division
H. L. CAVENESS, W4DW
2607 Vanderbilt Ave., Raleigh, N. C.
Alternate: J. Frank Key, W3ZA
Box 707, Buena Vista, Va.

Rocky Mountain Division
FRANKLIN K. MATEJKA, W0DD
P. O. Box 212, Estes Park, Colo.
Alternate: P. Arthur Small, W0KVD
529 No. Nevada Ave., Colorado Springs, Colo.

Southeastern Division
WILLIAM C. SHELTON, W4ASR
527 Revilo Blvd., Daytona Beach, Fla.
Alternate: William P. Slides, W4AUP
Fleming Road, Montgomery, Ala.

Southwestern Division
HANS R. JEPSEN, W6KEI
6837 Ethel Ave., No. Hollywood, Calif.
Alternate: Arthur E. Schifferman, sr., W6CGI
1445 Raymond Ave., Glendale 1, Calif.

West Gulf Division
WAYLAND M. GROVES, W5NW
P. O. Box 556, Odessa, Texas
W5NW at Humble Pipe Line Camp, Odessa
Alternate: Jack T. Moore, W5ALA
4531 Fairway Ave., Dallas 4, Texas

"It Seems to Us..."

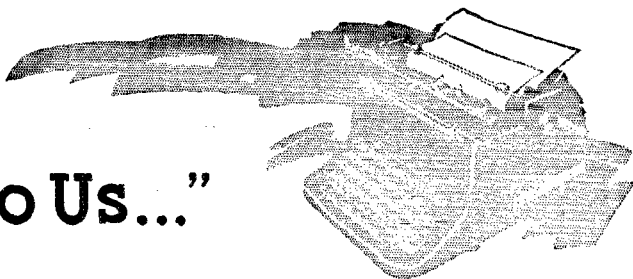

THE 'PHONE POLL

As the month of May draws closer the perennial argument over the division of our bands between 'phone and c.w. approaches its annual peak intensity of S9 and many plusses, and the radio amateur's bills for electric power, throat gargles and new key contacts are reaching new highs. This is democracy at work. It is a good thing, because in this difficult problem we must all be sure that we reach the wisest possible decision, the one that will do the greatest good over the longest period for the greatest number.

As we listen on the air, the arguments are running all the way from proposals that all frequencies be open to 'phone down to suggestions that no 'phone be permitted below 25 Mc. Our correspondence shows one group saying, in effect, "What on earth is the matter with ARRL that it cannot see that these proposals will ruin c.w.?" and another saying, in effect, "What on earth is the matter with ARRL that it cannot see that these proposals are pitifully inadequate for 'phone's needs?" There is indignation from both camps over the Board's present poll, some doubts of its wisdom and value, misunderstanding of its purpose and its status. And, despite the care with which the matter has been presented in *QST*, we hear it being said, "Let's fix up the bands the way *we* want them, not as a few individuals at Hq. want them."

There are enough misapprehensions implicit in the foregoing to warrant a careful review of this subject in this column. Let us endeavor again to sort out the facts:

This problem never ends. There is nothing new about the present rehashing; it comes up every year. Meeting after meeting, year after year, it occupies more preparatory time and more meeting time on the part of the ARRL Board of Directors than all other League problems put together. This year is just more of the same. It will probably continue that way.

It is essentially insoluble, in the sense that no conceivable solution will be equally acceptable to 'phone and c.w. men. Formula approaches and other attempts at automatic solution have been found unsatisfactory. The Board considers that all it can do is to get the widest

possible amateur opinion, to study the matter most conscientiously, and then, with due regard for the long-term safety of our basic rights as a radio service, to endeavor to give effect to majority desire on the basis of the greatest good to the greatest number. Each new review of the subject can be expected to reflect the changes in our operating preferences.

In the affairs of ARRL, 'phone-c.w. band planning is handled exclusively by the Board of Directors. It is in no sense decided by the service headquarters at West Hartford or by any individuals in the employ of the League. The field is preempted by the Board and, as a continuing question of important League policy, only the directors have jurisdiction.

From some of our recent letters we think it necessary to digress here a moment and explain that the League is a nonstock nonprofit membership corporation. It divides the United States into fifteen divisions and in each of these divisions the licensed-amateur members nominate and elect a director of their own choosing. These directors, and the similarly-elected Canadian General Manager and the president and vice-president of the League elected by those sixteen, constitute the Board of Directors of the League. That Board controls the affair of the League. It is that Board, thus elected, that we are talking about.

A year ago the Board decided to make no further requests of FCC for postwar rearrangement of our bands until after the Atlantic City conference. But it didn't want to wait until this coming May just to get up some proposals for band rearrangement, nor did it wish to decide the matter cold at that time without full knowledge of the wishes of members. The Board put it down as a principle that it was necessary to know amateur opinion on *specific proposals*. It therefore gave to one of its committees, the Planning Committee, the task of studying the problem, recommending desirable changes in assignments, and reporting to it — as soon as possible after Atlantic City. That could make it possible to get amateur reaction to specific proposals and still decide the matter, one way or the other, at the May meeting. That committee is just what its name implies,

a committee of the Board. It is not the League nor the Board nor the Headquarters. *It is made up exclusively of elected directors*, not of Headquarters men.

The committee sent its report to the Board. The Board has not adopted the committee proposals; it will not even consider them until May. But the Board did order, meanwhile, that the proposals be published in *QST* and a poll of amateur opinion thereon taken. *QST* is the official organ of the League, not a magazine owned by some guys in West Hartford. It is proper for the Board to use it as the medium for addressing members. The presentation of the subject in *QST* last month is in a form directed by the Board. The explanation of the pending proposals is a direct quotation of the language of the Planning Committee, not the words of any member of the Headquarters staff. The language of the polling card was written by the committee of directors and approved by the Board as a whole, not generated at Hq.

The poll idea itself is nothing new; the mechanism has long existed on the Board's books. Precisely what it is, and its position in our affairs, is shown in the following standing resolutions adopted by the Board ten years ago:

On any matter, the Board may order the taking of an advisory, informative poll, through the columns of *QST*, as to the wishes of the amateurs or the members, as the case may require; and thereafter the Board, in acting upon the question presented, shall take into consideration the result of such poll, the number of expressions received and the percentage of votes by which such poll was determined. Whenever an advisory, informative poll is taken through the columns of *QST* . . . , then there shall be provided a detachable postcard in the pages of *QST* to be used for balloting purposes; and the call for such poll and information published concerning it shall be printed in reasonably prominent form, using type and headings no smaller than those used for articles in the same issue.

This poll of opinion is now going on and you have until March 31st to get your card from February *QST* back to Hq. if you have not yet sent it. At Hq. the cards will be tallied for the information of all directors, by divisions, and the cards representative of each division's figures put in the hands of the director concerned. The Board will then finally consider the pending 'phone proposals at its May meeting, in the light of the opinions expressed in the poll and in the light of all the other information the division directors have collected.

The fear has been expressed that when the Board holds a poll it is "abdicating" and that it is bound by the results of the poll, pro or con, whether those results are in the interests of amateur radio or not. Such worries do not

seem justified. This is no referendum. Members are not deciding the 'phone allocations by a popular vote. The League is a corporation and its directors must and will carry out the usual functions of directors of deciding policy in this matter. The purpose of the poll is simply to adduce information on amateur desires for the directors. It is advisory only, not binding. It isn't even confined to members — an opinion is solicited from every U.S. licensed amateur, member or no. Unquestionably the Board will carefully study the statistics yielded by the poll before it decides what seems to be in the best interests of amateur radio, but let it be clearly understood that the Board cannot be bound by the poll, that it would be unlawful for it to bind itself, and that it is entirely free to accept the recommendations of its Planning Committee or to reject them or to alter them in any way it sees fit.

We have been getting quite a few letters at Hq. asking us such questions as these: "Howcum the Hq. staff dictates the form of the questions we can answer?" "Why can't we vote for how much we want for 'phone in each band?" "We believe every band should be 50-50 but there's no place for that on the card; what do we do about it?" Well, fellows, we hope the answers to such questions are clearer now. There is no board or committee at West Hartford; the only board is the one made up of your elected directors. The pending proposals are matters before that Board, written by one of its own committees, and we at Hq. are serving only as the Board's publishing agents. We can tell you, though, that the Board felt that the only poll expressions that would be helpful were yes or no opinions on specific proposals, and so it had its committee study the whole amateur situation and get up proposals that it thought represented the best possible over-all arrangement of operating privileges. That is what is before you now, and it comes to you from the Board of Directors and your answers are to be returned to the Board. You have it as a duty to yourself to understand the organization of your League and how it is functioning, through its Board, to decide the ARRL position on 'phone sub-assignments. It seems to us that the method being used incorporates every safeguard of the

(Continued on page 150)

OUR COVER

In preparation for the change from 235 to 220 Mc., expected some time in April, our V.H.F. Editor has been cooking up some gear for the new band. Built entirely of miniature components and using four 6J6 tubes and a 12.5-Mc. crystal, this exciter delivers two watts on 225 Mc. This and other gear for 220 Mc. will be described in an early issue of *QST*.

500 Watts of Audio from AB₁

High Output with No Driving Power and Low Distortion

BY HARRY A. MANDOLI,* EX-W6HAM, AND DAVID H. ATKINS,** W6VX

• Class B audio amplification gives high tube output and high efficiency, but is not distinguished for low distortion — particularly when the driver is “skimpy.” Here’s a speech system employing the principles of high-fidelity audio at an astonishing — relatively speaking — power level. Compact construction and lessened speech-system troubles are a natural accompaniment.

AFTER taking a quick listen over the 'phone bands it may be stated that “all modulators are not good modulators,” and that perhaps the first step in improving conditions should be to provide the beleaguered r.f. stage with some “clean” audio. With the general increase in power apparent since the end of the war, many modulators are doing duty not formerly expected of them. Described here is an audio source which will easily supply 500 watts to modulate 1-kw. input, and do it in very little space. The business of achieving “broadcast quality,” while not warranted from the standpoint of existing crowdedness in the amateur bands, is still a desirable characteristic in a really good audio system. The amplifier to be described has excellent quality from the standpoints of frequency response, low harmonic distortion, and low hum level. Having

* Formerly of Eitel-McCullough, Inc., San Bruno, Calif.

** % Eitel-McCullough, Inc., San Bruno, Calif.

first found the amplifier to be *stable on a wide-band basis*, the frequency response in the low-level stages may be trimmed to include a desired range.^{1, 2, 3} As a result, the modulator will be free of fuzz on peaks of audio, and will have no tendency to oscillate when subjected to the passband excitation impacts normal to voice operation.

Some Factors in Class B Operation

The introduction of Class B audio in 1931 came as a relief to those who sought a source of high-powered audio. However, many tubes tried in Class B exhibited mysterious characteristics and the modulator emitted strange sounds. Gradually the reasons for these troubles came to light — the result of work by many investigators.^{4, 5, 6} Today the Class B modulator can be endowed with fine properties, providing that the several points of good design are heeded. One of the most important of these is that the driver and its coupling transformer, and even the grids of the driven modulator tubes, be suited to be operated in conjunction with one another.

¹ Grammer, “House Cleaning the Low-Frequency 'Phone Bands,” May 1947 *QST*.

² Chambers, “A 120-Watt Modulator and Speech Amplifier,” August 1947 *QST*.

³ Smith, “More on Speech Clipping,” March 1947 *QST*.

⁴ Barton, “High Audio Output from Relatively Small Tubes,” July 1931 *Proc. of I.R.E.*

⁵ Collins, “Getting Quality Performance with Class B Modulation,” May 1933 *QST*.

⁶ McLean, “Distortion in Class B Audio Amplifiers,” March 1936 *Proc. of I.R.E.*

◆
With the exception of the modulator power supply, the whole 500-watt speech system is contained in one unit. Elimination of power drivers makes it possible to assemble the entire speech amplifier and power supply on the same chassis with the modulator tubes and output transformer. An outstanding electrical advantage is reduction of harmonic distortion to a very low value.
◆

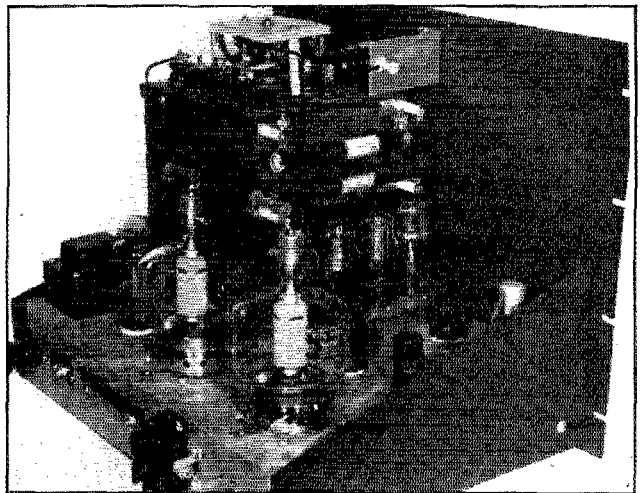

Most high-power audio amplifiers capable of 100 watts or more, operating Class B, require a substantial driver. This driver must push the modulator grids well into the grid-current region, which calls for considerable power ahead of the high-level stage and an input transformer of good design for use with a particular tube type.⁶ The total harmonic distortion is seldom less than 8 per cent in Class B modulators where the design has been passed over lightly, and no small part of this distortion is attributable directly to the grid circuit. Part of this distortion shows up as adjacent-channel interference resulting from higher-order harmonics generated because of the grid-circuit characteristics. This well-known effect is common in any of the 'phone bands, and the sound has been likened unto "sheet ripping." Several cures for the above defects are known and used where the economics of the design permits. These include oversized Class A driver equipment, "building out" the secondary of the driver transformer with corrective filters, etc.⁷

A point not usually given due consideration in modulators is the plate-voltage stability. Lack of regulation here and in the grid-bias supply (when zero-bias tubes are not employed) can cause distortion and a marked reduction in peak output. Bias-supply compensation will materially help the latter trouble.⁸

With the advent of the high-powered tetrode 4-250A, a compact resistance-coupled high-gain amplifier may be used to take the place of the high-level driver components needed for good Class B performance at this power level. To see what can be accomplished, let's take a typical "line-up" for both systems. The Class B system in its most elaborate form (see Fig. 1) consists of three amplifiers, and possibly three supplies furnishing filament and plate power. The amplifiers

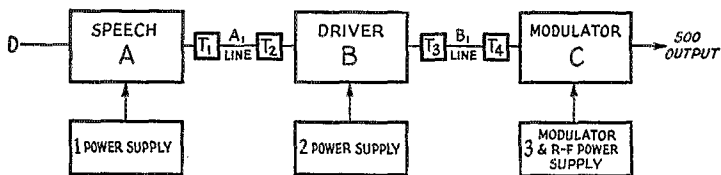

Fig. 1 — Class B modulator speech system in block form.

often are built with low-impedance couplings for interconnection as indicated by A_1 and B_1 , with associated transformers T_1 , T_2 , T_3 and T_4 . Simplification of this line-up might eliminate or combine Supplies 1 with 2, or 2 with 3. In the speech amplifier and driver, or driver and power stage, combinations may be made which should eliminate two or possibly three transformers, which is about as far as we may go in a 500-watt system.

⁷ Attributed to W. S. Mortley.

⁸ Rockwell & Platts, "Automatic Compensation for Class B Bias and Plate Voltage Regulation," April 1936 *Proc. of I.R.E.*

Utilizing the high gain of the 4-250As and Class AB_1 operation, the entire audio system may be built into one unit, eliminating all transformers shown in Fig. 1, and doing away with the "driver" and its supply, leaving the block diagram shown in Fig. 2.

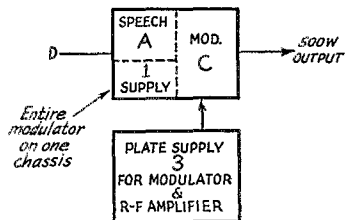

Fig. 2 — Block diagram of Class AB_1 modulator and speech amplifier.

Considerations in Class AB_1 Operation

Since AB_1 operation specifies no grid current during any part of the cycle, the "driver" may be reduced to a compact high-gain resistance-coupled amplifier. To take full advantage of the benefits offered by an amplifier of this kind as a driver — i.e., low distortion and high voltage gain — the power-stage tubes should have a high "maximum effective input resistance" rating, otherwise impedance or transformer coupling again becomes necessary. The 4-250A tetrode has an allowable grid-circuit resistance of 250,000 ohms, making it entirely suitable for direct application to resistance coupling. Published values for the resistance permissible in series with the bias for most large tubes range from 200,000 ohms to as low as 10,000 ohms. Such tubes require this low value as a safety measure because of:

- 1) Internal leakage, which reduces the actual bias because of voltage-divider action in combination with the grid-circuit load resistor.
- 2) Residual gas within the tube, which results in positive-ion grid current tending to lower the bias. Here the plate current is increased which produces a cumulative effect of less and less bias and higher current which may lead to
- 3) Grid emission, which also may contribute to this vicious circle resulting in the sudden demise of the vacuum tube.

This black picture is often partially offset by the compromise of employing cathode resistance; this tends to restore the bias but unfortunately lowers the peak performance of the stage at the same time. For the same plate voltage this amounts to roughly a 30% reduction in maximum output. For resistance-coupled amplifiers, a load much below 100,000 ohms in the grid circuit of

the driven stage results in rather low gain for the stage driving it. The preceding plate load resistor is normally equal to or several times less than the 100,000-ohm value. Therefore, the selection of the driven (output) tube type depends to some extent on the value of the maximum allowable grid resistance and the driver-stage characteristics desired.

Some tubes of a given type vary widely in respect to the input resistance allowable, and also in the control effect of the grid because of production limitations.⁹ To compensate for these effects the circuits for push-pull stages are often provided with individual bias adjustment.

Probably the most attractive feature of Class AB₁ is the elimination of the large complement of parts ordinarily needed to furnish adequate, distortion-free drive to a Class B output stage. In addition, the application of negative feed-back is simplified — if required at all — because of the absence of interstage transformers. A compact high-gain amplifier may be built into the same unit with the power stage, thus doing away with interconnecting cords and impedance-matching devices. R.f. feed-back such as that encountered near transmitters is easily handled because of the single-chassis ground. By using data now available⁹ a variety of output characteristic curves may be realized without resorting to distortion analyzers and other expensive equipment not usually found outside a laboratory. The gyrations of plate current are less severe than those encountered in Class B audio stages but the factor of plate-supply stability is still a major one, and where full output and low distortion are required the high-voltage supply must be designed to have little or no voltage drop on modulation peaks.

⁹ Terman, *Radio Engineer's Handbook*, pp. 223, 230.

Constructional Features of the AB₁ Modulator

As shown in the photographs, the entire speech amplifier, from microphone jack to high-level output, is built on a 3 × 13 × 17-inch chassis and supported on a standard 3/16 × 19-inch relay-rack panel 14 inches high. A large part of the chassis is occupied by the output transformer, which is proportioned to handle the plate current to the modulated 1-kw. r.f. amplifier. The small transformer near the output transformer furnishes power to the speech amplifier. Four metal tubes comprise this amplifier. The two 4-250A tetrodes are placed as shown to provide normal circulation of air around their envelopes. Plate-terminal coolers are employed to allow conduction of heat away from the plate seals. Plate and filament power are supplied from outside sources. The four tubes alongside the transformer are voltage regulators connected to furnish screen voltage to the 4-250As through the dropping resistors placed just above the VRs. The 6E5 tube located at the upper center of the panel indicates maximum permissible grid swing of the 4-250As. Besides this, the only parts on the panel are the microphone input connector, the gain control, and a toggle switch and pilot lamp in the speech power-supply circuit. For quick change to c.w. operation a relay (not shown in the circuit diagram, Fig. 3) mounted over the output transformer shorts the 4-250A screens to ground, thus cutting off the modulator plate current. The secondary of the transformer is shorted simultaneously to remove its inductance from the r.f. high-voltage supply. This protects the transformer and allows good keying characteristics.

As shown in the below-chassis view, a small fan draws air through a screened opening in the side

◆

This bottom view of the unit (with bottom plate removed) shows the small fan, at the left, for cooling the 4-250A bases. The speech amplifier occupies the lower right-hand corner. This photograph was taken before the voice-frequency filter was installed.

◆

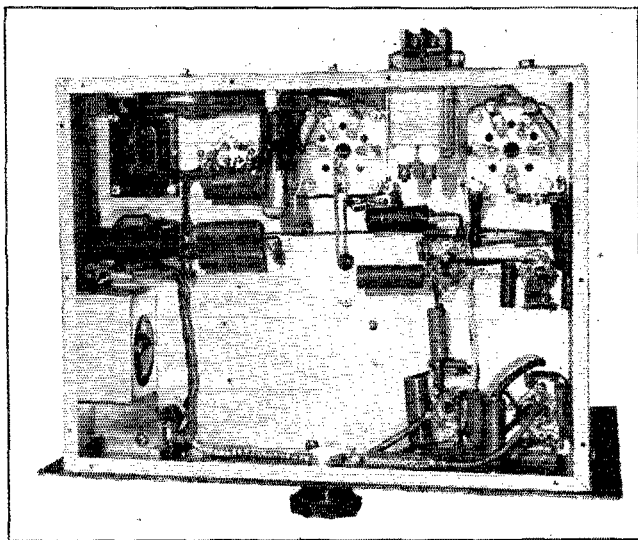

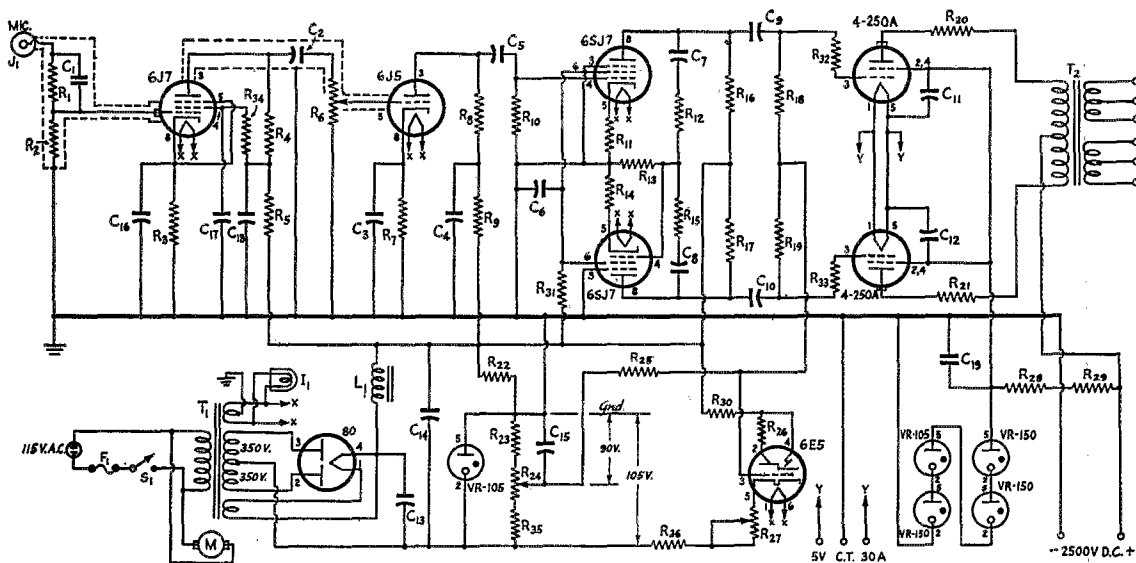

Fig. 3 — Circuit diagram of the speech-amplifier-and-modulator unit.

- | | |
|--|---|
| <p> C₁ — 10-μfd. 500-volt mica.
 C₂, C₅ — 0.1-μfd. 600-volt paper.
 C₃, C₁₆ — 50-μfd. 25-volt electrolytic.
 C₄, C₁₃, C₁₄, C₁₈ — 8-μfd. 450-volt electrolytic.
 C₆, C₁₇ — 0.5-μfd. 600-volt paper.
 C₇, C₈ — 0.03-μfd. 600-volt paper.
 C₉, C₁₀ — 0.1-μfd. 1000-volt paper.
 C₁₁, C₁₂ — 0.005-μfd. 1000-volt paper.
 C₁₅ — 50-μfd. 150-volt electrolytic.
 C₁₉ — 0.5-μfd. 1000-volt Pyranol.
 R₁ — 4 megohms, $\frac{1}{2}$ watt.
 R₂, R₁₂, R₁₃, R₁₅, R₂₈ — 1 megohm, $\frac{1}{2}$ watt.
 R₃ — 1000 ohms, $\frac{1}{2}$ watt.
 R₄, R₉ — 0.1 megohm, $\frac{1}{2}$ watt.
 R₅ — 0.3 megohm, 1 watt.
 R₆ — 0.25-megohm potentiometer.
 R₇ — 1500 ohms, $\frac{1}{2}$ watt.
 R₈, R₃₀ — 50,000 ohms, $\frac{1}{2}$ watt.
 R₁₀ — 0.25 megohm, $\frac{1}{2}$ watt.
 R₁₁, R₁₄ — 500 ohms, $\frac{1}{2}$ watt.
 R₁₆, R₁₇ — 0.1 megohm, 1 watt.
 R₁₈, R₁₉ — 0.2 megohm, $\frac{1}{2}$ watt.
 R₂₀, R₂₁ — 50 ohms, 10 watts.
 R₂₂ — 25,000 ohms, 25 watts.
 R₂₃ — 10,000 ohms, 10 watts.
 R₂₄ — 2000-ohm potentiometer.
 R₂₅ — 20,000 ohms, $\frac{1}{2}$ watt.
 R₂₇ — 3000-ohm wire-wound potentiometer.
 R₂₈, R₂₉ — 50,000 ohms, 100 watts.
 R₃₁ — 0.2 megohm, 2 watts.
 R₃₂, R₃₃ — 10,000 ohms, $\frac{1}{2}$ watt.
 R₃₄ — 0.5 megohm, $\frac{1}{2}$ watt.
 R₃₅ — 1000 ohms, 1 watt.
 R₃₆ — 3000 ohms, $\frac{1}{2}$ watt.
 L₁ — 9 henrys, 85 ma.
 F₁ — 2-amp. fuse.
 I₁ — 6.3-volt pilot lamp.
 J₁ — Microphone connector.
 M — Small 115-v. fan (data in text).
 S₁ — S.p.a.t. toggle switch.
 T₁ — 700 volts c.t., 70 ma.; 6.3 volts, 1.5 a.; 5 volts, 3 a.
 T₂ — 600-watt modulation transformer; pri. 10,300 ohms plate-to-plate. </p> | <p> R₂₀, R₂₁ — 50 ohms, 10 watts.
 R₂₂ — 25,000 ohms, 25 watts.
 R₂₃ — 10,000 ohms, 10 watts.
 R₂₄ — 2000-ohm potentiometer.
 R₂₅ — 20,000 ohms, $\frac{1}{2}$ watt.
 R₂₇ — 3000-ohm wire-wound potentiometer.
 R₂₈, R₂₉ — 50,000 ohms, 100 watts.
 R₃₁ — 0.2 megohm, 2 watts.
 R₃₂, R₃₃ — 10,000 ohms, $\frac{1}{2}$ watt.
 R₃₄ — 0.5 megohm, $\frac{1}{2}$ watt.
 R₃₅ — 1000 ohms, 1 watt.
 R₃₆ — 3000 ohms, $\frac{1}{2}$ watt.
 L₁ — 9 henrys, 85 ma.
 F₁ — 2-amp. fuse.
 I₁ — 6.3-volt pilot lamp.
 J₁ — Microphone connector.
 M — Small 115-v. fan (data in text).
 S₁ — S.p.a.t. toggle switch.
 T₁ — 700 volts c.t., 70 ma.; 6.3 volts, 1.5 a.; 5 volts, 3 a.
 T₂ — 600-watt modulation transformer; pri. 10,300 ohms plate-to-plate. </p> |
|--|---|

of the chassis for the required cooling of the tube bases, to exit by the openings in the tube-base shields. A small sheet-metal cover encloses the fan and its motor, which causes the fan to force air into the chassis more effectively than if there were an opening in the chassis alone. The dimensions of the cover are $2\frac{1}{4} \times 2\frac{7}{8} \times 3\frac{3}{4}$ inches. If desired, the chassis may be used to take the place of one side of the cover. The motor is of the inexpensive shaded-pole variety made by Barber-Coleman (motor^{no}d Yab 549-1, fan Yab 355-2, $2\frac{1}{4}$ -inch diam.). Clips are provided on the chassis to ground the tube-base shields. A metal chassis cover provides shielding and an air enclosure for tube-base cooling.

An 0C3/VR105 (or 0B2 miniature may be used) regulates the bias on the push-pull 4-250A grids. It is placed below the chassis to prevent

grid-plate coupling and possible r.f. feed-back.

On the rear of the chassis are mounted a 115-volt power socket, connector terminals to the filament-transformer secondary, a ground terminal, and two potentiometer controls, one for 4-250A bias adjustment and one for the 6E5 indicator bias adjustment.

No provision is made for high-voltage terminals since they are furnished on the output transformer.

Speech Amplifier — "Zero-Power" Driver

Two speech stages are used to drive a 6SJ7 phase inverter which in turn drives the 4-250A push-pull grids to 90 volts peak per grid. The input circuit is designed for a crystal microphone and includes an RC network which corrects the high-frequency response to compensate for the

by-passing action of the shield indicated in Fig. 3. A copper-tubing jacket, attached to the rear of connector J_1 , encloses the resistors R_1 , R_2 and capacitor C_1 . Complete shielding of the grid and plate circuits of the 6J7 input stage minimizes any feed-back and hum pick-up. A 6SJ7 originally tried in this position produced hum, presumably because of the proximity of the grid and heater leads within the tube itself.

The 6J5 stage includes the gain control and feeds a phase inverter, the constants of which were carefully chosen to give the utmost in balanced output. Two important factors leading to ideal balance in this circuit are a high value of amplification and a high value of resistance to ground across the inverting-tube grid circuit (V_2 , Fig. 4-B). The 6SJ7 is capable of very high gain, and its grid resistance may be as high as 1 megohm in conjunction with self-bias, which makes this tube excellent for use as a phase inverter.

It may be noted that the signal for the inverter is taken from the resistor combination R_{12} , R_{15} and R_{13} . The usual procedure is to take it from the following-stage grid resistors, such as R_{18} and R_{19} in Fig. 4-A. This can be done when the permissible grid resistance is normally quite high, as is the case with most receiving tubes. However, in this case the maximum allowable grid-circuit resistance for the 4-250A is 250,000 ohms. Since at 200,000 we are nearing the point at which the bias may be affected to some extent (for the reasons explained previously) a divider $R_{12}R_{15}$ is used instead across the preceding plate circuit. The resistance values, 1 megohm each, are not allowable in the grid circuits of large tubes, but have no deleterious effect when placed across the plates of the 6SJ7s (Fig. 4-B) as they are working into a combined load resistance of somewhat less than 100,000 ohms.

A high degree of balance is realized with this circuit. With various 6SJ7s tried, and 10-per-cent tolerance resistors, the maximum push-pull output unbalance proved to be less than 3 per cent and could be made apparently zero by selecting 1-megohm resistors for R_{12} and R_{15} . A General Radio v. t. v. m. was used in these tests in conjunction with a harmonic analyzer and a 5-inch oscilloscope. For practical purposes an unbalance of only 3 per cent is considered entirely adequate.

Resistors R_{32} and R_{33} in the 4-250A grids, as well as R_{20} and R_{21} in the plates, are not actually required, but were considered worth while from the standpoint of accidental application of excessive signal inputs. Their use therefore constitutes a precautionary measure to guard against overload oscillation.

6ES Peak-Signal Indicator

The 20,000-ohm resistor, R_{25} , located in the bias supply to the 4-250A grids, causes the 6ES bias to change when the signal peaks exceed the zero-bias point at the grids of the 4-250As. Any

grid current flowing through R_{18} and R_{19} to ground via R_{25} disturbs the bias on the "eye" tube, giving an immediate indication of overload distortion. Plainly enough, it is not the purpose of this indicator to show overmodulation, or distortion arising from some other cause.

Screen Supply for the Tetrodes

In Class AB₁ operation, the screen power taken by the 4-250As is quite low, in this case amounting to 6.5 watts with full signal input. With no signal, the power is very nearly zero. It is important that the voltage at the screen have excellent regulation. The power output and low distortion desired demand a fixed value close to 550 volts, which is easily furnished by the VR series of gas regulator tubes, since the maximum-signal screen current is only 13 milliamperes. The voltage needed is arrived at by the series combination $105 + 150 + 150 + 150$. Since the small power supply included for the speech amplifier has less than the nominal 550 volts, a dropping resistor from the 2500-volt plate supply is used to ignite these voltage regulators. A total of 100,000 ohms with a zero-signal screen current of zero milliamperes and a VR ignition current of 20 milliamperes gives a stable operating point. The I^2R

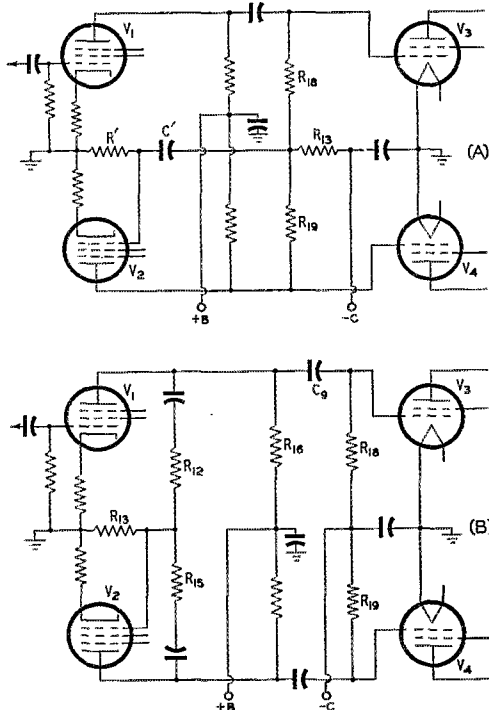

Fig. 4 — A — The conventional self-balancing phase-inverter circuit. B — Circuit for use with power tubes having a definite limit of allowable grid resistance. The two circuits are compared in the text.

loss in the resistance comes to 40 watts. The reason for the apparent discrepancy in the power ratings for R_{28} and R_{29} is that it is necessary to provide a high-enough voltage rating while keeping the mounting space sufficiently small. The two resistors specified should easily carry the peak current at a voltage drop of 1000 each. It is probable that resistors of half this power rating could be used for voice operation where the average screen current is low, provided they will stand the voltage drop involved.

Bias and Speech-Amplifier Voltages

T_1 furnishes 350 volts each side of center-tap. The center-tap returns to ground through a series of resistors across which a regulator tube is placed to furnish a steady source of bias to the 4-250A grids. Note here that the VR itself need not furnish the exact amount to satisfy the Class AB₁ bias conditions. The VR is used to keep the d.c. source constant with respect to line variations, and a potentiometer R_{24} permits setting the bias to the 90 volts (approximately) required for correct zero-signal plate current.

Operation & Results

To operate, the speech power supply is turned on and R_{27} adjusted to open the 6E5 approximately 20 degrees. Set R_{24} to give maximum negative voltage to ground. The 2500 volts may then be applied, a 500-ma. meter having been placed in the filament center-tap return to chassis ground. The plate current is now raised (by adjustment of the bias) to 140 milliamperes with no audio input. (This figure includes a current of 20 milliamperes drawn by the 4-250A screens.)

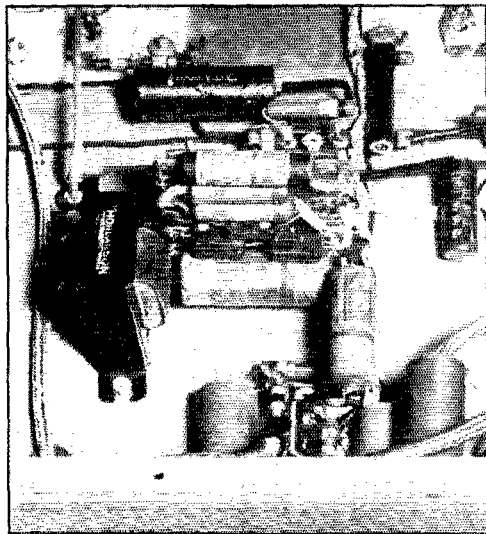

With the exception of the inductance coil, the voice-frequency filter is compactly mounted on a small terminal board installed near the input 6SJ7 tube socket.

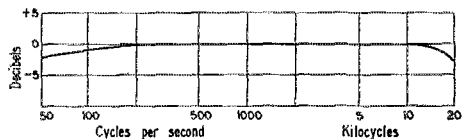

Ref. level 0db. at 1kc. = 520 watts into resistive load across secondary of output transformer T_2

Fig. 5—The amplifier, working into a correctly-adjusted Class C r.f. amplifier (resistive) load, is capable of this kind of response. Since the harmonic distortion is low over a very wide band, there will be no tendency for the system to generate undesirable high-frequency energy which, although possibly above audibility in some systems, creates a repulsive din when mixed with other carriers. A stable amplifier such as this readily lends itself to a narrow speech passband of high intelligibility in accordance with present-day requirements for 'phone communication.

The plates of the 4-250As should show color at this dissipation, which is approximately half maximum plate power per tube. With full-signal input just short of 6E5 overload indication, the meter current should rise to a steady value of approximately 410 ma. A sine wave is assumed as the signal source. For speech, the meter should seldom hit over 200 ma. at peak output, using a 500-ma. Weston 301 meter.

With a plate supply of ample proportions, making use of a swinging-choke input filter, the useful output at the secondary of the modulation transformer was measured at 520 watts. The total harmonic distortion was not over 3 per cent. Hum was extremely low, forming an insignificant part of the total distortion at full power output. The over-all frequency response was found to be within plus or minus 2 db. between 30 and 20,000 cycles, operating into a resistive load. No oscillations were evident over the entire input range, including the possible harmonics of these frequencies.

It was not necessary to use inverse feed-back because of these low values of distortion and noise, although extra gain was originally provided in the speech amplifier for this purpose.

In conclusion, attention is again called to the references in regard to limiting the amplifier frequency response. There has long been the thought on the part of those interested in making the most of the available 'phone channels that the high-frequency end of the voice spectrum could be suppressed with a reduction of interference. As revolting as it may sound to many of the "high-quality" brethren, there is always the lowly carbon microphone, which is certainly an inexpensive starter on the road to a narrower 'phone channel. The familiar "F-1" unit of the telephone handset falls off rapidly on both ends, which tends to balance the quality so that neither tinniness nor heavy bass prevails. It must be admitted that it is not difficult to recognize the speaker's voice, as well as to understand it readily, over modern

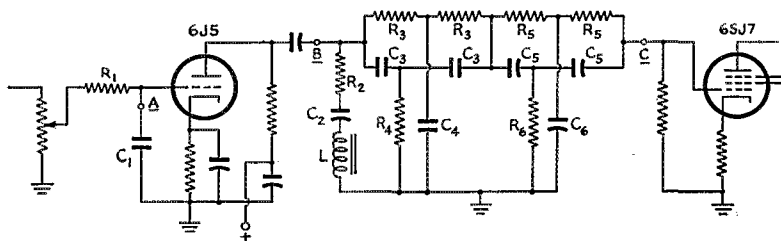

Fig. 6—Circuit diagram of voice-frequency filter. Note: the circuit designations should not be confused with those of the main diagram.

- C₁ — 500- μ fd. mica.
- C₂, C₅ — 0.1- μ fd. paper, 600 v.
- C₃ — 150- μ fd. mica.
- C₄ — 300- μ fd. mica.
- C₆ — 0.02- μ fd. paper, 600 v.
- R₁ — 25,000 ohms, $\frac{1}{2}$ watt.
- R₂ — 5000 ohms, $\frac{1}{2}$ watt.

- R₃ — 70,000 ohms, $\frac{1}{2}$ watt.
- R₄ — 35,000 ohms, $\frac{1}{2}$ watt.
- R₅ — 1 megohm, $\frac{1}{2}$ watt.
- R₆ — 0.5 meg., $\frac{1}{2}$ watt.
- L — Thordarson T81C15, 0.75 hy. at 0.5 ma., 30 ohms d.c. resistance.
- A, B, C — See text.

telephone circuits. With a microphone of this kind, connection to the amplifier should be made to the grid of the 6J5 stage through a microphone transformer. This transformer secondary, and the modulation-transformer primary and secondary, are all good locations for "building out" with suitable capacitors.³ Any objectionable harmonics attributable to the microphone itself are thus attenuated to a low level in the output.

A Bandpass Speech Filter

Bandpassing in the low-level stages may be done in several ways, most of which are involved.

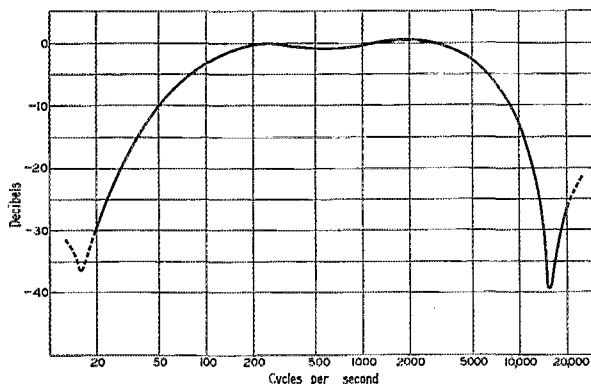

Fig. 7 — Response curve of speech filter shown in Fig. 6.

The circuit of Fig. 6 is simple to build and, aside from the 0.75-henry choke for the series-resonant section, is composed entirely of resistors and capacitors. While the slopes of the "cut-off" portions of the curve are not all that may be desired, measurement and listening checks show the circuit to do the job well and without the addition of appreciable distortion. The filter insertion loss at 1000 cycles is 15 db.

The elements of the circuit may be broken down into four parts. Two of these are parallel-T-"slot" circuits adjusted for the audio-band ends. The

third element is a series-resonant LC circuit to lower the response near 600 cycles and smooth off the passband region. Last, there is a low-pass RC circuit located in the grid circuit of the 6J5 at A. The purpose of this portion is to prevent the response above 17 kc. from rising too rapidly. Attempts to attenuate the high-frequency part of the response curve as shown in the wide-band characteristic curve by "building out" with capacitance were of no avail apparently because of the low leakage reactance of the particular transformer used.¹⁰

One of the photographs shows the additional components mounted under the chassis between the 6J5 and one of the 6SJ7 sockets. With the exception of R₁ and C₁, all capacitors are mounted on one side of the bakelite card, which is 2 $\frac{3}{4}$ inches square. The resistors are located on the reverse side of the card, with choke L near by on the chassis. R₁ and C₁ are mounted as shown in the diagram, close to the 6J5 grid terminal. If desired, a switch may be used at points A, B and C to give either the wide-band or passband response.

The AB₁ approach set forth here has helped in the attainment of better quality at higher audio levels. The application of "clean" audio will help in the greater utilization of the present bands, regardless of audio bandwidth.

¹⁰ Peerless Elec. Prod. Co. M-2121-T.



The recently-revised WWV schedule is carried on page 72 of this issue. A detailed announcement of the many WWV technical broadcast services, Pamphlet LC886, may be obtained without cost from the National Bureau of Standards, Washington 25, D. C.

Coaxial-Line V.H.F. Receivers

Improved Selectivity in Simple Receivers for 144 Mc.

BY JOSEPH SANTANGELO,* WINXY

ANYONE who has attempted 144-Mc. operation in the thickly-populated areas where there is extensive activity has long since become convinced of the necessity for a more selective receiver than the familiar superregen. The logical answer for the advanced home station is, of course, the superhet. It cannot be denied that a good converter ahead of a communications receiver will provide performance superior to that obtainable by any simpler method, but not everyone can afford this approach, and the superhet is seldom practical for mobile applications because of the excessive battery drain imposed by its extensive tube line-up. A good compromise was found in the employment of a coaxial-line circuit in an otherwise conventional superregen.

With only a detector stage it is possible to achieve sensitivity and selectivity equal to all but the better superhets, yet with a low cost and simplicity of construction which should make the coaxial-line job attractive to the mobile enthusiast and the fellow who likes to build his own receivers. No complicated and expensive equipment is required to get a receiver of this type working satisfactorily, as there are no alignment or tracking problems.

Actually the principal difference between this receiver and the conventional superregen is the substitution of the coaxial line for the coil-

• For mobile operation, and for the fellow who likes to build his own receivers, the superregen has its advantages. It can hardly be equalled for high performance with a few tubes, and its worst failings can be corrected to a large extent through the use of coaxial-line circuits and properly-designed r.f. stages. The receivers described here by WINXY have selectivity and sensitivity approaching that of the simpler superhets, yet their cost is low and their construction is simple.

condenser combination in the grid circuit of the detector. The high selectivity is attributable to the high Q of the coaxial circuit. It is desirable to obtain as high a Q as possible in this tank because the Q of the resonant circuit fundamentally controls the bandwidth of the receiver. Using the coil-condenser tank circuit, the average strong local signal covers 10 or 15 per cent of the band, making it possible to receive a maximum of only eight to ten S9 signals at a given time. With the coaxial-line detector these same signals cover only 3 to 5 per cent of the band, thus allowing a maximum of twenty to thirty S9 signals received. An even greater degree of selectivity may be achieved, approaching that of a communications receiver with a high-frequency i.f., but this was

* 194 Barbara, Waltham, Mass.

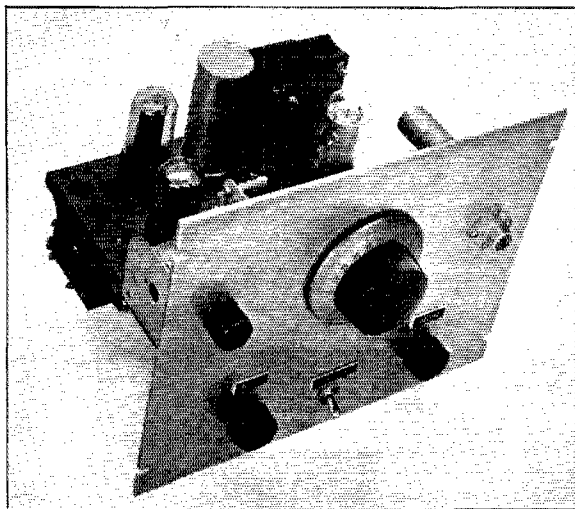

Panel view of the coaxial-line receiver built by WINXY. The broad-band r.f. stage requires no adjustment other than an original setting of its trimmer, which is reached through a hole in the top of the r.f. stage shield.

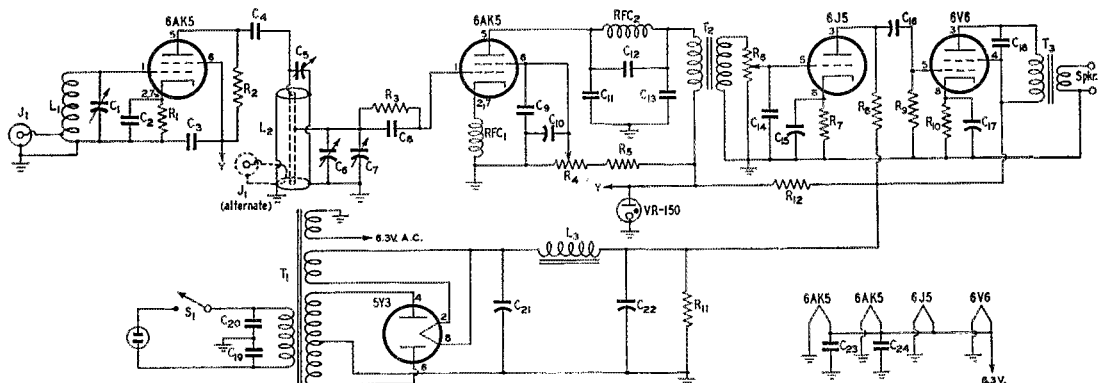

Fig. 1 — Schematic diagram of the 144-Mc. coaxial-line receiver. If no r.f. stage is used the antenna connection is made by means of a coupling loop inserted at the bottom of the coaxial line, or by a small capacitor at C_4 (see text).

- C_1 — 3–13- μ fd. ceramic trimmer.
- C_2, C_3, C_{23}, C_{24} — 470- μ fd. mica.
- C_4 — 2- μ fd. ceramic (when r.f. stage is used). For use as antenna coupling condenser, see text.
- C_5 — 25- μ fd. air trimmer.
- C_6 — 15- μ fd. air trimmer.
- C_7 — 15- μ fd. variable.
- C_8, C_9 — 56- μ fd. mica.
- C_{10} — 0.5- μ fd. tubular.
- C_{11} — 0.001- μ fd. mica.
- C_{12}, C_{18} — 0.0062- μ fd. mica.
- C_{14} — 0.00075- μ fd. mica.
- C_{15}, C_{17} — 25- μ fd. 50-volt electrolytic.
- C_{16} — 0.1- μ fd. tubular.
- C_{18} — 0.0051- μ fd. mica.
- C_{19}, C_{20} — 0.0022- μ fd. mica.
- C_{21}, C_{22} — 40- μ fd. 450-volt electrolytic.
- R_1 — 180 ohms, $\frac{1}{2}$ watt.
- R_2 — 3900 ohms, $\frac{1}{2}$ watt.
- R_3 — 1 megohm, $\frac{1}{2}$ watt.
- R_4 — 0.1-megohm potentiometer.

- R_5 — 47,000 ohms, 1 watt.
- R_6 — 0.25-megohm potentiometer.
- R_7 — 3900 ohms, 1 watt.
- R_8 — 0.12 megohm, $\frac{1}{2}$ watt.
- R_9 — 0.47 megohm, $\frac{1}{2}$ watt.
- R_{10} — 330 ohms, 2 watts.
- R_{11} — 0.125 megohm, 4 watts.
- L_1 — 4 turns No. 16, $\frac{1}{4}$ -inch diameter, $\frac{3}{4}$ inch long, tapped at $\frac{1}{2}$ turn from cold end.
- L_2 — Coaxial line $7\frac{1}{2}$ inches long. Outer conductor 2-inch diameter, inner conductor $\frac{1}{2}$ -inch diameter, tapped 2 inches from cold end.
- L_3 — Filter choke, 11 hy. at 50 ma.
- J_1 — Coaxial fitting.
- RFC $_1$ — V.h.f. choke, Ohmite Z-0.
- RFC $_2$ — 80- μ hy. r.f. choke.
- S_1 — S.p.s.t. toggle switch.
- T_1 — Power transformer, 600 volts a.c., center-tapped; 5 volts, 3 amp.; 6.3 volts, 2 amp.
- T_2 — Interstage audio transformer.
- T_3 — Pentode output transformer.

deemed inadvisable because there are still some modulated oscillators on the band. A compromise was made so that the better of these can be copied with little difficulty.

Building the Coaxial Line

The coaxial-line assembly was made of brass and then silver-plated. Copper and even aluminum pipes have been used and apparently work as well, but since it is rather difficult to solder aluminum without special apparatus, it is not recommended. Silver or hard soldering is preferable, although several successful units were made up by ordinary lead soldering over a gas flame.

The essential materials required for the coaxial tank are as follows: (1) a $7\frac{1}{2}$ -inch length of 2-inch diameter thin-wall pipe, (2) a $7\frac{1}{2}$ - to 8-inch length of $\frac{1}{2}$ -inch diameter pipe, and (3) a flat sheet stock of suitable thickness about $2\frac{1}{2}$ by 4 inches to be used as the shorting plate of the coaxial section as well as a means of mounting the assembly. This flat stock should, if possible, be of the same material as the pipes. The cost of the materials for the assembly was less than \$1.00 at a local plumbing shop. Suitable pipes are also available on the surplus market.

The above-mentioned dimensions may vary up to one-half inch in length without affecting results, but the diameters specified should not be altered. The important factor is to maintain a ratio of approximately 4-to-1 between outer and inner conductors, providing a coaxial-line impedance of approximately 80 ohms. More information is available for this type of line, hence the pipes were made to conform as closely as possible. The pipe may be mounted in any convenient position. The outside of the coaxial line is at ground potential and therefore may be fastened directly to a metal chassis or panel for firm support.

Circuit Details

As in all v.h.f. gear, short leads are absolutely necessary in the r.f. section. The schematic shows the grid leak of the 6AK5 and the tuning condenser connected to the pipe approximately two inches from the closed end. The usual practice is to mount these components on a bracket that is soldered or screwed to the pipe as close to this point as feasible. The resistance of the grid leak is a determining factor in the selectivity of the receiver, the value shown being chosen to give

reasonably-high selectivity without bringing the quench frequency into the audio range. If preferred, this may be a variable resistor of about 1 megohm in series with a fixed 0.5-megohm resistor, connected from grid to ground, acting as a bandwidth control.

The cathode choke for the 6AK5 is approximately 1.5 microhenrys. An Ohmite Type Z-0 may be used or a choke may be made by winding approximately 30 turns of No. 23 enameled wire on a $\frac{1}{4}$ -inch form. It is essential for smooth operation that the plate, screen, and ungrounded side of the filament be by-passed for r.f. at the tube socket. The screen voltage is obtained from a potentiometer or voltage-divider arrangement connected across a VR-150. The detector will superregenerate with approximately 25 volts on the screen. The plate of the 6AK5 is fed through a quench-frequency filter to a conventional inter-stage audio transformer. The audio level is lower than that obtained from the usual triode superregenerative detector; however, no additional amplification other than the ordinary 6J5-6V6 combination was found necessary.

The receiver is relatively inexpensive to build. As a matter of fact, for the receiver shown, with the exception of the cabinet, the most expensive single part was the vernier dial! It is not difficult to adjust, since no auxiliary equipment is needed and there are no tricky i.f. stages or mixers to align, but the care in layout and construction necessary for any 2-meter circuit must be exercised. The pipe circuit may be visualized as a tapped coil in which the tube is connected across a portion of the coil to maintain a higher effective Q . If the grid and cathode leads are too long, the circuit may oscillate without the pipe controlling

the frequency. The center-conductor connection was made with an 866 plate connector trimmed down so that the position could be varied. Changing the tap affects the amount of bandspread as would changing the ratio of the capacitance at the end of the pipe with respect to that at the tap. Moving the tap toward the shorted end increases the bandspread, while moving it away decreases bandspread and lowers the selectivity.

When the receiver is used without an r.f. stage the antenna may be coupled in either of two ways. At WINXY we use 72-ohm coaxial cable for all v.h.f. antennas, and this is coupled to the coaxial tank circuit by means of a small capacitance at C_4 . This coupling capacitance was obtained by extending the center of the coaxial cable and running it parallel to one of the stator bars of the band-set condenser, C_5 . When maximum signal was obtained the lead was cemented in place. This coupling arrangement does not work well with 150- or 300-ohm line, however, and on most other units that have been built locally a conventional coupling loop, shown in dashed lines in Fig. 1, has been employed. It was made by drilling several holes longitudinally through the outer pipe, about $\frac{1}{2}$ inch apart, and passing a loop of insulated wire from one hole to another until maximum signal is coupled into the detector. In this way a coupling loop could be formed and coupled as tightly as desired to match the particular feed system used.

The sensitivity of this coaxial-tank detector is equivalent to that of a conventional superregen circuit with one r.f. stage. The selectivity was found to be approximately 100 kc. at 20 times down. At the same time a conventional coil-condenser superregen circuit using a 9002 de-

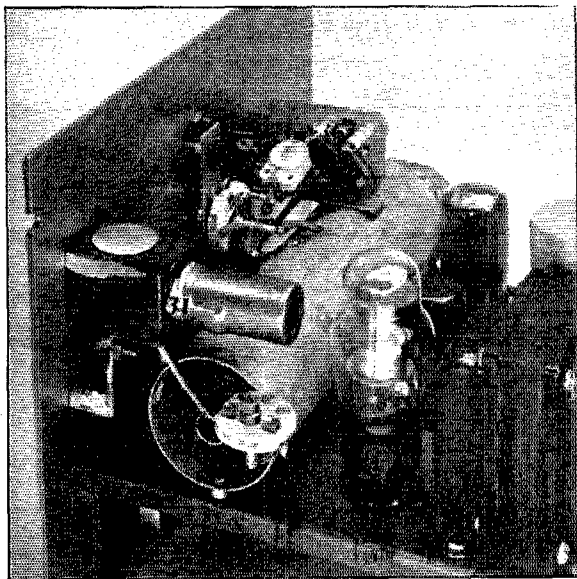

Side view of the coaxial-line superregen, showing the end of the coaxial assembly and the broad-band r.f. stage. The detector tube and associated components are mounted on a bracket attached to the top of the line assembly, at the right.

◆
 Below-chassis view,
 showing the audio
 components and
 quench filter.
 ◆

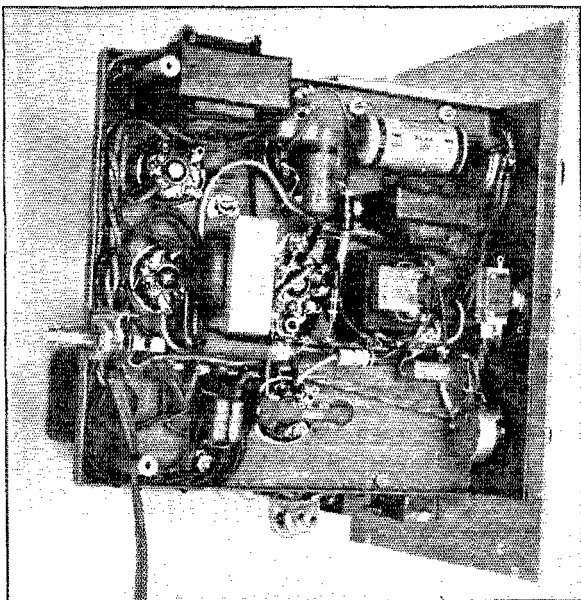

tor was found to be 600 kc. wide at 20 times down, or 6 times as broad.

With the home transmitter running on 147.5 Mc., it is possible to copy several stations in a crystal net operating on 147.96 Mc. Modulated oscillators with a high percentage of modulation are very difficult to copy, but the bandwidth is effectively widened as the regeneration control is advanced. Sometimes this helps in reading some of the broader signals.

Adding an R.F. Stage

Addition of a coaxial-line r.f. stage brings up the gain and selectivity to a point that far surpasses the conventional circuit. Several of the concentric-line receivers have also been built with a broad-band r.f. stage that gave a gain of about $2\frac{1}{2}$ times. The isolation provided by such a stage is so complete that with two such receivers separated by about 35 feet, it was possible to copy an S6 signal with both receivers tuned to the same frequency. If one receiver was detuned about a quarter of a megacycle, the radiation from the other could not be heard. The diagram, Fig. 1, includes the details of this broad-band r.f. stage, and the receiver shown in the photographs is of this type.

The most recent coaxial-pipe receiver, which includes a broad-band r.f. amplifier, was built by

W1JSM. It is compactly constructed so as to fit on the steering post in his car. The r.f. stage has some gain, but primarily its purposes are to isolate the antenna from the detector, keeping radiation down to a minimum, and to make the receiver easier to handle under mobile conditions. It has the variable-selectivity feature mentioned earlier.

Mention should be made of the work on this type of receiver done last year by W1KZD and W1LJN. The unit shown combines the good features of their receivers and some desirable modifications. The coaxial-line oscillator has also been used for transmitting with good results. W1KZD had a pipe oscillator feeding an 829 on two meters last year, and the stability was such that his signal could be copied on a conventional communications receiver.

About the Author

Joseph Santangelo, W1NXY, was first licensed as W2MGG in 1939, later holding the call W3JGT. His licenses include first-class 'phone and second-class telegraph. He is a graduate of RCA Institutes, and was a television engineer for Philco in 1940 and '41, previous to a four-year hitch in the Army which included 33 months of overseas service. Since his discharge in the summer of 1945, he has been employed in television engineering work for Raytheon, at Waltham, Mass.

He is a member of the Eastern Massachusetts Amateur Radio Association and the El-Ray Radio Club. His primary interest in radio lies in v.h.f. experimental work, with DX and traffic as side lines.

Strays

The following graybeards — ham-wise, that is — are charter members of the newly-formed Quarter Century Wireless Association: W1HRX; W2s BW, KR, AMJ, AMB, EF, RB, EZ, CO, LFR, CVF, FD, BJ, GX, DX, UD, FO, EC, II, FZ, YW, PL, MM, BT, KW, OG, BR, WZ, AFB, GG; and W3IXP. Officers of the Association, which is a purely-social group, are President John DiBlasi, W2FX, Vice-President George Droste, W2IN, Secretary Leon Hansen, W2FIT, and Treasurer Dave Talley, W2PF. Licensed amateurs who have been on the air for 25 years, or who were active 25 years ago and have since returned to the game, are eligible for membership in the organization.



Happenings of the Month

WASHINGTON NOTES

The moving of the temporary amateur assignment 235-240 Mc. to its permanent home at 220-225 Mc. is now in sight. Washington has been in touch with London and Ottawa about the arrangement which temporarily displaced our band and now FCC is preparing proposed rule-making for the shift. Best present guess is that it will be effective in middle April. . . . FCC has recently authorized the use of 420-460 Mc. for the obstacle detector carried by civil aircraft as a conversion of the APS-13. The operation of this device is not recognized as a safety service but only as a temporary experimental investigation, in no case to endure beyond early 1950.

The resignation of FCC Commissioner Jett making it impossible for him to head the U. S. delegation on the Provisional Frequency Board at Geneva, the Telecommunications Coordinating Committee named as the U. S. representative former Commissioner Ray E. Wakefield. PFB began its estimated 1½-year session in middle January.

On the legislative front, there is a new White Bill in the Senate to reorganize FCC, chiefly in the interests of improved regulation of broadcasting. In the House Congressman Lemke has introduced a resolution that would direct FCC to make a "downstairs" provision for f.m. broadcasting. Although ARRL maintains close touch with such matters, neither of the pending measures is of direct concern to amateur radio.

FCC announced as of the end of November that since the war it has issued 62,865 five-year amateur station licenses and 62,775 amateur operator licenses, these figures including both the renewal of the majority of the prewar licenses and the newcomers. With many licenses due for renewal only on the 1948 anniversaries of their dates of issuance, the total of outstanding amateur authorizations in the U. S. is about 81,000.

Have you a copy of the treaty and regulations for the control of radio signed by the governments of the world at Atlantic City last summer? You will find them interesting reading. ARRL acts as the Western Hemisphere agent of the International Telecommunication Union in the distribution of these books, which are available from the League at \$1.50, postpaid.

INTERLOPERS

League Headquarters zealously watches against unauthorized invasions of the amateur bands. For example, although broadcasting in 7200-

7300 kc. is permitted only outside the American Region, occasionally it is tried on this side, and we have recently prepared and filed formal complaints against the unauthorized operation of PJCI, Curacao, and a similar station in the Dominican Republic, both on about 7250, which complaints are now the subject of diplomatic representations by our Government. When the Harvard ionosphere station WIXJ began to cause widespread QRM in the low end of our 3.5-Mc. band, we filed a complaint with FCC and the station was closed down. We are now engaged in collating data collected by the Official Observers on unauthorized broadcasting in the 3500-3800 range in Latin America. Members will help along our work in this respect if they will send reports to Hq. when they come across such interlopers in our bands.

CALL-BOOK LISTINGS

We've had occasion recently to check up on a number of listings in the *Radio Amateur Call Book Magazine* where the QTH was no longer correct. In almost all the cases we investigated, the *Call Book* correctly reflected the FCC records — which is its job. The impressions we get are that the *Call Book* does its work with satisfactory accuracy and commendable enterprise but that many amateurs have been negligent in applying for modified licenses because of changes of address. The publisher of the *Call Book* is eager to cooperate with amateurs in making his book of maximum usefulness. As we pointed out in this department last month, all amateur licenses not yet renewed on the five-year form are due to expire on the 1948 anniversary of their dates of issuance. If yours is in that category, you should of course prepare to file for renewal as your date approaches. We would also suggest that you check your listing in the *Call Book* and, if it is not in accord with the data you are filing with FCC, that you advise the *Call Book* direct of your proper address.

ARE YOU LICENSED?

- When joining the League or renewing your membership, it is important that you show whether you have an amateur license, either station or operator. Please state your call and/or the class of operator license held, that we may verify your classification.

A Single-Control 180-Watt Transmitter

Bandswitching and Ganged Tuning for Three Bands

BY T. A. BENHAM,* W3DD

• This article describes a 180-watt transmitter with bandswitching and ganged tuning. After preliminary adjustments, the tune-up procedure consists of only a turn of a switch and the change of a single plug-in unit in going from one band to another. The antenna tuning is ganged along with the other tank circuits so that the transmitter is truly single-control in operation. As described, the unit covers 3.5, 7 and 14 Mc., but the principles may be extended to include other bands.

IT is probably not often appreciated that the design of a transmitter to meet present-day amateur requirements is, in many respects, a more difficult job than the planning of one for some of the various commercial services. While the commercial transmitter often need cover only a few fixed frequencies, the nature of ham operation, through gradual evolution, has come to the point where rapid selection of any frequency within a band, as well as shifting between bands, is almost as important in the transmitter as in the receiver. Meeting this requirement means, of course, single-dial control and bandswitching for the transmitter just as it does in the receiver.

Single-control transmitters follow one of two general lines in design. The tuning controls of the various stages may be ganged to a single control, or a bandpass system may be used. In the latter arrangement, the circuits are designed to provide essentially flat response over the width of an amateur band with fixed tank-circuit values, thereby eliminating the necessity for tuning controls. Although it solves the problems of tracking and ganging, a bandpass system is not the easiest thing to get working properly. Stages thus operated are relatively inefficient and therefore the idea cannot be applied feasibly to stages which are called upon to develop appreciable power. Thus, even in a bandpass arrangement, a minimum of two tunable stages

(the oscillator and the output amplifier) is required in addition to the antenna tuning. While the ganging of several condensers to a common control sometimes may constitute a mechanical problem, this is offset to a large extent by the fact that adjustment for uniform output over a band is relatively simple and straightforward with ganged tuning.

The unit shown in the photographs is of the gang-tuned type, operating from a single motor-driven or manual control, antenna circuit included. Bandswitching, 3.5 through 14 Mc., also is incorporated in the exciter stages. In the final amplifier and antenna tuner, bands are shifted by the change of a single common plug-in-coil unit, L_7L_8 . No resetting of padder condensers is required in any tank circuit. The output stage can handle up to 180 watts input and the entire transmitter is contained on a standard 8-inch chassis, which may be conveniently housed in a cabinet of receiver size.

Circuit Discussion

The circuit, shown in Fig. 1, incorporates features of several units which have appeared in previous issues of *QST*. The bibliography which terminates this article lists material to which reference was made in designing this transmitter. The VFO circuit makes use of a 6C4 triode in a tickler-feed-back arrangement. The oscillator operates at 1.75 Mc. with low-voltage battery plate supply. This is followed by a choke-resistance-coupled 6AG5 Class A isolating amplifier which drives a 6AG7 doubling to the 3.5-Mc. band. The 6AG7 drives a 2E25 which may be operated either as a straight amplifier at 3.5 Mc. or as a doubler to 7 Mc., depending upon the tank circuit selected by the bandswitch, L_4C_{22} for 3.5 Mc. or L_6C_{24} for 7 Mc. The output of this stage may be switched to drive either the

* Assistant Professor, Physics Department, Haverford College, Haverford, Penna.

◆
Complete gang-tuned transmitter in cabinet.

March 1948

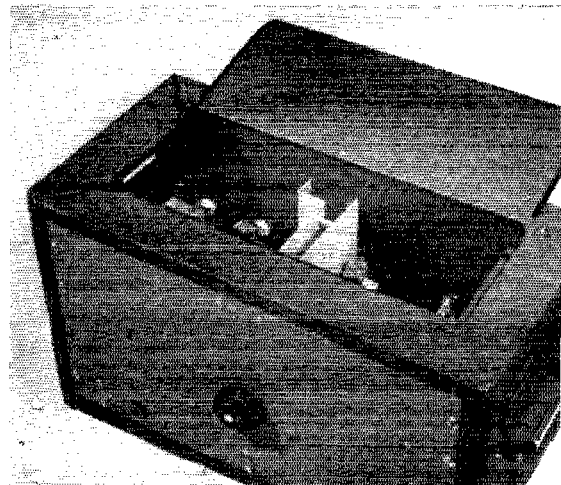

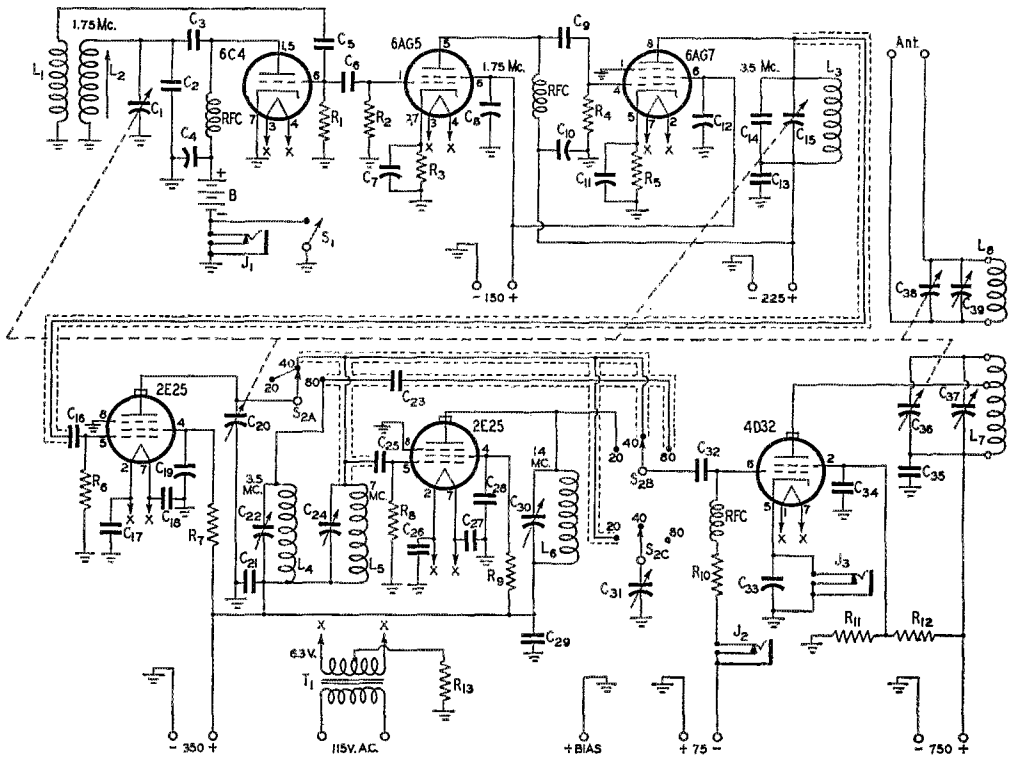

Fig. 1 — Circuit diagram of the gang-tuned transmitter.

- C₁ — 100- μ fd. midget-type variable (Hammarlund MC-100S).
- C₂ — 400- μ fd. mica; 350- μ fd. zero-temperature coefficient plus 50- μ fd. negative coefficient.
- C₃, C₁₃, C₂₁, C₂₉ — 0.0022- μ fd. mica.
- C₄ — 0.1- μ fd. paper.
- C₇, C₈, C₁₀, C₁₁, C₁₂, C₁₉, C₃₈ — 0.01- μ fd. paper or mica.
- C₅, C₉ — 100- μ fd. mica.
- C₁₄ — Approximately 50- μ fd. mica (see text for adjustment).
- C₁₅, C₂₀, C₃₀ — 20- μ fd. variable midget (Hammarlund MC20S).
- C₁₆, C₂₅ — 68- μ fd. ceramic.
- C₁₇, C₁₈, C₂₆, C₂₇ — 0.01 μ fd. (mica preferred).
- C₂₂, C₂₄, C₃₁ — 50- μ fd. variable (Hammarlund APC50).
- C₂₃ — 47- μ fd. mica (see text).
- C₂₈ — 0.0047- μ fd. mica.
- C₃₂ — 150- μ fd. mica.
- C₃₄ — 0.005- μ fd. 1000-volt mica.
- C₃₅ — 0.002- μ fd. 1500-volt mica.
- C₃₆, C₃₈ — Approx. 30 μ fd., double-spaced midget variable (Hammarlund MC35SX with 1 rotor and 1 stator removed).
- C₂₇, C₃₉ — 50- μ fd. double-spaced midget variable (Hammarlund MC50SX).
- R₁ — 47,000 ohms, $\frac{1}{2}$ watt.
- R₂, R₄ — 0.15 megohm, $\frac{1}{2}$ watt.
- R₃ — 470 ohms, 1 watt.
- R₅ — 1000 ohms, 1 watt.
- R₆, R₈ — 47,000 ohms, 1 watt.
- R₇, R₉ — 15,000 ohms, 10 watts, with adjustable slider.

- R₁₀ — 2000 ohms, 1 watt.
- R₁₁ — 30,000 ohms, 30 watts.
- R₁₂ — 10,000 ohms, 30 watts.
- R₁₃ — 500 ohms, 10 watts.
- L₁ — 20 turns No. 32 enam., wound at ground end of L₂. Ground ends of coils adjacent, turns in same direction.
- L₂ — 40 turns No. 30 enam., wound on $\frac{1}{2}$ -inch diam. form, with tuning slug (approx. 16 μ hy.; see text).
- L₃, L₄ — 38 turns No. 26 enam., 1-inch diam., 1 inch long (23.7 μ hy.).
- L₅ — 19 turns No. 22 enam., 1-inch diam., 1 inch long.
- L₆ — 13 turns No. 18 enam., 1-inch diam., 1 inch long (3.0 μ hy.).
- L₇ — 3.5 Mc. — 26 turns No. 16, 2 $\frac{1}{2}$ inches diam., 2 $\frac{1}{2}$ inches long, tapped at 11 turns from hot end (28 μ hy.).
- 7 Mc. — 10 turns No. 16, 2 $\frac{1}{2}$ inches diam., 1 inch long, tapped at 3 turns from hot end (7.1 μ hy.).
- 14 Mc. — 4 turns No. 12, 3 inches diam., 1 $\frac{1}{4}$ inches long, tapped 1 turn from hot end (1.8 μ hy.).
- L₈ — Same as L₇ for all bands except 11 turns for 7 Mc. and 5 turns for 14 Mc.; no tap. Final adjustment by spreading turns.
- B — 45-volt "B" battery, Type Z-30 (oscillator plate supply).
- J₁, J₂, J₃ — Closed-circuit jack.
- RFC — 2.5-mh. r.f. choke.
- S₁ — Push-button or toggle switch.
- S₂ — 3-section 3-position ceramic rotary switch.
- T₁ — 6.3-volt 6-amp. filament transformer.

final amplifier for 3.5- or 7-Mc. output, or a second 2E25 doubler to 14 Mc. which, in turn, drives the final amplifier when 14-Mc. output is desired.

The 14-Mc. band is sufficiently narrow so that satisfactory drive to the final may be obtained over this band without ganging the tuning of the 14-Mc. doubler stage with the others.

The final amplifier is a 4D32 which was selected because it will deliver a respectable amount of power at low plate voltage — 135 watts c.w. at 750 volts. The switching system shifts its grid to the appropriate driver stage for the desired output frequency. Plug-in coils in the output circuit of the 4D32 and the antenna tank circuit are not a great disadvantage in an otherwise completely-bandswitching transmitter, especially since it is unnecessary to reset the padding condensers. To maintain proper tank-circuit Q on all bands without the use of an excessively-high-capacitance tank condenser, the capacitance is made appropriate for 14 Mc. and the plate tapped down on the coil for the lower frequencies.

Straight inductive coupling, rather than link coupling, is used between the final amplifier and the antenna to facilitate tracking in the antenna tank circuit.

Although the frequency range covered can be adjusted to suit any requirements by the selection of proper tank-circuit values, in this case the oscillator range has been confined to cover only 1750 to 1925 kc. to give the output-stage range of 3500 to 3850 kc. and harmonics of this range. The fact that this does not provide full-scale bandspread for the 7- and 14-Mc. bands has not proved to be a handicap. The 7-Mc. band is spread out over approximately 90 degrees of dial rotation, while the 14-Mc. band is covered in about 60 degrees.

A miniature tube is used in the oscillator because its filament contributes less heat than that of a regular-size tube. This, together with the low plate-power input from the "B" battery and the use of zero- and negative-temperature-coefficient padding condensers, helps to minimize frequency drift. The oscillator is keyed in the negative high-voltage lead.

The parallel-condenser method of bandspread and tracking is used, although the tapped-coil method

¹ Mix, "Gang Tuning for the Multistage Transmitter," *QST*, June, 1938, p. 8.

may be used if preferred.¹ All padders, except those in the oscillator and 6AG7 doubler stages, are adjustable. It will be noticed in Fig. 1 that when the bandswitch is turned for 7-Mc. output, the grids of both the final amplifier and the 14-Mc. doubler are connected to the output of the 7-Mc. doubler, but when the switch is in the 14-Mc. position, only the input of the 14-Mc. doubler appears across the output of the first 2E25. To compensate for the loss of the 4D32 input capacitance, C_{31} is shunted across the output of the 7-Mc. stage when the switch is in the 14-Mc. position.

Normal coupling to the grid of the final amplifier results in proper excitation (10 to 15 ma. grid current) at 7 and 14 Mc. However, at 3.5 Mc. the available driving power is considerably more than that required for optimum excitation. Therefore the switching system reduces the coupling for this band by inserting C_{23} in series with the normal coupling condenser, C_{22} . Without this reduction in coupling, the grid current at 3.5 Mc. will run 30 to 40 ma.

Construction

The general mechanical arrangement can be seen best in the view of the front of the unit with the panel removed. The components are assembled on an $8 \times 17 \times 2$ -inch chassis with a standard $10\frac{1}{2}$ -inch rack panel. The ganged tuning condensers, with the exception of the one for the 6AG7 doubler, are mounted so that their shafts line up along the front of the chassis. The condensers should be of the type which has a tail shaft to which a coupling may be attached for ganging. Condensers with semicircular plates are preferable, since they will track regardless of the direction of rotation. Of the condensers in the gang, C_{15} , C_{36} , and C_{38} must be insulated from ground. Low-loss insulation should be used for the one in the antenna tuner; the rotors of the

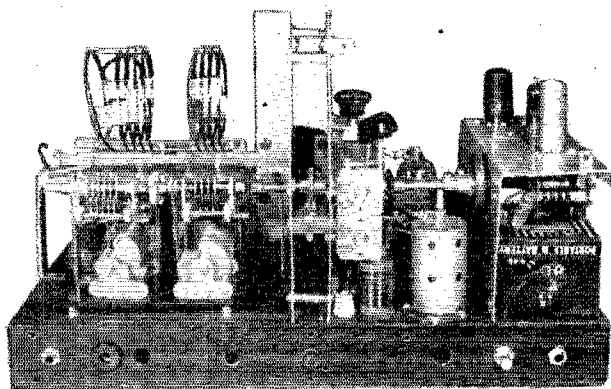

Front view of the gang-tuned transmitter with panel removed.

others require only d.c. insulation. Condenser mounting holes should be loose so that the shafts can be lined up accurately after they are in place.

The four condensers for the final amplifier and antenna tuner at the left are insulated from the chassis by mounting them on a sheet of bakelite. Those which are ganged are elevated above the padders on aluminum-strip brackets. The plug-in-coil assembly is supported on pillars to the rear of the gang. C_{20} , which tunes the first 2E25 tank circuit, is mounted behind the two padders, C_{22} and C_{24} , on the right-hand wall of the double partition at the center. This partition serves as a shield between the final amplifier and the rest of the transmitter, as well as a support for the

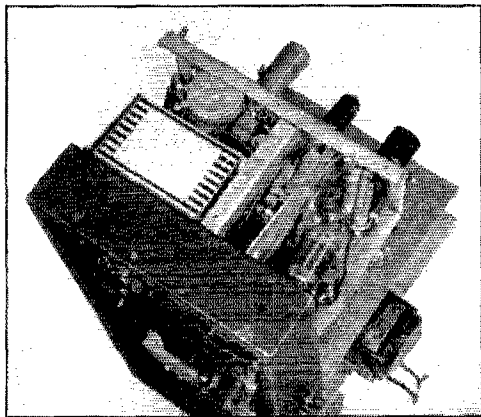

End view showing partitioning of shielding compartment containing first three stages. The oscillator is to the left and the 6AG7 doubler to the right, with the 6AG5 isolating amplifier in between.

driving-gear mechanism. The two coils, L_4 and L_5 , are mounted immediately below on the chassis, one behind the other, with the first 2E25 in the shield can to the right.

Components for the oscillator, the 6AG5 isolating stage and the 6AG7 doubler, including the Z-30 "B" battery for the oscillator, are mounted at the right in a shielding box made of aluminum sheet. The oscillator tuning condenser, C_1 , is mounted so that its shaft lines up with the others in the gang. The tuning condenser for the 6AG7 stage, C_{15} , is mounted at the rear of the compartment near the bottom and its shaft is cable-driven from a pulley on the shaft of the oscillator tuning condenser, C_1 . The end view shows the vertical partitions separating the first three stages of the transmitter.

The rear view shows the positions of the 14-Mc. doubler tube at the rear of the chassis, the band-switch mounted vertically between the two 2E25 stages, the tuning motor and the 4D32 to the right.

The leads indicated as shielded in Fig. 1 are sections of RG8-U concentric cable.

The tuning motor is a small one having a shaft speed of 1 r.p.s. It can be reversed with a s.p.d.t. switch. This switch should have a neutral position for stopping the motor. A shaft coupled to the motor carries the worm gear and runs through to a bearing near the front panel. The shaft then extends through the panel so that an external crank-type manual control may be fitted to it. The worm works against a pinion gear on the gang shaft. The gears, which provide a reduction of 50 to 1, are obtainable from the Boston Gear Works (worm gear No. LSH and pinion gear No. G1021). With this combination, it takes about 25 seconds to cover the 3.5-Mc. band, 12 seconds for the 7-Mc. band and about 8 seconds for the 14-Mc. band. The pinion can be drilled out and mounted on a short length of $\frac{1}{4}$ -inch shaft which will ride in the 1-inch space between bearings set in the shielding partitions. This short length of shaft is coupled to the ganged condensers on either side. The shaft may be of either metal or plastic, but a metal shaft will, of course, require an insulating flexible coupling at one end.

The pulleys or drums by which the 6AG7 tuning condenser is ganged may be of the type manufactured for h.c. receivers, or they may be turned out of sheet bakelite and fitted with brass hubs. If desired, a drum-type dial may be used in place of the gear combination for manual control.

Coils

The oscillator coils, L_1 and L_2 , are wound on a $\frac{1}{2}$ -inch form fitted with a permeability-tuning slug. This form may be salvaged from a surplus i.f. transformer or may be one of the Millen Type 74001 forms. The slug saves a lot of cutting and trying in setting the frequency range of the oscillator.

All doubler coils are wound on low-loss bakelite forms 1 inch in diameter.

The final-amplifier plate tank coils and the antenna tank coils are cut from Barker & Williamson strip coils, although similar homemade coils may be used.² They are mounted on strips of Plexiglas fitted with banana plugs. In making the plug strips and the jack into which the coils plug, it is advisable to space the plugs and jacks in such a way that the coils cannot be plugged into the jack in reverse direction.

Metering

Jacks are provided for checking the most significant currents. The condition of the oscillator battery may be checked from time to time by plugging a low-range milliammeter in the keying jack. Final-amplifier grid and cathode currents also may be checked readily. If desired, J_2 and J_3 may be open-circuit jacks shunted by

² Muldoon, "Low-Loss Low-Cost Transmitting Coils," *QST*, Dec., 1934, p. 41.

appropriate range-multiplying resistors so that the same milliammeter may be used for all readings. During preliminary adjustments, the currents of other stages may be checked by inserting a meter in the various plate and screen leads.

Power Supply

Four power supplies, mounted on a $7 \times 17 \times 3$ -inch chassis, are used with this transmitter. A small supply with a VR-150 and VR-105 in series with an appropriate dropping resistor across the output is used to supply 150 volts for the screens of the 6AG5 and 6AG7 and 225 volts for the plates of these tubes. A second supply delivers 350 volts at 80 ma. for the screens and plates of the 2E25s. Screen and plate voltages for the 4D32 are furnished by a conventional 750-volt 300-ma. supply. Fixed bias for the final amplifier may be taken from dry batteries or from a small pack with a VR-75 regulator. Protective bias for the 2E25s is supplied by the center-tap biasing resistor, R_{13} (which does not affect the other tubes since they are indirectly heated), while the 6AG5 and 6AG7 have their own cathode resistors.

Adjustment of Tracking

Since the circuits of a transmitter are loaded quite heavily, the problem of adjusting the tracking is not so critical as it might be in a receiver. Also, it should be remembered that the circuits need not track over the entire condenser range for 7 and 14 Mc. Each circuit must be tracked with the following stage coupled and its tube in place.

The oscillator is first set to cover the desired frequency range. Set C_1 at maximum capacitance. By listening on a calibrated receiver, or by other means, adjust the slug of L_2 until the signal appears at 3500 kc. At this point the tickler winding, L_1 , should be adjusted for best keying characteristics. Then set C_1 at minimum capacitance and check the high-frequency end of the range. If this frequency is lower than desired, use a condenser of lower capacitance at C_2 and repeat the entire process. If the high-frequency limit is too high, use a higher-capacitance condenser at C_2 .

To set the tuning range of the 6AG7 doubler stage initially, a pick-up coil connected to the re-

ceiver input was coupled to L_3 and the receiver tuned for maximum noise. The value of C_{14} was then changed until the point of maximum noise in the receiver came at the low-frequency end of the band with C_{15} set at maximum capacitance. From then on, grid current to the following 2E25 may be used to check the alignment.

Disengage the tuning condenser from the rest of the gang. Set C_1 at maximum capacitance and adjust L_3 until maximum grid current to the following 2E25 occurs with C_{15} set at maximum capacitance. Turn C_1 to minimum capacitance and retune C_{15} for maximum grid current. If maximum grid current occurs before minimum capacitance of C_{15} is reached, C_{14} should be made larger and the whole process repeated. If it is found impossible to tune $C_{15}L_3$ to resonance, the capacitance of C_{14} should be reduced and the adjustment process repeated. Since they can be bought reasonably, it is advisable to have several fixed mica condensers, 10 to 100 $\mu\text{fd.}$, on hand for trial. When the plate tank circuit of the 6AG7 has been adjusted correctly, it should be possible to gang it to the oscillator and obtain substantially constant grid current to the following 2E25 over the entire tuning range.

The adjustment of the first 2E25 plate tank circuit for the 3.5- and 7-Mc. bands is similar, but is facilitated by the fact that the padders are adjustable. The tracking may be checked, as described previously, by observing grid current to the 4D32. To help stabilize this stage when it is being operated as a straight amplifier, the screen voltage should be kept as low as possible without reducing excitation at 7 Mc. below normal requirements. When the tracking of this stage is complete for both bands, set the VFO and the rest of the gang for the center of the 14-Mc. band. Then, with the bandswitch in the 14-Mc. position, tune C_{30} for maximum 4D32

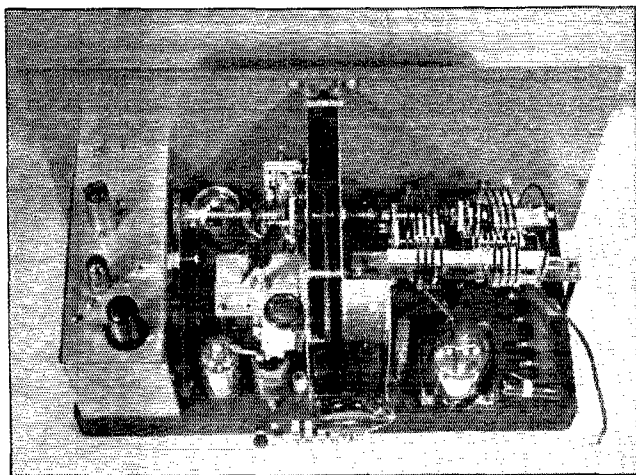

Rear view of the single-control transmitter with panel in place.

grid current. With this adjustment, the 4D32 grid current should hold quite constant over the entire 14-Mc. band, peaking at about 13 ma. at the center and dropping off to 11 ma. or so at the band edges.

Adjustment of Final-Amplifier and Antenna Tuning

To adjust the 4D32 plate tank circuit, couple a 50- or 100-watt lamp to the cold end of L_7 . Since the adjustment for 14 Mc. is the most critical, fire up the transmitter at the low-frequency end of this band (C_{36} at maximum capacitance) and tune C_{37} for resonance as indicated by minimum plate current. Tune the transmitter to the high-frequency end of the band and check the plate current to make sure that the tank circuit is still tuned to resonance. If it is not, retune to resonance with C_{37} . If retuning to resonance requires an increase in C_{37} , the size of the coil should be reduced slightly and the process repeated. If a decrease in C_{37} is required, the coil should be increased in size. Subsequent lining up of the circuit for 7 and 3.5 Mc. consists of carefully pruning the coil to tune the circuit to the low-frequency end of the band with C_{36} set at maximum capacitance. The setting of C_{37} should not be disturbed after having once been set for 14 Mc. This same setting should be made to serve for all bands by correct adjustment of the coils only.

Antenna tracking is simplified if the antenna system is cut so as to be self-resonant on all bands. Otherwise compensation must be made for the reactance which the antenna system presents at the antenna tuner. The antenna system chosen for use at W3DD is a center-fed half-wave with quarter-wavelength feeders for 80 meters. Thus on all three bands, the system is resonant with a high-voltage point at the ends of the feeders where they connect to the antenna tuner and parallel tuning can be used.

With the final amplifier tracking correctly, the antenna tuner with the antenna connected should be coupled in place of the lamp load and the trans-

mitter switched to the 14-Mc. band. With the transmitter tuned to the low-frequency end of the band (C_{38} at maximum capacitance), tune C_{39} for resonance as indicated by the peak in plate current. Adjust the coupling until the desired loading is obtained and readjust C_{39} for resonance as required.

During the adjustment of the antenna tank, it is important that the tuning of the 4D32 plate tank circuit remain fixed as adjusted previously. The reason for this is that tuning of the antenna circuit will detune the plate tank circuit temporarily until the antenna circuit is at resonance. When the antenna system is at resonance, however, its effect upon the final-amplifier tank circuit should be resistive only and therefore should not alter the original tuning of the final-amplifier tank circuit. This correct setting should be disturbed only as a means of checking to make certain that the antenna circuit is tracking as it should and the original setting should be restored as soon as the check has been made.

Now retune the transmitter to the high-frequency end of the band and retune C_{39} for resonance. As in the case of the final amplifier, decrease L_8 if C_{39} must be increased to restore resonance, or increase L_8 if a decrease in C_{39} restores resonance. If a check shows that the final-amplifier tank circuit does not stay close to resonance over the band with the antenna coupled and tuned, it may be necessary to readjust the tracking of the final amplifier slightly. Usually, however, this procedure should not be necessary.

When the coupling has been finally adjusted, the spacing between the two coils should be fixed by tying them together with strips of celluloid fastened with cement.

After the antenna tuning has been lined up for the 14-Mc. band, coils for the other bands may be checked by pruning them as described for the final-amplifier tank. The same setting of C_{39} must serve for all bands, and the coils pruned to suit.

With the antenna described, sufficient coupling was obtained at 7 and 14 Mc. with a spacing between coils of an inch or more. However, at 3.5 Mc., the amplifier could not be loaded up to maximum rated plate current with the two coils placed close together. The coupling was increased by augmenting the existing coupling by means of a single-turn link inside each coil. These links must be polarized correctly so as to assist, and not buck, the coupling between the two coils. At 14 Mc. it was found that the antenna coil had to be adjusted to within less than a full turn. This was accomplished by cutting the outer turn loose from the rest of the coil, except at the bottom, and then bending it away from the coil until the inductance was reduced to the correct value. This turn was then fixed firmly

(Continued on page 152)

Typical Current and Voltage Values in the Single-Control Transmitter

Oscillator plate current.....	17 ma.
6AG5 plate current.....	6.5 ma.
6AG7 plate current.....	7 ma.
First 2E25 grid current.....	2 ma.
First 2E25 screen voltage.....	265
First 2E25 plate current (3.5 Mc.).....	32 ma.
First 2E25 plate current (7 Mc.).....	28 ma.
First 2E25 plate current (14 Mc.).....	28 ma.
Second 2E25 screen voltage.....	275
Second 2E25 plate current (operating).....	28 ma.
Second 2E25 plate current (nonoperating).....	31 ma.
4D32 grid current.....	13 ma.
2E25 plate voltage.....	350-390
2E25 cathode bias.....	45-60

Adjusting the Matching Stub

Getting the Best Match with the Least Effort

BY WILLIAM L. SMITH,* W3GKP

THE shorted stub, illustrated in Fig. 1, is one of the simplest and most effective methods of matching a nonresonant transmission line to an antenna. When cut to a length of one-quarter wavelength, it works well with such high-impedance type antennas as the "J," Zepp, double Zepp, pitchfork, and end-fed W8JK array. When adjusted to a length of one-half wavelength it is suitable for matching low-impedance loads, such as the center impedance of a half-wave dipole or the radiator element of a beam antenna employing parasitic directors or reflectors. The shorted stub is considerably more flexible than either the open-ended stub or the quarter-wave "Q-bar" transformer, since the effective length can be adjusted readily by moving the shorting bar.

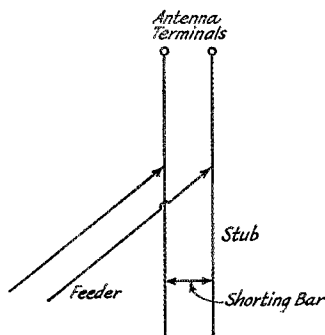

Fig. 1—The shorted stub, with feeders tapped on for matching. If the antenna impedance is higher than the line characteristic impedance, the stub should be approximately one-quarter wavelength long; if the antenna impedance is lower than the line impedance the stub should be one-half wavelength long.

The usual method of adjusting a stub of the type indicated in Fig. 1 is somewhat as follows:

- Disconnect the feeder.
- Remove the shorting bar, and replace it with a thermocouple galvanometer or other radio-frequency current indicator.
- Excite the antenna by placing it in the field of another antenna that is radiating on the desired frequency, and then adjust the position of the galvanometer on the stub for maximum current.
- Remove the antenna used for excitation.
- Remove the galvanometer, and place the

* 10110 Pierce Drive, Silver Spring, Md.

• The ordinary method of resonating and tapping a matching stub does not lead to optimum results because the system goes out of resonance when the feeders are tapped on the stub. This article describes a simple procedure for finding resonance and maintaining it while matching. No auxiliary antennas required.

shorting bar at the same position on the stub.

f) Attach the feeder to the stub, and couple the other end of the feeder to the transmitter.

g) Check the standing-wave ratio on the feedline, and adjust the position of the feeder tap on the stub for minimum s.w.r.

This method does not always yield an acceptably low s.w.r., because of the presence of factors that tend to make the first match obtained imperfect, and because in the final adjustment there is no definite procedure for making things any better. At the higher frequencies the galvanometer may not look like a "dead" short — i.e., it may have more inductance than the shorting bar. Furthermore, when the feeder is attached to the stub it tends to detune the stub and antenna system from the condition of resonance originally obtained. While this might be corrected by making additional adjustments in the position of the shorting bar, it is frequently found in practice that any such adjustment makes the s.w.r. higher instead of lower. Lastly, the position of the feeder tap on the stub for minimum s.w.r. is rather indeterminate in that there is no way of ascertaining in which direction the tap should be moved to get the s.w.r. lower.

Matching Procedure

The method to be described gets around most of these difficulties by providing a simple set of rules for determining which of the two adjustments should be changed, and in which direction it should be changed, to get the s.w.r. lower.

The procedure used is as follows:

- Cut the antenna to length, using the usual formulas for the type of antenna involved. Note that if the element to be matched is the radiator of a beam antenna that employs parasitic elements, then the antenna must be excited by any convenient means and the parasitic elements adjusted for best directivity before proceeding with

the matching. Any attempt to adjust the reflectors and directors after the feeder has been matched to the radiator will probably change the impedance of the radiator and upset the match.

2) Construct the stub and attach it to the antenna. If the antenna is being fed at a high-impedance point, set the shorting bar one-quarter wavelength from the antenna. If the antenna is being fed at a low-impedance point, set the shorting bar one-half wavelength from the an-

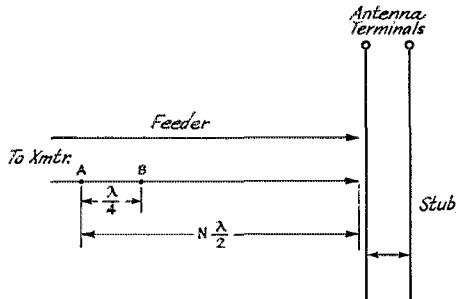

Fig. 2 — In the preliminary test, the feeders are disconnected from the stub and points A and B are located by measurement. A is any integral multiple of a half-wavelength from the open end of the feeder, B a quarter wavelength nearer the open end.

tenna. In either event the position of the shorting bar need not be exact; it can be found with sufficient accuracy simply by measuring it off with a rule.

3) String the feeder so it will reach from the transmitter to any point on the stub, but do not attach it to the stub. Arrange matters so that s.w.r. measurements can be made over a section of feeder about a half-wavelength long. It does not matter whether this section is near the antenna or back toward the transmitter.

4) Referring to Fig. 2, measure back from the antenna end of the feeder and locate point A, which is any full number of half-waves from the open end of the feeder. This point should fall within the section of feeder over which s.w.r. measurements are to be made. Mark point A with a piece of friction tape.

5) From point A, measure off one-quarter wavelength toward the antenna, thus locating point B, which should also be marked.

6) With the antenna end of the feeder disconnected from the stub, loosely couple the other end to the transmitter, thereby setting up standing waves on the feeder.

7) Using a standing-wave indicator,¹ locate a

¹The "Micro-Match" and similar indicators are not suitable for this type of measurement. The traveling-thermohammeter type indicator described in the measurements chapter in the *Handbook* is satisfactory. A crystal detector and d.c. milliammeter can be substituted for the thermohammeter if desired. Whatever the indicator, it should introduce as little unbalance on the line as possible; it should therefore have small capacitance to ground and should take negligible power for operation.

point of minimum feeder current in the vicinity of point A. Remove the marker from point A and place it at the point of minimum current, designated as point C in Fig. 3.

8) Locate a point of maximum feeder current in the vicinity of point B. Remove the marker from point B and place it at the point of maximum current — point D in Fig. 3.

9) Attach the feeder to the stub at a point about a quarter wavelength above the shorting bar — i.e., at the top of the stub if the stub is a quarter wavelength long, or at the middle of the stub if the stub is one-half wavelength long.

10) Using the standing-wave indicator, look around on the feeder in the vicinity of point C for a point of minimum current. The actual current at the minimum point may be higher than that obtained before the feeder was connected (Step 7 above) but this does not matter; the only thing of importance is the location of the minimum-current point with respect to point C. If the point of minimum current lies between point C and the antenna, the shorting bar must be moved up higher on the stub, but if the point of minimum current lies between point C and the transmitter, the shorting bar must be moved farther down on the stub. (If two points of minimum current are encountered near point C, the one falling closer to C is the one to be used as a guide.) Using this criterion, adjust the position of the shorting bar until the point of minimum current coincides with point C. Although the position thus found for the shorting bar is not the final one, the bar will not have to be moved very much in the course of subsequent adjustments.

11) Check the current at D and compare it with that at C. The current at D will be larger.

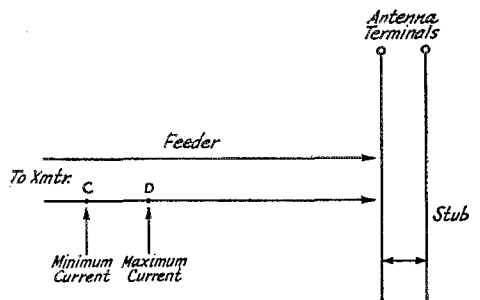

Fig. 3 — Points C and D are located by standing-wave measurements, C being a point of current minimum, D a current maximum.

Move the feeder taps on the stub down toward the shorting bar in small steps. Each time the feeder taps are brought closer to the shorting bar the current at D will drop slightly and the current at C will rise slightly. Continue to adjust the position of the feeder taps on the stub until the currents existing at points C and D are equal.

12) Run the standing-wave indicator down a section of line a half-wavelength or longer to get some idea of the maximum and minimum currents on the feeder. Now look in the vicinity of point *C* and there will be found a rather broad point of maximum or minimum current. Regardless of whether a maximum or minimum is found on this part of the line, note whether the maximum (or minimum) coincides with point *C*. If it does not, further adjustment of the shorting bar is in order. If the maximum (or minimum) falls between point *C* and the antenna, the shorting bar must be moved up, and vice versa.

13) Having gotten the maximum or minimum, as the case may be, to correspond with point *C*, compare the currents at points *C* and *D*. If they are not equal, another adjustment of the feeder taps is in order. If current *D* is higher than *C*, the feeder taps must be moved down slightly (toward the shorting bar) whereas if the current at *C* is higher than that at *D*, the feeder taps must be moved up (toward the antenna). In any event adjust the position of the feeder taps slightly until equal currents are found at *D* and *C*.

14) Run the standing-wave indicator down a section of line at least a half-wavelength long to find the s.w.r. The s.w.r. will probably be 1.5:1 or less, a value suitable for most amateur work, but if it is not acceptably low, Steps 12 and 13 may be repeated as many times as necessary to get it still lower.²

A Few Hints

Some general notes on the adjustment of antenna matching systems may be in order. In the first place, standing-wave ratios below 2:1 result in only a very slight increase in loss over the minimum possible. While still lower standing-wave ratios are desirable from the standpoint of uniform transmitter loading and uniform receiver matching over a band of frequencies, ease of loading cannot generally be used as an indication of s.w.r. Contrary to popular opinion, extremely "easy" loading of the transmitter usually indicates a high s.w.r. If uniform loading over any of the wider amateur bands is to be obtained, an antenna that is inherently unselective must be used. Antennas employing parasitic reflectors or having two elements excited 180 degrees out of phase are naturally selective—they have a high *Q*, and exhibit high currents and voltages for the power applied. The only remedy for this situation is to use thick elements or to use a folded doublet or multiwire doublet as the radiator. The attainment of s.w.r.s below about 1.5:1 demands that the coupling between the feeder and the standing-wave indicator be kept absolutely constant as the indicator is moved along the line.

² Since the methods depend on locating the position of the standing wave, it will not usually give a perfect 1:1 match because the standing wave then ceases to exist.

Last but not least, avoid making measurements on the line near the point where it joins the stub, because the field from the stub may affect the reading of the indicator. At 144 Mc. or higher frequencies be careful to drape the feedline in approximately its final position relative to the antenna, and make all measurements at a point on the feeder well removed from the antenna and with the antenna in the clear.

In speaking of antennas, the terms "high impedance" and "low impedance" have been used, and some additional explanation may be in order. If the feed-point impedance of the antenna is higher than the surge impedance of the type of feeder used, it is a high-impedance type; conversely, if the antenna impedance is lower than that of the feeder it is a low-impedance antenna. Cases may arise where the antenna impedance cannot be estimated in advance, but this difficulty can be resolved by a simple test. Leave the stub construction until last, and follow Steps 1, 3, 4, 5, 6, 7 and 8 to locate points *C* and *D*. Attach the feeder directly to the antenna and compare the currents at points *C* and *D*. If the current at *D* is the larger the antenna is of the high-impedance type, but if the current at *C* is the higher the antenna is low-impedance. If by any chance the currents at *C* and *D* are equal, check the section between *C* and *D* to see if a maximum or minimum is located on this part of the line. If such a maximum or minimum is found, satisfactory results can usually be obtained by treating the antenna as a high-impedance type, but if no maximum or minimum is found the antenna is already matched to the feeder and no matching stub is required.

If an extremely low s.w.r. is required, one curious effect may be noticed after Steps 12 and 13 have been repeated two or more times. Assuming that a broad maximum or minimum has been located near point *C*, and it is desired to adjust the position of the shorting bar to make the maximum (or minimum) coincide with point *C*, it may be found that moving the shorting bar will cause the broad maximum to change to a slight minimum, or vice versa. This is not a cause for alarm, but one should be aware of what is going on. At this stage the best scheme is to move the shorting bar only in very small steps, and after each step look over about a half-wavelength of line to determine the maximum and minimum line current before looking in the vicinity of point *C* to find if the maximum or minimum, as the case may be, coincides with point *C*.

**SWITCH
TO SAFETY!**



A Bandpass Converter for 144 Mc.

An Improved R.F. Section for Use with the 522 or Other Receivers

BY JOHN E. WILLIAMS,* W2BFD

POSSESSION of several surplus SCR-522s and dissatisfaction with the receiver portion of these equipments led the writer to seek methods of conversion other than those previously tried.

Amateurs who convert these receivers by altering the 8-Mc. crystal oscillator so that it is tunable soon learn that not only the oscillator but also the 2-gang harmonic generator and the 3-gang r.f. tuning condensers must be adjustable from the front panel. Nor is this all. As the condensers originally covered the range of 100 to 156 Mc. with an angular displacement of 90° from minimum to maximum, a motion of about an eighth of an inch at the periphery of a three-inch dial suffices to tune across the 144- to 148-Mc. band. Gearing the condensers together reduces the number of controls but imposes severe mechanical requirements such as freedom from back-lash, and if the condensers fail to track properly the penalty is a drastic loss of sensitivity. There is also the sad fact that no receiver tuning across so large a range will have *LC* circuits of optimum value for a narrow amateur band. Compare the BC-624's tuning ratio of 1.56 to 1 (or 44 per cent of the center frequency) to the tuning ratio of 1.028 to 1 needed to cover the 2-meter band (less than 3 per cent of the center frequency) and you will readily see how much improvement is possible with these sets.

Thinking along these lines inevitably will lead you to the conception of a fixed-tuned converter which can be set at the center of the band and which would require no tuning adjustment other than the oscillator. Conventional tuners will not accomplish this, as will be made apparent by considering that a tuner whose resonant circuits

* % The Electronics Device Co., 38-06 61st St., Woodside, N. Y.

• The SCR-522 transmitter-receiver, purchased on the surplus market in tremendous quantities for use on 144 Mc., has worked wonders in converting that band to the crystal-control-and-superhet-receiver approach. The transmitter is practically ready to go, as purchased, but the receiver conversion is more difficult, and at best the result is not too satisfactory. The simple bandpass converter here described by W2BFD was designed especially for use with the i.f. and audio sections of the 522, but it will work equally well in conjunction with any communications receiver. Its performance far exceeds the best that is possible through conversion of the 522 r.f. section.

are sufficiently broadened by shunting them with resistors (as in television practice) will have a considerable response to the image frequency, which is 24 Mc. away in the case of the BC-624. The energy dissipated in the shunting resistors would reduce the sensitivity appreciably as well.

"Well then, how about bandpass filters?" you ask. Fine, but what are we going to use to measure the precise values of inductance and capacitance which we must know to a high degree of accuracy in order that the filter may perform properly? And at 144 Mc.!

Cheer up; we are not beaten yet! The equivalent of bandpass filters can be had by the simple expedient of overcoupling pairs of ordinary tuned circuits. The effect of varying the mutual inductance between two circuits tuned to the same frequency is well known. Less than a value known as "critical coupling" transfers

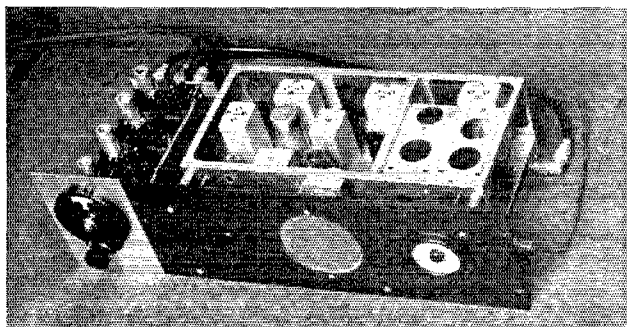

◆
The 144-Mc. bandpass converter designed by W2BFD in use with a revamped SCR-522 receiver.

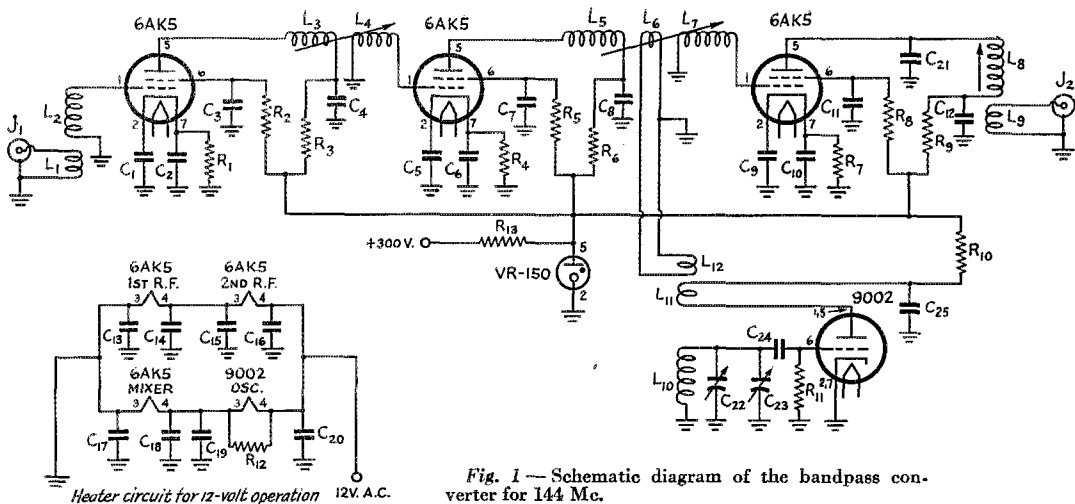

Fig. 1—Schematic diagram of the bandpass converter for 144 Mc.

- C₁-C₂₀, C₂₅ — Midget mica by-pass, any value between 250 and 500 μf d.
 C₂₁ — 15- μf d. ceramic.
 C₂₂ — 5- μf d. midget variable.
 C₂₈ — 3-30- μf d. mica trimmer.
 C₂₄ — 100- μf d. ceramic.
 R₁, R₄, R₇ — 560 ohms.
 R₂, R₁₀, R₁₁ — 10,000 ohms.
 R₈, R₆ — 5600 ohms.
 R₅, R₉ — 0.1 megohm.
 R₃ — 1.0 megohm.
 R₁₂ — 220 ohms.
 R₁₃ — 5000 ohms, 10 watts.
 All other resistors $\frac{1}{2}$ watt.

- L₁ — 2 turns No. 18 enameled wire, closely coupled to L₂.
 L₂, L₃, L₄, L₅, L₇ — 5 $\frac{1}{2}$ turns No. 18 enameled wire, $\frac{3}{8}$ -inch diameter, spaced approximately 1 diameter. (See text for detailed adjustment procedure.)
 L₆, L₁₂ — 1 turn push-back wire.
 L₈, L₉ — Output transformer; see text and photo.
 L₁₀ — 3 turns No. 18 enameled wire, $\frac{3}{8}$ -inch diam., spaced two wire diameters.
 L₁₁ — 2 turns No. 18 enameled wire, close-wound, $\frac{3}{8}$ -inch diameter, closely coupled to L₁₀.
 J₁, J₂ — Coaxial fitting.

energy, at the resonant frequency, of an amount dependent on the degree of coupling. Coupling in excess of the critical value results in a double-peaked response, with larger values of coupling producing greater separation of the peaks. The depth of the valley between the peaks is determined by the Q of the circuits. Experiments made in overcoupling the tuned circuits of the BC-624 without removing the gang condenser were fruitless because of the very low LC ratio; and, as the components of the r.f. and mixer portions utilize the gang condenser for their support, we would have just a handful of parts if we removed it.

The maximum value of LC ratio is obtained at these frequencies by resonating the coils with no other capacitance than the tube interelectrode and the distributed coil capacitance. Tuning is accomplished by varying the inductance of the coils.

If you have had the patience to read this far, by now you have reached the same conclusions that the writer did; that is, we want to build a converter to be used with the i.f. and audio portion of the BC-624, that will give uniform sensitivity across the band without sacrifice of gain by resistance loading. It must have the maximum value of inductance in its coils to make a substantial improvement in gain over the old

tuner, and a reasonable degree of discrimination against images must be provided. That these objects have been attained with the converter pictured on these pages can be attested to by the large number of amateurs who have already built "Chinese copies" of the one in use at W2BFD for the last several months.

Converter Details

Despite the size of the chassis (5 \times 10 \times 3 inches) shown in the pictures there are no parts or wiring inside. Everything is visible on the surface. Each stage is built separately on its own shielding partition which is cut out of pure sheet copper, 0.030 to 0.040 inch thick, with a pair of ordinary tinner's shears. The metal is obtained from any roofer or tinsmith shop.

A rectangle of copper 2 $\frac{3}{8}$ \times 2 $\frac{1}{16}$ inches wide is folded over a half inch at the bottom so that it will be self-supporting. Two holes 1 $\frac{1}{2}$ inches apart are drilled in the folded portion and tapped to take 6-32 screws. Two holes are drilled $\frac{5}{8}$ inch apart and $\frac{1}{16}$ inch down from the top of each partition with an $\frac{1}{32}$ -inch drill, and then cut out to form a mount for the Johnson ceramic miniature sockets. Stability will be difficult to achieve unless the copper tab is securely soldered up into the eyelet in the center of the tube socket. The tube sockets are also soldered to the

partition at the point where the socket mounting holes are located. Care should be taken to see that the grid prongs face in the same direction for the r.f. and mixer stages, but the socket of the 9002 oscillator should face in the opposite direction, in order that the wiring be kept at minimum length. R.f. by-pass condensers are laid flat against the partitions and soldered to the tube-socket prongs directly. The other lead of each condenser is soldered to the copper plate with no more than $\frac{1}{16}$ inch of wire left at each end. The three 6AK5 tubes must have both terminals of the cathode by-passed, one on each side of the partition.

Both sides of the heater of each of the four tubes are by-passed at the socket, even though that particular prong may be grounded elsewhere. If the heaters are run in series-parallel for 12-volt operation a 220-ohm $\frac{1}{2}$ -watt resistor must be connected across the 9002 heater to equalize its current with that of the other tubes.

All r.f. and mixer coils consist of $5\frac{1}{2}$ turns of No. 18 enameled wire wound on a $\frac{3}{8}$ -inch rod (which is removed) and given a preliminary spacing of the diameter of the wire. When the partitions are mounted on the chassis exactly $2\frac{3}{8}$ inches apart, the cold ends of the coils of each coupling unit should approach to within $\frac{3}{16}$ inch of each other. This spacing should be maintained in readjusting the coils during the alignment process. The oscillator coils have three turns with rather wide spacing for the grid coil, and two turns close-wound and closely coupled for the plate coil. Polarity must be observed for the connections of these coils or the tube will refuse to oscillate. For oscillator injection a one-turn link coil of No. 22 push-back wire is fastened near the cold end of the oscillator coil with a drop of Duco cement, and a link runs through several inches of twisted wire (which has one side grounded to the mixer partition) to another one-turn link coil inserted between the cold ends of the second-r.f. plate and mixer-grid coils. A tie-point strip runs vertically along one edge of each partition and all power wiring for that stage is brought to it.

The 12-Mc. transformer from the mixer plate to the coaxial line is one of the four slug-tuned coils which were originally the crystal-oscillator plate inductors. A two-turn link of hook-up wire wound tightly around the cold end matches the

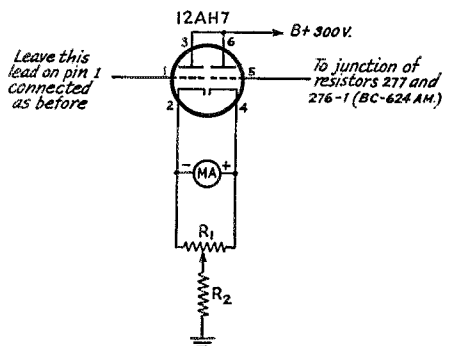

Fig. 2 — Diagram of an S-meter arrangement for use in the 522. The 12AH7 tube is already in the unit, having served previously as a crystal oscillator.

R1 — 5000-ohm potentiometer, wire-wound (zero adjustment).

R2 — About 10,000 ohms. Choose proper value for desired S-meter readings.

MA — 0-1 d.c. meter.

52-ohm coaxial very well. A similar link on the secondary of the first i.f. transformer in the BC-624, brought out to a coaxial fitting on the right side of the set, affords easy connection for the converter output. If the link is placed on the primary instead of the secondary there will be some improvement in i.f. selectivity at the expense of a small loss of gain.

As the photo shows, the first-r.f. grid coil is placed with its axis vertical so that the grounded end is just over the center connector mounted above the rear edge of the chassis. A two-turn link is tightly coupled to the grid coil and runs to the coaxial fitting with $\frac{1}{2}$ -inch leads.

Changes in the I.F. Unit

The r.f. unit is removed intact from the BC-624 and as a later project you can just increase the size of the coils and have an excellent f.m. broadcast tuner. The capacitance ratio of the tuning condensers is about right to cover the 88- to 108-Mc. range. In the compartment previously occupied by the tuner a piece of aluminum, $5\frac{5}{16} \times 5\frac{5}{8}$ inches, is mounted flush with the floor of the rest of the chassis. The power-supply components are supported by this plate.

The squelch relay is removed and an OD3 (VR-150) regulator tube is placed in a $1\frac{1}{8}$ -inch diameter octal socket, which fits the hole left

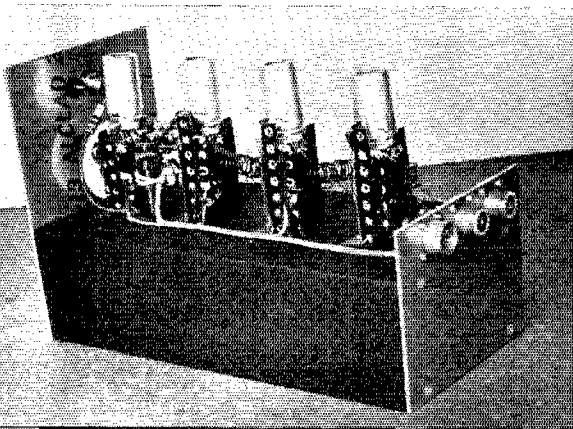

Rear view of the 144-Mc. bandpass converter. Each stage is mounted on an individual vertical copper shield, with the overcoupled tank circuits in between. The oscillator is nearest the front panel. Fittings across the rear panel are the power receptacle, and coaxial connectors for the antenna and 12-Mc. i.f. output.

by removal of the relay. In those models using electronic squelching the socket of the squelch tube is rewired for the regulator. Regulated voltage is fed to all the tubes in the converter, as the 6AK5s have very short life when subjected to higher-than-normal potentials. The receiver can be made completely hum-free if the intercom (crew microphone) transformer (No. 295) is disconnected and the circuit rewired to conventional resistance coupling. This will also increase the audio gain. Another source of hum in certain models having a 12H6 noise limiter under the chassis is the connection of a 6800-ohm resistor (No. 254-3) directly to the heater line which is now fed with a.c. This resistor should be replaced with a 0.1-megohm value going directly to B+.

A very sensitive S-meter arrangement utilizing the 12AH7 former crystal-oscillator tube as a push-pull cathode-follower amplifier is shown in Fig. 2. Only a single resistor and a potentiometer are needed in this circuit, which makes use of existing parts and wiring. The potentiometer sets the meter to zero and the resistor determines its sensitivity, its value falling between 10,000 and 20,000 ohms. An i.f. gain control is added to reduce the amplification of the set which becomes excessive when two high-gain r.f. stages are employed.

Tune-Up with a Grid-Dip Meter

A great deal of time will be saved by spending an hour to build the simple grid-dip meter shown in Fig. 3. It may be assembled on a piece of wood or other insulating material, and the only calibration needed on the dial are three marks

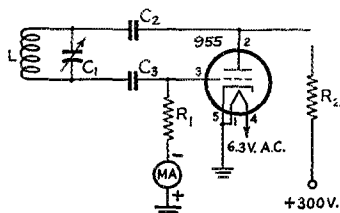

Fig. 3—A simple grid-dip oscillator for use in aligning the bandpass r.f. circuits.

C_1 —5- μ fd. air trimmer, with 3-inch insulated shaft extension.

C_2 —50- μ fd. ceramic.

C_3 —25- μ fd. ceramic.

R_1 —18,000 ohms, $\frac{1}{2}$ watt.

R_2 —47,000 ohms, $\frac{1}{2}$ watt.

L—4 turns No. 16 wire, $\frac{1}{2}$ -inch diameter. Spread turns to center band on dial.

MA—0-1 d.c. meter.

in the approximate neighborhood of 144, 146 and 148 Mc. Alignment of the r.f. section then consists of adjusting the turns in each copper-plate subassembly (after it is wired, and without any power wiring connected to it) until the grid-dip meter shows resonance at the center of the band. The oscillator subassembly can also be

given a preliminary adjustment before bolting to the chassis if two additional calibration marks are available on the grid-dip meter at 132 and 136 Mc. The final adjustment to the oscillator should be made, however, after it is completed and coupled to the mixer, as it is unavoidable that the frequency will shift with loading. The coils should be adjusted, keeping in mind that, after assembly of the partitions on the chassis, the cold end of the coils must be about $\frac{3}{8}$ of an inch apart. Greater coupling will widen the band unnecessarily and lesser coupling will allow the peak at the center of the bandpass response to build up considerably higher than the gain at either end of the passband. When everything is working right the level is substantially constant from about 142 to 150 Mc. with a rather sharp drop-off at each side of this 8-Mc. bandwidth. Even if only the 2-meter band is desired, the r.f. and mixer stages should be left 8 Mc. wide, and bandsread tuning accomplished by readjustment of the oscillator padder and spreading the turns of the oscillator grid coil.

Now for the pay-off! When you bought that SCR-522 you thought you were buying a rig for the 2-meter band only but you were mistaken. Converters of this general design can be built for the other v.h.f. bands and the object in the writer's case is to have a total of 4 of these tuners built for the 50-, 144-, 235- and 420-Mc. bands. The 4 tuners will be fastened side-by-side behind one 7 x 19-inch rack panel to match the BC-624 mounting, and placed under it to be convenient for tuning. As the 12-Mc. output coaxial line is at low impedance it could be switched from tuner to tuner, making an unbeatable 4-band v.h.f. receiver.

In closing, the writer wishes to give credit to the Amateur V.H.F. Institute of New York, of which club he is a member. The design of this tuner is part of an aggressive program of development of inexpensive v.h.f. and u.h.f. equipment sponsored by this up-and-coming organization. See you on 2 meters, fellers!

About the Author

* John E. Williams, W2BFD, has been in radio since 1920, having been a licensed amateur, under his present call, since 1927. He is a member of the Amateur V. H. F. Institute of New York, and is secretary of the V. H. F. Teletype Society, both of which give evidence of his primary leanings in amateur radio. The latter organization, already numbering 45 members, employs automatic page-printing teletypes, relaying automatically from originating to terminating stations. Thus far all such work has been done on 144 Mc.

Public Relations for the Amateur

A Guide for Promoting Good Will in Your Community

WHEN a recent *QST* editorial¹ remarked that good publicity is not something for amateurs to sneer at, the editor wasn't just beating his typewriter to hear the keys rattle. The suggestion deserves more attention than it probably received, for the time has passed when amateur radio, as an institution, can hide its light under a bushel and continue to survive. There are too many people and institutions who are not only revealing their merits to an immodest extent, but are erecting neon signs, both literal and figurative, to draw attention to themselves.

Why

The facts of the case are that amateur radio, in the United States, depends for its existence upon three interrelated elements: FCC, the Congress, and the American Public; every amateur, whether he realizes it or not, is obliged to remain in the good graces of all three. As to the good old American Public, once upon a time it could be depended upon to see through any sham, to eventu-



The Michiana Amateur Radio Club of South Bend, Ind., was one of numerous amateur groups which took advantage of 1947 National Radio Week to do a good public relations job. They arranged to broadcast the ARRL script over WHOT, with W9WCE and W9YWE participating. Then they obtained the cooperation of Robert Drain of the script department of WSBT in writing a new 15-minute program and put it on the following day with (above, l. to r.) W9RZO, Announcer Kryer, and W9ABL taking part.

ally discover the true merit of any proposition, and to make up its own mind. But that was before the days of Big Business . . . before it cost millions of dollars to start publishing a newspaper²; before 30-second spots were priced in three figures — or before there were any spots, for that matter. In other words, before the means of public expression became too expensive for the public to

• It has been said that public relations involves all the dealings of an enterprise with the general public. As an individual amateur and League member, you are part of our enterprise. The over-all picture of amateur radio to the general public is the sum of the good will — or lack of it — in every single community. If your dealings with John Q. reflect credit on the amateur, it adds to the total; if not, it subtracts. Here are some data on how to assure your community a place in the "plus" column — a sort of amateur version of "How To Win Friends and Influence People." It was prepared for *QST* by a W5, a public relations specialist who prefers to remain anonymous for business reasons.

express itself. And before the present Era of Public Relations.

Now the average guy, ham or otherwise, may think that his opinions are formed independently, but can he be sure? Can you? Think back over any recent public utterances by the head of your local power company. Did he ever refer to it simply as a "power company"? He may have been invited to speak about the weather, or the threat of Druidism in Pretoria; but if he mentioned his firm at all, it's ten to one he said, "your taxpaying electric power company," or "your business-managed power company." And woe to the REA when the utility industry decides that the public is convinced! There are endless varieties. Words such as "dictatorship," "communist," "monopoly," not to mention "free enterprise," have been printed so much in the past ten years that if one-tenth of a per cent of the charges were true we all would have perished long since in the red-hot ovens of concentration camps. Usually, such words are little eye-catchers, designed to give the public a bad impression of this proposition or that. The source will be forgotten, but the impression will remain.

Not only is the public unaware of most of the propaganda to which it is exposed, but editors and commentators frequently are unable to recognize it when it passes through their hands, and the more candid among them will admit it. That's one thing which makes public relations a difficult job, as will be pointed out later.

And why all this exposition on public relations? Simply because the future of amateur radio is

¹ "It Seems to Us," *QST*, Aug., 1947.

² Of course, country newspapers are cheaper, but have you priced a new *Goss* press lately? Or a linotype? Etaoin shrdlu!

going to depend to some extent, as it has in the past, upon the job it does in the field of public relations. Amateur radio's future existence will not be solely because amateurs have continued to provide vital communication in emergencies, continued to train a vast reserve of potential military communicators, and continued to lead in technical advances. Those things can pass virtually unnoticed — they actually have in the past! Amateur radio can survive only if every amateur accepts his new responsibility in this field and helps to build the reputation of amateur radio in the eyes of the public and the Government. We must not only justify our existence by our accomplishments, but we must make those accomplishments known. It will do us no good to be valuable, to render public service, if the public doesn't know about it.

No one is going to seek us out, or beat a pathway to our door. And the stakes are too high for us to indulge in that sort of wishful thinking. There are commercial interests which would sell their corporate souls for some of our frequencies. There are foreign governments which bitterly resent the international scope of amateur radio. And there are local cranks who would silence us permanently for messing up one stinking soap opera.

What

Obviously, something is needed, but what?

It is essential, of course, that amateur radio keep its nose clean as far as the FCC is concerned; every amateur knows this, and it needs no exposition here. Congress has set up FCC as a specialized agency to administrate all radio and communications matters. While amateur radio has no need to deal directly with Congress, it should be remembered that Congress is FCC's parent and what it does, in any controversial

matter, depends on what each member supposes to be the desires of his constituency — the voters. The voters are the public.

Therefore, amateur radio must make friends with the public — get acquainted — and impress upon the public the facts that amateur radio is an invaluable national and local asset, that amateur radio is the last lifeline of communication in emergencies, that amateur radio is the one and only large source of pretrained communication personnel for the armed forces, that amateur radio is largely responsible for the development of most technical advances in the field of electronics, that amateur radio has no profit motive, and that amateur radio, with public cooperation, can and does operate without inconvenience to the public.

This job must be so thoroughly done that no legislative body — Congress or state legislature or city council — will dare an attempt to curtail amateur radio operation for fear of arousing a public protest. State and local legislative bodies are mentioned, and are important, because while the authority to operate is provided through Congress, other legislative bodies can seriously hamper amateur operation. There are laws prohibiting the installation of short-wave receivers in automobiles — intended primarily to prevent thieves and the like from using police broadcasts as a warning system. And there are local building codes which can be and sometimes are used to prevent the erection of certain types of towers, masts and rotary beams.

How

There are two ways to reach the public: by direct, personal contact, and through public-information media — newspapers and broadcast stations. Both ways are important, because a poor job on the one hand will nullify a good job

Any community shows or expositions coming up in your vicinity? It's an ideal opportunity to tell the story of the usefulness of amateur radio. If you have plenty of room, you might make an elaborate installation showing many facets of the amateur service, as did the Des Moines, Iowa, Club last year (left). Or you may wish to pick one phase and hit it hard, exemplified by W0KV D and the AEC group in Colorado Springs (right), who distributed leaflets telling of local Emergency Corps planning.



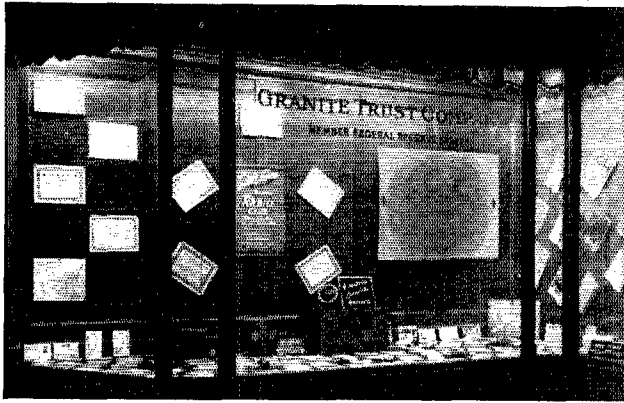

◆

“Show windows most easily borrowed for a few days are those of banks and utility companies, which usually have more window space than merchandise to display.” SCM WIALP and the South Shore Amateur Radio Club of Boston recently used this effective medium of public relations with a colorful exhibit.

◆

on the other. It won't do us any good to obtain favorable newspaper publicity, for example, if careless operation or failure to seek out and correct causes of interference keeps our neighbors in a constant, seething rage.

The files of *QST* are full of articles on how to cure BCI, once you find it, but not too much has been said on how to find it. It is not, usually, advisable to simply operate and wait for the complaints to come to you. They will, eventually, but by that time the BCI is usually too disgruntled to cooperate with you in curing the trouble; worse yet, he has for weeks or months been vilifying amateur radio for the benefit of all who will listen — giving all of us a black eye. This may sound drastic to some, but how about looking for trouble, instead of letting it find you? Some amateurs, living in apartment buildings, have been foresighted enough to canvass the other tenants, when making some radical change in power or frequency. The results, in most reported cases, have been excellent: BCI is nipped in the bud, and friends are made for amateur radio even among those neighbors who have no complaints — they put this bird down in their books as a good neighbor, and what reflects on him reflects on his hobby. Other hams, proud of their technical skill, occasionally transmit the *station location and telephone number*, inviting complaints from any who hear their transmissions in the broadcast band and offering full cooperation in correcting the trouble. That sort of thing pays off — in less BCI and more good will for amateur radio. It is good public relations!

In the field of personal contact, an excellent medium to get across the story of amateur radio is in the businessmen's groups and social clubs — Rotary, Kiwanis, etc. They are often on the lookout for interesting speakers at luncheons or evening meetings. If you personally aren't a good speaker, don't tackle it yourself; but surely among your local amateurs there is one who can do the job. Get the sample-speech source material from ARRL Hq., available on request; pick

a man for the job; and then contact the service club's secretary or program chairman telling him what you have to offer. In any such talk, of course, throw in plenty of local angles, particularly club activities of a public-service nature such as emergency preparation. Many community leaders are represented in the membership of these service clubs, and you can do much to promote good will by such appearances.

Other methods of direct, personal contact will suggest themselves. But now let's look at the press and radio side of public relations.

Newspapers

This problem is somewhat complicated by the fact that it is not the same in all localities. In larger cities, the newspapers usually are cramped for space, and there is plenty of competition for it, by all manner of publicity seekers. In small towns, the editor may be hungry for news, and willing to print anything he can get — provided it is about local people. The situation among broadcast stations is much the same: high-powered stations in metropolitan centers operate on very tight schedules, and asking them for time is like asking for money, while locals in small towns may welcome any relief from record sustainers.

There are several points to bear in mind, particularly in dealing with newspapers:

1) Newspaper editors are the most independent people on earth. They like to feel they are under obligation to no one, and they insist on making their own decisions as to what is news and what isn't. Never ask them to “print something”; instead, offer them information for whatever they think it is worth, in terms of space. If they turn it down, don't argue; try a different angle later on.

2) All through the war years and right up to the present time, newspapers throughout the country have been harassed by a shortage of paper (newsprint, they call it), and this makes

(Continued on page 138)



United States Naval Reserve

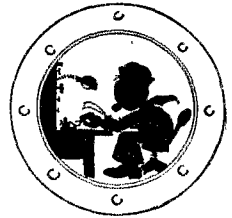

THE New Year's ice storm, which affected so many communities, struck hard at Burlington, Iowa, completely wiping out electric power and communications. The local Naval Reserve, Division 9-52, furnished a gas-engine-driven generator to power police-radio and fire-department communications. A TCS transmitter was set up in the railway station and for three days Reserve personnel maintained railway communications, the carrier's telegraph lines being completely out.

As in the past, the Naval Reserve Electronic Warfare program will be represented at the 1948 National Convention of the Institute of Radio Engineers, to be held in New York City on March 22nd-25th. Amateurs who attend will find much of interest to see and to hear.

W5USN, New Orleans, which operates under the call NDF when serving as control station for Reserve radio in the Eighth Naval District, reports a high score in the recent ARRL Sweepstakes: 570 contacts, 77,900 points. A total of 69 out of 71 ARRL sections was worked in 40 hours of operation; the Philippines and one Canadian section were missed.

The Chief of Naval Communications has congratulated the Eighth Naval District on being the first to place all its Reserve armory radio stations into operation. The Eighth District has a total of 50 Reserve armories.

Amateurs wishing more information on the Naval Reserve Radio Station Certificate illustrated in January *QST* should write to the commandant of their district (see list in October 1947 *QST*). W1GTS and W1IPU, active in the prewar NCR and now chief electronics technicians in the Organized Reserve Battalion at Providence, were among the first to receive this certificate.

One of the many positions at the Naval Reserve radio station located in the New York Naval Shipyard. This station is control for Naval Reserve radio in the Third Naval District, using the call NDB. On the amateur bands this station is licensed as K2NR. W2IWH appears in this photo operating a BC-610-E.

The Secretary of Navy has renamed all Naval Reserve Armories as Naval Reserve Training Centers.

W6NCM, CRM Gearhart, USNR, is now on active duty in the Naval Reserve Communications Office, Naval District Hq., San Francisco.

The following Naval Reserve amateur calls have been issued since the last list appearing on this page:

K1NAB	Salem, Mass.	K5NAE	Greenville, Miss.
K1NAC	Beverly, Mass.	K6NRN	San Carlos, Cal.
K1NRG	Waterbury, Conn.	K6NRU	Eureka, Cal.
K2NAC	Bethpage, L. I., N. Y.	K6NMC	Camp Pendleton, Cal.
K2NAD	New Rochelle, N. Y.	K8NRA	Cadillac, Mich.
K2NRJ	Buffalo, N. Y.	K8NRH	Hancock, Mich.
K3NR	Pittsburgh, Pa.	K9NAB	Zion, Ill.
K4NAE	Charleston, S. C.	K9NAC	Waukegan, Ill.
K4NAF	Montgomery, Ala.	K0NAD	Marshalltown, Iowa
K4NAG	Knoxville, Tenn.	K0NAE	Pueblo, Colo.
K4NAH	Lakeland, Fla.	K0NAF	Colorado Springs, Colo.
K4NAI	Augusta, Ga.	K0NAG	Minneapolis, Minn.
K4NRJ	Greensboro, N. C.	K0NRK	St. Joseph, Mo.
K4NRL	Columbia, S. C.	K0NRL	Lincoln, Nebr.
K5NAB	New Orleans, La.	K0NRR	Ames, Iowa
K5NAC	Monroe, La.	K0NRU	Sioux Falls, S. D.
K5NAD	Dallas, Texas	K0NRV	Salina, Kansas

Commander Coleman, W1NK, district Reserve operational communications officer for the First Naval District, recently met with officials of the Eastern Massachusetts ARRL Section at Boston City Club to lay plans for amateur-Naval Reserve cooperation during emergencies.

Amateurs in the Naval Reserve are invited to send items suitable for this page, via official channels, to Cmdr. D. S. Wicks, USN, Room 3062, Arlington Annex, Navy Dept., Washington, D. C.



• Technical Topics —

Single-Sideband Power Gain

THE elimination of the carrier and one sideband in 'phone transmission obviously offers the opportunity to put more power into the remaining sideband. The natural question is, "How much more?" The answer, from all appearances, is, "It all depends."

It all depends on how you want to figure it. Take a simple case first: If a carrier is 100 per cent modulated by a sine-wave signal, the total power in the two sidebands is half the power in the carrier. Thus if a 100-watt carrier is 100 per cent modulated, the sideband power is 50 watts — 25 watts in each sideband. The total power, therefore, is 150 watts. Eliminating the carrier and one sideband eliminates 125 watts of the 150. But the system obviously is capable of handling 150 watts, so it appears as though it ought to be possible to increase the remaining 25-watt sideband to 150 watts. This is a power gain of 6, or almost 8 db.

However, this simple line of reasoning leaves a lot of things out of consideration. The ordinary modulated amplifier operates Class C, while the single-sideband amplifier operates as a Class B linear in the systems so far in use. There is a difference in the amplifier efficiency in the two cases. It is not great, but it should not be ignored. The peak efficiency of a Class B amplifier is usually in the neighborhood of 65 per cent, while the efficiency of a Class C stage averages around 75 per cent. (We need only consider the peak efficiency in the Class B case because the power input varies with the sideband amplitude and is greatest on the modulation peaks. This is in great contrast to the Class B linear amplifiers we used years ago before Class B audio came along. The amplifier does not have to be adjusted for carrier conditions because there is no carrier; actually a Class B amplifier for single sideband is operated in just the same way as a Class B audio amplifier — except that it is unnecessary to use two tubes.) So, if plate dissipation in the final stage is the limiting factor, we arrive at an answer this way: With the ordinary transmitter, our total output of 150 watts at 75-per-cent efficiency requires an input of 200 watts, meaning that the tube or tubes have to dissipate 50 watts. At 65-per-cent efficiency the maximum input we can use on the same tube is 143 watts and the tube output is 93 watts. The gain ratio therefore becomes 93/25, or 3.7 to 1. This is a bit under 6 db.

As a matter of fact, neither of these answers is satisfactory from the amateur viewpoint.

Both are based on sine-wave modulation, a type we aren't particularly interested in. Actually, it is well known that on the average a voice waveform contains about half as much power as a sine wave of the same *peak* amplitude (which is why your Class B meter never should kick very high when you're modulating properly). The normal 'phone transmitter with a 100-watt carrier therefore will have only about 12.5 watts in each sideband under full modulation. Since the 93-watt figure arrived at above for single sideband was based on allowable plate dissipation, it can be considered to be independent of the waveform for the moment, and the ratio in favor of single sideband then becomes 93/12.5, or 7.4 to 1. This is almost 9 db.

But this leaves out of consideration the fact that no one talks at maximum intensity all the time. Plate-dissipation ratings are based on an *average* heating of the plate and tube as a whole. In the case of ordinary carrier-with-sidebands transmission the carrier, which is on continually, accounts for most of the heat and the modulation does not raise the average plate temperature very much. In single sideband the input varies with the sideband amplitude, and the syllabic ratio of average to peak, even with continuous talking, is certainly never greater than 1 to 2 and probably does not exceed 1 to 4. If we take this factor into account, it is easily possible to arrive at the conclusion that the power gain is 3 to 6 db. greater than the continuous-modulation figures would indicate. In other words, a gain of 12 to 15 db. can be expected. All this assumes, of course, that the amplifier can handle the peak power with linearity.

The foregoing figures ignore everything except the final stage, which is more or less customary amateur practice. But if we went at the thing as the commercials do, we ought to base our calculations on the *total* power consumption of the transmitter, amount of equipment necessary, and so on. If the power that has to be made available for a high-level modulator, high-power driver stages, and the usual concomitants of a plate-modulated transmitter are included in the total permissible power-input figure, at least 3 or 4 more decibels can be added. At this point single sideband begins to look a lot more attractive than a ten-acre rhombic.

Confusing, isn't it? We have one suggestion to offer, based on what seems to be a reasonable interpretation of our regulations. In all the communication systems we have previously

used, the permissible power input has been based on the input to the final stage under steady-carrier conditions, ignoring all types of modulation. Consider now what happens when single-tone modulation is used on a carrier. If the tone frequency is 1000 cycles and the carrier frequency is 3900 kc., sidebands will be set up at 3889 kc. and 3901 kc. Suppose we now transform this into single sideband by eliminating the carrier, 3900 kc., and lower sideband, 3889 kc. We have left a *pure c.w. carrier* on 3901 kc. Under our regulations there isn't any question about the maximum power input: we could use a kilowatt input on that single-frequency single sideband. The gain with single sideband under these conditions, assuming 65-per-cent efficiency for the Class B linear and 75 per cent for a Class C plate-modulated amplifier, can easily be calculated. Ignoring plate dissipation and assuming

equal power inputs, the output with single sideband is 65 watts for every 100 watts of input. For the plate-modulated amplifier, the equivalent output in one sideband is 17 watts, so the gain is 65/17, or 3.8. This is very close to 6 db.

The question of the power input permissible under our regulations is very pertinent and will have to be resolved before very long. One virtue of the suggestion above is that power input becomes easy to check. With single-tone modulation the output is essentially a single radio frequency, so the power input is measured with d.c. instruments just as we measure input to any of our present-day transmitters. A measurement based on power averaged over a period of time is inherently open to all kinds of interpretations because of the vagaries of voice waveforms and inevitably would lead to argument.

— G. G.

Inductive Coupling to Rotary Beams

• The article by W3IKX in September *QST*, outlining design details for inductive coupling to a rotatable antenna, brought the following comment from Glen D. Hallmark, W4AUT.

IN the September 1947 issue of *QST* an article by Mr. Louis Taich entitled "Do It Inductively" discussed the problem of inductive coupling to a rotatable antenna array. The example discussed in the article involved matching an 8-ohm antenna system to a 400-ohm line by means of an inductive coupling network.

It appears that a more general approach to the calculations would result if the initial assumption had been the Q of the tuned circuit under load, rather than the coefficient of coupling. It was pointed out in the article that the Q should be on the order of 10 or more, and a value of 12 is a frequently-used compromise.

With reference to the sketch (Fig. 1), and using the numerical example carried forward in the article mentioned, the impedance Z_t , between the terminals a - b of the primary of the coupling circuit, should be equal to the characteristic impedance of the transmission line to the transmitter. Then we have at resonance:

$$Z_t = 400 \approx XQ$$

and: $X = 33.3$ ohms with a Q of 12

The reactance of the condenser must then be approximately 33.3 ohms at resonance, or

$$\frac{1}{2\pi fC} = 33.3$$

$$C = 334 \mu\text{fd. at } 14.3 \text{ Mc.}$$

A design for the coupling loops that may be

applied at other frequencies might be of interest. The impedance required of the primary loop under load may be determined, since $Q = \frac{X}{R}$ at resonance. Neglecting losses in the condenser,

$$R = \frac{X}{Q} = \frac{33.3}{12} = 2.78 \text{ ohms}$$

The impedance of the primary loop must then be:

$$Z = R + jX = 2.78 + j33.3 \quad (1)$$

Neglecting the loss in the coil itself, the resistance, R , must be the coupled resistance due to the secondary, and the reactance X must be the vector sum of that due to the self-inductance of the coil, $2\pi fL$, plus the coupled reactance due to the secondary circuit. Then:

$$R + jX = 2.78 + j33.3 = jX_p + \frac{(\omega M)^2}{Z_s} \quad (2)$$

where Z_s is the complex impedance of the secondary circuit, $R_s + jX_s$, and X_p is the self-reactance of the primary loop. If the antenna is resonant, and connected directly to the secondary loop, R_s will be approximately the radiation

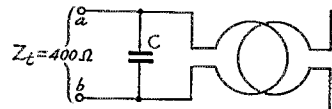

Fig. 1—The matching problem under discussion.

resistance of the antenna, taken as 8 ohms in the example given, and X_s will be the reactance of the secondary loop. For the type of construction illustrated, it will be most convenient for the primary and secondary loops to be identical, that is, with their self-inductance equal: $X_s = X_p$;

New Apparatus

Sideband Filter

then, from Equation 2:

$$R + jX = 2.78 + j33.3 = jX_p + \frac{(\omega M)^2}{R_s + jX_p}$$

$$= jX_p + \frac{R_s(\omega M)^2}{R_s^2 + X_p^2} - j \frac{X_p(\omega M)^2}{R_s^2 + X_p^2}$$

$$= \frac{R_s(\omega M)^2}{R_s^2 + X_p^2} + j \left[X_p - \frac{X_p(\omega M)^2}{R_s^2 + X_p^2} \right] \quad (3)$$

$$\text{or:} \quad R = \frac{R_s(\omega M)^2}{R_s^2 + X_p^2} \quad (4)$$

$$\text{and:} \quad X = X_p - \frac{X_p(\omega M)^2}{R_s^2 + X_p^2} \quad (5)$$

With the antenna resistance 8 ohms, as used in the before-mentioned article, we have, from Equation 4:

$$2.78 = \frac{8(\omega M)^2}{8^2 + X_p^2}$$

and from Equation 5:

$$33.3 = X_p - \frac{X_p(\omega M)^2}{8^2 + X_p^2}$$

These two equations may be solved for values of ωM and X_p , which yield the inductances for the coupling coils and the mutual inductance or coefficient of coupling. For this example, these are:

$$X_p = X_s = 51.1 \text{ ohms}$$

$$\omega M = 30.6 \text{ ohms}$$

$$\text{and at 14.3 Mc.} \quad L_p = L_s = 0.57 \text{ microhenry}$$

$$M = 0.34 \text{ microhenry}$$

$$k = 0.6$$

Using the formulas from *Radio Engineer's Handbook* by Terman, cited as a reference in the before-mentioned article, it is found that these values will be obtained using loops of $\frac{1}{4}$ -inch copper tubing about 10 inches in diameter, spaced 0.65 inch.

Perhaps it should be pointed out that the characteristics of the transmission line between the antenna and the secondary coupling loop have been neglected in the above discussion and in the original article by Mr. Taich. If the length of this line is appreciable compared to a quarter wavelength, and is not matched to the antenna at the operating frequency, the impedance presented to the secondary coupling loop by the line will be far different from the antenna resistance, and will have a reactive component that will alter the total secondary impedance, Z_s .

These results are in good agreement, of course, with the data given by Mr. Taich. It might be pointed out, however, that the required inductance of the coupling loops is not arbitrary, but is determined by the Q desired of the resonant primary circuit.

ONE of the obstacles in the path of the amateur who is building a single-sideband transmitter similar to that described in the January, 1948, issue of *QST* is the sharp filter used to remove one of the sidebands. This obstacle is now removed by the announcement of a filter designed expressly for the job. Neatly packaged in a case that measures $4\frac{1}{2}$ inches long, 3 inches wide and $4\frac{1}{2}$ inches high, it includes not only the filter but the balanced input and output transformers described in the *QST* article mentioned above.

As can be seen from the accompanying curve (furnished by the manufacturer), the filter is

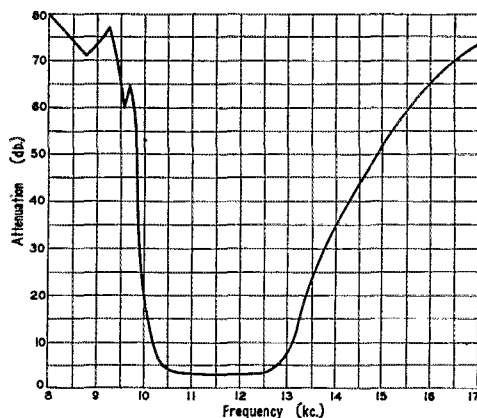

superior to that described by WØTQK in the *QST* article. Comparing this curve with the one shown in January *QST* will show the improved cut-off of this particular unit. This one, for example, drops 50 db. in 400 cycles, compared with the 40 db. in 1000 cycles used at WØTQK in his first experiments. The superior attenuation gives better suppression of the undesired sideband while permitting better low-frequency response to be used.

In building a single-sideband exciter around this unit, the amateur feeds ring-modulator output and output from a self-controlled 10-kc. oscillator into the filter and obtains push-pull output for the next balanced-modulator stage. A filter termination resistor (a simple carbon resistor), and a 100-ohm potentiometer for balancing the ring modulator, must be supplied by the constructor. This filter should go a long way toward simplifying amateur single-sideband construction.

The unit is designated the F-22 Sideband Filter and is manufactured by the National Company, Malden, Mass.

A Mobile Transmitter-Receiver for Shipboard

Building a 28-Mc. Self-Contained Unit

BY WILLIAM K. SQUIRES,* W2PUL

• In this article a seagoing ham describes a compact 7-watt 28-Mc. mobile rig which has proved itself in action. It is sized and shaped to fit into a small suitcase. Designed to operate from either a.c. or d.c. lines, it is readily adaptable to almost any type of shipboard power.

THE requirements for a mobile-marine station are numerous and vary considerably with the type of vessel aboard which the rig is to be used. The unit shown in the photograph was designed so that it can be used on almost any type of ocean-going vessel. It has been operated with excellent results on a recent European voyage.

The most important single consideration in gear for this work is size. The entire station should be small enough to pack in a suitcase with considerable room to spare. Next, provision should be made for a.c.-d.c. operation since most ships have 115-volt d.c. supply, yet a few have 115 volts a.c. available. A receiver or a converter ought to be included because very few ship receivers tune higher than 24 Mc. So that it would be possible to use the transmitter power supply and audio system for the receiver, it was decided to build the station as a completely self-contained unit on a single chassis.

Receiver Circuit

The receiver circuit is shown in Fig. 1. A 7J7 is used in the mixer-oscillator. This tube, similar to the 6K8, gives good conversion efficiency at high frequencies, with only slight interaction between oscillator and mixer sections. The mixer and oscillator are gang-tuned by a split-stator condenser. Both circuits are band-set by mica trimmers.

Two stages of 1.5-Mc. i.f. give good selectivity and satisfactory image rejection. The use of 7AG7

*86 George St., Tonawanda, N. Y.

◆

The 28-Mc. mobile transmitter-receiver is built as a single unit which fits into a small suitcase. The chassis is 18 × 12 × 3 inches. The receiver occupies the left-hand side of the chassis with the transmitter to the right. The audio equipment is at the rear.

March 1948

tubes in both stages provides excellent sensitivity. The 7AG7 is particularly well suited to this application because it has exceptionally high transconductance at the low plate voltage available. Gain is controlled by varying the bias on these two tubes.

The plate detector, using another 7AG7, was used primarily because it loads the i.f. transformer only slightly. Distortion is hardly noticeable on any but the strongest signals.

Transmitter Details

In the transmitter, a 50L6 is used as a Tri-tet oscillator with 7-Mc. crystals and its plate circuit tuned to 28 Mc. Although quadrupling at this low plate voltage, adequate excitation is provided to drive two 50L6s in push-pull. The final amplifier operates perfectly with no neutralization, but the circuit can be neutralized easily by bringing out two short leads from each plate near the grid of the opposite tube.

The load impedance presented by the Class C amplifier to the modulator is 1000 ohms at the full input of 100 volts 100 ma., which is just right for 50L6s as Class A modulators. Impedance coupling is used without a dropping resistor, since some distortion can be tolerated at the higher modulation percentages.

Switching System

A four-pole double-throw switch performs all functions necessary to change from transmitting to receiving, including antenna change-over.

When receiving or transmitting, the 7AG7 second detector drives the parallel 50L6 grids, but on transmitting the secondary return of the last i.f. transformer is switched to the microphone gain control and microphone input transformer. The carbon microphone receives 2 volts d.c. from a tap on the cathode-biasing resistor of the modulators.

When transmitting, the mixer-oscillator and i.f. tubes are switched from the plate supply, and

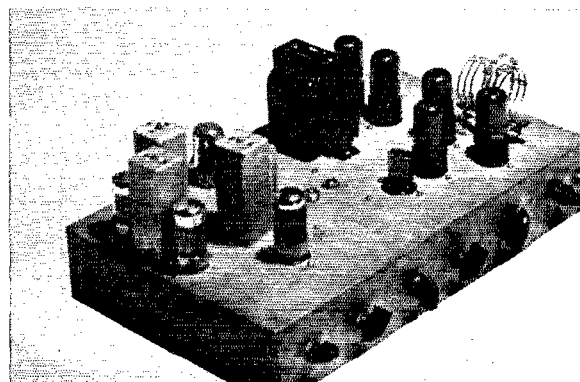

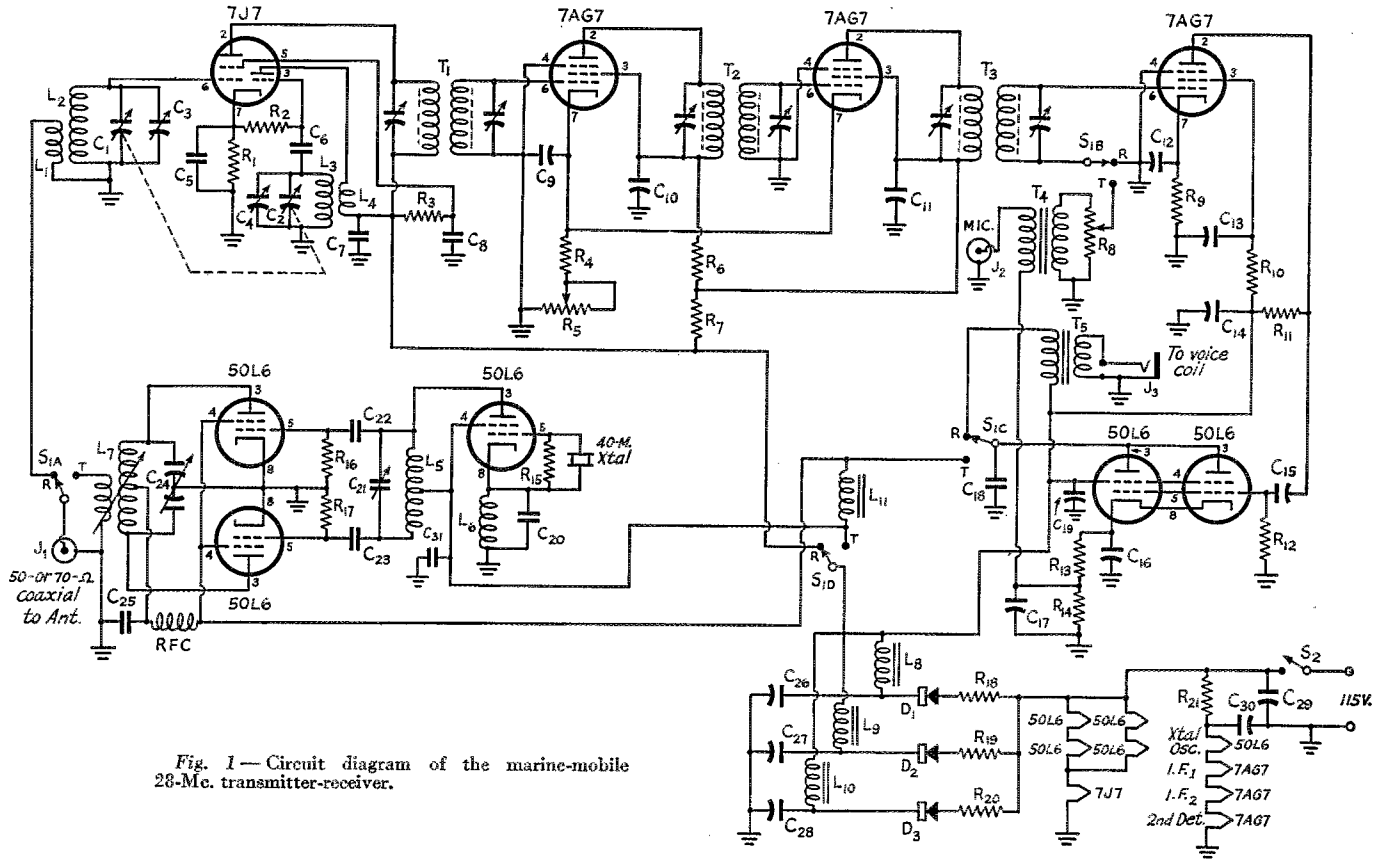

Fig. 1—Circuit diagram of the marine-mobile 28-Mc. transmitter-receiver.

the parallel 50L6s are connected to the modulation choke. When receiving, the crystal oscillator and Class C amplifier are switched from the plate supply, and the parallel 50L6s are connected to the output transformer. In either position, plate voltage is applied to the 7AG7 second detector.

Selenium rectifiers are used in the power supply to conserve space. As the current requirements of the transmitter are very high, three rectifiers and three separate filters are used, the outputs being paralleled to permit a total drain of 300 ma. This system results in d.c. with very little ripple, and the supply operates coolly and conservatively.

In operation, the receiver is very stable, even when subjected to the heavy vibration of a ship in a heavy sea. The sensitivity with a 10-db. signal-to-noise ratio was measured as seven microvolts. In operation the receiver proved better than ever expected from an a.c.-d.c. job. In several in-

stances when the supply voltage dropped while at sea the receiver portion of the unit was still usable at a line voltage one-half of normal. Some regeneration in the i.f. amplifier is noticed at full gain, but it is not objectionable.

The transmitter delivers about 6 watts output, on 115-volt d.c. supply; on a.c., the output is approximately 7.5 watts.

Aboard ship the unit was used with an antenna about 6 wavelengths long in conjunction with an antenna tuner. Operated over a period of two months, almost constantly, this equipment has proved that very low power can be used for reliable DX work. Consistent daily schedules were maintained without a miss for 10 days or more at distances of 2000 or 3000 miles. Every day, of course, the ship would be many miles from the position of the previous day's contact. Considering the size and versatility of this unit, it has proven to be almost perfect for the seagoing ham.

The author thanks Stuart Korkow, W2PUT, for his many excellent suggestions in the original schematic, and Merritt Malvern, W2ORG, and his brother Arnold for their help in the production of this article.

- R₁₃, R₁₅, R₁₉, R₂₀ — 22 ohms, ½ watt.
 R₁₄ — 47 ohms, ½ watt.
 R₂₁ — 250 ohms, 10 watts, wire-wound.
 L₁ — 3 t. No. 20 hook-up, interwound ground end L₂.
 L₂ — 7 t. No. 14 bare, ½-inch diam., 1¼ inches long.
 L₃ — Same as L₂, 1 inch long.
 L₄ — 2 t. No. 20 hook-up, interwound ground end L₂.
 L₅ — 2 t. No. 20 hook-up, ½-inch diam., 1½ inches long, tap for B + 4 turns from plate end.
 NOTE: All above coils self-supporting.
 L₆ — 15 t. No. 18 e., close-wound on ½-inch diam. form.
 L₇ — B & W 10TCL.
 L₈, L₉, L₁₀ — 10-hy. 100-ma. filter choke.
 L₁₁ — 5-hy. 200-ma. filter choke.
 J₁ — Coaxial-cable connector.
 J₂ — Microphone jack.
 J₃ — Open-circuit jack.
 D₁, D₂, D₃ — 100-ma. selenium rectifier (FTR).
 RFC — 2.5-mh. r.f. choke.
 S₁ — 4-p.d.t. wafer-type switch.
 S₂ — S.p.s.t. on R₂.
 T₁, T₃ — 1500-kc. iron-core input i.f. transformer.
 T₂ — 1500-kc. iron-core interstage transformer.
 T₄ — Single-button-microphone-to-grid transformer.
 T₅ — Output transformer, match 1500 ohms to v.c.

- C₃, C₄ — Split stator, approx. 10 µfd. per section (made from Hammarlund MCD-50-M by re-moving all but 1 rotor and 1 stator in each section).
 C₅, C₇, C₈, C₉ — 0.01-µfd. mica.
 C₆, C₂₂, C₂₃ — 22-µfd. midget mica.
 C₁₀, C₁₁, C₁₂, C₁₄, C₂₀ — 0.1-µfd. 200-volt paper.
 C₁₂ — 0.01-µfd. 200-volt paper.
 C₁₅ — 0.05-µfd. 200-volt paper.
 C₁₆, C₁₇, C₁₈ — 20-µfd. 150-volt electrolytic.
 C₁₈ — 470-µfd. mica.
 C₂₀ — 220-µfd. mica.
 C₂₁ — 100-µfd. variable (Hammarlund HF-100).
 C₂₄ — 140-µfd. split-stator variable (Hammarlund HFD-140).
 C₂₅ — 100-µfd. midget mica.
 C₂₆, C₂₇, C₂₈ — 40-µfd. 150-volt electrolytic.
 R₁ — 150 ohms, ½ watt.
 R₂, R₁₀ — 47,000 ohms, ½ watt.
 R₃, R₆, R₇, R₈ — 2200 ohms, ½ watt.
 R₄ — 100 ohms, ½ watt.
 R₅ — 50,000-ohm variable.
 R₉ — 0.5-megohm variable.
 R₁₁ — 0.33 megohm, ½ watt.
 R₁₂, R₁₅, R₁₆, R₁₇ — 0.1 megohm, ½ watt.

Silent Keys

It is with deep regret that we record the passing of these amateurs:

W1JUF, Carl K. Scott, Collinsville, Conn.
 W2BVE, Lt. Cmdr. Charles V. Schug, Ridgewood, N. Y.

W5BJX, President W. W. Robinson, Wichita Falls Radio Club, Wichita Falls, Texas

W5ZA, Louis Falconi, Roswell, N.M.

W6MMX, Richard F. Oppelt, Yucaipa, Calif.

W6ROX, C. Craft, Elsinore, Calif.

W6ZMP, Thomas M. Annis, Burbank, Calif.

W7GZN, Richard N. LaRue, Anacortes, Wash.

W9LQY, Arthur B. Damiani, Chicago, Ill.

W9PDE, J. Lessard, Ishpeming, Mich.

W0CRA, ex-W9CRA, Robert L. Heine, Montrose, Iowa

W0FDF, William R. Cheatham, Kansas City, Kansas

Associate Member W. B. Dobbs, Arlington, Mass.

F8NR, R. Gerrer, Lautenbach, H.R.

VE1BY, Thomas J. Nolan, former Chief Radio Inspector, D. of T., Halifax, N. S.

VK2ALD, R. B. Dransfield, Acton, Canberra

Ten Elements; Ten Meters

A Successful Experiment with Multielement Parasitic Arrays

BY E. C. S. LEAVENWORTH,* W6ZV

TO WHOM it may concern: For a year or thereabouts we have been working on the business of new beams with results that will prove interesting, crazy, or improbable — depending on the state of the reader's liver or preconceived notions. Our interest was stimulated one day when we heard a Back East station tell another one that there was no use transmitting any more because W6NOISE was on his frequency with a rhombic 300 feet high and a half mile long. It occurred to me then that what we city dwellers needed was a multielement beam that will give the boys with wide-open spaces and/or wide-open pocketbooks a good argument.

It will be remembered that in nineteen hundred and recently, one of the boys down Texas way hung a couple of directors on a regular three-element beam with results which he found to be the essence.¹ With that to go on we decided to hang four directors and two reflectors on a four-element beam. Surplus aluminum angle material — of which there is plenty in these parts — was used as support, and using a four-element beam as a basis we soon had a ten-element beam with a single radiator fed unsuccessfully and variously

* 1816 W. Sheridan, San Diego, Calif.

¹ W. W. Basden, "Five Are Better Than Three," *QST*, December, 1946.

² G. N. Carmichael, "Multielement Radiators in Close-Spaced Arrays," *QST*, June, 1947.

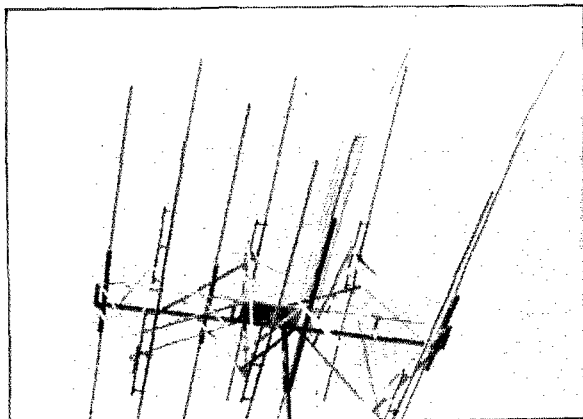

☞ Looking up at the ten-element beam. No photograph of a structure having as many members as this could make the construction obvious at a glance, but close study will bring out most of the features. The two elements projecting into the upper right-hand corner belong to a different beam.

• This almost has to be seen to be believed. But since we can't offer all of you a trip to San Diego, we're printing a picture in proof. And W6ZV's results prove that it works — better. Q.E.D.

by T-match, matching section and 75-ohm line.

This nonradiating miasma developed pains that aspirin and Alka-Seltzer could not touch. In due course a panacea appeared in the shape of W4GCA, who came forth with the cage radiator as per June *QST*.² Having heard of his experiments and results in October, 1946, we immediately applied that formula which, after some pruning and shearing, solved the feeding problem. Using nothing more exact than a good old-fashioned guess, we estimated the impedance of a ten-element beam to be from $\frac{3}{4}$ to 1 ohm. A 16-wire cage was used with this idea in mind. Our old-fashioned guess was considerably off and we finally wound up with a 12-wire cage, at which point loading was easier and results more so.

On Stateside contacts results with this "chicken roost," as the local boys immediately dubbed it, were most pleasing to the ear, but being a dyed-in-the-wool amateur of some 30 years experience, we had heard pleasing reports of "the loudest signal on the band" before and were not convinced. We cajoled three or four local amateurs with good three- and four-element beams to get on the same frequency while we did a check or two. The results were still lovely but the angle of radiation apparently was high, because the 60- or 70-db.-over-9 report in the Middle West and on the East Coast fizzled out to something less than spectacular on DX contacts.

After a few days of unscientific cogitation it was decided to construct a new 10-element beam — this one to have the elements staggered so that all directors were 0.1 wave from the next director and the reflectors 0.15 wave from the radiator and from each other. More sawing, drilling and teamster's English resulted in the photograph shown and also in the same high angle of radiation. Terrific reports Stateside and some dubious DX.

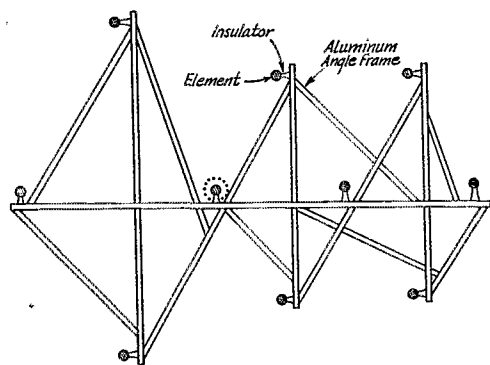
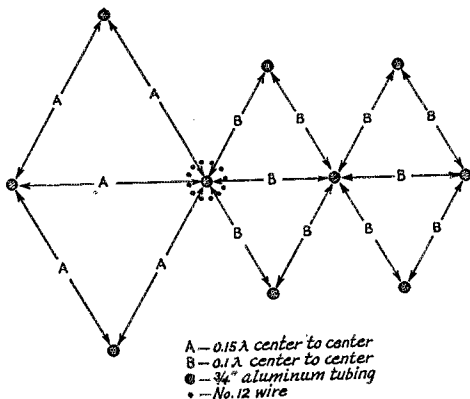

Fig. 1 — Upper drawing — element spacing in the ten-element beam, end view. Lower drawing — end view indicating the method of bracing. Cage wires are 14' 11" long, reflectors 17" long except for the one at boom level which is one inch longer. The three directors close to the antenna measure 15' 4", the three farther away 15' 2". This drawing is not to scale.

After much discussion, questioning of our local experts and perusing articles, it developed that the proper way to lower the angle of radiation on my ten-element pet was to soak it in a rain barrel, bury it under three feet of moist earth, or — sure-fire — eliminate six elements. Now we have in San Diego the finest group of amateurs on earth, but their imaginations take bizarre forms and I still felt that my ten-element beam would work if I could make it work! Much scratching of the balding scalp and puffing of the pipe did not bring anything of brilliance and the beam swung idly in the balmy breezes. The band sounded like 1 A.M. in the graveyard anyway (summer '47).

About this time interest became acute in television beams and it was noticed that the directors were shorter in length as they were removed from the radiator, because of "end effect," "broadening" and/or what have you.

Using the television-beam measurements as a virgin idea based on nothing electrical, mechanical or physiological, two inches was sliced off the three

farthest directors. That apparently has done the trick: 5 and 9-plus in the Middle West; 50-plus db. over 9 on the Atlantic Coast and 5 and 9-plus in ZS-land.

The back-to-front ratio on this beam runs from 30 to 60 db. Front-to-side ratios are considerably higher. Ground-wave results (100 miles or so) run from 2 to 10 db. higher than the best four-element beams. WHEN, portable-marine off the coast of India, reports "the only W station audible" at that time. ZS1P in Cape Town reports "the loudest W6 he has ever heard." There are many similar reports, mostly Middle West and East Coast, which were extravagantly glowing. All amateurs of experience have at one time or another gotten identical glowing reports, because of proper skip, freak conditions, or just plain good antenna plus good location. I have weighed this fact against the performance of this beam and also under the same conditions on the same frequency against some of our best San Diego beams with results that indicate that the ten-element is superior by one to four S-units on 90 per cent of contacts.

It is hoped that anyone who models after this beam will do so with a consideration for further experiments. I am sure that the possibilities have not been entirely plumbed and that different heights, further shortening of elements, quarter-wave spacing and so forth should be tried. Permit me to offer reassurance on the following points: the construction is easy; the rotation is simple and standard; and the space occupied is such that it can be mounted on any house, tower, garage or limited area.

Knowing the ingenuity of the average ham, little description seems necessary as to construction detail. The ten-element may be mounted in any fashion that is convenient. Elements are cut to frequency and no tuning is required. In the early months of experimenting, condensers were mounted in the center of each element and tuning each element was tried in that fashion. Each time one condenser was varied the other eight elements proceeded to change characteristics. It did not take a mathematical genius to decide that it was too complicated a job for the average amateur or even the above-average.

The beam is very pleasing in that it attenuates very little from 23.5 to 29.5 Mc. With this beam cut to 23.3, using the standard *Handbook* formula, the only change in length was to cut one inch from each end of the farthest three elements. As stated before, this shortening apparently resulted in the lowering of the angle of radiation and in concentration of the beam. The standing-wave ratios were found to be less than 2:1 at 23.35, about 3:1 at 23.5, 3:1 at about 29.15, and 20:1 at 29.6.

We were recently able to persuade W6UNU to change from a four-element to a ten-element

(Continued on page 138)



The World Above 50 Mc.

CONDUCTED BY E. P. TILTON,* WHDQ

THAT local contacts are the lifeblood of v.h.f. activity was never better demonstrated than by the First V.H.F. Sweepstakes, January 17th and 18th. When the dates selected for this v.h.f. version of ARRL's most popular operating activity were announced, a common response was, "Sounds like a good idea, but why in January, when v.h.f. conditions are at their lowest ebb?"

Well, that was just the idea; if there is any justification for v.h.f. operating contacts, other than the fun we get out of them, it is the increase in activity such contests invariably beget. The SS form is simple; other than the multiplier for sections worked it places no premium on DX, and working every station on the band is important, be he local or DX. By going after everyone, many of us reaffirmed a fact that we tend to forget at times; namely, that working locals *can* be fun. We found that there were fellows right in our own neighborhoods whom we had seldom or never worked, simply because they were not "DX," and the V.H.F. SS became a get-acquainted party as well as an operating contest. And since we cannot have DX unless we first develop consistent activity over wide areas, it appears certain that such contests can do much to keep activity going, particularly when propagation conditions are at their poorest and interest in operating on the v.h.f. bands tends to slump accordingly.

The week-end of January 17th and 18th provided little encouragement from any propagation angle. It is doubtful, indeed, if a worse two-day period, DX-wise, could have been selected; yet the reports already received at Headquarters total nearly three times the number turned in after any previous v.h.f. contest. At this writing we have received approximately 250 reports, representing 38 ARRL sections in 9 call areas, and the V.H.F. Sweepstakes bids fair rapidly to become a major institution in the ARRL Activities Calendar.

As might be expected, the large scores were turned in by operators situated in metropolitan areas, but since competition is confined to contestants within a given ARRL section, the more remote stations need not be discouraged by their slimmer totals. With 21 reports received to date, Eastern Massachusetts leads all other sections. W1ATP, Holliston, holds top place

* V.H.F. Editor, QST.

there with 88 contacts on 6 and 2 meters, in 6 sections, for a total of 1056 points. W2OHE, Brooklyn (N. Y. C.-L. I.) and W2RH, Port Chester (E. N. Y.) ran neck and neck right through the contest, winding up at midnight Sunday with 124 contacts in 5 sections — 1240 points apiece, two of the highest scores yet reported. Both stations worked on 144 Mc. exclusively.

Reports from points beyond the eastern part of the country are far from complete as we write, but 6 California sections are represented, and scattered reports have come in from Oregon, Washington, Kansas, Iowa, Illinois, Indiana, Michigan, Ohio, Western Florida, and all Eastern Seaboard sections from Maine to Virginia, as well as from stations in the Maritime and Ontario sections of Canada.

The contest rules, as set up for this affair, had several objectives. By limiting competition to stations within a section, it was hoped that everyone would feel that he had a chance. It seemed to work out that way, and local competition was keen indeed. The primary purpose of the affair was, of course, to stimulate activity, and it appears from the comments received that it did this almost universally. Hundreds of contacts were made, under conditions so poor that normally v.h.f. activity would have been almost nonexistent in most places. By providing a section multiplier and counting the sections worked on all bands combined, but by giving credit for each contact on each band, the rules encouraged versatility. It was demonstrated that, even under adverse conditions, 50 Mc. was best for collecting sections, while 144 Mc. produced the greater number of contacts. There was a considerable reward for being able to work on 6, as your conductor's 11 sections collected there demonstrate. Despite many more contacts made on 2, our score would have been meager, but for that multiplier provided by the greater working range on 6. Had any of the top scorers on 144 Mc. put in time on 50 Mc. their totals might have been four or five times larger, and if there had been a break in the form of a 50-Mc. band opening the advantage gained would have been even greater. As there is normally greater local activity on 144 Mc., the scores made on that band averaged much higher than those made by the fellows who worked 50 Mc. exclusively, but the contest rules offered a real premium to those who could work

both bands effectively. A few contacts were reported on 235 and 420 Mc., but general activity on those bands has not yet reached a point where it can be productive of an important difference in over-all scoring in a v.h.f. contest, unless a band multiplier is included.

This contest served to demonstrate what can be done under the most adverse conditions. Its results are gratifying, in many respects, but they could be a whole lot better. What happened to the great population concentrations in the Great Lakes areas? Only a handful of reports are in from Cleveland, Chicago, and other cities where v.h.f. activity abounds. There is none at all, so far, from numerous other sections where stations are known to be operating; none at all from W5, for instance. The next contest, exact details of which have not yet been formulated, is scheduled for May 22nd and 23rd. Coming as it does at a time when there is almost certain to be some interesting propagation development, it should result in much wider participation.

A common comment heard in the early stages of the V.H.F. SS was "Well, I'm not in the contest, but I'll give you a number." As the affair began to roll, however, many of these shrinking violets were calling each new station which appeared on the bands. They got into the spirit of the thing in short order, and had plenty of fun. All of us would like to see more activity on our v.h.f. bands — let's get into the operating contests sponsored for the express purpose of developing it. And not only get in; keep a record of your contacts, and send it in for *QST* listing. Rules for the next contest will be announced later, but remember the date — May 22nd and 23rd. Plan now to be in there, with both feet!

January Conditions

The year 1948 started auspiciously, with a good east-west F_2 opening on January 1st, and a fair one the following day. W7BQX, Sequim, Wash., worked W2s BYM, LAL, EUI, AMJ, MEU, W1s NWL, RX, QUR, EKT, COX, W4HVT, W4JEA, VE1QY and VE1QZ on the 1st, in a period of nearly four hours. W1HMS, Fairhaven,

Mass., reported contacts with W7s FIV, CTY, FIM, HOL and EVO, and VE7LD and VE7AEZ the same day. There was little sign of F_2 DX during the balance of the month, and no work across the Atlantic or Pacific has been reported. Things are expected to improve during February, particularly on north-south paths, and an appreciable amount of DX is expected at least through April.

January provided quite frequent sporadic-E openings, the 4th, 12th, 23rd and 24th being particularly good. Vermont contacts were a feature of the Jan. 23rd opening. W1MEP, Bennington, Vt., got his converter going in time to work W9ZHL and W9UNS. W1CGX, Brattleboro, made his first skip contacts with W9ALU, W9THL and W0KYF. Ray was unable to make any contacts during the early part of the opening because he was operating on 51,016 kc. Only up in the band *one-fourth* of the way, and nobody heard him, yet he was in one of the most sought-after states in the Union! Let's tune that band, gang. Just because there is a pile-up at the low end is no reason to assume that nobody works anywhere else. W0UNQ, Wichita, Kansas, has had some trouble getting answers on only 51.2 Mc., despite 350 watts, a good beam and an excellent signal.

This just doesn't make sense. When the band is open for F_2 , the low edge may have an advantage, but on sporadic-E skip there is almost certain to be no difference between 50 and 52 Mc. at least. More than likely the frequencies up to 70 Mc. or so are open — why jam up in the first 200 kc.? If you are one of the "Above 51 Club" send in your frequency and we'll be glad to publicize it. Just having a crystal for above 51 Mc. is no qualification for membership. You've got to guarantee to use it.

50-Mc. Allocations

The major task confronting the ARRL directors at their spring meeting will be, as always, a decision on the suballocations in our bands for various types of emission. The case for the frequencies below 30 Mc. has already been placed

◆

Maj. Ken Ellis, MD5KW, Suez Canal Zone, the white hope of American operators seeking a 50-Mc. WAC. He has heard W signals on 50 Mc. and hopes to make the first Africa-North America contact this spring.

◆

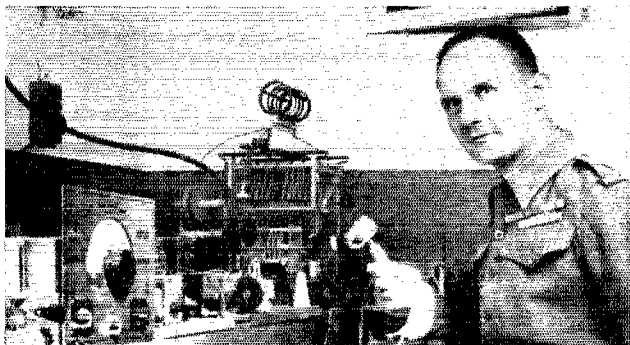

RECORDS

Two-Way Work

50 Mc.: CEIAH — J9AAO
10,500 Miles — October 17, 1947
144 Mc.: W3GV — W8WGW
660 Miles — September 18, 1947
235 Mc.: W1CTW — W2HWX
210 Miles — October 12, 1947
420 Mc.: W6VIX/6 — W6ZRN/6
186 Miles — July 27, 1947
1215 Mc.: W3MLN/3 — W3HFW/3
12.5 Miles — September 24, 1947
2300 Mc.: W1JSM/1 — W1LS/1
66 Miles — October 5, 1947
3300 Mc.: W6IFE/6 — W6ET/6
150 Miles — October 5, 1947
5250 Mc.: W2LGF/2 — W7FQF/2
31 Miles — December 2, 1945
10,000 Mc.: W4HPJ/3 — W6IFE/3
7.65 Miles — July 11, 1946
21,000 Mc.: W1NVL/2 — W9SAD/2
800 Feet — May 18, 1946

before the membership, with the opportunity provided, by means of a card, for all amateurs to express their opinions regarding possible changes in 'phone suballocations. It is the purpose of the next few paragraphs to outline possible changes in the 50-Mc. allocations, and to request written opinions from you, the 50-Mc. gang, as to their advisability.

At its 1947 meeting the Board approved a request to FCC for changes which would permit narrow-band f.m. in all our 'phone bands. On 10 it was decided that n.f.m. could be permitted wherever a.m. was used, and the allocation was so altered, with generally satisfactory results. On 50 Mc., the n.f.m. allocation was moved down from above 52.5 Mc. to 51 Mc. and higher. This change was made with a view not only to permitting more effective use of n.f.m. on 6 but to encourage use of more than the low edge of this wide band. Limitation of the use of n.f.m. to frequencies above 52.5 Mc. had had the practical result of eliminating this form of emission from successful use, because of the trend toward low-edge operation on the part of all 50-Mc. stations, and it was hoped that moving n.f.m. down part way might reverse this trend. There was no reason, other than the hoped-for spreading out of the stations on the band, why n.f.m. should not have been permitted anywhere in the band where a.m. was employed.

At first the desired result began to develop. More stations went on n.f.m. at once, and quite a few a.m. stations joined them in the territory above 51 Mc. Then came the F_2 DX! Day after day stations operating above 50.5 or so found themselves out in the cold as far as the European and transcontinental DX were concerned. True, there were a few days when the m.u.f. shot up

through the band, and European contacts were made as high as 52.5 Mc. on at least one occasion, but on most days the m.u.f. hung well below 51 Mc. and stations customarily operating above that point had to move down into the low-end QRM or be left out of the fun. For the first time there was something more than a psychological reason for working close to the low edge of the band. The net result, as far as the n.f.m. users were concerned, was that they had to go back to a.m., with its attendant BCI difficulties, if they wanted to make any DX contacts on voice. Thus an allocation change, made with the best of intentions, merely worked a hardship on the users of a new medium.

Question Number One on our 50-Mc. poll:

Should n.f.m. be permitted wherever a.m. is employed on 50 Mc.?

If the answer to this is to be "yes" we must face the fact that we will then have no measure left as a deterrent to low-edge cramming, and we may well come into another DX period with practically all our activity in the first 100 kc., with the rather ridiculous result of burying one another in needless QRM in a wide-open band. An alternative, which has been suggested from several quarters, is that we make an exclusive low-edge assignment for c.w. use.

Wait now — let's keep our heads here; this is not the usual 'phone-c.w. argument! On 6, there is almost no such thing as a "c.w. man." Probably not more than half a dozen stations in the whole country use c.w. exclusively, and many of the rest of us, including the writer, use it only as a means to an end, preferring voice operation whenever the latter is possible. But anyone looking at the picture with an open mind must admit that c.w. has its uses, and certainly not the least of these is its effectiveness as a DX medium.

Since c.w. is admittedly the most effective DX medium, and since DX is the primary reason for band-edge operation, would it not be logical to reserve a narrow slice at the low edge for c.w. only? If this were only 100 kc. it would work no appreciable hardship on voice operators during openings, and because we would have to change crystals to work voice, it would encourage the use of frequencies well up in the band. Under normal conditions there is no reason whatever for operating in the first 100 kc., and when there is a reason for low-edge work, c.w. would be the most effective use of those kilocycles. So —

Question Number Two:

Should a portion of the low end of the 50-Mc. band be set aside for c.w. operation exclusively, and if so, how wide should the c.w. band be?

Assuming that we do set aside a c.w. band, and permit the use of n.f.m. elsewhere, we still haven't done much toward more effective use of the four megacycles available to us. Can any changes be made in our allocations to encourage use of the rest of the band? We think so.

If there is a place in the whole amateur spectrum where duplex operation should be encouraged, it is 50 Mc. For local chats with low power; for a stand-by channel while tests are being conducted on other frequencies; for remote control purposes; for an information channel within a club group; for emergency purposes — these are just a few of the ways in which the high end of 6 could be profitably used if A0 emission (continuous or unmodulated carrier) were permitted there.

Question Number Three:

Should A0 emission be permitted on the high end of the 50-Mc. band, and if so above what frequency?

Please, everyone, let's do some thinking along these lines, and then drop a line to the writer with a copy to your director — soon. And let's also remember that even if we take all possible steps to encourage more effective use of the band, in the last analysis it rests with us, the individual operators, to employ the measures toward the desired end.

First, almost all of us have crystals for frequencies higher than 50.1 — let's use them. Second, there are a few hardy souls who operate high in the band on general principles — let's tune for them, so that they will get the break they deserve. Third, since 50 Mc. is such a doggone good band for local and extended-local working, let's make greater use of it for such purposes, relieving the congestion existing on lower frequencies, and providing more consistent occupancy of the band we like so well.

2-Meter News

Once again most of the correspondence received relating to 144 Mc. is concerned with the polarization question, and the arguments are familiar. Eastern operators take this department to task for suggesting that DX aspirants in W1, 2 and 3 try horizontal arrays, and outstanding users of horizontal polarization express their approval. Both sides say that it has been proven (by some "authorities" they are usually unable to name) that one or the other is "best," and each side takes the other to task for making blanket assumptions on the basis of somewhat inconclusive evidence. However, the fact remains that no amateur group has yet run comparative tests under such technically-sound conditions as to prove anything — or if it has been done we have not heard about it.

Published literature has shown slight variations in both directions, but to our knowledge the tests on which commercial findings have been made were not strictly applicable to amateur conditions. Here we are not interested in service areas evenly distributed about a nondirectional antenna system. We are not concerned, in the main, with which system produces the steadiest or strongest signal in mobile installations. What



Standings as of January 30th

W1CLS	44	W5VY	40	W9ZHL	43
W3CIR/1	42	W5ML	38	W9JMS	36
W1LLL	40	W5AJG	38	W9QKM	33
W1HDQ	39	W5JLY	38	W9ALU	32
W1CGY	38	W5FRD	38	W9ULA	30
W1HMS	36	W5FSC	34	W9AB	23
W1JLK	35	W5LIU	24		
W1LSN	33			W0USI	45
W1CLH	32	W6UXN	46	W6QIN	43
W1CJL	30	W6OVK	38	W9ZJB	43
W1AF	27	W6ANN	38	W6DZM	42
W1NF	25	W6BPT	34	W6TK	42
W1EIO	24	W6FPV	21	W6SV	42
		W6WNN	34	W6BJV	42
W2BYM	39	W6EUL	22	W6HXY	41
W2AMJ	38	W6HZ	13	W6INI	41
W2IDZ	37	W6BWG	12	W6YUQ	39
W2QVH	37			W6JHS	38
W2RLV	37	W7BQX	43	W6PKD	36
		W7ERA	43		
W3OR	35	W7HEA	40	VE1QY	28
W1KMZ/3	33	W7DYD	37	VE3ANY	27
W3MKL	33	W7FDJ	36	VE1QZ	24
W3RUE	31	W7FFE	35	VE5BY	24
W3MQU	15	W7KAD	35	VE2KH	17
		W7JPA	34	VE2GT	14
W4GJO	46	W7QAP	30	XE1KE	
W4QN	40	W7ACD	27		
W4GIY	40	W7JPN	19		
W4EID	38	W7OWX	15		
W4WMI	33				
W4FBH	31	W8QYD	38		
W4HVV	29	W8RFW	25		
W4FJ	26	W8TDJ	22		
W4FNR	25				
W4EMM	25	W9DWU	46		
W4JML	20	W9PK	43		

Note: This list covers states worked since March 1, 1946. Send in monthly reports of states worked in 1948 on 50, 144, and 235 Mc. and higher, for entry in the 1948 Most-States-Worked Contest. See January QST, page 150, for details.

we do want is the right combination for extending the working range to its absolute limit, and if we are ever to get an answer to the antenna polarization question we will probably have to get it ourselves.

The answer will not be obtained by rotating a dipole from vertical to horizontal, while a station at the other end of a short path does likewise. We can be reasonably sure that the answer would be "vertical," in that case. We will not find out by operating a 4-element parasitic array in both positions at both ends of a path, for the answer would then, almost certainly, come out "horizontal." If we are to prove anything at all, which is doubtful, we will have to use arrays which have uniform patterns in both planes, and check them very carefully under varying tropospheric condi-

tions, at various distances, over all sorts of terrain. Such a program is obviously beyond the scope of most amateurs.

One thing we *do* know: there is precious little difference between horizontal and vertical, when all things are considered. And we *do* know that both ends of a path must have the same polarization if best results are to be obtained. And we feel reasonably sure that the outstanding stations in the Middle West who have changed over to horizontal are not apt to change back again right away; thus, if the East Coast is to work through to W8, W9 and W0 during the coming DX season it will have to be with horizontal arrays. A few Eastern stations already have horizontals, and more will be up as soon as weather permits. If they make possible a new DX record, or even if they merely prove that the Allegheny Mountains can be bridged on 144 Mc., they will have been worth the trouble. And if nothing happens—well, we've still got some pretty good verticals.

On the horizontal side, W3LTN, Erie, Penna., points to the success of W3QKI using a 5-element array for mobile work. Not everyone can adorn his car with a 5-element horizontal beam, even for 144 Mc., but the results obtained by W3QKI are certainly of interest to those who can. From Erie to Fredonia, New York, is some 40 miles along busy Route 20, but signals are solid. Directional effects are not too pronounced at close range, and at least the customary local distances are workable without regard to the position of the array. On longer hauls it is usually possible to orientate the array correctly, since the trend is generally away from the station being worked. Some surprisingly long distances have been covered by W3QKI, using this horizontal array and a 522 rigged for mobile operation. He has worked W8WJC, Everett, Ohio, 125 miles distant, while traveling at a speed of 50 miles per hour.

Another horizontal stalwart, W9BBU, Elgin, Ill., admits that there has been no conclusive horizontal-vertical test by amateurs. His consistent results demonstrate that horizontals have what it takes, if one uses enough elements. He lists outstanding horizontal stations in the Milwaukee area, including W9PYM, W9LJV, W9AFT and W9GGH, all with 16-element jobs; W9PZS with 24, and W9BDQ leading the pack with 42! South and west of Chicago there are some impressive installations, too. W9JIL and W9AKM have 30-element arrays 80 and 60 feet high, respectively. W9BBU has been running skeds with W8CVQ and W8BTL, some 140 miles distant, right through the winter with fair success.

The effects of the polarization controversy are being felt in Baltimore, according to W3KRJ, who says that spring will see a number of the gang in that area with two arrays. W3KCA has been running checks with stations in Virginia who are equipped with flop-over arrays.

(Continued on page 138)



DX RECORDS continued to topple as March 1923 *QST* went to press. Latest confirmations have the signals of 6KA, 5PX, 6BCR, 9BED, 9UU, 9YAJ, 6KU, 9AJP, 9CNS, 5XAD, 6XAD and 6EN heard in New Zealand by Mr. R. Slade, who was using a regenerative one-tube receiver. Verification is also in hand of the reception off the coast of Australia of 9CXP, Waterloo, Iowa. Small wonder that this issue's follow-up reporting on the very successful Third Transatlantics is relegated to secondary position! Latest word on these eastward tests is that 53 United States and Canadian amateurs were copied in Holland by Mr. G. J. Eschauzier. Still absent, because of the tremendous task of compiling data, are the official English and French Transatlantic reception reports.

No time has been lost by ARRL Traffic Manager Schnell in arranging for trials at two-way contact with the Continent. Preliminary tests, hastily arranged by cable, between Leon Deloy, French 8AB, and 1CKP, South Manchester, Conn., the station of ARRL Assistant Secretary Charles A. Service, jr., have been unsuccessful to date. However, Mr. Deloy will continue his schedules and American amateurs are invited to participate. *QST* offers a trophy to the first amateur to QSO across the Atlantic—a handsome brown derby!

"A New Field"—"Exploring 100 Meters." Under these captions the Headquarters staff adds fuel to the campaign now under way to develop our QRM-free wavelengths below 200 meters. Thousand-mile paths have already been negotiated on 100 meters, and receivers and transmitters have been made to work in the vicinity of 50 meters. Pioneering this work are 3RP, 3ABI, Don Mix of 1TS, John Reinartz of 1QP, Boyd Phelps of 9ZT and 1HX, J. C. Ramsey of 1XA, Frank Conrad of 8XK, L. E. Dutton of 9ZN, B. J. Kroger of 3APV, 3ALN, 1RD, 3XM, 3JJ, and the listening stations of A. L. Budlong and Charles A. Service, jr. Upcoming is a "100-Meter C.W. Party" which is scheduled for March.

"The Inverse Duplex System of Amplification" entitles Assistant Editor Boyd Phelps' explanation of the workings of a new receiving circuit wherein the audio output is fed back into preceding r.f. stages for additional amplification. Mr. Phelps uses the Grimes' Inverse Duplex model as an example. The characteristics of a new low-current filament receiving tube, known as the UV-201A or C-301A, are favorably detailed by Editor Warner. Constructional notes on "Mak-

(Continued on page 140)

I.A.R.U. News

FRENCH RESISTANCE

Every recent copy of *Radio REF*, official organ of the *Rescau des Emetteurs Français*, has paid tribute to the participation of French amateurs in the resistance by a simple narration of their unselfish devotion to liberty. All are tales of heroism, many of tragedy. Of the long list, two have been picked at random. They are representative. These were *merit*!

Monsieur Dieutegard, F8AV, built equipment which provided communication leading to the destruction of the German V1 and V2 laboratory on Peenemund Island in the Baltic by the Royal Air Force. Arrested by the Gestapo, he managed to get himself released and was thus able to warn his colleagues.

The second time he was picked up by the Gestapo, he wasn't as fortunate. This time, he was sent to Buchenwald, later to Dora and finally to Hartzungen. While in these concentration camps, he managed to build three short-wave receivers, which contributed greatly to the morale of his fellow prisoners and enabled them to plan their escapes with much more hope of success. Just as he was about to be taken out and shot, F8AV made his own escape, taking with him eleven fellow prisoners.

In April 1945, he made contact with U. S. troops. Escorted immediately to their headquarters, his prompt warning was responsible for preventing destruction by the enemy of a near-by dump containing their latest weapons.

Messieurs Bord, FT4AI, Gorman, F3FQ, Borg, operator at FT4AE, and FT4AK and Attias manned an important "underground" information net which was set up in Tunisia during the 1940 armistice. They maintained perfect schedules up to the very moment when the police raided the station and confiscated the equipment.

Borg was caught and spent sixteen months in prison. Attias escaped to England, while Gorman, who was hidden at the home of Bord, kept the vital traffic flowing for an additional two months. F3FQ was finally slipped out to Malta by air where, in spite of continual intense bombing,

he set up a station and kept underground traffic moving.

After the Allied landings in North Africa, FT4AI met F3FQ and Borg in Algeria. They decided that in spite of the great danger they would return to Tunisia behind the enemy lines. They were put ashore by submarine to continue their work.

FT4AI was contacted by the U. S. forces and parachuted into France before D-Day — where he just escaped being shot, first by the Vichy militia and later by the Free French. After the invasion, he rejoined the French Army and was promptly parachuted into Germany. He completed his mission there and escaped back to France via Switzerland.

These are typical stories. Some of them are even more desperate. We wish we had space for more of them but these two serve to show that the quality of stuff of which hams are made is pretty uniform all over the world. It was the same story in Poland, Norway, Denmark and the other occupied countries.

— VESBLZ

ARGENTINA

The *Radio Club Argentino* will provide QSL service for LU1ZA, located in the South Orkney Islands. The station, now operated by Alfredo Torres, is installed in the meteorological laboratory which has been maintained on Laurie Island by the Argentine government since 1904. Many cards confirming contact with LU1ZA have been received. These will be answered by a special QSL having as its background a photograph of the station location and bearing postage of philatelic value.

R.C.A. requests amateurs not to send reply coupons with QSLs. It further asks for the exercise of patience in the face of inevitable delays, occasioned by correspondence difficulties, in receiving confirmations from LU1ZA.

(Continued on page 140)

◆

This well-planned operating position at ON4WX is the pride and joy of its owner, Paul Castaing, Courtrai, Belgium. It includes transmitting and receiving equipment for various amateur bands from five meters up as well as associated monitoring and test gear.

March 1948

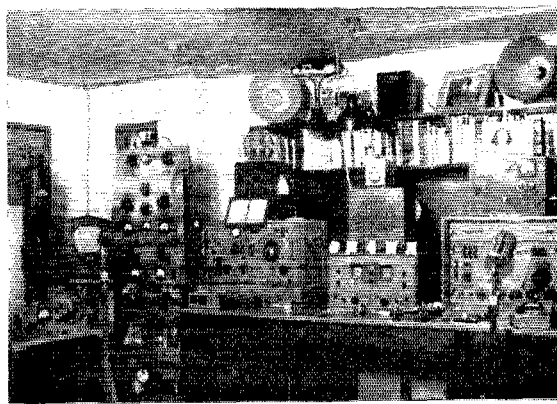

Underground Antennas

Are They Fact or Fiction?

BY PAUL M. CORNELL, * W8EFW

HAVE YOU, too, heard the rumors of super performance by stations using underground antennas on 14 and 28 megacycles? Well, when the talk first turned up, I started asking fellows about these buried antennas while making my regular travels of Ohio and Michigan as a salesman. With the help of my 8-watt 28-Mc. mobile rig, and through numerous personal contacts, I was able to uncover a few more threads of speculation, not to mention encountering a general pooh-poohing of the whole idea.

To a man, the experts agree that somebody is pulling somebody's leg. I talked over the feasibility of the idea with W8RNC, Detroit, who should know all there is to know about antennas, but this buried-antenna report was a new one to him — he's certainly not convinced! And Walt Bradley of the ARRL Technical Information Service has no concrete information either, although he has heard the rumors, too.

So now I write the saga of the underground-antenna rumor. Perhaps we can run the whole thing into the ground (pun?), or at least find out what the score really is!

While listening to the local gang on 10 one evening, I believe it was W8GMF, Parma, Ohio, who told about a W4 he had heard rolling in 40 db. over S9 on 14-Mc. 'phone. The W4 said he was using an antenna buried 4 feet in the ground and fed with EO-1 cable. Input to his rig was 14 watts. Further, the W4 said he had received the idea from a Britisher and it seems a lot of Gs have had good luck with underground antennas. Constructional details on the system were not forthcoming, but as you will see later on in this article, probable constructional information on it is supplied by W8RJF, the only successful user of an underground antenna that I have talked to personally.

Recently in Elyria, Ohio, I talked underground antennas with a young SWL, and a week or so later he sent me a card stating he had heard W4GLQ/ β say that an underground antenna was in use there. I wrote to the W4, but the letter came back from his North Carolina QTH marked "no forwarding address available."

One day, while having lunch with W8NYY at Akron, Ohio, Lloyd told me that he had worked W8RJF in Cleveland, on 10, and that RJF mentioned that his antenna was buried in the ground. Lloyd added that RJF was the loudest Cleveland 28-Mc. station heard in the Akron

area. I had heard previously about W8RJF's buried antenna, but had not been able to QSO him for more details.

Recently my Army footlocker, shipped at Ie Shima in September, 1945, arrived in Cleveland. On the way down to pick it up I hooked W8RJF with the mobile rig. Little time was lost getting into the meat of the buried antenna, and after picking up the shipment I was guided by radio to the W8RJF shack for a personal chat.

Here's the story as I got it from W8RJF: Some W5 (or W4 or W θ) had picked up the idea during his service as a colonel in the European theater. "Underground" forces had successfully used un-

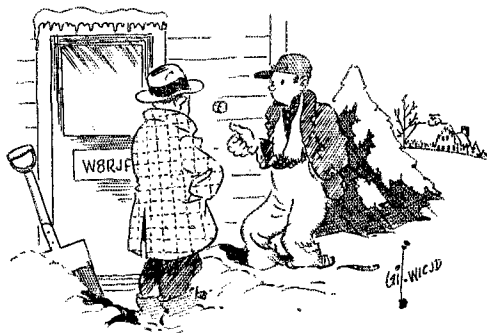

derground antennas during the war. (The two "undergrounds" are purely coincidental.) Clandestine radio operations were successful with such an antenna — why not ham radio? The W5 (or W4 or W θ) is using the buried antenna very successfully on 14 and 28 Mc., so says W8RJF.

Roy, W8RJF, being an inveterate antenna experimenter himself, discovered plumbers opening up the sewer next door, and before the excavation was threaded a doublet of 300-ohm ribbon had been threaded through a piece of garden hose and tossed into the hole.¹ The 300-ohm ribbon feedline came to the surface in another piece of garden hose. Actually the antenna does not lie flat, but follows an irregular line along the bottom of the excavation. Thoroughly covered with

¹ An early experimenter with amateur underground antennas, W. H. M. Watson, 5RX-5XAY, Dallas, Texas, reported on his experiences in this field in a letter printed in the correspondence columns of May 1925 QST. Mr. Watson described his transmitting antenna as consisting of 100 feet of No. 12 insulated wire encased in ordinary rubber garden hose and buried one foot in the ground. Transmitting on 80, 50 and 40 meters, 5RX-5XAY reported working Canada and Cuba and also being heard in England. — Ed.

* 4422 Silsby Road, University Heights, Cleveland, Ohio.

4 to 5 feet of earth, the antenna gave a good account of itself, so says Roy.

The underground antenna worked better than any skywire tried, both for ground-wave and sky-wave transmission. One day when the W8RJF rig was on 11 meters, Roy heard the DX saying they were listening from 11 through 10, and before the day was over 11 Europeans had been worked, with the antenna in the ground and lying in an east-west direction.

One thing though — I didn't see the antenna in use because the neighborhood kids had tripped over the feedline and put the system out of operation. The foot of snow outside also covered the evidence of a feedline, but my friend Roy says it's still there. I did see the cork plugging the hole in the wall where the feeder once came through. Of course W8RJF has taken a lot of kidding about his buried antenna, and he knows that most people are skeptical, but he'll give the details to all who ask about it.

On page 16 of the *ARRL Antenna Book* we find some dope on reflected rays and image antennas in the ground. Perhaps the experts can fit this theory into the picture of these underground antennas.

Old-timers tell me that years ago there was a noise-reducing broadcast receiving antenna on the market which consisted of a number of coils of wire in a large can, the whole thing buried in the ground. It worked, too, they say.

So that's the underground-antenna story as I've found it to date. I still haven't actually seen a buried antenna in use, but you can bet your boots that when spring comes around the XYL will wonder why the early spurt of activity in digging up the garden!

If this article can uncover a few basically sound facts, or just disprove the whole thing, it will have accomplished its purpose. Let's hear from the gang on the subject!

VE/W Contest

March 6th-7th-8th

Renew your old friendships in a week-end of hopscotching the 49th parallel! The Canadian Amateur Radio Operators' Association this year again will sponsor an operating contest open to amateurs in the United States and Canada.

Here's a dandy chance to complete WAS and qualify for CAROA's WAVE Certificate award, details of which may be found on page 74 of January *QST* or page 23 of October *XTAL*. Prizes will be awarded to the top-scoring contestant in each Canadian and U. S. section as well as to the national leaders in both countries. Polish up your contest fist, dust off the larynx,

and join the gang in one of the biggest fun features of the 1948 operating season!

Rules

Dates: The contest starts March 6th at 8:00 P.M. and ends March 8th at midnight (local times).

Operating Time Limit: Operate any 20 hours of the 28-hour period. Make sure your operating hours *on* and *off* are clearly indicated in your log.

Object: Each VE will work as many W stations as possible in as many W ARRL sections as possible. Each W will work as many VE stations in as many VE sections as possible. See page 6 of any *QST* for complete list of ARRL sections.

General Call: 'Phone — "Calling any 'phone station in VE/W Contest." C.w. — "CQ VE/W CQ VE/W CQ VE/W de [your call]."

Frequency Bands: Any or all amateur bands may be used. Indicate whether you use 'phone or c.w. — you must decide to use one or the other and stay with it.

Scoring: Preambles must be exchanged in the following manner: (1) Number of contact. (2) Your call. (3) Check (RST report. On 'phone the "T" will be omitted, of course). (4) Your location. (5) Time. (6) Date. Example: Nr 1 VE1KS CK 589 Sackville NB 10:12 PM Mar 6. *Each preamble sent will count 1 point. Each preamble received will count 1 point.* It is not necessary for preambles to be exchanged both ways before a contact may count, but one must be sent or received before credit is claimed. Mark each new section as it is worked. W stations multiply their contact points by 8, there being approximately eight times as many U. S. sections. VE stations multiply the number of points by the number of U. S. sections worked.

Power Multipliers: Under 30 watts, multiply by 2; between 30 and 100 watts, multiply by 1.5; over 100 watts, multiply by 1.

Operator Handicap: If more than one operator participates at a competing station, the total score must be divided by the number of operators having a part in the score.

Prizes: A Certificate of Merit will be awarded to the leader in each ARRL section. The Montreal Amateur Radio Club Trophy will be given to the U. S. high scorer and the Canadian Amateur Radio Operators' Association Trophy will go to the Canadian high scorer.

Logs: The following certification is requested with each log submitted: "I hereby state that in this contest I have not operated my transmitter outside the frequency bands specified by government regulation and also that the log submitted is correct and true." All logs should be mailed to the Canadian Amateur Radio Operators' Association, 46 St. George Street, Toronto 4, Ontario, Canada.

Navy Day - 1947

IN cooperation with the Navy Department, ARRL each year conducts a receiving competition celebrating Navy Day. The nineteenth such competition was held on October 27, 1947. Addressed to all radio operators, a message from the Secretary of the Navy was transmitted at approximately 25 words per minute from NSS, Washington, and NPG, San Francisco.

Letters of appreciation from the Secretary of the Navy have been awarded to the 209 operators who made perfect copy of the message. A total of 428 operators submitted entries. Of these, 23 utilized the transmissions of both NSS and NPG, 302 copied NSS, 103 NPG. Entries were received from 235 operators who are present or former members of the Naval service.

The Honor Roll lists all participants alphabetically and by Naval district. We extend hearty congratulations to the letter winners. Use of the W1AW code-practice transmissions and regular attempts at copying the monthly Code Proficiency Qualifying Runs should assist those who missed making perfect copy to reach that goal in the twentieth Navy Day Receiving Competition next October. — J. M.

1947 NAVY DAY HONOR ROLL

Letter Winners

First Naval District: W1BB, W1BMS, W1BDV, W1GNK, W1IB, W1ILO, W1JOW, W1LYX, W1QQ, W1QW, W1ZR. *Third Naval District:* W1BDI, W1HIN, W1LV, W1LVQ, W1MGX, W1MUW, W1QJM, W2BZJ, W2CJX.

1947 NAVY DAY MESSAGE

I am happy to extend greetings to all participants in this Navy Day broadcast for amateur and professional radio operators. Your continued interest in the art of radio operating is a source of great satisfaction to the communication service of the United States Navy. In the current advances of radio communications toward automatic operation there is a tendency to disregard the fact that the basic and fundamental method of transmitting information by radio is by hand using the Morse Code. Just as the good sailor must learn the rudiments of seamanship in order to provide a sound foundation so should the top operators of all radio communication equipment know the primary methods of operating. In case of national emergency or mobilization we are confident that the Navy will again find many of you well trained and ready to assume positions which must be filled at such time of expansion. Your continued interest and enthusiasm make me confident that Naval communications will never be found wanting in providing the nerve system upon which Naval operations are dependent. For those not currently affiliated with other activities may I suggest investigation of the opportunities offered to radio operators by association with the U. S. Naval Reserve.

The Secretary of the Navy

Text of the message transmitted from NPG.

THE SECRETARY OF THE NAVY

Washington

Dear:

It is my pleasure to inform you that you successfully received and reported correctly my Navy Day 1947 message which was sent out by the Navy transmitters at Washington and San Francisco. This message was sent as a radio test for all radio operators, and, through the auspices of the American Radio Relay League who assumed responsibility for checking all copies submitted, we have been supplied with the list of successful operators.

It is notable that most of the operators participating were amateurs and of these many are Navy personnel, either ex-Navy or currently in the Naval Reserve. We of the Navy are pleased to extend a feeling of friendship and cooperation with the amateurs at all times and it is felt that this annual Navy Day broadcast serves to bring us all together on the same network in that spirit.

I extend my personal congratulations on your successful participation in this broadcast and invite your continued interest in your Navy.

Sincerely,

John L. Sullivan

Letter of commendation.

W2CNC, W2CQB, W2DYF, W2HAZ, W2HUQ, W2JKT, W2KFB, W2KPU, W2KTF, W2KTR, W2MRL, W2NVB, W2PFB, W2QHB, W2QOM, W2QUJ, W2RZZ, W2TUK, W2VEH, W2VNO, W2VYW, W2WEM, W0DDE, Lyman A. Byam, Jr., Anthony Raymond Cataldo, Walter H. Grove, Jr., Anthony L. Lacesa, D. J. Stellitano, Ronald K. Thornton, Donald D. Vaughan, Robert H. Zinser. *Fourth Naval District:* W2AON, W2PEL/3, W2RPH, W2VQC, W3EU, W3KKA, W3LQZ, W3NCJ, W3OKS, W4AIIH/3, Beth Rosenberg. *Fifth Naval District:* W3GZF, W3IGX, W3IZL, W3VT, W4KSW, C. J. Griffith. *Sixth Naval District:* W4EJR, W4LYV, Henry F. De Court. *Seventh Naval District:* W4AKV, W4FPP, W4GEE, Floyd D. Adeock, Allen F. Peele. *Eighth Naval District:* W1OEP/4, W4OL, W5BUK, W5CDU, W5CNA, W5FAJ, W5FQG, W5GJG, W5GRC, W5HLK, W5NCN, W5P5, Broadus M. Bryant, Robert E. Camp, Edwin P. Champagne, Robert H. Clarke, J. H. Egbert, Boyce L. Graham, F. C. Holland, Jack Howell, P. V. Jenkins, Palmer W. Jenkins, W. A. Koepke, T. E. Malone, Nick Messina, Harold L. Miles, Joseph E. Nearns, Floyd Page, Jr., S. Posey, James T. Reeder, L. J. Smykal, V. E. Tucker, Robert H. White. *Ninth Naval District:* W8BKE, W8BKM, W8HSW, W8LEX, W8QHZ, W8UMX, W8UTC, W8YLQ, W9AKH, W9EDH, W9FIN, W9FKH, W9GMT, W9IML, W9JTX, W9KWW, W9LNR, W9LZM, W9NGS, W9RAR, W9RCJ, W9RLB, W9UBW, W9DJE, W9HEX, W9HKM, W9LDI, W9SIL, Jack G. Duff, Maurice L. Edmonds, Perry E. Freedland, Edwin W. Grove, III, Holroyd C. Howe, Walter H. Kahler, Robert L. Kendall, Jesse J. Perry. *Tenth Naval District:* NY4AD. *Eleventh Naval District:* W6AM, W6AOA, W6AWP, W6AXV, W6LS, W6MVF, W6NAZ, W6WV, W6ZTY, W7BCT/6, W7JU, W7TS/6, Percy E. Palmer, Vincent J. Meinhart; Div. 11-2, USNR, Tucson, Ariz. (one letter awarded); K6NRA (letters awarded to five operators at Santa Barbara, Calif. Naval Reserve Armory). *Twelfth Naval District:* W6CLV, W6DEC, W6FNG, W6HXG, W6OWP, W6PBV, W6PQ, W6TZK, W6WIS, W7BED. *Thirteenth Naval District:* W7AOS, W7CZY, W7EBQ, W7GHB, W7IM, W7JMZ, W7WU. *Seventeenth Naval*

(Continued on page 144)

No Turrets—Just Tune!

A 150-Watt Transmitter with a New Type of Tank Circuit

BY ALLEN KING, JR.,* W1CJL

• Here's a different wrinkle in band-changing—a tank that covers 3.5 to 30 Mc. without changing coils and preserves the L/C ratio while doing it. Compact, simplified construction is the result, as shown by this push-pull 807 transmitter complete with power supply on one chassis.

A TRANSMITTER with only two coils in the final plate circuit, and no need of either switching or plugging in additional coils to cover six amateur bands, probably suggests the idea of compact, economical construction. But there is another important angle—rapidity of band-changing. The transmitter described here affords a simple and rapid method of attaining these results, by utilizing a new and entirely different design of “all-band” tank circuit as the basic unit.

In fact, the speed with which the final tank can be tuned to any of the six bands presented a problem in the exciter design: frequency changing could not be accomplished with the same rapidity! However, this article describes one approach, based on speed of tuning and low cost. Before going into the entire transmitter, a simple analysis of the basic unit should be of interest.

Multiple Tuning

It would be a practical impossibility to build a tuned circuit that would cover the range from 3500 kc. to 30 Mc. in one sweep of the tuning condenser. Neither would such a circuit be especially desirable, because the difference between the L/C ratios at the extremes of the frequency range would be tremendous. However, by using a “multiple-tuned” circuit—one that tunes to two different frequencies at the same time—it becomes possible to cover a very wide frequency range and at the same time preserve a reasonably constant value of L/C ratio.

Such a multiple circuit is shown in Fig. 1. If L_1 is a coil of relatively large inductance while L_2 and L_3 are small, the inductances of L_2 and L_3 can be considered negligible at low frequencies. In that case, condensers C_3 and C_4 are, for all practical purposes, connected in parallel with C_1 and C_2 . Hence the low-frequency limit of the circuit is determined by a rather large coil and

*% National Co., Malden, Mass.

large value of capacitance, as indicated in Fig. 1-B.

On the other hand, the four condensers in series with L_2 and L_3 , also in series, form a circuit resonant to some high frequency. For this frequency, L_1 is large enough to be looked upon almost as a choke and hence does not have a pronounced effect on the resonant frequency of the circuit. This is indicated in Fig. 1-C.

At intermediate frequencies all three coils and all four condensers take part in the operation of the circuit, the effect being to provide a greater frequency ratio than would be possible with a single coil-condenser circuit. For any given setting of the tuning condenser (all four of them should be ganged for convenient operation) the circuit is resonant at two frequencies—for example, a low frequency of 3.5 Mc. and a high frequency of 12 Mc. These frequencies should not be in harmonic relationship in a circuit that is to be used as the

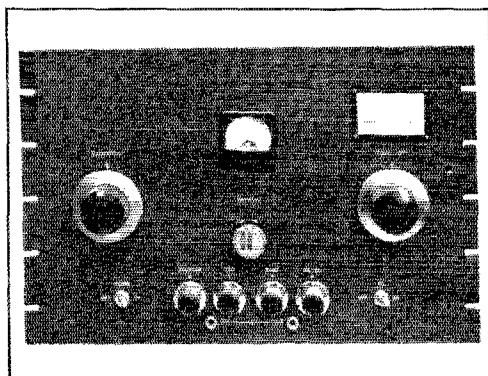

The transmitter layout leads to a symmetrical panel arrangement. The excitation control at the left, a potentiometer, is fitted with a dial matching the final-amplifier tuning control in the interests of balancing the panel.

output tank in a transmitter, a matter that can be taken care of in the circuit design.

Power can be coupled out of such a circuit by means of a tapped coil, L_4 , coupled to the low-frequency coil, L_1 , the taps being adjusted for the impedance into which the tank is to work. It has been found that the coupling to the load remains substantially constant over the entire tuning range. At the high-frequency end L_1 acts as an intermediary coupling coil between the tank circuit and the output coil, L_4 .

In the practical form of the tank shown in the

photograph of the transmitter, the total tuning range is from below 3450 kc. to above 30 Mc. This is split into two simultaneous ranges as shown in Fig. 3, one range being approximately 3.45 to 8.5 Mc. and the other from 12 to 30 Mc. The 3.45- to 8.5-Mc. range tunes in the conventional manner, with the lower frequency occurring at maximum capacitance. The 12- to 30-Mc. range is tuned in the same way as the low-frequency range; that is, with the 12-Mc. extreme coming at maximum setting of the tuning capacitor.

The operation of the circuit is conventional in that the tank is tuned for minimum plate current, and the taps on the link, L_4 , are adjusted for the rated plate current of the tube, or tubes, used. The fixed link can be used to couple into a higher-

powered amplifier, into an antenna, or into an antenna coupler. The taps should be set for use on the highest-frequency band, and then checked on the other bands to assure relatively constant input. A compromise setting may be necessary, and if the load impedance is different on different bands, an adjustment must be made with each impedance change.

If tubes requiring neutralization are used the usual procedure can be followed. However, the transmitter to be described uses 807s and no neutralization was found necessary.

Transmitter Circuit

This "all-band" tank is designed for use in transmitter stages where the plate input is in the neighborhood of 150 watts. The particular transmitter shown here runs 150 watts on c.w. and 120 watts on 'phone.

The complete transmitter, circuit-wise, is fairly conventional, and physically an attempt was made to keep it as compact as possible while still utilizing the full power rating of the "all-band" tank. The tubes were chosen with power and price as major considerations. Types 809, 829 and 832 will work equally as well, with some variations in power and circuits, so the selection of tubes can very well be governed by the individual's present supply — or the surplus market.

The circuit, shown in Fig. 2, uses a 6L6 grid-plate oscillator and a 6L6 buffer-doubler. Both plate circuits are arranged for bandswitching, using taps on the plate coils. The transmitter is designed for use on all bands with crystals in the 80-meter region. On each position of the exciter bandswitch (3 in all) the tuning range is such that two amateur bands are covered. The following table gives the tuning combinations:

Switch Position	Oscillator Plate	Doubler Plate
1	13.5 and 14 Mc.	27 and 28 Mc.
2	7 and 10.5 Mc.	14 and 21 Mc.
3	3.5 Mc.	3.5 and 7 Mc.

The oscillator thus can be used either straight through, or with second-, third-, or fourth-harmonic output, depending on the output frequency desired. The second 6L6 operates as a doubler on every band except 3.5 Mc., where it operates straight through. The latter case might seem to invite self-oscillation troubles, but two things prevent them. The cathode resistor of this stage is not by-passed, introducing a small amount of negative feed-back. Also, to avoid overexciting the 807s it is necessary to set the excitation control, R_7 , almost at the minimum end of its scale, and since this control operates on the screen-grid voltage of the 6L6 this means that the tube's screen voltage is very low. Although the 6L6 will oscillate if the screen voltage is in the normal region, it will not "take off" when the control is set for normal grid current in the 807 stage.

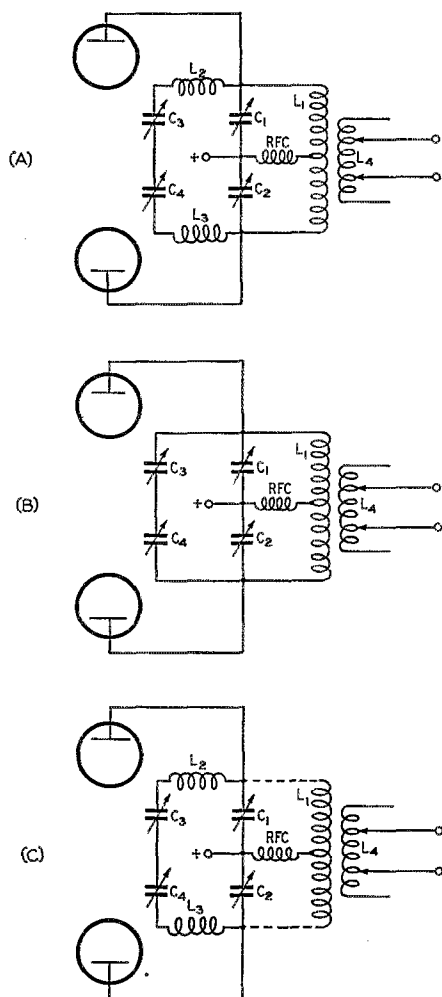

Fig. 1 — The circuit of the multiple-tuned tank (A) and equivalent circuits for low (B) and high frequencies (C).

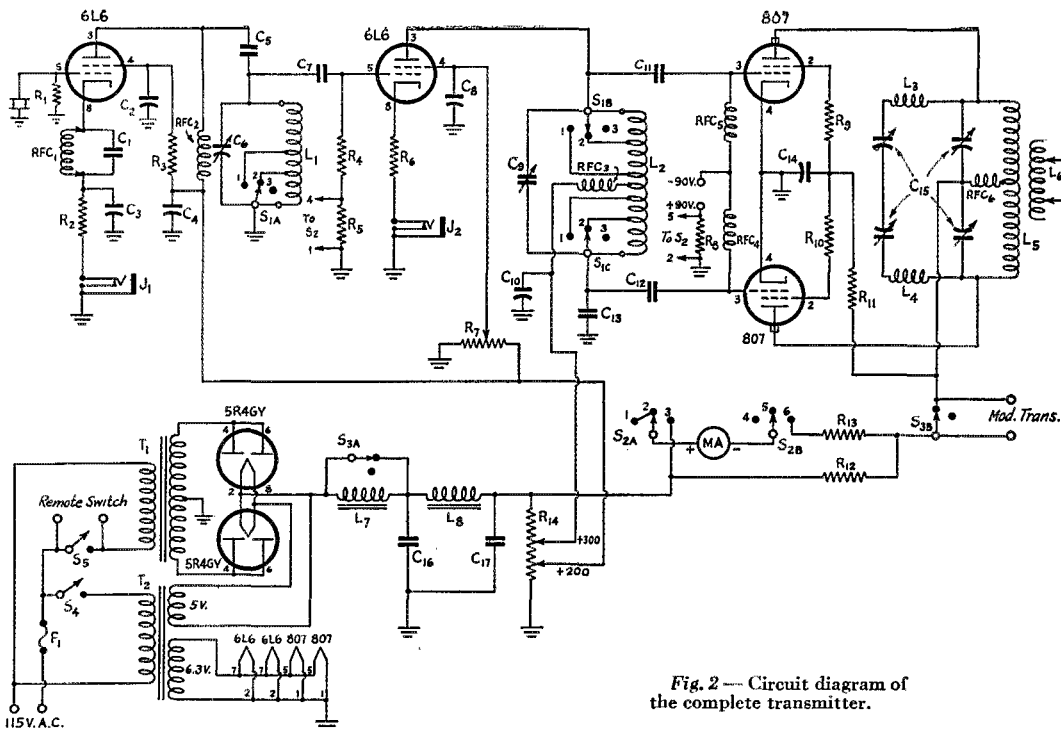

Fig. 2—Circuit diagram of the complete transmitter.

- C₁ — 270- μ fd. mica.
- C₂, C₃, C₄, C₈, C₁₀, C₁₄ — 0.01- μ fd. paper, 600 volts.
- C₅ — 0.001- μ fd. mica.
- C₆ — 150- μ fd. variable (National ST-150).
- C₇, C₁₁, C₁₂ — 100- μ fd. mica.
- C₉ — 200 μ fd.; two 100- μ fd. sections in parallel (National STHD-100).
- C₁₃ — 10- μ fd. mica or ceramic.
- C₁₅ — 4 sections, 110 μ fd. per section (part of National MB-150 all-band tank).
- C₁₆, C₁₇ — 2 to 4 μ fd., 1000 volts.
- R₁ — 0.1 megohm, $\frac{1}{2}$ watt.
- R₂, R₆ — 220 ohms, 2 watts.
- R₃ — 22,000 ohms, 1 watt.
- R₄ — 47,000 ohms, 2 watts.
- R₅, R₈, R₁₂ — 4.7 ohms, 1 watt.
- R₇ — 70,000-ohm potentiometer, 4 watts, wire-wound.
- R₉, R₁₀ — 100 ohms, $\frac{1}{2}$ watt.
- R₁₁ — 15,000 ohms, 20 watts.
- R₁₃ — 2200 ohms, 1 watt.
- R₁₄ — 7000 ohms, wire-wound, with sliders.
- L₁ — 25 turns No. 22 enam. on 1-inch form (National XR-2), close-wound, tapped at 9th and 18th turns from ground.
- L₂ — 27 turns No. 22 bare, diameter $1\frac{1}{4}$ inches, length 2 inches, tapped 2nd and 4th turns each side of

- center (National AR-16-40E with link and base removed).
- L₃, L₄ — 5 turns No. 12 on $1\frac{1}{4}$ -inch form, length $\frac{3}{4}$ inch. $\frac{1}{2}$ -inch spacing between L₃ and L₄.
- L₅ — 18 turns No. 12, diameter $1\frac{1}{4}$ inches, length 2 inches.
- L₆ — 12 turns No. 12, diameter $2\frac{3}{4}$ inches, length $2\frac{1}{2}$ inches; wound over L₅.
- (Note: L₃, L₄, L₅ and L₆ part of National MB-150 tank assembly.)
- L₇, L₈ — 10 henrys, 260 ma. (National Type 260).
- F₁ — 3-amp. fuse.
- J₁, J₂ — Closed-circuit jack.
- MA — 0-1 milliammeter.
- RFC₁ — 750-mh. r.f. choke.
- RFC₂, RFC₃ — 2.5-mh. r.f. choke.
- RFC₄, RFC₅ — 1-mh. r.f. choke.
- S₁ — 3-pole 3-position wafer switch (ceramic).
- S₂ — 2-pole 3-position wafer switch.
- S₃ — 2-pole 2-position wafer switch (ceramic).
- S₄, S₅ — S.p.s.t. toggle.
- T₁ — Plate transformer, approx. 750 volts each side c.t., 300 ma. (Stancor P-3042 or equivalent).
- T₂ — Filament transformer, 6.3 volts at 3.6 amp., 5 volts at 4 amp. (Stancor Type P-5008 or equivalent).

Of the six bands available, five can be reached with one 80-meter crystal, while the sixth, the 11-meter band, needs a separate crystal because it is not in harmonic relationship to the other bands. A crystal of approximately 4.5 Mc., tripling in the oscillator, or a 3.39-Mc. crystal quadrupling in the oscillator, and both doubling in the second 6L6, will furnish the necessary 11-meter excitation to the 807s.

It will be noted from the previous table that a tuning ratio of 2 to 1 is required only at the lowest frequencies used; that is, in Position 3 on the bandswitch where the doubler must tune either to 80 or 40 meters. The tuning ratios needed at the other switch position are 1.5 and 1.03 to 1.

The plate compensating condenser, C₁₃, helps to balance the doubler plate tank circuit, so that the excitation to the push-pull 807 grids is equal-

ized. This compensating condenser, in the event a tube other than the 6L6 is used, should be chosen so that it has a slightly higher capacitance than the output capacitance of the tube.

Closed-circuit key jacks are provided for keying either the oscillator or doubler cathode. To keep metering to a minimum, only the doubler-grid, final-grid and final-plate currents are checked. The doubler-grid metering could probably be eliminated, but the writer felt it was a good way to check differences in crystal activity.

Excitation to the 807s is controlled from the panel by a variable 4-watt potentiometer. As mentioned before, this control varies the screen voltage on the 6L6 doubler, and it is adjusted so that when it is on full the maximum rated screen voltage is applied. With 3.5-Mc. crystals it is not necessary to run this control on full, even on the 10-meter band, and 40-meter crystals give considerably more grid drive when the output is on 10. Grid drive to the 807s is critical. With a 600-ohm dummy antenna connected in series with an r.f. milliammeter to the output coil, maximum transfer of r.f. energy occurred when the grid current was at its rated value, 6 ma. Any increase or decrease in grid current resulted in a drop in r.f. current.

The change in plate voltage required for running the 807s at full ratings on either 'phone or c.w. is accomplished by using a choke-input filter for 'phone and a condenser-input filter for c.w. The switch, S_3 , that shorts out the input choke also shorts out the modulation terminals when in the c.w. position. This switch was not installed at the time the bottom-view photograph was taken, but was later mounted on the rear apron of the chassis at the center.

Construction

The layout, as shown in the below-chassis view, is practically self-explanatory. The coils are mounted directly on the exciter bandswitch.

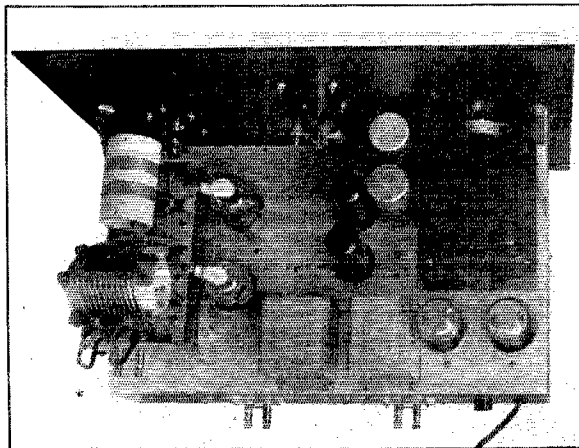

This top view shows the all-band tank at the left end of the chassis. The r.f. circuits for the two 6L6s are entirely under the chassis. The other components visible are for the high-voltage power supply.

The oscillator coil is wound on a National XR-2 form and mounted, by means of a small bracket, directly to the supporting rod of the rotary switch. The buffer-doubler coil is a standard item with link and plug-in base removed. The polystyrene supporting bar is then fitted with aluminum angle brackets and mounted directly across the back end of the wafer switch.

The ceramic wafers used in both the oscillator and doubler circuits are of the single-pole three-

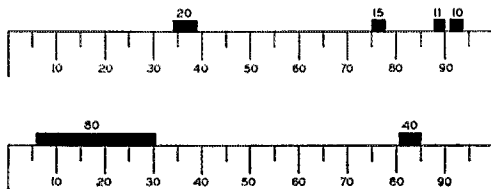

Fig. 3 — Positions of the bands on the dial. To avoid confusion, the two ranges are shown separately. In actual tuning, starting from the high-capacitance end of the scale, the tank goes through the following bands in succession: 3.5, 14, 21, 7, 27, 28 Mc.

position variety. An angle bracket, mounted on the switch supports between L_5 and L_6 , affords a method for securing the back end of the switch to the chassis as well as shielding one coil from the other.

The plate-tank tuning of the 807s is controlled by a National Type AM dial for vernier tuning, and the dial on the excitation control is the same type, minus the vernier movement, to balance the panel.

The terminal strip mounted on the rear of the "all-band" tank unit can be used with banana plugs for quick antenna changes, or wired permanently for one antenna. Room for mounting an antenna relay will be found on the rear apron directly beneath the tank.

The panel and chassis are both of the standard rack dimensions, the panel measuring

The tuning condenser for the oscillator is at the lower center in this bottom view. Just above it is the socket for the oscillator. The coils for the oscillator and doubler are close to the exciter bandswitch. The transformer at the left is for heating the filaments. The bias supply in the upper left-hand corner can be replaced by batteries in case the special components required are not available.

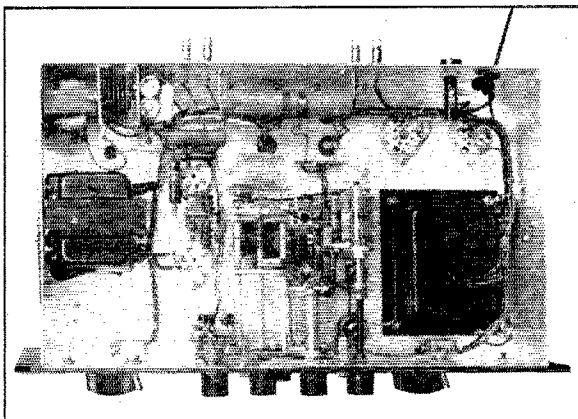

19 × 12¼ × 18 inches and the chassis 17 × 10 × 3 inches.

The 90 volts of bias used on the 807s is acquired from a small transformer and selenium rectifier in this case, but two 45-volt miniature batteries could easily be mounted in the same space. They should give lengthy service, since the current drain is low.

The bias supply has purposely been left out of the diagram because of the use of a special transformer which would be difficult to duplicate. Battery bias, or a 90-volt supply built to your own liking, will work as well and in case of strictly-'phone operation grid-leak bias will do a bang-up job. The plate transformer also differs from the parts list but, like the bias transformer, was used because of its availability. A terminal strip, mounted on the rear, is provided for external or remote relay control, and is jumped in case of front-of-panel control.

Operating Notes

With the metering system used, combined plate and screen current of the final stage is read. The plate current alone, with no load, runs in the neighborhood of 20 ma. on all bands except 10 and 11 meters, when it is of the order of 30 ma. When fully loaded to 200 ma. the efficiency, based on r.f. current in the 600-ohm dummy load, is between 65 and 70 per cent on all bands. With the full input of 150 watts on c.w., between 95 and 100 watts can be put into the antenna. In a few brief operating periods using a 40-meter doublet, consistent contacts have been made, both in and out of the States, and always with that gratifying T9x report.

A small capacitor, 5 μfd. or so, tied between the oscillator plate and control grid will help sluggish crystals get under way. Also connecting the screen by-pass condenser, C₂, directly back to the cathode will raise the oscillator output slightly; this would probably be advisable in the

event that a 6V6 or 6AQ5 tube is used in this circuit.

This was the writer's first attempt at making a pair of 807s operate in this manner, and the results have been very satisfying. At the price of these tubes, the watts-per-dollar value is high. Add the fact that the "all-band" 150-watt tank unit makes band changing or hopping a chore no longer to be shunned and you have a combination with outstanding advantages. An aside to the 6-meter man (the writer is one himself) is that high output can be obtained in the 25-megacycle region and utilized to drive succeeding 6-meter equipment.

Strays

W2PZF was in good hands when he took the fatal step recently. Bolstering the OM's morale were Best Man W2PTR, Bride's Father W2ABC, and Soloist W2BLO!

— . . . —

Time tells of the theft of a telephone pole in Palm City, Calif., while in Cleveland a similar purloining is reported by the *Plain Dealer*.

Whodunnit?

— . . . —

A recent steam-boiler explosion in the King's Hall Building, Montreal, which houses the studios of CFCF, CBF, and CBM, caused one death and 25 casualties, including a number of Canadian Broadcasting Corporation employees. Ironically, among the soap operas being aired at the time was "Life Can Be Beautiful."

— . . . —

W2s QQQ, EEE and SSS are all residents of Buffalo!

— R. G. Summers

Improved Break-In Keying

Some Better Solutions to the Big C.W. Problem

BY BYRON GOODMAN, * WIDX

BREAK-IN c.w. operation requires that the transmitting operator be able to hear, during "key-up" periods, the station he is working or calling. Using separate antennas for transmitting and receiving, keying the transmitter oscillator gives a type of break-in operation that has been used for years in many stations. The oscillator has to be keyed if both stations are on or near the same frequency (as is generally the case), because a steadily-running oscillator will block the receiver and the transmitting operator will be unable to hear the other station. Also, the operator has to have shock-resistant ears to with-

• Break-in operation on c.w. usually calls for oscillator keying, and oscillator keying generally introduces a chirp that can't be eliminated. Included in this article is a system that permits full break-in operation with amplifier keying, even on one's own frequency, without chirps.

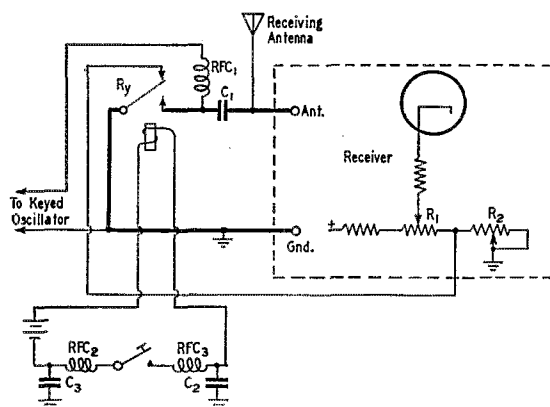

Fig. 1 — A break-in system devised by W1PMT for smooth break-in operation. The keying relay keys the oscillator, shorts the receiver input, and reduces the gain of the receiver. A new gain control, R_2 , must be added to the receiver — this control sets the receiver gain for the "key-down" condition.

The leads shown as heavy lines should be kept as short as possible, for minimum pick-up of the transmitter signal.

C_1, C_2, C_3 — 0.001 μ f.

R_1 — Receiver manual gain control.

R_2 — 5000- or 10,000-ohm wire-wound potentiometer.

RFC_1, RFC_2, RFC_3 — 2.5-mh. r.f. choke.

Ry — S.p.d.t. keying relay.

stand the overloading in his own receiver every time he hits the key! An audio output limiter¹ goes a long way toward reducing this effect, by limiting the available audio output of the receiver. Claude Robinson, W6KJV, showed² a clever approach that used a d.p.d.t. relay to disconnect the receiving antenna, short the receiver input, reduce the receiver gain and key the oscil-

lator, all at the same time! Henry E. Rice, jr., W1PMT, experimented with this and similar circuits for some time, and finally decided that the use of a d.p.d.t. relay was a big disadvantage, requiring too-careful adjustment of the contacts. Having established this thesis, W1PMT then devised a circuit, Fig. 1, to do the job with a s.p.d.t. relay. This system was demonstrated to the author but has never been described in print. It is a very smooth system, and is highly recommended to anyone who is satisfied with oscillator keying.

David Scott, W1CLM, is one of the many who aren't satisfied with oscillator keying but who nevertheless realize the advantages of break-in operation. He goes a step in the right direction with an improved version of a scheme suggested several years ago,³ in which the key controls the transmitter power supplies in addition to performing its regular function of keying an amplifier stage. With the circuit shown in Fig. 2, the power supplies are turned on as soon as the key is closed for the first character of a transmission. The control circuit holds the power-supply circuit relay closed unless the key remains open for an interval of time determined by the control-circuit constants. This system normally would operate too slowly to permit a break signal to be heard between dots and dashes or between words except perhaps at slow speed. But it provides the sort of break-in which seems to prevail generally at present — the transmitting operator can pause briefly at intervals to listen for a break signal without manually turning off the oscillator. And it does eliminate the disadvantages of oscillator keying.

The keyer unit shown in Fig. 2 consists of two

* Assistant Technical Editor, *QST*.

¹ Grammer, "Noise Limiting in C.W. Reception," *QST*, May, 1946.

² Robinson, "A Quiet Break-In System," *QST*, February, 1947.

³ Hilferty, "Break-In with Crystal Control," *QST*, February, 1932, p. 44; W8EXJ, "Break-In with Crystal Control," *QST*, February, 1933, p. 47.

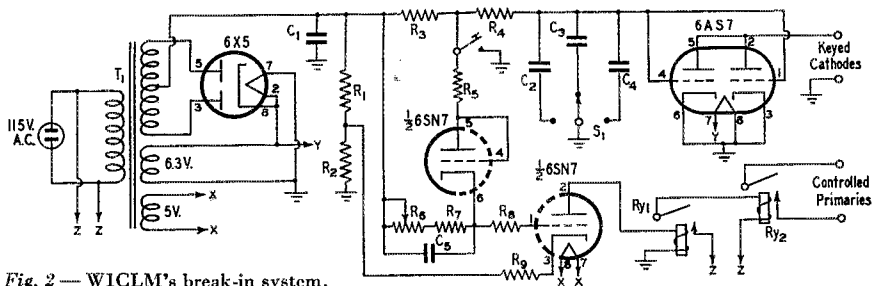

Fig. 2 — WICLM's break-in system.

- C₁ — 2- μ fd. 600-volt paper.
- C₂ — 0.0015- μ fd. mica.
- C₃ — 0.0024- μ fd. mica.
- C₄ — 0.0036- μ fd. mica.
- C₅ — 0.25- μ fd. 600-volt paper.
- R₁ — 2200 ohms, 2 watts.
- R₂ — 25,000 ohms, 10 watts.
- R₃ — 1 megohm or more, $\frac{1}{2}$ watt.
- R₄ — 2-megohm potentiometer.

- R₅ — 510 ohms, $\frac{1}{2}$ watt.
- R₆ — 5-megohm potentiometer.
- R₇, R₈ — 1 megohm, $\frac{1}{2}$ watt.
- R₉ — 20,000 ohms, 5 watts.
- RY₁ — 3000-ohm telephone relay.
- RY₂ — 115-volt a.c. power relay.
- S₁ — 3-position rotary switch.
- T₁ — Power transformer: 325-0-325, 10 ma.: 6.3 volts, 3 amp.; 5 volts, 2 amp.

sections. In the upper portion of the circuit a 6AS7 keyer tube is used in a conventional tube-keyer circuit. In the lower portion a 6SN7 is used to turn on all plate supplies when the key is first closed, and hold them on for a length of time predetermined by the operator. The supply for the unit is a very simple affair, consisting of only a small replacement-type transformer, a 6X5 rectifier, and a 2- μ fd. condenser. The output voltage under load is about 375 volts. In passing, it might be mentioned that this power supply could well be used also to provide protective bias for the transmitter stages, by adding a choke, condenser and regulator tube at the plate-transformer center-tap. The transformer will handle the additional load since the total keyer drain is only 25 ma. Conversely, the voltage for the keyer and control circuits could be obtained from an existing bias supply.

The 6AS7 keyer tube is connected between cathode and ground of the keyed amplifier stages. With -375 volts at the grid, current through the keyer tube is cut off completely. When the key is closed, the grid voltage rises to the cathode potential, so with no bias the keyer-tube resistance is very low. R₄ plus the condenser selected by S₁ provides the lag required on make and break to eliminate key clicks. There is no danger of a shock from the key because of the resistance of R₃.

The 6AS7 is a particularly good tube for keyer application, for although its cost is about twice that of a 6B4 or 2A3, the voltage drop across it when conducting is approximately one-seventh of these next-best types. Its d.c. plate resistance of roughly 160 ohms means that the cathodes of several stages may be keyed simultaneously, and the drop across the keyer tube used toward the required operating bias, if desired.

Power switching in the lower section is accomplished by a 3000-ohm telephone relay (or equivalent) operated in the plate circuit of one

section of the 6SN7. When the key is open a bias of 30 volts is placed on the grid of this tube which cuts it off completely. Upon initial closing of the key, the grid is made positive through R₅ and the other 6SN7 section which is connected as a diode. The triode will then draw plate current and close the relay. At the same time, C₅ will be charged up, through the diode, to the full supply voltage. When the key is released, C₅ will discharge slowly through the high resistance of R₆ and R₇, causing the triode to conduct sufficiently to keep the relay closed until C₅ has almost completely discharged. Computing the length of this time delay involves more than the RC time constant, as one must also consider the g_m of the triode, the sensitivity of the relay and the fact that C₅ will also discharge through R₁, R₃, R₉ and the triode, so long as grid current is being drawn. The range available for the values shown is about $\frac{1}{2}$ to 2 seconds. R₃ limits the grid current drawn by the triode, and increases the resistance of the C₅ discharge path through the tube.

R₉ limits the plate current through the triode. Its value should be chosen to give a plate current of 10 ma. R₅ reduces the spark at the key resulting from the initial charging of C₅ after a pause. R.f. chokes at the key will further minimize this. The total resistance of the charge path is sufficiently low to cause no more than slight clipping of the first "dit" of a transmission.

The filament of the 6SN7 has been successfully operated from the 5-volt winding for some time with no harmful effects. A definite advantage derived from the low filament voltage on this tube is the resulting 15-second delay, after initially switching on T₁, before RY₁ closes and the transmitter plate supply comes on. This is an important requirement for the 6AS7 as stipulated by its manufacturer. A separate filament winding is required for the 6SN7 because of its high cathode potential with respect to ground.

Quite independently, we have been working toward a more complete solution to the problem at W1DX. We know that to avoid clicks, the voltage must be applied slowly to, and removed slowly from, the oscillator. This may be done by the use of a choke-and-condenser key filter, or by using a tube keyer. Since the oscillator is generating power during these times when the voltage is going from zero to operating, and back to zero, it means that the oscillator frequency must be *completely* independent of applied voltage. Furnishing the plate power from a regulated supply doesn't help any in keying with click filtering, because the voltage must go from zero up to the regulated value and back down during each dot and dash. Regulation does help a constant-run-

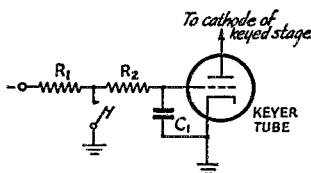

Fig. 3 — Basic circuit of a tube keyer. The negative voltage biases the keyer tube to beyond cut-off with the key up — when the key is closed the grid voltage becomes zero, by discharging C_1 through R_2 . When the key is opened, C_1 charges through $R_1 + R_2$.

ning oscillator that is voltage-sensitive, but an oscillator that could give completely chirpless output with any degree of click filtering wouldn't need a regulator! Remember when you start thinking that *your* oscillator has no chirp that we are talking about a change of a few *cycles*! When your oscillator is on 80 or 160 meters, a change of a few cycles is multiplied by four or eight at 20 meters, and it becomes noticeable.

One Answer

A solution to this chirpless break-in keying deal consists simply of turning on the oscillator before a character is started and turning it off after the character is completed. The oscillator gets turned on *fast*, and probably clicks all over the map, but the keying is done in a later stage, where the character is properly shaped, and no clicks get out on the air. The thing is simple, and it's like having your cake and eating it, too.

In the ordinary tube keyer, shown in Fig. 3, when the key is open the grid has a high negative voltage and the tube doesn't conduct. C_1 is charged to this high negative voltage. When the key is closed, the grid voltage goes to zero at a rate dependent upon the time constant of R_2C_1 , and the conduction through the tube follows much this same curve. When the key is opened, C_1 (and hence the voltage on the grid of the keyer tube) charges to the negative voltage at a rate dependent on the time constant of $(R_1 + R_2)C_1$. Thus a keyer tube inherently gives a desirable keying characteristic, in that the "make" time is

shorter than the "break" time. In other words, there may be a slight thump on "make" that doesn't appear on "break" if R_1 is larger than R_2 , as is usually the case.

Fig. 4 shows these rise and decay times plotted for a typical case. However, if the grid voltage at which the keyer tube starts to conduct is lower than the supply voltage, there is a part of these curves that we can use that is independent of the conduction of the keyer tube. All we have to do is to turn the oscillator on at some value between this point and the supply level and we're in business. If the oscillator goes on fast, it will be at operating frequency before the tube keyer starts to conduct, and it won't turn off until the tube keyer has cut off the amplifier it is keying. It still gives us some time to listen for the other station.

The Practical Circuit

A circuit that can be used to pull this trick is shown in Fig. 5. It combines with a tube keyer the Rice system for disabling the receiver, and requires the addition of a 6SN7 and a few resistors. R_7 , R_8 and C_2 are the usual tube-keyer resistors and condenser, and correspond to R_1 , R_2 and C_1 in Fig. 3. R_1 , R_2 and R_3 form a fairly "stiff" voltage divider across the negative supply. The plate current of the left-hand triode controls the relay that turns on the oscillator (and performs the other break-in functions). With the key "up," this plate current is held to a low level by the drop across R_2 (constant) and across R_4 . The right-hand triode is a cathode-follower type of amplifier, and its cathode potential will always be slightly more positive than its grid. When the key is closed, and the voltage of C_2

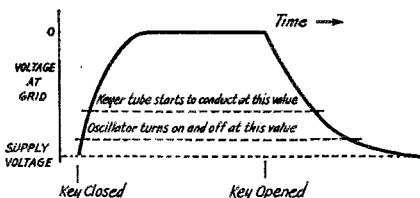

Fig. 4 — The voltage appearing across C_1 of Fig. 3 when the key is closed and opened.

starts toward zero, the cathode of the right-hand triode follows. It takes only a few volts for it to bring the left-hand triode grid up to the point where the relay closes. As the right-hand cathode goes on toward zero, R_5 limits the current that flows to the grid of the left-hand triode.

It isn't as complicated as it sounds. All you need is a voltmeter (or milliammeter) to tell where you are. With the key "up," the idling voltage across the relay should be less than one volt (idling current through the coil of less than 0.75 ma.), and with the key down the relay voltage should go to 18 (current of 13 ma.). If the idling voltage is too high, increase the value of

R_2 . If the voltage across the relay is too high with the key down, increase the value of R_6 . Different negative supply voltages and tube characteristics are bound to result in some variation.

Aside from the feature of receiver silencing, the principal difference between the arrangements of Figs. 2 and 5 is that the oscillator plate voltage, rather than the transformer primaries, is switched by the control relay in the latter. By doing this, the switching time can be limited to an interval only long enough to allow proper shaping of the keying characteristic in the amplifier which is being keyed. The system thus provides maximum break-in opportunity.

This system was installed at the author's station by mounting the relay, RFC_1 , C_1 and a binding-post strip on a small aluminum bracket that was bolted to the back of the receiver (an HQ-129) just above the antenna posts. This allowed short leads to be run to the antenna posts, as shown in Fig. 5. The auxiliary gain control (R_2 of Fig. 1) was substituted for the "send-receive" switch on the receiver, and the lead from it to the normally-closed contact of the relay was brought out at the rear of the receiver.

One word about the relay that is used. The only one that has been used at W1DX in this arrangement is a "Millisee" relay.⁴ This is the fastest-operating relay we have seen, and of course a system of this type requires an extremely fast relay. The Millisee relay closes in 0.001 second in normal operation. There may be other relays that will work, but don't blame the system if you use a slow relay. One simple way to check a keying relay's performance is to connect it to key between a dry cell and a voltmeter. Adjust the dots on your bug key until the indicated voltage from a string of fast dots is half the battery voltage. Now connect the key directly into the circuit and make the same check. In most cases, where the relay is poor, the reading with the key alone will be higher than with the relay, indicating that the bug had to be adjusted "heavy" to compensate for the lag of the relay. With a Millisee relay,

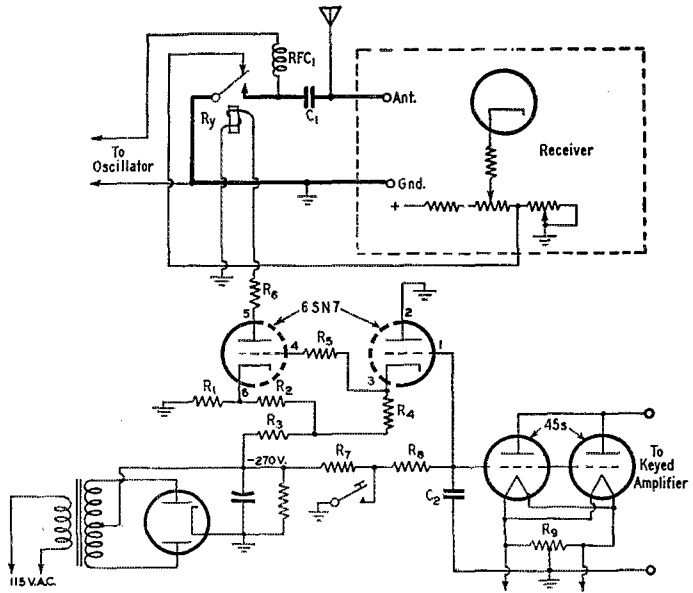

Fig. 5 — A break-in system that holds the oscillator circuit closed (and the receiver input shorted) during a string of fast dots but opens between letters or words.

- C_1 — 0.001 μ fd.
 - C_2 — 0.0047 μ fd.
 - R_1 — 20,000 ohms, 10 watts, wire-wound.
 - R_2 — 1800 ohms.
 - R_3 — 1500 ohms.
 - R_4, R_5 — 1.0 megohm.
 - R_6 — 4700 ohms.
 - R_7 — 6.8 megohms.
 - R_8 — 0.47 megohm.
 - R_9 — 50 ohms, c.t., 2 watts.
- All resistors 1-watt composition unless otherwise noted.
 RFC_1 — 2.5-mh. r.f. choke.
 Ry — High-speed type, 1400-ohm 18-volt coil (Stevens-Arnold Type 17 Millisee).

and any other type that can be used in the above break-in circuit, you won't find any difference at all!

When you put the system into operation, you will find that your oscillator goes off (and the receiver opens up) between each dot and dash at speeds up to 15 w.p.m. or so, but with the bug set for 25 or 30 w.p.m. the receiver will only open up between words. The reason is, of course, that the time between characters isn't enough to allow condenser C_1 of Fig. 3 time enough to charge to the point where the relay will open. At first glance this will appear to be a big disadvantage and your reaction is that you can't be "broken" under these circumstances. Forget it! Using the system in several operating contests, we have never missed being broken if the breaking station makes a long dash, as is the custom. When calling a station at 25 per on the bug, your receiver opens up between each call-letter group you send, and you'll hear him break you every time.

It is important, of course, that the oscillator turns on fast when the relay closes. This means using no more shunt capacitance and series resistance or inductance in the keying circuit than are

(Continued on page 148)

⁴ Made by Stevens-Arnold Co., Inc., 22 Elkins St., South Boston, Mass. The price is about \$6.00.

How's DX?

CONDUCTED BY ROD NEWKIRK,* W9BRD/1

How:

Well, this year's DX Contest is in full swing and everyone is much too busy adding up multipliers and replacing flat final tubes to pay much attention to sermons. So we'll just add a cheerful note this time.

Three new countries have been appended to the ARRL Countries List. Gloat if you have 'em: Lebanon Republic (AR8), San Marino, and Pakistan. The first is different than the Syrian Republic (AR1); the latter two have no official amateur prefixes as yet. MIA has been operating in San Marino, however.

On the subject of countries, then: Some of the gang are not aware that "country status" is designated in the List only on political (not necessarily geographical) grounds. For instance, there is deemed enough governmental difference between GW and G to warrant a List separation, while the Aleutians and Alaska are one and the same. And when you work KH6OC on French Frigate Shoals (administered as part of T. H.) it's just another KH6. Going down said List may strike you with apparent inconsistencies but considerable research has gone into its make-up and you will find a valid reason for every line that has been drawn on such terms.

All DX-interested amateurs should keep the Official List at hand and carefully amend it according to QST announcements. If you think you

have a new one that's been overlooked we're always open for constructive criticism! But present your grounds for separate designation therewith. The Committee will no doubt have an answer for you.

In closing, we might say that contrary to some reports which are circulating, we have no definite news of current amateur activities in Lower Slobovia.

What:

There is certainly no scarcity of reports on eighty this month. No current WACs have been reported, but several of the gang have five continents so far this season. W1IIM has knocked off 20 countries on 'phone, including a few dozen Gs, GW6BI, GW2ABJ, GM2DI, GM2UU, EI5Q, PA0NG, PA0BM, PA0CT, PA0CF, OZ4YEW, OZ5OR, HB9EU, D2DB, MB9AA and VO6J. Jack hears these all between 37-3800 kc. VO3X has an 807 on voice and raised G8VB and G5BJ W9NLP snared ZL2BE and OX3GE on the mike W2QHH has been running about 12 watts input on c.w. and has over two countries per watt on the band. Some of them: ZL1CI, VO2AH, NY4CM, KP4KD, GW8CT, G13SL, FA8BG, F8EX, PA0LB (3520), HB9EO and a carload of Englishmen W4ZZ roped onto KS4AI (3770) W4KFC is getting a kick out of this band, too. Vic has over 25 countries this season. Latest are YU7KX, D7AA and OX3MG. He reports that W4RQR now has five continents with VP4TAB (3485) accounting for that rare South American W0CFB gets his hand in from the Midwest and has been working his share of Europeans as well as FA8IH and ZK1AM (3530) W4BRB seems to be high man with over 30 postwar countries on 3.5 Mc. Among them are OK1FF, LA7Y, SM7JM, OZ4FT, G13CHX, ON4AU, CM2SW, HB9S, F3MS, YU7KX and ZL1HM. Gene worked PA0PN, PA0RE, PA0FLX, PA0VB, PA0DC, PA0UN, PA0MA and PA0XR during the Netherlands DX Test. He also hears OH1NI (3511) and has a schedule arranged for his WAC (ZC6BK) but no contact as yet W9DKH jumped upon ZL4DC and ZL1DI in between traffic skeds W9BMV clicked with GD3UB W6CEM and G5LI hooked up on 3501 kc. W1GKU has heard ZC6BK and worked OK3AL (3520), OK2VMX (3520) and some FA8s. He hears FA8BG's fundamental and 7-Mc. harmonic with equal strength! W1DLC and W1BPX have

* DX Editor, QST.



been collecting Europeans galore and also got in on ZL1DI and ZL1HM A 1740 at W3WJF clipped ZL1HS (3510), ZL4DU (3541), ON4HC (3514) and XE1DX (3541). Bob has heard HE1CT and ZS1M Another all-band enthusiast, KP4KD, has been working his share of stuff while having the difficult task of heeding W calls, too J2AIA may soon fire up a kw. on 80, according to W4BRB, so this band should provide a lot of multipliers for DX Test scores this year W1EFN fattened up the log on OZ3HR, F3KH, HB9FU and many previously listed. Walter rounded up 15 countries in a week of midnight oil.

Forty is stealing a lot of the show from twenty in the wee hours this season. KP4KD submits a nice list of station contacts along with frequencies: OK1RW (7100), OK3AL (7120), PY2AJT (7100), HH2LR (7055), PA0BK (7120), GM5IR (7035), SM4LB (7050), OH3NB (7010), ON4BYT (7060), GC2CNC (7030) and numerous Gs and Fs Listener L. Berge, of Antwerp, hears FO8TY (7050) on voice quite often — there's a good one if you can get him to read c.w.! At W2EWT we find a load of Europeans including HB9CX and also VO2R In good old Brooklyn, W2KIR had quite a time with stuff like UB5KAB, UB5BG, SM5BX, OH6NZ, PY2AFX, PY2AFS, EI9J and a myriad of Europeans in addition W2SYG offers GD3UB (7090), GM3BST (7085), GI3CHX (7021), OZ2RS (7085), SM5PV (7120), YU5ZO (7065) and MB9AS (7070) It's not so easy out his way, but W6DLX associated with W6YOT/C6 (7100), G6BQ (7125), ZL1FN (7125), ZS6GJ (7120) and KL7HR (7115). These five continents came easy in 1½ hours, but no South American showed up! A fast WAC by W8RDZ included ZS1M, ZC6SM, PY7WI and ZL1BY W8STE comes up with D4AJ in Bremen W2VJN is just 14, but managed XE2LA, G15DX, VE8NB, OX3MG, CM6AH, KZ5AX and gobs of Britishers. George is another 807 man W6KRI managed to slip past the Eastern gang for G5GK, G2NM, G5CW, G4QD and G8HX The 14-Mc. beam at W2GUR gave up the ghost, so he took a shot at 7 Mc. and unsnarled D4AX1, F3RW, OE7AH, W6YAW/KH6 and ZS2CR, and has been hearing J3AAD and J2SCS A new YL harmonic showed up at W2VAV. Thus inspired, Bill hooked a ZS and then F9DI (7080)

and OK1OK (7075) In Joisey, W2EQS conversed with VR5PL (7100), OX3ME (7031), KM6AA (7150), CE3BM (7092), PY1LQ (7050), J2SCS (7044) and MB9AA (7030) W3EVW nailed RV2 (7120) An old-timer at 7-Mc. DX chasing, W1EFN reports people like VK7JP, VK2AL, ZL2MM, ZL3CN, CT1SX, I1AKS and others W6WDH/2 has collected 38 countries on the band this season. To mention a few — CT1ET, HA1KK, YU7KX, KV4AA, HK5CR plus many Europeans An unusual one at W3JAK is LB4QA, an Antarctic whaler. Also worked were VP5MU, TIMR, KS4AF, OX3SE, GC2FMV, LA7Y, D4ALN, YR5I, UC2KBA, VK3AKP, ZL4IB, W00ZW/KS6, etc. W8SVS was another lucky man to work J2SCS. Rev. Bauer also ran across CO2PQ (7120) W8PCS dropped from 20 and chatted with a few Gs, I1HOE, F3RW and ZL3FP Ten watts to a 61.6 also gave W9MFY a solid ZL3FP QSO. Jim will be a new papa by the time you read this.

Twenty has been having fits of temperament; one night as hot as the proverbial pistol and the next — blotto. Despite this, we still have so many reports we don't know where to commence. News of FE is timely. It's FQ3AT/FE3 (14,090), first reported by W2CYS. Vince also admits to UA0KAA (14,130), UH8AF (13,390), UA1KEC (14,080), UC2CB (14,175), VU2EH (14,090), VQ8AY (14,040), J5AAL (14,080), UN1AA (14,170), CR6AI (14,040), EA9AA (14,085) and others A most complete report from the Orangeburg antenna farm, W4BPD, tips us off about VS1CF (14,010), ZS3D (14,090), ZD3B (14,100), ZA2A (14,135), VU2KP (14,055),

◆

The operating position at D4ALN. Operated in Berlin by M/Sgt. Charles H. Miller, the station is well known to most 28-Mc. men. The rig, not shown, is in the basement below and runs 500 watts to a 250TH with a pair of 100THs modulating. The antenna is a Vee beamed on the States, 14 full waves to the leg and 56 feet high.

March 1948

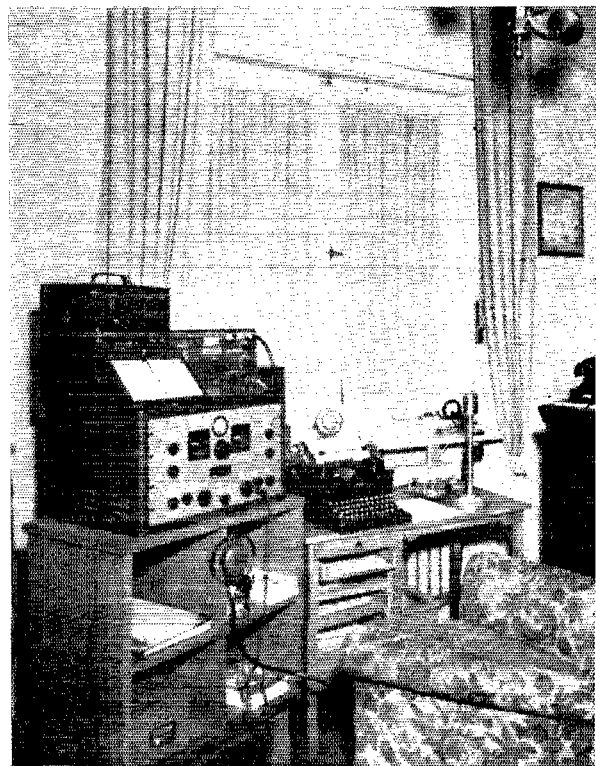



This absorbed gentleman is Will Rogers of G2SY — a familiar call on any DX band — shown punching brass at his station in Daventry. A 35T runs cool at 75 watts and the skywire is an all-band Zepp. Willing to chew the rag at any time, Will has nevertheless tallied up close to 100 countries, 'phone and c.w.

VU2SJ (14,045), LB3PA (14,100), EP1AL (14,000), TF3AB (14,035), CT2AB (14,060), UL7BS (14,055 t7), UR2KAA (14,050), UH8AA (14,045), UH8AF (14,040), UI8AE (14,050), YI2FDF (14,090), XT9F (14,070), C4RK (14,038), ZE1JV (14,055f), D4AVF/EL (14,360f) and VP7NA (14,100 t7). (Unpack that bag, Jeeves. Gus doesn't need a butler!) W8PCS caught up with UA6AA, EA7AV, EA9AI, EK1AA and YI2AM Some difficult ones are pinned down by W6VFR: KX6AB (14,320), KX6AC (14,142 — both 'phone and c.w.), and ZP2AC (14,120) Uncovered by W2PUD were VS6AR (14,060), J8AAG (14,130), G2FDF/YI, among others.

Also on twenty, W6DLX showed up with PY1DO (14,055), J3AAD (14,105), ZS5GB (14,040), ZS2F (14,045), KL7JQ (14,100), KM6AB, and KH6LU (14,090) GD2DF/A, ZC6AA, ZE1JU, OA4AK, VQ1HJP, HS1SS, CR7AP all bit the dust when W2GUR turned his late beam upon them W4KFC rose up to 111 postwar with ZB2A, W2WMV/C9, KB6AD, RV2 (14,060 t4) and ZD6DT While not pushing QTC on the police nets, W9BMV apprehended CR7VAL, VC6JL (?), VQ2GW and ZE1JI An 807 up at VO3X scraped up HE1CE, KL7UM, ET1KR, EL3A, UA1PA and others W2QHH got cards from MD5PC and LX1JW to make it 98 confirmed out of 111 worked. Howy has a brand-new Collins 75A receiver W6ZZ spent some time getting his new beam a-perkin' and tried it out on CX1BZ, G2UT, OH2NB and EI9J In the Motor City, W8MTE is in there pitching with VQ3HJP, OX3RC, UC2CD, VU7JU, KP6AA, FT4AN and UQ2AB KB6AD, VQ4RAW and some others made it 130 for W6CIS The zeroes are pretty quiet this month, but W0MLM comes through with KA1AP, ZS6MX, CR9AN, OH6NZ, OH6NR, OH8NG, UA3AM,

UA3KAE, UA3AC, OK2DD, SM7IA and HB9EU Things are still going FB in the Lone Star State as W5ACL crawled away with CN8MI, GD3BBS, HC1ES, HC1JW, HK3EO, HP1A, I6AB, I6ZJ, OA4CS, PY1HQ, TI2EXO, VK7LZ, VP8AI, VQ8AZ, VP8AI, ZD4AL and W7LGZ/KL7.

Arkie at W8NBK chose UA1KED (14,040), ZP8CN (14,065), KB6AC (14,110), UN1AO (14,085), ST2RL (14,115) and ZD3B (14,120), to push him up to 147 W5GJG eked out OH2NQ, ZE2JN, ZD4AB, CR7BB and LU1ZA It's 88 postwar at W3FQB, new ones including PX4AA, EA7AV, EL3A, LX1AS, YV1AI. FQB wonders where LD1A is . . . so do we! W1MRQ chawed with CN8BI, OX3MG, OX3RG, OZ4M, PZ1FM, PZ1OY, TI2OH, VP3JM and many others. Dick wants to compliment hams in Denmark for their high QSL percentage. Amen! W4BBP recorded contacts with YA3B, UA3BM and UD6BM Difficulty with South America has kept W2TXB down to 95 but he did pull through PY1QH and YV5AB to help things a little With a QTH like Widener, Ark., W5ASG ought to be able to keep the band open a little longer than the rest of us. Bill snatched MD1D on c.w. and then plugged in the mike for AR8AB, ZD2KC, CR9AG, HZ1AB, CN8EF, KX6AF, W2WMV/C9, J8AAR, W0MCF/C1, VQ4NSH, ZS4P and ZM6AF. A neat total of 180 postwar and 119 on 'phone! Here's another zero, W0NUJ, with ZD4AM, CN8BC, VP9E, CX4CZ, LU7BH, OA4BG and a mess of Europeans W7BE logged 602 different-European-station QSOs from March through December last year. Bill tells of recent sessions with ZC6JK, ZD4OA, ET1IR and VP3TR, and now stands at 122 Chopping out a few phonies knocked W6ZCY's accounting down to 147 and he still needs a couple of cards for the



We have a more formal photo of Sgt. E. G. Morgan, VS2BU, in full uniform but this ham-in-action shot strikes our fancy. An 807 at 25 watts input with 6L6s modulating make up the transmitter; the antenna is a dipole. George wants more eastern W contacts on 14 Mc.

sheepskin. MB9AA, EK1AA, EK1AZ, VQ1HJP, OQ5AQ, XAFQ, VR2AU and ZC6SM helped Frank, too W1RY misses his old antenna ranch, but dug up W3LYK/Antarctica, PK4KS, VK9AW, HELEO, VS1AG, FQ3AT and J8AAK.

Our spies report that W1FH needs just one or two countries for his 200 postwar. Oh, my W4MZ (ex-K6QYI) pinned down HZ1AA, J9ABB, UA1NR, UI8AA, UJ8AE, and is one of the few of us satisfied with his location! Details from W2HMJ reveal QSOs with D5LX, VQ3HJP, OA4BG, KZ5BE, VU2BB, CT1SX, SFLT (ship off Capetown), MD5PC, EA300, HK1AM, and EI4S. August worked EA1A who said, "Sorry, no QSL, OM."

Ten has grown quite spotty and reports have dwindled down to a trickle. W6ZZ was still in there trying with G5BY, G8SB, G6WT, G5DF, KH6AR, KH6MA, W0BEH/KH6, KG6CO, J2FOX, J8AAR, J9ANT, J8AAV, J9ABK, LU3DH, W3KTF/KG6, KX6AF, W6PJM/KG6 and KL7NA, all on 'phone. Miles has 83 confirmed now out of 91, not a bad average W0NUJ gathered up VP6JR, LU4BC, GW4CX, OQ5HR, CR9AG, OX3GE, J2IMR, J9KC, W2WMV/C9, SM7IA, D4AMX, ZS5J and C1MCC W6VFR reports KX6AB on 28,053 W2CYS modulated with VU2BJ (28,225) The XYLs are ably represented by W1MCW with 118 postwar 'phone on this band. Lou's latest are KG6AW/VK9, VU7BR, ZK1AA, MD7RJ, ST2JF, J8AAJ, MD5AF, AR8AB, XAFG and ZC1AF W3NPN's 807 did fine with a jugful of Gs, HB9X, IIAY, IIND, OZ4IM, OZ7ON and PA0CB Wonder if the Contest will bring out any reports of stuff on eleven, besides OM XE1A!

Where :

Get out the airmail stickers if you can use these:

CE7AF	Anthony Mattos, Casilla 26D, Punta Arenas, Chile
CE7ZA/CE7ZB	Radio Club de Chile, Casilla 761, Santiago, Chile
EA1D	Ed Agan, Taberg, New York
ET3AD	Claude Steen, jr., M.D., P.O. Box 145, Addis Ababa, Ethiopia
FQ3AT/FE3	Ivan Pastre, Base Aviation, Douala, French Cameroons
HK1AM	Anthony Gallen, CRM USN, USN Mission, Cartagena, Colombia
J2BGK	Capt. J. R. Kersten, Sugamo Prison, APO 181, % Postmaster, San Francisco, Calif.
J2SCS	AP0 500, % Postmaster, San Francisco, Calif.
MD3AB	P.O. Box 247, Asmara, Eritrea
MI6AB	A. Fontanelli, 31, via Molise, Asmara, Eritrea
MI6BC	(QSL via MI6ZJ)
MI6ZJ	G. R. Chiffey, P.O. Box 247, Asmara, Eritrea
VE8NB	Resolution Island, Via Churchill, Manitoba, Canada



Meet Mr. Magnus Blondal, shown operating his station in Reykjavik, TF3MB. So far exclusively on 14-Mc. c.w., an 807 final at 30 watts feeds a half-wave Zepp. One of the more active Iceland amateurs, Magnus has been quite busy giving many of us another country.

VP2KS	Basseterre, St. Kitts, BWI
VQ8AY	Ed Goldsmith, Phoenix, Mauritius
VR4AA	J. D. Davies, Honiara, British Solomon Islands
VU2PB	D. C. Dove, "Mill House," Scoulton, Norwich, Norfolk, England
VU2SJ	26 Church St., Langold, Worksop, Notts., England
W0OZW/KS6	% Naval Station, Pago Pago
XAFQ	Hq. & Hq. Co., 351 Inf., APO 209, % Postmaster, New York, N. Y.
XAFY	W. Valentine, W4LDW, Route 1, Dry Ridge, Ky.
XZ2JW	No. 302157 LAC Savage, Signals Servicing Section, RAF Station, Little Rissington, Gloucester, England
ZC6SM	Box 360, Cairo, Egypt
ZP2AC	Convencion 235, Asuncion, Paraguay
ZS6NU	Aeradio Palapye, Palapye Road, Bechuanaland

Thanks for the above to W1PEF, W2CYS, W2EQS, W4BRB, W6VFR, W8PCS, W0WIT, CE3AG, MI6ZJ and XZ2HP.

Tidbits :

W6VFR favors us with a one-man DX column of his own. To wit: LA4LA has gone back to Oslo but LB2FB is still on in Spitzbergen. FM8AC was vacationing in France but by now is back at the old stand. OY3IGO is trying 7 Mc. these days. VQ3HJP, who thrilled 89 fellers when he worked them from Zanzibar, probably won't be back there for some time; besides that session on the ham bands, he ran some successful v.h.f.-equipment tests in VQ1 GD2DF was incorrectly listed as GD6DF in last October's issue and has been using GD2DF/A. (For any wonderers, /A behind a G call means "alternate location," equivalent to W portables.) Fred likes 14,080 kc. VK3ACD, VK3AMG, VK3OY and VK7AE will accompany the 1948 Australian Antarctic Expedition and expect to man a station in the ham bands from the Heard and Macquarie Islands intermittently throughout

(Continued on page 148)

Phone-Band Phunnies

The Hi-Lo Boy



THIS specimen is something more than frequency-conscious; he is practically frequency-unconscious, having knocked himself out worrying about the percentages of "highs" and "lows" in his signal. On the one hand, he wants to eliminate the bass notes because he understands that they waste power without contributing to intelligibility. At the same time, he is determined to avoid the snare of having too many high frequencies, for he has been informed that they create an unnecessarily broad signal.

Every time you work him, he pleads for a "really critical" quality check. You are forced to listen for sibilants while he recites: "Sally saw six, slick, slim, slender saplings"; and then you are supposed to bend an ear for the lows while he moos into the mike like a lovelorn Ferdinand.

No matter what kind of a perjured report you give him, he is still unhappy because, as he points out, the human ear is easily fooled and a good audio oscillator and 'scope are really required to tell anything worth while about the frequency response. You heartily agree with this, but that does not prevent his asking for a repeat performance when next you contact.

Sometimes you wish, a little wearily, that he would do with his signal what the French chef advised doing with a catfish: cut the head and tail off and throw the rest away!

— John T. Frye, W9EGY

HAMFEST CALENDAR

NEW JERSEY—You are cordially invited to the Fourth Annual Old Timers Nite of the Delaware Valley Radio Assn., Saturday evening, March 27th, at the Hotel Stacy Trent, Trenton, N. J. Turkey dinner at 6:30, stag. Reminiscing; old-timer guest speakers from many branches of radio. Tickets \$4 if ordered with stamped envelope before March 20th from Ed Raser, W2ZI; \$5 thereafter.

Revised WWV Schedule

Effective January 30, 1948

STANDARD-FREQUENCY transmissions are made continuously day and night as a public service of the National Bureau of Standards over its standard-frequency station, WWV, on the following schedule:

Mc.	Power (kw.)	Audio Freq. (cycles)
2.5	0.7	1 and 440
5.0	8.0	1 and 440
10.0	9.0	1, 440 and 4000
15.0	9.0	1, 440 and 4000
20.0	8.5	1, 440 and 4000
25.0	0.1	1, 440 and 4000
30.0	0.1	1 and 440
35.0	0.1	1

A 0.005-second pulse may be heard as a faint tick every second, except the 59th second of each minute. These pulses may be used for accurate time signals, and their one-second spacing provides an accurate time interval for physical measurements.

The audio frequencies are interrupted at precisely one minute *before* each hour and each five minutes thereafter (59th minute; 4 minutes past hour, 9 minutes past hour, etc.), resuming after an interval of precisely one minute. This one-minute interval is provided to give Eastern Standard Time in telegraphic code and to afford an interval for the checking of radio-frequency measurements free from the presence of the audio frequencies. Ionospheric-disturbance warnings applicable to the North Atlantic path are given at 19 and 49 minutes past each hour. If a disturbance is in progress or is anticipated within 12 hours, the time announcement is followed by 6 Ws; if conditions are quiet or normal, the time announcement is followed by 8 Ns. The announcement of the station's services and of the station's call (WWV) is given by voice at the hour and half hour.

The accuracy of all the frequencies, radio and audio, as transmitted, is now better than a part in 50,000,000. Transmission effects in the medium may result in slight fluctuations in the audio frequencies as received at a particular place; the average frequency received, however, is as accurate as that transmitted. The time interval marked by the pulse every second is accurate to 0.000001 second. The beginnings of the periods when the audio frequencies are resumed are synchronized with the basic time service of the U. S. Naval Observatory.

SWITCH TO SAFETY!





Hints and Kinks

For the Experimenter



A REVERSIBLE FIXED BEAM

FOR some time the writer used a horizontal folded dipole in the 28-Mc. band, and while signals were received with good intensity, objectionable interference was also received from the direction opposite to that of the desired signal. Because of the difficulty of erecting rotating mechanisms, a rotary beam was out of the question. In the mornings we wanted contacts ranging from the north of Scotland through the Mediterranean to South Africa, and in the evenings with stations in the Pacific, Australia and New Zealand. Obviously, it was undesirable to construct a sharp fixed beam that would lay a satisfactory signal into England but that would not be very effective to South Africa. Also, in this particular residential district elaborate aerial structures are not entirely appreciated.

After a number of sheets of scratch paper had been filled and thrown in the wastebasket, there finally evolved what appeared, to the writer, to be a simple answer to his problem. The existing folded dipole, which was 30 feet above ground and constructed of heavy antenna wire with a spacing between the upper and lower conductors of six inches, was allowed to remain as originally constructed. An additional folded dipole, identical with the first, was constructed and the two dipoles were held 8 feet and 1 inch apart by spreaders about 8 feet 4 inches long. In other words, the two folded dipoles were placed in the same horizontal plane, parallel to each other and a quarter wavelength apart at the operating frequency. Twin-Lead 300-ohm transmission lines — *A* and *B* — of identical length were connected to each folded dipole. These transmission lines were made long enough to run to the operating room in the basement. Care was taken to assure that each transmission line was dropped away from its folded dipole at right angles for a distance of at least a quarter wavelength and that the two Amphenol Twin-Leads were spaced two feet throughout wherever possible. At W4SN this spacing is held except that a spacing of approximately 9 inches exists where they enter the operating room. At a convenient point in the shack the transmission lines are brought to opposite ends of a d.p.d.t. porcelain-based switch as shown in Fig. 1. The mechanical junction or bar between the switch arms is reinsulated with high-frequency insulating material for minimum losses. A quarter-wave phasing section of 300-ohm line is connected between the ends of the d.p.d.t.

switch. Its length, *l*, equals a quarter wave at the operating frequency times the propagation factor of 0.84. From the switch arms a length of 150-ohm line is run to the antenna send-receive relay and from this point 150-ohm Twin-Lead is run, respectively, to the transmitter coupling link and to the receiver input terminals.

After construction of this antenna it was necessary to check for proper polarization. First, a signal was tuned in which appeared to be on a

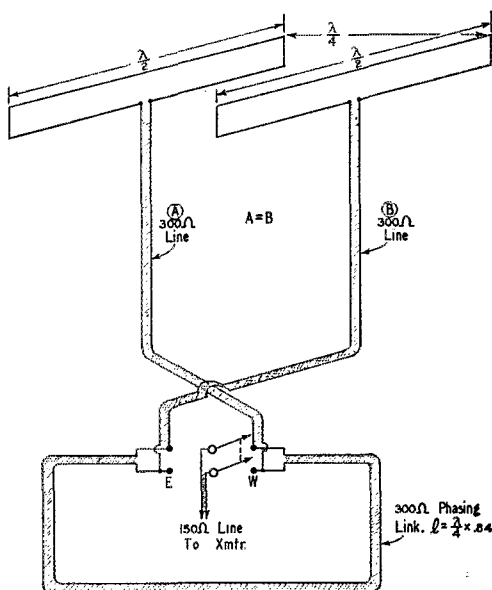

Fig. 1 — A reversible fixed beam. Two folded dipoles are mounted a quarter wavelength apart and are fed with 300-ohm line. The directivity is made reversible by a double-pole double-throw switch as shown. Forward gain is approximately 5 db., and the front-to-back ratio is approximately 20 db.

line perpendicular to the direction in which the folded dipoles were horizontally located. With the signal about S4 on the receiver as adjusted by the r.f. gain control, the d.p.d.t. switch was thrown from one position to the other to determine whether an appreciable difference in signal strength resulted from changing the switch position. The transmission-line connections of one antenna may be reversed at the d.p.d.t. switch to determine which connection produces the greatest

(Continued on page 150)



Correspondence From Members -

The Publishers of *QST* assume no responsibility for statements made herein by correspondents.

SINGLE SIDEBAND

219 South Sparks Street, State College, Pa.

Editor, *QST*:

I heartily agree with Messrs. Goodman, Villard and Nichols (January, 1948, *QST*) as to the potential advantages of single-sideband suppressed-carrier transmission for amateur communication.

However, I do not feel that the complete story has been presented. I refer to the almost total omission of any mention of the possibility of transmitting a pilot carrier reduced in amplitude below the normal carrier level by perhaps 20 db. or more. At the receiver, such a pilot carrier may be separated from the sideband, and either reinserted into the receiver detector directly or used in conjunction with automatic-frequency-control circuits to control the frequency of the receiver local oscillator.

Generation of a pilot carrier at the transmitter is not difficult, requiring only that a small, controlled amount of carrier voltage be fed around the first balanced modulator. However, use of the pilot carrier at the receiver requires equipment of special design, capable of separating the carrier from the sideband and of properly utilizing the carrier once it is isolated. In particular, isolation of the carrier represents a difficult filter problem, both because of the close proximity of the pilot carrier to the lower-frequency components of the sideband and because of its low amplitude. The filter may be a very narrow one, however, thereby facilitating achievement of the required sideband rejection.

A potential disadvantage of the pilot carrier lies in the possibility of heterodyning of the reinserted carrier with pilot carriers from other stations, producing audible beat notes in the receiver. The extent to which this occurs is to some degree a function of the excellency of filtering, but in any case it must be remembered that the pilot carriers are of low amplitude and the heterodynes will be correspondingly weak.

It is interesting to note that commercial users of single-sideband have found that agreement between reinserted carrier and the original carrier must be 5 c.p.s. or better if acceptable speech quality is to be maintained. For satisfactory transmission of music, agreement to within 2 c.p.s. or better is required. In general, commercial users have discarded a.f.c. circuits employing reactance tubes in favor of motor-tuned systems. This is a result of the requirement that a small frequency error must exist continuously in order for a reactance tube to retain control, whereas a mechanically-adjusted capacitor may be set exactly as desired and will remain at that setting until the occurrence of a frequency discrepancy sufficient to cause readjustment of the capacitor to a new setting. It should not be assumed, however, that the amateurs need necessarily follow the example of the commercials in this respect.

This letter is in no sense a criticism of the unquestionably valuable pioneering work of W6QYT and W0TQK. Neither is it a categorical statement that the pilot carrier is the way to do the job. It is rather a plea that the possibilities of the pilot carrier be investigated fully by all amateurs contemplating the use of single-sideband transmission and that we do not penalize ourselves by the use of existing receivers on a "make-do" basis when the construction of equipment specifically designed for the job may offer very great advantages.

— Raymond C. Miles, W2KBL/3

Editor, *QST*:

127 Bakerdale Road, Rochester, N. Y.

I was pleased to see a large portion of January *QST* devoted to single-sideband technique and construction. Mili-

tary and small-boat radio for communications are patterned after amateur equipment. Now is our chance to make another first for the radio amateur. Of course, commercials with their elaborate set-ups have been using this type of modulation for years, but amateurs can do lots toward developing simple but reliable equipment for single-sideband communication.

If the ARRL wants to see single-sideband take a real jump forward, just recommend to FCC that for a limited trial period, say 6 months, 25 kc. of the 75- and 20-meter bands be open exclusively to single-sideband 'phone and c.w. A portion of the c.w. bands would be ideal for this purpose. More of the boys would forego their rag-chewing and DX to build equipment to operate in this relatively QRM-free spectrum.

— Grady B. Fox, jr., W2VVC

11 South Gay Street, Baltimore 2, Md.

Editor, *QST*:

Great news on single-sideband in January *QST*!

Now, if some smart gent can figure a way to suppress the remaining sideband, and make it stick, we will have something worth while. Te-hee!

— Herb Walleze, W3BQ

O.O.T.C.

R.F.D., Epping, N. H.

Editor, *QST*:

We hope to ferret out the real old-timers, wherever they may be at present, with more than 40 years experience as hams. The membership roll to date of the OOTC (Old-Old Timers Club) is:

Present Call	Name	QTH	Old Call
WIZE	Irving	Mattapoisett, Mass.	VN
W1ANA	Roland	W. Hartford, Conn.	RB
W1TK	Wilkie	E. Hampton, Conn.	WL
W1NQ	Bert	Nottingham, N. H.	RJ
W1CQR	Artie	Feeding Hills, Mass.	FH
W1FZU	Frank	Fall River, Mass.	FHS
W1SS	Art	Arlington, Mass.	SY
W2FG	Clarence	Caldwell, N. J.	RD
W2DH	HH	Morristown, N. J.	BW
W2OUS	Erie	Red Bank, N. J.	VN
W2ENX	Lou	Auburn, N. Y.	LS
W2RBH	Lee	Mountain Lakes, N. J.	
W3CC	Charlie	Langhorne, Pa.	CW

Additional members are solicited. Qualifications necessary are that the applicant still be an active ham; that he have had some kind of wireless transmitter on the air prior to 1908; that he state with whom he had his first contact, whether Naval, commercial or other amateur station, his QTH at the time, and call letters used.

An appropriate certificate will later be issued to all members and it is planned to inaugurate an annual dinner and get-together similar to the present VWOA.

— Bert Ingalls, W1NQ, Secretary, OOTC

"REGIMENTATION"

166 North Main St., Southington, Conn.

Editor, *QST*:

No amateur in his right mind can deny the excellent job *QST* and the ARRL are doing, have done, and will continue to do to keep amateur radio as we know it.

However, all of us differ at times with any one on various (Continued on page 152)



Operating News



F. E. HANDY, WIBDI, Communications Mgr.
J. A. MOSKEY, WIJMY, Asst. Comm. Mgr.
ALBERT HAYES, WIIN, Natl. Emerg. Coördinator

GEORGE HART, WINJM, Communications Asst.
A. F. HILL, JR., WIQMI, Communications Asst.
LILLIAN M. SALTER, Communications Asst.

Using Our Bands. The success of DX, traffic-handling and rag-chewing activities — the good things that amateur radio operating has to offer — depends not only on station equipment and propagation conditions but also on such personal attributes as clean-cut efficient operating and coöperation with other amateurs. We have but one radio spectrum to use — a limited one. Standardizing operating practices expedites amateur communication and eliminates interference, which is why we have uniform voice phonetics, message procedure, special ending signals, Q code, round tables and systematic net operation.

A more uniform occupancy of *all* our frequencies, both c.w. and 'phone, may well be advantageous in improving our results. In some of our CD parties as well as in activities like the "SS" and DX Competition, the stations concerned confine activities too much to our lowest- or highest-frequency bands, or crowd the band edges or otherwise fail to operate under minimum interference conditions. The band-changing transmitter makes it possible to work on the lowest-frequency band when conditions there are best, and to utilize the 7-, 14- and 28-Mc. bands when these extend the range and are more suitable. The v.h.f.s are eminently suited for forwarding *local* traffic beyond one's local telephone zone as well as for a heavy load of rag-chewing in our larger cities. More traffic on "6" and "2" also seems called for to develop the best ability to use these frequencies well in event of local emergency! Know-how on message work should *not* be limited to those hams working only our lowest h.f. band!

The Amateur's Code reiterates those broad principles of helpfulness, tolerance and courtesy that all of us should adopt and keep constantly before us to secure maximum enjoyment from our hobby and to preserve its spirit. We have heard a great deal said about overmodulation and "splatter." There is increasing correspondence from voice operators about monitoring and tightening up on regulations — for the other fellow. At a recent meeting we heard a casual remark, "Why should I bother about my signal as long as it seems good enough?" The best answer to that: You can't expect the other chap to bother about improving his signal to help your reception unless you're willing to do the same thing for him. The need for improved practice goes equally for c.w., too.

Honest "T" reports and frank comment about chirpy or otherwise defective signals can do much to avoid FCC tickets and improve the bands for all of us. Read CD Operating Aid No. 3 and follow the exact T definitions in reporting, to get other amateurs a little more "on the ball," where necessary. When you give T5 or T7 reports they should represent exactly what they mean as to "musically-modulated" and "near-d.c.-note, smooth-ripple" signals respectively. These terms are not necessarily descriptive of signals beyond the pale! As we look at the definitions, T1 and T4 may well call for FCC notices but T5 and T9 may be merely descriptive terms, and without giving the *depth* of ripple, etc., no possible FCC citation would usually be indicated. Let's conscientiously use the whole range of our tone scale.

The formula "QSO" is definitely outdated in today's amateur radio. *Honest* reporting, supplemented by elaboration on signal conditions, can be the basis for improvement of band conditions. Help the other fellow improve his signal and retain his license through such comment.

ARL Check. Some years ago ARRL developed a list of numbered-text messages to facilitate communications. It has been pleasing to note the increasing use given this list in the recent holiday season, as well as in 1947 disasters in which amateurs helped. The complete list of *sixty numbered texts* appears on the reverse of the yellow number sheet in every ARRL Station Logbook. All such texts are identified by a number or series of numbers in the text and an ARL check in the message preamble. League members may request copies of the ARRL Numbered Radiograms by asking for CD Form 3.

Fixed-text messages are a special tool for special occasions. They make timesaving and QRM reduction possible in holiday seasons and emergency operating. It is important to send ARL in the check to identify the published list you are using so that the delivering station will not deliver a "number" instead of the words the number stands for. ARL? is the short way to ask, "Do you have the list of ARRL Numbered Radiograms, and are you ready for such a message?" ARL (reply) means, "I have the ARRL Numbered Radiogram List. I am ready for such a message." For the amateur who as yet has not included handling such a message in his amateur

experience, here is an example of use of one of the sixty texts:

NR 1 W1AW CK ARL 1 Newington Conn March 2
(Address) BT THREE BT JOHN AR

From the Logbook list we find that **THREE** stands for "Am perfectly all right. Don't worry." This *must* be written in full by the amateur delivering the above sample message to addressee or to another amateur who has no list.

New FCC Reg No Bar to ARRL Texts. FCC has just published a proposed new section to our regulations which parallels in the domestic field the international proviso that amateur communications must be sent in the clear. This prohibits use of codes and ciphers in our amateur work. The Commission makes it clear that its regulation to assist its own monitoring job is *not* intended in any way to limit our use of our customary abbreviations, published ARL-numbered texts, contest exchanges or systems by which we play checkers and chess or otherwise facilitate communications. The new regulation requires that custom or publication or availability to FCC establishes that the usage does facilitate contacts and is not employed to obscure or conceal meanings. Under the new rule ARRL Numbered Radiograms continue useful! Keep a list in your station and carry on.

Identify and Log All Transmissions. W2WGV protests the procedures of ". . . those yokels who park on the DX station's frequency and go into an act of testing without signing, test procedure consisting of running the carrier minutes at a time, then adjusting the bug to determine how many dots it will make." They *can* be spotted for FCC attention and cited, like our bootlegging brethren, for causing interference and for not identifying properly. Short tests are at times necessary, of course. Any extensive tests should be made with a dummy load, lamp bulbs serving nicely for moderate-power transmitters. Attention is invited to the fact that §12.82 of the amateur-service FCC regulations requires all operators to transmit their station calls "at the beginning and end of each transmission" as well as every ten minutes during long transmissions. The regulation provides that when there are several exchanges "with each transmission less than three minutes duration, the call of the stations need be transmitted only once every ten minutes of operation as well as at the beginning and end." This does not relieve every operator of the requirement that he identify during every transmission made on the air.

Newcomers to the ham game sometimes inquire as to whether it is necessary to log test calls and CQs. The answer is *yes*. Section 12.136 requires that "the date and time of *each* transmission" be entered. Review this section for all details that must go in the log.

Alert Observers Stop Call Bootlegger. ARRL Official Observer notifications have helped

many an amateur avoid FCC trouble! Monthly detailed reports from individual observers via SCMs inform Headquarters of the volume of useful work in progress throughout the year and enable SCMs to appraise activity, as prerequisite to their annual endorsement of OOs.

This month we have a story placing OO services to the fraternity in a new rôle. Call borrowers, beware! Vic Clark, W4KFC (ex-W4JIZ), received two observer reports on W4JIZ, this quickly leading to FCC apprehension of a call bootlegger! Vic was not exactly pleased to get reports from W4FKE and W1BKG on December 22nd. Checking with FCC he learned that W4JIZ had not been reassigned since he got his new call. Noting the possibility of illegal operation, Vic gave FCC the technical data from his observer notices. FCC alerted its system of field monitoring stations. On December 25th a station signing W4JIZ was heard on the 7-Mc. band. Cross bearings taken by FCC fixed the location of the station at a small town in Kentucky. FCC agents caught the operator "in the act" on December 28th. FCC had not spotted this station prior to the OO reports. Vic says, "Once FCC got the scent, they lost little time!"—*F.E.H.*

BRIEF

In February, 1947, the U. S. Army permitted the resumption of amateur operation in the Canal Zone, and for the first time allowed civilians to go on the air there (see page 49, April 1947 *QST*). As of late 1947, there were about 75 amateur stations authorized in KZ5, about two-thirds being operated by civilians. At present the Canal Zone is not attached to the ARRL field organization. However, it is anticipated that with the growth of amateur activity in the Zone the Board of Directors will act to attach KZ5 to one of the southern U. S. sections for field-operating purposes.

A.R.R.L. ACTIVITIES CALENDAR

Mar. 12th-15th: DX Competition (c.w.)
Mar. 17th: CP Qualifying Run
Mar. 19th-22nd: DX Competition
(phone)
Apr. 13th: CP Qualifying Run
Apr. 24th-25th: CD QSO Party
May 14th: CP Qualifying Run
May 22nd: V.H.F. Contest
June 12th-13th: ARRL Field Day
June 21st: CP Qualifying Run
July 24th-25th: CD QSO Party

— . . . —

Jan. 1st-Dec. 31st: Most-States V.H.F. Contest
First Saturday night each month: ARRL Officials Nite (Get-together for SCMs, RMs, SECs, ECs, PAMs, Hq. Staff, Directors, Alt. and Asst. Dirs.)

MEET THE SCMs

Lawrence R. Walsh, W5SMA, New Mexico SCM, adopted amateur radio as a hobby in 1937 and early in the following year succeeded in obtaining his first license with the call W8SMA.

SCM Walsh takes a keen interest in club activities and holds membership in the Los Alamos Amateur Radio Club, the Hamilton (Ohio) Radio Club, and the Twin City Radio Club, Champaign-Urbana, Illinois.

Equipment in W5SMA's shack consists of a Signal Shifter-2E26 doubler-807 buffer-doubler-p.p. 4-250As running 1-kw. input. An SX25 and converters are on hand for 50- and 28-Mc. work. Antennas include a three-element beam for 14 and 28 Mc., and rhombics for all bands. Although 14-Mc. 'phone is SMA's pet band, he also uses 3.85-, 14- and 28-Mc. 'phone.

Walsh attended Miami University and Miami University Graduate School at Oxford, Ohio, and the University of Illinois Graduate School. He holds a B.S. in education, has done graduate work in physics, and gained commercial radio experience as consulting engineer at WMOH, Hamilton, Ohio. He is currently a member of the staff of the University of California.

For recreation, when not engaged in ham work or his secondary hobby of photography, Larry swims and hikes. Football, baseball and basketball are his favorite sports.

TRAINING AIDS

Quizzes. The latest Training Aids wrinkle is a series of mimeographed quizzes on various phases of amateur radio. These quizzes are designed to test your knowledge and proficiency, and at the same time to be thought- and discussion-provoking among the members of your club. Questions are of the multiple-choice type. There are quizzes available (ten questions each) on the following subjects: (1) DX, (2) traffic handling, (3) general operating procedure, (4) ARRL organization and functions, (5) FCC regulations, (6) public relations and BCI, and (7) technical topics. There is also a 20-question general quiz covering all of the above subjects.

Who is the best traffic man in your club? Who is tops in DX know-how? How do you stack up in each category? Who is the best all-around amateur? Use of these quizzes will set up your "experts" in each category and, what is even more important, tell everyone, even the "experts" themselves, some things they didn't know about amateur operating and technique. There is an



opportunity here for a club educational program that need take only a few minutes of each meeting, and yet will do a world of good to increase the general knowledge and stir up the interest of your licensed amateur members. Write to ARRL Training Aids for further details.

COUNTRIES-LIST ADDITIONS

From time to time additions are made to the ARRL Countries List, the official standard used in connection with the Annual DX Competition and the DX Century Club. July 1947 *QST* announced the addition of the Isle of Man (GD) to the list published in the February 1947 issue. We are pleased to add three more countries: Lebanon (AR8), Pakistan and San Marino. No official prefixes have been designated for the latter two countries. Make these additions to your list and watch this department for other changes as they are made.

DX CENTURY CLUB

Next month a complete listing of all postwar DXCC members and their countries-confirmed totals will be published. It is expected that such a list will be run every three months.

More than 100 DXCC Certificates have been issued as of mid-January. Recipient of the Number 100 award was W. R. Joss, G2AJ.

DX CENTURY CLUB AWARDS

DXCC Certificates based on postwar contacts with 100-or-more countries have been made to the amateurs listed below. The countries-worked totals indicated have been certified by examination of written evidence under the award rules as published in March 1947 *QST*.

HONOR ROLL

W1FH	177	G2PL	155
W8HGWW	166	W3BES	151
G6ZO	157	W2BXA	150
W4BPD	155	W1TW	150
W3GAU	155	W1CH	150

NEW MEMBERS

W2SAI	114	W2ALO	101
W3JTC	110	W4JV	101
W6FSJ	107	W6LER	101
W6WKU	107	W6MHH	100
G2AJ	106	W6BPD	100
G3FJ	104	W6MEK	100
W6WB	103	W8CPI	100
W1BIH	103	W4FIJ	100
W2BRV	102	W6GFE	100
I1IR	101	W3CPV	100
W6SC	101		

ENDORSEMENTS

W2QKS	134	W8JIN	120
W1ADM	133	W9CKS	120
W2CYS	131	H8ECE	120
W6GHU	131	W3QD	111
W4CYU	130	W3TIF	111
W6ASG	130	W9NTA	110
NY4CM	127	W8VWV	110
W6TT	127	LA7Y	110
W8NBK	122		

RADIOTELEPHONE

W1FH	138	W2ZW	108
W1JCK	127	W1NWO	106
W4CYU	120	W2BXA	103
W1HKK	117	W9NDA	100
G2PL	112		



We proudly present Louise Baker, W9JTX, of East St. Louis, Ill. If you've handled any traffic lately, there's a good possibility that some of it has passed through her station. Louise is right in there this season pushing messages along in big batches. W9JTX holds ORS and RM appointments, is a member of the RCC and A-1 Operator Club, has a 30-w.p.m. Code Proficiency Certificate. She's a regular on the Illinois Net, QMW Net and TLAP, and is holding her own with the best of the male traffic handlers!

TRAFFIC TOPICS

W1LWH writes, "... Traffic handling, particularly in a net, is the most interesting and useful branch of amateur radio. The fundamental advantage of traffic handling is in case of emergencies, when an organized system of *experienced operators* is of the greatest utility." In addition to its training value, traffic handling is a lot of fun. If you have not experienced this pleasure in operating, start a few messages today. Newcomers in particular should give this phase of amateur radio a try. Join your section traffic net and gain experience for efficient operating in case of emergency. If you do not have the information on how to break into traffic handling, write to Headquarters.

The Eastern Mass. Net has formed a "slow-speed" net on 3745 kc. to help train new amateurs and others who feel their code speed is not up to handling regular net operation. The net meets at 6:15 P.M. EST, Monday through Friday. Interest in this project seems to be very high. It is producing "new blood" for the regular Eastern Mass. Net.

A note from the *OLZ Bulletin*, Oklahoma Traffic Net, brings up the point of punctuation marks in messages. If punctuation is required in the text, it should be spelled in full. Many old traffic men find it convenient to use the sign AA to separate parts of the address, and no other sign should be used except BT, the break sign, between address and text.

Many service messages have been noticed of late. *Address traffic correctly.* Make a careful check of all originated traffic to be sure the address is complete and correct. This little checking at the start will ease the burden on the delivering station and help insure delivery.

The Eastern Florida C.W. Net has conducted a contest for a name for the net. The results, or who won the prize, are not available at this writing. We will be interested to hear the outcome.

W2PQC, Irvington, New Jersey, advises that a net is being formed that will operate "high-speed." The boys are all using electronic keys and the average speed of the net is in the neighborhood of 40 w.p.m. All those interested in joining should contact W2PQC.

CHANGES AND ADDITIONS — DIRECTORY OF ACTIVE NETS

The directory of nets published on page 78 of November *QST* plus the supplement appearing on page 76 of the January issue and the list below provides complete information on 3.5-Mc. c.w. and 3.85-Mc. 'phone nets known to be active this season. If your net is not included in any of the listings thus far published, please drop a note to Headquarters giving your net name, times and days of operation, and frequency. Likewise, any changes from previously-announced net schedules or frequencies of operation should be forwarded. Such information will be published in a final 1947-48 supplement to appear in May *QST*.

Alberta Net	3730 7:00 P.M. MST Mon.-Fri.
Badger Emerg. Net (Wis.)	3950 6:00 P.M. CST Daily
Buckeye Net (Ohio) *	3730 7:30 P.M. EST Mon.-Fri.
Colorado Utility Net	3540 6:30 P.M. MST Mon.-Fri.
Cracker Emerg. Net ('phone)	3995 8:30 A.M. EST Sun.
Cracker Emerg. Net (c.w.)	3705 8:00 P.M. EST Wed.
Eastern Mass. (slow speed)	3745 6:15 P.M. EST Mon.-Fri.
Illinois Emerg. Net	3940 7:00 P.M. CST Tues., Thurs.
ILN (Illinois) *	3765 6:15 P.M. CST Mon.-Fri.
Kansas 'Phone Net	3920 7:30 P.M. CST Tues., Thurs.
Michigan Emerg. Net	3930 9:00 A.M. EST Sun.
New Mexico Traffic Net	3705 7:00 P.M. MST Mon.-Fri.
Missouri Traffic Net *	3755 7:30 P.M. CST Mon., Wed., Fri.
North Dakota Net	3525 7:30 P.M. CST Mon., Wed., Fri.
Ohio Emerg. Net (c.w.)	3725 8:00 P.M. EST Mon.
Slow-Speed Trunk	3545 7:00 P.M. EST Mon.-Fri.
Southern New Jersey *	3700 7:30 P.M. EST Mon., Wed., Fri.
Tall-Corn Net (Iowa) *	3560 6:45 P.M. CST Mon.-Fri.
Vermont Net	3740 7:00 P.M. EST Mon.-Fri.
Wyoming State Net	3760 8:00 P.M. MST Mon.

* Change in listing.

BRIEF

Reports reaching this office after the appearance of January *QST* praise the excellent work done in the Maine fire emergency by W1OIL as an operator for the Maine Air National Guard. FB, OM!

BRASS POUNDERS LEAGUE

(December Traffic)

Call	Orig.	Del.	Rel.	Extra Del. Credit	Total
W7WJ	37	238	1722	96	2093
W6REB	61	49	1406	22	1538
W0TQD	4	15	1432	12	1463
W7FST	119	77	643	71	910
W2TYU	7	20	750	10	787
W9EVJ	36	71	517	31	655
W5LSN	97	33	504	8	642
W9JTX	20	71	466	52	609
W2RPH	3	23	556	23	605
W8SAY	38	348	83	53	522
VE3ATR	211	165	122	22	520
W5NOC	511	3	0	3	517
W3ECP	34	64	357	60	515
W4PL	4	17	476	14	511

The following make the BPL with over 100 "deliveries plus extra delivery credits":

W9SYZ 226	W8SCW 133	W1INF 115
W6WNI 164	VE3XO 125	W9LQP 114
W8NOH 155	W2RTZ 124	W5KTE 106
W9RCB 138	W6IOX 124	

A message total of 500 or more, or 100 "deliveries plus extra delivery credits," will put you in line for a place in the BPL. The Brass Pounders League listing is open to all operators who qualify for this monthly "honor roll."

FMT RESULTS

Twice each year ARRL conducts a special competitive Frequency Measuring Test open to Official Observer appointees and other amateurs. Awards are made for the best measurements submitted, one to the leading OO and another to the top non-OO ARRL-member entrant. In the second 1947 test, 99 entrants reported measurements; of these, 40 were official observers and 59 non-OOs. Each participant received an individual report comparing the accuracy of his measurements with those of a commercial frequency-measuring laboratory.

Frequencies used in the September 19th-20th test were as follows:

3559.149	3606.352
7157.150	7280.803
14106.298	14377.569
28035.010	28114.210

Leader in the observer group was L. W. Franklin, W2BF, whose three measurements showed

W4BAZ (ex-W9BAZ) has been a mainstay in the ARRL traffic system for many years. Operator J. B. Wathen III is manager of Trunk Line J and chief RM of Kentucky. To the left of his operating position is a cabinet housing an RME-69, DM-36 and DB-20. The center cabinet contains a VFO and switches for controlling all equipment. At the right is the speech equipment and a modulation monitor. Two transmitters, one running p.p. T-150s and the other p.p. T-200s final, can be used at 1 kw., but input normally is kept at 300 to 400 watts. The antenna is a 132-foot Zepp strung between an 83-foot wooden tower and a 100-foot steel job!

March 1948

an average accuracy of 1.79 parts/million. W2BF was also high OO in the first 1947 FMT, held in January. Best measurement among the non-OOs was submitted by George W. Ewing, W6GM: 1.70 parts/million in three measurements. Each of these leaders has received as a prize an electric clock capable of controlling the on and off switching of any 115-volt a.c.-powered equipment.

The standings of other FMT leaders are given below. In accordance with the announced rules, no entry covering a single measurement was considered eligible for the prize competition. Except where indicated, entries consisted of two or more measurements.

LEADERS

Observers	Parts/ Million	Non-Observers	Parts/ Million
W2BF	1.79	W6GM	1.70
W1OJM	2.70	W2MRG	2.26
W9CIH	3.91	W3GEX	2.40
W9HQH	6.19	W1VDY	3.54
W1ETC	7.18	W7IM	4.49
W2ALH	8.98	W1UMU	4.89
W3VNE	9.46	W3HTK	5.26
W61WU	11.29	W2EB	5.31
VE6HM	14.03	W2ITO	6.17
W1AJQ	18.43	W3IGY	7.27
W3JDM	21.38	W0HYR	8.79
W6YYW	24.84	W6EY	10.12
W9DHT	26.64	W7JFS	10.26
W7IWU	30.44	W5LRD	11.03
W7CT	34.40	W7DAD	15.31
W8JRG	34.83	W3KWF	17.42
W9KA	40.49	W0NLA	19.20
W1PIA	43.55	VE3AIU	20.92
W6FMJ	44.05	W8TNE	22.04
W3AER	49.58	W0FUB	22.87

The following ratings are based on a single measurement: OOs—W3SHY 14.32 p/m, W5MC 27.80, W1BKG 29.49, W6ZF 30.89, W2BEI 42.41. Non-OOs—W9NUF 0.56 p/m, W1LQQ 1.68, W7RFE 8.22, W1APK, W2AIQ 15.16.

BRIEF

Thought for the ARRL DX Contest:

If you should go by VFO
To work another land,
Just crank it in, and don't begin
Till you're within the band!

Thanks to YLRL Harmonics.

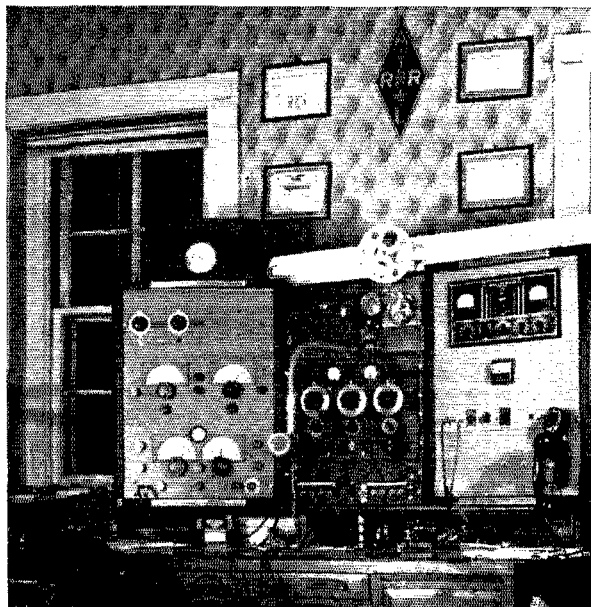

PRIZE-ARTICLE CONTEST

*The article by Everett L. Battey, W4IA, wins a prize in the CD Article Contest.

You are invited to submit entries in this contest. The author of each article used is awarded a \$10 prize, consisting of \$5 in U. S. Savings Stamps and \$5 in ARRL supplies or publications (except *QST*). Contributions may be on any subject of interest to amateur radio operators. Articles are selected on originality and value to the fraternity.

(Give this contest a try. You may wish to write on Emergency Corps planning work and drills; phone or c.w. operating procedures; work on radio-club committees; organizing or running a club; the most interesting band for you; code-proficiency techniques; DX activities; traffic work; getting the most out of ham radio; or some subject we haven't mentioned. You are not limited; make your contribution on any topic of interest to radio amateurs. Please mark your contribution "For the CD Contest.")

BREAK-IN CQs

By Everett L. Battey,* W4IA

This article describes an operating technique that deserves the study of all brasspounders. It introduces an advanced method of calling CQ. Several operators have tested the procedure and find that it has interesting possibilities, if more widely used and understood.

The principal requirement is a good break-in system. Break-in is the foundation of the technique.

Calling

Here is how the "Break-In CQ" works. Assuming you are set up so that you can hear incoming signals when your key is up, proceed to call CQ in the normal manner. At the conclusion of the first series of CQs, after you sign your call, insert the signal "BK." However, do not stop sending at this point; instead, start sending another CQ series, and *at the same time* tune your receiver for answers. Transmit "BK" at the end of each CQ series. Stop sending only when you hear an answer. That is the break-in CQ.

It may be difficult at first to listen and transmit simultaneously. In practice, however, you will find that you will pause momentarily in your sending when you hear a signal. This pause will be negligible since the operators answering you usually will send either "BK" or your own call letters, and you will quickly recognize the response.

Sign your call at frequent intervals. This is definitely advantageous when using this method since you will be answered the first moment your prospective correspondent hears you send "BK." Just one word of caution — there is a tendency to continue the routine until someone actually breaks in to answer you. Principally because the system is not yet widely understood, you will

* 2008 North Cleveland Street, Arlington, Virginia.

find that if you don't hear a reply in a very short time, you won't get a reply until you close down and tune in the old established manner. In using the new procedure, it has been found that two minutes is usually long enough to call before closing down. Presented graphically, the break-in CQ might look like this:

CQ CQ CQ DE W6XYZ W6XYZ W6XYZ BK
(Start tuning for replies)

CQ CQ CQ DE W6XYZ W6XYZ W6XYZ BK
(Continue tuning)

CQ CQ CQ DE W6XYZ W6XYZ W6XYZ
(Conclude) K

Transmission continues until the final K, unless a reply is received beforehand. The series will stop normally upon receipt of a reply. Two minutes is suggested as a maximum period of calling and tuning before concluding with K.

It is obvious that this procedure should reduce CQ time, since the first station to hear you will call as soon as you send "BK." He does not have to wait for you to finish your complete series. It saves your time and his, as well as the time of many who might have called upon hearing you later in your series. You may say this system will prevent you from selecting a contact from several answering stations. That is true to a degree, but when you call a nondirectional CQ you indicate that you will work anyone. If you want to *pick* your contacts, use a directional CQ, or don't CQ at all.

Under normal operating conditions, the break-in CQ has been found simple and effective. However, it must be mentioned that there are certain cases in which the system is difficult to use. These may be summarized as follows: (1) when background noise is so high that only the strongest signals may be heard; (2) when interference, static, or external noises are unusually heavy; (3) when the break-in system used does not permit hearing signals immediately upon lifting the key.

Answering

It has been found that some operators in answering break-in CQs send a series of "BK BK BK" until they are heard. Others send the call letters of the CQer. "BK" is much easier to identify quickly and it is believed to be the preferable method of answering. It is desirable, however, that further research be conducted on this point. Is it better to answer by sending "BK" or by sending the call letters of the CQer? Or, do we need a new, easily identified signal for attracting the attention of the CQer?

In answering, your transmitter should be tuned a bit off the frequency of the CQer. This not only avoids interfering with his transmissions, but more important, makes it easier for him to tune you in.

To date, the break-in CQ has been used by

only a limited number of operators. It is worthy of a more widespread workout to determine its practicability for general amateur use. It should be a "natural" in this day of break-in operating. Give it a try.

BRIEFS

The Manchester Radio Club (Conn.) requested the call of the late Bill Matchett, W1KKS, former operator at W1AW, for its new club station. FCC granted the request and the next time you hear W1KKS on the air it will be operated by BM's home-town amateur friends who have chosen to perpetuate his memory in this very fitting manner.

One evening W0VHR CQed on 28 Mc. He was answered by and worked VE3BDY. Upon completion of the contact VHR tuned over the band and heard W3BDY calling. Upon being worked the W3 advised that he had called in answer to the CQ and stood by at the same instant that VHR threw his carrier on in reply to Canadian 3BDY!

CODE PROFICIENCY AWARDS

The next Code Proficiency Qualifying Run will be made on March 17th at 10:00 P.M. EST. Identical automatically-transmitted texts will be sent simultaneously from Headquarters Station W1AW and W0CO. W0CO will transmit on 3534, 7053 and 14,040 kc. W1AW will use the frequencies listed in the schedule elsewhere on this page. Either station may be copied. Send your copies of the run to ARRL for grading, indicating whether you utilized the transmissions of W1AW or W0CO. If you qualify at one of the five speeds transmitted, 15 through 35 w.p.m., you will receive a Code Proficiency Certificate. If your initial qualification is for a speed below 35 w.p.m., you may try later for endorsement stickers indicating progress above the first certified speed.

Code-practice transmissions are made from W1AW each evening, Monday through Friday, at 10:00 P.M. EST. Take advantage of these transmissions to increase your proficiency. References to texts used on several of the practice transmissions are given below. These make it possible to check your copy.

Date	Subject of Practice Text from January QST:
Mar. 3:	<i>What Is Single-Sideband Telephony?</i> , p. 13
Mar. 5:	<i>Single-Sideband Operating Tests</i> , p. 16
Mar. 9:	<i>A Single-Sideband Transmitter for Amateur Operation</i> , p. 19
Mar. 11:	<i>Any DX Today?</i> , p. 25
Mar. 15:	<i>An Easily-Adjusted VFO</i> , p. 32
Mar. 17:	Qualifying run, 10:00 P.M. EST
Mar. 19:	<i>Technical Topics</i> , p. 40
Mar. 23:	<i>Parallel Standing Waves</i> , p. 45
Mar. 25:	<i>New England Amateurs Aid in Forest-Fire Emergency</i> , p. 54
Mar. 29:	<i>The World Above 50 Mc.</i> , p. 57

W1AW OPERATING SCHEDULE

Operating-Visiting Hours

Monday through Friday, 8:30 A.M.-1:00 A.M.
 Saturday, 7:00 P.M.-2:30 A.M.
 Sunday, 3:00 P.M.-9:00 P.M.

A mimeographed local map showing how to get from main state highways (or from Hq. office) to W1AW will be sent to amateurs advising their intention to visit the station.

Official ARRL Bulletins containing latest information on matters of general amateur interest are transmitted on regular schedules:

Frequencies: 3555, 7215, 14,150, 28,060 and 52,000 kc. (voice — 3950, 14,280, 52,000, 146,000 kc.)
Times: Monday through Friday, 8:00 and 11:30 P.M. EST (0100 and 0430 GCT, Tuesday through Saturday)
 Sunday 1:00 A.M. and 8:00 P.M. EST (0600 Sun. and 0100 Mon., GCT)

Bulletins are sent simultaneously, first at 25 w.p.m. and then repeated at 15 w.p.m., on all frequencies during the early schedule to facilitate code practice. Telegraph bulletins are followed, in turn, by voice transmissions on 3950 kc. and 52,000 kc. simultaneously, and then on 14,280 and 146,000 kc. simultaneously. Any changes from this schedule will be announced.

Code Proficiency Program: Practice transmissions at 15, 20, 25, 30 and 35 w.p.m. are made Tuesday and Thursday on the above-listed frequencies, starting at 10:00 P.M. EST, and on Monday, Wednesday and Friday at 9, 12, 18, 25 and 35 w.p.m. Approximately ten minutes practice is given at each speed. Next certificate qualification run is scheduled for Wednesday, March 17th.

General Operation: W1AW engages in two-way work with amateurs, as follows:

Monday through Friday, all times EST —

11:00 A.M.-11:30 A.M.	28,060-kc. c.w.
11:30 A.M.-12 noon	29,150-kc. voice
3:00 P.M.-3:30 P.M.	14,280-kc. voice
3:30 P.M.-4:00 P.M.	14,150-kc. c.w.
5:30 P.M.-6:00 P.M.	3850-4000-kc. voice
6:00 P.M.-6:30 P.M.	7215-kc. c.w.
7:30 P.M.-8:00 P.M.*	3555/7215-kc. c.w.
9:30 P.M.-10:00 P.M.	3555-kc. c.w.
12:15 A.M.-1:00 A.M. (Tues. through Sat.)	7215-kc. c.w.

* Traffic schedules are kept during this period.

Saturday and Sunday (excepting dates of official ARRL activities).

Saturday: Midnight-1:00 A.M. (Sun.)	3555-kc. c.w.
Sunday: 1:45 A.M.-2:30 A.M.	7215-kc. c.w.
6:00 P.M.-7:00 P.M.	3850-4000-kc. voice
7:00 P.M.-8:00 P.M.	7215-kc. c.w.

BRIEF

Wanted: W1AW Attendant. An amateur with ARRL-organization background, good construction and maintenance technique, and ability to set good procedure example when on the air, is invited to apply to permit us to start a new project and extend our summer visiting hours. If available and interested, state your past ARRL appointments and radio experience, in writing for details.

• All operating amateurs are invited to report to the SCM on the first of each month, covering station activities for the preceding month. Radio Club news is also desired by SCMs for inclusion in these columns. The addresses of all SCMs will be found on page 6.

ATLANTIC DIVISION

EASTERN PENNSYLVANIA — SCM, Jerry Mathis, W3BES — KZ won his Class A ticket and is on 14-Mc. n.f.m. VMF has the section's highest postwar traffic total. KMS has a new 14-Mc. two-element rotary beam and a kw. His 2½-inch drive pipe into the attic has adequate drainage unlike that of HBV reported last month. OO CAU says that propagation conditions during the last Frequency Measuring Test were such that he could not hear 1AW on any band and WVW was impossible to beat. AQN has been an ARRL member and has held the same call for 22 years; also he has been ORS for 17 years. He has turned the York Amateur Emergency Net over to the local radio club. HCT schedules the E. Pa. Net daily. OK worked five European countries on 3.5 Mc. DZ worked the West Coast on 3.5 Mc. with a 47-foot wire against ground. The Beacon Radio Amateurs are active again. New officers are FLY, pres.; and ATE, secy.-treas. DYL has a new QTH in Castor Gardens. Congratulations to ETA on his new jr. operator. EU is having a bad time keeping his surplus transmitter on frequency. He says it rolls like a P.T. boat. 2RTZ urgently requests a schedule for traffic into Valley Forge General Hospital. The E. Pa. Net is adding Saturday night at 6:30 to its operating schedule. It has tie-ins with the NNJ, NYS, NY-LI, WPA, and Wash., D. C., Nets. LCK is on 144 Mc. with a 522. WTS pinch-hits for OML as NCS on the E. Pa. Net. NWM is the call of the new Philadelphia Signal Corps Radio Club, located at 2800 S. 20th St., Philadelphia. They have 64 members and a pile of gear, including two BC-610s, two Super Pros, two Fanadaptors, SCR-211, Dumont 224 'scope, three BC-342 receivers and many other pieces of Army radio equipment. John L. Reinartz, RB, gave a talk on simplified 144-Mc. crystal-control, using 2E26s, DHM, GQK, FUF, KT, ANK, IXN, GYV, BXE, GHD, and BES are on 50 Mc. regularly. EKK designed and helped construct a three-element vertical colinear 144-Mc. antenna for BES which slays 'em. 144 Mc. is a new experience for RES. Traffic: W3VMF 208, ELI 139, QEW 124, OML 43, EU 39, AQN 19, HCT 17, DZ 13, KMS 6, OK 5, NNV 3, CAU 2.

MARYLAND-DELAWARE-D. C. — SCM, Eppa W. Darne, W3BWT — The second December meeting of the Washington Radio Club featured a very interesting lecture on "Printed Circuits" by Dr. Brunetti of the National Bureau of Standards. The third December meeting of the club was in the form of a Christmas Party, with about one hundred in attendance from the Washington area and Baltimore. The Delaware Amateur Radio Club officers at present are: DPA, pres.; KET, vice-pres.; MAQ, secy.; GL, treas. The Club publishes a fine bulletin with MZQ as editor and DPA as publisher. The January 6th meeting featured lantern slides and a talk, "Your Headquarters Station (WLAW)." The Capitol Suburban Radio Club held a farewell party Dec. 29th for KJF, who left for his new post in Los Angeles. The SCM would like to have a complete file of all clubs in the section, names and calls of officers, and meeting places. If you have not already done so, send in the information. This office receives many requests for data on active clubs in the different areas. A number want to join their nearest active ham organization. Write your SCM also of your club and individual activities so we may make mention of them in this column. WN and the Frederick, Md., Emergency Corps have their net on 28 Mc. MCG is on 3.5 and 7 Mc. DRD is arranging another separate trans-

mitter for 3.5-Mc. work. AQV operates mostly on 3.9-Mc. 'phone, but keeps his fist in shape using 14-Mc. c.w. MCD works nice DX on 3.5-Mc. c.w. using 45 watts. 2NDL/3 is new ORS recently transferred from New Jersey. Joe also has been appointed RM for the Annapolis area and is NCS for the section net. ECP made BPL both ways this month. EFZ brings his total countries worked up to 60. ISF is building a "Hi Fi" amplifier for his classical record collection. He also was heard in Scotland. DPA has a Super Pro and a Collins 75-A receiver, several large rack transmitters, a four-element 28-Mc. and a three-element 14-Mc. beam. We understand Jack's attic is a virtual ham paradise, even to shop facilities. BBP is operating on 144 Mc. FDK is on 144 and 28 Mc. MOP received a penguin as a QSL card from the South Polar region. JDP, MZQ, and FDK get out well on 144 Mc. DRD and DPA get out well on 14 Mc. GZH, DQZ, and NNK have worked some nice DX on 7 Mc. GAU worked a ZL on 3.5 Mc. NUP is active on 28 Mc. MHW got his television kit set to work on the first try. LTR is recovering from an appendix operation. MJZ is at school in Kansas City. 5LFI/3 is stationed at Fort Bliss, Texas. FMC is active on 28 Mc. HBK is back on 28 Mc. NL reports the Chess Club has resumed activity on 28 Mc. MNA now is 4DBG, at Auburn, Ala. MO has been doing considerable traveling of late but will soon be back regularly with the gang. DK is building a new rig. CJT gets out well on 3.5, 7, and 14 Mc. using c.w. and an indoor antenna. KH6EG, ex-W3CGK, now is associated with the technical information department of the Naval Research Laboratory in Washington, and expects to apply for a W3 call soon. Traffic: W3ECP 515, W2NDL/3 253, AKB 91, MJQ 82, BWT 80, QL 47, AKR 18, PV 14, EFZ 11, EIS 6, DRD 4, MCD 2.

SOUTHERN NEW JERSEY — SCM, G. W. (Bill) Tunnell, W2OXX — Congratulations to RPH for making the first postwar BPL. ZI will tie in with the E. Pa. Net. RG announces that 7:30 p.m., Monday, Wednesday, and Friday is the new drill time for the 3700-kc. net, resulting from a vote of the membership. ORS seeks emergency activity. PCF resigned all appointments because he is working away from home. AKI reports that FUN and QHM recently became fathers. PAX now is on 3.5-Mc. c.w. from Gibbstown. OQN was recently elected president of the SJ RA. AEW is organizing a Camden County Net on 3.85-Mc. 'phone for the low-powered rag chewers at noon on Sundays. BEI has a list of locals heard by G6BY on 3.85 Mc. Yours truly has been active on 'phone lately. BDI has converted an SCR-522 for 27 Mc. SAK sold his receiver. SUG has been marooned because of the snow storms. GFB is working on a VFO plus a new break-in system. BAY is on 50 Mc. and desires more local competition. EH has a damaged beam and 300 watts on 144 Mc. ZAE, ex-8ZAE, now is located in Audubon with a potent 3.5-Mc. signal. PAZ is active on 7 Mc. with a surplus rig. SAI soon may try his luck with an airborne rig. PWP is rigging up a new kilowatt final, which makes one on each band now. Traffic: W2RPH 605, ZI 107, SUG 41, RG 20, QUH 19, 3NF/2 17, ORS 13, CFB 9, BAY 2.

WESTERN NEW YORK — SCM, Harding A. Clark, W2PGT — SEC: SJV. In this first report I want to say thanks for the congratulations and request your continued support. The Binghamton Amateur Radio Club has reorganized with 60 members. Officers are: JOJ, pres.; QXX, vice-pres.; OW, secy. The Binghamton, Elmira, Sidney, and Seranton, Pa., clubs held a joint meeting at which time schedules were arranged for 144 Mc. The Niagara Falls Radio Club has erected a new 50-ft. tower. KBT Club officers are: QHF, pres.; UHI, vice-pres.; SZK, secy.; and TAO, treas. New ECs are: KHO, Niagara Co.; SZK, Erie Co.; QH, Broome Co.; RUK, Cayuga Co.; WU, Cortland Co.; BDK, Fulton Co.; RXW, Madison Co.; RDZ, Orleans Co.; PJV, Tioga Co.; and TIY, Sullivan Co. JPE has BC-610. AW is heading for DXCC with new beam. HFJ is back on with a kw. after several years' absence. UFI is busy tuning dual beam for 14 and 28 Mc. QHH, using 12 watts input, is looking for an Asian to complete WAC on 3.5 Mc. FMH

(Continued on page 84)

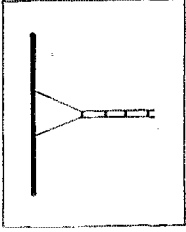

A FEW PAGES ago we mentioned a case in which a decibel is not a decibel. On this page we have a similar story in which a dipole is not a dipole.

At first glance one would think a dipole is a dipole at all times. We would like to show at least one case in which dipoles are different.

One of the first questions that often arises in one's mind is how effective a dipole is on one frequency as compared to a dipole on another frequency. Free space considerations give some insight into the problem.

Picture a transmitting antenna, which is out in space and radiating equally in all directions, as being at the center of a huge sphere. Due to the uniform radiation, the same amount of power must be transmitted to each unit of surface area of the sphere. If broadside half wave elements are used on the surface of the sphere to intercept or receive the power, they should be spaced side by side with a half wavelength spacing. Each half wave element in a sense, therefore, covers an area one-half wavelength on a side and each element intercepts the same amount of power as every other element. A two element antenna with the two elements widely separated on the surface of the sphere, but properly phased and matched to the load would, therefore, intercept twice as much power as a dipole and provide a gain of 3 decibels. Similarly, 4 half wave elements so used give 6 db gain and 8 elements give 9db gain and 16 elements give 12 db gain over a dipole.

Incidentally, power is the important consideration here because even though we want microvolts on the grid of the RF receiving tube, the microvolts are greatest when the power put into the Receiver input impedance is greatest.

When two dipoles are placed close together as in a double Zepp the gain is found in practice to be nearer 2 db instead of 3 db, which fact can be attributed to the proximity of the two elements. The extended double Zepp can be thought of as separating the dipoles, yet maintaining the proper phasing and matching the load; in this case the gain more nearly approaches the theoretical 3 db. In all actual arrays this proximity effect changes the 3 db figure so that each time the number of elements is doubled the theoretical gains are changed somewhat.

The same concept of antenna area can be used to predict the effectiveness of antennas on two different frequencies. For example, if the two frequencies are 100 and 200 Mc., the 100 Mc. antenna will be twice as long and correspond to an area 4 times as large as the 200 Mc. antenna. The 200 Mc. dipole will be 6 db poorer than the 100 Mc. dipole. Here we see a dipole is not equivalent to a dipole on a different frequency. (At very high frequencies this is true only for short distance transmission in which approximate free space conditions are obtained; for signals near the horizon dipoles on different frequencies may be nearly equivalent because propagation improves as the frequency is raised.) A 4 element 200 Mc. antenna having the same area as a 100 Mc. dipole will be needed for equivalent received power over short distances. It is of interest to note that if a 4 element 6 db gain beam is used at the 200 Mc. transmitter and also at the receiver, the 200 Mc. system will then be 6 db better than the 100 Mc. system using dipoles at each end for short distance work.

— RALPH HAWKINS, W1OEX



has new HT-18. RZP is interested in AEC work on 3.5 Mc. The Niagara Frontier Emergency Net holds drills each Tues. at 7 P.M. on 144.1 Mc. A number of EC, ORS, and OPS appointments have expired and should be forwarded to me for endorsement. The NYS Net has changed its name to New York State Traffic and Emergency Net. Active stations are AOR, BLO, FCG, GWY, PGT, PZC, PZJ, QZI, RAE, RUF, RYJ, VIQ, and WOE. ITX, NAI, PGT, EQD, and RUF are NCS respectively Monday through Friday. The net is looking for additional members, particularly in the northern and southern parts of the section, and meets each evening at 7 P.M. on 3720 kc. Emergency drills are held each Friday at 8 P.M. under the direction of EQD. I would appreciate all appointees forwarding their reports the first of each month either by NYST&E Net or by mail. Traffic: (Oct.) W2PGT 158, GWY 151, RUF 60, AOR 46, BLO 38, PZC 23, VIQ 20, RYJ 18, QZI 14, WOE 8. (Nov.) W2PGT 228, RUF 73, GWY 33, AOR 28, PZC 21, BLO 19, VIQ 16, FCG 12, SZK 5. (Dec.) W2PGT 319, RUF 193, BLO 70, VIQ 69, WOE 60, FCG 50, GWY 30, WFU 28, SZK 23, AOR 22, PZC 16, UYG 15.

WESTERN PENNSYLVANIA — SCM, Ernest J. Hlinsky, W3KWL — From up Erie way TFX reports that the RAE has scheduled 1BUOD of Headquarters to speak on ARRL affairs and Atlantic City Conference. KKT says Santa remembered him with a NC-173. KQB got a Sonar f.m. exciter. VIII got an HRO-7. NYU is a new ham in Erie. LTQ and MMI are experimenting with 420-Mc. gear. LJJ says his QSO on 28 Mc. with J2FOX Christmas Eve was a real treat. Anyone know where KRC is hiding? Down Pittsburgh way our two efficient Official Observers, AER and VNE, are doing a fine job. The ATA Christmas Party was well attended by 181. These boys collected \$40.20 for the Crippled Children's Fund. BHN won top prize. KSP announces he has discontinued code practice on 28 Mc. SHG has 106 DX stations with 60 confirmations on 28 Mc. YDJ, GJY, LIW, MJK, KKA, and NUG can be heard on WPA ORS Net. (Your SCM hasn't heard so much activity from the Pittsburgh area in 20 years.) AER had an accuracy of 49 parts in a million in ARRL Frequency Measuring Test. AAX worked all states on 28-Mc. mobile. UVD is the Wesco Amateur Radio Society ace reporter. MKH gave an interesting talk to the above club. UST and KRL spoke on PARCC merits, hoping to have this society join the PARCC. NJH wants a Collins VFO. FHH and LEJ are getting a 459-A. OIW and TTN can be heard on 28 Mc. KCU has the whole house plastered with DX QSLs. UVD is sporting a new bug. Your SCM apologizes for mentioning the Wesco Society as the Wesco Amateur Radio Society of Greensburg. It should have been Greensburg and surrounding cities. RAT has recovered from recent illness. New W. Pa. ORS appointees are NUG, LIW, and KKA. And speaking of ORS, our NCS, TOJ, reports that during December there were 20 net sessions, with an average of 7.04 stations reporting per session, and 12.2 messages, handled per evening, with a total of 244 messages handled. May I thank all who have cooperated and participated in making this column an enjoyable one. Traffic: W3KWL 462, TOJ 239, KKA 72, NUG 49, NCJ 47, PY 45, LOD 23, AER 22, YDJ 22, RAT 16 LQQ 5, MJK 4.

CENTRAL DIVISION

ILLINOIS — SCM, Wesley E. Marriner, W9AND — Chief RM; EVJ, RM; SKL, PAM; UQT, Networks: "ILN" 3785 kc., "IEN" 3940 kc. Please check your official appointments to see if they need endorsement, RM JTX has canceled her appointment for the present and will take a vacation while visiting her folks. The North Suburban Radio Club now is affiliated with ARRL. BON has given up 50 Mc. and is back on 3.85 and 14 Mc. NDA received 'phone DXCC No. 8. BUK has been working 'em with his 22-watt exciter. WDD has been on 7 Mc. mostly. He uses a BC-459A for VFO for an 813. His 7-Mc. DX is CO2YK. SKL has been struggling with bugs in 274N rig. He has new 50-Mc. five-element beam. The Tower Radio Club of Wheaton College elected IHT, pres.; Paul Nilson, vice-pres.; and Bob Smith, secy.-treas. Its call is ZXR. FHN, ex-president of the club, was killed on Aug. 30th when the plane in which he was flying crashed into the WAIT antenna tower. YPS is NCS for Knox County Emergency Net. Univ. of Illinois Branch at Galesburg soon will have its call operating on all bands. NCS of the College Net, 7105 kc., is 0EUY. KSQ sent in the above information on the net. The Starved Rock Radio Club net, 3785 kc., meets Tuesdays and Fridays

at 9 P.M. ZEN is NCS. BIN is alternate. The Park River Radio Club class meets 7:30 P.M. each Monday. Classes are open to everyone. TAL is using n.f.m. on 3.85 and 14 Mc. with new HT-18 unit. He heard seven countries in Europe Dec. 23th on 3500-3510 kc. CBZ has trouble with rig. EQJ has a new VFO. CKM, the "racehorse man," is on the air now and then. QBH was kept off the air because antenna was down. EBX is working seven days a week on a six-day-a-week job. WEA is a member of A-1 Operator Club. NN, of WGN, sends a nice letter. ASN now is RCC member and schedules LOA weekly. FKI now has 450-Mc. gear in operation. Trunk Line "L" now operates coast to coast. TZQ lost his 7-Mc. dipole New Year's Eve. Slect brought down the two masts at ZEN. He built a 1500-volt, 300-mill power supply and will be on 'phone soon with ½ kw. KOK worked UR2KAA for country No. 145 and has a new HRO-7 receiver. KA is planning rig with pair of 4E27s in the final at 400 watts. KA, with 60 watts, worked 59 countries in WAC during 1947. ACU has new home-built VFO, ganged tuning, output on 3.5 and 7 Mc. He recommends CPI for ORS. SES is interested in ARRL appointments. TAL has 53 countries postwar. SYZ and LQP are working on a c.w. rig at CQY, the "Voice of River Park" in Chicago. EVJ received A-1 Operator and Trunk Line Certificates. Net controls of "ILN" now are EOP, SKL, SYZ, KQL, and FKI. EVJ, LQP, SYZ, and JTX of the traffic gang are now big leaguers, all four having made the Brass Founders League this month, both on total traffic and deliveries. I want to thank all who operated in the emergency for their splendid work and cooperation. AWA is proud papa of a new jr. operator. ERU recovered equipment which was stolen from his store. GNU is rebuilding the whole station. HNE, back on the air after 7 years, is using B-19 surplus rig on 3.5- and 7-Mc. c.w. He also has a 235-Mc. rig, and wishes to contact and schedule hams on this band or 230 Mc. Traffic: W9EVJ 655, JTX 609, SYZ 274, LQP 152, SKL 32, ZEN 30, YTV 24, FKI 20, NIU 7, BON 6, CKM 6, EBX 1, TAL 4, TZQ 3, ZXR 1.

INDIANA — SCM, Ted K. Clifton, W9SWH — SEC: WNM, QIN, 3656 kc., and INP, 3905 kc. All EC renewals and appointments will be made by the SEC, H. E. McClellan, WNM, Evansville. UGH, of Franklin, is the new PAM for the Southern Indiana 'Phone Net. He will act as NCS for the net south of U. S. 40. BKJ will remain as NCS of the Northern Net. On Jan. 1st Northern Indiana suffered from a severe ice and sleet storm. During the entire emergency both the QIN and INP alerted and handled traffic for the public services. In the Fort Wayne area the EC, UDD, used a local 29-Mc. net for the county. It was very gratifying to observe that a number of stations in Indiana checked in for the first time in one of the nets. When a new emergency set-up was made by the ECs either 3656 or 3905 kc. was used. New officers of the Michiana Amateur Radio Club are SIQ, pres.; YWE, vice-pres.; LVS, secy.; and DMH, treas. While attending the TARS Christmas Party at Evansville I had the honor of presenting the ARRL Affiliated Club Charter to that club. The following night I attended the Indianapolis Club meeting. FMJ and SWH drove 25 m.p.h. to FEI's, at Angola, to attend the Northeastern Indiana Radio Club Christmas Party. DHJ is starting his 26th year in the game. On Dec. 14th a number of Indiana Club representatives met in Indianapolis and elected the following "Indiana Radio Club Council" officers: MVZ, chairman; FMJ, vice-chairman; DNQ, secy.; DOK, treas. The number one item on their list is a State hamfest or picnic in 1948. 0CWY/9, at Evansville, is a new ham from Des Moines. JBQ of Seymour, is back after 6 years. Thanks for the many cards received during the holidays. One came from IMQ. Bill Jubre the cartoonist, who draws "The Orbits" strip in a number of daily and Sunday papers. AB heard a PA and a G on 3.5 Mc. Dec. 29th. Activity on the Highs will be at a new low in the northern part of the State as a result of the sleet storm. Traffic: W9RCB 438, FSG 199, DGA 51, BKJ 41, NH 31, PMT 30, DHJ 29, TT 22, YDA 11, KTX 10, SNQ 6, JBQ 4, LPQ 4, QLW 4, SWH 4.

WISCONSIN — SCM, Reno W. Goetsch, W9RQM — Wisconsin C.W. Net meets on 3775 kc. 6:30 P.M., Mon. through Fri. Badger Emergency Net ('phone) meets on 3950 kc., 6 P.M. daily. ESJ now is OPS. YCV operated portable at La Crosse during holidays. RCY has been working DX on 28 Mc. with 15 watts to three-element rotary. YMY is heading for the Pacific again. KTP is pounding brass again. QO report from CIH discloses 12 off-frequency

(Continued on page 86)

there IS a difference.

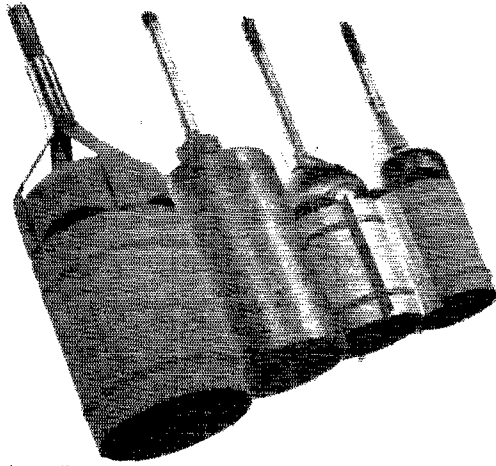

PYROVAC the new Eimac plate material makes a better vacuum tube anode . . . on all counts.

1 LIFE . . . Tubes with tantalum plates formerly giving 3000 hours of service, now, with Pyrovac plates operate in excess of 15,000 hours . . . a 400 percent increase.

2 OVERLOADS . . . With Pyrovac plate, 65 watt tubes have dissipated 900 watts—a 1280 percent momentary overload—without indication that the eventual life of the tubes or their characteristics were affected. In normal service these tubes are still going strong. Excessive plate dissipation due to tuning procedure and circuit failure normally won't mean the loss of your tube.

3 MECHANICAL CHARACTERISTICS . . . Pyrovac is easily welded, enabling rugged shock-resistant mounting. It is a "black body" radiator and possesses excellent characteristics as an electrical conductor.

4 COSTS . . . Pyrovac plates in Eimac tubes cost you no more, yet since they enable longer life you actually get more for your vacuum-tube-dollar.

5 PROVEN IN SERVICE . . . Pyrovac is the result of millions of hours of life tests. The universal acceptance of the 4-125A and the 4-250A in all fields of electronic endeavor can, in part, be attributed to Pyrovac for contributing overload resistance, life, and a general ability to "take it."

THESE ARE THE TUBES WITH PYROVAC PLATES

EIMAC TUBE TYPES	PLATE DISSIPATION watts
TETRODES	
4-65A	65
4-125A	125
4-250A	250
4-400A	400
4-1000A	1000
TRIODES	
25T	25
3C24	25
35T	50
35TG	50
75TH	75
75TL	75
100TH	100
100TL	100
152TH	150
152TL	150
250TH	250
250TL	250
304TH	300
304TL	300
450TH	450
450TL	450
750TH	750
750TL	750
1000T	1000
1500T	1500
2000T	2000

EITEL McCULLOUGH, Inc.
193 San Mateo Ave., San Bruno, California

Export Agents: Frazier & Hansen 3011 17th St., San Francisco, Calif.

notices for the month. KYI, formerly of Racine, now is 8BLD in Muskegon, Mich. IXQ is newly-appointed EC at Chippewa Falls. OVE and DKH are active on the BEN. RKT schedules BZU daily on 7 Mc. LBC is dabbling with 144 Mc. TYA would like to contact former Navy operators. KQB repairs radios all day and then relaxes with ham radio in the evening. New rig of QFC is taking shape. The Manco-rad Club is working on emergency communication plan. AFT now has sixteen-element horizontal beam on 144 Mc. JNU will give frequency check to any stations upon request. HMX is selling out and moving to West Coast. VLW has become a 14-Mc. 'phone addict. Eau Claire has a local net on 3700 kc. meeting each Mon. at 7 p.m. LMV and REQ are de-bugging their VFOs. AH, GIT, and AXQ are rebuilding. GIT gets out FB on 4-Mc. 'phone with 4 watts. KPG completed new rig. RME is call of Appleton High School Club; SPV, physics instructor is advisor. DXV has new p.p. 813 rig on 28 Mc. GYQ is active on 28-Mc. mobile. KBT is working on automatic tuning of final tank. MUM is Eau Claire EC. HSL is building all-band rig. Eau Claire Radio Club's members are building kw. rig. ZRZ is active on the BEN. ZGL is on 14 Mc. RUF and Milwaukee EC have 144-Mc. net. CIC is new call at Wausau. Traffic: W9DKH 150, LFK 113, CBE 90, IQW 38, DND 38, SZL 36, ESJ 29, YCV 26, PDK 23, RQM 19, CIH 17, UFX 16, MUM 12, BCY 2.

DAKOTA DIVISION

NORTH DAKOTA — SCM, Paul M. Bossoletti, W0GZD — EOZ finished portable rig and is building f.m. nod. TNL is new call in Jamestown. CAQ is planning a pair of 8005s for 500 watts. YZ is busy building 28-Mc. rig. BCH has HT-9 and SX-28. CGM and OEL are on 3.5 Mc. from Mayville. AQF is pounding brass on 28 Mc. periodically. 70NH/θ, chief engineer at KNOX, is running 813 with 811 modulators and HQ-129X. IKD put up new 3.5-Mc. Zepp and will be back on in G.F. with 6L6 final and homemade super. U. of N. D. has new license and call, OZG. IYH, in Washington, schedules the G. F. hams on 28 Mc. KOY and MLE schedule KH6GF for sister and brothers family round table. NAW and TUF are on again. KZL is making FB net outlet in Pembina. Too many exclusively 28-Mc. hams in the State. Why not come down in frequency for a good old-fashioned rag chew with your neighbor! Traffic: W0SSW 158, GZD 39, BCH 7, RGT 2.

SOUTH DAKOTA — SCM, P. H. Schultz, W0QVY — GCP, UVL, FAX, and BLK are asking for more stations to join the State Net. The Sioux Falls Club still is building on new transmitter. ZWY changed meeting date to Monday because of conflict with Naval Reserve. RRN has 2nd-class 'phone ticket. VHS, of Omaha, taught commercial radio class at Sioux Falls for about six weeks for 'phone company. CRY has new Supreme transmitter. RNP moved to Chamberlain and is working 3.5-Mc. c.w. IBP is handling theory and practice classes for club. BLZ is back on the air after an absence of several years. ZWH gave up 28-Mc. 'phone for 3.5-Mc. c.w. The Pierre Club reports ZPJ has a brand-new HT-9. OXC took a fling at 28 Mc. but says he likes 14 and 3.85 Mc. best. 5KVW/θ is on 3.85 Mc. FKE and FLP are new hams. BJV reports excellent ground wave on 50 Mc. over Eastern South Dakota. Traffic: W0UVL 67, BLK 48, FAX 2.

MINNESOTA — SCM, Walter G. Hasskamp, W0CWB. — CUE, formerly of New York Mills, now is 7LBC, in Portland, Ore. EHO has moved from Olivia to Redwood Falls. FLK has moved from Effie to West Brook and has changed power from 10 to 300 watts. New 'phone net members are GKC and HY. 4TIS, with 8AQU operating, reports directly into the MSN C.W. Net. YBM's New Year's Resolution — to go back to a.m. after trying n.f.m. TQV is building an n.f.m. adaptor for his receiver. OGU is building a kw. final. OMC says he has licked the second harmonic! DSF is sporting a new Meissner Signal Shifter for his kw. rig. The Arrowhead Radio Amateurs held its annual Christmas Party with a special treat for two of the members, DOQ and KYE. These two got in on everything but refreshments by the use of 144-Mc. gear, put in operation by GKP, NRV, QVU, and Al Jarvi. BOL, after seven months layoff, has a 450 Eimac in a kw. final using exciter from BC-610. FAH converted to VFO. C.w. men! Interested in our c.w. net? Contact our new RM, HKF, St. Paul. JIE installed an FB splatter choke. EG has plans now for the "ham's dream" transmitter to end all transmitters. Two separate areas in the State report a good deal of 144-Mc. activity. GKO,

Duluth, and BBN, Grand Marais, have established consistent contact between them, a distance of 125 miles, using horizontally-polarized beams. Also active in the Arrowhead Country are NRV, GKP, QNU, LNV, KYE, 9GDD, QIG, DOQ, and MCJ, with ZGO and WYT listening. The other center of 144-Mc. activity is the Twin Cities. Consistent communications have been established between St. Cloud, St. Paul, Minneapolis, and Oglevie. Active stations are: St. Paul: BBL, ORA, BHY, TOZ, OYC, Minneapolis: QHC, QIN, HCY, Champlain: JHS, Robbinsdale: KPF, Oglevie: UYU, St. Cloud: SV, RIL, HXY. This gang also is thinking about an emergency network. The next achievement is to establish contact between these two groups. All stations are requested to report their 144-Mc. distance record to the SCM. Traffic: W0RPT 120, VJH 106, ITQ 92, YBM 45, CWB 37, JIE 31, FAH 28, ORJ 20, YUN 18, HEO 14, OMC 13, TPN 13, DSF, 9, TUO 9, BGY 7, CCF 3, EPJ 3, QXI 3.

DAKOTA DIVISION QSO PARTY

April 1-30, 1948

This contest is open to all amateurs in the Dakota Division. Either 'phone or c.w. may be used, but all contacts must be made in the 3.5 to 4 Mc. band. General call will be "CQ DAK" on c.w. and "CQ Dakota Division" on 'phone.

Scoring: 10 points will be allowed for each contact with another Dakota Division amateur and 2 points for each contact with an amateur outside the division. 'Phone-to-c.w. or c.w.-to-'phone contacts will count double. Multipliers will consist of Minnesota, North Dakota, South Dakota, W1, W2, etc., VE1, VE2, etc., and foreign countries. No station may be worked more than once during the contest which will start at noon, CST, April 1st, and end at noon, April 30th. Total points multiplied by the total multiplier will equal the final score. If power input for the entire contest is 50 watts or less, this final score may be multiplied by 1.5.

Logs must be received by the St. Paul Radio Club, C. W. Davies, W0YCR, 338 West Baker St., St. Paul, before May 20th to be eligible for prizes. If possible, a prize will be given to the high scorer in each section of the division and each entrant will receive a mimeographed copy of the final results.

Get on 80 meters and meet the gang around the division!

DELTA DIVISION

ARKANSAS — SCM, Marshall Riggs, W5JIC — BUX has returned to the air after several years' absence. He now is on 7-Mc. c.w. and is doing OK. Harrison has a new club going strong, with four members going up for examination soon. LUX is working on p.p. 813 and hopes to burn up 3.85 Mc. soon. JXO is burning up the country with a snazzy 150-watt rig with 811 in final. NCL has new means of livelihood. LQG is building new rig and working 144 Mc. in the meantime. MRD and LUX hold schedules each night at 7:00. ARX has new e.c.o., a converted BC-458. LUY has moved to 3.5 Mc. and seems to be doing OK. JIC has new emergency rig, the BC-459A. FMF has joined the Ozark Net. FPD is new member of the 'phone net. HYS has finished one stage of new e.c.o. JIC has new Christmas present — a barometer. The Fayetteville gang is going in good shape. Let us hear from you boys more often. Traffic: W5EA 48, JIC 8, DSW 2.

LOUISIANA — SCM, W. J. Wilkinson, jr., W5VT — HHT and AVO are assisting KTE with his Emergency Corps duties. QH has been made EC for Shreveport, succeeding CEW, who is PAM. VRA is ex-8VRA. LQO has been on the sick list. MJT still is trying to keep his rig on 7 Mc. BSR is active on 7- and 3.5-Mc. c.w. and 3.85-Mc. 'phone. KRX, KTG, and KTE are active on the Rebel Net. CNG, GHF, and ADM operated emergency rigs during the Springhill and Cotton Valley tornado disaster. To all others who assisted we extend our thanks and appreciation. Sorry we did not receive more reports. LDH is not very active since college work keeps him QRL. GUT has been on 14-Mc. 'phone after being off for several months. KOU is

(Continued on page 88)

"For Unfailing Dependability Give Me OHMITE"

You can be sure the resistors, rheostats, and tap switches you buy will provide accurate, dependable service if they're made by Ohmite. Every Ohmite product is designed and constructed to stand up under severe operating conditions . . . to give extra performance . . . to withstand the effects of shock, vibration, temperature extremes, altitude, and humidity. This *extra* performance is the reason thousands of particular parts buyers are regular Ohmite customers.

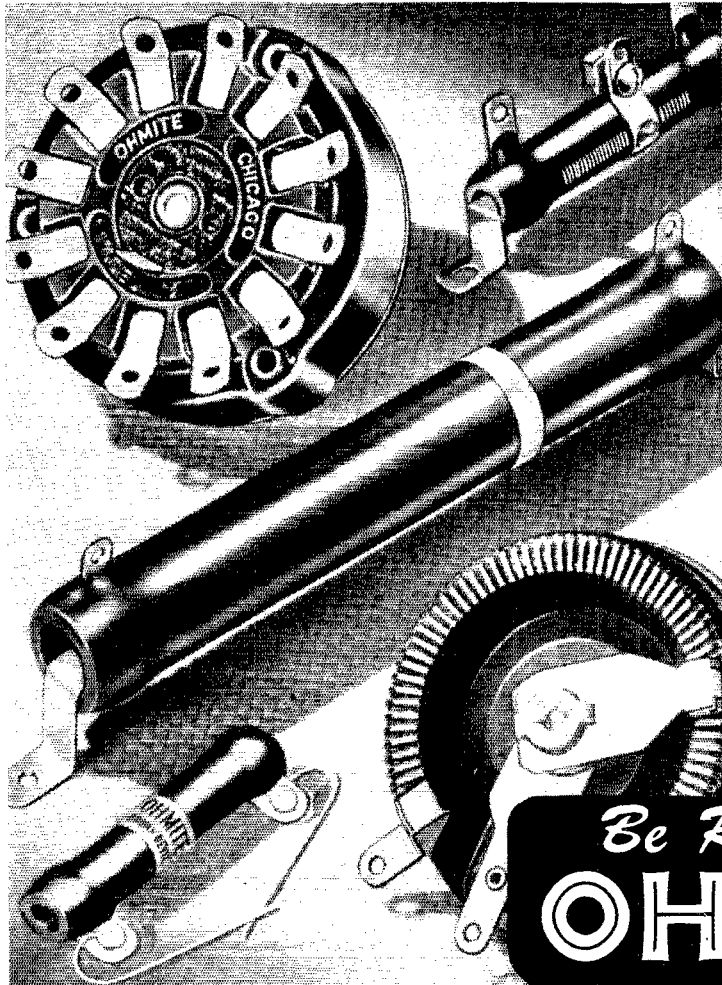

● Close Control RHEOSTATS

All ceramic and metal. Winding is permanently locked in vitreous enamel. Metal-graphite contact brush insures perfect contact with negligible wear on the wire. Available in 10 sizes from 25 to 1000 watts.

● Vitreous-Enameled RESISTORS

Vitreous enamel permanently locks and insulates each turn of wire on ceramic core. Prevents shorts, conducts generated heat away. All types and resistance values from 5 to 1500 watts.

● High Current TAP SWITCHES

Compact, dependable, and convenient to operate. Heavy, one-piece ceramic body is unaffected by arcing. Five models, A. C. ratings 10 to 100 amperes.

SEND FOR
CATALOG 19

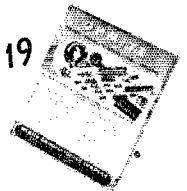

OHMITE
MANUFACTURING COMPANY
4865 Flournoy St., Chicago 44, Ill.

Be Right with
OHMITE

RHEOSTATS • RESISTORS • TAP SWITCHES • CHOKES • ATTENUATORS

MICROPHONES BY TURNER

world wide
favorite
for
quality
reports

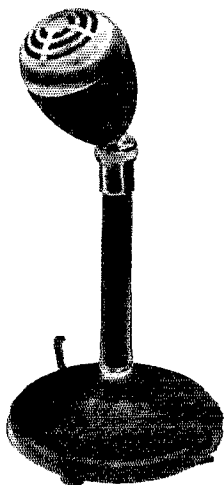

THE TURNER VT-73

Crystal Desk Microphone

Praised by thousands of amateurs for its crisp, clear results. The Turner VT-73 is engineered especially for quality speech recording, public address and amateur work. **Rising curvature of response between 500-4000 c.p.s.** increases intelligibility at effective voice frequencies without over-modulation. Two-conductor cable design reduces R.F. pickup and harmonic resonance problems. Crystal circuit utilizes corrosive resistant diaphragm and high quality moisture sealed crystal. Output: 52 db below 1 volt/dyne/sq. cm. Response: 50-7000 c.p.s. Attractively finished in rich black wrinkle and chrome. Complete with ball swivel head, stand, and 7 ft. cable. Ask your dealer or write.

THE TURNER COMPANY

917 SEVENTEENTH STREET N.E.
CEDAR RAPIDS, IOWA

Crystals licensed under Patents of the Brush Development Co.

handling traffic and keeping schedules. JYK was married recently and honeymooned in Mexico. NTZ has a BC-459 and about 50 watts. So far his total is 44 states toward WAS. LVG is working out nicely with low power on 28 Mc. KXU has been active on 50 Mc. Eddie boast a new VHF-152. KTB has increased power to about 700 watts. NPM is new on 28 Mc. NYC and NGA are two newcomers to the game in New Orleans. BFX and LQV were in Cotton Valley following the tornado but had trouble. KC has everything set for the ARRL Member Party. We regret to have to report the death of AMZ, of Opelousas. KHC and NBA were visitors in Shreveport. BAF (Barksdale Field Radio Club) is active on all bands. BZR has moved to New Orleans. Let's have more reports next month. Traffic: W5KTE 167, VT 26.

MISSISSIPPI — SCM, Harold Day, W5IGW — SEC: JHS. RM: WZ. PAM: LN. JTI, at Jackson, reports on v.h.f. activity. IHP, at Brookhaven, uses a model 701 on 50 Mc. NLP is active on 50 Mc., having worked 7 states. RY uses an 829-B with 100 watts on 50 Mc. JTI is active on 50 Mc., along with three other Jackson hams. LN, PAM, EC, and NCS for the Mississippi section of the Tri-State Emergency 'Phone Net, served faithfully and well under very trying conditions helping out amateurs during the tornado which struck Cotton Valley, La., and vicinity. JHS, our new SEC, is looking for new EC appointees. LAK goes to the front this month on traffic. The following stations are members of the Mississippi section of the Tri-State Emergency Net: ANP, BOT, CUU, DFK, DLA, DNV, FGH, GIA, HAV, HEJ, HMZ, IGW, JHS, KUT, LBY, LN, and NNZ. Rebel Net members in the State are: DEJ, DNS, EGE, IGW, KUT, LAK, and WZ. Traffic: W5LAK 301, WZ 161, IGW 148, LN 8.

TENNESSEE — SCM, James W. Watkins, W4FLS — AWB has a 14-Mc. doublet in the attic that really works. AXD has promised to start working on that p.p. 809 job. DDF now has p.p. 813 rig going at 300 watts. DKX has the kw. going and can't stop it, but is having trouble with e.c.o. unit. EBQ has a converter working on 50 Mc. FLY is converting BC-221 into an e.c.o. HWC is known as T9X since licking the chirp troubles in a BC-459. HUB has a new folded dipole antenna. JAF, who lost his equipment in a fire back in June, will be back on soon with 300 watts, all bands, 'phone and c.w. FWH is experimenting on 144 and 50 Mc. LCB is new Assistant EC in Nashville. FEL has a new p.p. T55 rig on 28 Mc. with 450 watts. HOJ is having trouble blowing fuses on the new half-gallon plus. MZK is new call in Chaitanooga. LEB is new AEC member. MEA is revamping his station. LNF has a new YL. GCS is on 14-Mc. 'phone. AQR finally got over the 100 mark with countries worked on 'phone. VT is experimenting with 400-Mc. equipment and 144 Mc. but has made no contacts outside of Memphis. PL has returned from his Florida vacation and is keeping schedules. Benton reports FCF was a recent visitor. Check the dates on your certificates and if appointments have expired, please send in certificates for endorsement. The Tennessee 75 'Phone Net has been re-organized and is very active, meeting weekly on Sunday morning at 9 A.M. CST on 3985 kc. Traffic: W4PL 511, TWI 298, LNM 95, BAQ 18, IQY 17, GHL 2.

GREAT LAKES DIVISION

KENTUCKY — SCM, W. C. Alcock, W4CDA — Key ARRL appointments still are open. Postwar appointments are: BAZ (RM), TXC (PAM), FQQ (ORS), FR (OO), and RPF (OBS). FKM worked England on 3.85-Mc. 'phone. FQQ and BAZ work trunk lines for out-of-State traffic. AZY is back on the air with 160-watter; he also has 400-watt rig and is building kw. KKW is located at Dayton, Ky. KUT, now at Erlanger, works 3.5, 3.85, 7, and 28 Mc. JRO, ex-9FLU, is on 3.5 and 7 Mc. at Clay. Rev. C. L. White, ex-8GTA, is Class A man at Harlan. IMC reports U. of Ky. Club includes: JMG, JAY, LQP, LQF, KTF, LSE, GPR, MEC, KAM, IMC, and ex-KG6AK. LUB has beam on 40-ft. mast. QDZ is building bandswitching 813s. JXB has 600-watter for 3.85 and 14 Mc. ERH runs 325 watts on 28-Mc. 'phone, and snagged J9AAI on Okinawa and J2BON near Tokyo for 100 per cent QSOs, making WAC. K4NRR, Owensboro, provided room for Owensboro Radio Club, furnishing use of BC-610 and receiver. The club membership includes 21 hams and many beginners in the ham game, and officers are: LUB, pres.; LQT, vice-pres.; LTO, secy-treas.; MMY, act. mgr.; JXB,

(Continued on page 90)

Plasticon HiVolt Supplies

High Voltage—Low Current DC Power Supplies

for

Television — Radiation Counters — Photoflash Devices —
Electrostatic Precipitators — Spectrographic Analysers,
Oscilloscopes, etc.

HiVolt Supplies are self-contained in hermetically sealed metal containers. They are designed to transform low voltage AC to high voltage-low current DC.

HiVolt PS-2

SPECIFICATIONS:

Volts Input: 118VAC, 60 cycles.
Volts Output: 2400 VDC, maximum.
Current Output: .005 Amps. DC, maximum.
Max. Watts Input: 10 watts.
Type of Filter: RC Filter: 50,000 ohms, 2x.1 mfd.
Terminals: 8-32 screw and nut.
Insulators: 118 VAC—2 bakelite washers; 2400 VDC—2 porcelain standoffs; container neutral.
Container: Terne plate steel—gray lacquer finish.
Size: 3 $\frac{3}{4}$ " x 3 $\frac{3}{16}$ " x 5 $\frac{1}{2}$ ".
Weight: 2.5 lbs.

LIST PRICE **\$25.75** F.O.B. CHICAGO

Note: The PS-2 is similar in appearance to the PS-1 except that all four terminals are on the recessed top of the container.

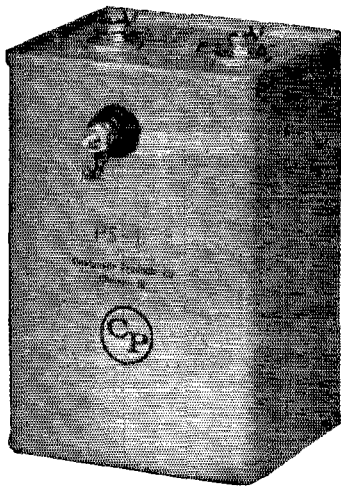

HiVolt PS-1

SPECIFICATIONS:

Volts Input: 118 VAC, 60 cycles.
Volts Output: 2400 VDC (capacitor load)
Current Output: .006 Amps., half-wave DC.
Max. Watts Input: 15 watts.
Type of Filter: Not filtered.
Terminals: 8-32 screw and nuts.
Insulation: 118 VAC—2 bakelite washers; 2400 VDC—1 porcelain standoff; 2400 VDC—lug spotwelded to case.
Container: Terne plate steel—gray lacquer finish.
Size: 3 $\frac{3}{4}$ " x 3 $\frac{3}{16}$ " x 5 $\frac{1}{2}$ ".
Weight: 2.2 lbs.

LIST PRICE **\$18.95** F.O.B. CHICAGO

Note: The PS-1 is designed to charge a parallel-wired bank of not more than 15 AOCOE22C3 Plasticon Energy Storage Capacitors (48 mfd.).

Plasticon Photoflash Capacitor

Due to weight and size limitations, it is accepted practice to over-rate capacitors for intermittent photoflash use. This leads to frequent failures and costly replacements of large multi-section capacitors. Plasticons are made in individually cased units which cost no more, weigh less, and take up only 5-10% more volume than multi-section blocks.

SPECIFICATIONS:

Catalog No.: AOCOE22C3.
Watt seconds: 7.6.
Capacitance: 3.2 mfd.
DC Operating Volts: 2250-2400V.
Duty Cycle: Intermittent.
Terminals: 8-32 screw and nut; one bakelite washer insulated; can grounded.
Container: Terne-Plate Steel.
Size: 2" x 1 $\frac{1}{4}$ " x 4".
Weight: $\frac{1}{2}$ lb.

LIST PRICE **\$4.95** F.O.B. CHICAGO

Note: Plasticon Photoflash Capacitors are made from 1600 to 5500 volts and up.

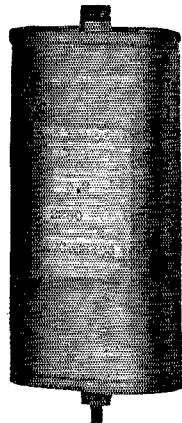

CP Condenser Products Company

1375 NORTH BRANCH STREET • CHICAGO 22, ILLINOIS

JOHNSON

a famous name in Radio

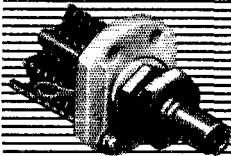

SINGLE

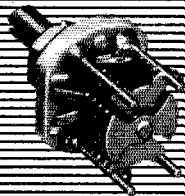

BUTTERFLY

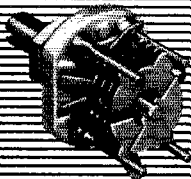

DIFFERENTIAL

**SMALLEST
AIR VARIABLES
EVER PRODUCED!**

Pictured are three of the smallest air variables ever produced. Each of the three types is available in four different capacities.

SINGLE TYPE — Takes the place of adjustable padders for trimming RF and IF oscillator circuits. Available in four models: 1.55 to 5.14 mmf, 1.73 to 8.69 mmf, 2.15 to 14.58 mmf and 2.6 to 19.7 mmf.

BUTTERFLY TYPE — Applicable wherever a small split stator tuning condenser is required. Available in four models: 1.72 to 3.30 mmf, 2.10 to 5.27 mmf, 2.72 to 8.50 mmf, and 3.20 to 11.02 mmf.

DIFFERENTIAL TYPE — For switching capacity from rotor to either of two stators, and for shifting tap on capacity divider. Available in four models: 1.84 to 5.58 mmf, 1.98 to 9.30 mmf, 2.32 to 14.82 mmf and 2.67 to 19.30 mmf.



For Full Details Write for
Latest JOHNSON Catalog

E. F. JOHNSON CO.
WASECA, MINNESOTA

acting station trustee. WYW has new c.w. rig on 3.5 Mc. TFG finished 450-watter for 3.85-Mc. 'phone. MRS and JTO have new rotary-beam mechanism built by CAK. IZU fired up portable at McKinney. ZRE has worked 49 countries. FR worked Syracuse station using 10 milliwatts. KKG is rag-chewing with kw. on 14-Mc. 'phone. Traffic: W4BAZ 296, TXC 40, CDA 27, PKM 22, FQQ 18, KKG 3.

MICHIGAN — SCM, Joseph R. Bellan, jr., W8SCW — SEC: SAY. RMs: NOH, PVB, and UKV. CYH and TRN are new ORS appointees. CYH has been appointed OBS. Section Net Certificates went to ARJ and GSJ. The Detroit Amateur Radio Assn. elected the following: BIU, pres.; UQR, vice-pres.; FX, financial secy.; and MGQ, recording secy. The Allegan Area Radio Club elected the following: VPE, pres.; JUQ, vice-pres.; Flinn, secy.; Winter, treas.; and ZZU, act. mgr. Congrats to YBU and YDR on the new YL additions to their families. ZHB is in Texas for a few months. SWF is working nice DX on 27 Mc. UGR is interested in reactivating the Early Bird Net on 7122 kc. and those interested are asked to drop Paul a line. HA built the dial-less converter as per QST and is proud of its operation. RER discovered that crystal mikes don't bounce. DPN is working on 28-Mc. beam and on EC set-up for the club. WXX moved to new QTH. WNT moved to Marquette. YLS is getting lumber for new QTH. TZD has 814s all set to fire up. OCE blew out h.v. power transformer again. SYL is 28-Mc. mobile. YCT moved to new QTH at Utica. INF and PUV are planning on QMN soon. PUV has Command transmitter on 7 Mc. SDR worked his 103rd country. NZ is working 50 and 144 Mc. YPU and YPV are rebuilding. BTF is new high school station at Battle Creek and SIO is high school at St. Joe. ZUI and BWS are snagging nice DX. INY, ex-9INY, now is at Battle Creek with CAA. RJC is working on new e.o. Hams at Allegan Primary Station include ALV, EH, EYD, JUQ, ZMO. FLA, ZZU, IW, and 3NTE. CSI made WAC with twenty-five watts and beam on 14 Mc. YOO has fifty-foot pole with beam on top. JUQ puts code practice on the air Monday through Friday, 3556 kc., at 7 p.m. at 13 w.p.m. GR, c.w. emergency net, meets each Friday at 8:30 p.m., 3663 kc., with UFR as NCS. NCB did nice conversion job on his SCR-522. UBF is conducting code classes. WNF has kw. on 14 Mc. with three-element beam. BIJ now is Class A. AJL now is VFO. LKV is putting new rig on 14 Mc. FYN has new tower for his beam. YKP has new 28-Mc. beam. SAY, NOH, and SCW made the BPL. Traffic: W8SAY 522, NOH 323, SCW 255, YNG 156, UKV 130, GSJ 113, ARJ 94, PVB 80, DNM 63, YBR 61, TRN 57, VPE 50, YAO 44, QBO 36, IV 34, RJC 32, FX 30, TBP 28, DPE 26, AQA 23, ATB 21, ZHB 20, ZRW 19, BCX 16, BBJ 15, SH 12, YDR 9, ZWN 8, GP 3, ABH 2.

OHIO — SCM, William D. Montgomery, W8PNQ — December closed out the year with a new all-time traffic high for Ohio — 1510. The Dec. 6th meeting of the Ohio State Council of Radio Clubs and Nets at Columbus was attended by one or two delegates from each of 18 clubs and nets. Also present were DPE, our Director, PNQ, your SCM, and UPB, your SEC. A board of directors was elected to carry on at future meetings, consisting of TRX, ALW, TNB, QQ, and IVC. TNB was appointed secretary-treasurer. From Cleveland, via TNB, we hear that an emergency 144-Mc. net has been organized, consisting of NKH, RPT, TNB, BDU, OZA, ZMH, AVU and BPN; that the NEARC has moved to 774 East 185 St. to a swell clubroom furnished by fellow club members ZMH and UEH; and that ex-UCY now is 7KVS in Reno, Nev. We see from the Q-5 that the Springfield Amateur Radio Club is conducting regular club contests on the ham bands, and seems to be getting the desired result of stimulating amateur operating interest. 1BUD, ARRL Senior Assistant Secretary, favored Ohio with very informative and interesting talks in Cleveland, Columbus, and Cincinnati. From the *Central Ohio Radio Club News*, we see that TZI has a new Supreme transmitter and that 2RVY/8 has a new Ultra phone for mobile 144-Mc. operation. From Canton, TND reports the election of the following club officers: RT, pres.; HHU, vice-pres.; and WNM, secy.-treas. The club meets the first and third Wednesdays of each month in the Red Cross Bldg. The club transmitter, RTR, operates on regular or emergency power on all bands down to 144 Mc. PSE is back on the air again as a regular Dog-Houser after an absence of several months. AYS is looking for West Virginia for WAS 14-Mc. c.w. ZEI reports the Fort Steuben Radio Club held a Christmas gift exchange on Dec. 22nd. UW

(Continued on page 98)

ALSiMAG
ALSiMAG
ALSiMAG
ALSiMAG
ALSiMAG
ALSiMAG
ALSiMAG
ALSiMAG
ALSiMAG

TRADE MARK REG. U.S. PAT. OFF.

Custom made technical ceramics

FOR ELECTRONIC AND ELECTRICAL USES

SOLD ONLY TO MANUFACTURERS

AMERICAN LAVA CORPORATION

4-6TH YEAR OF CERAMIC LEADERSHIP

CHATTANOOGA 5, TENNESSEE

**McMurdo
SILVER**

**MODEL 703
PRE-TUNED FREQ.
MULTIPLIER**

In shipment at last, Model 703 is the answer to fast transmitter band change. Fed by any 80 meter oscillator, a flip of two knobs gives 40 watts output 80 thru 10, and 18 watts on 6 meters. See October, 1947 QST. Only \$49.90 less 2-6AG7, 2-6L6, 1-807 tubes and power supply.



MODEL 802 SUPER-HETERODYNE RECEIVER

An amateur-band-only receiver using i. f. regeneration to give variable phone up to single-signal CW selectivity. Following A. R. L. HAND-BOOK teachings, it provides more than usual 8-tube results, over 7 feet of band spread on 80, 40, 20, 16, 11 — 10, and 6 meter bands, all for only \$38.95 less tubes, power supply and coils at \$1.00 per pair.

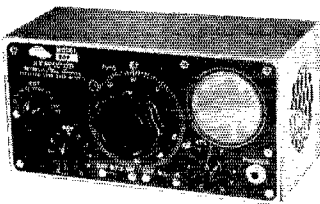

MODEL 701 TRANSMITTER

Goes into more amateur stations to produce more CW and phone DX than anything else, it seems. A 6AQ5 Tritet drives an 807 to 75 watts CW, 30 watts phone, input; 80 through 6 meters. Modulator is built-in. Less coils (3 per band at \$.50 ea.), power supply, 4 tubes and crystal, it's the outstanding transmitter "buy" at \$36.95.

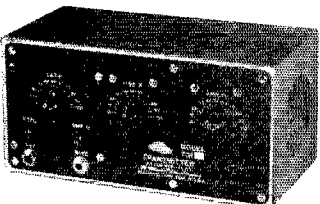

MODEL 903 ABSORPTION WAVEMETER

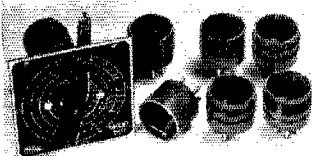

Is close to the most useful instrument in any shack. Thousands in use attest its prime necessity. Price is but \$3.30 net, plus \$.65 ea. for

plug-in coils covering 1600 kc. up to 500 mc.

SEND FOR NEW AMATEUR CATALOG

OVER 36 YEARS OF RADIO ENGINEERING ACHIEVEMENT

McMurdo Silver Co., Inc.

EXECUTIVE OFFICES: 1240 MAIN ST., HARTFORD 3, CONN.
FACTORY OFFICE: 1249 MAIN ST., HARTFORD 3, CONN.

returned this month from a voyage to Siam and Java as "sparks." WAV reports a new ham in Cambridge, BMS. AQ finally got his new pole up and is back on 3.5 Mc. for the first time since last spring. The CARASCOPE, new paper of the Columbus Amateur Radio Assn., is staffed by WAB as editor, WZK as circulation manager, and S. Bell as business manager. BMR is a new call in Columbus; "Milt" is totally blind. The Cuyahoga Radio Assn. 1948 officers include QV, pres.; UJ, vice-pres.; FPL, treas.; and EFW, secy. ROX reports that AIY now is in Georgia working at a b.c. station; that VTF now is on with a new 300-watt rig and a new IRO; that ZOD has a new NC-173 receiver; that VTF and UWM are now ex-bachelors; and that BRA, in Cleveland, is ex-9TWC. FUN reports two new amateurs in Chillicothe — BLS and BLU. WXA found his first DX in 12 years with G5LP on 7-Mc. c.w. EBJ says the Buckeye Net needs stations in Southeastern Ohio. New officers for the Queen City Emergency Net in Cincinnati are 4HAY, pres.; YHIG, vice-pres.; YGH, secy.; and 4IYH, treas. From the Mike and Key of the Greater Cincinnati Amateur Radio Assn., we see that ANB now is RY; JIN moved to the hills of Mt. Carmel, where DX is good and where there is room for a full wave on 3.5 Mc.; that QEB has completed 45 years of service with Western Union and retired; that AQV and BCR each have new Harvey-Wells all-band transmitters; that PR has a new HQ-129X; that ZMC has a new Collins transmitter and receiver; that SDD and RY have new Collins receivers, and that AHG, who is blind, visited in Cincinnati from Toledo. Traffic: W8RN 300, EBJ 214, PIH 183, CBI 154, QBF 147, TAQ 96, UPB 85, WXA 57, DAE 43, IVC 32, PUN 30, ROX 26, APC 24, BEW 22, VWX 21, EQN 20, QIE 20, ZAU 13, EFW 8, WAB 6, AQ 4, WAV 3, BUM 2.

HUDSON DIVISION

EASTERN NEW YORK — SCM, Ernest E. George, W2HZL — RM ITX reports the name of the New York State Net has now been changed to the New York State Traffic and Emergency Net. It has 32 active members and is doing a swell job. See traffic reports for this month. Eastern New York members in the net include EQD, ITX, LRW, NHY, NVB, OGH, QOM, TYC, SZ, and WOP. Local c.w. rag-chewing net around Schenectady is BSH, NHY, TYC, and WPO. NHY and WPO have new high power and LRW is down to 6 watts. LRW reports DX swell on 3.5 Mc. His contacts include F8, ON4, YU7, VO2, G8, PAØ, G6, G5. WARA has started a county-wide 28-Mc. net, mobile and fixed. It should make a fine emergency set-up for that area. Congratulations to EQD on his new jr. operator. Who'da think it? Ernest George (that's me, W2HZL) received a letter the other day from George Ernest (that's not me), a ham-to-be. He wants to meet the hams who live nearest him in Phoenicia, N. Y. Here's a problem. BAU can't tell by looking at his oscilloscope whether his transmitter or his next-door neighbor's transmitter is on. They both appear the same! Did some one say QRM possibilities! GYV, KLM, and HZL are recent appointments to the office of Special Constable so be on your toes, men, when you work mobile in Niskayuna, N. Y. Traffic: W2ITX 361, LRW 309, EQD 257, RH 95, WPO 87, PEO 10.

NEW YORK CITY & LONG ISLAND — SCM, Charles Ham, jr., W2KDC — Our SEC, reliable BGO, continues to spark the AEC even while seeking a successor. A better response on monthly reports makes Vince happier. In Suffolk, OQI has the ARC-3 working very well on 144 Mc. Van can hear all of the Suffolk County Radio Club. Emergency Committee: LCU, BRU, ADW, IRC, KNA, and IPSQ 2. Club officers are PDU, PLA, CZJ, and AJF. JFP, in Huntington, is on 28 Mc. with a Lazy H antenna. UDP is about ready to fire up new hundred-watter on 3.5, 7, and 14 Mc. WGZ needs only a few more for WAS on 3.5 Mc. MZB has been designated as Acting NCS for the 3.5-Mc. c.w. net. WOX, at Center Moriches, is on 7 Mc. with 100 watts. FCH has a fancy 5 half-waver on 144 Mc. OHE reports the following: QRM from neighboring counties still is a problem. NKQ and UQA are welcomed to the Brooklyn Net. KU and HG continue to improve their gear on 235 Mc. A high-powered rig on 144 and 224 Mc. is planned by AUF, who is trustee for WCR, the AVHFT's station. NXT is playing with twelve-element beam. ER is 'way ahead of that, allegedly using 32 elements! JSJ still is working on the 522 which will be welcomed by the 144-Mc. gang when finished. BPV and ODS are heard again. From Queens,

(Continued on page 96)

Bliley

CRYSTALS AND CRYSTAL CONTROLLED OSCILLATORS

CCO — CRYSTAL CONTROLLED OSCILLATOR — MODEL 2A

For 2-6-10-11 Meters

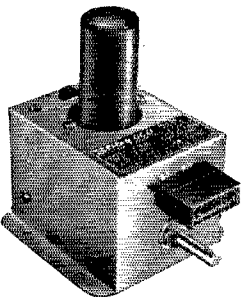

With this basic oscillator, employing a 6AG7 tube, the advantages of VHF crystal control are easily achieved. Has direct output on 6-10-11 meters and ample output to drive tripler stage on 2 meters. Single tuning control, bandswitch and crystal socket are mounted on outside of painted metal subchassis with power and output

terminals at back. Uses Bliley AX2 20-meter crystals for output on 10 and 11 meters, new Bliley AX3 crystals for 6 and 2 meter operation. Ideal as nucleus for new construction or conversion of existing equipment.

Supplied less tube and crystal. . . . \$9.95

AMATEUR FREQUENCY CRYSTALS

TYPE AX2

These high stability advanced design crystals are plated to insure long term precision and reliability. Calibrated to $\pm .002\%$ with drift less than $.0002\%$ per degree Centigrade. Holder pins spaced on .486" centers.

Supplied	Range	Price
± 2 Kc	3500—4000 Kc	\$2.80
± 2 Kc	7000—7425 Kc	2.80
± 30 Kc	12500—13500 Kc	3.95
± 30 Kc	13580—13714 Kc	3.95
± 30 Kc	14000—14850 Kc	3.95



TYPE MC9 3105 Kc

This unit is suggested for use in private aircraft transmitters operating at 3105 Kc. The crystal is guaranteed to be within $\pm .02\%$ of 3105 Kc at any temperature between 0° C and 50° C and is factory tested for performance over this temperature range. Plug-in type holder is gasket sealed against moisture and humidity.

Price \$5.50

TYPE VX2 3105 Kc

Designed for applications where space is at a premium, this unit is recommended for private aircraft communication at 3105 Kc. Guaranteed to maintain frequency within $\pm .02\%$ at any temperature between 0° C and 50° C. Solder lug connections permit mounting under chassis and assembly is gasket sealed against moisture and humidity.

Price \$5.00

TYPE AX3

A new third overtone crystal unit produced for use in the Bliley CCO-2A. Has exceptionally high activity at operating frequency. Calibration accurate to $\pm .003\%$ in CCO-2A with drift less than $.0002\%$ per degree Centigrade. Plated crystal is mounted in gasket sealed holder with pins spaced .486" centers.

Supplied	Range	Price
± 5 Kc	24000—24333 Kc	\$3.95
± 5 Kc	25000—25500 Kc	3.95



TYPE KV3 100 Kc

A precision crystal designed for use in secondary standards. Crystal is silver plated and mounted between wire supports which are soldered to the plated surfaces. Exceptionally low drift crystal is adjustable to exactly 100 Kc at 25° C when used in recommended oscillator circuit.

Price \$6.95

TYPE CF6 455 Kc

Single signal filter crystal unit. Exceptionally low holder capacity permits sharp signal discrimination in filter network of general communications receivers. Frequency 455 Kc free from spurious responses within ± 7 Kc.

Price \$4.50

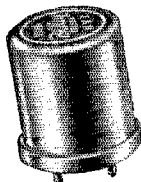

TYPE CF3 455 Kc

Single signal filter crystal unit. Frequency 455 Kc, ± 5 Kc—free from spurious responses within ± 7 Kc of fundamental. Designed for intermediate frequency filter in general communications receivers.

Price \$5.00

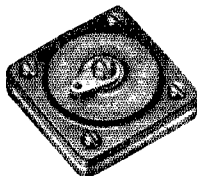

TYPE SMC100 100-1000 Kc

Dual frequency crystal provides either 100 Kc or 1000 Kc frequency source. When used in recommended oscillator circuit 1000 Kc frequency is within $\pm .05\%$ at 25° C and 100 Kc frequency can be adjusted to zero beat at 25° C. Suggested for signal generators used in alignment of radio receivers.

Price \$8.75

For complete dimensional information consult Bulletin 35 available at any Bliley distributor.

Bliley CCO

MODEL 1C

CRYSTAL
CONTROLLED OSCILLATOR

For instant channel selection and frequency accuracy, radio service technicians use this Bliley test instrument.

It provides direct crystal control for if-alignment. Write for descriptive Bulletin 32.

Complete with 7 Bliley crystals, tubes and concentric output cable. . . . \$69.50

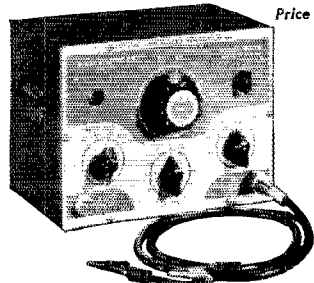

MALLORY HAM BULLETIN

The Mallory 3-Gang INDUCTUNER* Tuning Device as an Amateur VHF Tuner

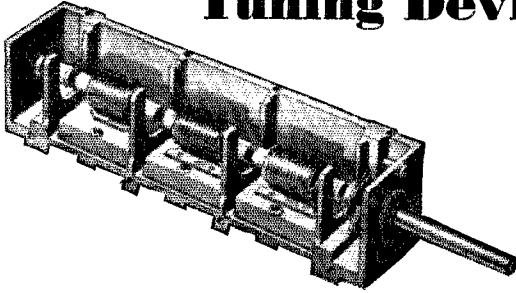

FOR some time Mallory has been building and supplying the Television Industry with a 3 coil, variable inductance tuning device, called the Inductuner. This unit consisting essentially of 3 precisely wound coils each equipped with slider shorting mechanisms, mounted on a single, panel controlled shaft, has proven to be eminently successful in providing continuous tuning over the entire TV and FM range of 44 through 216 Mc.

The Inductuner tuning device, equipped as it is with the mechanics for varying the inductance of each of its 3 coils continuously, accurately and smoothly, from the front panel, provides all essentials for tuning without recourse to variable condensers, band-switches or plug-in coils. The elimination of these "extra" parts from the VHF circuit not only simplifies wiring, but also, and more important, reduces the length of RF wiring to practically an irreducible minimum . . . and further, it permits use of a maximum of inductance with a minimum of capacitance at all frequencies tuned. The serious VHF worker will recognize immediately the advantage this condition supplies for improved efficiency at the Very High Frequencies.

After we observed the efficient manner in which the Inductuner tuning device provided the Television Engineer with entirely practical tuning of the 44 through 216 Mc band, the decision was made to investigate the possibilities this tuner might offer to the Amateur designer. Accordingly, a Converter using the Inductuner tuning device as its basic tuning element was constructed. As a result of considerable experimentation a tube line-up consisting of a 6AK5 TRF, a 6AK5 Mixer and a 6J6 two terminal oscillator was selected as giving best results for Amateur service. In order to include as many Amateur VHF bands as possible, the original TV-FM frequency coverage was modified for 50 through 240 Mc (6, 2 and 1½ meters) operation. The IF of this unit was 11 Mc.

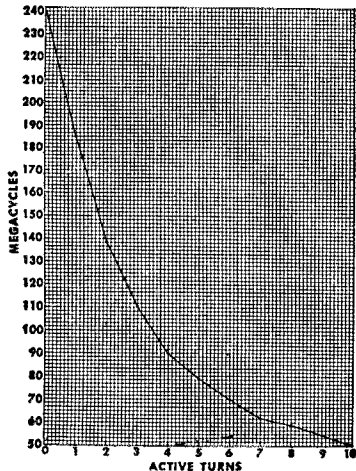
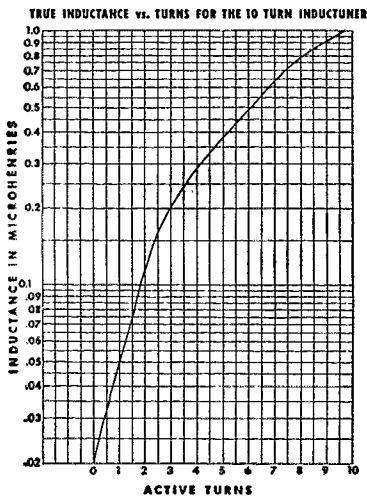

Calibration Curve of Inductuner Converter

*Registered Trademark of P. R. Mallory & Co., Inc., for inductance tuning devices covered by Mallory-Ware patents.

MALLORY HAM BULLETIN

Once circuit constants of this Converter had been worked out, little difficulty was experienced in getting it to perform in a highly satisfactory manner. "Listening" tests conducted with it in conjunction with a conventional communications receiver tuned to 11 Mc as its IF, more than surpassed predicted performance. Oscillator stability was excellent after only a 10-minute warm-up, tuning was accomplished without a trace of backlash or "pulling" and the sensitivity of the unit appeared to be unusually satisfactory throughout its very wide tuning range. Six meter stations from the East Coast were logged as well as 100 Mc FM stations from Chicago (about 175 miles) using a very poor indoor dipole antenna cut for 160 Mc operation!

(We have prepared constructional and circuit details of how to duplicate the Inductuner Converter. This information is free for the asking. Just write us at Box 1558, Indianapolis 6,

Indiana, and mention Inductuner Converter. In the meantime, be sure to see the Inductuner at your Mallory distributor's.)

In addition to a VHF application, we have reason to believe that the Inductuner tuning device may also have a number of medium frequency applications of equal importance. It has just occurred to us that the coils and contacts of the Inductuner should be able to "take" at least 10 watts of RF power . . . this sounds like good dope for the construction of a ganged control VFO exciter. But more on this later.

You can rely on Mallory Precision manufacturing to supply you with the most dependable line of: resistors, ham band switches, push button switches, controls — rheostats — potentiometers — pads, tubular capacitors, transmitting capacitors, dry electrolytics, dry disc rectifiers, vibrators and vibrator power supplies, practically every component you need to keep your rig in A-1 condition.

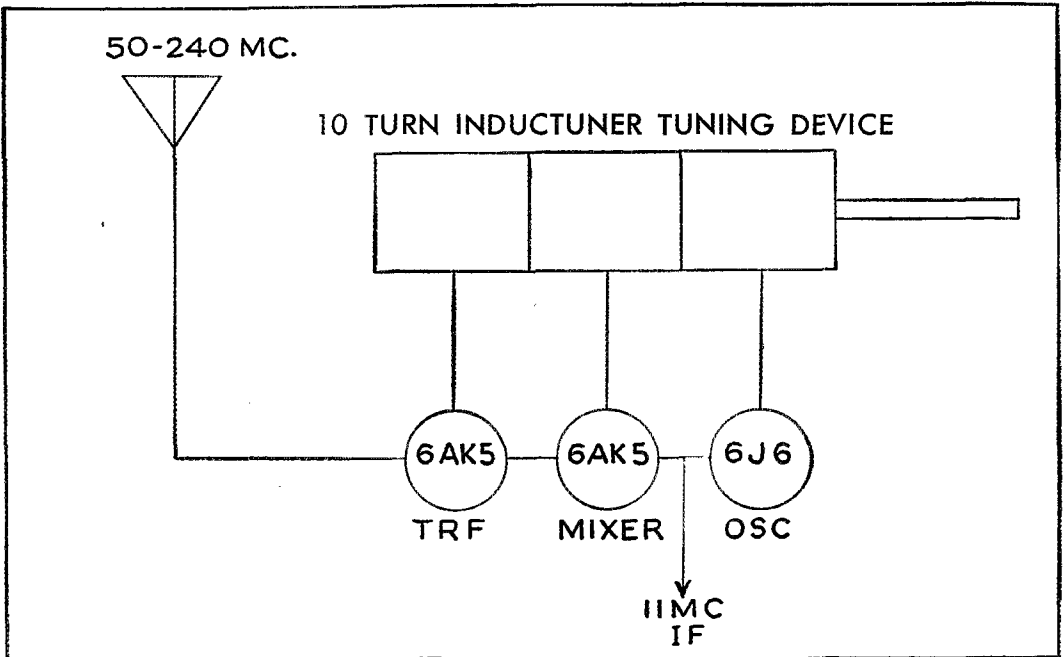

P. R. MALLORY & CO. Inc.
MALLORY

P. R. MALLORY & CO., Inc.
INDIANAPOLIS 6 INDIANA

Johnson Announces

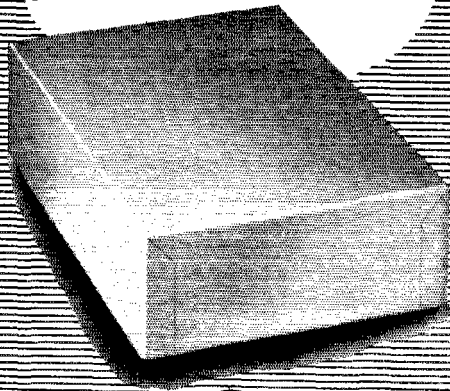

A GREAT ADVANCE IN CHASSIS DESIGN

NO OVERLAPS PERMIT LOCATING HOLES ANYWHERE

The new JOHNSON chassis mark a real advance in design by eliminating bulky butt overlaps at chassis corners. Because the chassis are single thickness at all usable areas, you can locate holes all the way to the corners. You can mount volume controls, toggle switches, etc., without trouble — and mount them flush inside of the cabinet because of the single thickness feature.

There has been no sacrifice of strength! Ruggedness, rigidity, and durability are assured by welded tie bars on the inside of the "turned under" bottom edge. These tie bars do not interfere with hole location or with the mounting of any components. Bottom plates may be fastened to the reinforced edges at bottom.

These new JOHNSON chassis in various sizes are now available from stock in limited quantities.



JOHNSON

a famous name in Radio

E. F. JOHNSON CO. WASECA, MINN.

(Continued from page 98)

BSP reports he has signed up the Sunrise Radio Club en masse for the AEC, also BSL, VDT, HN, FCP, NKII, KDB, MFK, and KNV. Bill claims Queens is out in front in organization work in this section. Technical improvements are under way here, too. BSP welcomes suggestions regarding any phase of activities of the Queens County ADC. In the 3.5-Mc. c.w. net better and more efficient operation is an outcome of the regular weekly drills, consistent attendance is reported and the following have a perfect record this season: RTZ, UGV, UZX, BSP, KTF, OXM, and TUK. A very good attendance record also is held by NVB, VOS, SMQ, VAF, QYZ, and WFL. This net can be reached on 3600 kc., when any hint of an emergency threatens. RTZ spent nine days in the hospital and she still worries because seven of them were official net nights. VOS took over for her, however. During the recent blizzard TJA called together nine stations in Brooklyn, Bronx, and Queens, and monitored 144 Mc. for calls resulting from the failure of many fire alarm boxes in Queens. VDT taking over until 4 a.m. The NYC-LI Net really is pushing some businesslike efficient and commercial QSP these days; the various NCS are doing a particularly good job. OBU's efforts resulted in five new members during December. VOS has p.p. 807s working on 7 and 3.5 Mc. BGO manages to work plenty of European DX beside his other activities. IXZ is QRL school but hopes to report to NYC-LI Net at least once a week. EC increased power to 375 watts and concentrates on Trunk Line Atlantic-Pacific. TYU still battles fierce QRAM on supposedly "clear" net frequencies. Pop suggest that others note value of traffic-handling and operate elsewhere. TUK, with the help of a strong west wind, worked YU7KX, F8EX, and G6Z0 on 3.5 Mc. The same breeze may have helped QYZ work an HB9 and an ON4. PWJ wishes for antenna on 7 Mc. PZE still is trying for WAS. Cal schedules 8LUS, who started him in radio in 1936. PF still is "tripping" but always hopes to return to the air when he gets back. LGK builds three-element beams from wood, wire, and tape. KDC had dead heat in construction of television and big rig. Video novelty is claiming attention, however. Traffic: W2TYU 787, RTZ 189, QYZ 170, TUK 170, OBU 91, EC 48, SJC 41, BGO 26, JBQ 13, IXZ 12, RQJ 8, LGK 7, PF 7, PWJ 2.

NORTHERN NEW JERSEY — SCM, John J. Vitale, W2IIN — Asst. SCM, T. J. Lydon. ANW. SEC: GMIN. NNNJ Net, 3630 kc., 7 p.m. except Sundays. NY Phone Net, 3900 kc.; 9 a.m. Sundays. TRN is operated by Rutgers Amateur Radio Club. 4MJC/2 is president and NCS of the College Net on 3900 kc. Fridays at 5 p.m. with SCR-399 and NC-101X. GVP reports 28 countries and 46 states on 7 Mc. CQB's shipmate on the SS *Pankraft* is WUD, with 140 watts to an 828 on 7 and 28 Mc. also n.f.m. 500 watts to pair of HK257Bs. Receiver is NC-173. LTP has 87 countries, and with new antenna for 3.5 and 7 Mc. made 610 QSOs and WAS in recent SS. UWN, WEY, and HRN are working 144 Mc. with 522s. HRN also is mobile. WEY also is on 28 Mc. NRA is on 3.9-Mc. phone with new 300-watt rig, p.p. 35Ts. TXG is back home and on 28 Mc. again. RCL is pounding brass on 7 Mc. NNNJ Net reached a new high in traffic-handling over the holidays. The UCARA wishes to express its sympathy in the passing of 1KKS. In a plan being developed for emergency operation in Elizabeth, the Red Cross and UCARA expect to permanently install at R. C. Headquarters, high- and low-frequency equipment and have ready some fixed portable and mobile emergency-powered equipment. IIN is the EC for Elizabeth. UCARA meetings are held the second and fourth Mondays at Elizabeth YMCA. PIX is president. NDL/3 now is RM and ORS and still a regular member of NNNJ Net. OEC is sorry to lose 9EHR to the Merchant Marine circuits. BZJ, EC, for Freehold has a Navy VFO transmitter, 50 watts with battery supply in operation for 3.5- or 7-Mc. bands, and also is helping to organize the USNR Net in this area. Every two months the NNNJ Net rotates the NCS so that everyone in the Net will have a turn at control-handling. They are appointed at the bi-monthly meeting, held at Elizabeth YMCA the first Wednesday of the even-numbered month. The next one will be April 7th at 8:30 p.m. All ORS and interested traffic-handlers are invited. BRC is working on plans for a 7-Mc. traffic net for NNNJ. The Inter-City ARA of Irvington is sponsoring checker matches over the air. PDL, the local EC, is doing very well organizing AEC. QLF reports that the "EK" (Electronic Key) Net is very active. Get in touch with GID

(Continued on page 98)

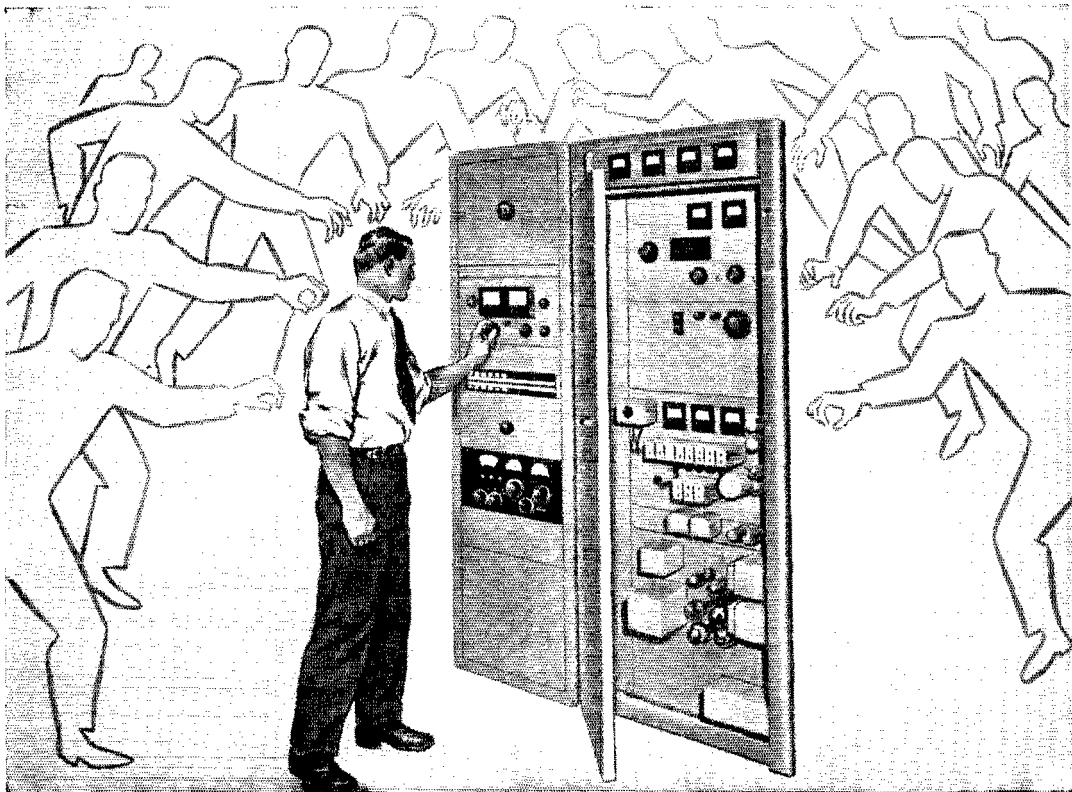

How Much Competition Have You

... For Your Present Job — For a Better Job?

Again employers can afford to be "selective", particularly when there are thousands of new, ambitious, young men who have entered the radio industry since the war. This means both you newcomers and "old timers" must improve your technical knowledge not only to qualify for the better job you want, but to hold the job you now occupy.

Your own success in radio depends upon the effort you make *now* to fortify yourself with modern technical training. You may have "gotten by" up to this point. But, if you are like some radiomen, many wartime and postwar technical advances of the industry have passed you by. If you want to progress with the industry . . . if you want an important, good-paying position and future security — you must acquire up-to-date technical training.

We invite you to investigate the CREI proved program for professional self-improvement for which thousands of radiomen have enrolled since 1927. CREI can help you by providing down-to-earth, practical technical training that should equip you to advance to the better-paying radio jobs that offer security and happiness. CREI home study courses are adaptable to the needs of every radioman — for the man who is just beginning or the man who wants advanced engineering training.

CREI courses are still available at pre-inflation prices, and today give you *more thorough instruction service* per dollar than ever before — on convenient terms. The facts about CREI and what it can do for you are interestingly described in our 24-page booklet. *Send for it today.*

Mail Coupon for FREE BOOKLET

If you have had professional or amateur radio experience and want to make more money, let us prove to you we have the training you need to qualify for a radio job. To help us intelligently answer your inquiry — in writing, PLEASE STATE BRIEFLY YOUR BACKGROUND OF EXPERIENCE, EDUCATION AND PRESENT POSITION.



VETERANS! CREI TRAINING AVAILABLE UNDER THE "G.I." BILL!

Capitol Radio Engineering Institute

An Accredited Technical Institute

DEPT. Q-3 16TH AND PARK ROAD, N. W., WASHINGTON 10, D. C.

Branch Offices: New York (7): 170 Broadway • San Francisco (2): 760 Market St.

CAPITOL RADIO ENGINEERING INSTITUTE
16th & Park Rd., N. W., Dept. Q-3,
Washington 10, D. C.

Gentlemen: Please send me your free booklet, "CREI Training for Your Better Job in RADIO-ELECTRONICS," together with full details of your home study training. I am attaching a brief resume of my experience, education and present position.

Check Practical Radio-Electronics
Course Practical Television

Name

Street

City Zone State

I am entitled to training under the G.I. Bill.

Munger ELECTRO-BEAM ROTATOR

A Sensational Value!

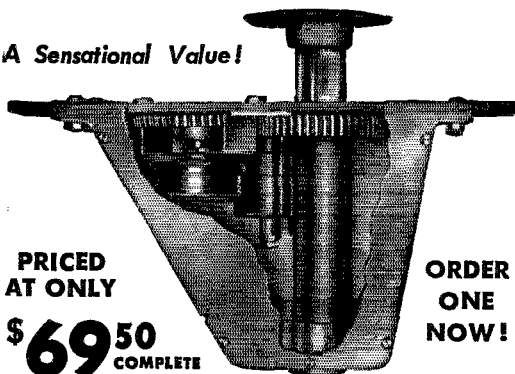

PRICED
AT ONLY

\$ **69.50**
COMPLETE

ORDER
ONE
NOW!

- Price Includes Reversible Electro-Beam Rotator and Accurate Direction Indicator.
- Foolproof Potentiometer and Meter Circuit. Calibrations in Both Degrees and Directions.

Inquire About Our
Time Payment Plan



Don't Lose Those Good QSO's While Turning Your Beam by Hand

There's no longer any need to run down stairs, out in the backyard to turn your beam. The Munger Electro-Beam Rotator's positive-action drive saves you those trips in any weather, any time of the day or night. A reversing switch mounted on the calibrated direction indicator permits you to peak up your own and received signals in a few seconds. Enjoy the thrill of holding those rare DX contacts right through heavy QRM! Ruggedly built for all-weather, year 'round operation without attention. Swings any 10 meter beam or a light 20 meter array at 1 R.P.M. Rotator weighs only 10½ lbs. 115 V., 60 cycle operation.

FREE Inspection Offer — No Risk

Send your check for \$69.50 for one Electron-Beam Rotator complete with Direction Indicator and instruction sheet. Pay small shipping charge upon arrival. If you are not completely satisfied, return the units in ten days and your money will be instantly refunded in full. You can't go wrong! Order your Munger Electro-Beam Rotator today! (Control-power cable supplied at 10c per foot in 50' or 100' lengths.)



W9LUP

Illustrated Bulletin on Request
MANUFACTURED AND SOLD
EXCLUSIVELY BY

Rex L. Munger Company

4701 Sheridan Rd.,

Chicago 40, Illinois

for information. The NNJARA of Hackensack is active in organizing AEC in Bergen County with DZA, Bergen County EC, as chairman of emergency committee. TZF has 522 on 144 Mc. DRA's nephew, WLJ, is pounding brass on 3.5 and 7 Mc. DAB is on 14-Mc. 'phone. ZT is OO and has quite a lab for frequency-checking. GFG added audio diode limiter. MRG and BF (OOs) were splitting cycles during the last FMT. ANW is very busy with NNJ Net six nights a week and TL "C." IIN will be glad to talk to your club about the AEC. Just write or phone me. OSQ, GJC, BWI, and IIN have 522s and five-element beams on 144 Mc. Traffic: W2OEC 1565, LFR 583, CGG 364, ANW 382, CQB 177, NCV 108, CWK 107, PPH 76, DRV 75, NKD 44, MTV 35, APL 18, ANG 16, BRC 14, BZJ 13, CJX 12, BLS 12, OXL 12, IIN 11, QLF 8, GVZ 4, TRN 3, MIG 2, LTP 1.

MIDWEST DIVISION

IOWA — SCM, William G. Davis, WØPP — QVA has new Stancor 202A transmitter and works all c.w. bands. WMP is building a ½-kw. c.w. rig. BGU has new rig using BC-610 tuning units with 807 final. NLA is converting surplus ART-13 and SCR-522. SWW worked 20 Gs on 28 Mc using 60 and a doublet antenna. LAC now reports in on the Iowa 75 'Phone Net. A sleet storm took SEF off the air for a week. CNK is back on the air for the first time since Pearl Harbor. FP, AFQ, LAC, SWI, HBG, TIX, TWX, QFY, OM, ETJ, LJE, ETT, WML, PP, and many others furnished communication for the southeastern section of Iowa during the emergency resulting from the New Years' Day storm. ETJ built a 'phone rig in forty-five minutes to get on the air for communication out of Ft. Madison. The c.w. boys handled AP news out of the area. Those participating were AUL, HMM, SCA, WMT, WNL, QVA, and ACL. FKB puts out a swell QSL. SQF is operating portable out of Great Lakes. AEH is talking up interest in 144 Mc. SQQ, on with new Federal surplus transmitter, had to use penetrating oil on the old wrist. QVA qualified and has been appointed OO. FP, Iowa SEC, got a workout during emergency. BAL is all set up in his apartment with 600 watts on 28 and 14 Mc. into a "V" beam. BAL, CK, OLY, and PP are polishing up new 304TLs. FP appreciated the efforts of "The Voice of the Iowa 75 'Phone Net" in his behalf on his birthday. Traffic: WØAUL 290, HMM 232, PP 56, TIU 48, FKB 26, AYC 13, SEF 13, ACL 8, HKN 8, OM 5.

KANSAS — SCM, Alvin B. Unruh, WØAWP — New appointments: ECs: CUL, HEC, VBQ, OBS; ES: L, OPS: PAH, ICV, and ESL, ORS: AHM. The Radio Communication Club of Haskell Institute, UTI, has been reactivated. Kansas State Radio Club, QQQ, has been organized with TLG, pres.; SJP, secy.-treas.; OPH, chief c.w. op.; CMY, chief 'phone op.; PAH, trustee. PAH has NC-173. OZA is on 3.85-Mc. n.f.m. PNN has VFO and p.p. 8005s with 300 watts. LIR received Class A. GOV is active on 'phone net with BC-610. NXJ is on with 6L8 on 7 Mc. IFR has p.p. V70s. CXF is active on QKS Net. IPI is active on 144 Mc. with HY75 and VHF-152. SRI has SCR-522. ZQJ has ten watts to four-element beam, all on 144 Mc. UNQ is active on 51.2 Mc. with 350 watts to p.p. 35TGs, four-element rotary (on 65-ft. tower), and VHF-152 ahead of Super Pro. Also active on 50 Mc. are ZKA, CLN, LSY, and UUS. Hams of the Wichita Police Department have organized a club. LFB is president-custodian, OKD, vice-pres.; and OZN, secy.-treas. KRZ is active on 7, 28, and 50 Mc. New calls are: EUU, AZZ, EIM (28-Mc. n.f.m.), and 5AZZ. KIW and ZEE are working 28-Mc. mobile. FMR substituted on 'phone net for ICV. ZMC and KKK have three-element beams for 28 Mc. Also on 28 Mc. with beams are KSY and UPU. Traffic: WØNCV 180, NJS 126, ICV 110, KSY 77, PZP 55, KØNAB 54, WØPNN 52, PAH 50, AEY 49, AWP 48, AWB 34, OZN 33, OAQ 31, WKA 23, WGM 18, CXF 16, BNU 15, AHM 8, IFR 8, HEC 8, FLZ 7, FON 6, VBQ 6, ISZ 4, FRK 3, JDX 3, LFL 2, LIX 2, PBX 2.

MISSOURI — SCM, Mrs. Letha A. Dangerfield, WØUD — Two things indicate we have just passed the holiday season. One is the high traffic totals and the other is the lack of reports. Topping the traffic list is QXO, with so many schedules it keeps him spinning. ARH was second although he was working nights and had to sandwich schedules into his spare hours. JWJ said the OM got tired of 28 Mc. and put a 3.85-Mc. antenna on the roof. Midwest Division Director DEA says he is too busy for schedules but not for rag-chewing. YSM works Trunk Line "L" and

(Continued on page 100)

TRULY HERMETICALLY SEALED... FOR POST-WAR PERFORMANCE

SEALED LIKE A VACUUM TUBE

100% GUARANTEED







Marion Glass-To-Metal Truly Hermetically Sealed Electrical Indicating Instruments are guaranteed for six months. You get top performance... critical accuracy... at a cost no more than that of most competitive unsealed instruments.

Additional economy is offered in Marion's special replacement offer. After the initial six-month guarantee expires, any 2½" and 3¼" type, ranging from 200 microamperes upward, will be replaced, regardless of whether the instrument has been overloaded, burned out, or mistreated... provided the seal has not been broken, for a flat fee of \$1.50. Instruments with sensitivity greater than 200 microamperes will be replaced for \$2.50.

MARION "4 FOR 1" FEATURE

Interchangeable Round and Square Colored Flanges... one instrument can thus fill four different needs:

1. ROUND 
2. ROUND FOR STEEL PANEL 
3. RECTANGULAR 
4. RECTANGULAR FOR STEEL PANEL 

Stop in at your nearest radio supply shop today and see the best in electrical indicating instruments... the Marion line.

MORE EXTRAS WITH MARION "HERMETICS"

DURABLE
... Unaffected by extremes of heat or cold... permanently protected against dust, dirt, moisture
... instrument malfunctioning eliminated.

SHIELDED
... Heavy steel case gives magnetic and electrostatic shielding so important in modern high frequency equipment.

INTERCHANGEABLE
... The Marion case, with its high conductivity plating, eliminates the need for separate shielding and permits interchangeability on any type of panel without affecting calibration.

DRESSY!
... Marion "hermetics" are supplied with either round or square flanges in black... or any one of 12 iridescent colors at no extra cost.



MARION ELECTRICAL INSTRUMENT CO.

MANCHESTER, NEW HAMPSHIRE

Export Division 458 Broadway New York 13, U. S. A. Cables: MORHANEX

THE NAME "MARION" MEANS
THE "MOST" IN METERS

IN CANADA: THE ASTRAL ELECTRIC COMPANY, SCARBORO BLUFFS, ONTARIO

Now...

the "Slipstick" Wavemeter*

DM-103-W

The Decimeter Slipstick fills a real need for the first time ... it gives quick frequency readings on oscillators, receivers or transmitters.

- Enormous range, 90-3000 MC
- Rapid direct-reading scale
- 2% accuracy or better
- Sturdy construction
- High-Q polished silver finish

REASONABLY PRICED

Remember . . .

✓ DM-240-A Oscillator for 2400 MC receivers and transmitters

✓ Decimeter Decals on your rig for professional appearance

✓ Silver-Q Flux for perfect radio soldering

*For further information write for Bulletin 11-B

DECIMETER

INC.

1430 MARKET ST. DENVER 2, COLO

MON. GCL is working 7 Mc. GBJ is still on 14 Mc. AOP helped W. U. in storm emergency. DQY is a new ham at O'Riley Hospital. KIK is putting in lots of overtime on MON. SKA has upped power to 100 watts, and runs six schedules between 6 and 9:30 P.M. TLW is building a station unit of duraluminum that will contain transmitter, receiver, and operating position. OUD's 100 watts and vertical C antenna is bringing forth surprising reports early in the morning. VMO is organizing the Springfield AEC to work on 3995 kc. at 8 A.M. alternate Sundays. The old 75-meter 'phone net is being revived by VMI and KRC on 3903 kc. — time 12:30 P.M. on Wednesday and 10 A.M. on Sunday. CMARC is moving the club transmitter to the police station where it will have auxiliary power and can work closely with police and Highway Patrol in emergencies. ROB was on 3.5-Mc. c.w. because a throat operation kept him temporarily off 28-Mc. 'phone. That's one solution for the 'phone QRM problem although a little extreme. That's all, gang, but it makes a better showing than I expected. I hope to hear from more of you in 1948. Traffic: W0QXO 275, YSM 77, ARH 71, OUD 53, SKA 52, VMO 40, KIK 27, ECE 12, DEA 4.

NEBRASKA — SCM, William T. Gemmer, W0RQK — FHA is a new ham at Chadron. EXP has a new NC-183. DNW received a VHF-152 for Christmas. GPX recorded and played back the voices of the North Platte 28-Mc. 'phone gang with his new wire recorder, to the astonishment of many of the gang. FQB says UPY has a new 28-Mc. three-element beam. EAO, formerly of Chicago, now is active in Omaha with 300 watts. EHD, a new ham in Omaha, is active on 28 Mc. with an HT-9. EIL reactivated in Omaha with HT-6. LHZ is with CAA in Kansas City. The Ak-Sar-Ben Radio Club purchased a Micro Match for use of club members. Thanks, FQB, for all the dope. EXJ boosted power to 975 watts. CMO is rebuilding antenna coupler for 3.5-Mc. c.w. operation. UBN is on 14 Mc. with BC-610 and three-element beam and has worked some of the rare ones such as PK2GA. He is hearing them on an NC-173. ZOQ received a D-104 mike from Santa. RWV borrowed an accurate voltmeter and found he is running only 60 instead of 150 watts. The North Platte Amateur Radio Club set a tentative date of June 6th as the day for the hamfest. TQD racked up a traffic total of 1463 this month. The c.w. net needs outlets around the State. ECs are needed in the State. Drop a line stating your interests. Is anything new happening around the State that your neighbors might want to know? Send it in for the Nebraska report. Traffic: W0TQD 1463, FAM 67, FQB 44, SAI 27, HYR 19, RWV 16, VMP 13, ZNI 12, NVE 8, AMY 4, DHO 3, JED 3, COU 2.

NEW ENGLAND DIVISION

CONNECTICUT — Acting SCM, Walter L. Glover, W1VB — FTX and JJR are rebuilding. Rod, of AW, complains that too many holidays upset his traffic total. Tom, ex-8YCK, now QVF, is new operator at AW. BDI is handling some traffic on 144 Mc. 3HUM is moving to Hartford and will be an asset to the Nutmeg Net. NJM states the rig is a mess. Sounds OK on the air. George. CARA members meet on 3539 kc. Mon. nights at 8:30. JHN and TD are working on kw. finals. NWC has new e.c.o. EUG and MVH are experimenting with television receiver. JAK, BHM, and OTD are looking for more DX. KQY, in Hartford for two weeks, visited BDI, AW, INF, and Manchester Radio Club. MSB is busy with architect work. OKX and IGT are on 3.5 Mc. LVX is on the sick list. AGT has moved. FMV is back on 3.5 and 7 Mc. Bob Oberst, in Laurel Heights Sanatorium, is looking for a code oscillator to practice for his ticket. Can any of the gang help him? QVJ, in Westport, just received his ticket. EMF is transmitting code practice on 28 Mc. FSH worked G5MU and ON4AU on 3.5 Mc. DJC worked ZL3LE on 28 Mc. at 7:45 P.M. QUJ is a new ham in Rockville. The Manchester Club has been assigned the call KKS, a fitting tribute to Bill Matchett. LKF is organizing Connecticut River Valley Net in cooperation with Hartford Weather Bureau. EFW, RM, is planning second edition of *Nutmeg Net Bulletin*. CTI is on the air again after a layoff. INF reports into TLAP now and then. ARB has new VFO perking nicely. VW, SEC, requests that all ECs send in monthly reports on their activities to him. This is important if we are to have a live Emergency Corps in this state. Let us show the rest of the country Connecticut is on the map. VB finally finished 14-Mc. final and now has

(Continued on page 102)

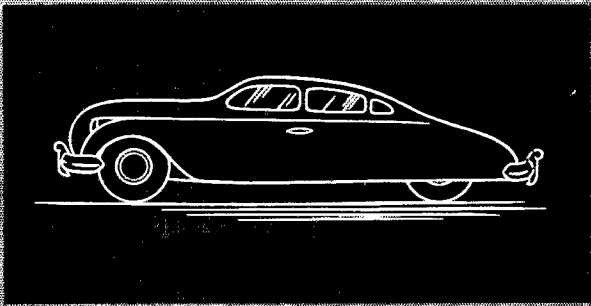
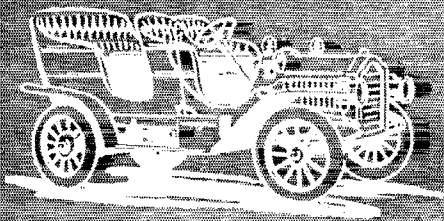

MODERN DESIGN IS COMPACT!

Ken-Rad miniature tubes — compact — do all their larger counterparts will do, while conserving needed space.

NO NEED to jam-pack every cubic inch of chassis area... not with Ken-Rad miniatures available! *Now* you can add new circuit features to your rig without overcrowding or loss of accessibility.

Front and center for the nine-pin 12AU7, newest big-league performer in Ken-Rad's line! Lots of tube here in small compass; for this husky midget, with a filament taking either 6.3 or 12.6 volts, does the full job *plus* of a 6SN7-GT or 12SN7-GT!

Use the twin-triode 12AU7 as two audio-amplifier stages, self-contained—or with one unit functioning as an audio-amplifier, and the other as a phase inverter. Other applications will develop as you become familiar with this tube, since structurally it is the equivalent of two 6C4's.

Lead inductance, of course, is low. That's because (1) the internal leads of the 12AU7 are short due to ultra-compact tube design, and (2) the tube, like all miniatures, has no base, therefore external lead inductance is reduced.

Your Ken-Rad distributor or dealer will be happy to show you the 12AU7, as well as other tubes in the extensive Ken-Rad miniature group. See him today!



**12 A U 7
NINE-PIN MINIATURE**

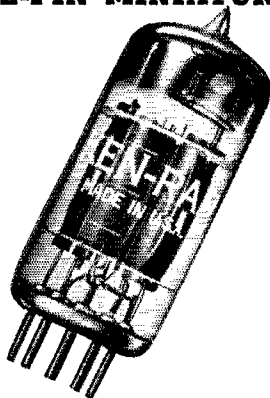

**TYPICAL OPERATION
CLASS A₁ AMPLIFIER
(each triode section)**

Plate voltage	250 v
current	10.5 ma
Amplification factor	17
Transconductance	2,200 micromhos

KEN-RAD *Radio Tubes*

PRODUCT OF GENERAL ELECTRIC COMPANY

Schenectady 5, New York

178-GA4-8880

Make the nearest Ken-Rad distributor or dealer your preferred source for amateur tubes



**PILOT
LIGHT
ASSEMBLIES
WILL BEAUTIFY YOUR
INSTRUMENT PANEL**

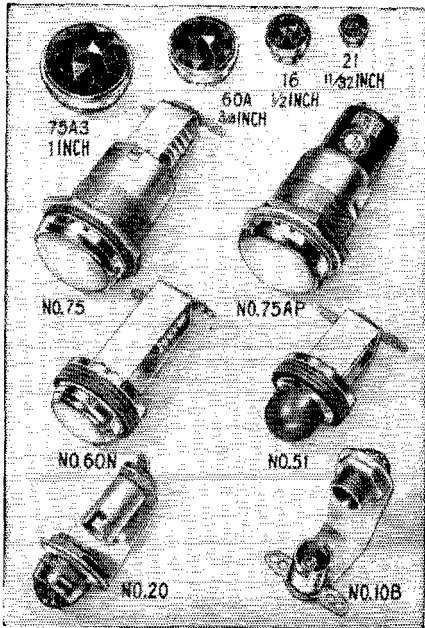

Give your instrument panel that professional look with *Drake Jewel Light Assemblies!* These highly finished glass jewels and bull's-eyes, attractively mounted in polished chrome-plated holders, are exactly the same as those used by leading commercial manufacturers throughout the country. Efficient, good-looking, well made—*Drake Pilot Light Assemblies* will give you the best in performance and, at the same time, real pride in the appearance of your panel.

Ask your local jobber to show you the big Drake line. If he doesn't have a complete stock, write us for Catalog Q — just off the press.

**Socket and Jewel
LIGHT ASSEMBLIES**

**DRAKE
MANUFACTURING CO.
DEPT. Q, 1705 W. HUBBARD ST., CHICAGO 22**

separate finals on 3.5, 7, and 14 Mc. running over 500 watts. Please send your appointment certificates to the SCM if they need endorsement. Monday Nighters, two-meter net, reports Jan. dinner enjoyed by QMR, PRT, PGT, PEN, OLG, OA, MBK, LXB, LIH, IKX, HOP, HAX, FKF, FWH, and BDI. Traffic: W1NF 236, NJM 224, AW 218, VB 218, EFW 204, KQY 158, DAV 146, BDI 95, ADW 92, LKF 64, ORP 59, FTX 37, DXT 12, T2, CTI 8, JJR 6, BGJ 3.

MAINE — SCM, F. Norman Davis, WIGKJ — PAM: FBJ. SEC: LNI. RM: NXX. PAWA News: AQL was a visitor at a recent meeting. QDO is expected to visit the club before leaving us to become a KP4. The club transmitter will use a pair of 304THs in the final. Attendance at the meetings has been fine with a few new fellows showing up every week. New folding chairs have been ordered to take care of the growing membership. University of Maine News: QEQ gave an account of his experiences with radar at one of the club meetings. JOL is building up a rig using a pair of 100THs. MDM is on c.w. with an 807. KYO also is using an 807 on 3.5- and 7-Mc. c.w. and says there is no room for a bigger rig in his trailer if he is going to live in it! DX has been good on 3.5 Mc. of late. BPX and DLC each worked a ZL. ECM, FO, IGW, LNI, and QQY all have SCR-522s on the air. GKJ now is using a pair of 810s in the final at 500 watts. AMR and FBJ have been on 28-Mc. 'phone quite regularly. AUC has gone to Florida for the winter and listens on 28 Mc. for the boys back home. ECs: Please remember to make your reports to the SEC promptly on the first of the month so he can make out his report by the fourth. We need more ORS. How about dropping a post card in the mail asking for an application? PNM, son of KTT, now is on 3.85-Mc. 'phone. JRS claims his call has never been in this column. Wonder whose fault that is? Traffic: W1NXX 200, LKP 74, OHY 27, GKJ 25, FBJ 24, JAS 19, AFT 17, VV 16, AMR 6, ODA 6, AI 3 NHT 2.

EASTERN MASSACHUSETTS — SCM, Frank L. Baker, jr., W1ALP — A new section of the Eastern Mass. Net, on 3745 kc. Monday through Friday, 6:15 p.m. to 7 p.m. is being started for new hams, old 'phone men (hi) and any others interested. The TOP SPEED is 15 w.p.m. If interested, drop a card to CCF in Haverhill. The old section of this Net will be on at the same time from 7 p.m. until QNF. New ECs: AY for Dartmouth; QMJ for Norwell; BKR for Westford, Tyngsboro, Carlisle, and Littleton. VDY is new OO Class I, II, IV. OJM now is OO, Class I, II. The following have renewed appointments: WL, MTQ, AGX, HA, TY, as ORS; GOU, GDY as OBS; GOU, HIL, JXU, LXQ, GDY, MRQ, DJ as OPS; HIL, KYX, KCT as EC; KTE as PAM for 3.85-Mc. 'phone. OMI made 556,297 points in the SS. QQD, QS, BNS, and FI are on 3.5-Mc. c.w. JNW is on 3.85-Mc. 'phone. AKN's boy now is QJS. QPY is on 144 Mc. The Suburban Radio Club in Everett held an election of officers: KMR, pres.; JTR, vice-pres.; MGQ, treas.; Arnold Finley, secy. QEP has new rig on 28 Mc. BHD has 300 watts n.f.m. on 14 and 28 Mc. KRD, on 14-Mc. c.w. keeping schedules with Kansas City pals, will have a 500-watt rig for 'phone bands. EL's famous 829-B still is going to town. NBM is on 14,272 kc. from Japan using call J2AHA. Submarine Signal Amateur Radio Club elected new officers: JLI, pres.; BWH, vice-pres.; QUN, secy.-treas.; FBX, chief eng.; KAE, act. man. PIM and KVQ are experimenting with television receivers. MF is chairman of the committee on an emergency set-up for the Yankee Radio Club. IYU gave a talk before the Brockton Radio Club. The T-9 Club held a meeting at IPK's. The Framingham Radio Club had a 50-Mc. discussion. NXM gave a 420-Mc. talk and demonstration at the South Shore Radio Club. WK gave one on "Successful Operating." ZI gave a talk at Eastern Mass. ARA on "Electronic Computers." LXQ checks in on Seagull Net. BWN is on 14-Mc. 'phone. LAO has rotary on 28 Mc. GAD sends code practice each night on 28 Mc. JTY/CTD also has a beam on 28 Mc. AWM is on 3.5-Mc. c.w. MDU has a bandswitching exciter and a beam on 28 Mc. OBN worked CM6AH with 8 watts on 7 Mc. NF is getting out on 50 Mc. very well. ORT has HT-9s on 14-Mc. 'phone and 3.5-Mc. c.w. CMU worked F3MS and HBAW on 3.5 Mc. QQJ is on 28-Mc. 'phone. EMG is very busy with drills for National Guard. AGX has been helping 5JHS, the SEC for Mississippi, with tests on a beam. BB says all his beams are still up. LMU is going on 3.5-Mc. c.w. FUR received a Millen 50-Mc. rig for Christmas. AGR will have 1 kw. on 3.9 Mc. KVX worked G5BY

(Continued on page 106)

Scoop!

GIANT SAVINGS ON FAMOUS HAMMARLUND XMTG EQPM

IN KIT FORM

Save \$80.50 on

HAMMARLUND FOUR-20 XMTR
Regularly \$120.00
Radio Shack
Kit Price

\$39.50

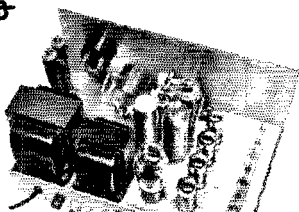

includes complete set of parts, punched chassis and cabinet, meter, tubes, sockets, resistors, capacitors, wire, insulation, screws, nuts, switches, knobs, and 10-meter coil.

EVERYTHING YOU NEED TO ASSEMBLE A GENUINE HAMMARLUND FOUR-20 XMTR by following the detailed instructions we furnish . . . schematic diagram, alignment data, pictorial construction details. . . YOU CAN'T GO WRONG!

THESE FAMOUS XMTR FEATURES:

- ★ all-band operation; 80-40-20-11-10 meters
- ★ crystal control (3.5-4 mc fundamental)
- ★ CW or phone operation
- ★ built-in, self-powered, high-speed keying relay
- ★ efficient, sharply tuned oscillator and multiplier circuits
- ★ single-dial tuning; four-gang condenser tunes xtal and three doublers
- ★ variable output matches 50-600 ohms
- ★ 100-mil meter switches to meter each r.f tube
- ★ power input 35 watts at 105-120 volts 50/60 cycles
- ★ tubes include 7C5LT (4) ocs., 1st, 2nd, and 3rd mult., 807 final amp., 5U4G rect.

★
Coils for 11-20-40-80 meters.....each \$1.70
Crystal for Four-20 (Bliley or Valpey)..... \$2.80

Save \$430.00 on

HAMMARLUND FOUR-11
MODULATOR

Regularly
\$72.50
Radio Shack
Kit Price

\$29.50

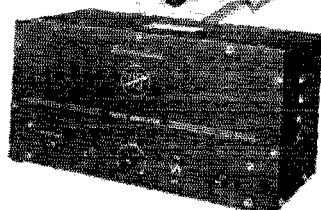

includes complete set of parts, punched chassis and cabinet, tubes, sockets, wire, screws, nuts, resistors, capacitors, insulation, switches, knobs, and instructions.

THIS KIT OF GENUINE HAMMARLUND PARTS lets you put together the popular Hammarlund Four-11 Modulator. Just follow the clear, complete, written and pictorial instructions we furnish and you'll quickly have this unit working — and save yourself \$43.00.

Use the Four-11 with your present rig or your new Hammarlund Four-20.

YOU'LL VALUE THESE FEATURES!

- ★ eleven-watts of audio with less than 5% distortion
- ★ substantially flat in speech range 200-3000 cycles; drops off sharply above and below
- ★ high-impedance mike input
- ★ 8000-ohm output to match Four-20 transmitter
- ★ 110 DB gain
- ★ works on 105-120 volts 50/60 cycles
- ★ tubes furnished are: 6SL7GT 1st and 2nd AF; 6C5 phase inverter; 2 — 7C5LT PP pwr output; 5U4G rectifier.

ORDER THESE KIT BARGAINS TODAY!

It's a rare opportunity to own this high-quality gear at a never-before-possible price.

Send check or money order with your order; sorry, no C.O.D.'s.

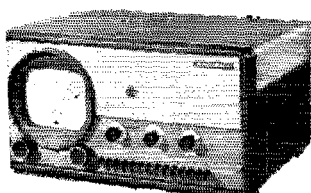

You've been hearing about it . . . here it is!

HALLICRAFTERS TELEVISION RECEIVER MODEL T-54

Compact, efficient, easy to operate, low-priced. Complete \$169.50

Order now from the Radio Shack for early delivery.

The RADIO SHACK Corp.

CABLE ADDRESS: RADIOSHACK
167 WASHINGTON ST., BOSTON, MASS., U.S.A.

Play as you Pay-the RADIO SHACK Way

SEE HOW EASY IT IS

It's easy now to fit up your ham shack with new, modern gear. Just choose what you want . . . whether it's a receiver, transmitter, amplifier, wire recorder, or test instrument . . . and send us only 10% of its price. Start using your new equipment right away . . . while you take a full year to pay for it.

Model No.	Net Price	Down Payment	Per Mo. for 12 Months
NATIONAL			
NC-46	107.40	10.74	8.54
NC-57	89.50	8.95	7.12
NC-173	189.50	18.95	15.07
NC-183	269.00	26.90	21.39
NC-240D	241.44	24.14	19.20
HRO-7	311.36	31.14	24.75
HALLICRAFTERS			
S-38	47.50	4.75	7.55*
S-40A	39.50	3.95	7.12
SX-42	275.00	27.50	21.86
SX-43	189.00	18.90	15.03
S-47	200.00	20.00	15.90
HT-9	350.00	35.00	27.83
Coils: 10M—\$10.50; 20M—\$15.50; 40M—\$11.75; 80M—\$10.85			
HT-17	69.50	6.95	5.53
Coils: 80M or 40M—\$3.50 per set; 20M or 10M—\$7.00 per set			
HT-18	110.00	11.00	8.75
HAMMARLUND			
HQ-129X	189.15	18.92	15.04
R.M.E.			
RME-84	98.70	9.87	7.85
RME-43	198.70	19.87	15.80
RME-152A	86.60	8.66	6.89 or 13.77*
RME-DB-22A	66.00	6.60	5.25
MEISSNER			
Signal Shifter	66.00	6.60	5.25
Coils: any band — \$4.00 per set			
Power supply — \$13.00			
SONAR			
VFX-680	87.45	8.75	6.95
Coils: any band — \$1.50 per set			
MB-611	72.45	7.25	5.76
HARVEY-WELLS			
TBS-50	99.50	9.95	7.91
50-watt xmtr with tubes and coils for 8 bands; less power supply			
WEBSTER			
Wire Recorder	149.50	14.95	11.89
SYLVANIA			
7" Scope	124.50	12.45	9.90
R.C.A.			
Voltohmyst 195A	79.50	7.95	6.32
Voltohmyst WV75A	125.00	12.50	9.94
Chanalyst 162C	162.50	16.25	12.92
3" Scope 155C	115.00	11.50	9.14
3" Scope W079A	550.00	55.00	43.73

We carry a full line of test equipment by RCA, Simpson, Supreme, Triplett, Precision, Dumont, Hickok . . . All available on our easy 10%-down deferred-payment plan.

BUY THE RADIO SHACK WAY . . . AND PLAY AS YOU PAY.

SPEAKER SPECIAL \$4.95

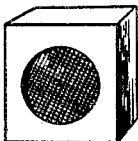

Jensen 6" PM heavy-duty speaker with 8-ohm voice coil. Mounted in grey-finished steel cabinet. A buy that's hard to beat at only \$4.95.

NEW AUTOMATIC KEY with monitor and keying relay \$29.95

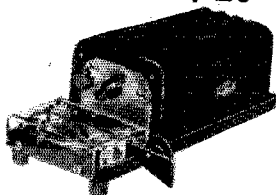

Keying perfection is yours with the "MON-KEY" electronic monitor and speed key. Faster and easier than conventional "bugs". Uniform electro-timed dots, dashes, and intervals at your choice of six speeds. Variable monitor tone from 2-inch dynamic speaker. Keying relay has 2-amp. contacts. Feather-touch aluminum key, with plastic knob, paddle, and transparent cover. Fully shielded in cast aluminum housing 11 x 4 1/2 x 4 inches—works on 110 volts a-c or d-c.

ABSORPTION-TYPE UHF WAVE METER

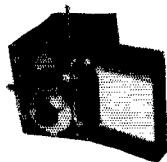

Complete with tubes \$29.50

Type BC 906 D coaxial pot wave meter for 160-220 MC. Diode rectifier, and amplification for aural or visual detection.



EIMAC

304-TH Brand New \$3.95 ea. JAN.-insp. 6 for \$23.20

TUBE SUPER SPECIALS

All brand new JAN-inspected

Westinghouse 807\$0.90 each 4 for \$3.10
826\$0.50 each 3 for \$1.45
832A\$1.50 each
866/866A\$0.75 each 6 for \$4.10
872/872A\$1.13 each 6 for \$6.29
3C24/G\$0.49 each 6 for \$2.25
316A\$0.45 805\$3.75 each
6C410 for \$1.50



NEW LOW PRICES ON POPULAR TUBES

Type	Net	Type	Net	Type	Net	Type	Net
2C34	\$0.45	2X2	.30	VR150	.75	1626	.25
2C40	.45	801	.75	931A	1.87	1629	.15
2D21	.60	803	9.00	954	.23	1651	.75
3B24	.75	809	1.50	955	.23	8005	3.15
3BP1	1.50	811	1.95	957	.30	9001	.23
5BP4	1.73	813	6.00	958	.38	9002	.30
6AK5	.60	815	2.25	959	.38	9003	.23
211	.37	836	1.00	1619	.15	9004	.23
6C21	13.50	874	1.95	1625	.15	9006	.23
3E29	1.50	VR105	.75	1624	.45		

Minimum tube order \$2.00

Meter Specials



You'll find these popular instruments mighty handy . . . and at these low prices they represent real values.

A-C VOLTMETERS	
0-1 volt, Western Electric, round, 3", rectifier-type\$3.95
0-8 volts, Weston 476, square, 3"	3.49.
R-F AMMETER	
0-1 ampere, G.E. and Westinghouse thermocouple-type, round, 3"	4.95
D-C VOLTMETER	
0-3 volts, Gruen, round, 2"	2.19
DC MILLIAMMETER	
50-0-50 ma., Weston 301, round, 3" ..	2.95

BRAND NEW: CW3 RADIO RECEIVER only \$10.95

Highly selective crystal-controlled superhet for fixed-frequency operation in 1900-16,500kc band. Has variable BFO, r.f. sensitivity control, audio peak limiter, built-in power supply for 115 volts a-c; rack mounting. Furnished with full set of 7 tubes; less plug-in coils; detailed instruction manual included.

Standard or Surplus—its here at the Right Price

BRAND NEW G.E. BC-645A — ONLY **\$9.95**

Get going on 420 with this "hot" xmtr-rcvr for phone and i.c.w. Originally priced over \$2000, they cost you less than the price of the 15 tubes you get with the outfit. Full conversion instructions furnished.

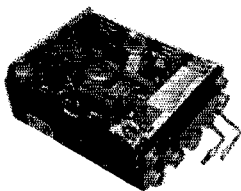

BRAND NEW GE SELSYNS **\$4.95 PER PAIR**



they'll give you permanent, efficient performance.

Ideal for beam position indicators and many other uses. You can run these splendid selsyn control transformers at 35 volts 60 cycles and

Genuine "MAC" Key



Model 200 69c

BC-221 FREQUENCY STANDARD **\$36.95**

Fundamental ranges 125-250 and 2000-4000 kc; stability better than 0.005%; works on 110 vac, batteries, or vibrapaack. Use it for a signal generator or to make a wonderful VFO. Complete with tubes, original crystal and calibration charts. Used but excellent working condition

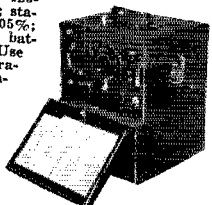

BC-221-AK with built-in modulation **\$79.50**

R-5/ARN-7 RADIO COMPASS UNIT

ONLY **\$19.50**

Brand new unit for 100-1750 KC service. Complete with tubes and instruction book. Designed for 28 v-d-c.



PE-103 DYNAMOTOR **BRAND NEW—only \$6.95** (less base)

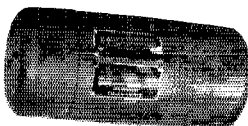

Here's your opportunity to get one of these popular units at a rock-bottom price. Operates from 6 or 12 volts d-c; delivers 160 mils at 500 volts d-c.

54-foot ALUMINUM ANTENNA MAST **Brand New \$79.50**

Here's the antenna mast you've always wanted! Six sections of rigid, 24-ST aluminum tubing, telescoping together with silver-plated spring brass contacts between sections; 3" OD at base; 2" OD top section. Welded steel base 12" square by 12 1/2" high has phenolic sleeve insulating mast from base.

Brand New J-36



\$6.95

You'll be pleasantly surprised at this value... its counterpart has been sold by a well-known speed key manufacturer at more than double our bargain price. Made for the Signal Corps by Lionel Corp.; supplied complete with cord, wedge plug, and switch.

TS-10 SOUND-POWERED HANDSETS



No batteries needed... yet these handsets let you talk up to 12 miles. Use them outdoors, indoors, anywhere... they're sturdy, dependable, trouble-free. Order yours today...

BRAND NEW \$15.00 each \$27.95 per pair

Protect your rig with this HEINEMANN CIRCUIT BREAKER

89¢ each 10 for \$8.50

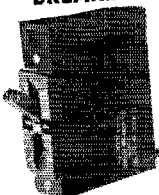

Better than fuses. Carries starting surges but trips on sustained overloads. Resets at finger touch. Can be tripped manually and used as on-off switch. SPST; 4, 15, or 20 amp. ratings at 117 volts. Specify current. Brand new.

BC-788-AM XMTR-RCVR for 420 mc. Complete with tubes **\$11.95**



Here's a real bargain — a complete transmitter-receiver for 420 mc. work. Fourteen tubes include 3-2J6, 9-6AG5, 1-6L6, and 1-5Y3. Six wide-band I.F. stages. Has 98,356 KC crystal. Details on page 53 of QST for November 1947.

TELEVISION

is about to break in our territory. Make the **RADIO SHACK** your headquarters for parts, tubes, kits, receivers, antennas!

The RADIO SHACK Corp.

CABLE ADDRESS · **RADIO SHACK**
167 WASHINGTON ST., BOSTON, MASS., U.S.A.

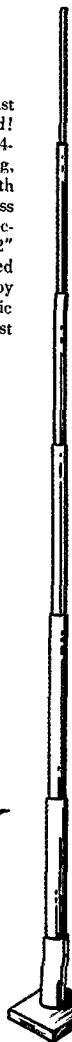

Have a "fist
like a tape"
with...

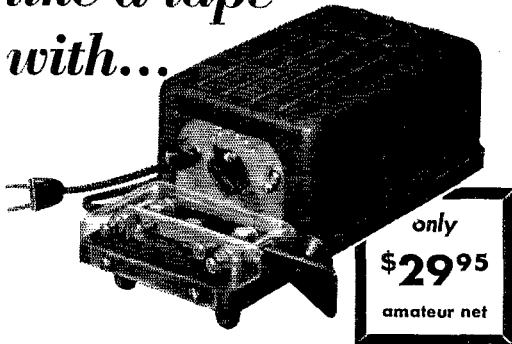

Electronic

MONITOR and SENDING KEY

Now you can send code like a professional. MON-KEY gives you electro-timed rhythm... with dots and dashes made for you... perfectly spaced and uniform for your sending speed.

Simple... Easy to Use

Press the key to the right and you get dots... evenly spaced. Press left and you get a series of evenly spaced dashes. Just relax and let the code roll out with the most perfectly timed rhythm you ever heard. Send fast or slow... there's a dial setting to regulate speed. It's a monitor, too, producing a clear tone that can be regulated for volume and tone or cut out entirely.

Compact... Precision Built

This compact unit is only 11" x 4½" x 4½" high. Plastic base, rubber feet, cast aluminum housing with black crackle finish, transparent plastic dust cover for key. 2" dynamic speaker. Uses only 3 tubes including rectifier. Fully shielded. 110 volt A.C. or D.C.

Designed by experienced electronic engineers... tested by experts... tried out and enthusiastically approved by amateurs and professionals alike.

MON-KEY is easy to learn, easy to use, easy to read. This combination sending key, monitor, and keying relay costs you only \$29.95. Get yours today and go on the air with a near-perfect fist. See your dealer or write for descriptive folder.

ELECTRIC EYE EQUIPMENT CO.

6 West Fairchild St., Danville, Ill.

Manufacturers of Specialized Electronic Controls and Inspection Devices

(Continued from page 108)

on 50 Mc. BR is working on an SCR-522. Stations heard in on new section of E.M.N. at 6:15 P.M.: PLQ, QQD, NBS, UE, BL. ECs reporting in on Sunday tests: PLQ, BKR, EK, BL, NBS, MCR, MRQ, ALP, FIK, UE, AHP, COX. QKX is building new 400-watt rig. Traffic: (Nov.) W1OJM 45, JDP 5, AGX 4. (Dec.) W1CCF 348, JCK 205, LML 162, BDU 152, EPE 121, PYM 74, AQE 61, LM 50, BB 40, TY 26, DWO 19' EMG 13, QHC 6, HA 5, LAO 4, AGX 3, MGP 3, MRQ 3.

WESTERN MASSACHUSETTS — SCM, Prentiss M. Bailey, W1AZW — RM: BVR. SEC: UD. New appointees this month are MUN and MND as OO. GVJ, OMI, and BDV are new OPS. BDV is also ORS. JAH has an SCR-522 and is trying to find time to convert it. IHI is doing a swell job of controlling the 'phone net. JE has new VFO and gets around in the different nets. IBZ got his Class A. He sends official bulletins on 28,576 kc. EOB is busily working on the outfit at KINRU. HNE worked G5BB on 3.85-Mc. 'phone using but 41 watts. COI has been busy putting complete bandswitching except for final. BVR craves more traffic. BVR's RM appointment was renewed. The Westfield Amateur Radio and Emergency Communications Assn. elected new officers. NZB, BVR, PKI, and PIR hold offices. New ECs are NLE, Springfield; BVR, Westfield; NY, Wilbraham; MBT, Chicopee Falls; MIV, West Brookfield and control station on Mt. Tom; and CQC, Worcester. A new club in Northampton is called the A and B Club. Active members are PLF, PLE, QCC, QEB, OCG, NGH, LJQ, OKR, and PWF. NLE is member of Red Cross Communications Committee in Springfield. He has secured a room and antenna location at R.C. headquarters. PHU has new transmitter. QUQ has BC-610 and three-element rotary. LRE, CCH, and KZU are experimenting on 430 Mc. KK has a beautiful n.f.m. signal. NY was called on by local press to relay press to Pennsylvania when lines were down due to ice in New Jersey. A new organization, tentatively named the Connecticut Valley Amateur Radio Council, is being organized. KUE is acting secretary. JGY is making VFO from TU5B tuning unit. The Pittsfield Radio Club has acquired another gas-driven generator. BEG, as OO, brought an illegal station to FCC's attention. OIJ is back on with a BC-610E. Traffic: W1BVR 83, JE 33, IHI 26, AZW 26, BDV 17, BV 14, GVJ 8, IBZ 4, JGY 2.

RHODE ISLAND — SCM, Clayton C. Gordon, W1HRC — INU is on NENET and TL "C" daily at 7 P.M. GR and
(Continued on page 108)

VERMONT QSO PARTY

April 10-11, 1948

Here is your chance to get VERMONT for WAS!
Time: Saturday 6 P.M. EST to Sunday 6 P.M. EST.
There will be no time limit and no power restrictions.
Scoring: FOR STATIONS OUTSIDE OF VT., 5 points per contact with each Vt. station, total points to be multiplied by the number of different Vt. cities or towns worked. FOR STATIONS IN VT., 5 points per contact with each Vt. station, 1 point per contact with stations outside Vt., total points to be multiplied by the number of Vt. cities and towns worked.

Exchange of information required: Stations outside Vt. give RST (or RS on 'phone) report, plus their city or town and state. Stations in Vermont give RST report plus their city and town. Contest reports must list all information exchanged. The same station may be worked for additional credit on another band, 'phone or c.w. The general call will be "CQ VT" on c.w. and "CQ VERMONT" on 'phone.

Scores must be received not later than May 1, 1948. The decisions of the Committee will be final. Reports and scores should be mailed to Burt Dean, WINLO, P. O. Box 81, Burlington, Vermont. Committee members include W1GKA, WINLO, W1OHD.

The Vermont QSO Party is being sponsored by the Burlington Amateur Radio Club, of Burlington, Vermont, who extend to all interested hams an invitation to join in the fun.

Here it is . . .

WEBSTER  CHICAGO

WIRE RECORDER

FOUNDATION UNIT



MODEL 79

\$7500
LIST

... hook it up yourself

This is it—the wire recorder foundation unit you've been waiting for. Use it as auxiliary equipment for your rig—record messages—relays—programs . . . use it to check your speed and accuracy with the key. Build a complete wire recorder or add this unit to your present system. You can record music or speech up to a full hour on the Webster-Chicago Model 79 Wire Recorder. Wire can be “erased” and recorded again as often as you wish.

Complete unit consists of a wire transporting mechanism, a triple-purpose recording head (records, erases, plays back) oscillator coil, 15-minute spool of wire and necessary connecting wires for easy installation.

Made by the makers of famous Webster-Chicago Record Changers.

SEE YOUR
SUPPLIER

WEBSTER  CHICAGO

The Choice of Music Lovers

5610 BLOOMINGDALE AVENUE • CHICAGO 39, ILLINOIS

Amateurs!

CHOOSE the FINEST in TRANSMITTING EQUIPMENT

- 1** Set Band Switch **2** Set Dial to Frequency **3** Turn Power on

you're **ON THE AIR!**

WITH THE

El-Tronics INC. **AE-30**

FIVE BAND SINGLE DIAL GANG-TUNED
BAND-SWITCHING 30 WATT
AMATEUR TRANSMITTER

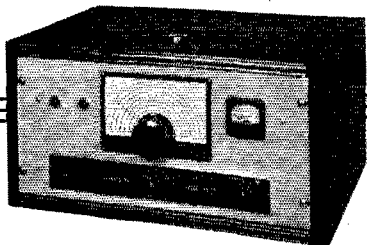

Not just another "ECO" BUT a complete transmitter with 30 watts output on five bands PLUS THE FACT that it is single dial tuned and band switching. (Makes excellent exciter for high power amplifier)

CHECK JUST A FEW OF OUTSTANDING FEATURES

- | | |
|---|---|
| 1 - Completely band switching | 7 - Oscillator keying for break-in operation |
| 2 - Single dial gang-tuned | 8 - Provision for plate & screen modulation |
| 3 - 30 Watts output on 5 bands | 9 - Blocked grid keying; clean & chirpless signal |
| 4 - Covers 80, 40, 20, 15 and 10-11 meter bands | 10 - All critical voltages are regulated |
| 5 - Very low frequency drift | 11 - Three complete power supplies. |
| 6 - Link coupled output | 12 - Phone-CW switch and remote control |

TEN TUBES: 1-6SK7, 1-6AG7, 1-6V6, 1-807, 2-816, 1-5Y3, 1-5Z4, 1-5Y3, 1-VR150, 1-VR105.

PRICE only \$220 complete with all tubes - rack mounting

El-Tronics INC. Two old experienced companies now expanded and reorganized under a new name.

Main Office: LINCOLN LIBERTY BLDG.
BROAD & CHESTNUT STS.
PHILADELPHIA 7, PENNA

SEE YOUR NEAREST DEALER

HRC have built G.D. oscillators. AFO has found 1000-cycle filter works excellent for c.w. receiving. The code is FL-9-B if you can find them in surplus or in dumps. Complaints reach us that the 144-Mc. band is "dead." By the time you read this it probably will be very much alive again. However, some local comment to the effect that the modulated oscillator boys are to be intentionally left alone by the crystal boys does not help matters any. If the modulated oscillator boys will cut the per cent modulation way down they can be worked and if the crystal boys bear with them for a while longer, when the summer 144-Mc. DX shows up, the modulated oscillator boys are sure to see what they are missing by not stabilizing, and then everybody ought to be happy. No sense in feuding about a hobby, I sez. Just a word to the 28-Mc. boys. I hear some of you on your 144-Mc. harmonics plenty strong in my 522 receiver. Either I've got a pretty good 522 or you've got some pretty bad harmonics, or both. Traffic: (Nov.) WIINU 40, JDX 15, AJQ 2.

VERMONT — SCM, Gerald Benedict, W1NDL — QVS is a new ham in Burlington; he has an Atom X transmitter and 28-Mc. three-element beam. MXH, formerly in Rhode Island, is located in Montpelier. GKA is rebuilding and using ARC-5 for temporary rig. Your RM, PSD, reports almost no interest in Vermont Net, and has to advise other nets and Trunk Lines that Vermont amateurs are not interested in traffic. It was nearly impossible to get Vermont amateurs away from their rag-chewing to try to form an emergency net to handle CAP fire traffic during the drought. Public service at such times is one way to prove the value of amateur radio. Traffic: (Nov.) W1PSD 14, AVP 6, MCQ 4, GKA 2. (Dec.) W1GKA 24, PSD 2.

NORTHWESTERN DIVISION

ALASKA — SCM, August G. Hiebert, K7CBF — New AO officers of the Arctic Amateur Club, Fairbanks, include AO, pres., EC, vice-pres.; and CM, secy.-treas. CM is believed to be the youngest Alaskan amateur. He had his Class B license when he was 13 years old, and his Class A when he turned 15. MH contacted his family, in the Midwest from Shemya twice on 28-Mc. 'phone, and keeps regular schedules with his home town. An all-night New Year's Eve Party on 3.85-Mc. 'phone kept the following Territorial celebrants busy in various degrees of participation: CX, AH, LV, DJ, DB, FC, and FN. W7BOP had his fling at the round robin for a time as well. BK and EC have been scheduling CBF on 3.5-Mc. c.w. Traffic: KL7MH 19, BD 16, BF 1, DM 1, EC 1.

IDAHO — SCM, Alan K. Ross, W7IWU — American Falls: DMZ is running 900 watts on 3.9 Mc. His FARM Net on 3935 kc. has connections with the newly-organized Washington WARTS Net on 3950 kc. Mountain Home: IY worked a few VKs on 7 Mc. and is looking for an SCR-522 to join the Boise gang on 146 Mc. Nampa: IYG has a new SX-42A. Jerome: GFW sends in first report via the FARM Net and is on 3.9 and 14 Mc. with 750 watts. Kuna: EMT has four ZLs to his credit on 3.5-Mc. c.w. Boise: New Gem State Radio Club officers are: APK, pres.; JMH, secy.-treas. The club, which has been issued the call K7NRN now meets in the new Naval Reserve Army. The 146.25-Mc gang meets every Sunday evening for a round table. IWU has a new DB22-A preselector. We would appreciate hearing from North Idaho. Traffic: W7EMT 23, DMZ 18, GFW 17, IWU 12, IYG 12, ETU 5, IY 2.

MONTANA — SCM, Albert Beck, W7EQM — SEC: EMF. FGB reports GFW soon will have new 807 job on the air. The rig was assembled by KJX. The Livingston gang is organizing the Yellow Stone Radio Club. GEF, at Wilsall, has new transmitter in operation. KUH is getting material to rebuild. EMF is very busy as SEC. EQM and EMF are planning trips for emergency organization meetings in different parts of the State. JDZ has nice rig on the air from Belgrade and works 4 Mc. CT gave SMARA an interesting talk on power supply designs. HZS has joined ranks of the VFOs. LBK is planning on increasing power soon with a pair of 807s. Ground your antennas, gang, when IWV points his new 14-Mc. beam your way with that kv. LCM is working 28-Mc. 'phone now. KGF is building 28-Mc. 'phone rig for himself. JDZ reports Gallatin Amateur Radio Club has 25 members with KUX, pres.; BI, vice-pres.; JDZ, secy.-treas. KUX runs 300 watts to a pair of 813s on 7 Mc. KVVU has nice collection of DX cards. LTT is new ham in Belgrade. EGN worked ZL1HM on 3.5-Mc. c.w. with a single 815 in the final. The Butte Amateur Radio

(Continued on page 112)

your
basic
3R's
for correct
current control

Ward Leonard
RELAYS
Ward Leonard
RESISTORS
Ward Leonard
RHEOSTATS

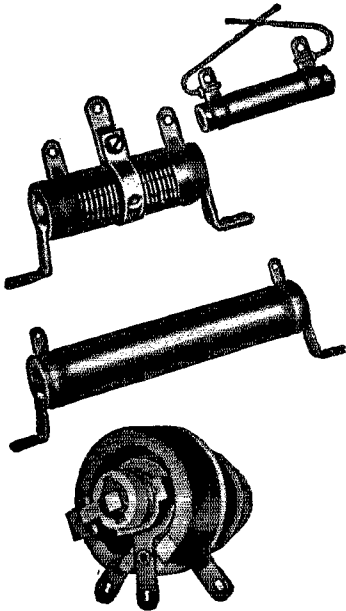

RELAYS—provide convenient circuit control, protection, and greater operating efficiency . . . help reduce length of connecting leads. Amateur Relays available from stock: Antenna Change-Over, Antenna Grounding, Keying, Band Switching, RF Break-In, Safety, Overload, Underload, Latch-In, Remote Control, Sensitive, Time Delay. Also Industrial and General-Purpose Relays.

RESISTORS—exclusive features of VITROHM wire-wound resistors insure that *extra* performance needed in critical circuits. Fixed type in 8 stock sizes from 5 to 200 watts. Adjustable type in 7 stock sizes from 10 to 200 watts. Wide range of resistance values. Stripohm, Discohm, and Plaque types also available.

RHEOSTATS—for fixed or variable close control. Protected by tough, acid resistant, crazeless vitreous enamel. Sizes: 25, 50, 100, and 150 watts, in wide range of resistances.

Authorized Distributors Everywhere

WARD LEONARD ELECTRIC COMPANY

Radio and Electronic Distributor Division

53-B West Jackson Blvd., Chicago 4, U. S. A.



**SEND FOR
FREE CATALOG**

Write for Catalog D-30. Gives complete information on stock resistors, rheostats and amateur relays. Includes helpful data and basic resistor formulas.

WARD LEONARD
RELAYS • RESISTORS • RHEOSTATS

Electric control  devices since 1892

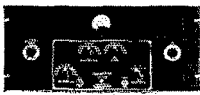

**MILLEN
90810
High Freq.
XMITTER**

75 Watt, Crystal-controlled, for 2-8, 10-11 meters. Uses new Billey CCO-2A. Quick band shift with Millen plug-in coils. Uses 6AG7 Xtal Osc., 2E26 Tripler, 829B Final, driven by xtal unit. Supplied with 10 meter grid & plate coils. Panel 8 3/4" x 19" **\$69.75**
Less tubes and crystal 25 lbs. No. A-19405 Amateur Net
10, 6, 2 meter grid coils & links, and plate coils and links, each\$1.80

**Millen 90600 Absorption
FREQUENCY METERS**

Set of Four
Meters
Covering



3.0 to 140 Mc.

Midget Absorption Meters with many applications for circuit analysis, etc. Set consists of 4 midget meters: 3.0-10 mc. 0.0-23 mc. 23-60 mc. 50-140 mc. each directly calibrated, in carrying case No: 8415 Per set **\$18**

Meters available individually at \$4.50 each.



Full Wave Meter Rectifier
Made by leading mfrs Replacement for Multi-Tester or AC Voltmeter 1/2" diam. Add Postage **\$69c**
No. S-632 Only

T-17B HANDMIKE

BRAND NEW! Single button, carbon mike. 200 ohms. Press-to-talk switch, 5 ft. cord, PL-68 Plug and dust cover (Add Postage) No. S-467. Only **\$8c**

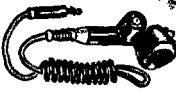

BC-605 S. C. INTERPHONE

BRAND NEW. Made by W. E. Heary Duly Intercom. Can be converted for general use. Swell foundation unit for ham modulator or low power xmitter. Has 2-1619's (2.5 V screen grid R F Power Amp.) Many fine quality components worth many times this low price. Heavy steel case 11 1/2" x 6 3/4" x 13 1/2" Wgt 28 lbs. Cat No. No. S-670 Special **\$49.50**

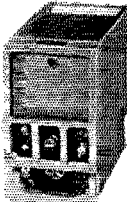

**NATIONAL
New NC-33
RECEIVER**

\$65.95 With Tubes & Spkr.

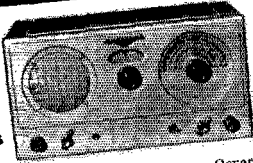

The very latest National AC-DC Superhet Receiver. Covers 500 Kc to 35 Mc in 4 bands including ship-to-shore Telephone Freq. and 500 Kc S.O.S. Band Built-in 5" PM Speaker. Aut. Noise Limiter. CW Osc and Pitch Control. S/R switch. Electr. Bandspread. 12SA7, 12SG7, 12H6, 12SL7GT/G. 35L6GT/G. 35Z5GT/G A swell, inexpensive versatile set for beginners or old timers. For 115 V. AC or DC Wgt 30 lbs No. A-19139 **\$65.95**
All National Equipment In Stock.

Include Postage
All Prices F.O.B.
New York or Chicago
Send 20% Deposit
with C.O.D. Orders

NEW YORK
Offices & Warehouse
242 W. 55th St., N.Y. 19

**NEWARK
ELECTRIC COMPANY, INC.**

CHICAGO
323 W. Madison St.
Chicago 6, Ill.

New York City Stores: 115-17 W. 45th St. & 212 Fulton St.

Send Orders To
242 West 55th St.
New York 19, N. Y.
or
323 W. Madison St.
Chicago 6, Ill.

PRICES SLASHED!

HAMMARLUND RIGS REDUCED!

**Hammarlund FOUR-20
35-W XMITTER KIT**

Regular Price **\$120**
Reduced To... **\$39.50**

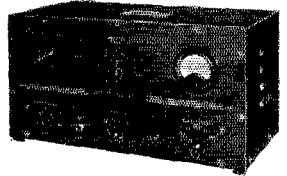

Sensational Value! N.w. Improved Transmitter delivers 35 WATTS. (Complete CW rig for 10-20-40-80 meters Xtal Oscillator — 3 multipliers (3-7C5LT) driving 807 final 7C5LT Osc Built-in Power Supply (5U3G). One control tunes 4 circuits to 4 different frequencies. In Kit form, with all parts, materials, tubes, cabinet, pictorial and constructional details, alignment data. Less Xtal. For 105/120 V. 50/60 cycles 31 lbs No. S-712.

Order from N. Y. or Chicago—Shipments FOB New York Only

**Hammarlund FOUR-11
MODULATOR KIT**

Regular Price **\$72.50**
Reduced To... **\$29.50**

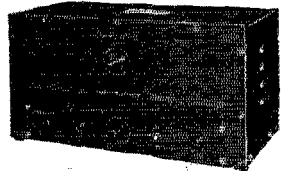

Terrific Buy! 11 Watts Audio Output. Designed to modulate Four-20 above. Fine speech amplifier for hi-power modulator 6SL7GT — 1st and 2nd Audio Amp. 6C5 Phase Inverter, 2-7C5LT PP Audio. All parts, material, tubes, cabinet, and instructions 105/120 V. 50/60 cycles Less Xtal 41 lbs. No. S-713.

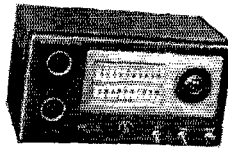

**HALLICRAFTERS
HT-17 XMITTER**

Reduced **\$49.50**
To...

Regular Price **\$69.50**

Great Buy! SAVE \$20 on this Famous HT-17 Transmitter. Covers all amateur bands from 3.5 to 30 Mc. Provides honest 15 watts crystal — controlled CW output on 3.5 and 7 Mc. and 10 watts on 14, 21 and 28 Mc. Complete with tubes and 40 meter coils. Other coils available 105/125 V. 50/60 cycles AC. Wgt. 25 lbs. No. A-2056.

**HALLICRAFTERS
PANORAMIC ADAPTOR**

Reduced to **\$49.50**

Regular Price **\$99.50**

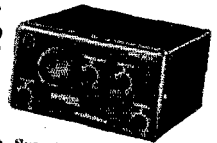

SAVE \$50 on the wonderful 10 tube Superhet "Seeing Eye of Sending" Electronically tuned, with self-contained scope — monitors up to 200 Kc visually and analyzes signal from your own or other Xmitters Hooks into any receiver Complete with tubes For 115 VAC Wgt 20 lbs. No. A-2080.



Super-Sensitive RELAY

Precision-made, SPDT 8,000 ohm coil. Operates on from 1 to 2.5 Ma Low drain **\$8c**
Made by Sigma. No. S-383 only
(Add Postage)

Select a **CRYSTAL UNIT** as easily
as you would a vacuum tube!

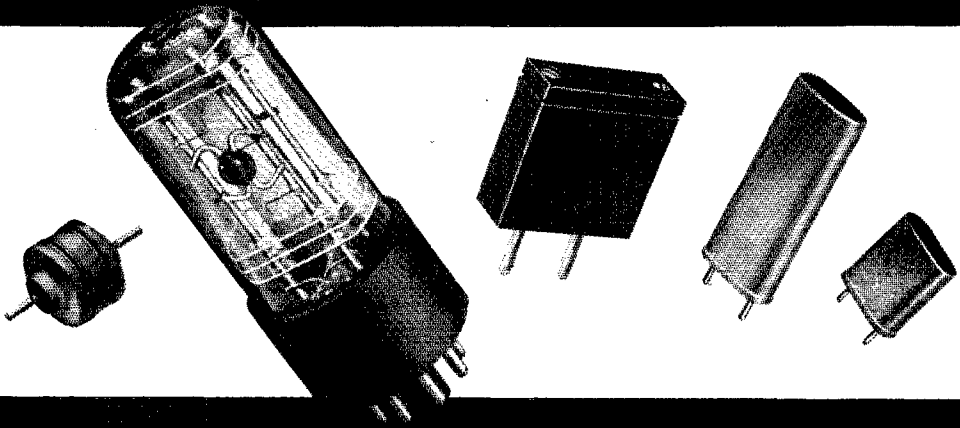

**10 standard crystal types — between
1.2 and 50,000 KC**

THE new Western Electric standardized line of quartz crystals will eliminate many of your circuit design problems. This new line consists of ten crystal types—listed in the table at the right—for operation within specific frequency ranges. Each of these ten crystal types consists of a number of separately coded crystal units which are designed to operate, with nominal tolerances, within specific temperature limits.

Whether you're concerned with frequency standards, mobile radio, point-to-point radio systems, commercial airline communications, AM or FM broadcasting, police, ship-to-shore systems, military communications or radar, you'll find that the job of selecting the proper Western Electric crystal unit is as simple as that of choosing a standard vacuum tube.

TYPE	FREQUENCY
20J	1.2 to 10 kc
21N	16 to 100 kc
21E	90 to 300 kc
22D	200 to 500 kc
22C	300 to 1,000 kc
24A	2,000 to 10,000 kc
22A	3,950 to 10,000 kc
24B	4,000 to 15,000 kc
22B	5,000 to 15,000 kc
23A	15,000 to 50,000 kc

For complete data on Western Electric crystals—
designed by Bell Telephone Laboratories—send
the coupon below.

Western Electric

—QUALITY COUNTS—

Distributors: In the U. S. A.—Graybar
Electric Company.
In Canada and Newfoundland—Northern
Electric Company, Ltd.

Graybar Electric Company
420 Lexington Avenue, New York 17, N. Y.

Q-31

Gentlemen:

Please send me Bulletin T-2471 on Western
Electric's new line of quartz crystals.

Name _____

Company _____

Street Address _____

City _____ Zone _____ State _____



WIRE RECORDERS?

You'll Find Them at *Resco*

AIR KING Portable WIRE RECORDER PHONO-COMBINATION

The Royalty of Radio Since 1920



TOPS ALL COMPETITION!

- For home, professional, industrial and commercial use. Excellent for either voice or music reproduction.
 - Records on wire directly from radio, phonograph or microphone. All three features for the price of one.
 - Plays 10 or 12 inch records, is equipped with Fidelitytone needle.
 - 5 tube amplifier (inc. rectifier).
 - Compact, luggage-type carrying case.
- Price complete! Includes 2 Spools of Wire; Cord for Radio Recording; Microphone and Stand.

\$129.50 LIST

Write for Dealer Net Price

RCA WIRE RECORDER

With Plug-In Recording Cartridge

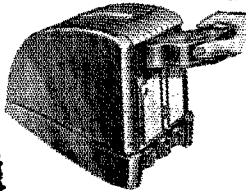

\$1.95

LIST
Write for Dealer Net Price

- Simple to operate — just plug in recording cartridge and make your recording . . . no wire-threading!
 - Previous program automatically erased as new program is recorded.
 - High-quality, 3-watt amplifier.
 - Lightweight—only 24 1/2 lbs. complete!
 - No wire handling . . . immediate playback . . . continuous program recording . . . timing indicator.
 - Includes recorder, microphone and desk stand, 1/2-hour cartridge.
- Additional cartridges \$15.00 each list

Write for Big New Bulletin—Just Out!

Radio Electric SERVICE CO. OF PENNA., INC.

7TH AND ARCH STREETS, PHILA. 6, PENNA.
Branches: 5133 Market St. and 3145 N. Broad St. in Phila.
Also in Wilmington, Del., Easton, Pa., Allentown, Pa., Camden, N. J.

Monday nights with KH6KX and KH6MG on Maui, KP6AA on Palmyra, and KG6DB on Guam. Traffic: KH6LF 82, BW 8.

NEVADA—SCM, N. Arthur Sowle, W7CX—Asst. SCM, Carroll Short, Jr., 7BVZ. SEC: JU. ECs: OPP, KEV, TJJ, QYK, JLV, JVW. RM: PST. PAM: KHU. Ken Taylor of KBNE now is LV5. NCR, now Class A, is on 14-Mc. 'phone. SXX now is Class A, but is concentrating on 28-Mc. mobile. The Southern Nevada Amateur Radio Club held a "White Elephant" party. The XYLs of LFW and JLN are taking code lessons. JOS, of Yerington, reports his dad, VO, is on 28-Mc. 'phone daily. Ex-6EGA now is 7LSD at Hawthorne. JU reports activity on two nets. JLV has built an n.f.m. detector unit for his receiver. BIC has his rig on n.f.m. GC has 41 countries now; he has a new Panadaptor. CX has a three-wire folded doublet on 3.5 to 4 Mc. KLK is active on Mission Trail Net. Those who need Nevada should watch for VVZ daily 4 p.m. to 8 p.m. PST and 6 a.m. to 7 a.m. PST on 14,020, 14,030, 14,050, and 14,083 kc. Traffic: W7KHU, 145, JU 79, TJJ 73, CX 21, BVZ 8, JOS 5.

SANTA CLARA VALLEY—SCM, Roy E. Pinkham, W6BPT—Asst. SCM, Geoffrey Almy, 6TBK. RM: CIS. PAM: QLP. EC: CFK. BUM is using a new four-element beam on 28 Mc. with very good results. WNI has a new Turner 22X microphone and may be on 'phone soon. CIS still is rolling up countries with a total of 132, postwar. LCF is installing new 28- and 14-Mc. rotary beam and hopes to add to his total of 90 countries. New call issued in Los Altos is HJS. Welcome to 28 Mc., Roger. SYW is rebuilding his rig and may go n.f.m. DZE is working Mission Trails Net on Sundays. JSB held twenty personal QSOs during the month of December. ZZ has new 14- and 28-Mc. beam and expects some good DX contacts. CFK is getting net lined up for emergency communication for the Red Cross. SCCARA installed new officers at its last meeting: LCF, pres.; RYI, vice-pres.; QBO, treas.; MUR, secy.; NX, ZUJ, JTE, NKP, and BPT, directors; HC, operator. RUO is back on 28 Mc. after a long absence. VHE is holding schedules with Pacific area on 28 Mc. 7KSA now is in our midst. Glad to see you back, Clyde. KG blew power transformer on his modulators so is off the air at present. QR, of Carmel, is heard very well in the Santa Clara Valley. Gil has QTH on top of hill and works into San Joaquin Valley with ease. Traffic: W6WNI 290, WJM 272, NNX 141, JSB 90, CIS 38, VZE 12, KMM 5, ZZ 3.

EAST BAY—SCM, Horace R. Greer, W6TI—Asst. SCM, C. P. Henry, 6EJA. SEC: OBJ. ECs: AKB, AHW, EES, NNS, IT, IDY, QDE, WGN. Asst. EE u.h.f.: OJU. RM: ZM. The following are the new officers of East Bay organizations: SARO: EHS, pres.; KPO, vice-pres.; KMQ, secy.; IUZ, treas.; LCG, communication mgr. Oakland Radio Club: KZN, pres.; MFZ, vice-pres.; MNG, secy.; OLL, treas.; AKB, sgt. at arms; OBJ, director; SSN, chief op. Richmond Radio Club: KEK, pres.; QDE, vice-pres.; YDI, secy.; EJA, treas.; VYJ, sgt. at arms. Northern California DX Club: TI, pres.; AED, vice-pres.; PB, secy.-treas.; WB and BUY, directors. CX sends in his first traffic report in years. FDR has new 1-kw. rig and a new 50-ft. mast. YDI is QRL Mission Trail Net. RRG, secy. of NBARA, says that the Vallejo gang have big plans for the club this year. ZM reports that the American Legion Net is getting under way once again. RMM has new 28-Mc. mobile receiver for a.m. and f.m. CRF is QRL on Buzzard Net. VDR sends in first report. BE is a new-comer to East Bay, and says he is strictly c.w. SAN reports he has a new Sterba Curtain Array up for South America which works FB. ZUI is really running after this thing called DX and is knocking over some good ones. AED has new AR-88 receiver. UPV and IKQ have new finals. PB sent cards for DXCC. NZ is having beam problems. UZX has new 28-Mc. rotary. IDY claims his new final is the berries. WP has new e.c.o. MVQ has new 14-Mc. rotary. NZG is playing with an ART-13. TT has 91 postwar countries on 'phone. TI has new National 183 receiver. EE has a nice-sounding signal on 28-Mc. 'phone. SSN is back on the air after a serious illness, and likes his new Collins receiver. "Remember in '48 it's not too late." Send in that membership to ARRL. For the period July to December, inclusive, we find that YDI wins the Hammond Memorial Bug, given each six months to the person in the East Bay section handling the most traffic and reporting each month on time. This time there were other stations with a higher total, but each one fell down by failing to report one or more times

(Continued on page 116)

Detachable
Base
Standard
Thread

May be Used as
Desk Stand
Microphone

May be
Mounted on
Floor Stand

May be Used as
Hand Mike

Bright Chrome
Grille

OFF-ON
Switch
(Optional)

Gold Finish
Housing and
Handle,
Dark Brown
Baked
Enamel Base

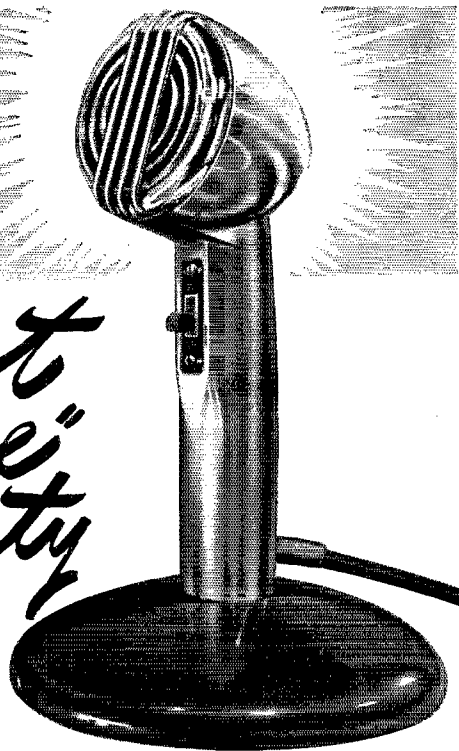

*"Velvet
Voice"
Beauty*

**CONVERTIBLE
TYPE
CRYSTAL MICROPHONE**

An all purpose microphone providing ultra-smooth, velvety soft, wide range response. Supplied in two models: Model 200, with smooth even response over the entire frequency range; and Model 241, (of particular interest to amateurs), having the same frequency range but with rising characteristics between 1500 and 5500 c.p.s., for added brilliance in the speech range. The Velvet Voice is tops in both performance and appearance. Output level, -50 db. below 1 volt per bar. Recommended load impedance, 5 meg. Overall height, 8 inches. Special literature is available.

THE
Astatic
CORPORATION
CONNEAUT, OHIO

IN CANADA, CANADIAN ASTATIC LTD., TORONTO, ONTARIO

Astatic Crystal Devices Manufactured
under Brush Development Co. patents.

Sign of Transformer Reliability

KENYON

For over 20 years, the KENYON "K" has been a sign of transformer reliability. Ever since the cat's-whisker, crystal-set days, KENYON has pioneered high quality transformers. Skillful engineering, progressive design and sound construction have resulted in dependable, conservatively-rated transformers with an enviable record for minimum field rejections. Cut engineering and replacement costs. Improve products. Insure repeat business. Specify KENYON!

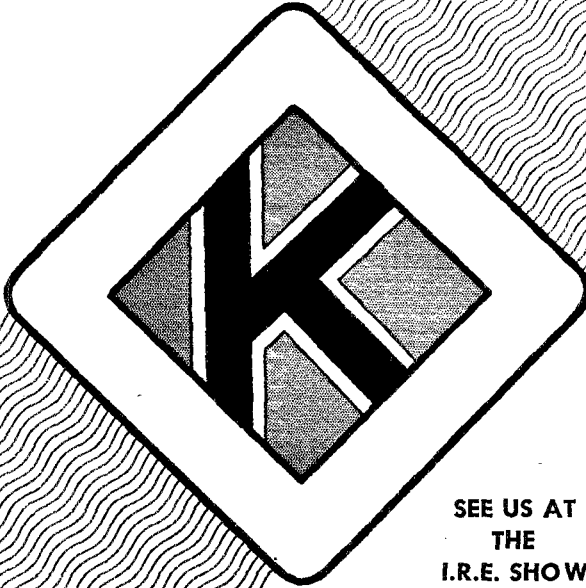

SEE US AT
THE
I.R.E. SHOW

Consult KENYON
About Your Transformer Problems

KENYON TRANSFORMER CO., Inc. 840 BARRY STREET
NEW YORK 59, N. Y.

PEERLESS PACKS

Value PUNCH!

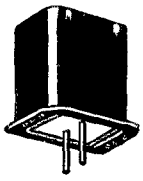

MODULATION TRANSFORMER

Stancor A-3871

Fully shielded plate modulation transformer. Primary 4500 ohms, secondary 8500 ohms for single 6L6, 6X4 in class A, or single 6B5, 6P6, 6N6 class A (with sec. used as pri.) 10 Audio Watts. DC primary 60 ma, secondary 30 ma. 2 1/2" x 2 1/2" x 2 3/16". Shpg. Wt. 2 lbs. Individually boxed. List Price \$4.50. **OUR LOW PRICE \$1.49**

SOLDERING IRONS



INDIVIDUALLY BOXED

ESTICO 65-Watt "Midget" Model 16P. 3/8" dia. Tip. Reg. Price \$2.95. **OUR PRICE \$1.49**
 DRAKE 100-Watt Model 316, with 3/8" dia. tip. Reg. Price \$2.95. **OUR PRICE \$1.49**
 KWIKHEAT 225-Watt Thermostatic Iron, Model 300. Reg. Price \$11.00. **OUR PRICE \$6.25**

14-WATT — Model 14B

EASTERN AMPLIFIER

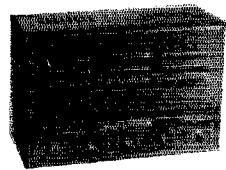

Reg. Price \$65
OUR LOW PRICE
\$24.75

COMPLETE WITH COVER AND TUBES

Exceptional performance at an amazingly low price! This fine amplifier has two inputs, mike and phono, with separate controls, variable tone control; Outputs 4, 8, 15, 30 and 500 ohms; Tone control: 50 to 12,000 cycle response; Low hum level; Uses 6S17GT, 6SL7GT, 2-6V6G1, 5Y3GT. Two-tone brown finish with red and ivory trim. Size 14" x 6" x 9 1/2" high. 115 V. 60 cycle A.C. Shpg. wt. 22 lbs.

BRAND NEW TRANSMITTING TUBES

Made by well-known tube mfr., specially priced while our limited quantities last!

Type	Reg. Price	OUR LOW PRICE
100TH	\$17.00	\$12.75
250TH	30.00	22.95

Write for **YOUR FREE COPY** of General Electric **TUBE CHARACTERISTIC MANUAL** includes all latest type tubes

MINIMUM ORDER \$2.00

All prices F.O.B. Jamaica, N. Y. Please add postage.

Write Dept. Q



92-32 Merrick Road, Jamaica 3, N. Y.
 Branch: 71 Murray Street, New York 7, N. Y.

umpteenth time, according to DCW. with the caution—DX please be patient! 3HGD/4 has put up a new beam HUL is active on 3.85-Mc. 'phone most of the time. MYO is the newest call to be added to the K. & M. Club register. Look for a week or two and you will locate DCW on 3.85 Mc. New ORS appointees are KJS and JPY. If you have any traffic you can move it nightly Monday through Friday on 3605 kc. The N. C. N. is going to town, but many more outlets are needed. If interested, please contact the SCM or CFL. The above represents the total information supplied for publication in this column. It is up to you, gang. No reports, no column. Traffic: W4CFL 368, IMH 74, FXU 67, KJS 33, CYB 32.

SOUTH CAROLINA — SCM, Ted Ferguson, W4BQE/ANG — JGM is putting up a three-element rotary beam. HEV is working 14-Mc. c.w. BZX is on 3.85-Mc. 'phone about once a week. KIM can be heard on 3.5-, 7-, and 14-c.w. and 28-Mc. 'phone. MAS is trying to get his rig on 14-Mc. c.w. LJJ still is trying to get out on 28-Mc. 'phone. BFQ is EC for the Lake City area. CXO reports that the ham population of Rock Hill is increased to two; the young squirt is MYM. CZA's ham activities consist of a little local 28-Mc. 'phone. DPN reports that MMS is a new ham in Orangeburg. MAO is working 7-Mc. c.w. IW is working 14-Mc. 'phone. MAQ is on 7-Mc. c.w. and 28-Mc. 'phone. BEN is to be heard on 7-Mc. c.w. MJT has an ARC-5 on 7-Mc. c.w. EDQ can be heard trying out his n.f.m. Thanks to CW for the report on the Charleston gang. MRJ has 70 watts on 3.5 and 7 Mc. DBK is on 28-Mc. 'phone n.f.m. with a 8JK beam. DFC is new president of the Charleston Club and works 7, 14, and 28 Mc. HTR works all-band c.w. and 28-Mc. 'phone and is constructing new 28-Mc. beam. DAW is on 7- and 3.5-Mc. c.w. and is operating K4USN, Naval Base master control station. FNS is using a pair of T125s with 400 watts. DQY hopes to be on soon.

WEST VIRGINIA — SCM, Donald B. Morris, W8JM — Wesleyan College Radio Club has been reactivated with ZJL as president. The club's call, AEE, will be heard on 3.85, 14, and 28 Mc. with 600 watts to all types of aerals. JKN has BC-522 and is trying to work West Va. U. on 144 Mc. MOP is active after a long illness. 3ZW is old 8ZW from Wheeling. With EP as NCS, the following are working each other on 28-Mc. ground wave: EHA, FEO, KWL, QG, YGL, FMU, YBQ, ASO, AEN, and JM. EHA and AEN have new four-element 28-Mc. beams. BTV and his XYL visited Charleston and Princeton amateurs. VAN is active on 3.85 and 28 Mc. YCK, a reliable 3770 Net member while in West Virginia, now is on the Headquarters Staff as operator at 1AW. DNN reports that activity is increasing in the Parkersburg area. An active station is needed in this vital Ohio River town. GBF, NCS for West Va. 3770 Net, would like to see a Parkersburg outlet on the Net. PAJ now is 3MNO, of Annapolis, and schedules his father, 8MIP, on 3.5-Mc. c.w. REH has new rig on 14-Mc. c.w. in (Continued on page 120)

4th WEST VIRGINIA QSO PARTY

The Mountaineer Radio Assn. will sponsor the 4th All-West Va. QSO Party beginning at 6 p.m. April 1st and ending at 6 p.m. April 10th.

Rules: Open to all West Va. amateurs. No power limitations. Any and all Amateur Bands may be used. Both c.w. and 'phone may be used during contest. C.w.-to-'phone and cross-band QSOs permitted but no extra credit allowed for such contacts. No credit for more than one QSO per station unless the station is in a different county from that of the first QSO. Two points for each completed QSO. One point for one-way exchange. The following information must be exchanged: Date, time, call, city and county. Multiply total QSO points by number of different W. Va. counties worked for final score. All logs must contain the exchange information and will be cross-checked. Incomplete and incorrect logs will not be counted.

To be eligible for prizes logs must reach Raymond Wardle, Activities Mgr., MARA, 501 Pythian St., Morgantown, W. Va., not later than April 20th. Highest scorer will receive a two-year ARRL membership, second an ARRL Handbook.

Now . . . heavy duty Features in new small



BUTTERFLY VARIABLE CAPACITORS

No other Capacitor of this size offers all these features!

Split Stator and Butterfly-Type Rotor Achieve Mechanical and Electrical Symmetry
Opposed Stator Sections of the B&W Type JCX Capacitor Provide Short R-F Paths
Double Stator Construction Permits Rotor

Grounding at Same R-F Point—With Respect to Each Stator
Tank Coil Assembly May be Mounted on Capacitor Frame—Eliminates Tank Circuit Wiring and Reduces Length of Tuned Circuit Leads

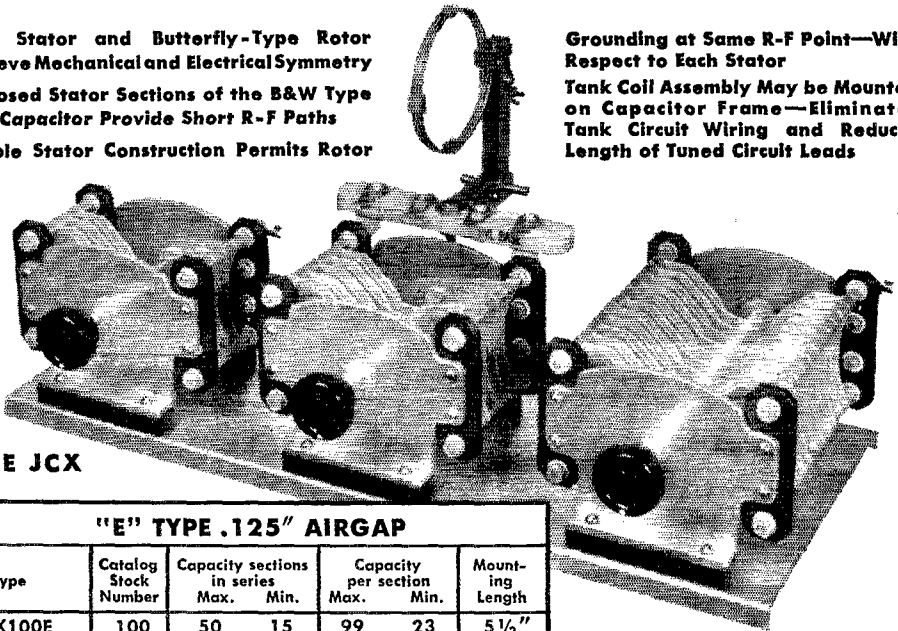

TYPE JCX

"E" TYPE .125" AIRGAP						
Type	Catalog Stock Number	Capacity sections in series		Capacity per section		Mounting Length
		Max.	Min.	Max.	Min.	
JCX100E	100	50	15	99	23	5 1/2"
JCX50E	101	25	10	42	13	3 3/8"
JCX25E	102	16	8	25	10	2 3/4"

Now—the popular B&W split stator, butterfly type of variable condenser construction has been adapted to small, compact units for medium power stages of up to 250 watts.

Having just 25% of the frontal area of the famous heavy-duty CX types, these new B&W JC Variable Capacitors are ideal for triode or tetrode stage plate circuit applications where modulated plate voltage

does not exceed 1250 volts and unmodulated plate voltage 1500 volts.

Featuring stainless steel shafts, heavy, rounded aluminum plates and high quality insulating materials, these new B&W Butterfly capacitors bring top features . . . top performance to the amateur who is looking for peak efficiency in low and medium power transmitter stages. Write for complete details.

BARKER & WILLIAMSON, INC.
237 Fairfield Ave., Dept. Q38, Upper Darby, Pa.



NOW...For The First Time!

A Rotary-Beam

TOWER

At A Price You Can Afford!

Attractive — Self-Supporting

NO GUY WIRES

- Galvanized Steel—Will Last A Lifetime!
- SAFE—Ladder to Top
- COMPLETE—Ready to Assemble
- Easy to Assemble & Erect
- Withstands Heaviest Winds

LOOK AT THESE LOW PRICES!

Three popular sizes. Assembled on the ground with a wrench in a few hours. Made by one of the oldest manufacturers of steel towers.

33 ft. -\$89.75 **39 ft. -\$107.25** **61 ft. -\$199.75**
 Ship. Wt. 516lbs. Ship. Wt. 616lbs. Ship. Wt. 1246lbs.

Shipped FOB Kansas City, Mo., 4th class freight. Prices subject to change. Send check or money order or write today for complete FREE information!

Vesto "Tilt-Top"
MOUNTING
HEAD

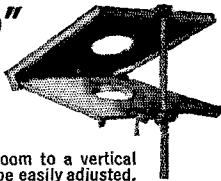

Makes it possible to swing boom to a vertical position where elements may be easily adjusted.

- Easy to attach to any type pole or tower
- Any Rotary Head will fit it
- Made of heavy cast aluminum, 16" x 16", hinged, with automatic steel stop bar. Heavy steel hinge rod.

Shipping Weight 22 lbs. Price \$24.50 fob Parkville, Mo.

VESTO CO., PARKVILLE, MO.

EASY TO LEARN CODE

It is easy and pleasant to learn or increase speed the modern way — with an **Instructograph Code Teacher**. Excellent for the beginner or advanced student. A quick, practical and dependable method. Available tapes from beginner's alphabet to typical messages on all subjects. Speed range 5 to 40 WPM. Always ready, no QRM, beats having someone send to you.

ENDORSED BY THOUSANDS!

The **Instructograph Code Teacher** literally takes the place of an operator-instructor and enables anyone to learn and master code without further assistance. Thousands of successful operators have "acquired the code" with the **Instructograph System**. Write today for full particulars and convenient rental plans.

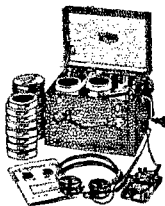

INSTRUCTOGRAPH COMPANY

4709 SHERIDAN ROAD, CHICAGO 40, ILLINOIS

new location. SPY/TDJ worked England on 50 Mc. for the first West Va.-England contact on that band. Traffic: W8GBF 83, BTV 64, JM 53, DFC 36, PQQ 8.

ROCKY MOUNTAIN DIVISION

COLORADO—SCM, Glen Bond, W#QYT—The Colorado Utility Net is going full blast under the able direction of DRB, in Canon City. Here are some of the stations active: EKQ, ADV, FVI, CNB, QHI, HLB, RVW, NDM, MOM, CUG, DYS, LZY, GBC, and DRB. The net operates on 3540 kc. almost any time day or night so any Colorado station who would like to join the net may do so by getting on the above frequency Mondays through Friday at about 6:00, 7:00 or 8:00 p.m. IQZ has a new Super Pro and converter. Mitch says that he now can hear stations 88 to 9 that were unreadable on his old receiver. He says it is all right for Denver stations to read his mail but when he has direct traffic to a local broadcast station from out of the Arctic Circle he would like to deliver it himself. The Denver Radio Club is eager to get every Denver amateur on its rolls. Meetings are held every third Wednesday of the month in the Public Service Building, 3rd and Lapan. The Colorado Wing of the Civil Air Patrol has applied for an amateur station license and should be on 3.85-Mc. 'phone by the time you read this. Operators will be FPZ, GOQ, ZSQ, CQR, ICR, QYT, and other Denver hams. The transmitter will be in the CAP Headquarters Building at Lowry Field. FPZ has taken a position with Walker Radio in their Denver store. BQO says that n.f.m. is one good way to keep his neighbors out of his hair. Willard has been running 500 watts and no BCI. Traffic: W#DRB 211, MOM 94, LZY 37, DYS 21, QYT 7.

UTAH-WYOMING—Alvin M. Phillips, W7NPU—BSE is on 7 and 3.5 Mc. with a pair of 210s while rebuilding. A new call in Smithfield is LRZ, on 14- and 7-Mc. c.w. and 28-Mc. 'phone. Fellows who live in areas without an EC please contact the SEC, JQU, at 347 N. 2nd East, Smithfield, Utah. Kiy received his A-1 Operator Certificate and worked his 48th state. TST is active in FARM Net and 28-Mc. traffic. FST is doing an FB job on the *Grid Leak*, FARM Net publication. TAR is a newlywed FYR is rebuilding surplus equipment. UTM was pleased to receive his A-1 Operator Certificate. Kiy is lined up to teach high school code class. DAD reports a new baby girl. Congratulations. DAD is working toward getting a Class I 00. He did a nice job on the last frequency run which netted him a Class II 00 appointment. DLR got a new batch of QSL cards from his XYL for Christmas. Traffic: W7FST 910, Kiy 223, UTM 158, RPX 28, DLR 24, TST 12, FYR 5.

SOUTHEASTERN DIVISION

ALABAMA—SCM, Dr. Arthur W. Woods, W4GJW—The Alabama Emergency Net, under the guidance of KCQ, was activated January 1st and initial EC appointments have been allocated to eight State areas or districts. Coöperative response continues to be good, but more newcomers to amateur radio are needed for this work to help the old-timers. The Montgomery Club reports consistently, with JYB as president. KSE has new 50-Mc. transmitter and TQB plans to join him on that band. MVM is a new station in Saraland, Ala. Greetings and thanks for writing. OM. DX problems, as encountered by ex-J9AAK, were discussed before the Montgomery Club for the edification of C.C. aspirants. EBZ is experimenting with p.p. 4-125A final. BTU has constructed windproof antenna systems. DRW married recently. GYJ has new jr. operator and GJW is the baby's doctor. 5FPZ/4 is on with p.p. 4-250A final at 1 kw. ECI runs 60 watts on 28-Mc. mobile rig with 4-65 in final. DEW is on 'phone from Birmingham with kw final. BSH has a new jr. operator. JYB has ART-13 converted for mobile operation. Traffic: W4KYB 4, GJW 2.

EASTERN FLORIDA—SCM, John W. Hollister, W4FWZ—Clearwater: AYX has 75 watts on 28- and 3.85-Mc. 'phone and 100 watts on 144-Mc. 'phone and is active in Emergency 'Phone Net with VFO. Canal Zone: Merf writes that the KZs want in with Eastern Florida section. Calm Bay: KXH, ex-8SAC, paralyzed from the waist down, operates from a wheel chair, thanks to coöperation of LXS. He has 600-ft. long wire and vertical. Deland: LXA is working on Class A and got RCC on 7 Mc. WS talked to the XYL in Washington via 3BHK and telephone for swell Christmas present. It was fine coördination of facilities. Jax: AHK is Silent Key. IQV souped up 348 with 1852.

(Continued on page 128)

Now Available...

STANCOR'S

MATCHED POWER SUPPLIES

FOR THE AMATEUR...

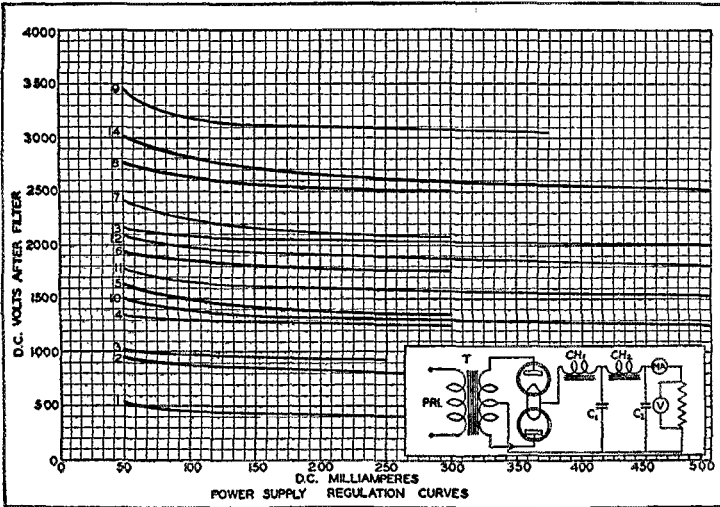
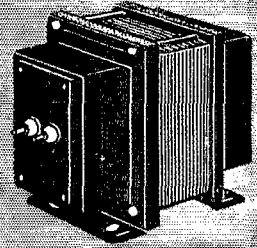
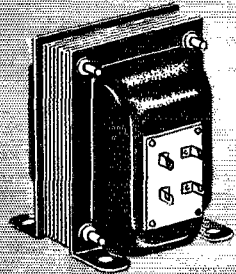
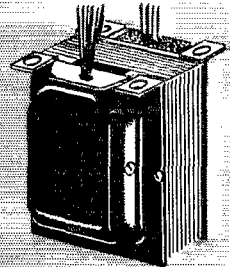
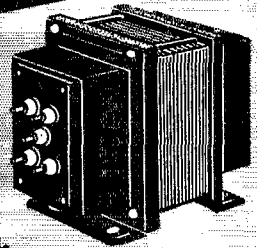

Stancor's Components Are Matched



See Your Stancor Distributor or write direct for a complete catalog.

In the design of communication equipment, of most vital consideration is the power supply which must furnish the "life-blood" of the proposed unit.

Stancor manufactures a complete line of matched plate transformers and filter reactors covering all amateur applications. These power supply combinations will deliver *Well-Regulated, Adequately Filtered Output*, that will dependably meet the voltage and current demands of *Continuous Duty*.

STANDARD TRANSFORMER CORPORATION

ELSTON, KEDZIE AND ADDISON • CHICAGO 18, ILLINOIS



LOOK

STRUTHERS-DUNN RELAY

Control all of your equipment with this one relay. 110 VAC coil, 4-pole, 2 double throw, 2 single throw, 6 Amp. contacts, screw terminals, insulated base, 3" x 3 1/2", a terrific bargain at... **\$2.00**



U. S. ARMY HEADSET HS-30-R



Lightweight, complete, with extra pair rubber ear inserts, clip to take weight off ears, and adjustment instructions. Standard low impedance (500 ohms)..... **50¢**

Matching Transformer HI-Z to 500 ohms..... **39¢**

THORDARSON MULTI-FILAMENT TRANSFORMER

2.5 Volt 10 Amp., 6.3 Volt 5.5 Amp., 6.3 Volt 1 Amp. 5000 Volt insulation, hermetically sealed, ceramic feed thru connections, 110 Volt, 60 cycle primary, 4 1/2" x 3 1/2" x 3 1/2"..... **\$2.95**



POWER SUPPLY 350 PS-1

2 complete new high voltage supplies and one low voltage supply. 600V DC @ 250 ma., 300V DC @ 150 ma., 6V DC @ 1.5 amp. Black crackle finish to all components. Mounted on 17" x 10 1/2" x 3 1/2" chassis unit 9 1/2" high with cover. Complete with both input and output cables and plugs, instruction book, in sturdy carrying chest which is useful as a tool chest. Needs only one RK22..... **\$35.00**

Steinberg's

633 WALNUT STREET CINCINNATI 2, OHIO

JARS News Letter is a honey. LZM showed radar pictures to JARS and gave an FB talk. JKI is new EC. EID works Orlando on 144 Mc. IVX has 522 on 144 Mc. Lake City: NN has real dope on converting the CW-3 receiver for 14 Mc. IQV, NCS on 3875 kc., issues Net bulletin of real interest to all Florida hams. IQV is on 3.85 Mc. and active on 3910-kc. net. Melbourne: LXS now is Class A and active in net. Orlando: 2LP/4 is doing FB with flea power on 7 Mc. Miami: BYF has Gator Net going on 7290 kc. MKP, OBS. is on Mondays and Tuesdays at 8:30. BYF has Collins 75-A and 130-B. BXL takes traffic on 28 Mc. IKI sends OBS on Wed. and Thurs. at 8:30 and BYF on Fri. AAR schedules 4CFD Sun. on 14 Mc. IKI is on 3.5 Mc. with a good signal from ARC-5. BT sends OBS simultaneously at midnight on 14,140 and 7170 kc. St. Pete: HXF is operator at MX, C. G. Air Station on 7180 kc. IK is active in 'phone nets. Tampa: LXX now is active in Miami on 3875 kc. Zephyr Hills: KHY is active on 'phone nets. Knights of the Kilocycle officers: QR, master osc.; AFO, buffer-doubler; JKI, speech amp. Traffic: W4IQV 294, AYV 118, AAR 98, DQW 84, FWZ 39 EVA 10, AXX 3, LXA 3, DRH 1, GWH 1.

WESTERN FLORIDA—SCM, Luther M. Holt, W4DAO—SEC; ACB, TL is heard regularly on 7 Mc. LDT has become known as the "hermit of Lake Bradford" because of location of WTAL transmitter. ACB is new SEC and is eager to organize efficient emergency net throughout the section. Those interested are urged to contact Monte. BGI is ex-8BGI. MUN has new HT-9; his XYL is MYG. MUQ got new S-40 for Christmas. MZD is ex-9ERT. 8YCK has new Bliley CCO oscillator. MUX works 7 Mc. exclusively. GTJ reports by radio; he says most of the Panama City gang are operating 28-Mc. 'phone, but LT rules 3.85-Mc. 'phone. BKQ shoots skeet now. FHQ has fun with flea power on 7 Mc. DHP is about ready to go with new rig. MSX, COS, and NAF are new calls at Eglin Field. EQR moved from 54 to 28-Mc. 'phone. MS got Signal Squirter in operation. HIZ is building 144-Mc. beam. AXP is building three-element 28-Mc. rotary. Traffic: W4AXP 58.

WEST INDIES—SCM, Everett Mayer, KP4KD—AM worked KH6, G2, and G5 with 25 watts on 28 Mc. BE, 28 Mc., worked G5 for best DX of the month. EZ has three-element rotary up 35 ft. and is getting lots of Europeans on 28 Mc., including OKI. DP has new HT-9 and three-element rotary working 28-Mc. DX. CC works KH6 and K17 on 3.85 Mc. FZ, on 14-Mc. c.w. with 40 watts to 6L6 final, works G2, and VK3. FX reports W6WKV now is KP4 GJ. FX also is CE3EH and ex-KA6FB. He operates on 14-Mc. c.w. and he keeps two schedules weekly with CE. GJ's first QSO was with CES. FP, on 28 Mc., goes to town with CP, D4, F3, G2, 3, 6, 8, II, OH2, OZ1, PA8, SV8 and KH6. KD adds XAFQ (Trieste) and CR7 to DX bag for 126C/27Z. He worked ON4, NY4, G2, 5, 6, PA8, and W on 3.5-Mc. c.w. during December and came up with 14 countries on 7-Mc. c.w. NY4CM had four-way 7-Mc. c.w. round table with G5LI, G8ZO, and KP4KD. Traffic: KP4FP 5, KD 3.

SOUTHWESTERN DIVISION

ARIZONA—SCM, Gladden C. Elliott, W7MLL—RIA is on 28-Mc. 'phone. KRY is on 3.5- and 7-Mc. c.w. LUN, ex-9BDE, is on 7-Mc. c.w. Prescott stations are: LVV, 500 watts on 28, 7, and 3.5 Mc.; LND, 75 watts on 28 Mc.; UUN, 75 watts on 28 Mc.; BFA, 300 watts on 28 Mc.; HKV, 7-Mc. c.w. PEY, UPR, LHX, KWW, and KXB made Class B tickets. KAE is Class A and on 3.85-Mc. 'phone. New officers of the 25 Club are: OZM, pres.; RMB, vice-pres.; LHD, secy. 6AMR is running 800 watts on 7- and 14-Mc. c.w. at D-M Field. New calls: LVR, LVT, LVD, and LTM. QAP, OWX, and SLO are on 420 Mc. JMQ continues his outstanding DX work on 3.85 Mc. KUN has 6 watts on 7 Mc. and reports lots of East Coast contacts. TOR is on 3.85-, 14-, and 28-Mc. 'phone with a Meck T-60. 6RZN is working mobile on 50 Mc. LHD and 3HKC have new e.c.o.s. JTO is on 7-Mc. c.w. and 3.85-Mc. 'phone. Benson amateurs are: GMG, 28-Mc. 'phone, 7-Mc. c.w.; NAF, 28-Mc. 'phone, 7-Mc. c.w.; LVT, 3.5 through 28 Mc.; QMG, 28-Mc. 'phone, 7-Mc. c.w. 3HKC/7, 28-Mc. 'phone. Tucson has a 27-Mc. c.w.-i.c.w. net. KWF is on all-band c.w. If your c.w. is rusty get in the low-speed net, 13 w.p.m. limit, on 3552 kc. at 9:15 p.m.

SAN DIEGO—SCM, Irvin L. Emig, W6GC—Asst. SCM and SEC, Gordon Brown, 6APG. BAM schedules 1AW

(Continued on page 124)

* KYTOON!

THE STABLE SKY HOOK

DEWEY AND ALMY CHEMICAL CO.

Whittemore Avenue
Cambridge 40, Mass.

*T.M. REG. U. S. PAT. OFF.

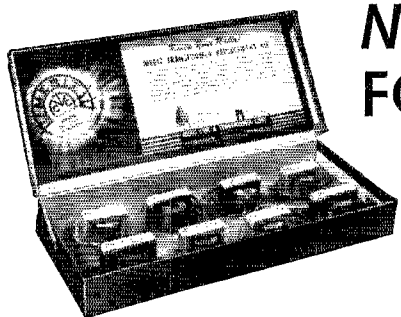

New! MERIT HELP FOR REPAIR MEN

Compact Replacement Kit containing 8 MERIT Quality Transformers for wide range of requirements. The MERIT Kit takes the place of so-called "universal replacement transformers," and brings much greater convenience to repair men. Each transformer is designed for its particular use, and indi-

vidually labeled on frame with its number and data. Each kit is packed in handsome display box. For further information see your jobber, or write us.

List Price	OUTPUT TRANSFORMERS
Kit. No. 1.....\$11.75.....	(2 ea.) A-2928, (1ea.) A-2930, A-2931, A-2932, A-2934, A-2936, A-2937
Kit. No. 2..... 12.20.....	(2 ea.) A-2928, A-2937, (1ea.) A-2930, A-2931, A-2934, A-2936
Kit. No. 3..... 11.80.....	(1ea.) A-2928, A-2930, A-2931, A-2932, A-2933, A-2934, A-2937, A-2938
Kit. No. 4..... 12.90.....	(2 ea.) A-2928, A-2931, A-2936, A-2937

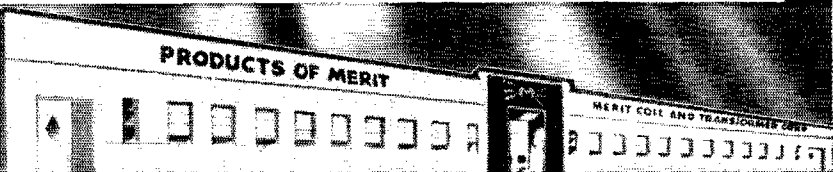

MERIT COIL & TRANSFORMER CORP.

TELEPHONE

4427 North Clark St.

Long Beach 6311

CHICAGO 40 ILL.

*Quality Products
since 1923*
BIRNBACH



pioneers in the design and manufacture of all types of radio hardware, wires, cables, steatite and porcelain ceramics.

Write for new 1948 catalog

BIRNBACH RADIO CO., Inc.
145 HUDSON ST. NEW YORK, 13, N. Y.

**RECEIVING SENDING
CODES** *Speed* *without strain*

CHAMPIONS ENDORSE CANDLER WAY



Get skill, accuracy, speed with the highly endorsed Candler System. Learn to send and receive by telegraph or radio code. Government service and commerce need thousands of better trained operators. Air commerce, mail, freight, etc., demand expert, reliable operators. Good pay. Get the Candler System, the maker of champions. It teaches you the "knack" of sound sense, alertness, speedy sending and receiving without strain. Adventure — good pay. Learn at home or wherever you are. Rush name today for free book.

FREE! **CANDLER SYSTEM CO.**

Dept. 4-C7 Box 928, Denver 1, Colorado, U.S.A.
and at 121 Kingsway, London, W. C. 2, England

Mass. Radio School

271 Huntington Ave., Boston 15, Mass.

For over 28 years the educational radio center of New England. Prepares for all U. S. Government Radio Operators' Licenses. Also gives Radio Technician Training. Approved courses for Veteran Training under G.I. Bill.

Send for Catalog

Licensed by Commonwealth of Mass.
Department of Education

Sundays and reports new officers of Orange County Club as follows: BWO, pres.; YDM, vice-pres.; FCT, secy.; and LDJ, act. mgr. LUJ now is PG and still schedules W6YOT-/C8 daily except Saturday. FMJ holds down Mission Trail Net for San Diego. DEY has WE-316A on 420 Mc. but the wind blew down his beam. ZWL and NGN now are on 144 Mc. DKN bought an SCR-522. CHV still is knocking them off on 14-Mc. 'phone. WNN lost 50- and 14-Mc. beams in wind. New officers of Helix Club are NBJ, pres.; FMJ, secy. HJO from San Francisco, now is in La Mesa. MXX has a 824-A on 144 Mc. LYF reports in to the SC Net and adds that the stork left a new boy for BKZ. LKC also is a new papa while BGF is next to pass cigars. CNQ keeps the section informed regarding affairs in Imperial Valley. A new club has been formed in the El Centro-Calexico area with CNQ, chairman, and LVN, secy. Meetings are held at the Chamber of Commerce Hall. A club booth is being planned for the coming Valley Fair. DWA is adding a p.p. 450TH final to his Tempeco GA75. ZMF now is 7LUL at Yuma. LVN has a 14- and 28-Mc. beam ready to go. UZP gets on 28-Mc. 'phone occasionally. NA is heard on 3.85-Mc. 'phone. BLV is a new call on the air. BCU and BLF are new XYLs. RPO is interested in ARRL appointments. The San Diego Young Ladies Radio League (YLRL) now consists of sixteen girls, eight of which are licensed amateurs. Officers are YYM, pres.; ZYD, vice-pres.; AQL, secy.; BCU, treas.; BGC, editor; YXI, printer; AWW, publicity; and YZV, chairman. Appointment-holders, please examine certificates for possible expiration and if in need of endorsement please mail to the SCM. Traffic: W6LYF 95, LDJ 60, CHV 30, PG 22, FMJ 13, CNQ 7, WNN 6, BAM 1, RDI 1

WEST GULF DIVISION

NORTHERN TEXAS — SCM, N. C. Settle, W5DAS-/MNL — A mobile radio club is being formed with meetings scheduled for Sunday afternoons on 30 Mc. Contact JQY for application. Thirty-one already have made application. Activity is expected to begin in the early spring. If you are operating mobile, join the Caravan Club. Directions for reaching the meeting place may be obtained only by reporting in to the NCS via mobile 'phone. CC purchased SH's BC-610 and SH is hunting another transmitter. ARV completed receiver-rebuilding. LOA, MXE, KCP, and KYD have rigs on 7 Mc. in the same dormitory at Texas Tech. while the economics class includes LOA, MXE, MIL, KYD, and LJG. LVQ expects to rebuild. AAK completed Class A exam in 30 minutes and expects to work 14-Mc. 'phone. EVI has his new beam working. JV missed frequency check by one cycle in recent ARRL run. JEF, of Baird, now is Class A and on 3.85-Mc. 'phone. NFT of Gladewater, is active with NTX Traffic Net. JDZ keeps 3.85-Mc. 'phone band hot. DAS now uses a balloon to fly his antenna. ILZ has power-line QRM. ISN, NTX one-man Trunk Line, made first postwar BPL. NPU is working on 28 Mc. LTP, KI, FDI, EVI, III, JNK, KXZ, RG, BNQ, JNN, and many others make up the night-time round-up on 28 Mc. DARC will hold election of officers at next club meeting. GGD still threatens to get on the air. Please send station activity reports. Traffic: W5LSN 642, CDU 94, MXV 78, GZU 72, ISD 47, ARK 18, ASA 16, ILZ 11.

OKLAHOMA — SCM, Bert Weidner, W5HXI — Asst. SCM, George Bird, 5HGC. SEC: AHT. HXT is on 3.9 Mc. The Oklahoma City University Club will be on all bands with eight 70-ft. antenna poles. ADB reports into OLZ Net. LHP has only a Signal Shifter to report into the net. W5HXU/KL7, at Summit, Alaska, is on 7022 kc. Wednesday nights. AQE is back handling traffic. HKH and NMM are new ORS. IGO had quite a trip to Houston. Let her tell the story. MXV has offered several valued suggestions to both nets, and they are getting results. EARC held its annual get-together — it was really a great meeting. NEWS is the new publication of the Lawton-Ft. Sill Club. CNK seems to be the DX hound for this section. The prize DX for 144-Mc. work is between EIO and EZK for 95 miles. OCARC is planning a transmitter hunt for the spring. MMN and FRB were at ATJ for a day, and FRB showed up at HRZ. FRB admits he is trying to get a new rig on the air. ATJ, FMB, GZK, GOL, and KLH are checking for harmonics during OEP Net drill Sunday mornings. EAK finally gave up and moved his transmitter into the house. HGC, Net Control for 'phone net, is trying to get more traffic moving. Please send in reports the first of each month. Traffic: W5FMF 143, GVS 136, IGO 111, NMM 90.

(Continued on page 128)

It's Front-page News!

45 WATT - 3 BAND CW TRANSMITTER KIT

MICAMOLD

XTR-1

\$34.
Only less tubes,
crystal and key

Micamold fires the opening shot in the war on high prices with a low priced, high quality transmitter kit priced within easy reach of every amateur. Very simple to assemble. Complete from power supply to antenna matching network. Just plug in the tubes, crystal and key and you're on the air.

**Operates on
80, 40 and 20 meters**



Quality Engineered and Equipped Throughout

BAND SWITCHING . . . No coils to plug in. A flip of the switch puts you on 3.5, 7 or 14 MC band using suitable crystal.

SUREFIRE CIRCUIT . . . Electron coupled Crystal oscillator driving final amplifier. No neutralization is required. Crystal current is less than one milliamper. Band switch controls both a tapped broad tuned oscillator plate coil and the final output circuit. Pi-network matches any antenna. Puts out a clean cut signal, no chirps.

ABSOLUTE SAFETY . . . No exposed live parts. When used with insulated lead-in wire it is impossible to get a shock during adjustment or operation.

SOUNDLY ENGINEERED . . . Designed to last and fully guaranteed! Every Micamold XTR-1 kit contains Grade A components including Micamold Capacitors, and is sold under the provisions of the standard warranty of the Radio Manufacturers Association. Simple, clear instructions for assembly, wiring and operation.

If your dealer does not have a kit on hand write to us for the name of the nearest dealer or send your order direct to Micamold with your remittance. Your kit will be shipped promptly.



MICAMOLD RADIO CORPORATION

Manufacturers of High Quality Electrolytic, Paper, Mica Capacitors and Resistors

1087 FLUSHING AVENUE, BROOKLYN 6, N. Y.

THE Radio Amateur's Library

THESE ARE THE PUBLICATIONS WHICH EVERY AMATEUR NEEDS. THEY FORM A COMPLETE REFERENCE LIBRARY FOR THE AMATEUR RADIO FIELD; ARE AUTHORITATIVE, ACCURATE AND UP TO DATE

Title	Price
<i>QST</i>	\$3.00 per year*
Operating an Amateur Radio Station — Free to members; to others	10c
The Radio Amateur's Handbook, \$2.00**	
The Log	50c
How to Become a Radio Amateur ..	25c
The Radio Amateur's License Manual	25c
Hints & Kinks for the Radio Amateur	50c
Lightning Calculators:	
a. Radio (Type A)	\$1.00
b. Ohm's Law (Type B)	\$1.00
A.R.R.L. Antenna Book	50c
The Minilog	25c
Learning the Radiotelegraph Code ..	25c
A Course in Radio Fundamentals ..	50c

* Subscription rate in United States and Possessions, \$3.00 per year, postpaid; \$3.50 in the Dominion of Canada, \$4.00 in all other countries. Single copies, 35 cents.

** Postpaid \$2.00 — United States, its possessions and Canada. \$2.50 elsewhere. Buckram bound \$3.00.

The American
RADIO RELAY LEAGUE
• INCORPORATED •
WEST HARTFORD 7, CONNECTICUT

HGC 66, AQE 62, AHT/AST 61, FRB 27, IOW 25, HXC 21, ATJ 18, EHC 18, PA 16, ADC 8, ADB 6, EAK 6, GOL 5.
SOUTHERN TEXAS — SCM, Ted Chastain, W5HIF — SEC: HQR. PAM: EYV. GQF, San Angelo, is new EC, and reports MTO, MUU, and NKS are active there. N1Y is working good DX on 7, 14, and 28 Mc. MN, of San Antonio still leads the section in traffic-handling. MWN is sweating out his Class A ticket. DAA, EC for Kingsville, reports LGL received 144-Mc. beam for Christmas and 11KW/5 is active on 50 Mc. NOC, of Corpus Christi, originated 511 messages on his first try at traffic-handling; he is ORS. GKI, LFM, LGG, and LSO have left for foreign service. LWV, of El Paso, schedules J2COM each Saturday. Those of you who have traffic for Japan, contact him. BGH is new secretary of Austin Amateur Radio Club. CCD, EC for Corpus Christi, received new Panadapter for Christmas; his postwar DX total is 62 countries. FRC has new Panadapter and is back on 28 Mc. after repairs to beam. LOF received a new three-element beam for Christmas. On Dec. 17th the Rio Grande Valley International Radio Club elected the following officers: KSW, pres.; FAH, vice-pres.; EVL, secy.; and CZF, act. mgr. The club extends a standing invitation to all South Texas hams to attend its square dance and club meeting once a month. FNA, BE, LGG, LVD, VY, and GKI are all over the 100-country hump. 50-Mc. activity is booming in San Antonio; VY has nine countries. JLY has 6, LIV has 5, and LBG has 2. FNY is new EC for San Antonio area. KJY has new 28-Mc. rotary beam. HZJ gets out nicely on 28 and 14 Mc. using f.m. LVD is handling traffic on 7-Mc. c.w. KZT reports loss of antennas. His postwar DX is 119. BDI has new type folded dipole on 3.85 Mc. New Class A licensees in Houston are IYR and JWM, who also has a new beam. JLY has new sixteen-element beam on 144 Mc. FGG, in Seguin, is on 144 Mc. and is looking for contacts. The c.w. section of STEN has changed its drill time from 6:30 to 8 p.m. on Monday nights. The XYL of CU, of Zapata, now has her own call — NWR. IVU has his private pilot's license. Traffic: W5NOC 517, MN 278, DAA 40, CCD 23, N1Y 14, IC 9, JPC 5, KSW 5, ACL 3, HIF 3.

NEW MEXICO — SCM, Lawrence R. Walsh, W5SMA — The 7-Mc. net on 7266 kc. got off to a good start December 14th. MYI was on 28-Mc. 'phone from Santa Fe during the holidays. JKK is active on 7 Mc. with both "Doc" and "Cran" operating. MXF was in Pittsburgh, Pa., during the holidays. NQP has new antenna — a center-fed Zepp. ZA joined the Silent Keys. KAD, OO, has been giving out true reports on 14 Mc. and losing contacts. HI. GHG is ready to go on 7 and 3.5 Mc. as soon as antenna problem is solved. 9BPX/5 now is NXE. We'd like to welcome 8BYB/5 and his XYL, 8DYY/5, to New Mexico. HWR and KWP visited SMA and NXE at Los Alamos on January 11th. Los Alamos Radio Club, MBF, and SMA received nice publicity in an article in Santa Fe newspaper. SMA has a new jr. operator — a daughter born on Christmas Day. Appointments: RM: HJF, ECs: FAG, GHG, JYW, KWP, and NXE. Traffic: (Oct.) W5CTP 58. (Dec.) W5NXXE 59, ZM 43, HJF 38, ZU 13, MXF 9, SMA 8, KWP 5, JYW 4.

CANADA MARITIME DIVISION

MARITIME — SCM, A. M. Crowell, VE1DQ — BV has turned up again on 7 Mc. DB has schedule with VO2AJ each Sunday at 10:30 a.m. AST on 14 Mc. ES had added some new gear and works mostly on 3.6 and 14 Mc. DQ has been keeping some nice schedules with 80E and 8NB so that the Halifax boys in isolation there might have an occasional chat with their XYLs and friends at home. Traffic for one of the weather station boys at 8MB was handled to his home town of Denver. Traffic for the boys "up north" also was handled by FQ, EE, FL, LR, and GR. At a recent meeting of the LCARC much important business was handled, including an election of officers. IW is a "40-40" man — 40 watts and 40 meters, and recently worked 7ACP, another 40-40er. EW is champion DX man. GP and EI have beam antenna arrays. Some 28-Mc. jottings from our St. Charles correspondent, W9EJX; Officers of South Shore Club are: LR, pres.; OY, vice-pres.; NA, secy.-treas. The Dartmouth Club call is DN. NT had his portable-mobile hooked to CM's beam at Fredrickton recently. LU has converted an English surplus job into nice e.c.o. OY has a new 'scope. QZ has been on 14 Mc. keeping schedules with VO6EP. Traffic: VE1HJ 67, DB 9, NY 7, ES 1.

(Continued on page 128)



TO HELP YOU PICK THE BEST

Here are a few facts to help you choose the best: In approximately 90% of the new commercial mobile transmitter designs, you will find Hytron instant-heating tubes. Over 2,500,000 Hytron gaseous voltage regulators speak for themselves. Ratings of Hytron vhf tubes are CCS and based on actual equipment performance which you can duplicate. No other transmitting triode can touch the new all-purpose 5514 for economical versatility. Famed for transmitting tubes, Hytron also originated the popular "GT", and is the oldest manufacturer specializing in receiving tubes. You pick the best when you pick Hytron.

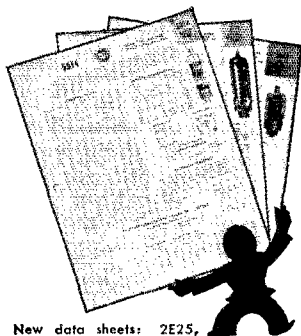

New data sheets: 2E25, 2E30, HY31Z, HY69, HY75A, HY1231Z, HY1269, 5514, 5516. Free.

HYTRON TRANSMITTING AND SPECIAL PURPOSE TUBES CONTINUOUS COMMERCIAL SERVICE RATINGS

Description	Type No.	Filament Ratings		Type	Max Plate Volts	Max Plate Ma	Max. Plate Dis	Amateur Net Price
		Volts	Amps					
LOW AND MEDIUM MU TRIODES	10Y	7.5	1.25	Thor	450	65	15	\$1.95
	HY24	2	0.13	Oxide	180	20	2	1.50*
HIGH-MU TRIODES	801A/801	7.5	1.25	Thor	600	70	20	3.00
	864	1.1	0.25	Oxide	135	5	—	1.50
VHF TRIODES	1626	12.6	0.25	Cath	250	25	5	1.60
	HY31Z \$	6	2.55	Thor	500	150*	30*	5.50
	HY1231Z \$	6	3.2	Thor	500	150*	30*	5.50
	5514*	7.5	3	Thor	1500	175	65	4.95
BEAM PENTODES AND PENTODES	2C26A	6.3	1.15	Cath	3500	NOTE	10	7.75
	HY75A# \$	6.3	2.6	Thor	450	90	15	4.70
	HY114B \$	1.4	0.155	Oxide	180	12	1.8	2.25
	HY615	6.3	0.175	Cath	300	20	3.5	2.25
	955	6.3	0.15	Cath	200	8	1.8	3.10
	9002	6.3	0.15	Cath	200	8	1.8	2.15
ACORNS MINI-TUBES	2E25# \$	6	0.8	Thor	450	75	15	5.50
	2E30 \$	6	0.65	Oxide	250	60	10	2.25
	3D21A	6.3	1.7	Cath	3500	NOTE	15	7.50
	HY69 \$	6	1.6	Thor	600	100	30	5.50
	807	6.3	0.9	Cath	600	120	25	2.30
RECTIFIERS	837	12.6	0.7	Cath	500	80	12	4.15
	HY1269 \$	6	3.2	Thor	750	120	30	5.50
	1625	12.6	0.45	Cath	600	120	25	2.30
GASEOUS VOLTAGE REGULATORS	5516 \$	6	0.7	Oxide	600	90	15	5.95
	954	6.3	0.15	Cath	Sharp cutoff pentode			4.90
	9001	6.3	0.15	Cath	Sharp cutoff pentode			2.70
RECTIFIERS	Type No.	Filament Volts	Ratings Amps	Type Rect	Peak Plate Ma	Max D-C Ma†	Inv Peak Pot.	Amateur Net Price
	816	2.5	2.0	Mer	500	250	5000	\$1.25
	866A/866	2.5	5.0	Mer	1000	500	10000	1.75
GASEOUS VOLTAGE REGULATORS	1616	2.5	5.0	Vac	800	260	6000	7.50
	Type No.	Average Operating Voltage	Operating Ma	Av Volts Reg	Min Starting Voltage			Amateur Net Price
	OA2	150	5	30	2	185		\$2.00
OB2	108	5	30	1	133		2.30	
OC3/VR105	108	5	40	2	133		1.20	
OD3/VR150	150	5	40	3.5	185		1.20	

*Both sections of twin triode. NOTE: Special pulse tube, not recommended for c-w; consult Hytron Commercial Engineering Dept. for data. #5514 supplants the HY30Z, HY40, HY40Z, HY51A, HY51B, and HY51Z; the HY75A the HY75; and the 2E25 the HY65. †Current for full wave, instant-heating.

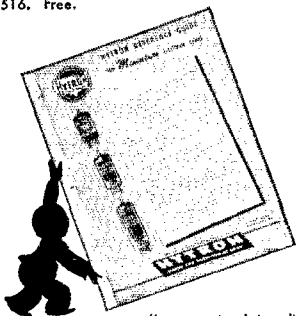

Keep up to date with the Hytron Reference Guide for Miniature Electron Tubes. Free.

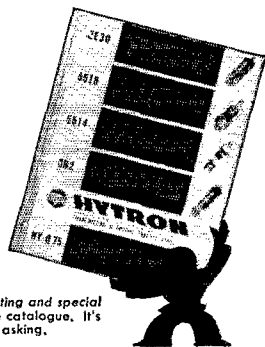

New transmitting and special purpose tube catalogue. It's yours for the asking.

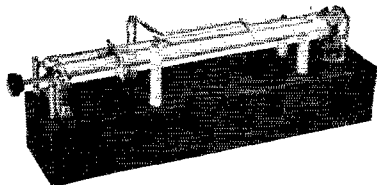

Simple, sure-fire vfo for 1 1/4 or 2 meters. HY-Q 75 kit: unassembled, \$9.95; assembled, \$11.95.

For better reception, it's also Hytron — GT, G, lock-in, or miniature.

HYTRON RADIO & ELECTRONICS CORP. SALEM, MASSACHUSETTS



**HERE'S A
TRYLON TOWER
FOR AMATEURS**

Buy only the genuine, lightweight TRYLON Steel Ladder Tower. Easily adapted to Amateur use, it employs the same basic design of the famous TRYLON vertical radiators. Look for these features:

- Designed and engineered for 100 mph winds
- All steel parts hot dip galvanized after fabrication to rigid Army and Navy specifications
- Easy-to-climb ladder on all towers
- Prefabricated guys with factory assembled compression sleeves
- "Palmits" supplied with each and every bolt
- Easy to install

6' TYPE 1245 TRYLON STEEL LADDER TOWER - Shipped completely knocked down with 2 sets of 3 prefabricated guys, 3 earth anchors, top castings and top plate. 12" face size - \$140.60 (Amateur's Net Price) l.o.b. West Chester, Pa. Approx. Shipping Wt.: 420 lbs.

Write, write or call Tower and Antenna Division
WIND TURBINE COMPANY
West Chester, Pennsylvania

TRYLON TOWERS

ONTARIO DIVISION

ONTARIO—SCM, David S. Hutchinson, VE3DU—WK had to cancel schedule with BAJ because of conditions. Hamilton has the "Screwball Net" on 28-Mc. 'phone Sundays at 10:30 P.M. BMG is on Ontario 'Phone Net and Beaver Net. DH, our Ottawa outlet, is on BN. VD is confined to 7-Mc. traffic work. KM is active on OPN. AXQ is on AFARS. AWE, new-comer to Beaver Net, is building VFO. BCE is new EC for Peterboro and district. KE, formerly of Ottawa, is a new 50-Mc. man in Galt. AWJ has returned to the air after rebuilding. GW2WV/G2WV now is living in Toronto and waiting for his HRO to catch up with him. The following news was sent by BBQ, Kirkland Lake. ALT now is club activities manager. ALU has forsaken c.w. to chew the rag with the OPN gang. AQN has FB Stewart Warner receiver. BGI got endorsement for 28-Mc. 'phone but now is back on 7 Mc. with BC-457. BHU is on 7 Mc. with 40 watts. BJE is active on 28-Mc. 'phone and is getting gear together for 144 and 50 Mc. BNI is a new-comer on 7 Mc. with 15 watts and 17-ft. antenna. PIH is back on 28- and 14-Mc. 'phone. BTC, a new ham, has MKIII No. 19 tank set. PA is busy changing diathermy machines to crystal control. WI is on 28 and 14 Mc. most week ends. TZ is keeping Swastika on the map. ANH is most for WAS and WAVE. AZH now is at Timmins. Toronto East AFARS Squadron now has the following member stations; EF, GG, IE, AFW, ALO, AUW, AXQ, BCE, and BCZ. AFW asks for a QSL from any VE who served with him in the RCAF; he would like to locate as many of the gang as possible. BCE has new rig with 180 watts to 828. EF has completely rebuilt and uses VFO with 225 watts to 811 final on 3.5, 7, and 14 Mc. Congrats to ATR on his FB traffic total. Traffic: VE3ATR 520, SF 339, TM 165, XO 133, BCP 129, CP 112, WX 78, GI 55, DH 51, DU 49, BMG 47, KM 27, AWE 14, VD 9, WK 4.

QUEBEC DIVISION

QUEBEC—SCM, Gordon A. Lynn, VE2GL— Please note that your SCM has changed QTH. Reports and correspondence should be addressed to him, care Radio Division, Montreal Airport. TM reports regular schedules with VE8NB in the frozen north. HB's 14-Mc. antenna is down. XC is new on 28-Mc. 'phone in Quebec. IS worked his first J on 28 Mc. recently and 4 other continents in 20 hours with 35 watts to three-element beam. JJ has worked 21 ZLs and has over 60 countries to his credit. PK and BR both worked ST2CH in Sudan. VL and JJ had TG9JW as visitor. ABJ is new-comer in St. Maurice Valley and doing well on c.w. EC continues to maintain schedules on 'phone net and is handling lots of traffic. SM has new modulator. VB has new RAIB receiver. KS has worked 92 countries. DU worked 4 Gs on 3.85-Mc. 'phone and DX worked several Gs and an Austrian on 3.85-Mc. 'phone. WW made WAC in 7 hours, his Asian being CR9AN, Macau, on 14,109 kc. LO continues to have good results on 7 Mc. WR worked the West Coast on 3.5 Mc. with 10 watts. XO is new on 7 Mc. in Yamachiche. MARC held a very successful meeting in December when Jock Black, a "GM" who is staying with CY, won the NC-173 receiver. WISZ and Mr. McGrath, from Malden, were guests. LP has stirred up considerable activity on 50 Mc. in Montreal and South Shore. DY's XYL now has her own call, ABW. RC is new-comer on South Shore. Another reminder, mail me your reports. Traffic: VE2GL 66, EC 31, HH 28, TM 23, BB 21, DY 12, PT 8, CA 7, KS 3.

VANALTA DIVISION

ALBERTA—SCM, W. W. Butchart, VE6LQ—The Alberta Net resumed activity Dec. 1st with QS, BN, and LQ operating. WG does an excellent job on Trunk Line "I." HM lined up his HRO. He has new Bach-Simpson Mod-Meter. MJ got 28-Mc. beam hung up. BM, of Vulcan, visited the Edmonton gang. WS is experimenting with five-element 28-Mc. array. 7TC is ex-4EC. BN got new bug for Christmas. EY got hold of a bum 100-ke. rock. AL works out well with his low-power rig. VX was transferred from Edmonton to Medicine Hat. Maybe we'll hear Joe on the air once in a while now! DN has trouble getting his various receivers working on 28 Mc. HM has been appointed Assistant CGM for Alberta. QS is struggling with VFO. IN has QTH

(Continued on page 130)

PRE-EXAM TESTS

For Commercial Radio Operator **FCC LICENSE EXAMINATIONS**



Don't Take A Chance!
Avoid Failure on FCC Commercial Radio Operator License Examinations!

USE NILSON'S COMPLETE PRE-EXAMINATION TESTS AND COACHING SERVICE

Enables You To Rehearse the FCC license examinations Practice the procedure

Practice the multiple-choice examination methods used by FCC

Check your knowledge
Locate your weak points
Correct your weak points before taking the actual examination

Prepared by Arthur R. Nilson, Famous Co-author of Nilson and Hornung's RADIO OPERATING QUESTIONS AND ANSWERS

Use Coupon or write for Descriptive Folder No obligation—no salesman

CLEVELAND INSTITUTE of RADIO ELECTRONICS
QT-3 Terminal Tower Cleveland 13, Ohio

MAIL THIS COUPON

Cleveland Institute of Radio Electronics
QT-3 Terminal Tower, Cleveland 13, Ohio
Gentlemen: Please send information about Pre-Exam Tests. Does not cover Amateur License Exams.

Name.....
Address.....
City..... Zone..... State.....

TERMINAL IS YOUR BEST BET FOR BETTER BUYS

NEW YORK'S LEADING SUPPLY HOUSE for RADIO PARTS & ELECTRONIC EQUIPMENT

Terminal has tremendous stocks of Everything in Radio at Lowest Prices! Prompt attention given all orders! IMMEDIATE DELIVERY of ALL ITEMS in this AD!

HEADQUARTERS FOR AMATEUR EQUIPMENT

HALLICRAFTERS HT-17



XMITTER WITH TUBES AND 40 METER COIL
49.50 NET

NEW LOW PRICE

TELEVISION KITS & PARTS

Hams who'd like to build their own television set are invited to drop in or write for our low prices. We carry Transvision and Television Assembly Co. kits in 7", 10", 12" and 15" picture tube sizes. We also have a complete stock of television components, tubes, lens magnifiers, projection optical systems and other accessories.

'BEST BUYS' IN SIMPSON MULTIMETERS

HANDY and INEXPENSIVE!
Model 240 HAMMETER AC-DC VOLT-OHM-MILLIAMMETER

Ranges: 0-15, 150, 750, 3000 A.C. volts; 0-15, 75, 300, 750, 3000 D.C. volts; 0-15, 75, 300, 750 D.C. milliamperes; 0-3000 ohms (center scale 30), 0-300,000 ohms (center scale 3000); 1000 ohms per volt A.C. and D.C. Completely self-contained, with the variety of useful ranges needed to do an all-around general service job. Supplied with test leads. Your cost, only

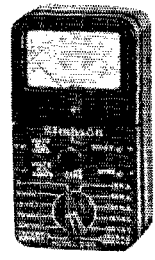

21.31 NET

OUTVALUES THEM ALL!
Model 260 Super-Sensitive VOLT-OHM-MILLIAMMETER

Ranges: 0-2.5/10/50/250/1000/5000 volts A.C. and D.C.; 0-2000 ohms (center scale 12), 0-200,000 ohms (center scale 1200), 0-20 megohms (center scale 120,000); 5 DB ranges from -10 to +52 db.; D.C. current readings from 1 micro-ampere to 500 milliamperes in four scales, plus 0-10 amperes D.C.

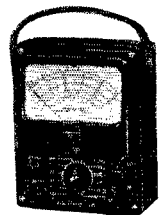

At 20,000 ohms per volt D.C., the Simpson 260 can measure a wide range of unusual conditions not possible with ordinary servicing instruments. Complete with test leads, your cost..... **38.17 NET**

BEAM ANTENNAS

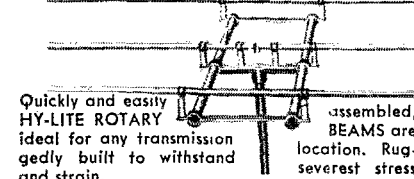

Quickly and easily assembled, HY-LITE ROTARY BEAMS are ideal for any transmission location. Ruggedly built to withstand severest stress and strain.

Supplied complete with telescoping 5/8" - 3/4" aluminum elements, locking clamps, heavy Steatite insulators, strong aluminum castings, all hardware and fittings and 6' mast.

HY-LITE 10 METER BEAMS

3E10 Jr.—3 elements, complete as described.....**19.95**
3E10F Jr.—3 elements, with folded dipole **23.95**
4E10F Jr.—4 elements, with folded dipole **29.95**

KENYON TRANSFORMERS

Kenyon Transformers are not the cheapest, but they certainly are good! Conservatively rated and ruggedly built to last and last!

KEN-O-TAP MODULATION TRANSFORMERS

Never grow obsolete! Ideal for amateurs who wish to keep up to date with new tube combinations. Will match any Class B tube or tubes to any Class C load.

Type	Audio Output Primary	Class "C" Secondary	Net Price
T-489	15 watts	30 watts	5.23
T-493	40 watts	80 watts	7.85
T-494	75 watts	150 watts	10.64
T-441	125 watts	250 watts	14.82
T-496	300 watts	600 watts	32.95
T-442	600 watts	1200 watts	39.69

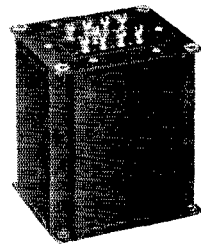

High Voltage PLATE TRANSFORMERS

Type	Secondary A.C. Volts	D.C. Volts	D.C. Ma.	Net
T-668	1000/750-0-750/1000	500/750	300	12.82
T-669	1460/1180-0-1180/1460	1000/1250	300	21.05
T-670	2360/2080/1760-0-1760/2080/2360	1500/1750/2000	300	27.49
T-671	1460/1180-0-1180/1460	1000/1250	500	26.31

We carry a complete stock of Kenyon transformers and chokes for power and audio requirements.

TELEVISION ANTENNAS

Elincor "H" stacked array, 5/8" aluminum tubing, all elements adjustable. The finest antenna of its type, regardless of cost. Type 350SA.....**17.64**

Elincor's economy stacked "H", similar to type 350SA, but with 1/2" aluminum tubing, non-adjustable. Type 310SA.....**12.64**

Elincor folded dipole with reflector, 5/8" aluminum tubing, fully adjustable in length. Best of its type available. Type 300FDR.....**10.58**

Other makes and types in stock—TERMINAL'S low prices prevailing, as always.

AMATEUR & COMMERCIAL CALL LETTER PLATES

for

- MICROPHONES • MIKE STANDS • LAPEL PINS • DESKS
- PANELS • STUDIO DOORS • WALLS • ASH TRAYS
- TELECAMERAS • AUTOS

Terminal can supply over 100 different styles of call letters and name plates as used in the radio industry. Made of sturdy, light-weight cast aluminum with letters and borders raised and satin-finished against a baked crackle-enamel background. Colors available include black, gray, green, blue, red, goldenrod and mahogany. Moderately priced, with special discounts for quantity orders. Write today for complete illustrated catalog!

GUARANTEE — Every item, regardless of its low price, is fully guaranteed by TERMINAL RADIO CORPORATION.

If unable to visit our store, send us your mail orders with 25% deposit. Remit in full all orders under \$5.00. Prices are F.O.B. New York.

ESPEY TELEVISION KIT

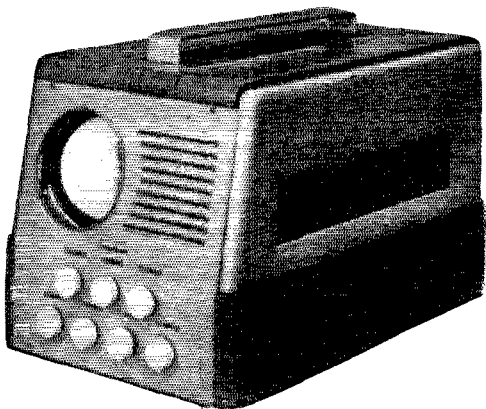

Designed around modern circuits, and manufactured of the finest materials, this ESPEY Television Kit offers you the opportunity of building your own personal television set at unbelievably low cost. Kit is supplied complete (less tubes and cabinet) with all parts, punched and welded chassis, instruction book, etc. for only.. **\$69.50**

For full details, write to Dept. B

ESPEY MANUFACTURING CO., INC.
528 East 72nd St. New York 21, N. Y.

THE AMATEUR'S First Choice

A good volt-ohm-milliammeter is usually the first test instrument purchased by any radio man. Chicago Featherweights offer so great a value in accurate quality, small size, in a wide selection of ranges and sensitivities, that they are the first choice of amateurs everywhere.

Chicago volt-ohm-milliammeters are priced from \$5.25 to \$26.00 depending on sensitivity, ranges, etc. At our modest prices, no ham shack need be without the benefit of this most useful instrument.

Chicago
INSTRUMENTS

See your Jobber or write us today for Bulletin No. 11

Chicago Industrial Instrument Co.

536 W. Elm Street

Chicago 10, Ill.

130

near Nanton. AO is knocking off the DX, ably assisted by TM. HB rebuilt his receiver. OT put up semi-fixed beam. CS controls AFARS Net in Edmonton. Traffic: VE6WG 171, BN 24, LQ 19, QS 8, MJ 7.

PRAIRIE DIVISION

MANITOBA — SCM, A. W. Morley, VE4AM — Traffic shows a definite upswing in the Section but a lot of it still isn't reported. From Flin Flon, FG reports that he is interested in CD appointments and will be applying for ORS soon. He keeps active on 7 Mc. and has several schedules lined up. YM is running 500 watts on c.w. and is using a 19 set on 3.8-Mc. 'phone. EQ is using BC-348 and likes it very much. EO is working on 28 Mc. OB will be active on all bands. More activity is noted on 3.5 Mc. RG, at Deloraine, is heard occasionally. LS is winding 1000-volt plate transformer. FN keeps WT active. AX, at Rivers, ex-7ADK, uses a Collins with 250 watts input. SS has his RCC Certificate. FW is working 'phone on all bands. EL is on 7 Mc. MM and HH keep Portage on the map. The Manitoba section of AFARS is being revamped and should shape up into a nice Provincial net. If interested, write me. Traffic: VE4AM 378, AN 6, GQ 6, JM 4, KX 3, EA 2, EL 2.

SASKATCHEWAN — SCM, Norman Thompson, VE5CO — New officers of the Saskatoon ARC are RJ, pres.; MQ, vice-pres.; KQ, financial secy.; RC, recording secy. WZ is on 'phone and is building a new rig. FD has new rig on. AJ has new QTH and new rig with 813s in final. AX moved to Victoria and was given a farewell party by the gang. Saskatoon has two new XYL operators — YF and FL. KJ is passing traffic to Victoria with 50 watts. CP claims new low power record working from Lac Vert to Tivan with .00585 watts. He started with 4 watts getting S9 and worked down to S4. Dick Patten has left Moose Jaw for Fort McMurray, Alberta. EK's license arrived on his wedding day. DP is on regularly with 15 watts. DQ is on from Saskatoon with 30 watts. Traffic: VE5MW 5, CZ 3.

It Seems to Us

(Continued from page 12)

American democratic processes. For the next two months the subject is wide open to debate, and the fullest expression of opinion is invited. If you have something to get off your chest beyond answering the questions asked you by the Board, that opinion should be expressed to your division director, not to Headquarters, since the Hq. staff has no participation in the matter and you are to be represented at the May Board meeting by the director from your division. He will be glad to hear from you.

A closing thought: Come early May there will be a Board decision, one way or the other, and the news will be broadcast. Inevitably some of us won't like it. In political campaigns we Americans have the habit of fighting doggedly for our convictions right up to election day — but then accepting the results, whatever they are, as in the best interests of the majority. In our own 'phone matter we have ample evidence of sincere and searching study by the directors, of their conscientious endeavor to find the best all-around answer for us all. Can we not hope that, in good traditional American fashion, we will all accept that answer, whatever it turns out to be, and do our best to live with it?

Edgar

The Radio Amateur's **HANDBOOK**

The twenty-fifth edition of the *Handbook* is featured by the complete rewriting of the material to give a more understandable discussion of those basic facts that an amateur should know to get the most out of constructing and using his apparatus. Owners of previous editions will recognize immediately that the over-all plan of the book has been changed — achieving, we believe, the object of segregating the material so that it can be most conveniently used. A great deal of new equipment has been constructed especially for this edition. As always, the object has been to show the best of current technique through equipment designs proved by thorough testing. As the art grows, the problem of presenting a representative selection of gear grows with it — a state of affairs that is reflected in an *increase of well over a hundred pages* in this edition. New chapters on ultrahigh frequencies, station assembly, and the elimination of interference to broadcasting have been added to round out the treatment of all phases of amateur radio. The material on operating has likewise been greatly expanded. Altogether, this revision is the most comprehensive of recent years.

PRICE \$2.00 — UNITED STATES, ITS POSSESSIONS AND CANADA

\$2.50 ELSEWHERE • BUCKRAM BOUND \$3.00

American Radio Relay League, West Hartford, Conn., U.S.A.

CLARK CRYSTALS

for the famous

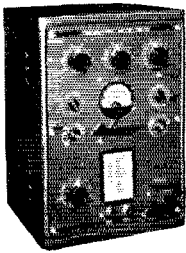

Harvey-Wells TBS-50 TRANSMITTER

The most versatile small transmitter on the market — only 8" x 13" x 9" — 50 WATTS — Phone or CW — 8 BANDS with band switch (NO plug-in coils) — Crystal controlled on all bands — For fixed or mobile operation — Supplied complete with tubes. It's today's BEST BUY!

Only \$9950 ORDER YOURS TODAY

Kits of FOUR type PM-2C Clark Crystals — Guaranteed, tested and calibrated in the TBS-50 — now available in the following frequency ranges:

- Kit A-3500 kc to 4000 kc for 80 meters
 - Kit B-3500 kc to 3650 kc for 40 meters
 - Kit C-3500 kc to 3600 kc for 20 meters
 - Kit D-6790 kc to 6857.5 kc for 11 meters
 - Kit E-7000 kc to 7425 kc for 10 meters
 - Kit F-5555.5 kc to 6000 kc for 6 meters
 - Kit G-8000 kc to 8222 kc for 2 meters
- 4 Random frequencies in any kit (specify phone or CW) \$7.50
- 4 Specified frequencies ± 5 kc in any kit \$8.75
- 4 Specified frequencies $\pm 0.1\%$ in any kit \$10.40

Order from your jobber or direct from

CLARK CRYSTAL COMPANY

Marlboro, Massachusetts

180-Watt Transmitter

(Continued from page 50)

in place by cementing it to celluloid tie-strips.

Typical current and voltage values under adjusted operating conditions are shown in the accompanying table.

Results with this rig on the air have more than fulfilled all expectations. The author has had several races with other hams, choosing a random frequency in any band. Usually it is possible to get to the selected frequency faster than the other fellow can get his receiver there. In fact, only those with receivers that do not require setting a general-coverage dial stand a chance of winning. It has it all over the BC-348 or equivalent when it comes to rapid tuning to frequency.

Bibliography

- Bradley, "A Bandswitching VFO Exciter Unit," *QST*, March, 1946, p. 29.
- Robinson, "A Search for VFO Stability," *QST*, May, 1945, p. 18.
- Harms, "Single Control in the Bandswitching Transmitter," *QST*, December, 1946, p. 19.
- Goodman, "A Four-Band 125-Watt Transmitter," *QST*, December, 1945, p. 22.
- Mix, "Using the New High-Power Beam Tubes," *QST*, October, 1945, p. 67.

Public Relations

(Continued from page 40)

them more zealous than ever in hoarding their precious space. If you give the editor two columns of material and he prints two paragraphs, don't beef about it — he feels as if he has given you his left eye.

3) You mustn't expect technical accuracy. It is an odd fact that newspapers and press associations which boast about their accuracy are more than likely to stumble, on technical grounds, when they try to discuss radio. So, don't be surprised if your material, when it appears in print, is full of technical errors. And — this may sound strange — don't try to correct them; the editor will think you ungrateful for carping about it. Besides, most of the people who read it won't know the difference anyway. Just pat yourself on the back if you managed to get a favorable mention of amateurs or amateur radio — that's what you were after.

4) All through the war, newspapers and broadcast stations were literally deluged with publicity material, largely of Governmental origin. In ordinary times, a surplus of this stuff would simply lead to larger wastebaskets, but during the war the editors and program directors felt they had a moral obligation to use as much of it as they could, as a contribution to the war effort. But gorging on publicity material was like gulping castor oil, and the bad taste lingers on. This means the people you are dealing with are super-sensitive to publicity, as such. So tread lightly when you walk up to the desk. Avoid, completely,

(Continued on page 134)

Valpey Xtalector provides INSTANT QSY with UNEQUALLED STABILITY

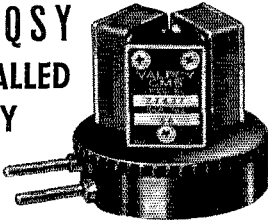

The VALPEY Xtalector

is BETTER than a "rubber" crystal

- Provides 3 exact spot frequencies at your finger tips.
- Eliminates erratic operation.
- Maintains constant activity.
- Actually costs you less!

If your dealer cannot supply you, write to

XTALECTOR ONLY
\$1.35

Specify "X2" for $\frac{1}{2}$ " sockets or "X3" for $\frac{3}{4}$ " sockets. Each designed for crystals with $\frac{1}{2}$ " spacing, .094 diameter pins.

★ ★ ★

Valpey type CM5 crystals for 80 and 40 meters, only \$2.80; for 20 meters, only \$3.50; for 10 meters, only \$4.50.

VALPEY
CRYSTAL CORP.

Holliston, Mass.

Craftsmanship in Crystals Since 1931

WIATP • WIHVP • WIBZJ • W1PLX • W1PFX

USE BOB HENRY'S PERSONAL SERVICE



I personally promise that you can find nowhere else lower prices, more complete stocks, quicker delivery, easier terms or more generous trade-ins. I give you 10-day free trial and 90-day free service. You can't go wrong in dealing with me because I personally guarantee that you will be completely satisfied on every deal. Write, wire or phone me today.

Bob Henry
WØARA

A FEW OF THE ITEMS WE STOCK ARE LISTED BELOW

Collins 75A-1.....	\$375.00
Hallicrafters S38.....	47.50
Hallicrafters S40A.....	89.50
Hallicrafters SX43.....	169.50
Hallicrafters SX42.....	275.00
Hallicrafters SP44.....	49.50
Hallicrafters HT18.....	110.00
Hallicrafters HT9.....	350.00
National NC57.....	89.50
National NC173.....	179.50
National NC183.....	269.00
National NC240D.....	225.00
National HRO-7.....	279.00
Hammarlund HQ129X.....	177.30
Hammarlund SPC400X.....	398.25
Hammarlund Four-20.....	120.00
Hammarlund Four-11.....	72.50
RME 84.....	98.70
RME 45.....	198.70
RME VHF152A.....	86.60
RME HF-10-20.....	77.00
RME DB22A.....	66.00
Collins 32V1.....	475.00
Meck T60.....	150.00
Signal Shifter model EX.....	99.50
Bud VFO-21.....	52.50
Millen 90800 exciter.....	42.50
Millen 90700 VFO.....	42.50
Millen 90281.....	84.50
Millen 90881.....	89.50
Millen 90810.....	69.75

McMurdo Silver, Sonar, Gordon, Premax, Workshop, Gonset; we have everything.

Prices slightly higher on the West Coast.

COMPLETE STOCKS

Henry has *everything* in the ham field.

QUICK DELIVERY

Shipments *4 hours* after receipt of order. Send \$5.00 with order and shipment will be made at once C.O.D.

TRADE-INS

You can't beat Bob Henry for trade-ins. Write, wire or phone today about your equipment and Bob Henry will make you a better offer than you can get anywhere else.

TIME PAYMENT

Because Bob Henry finances the terms himself you get a better break. Save time and money, deal with Bob Henry on his personal, profitable time payment plan.

Orders and inquiries from outside U.S.A. welcome.

Butler, Missouri

HENRY RADIO STORES

Los Angeles 25, Calif.

"WORLD'S LARGEST DISTRIBUTORS OF SHORT WAVE RECEIVERS"

HAMS SWL'S

- ALL-ALUMINUM
- FULLY ADJUSTABLE
- STRONG AND RIGID

.15 and .1
SPACING
3 ELEMENT
10-11 MTR.
ROTARY
JR. MODEL

\$1995

COMPLETE

3/4" & 5/8"
TELESCOPIC
ALUMINUM
TUBING

ALUMINUM
CASTED
SUPPORTS
6 FT. MAST

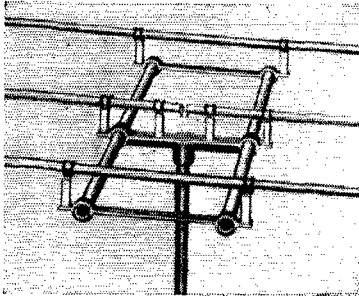

Write us FOR OUR
LOW PRICES AND CATALOG
WITH VARIOUS COMBINATIONS

HY-LITE Studios

528 TIFFANY ST., BRONX 59, N.Y.

GET YOUR FCC Commercial Radio Operators' LICENSE

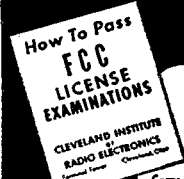

Now...

IT'S EASY IF YOU FOLLOW OUR PLAN! Thousands of new jobs are opening up — FM, TELEVISION, MOBILE COMMUNICATION SYSTEMS, are only a few of the new radio fields which require licensed operators.

Don't Delay—
Write Today!

FREE BOOKLET Tells you the Government Requirements for all classes of commercial licenses. Saves you many hours of random, undirected study. Assures a minimum of time in getting your ticket.

CLEVELAND INSTITUTE of RADIO ELECTRONICS
QT-3, TERMINAL TOWER CLEVELAND 13, OHIO

Approved for Veteran Training under GI Bill of Rights
MAIL THIS COUPON

Cleveland Institute of Radio Electronics
Q.T.-3, Terminal Tower, Cleveland 13, Ohio

Gentlemen: Please send your FREE Booklet: "How to Pass FCC License Examinations." (NOTE: This booklet does not cover examinations for Amateur Licenses.)

Name.....Address.....
City.....State.....
 Check here, if a veteran

the appearance of seeking public notice. Simply offer what you have as a matter of interesting information, and try to make your offerings live up to that definition.

There is no definite recipe for a news story. You will probably find that the easiest way to break the ice is with routine items about club activities: meetings, parties, banquets and the like. Your newspaper is already printing such items about other organizations — Modern Woodmen, Thursday Afternoon Circle, etc. — under such headings as Club Notes, Meetings About Town, or something similar. From such items it is an easy step to stories about Field Days, hamfests and conventions. Newspapers are invariably interested in the formation of new organizations, and a "natural" in this line would be the formation of your local Emergency Corps, linking the name of your club with the Red Cross, Naval Reserve and possibly others. Coöperate with such organizations to the end of having them mention amateur radio liaisons in their own publicity material. Subsequent emergency drills, demonstrating the ability of the local amateur group to handle communications rapidly and over a considerable area, then should be worthy of favorable notice.

Once the editors have become acquainted with you and your organization, they may become interested in semitechnical material, such as u.h.f. DX records, flea-power DX, or even feature articles — with pictures — on impressive-looking ham stations. Bear in mind that this stuff must be explained in the simplest of layman's terms, even at the expense of garbling fine technical points; no editor is going to print something that he doesn't believe his readers will understand.

By all means, keep the press informed of all actual emergency activity — not a day or two later, but just as it happens. But remember the secrecy provisions of the Communications Act. Limit your news of message handling to general terms. Statistics on the number of messages handled, places contacted and types of messages are okay. But the specific contents of individual messages and names of individual persons (such as the victims or relatives of victims of disasters) may not be released without the advance consent of the author and addressee of the message. If you are asked for information concerning an emergency, be sure that your answer is based on your own knowledge, and not on the contents of messages you are handling. Remember that people get excited during emergencies, and they naturally tend to exaggerate. Qualify your information by stating where you got it and under what circumstances.

In all dealings with newspapers, make sure that your information is accurate and complete. The average newspaper editor will merely reward you with a curious gaze if you tell him that "W9XXX worked VK3XX on 6-meter 'phone with 20 watts input and got an SS report." But he may prick up his ears if you tell him that:

(Continued on page 156)

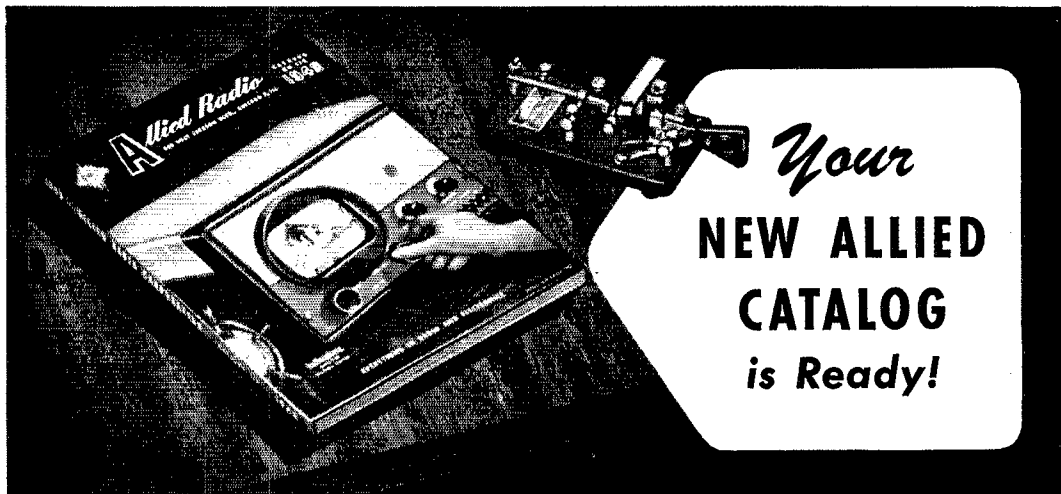

Your
**NEW ALLIED
 CATALOG**
is Ready!

**YOU'LL FIND ALL THE NEW GEAR IN THIS
 NEW ALLIED CATALOG—GET IT TODAY**
Immediate Delivery on Latest Receivers!

Hallicrafters S-51.....\$129.50	National NC-57.....\$ 89.50
Hallicrafters S-53..... 79.50	National NC-173..... 189.50
Hallicrafters SX-43... 169.50	National NC-183... 269.00
Hallicrafters SX-42... 275.00	National HRO-7..... 311.36

Net FOB Chicago. Prices subject to change without notice.

NEW! Sensational Time Payment Plan

Buy on ALLIED'S new Easy Payment Plan that saves you money! Full refund of carrying charges if you complete payment in 60 days—50% refund on payment in half the required time. Minimum order is only \$45.00—take up to 12 months to pay. Carrying charges are only 6% of balance after 20% down payment. Get the equipment you want this easy, economical way. No red tape—no delay—you save on ALLIED'S Easy Payment Plan.

**Send for the Leading
 Amateur Buying Guide**

Your 1948 ALLIED Catalog is off the press—the greatest Buying Guide in Amateur Radio! Name your needs—we've got everything you want—all the newest and finest in receivers, transmitters, instruments, parts and station equipment, at lowest, money-saving prices!

Take advantage of our new Time Payment Plan—nothing like it in radio. Get the benefits of our liberal trade-in allowances, 15-day trial on all receivers, full 90-day guarantee, and all the help in the world from ALLIED'S old-time Hams. Follow the lead of thousands of Amateurs who depend on ALLIED for all their station needs. Write today for your FREE copy of the new 172-page ALLIED Catalog, the world's Leading Amateur Radio Buying Guide.

It Pays to be "Equipped by ALLIED"

Keep This Buying Guide Handy . . .



ALLIED RADIO CORP., D. L. Warner, W9IBC
 833 W. Jackson Blvd., Dept. 27-C-8
 Chicago 7, Illinois

- Send FREE New ALLIED Catalog
- Enter order for
- Enclosed \$..... Full Payment Part Payment (Balance C. O. D.)
- Put my name on mailing list for the Allied Ham Bulletin.

Name.....
 Address.....
 City.....Zone.....State.....

**ALLIED
 RADIO**

Everything for the Ham

CUT HOLES FAST IN RADIO CHASSIS

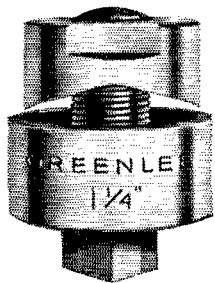

WITH A GREENLEE RADIO CHASSIS PUNCH

Eliminate tedious reaming and filing. Just turn GREENLEE punch with an ordinary wrench and make clean, accurate holes in a hurry. There's a GREENLEE for each of these sizes: $\frac{1}{8}$ "", $\frac{3}{16}$ "", $\frac{1}{4}$ "", $\frac{5}{16}$ "", $\frac{3}{8}$ "", $\frac{7}{16}$ "", 1 "", $1\frac{1}{8}$ "", $1\frac{1}{4}$ "", $1\frac{3}{8}$ "", $1\frac{1}{2}$ "", $1\frac{3}{4}$ "", $1\frac{7}{8}$ "", $2\frac{1}{8}$ "", $2\frac{1}{4}$ "". Also GREENLEE Knockout Punches and Cutters for conduit and meter holes up to $3\frac{1}{2}$ ". Write for facts. Greenlee Tool Co., 1863 Columbia Avenue, Rockford, Illinois.

TOOLS FOR CRAFTSMEN

GREENLEE



ANOTHER *New* BROWNING DEVICE

FREQUENCY METER MODEL S-6

Measures any radio frequency signal between 100 KC and 50 MC. Accurate to $\pm .025\%$.

Frequency meters. WWV standard frequency calibrator. Oscilloscope. Power supply and square wave modulator. Capacitance Relay. FM-AM Tuners. FM Tuner.

KNOW THE ENTIRE BROWNING LINE • ENGINEERED FOR ENGINEERS

WRITE TO DEPT. D FOR CATALOG



BROWNING LABORATORIES, INC.
WINCHESTER, MASS.

Ham Post!

VHF-152.....	\$86.60	Hammarlund	
Gon-set 10-11..	39.95	HQ 129X.....	\$177.30
Sonar MB 611..	72.45	RME-45.....	198.70
Sonar VFX680..	87.45	Halicrafter	
		SX42.....	275.00
		National	
		NC-2-40-D...	240.00



**CONTINENTAL
SALES COMPANY**

195-197 CENTRAL AVENUE, NEWARK 4, N. J.

"What is believed to be a new record for short-wave radio communication was established by a local amateur radio operator last night when W9XXX established two-way voice contact with VK3XX, in Melbourne, Australia, on a wavelength of only six meters.

"W9XXX is a private, noncommercial radio station, owned and operated as a hobby by John Gridleak, 88 Harmonic Drive, sales manager for the Punkwood Lumber Company. Amateur directories list VK3XX as being operated by Dr. George Sawbone, 73 Mycalex Circle, Melbourne, Australia. Oscar Socketpunch, secretary of the Blanktown Amateur Radio Club, said this was believed to be the first two-way contact between Illinois and Australia on such a high frequency.

"According to Gridleak, the contact was maintained for 50 minutes, and the Australian operator reported his voice was loud and clear in Melbourne. During that time, Gridleak said, he was using a power of only 20 watts, or about one-third the amount of electricity consumed by an ordinary electric light bulb.

"Gridleak has been a federally licensed amateur since 1931, and served as a radio technician in the Navy during World War II."

As you may have gathered from the foregoing, in all matters other than the contents of third-party traffic, the newspapers want complete names and addresses, plus occupational identification and personal background.

You should emphasize, in your initial contacts with newspapers, that amateur radio is a hobby, is noncommercial, and is not linked in any way with the broadcast industry. Many newspaper publishers bitterly resent the inroads of broadcasters in the advertising field, and therefore regard everything pertaining to radio with suspicion. It may take considerable tact and diplomacy to clear away these misapprehensions.

Before seeking any time on a broadcast station, club officials should study the basic script available from ARRL headquarters, and if possible, obtain expert advice from someone in the program department of a broadcast station. If possible, link your "show" with some current event in the communications field, currently or recently reported in the press. As your air spokesmen, try to select people who can read from a script without overenunciating, stumbling, or otherwise betraying the script. Rehearse it, aloud, until it sounds perfectly natural. And don't bite off more than you can chew: a good five-minute show is far better than a dull 15 minutes.

As yet unmentioned is the "visual" form of public relations, such as window displays, and here are some pointers:

The show windows most easily "borrowed" for a few days are those of banks and utility companies, which usually have more window space than merchandise to display.³ A window display

(Continued on page 138)

³ Avoid theater lobbies, unless you can chain everything down. Otherwise small boys may slip under the ropes and make off with your moss-covered Duck loose-coupler, or your new 4-250A.

HARRISON HAS IT!

HARRISON HAS IT!

Stocks of new things most complete —
Real values that can't be beat —
Plus service that you'll find a "treat"!

If you can't visit either of my well-stocked stores, phone or mail in your orders for really superior SERVICE. All standard lines at lowest prices.

73, *Bil Harrison*, W2AVA

Complete TRANSMITTERS

Embodiment the Millen 90800 exciters, 90881 power amplifiers, Sonar VFX680 VFO NFM Phone exciters, and full power equipment — all of the highest quality. For full details see our Feb. ads.

Model C75, 75 watt CW..... \$145
Model FV75, 75 watt VFO NFM Phone..... 235
Model G500, 500 watt CW..... 345
Model FV500, 500 watt VFO NFM Phone.... 435
ALSO — Hallcrafters, Harvey-Wells, Subraco, Collins, Temco, etc. —

Harrison has it!

NEW LOW PRICE!

Hallcrafters HT-17

An FB, compact, good quality transmitter with output of more than 10 watts on all bands, 10 to 30, 6V0 crystal oscillator, 807 amplifier, 5U4G rectifier. Antenna matching network. Terminals for external modulator for phone. Works on 110 Volts AC or vibrator pack. Cabinet 13" x 7" x 8". Complete with \$49.50 tubes and 40 meter coils — now only.....

With companion S-38 receiver (\$47.50) you have an excellent low cost ham station!

MIDGET VIBRATOR PACKS

For Navy models MU, MX, MAB, etc., or any portable equipment requiring 135 volts at 30 ma., 67% at 8 ma., 1.5 filament or 6.3 heater, bias and nuke voltages. Works on any 6 volt battery (or 4 flashlight cells). Compact, weighs only 2 lbs. Each..... \$3.95

STORAGE BATTERY

Willard RECHARGEABLE battery to clip into pack. 3 cell, 6 volt, 30 watt hour. NON-SPILL unbreakable plastic case. Com..... \$1.55

PRIMARY BATTERY

Willard. To be used in pack when recharging facilities are unavailable. Indefinite shelf life. Each..... 90¢

20 for \$9.95

"MON-KEY"

Ditch that Lake Erie swing! Be one of the few to have a tape-perfect list by using this first ELECTRONIC KEY priced for the Amateur. Makes uniform dots, dashes, and spaces — automatically! One control sets speed 8 to 45 WPM, maintaining correct ratios. Side-swipe lever. Built-in speaker permits monitoring of transmission and code practice. Internal keying relay. MONITOR-KEYER, complete with tubes, for 110 volts AC-DC..... \$29.95

IN NEW YORK — ONLY HARRISON HAS IT!
Come in and try it out — you'll be fascinated!



NEW Receivers —

NATIONAL NC-33. Covers 500 KC (Ship frequency) to 35 MC. 110 Volts AC-DC. Internal speaker — noise limiter — electrical band spread — many other features, plus National dependability!

\$65.95

HALLICRAFTERS S-53. Covers .54 to 54.5 MC — eight tubes — two MC IF stages throw images outside band — series type noise limiter — and many other new improvements. An exceptional value at

\$79.50

TELE-BOOSTER

A preamplifier for your (or your neighbor's) television receiver that greatly increases signal strength and reduces TVI. Brighter pictures — less QFN and interference — in many locations eliminates need for outdoor antenna or expensive arrays. Works on any TV receiver, connect in antenna lead. Complete with tubes, in wooden cabinet 5" x 6" x 3", for 110 Volts AC. Model TVL — 50 to 100 MC \$19.80
Model TVH — 170 to 220 MC

LINE VOLTAGE JUMPS?

Control it and protect your equipment, lengthen tube life, improve performance, etc.

Superior POWERSTAT — A manual regulator of improved design and construction. Provides output of 115 volts from line voltage of 95 to 135 (up to 270 volt input model available).

Max. Output	Type	Price
3KVA.....	30.....	\$14.50
1KVA.....	116U.....	19.00
2KVA.....	1126.....	46.00
6KVA.....	2106LC.....	98.00
15KVA.....	2115LC.....	280.00

Larger capacity, multi-phase, and motor driven models available.

SOLA Constant Voltage Transformers

Automatically deliver constant and dependable output of 115 volts when 60 cycle line voltage fluctuates between 95 and 125 volts.

Output	Model	Price	Output	Model	Price
30 VA	30804	\$17.00	500 VA	30808	\$75.00
60 VA	30805	24.00	1 KVA	30809	125.00
120 VA	30806	32.00	2 KVA	30811	225.00
250 VA	30807	52.00	3 KVA	30M813	300.00

For 50 or 25 cycles, higher line voltage, larger capacity, or special applications, consult our Industrial Engineering Dept.

SYLVANIA

1N34

DIODES

New LOW price \$1-20

OPEN NIGHTS

To make it easier for you to buy good gear — at lowest prices —
New York — Wednesdays
Jamaica — Fridays
UNTIL 9

HAM HEADQUARTERS
Since 1925!



HARRISON RADIO CORPORATION

12 WEST BROADWAY • NEW YORK CITY 7

PHONE — BRa clay 7-9854 • EXPORT DEPT. — CABLE — "HARRISORAD"

[JAMAICA BRANCH — 172-31 Hillside Ave. — REpublic 9-4102]

★ YOUR FUTURE ★ IN RADIO . . .

May depend on the integrity and ability of your School's Administration. At MELVILLE no effort is spared to provide the best in facilities and service for the serious student of RADIO, TELEVISION, FREQUENCY MODULATION, TELEGRAPHY, SLIP TRANSCRIPTION, RADIO MATHEMATICS, etc.

Approved for Veterans

Licensed by the State of N. Y.
Write or call today for FREE Bulletin B

**MELVILLE
RADIO INSTITUTE**
MELVILLE BUILDING
15 W. 46th St., N. Y. 19, N. Y.
Longacre 4-0340
"Managed by Radio Men"

NOW

**The math you need
to solve everyday radio
and electrical problems**

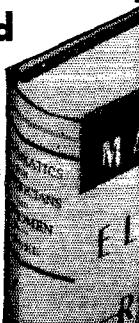

Out of the U. S. Navy Radio Matériel School at Anacostia Station comes a complete home-study text that teaches you mathematics from elementary algebra through quadratic equations, logarithms, trigonometry, plane vectors and elementary vector algebra . . . with direct applications to electrical and radio problems.

MATHEMATICS for ELECTRICIANS and RADIOMEN

Based on more than 8 years' experience teaching mathematics to U. S. Navy electricians and radio operators. By N. M. Cooke, Chief Radio Electrician, U. S. Navy. 604 pp., 6 x 9, \$4.50.

10 DAYS' FREE EXAMINATION

McGraw-Hill Book Co., Inc., 330 W. 42nd St., N. Y. C. 18
Send me Cooke's Mathematics for Electricians and Radiomen for 10 days' examination on approval. In 10 days I will send you \$4.50 plus few cents postage or return book postpaid. (We pay postage if you remit with order.)

Name
Address
City and State
Position
Company QST-3-48

should be planned to actually depict something, such as "20 Years of Progress in Radiocommunication Equipment," with contrasts between old and new gear, large and small tubes, high and low power, etc. Or: "Radio Equipment Used To Maintain Communication in the Blanktown Flood," with the actual transmitters, receivers, batteries, motor generators, soap boxes and coffee pots, set up in an approximation of the operating position. Everything in a window display should be fully identified with neatly-lettered signs, explaining its nature and use.

Window displays, like radio shows, can be linked with current events. A display is infinitely more effective if the passersby who see it can remember reading about it in the paper. In smaller cities, the display itself may be worthy of an item in the press.

You can get a lot of satisfaction out of this sort of thing, and amateur radio can gain a lot of friends. That's what we need.

Ten-Element Array

(Continued from page 49)

beam. His four-element beam had been tuned on the nose and good results were obtained. Many comparative reports were obtained between his four-element and my ten-element over the eastern United States, over many days and under varying conditions. In all cases his reports varied from two to three S-points lower than the ten-element beam. He then attached the ten elements and his reports from then on have been identical with my own. Our conclusion is that the ten-element beam is all the way from two to four S-points stronger than a four-element beam in any given location. We are both able to work solid through holiday and week-end QRM.

Fig. 1 shows the side view and distances between the mounted elements, and is self-explanatory.

For their help on comparative checks, I wish to thank W6MI, W6FGU, W6VYU, W6UNU and the many fellows in Los Angeles, eastern United States and elsewhere, who have given us comparative checks.

It is your beam if you want it.

50 Mc.

(Continued from page 54)

On the vertical side, W1CTW contests the statement made by the proponents of horizontal polarization that the latter improves signal-to-noise ratio. He grants that this is so, if man-made noise (rather than receiver noise) is being considered, and also if such man-made noise is ignition. Your conductor can verify the fact that all noise is not vertically-polarized — at W1HDQ the

(Continued on page 140)

SUN RADIO OF WASHINGTON, D. C. WAR SURPLUS EQUIPMENT

At A Fraction of Original Gov't Cost

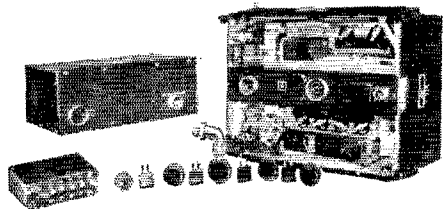

SCR-522 VHF TRANSCEIVER

The finest all purpose equipment on the surplus market. Tunes 100-156 MC. Don't confuse these with other incomplete and abused 522s. Sun Radio offers electronically perfect and guaranteed 522s. . . . AND COMPLETE with tubes (one 10 tube superhet receiver squelch circuit and one 7 tube transmitter), remote control box, 28 volt dynamotor (can be converted to 110 V operation), 4 crystals and ALL **\$24.95** CABLE CONNECTORS but less cable.

100 WATT BENDIX TRANSMITTER

TA12 **\$49.95**

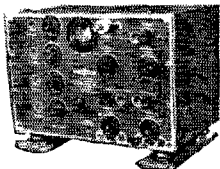

These can be easily converted to 20-40-80 meters. Crystal required for 10 meters. Each electronic coupled oscillator dial has 3000 divisions enabling quick precision shifting. This transmitter was constructed of the highest quality of precision parts, with laboratory precision. Four separate output tanks; one 4-position selector channel switch having seven sections which changes the ECO, IPA and output tanks simultaneously. All the controls are mounted on the front panel. The housing is cast aluminum; shields and case are sheet aluminum. Dimensions 11 x 12 x 15 inches, weighing 35½ lbs. Complete, simple instructions for conversion furnished. Uses three 807, four 12SK7 tubes; one 2-inch 5 amp. R.F. meter. A complete coverage transmitter, for the new or experienced amateur. A TRUE HAM VALUE—BRAND NEW, complete with tubes. **\$49.95**



110-VOLT AC SUPERHETERODYNE RECEIVER

This crystal fixed frequency receiver comes with full conversion instructions for variable tuning of all ham bands and broadcast. A highly selective superheterodyne receiver, 110 V. A.C. power supply built in. Using the following tubes: 6K7—RF Amplifier; 6K8 Mixer and Oscillator; 6K7 I. F. Amplifier; 6F7 Detector and A. V. C.; 6C8 Output and Noise Suppressor; 80 Rectifier. Dimensions—3½ x 19 x 11½ inches. Comes complete, brand new, with one set of coils and two sets of tubes. **\$16.95**

WALKIE TALKIES

SET
\$129.90



SCR195 Walkie Talkies, brand new, weight 27½ pounds including knapsack. Range up to 25 miles in open country. Frequency 52.8 to 65.8 MC. Transmitter and receiver with regular hand set. Complete ready to operate with spare parts. Each. **\$59.95**



1-222 SIGNAL GENERATOR

Brand new; Frequency from 8 MC to 250 MC in 2 bands. Calibration graph furnished. Crystal controlled check points. 110V AC power supply. Output attenuator. Dial calibration 10 points per division. A true laboratory instrument. A \$350 value for only. **\$54.95**

CRYSTALS!

In the greatest purchase of radio transmitting crystals ever made by one wholesaler in the history of the Radio Parts Industry, Sun Radio acquired title to over a half million dollars (\$500,000.00) of Army Surplus, precision built, exactly tooled crystals in moisture proof holders which are shock mounted. Please note that crystal shipments of 6 or less are packed in cloth containers to expedite handling. . . . No worry because all crystals are shock mounted and guaranteed delivered perfect. All crystals have Army MC harmonic rating but Sun encloses directions for deriving the correct fundamental frequency in kilocycles.

CRYSTALS WITH A MILLION USES

Fractions Omitted

kc	kc	kc	kc	kc	kc	kc	kc	kc	kc	kc	kc	kc
412	420	429	437	445	457	469	479	490	497	506	516	
413	422	430	438	446	458	470	481	491	498	507	518	
414	423	431	440	447	459	472	483	492	501	508	519	
415	424	433	441	448	462	473	484	493	502	509	522	
416	425	434	442	451	463	474	485	494	503	511	523	
418	426	435	443	453	466	475	487	495	504	512		
419	427	436	444		468	477	488	496	505	515		

49¢
each

I.F. Frequency Standards	Crystal Frequency Standards	For Crystal Controlled Signal Generators
kc	kc	kc
450	454.166	461.111
451.388	455.556	464.215
452.777	459.259	468.825
99¢ each	\$3.89 each	99¢ each

Easily altered for 100 kc Standard Mounted in low loss 3 prong holder.

\$26.388 \$31.944 \$36.111
\$27.777 \$33.333 \$37.500
\$29.166 \$34.722 \$38.888
\$30.555

ASSORTED MISCELLANEOUS CRYSTALS

Fractions Omitted

370kc	376kc	381kc	384kc	387kc
372	377	383	386	388
374	379			
375	380			

39¢ each

priced at a fraction of the cost of their holders alone.

FOR HAM AND GENERAL USE

Fractions Omitted

390kc	395kc	402kc	405kc	408kc
391	396	403	406	409
392	397	404	407	411
393	398			
394	401			

79¢ each

• Payments must accompany order. Enclose 20¢ for postage and handling. Minimum order — \$2.00 plus postage.
• Crystals are shipped packed in cloth bags inasmuch as they are shock mounted. All shipments guaranteed.



SPERRY AMPLIFIER

Manufactured by Sperry Gyroscope Co. These amplifiers contain 2 beam power output tubes (1632) similar to 251.6, 2 twin triodes (1633 & 1634) similar to 6SC7, 2 mica condensers, dozens of color coded half watt resistors, 3 bathtub condensers, 2 dual bathtub condensers, 1 bathtub condenser with 4 sections, 3 hermetically sealed transformers, 2 wafer shielded rotary switches with resistor assembly, 1 volume control, 4 octal sockets, measurements 9¼" x 5¼" x 3¼". Brand new. Easily converted to excellent audio amplifier. . . . **\$3.95**



D.C. MILLIAMMETER

Brand new General Electric 2" round panel meters 0-300. **\$2.97**



A.C. VOLTMETER

Brand new G.E. 3" square panel meter 0-150 v ideal for checking primary voltage. **\$3.49**

SUN RADIO

OF WASHINGTON, D. C.

933 F STREET, N. W. WASH. 4. D. C.

MODULATION & DRIVER TRANSFORMERS

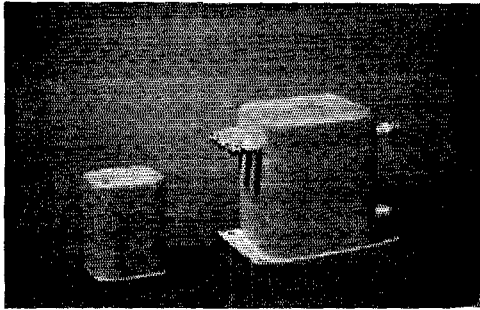

These transformers are suitable for use with type 811, 809, TZ40, TZ20, etc. to modulate either triode or beam tube RF amplifiers. Two secondaries are provided. Impedance ratio primary to secondary number one, 2 to 1. Primary to secondary number two, 16 to 1. Will modulate up to 300 watts input. Modulation transformer, driver transformer, circuit diagrams and other information all for \$6.90 Please include 50 cents for postage and handling.

Send full amount to speed delivery and save C.O.D. charges. Shipped only in the U. S., its possessions and Canada.

ELECTRONIC NAVIGATION, INC.
Box 735, Church Street Station
New York 8, New York

ANOTHER *New* BROWNING DEVICE

OSCILLOSYNCHROSCOPE MODEL OL-15A

Versatile laboratory instrument designed for observing phenomena requiring extended range amplifiers and a wide variety of time bases.

Frequency meters. WWV standard frequency calibrator Oscilloscope. Power supply and square wave modulator Capacitance Relay. FM-AM Tuners. FM Tuner.

KNOW THE ENTIRE BROWNING LINE • ENGINEERED FOR ENGINEERS

WRITE TO DEPT. D FOR CATALOG



BROWNING LABORATORIES, INC.
WINCHESTER, MASS.

HEADQUARTERS

for

hallicrafters

★ ★ ★

AMATEUR EQUIPMENT

★ ★ ★

RADIO PARTS DISTRIBUTING CO.

128 W. Olney Road
Norfolk, Va.

noise level is lower on vertical arrays, as our main power source is a power line close by. Like most power lines, it is horizontal! Cal grants that horizontal may be best for 50 Mc. and lower, but he is "from Missouri" as regards 144 Mc. and up. WIBBM chides us, in a similar vein, for suggesting a start on 420 Mc. with horizontal polarization.

220 or 235 Mc.?

The projected change from 235 to 220 Mc. mentioned last month is still in the paper stage. Various matters have arisen to cause some delay in issuing the change order, and it is expected to be released not earlier than mid-April. When the change comes it will be announced at once on W1AW, and confirmed in *QST* as early as possible.

25 Years Ago

(Continued from page 64)

ing Edison 'B' Batteries for C.W. Transmission," by Gerard H. Hall, 8AHG, round out the month's technical fare.

BCI and interference between commercial radiophones are common complaints nowadays; even President Harding is noting their existence, this issue reports. Responding to ARRL's soundings, Department of Commerce RIs have complimented amateurs on their spirit of cooperation in observing quiet hours.

There are full introductions to A. H. K. Russell, Canadian 9AL, general manager of the Ontario Division, and to John L. Reinartz, 1QP, inventor of the famed Reinartz tuner. The M.I.T. Radio Society station, 1XM, receives glowing description in the amateur stations section.

Random gleanings: A Trans-Canadian Relay is announced for March. . . ARRL, along with IRE and AIE, has been sitting in on meetings called by the Bureau of Standards in cooperation with the American Engineering Standards Committee, to formulate new standards for the radio art.

I.A.R.U. News

(Continued from page 56)

JAPAN

FEARL News, monthly publication of the *Far East Amateur Radio League*, reports that servicemen-amateurs in Japan are authorized to employ the frequencies 3560-3660 kc., subject to the condition that only A1 emissions may be used. Traffic nets already are being organized, taking cognizance of possible communications emergencies as well as the need for handling routine correspondence.

A hamfest, complete with refreshments and a highly interesting program, was held December 16, 1947, to celebrate the moving of J2USA, the Headquarters station, to its new location.

(Continued on page 148)

FLASH -
HARVEY does it again

**HAMMARLUND
 FS-135-C FREQUENCY STANDARD**

With the FS-135-C, your receiver becomes an accurate frequency meter. The special 100 kc crystal generates marker signals every 100 kc throughout the entire range of the receiver. You can calibrate your receiver, check your transmitter frequency, or make any other checks required. The crystal frequency can be adjusted for zero beating with WWV and once this has been done the accuracy of the unit equals that of a costly frequency standard. The unit is so small it can be mounted in any receiver.

Specifications: 100 kc low-drift, silver-plated crystal, completely sealed; voltage requirements, filament 6.3 A.C., plate, 150-250 volts D.C.; consumes: filaments 300 mils, plate less than 2 mils; measures 2 by 2 by 3 3/8 inches high. Complete with instructions, tube and 100 kc crystal.

Brand New **\$6.95**

Brand New 6AU6G tubes.

Order a spare for the FS-135-C.....65c

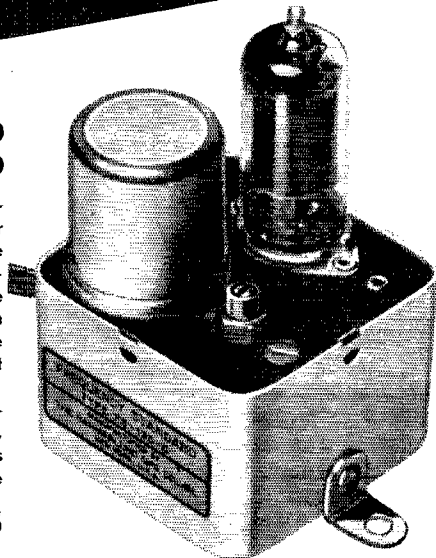

HARVEY'S HITS OF THE MONTH

Harvey has 20 meter crystals for a buck! Mounted in holder with 1/2" pin spacing. Also 40 and 80 meter and 6 and 13 mc. bands at the same low price.....\$1.00
 Special 8 mc. xtals for 2 meter xtal control, only.....\$1.50
 Also in stock complete line of Biley AX-2 xtals. include 10¢ postage with your crystal order.

HARVEY'S HAMFESTIVAL OF VALUES



Micamold 45-watt CW Xmitter Kit. All parts with punched and lettered chassis; crystal control, band switching for 20, 40, 80; excellent design for operation and safety; stable circuit with pi network to match any antenna; only tubes, crystal and key needed to put in operation. Uses 83, 6AG7 and 1614/6L6 **\$34.00**



Type 1616 tube; Half wave, high vacuum rectifier. Filament 2.5 volts, 5 amps; peak inverse 5500 volts; peak current .8 amps; surge current 2.5 amps; average plate current .130 amps. List price \$7.50, Harvey special price, while they last..... **95¢**

New, Surplus Meters

Simpson 2" 0-1 mil D.C. **\$2.95**
 Westinghouse 2" 0-10 V. A.C. **\$2.95**
 Westinghouse 2" 0-15 V. A.C. **\$2.95**
 Westinghouse 3" 0-150 V. A.C. **\$3.95**



RCA Sound Powered Phones of type originally used by Navy for fire control direction, general communication, etc. These phones will easily feed thru 2000 ft. any type 2-conductor wire or cable. Can be used for a number of jobs such as between television antenna and receiver or transmitting antenna and transmitter for adjustment or directional control. Also between shack and XYL, farmhouse and barn or any other job requiring clear voice communication. No batteries or external power of any kind required. These units are absolutely **Brand New** in original cartons. Each..... **\$15.00**; per pair..... **\$24.50**

Signal Corps RA-20 Power Supply designed for installation in the BC-312-314 receivers. Fits in space now occupied by dynamotor. Operates on 110-120 volts, 60 cycle A.C. Can be used for many other purposes; supplies 12 V. A.C. and D.C. plate voltage. Complete with 5Y3/GT. **Brand New**..... **\$9.95**

Telephone: **Three** Longacre 3-1800



103 West 43rd St., New York 18, N. Y.

NOTE: All prices are Net, F.O.B. NYC and are subject to change without notice.

Get Your Order In Early For Immediate Delivery.

Crystals for the Critical

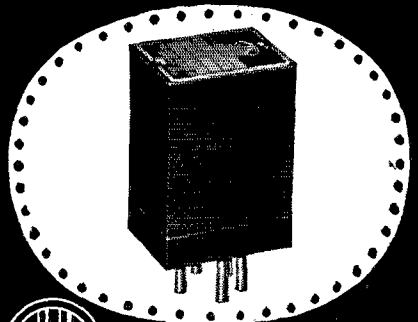

"STABILIZED"

JK STABILIZED JKO-3

This is a crystal oven designed to accommodate the following JK crystals: H7, H15, H17 and others. Operating temperature is adjustable and temperature stability is plus or minus 1° C. Heater is 6.3 volt and consumption is approximately 1 amp. Others on special order.

VISIT JAMES KNIGHTS EXHIBIT
BOOTH H, IRE SHOW
GRAND CENTRAL PALACE

The JAMES KNIGHTS CO.
SANDWICH, ILLINOIS

• LEARN CODE •

SPEED UP YOUR RECEIVING

with

G-C Automatic Sender Type S

\$20.00 Postpaid



Housed in Aluminum Case. Black Instrument Finished. Small—Compact—Silent induction type motor. 110 Volts—60 Cycle A.C. Adjustable speed control, maintains constant speed at any Setting. Complete with ten rolls of double perforated tape. A wide variety of other practice tapes available at 50c per roll.

GARDINER & COMPANY • Box 56

STRATFORD, NEW JERSEY

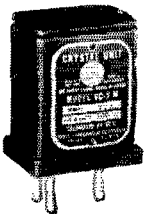

**HIGH PRECISION
100 KC XTALS**

Price **\$3.95** Each

(No C.O.D.'s. Include 25c for postage and handling.)

Brand New Surplus at about 1/10 Gov't cost. An Ideal Frequency Standard for Amateurs, Servicemen, Laboratories, etc.

Exceptional Frequency Stability ± 15 cycles from -50° to $+80^{\circ}$ c. (.0015) 10G Vibration Test. Calibrated at 30° c. Brand New, Mounted in Sealed Cases as Shown. Reprint of article from March 1947 CQ "Make Your Receiver a Frequency Standard," furnished with each crystal.

ELECTRONICRAFT, Inc.

5 Waverly Place

Tuckahoe, N. Y.

Although operating privileges have not been restored to Japanese amateurs, the *Japanese Amateur Radio League*, prewar member-society of the Union, holds meetings and publishes a news bulletin in addition to their magazine *CQ*. Japanese amateurs are keenly desirous of obtaining operating privileges and many servicemen-amateurs join them in hoping for early restoration of amateur rights for Japanese nationals.

WAC CERTIFICATE ENDORSEMENTS

With international amateur communications on the 50-Mc. band already an established fact, the possibility of qualifying for WAC with contacts made exclusively on that band exists for v.h.f.-minded amateurs. I.A.R.U. headquarters will issue WAC Certificates with appropriate 50-Mc. endorsement stickers to those who qualify.

A dozen years ago, the 28-Mc. amateur band was not as thickly populated by amateurs all over the world as it is today. DX potentialities of the band had not yet been fully realized. As a special award for the 28-Mc. pioneers, as an incentive for increased use of the band and to encourage development of equipment and techniques for operation in that frequency range, a 28-Mc. endorsement was made to WAC Certificates whose holders qualified by virtue of having effected WAC-contacts exclusively on 10 meters. The conditions which led to the establishment of this extra award no longer prevailing, notice is hereby given that after June 30, 1948, the issuance of endorsement stickers for 28-Mc. work will be discontinued.

GREAT BRITAIN

The *Radio Society of Great Britain* announces that amateur population in Great Britain had grown to a total of 5528 as of September 30, 1947. A year earlier, the total was 3808. A substantial portion of the increase is attributed to the decision of the G.P.O. to grant exemptions from the code or written portion of the examination to applicants who have served in certain branches of the armed forces.

—••••—

The *British Empire Radio Union* contest, open only to British subjects living within the British Empire and British mandated territory and to British occupational forces operating duly authorized stations, will begin 0001 GCT, April 3, 1948, and run until 2359 GCT, April 4, 1948, and for a similar period April 17 to April 18, 1948. Copies of the rules are available at A.R.R.L. Headquarters for interested members of the Canadian Section of A.R.R.L.

FRANCE

The Council of the *Reseau des Emetteurs Français*, in common with all of the members of R.E.F., has taken cognizance of the conclusions of a *Jury d'Honneur* concerning their colleague Barba, FSLA, whose connection with the Vichy government had been the subject of some speculations. The Jury found that Barba had not taken

(Continued on page 144)

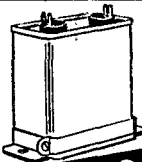

FILTER CONDENSERS
3 MFD. x 400 VAC. Good for about 1500 VDC. Metal can. Shpg. Wt. 3 lbs.
Only .98c

HV BY-PASS CONDENSER
.002 x 3000 VDC. Bakelite case. Shpg. Wt. 1/4 lb.
ONLY 59c

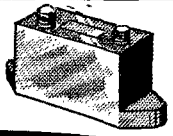

SMASH! BARGAINS



IN SURPLUS EQUIPMENT

Army Surplus Headphones HS23-A



HS-23A—Used but in A-1 electrical condition 3000 ohms impedance. Complete with leather headband and rubber cushions. Shpg. Wt. 3 lbs.
ONLY 98c

HS-16A—Brand new. 2000 ohms impedance. Canvas web headband and long cord. Shpg. Wt. 3 lbs.
ONLY \$1.47

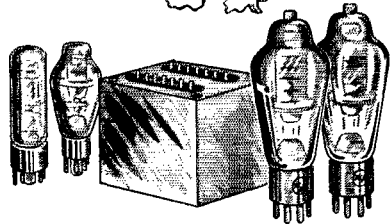

SURPLUS FILAMENT TRANSFORMER
12 or 24 VAC secondary for operating any one unit of the SCR-274-N Type equipment such as the BC-459-A, BC-696-A, BC-454-A and BC-455-A, or any similar unit. Pri 110/230 VAC 60 cy. Metal Case. Shpg. Wt. 5 lbs.
ONLY \$1.47

SURPLUS SPARE TUBE KIT

Complete set of spare tubes for BC-459-A or similar unit. Consists of 1-1626, 2-1625 and 1-1629. Brand new in original boxes. Shpg. Wt. 2 lbs.
ONLY 98c

PLATE TRANSFORMERS

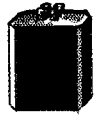

No. 8931—1200/-1400 VCT x 290 MA. PRI 115 VAC 60 cy. Shpg. Wt. 13 lbs.
ONLY... \$7.95



No. 4891—1200/-1400 VCT x 290 MA. PRI 115 VAC 60 cy. Shpg. Wt. 13 lbs.
ONLY... \$7.45

Filament Transformers

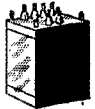

Dual 5 Volt x 5.25 amps per section. Shpg. Wt. 8 lbs. PRI 115 VAC 60 cy.
ONLY... \$1.95

Modulation Transformers

RCA 1 KW Modulation Transformer. Primary will match tubes up to 10,000 ohms plate to plate. Secondary No. 1 450 MA. Secondary No. 2, 80 MA for beam tube screen grids. Shpg. Wt. 55 lbs.
ONLY \$14.95

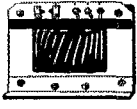

30 Watt. Primary 5000 ohms CT. Secondary, 1750/2000/2250. Common B plus. Shpg. Wt. 6 lbs.
ONLY... \$2.00

Time Payments Available

GET YOUR FREE COPY OF OUR NEW 1948 CATALOG

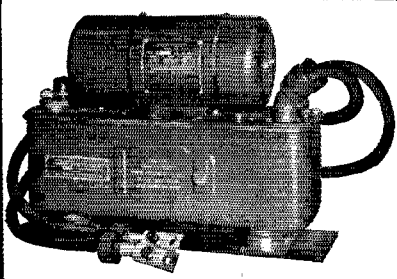

PE-103 DYNAMOTOR

Brand new PE-103 Dynamotor. Will deliver 500 VDC at 160 MA with either 6 or 12 VDC input. Complete with overload circuits; filter and connecting cable. In original overseas shipping crate. Shpg. Wt. 81 lbs.
ONLY \$995

Output plug for above: Cannon P8-CG-19S. Shpg. Wt. 1/2 lb.
ONLY... 95c

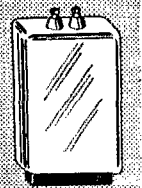

FILTER CHOKES

No. 8056—8 HY x 500 MA. 55 ohm DC Res. Shpg. Wt. 23 lbs.
Only \$11.85

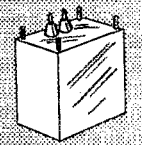

No. 8783—2-6 HY x 500 MA. Swinging Choke. Shpg. Wt. 28 lbs.
Only \$11.85

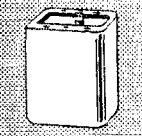

No. 6317—4 HY x 300 MA. 40 ohms DC Res. Shpg. Wt. 13 lbs.
Only \$4.95

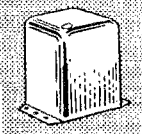

No. 0122—10 HY x 250 MA. 164 ohm DC Res. Shpg. Wt. 13 lbs.
Only \$3.95

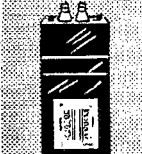

No. 2785—Dual 12 HY x 250 MA. 150 ohm DC Res. per section. Shpg. Wt. 17 lbs.
Only \$4.95

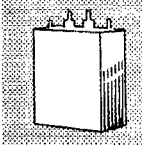

No. 5269—4.5 HY x 150 MA. 79 ohms DC Res. Shpg. Wt. 6 lbs.
Two for 79c ea. One only... 99c

SELSYN MOTORS

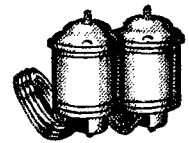

No. 806—Navy surplus. Heavy brass case. Large continuous duty type 115 VAC, 60 cy. Shpg. Wt. 25 lbs.
Per Pr. Only \$12.50

ALL PRICES F. O. B. ST. LOUIS W0JWD W0WTM W0PGI W0ULH W9NRF W0QDF W0IYD

Walter Ashe RADIO CO.
1125 PINE ST. • ST. LOUIS 1, MO.

All the Big Name Brands of Receivers, Transmitters and Test Equipment in Stock... Ready for Immediate Delivery.

Phone: CH 1125

REMEMBER . . . your Trade-In's worth more at the Walter Ashe Store! So get Walter Ashe's offer before you make that trade.

A CAREER WITH A FUTURE! TELEVISION

Shop Work • Shop Techniques • Theory
FULLY EQUIPPED LABORATORIES

- RADIO SERVICE & REPAIR
- F. M. & TELEVISION
- TRANSMITTER COURSES

Preparing for F.C.C. LICENSES

- RADIO TECHNOLOGY

A Junior College Level Course preparing for positions in
Radio-Electronic Engineering Field.

MORNING • AFTERNOON • EVENING CLASSES
MODERATE RATES • INSTALLMENTS

Available Under G. I. Bill
COME IN AND SEE OUR STUDENTS AT WORK

DELEHANTY SCHOOL OF
RADIO • ELECTRONICS • TELEVISION
105 EAST 13 ST., N. Y. 3, N. Y. • DEPT. T
LICENSED BY STATE OF NEW YORK

ANOTHER *New* BROWNING DEVICE

AMATEUR FREQUENCY METER - MODEL MJ-9

Now most widely used ham
frequency meter. Accuracy
.05% on all frequencies.
Direct frequency reading on
7 ham bands.

Frequency meters.
WV standard
frequency cali-
brator Oscillo-
scope. Power supply
and square
wave modulator
Capacitance Re-
lay. FM - AM
Tuners. FM Tuner.

KNOW THE ENTIRE BROWNING LINE • ENGINEERED FOR ENGINEERS

WRITE TO DEPT. D FOR CATALOG



BROWNING LABORATORIES, INC.
WINCHESTER, MASS.

ELECTRICITY

FOR RADIO AND ELECTRONIC APPLICATIONS

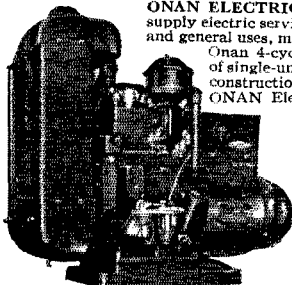

ONAN ELECTRIC GENERATING PLANTS
supply electric service for electronics applications
and general uses, mobile or stationary. Driven by
Onan 4-cycle gasoline engines they are
of single-unit, compact design and sturdy
construction.

ONAN Electric Plants are available in
many sizes and models.
ALTERNATING CUR-
RENT: 350 to 35,000 watts
in all standard voltages and
frequencies. DIRECT CUR-
RENT: 600 to 10,000 watts,
115 and 230 volts. BATTERY
CHARGES: 500
to 3,500 watts; 6, 12, 24 and
32 volts. Write for detailed
literature or engineering
assistance.

D. W. ONAN & SONS 4669 Royalston Ave.
Minneapolis 5, Minn.

144

advantage of his title of President of the R.E.F. and that he has never compromised the association either morally or materially. It was further noted by the Jury that Barba had encouraged and counseled some comrades who rebelled against the existing order and had been able to ameliorate the lot of radio amateur prisoners. These conclusions, the Council felt, put an end to the loose talk that has prevailed too long.

The *Jury d'Honneur*, the integrity of which is above reproach and which deserves acclaim for undertaking the particularly disagreeable task, publicized its conclusions, making it possible for the Council to receive its former president with open arms.

Navy Day — 1947

(Continued from page 58)

District: Albert E. Chew, jr., Warren Grolz, Edward V. Kieler, Joseph A. Piteher, Paul J. Rogers, William D. Shepherd, Lawrence A. Welage, Benny L. Williams. *Potomac River Naval Command:* W3ISF, W3KBL, W3LZC, W3MSR, W3VYN, W4BABY, W4CVO, W4JA, W4KMG. *Canada:* VE2YA, VE3BAJ, VE7AIZ, VE7GS, W. M. Guillot. *Miscellaneous:* R. A. Baker, George E. Cooper, Harlan C. Cromer, John W. Williams.

Other Participants

First Naval District: W1AHX, W1AJK, W1DJQ, W1GHB, W1GKM, W1JWG, W1KWU, W1KXU, W1KYK, W1N1Y, W1NRS, W4FSM, W6YKG/W2LOD, George E. Rogers, Richard D. Thayer. *Third Naval District:* W1LZE, W1MHU, W1OSW, W1PXS, W2ANM, W2CEE, W2CFX, W2CHA, W2DQH, W2GVZ, W2IHE, W2JJT, W2JKY, W2LFR, W2OAF, W2OCH, W2OE, W2ORZ, W2OXL, W2PFI, W2PFS, W2PGI, W2PLN, W2QB, W2QHU, W2RIJ, W2SOU, W2TMA, W2UIG, W2ZJ, W3Z1, W8KDV, Raymond Architzel, Wiley V. Cariker, Frank Chan, Ralph A. Gonzales, R. E. Jenkins, Aloys F. Lalak, James Leishman, Linek, Alta H. MacIntosh, Karl W. Oeh, Robert C. Oehmer, Charles W. O'Neil, J. Peterson, Edward R. Ronner, Robert S. Sweet, Keiran J. Watters. *Fourth Naval District:* W3ADE, W3ARK, W3CAP, W3FYK, W3GJY, W3HLZ, W3KWA, W3NRQ, W3NUG, W3SNZ. *Fifth Naval District:* W2VKV, W3KRE, W8CSF, W8ORD, W8QHG, Charles E. Johnson. *Sixth Naval District:* W4ANK, W4BIN, W4DFC, W4WM. *Seventh Naval District:* W4AAR, W4MUC, William E. Ekdahl. *Eighth Naval District:* W4GVJ, W4IMK, W5ACY, W5AQN, W5EGX, W5FPX, W5HFO, W5IRJ, W5KC, W5LF, W5NCT, W5NIY, W5NKA, W5USN, Mario E. Alarcon, F. W. Byrne, Marsh F. Canion, George M. Frank, A. L. Grant, James C. Miller, III, Charles E. Parnell, T. A. Skeahan, N. Tilman. *Ninth Naval District:* W3NTE, W4CDA, W4NYW, W8DAE, W8EIU, W8FLA, W8HS, W8JES, W8KZC, W8MGR, W8RSW, W8SLH, W8TNB, W8TRN, W8UMR, W8WET, W8YJE, W8ZGN, W8ZZU, W9ACU, W9AYH, W9BDP, W9DHA, W9DKH, W9DXL, W9EDU, W9FFD/W9NS, W9IZQ, W9JKN, W9LFK, W9LOH, W9YIX, W9ZSH, W9ZUO, W9ARI, W9CES, W9CHY, W9ESX, W9FTJ, W9KXV, W9RJP, W9VFM, W9YCG, W9ZGB, Lorne P. Munford, William L. Newton, James R. Wise. *Tenth Naval District:* W6ARK, W6BOM, W6HII, W6IQX, W6JTN, W6LM, W6SCO, W6TCA/3, W6TUK, W6UYF, W6WOS, W6WVQ, W6YCO, W6ZZU, W7BVZ, W7LGS, W7UB, Francis J. Burns, Darel Gammill, P. A. Kelwin, Diego Ortiz, Norman V. Style, E. E. Wayman. *Twelfth Naval District:* W6CDG, W6CJA, W6CWR, W6MCS, W6OBK, W6OJW, W6RRT, W6VPV, W6VXL, W6ZG, W7BSE, W7JOS. *Thirteenth Naval District:* W7ABH, W7ANU, W7EBS, W7ETO, W7FRU, W7PXS, W7HBO, W7KUH. *Fourteenth Naval District:* KH6IJ. *Fifteenth Naval District:* KZ5AW. *Seventeenth Naval District:* William F. Blake, Daniel N. Geiger, Kermit C. Stump. *Potomac River Naval Command:* W2BYO, W3IL, W3MCG, W4IZG. *Canada:* VE2GJ, VE3BOC, VE5QZ, VE7AEU, VE7AGM. *England:* G3HP. *Miscellaneous:* W8AWT, Cecil Jones.

ANNOUNCING THE NEW ARROW ECONOMY LINE

OF POWER SUPPLY COMPONENTS

A complete line of low and high power plate transformers, chokes, filament transformers, and modulation transformers, at the lowest prices possible. No "frills", no chrome or fancy boxes—just the essentials—with conservative ratings and highest quality materials for long life efficiency. Below is the first group of our new Economy Line. These are not war surplus, as the price would indicate, but are built for us by a leading manufacturer to our rigid specifications at a terrific saving to the Ham.

**WATCH FOR MORE
NEXT MONTH**

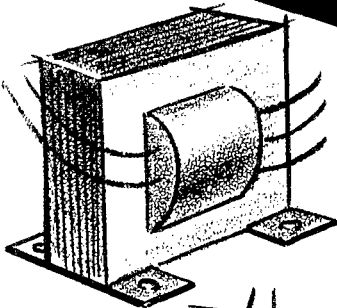

POWER PLATE XFMR —
1750-0-1750 VAC—300 MA.
PRI. 115 VAC 60 CY.

\$14⁷⁰

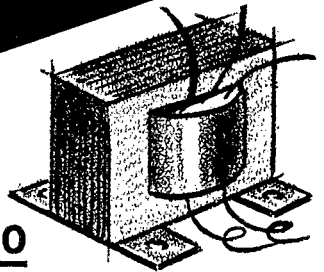

SWINGING CHOKE —
5-10 HENRIES—300 MA.
5000 V. INSUL.

\$3⁴⁹

FILAMENT XFMR —
2.5 V. 10 AMP.
5000 V. INSUL.

\$2⁷⁵

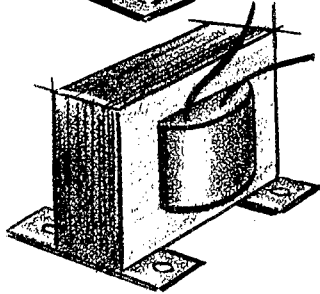

SOME EXTRA BARGAINS

HAMMARLUND CH-500

HI-PWR. RF CHOKE
REG. 1.50

\$.65

2" ROUND 0-1 MA. DC MTR.

\$2⁹⁵

50,000 OHM IRC 100 WATTS

\$.59

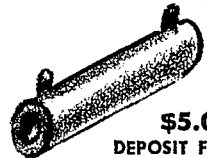
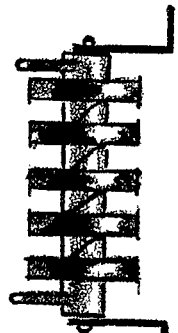

**\$5.00
DEPOSIT FOR
ANY C.O.D. ORDER**

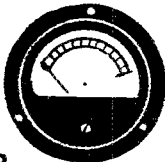

**WRITE FOR
EASY PAYMENT PLAN**

ARROW ELECTRONICS, INC.

HAM DEPT., 82 CORTLANDT ST., N.Y. 7, N.Y.



BARGAIN SPECIAL

2 Mfd. 2500 Volt OIL FILLED CONDENSER

Well known brand. Ceramic pillar terminals, in hermetically sealed metal case, size overall $1\frac{3}{4} \times 3\frac{3}{4} \times 5\frac{1}{2}$ " high. Comes with handy removable mtg. bracket and solder lug terminals. No. 21T3990, Special, Each.....

\$2.95

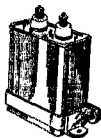

1000 V.—200 Ma. POWER SUPPLY FILTER KIT

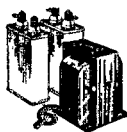

Consist of Two 4 mfd. 1000 volt DC oil filled condensers size $2\frac{1}{2} \times 1\frac{1}{8} \times 5\frac{1}{2}$ " high overall and One Thordarson 10 Hy.-200 Ma. filter choke fully enclosed metal case size $3\frac{3}{8} \times 3\frac{3}{8} \times 4\frac{5}{8}$ " H.

No. 21T3983, Special, Per Kit.....

\$3.65

12 1/2 Ft. ANTENNA

TELESCOPES DOWN TO 1 FOOT 4"

"Just it" for mobile equipment, portable receivers, and transmitters. Solid Brass—Ruggedly constructed—smooth telescopic action. Base is $\frac{7}{8}$ " dia.

\$1.95

No. 38A39, Special Each.....
Order now from this ad. Add for Postage.



DID YOU GET IT? the Big NEW B-A 1948 Catalog No. 481—Everything in Radio and Electronics. Write if you have not received it. **FREE** on request.



BURSTEIN-APPLEBEE company
1012-14 MCGEE STREET.
KANSAS CITY 6, MISSOURI

W8GFK

ALUMINUM CALL PLATES

Your call cast in aluminum with black background and mounting, L for car license and D for desk use. \$1.75 each postpaid.

P & H SALES CO.

619 Jasper St.

Kalamazoo 31, Michigan



Founded in 1909

RADIO TELEPHONY RADIO TELEGRAPHY

Courses ranging in length from 7 to 12 months. Dormitory accommodations on campus. The college owns KPAC, 5 KW broadcast station with studios located on campus. New students accepted monthly. If interested in radio training necessary to pass F.C.C. examinations for first-class telephone and second-class telegraph licenses, write for details.

PORT ARTHUR COLLEGE PORT ARTHUR TEXAS

Approved for G.I. training

Break-In Keying

(Continued from page 67)

absolutely necessary. The usual oscillator with 0.01 μ d. or so in this circuit will key fast enough if there is no appreciable series resistance. An ECO with the screen fed through a large dropping resistor and with a 0.01- μ d. screen by-pass might give trouble, since the operating voltages to the ECO might not settle down immediately. In this case, the cure would be to feed the plate and screen individually from VR-tube regulated sources, through circuits with low series resistance, and key in the cathode circuit. The whole idea is to make the oscillator turn on fast—you'll get clicks but you should get no chirp. But the clicks won't get past the tube-keyed stage.

The tube-keyer portion of the unit can be connected in the cathode circuit of some amplifier along the line of your transmitter where it has no effect on the oscillator frequency. At WIDX, the tube keyer is in the cathode circuit of a 6L6 output stage of the three-stage VFO unit. This is not the best place in the world to key, since some "shaping" of the keying characteristic takes place in the later stages, as pointed out by W6-BET,⁵ but it represents standard practice and is not too bad. It would be better, however, to key farther down the line toward the output stage.

To check whether or not the gadget turns on fast enough, send a string of fast "Vs" with your bug and monitor your signal on a monitor or other receiver borrowed for the occasion. While you send the Vs, short and unshort (with a screwdriver) the leads running to the oscillator, so that you compare the effect of a free-running oscillator with the relay-keyed one. If the first dot of the V is short when the oscillator is relay-keyed, it indicates that either the relay is slow or the oscillator is slow. We haven't been able to detect any difference in our installation at the highest speeds used (30-or-so w.p.m.).

During the summer months, when the humidity runs high here in New England, we have had a little trouble with leakage at the key. The effect is that the relay closes with the key "up," because the lowered resistance across the key moves the "key-up" voltage up on the curve of Fig. 3. A similar trouble is often noticed with keyer tubes in the form of a slight back-wave when the insulation in the key circuit is poor. The solution is to use good wire and insulation.

If you are one of the many who have given up break-in operation because you don't like the chirp with oscillator keying (bless you for being so discriminating!) and are using a tube keyer in an amplifier stage, it will take only an evening or so to convert to the system described above. The satisfaction of working true break-in without a chirpy signal is a nice feeling, and the complete protection the W6KJV/W1PMT break-in system gives your ears makes operating a real pleasure. Now what we need is a hamband T-R box that will allow the same beam antenna system to be used for both transmitting and receiving!

⁵ Ballou, "Keying the Tetrode Amplifier," QST, December, 1947.

**LOADS OF CONDENSERS!
TAKE 'EM AWAY - FELLERS!**

2 MFD. 7500 W.V.D.C. @ \$5.95
 10 MFD. 1000 W.V.D.C. @ \$0.98
 10 MFD. 600 W.V.D.C. @ \$0.75
 .05 MFD. 600 W.V.D.C. @ \$0.15
 1616 RECTIFIERS @ \$0.85
 5 MFD. 600 W.V.D.C. @ \$0.15
 .1 MFD. 400 W.V.D.C. @ \$0.15
 (BATHTUB)

**DeMAMBRO
RADIO
SUPPLY CO.**

BOSTON
111 Commonwealth Ave.

WORCESTER
729 Main Street

MANCHESTER, N. H.
1308 Elm Street

PROVIDENCE
90 Broadway



WVTP - LOU JACOBS WVTF - JACK CAMPBELL WVPR - VINCENT SIGHTLER
 WVIP - WILL PILON WVOR - BILL MORISON WVJS - LES STARRETT
 WVIK - WALLY CATKINS WVIWA - WALT KOCHANER WVON - BILL GORMLEY

WELCOME

WI-691

(Continued from page 71)

For close quarters
DRAKE



400
soldering
iron

Only 9 inches overall, this iron is ideal for close quarters. It carries a 1/4 inch tip and 60 watts. Its quick heating factor will cut down your soldering delays.

DRAKE ELECTRIC WORKS, INC.
3656 LINCOLN AVENUE CHICAGO 13

Carter GENEMOTOR

The Finest Rotary Power Supply!
Used by Police Depts. over 15 years! The favorite mobile supply of Hams everywhere. Up to 150 watts output, 600 volts at 250 MA., 5.5-6-12-24-32-115 volt DC input available. Try a model 320 AS for your next ten watt mobile rig, model 520 AS for 25 watt rig. Write for latest free bulletin and name of nearest Carter Distributor today.

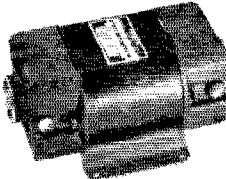

Carter Motor Co. 2649 N. Maplewood Chicago 47, Illinois

A Well Known Name In Radio for Over a Quarter Century

NOW Sending is Easy for Anyone

GENUINE DELUXE

VIBROPLEX

Reg. Trade Marks: Vibroplex, Lightning Bug, Bug

"Original" Deluxe Model Illustrated

Polished Chromium Base and Parts

ONLY \$19.50

The ONLY Bug with Patented JEWEL Movement

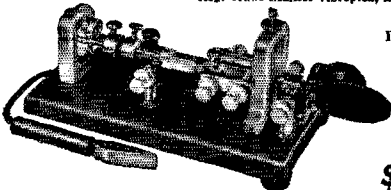

Don't worry if you lack sending skill. Sending is easy for anyone with a Genuine DeLuxe Vibroplex key. No special skill required. No tiresome effort involved. The secret is in the Patented JEWEL Movement feature. Harder than metal, the jewels in DeLuxe Vibroplex keys as the jewels in the finest-made watches reduce friction, maintain smoother, easier operation and lengthen life of key. Try this amazing key! Note its confidence-inspiring feel, superior signals and ease of operation. Your choice of three DeLuxe models. Original, Blue Racer and Lightning Bug. Order yours to-day! Money order or registered mail. FREE catalog.



The "BUG" Trade Mark identifies the Genuine Vibroplex. Accept No Substitute.

THE VIBROPLEX CO., Inc.

833 Broadway, New York 3, N. Y.

the year. Scientific observations are the purpose of the jaunt, preliminary to the projected Australian expedition to the South Pole in 1950 EA1D is now QRT — QSL via listed address The Egyptian QSL Bureau, P.O. Box 360, Cairo, has cards for stations formerly or at present operating in Arabia, Libya, Iraq, Dodecanese, Ethiopia, Turkey and Persia, as well as unknown Egyptian stations and advises stations in said areas to claim their cards pronto Through W2TXB, LX1AS issues the discouraging statement that there are supposedly no legit LX stations on c.w. at the present time. LX calls are favorite pirate material on the Continent, which may account for the numerous LXs one hears on ten c.w. these days. Has anyone a recent Luxembourg c.w. QSL to make us all feel better? It's not too late to mention that VR5PL intends a lot of operation during and after the DX Contest on 7100 and 14,100 KS4AI, who has held the calls W5KWY and W8VKF, gives us the low-down on the latest Swan Island gossip: AF, AH and AI are the present active stations there. AC is now in New Mexico, AB and AD are back in Louisiana, AE is now a KA1, AA is in KP4 and AG is in the Canal Zone. Those boys really get around! To keep his records straight, Ralph is going to answer cards 100 per cent, but wants your cards first. A penny stamp is sufficient, too. The boys use all of the four lower-frequency bands, but like 7 and 28 Mc. best XZ2HP has done a lot of the gang a good turn by working hard to forward cards to VU2PB and XZ2JW. The former operators of these two stations can now be reached via the listed QTHs A Call Book is on the way to CIMCC who states he will QSL every station contacted W2CYS has it that FQ3AT is QRT. Ivan is now FQ3AT/FES in the Cameroons and just as good a catch So many birds kept breaking up HC1ES's skeds that now Charles never sends the call of the station he's contacting unless he intends just a short QSO anyway. He says Ws should listen more and CQ less to help clear up 14 Mc. Ex-XZ2AA, now G3DAQ, is shaking hands with radio pals again from Derbyshire with 25 watts on all DX bands. Ron is getting the v.h.f. bug, too G3ZJ/M13ZJ clears up the situation in Eritrea. The prefix is now M16 (MD3 for military personnel). M16ZJ will be found on 14,026, 14,062, 14,122 or 28,052 kc.; M16AB is VFO on 14- and 28-Mc., 'phone and c.w.; M16BC stays on 14-Mc. c.w. and is newly active; MD3AB is rock-bound on 14 Mc., usually 14,250 (!). M16ZJ will temporarily become G3ZJ again this summer for his leave in England C3JM is having a tough time assembling a station in Foochow. You may remember him as old XU7A and XU7CW. He's willing to swap some fancy Chinese art articles for some decent equipment (QTH listed)

(Continued on page 160)

LEEDS

The Home of RADIO

IN OUR
25th YEAR

QUALITY—PRICE
DEPENDABILITY

NATIONAL CO. PRODUCTS

- AR-16 Exciter Coils** air-spaced: For 5, 10, 20, 40, or 80 meters, with end, center or swinging link plug in type. Each.....**\$1.15**
- XB-16 Socket** for Above.....**33c**
- TMK-50D Condenser** 50-50 mmfd., .077" spacing; 3000V Peak.....**\$4.15**
- STD-50 Split Stator Double Bearing** 50-50 mmf., .026 Air Gap.....**\$2.56**
- High Freq. Permeability Tuned RF coils
- AR-2** 75-220 MC.....**\$1.71**
- AR-5** 37-110 MC.....**1.46**
- XR-50** Coil form only.....**1.01**
- 10.7 MC Transformers** for AM or FM superhets.
- 1 FL, FM Discriminator @ 1.5 DB**.....**\$6.90**
- 1 FM, IF with 150 KC Band with Pass Band**.....**6.45**
- 1 FN, IF with 100 KC Pass Band 1.5 DB**.....**6.45**
- 1 FO, FM Ratio Discriminator**.....**6.98**
- ACN Dial.** Swell for Freq. Monitors and VFO's Dial Bezel Size 5" x 7 1/4". Five Blank Ranges for Direct Calibration, 5:1 Ratio Velvet Vernier Drive.....**\$3.00**

A most complete line of National Co. Products in stock

OIL FILLED CONDENSERS

- 1 Mfd., 600 VDC**...**35c** **7 Mfd., 330 VAC**...**\$1.25**
- 2 Mfd., 600 VDC**...**35c** **0.1 Mfd., 7500 VDC**.....**1.50**
- 10 Mfd., 800 VDC**...**98c** **2x.1 Mfd., 7000 VDC**.....**2.00**
- 2 Mfd., 1000 VDC**...**69c** **0.2 Mfd., 8000**...**98c**
- SPECIAL 16 Mfd., 400 VDC W.E.**.....**98c**
- 1 Mfd., 5000 VDC Solar**.....**\$2.95**

Wire Wound Potentiometer

100,000 ohm, precision made. G.R. type, 25 watt, 6" diameter. Brand new.....**\$1.95**



Heineman Circuit Breakers

3 and 5 amp. sizes.....**95c**

5BPI CATHODRAY TUBES. 5" Green Screen, Brand New in Original Cartons. Priced so low you'll want a few. Each.....**\$1.45**

STEEL CHASSIS

- 10 x 17 x 3**.....**\$1.38** **11 x 17 x 3**.....**\$1.86**
- 5 x 10 x 3**.....**87c** **13 x 17 x 3**.....**\$2.22**
- 7 x 13 x 2**.....**96c** **7 x 7 x 2**.....**63c**
- 10 x 14 x 3**.....**\$1.35** **4 x 17 x 3**.....**99c**

STEEL CANS AND BOXES

- 4 x 4 x 2**.....**58c** **12 x 7 x 6**.....**\$1.68**
- 4 x 5 x 3**.....**78c** **15 x 9 x 7**.....**\$2.35**
- 6 x 6 x 6**.....**99c** **11 x 12 x 8**.....**\$2.25**

1/8 INCH STEEL PANELS

- 3 1/2 x 19**.....**66c** **10 1/2 x 19**.....**\$1.22**
- 5 1/2 x 19**.....**87c** **12 1/2 x 19**.....**\$1.46**
- 8 3/4 x 19**.....**\$1.10** **14 x 19**.....**\$1.62**

1/8 INCH ALUMINUM PANELS

- 3 1/2 x 19**.....**\$1.38** **8 3/4 x 19**.....**\$2.25**
- 5 1/2 x 19**.....**\$1.74** **10 1/2 x 19**.....**\$2.87**

FULL WAVE BRIDGE RECTIFIERS

Type B: Up to 144 VAC in, up to 96 VDC out @ 1.2 amps. Signal Corps. No. 9DO612B.....**\$2.50**

Type A: Up to 54 VAC in, up to 39 VDC out @ 1.2 amps. Signal Corps. No. 4DO238.....**\$1.50**

RESISTORS—100 watt—Ferrule Type. Wire wound, 25,000, 30,000, 40,000, 50,000, 100,000 ohms, Each **25c**

METERS

- 0-1 Ma DC.** Gruen 2" Round Metal Case.....**\$1.95**
- 0-30 Ma DC.** Westinghouse 2" Round Bakelite Case. **1.95**
- 50 Millivolt** movement 3" Round Bakelite with arbitrary scale.....**1.95**

Radio Transmitter & Receiver Aps 13

Tunes 410/420 megacycles; light weight, airborne Radar, 17 tubes, including 5/6J6; 9/6AG5; 2/2D21; 1/VR105 and 30 megacycle I.F. strip. With schematic. All for..... **\$11.95**



KEYING UNIT. McElroy Model G-813

Complete with Tubes, 117N7GT, 1A7GT, 117Z6GT—Photo Tube, Exciter Lamp. Designed for Army Operator Training Schools. Mounted on handsome Wooden Case. **\$19.95**
Brand New.....

CS Differential Relay 2 amp. contacts 110 VAC 8000 Ohm each coil, 8 ma to close will; take up to 250 VDC on each coil. Swell for Balanced or Bridge type circuit where limited current or power is available. Will withstand 12G Vibration at 35000 Ft..... **95c**

REAL VALUES

- 832 Tubes** Brand New, Fully Guaranteed. Special...**\$2.15**
- 1N23A X-Tal Diodes.** **35c** Each; 3 for.....**\$1.00**
- Ouncer Transformer,** Mike to Grid, 25:1 Ratio, Low to High Impedance. **35c** Each; 10 for.....**\$2.95**
- De Jur Wire Wound 2000 ohm Pot.** 12 Watts.....**49c**
- Arc-5 Silver Plated Banana Plugs,** per dozen.....**10c**
- 24 Volt GE Relay** 200 amp Silver Plated contacts.....**39c**
- 6 Volt Bayonet Base Pilot Assemblies,** with Dimmer, Red or White. Each.....**19c**
- 39" Telescopic Antenna**.....**25c**
- Octal Sockets,** Low Loss Bakelite.....**8c**
- .006 Mfd.** 2000v Postage Stamp Mica Condensers, **5c** Each; 100 for.....**\$4.75**
- .01 mfd.** 2000v Mica conds **5c** each; 100 for.....**\$4.75**
- .003 mfd.** 2000v Mica conds **5c** each; 100 for.....**\$4.75**
- Meissner 2.5 M.H. R.F. Choke** Shielded in Boxes. Each...**19c**
- APC-25 Air Trimmers.** Screw Driver Adjusted 12 plates, 25 mmfd. Silver plated **15c** each, 10 for.....**\$1.25**

DYNAMOTOR—5047—D.C. input 27.0 Volts at 1.75 Amps, D.C. output 285 Volts at .075 Amps. Continuous Duty Rating. Brand New. Each.....**95c**

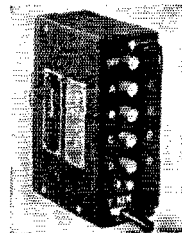

ATTENTION !!!

ALL SCR-522 OWNERS:

Remote Control Boxes for SCR 522's, Brand New in Original Packaging, Consists of 5 push button switches, 5 Western Electric Pilot Assemblies, with Pilot Bulbs and Dimmer, and lever Switch all finished in Black Crackle. Order yours To-Day for only.....**\$1.25 ea.**
Antenna Plug 46-PS-1 for 522A. **15c ea.**

If not rated 25% with order, balance C.O.D. All prices F.O.B. our warehouse New York. No order under \$2.00. We ship to any part of the globe

LEEDS RADIO CO.

75 Vesey Street
Cortlandt 7-2612

Dept. Q53
New York City 7

Magnetrons & Klystrons

AT *sensationally* LOW PRICES



Magnetrons

2122 . . \$15.95 4J26 . . \$15.95
 2132 . . 15.95 5J23 . . 15.95
 2138 w/magnet 5J29 . . 15.95
 15.95 714AY . . 9.80
 2148 . . 15.95 725A . . 12.50

Klystrons

417A . . \$9.80
 723A/B . 3.95
 726A . . 4.75

Write for Complete List of Tubes

TERMS - cash with order or 20% deposit,
 balance C.O.D.

ALL PRICES ARE NET, F.O.B. DAYTON, O.



STANDARD RADIO & ELECTRONIC PRODUCTS CO.
 135 E. Second St. DAYTON 2, OHIO. Tel. FUlton 2174

COMMERCIAL RADIO INSTITUTE

A RADIO TRAINING CENTER FOR 28 YEARS

Resident Courses Only • Broadcast, Service, Aeronautical, Television, U.H.F., Preparatory Course, Frequency Modulation and Marine telegraphy classes forming for Mid-Year Term Feb. 2nd. Classes now forming for Summer term June 1st. Entrance examination May 17th.

Literature upon request. Veteran training

Dept. B, 38 West Biddle Street, Baltimore 1, Maryland

QST YEARLY BINDERS

ARE WE RIGHT? You should have at least two of them—one for your complete 1947 file of copies, and one for each 1948 issue as published. **Price \$2.00 postpaid.** Available Only in United States and Possessions.

THE AMERICAN RADIO RELAY LEAGUE
 West Hartford 7, Connecticut

COMPLETE RADIO TRAINING!

Prepare now to accept a responsible position in Commercial Radio. New developments will demand technicians with thorough basic training, plus a knowledge of new techniques discovered during the war. Training open to high school graduates or those with high school equivalency. Courses 6 to 18 months' duration in RADIO AND ELECTRONICS. Approved Veteran training in Radio. Write for Particulars.

VALPARAISO TECHNICAL INSTITUTE
 DEPT. TN Valparaiso, Ind.

PROFESSIONAL TRAINING
 IN A MINIMUM OF TIME

RADIO-ELECTRONICS ENGINEERING

TELEVISION • BROADCAST

An Accredited Technical Institute nationally recognized for high calibre training. Prepares high school graduates for technical careers. Classes start every Monday. Comprehensive courses in Radio-Electronics Engineering, Broadcast and Television Engineering, Broadcast and Television Servicing; 2,100 hours classroom and laboratory study.

Write today for free informative booklet, "RADIO ENGINEERING AS A CAREER"
CAPITOL RADIO ENGINEERING INSTITUTE
 DEPT. QS-3, 16th STREET & PARK ROAD N. W., WASHINGTON 10, D. C.

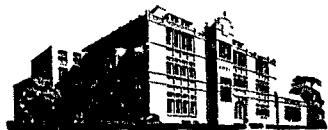

..... We await clarification of the prefix status in Germany; besides D2 and D4, there are D3, 5, 7 and DA prefixes floating around
 W5NIY, ex-W9MUX, reports a visit from Santa on Christmas Eve. After years of toil, Bernie succeeded in raising Tanganyika in the person of VQ3HJP. Three minutes after that QSO he nailed VQ3TOM Harken, all ye grizzled, signal-scarred DXers who believe that the 14-Mc. free-for-all is no place for the younger squirts to spread their wings. On his 14th birthday, W2UFT tallied up the score for his first year of ham radio to find 79 confirmed countries out of 137 worked. This was on January 22nd. Don's OM, W2ANX, reports the W2UFT vertical about to be replaced by a rotary beam, too. Just for record, who is the youngest DXCC man in the crowd? Sandy, of MB9AS, is heading back home after livening up 7 Mc. a bit for the boys W3JTC was formally presented with his DXCC diploma at a recent meeting of the Potomac Valley Radio Club, he being the first member to break the ice. W4KFC, W4LXN and W9NWX/4 are awaiting enough confirmations to join him The SARRL and ARRL shook hands across the sea when W1AW bumped into ZS6A not long ago on 14 Mc. W4BBP relates that VS6AC will be off the air indefinitely; he may be back home for a G call shortly Somehow, in spite of director duties, traffic work and contests, W6RBQ reports with 136 postwar and 9 to go for his sheepskin W2HMJ quotes MD5PC as saying that MD5DA has gone to Cyprus — maybe another chance for MD7 Who has info on FR3CE (14,090 t5), heard by W1MRQ?

When not gathering material for his newest book, "The Psychology in Choosing a Bootleg Call," Jeeves is putting with his new rig for the DX Contest. He's hooking everything up backward, starting with the power supply and figures to run something like minus-5 kw. into a one-element beam. We tried to reason with him, that power is power even at -4000 volts on the plate, but he says he knows a smart criminal lawyer. Oh well . . . if he raises that CM2 we've promised to write him regularly in Leavenworth.

Hints and Kinks

(Continued from page 73)

front-to-back ratio; the connection producing the greatest figure is the correct one. If everything is connected properly and the station is in the preferred direction, a considerable increase — on

(Continued on page 158)

Here is the ANSWER!

For U.H.F. PORTABLE/MOBILE WORK

The Sperti Handie-Talkie is good plain operating fun

- on trips
- at camp
- from boats
- from airplanes
- from hills or mountains

The Sperti Handie-Talkie is a small unit developed by a well-known large company to meet your 2 meter portable/mobile needs. You can drive to a good DX location and operate from there.

- Size 2" x 3" x 10" — Weight only 3½ lbs.
- Self-contained 135 volt B Battery! Long Life!
- No external connections
- Dipole antenna — efficiently coupled
- Covers the whole band, 144-148 mc.
- Can be used with a remote antenna
- Not surplus equipment!

This little set is fine for the newcomer, or for the man who wants to get on the air, doesn't have time to build — and doesn't have much money to spend.

For field days, transmitter hunts, ham fests, emergency work, this compact unit can't be beat. Useful in adjusting your directional antenna and reporting field strength measurements. See your local dealer now or write to the factory. Amateur net price \$34.50.

SPERTI, INC.
Dept. WT
CINCINNATI 12, OHIO

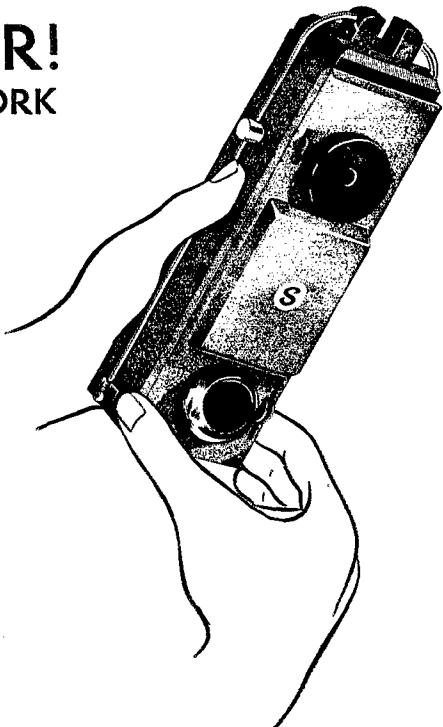

Step Up Your QSO's with . . .

THE NATIONAL NC-173

The NC-173 will give you a higher percentage of QSO's because it has:

Frequency Coverage from 540 KC to 31 mc plus 48-56 mc —
Calibrated Amateur Band Spread on 6, 10-11, 20, 40, and 80 meter bands — 6 Position Wide Range Crystal Filter — Double-Diode Noise Limiter For Both Phone and C. W.

Reception — AVC for both Phone and C. W. Reception — S-Meter with Adjustable Sensitivity for Phone and C. W. — AC-Powered . . . 110/120 or 220/240 volts, 50/60 Cycle — Low Price.

WRITE FOR FREE BOOKLET TODAY

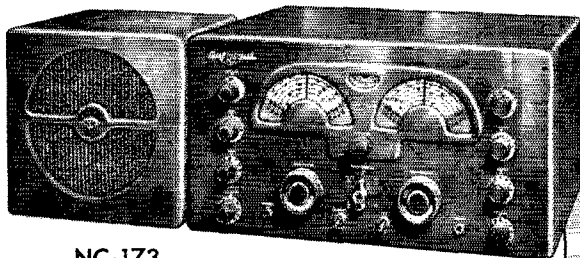

NC-173

NATIONAL UHF COILS AND COIL FORM

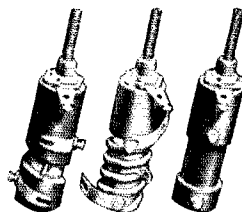

AR-2 AR-5 XR-50

The AR-2 and AR-5 coils are high Q permeability tuned RF coils. The AR-2 coil tunes from 75 mc to 220 mc and the AR-5 coil tunes from 37 mc to 110 mc with suitable capacitors.

XR-50 coil forms may be wound as desired to provide a permeability tuned coil. The form winding length is 1½", and the form winding diameter is ½". The iron slug is ¾" diameter by ½" long.

TYDINGS COMPANY

632 GRANT ST.
PITTSBURGH 19, PA.

A HIT WITH AMATEURS

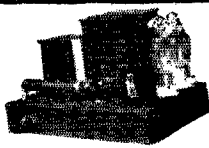

"Buck" Strelcher
POWER SUPPLY KITS
 500 to 3000 Volts

They contain everything you need, all parts being brand new and nationally famous, including RCA, Kenyon, Milten, etc.

- | | | |
|--|--|----------|
| #1 | 500 or 700 V DC @ 300 ma..... | \$39.50 |
| #2 | 1000 or 1250 V DC @ 300 ma..... | \$49.50 |
| #3 | 1500, 1750, or 2000 V DC @ 300 ma..... | \$59.50 |
| #4 | 2000 V DC @ 600 ma..... | \$103.50 |
| Use this one supply for double duty (600 ma CCS) | | |
| #5 | 2000 V DC @ 500 ma or
3000 V DC @ 400 ma..... | \$119.50 |

Power Supply kit for the BC-221..... \$ 5.95

Complete wiring diagrams with all kits

ORDER NOW! Prices subject to change without notice.

SUN RADIO

& ELECTRONICS CO., Inc.

ESTABLISHED 1927

122-124 DUANE ST. · NEW YORK 7, N. Y. · Barclay 7-1840

YOU WANT 'EM . . .

UNIVERSAL'S GOT 'EM!

Brand new FT 171B

CRYSTALS

99¢ each

FOB CASH WITH ORDER

3510 — 3570 — 3580

3945 — 3955 — 3995 KCs

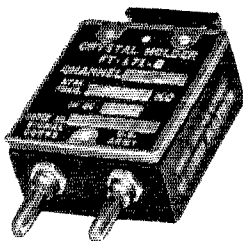

UNIVERSAL

RADIO SUPPLY CO., INC.

715 South 7th Street

Louisville 3, Kentucky

RADIO

TECHNICIAN and RADIO SERVICE COURSES
 FM and TELEVISION

Approved under G. I. Bill of Rights

AMERICAN RADIO INSTITUTE

101 West 63rd St., New York 23, New York

TEACHING RADIO SINCE 1935



RCA INSTITUTES, INC.

Offer thorough training courses
 in all technical phases of

RADIO and TELEVISION

WEEKLY RATES

DAYS — EVENINGS

VETERANS: RCA Institutes is approved
 under G. I. Bill of Rights
 For Free Catalog write Dept. ST-48

RCA INSTITUTES, INC.

A Service of Radio Corporation of America
 75 Varick Street, New York 13, N. Y.

the order of three or four S divisions — should be noted.

Although the folded dipoles described are heavily constructed to withstand heavy winds and considerable buffeting, there appears to be no reason why two folded dipoles constructed entirely of 300-ohm line would not serve, during periods of light winds or in protected areas. Greater frequency coverage (within a given band) may result from the use of open-wire construction than with 300-ohm line, but for those who do not operate over a wide frequency range little difference should be noticed. Parenthetically, it may be stated that with the antenna arrangement in use at W4SN little change in antenna loading is observed between 28 and 29.4 Mc. Reception is quite satisfactory throughout the ten-meter band.

Phasing of two folded dipoles constructed to operate on the 20-, 40- or 80-meter bands should be satisfactory and should be productive of results. The physical requirements of support, spacing and arrangement of antennas and phasing stub will be proportionately greater than for a ten-meter antenna but, theoretically, the antenna is practical on any band.

Experience at W4SN indicates that this antenna gives a worth-while gain over an azimuthal area of approximately 75 degrees. The horizontal pattern produced by this array, simple though it is, approximates a cardioid. With the assistance of W4ILF and other amateur stations with whom tests were made, the front-to-back ratio was measured to be of the order of 20 db.; the forward gain is approximately 5 db. The addition of this folded dipole and the phasing arrangement shown in Fig. 1 made a worth-while improvement in the signal transmitted by our little 25-watter, and has accomplished a very encouraging reduction in interference from other stations operating on the same frequency in a direction opposite to Europe, in the morning, and Australia and New Zealand, in the evenings.

— Stacy W. Norman, W4SN

Correspondence

(Continued from page 74)

subjects. At the moment my question is why doesn't the tone of QST on such things as amateur manners ('Phone Phunnies, DX hogs', type of transmission (n.b.f.m., etc.), and now single-sideband operation be put forth in the spirit of inquiry and advancement of the art rather than as a dogma to be imposed on the fraternity. Probably, the latter is not the intent of the writers, but to me it smacks too much of this dictation and regimentation we heard so much about and still get in doses from various quarters.

As long as a ham stays in the assigned frequencies and obeys the spirit of the FCC regulations why not let the little grunts and groans work themselves out. We are a growing mass of humanity — being born, learning, and dying — and you will hear all kinds of ideas and operating as long as there is American democracy. To try and set up a rigid scheme of operating, be it 'phone or c.w., and a set way of transmitting and so forth is just repugnant to our way of life.

In any event, good luck to you and your staff in 1948 and may you continue to keep the leading radio thinkers and writers associated with QST.

— Kurts A. Fichthorn, W1BGJ

IT'S **Harvey-WELLS** FOR **P**ERFORMANCE

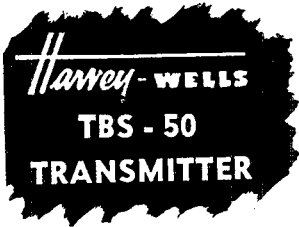
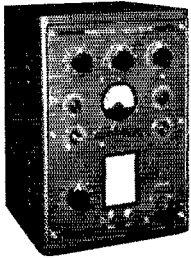

➔ Now **AVAILABLE**
POWER SUPPLY for TBS-50

No. APS-50 A.C. Supply with a "HI-LO" switch delivering either 425 volts or 300 volts at 275. **\$39.50**
ma. and 6.3 volts at 4. amps. Price.....



and the **STATION MONITOR, SM-1**

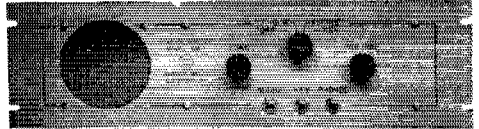

Provides audio note for monitoring any CW Transmitter . . .
No tuning or band switching required . . . Provides phone
monitor with speech amplifier . . . Has 4" PM
speaker, phone jack and built-in power supply. **\$34.75**
Price including tubes.....

Manufactured by

HARVEY-WELLS ELECTRONICS, INC.
SOUTHBRIDGE MASSACHUSETTS

America's Most Versatile Small Transmitter

**50 WATTS — 8 BANDS — PHONE OR CW
NO PLUG-IN COILS**

80, 40, 20, 15, 11, 10, 6, and 2 METERS

(Completely wired and tested — not a kit)

Crystal controlled on all bands, yet requires no oscillator or multiplier tuning. Serves equally well for fixed station or mobile operation. TBS-50 may be mounted on rack panel with power supply. **TUBES:** 6AQ5 Crystal Oscillator, 6AQ5 Buffer-Multiplier, 807 Final Amplifier, 2-6L6 Class B Modulators. In sturdy steel cabinet, 8" wide by 12" high by 8" deep. **TBS-50**, complete with **\$99.50** tubes.....

SEE IT AT YOUR SUPPLY HOUSE TODAY

**Breaking All
Performance
Records**

10 METER BEAM ANTENNA

- ... "increase in DX is terrific
- far ahead of all beams in my previous experience
- clean-cut design, easy to assemble
- worked all continents."

These enthusiastic comments from owners of Workshop 10-meter beams are the result of many months of painstaking research and testing to obtain constant gain, impedance match, and "front-to-back" ratio over the entire band. For structural strength, clean-cut design, and maximum performance, you cannot surpass the Workshop 10-meter beam antenna. Model #29, price \$39.50.

The WORKSHOP ASSOCIATES, INC.

Specialists in High-Frequency Antennas

63 NEEDHAM STREET, NEWTON HIGHLANDS 61, MASSACHUSETTS



**Workshop Antennas and
Equipment**

2-Meter Beam Antenna #146AB	\$21.50
6-Meter Beam Antenna #52AB	\$9.00
10-Meter Dipole Antenna #29AD	\$8.00
10-Meter 3-Element Beam Conversion Kit #29B	\$31.50
20-Meter 3-Element Beam Antenna #14	\$120.00
Antenna Mast Kit #AM	\$8.25
Model #AM1	\$1.30
Rotating Accessory Kit #AM2	\$3.00
Workshop Rotator	\$157.50

Available at better dealers

"IT'S REALLY A SWELL RIG"

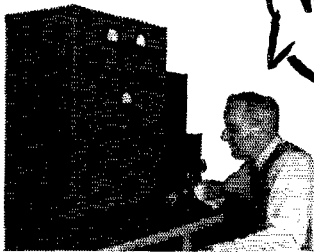

Harry Rex, Jr.-W1QLL says . . .
 "It's a swell looking rig, well engineered and the wiring is something to be complimented." Harry is one of many satisfied users. Write to Leo for the names of users in your locality.

10 DAY FREE TRIAL—UNCONDITIONALLY GUARANTEED

The WRL 275 watt "GLOBE KING" is a versatile, advanced design transmitter kit that will give you efficient performance on 6, 10, 20, 40, and 80 meter bands on phone and C. W. COMPARE THESE FEATURES and take another look at the price . . .

Front Panel control of link to final input—Voltage controlled osc and Buffer stages—Provisions for Eco—New Speech Modulator circuit—modulate up to 350 watts—Dual power supply for osc—buf and R.F. Stage—Most compact Xmtr on the market—stands 28 1/4" high—275 to 300 watts input on 10 meters—All standard parts such as Stancor, National, Thordarson, etc.

Write for complete detailed description and trade in price on your present equipment, all inquiries answered same day.

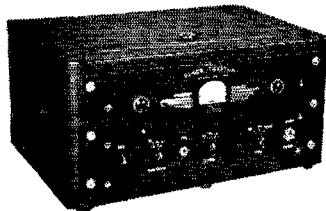

Monthly Payments
to fit your needs
It's easy
We finance
our own paper
No red tape
20% Down

WRL Globe Trotter XMTR Kit

Amateurs the world over are praising the performance of this high quality, low cost rig. It's a 40 watt input-kit including all parts, power supply, chassis panel and streamlined cabinet. Write for export prices.

- Cat. No. 70-300 less tubes. \$69.95
- Cat. No. 70-312 same as above, wired. . . . \$79.50
- 1 set of coils, meters, tubes, extra. . . . \$17.49



WRL Exciter Kit

From our own labs, 1 uses 6L6 regenerative Osc. into an 807 driver or final. Similar to unit described in A. R. R. L. Handbook. Output 35 to 40 watts. Comes mounted on standard relay rack panel 31"x19"

- Cat. No. 70-302 less accessories. . . . \$19.95
- Cat. No. 70-310 same as above, wired \$25.95
- Set of coils, meter tubes. . . . extra, \$10.78
- Power Supply wired with tubes. . . . \$22.75

Leo F. Meyer
W6G6Q



COUNCIL BLUFFS, IOWA

Immediate Delivery

This new WRL 275 Watt GLOBE KING Transmitter kit is available as a complete unit, or individual sections may be purchased separately as priced below.

WRL 275 Watt Kit	Kit form	Wired
Complete with R. F. Speech Amplifier and Modulator, and Power Supply sections.	\$295.00	\$315.00
RF Exciter section.	44.50	52.00
Final RF section.	59.50	65.00
Speech Amplifier, Modulator section and Power Supply.	95.00	104.95
Dual Power Supply section.	82.50	89.50
Above less tubes, meters, coils, and cabinet.		
3 section cabinet for complete kit, with antenna feed insulators installed. Size 28 3/16" high, 22" wide, 11 3/4" deep. Weight 38 lbs.	\$19.50	
Tubes for Modulator. . . \$8.80	Tubes for RF Final. . . \$13.90	
Meter for Modulator. . . 5.50	Meter for RF Final. . . 5.50	
Tubes for RF Exciter. . . 6.80	Coil set for RF	
Meter for RF Exciter. . . 5.50	Final, per band. . . 4.00	
Coil set for RF Exciter, per band. . . 2.95	Tubes for Power Supply 4.50	
Crating charge for complete kit.	\$10.00	

Complete with tubes, meters, cabinet, set of coils.
KIT FORM WURED AS LOW AS PER MONTH
 \$366.45 \$386.45 \$73.00 down \$25.92 12 Months

LATEST IN HAM GEAR WE HAVE IT

Get fast delivery from Leo.

ST 202 STANCOR XMITTER KIT	\$ 90.85	Bud VFO 21.	\$ 52.50
Wired by our engineers.	119.95	Meissner Signal Shifter.	99.50
Hallcrafters HT18	110.00	Gonset 6-15 Converter.	75.00
Hallcrafters S 38.	47.50	Gonset 10-11 meter Converter.	39.95
Hallcrafters S 40 A.	89.50	Harvey Wells TBS-50 XMTR.	99.50
Hallcrafters SX 43.	169.50	Sonar MB 611 Mobil Xmtr.	72.45
RME VHF 152A Converter.	86.50	Sonar VFX-680	87.45
RME H.F. 10-20 Converter.	77.00	Sonar's New CPC.	59.75
National NC 37.	89.50	Hammaland HQ129X	177.30
National NC 173.	180.50	RME DB22A Preselector.	66.00
National NC 133.	269.00	Millen 90810 H.F. Xmtr.	69.75

Lots of Bargains too—

Kit of 4 tubes original type for 274 XMTRS, brand new. . . \$1.95	New Shielded transformer operates 274 Xmitr.—1200V.C.T. 200 MA. 5V @ 3a
304TL Xmtr. tubes. 1.95	—Two 6.3V C.T. III. @ 3a each series these for 12 Volts to operate Xmitr. \$5.95
75TL Xmtr tubes. 2.49	
6 Ft. Cable and 2 Plugs to Fit 651 and PE103. 1.95	

RADIO REFERENCE MAP



ONLY 25c

Just right for your control room wall. Size 28" x 42". Contains world-wide short wave broadcast station, world radio amateur prefixes, United States amateur zones, time zones, monitoring stations, etc.

GET THIS 68 PAGE BARGAIN CATALOG

World Radio Laboratories
 744 West Broadway
 Council Bluffs, Iowa

- Send latest free flyer with bargains
 - Enclosed is 25c for radio reference map
 - Send more data on "Globe King" Kit
 - Send more data on WRL Exciter Kit
- Name
 Address
 City
 Zone
 State



HAM-ADS

(1) Advertising shall pertain to radio and shall be of nature of interest to radio amateurs or experimenters in their pursuit of the art.

(2) No display of any character will be accepted, nor can any special typographical arrangement, such as all or part capital letters be used which would tend to make one advertisement stand out from the others.

(3) The Ham-Ad rate is 30¢ per word, except as noted in paragraph (6) below.

(4) Remittance in full must accompany copy. No cash or contract discount or agency commission will be allowed.

(5) Closing date for Ham-Ads is the 25th of the second month preceding publication date.

(6) A special rate of 7¢ per word will apply to advertising which, in our judgment, is obviously non-commercial in nature and is placed and signed by a member of the American Radio Relay League. Thus, advertising of bona fide surplus equipment owned, used and for sale by an individual or apparatus offered for exchange or advertising inquiring for special equipment, if by a member of the American Radio Relay League takes the 7¢ rate. An attempt to deal in apparatus in quantity for profit, even if by an individual, is commercial and all advertising by him takes the 30¢ rate. Provisions of paragraphs (1), (2), (4) and (5), apply to all advertising in this column regardless of which rate may apply.

(7) Because error is more easily avoided, it is requested signature and address be printed plainly.

(8) No advertiser may use more than 75 words in any one issue.

Having made no investigation of the advertisers in the classified columns, the publishers of QST are unable to vouch for their integrity or for the grade or character of the products or services advertised.

QUARTZ — Direct importers from Brazil of best quality pure quartz suitable for making piezo-electric crystals. Diamond Drill Carbon Co., 719 World Bldg., New York City.

QSLs in colors. Stamp for samples. Glenn Griffith, W3FSW, 1042 Pine Heights Ave., Baltimore 29, Md.

COMMERCIAL radio operators examination, question-and-answers. One dollar per element. G. C. Waller, W5ATV, 6540 E. Washington Blvd., Tulsa 15, Okla.

AMATEUR radio licenses. Complete code or theory preparations for passing amateur radio examinations. Home study and resident courses. American Radio Institute, 101 West 63rd Street, New York City.

QSLs in plastic — record cards, Ham cards. Stamp for samples. Reber Print, R.D. 1, Sewell, N. J.

CRYSTALS: Precision low drift units. Type 100A in 80, 40, and 20 meter bands. Two units plus in one octal socket. Plus or minus 5 Kc. One dollar each. Exact frequency. \$1.95 ea. Rex Bassett, Inc., Ft. Lauderdale, Fla.

QSLs, Samples, Albertson, W4HUD, P.O. Box 322, High Point, N. C.

TRANSMITTER kits, 40 watts, \$69.50. Exciter kit, \$17.95. 275 watt Globe King. All makes and models new and reconditioned receivers. Trade ins accepted; low payment plan; terms financed by Leo, W6GFQ. Write for specials. World Radio Labs., Council Bluffs, Iowa.

TREMENDOUS stock of new guaranteed Government radio parts. Handie and Walkie Talkies for portable operation — Ground plane antennas \$12.50 — Transmitting tubes and condensers — Coaxial Cable and connectors — panoramic adaptors. See our display ads Radio News, CQ, Amateur Callbook, Electronics, Proceedings of I. R. E., Communications, American Aviation, Popular Mechanics, and Electrical World. Write for new illustrated Ham Catalog H200C. Wells Sales, Bob Whan, Pres. (W9BEQ), 320 N. La Salle St., Chicago 10, Illinois.

METERS repaired. Springfield Testing Laboratory, 815 North 12th St., Springfield, Ill.

BEAM control cable, new material: 2 #16; 6 #20 rubber insulated, coded, tinned conductors. Weatherproof rubber jacket. Heavy overall braided shield. 1/2" diameter. Value 30¢ ft. Real buy 1 1/2¢ foot. F.o.b. Chicago. Anatomet Industries, 6639 Aberdeen Street, Chicago 21, Ill.

ERECO Beam Rotator. 110 VAC, heavy duty, variable speed, selsyn indicator, weatherproofed. Complete indicator and rotator ready to plug in, \$69.95. Satisfied users all over the country. Buy from your dealer or direct. Free literature. Dick Rose, Erecos, 2912 Hewitt, Everett, Washington.

HAMS, Experimenters! Now you can get specialized technical training in radio, electronics, and frequency modulation. For complete information, write Department N 1, Louisville Radio School, 413 W. Jefferson, Louisville, Ky.

ALUMINUM tubing for beams 1 1/8" O.D., hard lightweight, Bargain. W2PUK 347 Belleville, Bloomfield, N.J.

DON'S QSLs: "Leaders in the Field." Samples. 2106 South, Sixteenth Ave., Maywood, Illinois.

QSL cards, 2-colors, 100, \$1.75. Send copy wanted on cards. State colors. Varney's Printery, 415 South Camden, Richmond, Mo.

VESTO self-supporting steel towers. No guys. Easily erected. Every Ham can afford one. Write Vesto Company, Parkville, Missouri.

COMPLETE transmitter, receiving set. Government surplus. Tank-type. Paid \$78.50 from government. Sacrifice, \$35.00. Vernon Stahl, 116 Shaffer Avenue, DuBois, Penna.

PANELS, magnesium, machined, painted, engraved. Gilpin-Box 638R4, Mt. Clemens, Michigan.

CLEVER, tube-shaped "Birth-O-Grams" announce junior operator. Unique! 60¢ dozen postpaid. Samples. W9TSX, 1033 Spaight Street, Madison 3, Wisc.

NEW or used: all popular brands in stock. Hallicrafters, National, Hammarlund, RME, Gon-set, Millen, Meissner, others. Send deposit for new gear or write for list of used or surplus. Van Sickle Radio Supply, Indianapolis 6, Ind.

QSLs, Kromkote cards at fair price. Dauphinee, W1KMP, Box 219, Cambridge 39, Mass.

POLE "pig" transformer, 2000 volts at 5 amperes. \$25.00 or best offer., W3ERV, 2216 So. Seventh St., Philadelphia, Pa., Dewey 7-4878.

FOR SALE: RME -45 Calomatic, complete. Good condition, \$125.00. E. R. Zobel, 271 Univ. Station, Grand Forks, N.D., Dakota.

COMPLETE ham station — 200 watt factory built xmtr. All bands. Phone and c.w. In two matching black crackle cabinets. Cost \$750 in 1941. Sacrifice, \$290.00 or best offer. Also Bretting 12 rcvr and preselector. Cost \$125.00. Sacrifice \$45. Perfect condition, beautiful appearance. V. A. Padula, R.F.D. 5, New Brunswick, N. J.

SACRIFICE. Complete 375 watt phone transmitter in Par-Metal cabinet. Gammatron 54s final. T240s modulator. Also Meissner Signal Shifter and HQ-120 receiver. W2MNG, 165 Sussex Street, Paterson, N. J.

TRANSFORMERS, plate to Class B grids, 211s or smaller modulator tubes. Tapped tertiary case, porcelain terminals. A good buy on a hard to get item. \$2.95 post paid. E. J. Gozzi, 312 South 4th Ave., Mount Vernon, N. Y.

BARGAINS in new and used ham gear. HQ-120X, \$99.50; R.M.E.-45, \$99.50; R.M.E.-69, \$79.50; HRO, \$150.00; WRL Exciter, \$19.95; SX-42, S40, S20R, NC-46, R.M.E.-84, DB-20, R.M.E.-99 and other receivers. Trade-ins accepted. Easy time payments. Tubes 866-A \$98; 75TL, \$2.49, and many others. Write today for 64 page bargain catalog to Leo W6GFQ. Get best deal. World Radio Laboratories, Council Bluffs, Iowa.

BEAM rotators-Propeller mechanisms 24v. AC or DC. \$10.50, W10S, R.F.D. 3, Bridgeport, Conn.

JUNIOR needs space. Make offer. 40 watt fone-c.w. xmtr. VFO/xtal, in cabinet with microphone, meter, relays, lights. Phillips communications rcvr. with power supply, 6 bands, 2 r.f., 3 i.f., xtal. Revzin, W2MYI.

SINGLE sideband. Design your own filters without mathematics: Filters (Group 2) one dollar postpaid, guaranteed. Nomographs, Inc., Lawrenceville, New Jersey.

SELL: National SW-3, Power supply, 3 sets coils. \$20.00. W2NNF, 284 Howe Ave., Passaic, N. J.

SELL: 75 watt c.w. xmtr \$30.00. 700 v. power supply \$20.00., A. L. Bogart, Emporium, Pa.

FOR SALE: HT-9 Transmitter coils for 10, 20, 40, 80. Spare 814. \$300.00. F.o.b. Tonawanda, N. Y. W25JV, 81 King St.

SELL: Hammarlund HQ-129X with spkr. \$150.00; VHF-152-A, \$70.00; Suburban Sentinel, all band (80-10-mtrs.) Fone, c.w. rig. 140 watts inpt. 828 final. Predecessor of present Suburo 75-T. \$225.00 or will sell all for \$400.00. Reason for sale, just built K.W. rig, want new rcvr. W2UME, 246 Forest Ave., Glen Ridge, New Jersey.

SELL: 1938 model Signal Shifter with tubes. 10, 20, 40, 80, 160 meter coils in good condition. Best offer. Randolph Neal, Westminster, Mass.

FOR SALE: Factory built Globe Trotter transmitter complete tubes, meter, 10 and 20 meter coils. All offers promptly answered. W4LZB, 206 So. Lee Street, Falls Church, Virginia.

SX-28, excellent condition, \$147.00. Jack Irwin, Candler Field Br. P. O., Atlanta, Ga.

HALLICRAFTERS HT-9 transmitter. Purchased new 11 months ago. Good as new. Complete, tubes, coils, eighty, forty, twenty, eleven, ten meters. First \$289.00 F.o.b. NC-173 with speaker, slightly used, good as new. Best offer over \$145.00 takes it. F.o.b., W5KVM, Box 799, Galveston, Texas.

FOR SALE: Meissner 150-B complete. W8BZV, Box 742, Chadron, Nebraska.

HT-9 TRANSMITTER for sale. New condition. Complete with tubes, crystals, and coils for 10-, 20-, 40-, 80-meter operation. Price \$375.00. W. D. Penn, W5AAK, 4845 Nakoma Drive, Dallas, Texas.

SELL: AC operated Instructograph with ten tapes and instruction book. Used, but good as new. Best offer. W9YDP, Butlerville, Ind.

NEW Cornell-Dubilier, 4 mfd., 1500 v. oil condensers 2 for \$3.00. P. Wandelt, R.D. 1, Unadilla, N. Y., W2AU.

COMPLETE issues QST's 1934 to 1946 \$25.00. Jones Micro-mat \$20.00. Collins transmitter 30K-1 Exciter Unit, tubes \$1275.00. Shure crystal mike 70H \$9.00. Mark II tank set, new \$29.00. W2TG, 150-38 N. Hempstead Tpke., Flushing, L. I., N. Y.

PRICED for quick sale. Stancor-60-P. All tubes. \$50.00. New York hams only. W20BI, P. Brenner, 1105 Jerome Ave., N. Y., Je-6-1544.

FOR SALE: One complete "One Ten" Natl. rcvr with Natl. pwr. supply and Utah sprk. \$35.00. Marion Henderson, 771 Stewart Ave., Atlanta, Ga., W4BCQ.

IN STOCK: New and used Collins, Hallicrafters, National, Hammarlund, RME, Millen, Sonar, Meck, other receivers, transmitters, etc. Lowest prices. Terms financed by me. Reconditioned S38 \$35.00, S40 \$59.00, SX28 \$139.00, SX28A \$189.00, HQ129X \$139.00, SPC400X \$249.00, HRO Sr \$119.00, NC240D \$149.00, DB20 \$29.00, VHF152 \$59.00, DB22A \$49.00, SX24, SX25, SX16, SX17, RME84, RME45, NC173, NC101X, NC100X, other receivers, transmitters, etc. Shipped on approval. Write. Henry Radio, Butler, Mo.

QSTs complete Jan. 1938 thru Dec. 1947. Best offer. W21XV, 33 Rosemere St., Rye, N. Y.

TRYING to get through college. Complete 813 transmitter. Write for exact list of components and the extremely low price. W4MKO, 20 1/2 Audubon, Tuscaloosa, Alabama.

ELECTRONIC bug. No relays. 13 to 40 wpm by switch, \$35.00 cash, prepaid express in U.S. Write, J. D. Gallagher, W5H2B, Box 4562, College Station, Tex.

SELL: 60 watt c.w. amitter with power supply, 30 watt matching modulator with power supply. \$65.00 complete. Rev. Robert Mark, Wellsboro, Pa.

FOR SALE: Millen 90800 exciter. Very good condition with coils and tubes, offer over \$30.00. Bug key by Telegraph Apparatus Co. good condition, offer over \$6.00. Abbott TR4A with mike, offer over \$25.00. W2VDQ, 17 Pine, Amsterdam, N. Y.

SELL: AR88LF RCA Communications receiver with S-meter. 6 Bands 125-550 Kc, 1.5-30 Kc, no speaker. \$200.00 f.o.b. Winnipeg. Will trade for RME HF 10-20 Converter plus cash difference. New used 100 hours. W. A. M. Wood, VE4MW.

SURPLUS — Deluxe crystal finishing kits containing holders, quartz blanks, abrasive, etching fluid, complete instructions. Only a few hundred left at \$2.00 each postpaid. Formerly sold \$8.75. Vesto Company, Department A, Parkville, Missouri.

QSLs? SWLs? One-day service! Super-gloss stock! Samples 10¢. QSL-printer. Sakers, W8DED, Holland, Mich. "America's finest QSL cards."

FOR SALE: Complete station, like new, and guaranteed perfect. Transmitter: Temco 75GA; Receiver: NC240D; Microphone: Cardax Model 950; Antenna: Rotatable-Four-Element-Wide Spaced-Ten-Meter-Beam. Best Brush crystal phones, and Jensen JHP-52 15" co-axial speaker in walnut base reflex cabinet with best UTC high fidelity output transformer. Price \$700. J. Cordover, 1565 Selwyn Ave., N. Y., 57, N. Y.

MODULATOR: PP 811s, power supply in black relay rack. Separate 15 watt speech amplifier driver. First \$70.00 takes. Donald McNamara, 2929 West Michigan, Milwaukee, Wis.

BC-348-J, N, Q OWNERS. Special Service Manual now available. Contains schematic, wiring diagrams, alignment, etc. Martin, 3516 Sacramento, El Paso, Texas.

SELL: NC-200, HRO, FB7, Millen VFO, Exciter, Bliley Vari-X, KW final 810s B & W coils cond., "B" & "C" supplies, misc. tubes and coils. W3QP, Blue Bell, Pa.

FOR SALE: BC 610-C xmtr TU-AT-3 spch amp. for rack mount, good cond. Warren Kayler, 3816 So. 57 Ct., Cicero, Ill. W9OWV.

CHANGING frequency? Fine commercial crystals for police, aircraft, marine, geophysical, SCR-522, taxi, and other services. Commercial regrounding: many crystals can be economically reground to new frequencies — inquire. Over twelve years of satisfaction and fast service! Try us first. Eidson Electronic Company, Temple, Texas.

SACRIFICING rack, panels, KW final, etc. Send for description and prices. Donald J. Baker, W2QGR, 170 Woodward Avenue, Buffalo 14, New York.

HALLICRAFTERS portable, S39 Sky Ranger, excellent condition with good batteries, \$85.00. Jim Boyd, 3434 Northwood, Toledo, Ohio.

WANTED: AN/APR-4 complete with tuning units. Send information on price and condition to James F. Sears, W9DFD, 1736 Washington Avenue, Evansville, Ind.

HALLICRAFTERS S-39 new with batteries \$60.00. C.o.d. W9OJW, 907 W. Illinois St., Urbana, Ill.

W8FOR SELLING out. Bargains galore in everything in radio. Also Instructograph, oscillator, tapes. Baker, KWPFM, West-plains, Mo.

SWAP Bolex L8 \$140.00 movie camera used once for receiver or AC power supply for ART 13 or what have you. State make and condition. Adjusted price difference. Thomas Horl, Box 162 Honokaa, Hawaii, KH6OS.

SELL: NC240-D receiver with matched speaker like new \$175.00. DM-36 converter 5-10 meters \$28.00. C. Horn, 325 E. 163 St., New York 56, N. Y.

PROCEEDINGS IRE 1939-1947, \$7.00 per year, binders \$2.00. Roush, 111 No. Broadway, Irvington, N. Y.

RIDER Chanalyst 162-C complete with instruction book, \$95.00. Vols. 13 and 14 Riders Manual, new \$25.00. Stuart, W4LOV, R.R. 1, Henderson, Ky.

D.C. METERs, new 3 1/2", \$1.39 each, 5 for \$5.00, send for list G2. Boutwell Electric, 203 Gilbert, Kirkwood 22, Mo.

EQUIPMENT for sale: Write for list. Doersam, Ex-W2BZB, Palisade, New Jersey.

QSLs. Quality cards, priced right. Samples. Ham stationery. W9UTL, 1768 Fruitdale, Indianapolis, Ind.

SELL: Hallicrafters S-36, Just aligned. Best offer over \$135.00. Also BC-1068 receiver modified, rack mount, 137-181 Mc., 110 AC. Lester Rayner, 2054 W. Lake Street, Chicago, Ill.

SELLING OUT! Lots of brand new and used transmitting gear at money saving prices. Big list for stamp. Will not last long! W5AUB, Tupelo, Miss.

QSLs in plastic colors: woodgrain, metalized and velour stocks. Fast service, cuts, specials, stamp for samples. Reber Print, R.D. No. 1, Sewell, N. J.

SELL: New Webster wire recorder \$100.00., Sonar VFX 680, complete coils, black with cabinet \$70.00. W8ZMC, 1226 Rutledge St., Cincinnati, Ohio.

QSLs for discriminating hams. Distinctive! Colorful! New! Satisfaction guaranteed! Stamps for samples. Firman, W7JFX, 6338 23rd S.W., Seattle, Washington.

FILAMENT transformers: New 866 \$3.00 postpaid. 10V @ 10A \$4.80 postpaid. Electrical Assemblies, Grand Haven, Mich.

WANTED: OLD wireless gear from 1905 on up. State condition, price, details. W1CPI.

WANTED: Early wireless equipment, and literature prior to 1925. Franklin Wingard, Rock Island, Illinois.

FOR sale: Standard spring wound Instructograph, complete with oscillator and phones, \$23.50. Bud JC-1555 transmitting condenser \$4.00. Bud NC-1000 neutralizer, \$1.50. Philco AR-55 auto radio, \$15.00. Ghirardi's "Radio Physics Course," \$3.00. General Industries fono motor, \$4.50. W4MVM, Saraland, Ala.

PRACTICALLY new Hallicrafters, model SX28-A, 5 band ham receiver, complete with Hallicrafters speaker. \$175.00. Call Mt. Vernon 8-2948.

30 WATT G.E. F.M. police mobile transmitter and receiver, 30 megs, with 6 volt dynamotors \$85.00, 110V AC \$100.00; Bendix TA12 100 watt transmitter, \$49.50; W7AEA, 2409 No. Lawrence, Tacoma 7, Wash.

SELL: National NC-81-X Perfect condition. W8AOV.

PATENT attorney, Registered U. S. Patent Office. Electronics, mechanics, chemistry. I. Jordan Kunik, 75-S Pearl, Hartford, Conn.

QSLs, SWLs, plain or cartoons of amateur radio. Jaggi, W5FAY Press, 6118 Goliad, Dallas, Texas.

CREI course, advanced radio, broadcast engineering, advanced math: all \$50. Fine, 247 Charles, Providence, R. I.

FIRST \$100 or best offer takes practically new Mark II transmitter-receiver (40, 80 1 1/2 meters) with dual 110 V A.C. power supplies, dynamotor, antennae, phones, mikes, extra tubes, etc. John Oliver, 202 Vineland, Baldwin Park, Calif.

SELL or trade: HRO receiver and power supply. 80, 40, 20, and 10 meters; \$135. Cardwell DC-221 complete, 110 AC operated w/modulation; \$65. W9CO, Knochel, Lincoln, Ill.

BEAM elements, dural tubing. 6-12' lengths, 5/8" dia., \$5. Three complete elements 3/4 and 1/2 dia. Telescoping, 10-11 meter, \$9; 15 meter, \$12, 20 meter, \$18, f.o.b. 1" clamps, 20 for \$1. 1/2" clamps, 25 for \$1.00. P. P. Pallme, W2SYG, 375 Oak Place, Mineola, L. I., N. Y.

FOR Sale: Two McMurdo Silver Atom X 75 watt transmitters complete set coils, 3.5 Mc thru 54 Mc and tubes. Never used, \$35 each. Two power supplies complete for above \$15 each. Linguaphone five record code set, \$5. H. L. Moersfelder, 140 High Park Blvd., Buffalo 21, N. Y.

NEARLY new Hallicrafters SX-42, \$255; Hallicrafters HT-9 with 20 and 80 M coils, \$265; Two Mark II transceivers complete, \$39 each. Lt. Stephen Youngberg, Ford Ord, Calif.

FOR Sale or Trade: Abbott TR4B, like new. Want good oscilloscope or test equipment. W2OII, 8534 161st St., Jamaica 2, L. I., N. Y.

POLE transformer, secondary 1100 v. each side CT, primary 110 v. Have been running whole rig off this transformer, drawing 750 Ma. Could power high power final with bridge rectifier. \$25, express extra. W0QXT, Pleasant Hill, Mo.

SELL: first year complete, CQ magazine, good condition. Also 21 various "Radio" issues, 1938 to 1942 including 3 "yearbook" numbers; 8 various copies "R9", rare. Make offer. W3OJW, 6913 Churchland St., Pittsburgh 6, Penna.

50-WATT exciter with coils and tubes, 10 to 80 meters, \$22. W2HFM, Merrick, N. Y.

BEST offer takes my 125-watt all-band transmitter Bretting nine receiver D104 mike, etc. Paulsen, Avon, So. Dakota.

WANTED: SCR608, BC683, BC684 transmitter and one or two receivers; advise condition, price. W9FCL, 585 Turner, Glen Ellyn, Ill.

SELL S-27 Hallicrafters. A-1 condition with J2" speaker. \$125.00. W8DYH, 18030 Waltham, Detroit 5, Mich.

WANTED: NC-240C or 240D rack mounted receiver less speaker. 547-A General Radio temperature control box complete, 575-D General Radio oscillator (oscillator unit of 581-A frequency-deviation meter) even must be in good condition. State condition and best offer for each. Claude M. Gray, Box 602, Birmingham, Ala.

SELL: good BC348P converted to 110 AC. \$55, W9NCC, 1937 South Courtland, Kokomo, Ind.

QSLs, SWLs, by the QSL king, Samples? Dossett, W9BHV QSL Factory, 857 Burlington, Frankfort, Ind.

SELL Hallicrafters S-40, little used, perfect condition. \$65. W8WV, 1753 Kensington Ave., Youngstown, Ohio.

SWAP Hamilton 22-jewel Navigation watch, 24-hour face, for good receiver. W4IZM, 880 No. Highland Ave. NE, Atlanta 6, Ga.

FOR Sale this area BC342N, 110 V, and National 1-10A with power supply, \$50 each. Both for \$90. W2VYW, 12 Hudson View Terr., Newburgh, N. Y.

QSLs — SWLs! They satisfy! Cushing, W1JHI, P. O. Box 32, Manchester, N. H.

SELL postwar DB-20, little used. Offer? Trades considered. W2OZS, Tribes Hill, N. Y.

TRADE Busch press camera outfit complete for commercial receiver. Details, foto. W6NFV, 2408 Malabar St., Los Angeles 33, Calif.

FIRST offer of \$169.50 takes unused National NC-2-40D in original carton. Lloyd Walker, Lincoln, Kansas.

WIAW attendant wanted. An amateur with ARRL organization background, as well as constructional and maintenance experience and ability to set a good procedure example when on the air, is invited to apply. If available and interested, state your past ARRL appointments held and radio experience, in writing for details and application form. Handy, AKRL.

BC-221 frequency meters, 125-20,000 Kc., perfect condition, \$37. Continental Electronics Brooklyn 22, N. Y.

FOR Sale: UTC, S47, 3000 Vet, 300 Ma., new, \$16.50. W3KHU, 334 Champlain Ave., Wilmington, Del.

SACRIFICE, \$100.00 lot technical and ham surplus. Write for Bargain Bulletins. Electronic Research, 5832 Hegerman, Phila., Penna.

MAPS 5 color, 50" x 38", USA or world. 75¢ each. Both \$1.25. Satisfaction guaranteed. Powell, W2PLH, 68 Lyall Road, Clifton, N. J.

SELL or trade: 120-watt modulator and speech amplifier. Partially completed 175 watt bandswitching R.F. unit. Want 6 v.d.c. 110 v.a.c. inverter. Joseph Reinhardt, jr., Fortescue, N. J.

WANTED: Modulator to deliver 100 watts audio. Send full particulars. For sale: DC voltohmmeter; 10/50/100/500/IMVS 10 m ohms/volt. Cost \$14. 6 mos. ago. W9PQJ, 3105 Leighton, Baltimore, Md.

COLLINS ART-13 Autotune transmitter, 813 final \$75. W8OEC, 2287 Laleman, University Heights, Ohio.

MEISSNER Deluxe signal shifter. Latest model 9-1079. Complete coils 160-80-40-20-10. Excellent condition, new tubes. Best offer over sixty dollars accepted. W0CVU, P. O. Box 224, Cedar Rapids, Iowa.

W6BWS/KG6 now ex-KG6 thanks fellows for the many fb QSOs and QSPs. Will QSL anyone missed let me know at 2713 West 154th St., Gardena, Calif.

BUILD a portable radio tube tester; improved design, checks all type radio receiving tubes; complete kit with easy-to-follow assembly blueprints; saves you \$20. Brand new factory parts. Dept. C, Standard Appliance Co., 1438 West Third St., Dayton, Ohio.

FOR Sale: Meissner 150-B xmtr. One set of coils altered for 20-meter operation. \$200. WILLZ, 49 Crest Ave., Revere, Mass. Tel. Rev. 8-1031R.

HIRO complete with coils and pwr supply, good condition, best offer takes. Hewlett-Packard lab audio oscillator 7 to 70,000 cycles in four ranges, rack mounting, \$75. Lampkin micrometer frequency meter complete with self-contained power supply, crystal, schematic and calibration tables, new \$29. QSTs wanted. Issues of 1927 and older, also 1930. W6KEG, 1124 Parkway, El Monte, Calif.

CRYSTAL kit: includes 4 low-drift, active crystals, 2 hdrs, abrasive, instructions, treatise. State band preferences 3500 to 3700 kilocycles. \$1 plus postage. Precision, low-drift, mounted crystals, 3500 to 14,400 kilocycles. Specify mounting as 5 kilocycles, \$1. Exact frequency, \$1.50. Breon Laboratories, Williamsport, Penna.

FOR Sale: custom-built transmitter. Input 450 watts, Class B modulation. Relay rack construction. Separate power supply for each stage. Commercial construction. Description, pictures, price on request. William F. Gleason, jr., WILLY, Hopedale, Mass.

NEW ART-13 transmitter, converted for 10 meters, 300 watts, 80 through 10; cw, mcw, phone. All A.C. power supplies, cables, spare parts. \$200.00. W2TTZ, 204 Veterans Pl., Ithaca, N. Y.

NEW National NC-2-40D receiver, matching speaker, original carton. First \$175 takes. W. L. Curry, 2701 Twentieth West, Birmingham 8, Ala.

HQ-129X, almost new. Best offer over \$130 takes it. James Wilts, W0DOC, 719 Grand, Ames, Iowa.

10 CM. radar R.F. unit, BC1091A, and modulator, BC1007A with magnetron, klystrons, PPI indicator and range scope, \$89. 30" parabolic dish with motor driven turntable, selsyn and dipole antenna with Lucite cover, \$44. W7GDW, 5001 No. 10th St. Tacoma 6, Wash.

SALE or trade: Pre-war Gross CW20 xmtr, complete with coils, new BC645 unmodified, good used SCR522 unmodified. Instructograph with 5 tapes, ICA Signatone osc, new, lefthanded Champion Vibroplex, new Turner V173 mike, xtals xfrms, chokes, filters. Blum, 2661 Dibblee Ave., Columbus 4, Ohio.

FOR Sale: RCA transmitter. Model ET4336-B. Input: 800 watts, c.w., 500 watts phone. Crystal controlled. Tunes 2 to 20 megacycles without coil changing. Class B plate modulation. Matching speech amplifier. 2 KVA General Electric autoformer. 115/230 volt, 60 cycle operation. This is standard RCA equipment in perfect condition. \$600 plus crating and shipping. Prefer local buyer. Will consider trade for BC610. Ken R. Lundy, W5NWL, 414 W. Lorance St., Tyler, Texas.

CAA type CA-1224 limiting audio amplifier, 84 db gain, 115 v. 60 cy. response = 2 db 100-4,000 cps, relay rack mounting with dust cover. First \$90 takes it. AN/APR-4 receiver with TN-17/APR-4 and TN-18/APR-4 tuning heads, range 74 to 1,000 megacycles, first \$95. W2SYD, 37 N. Dudley St., Camden, N. J.

RCA model 155, 3" oscilloscope, guaranteed condition. \$37.50 F.o.b. General Radio variac, variable auto transformer, Type 100, 2000 Va. \$17.50 F.o.b. VTVM, special laboratory built instrument, reads peak to peak volts and RMS volts, 0-1000 volts. Guaranteed \$18. F.o.b. Also Leeds and Northrup Galvanometer, best offer. CW 40 meter regenerative receiver per April QST. Complete with power supply, speaker, cabinet and "ACN" type bandsread dial. \$12. F.o.b. W2RTM, Rt. 72, Schenectady, N. Y.

ART-13 converted to 10 meters, AC or dynamometer supply, with AC supply \$225 or with dynamometer (can be externally driven) remote control box, cables, \$150. Corbett, West Sayville, L. I., N. Y.

ALUMINUM tubing for antennas: 5/8" OD x .035" wall x 11 ft. length, 24ST alloy (rigid), \$1.50 per length; 3/4" OD x .058" wall x 12 ft. length (telescope fit over 5/8") 61ST alloy. \$2.50 per length. Metalcraft Toy Company, 455 Paul Brown Bldg., St. Louis, Mo. Will ship C.o.d.

FOR Sale or trade: Kodak Retina, F3/5 Ektar (German) lens, Compur rapid shutter, with case shade, two filters, copying lens, Pola Screen, flash gun. Have Foth enlarger with 2" F3/5 Foth anastigmatic lens, F.R. tank. Also have Abbott TR4 ready for operation on 2 meters with 6V Vibrapak. Carbon mike. Slightly used but in excellent condition. Want larger camera, radio apparatus. Make me an offer. Albertson, W4HUD, Box 322, High Point, N. C.

SUBSCRIPTIONS to all radio magazines. Earl Mead, Huntley, Montana, W7LCM.

SALE: Sonar 611 mobile xmtr, won at recent hamfest, never used. \$50. Semel, 111-55 77th Ave., Forest Hills, L. I., N. Y.

Designed for



Application

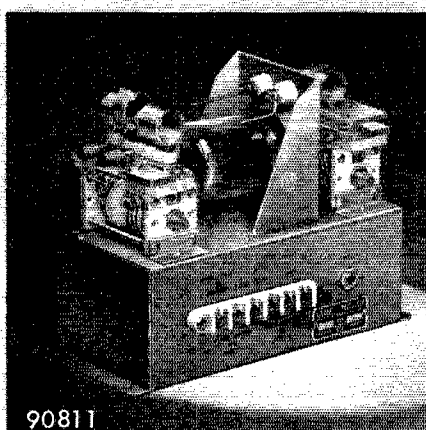

90811

**90811 HIGH FREQUENCY
RF AMPLIFIER**

The No. 90811 RF Amplifier is the same unit as used in the No. 90810 complete 2-6-10-20 meter Ham Band crystal controlled transmitter. Can be panel or base mounted. Uses 829B or 3E29 tube with normal 75 watt output. (Higher output may be obtained by the use of forced cooling.) Provisions are made for quick band shift by means of the new 48000 series high frequency plug-in coils. Extremely compact. Chassis 4" x 7 3/4" exclusive of flanges. Over-all height 6 3/4".

**JAMES MILLEN
MFG. CO., INC.**

MAIN OFFICE AND FACTORY
**MALDEN
MASSACHUSETTS**



Index to Advertisers

Allied Radio Corporation	135
American Lava Corporation	91
American Radio Institute	152
Arrow Electronics, Inc.	145
Ashe Radio Co., Walter	143
Astatic Corporation, The	115
Barker & Williamson, Inc.	119
Birnback Radio Co.	124
Billey Electric Co.	93
Browning Laboratories	136, 140, 144
Burstein-Applebee Co.	146
Candler System Co.	124
Capitol Radio Engineering Inst.	97, 148
Carter Motor Company	148
Chicago Industrial Instr. Co.	130
Clark Crystal Company	132
Cleveland Institute of Radio Elec.	128, 134
Collins Radio Company	160
Commercial Radio Institute	150
Condenser Products Company	89
Continental Sales Company	136
Decimeter, Inc.	100
Delehanty School	147
DeMambo Radio Supply Co.	147
Dewey & Almy Chemical Co.	122
Drake Electric Works	148
Drake Manufacturing Co.	102
Eitel-McCullough, Inc.	85
Electric Eye Equipment Co.	106
Electronic Marketers, Inc.	116
Electronic Navigation	140
Electroncraft, Inc.	142
Electro-Voice, Inc.	8
El-Tronics, Inc.	108
Espey Manufacturing Co.	130
Gardiner & Company	142
General Electric Co.	1
Greenlee Tool Company	136
Halicrafters Co., The	4, 5
Harrison Radio Corp.	137
Harvey Radio Co.	141
Harvey-Wells Electronics	153
Henry Radio Stores	133
Hi-Lite Studios	134
Hytron Radio & Electronics Corp.	127
Instructograph Co., The	120
Jensen Manufacturing Co.	7
Johnson Co., E. F.	90, 96
Ken-Rad	101
Kenyon Transformer Co., Inc.	117
Knights Co., James	142
Leeds Radio Company	149
McGraw-Hill Book Co.	138
Mallory & Co., P. R.	94, 95
Marion Electrical Instr. Co.	99
Mass. Radio School	124
Melville Radio Institute	158
Merit Coil & Transformer Corp.	123
Micamold Radio Corporation	125
Millen Mfg. Co., Inc., James	158
Munger Co., Rex L.	98
National Co., Inc.	83, Cov. III
Newark Electric Co.	110, 111
Ohmite Manufacturing Co.	87
Oman & Sons, D. W.	144
P & H Sales Company	146
Peerless Radio Distributors, Inc.	118
Petersen Radio Company	9
Port Arthur College	146
RCA Institutes	152
Radio Corporation of America	Cov. IV
Radio Elec. Service Co. of Penna.	114
Radio Manufacturing Engineers	2
Radio Parts Distributing Co.	140
Radio Products Sales Co.	112
Radio Shack Corp., The	103, 104, 105
Silver Co., Inc., McMurdo	92
Sonar Radio Co.	159
Sperli, Incorporated	151
Standard Radio & Elec. Products Co.	150
Standard Transformer Corp.	121
Steinbergs	122
Sun Radio & Electronics Co., Inc.	152
Sun Radio of Washington	139
Terminal Radio Corp.	129
Turner Company, The	88
Tydings Company	151
United Transformer Corp.	Cov. II
Universal Radio Supply Co.	152
Valparaiso Technical Institute	150
Valpey Crystal Corp.	132
Vesto Company	120
Vibroplex Co., The	148
Ward Leonard Elec. Co.	109
Webster-Chicago Corp.	107
Western Electric Co.	113
Wind Turbine Co.	128
Workshop Associates	153
World Radio Labs.	154



FOR YOU OPERATORS

— who want a separate calibrated oscillator — without a modulator — the CFC was developed. An ideal unit with 5 watts output on either 80 or 40 meters. Can be easily coupled into your present buffer/doubler stages. — Move after the DX; it won't come to you!

Know where you're going with a *calibrated CFC* — and have the assurance that's exactly where you'll be when you go back to him after you have raised him.

WHEN YOU WANT to use the MB-611 at home with VFO control, couple it to the CFC on 40 meters. The MB-611, using Sonar Phase Shift Modulation, gives 30 watts output and will load into any existing antenna. (See page 119 of June *QST* for details of the MB-611 or write us.)

WATCH FOR SONAR'S NEW XMITTER
SRT-75 — 60 WATTS IN YOUR ANT. • ALL BANDS



SONAR
RADIO CORPORATION
59 MYRTLE AVE., B'KLYN 1, N.Y.

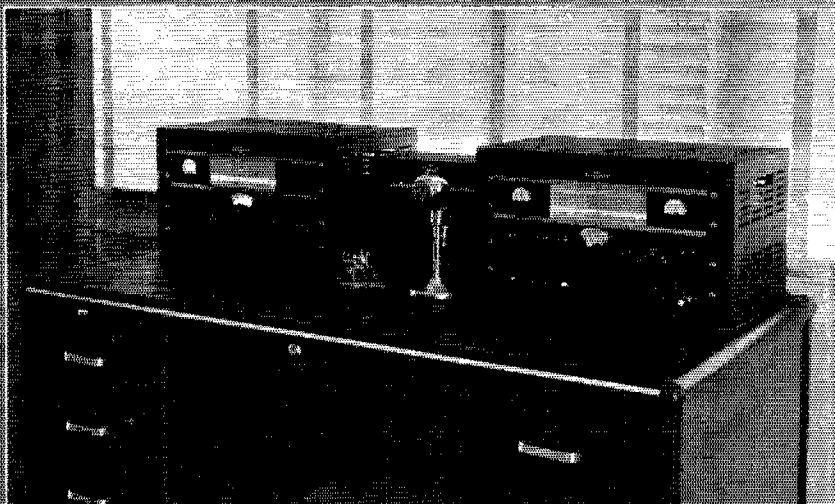

This can be your complete ham shack

YOU will have an outstanding station with a Collins 75A-1 receiver and a Collins 32V-1 transmitter. Both cover the 80, 40, 20, 15, 11 and 10 meter bands. Both, with their individual power supplies, are housed in cabinets of the same size and styling, and the speaker cabinet is styled to match.

The compact, bandswitching, gang-tuned 32V-1 is conservatively rated at 150 watts input on cw, 120 watts on phone. It employs the 70E-8 PTO as the VFO. The dial calibration is very accurate, and the frequency stability compares favorably with most crystals used by amateurs. The single ended pi output network will load the transmitter into a wide variety of antennas. It has two tuning controls, one for tuning the final, the other for loading the antenna. The net price of the 32V-1 to amateurs, complete with tubes and instruction book (exclusive of state tax), F.O.B. Cedar Rapids, Iowa, is \$475.00.

The 75A-1 receiver utilizes a double conversion

circuit (triple detection) to give you 50 db image rejection on all bands. The 6AK5 r-f stage makes possible a threshold sensitivity far better than can be realized in normal installations. This threshold sensitivity corresponds to a receiver noise factor of from 5 to 10 db above a perfect receiver of the same bandwidth. Crystal filter controls provide a bandwidth variation in 4 steps from 4 kc to 200 cycles at 2X down. Accuracy and stability are very high. The net price of the 75A-1 to amateurs, complete with tubes, speaker and cabinet assembly, and instruction book (exclusive of state tax but including excise tax), F.O.B. Cedar Rapids, Iowa, is \$375.00.

All Collins amateur equipment may be bought direct from the factory, and all except the 70E-8 on the following terms:

20% cash with order, the balance plus 5% carrying charge to be divided into twelve equal monthly installments.

FOR BEST RESULTS IN AMATEUR RADIO, IT'S . . .

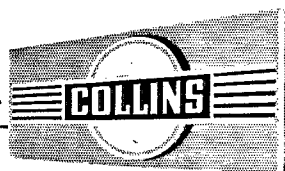

COLLINS RADIO COMPANY, Cedar Rapids, Iowa

11 West 42nd Street, New York 18, New York

458 South Spring Street, Los Angeles 13, California

Now! BIG RECEIVER QUALITY IN THE LOW-PRICED FIELD!!

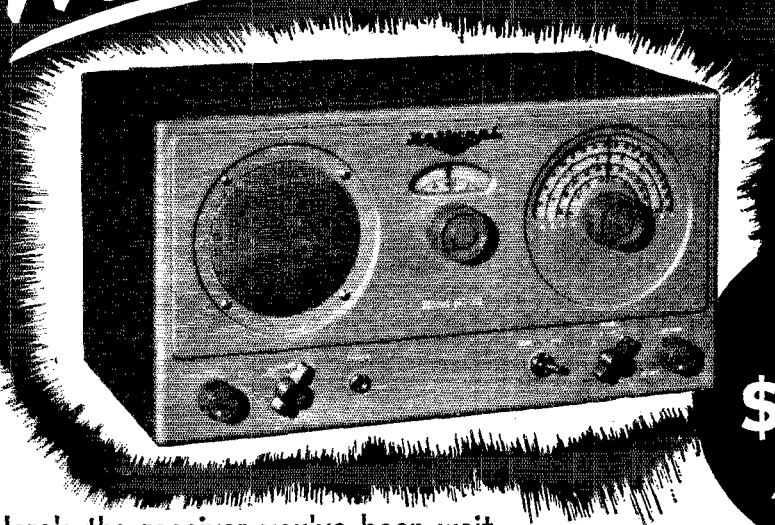

THE NEW NATIONAL NC-33
\$65⁹⁵
 AMATEUR NET

Here's the receiver you've been waiting for! A real communication receiver covering all frequencies from 500 kcs to 35 mcs, the brand new NC-33 offers the same fine workmanship that distinguishes National's more expensive receivers. Dollar for dollar, feature for feature, it's better built, better looking, better performing! See it — compare it — today at your dealer's. You'll decide it's the perfect choice for your shack, living room, playroom or den!

- Operates from 110-120 volts AC or DC. Ideal for shipboard and other uses where DC only is available.
- Electrical bandspread on all bands! Broadcast, amateur, police and foreign bands plainly marked.
- Automatic noise limiter assures optimum reception under all operating conditions.
- CW oscillator with pitch control provides superb CW reception.
- Lightweight — easy to carry.

FREE! Big New 1948 National Catalog!



TO FIND YOUR NEAREST NATIONAL DEALER SEE THE CLASSIFIED SECTION OF YOUR 'PHONE BOOK

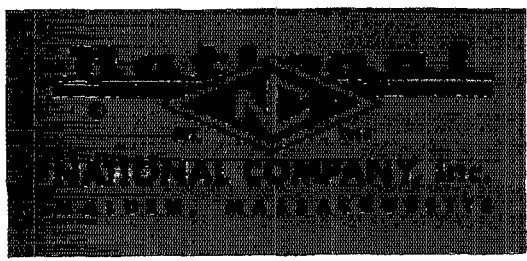

NATIONAL COMPANY, Inc.
 61 Sherman St., Malden 48, Mass.

Gentlemen: Please send me your new 1948 catalog of National receivers, components and parts.

NAME

STREET

CITY ZONE STATE

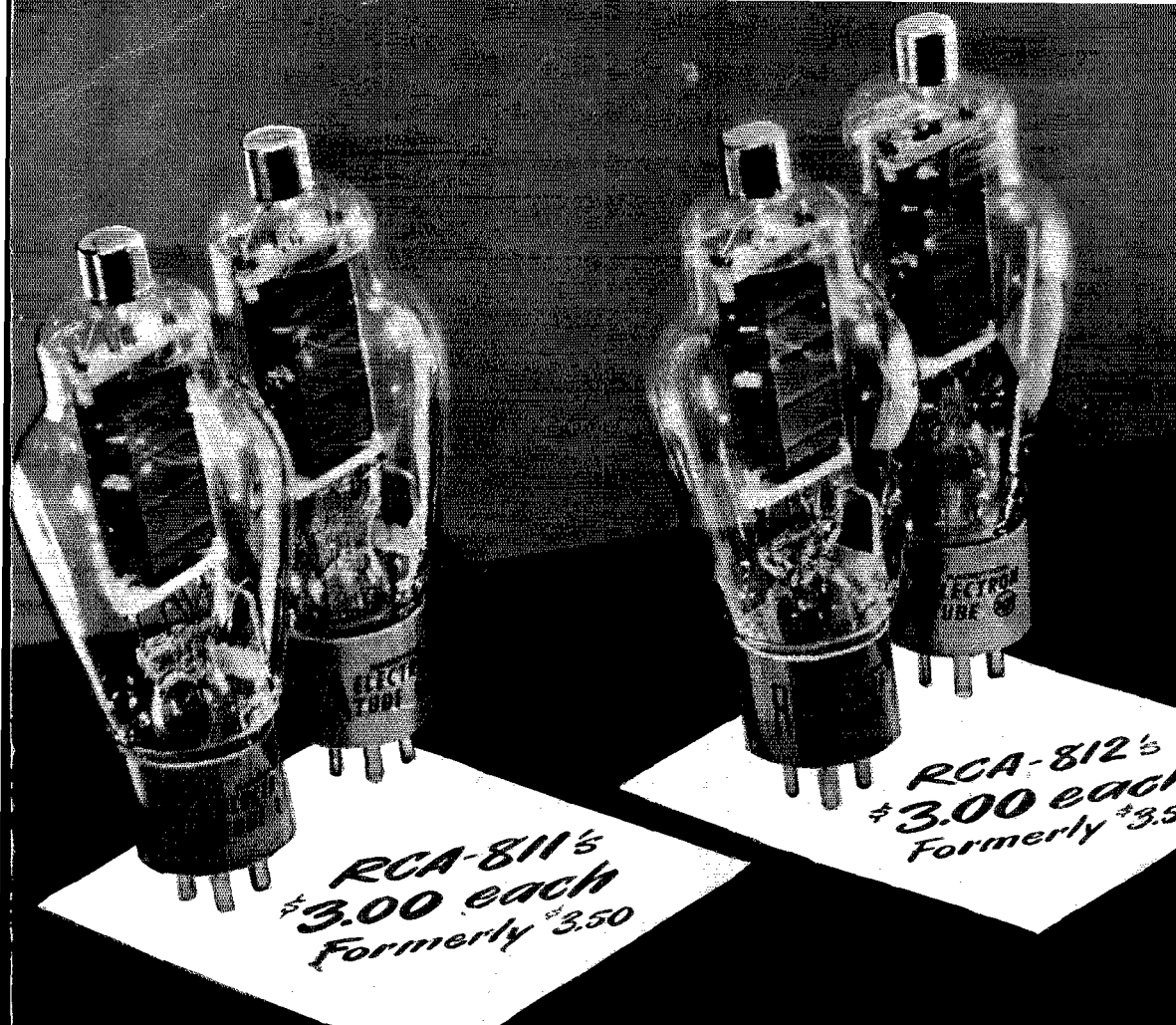

For 450* watts with certainty— brand-new RCA 811's and 812's are the buys

● Brand-new tubes are the best buys...and RCA 811's and 812's are still the leading transmitting triodes in price and performance. Here's why—

Husky, 25-watt, thoriated-tungsten filaments provide an enormous reserve of emission and insure long tube life.

Zirconium-coated molybdenum anodes provide rapid heat dissipation...hence greater power input.

A pair of either type will deliver 340 watts output in class C telegraphy (ICAS) ... or 220 watts of audio in class B modulator service.

*Class C telegraphy (ICAS). Input rating for two tubes.

Full power input up to 60 Mc. makes these tubes ideal for "multi-band" operation. And they're so easy to drive!

That's why RCA 811's and 812's—now only \$3.00 each—remain the most popular types for medium power cw and phone transmitters.

For further information, see your local RCA Tube Distributor or write RCA, Commercial Engineer, Section CM54, Harrison, New Jersey.

RCA Tubes can really take it!



TUBE DEPARTMENT

RADIO CORPORATION of AMERICA

HARRISON, N. J.