

July, 1946

25 cents

35c In Canada

QST

devoted entirely to

amateur radio



Published by the Radio Society of America, Inc., 1430 East 15th Street, New York, N. Y.



Foremost Manufacturers of Transformers
for the AMATEUR

United Transformer Corp.
150 VARICK STREET • NEW YORK 13, N. Y.
EXPORT DIVISION: 13 EAST 40th STREET, NEW YORK 16, N. Y., CABLES: "ARLAB"

THE RIGHT TUBE FOR YOUR M. O.

as proved by its

Army-Navy
popularity!



Type GL-837

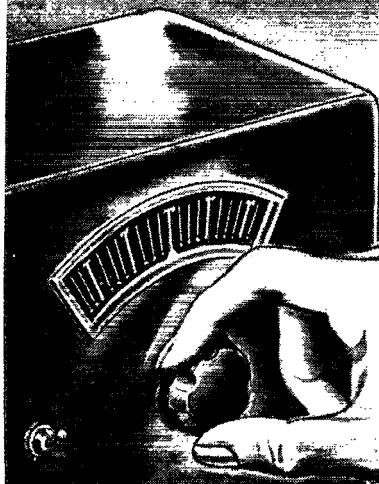

DO you want fast QSY? Here is the tube for the job. During the war, Type GL-837 was the favorite master-oscillator tube with both armed services. These are some of the reasons:

- Frequency in your output circuit is less affected by filament-voltage variations when Type GL-837 is employed.
- The non-inductive filament minimizes hum modulation, which can be critical when your M. O. is followed by several frequency multipliers.
- Precision manufacture to meet the armed forces' requirements on close tolerances, gives GL-837's their uniform electrical

characteristics. These tubes will perform as rated!

Besides M. O. service (self-excited or crystal-controlled), Type GL-837 is ideal for use as a frequency-doubler or buffer. Thorough internal shielding gives freedom from parasitics. Circuit arrangements for the tube can be versatile, because both the suppressor grid and a special internal shield are connected to their own, separate base pins.

Ask your G-E tube distributor to tell you more about this low-cost, high-value pentode that does so many ham-rig jobs well! Or write *Electronics Department, General Electric Company, Schenectady 5, N. Y.*

Electrical Characteristics

Heater voltage	12.6 v
Heater current	0.7 amp
Transconductance	3,400 mhos
Interelectrode capacitances:	
grid-plate	0.20 mmfd
input	16 mmfd
output	10 mmfd

Ratings for Typical Operation

(r-f oscillator, Class C telegraphy)

Plate voltage	400 v
Suppressor voltage	0 v
Screen voltage	200 v
Grid voltage	-40 v
Plate current	70 ma
Screen current	32 ma
Power output	16 w

Have you picked up the latest "Ham News" at your G-E tube distributor's?

ELECTRONIC TUBES OF ALL TYPES FOR THE RADIO AMATEUR

GENERAL  ELECTRIC

161-E12-8850

"The CONNEAUT"

NEW STREAMLINED CRYSTAL MICROPHONE IDEAL FOR MODERN AMATEUR RIGS

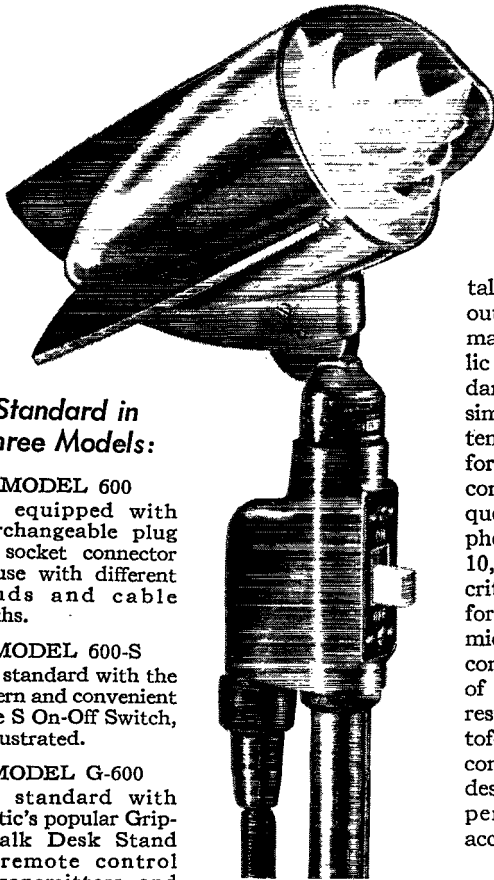

Standard in Three Models:

MODEL 600

— is equipped with interchangeable plug and socket connector for use with different stands and cable lengths.

MODEL 600-S

— is standard with the modern and convenient Type S On-Off Switch, as illustrated.

MODEL G-600

— is standard with Astatic's popular Grip-to-Talk Desk Stand for remote control of transmitters and amplifiers.

BECAUSE of its streamlined attractiveness, its desirable characteristics and its grand performance, Astatic has proudly given the name "Conneaut" to this new-model crystal microphone, in honor of Astatic's new home location in this historically important Ohio community on the Great Lakes.

Here is a semi-directional crystal microphone with a relatively high output and wide frequency range, making it especially desirable for public address systems in night clubs, dance halls, public auditoriums and similar applications; for paging systems in offices, factories and hotels; for amateur rigs and countless other communication uses. The overall frequency response of this new microphone is exceptionally smooth up to 10,000 c.p.s. and will satisfy the most critical demands for high fidelity performance. In the finishing of this microphone, Astatic's engineers have combined, for the first time, the use of bright chrome and blond plastic, resulting in a degree of beauty heretofore unparalleled in microphone construction. The "Conneaut" is destined to go places. Its faithful performance insures its ready acceptance.

*Astatic Crystal Devices
manufactured under
Brush Development Co. patents*

THE *Astatic* CORPORATION
CONNEAUT, OHIO
IN CANADA: CANADIAN ASTATIC LTD., TORONTO, ONTARIO

JULY 1946

VOLUME XXX

NUMBER 7



STAFF

Editorial

KENNETH B. WARNER, WIEH
(Managing Secretary, ARRL)
Editor

HAROLD M. MCKEAN, WICBG
Assistant to the Editor

GEORGE GRAMMER, WIDF
(Technical Director, ARRL)
Technical Editor

DONALD H. MIX, WITS
BYRON GOODMAN, WIFE
Assistant Technical Editors

RICHARD M. SMITH, WIFTX
Technical Assistant

EDWARD P. TILTON, WHDQ
V.H.F. Editor

WALTER E. BRADLEY, WIFWH
Technical Information Service

Production

RALPH T. BEAUDIN, WIBAW
Superintendent

ELSIE C. HOCHMEISTER
Assistant

Advertising

F. CHEYNEY BEEKLEY, WIGS
Advertising Manager

Circulation

DAVID H. HOUGHTON
Circulation Manager

RALPH T. BEAUDIN, WIBAW
Assistant Circulation Manager



OFFICES

38 La Salle Road
West Hartford 7, Connecticut

Subscription rate in United States and Possessions, \$2.50 per year, postpaid; all other countries, \$3.00 per year, postpaid. Single copies, 25 cents. Foreign remittances should be by international postal or express money order or bank draft, negotiable in the U. S. and for an equivalent amount in U. S. funds.

Entered as second-class matter May 29, 1913, at the post office at Hartford, Connecticut, under the Act of March 3, 1879, acceptance for mailing at special rate of postage provided for in section 1103, Act of October 3, 1917, authorized September 9, 1922. Additional entry at Concord, N. H., authorized February 21, 1929, under the Act of February 28, 1925.

Copyright 1946 by the American Radio Relay League, Inc. Title registered at U. S. Patent Office.

QST

devoted entirely to

AMATEUR RADIO

PUBLISHED MONTHLY, AS ITS OFFICIAL ORGAN, BY THE AMERICAN RADIO RELAY LEAGUE, INC., AT WEST HARTFORD, CONN., U. S. A.; OFFICIAL ORGAN OF THE INTERNATIONAL AMATEUR RADIO UNION



CONTENTS

It Seems to Us	11
Audio-Modulated Detection	
<i>D. A. Griffin, W2AOE, and L. C. Waller, W2BRO</i>	13
A Beginner's Two-Stage Transmitter	
<i>A. David Middleton, W2OEN</i>	16
Happenings of the Month	23
Claim Your Old QSL Cards Now or Never	31
"Q 2400 Megacycles"	
<i>A. R. Koch, W9WHM/2, and G. H. Floyd, W60JK/2</i>	32
Band-Warming Party Results	39
<i>E. L. Battey, W1UE</i>	
Foreign Notes	46
Converting Your Converter.	
<i>Richard M. Smith, W1FTX</i>	47
The World Above 50 Mc.	50
A Conservative Kilowatt	54
<i>Donald Mix, W1TS</i>	
Silent Keys	56
How's DX?	57
In QST 25 Years Ago This Month	60
More Stations per Megacycle at Two Meters	
<i>Calvin F. Hadlock, W1CTW, and</i>	
<i>Ralph S. Hawkins, W1OEX</i>	61
Feed-back	66
WWV	66
Hints and Kinks	67
Looking over the Postwar Receivers	
The Hallicrafters Model S-40	69
Correspondence from Members	70
Operating News	72
Station Activities	80



THE NEW S-38's 4 Bands—540 kc. to 32 Mc.

\$39.50
ADD 3%
IN
ZONE 2

The Model S-38 meets the demand for a truly competent communications receiver in the low price field. Styled in the post-war Hallicrafters pattern and incorporating many of the features found in more expensive models, the S-38 offers performance and appearance far above anything heretofore available in its class. Four tuning bands, CW pitch control adjustable from the front panel, automatic noise limiter, self-contained PM dynamic speaker and "Airodized" steel grille, all mark the S-38 as the new leader among inexpensive communications receivers.

FEATURES

1. Overall frequency range—540 kilocycles to 32 megacycles in 4 bands.
Band 1—540 to 1650 kc.
Band 2—1.65 to 5 Mc.
Band 3—5 to 14.5 Mc.
Band 4—13.5 to 32 Mc.
Adequate overlap is provided at the ends of all bands.
2. Main tuning dial accurately calibrated.
3. Separate electrical band spread dial.
4. Beat frequency oscillator, pitch adjustable from front panel.
5. AM/CW switch. Also turns on automatic volume control in AM position.
6. Standby/receive switch.
7. Automatic noise limiter.
8. Maximum audio output—1.6 watts.
9. Internal PM dynamic speaker mounted in top.
10. Controls arranged for maximum ease of operation.
11. 105-125 volt AC/DC operation. Resistor line cord for 210-250 volt operation available.
12. Speaker/phones switch.

CONTROLS: SPEAKER/PHONES, AM/CW, NOISE LIMITER, TUNING, CW PITCH, BAND SELECTOR, VOLUME, BAND SPREAD, RECEIVE/STANDBY.

EXTERNAL CONNECTIONS: Antenna terminals for doublet or single wire antenna. Ground terminal. Tip jacks for headphones.

PHYSICAL CHARACTERISTICS: Housed in a sturdy steel cabinet. Speaker grille in top is of airodized steel. Chassis cadmium plated.

SIX TUBES: 1—12SA7 converter; 1—12SK7 IF amplifier; 1—12SQ7 second detector, AVC, first audio amplifier; 1—12SQ7 beat frequency oscillator, automatic noise limiter; 1—35L6GT second audio amplifier; 1—35Z5GT rectifier.

OPERATING DATA: The Model S-38 is designed to operate on 105-125 volts AC or DC. A special external resistance line cord can be supplied for operation on 210 to 250 volts AC or DC. Power consumption on 117 volts is 29 watts.

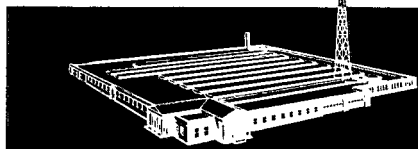

hallicrafters RADIO

THE HALLICTRAFTERS CO., MANUFACTURERS OF RADIO
AND ELECTRONIC EQUIPMENT, CHICAGO 16, U. S. A.

...AND MORE TO COME



the hallicrafters co.

DESIGNERS AND MANUFACTURERS OF RADIO COMMUNICATIONS EQUIPMENT

TO ALL AMATEURS:

The Model S-38 described on the opposite page and the Model S-40 previously announced are among the first of a long line of new and exciting pieces of communications equipment that will be coming forth from Hallicrafters radio laboratories. Compact in size, moderate as to price the Model S-38 is nevertheless expensively and beautifully engineered and it is a prime example of the kind of workmanship that will keep Hallicrafters pre-eminent in the amateur field.

The two planks in the platform that will continue to uphold the great Hallicrafters tradition are: 1. The conception, design and engineering of all receivers and transmitters to meet the most exacting standards of amateur radio. 2. The custom-built reproduction of these units in quantities large enough to assure economical distribution and a real saving to the ultimate user -- the ham. Where others could only dream about or build by hand expensive equipment, Hallicrafters by virtue of 20 years' experience in the field and a severe adherence to the likes and dislikes of the amateur, can continue to bring into the market place the finest equipment available at the lowest possible price.

For Hallicrafters the introduction of the S-38 and the S-40 is only a beginning -- the beginning of a new phase of development that will see more and more models available with the latest improvements. Working side by side with the ham for the extension of the whole science of communications, Hallicrafters will continue to deserve the reputation as builders of "the radio man's radio".



Sincerely

Bill Halligan

W9WZE

GENERAL OFFICES: 2611 INDIANA AVENUE, CHICAGO 16, ILLINOIS, U.S.A. TELEPHONE CALUMET 1400

Section Communications Managers of the ARRL Communications Department

Reports Invited. All amateurs, especially League members, are invited to report station activities on the first of each month (for preceding month) direct to the SCM, the administrative ARRL official elected by members in each Section. Radio Club reports are also desired by SCMs for inclusion in *QST*. All ARRL Field Organization appointments are now available to League members. These include ORS, OES, OPS, OO, and OBS. Also, where vacancies exist SCMs desire applications for SEC, EC, RM, and PAM.

ATLANTIC DIVISION			
Eastern Pennsylvania Maryland-Delaware-District of Columbia Southern New Jersey Western New York Western Pennsylvania	W3BES W3CIZ W3GCU W8UPH W3NCJ	Jerry Mathis Hermann E. Hobbs Ray Tomlinson Charles I. Otero R. R. Rosenberg	623 Crescent Ave. 9701 Monroe St. Silver Springs P. O. 623 E. Brown St. 4158 Ridge Road, West 927 East 23rd St.
CENTRAL DIVISION			
Illinois Indiana Kentucky Michigan Ohio Wisconsin	W9NUX W9SWH W5IEZ/4 W8DFE W8MFP W9RH	David E. Blake, II Ted K. Clifton Joseph P. Colvin Harold C. Bird Carl F. Wiehe Emil Felber, Jr.	4501 N. Malden St. 550 Eben St. 1635 Beechwood Ave. R.F.D. 2, Box 228 122 St. Albert St. 1625 N. 18th St.
DAKOTA DIVISION			
North Dakota South Dakota Northern Minnesota Southern Minnesota	W9EVP W9QVY W9FUZ W9OMC	Raymond V. Barnett P. H. Schultz Armond D. Brattland Vernon G. Pribyl	406-17th St. 118 N. Yankton Ave. 2802 S. Western 15 Glen St., South.
DELTA DIVISION			
Arkansas Louisiana Mississippi Tennessee	W5GED W5DWW W5HAV W4SP	Ed Beck W. J. Wilkinson, Jr. P. W. Clement James B. Witt	2503 Bishop St. Room 313, Jefferson Hotel 524 Santini St. R.F.D. 6, Shady Dell Trail
HUDSON DIVISION			
Eastern New York N. Y. C. & Long Island Northern New Jersey*	W2HZL W2KDC W2IIN	Ernest E. George Charles Ham, Jr. John J. Vitale	2044 Lexington Parkway 151-06 84th Drive 57 Sayre St.
MIDWEST DIVISION			
Iowa Kansas Missouri Nebraska	W0PJR W9AWP W9OUD W9FQB	Leslie B. Vennard A. B. Unruh Mrs. Letha A. Dangerfield Arthur R. Gaeth	2712 Washington St. 1617 S. Seneca St. 411 Moffett Ave. 6105 N. 37 St.
NEW ENGLAND DIVISION			
Connecticut Maine Eastern Massachusetts Western Massachusetts New Hampshire Rhode Island Vermont	W1KOY W1AOL W1ALP W1AJH W1AXL W1HRC W1WDL	Edmund R. Fraser G. C. Brown Frank L. Baker, Jr. William J. Barrett John H. Stratton Clayton C. Gordon Gerald Benedict	48 Willow St. 379 No. Main St. 91 Atlantic St. 239 Columbia St. RFD 2 70 Columbia Ave., Gaspee 23 Foster St.
NORTHWESTERN DIVISION			
Alaska Idaho Montana Oregon* Washington	K7CBF W7AVP W7CPV W7BEE W7PFD	August G. Hiebert Don D. Oberbillig Rex Roberts Cliff Ties O. U. Tatro	c/o K FAR P. O. Box 486 Box 1088 McKay Dam 513 N. Central
PACIFIC DIVISION			
Hawaii Nevada Santa Clara Valley East Bay San Francisco Sacramento Valley Philippines San Joaquin Valley	K6RLG W6CW W6BPT W6TI W6CVP W6MGC KA1GR W6PSQ	Howard S. Simpson N. Arthur Sowle Roy E. Pinkham Horace R. Greer Samuel C. Van Liew John R. Stangor George L. Rickard James F. Wakefield	2668 Wells St. Box 2025 1061 Fremont St. 414 Fairmount Ave. 215 Knowles Ave. 5240 Jay St. Box 849 1548 L St.
ROANOKE DIVISION			
North Carolina South Carolina Virginia West Virginia	W4CYB W4BOE/ANG W3AKN W8JM	W. J. Wortman Ted Ferguson Walter G. Walker Donald B. Morris	c/o Duke Power Co. 3422 Rosewood Drive 217-51 St. 303 Home St.
ROCKY MOUNTAIN DIVISION			
Colorado Utah-Wyoming	W6OYT W6LLH	Glen Bond Victor Drabble	2550 Kendall 1024 Oak St.
SOUTHEASTERN DIVISION			
Alabama Eastern Florida Western Florida Georgia West Indies (Cuba) (Puerto Rico-Virgin Islands)*	W4GBV W4IP W4MS W4HYW K4KD	Lawrence J. Smyth Robert B. Murphy Lt. Comdr. Edward J. Collins Thomas M. Moss Everett Mayer	808 Winona Ave. 3302 S.W. Grapeland Blvd. 1215 N. 12th Ave. 570 Oak Drive P. O. Box 1061
SOUTHWESTERN DIVISION			
Los Angeles Arizona San Diego	W6QWZ W6MLL W6CHV	Ben W. Onstent Gladden C. Elliott Ralph H. Culbertson	9631 3rd Ave. 1408 West Fresno St. 7172 Eads St.
WEST GULF DIVISION			
Northern Texas Oklahoma Southern Texas New Mexico	W5ALA W5AYL W5IC W5HJF	Jack T. Moore Ed Oldfield James B. Rives J. G. Hancock	4529 Fairway Ave. 2141 N.W. 35th St. 1721 Kentucky Ave. 110 S. E. Nevada St.
MARITIME DIVISION			
Maritime	VE1DQ	A. M. Crowell	69 Dublin St.
ONTARIO DIVISION			
Ontario	VE3DU	David S. Hutchinson	827 Lovett St.
QUEBEC DIVISION			
Quebec	VE2CO	L. G. Morris	4114 Hingston Ave.
VANALTA DIVISION			
Alberta British Columbia	VE6LQ VE7WS	W. W. Butchart W. W. Storey	10740 107 St. 3915 W. 32nd Ave.
PRAIRIE DIVISION			
Manitoba Saskatchewan	VE4AM VE4SY	A. W. Morley Arthur Chesworth	26 Lennox St. 1084 Redland Ave.

*Officials appointed to act temporarily in the absence of a regular official.

Almost Unbelievable!

Only 8 Watts Drive
 for 1/2 K. W. Phone Input
 with NEW UNITED
 GRAPHITE TRIODES

Highest Ratings On Record for Graphite Anode Tubes Made Possible by New Getter Trap

A great development in graphite anode tubes ... the United *Isolated Getter Trap* ... has resulted in new, clear glass tubes free from the familiar dark metallic deposit on the bulbs, and utilizing for the first time all the superior advantages of graphite.

The net result of this United achievement in the two types illustrated is a very low cost replacement for lower rated tubes of the 40 or 55 watt plate dissipation class as well as original tubes for new equipment with minimum driver construction cost.

Choice of two types, V-70-D and 812-H bridge many replacement needs with little or no circuit changes.* A pair of either type will take 1/2 K. W. phone input at 30Mc—up to 60Mc with reduced input. Available now at all leading Radio Parts Distributors.

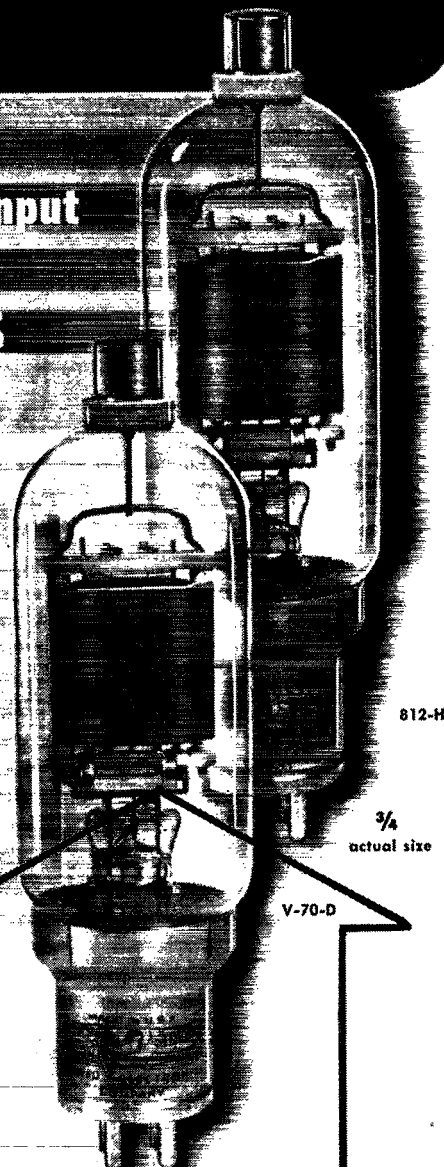

812-H

3/4 actual size

V-70-D

\$5.90 ea.

Type	Filament		Max. Plate Dissipation	Capacitances uuf			Max. input per tube	Max. Plate	
	Volts	Amps		cgp	cgf	cpf		Volts	Mils
V-70-D	7.5	3.25	85 Watts	4.5	4.5	1.7	300 Watts	1750	200
812-H	6.3	4.0	85 Watts	5.3	5.3	0.8	300 Watts	1750	200

LOOK FOR THIS
GETTER TRAP
 in all UNITED TUBES



UNITED ELECTRONICS COMPANY
 AMATEUR RADIO DEPARTMENT
 42 SPRING ST. • NEWARK 2, N. J.

Transmitting Tubes EXCLUSIVELY Since 1934



Now!

**RESISTANCE RANGES RIGHT AT YOUR FINGERTIPS
EASY TO TELL AT A GLANCE!**

**NEW...
HANDY...
QUICK...
ACCURATE...**

THE
Resist-O-Guide
10¢ at all IRC Distributors

HERE'S SOMETHING NEW—The RESIST-O-GUIDE, a practical aid in resistor range identification for every Radio Serviceman, Ham, Electrical Designer and Electronic Engineer.

To use the pocket size RESIST-O-GUIDE simply turn its three wheels to correspond with the color code on any composition-type resistor—the standard RMA range is automatically and accurately indicated. Readings are direct... no cumbersome calculations! Or, turn the wheels to indicate any desired standard range, and you are immediately shown the correct color coding.

The RESIST-O-GUIDE is convenient and accurate—and varnished for durability. To get the RESIST-O-GUIDE contact your IRC distributor—it's not sold elsewhere.



INTERNATIONAL RESISTANCE CO.

401 N. BROAD ST., PHILADELPHIA 8, PA.

Canadian Licensee: International Resistance Co., Ltd., Toronto

3 cm. RADAR PLUMBING

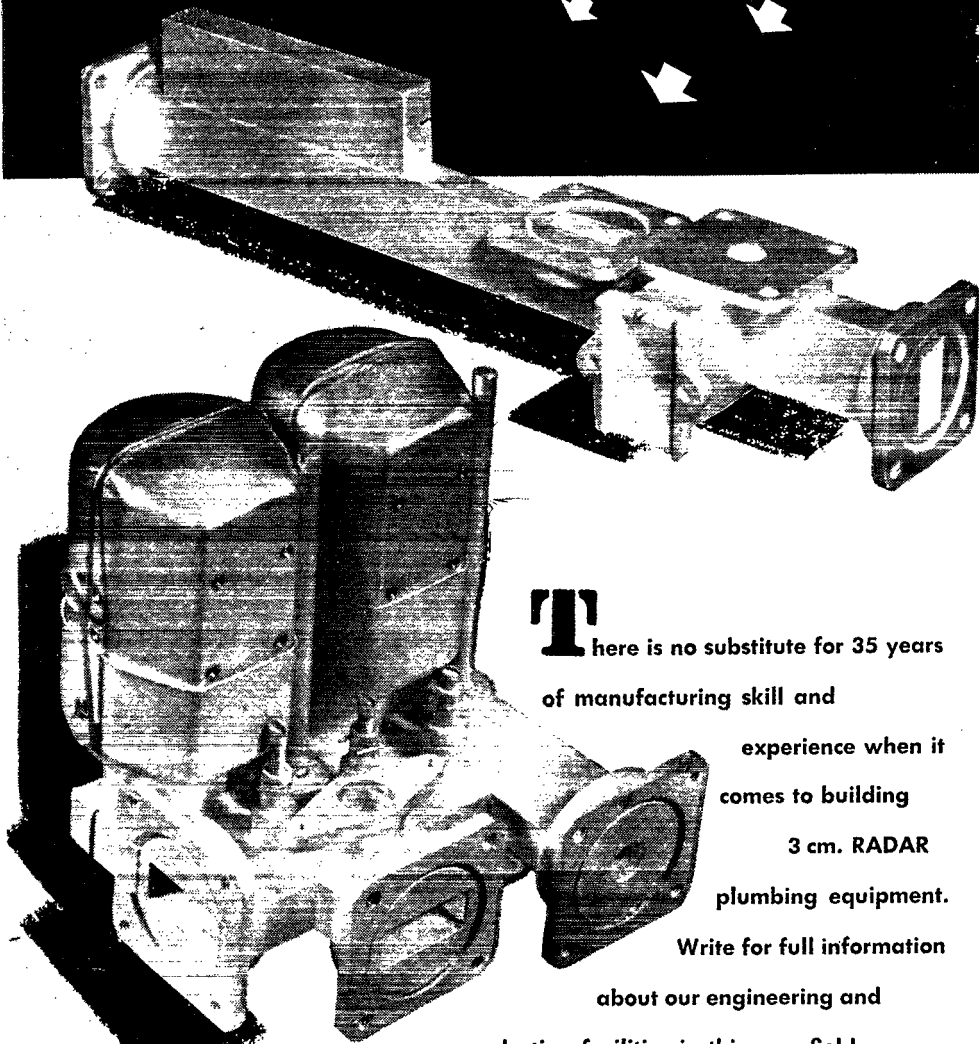

There is no substitute for 35 years
of manufacturing skill and
experience when it
comes to building
3 cm. RADAR
plumbing equipment.
Write for full information
about our engineering and
production facilities in this new field.



HAMMARLUND

THE HAMMARLUND MFG. CO., INC., 460 W. 34TH ST., NEW YORK 1, N.Y.
MANUFACTURERS OF PRECISION COMMUNICATIONS EQUIPMENT

THE AMERICAN RADIO RELAY LEAGUE, INC.,

is a noncommercial association of radio amateurs, bonded for the promotion of interest in amateur radio communication and experimentation, for the relaying of messages by radio, for the advancement of the radio art and of the public welfare, for the representation of the radio amateur in legislative matters, and for the maintenance of fraternalism and a high standard of conduct.

It is an incorporated association without capital stock, chartered under the laws of Connecticut. Its affairs are governed by a Board of Directors, elected every two years by the general membership. The officers are elected or appointed by the Directors. The League is noncommercial and no one commercially engaged in the manufacture, sale or rental of radio apparatus is eligible to membership on its board.

"Of, by and for the amateur," it numbers within its ranks practically every worth-while amateur in the nation and has a history of glorious achievement as the standard-bearer in amateur affairs.

Inquiries regarding membership are solicited. A bona fide interest in amateur radio is the only essential qualification; ownership of a transmitting station and knowledge of the code are not prerequisite, although full voting membership is granted only to licensed amateurs.

All general correspondence should be addressed to the Secretary at the administrative headquarters at West Hartford, Connecticut.



Past Presidents

HIRAM PERCY MAXIM, W1AW, 1914-1936
EUGENE C. WOODRUFF, W8CMP, 1936-1940

Officers

President.....GEORGE W. BAILEY, W1KH
Washington, D. C.
Vice-President.....J. LINCOLN McCARGAR, W6EY
Oakland, California
Secretary.....KENNETH B. WARNER, W1EH
West Hartford, Connecticut
Communications Manager.....F. E. HANDY, W1BDI
West Hartford, Connecticut
Treasurer.....DAVID H. HOUGHTON
West Hartford, Connecticut

General Counsel.....PAUL M. SEGAL
1026 Woodward Building, Washington 5, D. C.

Directors

President
GEORGE W. BAILEY.....W1KH
1530 P St., N.W., Washington 25, D. C.

Vice-President
J. LINCOLN McCARGAR.....W6EY
66 Hamilton Place, Oakland 12, Calif.

Canadian General Manager
ALEX REID.....VE2BE
240 Logan Ave., St. Lambert, P. Q.
Alternate: Leonard W. Mitchell.....VE3AZ
78 Raglan Ave., Toronto, Ont.

Atlantic Division
EDWARD G. RASER.....W3ZI
315 Beechwood Ave., Trenton 8, N. J.
Alternate: J. Victor Brotherson.....W8BHN
1743 Ottawa Drive, Erie, Pa.

Central Division
JOHN A. KIENER.....W8AVII
3462 Edlson Rd., Cleveland Heights,
Cleveland 21, Ohio
Alternate: Earl S. Nelson.....W8D5
22,551 Hadden Rd., Euclid 17, Ohio

Dakota Division
TOM E. DAVIS.....W9VVA
915 W. Becker Ave., Willmar, Minn.
Alternate: Harold B. Love.....W9ZRT
Box 426, Mandan, N. D.

Delta Division
GEORGE S. ACTON.....W5BMM
Plain Dealing, La.
Alternate: Eugene H. Treadaway.....W5DKR
P. O. Box 44, La Place, La.

Hudson Division
ROBERT AKERIDGE KIRKMAN.....W2DSY
Werah Pl., R.F.D. No. 1, Box 61, Long Branch, N. J.
Alternate: George Rulfs, Jr.....W2CJY
38 Brookwood Drive, Manhasset, L. I., N. Y.

Midwest Division
FLOYD E. NORWINE, JR.....W9EFC
7405 Hiawatha Ave., Richmond Heights 17, Mo.
Alternate: C. A. Colvin.....W9VHR
% Omaha & Council Bluffs St. Railway Co.,
Omaha 2, Nebr.

New England Division
PERCY C. NOBLE.....W1BVR
37 Broad St., Westfield, Mass.
Alternate: Clayton C. Gordon.....W1HRC
70 Columbia Ave., Warwick, R. I.

Northwestern Division
KARL W. WEINGARTEN.....W7BG
3219 N. 24th St., Tacoma 7, Wash.
Alternate: R. Rex Roberts.....W7CPY
110 W. Brennan St., Glendive, Mont.

Pacific Division
J. L. McCARGAR.....W6EY
66 Hamilton Pl., Oakland 12, Calif.
Alternate: Elbert J. Amarantes.....W6FBW
1675 Dale Ave., San Jose, Calif.

Roanoke Division
H. L. CAVENESS.....W4DW
2607 Vanderbilt Ave., Raleigh, N. C.
Alternate: J. Frank Key.....W3ZA
Box 707, Buena Vista, Va.

Rocky Mountain Division
Acting Director:
HOWARD R. MARKWELL.....W9TFP
355 Monroe St., Denver 6, Colo.

Southeastern Division
WILLIAM C. SHELTON.....W4ASR
527 Revilo Blvd., Daytona Beach, Fla.
Alternate: William P. Sides.....W4AUP
Fleming Road, Montgomery, Ala.

Southwestern Division
JOHN E. RICKEL.....W6BKY
1834 E. Whittier Blvd., Whittier, Calif.
Alternate: Eldridge E. Wyatt, Jr.....W6ARW
P. O. Box 3597, Long Beach 3, Calif.

West Gulf Division
WAYLAND M. GROVES.....W5NW
% Humble Pipe Line Co., Odessa, Texas
Alternate: Jennings R. Poston.....W5AJ
P. O. Box 848, Curundu, Panama Canal Zone

"It Seems to Us..."



THE 160-METER BAND

Have you been wondering what the present score is on the 1750-2050-kc. band and what the League is doing about it? Here is another in our series of reports to members.

In the middle of the war a large-scale planning effort for postwar radio allocations was begun in Government circles in Washington. It eventually took the form of a series of conferences between the Interdepartment Radio Advisory Committee, representing the Government agencies that use radio, and the Federal Communications Commission, which administers non-Government radio. After months of work they came to joint agreements on a proposed allocation. Early last year FCC announced the proposals for the part of the spectrum above 25 Mc. It then held extended public hearings, after which there was further IRAC-FCC conference and some changes were jointly made in the proposals, IRAC accepting the modified table for the Government services and FCC putting it into effect for the commercial and amateur services. Prodigious work is covered by that last clause — the relaunching of f.m. and television and the establishing of a myriad of new services in the higher reaches of the spectrum. Then in May a year ago FCC announced the proposed allocation below 25 Mc. and in June another public hearing was held. The matter has rested in substantially that state from that time to this. There have been so many things to do that the final phase of the work — further FCC-IRAC conferences and simultaneous announcements of final decisions — has not yet been accomplished. Not only were there priorities but the need wasn't so pressing, since this part of the spectrum includes the DX frequencies, on which only the decisions of a world conference can be finally binding and no conference was in the immediate offing. With such a conference now planned for early next year, it is to be expected that FCC and IRAC will resume their reviewing task and make some announcements before very long. For the DX frequencies these decisions will still be U. S. proposals for the world conference.

For frequencies of the order of something like 1500 to 4000 kc. they will be a domestic or, at most, a regional matter, and can be put into effect sooner.

Now the FCC-proposed allocation of May, 1945, eliminated our 160-meter band. A little of it went to the expansion of the maritime mobile service. Most of it — 1800 to 2000 kc. — went to loran at the insistence of the military services, who otherwise were our strongest backers. The only thing proposed for amateurs was shared rights in some disaster-network frequencies to be assigned somewhere between 1605 and 1800 kc. This proposal wasn't as big a surprise to us as it might have been, for, as we've remarked before in *QST*, hundreds of amateurs in high places in the war effort had known for some years that the United States intended to retain loran for its peacetime value and not give us back the band, and our Board of Directors had confidential assurances to this effect at its several wartime annual meetings. What course, then, should the League follow when it came to offering further testimony on the Commission's proposal? On the face of it, according to expert inside dope, we were licked before we started. Nevertheless, a careful course was plotted by our Board's Planning Committee and approved by the Board. We had to acknowledge the then importance of loran but we didn't have to go overboard for it. As later events proved, we were farsighted in challenging loran's omniscience and wise in not knuckling under too completely or too rapidly. Let us quote from the League's brief in the June hearing a year ago:

The navigation aid presently occupying the frequencies 1,800-2,000 kc. is a secret war device. The proposal to assign these frequencies for this purpose originates with the Interdepartment Radio Advisory Committee and has been accepted by the Commission at the request of that agency. The League concedes the present importance of this device. It also concedes its importance as long into the era of peace as American navigators continue to depend upon this device operating upon these frequencies.

But we wish to point out that this situation is not necessarily, or even probably, a permanent

one. This device is a new wartime invention. It was put into operation with the greatest possible haste to fill a pressing wartime need. It was established in a range of frequencies that had always been amateur frequencies because those frequencies were temporarily unoccupied through the closing down of amateur stations during the war. There is grave doubt whether it is good engineering practice to permit transmissions of the type emitted by this device to occur in this part of the spectrum. Competent Government engineers are of the belief that this device sooner or later will be moved to a different part of the spectrum, thus vacating these amateur frequencies.

There is, moreover, room for doubt whether this system, on these or any other frequencies, will remain as important to navigators in the years of peace as has been the belief until recently. The progenitors of this system have visualized a globe-circling network of these installations which would be relied upon by mariners and aerial navigators of every nation. The League has been told by representatives of the armed forces that only a device of such transcendental usefulness to a peacetime world would warrant the displacement of amateur radio from these frequencies. Yet it is now known that there are a number of other systems to accomplish this same objective; and, in the opinion of competent persons, some of these other systems may well be superior to the American one. There is also some evidence that some other nations have committed themselves to the employment of some of these other devices and will not rely upon the American device, as had been originally contemplated.

The League therefore cannot feel persuaded that it is established that this is a device of such enormous potential value to the world that it must be deemed the permanent assignee of these amateur frequencies. On the contrary, the League believes that it is only a question of time until, for one reason or the other, this device will no longer be in operation on these amateur frequencies. We therefore request that the Commission regard the tenure of the navigational aid in these frequencies as a temporary one, and earmark the frequencies to be returned to amateur radio if and when the navigation aid can be moved. To make such a re-assignment immediately practicable in that event, the League requests that the Commission alter its proposed international allocation for the frequencies 1,800-2,000 kc. to provide for a shared assignment to both the navigation aid and the amateur service. Thus the way will remain open for the return of these frequencies to amateurs if and when the navigation aid can be moved.

But there was more to our position than that: Even if Ioran were to stay in there, its installations in this country use widely-separated frequencies and we believed a shared use of the band should be possible. So we told the Commission:

Even the temporary loss of these frequencies is a serious blow to amateur radio. The right to operation on even a part of them would be of considerable benefit in our expected increased congestion after the war. The League believes that

it is feasible from the technical standpoint for the range 1,800-2,000 kc. to be shared between amateurs and the navigation aid. It is our understanding that certain frequencies in this range, employed for this purpose in certain portions of the country, are not employed in other portions of the country and could be utilized by amateurs there without interfering with the operation of the device in those sections of the country where the frequency is under employment for the navigation aid. While such a system of geographical sharing would result in amateurs in one part of the nation having a different subassignment within this range than amateurs in another part of the country, there would be no great practical disadvantage since these are relatively short-distance frequencies. In consequence, the League requests the Commission to make inquiry of the appropriate Government agencies concerning the possibility of authorizing shared operation in this frequency range, with the objective of making half of the 1,800-2,000 kc. range available to every amateur.

Then, too, we had something to say about the proposed disaster networks, since an assignment at 1605 kc. wouldn't mean much to us. In fact, amateur emergency service flows from our first being prepared for ordinary amateur communication. Here is what we said on that score:

Coming now to a consideration of the proposed amateur disaster networks in the range 1,605-1,800 kc., we have first to approve the Commission's general provision in this matter. We believe it to be a wise national policy, as it has been established that amateurs can render a service of incalculable value on these frequencies in time of emergency. We request, however, that the Commission arrange that the frequencies provided for the amateur service shall lie between 1,750 and 1,800 kc. The frequencies 1,605-1,750 kc. have not been assigned to amateurs for many years and there is almost no equipment for them in the hands of amateurs today. On the other hand, not only are the home stations of most amateurs capable of operating on the frequencies lying immediately above 1,750 kc. but a considerable amount of portable and other special equipment has been built for such frequencies by amateurs, for the special purpose of serving emergency-communication needs. Additionally it is to be observed that all amateur transmitting equipment designed to multiply frequency into the higher-frequency amateur bands would be capable of operation on frequencies beginning at 1,750 kc., and so a considerably greater number of stations would be available for disaster-relief operation.

To permit the efficient organization and coordination of the amateur's work in this service, the assignment made available to amateurs for this purpose should be an exclusive one. We believe it to be in the national interest for the Commission to assign the range 1,750-1,800 kc. exclusively to amateurs for this purpose. The mini-

(Continued on page 116)

Audio-Modulated Detection

An Improved Method for the Reception of C.W. Signals

BY D. A. GRIFFIN, * W2AOE, AND L. C. WALLER, * W2BRO

THE most common present-day method of receiving keyed continuous-wave signals employs a beat-frequency r.f. oscillator which is tuned to within about 1000 cycles per second of the last intermediate-frequency signal and mixed with the latter in the second detector, thus producing an audio signal of about 1000 cycles per second, corresponding to the difference between the frequencies of the b.f.o. and the i.f. This arrangement has several disadvantages, among the more serious of which are the following:

1) The components of noise signals present in the i.f. system also beat with the b.f.o. and thus cause a large increase in the receiver's noise level when the b.f.o. is functioning.

2) There is an "audio image" signal created by any interfering signal which happens to be twice the audio beat away from the desired signal, and whose i.f. component is on the opposite side of the b.f.o. frequency from that of the i.f. component of the desired signal. This effect can be minimized by a highly-selective i.f. system, and by proper adjustment of the phasing control in the crystal filter.

3) The tone frequency of the audio beat can not readily be held constant, because it depends directly on the frequency stabilities of the received signal, the receiver's high-frequency oscillator, and the b.f.o. itself. This inherent instability of the audio beat frequency is the reason that selective a.f. filters and reproducers have not found general favor in c.w. reception, in spite of the enormous advantages which such devices are recognized to have in the elimination of noise.

4) The relatively pure tone of the audio beat quickly becomes fatiguing to the operator's ear. Numerous tests have shown conclusively that a tone rich in harmonics is much better for long periods of steady copying.

5) Most operators set the b.f.o. to give a beat frequency near 1000 cycles. Although many operators would much prefer a lower frequency, such as 400 to 500 cycles, they usually listen to the higher frequency without stopping to wonder why they do so. The principal reason, of course, is tied up with the *percentage drift* of the audio beat. That is, a 200-cycle frequency drift from 400 cycles produces either 200 or 600 cycles — a 2:1 or 1½:1 frequency change, which is

inherently obnoxious to the average operator. The same 200-cycle shift from 1000 cycles, however, produces either 800 or 1200 cycles, a much smaller percentage change.

The authors have recently developed a new method of modulating a received c.w. signal which either eliminates or greatly minimizes every one of the foregoing objections to the b.f.o. and in addition provides positive audio a.v.c. The new system is called *Audio-Modulated Detection*, or A.M.D. for convenience of reference. The outstanding performance characteristics of A.M.D. are as follows:

1) Provided a signal/noise ratio of 200/1 or better in tests made with about 0.6-microvolt input at 4.6 Mc., using a standard SX-28 Halli-crafters receiver in conjunction with an A.M.D. adapter unit. This compares with a signal/noise ratio of about 8/1 with the b.f.o. and the same signal.

2) Delivers a constant audio-tone frequency for all signals, and thus makes practicable the use of a highly-selective audio filter of the electrical and/or mechanical type.

3) Provides a choice of audio tone so that aural fatigue of human operators can be minimized.

4) Provides automatic noise reduction on large noise peaks and substantially eliminates all sustained residual noises having small peak values.

5) Provides audio-signal limiting at almost any desired output-voltage level, over a tremendous r.f. input-signal range (100,000/1 or better). Effectively, this feature tends to eliminate fading of the received signal so that it does for code reception what a.v.c. does for radio-telephone signals.

6) Modulates weak and strong signals alike, whereas it is well known that the amplitude of i.f. signal voltage which will provide a good beat note when mixed with a fixed amount of b.f.o. voltage is definitely limited. This feature eliminates the necessity for constantly changing the r.f.-gain setting when the receiver is tuned from a weak signal to a strong one, and vice versa.

7) Provides for the first time true *single-signal* reception, thus increasing the adjacent-channel selectivity of the receiver without the necessity for "diddling" with the crystal-phasing control in search of the zero-response notch. In fact, with A.M.D. the panel control for crystal-phasing can be discarded.

8) Can readily be adapted to any existing

*Communication Measurements Laboratory, New York City.

communications receiver which employs a diode final detector, by means of a simple adapter unit located outside the receiver. For example, a self-

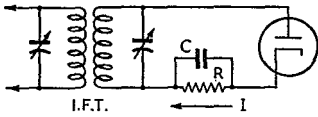

Fig. 1 — Simple diode-detector circuit.

powered A.M.D. adapter has been constructed so that it can quickly be attached to an SX-28 without soldering or unsoldering a single wire in the receiver. The "conversion" to A.M.D. can be made in about two minutes.

Theory of Operation

A simple diode-detector circuit is shown in Fig. 1. The theory of the circuit's operation is too well known to justify much discussion. Suffice to say that the diode rectifies the positive half-cycles of the i.f. signal voltage and thus, under steady-signal conditions, causes an average d.c. current I to flow through diode load resistor R in the direction indicated.

If we now connect another diode (2) in parallel with detector diode (1), but *reversed*, as shown in Fig. 2-A, it is apparent that *diode 2* will rectify the *negative* half-cycles of the i.f. signal voltage, thus producing an average d.c. current I_2 which flows through resistor R in the opposite direction to current I_1 , but practically equal to I_1 in amplitude. Thus, the two equal-and-opposite average d.c. currents cancel each other, with the result that no signal voltage is built up across R . Operational diagram Fig. 2-B shows what happens.

We now proceed to insert battery E_{sd} , as shown in Fig. 3-A, with its negative terminal facing the

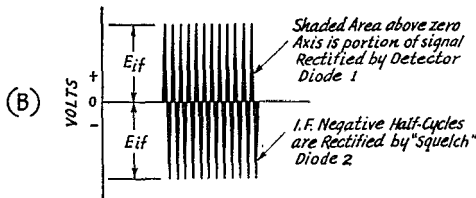
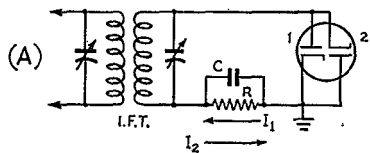

Fig. 2 — (A) Diode detector (1) with reversed diode (2) connected as a "squelcher." No signal voltage is built up across R because I_2 cancels I_1 . (B) Operational diagram showing how the rectified currents of each of the two diodes in (A) cancel each other.

anode of *diode 2*. This battery provides a delay bias on *diode 2* so that it will not rectify negative half-cycles of the i.f. signal voltage until their peak-voltage value exceeds the d.c. voltage of battery E_{sd} . For small signals, therefore, *diode 1* goes right on rectifying the *positive* half-cycles of i.f. voltage just as if *diode 2* did not exist. Fig. 3-B helps to explain the operation.

This procedure again gives us a d.c. signal voltage across R , but still no audio modulation. To obtain that, we obviously must *vary* or *modulate* the delay bias applied to *diode 2* so that the latter alternately squelches and unsquelches, at an audio rate, the signal current produced in R by *diode 1*. To accomplish this modulation of the squelch-diode delay bias, we employ the circuit of Fig. 4-A, which is probably the simplest form of A.M.D.

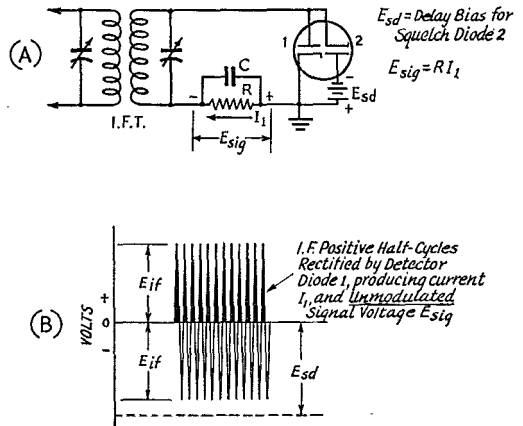

Fig. 3 — (A) Same as Fig. 2-A but with d.c. delay-bias E_{sd} added to squelch-diode 2 only. (B) Operational diagram showing how squelch-diode 2 is prevented from rectifying the i.f. negative half-cycles so long as E_{sd} is larger than E_{if} .

The operation of this circuit can readily be understood by reference to Fig. 4-B. From an inspection of this diagram we can see that we not only get a.f. modulation of the i.f. signal at whatever tone frequency we desire to inject, but also that we have established an "upper gate" which *limits any i.f. signal or i.f. noise component whose peak amplitude exceeds the upper-gate limit*.

This i.f. limiting does two things, both highly desirable. It effectively squelches all noise peaks above the predetermined upper-gate level, and it also puts a definite audio-volume "ceiling" on the received signal. An "S9-plus" signal which greatly exceeds the upper-gate level produces exactly the same headphone volume as an "S2" signal (for example) which just reaches the upper-gate level. This feature of A.M.D. not only greatly improves the signal-noise ratio but also completely eliminates fading over an input-signal range of better than 100,000 to 1 (100 db.). An-

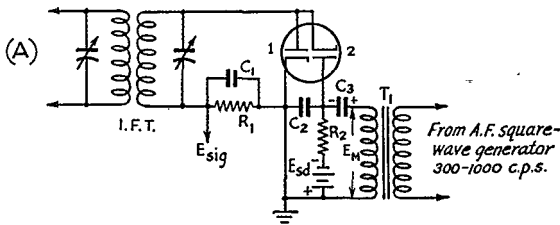
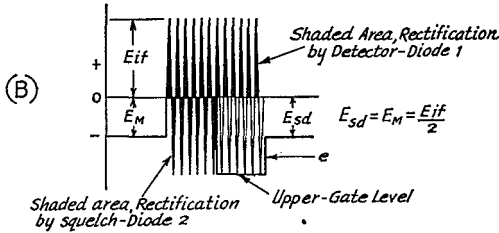

Fig. 4—(A) Basic single-gate A.M.D. circuit. (B) D.c. delay bias on squelch-diode 2 is modulated by local a.f. voltage E_M , thus modulating the signal practically 100 per cent. E_{if} = peak i.f. signal voltage; E_M = peak a.f. modulating voltage; E_{sd} = squelch-diode d.c. delay bias; e = squelch-diode instantaneous delay bias.



other inspection of Fig. 4-B shows that noise is further reduced by the fact that 100 per cent squelching occurs on each *positive* half-cycle of the audio modulating voltage — i.e., for approximately half the time — provided that the voltage has a symmetrical square-wave form. This squelching action cuts even the sustained low-level noises exactly in half. In a conventional receiver, these noises are actually amplified in magnitude when the b.f.o. is turned on.

The next logical step, of course, is the placing of a delay or "threshold" bias on the detector diode. Such a bias enables us to eliminate the low-level residual-noise voltages which usually buzz merrily along when the receiver is operated at maximum gain, even in a very quiet receiving location. This delay bias, E_{dd} , can be inserted as shown in Fig. 5-A. This circuit shows the "Double-Gate A.M.D." system, and works as indicated in operational diagram Fig. 5-B. With this arrangement, very small i.f.-signal and i.f.-noise components are not modulated because their amplitude is less than d.c. delay-bias E_{dd} . Thus, the receiver actually sounds completely "dead" until a signal or noise appears whose peak i.f.

amplitude exceeds the voltage E_{dd} . In a manner of speaking, the small noises are cut out from under the useful portion of the desired signal and the high-amplitude noise peaks are neatly clipped at any desired upper-gate level which does not result in excessive signal-peak clipping.

Inasmuch as the locally-generated audio tone frequency can easily be held to a fixed value, A.M.D. makes practicable the use of a highly-selective a.f. filter in the output system of the receiver. This a.f. filter should be of the band-pass type having a pass-band of 20 cycles or more, depending on the maximum keying speed it is desired to pass. If the pass-band is too narrow (say 10 or 15 cycles), high-speed keying will not be faithfully reproduced, because the dots and dashes will have pronounced "tails." A 400-cycle band-pass filter (consisting of three LC sections) having a pass-band 180 cycles wide at 5 db. down, and being down at least 40 db. at 200 and 1000 cycles, respectively, has been found to give extremely good results.

Tests with a double-gate A.M.D. adapter attached to a Hallicrafters SX-28 receiver were

(Concluded on page 184)

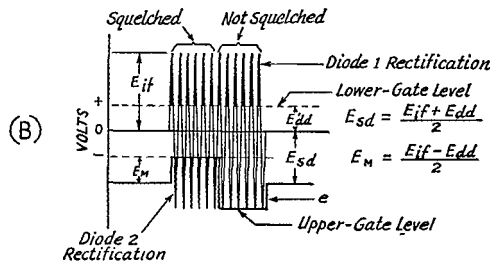
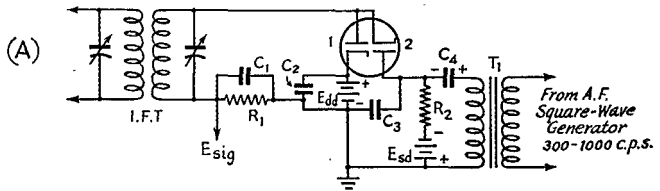

Fig. 5—(A) Basic double-gate A.M.D. circuit. (B) That portion of the signal represented by $E_{if} - E'_{dd}$ is fully modulated by E_M . E_{if} = peak i.f. voltage; E'_{dd} = detector threshold level (lower gate); E_M = peak a.f. modulating voltage; E_{dd} = squelch-diode d.c. delay bias; E_{dd} = detector-diode d.c. delay bias ($= E'_{dd}$); e = squelch-diode instantaneous delay bias.

A Beginner's Two-Stage Transmitter

The "Longfeller" — on Wood or Metal

BY A. DAVID MIDDLETON, * W2OEN

AT A RECENT hamfest in Rochester, N. Y., the writer mentioned that he had just finished a two-tube beginner's c.w. transmitter built without tools other than pliers, a soldering iron, a screwdriver and a hacksaw blade. The toastmaster, W8ATH, commented that he could not see how an old timer like W2OEN could have gotten by, all these many years, without discovering long ago that ham gear was usually built without any tools other than Mom's butcher knife and the two-bit pliers from the OM's Model T.

The real truth is that with the modern trend toward complexity, the simple things in amateur radio have been somewhat neglected, with the result that a beginner is faced with the immediate problem of learning how to become sheet-metal worker, journeyman-assembler, and wireman before he can put his newly-acquired (but sometimes limited) radio knowledge to work. He either has to learn those trades and obtain some almost-impossible-to-find tools, or use the "good old breadboard" style of construction. And even breadboards are reported to be in short supply these days.

So, with this situation in mind, the problems of the genuine beginner (who has neither tools, or much knowledge of amateur design) were recently approached anew by Don Mix, W1TS, and the writer. Don had already started the ball

*Technical Assistant, *QST*.

rolling with his article aimed at the Junior Constructor in *QST* for June, 1941. Then in July of the same year W1CTW described a two-stage portable-emergency transmitter having neat circuit features. What about a 1946 combination of the simple wooden-frame construction with W1CTW's circuit features? "Can do?" asked W1TS, and W2OEN replied, "Wilco." Thus was born the "Longfeller," a neat-appearing two-stage beginner's transmitter and power supply for the amateur without a drill or a socket punch.

Specifications for the "Longfeller"

Basic specifications included ease of construction with a minimum of tools, a noncomplicated circuit furnishing two-band output from a single crystal, a built-in antenna tuner that would feed anything from a piece of wet string to a farmer's wire fence, and a layout utilizing low-cost components that could be purchased now — without any back-orders.

The chosen circuit has proven reliable in many varied forms. It consists of a 6V6G Pierce oscillator operating on the crystal frequency with an untuned plate circuit, capacity coupled to a 6V6G or 6L6G output tube having a shunt-fed plate circuit that may be operated either on the fundamental frequency or on the second harmonic of the crystal in the 3.5- or 7.0-Mc. bands. Operation on the higher frequencies is not recom-

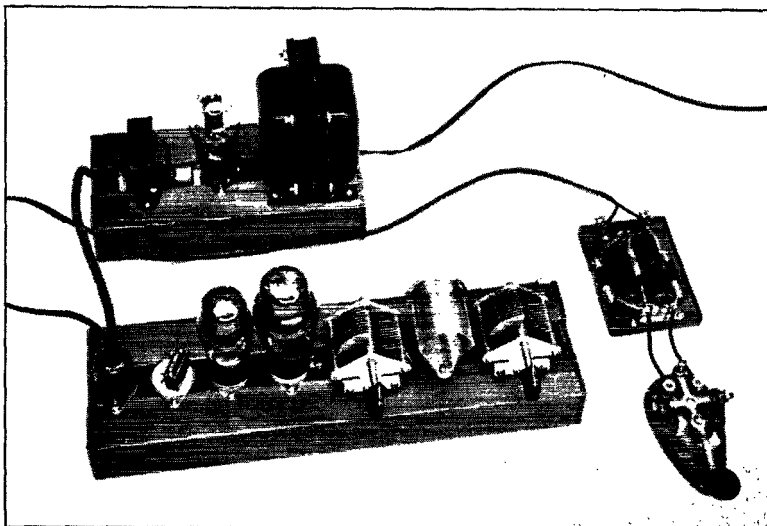

The complete "Longfeller" — lacking only an antenna to make it a whole transmitting station. This photograph depicts the construction and layout of the wooden-chassis transmitter, power supply and key filter. Shunt feed eliminates high-voltage d.c. from the top of the chassis. Coil and both condensers have r.f. present under "key down" conditions.

Fig. 1 — Schematic diagram of the "Longfeller" — a two-stage beginner's transmitter built on two wooden chassis.

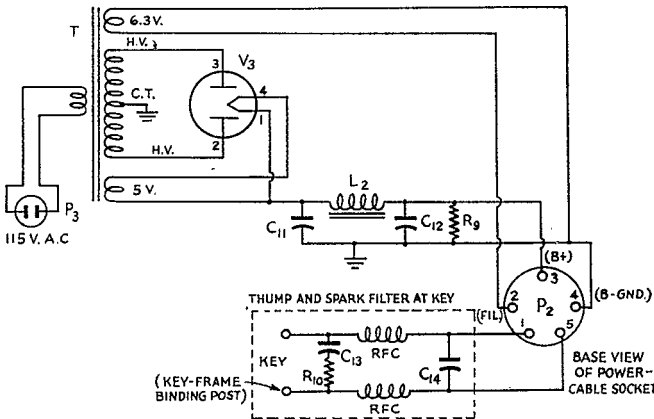
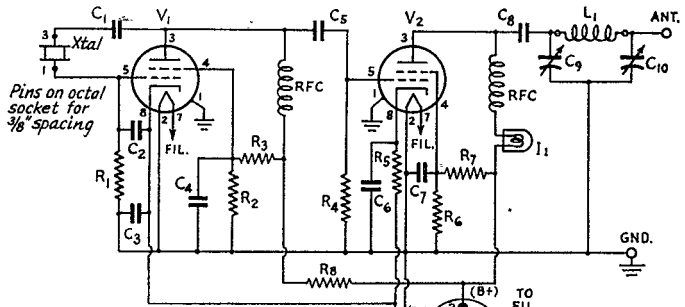

mended for the "Longfeller." Although the transmitter will work on the higher harmonics, their output is not recommended for use on the air in order to assure ease in tuning

and afford sure-fire operation.

Two variable condensers in the output circuit permit proper loading to almost any length of wire. Shunt feed keeps d.c. off the coil and condensers. However, these components are "hot" with r.f. when the key is closed.

The transmitter crystal-output-frequency combinations are as follows:

Crystal Frequency (Band)	Output Operation and Frequency	
	Fundamental (Straight Through)	Second Harmonic (Doubling)
1.75 to 2.0 Mc.	Not used	3.5 to 4.0 Mc.
3.5 to 3.65 Mc.	3.5 to 3.65 Mc.	7.0 to 7.3 Mc.
3.65 to 4.0 Mc.	3.65 to 4.0 Mc.	Not used
7.0 to 7.3 Mc.	7.0 to 7.3 Mc.	Not used

Break-in operation is provided as the cathodes of both tubes are opened by the key. A key-thump and key-click filter are included in the complete transmitter layout. (See Fig. 1.)

After the "Longfeller" (wooden version) was completed a tally of the costs showed that all parts for the complete transmitter and power supply (with all tubes, a \$2.80 crystal, one coil and an inexpensive key) could be purchased at amateur net prices for approximately \$26.00. Standard components were used throughout. The quality and type of components used permits their re-use in a future and possibly more elaborate transmitter. The metal-chassis unit would cost a couple of dollars more.

- C₁, C₃ — .002- μ fd. mica.
- C₂ — 47- μ fd. mica.
- C₄ — 470- μ fd. mica.
- C₅, C₆, C₇ — 220- μ fd. mica.
- C₈ — .001- μ fd. mica.
- C₉, C₁₀ — 220- μ fd. variable.
- C₁₁, C₁₂ — 16- μ fd. 475-volt electrolytic.
- C₁₃ — 1.0- μ fd. 400-volt paper.
- C₁₄ — 0.5- μ fd. 400-volt paper.
- R₁, R₃ — 47,000 ohms, 1 watt.
- R₂, R₆ — 0.1 megohm, 1 watt.
- R₄ — 22,000 ohms, 1/2 watt.
- R₅, R₁₀ — 330 ohms, 1 watt.
- R₇, R₈ — 15,000 ohms, 2 watts.
- R₉ — 20,000-ohm 10-watt wirewound.
- L₁ — Tank coil for 3.5- or 7-Mc. band depending on output frequency desired.
 - 3.5 Mc. — 32 turns No. 20 enam., 1 1/2-inches long.
 - 7.0 Mc. — 16 turns No. 20 enam., 1 1/2-inches long.
 Both coils are wound on 5-prong Hammarlund coil forms, 1 1/2 inches in diameter. Manufactured coils (five-prong 80- and 40-meter "End-link") may be used.
- L₂ — Filter choke, 10 henrys, 130 ma., 100 ohms (Stancor C-2303).
- I₁ — 60-ma. 2-volt pilot lamp.
- P₁ — Chassis-mounted power plug, five prong.
- P₂ — Power-cable socket, five prong.
- P₃ — A.c. line-cord plug.
- RFC — 2.5-mh. r.f. chokes.
- T — Power transformer. 350 volts each side of center-tap; rectifier filament winding, 5 volts, 3 amperes; r.f. filament winding, 6.3 volts, 4.5 amperes (Stancor P-4080).
- V₁ — 6V6G or metal equivalent.
- V₂ — 6V6G or 6L6G or metal equivalent.
- V₃ — Rectifier tube, Type 80.

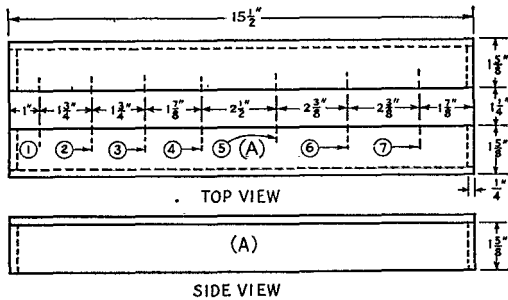

Fig. 2 — Working plan of the wooden chassis for the transmitter. (The chassis for the power supply is constructed in the same manner, and its dimensions are the same except for the length, which is 9 1/2 inches instead of 15 1/2 inches.)

The functions (and direction of the socket key) of the various top-chassis-mounted components are:

- 1 — Male power plug, key toward left end of chassis.
- 2 — Crystal socket, key toward front of chassis.
- 3 — Oscillator V_1 , tube socket, key toward right end of chassis.
- 4 — Output tube, V_2 , socket, key toward front of chassis.
- 5 — Tuning condenser, C_9 .
- 6 — Coil socket, key toward left end of chassis.
- 7 — Loading condenser, C_{10} .

Chassis Construction

The wooden chassis was made from pieces cut from a length of $\frac{1}{4} \times 1\frac{5}{8}$ -inch white-pine strip, known locally as "lattice stripping." It cost 2 1/2 cents per linear foot. The width of this stripping varies but this does not affect the construction of the chassis provided the lattice is at least $1\frac{1}{4}$ -inch wide. The only critical dimension on either the transmitter or power-supply chassis is the spacing which should be the exact width required to clear the holding ring of a tube socket. For the sockets used, this dimension is $1\frac{1}{4}$ inches.

To make the transmitter chassis, four pieces $15\frac{1}{2}$ -inches long were cut for the top, front and back sides (Detail A in Fig. 2). Two more pieces were cut 4 inches long to make the ends (Detail B in Fig. 2). These pieces were nailed together, using 1-inch wire brads, to form a frame with an open space running the length of the top, leaving just enough room between the top-inside edges to place the tube sockets crosswise on the chassis. (See Fig. 2.)

The power-supply chassis was made in the same manner, using $9\frac{1}{2}$ -inch sides and top strips (Detail A) and 4-inch end pieces (Detail B).

After assembly, the chassis were given several coats of grey lacquer.

Assembly and Wiring

Fig. 2 shows the center-line spacing for the various components mounted on top of the chassis. Thin $\frac{1}{2}$ -inch round-headed wood screws fasten the sockets to the strips. The variable condensers were mounted with $\frac{6}{32}$ machine screws inserted from underneath the top strip, and shimmed with small pieces of wood cut to shape. (See the photograph for a close-up view.) Fig. 2 also includes the function of each chassis-mounted device. A 5-prong male chassis plug was used on the transmitter to permit an enclosed (female) receptacle on the end of the power cable, in line with the ARRL Safety Code. An octal socket was installed for use with the $\frac{3}{8}$ -inch-spaced crystal holders.

After fastening the sockets and condensers in place, the wiring was begun. A bare bus wire was placed in first and connected to power-plug Pins 4 and 5, to form a "ground" along the chassis. The "hot" filament wires were run in next. Bypass condensers were placed in position and connected between their respective socket lugs and the ground wire. Starting with crystal-socket Pins 1 and 3, the various circuits were wired progressively to the right. Tie-points were used to advantage as shown in the photographs. The r.f.

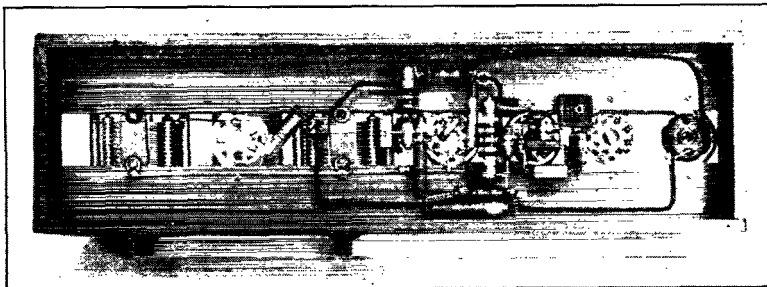

Looking underneath the "Longfeller." That "clean" look is attributable to careful arrangement of components and leads. Machine screws (shimmed by small blocks of wood, whittled to size) hold the variable condensers in place. The pilot-lamp bulb is located in a protected position where it can be seen but not touched, as there is 350-volts d.c. on its terminals. The ground bus bar extends from the power-supply socket across the chassis and connects to the frame of the loading condenser. All ground connections are made to this bus bar. The right-hand r.f. choke is in the plate circuit of the oscillator tube and the choke on the left is in the plate feed to the output tube. Components are grouped around their respective sockets for convenience and for short r.f. connections.

leads connected to the grids and plates were kept short and direct. Resistors carrying d.c. were arranged to place them in suitable locations and avoid crowding. Unused tube-socket pins were not used as tie points, thus avoiding complication and difficulty in servicing the unit.

The wiring around the tubes was placed first. The r.f. output circuit was then completed using bare tinned wire. The pilot-light bracket was mounted on an insulated tie-point and connected between the cold end of the r.f. choke in the output tube's plate circuit and B+. A 60-ma. 2-volt pilot bulb serves as the plate-current indicator for the output tube.

By placing the coil socket as shown (with Pin 3 towards the right end of the chassis) the r.f. leads are short and the link winding on the coil is at the "cold end" of the circuit, if desired for use with a low-impedance line.

The *stators* (fixed plates) of the two variable condensers, C_9 and C_{10} , are connected to the tank coil, L_1 , and the *rotors* (frames) are grounded to the common-ground bus.

A Fahenstock clip is fastened to the stator of the antenna loading condenser C_{10} for an antenna connection. Another such clip is fastened to the frame of this condenser for a ground connection.

Key-Thump and Key-Click Filter

A key-thump filter, shown in Fig. 1 and in the photograph, was made up on small pieces of the lattice strip for installation directly at the key. On-the-air tests revealed that more effective thump and click elimination was obtained by connecting the filter right at the key and not in

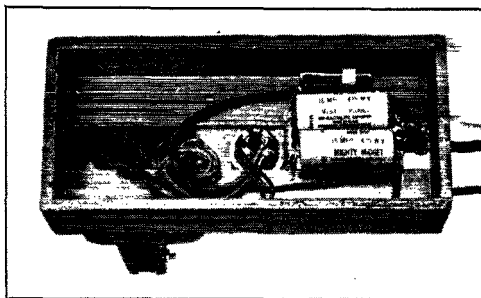

There's nothing much to the underside of the power supply, just a pair of electrolytic condensers and a wire-wound bleeder resistor. The leads of the transformer were curled up to eliminate cutting them short, just in case they should be needed "next time." The cable connecting the power supply to the transmitter is terminated on an insulated tie-point strip.

No — the transformer does not normally hang in midair. We wanted you to be able to read the labels on the electrolytics without standing on your head!

the transmitter. The *ground* side of the filter circuit should be connected to the *frame* of the key. The values used in this filter were found after a series of tests with various circuit combinations, using the "Longfeller" and a broadcast receiver under actual operating conditions. As a result, keying is clean and free from clicks.

Power Supply

The power supply includes a broadcast replacement-type transformer (350 volts each side of center plus 5- and 6.3-volt filament windings) and a condenser-input filter circuit comprised of a 10-henry choke and two 16- μ fd. 475-volt

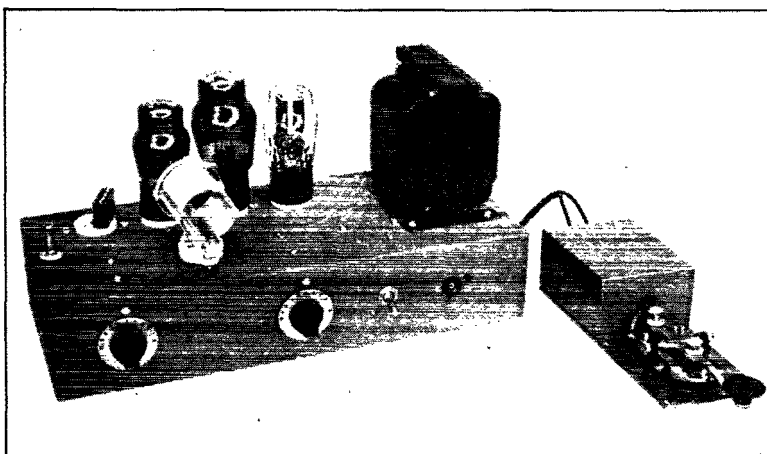

The complete metal "Longfeller" with dials and everything. This transmitter and associated units incorporate the same circuit and group of components as those included in the original wooden "Longfeller" but it has a few added conveniences. The key and its shielded filter are mounted on a sheet of aluminum which may be screwed to the operating table. The pilot lamp protruding from the chassis (through a rubber grommet) serves as an output-tube plate-current indicator. The toggle switch is the on-off control in the a.c. line. The insulated antenna binding post stands out like a miniature "lighthouse in the fog." Fahenstock clips (not shown) on the rear apron serve as ground and key connections.

electrolytic condensers. A 20,000-ohm wire-wound 10-watt bleeder resistor was used. Approximately 350-volts d.c. is available with a load of from 50 to 60 ma. on the output tube.

Bench-Testing the Transmitter

After the unit was completely wired, two 6V6G tubes, a crystal and a coil were inserted in their respective sockets. As 3.5-Mc.-band output was desired, both coil and crystal were chosen for that frequency. The loading condenser, C_{10} , was turned so that it was completely meshed and the tuning condenser C_9 was set about one-third in. The line cord was plugged in and after a 30-second wait for the tube filaments to heat the key was closed. Fortunately, no wiring errors had been made and the pilot light glowed at about half brilliancy indicating that the output 6V6 plate was drawing current. Rotating the tuning condenser C_9 tuned the plate circuit to resonance and the pilot bulb went out indicating the normal condition of a low value of plate current.

A "loop and a lamp" was then made up, consisting of a pilot-lamp socket connected in parallel with a one-turn coil about 2 inches in diameter. A 6-8-volt 0.250-amp. bulb was inserted in the socket and this absorption loop placed near the transmitter tank coil. Maximum brilliancy of this absorption-loop lamp was obtained when the plate circuit was in resonance and loose coupling was required to prevent burning out the pick-up lamp. About one-third of the capacity of C_9 was required to hit resonance on the 3.5-Mc. band.

A long-wire antenna was connected to the antenna post and a ground connection made to the frame of the loading condenser. By adjusting the

loading condenser C_{10} and then resonating the circuit by means of the tuning condenser, C_9 , a point was reached where only a slight dimming of the plate-current lamp was noticed. As the loading-condenser capacity is *decreased* (plates unmeshed) the loading is increased. If the circuit is loaded too heavily (indicated when the bulb will not dim on resonance) *increasing* the capacity of the loading condenser slightly will reduce the loading on the circuit. A pilot lamp (6-8 volts, 0.250 amp.) may be inserted in series with the antenna and the loading and tuning condensers adjusted to give maximum brilliancy of this lamp, indicating that maximum antenna current is being obtained. It is wise to disconnect this test lamp after the antenna has been tuned.

Both 6V6s and 6L6s and their glass equivalents were tried in the "Longfeller's" output stage. The 6L6s gave more output. Either a glass or a metal 6V6 worked well as an oscillator.

Harmonic Operation

Tests were made using 3.5-Mc. crystals with a 7-Mc. coil and slightly-less output was obtained on the second harmonic. 7-Mc. crystals and coils gave good output on the fundamental but when a 14-Mc. coil was used, the 7-Mc. crystals gave good output performance but with a slight chirp in the signal. The operation of the "Longfeller" on harmonics above the 7000-7300 band requires critical adjustment of the tuning and loading condensers. Also, an absorption wavemeter is required to determine to which harmonic the output is tuned. Therefore, operation above 7300 kc. is *not* recommended. However, the unit was intended primarily for operation on either the 3.5- or 7-Mc. c.w. bands, and it does that with excellent results.

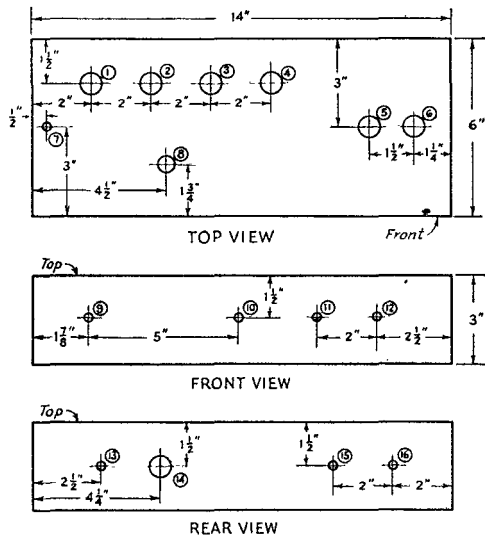
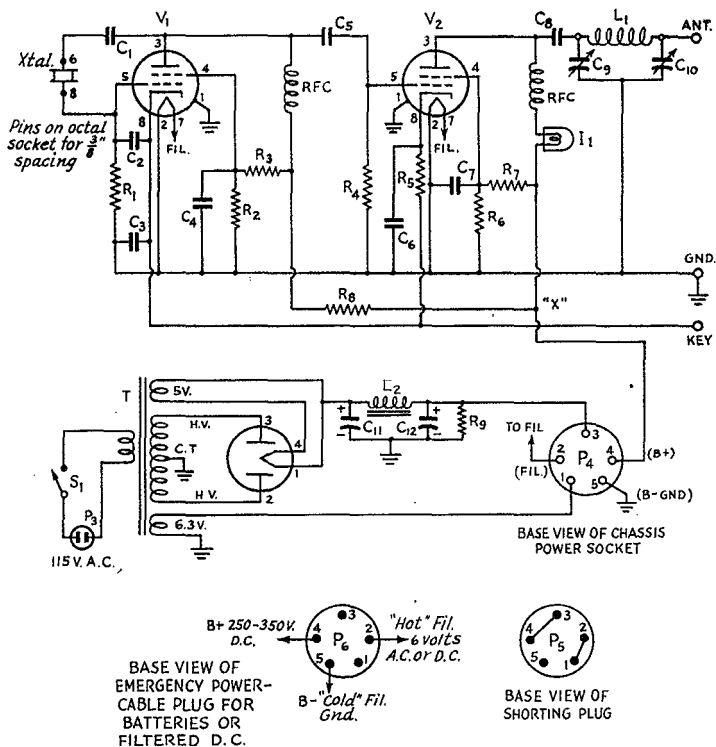

Fig. 3 — Working plan of the layout of the 6 x 14 x 3-inch metal chassis for the complete transmitter and power supply.

The function (and direction of the socket key) and the location of the various holes are shown. Diameters are not given as they will vary with components.

- 1 — Crystal socket, key toward front of chassis.
- 2 — Oscillator tube, V_1 , socket, key toward right end of chassis.
- 3 — Output tube, V_2 , socket, key toward front of chassis.
- 4 — Rectifier tube, V_3 , socket, key toward front of chassis.
- 5-6 — Clearance holes for leads from power transformer.
- 7 — Antenna post, insulated bushing.
- 8 — Coil, L_1 , socket, key toward left end of chassis.
- 9 — Loading condenser, C_{10} , shaft-clearance hole.
- 10 — Tuning condenser, C_9 , shaft-clearance hole.
- 11 — A.c. on-off switch, S_1 .
- 12 — Clearance hole for pilot lamp used as plate meter (in grommet).
- 13 — Clearance hole for a.c. cord, in grommet.
- 14 — Socket for connection of transmitter to external source of filament and plate power.
- 15 — Ground connection.
- 16 — Key connection, insulated bushing.

Fig. 4 — Schematic diagram of the metal "Longfeller" — a two-stage beginner's transmitter and its associated power supply built on a single metal chassis. Components are the same as for the wooden version except for the wiring arrangement of the power socket, P_4 , and its associated plugs, P_5 and P_6 . An a.c. on-off switch, S_1 , has since been added to this metal unit.



Voltages and Currents

Measurements of plate and screen voltages and plate currents, taken under test, are as follows:

Crystal (Band)	Output (Band)	Tube (Amp.)	Plate Voltage	Plate Current (Loaded)	Screen Voltage
3.5 Mc.	3.5 Mc.	6V6G	380 v.	40 ma.*	220 v.
3.5 Mc.	3.5 Mc.	6L6G	350 v.	50 ma.	220 v.
3.5 Mc.	7.0 Mc.	6V6G	350 v.	50 ma.**	220 v.
3.5 Mc.	7.0 Mc.	6L6G	350 v.	60 ma.	220 v.
7.0 Mc.	7.0 Mc.	6V6G	350 v.	50 ma.***	220 v.
7.0 Mc.	7.0 Mc.	6L6G	350 v.	60 ma.	220 v.
		6V6G (osc.)	170 v.		90 v.

* 10 ma. unloaded. ** 20 ma. unloaded. *** 5 ma. unloaded.

The input (15 to 21 watts) varied with the type of tube and with frequency, depending on the loading of the output tube. In actual on-the-air use, about 15- to 18-watts input is normal with the transmitter properly loaded.

A Simple Antenna for the "Longfeller"

A simple easily-erected antenna for this transmitter is a "long wire," strung up as high as possible in the clear, and in as straight a line as the

area will permit.

This end-fed antenna should be a half-wave long on the 3.5-Mc. band and a full wave on 7.0 Mc., and should load properly and easily using the built-in antenna matching network.

The antenna should be put up so that the length of the lead-in and the "flat top" (either "straight out" or put up as an inverted-L) will be approximately 133 feet long over all.

The "Longfeller" on Metal

After the completion of the "Longfeller," a single-metal-chassis job was built using the same circuit and values of components but with the addition of a few refinements such as dials, an a.c. on-off switch, and a versatile socket-and-plug arrangement permitting the connection of an external source of power.

A 6 x 14 x 3-inch metal chassis was laid out and drilled and the components mounted as shown in Fig. 3. Drills and a socket punch were used to make the required holes. The dimensions shown may vary slightly with different components and are given merely to show a placement that worked out satisfactorily and one that may be used as a guide.

In wiring the metal "Longfeller," the power supply was connected up first, followed by progressive wiring of the r.f. stages and ending with the tank-coil circuit connection to the antenna

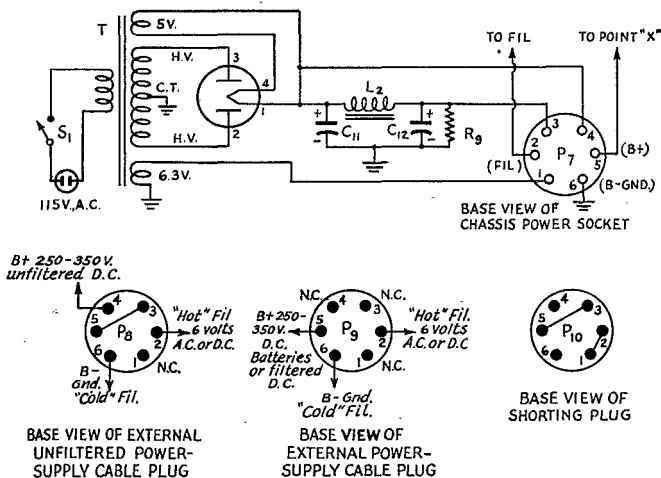

Fig. 5 — Modified schematic diagram of the power supply for the metal-chassis beginner's transmitter. Components are the same as in Fig. 1, except for the power connector P_7 (a six-prong socket) and P_8 , P_9 and P_{10} (six-prong plugs), connected as shown. The lead marked "to point X" connects to the junction of R_7 and R_8 , marked "X" in Fig. 4.

post. The complete circuit of the metal-chassis transmitter is shown in Fig. 4.

Soldering lugs were placed under many of the nuts holding down the sockets and were used to ground the components where necessary. Insulated tie-points were placed for proper and convenient location of parts.

The pilot lamp used as a plate-current indicator was connected to flexible leads and terminated on an insulated tie-point. This permits the ready availability of this inexpensive "hermetically-sealed vacuum-type current indicator."

A key-thump and key-click filter complete with key was built-up on a metal base. The circuit and components are the same as for the key filter in Fig. 1.

The metal "Longfeller" performed exactly like its wooden cousin and was immediately put on the air connected to a random hunk of wire running from the lab to another part of the building. With W1LOP at the key, signing W1INF on 3750 kc., W2OEO was worked giving him the second contact of his newly-begun ham career.

Connections for Emergency Use of the Metal "Longfeller"

This unit was so arranged that, by the removal of the plug on the rear apron of the chassis and the insertion of a five-prong plug attached to a source of filament power (6 volts) and a 250-350-volt d.c. plate supply, the transmitter could be

(Continued on page 126)

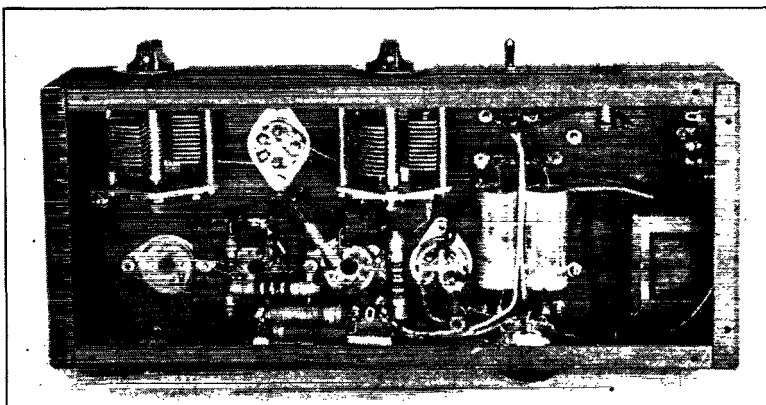

This "below-deck" view of the metal "Longfeller" depicts many of the components and most of the construction features. The black object on the outside of the lower apron of the chassis is the shorting plug in the power-supply socket. At the lower left can just be seen the "hot" connection to the key. The pilot lamp, connected by flexible leads to an insulated tie-point, is located near, but not connected to (as it appears) the a.c. "on-off" switch. The r.f. output circuit features short direct leads, ending in the insulated antenna binding post at the right of the photograph.

As r.f. and power-supply components are contained in this single chassis, it may appear more complicated than the wooden version. Actually, each section is separated physically for easier assembly, connection and servicing.

Happenings of the Month

BOARD MEETING

The first postwar meeting of the ARRL Board of Directors was a cram-packed all-day session at West Hartford on May 10th with every director present — and with the League's other officers and the Board's technical and legal experts in attendance as aides. Preparatory to this first postwar meeting, Board committees had been at work making studies and each director had visited clubs and hamfests in his division to collect amateur opinion. It was a very busy meeting in which a lot was accomplished, as you may see from the minutes. Prior to the meeting the directors had inspected the headquarters offices and WIAW and had received studies and recommendations from some of their committees.

(except 430-450 Mc.), our regulations revised, new licensing moving smoothly, prospects for good news on "40 and 20" about the time you read this, and a good outlook for the proposed new 15-meter band. The Board made a particularly careful examination of our 160-meter position and reviewed and reaffirmed its instructions to the officers in that respect. It ordered that a full account be prepared for *QST*, for your information, on the position that we take and what we are doing about it — see editorial page. It reaffirmed its grant of special powers to the President and its open authorization to him of \$10,000 for the protection of amateur frequencies.

Your chief interest undoubtedly lies in learning what requests the Board made of the Federal



GEORGE W. BAILEY, W1KH
Relected President



J. LINCOLN McCARGAR, W6EY
New Vice-President

At the meeting the Board received other reports and quickly cleared its decks for "new business" by walking rapidly through the matter of acceptances, ratifications and appropriations. The latter heading, by the way, includes a new appropriation that will make possible the attendance of SCMs and QSL Managers at divisional conventions and will send the SCMs to organization meetings throughout their sections.

The Board heard up-to-the-minute reports on our frequency position and made a thorough examination. We have come a long way in the past year, with all of "80" restored (except in K6 and west) and all our frequencies above 25 Mc. open

Communications Commission for changes in the amateur regulations. A Regulations Committee, under Director Norwine's chairmanship, had been studying these problems since V-J Day and made numerous recommendations in its report. Other studies and surveys had also been made, and each director came armed with data on his own members' wishes. As is traditional in our Board meetings, these subjects occupied the major portion of the Board's time; and as is also traditional, they were not only eventually decided but were reviewed and redecided. While the minutes report only the formal actions taken, these topics were the subjects of long hours of examination and

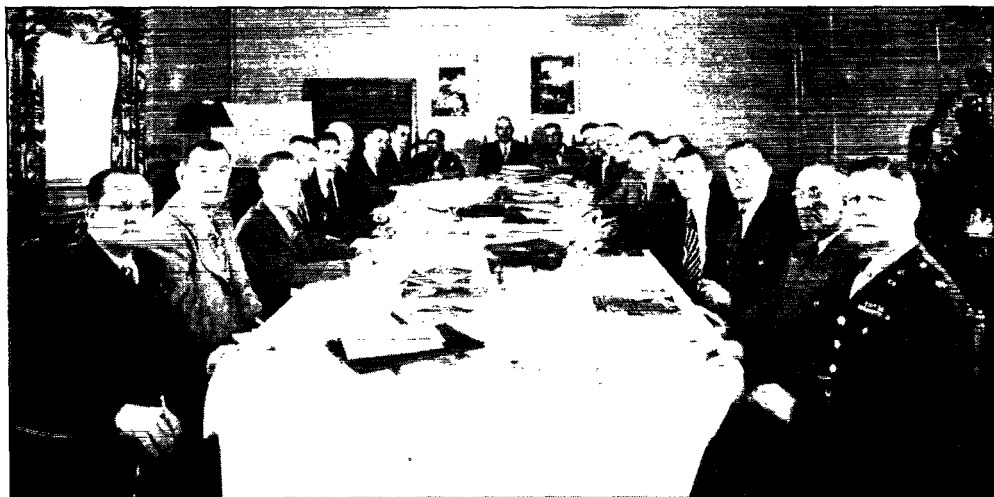

What an ARRL Board meeting looks like. In this picture many of the heads overlap but here are their names, left to right: Messrs. Shelton, Davis, Groves, Acton, Markwell, Weingarten, Handy, Norwine, Segal, Bailey, Warner, Huntoon, Raser, Houghton, Reid, Kiener, Noble, Kirkman, McCargar, Bickel, Caveness.

debate. Here are the decisions:

The League will ask for no changes in the Class A, B and C licensing arrangement. There was a proposal to recommend a relaxation in the Class A license requirements, on the basis that they had outlived their usefulness, but it was defeated.

The League will ask FCC to set up a new Class D license, to be good only on frequencies above 200 Mc., and to consist of the same examination as Class B-C except for the code test; and to be so arranged that it can be endorsed for Class B privileges when the code test is taken. The purpose is not to relax our standards and "let in the butcher boys" but on the contrary to recognize that amateur radio needs the skill of the war-trained u.h.f. and s.h.f. technicians to help develop our microwave assignments. It is intended to be simply realistic in recognizing that code is practically never used on such frequencies. It is felt that many highly-skilled technical people would be deterred from entering amateur radio by the need to get up a code speed of 13 words per minute which they would never use in development work on such frequencies; and the way would be left open for them to qualify for lower frequencies at any future date.

The League requests the Commission to expand the 75-meter 'phone band to 3850-4000 kc. as soon as possible. There was considerable effort made by some directors to extend the band down to 3750 or 3800, but 3850 won out as the figure.

The League requests FCC to open 7200-7300 kc. to 'phone operation by all amateurs (B-C as well as Class A) as soon as all of the 40-meter band is returned to us. Say late this year.

Similarly, FCC is requested to expand and move the 20-meter Class A 'phone band so that,

after all of the band is returned to us, the upper half of 14,200-14,400 kc. will be available for voice operation, Class A only.

It is requested that the exclusively-c.w. frequencies at the low end of the 10-meter band be expanded to read 28,000-28,500 kc. We had it that way up to 1940 and then dropped the figure to 28,100 after the foreigners went off the air and when there was not much 'phone activity in the band. Now, on good days, foreign 'phones have small chance to get through our own 'phone QRM, and the restoration of the old figure of 28.5 Mc. will make it possible for them to get through to us well on frequencies just below our own 'phone band.

The Board also requested FCC to rescind its recent prohibition of the use of the names of countries, states and cities as phonetic aids in the identification of 'phone calls.

Further on 'phone matters, the Board requested its Canadian General Manager to secure uniformity in the Canadian 'phone regulations to conform with those of the United States. . . . Although, to protect our legal position, every amateur frequency must be open to c.w. work, the Board went on record as opposing any unnecessary c.w. operation in the 'phone sub-assignments. . . . To promote the economical use of available 'phone frequencies, the Board ordered an educational program in good operating practices and in good technical practices calculated to minimize the required channel width.

On the administrative side, the Board rejected a proposal to rearrange ARRL divisions to accord with the new call areas but committed the subject to its Planning Committee for further study and a report next year. It did, however, arrange to di-

vide the too-large Central Division, so that, effective the first of next year, the Central becomes the W9 call area of Illinois, Indiana and Wisconsin, and a new Great Lakes Division comes into existence consisting of the states of Ohio, Michigan and Kentucky. The elections this coming autumn will be in terms of these new divisions.

The Philippine Islands finally achieving independence on July 4th and thereby becoming a "foreign country," the by-laws were amended to change them from being an actual part of our Pacific Division on that date but continuing our Communications Department relations with them by attaching them to the Pacific Division for communication purposes—precisely in the relationship that exists between Cuba and our Southeastern Division.

We shall have a national convention in the late summer of 1947 at Chicago! Not this year but next year. Subject to the negotiation of a satisfactory contract, the Chicago Area Radio Club Council, sponsors of our bang-up nationals of the past, were authorized to throw another one around Labor Day of 1947. Start saving your pennies!

The Board set up a Building Fund of \$150,000 for the eventual construction of a modern head-

quarters establishment for the League. By the present looks of things, this is still a good many years away. . . . Tens of thousands of unclaimed prewar QSL cards encumber the files of the QSL managers. The Board authorized their destruction after this year if not claimed by then. . . . There are numerous other smaller actions of which you can learn by reading the minutes and which will gradually find their way into our affairs.

The concluding acts of the Board were the election of president and vice-president. George W. Bailey, W1KH, our president since 1940, was unanimously reelected for another two years, the only candidate. For vice-president the Board chose J. Lincoln McCargar, W6EY, who since the first of 1938 has been the director from the Pacific Division. Automatically resigning the latter post, a special election is being called to choose his successor. Vice-President McCargar has been an amateur since 1911 and active in amateur affairs in the Bay Counties for many years. Railroadng with Southern Pacific, he is an expert in freight rates; and his early railroadng gave him Morse as well as Continental. During World War I he was a Chief Radioman in the Navy, being the chief in charge of radio on the



The 1946 Board meeting has its picture taken. Front row, standing, left to right: Directors Caveness, W4DW; Kirkman, W2DSY; Bailey, W1KH, Chairman; Norwine, W9EFC; Markwell, W9TFP. Back two rows, named together left to right: Directors Weingarten, W7BG; Raser, W3ZI; Noble, W1BVR; Groves, W5NW; Acton, W5BMM; McCargar, W6EY; Reid, VE2BE; Davis, W9VVA; Atlantic Alternate Brotherson, W8BHN; Kiener, W8AVH; Bickel, W6BKY; Shelton, W4ASR. Seated, left to right: Secretary Warner, W1EH; Communications Manager Handy, W1BDI; General Counsel Segal; Treasurer Houghton; Assistant Secretary Huntoon, W1LVQ.

OFFICERS' REPORTS AVAILABLE TO MEMBERS

• In April of each year the officers of the League make comprehensive written reports to the directors. The Board of Directors has made these reports available to the membership of the League. Interested members may obtain copies postpaid at the cost price of 50 cents per copy. Address the Secretary at West Hartford.

U.S.S. *George Washington* during one of President Wilson's peace trips to France. A member of the League since almost its beginning, he is also a director of the Oakland Radio Club.

The minutes will be found at the end of this department.

SPECIAL ELECTION NOTICE

To All Full Members of The American Radio Relay League Residing in the Pacific Division:

You are hereby notified that a special election is about to be held in the Pacific Division to elect a new director to succeed J. Lincoln McCargar, W6EY, who has resigned to accept the vice-presidency of the League. He continues in his duties as director until his successor is chosen. The election will be for the unexpired remainder of the 1946-1947 term. Your attention is invited to Sec. 1 of Article IV of the Constitution, providing for the government of ARRL by a board of directors; Sec. 2 of Article IV, and By-Law 12, defining their eligibility; and By-Laws 13 to 24, providing for the nomination and election of division directors. Copy of the Constitution & By-Laws will be mailed to any member upon request.

Voting will take place between September 1 and October 20, 1946, on ballots that will be mailed from the headquarters office in the first week of September.

Nomination is by petition. Nominating petitions are hereby solicited. Ten or more Full Members of the League in the Pacific Division may join in nominating any Full Member of the League residing in that division as a candidate for director therefrom. The following form is suggested:

Executive Committee

*The American Radio Relay League
West Hartford, Conn.*

We, the undersigned Full Members of the ARRL residing in the Pacific Division, hereby nominate of as a candidate for director from this division for the remainder of the 1946-1947 term.

(Signatures and addresses)

The signers must be Full Members in good standing. The nominee must be a Full Member and must have been both a member of the League and a licensed radio amateur operator for a continuous term of at least four years immediately preceding receipt by the Secretary of his petition of nomination, except that a lapse of not to exceed ninety days in the renewal of the operator license and a lapse of not to exceed thirty days in the renewal of membership in the League, at any expiration of either during the four-year period, will not disqualify the candidate; provided that if a candidate's membership has been interrupted by reason of service in the armed forces of the United States, he shall not be deemed to be disqualified so far as concerns continuity of membership if he has, since May 7, 1943, renewed his ARRL membership within ninety days of discharge from the military service. He must be without commercial radio connections: he may not be commercially engaged in the manufacture, selling or renting of radio apparatus normally capable of being used in radio communication or experimentation, nor commercially engaged in the publication of radio literature intended, in whole or part, for consumption by licensed radio amateurs. Further details concerning eligibility are given in By-Law 12. His complete name and address should be stated. All such petitions must be filed at the headquarters office of the League in West Hartford, Conn., by 11 A.M., EST, of the 20th day of August, 1946. There is no limit to the number of petitions that may be filed on behalf of a given candidate but no member shall append his signature to more than one such petition. To be valid, a petition must have the signature of at least ten Full Members in good standing; that is to say, ten or more Full Members must join in executing a single document; a candidate is not nominated by one petition bearing six signatures and another bearing four. Petitioners are urged to have an ample number of signatures, since nominators are frequently found not to be Full Members in good standing.

League members are classified as Full Members and Associate Members. Only those possessing certificates of Full Membership may nominate candidates, or stand as candidates; members holding certificates of Associate Membership are not eligible to either function.

This election provides the constitutional opportunity for members to put their representation in the hands of a member of their own choosing. Full Members are urged to take the initiative and file nominating petitions immediately.

For the Board of Directors:

K. B. WARNER,

Secretary

June 1, 1946

CANADIAN HAPPENINGS

During the time that our 80-meter band was only 3625-4000 kc., Canadian amateurs enjoyed the whole band but were limited to low power on the portion 3500-3625. And, until the whole band should be restored in the United States, the VE 'phone assignment was the same as the W-K one, 3900-4000. With the May restoration of the whole band in the United States, Canadian amateur radio resumed full prewar status. 'Phone is now authorized on 3800-4000 kc., and authorized power may be used throughout the range 3500-4000.

Walter A. Rush, veteran Controller of Radio of the Department of Transport at Ottawa, has recently retired, showered with honors for his accomplishments as the head administrator of Canadian radio affairs and with the gratitude of amateurs for the fair and sympathetic consideration he always gave their matters. He is succeeded by the deputy controller, G. C. W. Browne, who, during the period of Mr. Rush's retirement leave, will be known as Acting Controller of Radio. "Brownie" has handled most amateur matters in recent years, amongst his other duties, and amateurs may count on his continued understanding. He has the good wishes of us all for a successful administration.

ENGINEERS & TECHNICIANS WANTED

The marvelously-equipped Langley Memorial Aeronautical Laboratory of the National Advisory Committee for Aeronautics, at Langley Field, Hampton, Virginia, needs technicians and engineers for development work in instrumentation and electronics in a wide field covering the multitude of measurement problems arising in aerodynamic research. These are Civil Service positions of great interest to the experimenter, skilled mechanic and development engineer. One group of openings covers the application of electronic and radar techniques to the radio telemetering of test data from aircraft and pilotless missiles to ground. Another group is in the field of general instrument development, in which mechanical and electro-mechanical experience apply. In both groups, both engineering and laboratory help are required. There is plenty of opportunity for the individual to exercise his initiative in his work. Technicians should have had experience in construction, tests, calibration, installation, operation or maintenance, preferably on scientific or research instruments or on the more complex types of commercial equipment. Engineering positions require training and experience at least equivalent to a B.S. degree in electrical or mechanical engineering, but there are also some engineering-aide positions.

Civil Service application forms and additional information can be obtained from the clerk of the Civil Service Board at your local post office or direct from the Personnel Officer, National

Advisory Committee for Aeronautics, Langley Field.

NEW ALTERNATE DIRECTOR

Eugene H. Treadaway, W5DKR, of LaPlace, La., has been elected alternate director from the Delta Division for the remainder of the 1946-47 term in a special election to choose a successor to the late Samuel H. Dowell, W5ERV. There were three candidates, the results being as follows:

Mr. Treadaway	146 votes
James W. Watkins, W4FLS	125 votes
Jesse M. Hilton, W5IDK	69 votes

Mr. Treadaway, a toll test-board man for the Southern Bell Telephone & Telegraph Co., served two previous terms as Delta alternate and is the retiring ARRL SCM for Louisiana, a post in which he has several times served his members. He was also the first W5 QSL Manager. He is active both on the air and in New Orleans Club affairs.

NOTICE TO MEMBERS DISCHARGED FROM THE MILITARY SERVICES

ARRL by-laws provide that an amateur must be continuously a member of the League for at least the preceding four years to be an eligible candidate for director or alternate, and at least one year for SCM. They also normally provide that if a member falls in arrears in his dues for more than thirty days, his continuity of membership is broken. Your attention is invited to the fact that the by-laws were amended in 1943 on behalf of members serving in the armed forces of the United States and Canada. It is now provided that such a member, who becomes in arrears, will not make himself ineligible to hold League office, insofar as concerns a discontinuity of membership while he was in uniform, if he resumes his membership within ninety days after release from active military duty. All such persons are accordingly advised that if they will renew ARRL membership within ninety days following discharge they will be deemed to have had continuous membership during the period of their military service, so far as the requirement of continuity for office eligibility is concerned. Those desirous of taking advantage of this arrangement are asked to claim the right when renewing membership, stating the beginning and ending dates of military service.

BOARD MEETING MINUTES

MINUTES OF 1946 ANNUAL MEETING OF THE BOARD OF DIRECTORS, AMERICAN RADIO RELAY LEAGUE

May 10, 1946

Pursuant to due notice and the requirements of the by-laws, the Board of Directors of the American Radio Relay

League, Inc., met in regular annual session at the Hartford Golf Club, West Hartford, Conn., on May 10, 1946. The meeting was called to order at 9:30 A.M., Eastern Daylight Saving Time, with President George W. Bailey in the chair and the following other directors present:

Alexander Reid, Canadian General Manager
 George S. Acton, Delta Division
 John E. Bickel, Southwestern Division
 Hugh L. Caveness, Roanoke Division
 Tom E. Davis, Dakota Division
 Wayland M. Groves, West Gulf Division
 John A. Kiener, Central Division
 Robert A. Kirkman, Hudson Division
 Howard R. Markwell, Rocky Mountain Division
 (acting)

J. Lincoln McCargar, Pacific Division
 Percy C. Noble, New England Division
 Floyd E. Norwine, jr., Midwest Division
 Edward G. Raser, Atlantic Division
 William C. Shelton, Southeastern Division
 Karl W. Weingarten, Northwestern Division

Also in attendance, at the invitation of the Board as a nonparticipating observer, was Atlantic Division Alternate Director J. Victor Brotherson. There were also present Technical Director George Grammer, Communications Manager Francis E. Handy, Treasurer David H. Houghton, Assistant Secretary John Huntoon, General Counsel Paul M. Segal, and Secretary & General Manager K. B. Warner.

The meeting first stood in silent tribute to the memory of two recently-deceased directors, Vice-President Charles E. Blalack and Rocky Mountain Division Director C. Raymond Stedman. It was then welcomed and briefly addressed by President Bailey.

Moved, by Mr. Kirkman, that the Board proceed now to examine the desirability of amending the rules of order. But there was no second, so the motion was lost.

On motion of Mr. Norwine, unanimously VOTED that the minutes of the 1945 annual meeting of the Board of Directors are approved in the form in which they were issued by the Secretary.

On motion of Mr. Kirkman, unanimously VOTED that the annual reports of the officers to the Board of Directors are accepted and the same placed on file.

On motion of Mr. Weingarten, unanimously VOTED that the Board, having examined its mail action by which it amended its pending proposal before the Federal Communications Commission in the matter of amateur call areas as presented in Secretary's Letter No. 619, and having examined the same, now ratifies the action taken and decides to take this position as of July 6, 1945.

On motion of Mr. McCargar, unanimously VOTED that the Board, having examined its mail action by which it set Communications Manager Handy's salary at \$7500 per year, effective November 1, 1945, and having examined the same, now ratifies the action taken and decides to take this position as of November 19, 1945.

On motion of Mr. Reid, unanimously VOTED that the Board, having examined its mail action by which it ordered the election of Section Communications Managers in Canada, and having examined the same, now ratifies the action taken and decides to take this position as of February 4, 1946.

On motion of Mr. Davis, VOTED that all acts performed and all things done by the Executive Committee since the last meeting of the Board, and by it reported to the Board, are ratified and confirmed by the Board as the actions of the Board. Mr. Kirkman voted opposed and asked to be so recorded.

At Mr. Reid's request, without objection, the submission of the report of the Finance Committee was ORDERED put over until later in the day.

Mr. Norwine reported for the Planning Committee, stating that they had nothing more to report than had already been transmitted to the Board. On motion of Mr. Bickel, unanimously VOTED to accept the report.

Mr. Norwine reported for the Regulations Committee, stating that they had nothing more to report than had already been transmitted to the Board. On motion of Mr. Kiener, unanimously VOTED to accept the report.

ARE YOU LICENSED?

• When joining the League or renewing your membership, it is important that you show whether you have an amateur license, either station or operator. Please state your call and/or the class of operator license held, that we may verify your classification.

On motion of Mr. Caveness, unanimously VOTED that the annual reports of the directors to the Board of Directors are accepted and the same placed on file.

On motion of Mr. Bickel, unanimously VOTED that the consideration of miscellaneous motions originated by directors shall go over until after the consideration of the recommendations of the Regulations Committee.

On motion of Mr. Shelton, unanimously VOTED that there is hereby appropriated from the League, as of this date, the sum of four thousand dollars (\$4000), for the purpose of defraying the expenses of holding this meeting of the Board of Directors, any unexpended remainder of same to be restored to surplus.

On motion of Mr. Caveness, unanimously VOTED that there is hereby appropriated from the surplus of the League, as of January 1, 1947, the sum of three thousand seven hundred dollars (\$3700), for the legitimate administrative expenses of the directors in the calendar year 1947, said amount allocated as follows:

Canadian General Manager.....	\$ 150
Atlantic Division Director.....	200
Central Division Director.....	400
Dakota Division Director.....	200
Delta Division Director.....	300
Hudson Division Director.....	300
Midwest Division Director.....	250
New England Division Director.....	200
Northwestern Division Director.....	200
Pacific Division Director.....	250
Roanoke Division Director.....	150
Rocky Mountain Division Director.....	250
Southeastern Division Director.....	200
Southwestern Division Director.....	250
West Gulf Division Director.....	400

\$3,700

any unexpended remainders of these funds at the end of the year 1947 to be restored to surplus.

On motion of Mr. Davis, unanimously VOTED that the sum of two hundred dollars (\$200) is hereby appropriated from the surplus of the League, as of this date, for the expenses of the Finance Committee, any unexpended remainder of same on the date of the next annual meeting of the Board to be returned to surplus.

On motion of Mr. Weingarten, unanimously VOTED that the sum of two thousand dollars (\$2000) is hereby appropriated from the surplus of the League, as of this date, for the purpose of defraying the traveling expenses of the Section Communications Managers and QSL Managers of the League, in the period between May 1, 1946, and the date of the next annual meeting of the Board, as follows: (1) Within the continental limits of the United States and Canada, SCMs to attend one official ARRL convention within their respective divisions. (2) Within ARRL sections in the continental limits of the United States and Canada, SCMs to attend in their own section, in addition to the above, not more than five major ARRL organization meetings per year, to include hamfests only if sponsors schedule an ARRL organization meeting. The SCM shall have the option of giving written approval to the attendance of his Section Emergency Coördinator at such a meeting, in his stead. In exceptional cases, with the written approval of both the Director and Communications Manager, attendance may be

authorized for some other designated appointee as representative of the SCM. (3) Within the continental limits of the United States and Canada, QSL Managers of the League to attend one official ARRL convention within their respective call areas, provided such convention be held within 500 miles of the QSL Manager's residence. And it is further VOTED that reimbursement shall be made in all the above at the rate of five cents a mile via the shortest commonly-traveled route. In (1) and (3) expenses may include one night's hotel accommodation at actual cost but not to exceed four dollars, and the convention registration fee. All allowances for expenses shall be subject to approval by the Communications Manager in the case of the SCMs, and by the Secretary in the case of the QSL Managers, of a report submitted with the itemized request for reimbursement, covering the representation of ARRL accomplished, the attendance at an organization meeting, discussion, questions, recommendations, or QSLs distributed, etc., by the individual attending the meeting. At the end of the designated period any unexpended remainder of this appropriation shall be restored to surplus.

Moved, by Mr. Noble, that By-Laws 5 and 22 be amended to read respectively as follows:

5. For administrative purposes the United States & Possessions and the Dominion of Canada shall be partitioned into divisions as follows:

(a) In the United States and Possessions —

(1) Until noon of January 1, 1948: ATLANTIC DIVISION, those portions of the states of New York and New Jersey . . . (Etc., as now, without change.)

(2) Effective at noon of January 1, 1948, and also for the purpose of 1947 elections to choose directors whose terms of office begin January 1, 1948: ATLANTIC DIVISION, the states of Delaware, Maryland and Pennsylvania and the District of Columbia; CENTRAL DIVISION, the states of Illinois, Indiana and Wisconsin; GREAT LAKES DIVISION, the states of Michigan, Ohio and West Virginia; HUDSON DIVISION, the states of New Jersey and New York; MIDWEST DIVISION, the states of Colorado, Iowa, Kansas, Minnesota, Missouri, Nebraska, North Dakota and South Dakota; NEW ENGLAND DIVISION, the states of Connecticut, Maine, Massachusetts, New Hampshire, Rhode Island and Vermont; PACIFIC DIVISION, the state of California, the territory of Hawaii, the Philippine Islands, and the United States Possessions in the Pacific except those adjacent to Alaska; SOUTHEASTERN DIVISION, the states of Alabama, Florida, Georgia, Kentucky, North Carolina, South Carolina, Tennessee and Virginia, and the United States Possessions in the Caribbean; WESTERN DIVISION, the states of Arizona, Idaho, Montana, Nevada, Oregon, Utah, Washington and Wyoming, and the territory of Alaska and United States Possessions adjacent thereto; WEST GULF DIVISION, the states of Arkansas, Louisiana, Mississippi, New Mexico, Oklahoma and Texas.

(b) In the Dominion of Canada — MARITIME DIVISION, the provinces of Nova Scotia . . . (Etc., as now, without change.)

22. (a) In the year 1946 a Director shall be elected in each of the following divisions, as defined in Paragraph (a) (1) of By-Law 5, to serve for a term of one year or until a successor is duly elected and qualified: Central, Hudson, New England, Northwestern, Roanoke, Rocky Mountain, Southwestern and West Gulf.

(b) In the year 1947 a Director shall be elected in each of the following divisions, as defined in Paragraph (a) (2) of By-Law 5: For a term of one year, or until a successor is duly elected and qualified, in the Great Lakes, Hudson, Midwest, Pacific and Southeastern. For a term of two years, or until a successor is duly elected and qualified, in the Atlantic, Central, New England, Western and West Gulf.

(c) In the year 1948 and in each even-numbered year thereafter a director shall be elected in each of the following divisions, as defined in Paragraph (a) (2) of By-

Law 5, for a term of two years or until a successor is duly elected and qualified: Great Lakes, Hudson, Midwest, Pacific, and Southeastern. In the year 1949 and in each odd-numbered year thereafter a director shall be elected in each of the following divisions, as defined in Paragraph (a) (2) of By-Law 5, for a term of two years or until a successor is duly elected and qualified: Atlantic, Central, New England, Western and West Gulf.

After extended discussion, the yeas and nays being ordered, the said question was decided in the negative: Whole number of votes cast, 14; necessary for adoption, 10; yeas, 3; nays, 11. Those who voted in the affirmative are Messrs. Kiener, Kirkman and Noble. Those who voted opposed are Messrs. Acton, Bickel, Caveness, Davis, Groves, Markwell, McCargar, Norwine, Raser, Shelton and Weingarten. Mr. Reid abstained. The President abstained as required. So the by-laws were not amended.

Moved, by Mr. Kiener, that the Central Division be split to form a Central Division, and a new Great Lakes Division, of three states each. Moved, by Mr. Kirkman, that the subject be placed on the table; but the said motion was rejected. After further discussion, on motion of Mr. Kirkman, VOTED that the pending motion is amended to provide that it is the sense of the meeting that the Central Division shall be split as proposed and that the Secretary is directed to prepare a draft amendment of by-laws to accomplish same and present it later in the meeting. The question then being on the adoption of Mr. Kiener's motion as thus amended, the same was ADOPTED.

The Board was in recess from 10:45 to 10:48 A.M.

On motion of Mr. Groves, after discussion, VOTED that the Planning Committee is requested to study the desirability of a reapportionment of the ARRL divisions as they now exist, and report to the Board at the next annual meeting.

The Board was in recess from 10:53 to 11:02 A.M.

Proceeding to an examination of the amateur frequency position, the Board heard oral reports from the President and Secretary, followed by extended discussion, during a short portion of which Mr. Reid occupied the Chair. Mr. Shelton requested that an endeavor be made to remove British commercial stations, now operating in the Caribbean, from the amateur frequencies 3897 and 3950 kc. Moved, by Mr. Davis, that the Secretary be instructed to republish in QST abstracts of the League position in the matter of the 160-meter band, as shown in our brief filed with FCC. On motion of Mr. Kiener, seconded by Mr. Kirkman, unanimously VOTED that the motion is amended by adding the further provision that the QST mention shall also report current League activities toward the recovery of that band. On motion of Mr. Kirkman, unanimously VOTED that the motion is further amended to provide that the League shall continue to take a firm position toward the return of that band. The question then being on Mr. Davis' motion as thus twice amended, the same was then unanimously ADOPTED.

Proceeding now to a consideration of the recommendations of the Regulations Committee for certain rearrangements of amateur operating privileges, the Board heard recommendations and explanations from the committee chairman, Mr. Norwine, and, after extended discussion of each item, took actions as follows:

On motion of Mr. Markwell, VOTED that it is the sense of the Board that the Class A, B and C licenses should be retained. Mr. Shelton requested to be recorded as voting opposed.

On motion of Mr. Markwell, VOTED that, to encourage the entrance of technically-trained u.h.f. and s.h.f. workers into the higher amateur frequencies, the League request the Federal Communications Commission to make available a Class D amateur license to be valid only for operation above 200 Mc., the examination requirements for this class to embrace the same knowledge of theory and of law and amateur regulations as required for other licensees, and to differ from the Class B examination only in the elimination of the code test; and with provision that the holder of a Class D license may qualify for Class B endorsement by passing the code test. Messrs. Davis, Kiener, Reid and Shelton voted opposed and requested to be so recorded.

On the Regulation Committee's recommendation that 3850-4000 kc. should be opened to 'phone operation, moved, by Mr. Groves, that the League request the Federal Communications Commission to make the frequencies 3750-4000 kc. available for Class A 'phone operation. Moved, by Mr. Bickel, that the motion be amended by changing the lower figure to 3800 kc. After further discussion, on motion of Mr. Norwine, unanimously VOTED that the subject shall lie on the table until after the consideration of the standards for a Class A license.

After further discussion, on motion of Mr. Kirkman, unanimously VOTED that the Board shall first consider the manner in which a Class B licensee should obtain a Class A license, and then determine to which bands Class A privileges should apply. Moved, by Mr. Shelton, that a Class B licensee should obtain Class A privileges by examination in code speed only, at 15 words per minute, after one year's experience, with no further technical examination. After further discussion, on motion of Mr. Kirkman, unanimously VOTED that the motion is amended to require the present advanced theory examination as well as the code examination. On further motion of Mr. Kirkman, VOTED that the question shall now be divided, Mr. Acton requesting to be recorded as voting opposed. Concerning the proposal that the Class A license should require one year's experience and a new code examination at 15 words per minute, the same was rejected. Concerning the proposal that the Class A license should require one year's experience and the present advanced theory examination, on motion of Mr. Caveness, VOTED that the subject shall lie on the table. And so no changes were proposed at this time in the Class A examination.

Moved, by Mr. Bickel, that the Board request the Federal Communications Commission to make the frequencies 28,000-28,200 kc. available exclusively for c.w. telegraphy. On motion of Mr. Kiener, unanimously VOTED to amend the motion to read 28,000-28,500 kc. The question then being on Mr. Bickel's motion as thus amended, the same was unanimously ADOPTED.

On motion of Mr. Norwine, unanimously VOTED that the subject of 'phone allocations in the remaining bands is now taken from the table, the pending question being Mr. Groves' motion that 3750-4000 kc. should be available for Class A 'phone, and Mr. Bickel's motion to amend the lower figure to 3800 kc. After further discussion, on motion of Mr. Noble, VOTED, 9 votes in favor to 5 opposed, that Mr. Bickel's motion is amended to make the figure read 3850 kc., Messrs. Acton, Bickel, Groves, Markwell and Raser requesting to be recorded as voting opposed. The question then being on Mr. Bickel's motion to amend, as thus amended, the same was then ADOPTED, Messrs. Bickel and Markwell requesting to be recorded as voting opposed. After further discussion, the question then being on the adoption of Mr. Groves' original motion as amended, the same was thereupon ADOPTED. So the League requests FCC to make the frequencies 3850-4000 kc. available for Class A 'phone operation.

Moved, by Mr. Groves, and seconded by Mr. Weingarten, that the League request the Federal Communications Commission to make the frequencies 7200-7300 kc. available for Class B 'phone operation when the 7-Mc. band is returned to amateurs in its entirety. After discussion, on motion of Mr. McCargar, VOTED, 8 votes in favor to 7 opposed, that the motion is amended to read Class A instead of Class B, Messrs. Acton, Groves, Markwell, Noble and Weingarten requesting to be recorded as voting opposed. On the motion as thus amended, after further discussion the same was ADOPTED, 9 votes in favor to 6 opposed, Messrs. Davis, Markwell, Noble and Raser requesting to be recorded as voting opposed. So the League requests FCC to make the frequencies 7200-7300 kc. available for Class A 'phone operation after the band has been returned in its entirety.

Moved, by Mr. McCargar, that the League request the Federal Communications Commission to make the frequencies 14,200-14,400 kc. available for Class A 'phone operation when the 14-Mc. band has been returned to amateurs in its entirety. After discussion, moved, by Mr. Noble, to amend the motion to provide that the portion 14,200-14,300 kc. be also open to Class B 'phone operation. But the said motion

was rejected. The question then being on Mr. McCargar's motion, the same was ADOPTED.

On motion of Mr. Shelton, after further discussion, unanimously VOTED that the Board requests Canadian General Manager Reid to secure uniformity in the Canadian 'phone regulations to conform with those of the United States.

Moved, by Mr. Kirkman, that the 'phone portion of the 10-meter band, 28,500-29,700 kc., be exclusively Class A. But there was no second, so the motion was lost.

The Board was in recess from 3:37 to 3:51 p.m.

On motion of Mr. Caveness, VOTED, 11 votes in favor to 3 opposed, that the proposal that a Class B licensee should obtain Class A privileges, after one year's experience, by passing the present advanced theory examination, is taken from the table. Moved, by Mr. Caveness, that the motion be amended by striking out the words, "by passing the present advanced theory examination." Moved, by Mr. Noble, that the said motion to amend be amended by adding the additional provision that Class A be available after two years' experience and proof of use of 'phone on a Class B band, without further technical examination. But the said proposal was rejected, 7 votes in favor to 8 opposed. After further discussion, the question then being on Mr. Caveness' motion to amend, the same was rejected, 5 votes in favor to 10 opposed. Thus no amendments were made. After further discussion, on motion of Mr. Norwine, unanimously VOTED that the subject shall again lie on the table.

Proceeding to a consideration of subjects raised by individual directors at their own initiative:

On motion of Mr. Groves, after discussion, unanimously VOTED that the Board goes on record as being opposed to any unnecessary operation of c.w. in the 'phone sections of the bands.

Moved, by Mr. Groves, that it be the policy of the League when employing additional personnel (exclusive of minor positions), that same be secured as nearly as possible from a cross-section of the country. But there was no second, so the motion was lost.

On motion of Mr. Kiener, and by unanimous vote, affiliation was GRANTED the following societies:

Owensboro Amateur Radio ClubOwensboro, Ky.
Norwalk Amateur Radio AssociationNorwalk, Conn.
Skagit Amateur Radio ClubSkagit County, Wash.
Elgin Amateur Radio SocietyElgin, Ill.
Society Radio OperatorsChicago, Ill.
The Electron ClubClinton, N. C.
Foothill Radio ClubBaldwin Park, Calif.
San Francisco Naval ShipyardAmateur Radio Club
San Francisco, Calif.
Monmouth County Amateur Radio Association
Eatontown, N. J.
The Electron Club of DenverDenver, Colo.

Mr. Kiener presented a petition from the Chicago Area Radio Club Council, seeking authorization to hold a national convention in 1947. On his motion, after discussion, the following resolution was unanimously ADOPTED:

Whereas the Board of Directors of the American Radio Relay League, Inc., at its meeting June 1, 1940, authorized the Chicago Area Radio Club Council to hold a national ARRL convention in Chicago in the fall of 1941; and

Whereas, because of emergency circumstances, this convention was postponed with the unanimous approval of the Board of Directors at its meeting May 8, 1941; and

Whereas the Chicago Area Radio Club Council now desires to hold a national ARRL convention in 1947, and has requested such approval from the ARRL Board of Directors; and

Whereas the national conventions of 1936 and 1938 held in Chicago were such outstanding successes;

Be it hereby RESOLVED: that the Board of Directors authorizes the Chicago Area Radio Club Council to hold an ARRL national convention in Chicago in the fall of 1947, subject to the terms of a satisfactory contract to be executed between the Council and the

(Continued on page 186)

Claim Your Old QSL Cards Now or Never

THERE are thousands of foreign QSL cards, some dating back to the early 1930s, awaiting American and Canadian amateurs in the files of the ARRL QSL System. Some of them may be for you! Our Board of Directors has ordered that all prewar cards not applied for by January 1, 1947, be disposed of at that time. This is going to be a last call.

As most amateurs know, under an arrangement set up in 1932, foreign stations mail cards for W, K and VE in bulk to ARRL Hqs., where they are sorted and distributed to an amateur in each call area who has volunteered to act as district QSL manager. Individuals expecting cards send their district manager a self-addressed stamped envelope, as described below. Over one million cards have been delivered by this system, but there are an estimated 33,000 unclaimed cards still on hand. It is this backlog of older cards which must be cleared out so as not to hamper future work. First, however, by this announcement we want to make certain every amateur has the opportunity to learn about the system and to apply for such cards as there may be for him.

The procedure is simple: Send a self-addressed stamped envelope, size No. 10, to the QSL manager of the home district indicated in your call (address below). If you are overseas, show a home address on your envelope. Be sure to get the *proper-sized envelope*, and be sure to *fill it out as shown*. If there are cards on file for you, your manager will mail them back — at which time you should send him another envelope to keep on file for possible future cards.

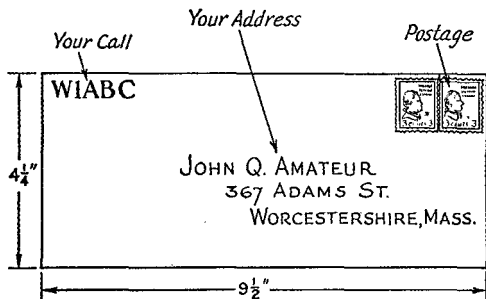

If you've *ever* worked any DX, or even worked on a long-distance band, submit an envelope. If you used a different call in previous years, apply for possible cards from such operation by sending a separate envelope for that call. If you know any former amateurs who were active in the 30s, tell them of this announcement. If you submitted an envelope prewar and have since changed address, send your manager another with the correct address to obviate delay. If you are one of the

fellows who operated in the smaller Pacific Islands (for which there are no managers) send your envelope to Hq.

Remember: Envelopes should go to the *home* district manager. If you have a W9 call, for example, your cards will still be routed via the W9 manager even if you are operating portable in WØ or W6 or J.

It is going to be hard to have to destroy some of these choice DX cards, particularly Asian, but we can't keep them forever. Sit down right now and make out that envelope, OM — or make a note to get the proper-sized envelope at the post office tomorrow. This will be your last chance; don't miss it!



- W1 — Jules T. Steiger, W1BGY, 231 Meadow St., Williamsett, Mass.
- W2 — Henry W. Yahnel, W2SN, Lake Ave., Helmetta, N. J.
- W3 — Maurice W. Downs, W3WU, 1311 Sheridan St., N. W., Washington 11, D. C.
- W4 — Edward J. Collins, W4MS, 1215 North 12th Ave., Pensacola, Fla.
- W5 — L. W. May, jr., W5AJG, 9428 Hobart St., Dallas 18, Texas.
- W6 — Horace R. Greer, W6TI, 414 Fairmount Ave., Oakland, Calif.
- W7 — Frank E. Pratt, W7DXZ, 5023 So. Ferry St., Tacoma, Wash.
- W8 — Fred W. Allen, W8GER, 1959 Riverside Drive, Dayton 5, Ohio.
- W9 — F. Claude Moore, W9HLF, 1024 Henrietta St., Pekin, Ill.
- WØ (as established) — Alva A. Smith, W9DMA, 238 East Main St., Caledonia, Minn.
- VE1 — VE1FQ will resume service soon.
- VE2 — C. W. Skarstedt, VE2DR, 3821 Girouard Ave., Montreal 28, P. Q.
- VE3 — W. Bert Knowles, VE3QB, Lanark, Ont.
- VE4 — c/o ARRL.
- VE5 — Same as VE7.
- VE6 — W. R. Savage, VE6EO, 329 15th St. North, Lethbridge, Alta.
- VE7 — H. R. Hough, VE7HR, 1785 Emerson St., Victoria, B. C.
- VE8 — Yukon A.R.C., P.O. Box 268, Whitehorse, Y. T.
- K4 — E. W. Mayer, P.O. Box 1061, San Juan, P. R.
- K7 — J. W. McKinley, K7GSC, Box 1533, Juneau, Alaska.
- KA — G. L. Riekard, 48 Ortega, San Juan, Rizal, P. I.

"CQ 2400 Megacycles"

Transceivers and Antennas for the 13-Centimeter Band

BY A. R. KÖCH,* W9WHM/2, AND G. H. FLOYD,* W6QJK/2

DURING the war the portion of the spectrum above 300 megacycles became tremendously important, and as we now know, was used primarily for radar work. Tubes, circuits and equipment were developed to work efficiently at these ultrahigh and superhigh frequencies.

When amateurs were assigned the 2300-2450-megacycle band, W9WHM/2 decided to build a rig for use at this frequency. After much consideration, a transceiver type of equipment was decided upon, from the standpoint of simplicity and size. Another important factor influencing this decision was that the band is so wide (150 megacycles) that tuning for an answer to a call is something of a problem unless the frequency of the other station is known beforehand. By using transceivers, transmission and reception are automatically maintained on the same frequency.

Operation on 2400 Mc. offers a splendid opportunity for experimental work with antennas, because the wavelength is so short (approximately 13 centimeters) that, for example, a V antenna with 12 wavelengths per leg can be built on the top of a table! The antenna described for use with this particular transceiver is a three-band parabola, capable of operating on 420, 1250, and 2400 Mc. On the latter band a power gain of approximately 200 is achieved. Compare this with the power gain of 3 or 4 which may be obtained on 10 meters with a good rotary beam!

Lighthouse Tubes

The lighthouse tube, a member of the disk-seal tube family, represents an innovation in tube design. It is a peculiar creature, a specialized tube in that it was designed to work in conjunction with cavities, yet conventional in that

*Tube Division, General Electric Co., Schenectady, N. Y.

it may be used in standard circuits at low frequencies. For operation at 2400 Mc. it is necessary to use the lighthouse tube with a cavity, but this need not present too great a problem to the ham interested in duplicating the transceiver described in this article.

The 2C40 lighthouse tube was chosen for the two transceivers built by the authors in preference to the 2C43, because the former tube operates more readily as a c.w. oscillator at 2400 Mc., even though the 2C43 is rated to give greater peak output as a pulse oscillator. Primarily intended for use as an r.f. amplifier, converter or local oscillator in a receiver, the 2C40 requires a plate potential of only 250 volts for efficient operation, thus it is possible to make the entire transceiver capable of operating from a vibrator-type power supply.

Circuit Details

Reference to the schematic diagram, Fig. 1, shows the 2C40 as the only part of the circuit operating at 2400 Mc. The remaining tubes serve solely as auxiliaries for reception or modulation. The photographs show the 2C40 and its associated cavity mounted on the right of both equipments.

Superregenerative detection was the only type that seemed practical as well as simple for this frequency. Self-quenching of the 2C40 was avoided because it was feared that too great a frequency change might occur between transmit and receive conditions, making transceiver operation difficult. The 6SN7 and 6H6 tubes form the separate quench-oscillator circuit. One triode section of the 6SN7 acts as the interruption-frequency oscillator, and the second section is used to isolate the oscillator and to provide a better impedance match to the grid resistor of the 2C40. Since the bias resistance used in the grid circuit of the r.f. tube is quite low — 5000

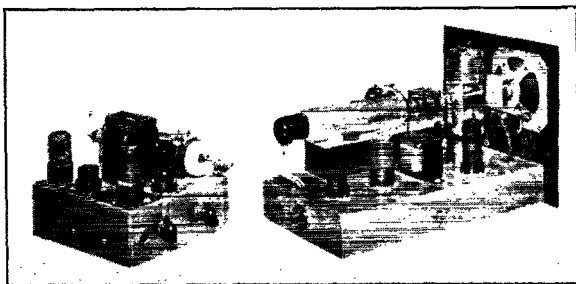

The two transceivers with which first contact was established on the 2400-Mc. band. Both use the same circuit, although the construction differs somewhat.

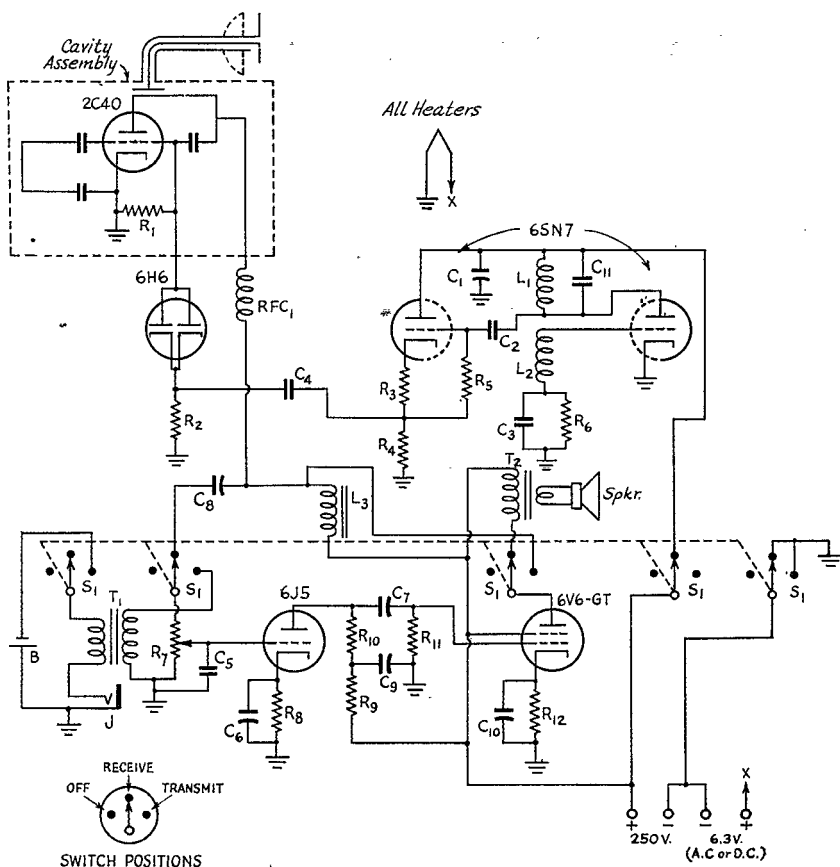

Fig. 1 — Circuit diagram of the 2400-Mc. transceiver.

- C₁ — 0.05- μ fd. paper, 400 volts.
- C₂ — 200- μ fd. mica.
- C₃, C₁₁ — 0.001- μ fd. mica.
- C₄ — 500- μ fd. mica.
- C₅ — 100- μ fd. mica.
- C₆, C₁₀ — 10- μ fd., 50-volt electrolytic.
- C₇, C₈ — 0.03- μ fd. paper, 400 volts.
- C₉ — 0.1- μ fd. paper, 400 volts.
- R₁, R₉ — 5000 ohms, $\frac{1}{2}$ watt.
- R₂, R₄ — 10,000 ohms, $\frac{1}{2}$ watt.
- R₃ — 1000 ohms, $\frac{1}{2}$ watt.
- R₅, R₁₁ — 0.5 megohm, $\frac{1}{2}$ watt.
- R₆ — 50,000 ohms, $\frac{1}{2}$ watt.
- R₇ — 0.5-megohm potentiometer.

- R₈ — 2000 ohms, 5 watts.
- R₁₀ — 50,000 ohms, 1 watt.
- R₁₂ — 250 ohms, 5 watts.
- L₁, L₂ — See text.
- L₃ — 12 henrys, 80 ma. (Thoradson T44CO2).
- B — 1.5-volt flashlight cell.
- J — Open-circuit jack.
- RFC₁ — 2.5-millihenry choke.
- S₁ — 3-position 6-pole rotary switch (Mallory 3236J).
- Spkr. — 4-inch p.m. speaker.
- T₁ — Single-button microphone transformer (Stancor A-4707).
- T₂ — Output transformer (UTC-R58).

ohms — some sort of impedance match was necessary. Both sections of the 6H6 are tied together and the tube is connected as a half-wave rectifier to provide the negative voltage pulses which are applied to the grid of the 2C40. These negative pulses bias the 2C40 periodically so that r.f. oscillations are stopped and super-regeneration achieved.

The usual type of superregeneration control varies the d.c. voltage applied to the plate of the oscillator, but such variation is almost always accompanied by a frequency change. The circuit shown, using R₇ as the regeneration control,

avoids this. It has given very smooth control of "supering" in both transceivers, despite different physical layouts. Capacitor C₅ was added to reduce an audio squeal which occasionally resulted when the cavity phasing control (to be described later) was altered.

The interruption frequency may be from 100 to 250 kc. Higher frequencies might give trouble unless particular care is taken with the shielding in the circuit. Using the circuit shown, no trouble has been experienced in getting the tube to "super," and the frequency change when going from transmit to receive is negligible — an

important factor at 2400 Mc.

The 6J5 and 6V6-GT are the audio-amplifier tubes, and sufficient gain is realized to overdrive the small speaker. Earphones could be used, but until the time comes when it is possible to work DX, the speaker will be more satisfactory.

Despite the use of a superregenerative detector, the receiver section provides a surprising amount of selectivity. This is probably because the interruption frequency and the operating frequency are so very far apart. Using the bandwidth covered by the signal from the second transceiver as a measuring stick, the authors estimate that 50 to 100 signals could be properly separated and read over the 150-Mc. spread provided on this band. This is not too bad for a start, and yet leaves ample room for improvement!

A 5-pole triple-throw switch, S_1 , is shown in the diagram as the Off-Receive-Transmit switch. Actually, a 6-pole switch was used, with two of the contacts tied in parallel to carry the negative of the two power supplies to ground. The power supply was not built in because it appeared desirable to make provision for using either an a.c. supply for fixed station operation or a vibrator supply for portable or portable-mobile work. Wouldn't that parabola look beautiful mounted on the top of your car!

Mechanical and Constructional Details

The mechanical layout of components is not critical. The radio-frequency section is automatically separated from the remainder of the circuit by virtue of the fact that it is all contained in the cavity. Some care might be taken to shield the input section of the 6J5 circuit, since feedback could conceivably occur.

The biggest problem which existed — and still exists — is the matter of tuning the radio-frequency circuit. The cavity shown in the photographs and Fig. 2 is a tuned-grid tuned-plate circuit, with a relatively low- Q grid circuit and a fairly high- Q plate circuit. However, any cavity is essentially a one-frequency device, in that it operates best at only one frequency. The phasing control, which is shown in place over the grid cylinder in the foreground of the cavity photograph, and in the diagram as detail "F," is an aid in broadening out the resonance curve. Thus the cavity may be operated over a fairly wide frequency range without dropping out of oscillation.

The function of the phasing control is to provide the optimum feed-back between the grid and the anode. It is definitely not a tuning control, although some slight shift of frequency may occur when the phasing control is adjusted. Tuning must be accomplished by changing the

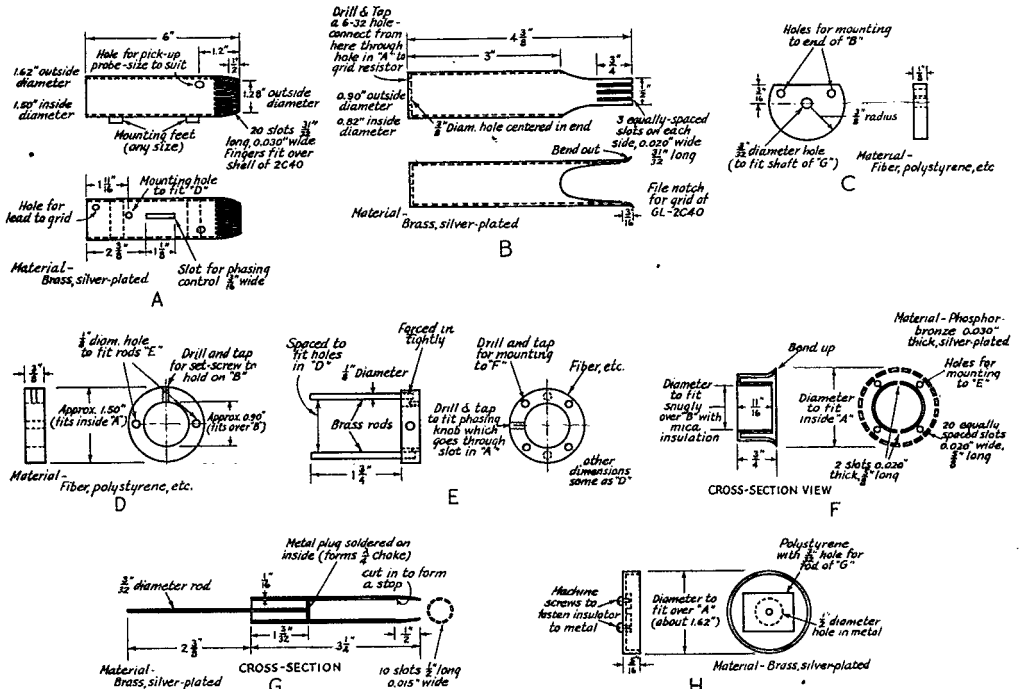
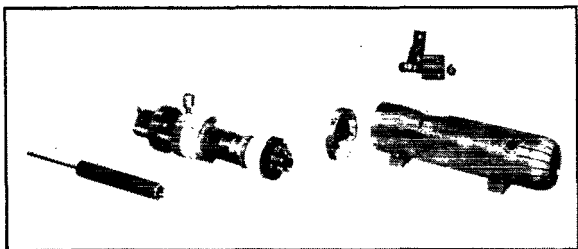

Fig. 2 — Constructional details of the 2400-Mc. oscillator cavity.



A view of the cavity partially disassembled. The various parts are identified and dimensioned in Fig. 2.

electrical length of the anode circuit. This has been done by changing the position of the connector (detail "G" in Fig. 2) on the anode of the 2C40. As the anode connector rod is pulled in and out of the cavity, while still in contact with the anode cap of the tube, the effective size of the anode cavity, and hence the resonant frequency, is altered.

Since the anode cap on the 2C40 is not sufficiently long to provide for tuning over the entire 2400-Mc. band, an additional cap of brass or copper must be added. The particular cap used for this transceiver is made of silver-plated brass with an inside diameter to match the outside diameter of the 2C40 anode (0.250 inch plus or minus 0.002 inch). A length of one-half inch was used in order to double the tuning range (the 2C40 cap is one-quarter inch long). The outside diameter of the extra cap is not critical, so long as it fits inside the anode connector sleeve ($\frac{3}{8}$ inch in this case).

Care must be taken when the extra brass cap is soldered on the anode of the 2C40. The anode cap and the extra cap must be well cleaned and the extra cap must be tinned. With the cap in place, a soldering iron may be applied to the top of the brass cap (away from the tube) and the heat maintained only until solder flows and a small fillet is placed on the inside of the cap.

The second problem involved with this method of tuning is that the entire band of 150 Mc. is covered by a movement of approximately $\frac{3}{8}$ inch. It is definitely not feasible to hand tune by pulling or pushing the anode rod! The motion was achieved by using a 5/16-48 tap, and finding a

lathe which would thread at 48 turns per inch. Two sliding fingers hold the anode cap so that it will not turn (see photograph). These fingers slide in and out of the brass blocks which support the threaded bushing. The anode connector is fastened to a threaded shaft and engages the large threaded bushing, which turns inside the brass blocks but is restrained by them from moving axially.

Experiment showed that the 2400-Mc. band could be covered by approximately 15 turns of the thread, or a movement just under $\frac{3}{8}$ inch. In order to have an idea of just where the unit was tuning, it was decided to use a counter dial of some sort. The Millen instrument-type counter dial (No. 10030) shown in the photograph is ideal for this job, and provides 1500 divisions for the 15 revolutions required to cover the band. Inasmuch as a typical signal covers about 25 divisions, a slightly more coarse drive could be used, but is not recommended. Even with the dial used, a signal is rather hard to locate unless it is being modulated.

Details of the cavity are given for those who desire to construct a device of this sort. None of the dimensions is too critical, and if the various units fit together well no trouble should be had in getting it to operate. With reference to the sketches, "A" is the main body of the cavity, with the 2C40 fitting in the end with the fingers and cap "H" fitting over the other end. The mounting feet used are merely brass blocks cut to the curvature of the cavity and drilled and tapped for mounting. In one transceiver the entire unit was mounted on a piece of wood in

The 2400-Mc. transceiver and its electric-heater antenna system. The approximately parabolic shape and copper construction of the heater make it a useful reflector for this amateur band. The "feed" in the antenna shown at the right is a half-wave radiator backed by a parasitic reflector.

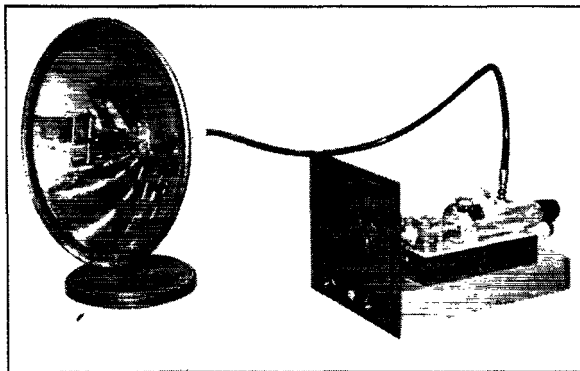

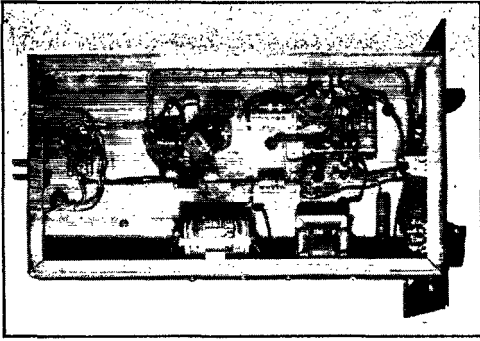

This bottom view of the transceiver shows that there is relatively little wiring to be done. Since the r.f. is confined entirely to the cavity, ordinary power-frequency practice may be followed in the below-chassis wiring.

order to align the anode shaft properly with the dial, although an electrical connection must be made from the case of the cavity to the ground of the chassis.

The grid shell is shown at "B," and the way in which the tube fits may be seen by reference to the photograph. The end piece may be soldered on, as its only function is to provide a mount for "C," which is an insulator to support the anode tuning rod.

The photograph shows "B," "C," "D," "E," and "F" assembled. "D" is an insulator to support the rods that govern the travel of the phasing unit, "E" and "F." The insulator "E" is used to isolate "F" from the sliding rods and also to provide a mounting for the phasing knob which projects through the body "A." A thin sheet of mica is placed between the phasing unit "F" and the grid shell "B," and should be fitted so that it slides along as "F" moves. The two slots on the inner diameter of "F" assist in holding the mica.

The anode connection and tuning rod are shown in "G." The quarter-wave choke formed by this unit is effective in isolating the r.f., although another r.f. choke is used externally as an additional precaution. Since no parasitic trouble was found, this second choke ($2\frac{1}{2}$ mh.) was left in, although it may not be required.

Silver plating of all units is a necessity. Furthermore, good contact must be made by all fingers, because even one finger making poor contact may cause the results to be unpredictable. If some of the fingers seem obstinate, it is permissible to shim them with a tiny piece of silver-plated brass in order to make good contact. If the dimensions as given are adhered to closely, the cavity should tune to the band without difficulty.

No details of the pick-up probe are shown, because each experimenter will undoubtedly want to try his own version. In general, all that is

required is a wire which extends into the cavity at the location shown in sketch "A." It may be desirable to solder a regular connector to the cavity at this point, although this would give fixed coupling. Some arrangement whereby the amount of wire inserted may be varied is desirable. From this pick-up the energy is carried through flexible coaxial cable (as short a length as possible) to the antenna.

The connector shown in the photograph is a combination coupling and adjustable probe, with a Sperry connector used for coupling to the antenna. Once the proper coupling is found this need not be varied, and for that reason it is probably not necessary to provide such a fancy gadget.

The interruption-frequency coil and its pick-up

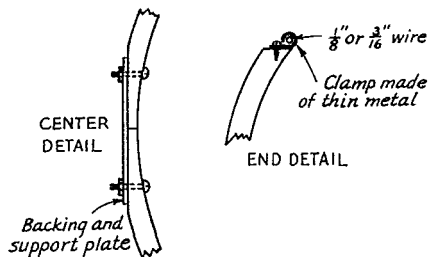
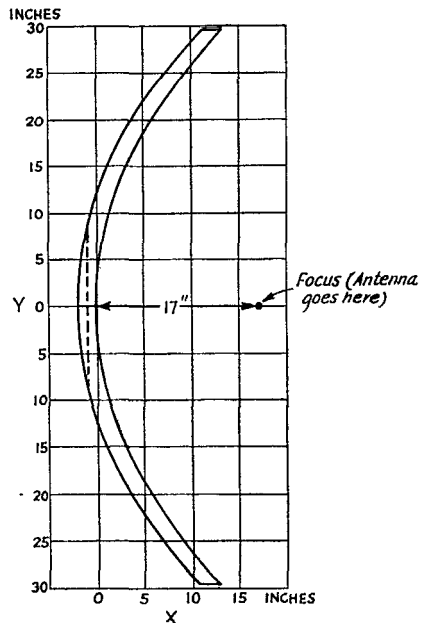

Fig. 3 — Parabola dimensions and mounting details. The shape of the curve can be computed from the formula $Y^2 = 4AX$, where A is the distance from the center to the focal point. The curve in this drawing is for a focus of 17 inches.

coil (L_1 and L_2) may be made from any standard oscillator coil available. The one used was made by taking a 175-ke. i.f. coil and winding a feed-back coil of 25 turns of fine wire directly under it. A 30-millihenry choke might also be used, with an additional feed-back coil, although the capacity of C_{11} would have to be varied in order to tune to the proper frequency. Some experimentation may be required with the feed-back coil, but in general 20 to 30 turns of wire should give the desired results. Remember, if the circuit doesn't work, reversal of the feed-back coil connections may be required.

Parabolic Antennas

Since the power output of the transceiver described is in the order of 100 milliwatts (California-kilowatt amateurs may stop reading at this point!) an antenna system with high gain is not only desirable but almost imperative. The large screen-mesh parabola pictured is an antenna which will work very nicely on three ham bands — 420 to 450 Mc., 1215 to 1295 Mc., and 2300 to 2450 Mc. The power gain of 200 (approximately) which is achieved on the 2400-Mc. band converts a 0.1-watt signal into a 20-watt signal, which becomes of sufficient strength to be of some consequence. Even at 420 Mc. a sharp beam and good gain is obtained (25-30). The beam produced by this size of antenna is really sharp compared to the normal low-frequency beam, being approximately 7-degrees wide at the half-power point.

Fig. 3 gives the layout dimensions for the wooden supports (one-inch pine boards), which are fastened on a metal, plywood, or similar back support. Eight supports are ample to insure a parabolic shape, and the entire unit is light enough to carry with one hand. Galvanized-iron screen material was used as the reflecting surface, and coarser material can be used so long as the mesh openings do not exceed 0.1 wavelength. Undoubtedly copper screen would be an improvement, and its use is recommended to those who desire to duplicate this antenna. The width of screening available makes it necessary to overlap at the middle of the parabola, and electrical contact should be made at this point.

Sufficient space is left between the eight wooden arms so that the antenna feeder may be brought in at the rear. This feeder consists of a length of 7/16-inch inside-diameter brass tubing with a 0.140-inch outside-diameter inner conductor, supported on four polystyrene washers. Provision for connection to the coaxial cable is made at one end of this feeder and the antenna proper is placed on the other end.

Fig. 4 also shows the details of the antenna and of the feeder line. The reflector used on the large parabola pictured is a solid sheet of thin metal, 4 inches in diameter. The smaller parabola has a similar reflector made of a single rod,

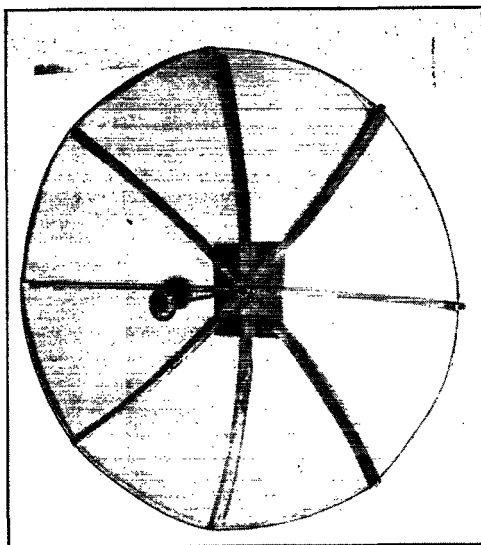

This parabola, constructed of wire mesh mounted on shaped wooden supports, gives a power gain of approximately 200. Dimensions and details are given in Fig. 3.

which acts in a similar manner. The antenna proper consists of two rods which are soldered to the pipe as shown, with the inner conductor terminating on the inside of the pipe at the point where one of the antenna rods is affixed. To enable the antenna to be easily tuned, it is desirable to tap these antenna rods and insert a small brass machine screw, which may be adjusted until the resonant length is obtained.

The type of parabola pictured connected to the transceiver was made by dismantling a standard G-E electric heater and removing the heating element. The hole which remains is slightly large, but a clamp may be made up so that the feeder can be held in place. The antenna structure is identical to that of the larger parabola. The shape of the heater is a close approximation of a parabola and the unit makes a simple antenna with a power gain of approximately 25.

Operation

When the switch is set to the receive position, and the control R_7 is advanced, the typical superregenerative hiss should be heard. If this is not present, the phasing control on the cavity should be moved back and forth until the tube "supers." The antenna matching will also have some effect upon the superregeneration; as a matter of fact, the particular transceivers described put out such a sufficiently-strong signal when receiving; that it was possible to tune the antenna circuit by using a field-strength meter!

If trouble is encountered in getting the tube to superregenerate, the various contacts in the cavity should be investigated. It may be nec-

essary to disassemble the cavity and clean all the contacts with steel wool and carbon tetrachloride. This may also be necessary if the transmitter exhibits erratic operation when the cavity is tuned, because the fingers on the anode cap may be making poor contact as they are pulled along.

If the unit is operating properly, it should be possible to transmit and receive without re-tuning the main dial. If some frequency change is encountered, investigate the change in plate current to the 2C40 when changing from the transmit to the receive position. Ideally, there should be no change in plate current. If the impedance in the grid circuit is constant when the set is switched from transmit to receive, no change in frequency should be encountered. The 2C40 grid current is in the order of 5 ma. and the plate current approximately 25 ma.

The parabolic antennas should be adjusted for optimum field strength by changing the position of the radiator. A field-strength meter may be made by using a crystal detector and a 0-50-microampere d.c. meter, with the pick-up antenna made in a manner similar to the antenna used on the parabolas.

With the field-strength meter placed in a

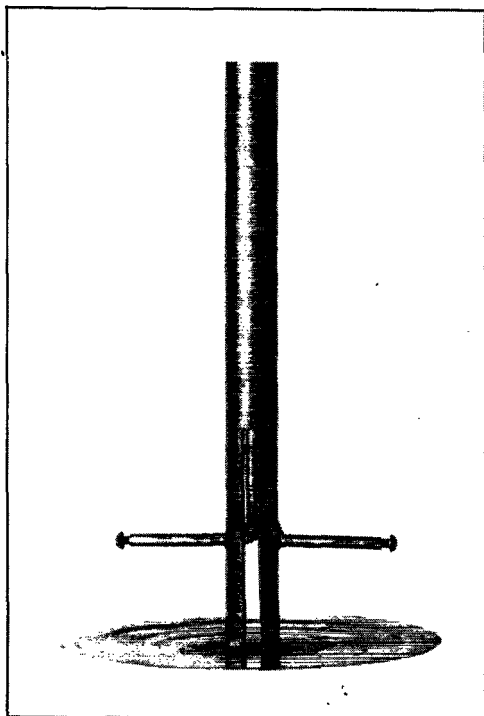

Radiator and reflector for illuminating the wire-screen parabola. Fig 4 shows details of construction and dimensions.

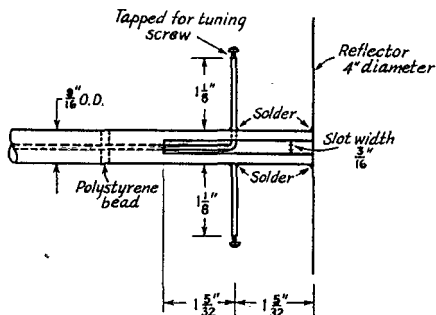

Fig. 4 — Construction of the 2400-Mc. antenna and reflector.

position to read some value, the antenna feeder line should be slipped in and out of the parabola very slowly until the maximum reading is obtained. For best results the meter should be at least eight or ten feet away from the large parabola, or three or four feet away from the small parabola. At this point the pattern of the parabola should be examined to ensure that there are no strong side lobes.

There is no simple method for determining the frequency of the oscillator, although wavemeters suitable for use at this frequency have been described in several issues of *QST*. The plunger-type coaxial-line wavemeter is perhaps the easiest to construct, and if a commercial u.h.f. wavemeter is available for calibration purposes, satisfactory results should be obtained. At least, it should be accurate enough to prevent you from getting a pink ticket!

If the cavity is made to the dimensions given, the band should be found when the anode tuning fingers are located in the middle of their tuning range.

The QSO

After some preliminary tuning-up contacts on the morning of April 29th, and an unsuccessful try the previous week, the first real contact was made at 10:44 a.m. EDST, April 29th. Actual visual observation was not possible, as both units were located in buildings approximately 0.7 mile apart. W9WHM/2 and W6OJK/2 had planned to work from the roofs of these buildings, but on that particular day rain prevented. The frequency used was 2410 Mc., and contact was made for about 15 minutes.

The transceivers described are but a first attempt to operate on the new band. A simpler type of tuning is needed, and W9WHM/2 is already at work on a new type of cavity with a simplified tuning system. Aside from the r.f. end, the circuit has given no trouble, and will undoubtedly be used in the improved version of these transceivers.

Band-Warming Party Results

BY E. L. BATTEY,* WIUE

NO BETTER name could have been chosen for our first postwar QSO party than "Band Warming," unless possibly higher temperatures should have been indicated! Activity was at fever pitch. Typical comments from the victims: "Man, man, was it good to hear so many fellows back on the air. QRM was as bad as it used to be on 20 and 40 on Saturday nights, not to mention such trifles as having a W3 or W6 fade out and an LU7 or KB6 'phone come banging in in their place. Wotta band is 28 Mc.!" — *W5AWT*. "The BW Contest was a great idea in that a lot of us who were waiting for 80, 40, and 20 to open found that ten meters is a mighty-nice hunk of megacycles to pound brass on. . . . It was a lot of fun and a revelation to me." — *W6DTY*. "Well, the BW Clam Bake is over. It sure was good to hook up with some of the old gang we used to QSO in the ORS Parties and Sweepstakes. . . . By the second week-end QRM was so terrific that it was worse than forty meters used to be." — *W6EJA*. "Each and every time I enter one of the CD's QRM endurance contests, I swear that I'm never going to enter another one; but so help me, this one took the cake! Never in my life have I heard so many stations on at once." — *W7EYS*. "Best time I've had in five years." — *W1BFT*. "Sure did sound wonderful to tune down through the band and hear all those signals on the air." — *W9BMU*. "The competition in this Section just about broke my old 6L6 final's heart, but she did her best." — *W2ATE*. "It was a lot of fun, and just a taste of what we have to look forward to in the line of operating contests." — *W9RQM*. "Met a lot of friends and suspect I talked to some hiding behind new calls." — *W9DVO/8*, *ex-W6KFC*, *W7IXH*. "I really enjoyed this contest more than any of the others because I was so glad to get back on the air. . . . Have not missed an ARRL contest since the DX Contests first started and that's many, many years ago." — *W6TT*. "Although this was as rough a contest as I have ever participated in, it was a lot of fun and I wouldn't have missed it." — *W9WEN*. "I enjoyed the contest very much. Now I know just how much I can do with a 6L6G and 15-watts input on 28 Mc." — *VE4AJT*. "W2JXH and I have been pals in ham radio for years and we are constant rivals on the air. . . . when this contest came about, we decided that we would make a bet of a little party to be paid for by the loser. . . . We agreed that we wouldn't tell each other our scores until we had mailed the logs to ARRL.

* Assistant Communications Manager.

. . . Well, came the end of the contest, and I totalled up my points. . . . After much delay, which was probably to make me worry, W2JXH gave me his total and it came out on the nose to be the same as mine — 12,390!!" — *W2JRE*. "I had a grand time, and know that plenty of us have to give our XYL a hand for the patience she displayed during those days." — *W6KNH*. "How much credit is allowed for 24-hour CQ (Charge of Quarters) stood in the middle of the contest? Hi!" — *W9DER/5*. "That BW Contest was certainly something! It brought out a lot of old-timers. . . . and it showed how busy ten can really be. . . . Sunday, February 24th, was about as busy and congested a time on ten as on any band I've ever seen in the past 17 years of operating. Am sure the contest did a lot to stir up activity on the band." — *W7RT*. "It was surely a pleasure to hear the old DX gang again, especially such old faithfuls as LU7AZ, XE1A, ZS2AL. . . . not to mention the Stateside gang." — *W4FIJ*. "Highlights: Called two VE1s on and off for three-quarters of an hour to no avail. Later had five VE1s answer my CQs. . . . Lucky spell on the 24th when worked 23 stations in 58 minutes, 9:10 to 10:08 A.M. . . . Thrills from meeting old friends. . . . Pet gripe: No soap on any of California's seven Sections, except Los Angeles; so close but so far!" — *W6BXL*. "What QRM, and the skip just wouldn't help us. . . . So many CQ's!" — *VE3AIU*.

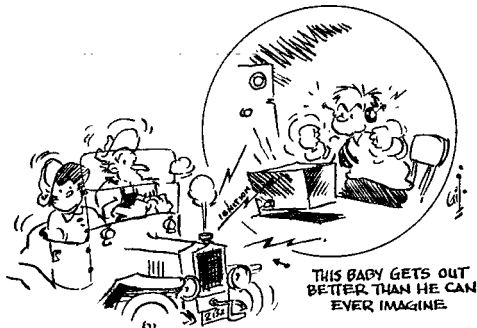

What it was About

The Band-Warming Party was a general QSO contest, open to amateurs all over the world, on all bands available to Ws and VEs, with contacts permitted by c.w. or by voice, or both, and contacts between code and voice stations counting double credit. Each participant was allowed 50-hours operating time in a 118-hour period within two week-end sessions, February 22nd-25th, and

March 1st-4th. The total points for QSOs multiplied by the number of different ARRL Sections worked (plus one for contacts outside the League Sections) determined the final score.

Of the 352 reporting participants, all but 12 used 28 Mc. exclusively. 2 used 144 Mc. entirely, while 10 used 144 as well as 28 Mc. 141 made all their contacts using c.w., 130 using 'phone only, and 81 used both c.w. and 'phone. The best record for 144-Mc.-only operation was submitted by W6ULE, Los Angeles, who worked 26 stations. W9GVZ/2, Northern New Jersey, also stuck by 144 Mc. exclusively and made 15 contacts. Others using 144 Mc., with their contacts on that band indicated, were W2JRE (22), W6UBT (16), W2BWC (15), W2JXH (13), W2VL (11), W6RBQ (10), W2DZA (6), W6LEE (2), W6CBE (1), W9YMV/1 (1).

Section and Country Leaders

The first-listed in the score tally for each country and ARRL Section is the winner for his area. The figures tell the story. Nice going, OMs! It is interesting to note how the leaders spent their time. . . . 40 operated both c.w. and 'phone, 23 used code only, and 14 made all transmissions by voice. W6TT, East Bay winner, although using both modes, actually made only nine of his

400 contacts by c.w. Only two of the 325 contacts by W6PKZ, Arizona winner, were by c.w. W5FRD, winner in Northern Texas, used both c.w. and 'phone, but of his 323 contacts only nine were by c.w. Similarly, VE4ALO, leader in Alberta, established only two c.w. contacts in his 246 total QSOs. W8OFN, leading W8, used both modes, but only one of his 220 contacts was by 'phone. W4DWB/5, second high in New Mexico had only one contact by 'phone out of 244 total QSOs, and W9DER/5, third high in New Mexico, had only one contact by c.w. out of 259 total.

New Record Established

Juan Lobo y Lobo, XE1A, established an all-time high QSOs-per-hour record for top contest participants by working them at the rate of 22.86 per hour during his 36-hours-and-10-minutes in the Band Warming!! This beats the previous record, made by himself under the call XE2N in the 1939 DX Contest . . . 22.4. The highest record for an All-Sections Contest was made by W9FS in the 1941 Sweepstakes when he averaged 21.2 QSOs per hour over a 39-hour period.

Top Scorers

As might be expected from the above, XE1A leads the field in the BW. His score is 112,384,

Top left: Few Band Warmers will not remember W5GEL, who made more contacts than any other W or VE. This is the layout that did it. For 'phone operation, the transmitter used a 6V6 crystal Tri-tet, 6L6 doubler, and HY69, plate modulated at 60 watts. On c.w. the final was P.P. HK-54s at 500 watts. Antenna used was a vertical half-wave, fed with quarter-wave Zepp feeders. Receiver is an SX-24. Also shown in the photo is a 3.5-Mc. v.f.o., not used during the contest, but currently in good use on 80 meters.

Top center: Interest was expressed in the reason for the consistency of W8OFN's signal throughout the BW. This beautiful 4-element rotary beam may have had something to do with it. It uses a folded dipole, fed with 75-ohm Amphenol cable through a 52-ohm matching section. The reflector is spaced five feet, the directors four feet. The tubing is one-inch magnesium-aluminum alloy, total weight of all elements less than eight pounds. The elements are mounted on a ladder framework, and are adjusted at the center by an aluminum rod about two feet long, threaded both right and left with six threads per inch; thus, six turns will change the element length by two inches. W8OFN finds that this method of adjustment works well. In the shack is a c.c./v.f.o. rig running 900 watts to a 250TH. The receiver is an HQ120.

Top right: W2JRE, co-winner with W2JXH in the N.Y.C. & L.I. Section. The six-foot metal cabinet contains (1) two high-voltage power supplies, 3800 volts each, one for the final, the other for the modulators, with Variac control of voltage; (2) four TZ40s, Class B modulators; (3) power supply for the Super Pro; (4) a converted Stancor 69, consisting of 6L6 crystal oscillator, 807 first buffer (doubler), and speech amplifier, a 6AC7 driving a pair of 6L6s; (5) P.P. 100THs, and bias supply. Alongside the tall rack is a Mims indicator, a TR4 converted for 144 Mc., and a Panoramoscope with three-inch screen. Other equipment includes a field-strength meter, a Presto recorder, and a BC221 frequency meter.

Left center: VE5AEC (now VE7AEC), with fifty-watts input, amassed one of the highest VE scores. The rig in the cabinet is the 28-14-Mc. job, 809 final. Atop this is 7-3.5-Mc. final with its modulator to left of the desk. Above the NC240-C is a 144-Mc. mobile rig. To the right of the receiver is a 'phone monitor and modulation indicator, and below is a c.w. monitor. The 28-Mc. antenna is a close-spaced four-element beam.

Bottom left: H. O. Douglass, W6OZC, made a higher score than any other participant who used 'phone only — 36,873. Transmitter: Meissner Signal Shifter, 811 doubler-buffer, 805s with 400-watts input, modulated by 811s. A Thordarson 14-watt speech amplifier drives the modulators through a 500-ohm line. Receiver: NC200. Antenna: Three-wire folded dipole. W6OZC is located 350 feet above sea level, about 400 yards from the western edge of San Francisco Bay, with a beautifully-clear shot to the east.

Right top center: One outstanding low-power record was that of W6SIG, San Diego, who made 179 contacts and a score of 15,200 with 20 watts on c.w. Above the Meissner Signal Shifter (7 Mc.) are two 6F6 doublers and an 832 amplifier on 28 Mc. An SX-17 pulls them in. Antenna used was a half-wave dipole, fed with 75-ohm Twin-Lead, atop a 20-foot pole, which could be rotated to take advantage of the broadside directional characteristics.

Right lower center: In this very neat radio room, Bill Ladley, W6RBQ, made the highest score of all Ws and VEs. W6RBQ has been a familiar call in ARRL organization work and operating activities for many years. Most of the League's appointments have been held and until recently Bill was SCM, San Francisco Section. His record in prewar contests places him among the topnotchers in the Sixth District, to say nothing of his latest showing — 409 contacts, 49,822 points!

Bottom right: Meet Juan Lobo y Lobo, XE1A, contesteer supreme! The equipment used to shoot to top position in the Band Warming: Transmitter — 807 crystal oscillator-doubler, 807 amplifier-doubler, 813 final, with 200-watts input, modulated by a pair of 805s. Receiver — SX-25. Antenna — Half-wave at 28 Mc., single-wire feeder.

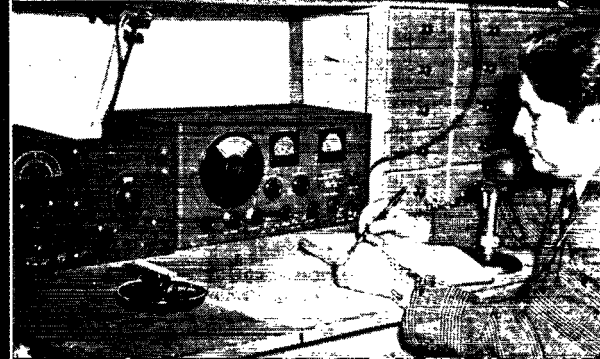
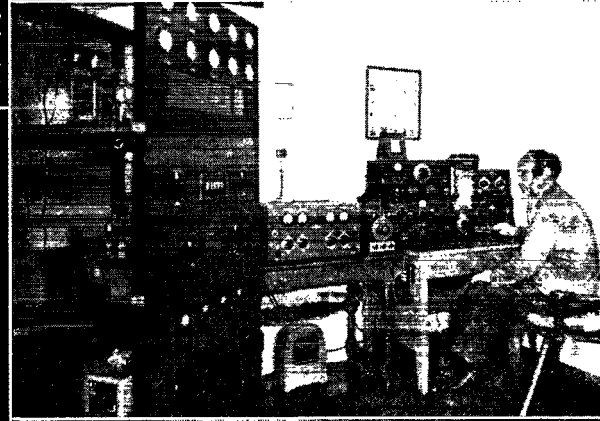
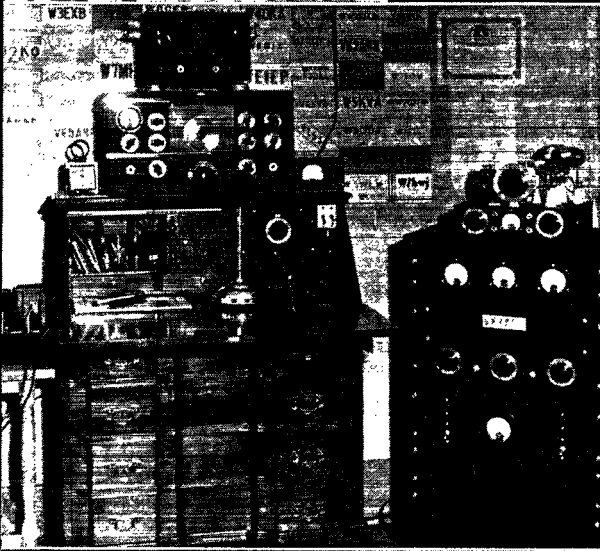
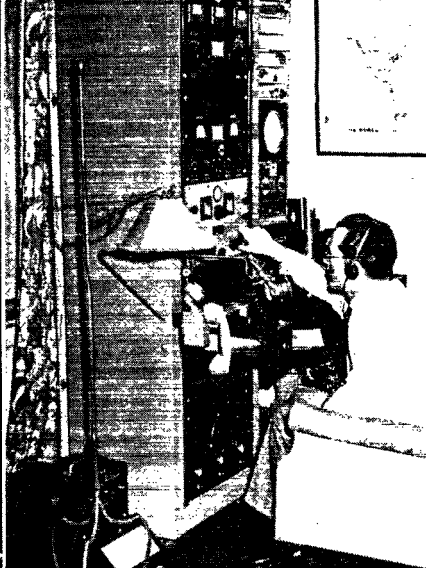
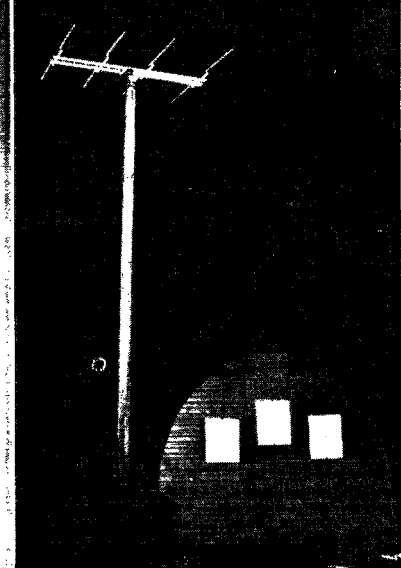

based on 823 contacts, and a multiplier of 64!! A mighty slick bit of 28-Mc. operating. You wouldn't expect a man with a score like that to worry about his total, but XE1A writes: "The reason why there are only four QSOs on February 22nd is that I did not know of the Contest until a few days before it started. I was out of town, arriving back the day before the start . . . and as at present I live in downtown Mexico City, I had to move my equipment to my brother's house in a suburb to improve the reception. . . . I spent the first day of the contest installing equipment and a provisional antenna. . . . Those four QSOs were made while trying the antenna. . . . Hope my score will not be low compared with those who were able to work the full time." Worry no longer, OM! Congratulations!!

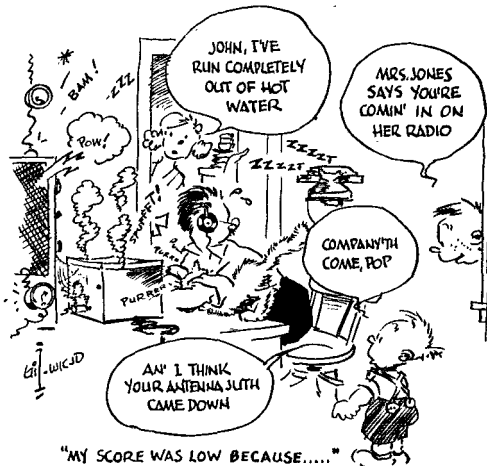

It will be no surprise to contest operators to find K6CGK close to the top! This operator deluxe is actual tops in multiplier — 68 — and together with his 585 contacts, has a score of 88,060!! This adds one more to K6CGK's long list of "wins." His rig already carries notches for Hawaii in three ARRL DX Contests, five Sweepstakes, two ARRL-Member QSO Parties, and three W/VE Contests. Leading in contests is old stuff for K6CGK, but it takes a young heart to do it in intense competition like the BW. Smooth operating, CGK!

Due to an unfortunate performance of the mails, LU7AZ's log was never received, although mailed in early March. We know that all BW contestants will agree with us in feeling that the results of such an outstanding participant should be noted, since his log failed to arrive through no fault of his own. We got some of the necessary details by radio and are able to report that LU7AZ claims a score of 79,424, from 595 QSOs, and a multiplier of 64. Although his score cannot be listed in the official tabulations, his work deserves a big hand. Well done, OM!

Highest Scorers — W/VE

The West Coast gang really took the boys over the hurdles in this contest! The four highest-scoring Ws are all W6s!! San Francisco and East Bay vied for top honors, with W6RBQ, S.F., edging out W6TT by a comparatively-small margin. W6RBQ rolled up a score of 49,822 with 409 contacts and a multiplier of 58. W6TT made 47,216 points from 400 contacts, 52 multiplier. W6RBQ had some tough competition in his own Section from W6WB, who made 408 contacts and a multiplier of 53, for a score of 43,831. The 40,704 score of W6MLY, Santa Clara Valley, is fourth high, the result of 338 QSOs and a 53 multiplier. The BW crowd doffs its collective hat to you W6 operators!! A grand showing!

The Fifth District was the second most-deadly factor in the fracas and the leaders in that area also deserve a bow. W5KSV hit 38,258 with his 368 contacts and 47 multiplier. To W5GEL goes the honor of making more contacts than any other W or VE contestant . . . 414!! His score is 35,826, second-high W5.

Leading the Canadian group by a wide margin is VE5ZM with his 34,450 points. 325 contacts times 50 did it for him. He was not without competition, either. Witness VE5AEC's 20,706, VE4ALO's 20,080. It was good to have the VEs back with us; we missed them in the last few pre-war contests.

High-Scorer for Each W/VE District

W3EHW/1	12,628
W2JRE and	
W2JXH (tied)	12,390
W3BES	31,000
W4GOG	7,776
W5KSV	38,258
W6RBQ	49,822
W7FNM	22,044
W8OFN	22,736
W9IU	19,383
VE1EP	10,220
VE3KE	11,285
VE4ALO	20,080
VE5ZM	34,450

Ten High-Scorers

	Using c.w. & 'phone	Using c.w.	Using 'phone
XE1A	112384	W6TZZ/K6	30878
K6CGK	88060	W5ADZ	21294
W6RBQ	49822	W3DGM	19266
W6TT	47216	W1DCE/6	17640
W6WB	43831	W6PYG/7	17388
W6MBA/Tinian	42075	W6SIG	15200
W6MLY	40704	W6SRU	14120
W5KSV	38258	W7RT	11620
W6LEE	37400	W6OMC	11433
W5GEL	35826	HK1AB	10820
		W6OZC	36873
		CE2CE	27136
		W6UBT	26174
		W6IKQ	24910
		W6LKC	20548
		W9BEZ/5	18784
		W6LJU	16002
		W3JSD/5	14945
		W7HZE	12836
		W1MON	11507

Ten High-Scorers in Contacts

Using c.w. & 'phone	Using c.w.	Using 'phone
XE1A	823	W6TZB/K6
K6CGK	585	W5ADZ
W5GEL	414	W3DGM
W6RBU	409	W6PYG/7
W6WB	408	W1DCE/6
W6TT	400	W6SIG
W6MBA/Tinian	385	W6SRU
W5KSV	368	W5HGG and
W6BXL	360	HK1AB
W3TTO/5	354	W6OMC and
		W7RT
		VE1EP

Ten High-Scorers in Multipliers

Using c.w. & 'phone	Using c.w.	Using 'phone			
366	K6CGK	68	W6TZB/K6	59	W6IKQ, CE2CE
288	XE1A	64	W1DCE/6	45	W6OZC
257	W6RBU	58	W6PYG/7	42	W6UBT
240	W4EPT/K6	57	W6SRU, W6SIG	40	W6LKC
234	W6MBA/Tinian	55	W5ADZ, VE4AEU	39	W6LJU
218	W6MLY, W6WB	53	W3DGM	38	W7HZE
207	W6TT	52	W6OMC, W4GOG,		CO2RG
203	W6LEE, VE5ZM	50	W6TZD, HK1AB	36	W1MON
164	W8OFN, W6KNH	49	W7RT, VE1EP	35	W4FUM
146	W5KSV, XE1FG	47	W1BFT, W6DOT	34	W1CJH, W3JSD/5,
			W2AGW, W4BPD	33	W8RCU/K6
				35	

SCORES

Band-Warming Party, Feb.-Mar., 1946

Scores are grouped by Divisions, Sections, and Countries. . . . The operator of the station first-listed in each Section or Country is winner for that area. . . . Asterisks denote stations not entered in contest, reporting to assure that stations they worked get credit. . . . The number of contacts, multiplier, operating time in hours, and indication as to mode of transmission used (c.w.; 'phone [f], or both [c.w./f]) are shown following each score. Example of listings: W6RBU 49822-409-58-46-cw/f, or, Final Score 49,822, number of contacts 409, multiplier 58, operating time 46 hours, both c.w. and 'phone used. . . .

ATLANTIC DIVISION

E. Pennsylvania

W3BES	31000-301-40-50	-cw/f
W3DGM	19266-200-38-50	-cw
W3ALB	3872-80-22-	-cw/f
W3DHM	864-26-16-	-f
W3ASW	832-32-13-	-f
W3HHS	204-30-3-13	-cw/f
W3IRS	174-19-3-4	-cw/f

Md.-Del.-D. C.

W8MSK/3	5600-104-25-46	-f
W3DPA	4200-77-25-25	-cw/f
W3KAA	3444-82-21-50	-cw
KB6RSJ/3	2052-55-18-22	-cw
W9VES/3	1992-64-12-	-cw
W3BZB	1411-41-17-	-cw/f
W3FPQ	1258-38-17-10	-cw
W6UUQ/3	1206-62-9-41	-cw/f
W3CDG	1120-30-16-19	-cw
W3DRD	352-21-8-16	-cw
W3JUX	147-11-7-	-cw
W8SCU/3	144-14-4-	-f

So. New Jersey

W3BDL	4704-75-28-39	-cw/f
W3BVE	468-27-9-26	-cw/f
W3BZI	64-7-4-2	-cw

W. New York

W8SSC	2360-40-20-	8-cw
W8KEL	611-24-13-	-cw

W. Pennsylvania

W8AOE	896-27-16-10	-cw/f
W8GMH*	430-22-10-	-cw/f
W8EYH	98-7-7-	-cw
W8TSV	2-1-1-	-f

CENTRAL DIVISION

Illinois

W9GRV	7800-102-30-24	-cw/f
W9TQL	7480-159-22-48	-cw/f
W9AGM	7100-126-25-36	-cw/f
W9WEN	6486-133-23-50	-cw/f
W9MFY	4957-120-19-	-cw
W9CFF	1680-53-14-16	-cw
W9AND	1560-49-15-25	-cw
W9BWN	624-26-12-14	-cw
W9NVY	611-24-13-	-cw
W9VKF*	224-15-7-	-cw
W9KYX*	184-13-4-	-cw/f
W9KN	182-13-7-	-f

W9ZQT

30-	10-4-3	-cw
W3JWU/9	6-3-1-3	-cw
W9WXT	8-2-2-	-f

Indiana

W9IU	19383-233-39-50	-cw/f
W8TDN/9	4004-89-22-23	-cw
W9LTR	2983-75-19-30	-f
W9AMM	1332-35-18-23	-cw
W9QLW	912-33-12-25	-cw
W9RCB	768-32-12-12	-cw

Kentucky

W3JXT/9	459-26-9-20	-cw
W9BAZ	324-18-12-	-cw

Michigan

W8ONK	7803-130-27-32	-cw/f
W8SPJ	6480-129-24-48	-f
W9DVO/8	2289-53-21-15	-cw
W8MKZ	1216-33-12-25	-cw
W8QGZ*	702-27-13-	-f
W8GG	552-23-12-9	-f
W9NQI/8	350-17-10-	-cw/f

Ohio

W8OFN	22736-220-49-37	-cw/f
W8PMJ	5400-106-24-43	-cw
W8DAE	3660-88-20-26	-cw
W8UZJ	2772-63-21-24	-cw/f
W8CXF	1376-39-16-24	-cw
W8IWS	1050-38-15-18	-cw
W8RN	980-32-14-10	-cw/f
W8BUM	702-26-13-11	-cw/f
W8SXU	333-19-9-9	-f
W8AL	40-4-4-2	-cw/f
W8MQG*	30-4-3-	-cw/f
W8WRN	14-3-2-	-f

Wisconsin

W9RBI	7500-125-25-42	-cw/f
W9RQM	6480-141-23-20	-cw/f
W9CAS	3036-69-22-20	-cw
W9PTE	1751-55-17-15	-f
W9GQO*	180-36-5-	-f
W8WEP/9*	8-2-2-	-f
W9LJC	2-1-1-	-cw

DAKOTA DIVISION

North Dakota

W9KOY	1173-37-17-25	-cw/f
W9KZL	826-23-14-10	-cw/f

South Dakota

W9KQO	444-20-12-16	-f
W9OLB	108-8-6-	-cw/f

No. Minnesota

W9JRI	8106-172-21-42	-cw/f
W9YCR	2010-57-15-18	-f
W9TYN	588-34-7-	-cw
W9SZC*	8-2-2-	-cw

So. Minnesota

W9NCS	4267-109-17-21	-cw/f
W9RVS	2376-66-18-32	-f
W9RUF	756-26-14-	-cw

DELTA DIVISION

Arkansas

W5LWL	5350-105-25-24	-cw/f
W8MHH/5	4576-100-22-23	-f
W5FPD	3192-74-21-	-cw/f

Louisiana

W5KC	25652-287-44-34	-cw/f
W8VKF/5	3522-81-22-33	-cw/f
W4DTV/5*	300-16-10-	-cw/f

Mississippi

W8QYD/5*	6-3-2-	-cw
----------	--------	-----

HUDSON DIVISION

E. New York

W2EWD	4784-108-23-35	-cw
W2KCB	64-7-4-12	-cw

N. Y. C. & L. I.

W2JRE	12390-185-30-48	-cw/f
W2JXH	12390-187-30-50	-cw/f
W2VL	10508-134-37-36	-cw/f
W2HMJ	8640-134-30-36	-cw
W2BWC	6660-99-30-31	-cw/f
W2LHQ	2440-61-20-10	-f
W2HXT	880-35-11-6	-cw
W2GTL	819-29-13-14	-cw/f
W2JGF	600-25-10-10	-cw
W2NNB	518-28-7-17	-cw
W2NAZ	328-37-4-	-cw/f
W2BO*	56-7-4-	-cw/f

W2ECR 16- 4- 4- —f
 W8UW/2 6- 3- 1- —cw
No. New Jersey
 W2AGW 8580-125-33-13-cw
 W2DMJ 6336-109-24-31-cw/f
 W2GFW 3822- 82-21-16-cw/f
 W2LMO 2088- 54-18-22-f
 W2ATE 1548- 42-18-18-f
 W2FCQ 684- 35- 9-13-cw/f
 W2DZA 640- 37- 8-19-cw/f
 W9BQZ/2 196- 14- 7- —cw
 W9GVZ/2 108- 15- 2- —f
 W2GJC* 70- 7- 5- 4-cw/f
 W2GVZ 30- 5- 3-10-cw
 W2JKH 8- 2- 2- —f

MIDWEST DIVISION

Iowa
 W9FZO 1365- 51-13- —cw/f
 W9CFB 726- 28-11-16-cw
Kansas
 W9KIU 4836- 90-26- —cw/f
 W9NXV 4224- 89-24-13-cw/f
 W9QQT 4032- 82-24-22-f
 W9YZB 2484- 65-18-30-cw
 W9KXL 1456- 45-16-26-cw/f
Missouri
 W9BAF 12546-181-34-50-cw/f
 W9WCM 1200- 44-13- 9-cw
 W9BMU* 196- 13- 7- —cw/f
 W9YHZ 2- 1- 1- —f
Nebraska
 W9FQB 550- 23-11-28-f
 W9CDL* 8- 2- 2- —f

NEW ENGLAND DIVISION

Connecticut
 W3EHW/1 12628-155-41-38-cw/f
 W1RY 4732- 82-26-29-cw
 W1UE 2057- 54-17-32-cw
 W2OEN/1 1290- 42-15-25-cw
 W9YMW/1 1200- 35-15-34-cw/f
 W1BIH 1072- 32-16- —cw/f
 W1JPE 868- 29-14-10-cw
 W1MRJ 480- 20-12- —f
 W1BDI 320- 20- 8- 7-cw
 W1AW 136- 15- 4- 7-cw/f
 W1EH* 75- 8- 5- —cw
 W1WR 36- 5- 3- 5-cw/f
Maine
 W1DLC 8208-109-36-32-cw/f
 W1GKJ 2728- 65-22-34-cw/f
 W1MCW 2461- 51-23- —f
E. Massachusetts
 W1MON 11507-146-37-34-f
 W5HQN/1 7308-128-29-40-cw
 W1KMY 7000-103-28-34-cw
 W8IOJ/1 5751-108-27-36-cw/f
 W7AQE/1 4853- 97-23-35-cw
 W1NIZ 3640- 79-20-32-cw
 W9VDY/1 3633- 77-21-21-cw/f
 W1NBI 3240- 77-20- —f
 W1LQQ 1260- 60-10-25-f
 W9ECO/1 918- 42- 9-27-cw/f
 W1HSX 765- 55-13- —cw/f
 W1ZR 680- 42- 8-32-cw
 W1SS 640- 63- 5-18-cw/f
 W1MQX 200- 18- 5- 7-f
 W1MRQ 64- 5- 4- 4-cw
 W1LVZ 52- 13- 2-23-f
 W1BB 2- 1- 1- —cw
 W1IQO 2- 1- 1- —f

W. Massachusetts
 W1EFN 1258- 37-17-18-cw
 W1MQK 676- 26-13-34-f
 W1KRV* 110- 10- 5- —cw
New Hampshire
 W1BFT 9758-123-34-45-cw
 W1AQQ 1232- 35-16-24-cw/f
Rhode Island
 W1CJH 6230- 88-35-40-f
Vermont
 W1BJP 114- 10- 6- 7-cw

NORTHWESTERN DIVISION

Alaska
 W7AFG/K7 2376- 48-24-18-cw
 W7EGN/K7 96- 9- 6- —cw/f
 K7HMS 8- 2- 2- —f
Montana
 W7IVY 3016- 50-29-17-f
 W9DSP/7 900- 30-15- —cw
 W7EWR 40- 4- 4- 8-cw/f
Oregon
 W7FNK 22044-254-45-41-cw/f
 W7GNJ 680- 27-13- —cw/f
 W7HHH 420- 18-12- —f
 W7GOF 252- 13- 9- —f
Washington
 W6PYG/7 17388-194-42-46-cw
 W7HZE 12636-164-39-28-f
 W7RT 11620-149-35- —cw
 W7CZY 4410- 68-30-30-cw/f
 W7EYS 4408- 72-29-25-cw/f
 W6DKM/7 3000- 62-25- —cw
 W7IEE 1911- 47-21- —cw
 W7BYK 1273- 33-19-12-cw

PACIFIC DIVISION

Hawaii
 K6CGK 88060-585-68-43-cw/f
 W4EPT/K6 34599-308-57-28-cw/f
 W6TZB/K6 30878-333-59-33-cw
 W8RCU/K6 5810- 83-35- —f
 W1MVF/K6 3248- 57-29-29-cw/f
 W9DTE/K6 560- 19-14- —cw
 W1NSS/K6 8- 2- 2- —cw
Santa Clara Valley
 W6MLY 40704-338-53-47-cw/f
 W6RDP 15972-178-44-38-cw/f
 W6OMC 11433-149-36- —cw
 W6PBV 4472- 81-26-21-cw
 W1WV/6 1806- 42-21-27-cw/f
 W6DBB 1512- 36-21-11-cw
 W6SYW 18- 3- 3- —f
East Bay
 W6TT 47216-400-52-43-cw/f
 W6IKQ 24910-240-53-43-f
 W6KEK 9731-131-37-24-cw/f
 W9YXY/6 7676-102-38-20-cw/f
 W6EJA 2016- 46-18-19-cw
 W9EYH/6 72- 6- 6- 1-cw/f
 W6HLY 16- 4- 2- —f
San Francisco
 W6RBQ 49822-409-58-46-cw/f
 W6WB 43831-408-53-40-cw/f
 W6OZC 36873-366-51-47-f
 W6KNH 28322-261-49-45-cw/f
 W6DOT 7276-101-34- —cw
 W6NLQ 144- 9- 8- 1-cw

Sacramento Valley
 W6NHA 4514- 86-26-15-cw
 W6CBE 2626- 46-27-37-cw/f
 W6AYZ 630- 20-15- 6-f
 W6HIR 126- 9- 7- 6-cw
San Joaquin Valley
 W6OKK 15708-177-44-27-cw/f
 W6SRU 14120-172-40-41-cw
 W6BVM 4228- 75-28- —cw
 W6DTY 1040- 33-16- —cw
 W6QXF 800- 24-16- —cw

ROANOKE DIVISION

South Carolina
 W4BPD 7062-104-33-25-cw
 W2JUW/4 2310- 54-22- —f
Virginia
 W3HWT 10592-133-32-47-cw/f
 W3USA 5184- 95-24-43-cw/f
 W9EWL/4 154- 11- 7- —f
West Virginia
 W8VAN 2552- 61-22-33-f
Rocky Mountain Division
Colorado
 W9SJT 1800- 29-20-20-cw
Utah-Wyoming
 W6SID 5425-112-25-16-f
 W9OWZ/7 1104- 35-16-10-cw/f
 W7ILL 650- 25-13-19-f
 W4IHW/6* 12- 3- 2- —f
 W7HDS* 12- 2- 2- —f
 W7EUZ* 2- 1- 1- —cw

SOUTHEASTERN DIVISION

Alabama
 W4GVP 1328- 40-16- —f
 W6ANM/4 340- 15-10- 9-f
E. Florida
 W4GOG 7776-107-36-34-cw
 W4FUM 5616- 76-36- —f
 W4HKJ 4642- 92-22-21-f
 W3EAN/4* 380- 18-10- —cw
W. Florida
 W4EQR 2882- 64-22- 25-f
 W3IHC/4 480- 20-10- —cw/f
Georgia
 W4FIJ 7714-127-29- —cw/f
 W4EGX 24- 5- 2- —cw
West Indies
 K4KD 10032-132-37-21-cw/f
 CO2RG 9614-126-38- —f
 K4ESH 6467-114-29-20-cw

SOUTHWESTERN DIVISION

Los Angeles
 W6LEE 37400-314-50-30-cw/f
 W6BXL 31519-360-43-49-cw/f
 W6UBT 28174-288-45-45-f
 W6NLI 16920-180-45-29-cw/f
 W2OIQ/6 15614-133-37-31-cw/f
 W6TZD 9000-122-36-23-cw
 W6AM 7854-114-33-16-cw/f
 W6LD 4680- 78-30-22-cw
 W6LVQ 1054- 30-16-10-f
 W6OGM 896- 23-16- —cw/f
 W6DQZ 784- 24-16- 6-cw
 W6ULE 50- 26- 1-14-f
 W6PTZ* 4- 2- 1- —f

Arizona
W6PKZ 25272-325-30-42-cw/f
W5EGG/6 350- 17-10- 5-cw

San Diego
W6LKC 20548-234-44-46-f
W6CHV 18180-201-45-47-f
W1DCE/6 17640-192-45-39-cw
W6LJU 16002-218-42-47-f
W6SIG 15200-179-40-48-cw
W6LUJ* 105- 21- 5- --cw

WEST GULF DIVISION

Northern Texas
W5FRD 24820-323-34-40-cw/f
W5CKK 7252-131-28-41-cw
W5DWO 6480-117-27-30-cw
W5AWT 6084-116-21-21-cw/f
W5BXM 3725- 73-25-23-cw

Oklahoma
W5AQE 2808- 59-24-14-cw
W5IOW 2080- 51-20-19-cw
W5DY 192- 10- 8- 3-cw
W5JME* 70- 7- 5- --f

Southern Texas
W5KSV 38258-368-47-44-cw/f
W5GEL 35826-414-42-46-cw/f
W3ITO/5 34200-354-45-49-cw/f
W5HZM 31693-350-41-43-cw/f
W5ADZ 21294-268-39- --cw
W5IGJ* 20026-245-38- --cw/f
W5HGG 9792-150-32-18-cw
W5CXS 8181-126-27- --cw/f
W5DAA 7412-103-34-37-cw/f
W5BD 6570-105-30-17-cw
W5GWD 2147- 57-19-15-f

New Mexico
W9BEZ/5 18784-207-32-26-f
W4DWB/5 17465-244-35-27-cw/f
W9DER/5 15428-259-29-30-cw/f
W3JSD/5 14945-203-35-37-f

CANADA

Maritime
VE1EP 10220-143-35-47-cw
VE1FQ 4160- 73-26-47-cw/f
VE1DB 2675- 52-25-20-cw/f
VE1CW 1065- 38-15-16-cw
VE1EV 600- 25-12- --cw
VE1HJ 440- 20-11- 8-cw
VE1FB 279- 16- 9-10-cw
VE1KN 260- 13-10- --cw
VE1CU 126- 9- 7- --cw
VE1PV* 120- 10- 6- 6-cw
VE1IM* 72- 5- 4- --cw

Ontario
VE3KE 11285-142-37-41-cw/f
VE3APF 6672-111-24-48-cw
VE3ATU 4452- 86-26-29-f
VE3AQB* 2686- 23-19- --cw/f
VE3QL 2280- 58-20-35-f
VE3CAR* 1968- 65-12- --cw
VE3AVT 730- 48- 5-22-cw/f
VE3IR 260- 23- 5- --cw
VE3QU 252- 18- 6-10-cw
VE3AKW 170- 10- 5- --cw
VE3BDB* 8- 2- 2- --f

Alberta
VE4ALO 20080-246-40-35-cw/f
VE4GD 9418-140-34-20-cw/f
VE4WG 4200- 41-25- --cw
VE4EY 50- 5- 5- 1-f
VE4UP* 2- 1- 1- --f

British Columbia
VE5ZM 34450-325-50-48-cw/f
VE5AEC 20706-238-42- --cw/f
VE5AEU 10530-131-39- 9-cw
VE5EH 1816- 47-16-21-cw
VE5AC 704- 27-11-15-cw

Manitoba
VE4RO 9408-153-28-29-cw/f
VE4SO 9019-111-29-34-cw/f
VE4SH 2342- 47-18- --cw/f

Saskatchewan

VE4AJT 6580-116-28-22-cw
VE4ADW 658- 24-14- 5-cw

FOREIGN

Chile
CE2CE 27136-257-53-39-f

Colombia
HK1AB 10620-150-36-24-cw

England
G2WQ 198- 12- 9- 5-cw

Germany
D4AAU 520- 20-13- 6-cw
D4ABK 18- 3- 3- 1-f

Mexico
XE1A 112384-823-64-36-cw/f
XE1FG 22936-239-47-37-cw/f

Newfoundland
VOIS 1308- 55-12-17-cw/f

Peru
OA4AK 2266- 52-21- 9-f

Scotland
GM8SQ 918- 28-17- 6-cw

South Africa
ZS6AM 720- 24-12-11-cw

Tinian
W6MBA/ 42075-385-55-36-cw/f
Tinian

Uruguay
CX1FB 198- 11- 9- --cw

Marine
W6ITY/ 5112- 71-36-25-cw/f
Marine
W3JJE/Marine 40- 5- 4 --cw

BEGINNER'S NOCTURNE

We all went to the party,
It was a swell affair.
The Gilberts and Oersteds,
The Ohms and Volts were there

The Pith balls swang it madly,
Boy! everyone was gay, and
There was Anty J cavorting
With arduous Operator J.

A. Hydrometer tested
And found the punch was low,
So Q. Coulomb fixed it up
With his electron flow.

Why, everything was lovely —
They assumed a rosy hue;
While Feed Back up and recited
All the formulas that he knew.

Capacitor took on a charge
And shocked Miss Meta Volt,
So Electrostatic took it up
And gave him a heckofa jolt.

There was Deccy Belle, and Mike
Farad was with Miss Epsilon;
While E-sub-b and E-sub-c
Had Space Current going to town.

I had Mrs. Ohms Law cornered;
'Twas in my daily hunt
Of finding the Resistance
Of Milly Meter's shunt.

She was just about to tell me
When, oh RI! Take a lam!
I heard the XYL shouting, "Wake!,
Today you take your exam."

— John N. Kostad
(via W6SSP, ez-W8TNH)

Foreign Notes

Perhaps this should more aptly be called the "good news" department. At least, again this month we can report the reopening of amateur radio (or the liberalization of operating privileges) in several additional countries. Each action is a step forward in returning international amateur radio to its prewar status.

BELGIUM

In early May, ON amateurs were opened on "five and ten," the exact frequencies being 28,140-29,850 and 58,500-60,000 kc. (the latter is the 5-meter band as provided in European areas under Cairo regulations). A temporary amateur license is made available to those who possessed licenses before the war and who can produce a "civism certificate" — that is, an affidavit attesting to the holder's loyalty throughout the war. The temporary license will be good until January 1, 1947, at which time postwar regulations will have been revised and examinations prepared for regular licenses.

CZECHOSLOVAKIA

In addition to "five and ten," Czech amateurs have been opened on 1.75 Mc., 50-watts maximum input, and no telephony yet permitted.

The society on March 23rd elected officers as follows: A. Schubert, OK1SC, president; K. Charuza, OK2KJ, and J. Randysek, OK1JR, vice-presidents; K. Bruzek, OK1KB, secretary; Dr. J. Holda, OK1DR, foreign secretary; K. Kaminek, OK1CX, treasurer.

NORWAY

The Norwegian telegraph authorities have released 3505-3630 and 14,020-14,380 kc. to LA amateurs with prewar licenses, and under prewar regulations. The former channels constitute the 80-meter band as it is in much of Europe. A complete revision of amateur regulations is at present under way, with the full coöperation of the society.

ADDENDUM, QSL BUREAUS

The following are additions or corrections to the list of QSL Bureaus of the world published by this department in May *QST*:

Costa Rica: F. Gonzalez, Box 365, San Jose.

Eire: R. Mooney, Aughnacloy, Killiney, Co. Dublin.

Peru: Radio Club Peruano, Box 538, Lima.

Philippine Islands: Geo. L. Rickard, 48 Ortega, San Juan, Rizal.

Porto Rico: E. W. Mayer, P. O. Box 1061, San Juan.

American and Canadian readers of this column are reminded that a large number of foreign QSLs are on hand for them, and must be applied for by January 1, 1947. See complete announcement elsewhere in this issue.

MISCELLANY

Another sure indication of the return of amateur radio in other lands is the reappearance of society publications. In France, *Radio-REF* comes forth after six years of silence, in a form and with material that delights a reader's heart. *Kratke Vlny* again carries the torch in Czechoslovakia, an amazingly-fine little magazine from a country ravaged by war. . . . S.R.A.L. celebrated its silver anniversary recently, and we hope to have more information in the next issue. . . . The Hungarian society is inactive, having lost their headquarters building during an U. S. bombing attack, and during later "occupation" years losing the identity of an amateur society. It is hoped the group may be re-formed soon.

Strays

Silicon carbide, long useful in the electric power industry in lightning arrester protective devices, is becoming more generally used in radio. In one Navy aircraft radio transmitter built by Aircraft Radio Corporation, a cylindrical piece of silicon carbide about 1 inch in diameter and $\frac{3}{4}$ of an inch long is permanently connected across the modulation transformer winding which feeds two 1625s in parallel. Over-modulation peaks and transient voltages set up in the modulation transformer are effectively kept to a safe level. This is because the resistance of the silicon carbide (GE's trade name: "Thyrite." Some users call it a "varistor,") goes down very fast as the voltage applied to it increases. The particular piece of silicon carbide used in the communication equipment referred to has a resistance of about 50,000 ohms at 500 volts and 15,000 ohms at 720 volts. The result is that over-modulation and transient peak voltages are kept down to values which the transformer, tubes, and sockets will safely withstand.

Another Navy receiver has a small "varistor" about the size of a 1-watt carbon resistor connected across the primary of the output transformer of a receiver for the same purpose as in the equipment described above.

Converting Your Converter

Covering 50-54 Mc. with Prewar 56-60-Mc. Units

BY RICHARD M. SMITH, * W1FTX

ONE THING that is keeping most of the old five-meter gang from getting into high gear on the new six-meter band is the lack of receivers. The writer found himself in similar circumstances, being the owner of a 5- and 10-meter converter which was doing a pretty good job on Ten, but which was now exactly half obsolete because of the new frequency allocations. This particular converter, the RME DM-36, was to be found in a great many ham shacks in prewar days, so no doubt many others are faced with the problem of making it work on 50-54 Mc. Also, while every converter has its own peculiarities, it is quite possible that the same techniques that work for the DM-36 can be used with other models.

The DM-36, in case you are not familiar with it and want something to serve as a basis for comparison with others, uses three tubes — an 1852 tuned r.f. stage, a 6SJ7 mixer, and a 6J5 oscillator. The oscillator is tuned 10 Mc. higher in frequency than the signal, producing i.f. output at 10 Mc. It contains two sets of coils, one for tuning the 28-30-Mc. range, the other for 56-60 Mc. Almost 180-degree rotation of the main tuning control is required to tune each band.

* Technical Assistant, QST.

With the set removed from its cabinet and turned bottom side up, all of the coils are readily accessible, being grouped around the bandswitch as shown in the photograph. Apparently no jigs or special fixtures were used in the manufacture of this part of the set, and coil removal is not at all difficult.

Before heating up the soldering iron, a little preliminary checking is necessary, the first thing being to check the ten-meter calibration. This is important, because the ten-meter calibration determines the selection of the exact output or intermediate frequency to be used. First tune your receiver to exactly 10 Mc. This should be easy to locate, because WWV puts out a standard signal there. (Don't rely too heavily on the calibration of the receiver dial.) Next, connect the converter to the receiver, and check the calibration of the converter dial at both ends of the ten-meter band. This can be done by listening to signals from stations of known frequency, or better yet, to the harmonics of a 1000-kc. oscillator. If the dial calibration is not correct, adjust it by turning the oscillator padder. Check again at the high end of the band. If the calibration is now found to be correct at the low-frequency end, but incorrect at the other end, shifting the i.f. by

◆
Bottom view of the DM-36 converter. The four holes in the chassis side permit easy removal of the 5-meter r.f.- and mixer-coil assemblies. The oscillator coil has an inductance-trimming loop connecting it to the rear section of the bandswitch.
◆

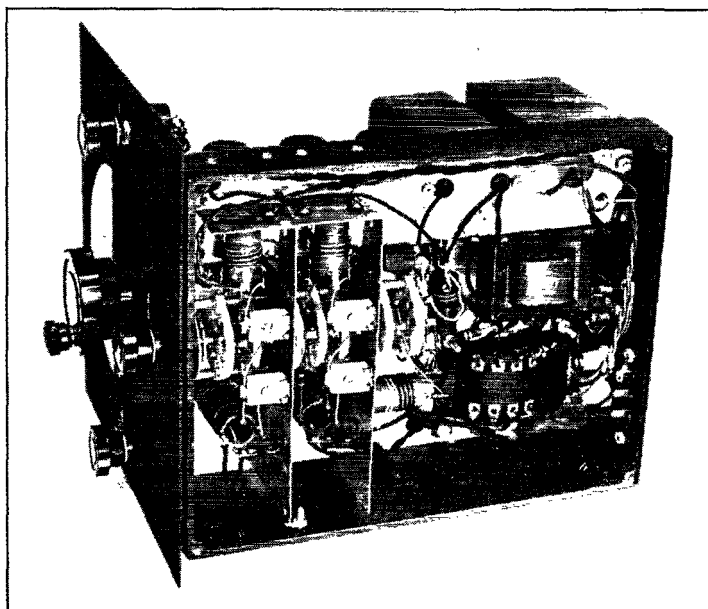

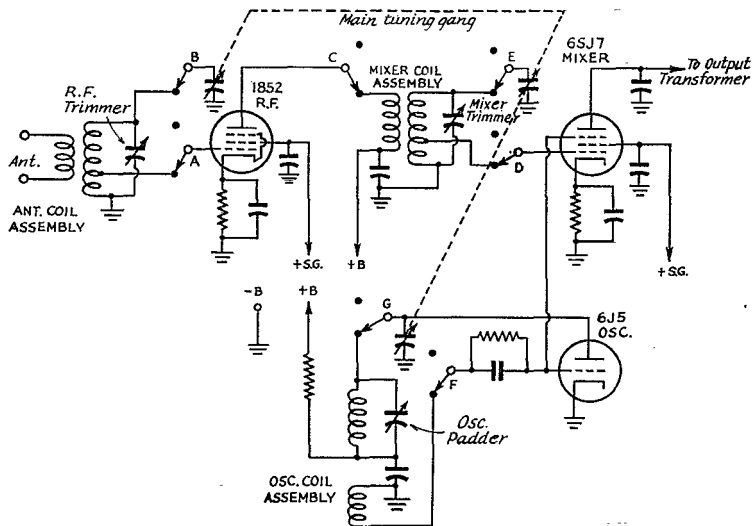

Fig. 1—In this schematic, the 10-meter section and the power supply of the DM-36 are omitted. A, B, C, D, E, F, and G are ganged sections of the band switch.

tuning the communications receiver to a frequency slightly higher or lower than 10 Mc. may improve things. By making a few trials, one i.f. will be found that permits the dial calibration to be very close to perfect at both ends of the ten-meter band.

All of this preliminary work serves to determine what intermediate frequency is best for the particular converter you happen to have. Once you have found it, peak the output transformer of the converter at that spot, and you are ready to start work on the conversion to 50-54 Mc.

We found that it was not possible to make the DM-36 cover the six-meter band by squeezing the turns on the coils closer together and screwing all of the padders and trimmers down tight. That would be too easy! It was not difficult, however, to do the job by modification of the coils themselves. The procedure described below should do the trick.

You will need a signal source of known frequency in the six-meter range. This can be a strong harmonic from an e.c.o., the signal from a six-meter transmitter, or better yet, the previously-mentioned 1000-kc. oscillator. Before tearing into things, you will want to have a copy of the schematic diagram of the converter at hand, "just in case." A simplified schematic of the DM-36 is shown in Fig. 1.

To make the job of removing the coils easier, drill four holes through the side of the cast-aluminum chassis as shown in the photograph, locating them so that a screwdriver can be inserted to contact the screws that hold the r.f.- and mixer-coil assemblies in place. It is not necessary to dismount the entire bandswitch-and-coil assembly. If you don't care to drill holes through the chassis, you may be able to use a small offset screwdriver or even a knife blade to

get at the screws, but much time will be saved by using a screwdriver.

Work on the oscillator coil first. This is located toward the rear of the chassis, mounted with its axis parallel to the front panel. Before removing the coil from the set, mark one side to indicate the position in which it should be replaced after it has been rewound. Remove the oscillator coil by unsoldering the connections at the lug terminals on the coil form. *Don't* unsolder the leads from the bandswitch end. One of them, the one that looks like a sloppy wiring job, is an inductance trimmer that you will have to readjust later to get the oscillator to tune over the desired range. Remove the secondary winding from the coil. Jot down the coil connections before you do this; it's a tough job trying to trace circuits through the bandswitch! Rewind the coil, adding exactly one-half turn. The wire can be wound in the same grooves, with the added half-turn going on at the end of the coil that is farthest from the tickler coil. It is not necessary to alter the tickler coil itself, but the original spacing between the tickler and the new secondary should be maintained.

Replace the oscillator coil, and turn the set on. Apply a 50-Mc. signal to the antenna post of the converter, and adjust the oscillator padder to bring the signal to the 56-Mc. mark (where the old 5-meter band started) on the converter dial. It is desirable to have the inductance of this coil adjusted so that it is possible to tune to 50 Mc. with the oscillator padder turned about halfway in. This will permit better tracking to be obtained.

After the oscillator padder has been set for 50-Mc. reception, tune in a 54-Mc. signal. It should be found somewhere near the 60-Mc. mark on the converter dial. If it is more than a few degrees away from this point, it can be brought

closer by using the inductance trimmer mentioned above. This "trimmer" is merely a half-loop of the wire that connects the coil to one of the terminals on the bandswitch. Being careful not to break any soldered connections, move this loop toward the oscillator coil form, and check to see whether the 54-Mc. signal is now tuned in closer to the 60-Mc. point on the dial. If the signal moves in the other direction, the loop should be pushed away from the coil form. A few trials should bring the oscillator tuning close to the desired range. In our case, we were able to get the bandspread of the 50-54-Mc. range to come within a few degrees of what it was for the former 56-60-Mc. range. This has also been the experience of others who have done the same job. Thus, the calibration of the dial will now be almost the same as it was for the five-meter band. It can be made to be very close over the lower three-quarters of the band, with 50 Mc. now being at the old 56-Mc. mark, 51 Mc. at the 57-Mc. mark, and 52 Mc. at the 58-Mc. mark. The calibration from 52.5 Mc. to 54 Mc. will not be as accurate, but it is not much of a task to recalibrate this portion of the dial if desired.

Once the tuning range for the oscillator has been set, mark the mixer coil form and remove it from the set. Unsolder from the coil-form lugs, not from the bandswitch. Jot down the connections of the windings to the coil-form lugs. The mixer coil-assembly also has two windings, the larger of the two being the mixer grid coil, and the other, interwound with it, the plate coil of the r.f. stage. The mixer grid coil is tapped. Remove this winding, leaving the wire which runs from the tap to the lug on the coil form still protruding through the side of the form. Wind a new coil in about the same position as the old one, and again add one-half turn. Solder the tap connection to the new winding at the same point as on the old. It is not necessary to alter the r.f. plate coil.

Replace the coil in the set, tune the converter to the high-frequency end of the band, and peak the mixer trimmer on noise. It should peak quite sharply at one point. If it does not peak, check the connections (it's easy to go wrong on the simple things!) and if they seem to be correct, try squeezing turns on the mixer coil. A slight adjustment of this nature should bring the inductance to the right value. When the coil is peaked at the high-frequency end of the band, tune to the low-frequency end and again peak the trimmer on noise. If the setting of the trimmer has to be changed more than a few degrees the stage is not tracking properly, and further adjustment of the coil inductance is required. If you had to use less capacitance to make the circuit peak at the low end of the band, decrease the inductance of the coil by spreading turns a bit. If more capacitance is required, add inductance by squeezing the turns together. If the

desired results cannot be obtained by these methods, relocation of the tap on the coil may improve things. We didn't try this, because we were able to get almost perfect tracking with the tap in the same place that it had been on the old coil.

Tackle the r.f. stage next. The same general methods are used as in the case of the mixer coil, but it is to be expected that considerable variation will be found from one set to another, primarily because an 1852 tube is used. We tried several things before we were able to get satisfactory performance, the main problem being that of preventing the r.f. stage from oscillating. The original assembly consists of the antenna coil and the 1852 grid coil wound on the same form, with the single turn of the antenna coil spaced about one-eighth inch from the grid coil. It was necessary to add one turn to the antenna coil and to interwind this added turn with the first turn of the grid coil to prevent the stage from oscillating.

In other cases this condition may not exist, and the best arrangement will have to be determined experimentally. The grid coil should be $2\frac{3}{4}$ turns of No. 20 enameled wire, spaced to occupy $\frac{1}{4}$ inch on the coil form. Locate the tap about $\frac{1}{4}$ turn from the bottom (when looking at the coil form with its mounting feet up).

With the new r.f. coil soldered in place, connect the antenna that you plan to use with the converter to the antenna terminals. If this is not possible, connect a dummy load (a 300-ohm non-inductive resistor, or three 1000-ohm carbon resistors in parallel) across the antenna terminals. Peak the r.f.-coil trimmer on noise with the main tuning dial set at the high-frequency end of the band. The tuning should be fairly broad. If it peaks sharply, it is because regeneration is present, and this difficulty will have to be cured before it will be possible to get the stage to track. Regeneration can be caused by the fact that the antenna input leads run from the antenna posts along the side of the chassis fairly close to the coil assemblies. By moving the twisted-pair from one position to another and noting the effect on the way the r.f. stage behaves it should be possible to determine if the "dress" of these leads is causing the trouble. If it is, disconnect the twisted-pair from the feed-through bushings on the rear of the chassis and pull them out to the front away from the mixer coil, shielded from it by the front panel of the set. Reconnect the antenna or the dummy load, as the case may be, and again peak the r.f. coil trimmer. If the circuit now tunes broadly, as it should, check the tracking by tuning first to the high end of the band, then to the low, noting whether any readjustment of the trimmer is necessary to peak the coil at the low end after it has been peaked at the high end. The inductance-adjusting procedures described above can be used. We were able to get the r.f. coil to

(Concluded on page 138)



The World Above 50 Mc.

CONDUCTED BY E. P. TILTON,* WIHDO

WANTED: More stations on 50 Mc.! Though activity is increasing rapidly in the traditional v.h.f. strongholds, the East Coast and Great Lakes areas, there are many sections of the country where practically no stations are operating on 50 Mc. During the month of May there were several instances of the band being open for skip-DX work to places where no activity existed.

Why should this be? We know, of course, that the radio-parts shortage is holding some fellows back. Others are waiting for commercial converters, in order to be able to receive on the new frequency. But when getting started is such a simple matter (is it too much to ask that a fellow make a simple 2-tube converter?), and the possibilities of the new band are so intriguing, it seems a shame to have the band going to waste anywhere.

Despite all the clamor for more frequencies we have the spectacle of a band 4000 kilocycles wide going practically unused in many sections of the country. In 50 Mc. we have a band where many fellows who are now engaged in a nightly struggle to work a few miles on 75 could be working farther, and with a fraction of the power, if they would give 50 a real try. How often can anyone with a 100-watt station have a solid QSO on 75-meter 'phone over a distance of 100 miles during the evening hours? Yet scores of fellows are doing that, and better, just about any evening on 6. Not only do they cover surprising distances regularly, but they have the added pleasure of occasional opportunities for DX up to several thousand miles, and thrills such as no low-frequency operator ever experiences — and QRM is practically unknown! What's holding us back?

A typical example of the opportunities for good work now being missed was the sad case of the night of May 12th. Early in the evening it became obvious to many v.h.f. workers in the northeast that 6 was open to W4. Skip on 28 Mc. was very short, and harmonics of 28-Mc. W4s were heard at several points before the first (and *only*) W4 broke through on 50 Mc. Starting at 7:45 P.M. EDST, W4FKN, Atlanta, Ga., worked, in continuous succession, W1LLL, Hartford, W8CLS/1, Waltham, Mass., W1FJN, Scituate, Mass., W2EUI, Roselle, N. J., W1LSN, Exeter, N. H., W1KJC, Wethersfield, Conn., W1AEP, Spring-

RECORDS

Two-way Work

50 Mc.: W1LSN-W9DWU
1100 Miles — April 23, 1946

144 Mc.: W3HWN-W2BRV
200 miles — May 15, 1946

420 Mc.: W1LAS/2-W8WCG/2
17 miles — March 25, 1946

2300 Mc.: W6GJK/2-W9WHM/2
0.7 mile — April 29, 1946

5250 Mc.: W2LGF/2-W7FOF/2
31 miles — December 2, 1945

10,000 Mc.: W1LZV/2-W2JN/2
2 miles — May 5, 1946

field, Mass., W1IN, Woburn, Mass., W2JPK, Larchmont, N. Y., W2CVF, Englewood, N. J., VE3ANY, Lakeview, Ontario, and W8RUE and WSOMY, Pittsburgh, Pa. Heard were W2IQQ, Caldwell, N. J., and VE3AEU. The band went dead at 9:45 P.M.

From this it may be seen that 50-Mc. men in the whole northeastern part of this country and part of Canada were in a position to work into W4 that night. If only a few W4s, instead of just one, had been active, everyone would have had a vastly better time of it. And what did it take to do this? Take a deep breath, you boys who are running thousands of watts on 75 to work 50 miles — W4FKN was running 40-watts input to an HK-24, and using a delta-matched half-wave inside his attic! The next time you are irked by the narrowness of your 100 kc., remember that there is a band 40 times as wide, where such contacts can be made, and its occupants are begging for company!

Four days later 6 was again open for north-south work, this time from W5 to W8 and W9. Again one man was holding down the southern end, and between 7:30 and 10:30 P.M., W5AJG, Dallas, Texas, worked W9s GRV, Wilmette, Ill., ZHB, Zearing, MAD, La Grange, QUV, Moline, PK, Downers Grove, NFM, Solon, Iowa, HIAQ, Davenport, and W8MYZ, Frankenmuth, Mich. Did this require a kilowatt? Hardly — W5AJG was running 30-watts input, and using a ten-meter antenna! During part of this time the W1-W4 path was open, and W4FKN again worked most of the boys who were active in New

* V.H.F. Editor.

England. There were rumors of a couple of other W4 signals that night, but no one seems to have worked anyone but W4FKN. What has happened to all the gang in Florida?

The first skip-DX reported from the far west occurred on May 23rd, when W6OVK/6 at San Francisco worked W7QAP, Tucson, Arizona, on and off all evening. Skip on 28 Mc. swung around to the north, and W7s and VE7s were heard in that direction, but no other signals were heard on 50 Mc. Several W7s in addition to W7QAP are about ready to go on 6, so there is hope that we may yet have a 50-Mc. WACA this summer.

Several of our openings have been brief flashes, when only the most alert operators knew anything about them. On the afternoon of the 17th, W9ZHB, with WØZJB as visiting operator, popped into W1 long enough for a fleeting contact with several of the boys who had rushed home from work. A noontime opening on May 24th found W4FKN, W1s LLL, HDQ, FJN, W8CLS/1, W2BYM, W9QCY, Ft. Wayne, Ind., and W9ZHB making the most of another "quickie." Unfortunately, to date most of the openings have broken at times when few stations were active. May 19th was only ten-minutes old when W2BYM, Lakehurst, N. J., found the path to W9ZHB open.

Some very peculiar conditions have attended these openings, and the close observation of propagation peculiarities is one of the sources of real interest in 50-Mc. work. During the noon opening on May 24th, for instance, the signals of W8CLS/1 and W2BYM were heard in the Hartford area with a rapid fading which is characteristic of skip-DX signals. W8CLS/1 at Waltham, Mass., (bearing northeast) was heard best when the beams here were pointed southwest. Turning the beam toward Waltham dropped the signal to a steady but barely-audible level, while he was over S9 most of the time when the beam was pointed in the opposite direction, toward W4FKN. Obviously there was a sharp-angle rebound involved, as the signal had the peculiar distorted characteristics resulting from multipath propagation. As soon as the skip from the south and west faded out, the signals of W2BYM and W8CLS/1 resumed their normal characteristics.

Listening during this opening was W4ZZ, Greeneville, Tennessee. He was using an f.m. receiver, and he heard numerous skip signals in the f.m. band for some time. When the 50-Mc. amateur signals came through around noon some of them sounded like f.m. signals, though all were using amplitude modulation. He heard W1LLL, W8CLS/1, and W1HDQ. The signals of W1LLL and W8CLS/1 sounded like true f.m. signals, while W1HDQ had to be tuned off to one side, indicating absence of f.m. characteristics. We guess that this was the result of the multipath effect on the first two stations, their beams having been pointed somewhat off the line to the stations

with which they were in contact. The array at W1HDQ, being rotatable from the operating position, was centered on the position which produced maximum signal strength, and consequently there was probably less Doppler-effect distortion resulting from multipath propagation.

Here and there around the country isolated stations are doing their best to get things started on 50 Mc. We do not always have space to report individual-station details, so we are running a list of calls, locations, and frequencies. If you have not already been listed, send us your frequency so the gang will know where to look for you. Let us know whom you hear and work, and the prospects for more activity in your neighborhood.

W1CGY Athol, Mass.	50.4 Mc.
W1CK Scituate, Mass.	50.5
W1HXP Newton, Mass.	50.24
W1IHA Wollaston, Mass.	50.25
W1KLO Brockton, Mass.	50.24
W1LSN Exeter, N. H.	51.2
W1NNQ Windsor, Conn.	51.7
W8CIR/1 Boston, Mass.	50.5
W2AMJ Bergenfield, N. J.	51.0
W2BQK Bergenfield, N. J.	50.4
W2BYM Lakehurst, N. J.	50.8
W2CDL Montclair, N. J.	50.7
W2FID Montrose, N. Y.	51.5
W2IQQ Caldwell, N. J.	50.4
W2IQQ/2 Mobile	50.05
W2JPX Larchmont, N. Y.	52.0
W2JQR Plainfield, N. J.	50.05
W3GQK Germantown, Pa.	51.0
W3IUN Washington, D. C.	52.8 (f.m.)
W1KMZ/3 Washington, D. C.	50.008
W1MUX/3 Washington, D. C.	50.5
W4FKN Atlanta, Ga.	52.0
W5VV Austin, Texas	50.18
W9LLM/6 La Mesa, Calif.	50.005, 50.64
W8TOB Lorain, Ohio	52.0
W9HAQ Davenport, Iowa	50.7
W9IFB Iowa City, Iowa	52.5
W9PK Downers Grove, Ill.	50.4, 51.6
W9QUV Moline, Ill.	50.8
W9NFM Solon, Iowa	51.3
W9ZHB Zearing, Ill.	50.008

International DX!

To exploit the possibilities of two-way v.h.f. work between British and American amateurs, G5BY is running a series of test transmissions on high-gain antennas beamed at the United States. Each Sunday through June and July, and as much longer as there may be interest in the project, G5BY will make automatic c.w. transmissions on 58,632 kc. Beginning at 1300 GCT (7:00 A.M. EDST) he will transmit for ten minutes on the hour and half hour for eight hours, listening for ten minutes following each transmission for replies from American amateurs on 50 Mc. If any stations are heard he will attempt to work them immediately following the ten-minute lis-

tening period. He will also cable ARRL at once, giving details of reception.

All operators having receiving equipment capable of tuning to 58,632 are urged to listen during the above periods, and wire ARRL at once, collect, if signals are heard. Stations calling during the test period for W transmissions (7:10, 7:40, 8:10, 8:40, etc.) should use c.w. wherever possible, and call "CQ G" or "CQ 5" unless G5BY has actually been heard. The call G5BY should be used *only* when reception has been accomplished.

In addition to the above test periods, all amateurs are urged to watch the British band, 58.5 to 60 Mc., whenever conditions indicate the possibility of skip-DX in that range. Many other Gs and v.h.f. workers in other countries will be listening in our 50-Mc. band, and international v.h.f. DX may well result.

Because we have had no company on our v.h.f. bands since 1939, some of us have the idea that v.h.f. interest exists only in this country. Far from it! Actually, in the years before the war, many British stations were active on 5 meters, and some excellent work was done there. The prewar inter-G record was 187 miles, a mark set in late August, 1939. This record was broken on April 16th of this year, when G5BY worked G6CW, a distance of 233 miles. Between April 7th and May 9th, G5BY had 22 QSOs over distances in excess of 150 miles, including 8 on two-way voice over a 184-mile hop.

The location of G5BY leaves little to be desired — he is right on the edge of a 400-foot cliff, with the sea on three sides, and plenty of space for antennas! For transmitting to the United States he has an 8-element array consisting of two 4-element W6QLZ arrays stacked one above the other and fed in phase. For receiving he uses a rhombic 240 feet on a leg, and is planning to try parasitic arrays, both horizontal and vertical, cut for our 50-Mc. band.

The first skip-DX of the postwar period occurred on Sunday, May 19th, at 1600 GCT, when I1FA, I1AY, and F3JB were worked by G5BY on voice. Both 50- and 58-Mc. bands were full of commercial harmonics between 1530 and 1900 on the 19th and 20th, and F3JB was contacted again on the 20th. A Russian commercial harmonic was heard on 52 Mc., and many French and Italian harmonics in the range from 50 to 60 Mc. The frequencies of the stations worked follow: I1FA, 58.8; I1AY, 57.2; F3JB, 58.9 Mc. Apparently some European operators are unaware of the existence of sporadic-E skip, as evidenced by the following transcript of the G5BY-I1FA QSO.

I1FA, in very broken English, prompted by female voice in background: "You R9 — must be Englishman in Italy — yes?"

G5BY: "No, here English station in England, in England, *in England!*"

I1FA: "You not in England!" (female voice again prompts) "It is not possible on 5 metres, I say — not possible, not possible — you not in England. I QRT on you!" And he did just that!

Later, I1FA called again, with a different voice at the microphone, saying how glad he was to work England. This was after I1AY had been worked, and after the two Italian stations had gotten together, talking about 1000 w.p.m. re G5BY!

Another DX possibility reported by G5BY is SUIRD, who is said to be working on 58.5 Mc. exclusively. Several South Africans are in this band, and some are reported to have provided for monitoring our 50-Mc. band for possible DX contacts.

There is considerable interest in 50-Mc. work in Australia, one of the few other countries to have the new assignment. Stations reported to be active "down under" include VKs 2WJ, 2ABZ, 2LS, 2LZ, and 2NO. From the column conducted by VK2NO in *The Australasian Radio World* we learn that VK2LZ has worked 60 miles using only an 1852 quadrupler on 52.8 Mc. VK2NO is running automatic transmissions on 50.4 Mc. — but you'll have to get up at 6 A.M. EDST if you want to listen for him!

New DX Record for 144 Mc.!

The holders of DX records for our 144-Mc. band don't have much time to bask in glory, for new records are made and broken rapidly, as technique is improving fast, and the favorable conditions of the summer months are just coming up. The 145-mile record of W1LAS/2 and W1IVA fell on May 15th, at 11:45 P.M., when W3HWN, Mechanicsburg, Pa., worked W2BRV, Huntington, L. I., a distance of 200 miles! Signals were as high as S7 at each end, and although there was some fading the contact was solid both ways. The rig at W3HWN normally runs 300-watts input to a pair of HK-54s, crystal controlled on 145 Mc. On this night, however, trouble had developed in the final, and Paul was running only 60-watts input to his 829 buffer stage! W2BRV runs 125 watts to a pair of HK-24s in a linear oscillator. Both men use superhet receivers. The antenna at W3HWN is a 16-element array. Worked that same evening by W3HWN were W2JN/2, Upper Montclair, N. J., 140 miles, and W3GQS, Feasterville, Pa., 100 miles.

Work like this serves to prove that good gear, high-gain antennas, and wide-awake operating are much more important in working over great distances than mere high elevation. We feel sure that the DX record for 144 Mc. will go well over 300 miles before the summer is over, and we have the idea that no one will have to climb a mountain or go up in an airplane to accomplish this feat. If we use the best possible equipment, and watch conditions carefully, the above record may well be broken before another month has passed.

As activity increases the need for sharply-directional arrays for 144 Mc. becomes more acute. Aside from the high gain one can derive from an array like the one shown on the cover of May *QST*, the physical selectivity it provides is perhaps even more important in areas where the band is heavily populated. Numerous arrays of this variety have been erected in Eastern New England, where there is probably more 144-Mc. activity per square mile than almost anywhere else, with the possible exception of the Greater New York area. Some stations using 16-element arrays with excellent results are W1EL, Malden, Mass., W1MWF/1, Brighton, and W1CTW, Arlington Heights. W1DTW, West Greenwich, R. I., has gone us one better, and added 8 directors ahead of his array, making a total of 24 elements. His signal, one of the strongest heard from Eastern New England, is proof that the array is working. He found it necessary to use a half-wave matching stub with this arrangement, the extra parasitic elements having lowered the center impedance of the system.

We've had many inquiries recently about the use of plane reflectors, mounted in back of phased arrays in the manner of early air-search radar antenna systems. W3GKP, Silver Spring, Maryland, uses such an array, the driven portion of which consists of 8 half-wave dipoles in phase. He has worked W3CGV, Wilmington, Delaware, 100 miles, and W3LN, Lancaster, Pa., more than 80 miles, with only 30-watts input to an 832-A in the final. The receiver at W3GKP is a superhet with 10-Mc. i.f. and a 6AK5 r.f. stage.

W1JFF, Newport, Rhode Island, reports some peculiar 144-Mc. propagation effects on the night of May 10th. Starting at around 9:30 and continuing until after 1:00 A.M., Fred was hearing W2LXO, West Orange, N. J., W2JJR, Rutherford, N. J., W2MMY and W2LVQ, of New York City, and a portable (probably W2JN) at High Point, N. J. These stations were working a number of Southern Connecticut W1s whose locations lie along the path between Newport and New Jersey. All the stations being worked were ones which are normally heard by W1JFF on moderately-good nights, yet on this phenomenally-good night for long-haul work none of the Connecticut stations could be heard at Newport. Fred was unable to raise any of the W2s heard, though they were coming through with good strength most of the time at Newport.

This was undoubtedly due to a tilted air-mass boundary, which made for one-way transmission, as a somewhat similar condition was noted by the writer on his nightly schedule with W8CLS/1 on 6 meters. Our signal was reported better than average at Waltham, while we were experiencing some trouble with W8CLS/1, due to low signal levels and severe fading. The difference in propagation seemed to favor the west-east path by about 10 db.!

From W8UMI, Highland Park, Michigan, comes word of more peculiar behavior on the part of the 2-meter band, this time on May 9th, when about 20 weak signals were heard in the band in the course of the evening. They were unstable signals of the modulated-oscillator type, yet nothing like that number of stations has been active at one time around Detroit. The signals were too weak to copy, so the mystery of their source remains unsolved. A likely guess is that they were inversion-bent signals from the various other cities around the Great Lakes where there are concentrations of activity. A high-gain directional array would have helped to solve that one.

Activity is just getting under way in the vicinity of Cincinnati, according to W8QHW, Bromley, Kentucky. The boys concentrate on Thursday nights and Sunday afternoons. No DX has been worked as yet, the limit being about 25 miles, but more beams are being erected and some of the gang are going to stabilized rigs and superhet receivers.

An organized onslaught on the existing 144-Mc. DX record will be made on July 27th and 28th, when W6TYP will be operating his 2-watt portable with a high-gain beam from the summit of Mt. Shasta in Northern California. W6OIN will be on Frazier Peak, near Bakersfield, some 450 miles distant. On Mt. Diablo, about 250 miles from Mt. Shasta, will be W6RBBQ. Good luck, boys!

A Novel 144-Mc. Converter

Did you ever happen to have a superregenerative receiver near a broadcast set and hear the station being picked up on the rush-box coming through on the b.c. receiver also? A simple converter utilizing the radiation at the quench frequency was sent in to us for inspection recently by W3KIL, Sharon, Pa. At first we could hardly believe our ears when we heard the signal from a station, known to be using a modulated oscillator, coming through with good voice quality on the selective communications receiver to which we attached the converter for test purposes. Actually, the broadcast or communications-type receiver picks up the harmonics of the quench oscillator, which is modulated by the incoming signal. As the low-frequency oscillation in a superregenerative detector is quite stable (as to degree of frequency modulation) the result is a very respectable-sounding voice signal, whether the received station is a modulated oscillator, a crystal-controlled rig, or an f.m. station.

To try the idea, take any ordinary 144-Mc. receiver (or any superregen on any frequency) and, by means of a very small coupling capacity (or a loosely-coupled link) transfer a small amount of energy from the tuned circuit to the antenna terminals of a receiver tuned to the low end of the broadcast band. Tune in a signal with

(Continued on page 138)

A Conservative Kilowatt

A High-Power Push-Pull Amplifier for Four Bands

BY DONALD MIX,* WITS

THERE WAS a time when any ham who wouldn't try to cram a kilowatt into a pair of five-watters was a sissy. Perhaps there was some justification for overloading small tubes in those days, for even though they were expensive and their life short under such conditions, these small tubes provided the only means of getting high power. Today, however, at a cost of 25 dollars each or less, a ham can buy a pair of tubes that will loaf along at an input of a kilowatt. With conservative operation, tube life is multiplied many times, so that the cost spread over a period of time becomes very small indeed.

The push-pull amplifier shown in the photographs is built around a pair of Eimac 250THs. It will handle a full kw. input at a plate voltage of 2000 or less, although the plate tank-condenser spacing is sufficient for 3000-volt operation with plate modulation. The driving stage should be capable of delivering approximately 100 watts. The amplifier may be shifted to any amateur band by a system of plug-in coils.

The circuit, shown in Fig. 1, is standard for a push-pull link-coupled neutralized amplifier. The only departure from strict conventionality is the use of the fixed vacuum-type padding condenser across the plate tank coil when operating at 3.5 Mc. This makes it possible to reduce the size of the variable tank condenser required for all-band operation. A filament transformer is included on the chassis to permit short leads which must carry the high heating current.

* Assistant Technical Editor.

Construction

The components are mounted on a standard 10-inch by 17-inch by 3-inch chassis, with the 10-inch side against the panel to provide the necessary depth. The B & W "butterfly"-type plate tank condenser is mounted on heavy 2-inch stand-off insulators, with its shaft along the center line of the chassis and its front mounting feet centered 2 inches from the panel. Since its rotor is connected to the high-voltage supply, use of a good insulating shaft coupling is of utmost importance as a safety measure. The output tank-coil base assembly, with its adjustable link, is fastened to the two upper-rear stator nuts of the condenser by means of a pair of aluminum angle pieces. Similarly, the clips for the 3.5-Mc. vacuum-type padding condenser are mounted at the front of the condenser. Link output terminals are provided in the form of a pair of large stand-off insulators fastened to the rear of the panel near the top.

The neutralizing condensers are special units designed as accessories to the tank condenser. Each consists of a single disk connected to the grids, the rear stator plates of the plate tank condenser serving as the other side of the neutralizing condenser. The plate r.f. choke is fastened to the back of the condenser frame. The by-pass condenser, C_7 , is located under the rear end of the tank condenser and is fastened to the chassis with a small metal angle piece which makes the ground connection.

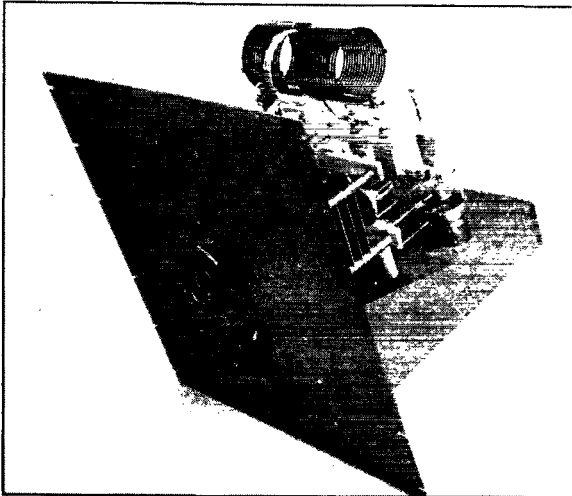

◆
Front view of the kilowatt amplifier. The panel is 21-inches high and of standard 19-inch width.
◆

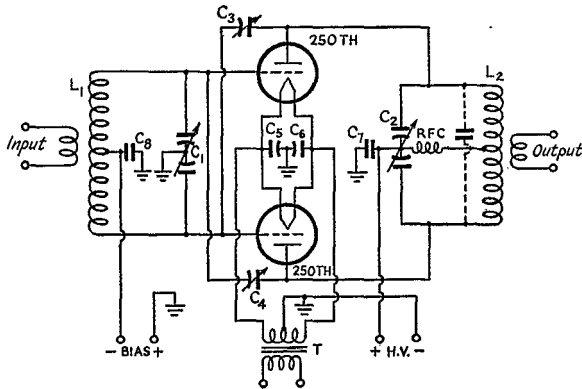

Fig. 1—Circuit diagram of the high-power push-pull amplifier.

- C₁—100 μ fd. per section, 0.05-inch spacing (Hammarlund HFBD-100-C).
- C₂—60 μ fd. per section, 0.25-inch spacing (B & W type CX-62-C).
- C₃, C₄—Disk-type neutralizing condensers (B & W type N-3).
- C₅, C₆, C₇—0.01- μ fd. paper.
- C₇—0.001- μ fd. mica, 10,000 volts.
- L₁—B & W type BCL coils.
- L₂—B & W type HDVL coils.
- RFC—1-mh. r.f. choke (Hammarlund CH 500).
- T—5 volts, 22 amperes (Stancor P-6302, see text).
- Plate padding capacitor—25 μ fd., 16,000 volts (G. E. GL122).

The sockets for the two 250THs are sub-mounted. They are spaced 5 inches center to center, and 4 inches in from the rear edge of the chassis. The grid tank condenser is mounted between the tubes with an extension shaft to the front of the panel. The rotor plates are not insulated from the chassis. The high-voltage line to the plate tank condenser and the plate r.f. choke is brought up through the chassis via a large ceramic feed-through insulator.

Underneath, the jack bar for the grid coil is centered between the two tube sockets. Connections between this coil mounting and the condenser on top are made through large-clearance holes lined with rubber grommets. Short, direct leads connect the tank circuit to the grid terminals of the tubes.

The filament transformer is mounted directly underneath the plate tank condenser. Since this transformer, as well as the grid coil, protrudes

from the underside of the chassis, the chassis is set with its bottom edge $2\frac{1}{2}$ inches above the bottom edge of the panel. The transformer shown in the photographs, and listed under Fig. 1, is one designed for rectifier service and has high-voltage insulation. If one with 1600- or 2000-volt insulation is available it may be substituted, of course. A Millen safety terminal for the positive high-voltage connection, a three-terminal ceramic strip for bias and ground connections, and a male power plug for the 115-volt connection to the filament transformer are set in the rear edge of the chassis, while a pair of insulated terminals in the right-rear corner are for the excitation input.

Adjustment

When the amplifier is completed and ready for operation, the first step in adjustment is the neutralization. This may be done with the amplifier set up with all external connections made,

Rear view of the push-pull 250TH amplifier showing the mounting of the plate tank coil and 3.5-Mc. padding condenser.

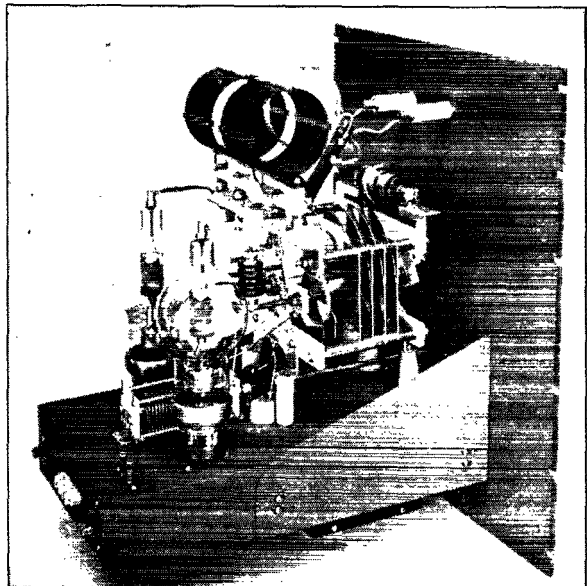

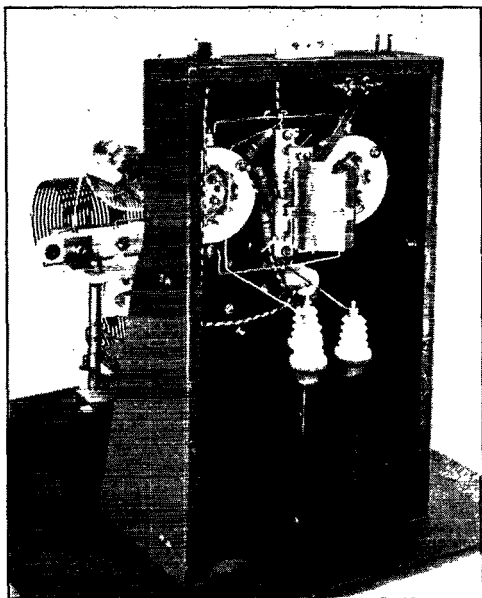

The filament transformer and grid coil are mounted underneath the chassis.

except for the antenna, but with the high voltage turned off. Bias for 2000-volt operation may be provided by a small pack with a biasing transformer delivering between 60 and 100 volts and a 1- μ fd. 350-volt condenser as the filter. A grid-leak resistance of 600 ohms should be connected across the output terminals of the supply, and the pack then connected to the bias terminals on the amplifier.

With the coils for the desired band plugged in, the tuning of the grid tank circuit should be adjusted until a grid-current reading is obtained. Then the neutralizing condensers should be adjusted simultaneously, bit by bit, keeping the spacing equal. When the amplifier is not neutralized, a dip in grid current will be found as the plate tank condenser is tuned through resonance. The neutralizing condensers should be adjusted until no change in grid current occurs as the plate tank condenser is swung through its range. This should occur with the adjustable plates of the neutralizing condensers spaced about $1\frac{3}{16}$ inches away from the rear stator plates of the tank condenser.

Although plenty of plate dissipation is available, it is desirable to do the preliminary tuning and loading of the amplifier at reduced plate voltage. Before plate voltage is applied, a grid-current reading of at least 200 to 300 ma. should be possible. The antenna link should be swung out to the minimum-coupling position. As soon as plate voltage and excitation are applied, the plate

tank condenser should be adjusted for minimum plate current. Grid current still should be above 200 ma. When the excitation is removed, there should be no indication of oscillation at any setting of the grid- or plate-tank condenser.

The output link may be connected directly to a properly terminated low-impedance line, or through a link-coupled antenna tuner to the feeders of any antenna system. With excitation and plate power applied, the plate current should increase as the link coupling is tightened and the antenna system tuned to resonance. With each adjustment of coupling or antenna tuning, the plate tank condenser should be retuned for minimum plate current. The minimum reading will increase as the coupling is tightened with the antenna tuned to resonance. The loading may be increased up to the point where the minimum reading is 500 ma., when the input will be 1 kw. at 2000 volts. With the amplifier loaded, the excitation should be adjusted to 200 ma. for the two tubes.

Silent Keys

It is with deep regret that we record the passing of these amateurs:

W6EQS, Dr. Edwin R. Kluss, Santa Barbara, Calif.

W6JNN, Chadwick B. Nelson, San Anselmo, Calif.

W6PTP, Vincent L. Phillips, Los Angeles, Calif.

W7AQK, Arthur V. Dunkle, Troy, Mont.

W7FMN, James C. Wurtz

W8BOW, William W. McLain, Wheeling, W. Va.

Ex-9BOL, Al Miller, Rockford, Ill.

W9OAS, Warren S. Houser, Ft. Wayne, Ind.

W9ZBR, John R. Brentlinger, Terre Haute, Ind.

K6TOP, Capt. Fred L. Bumgarner, Honolulu, T. H.

Strays

Can Hamdom beat or equal this record? Four brothers of the Winter family of York, Pa., are hams! They're Red, Stan, Russ and Glenn, W3GZX, W3HFG, W3HIE and W3KII, respectively. Members of the York Amateur Radio Club, the brothers have separate rigs and QTHs, which helps keep peace in the family though they do have a terrific QRM problem on the air.



How's DX?



How:

Did you get yourself a load of KBW's editorial last month on v.f.o. operating? If you didn't, go back to it now and read the best suggestion on v.f.o. QRM-reducing that has been proposed so far. The gist of it is that we call stations not closer than 1 kc. to their own frequency, and if we raise them we move on to them for all subsequent transmissions. Nothing could be simpler, and it would certainly eliminate a lot of QSOs jammed by long-winded callers. Pessimistic die-hards react by saying, "Phooey, it won't work — someone will always call closer than 1 kc. and thus jam the DX station." Which brings us to the point of this discourse and one that was left out of KB's editorial. *Most of our trouble with v.f.o.s. stems from receiving practices, not transmitting!* Why do we call DX on its own frequency now? Because that's where we've found by experience that they do their listening. If we knew equally well that they weren't going to listen there, we wouldn't call them, unless we wanted to show how dumb we can be. Before the war a few DX stations let it be known that they wouldn't answer stations who called them on their own frequency, and it didn't take long for the word to get around. This seems like a good time to make it the rule rather than the exception, and all that is required is passing the scheme along and strict observance of it by the DX stations. To indicate that the DX station expects to be called at least 1 kc. off his frequency and will look for you on his own frequency during subsequent transmissions, we suggest he sign "NS" after his call during a CQ. Don't try to get a fancy meaning out of that letter combination — it just happens to be a rhythmic one that could mean "Not Smack on," "No Soap," "Nuts to Swishers" or anything else. If the DX happens to be out of our c.w. bands and it wouldn't be wise for us to move on to his frequency because we would be interfered with by our own 'phones, or if we are using crystal and can't move right on to the DX station's frequency, we would send "SN," which again has no significance except a reversal of the letters, but it could mean "Stuck here Now" if you're looking for deep connotations. The success of the scheme is dependent entirely upon its strict observance by the DX stations — once they start refusing to answer calls on their own frequencies the plan will take care of itself. Talk it up and over on the air, and let us have any suggestions or further ideas that result. Here's your chance — you can have QRM and lousy

QSO conditions or you can have intelligent operating. The choice lies with you.

What:

The stuff is still there on 80 if you dig around a little. W2BO heard a ZL, to prove the route is open, W3FXN/2 worked W9QCI/CT2 (3720), and it is reported that W9VES/3 scared up F08FN (3740). W4IEN/CO (3820) is on at Guantanamo Bay, and W1ZL found W4FAY/K4 (3885). VO1P (3880) worked PY2RG (3880), the latter reputedly a "ship off the coast of Brazil." W7RT still haunts 80 and finds haunting pretty good, with W7VM/K7 (3885) and K7HAR/K7 (f) worked and W6URY/J5 (3800) heard. W6ITH worked KUIRO (4000 f), a ship in the Pacific.

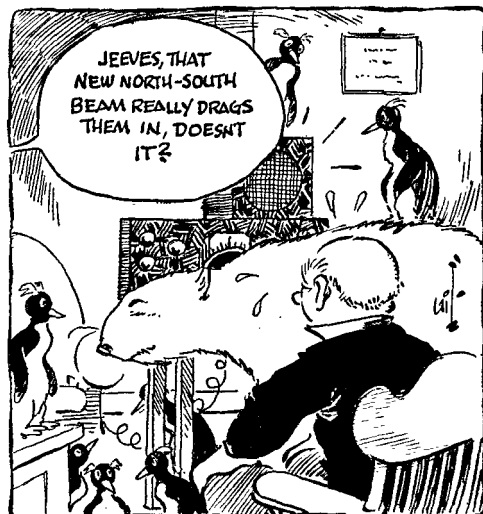

The 10-meter band isn't exactly a shooting-fish-in-a-barrel proposition, but it takes more than "conditions punko" to hold down the hardy ones. W2CYS is up to 75 countries, using both 'phone and hand-talking, and recent ones include W8SIR/VP9 (28,060 f), TR1P (28,200 f) in Tripoli, VQ6MI (28,080), KA1SS (28,020), W8WSY/KP6 (28,500 f) and VK7CM (28,060). He also grabbed off PZ1A (14,325 f) by arranging a cross-band QSO through VP3LF. This latter we consider a very slick trick indeed and bears out our contention that the old hands at DX aren't going to be pushed aside by any new crop of upstarts. It isn't always easy to find a time when 10 and 20 are good over the same route — W2MPA snagged XZ2DF (28,800 f),

W8QEN/CT2 (28,750 f) and **ZB2A** (28,050 f), and heard **KH6RI** (28,200) in American Samoa **VE7CE**, ex-**VE1ME/5**, used only 30 watts to grab off **W2ILE/K6** (28,030) at Palmyra Island, **FK8AN** (28,035) on New Caledonia, **XE1AM** (28,200), **KA1AZ** (28,040) and a flock of VKs and ZLs **VE1EP** reports hearing **VQ2FR** (28,060) **W6PBV** has quite a list of VKs, ZLs and less frequent stuff like **OA4AS** (28,035), **CM2SW** (28,140), **TG9JK** (28,010), **K6HOT/KF6** (28,060) on Canton Island, **W3GZT/J5** (28,055) on Okinawa, **KA1ZU** (28,045), **KA2SD** (28,090) and **VS6DY** (28,050). Heard were **YV5AP** (28,035), **VP9RC** (28,085 f), **KA1AI** (28,025), **FM8AC** (28,040) and **HK3BA** (28,045 f).

Where:

W8REC/5 corrects us on **CX4CS**, whom we erroneously listed as **CX4CX**, and tells us that his correct address is Jose Goyret, 1012 Blanes St., Montevideo. Louis also passes along the info that **WIKUY/HC** (28,250 f), marine portable around the Galapagos, can best be reached for QSL purposes through Bob Evans, PanAm Airways, Balboa, C.Z., and that **TI6TA** (28,240 f) is on. DX at **W8REC/5** is 12 countries in 15 days **W8ROX** says **TG9JK** can be reached care of Pan-American Airways, Guatemala City, Guatemala, and **XE1OQ** is Louis Valdez Miranda, Liceo 470, Guadalajara, Mexico Sgt. J. A. Hunt, **VS5/VS3JH**, and also **G2FSR**, writes to assure us that cards to those who worked him will be sent at the earliest opportunity. (Yes, Jeeves, I know that doesn't affect my sleep problem one way or the other!) He operated from Labuan Island off North Borneo, which would

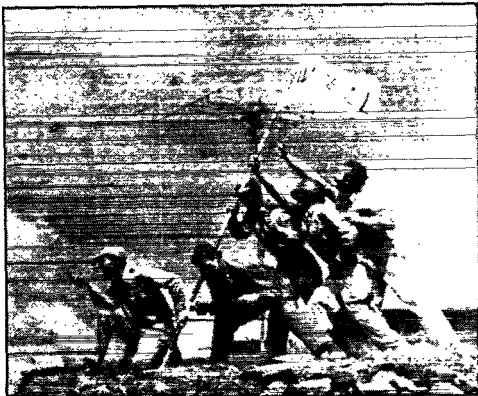

This picture is part of the clever QSL card of **W7ELL**. Iwo Jima. The four-element rotary in the background is authentic and so is Lt. B. H. Thomas, **W7ELL**, the guy with the half-mast pants and the undersize helmet. Naturally the gang is very enthusiastic about the location, and during calls apply to it such tender appellations as " . . . the Volcano on the Rock of Despair," and "the big ash heap of the Pacific."

make him a **VS4** in our book **W3EVW** gives us **OA4AB**, care of Pan American Grace Airways, Lima, Peru, and says that **PJ3X** is ex-**PAØDH** **W9VND** gives us a few hopes on the authenticity of stations by telling that he has received QSLs from **LZ1ID**, **EP1A**, **YI6JS**, **LI6ZY** in Libya, and **LB1A** in Lebanon. Incidentally, that **LB1A** was on one Sunday morning for three contacts and is now back in England. Some of those others were ones Ozzie worked while mobile marine, but it's good to know that they exist.

Who:

VE7ZM has worked 41 states and 18 countries on 80 since April, the prize being **F08FN** at Borobora near Tahiti, operated by **W4GSJ**. Post-war DX on 10 is **WAC**, 44 countries and 44 states, and the big total is 126 Nice letter from **W2OAA/J8** in Seoul, Korea. He will QSL this fall when he returns to 226 Coligni Avenue, New Rochelle, N. Y. He has been on over there with **JO1MO**, **AK1MO** and then his own call with the **J8** designation. The rig is a kilowatt to an HT-4, and 47 countries have been worked Our ears are pinned back, very justifiably, by one of the ops, **Matty Matteson**, of **W5ILN/Tinian** and **W9CPJ/Tinian**, for erroneously tying in those and other stations with **W6MBA/Tinian** in a recent edition. They were all separate stations and weren't even on a common power line, and the only thing they had in common was an occasional interchange of operators for the usual social reasons. So we weren't giving you the bargain we thought we were. The rig at **W5ILN** was housed in the shack from an **SCR-399** and a lazy-II antenna was used. The boys had a cute trick out there. They stacked bomb-tail crates — empty ones! — to get experimental masts **W9WUG/KB6** and **W6QKB/KB6** are looking for East Coast contacts around 0900 to 1100 EST. Beams should point 180° from the normal Western bearing to work the Pacific islands at that time. Sounds funny, but they have worked into Illinois that way, talking to them twice during 24 hours. That's real world coverage. The receiving system at **W9WUG/KB6** uses two acorn-tube stages from an **S-36** as a preselector ahead of another **S-36** which acts as a converter to 5 Mc. into a Super Pro! The antenna is a 4-element job 53 feet high We couldn't think up any gags about a fast **WAC** that the GI boys wouldn't be able to top, so we'll be content to list a couple: **W9BBD/2** worked **W3JZZ**, **CSZ** (Lisbon), **ZC2CU**, **XZ2DF**, **PY7AF** and **ZS6FC** between 1020 and 1250 on April 8th for a 2½-hour one on 10 'phone, and **W5ALA** was the 6th contact for a 91-minute **WAC** by **LU9EV** via the same medium **W6PUZ/Tinian** — also not to be confused with **W6MBA/Tinian** — with **W8RXL** as second op, has run up a sweet score

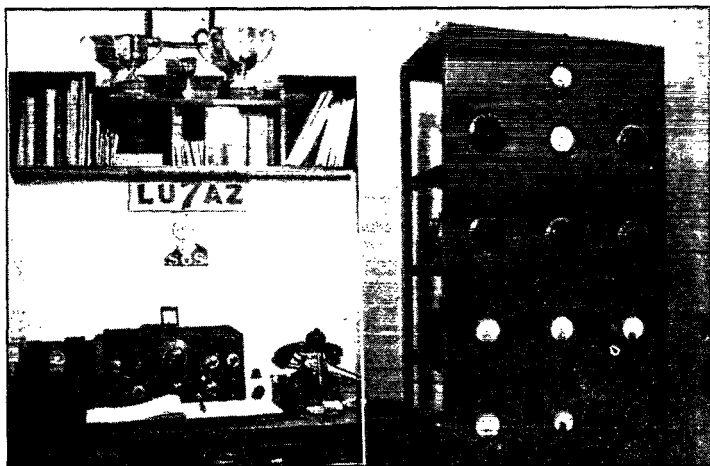

The new station at LU7AZ. The shack is considerably smaller than the old one, accounting for the two-part photograph, but it still shows the touch of the experienced DX man. The preselector to the left of the NC101X is homemade, and the receiver has been revamped with iron-core i.f. transformers and a noise limiter. The transmitter uses a v.f.o. and four 6L6C doublers which drive a handswitched 814 stage on any band from 80 to 10 meters. The final amplifier is a Philips IIF300 running at 500 watts, modulated by a pair of 838s. At present the antenna is a center-fed 14-Mc. half wave.

Camilo Raffo was first licensed in 1928 as LU5CN and has been LU7AZ since 1931. He is WAC, WBE, DXCC, and was the first LU to make WAS. You will usually find him close to the top in DX contests, and even the war didn't hold him down — the cups in the photograph were local awards received for 56- and 112-Mc. work. His postwar countries list is up to 66.

out there, to the tune of 77 countries, including guys like VQ6MI (28,100), XZ4AM (28,160), VQ4AA (28,000), CN8AC (28,040), YL2XG (28,020), VS7CX (28,100), YR5K (28,050), SU2GV (28,080), VS1RP (28,500 f), VQ2HC (28,260), HS2F (28,000), VQ3EDD (28,040), CR9AG (28,180), VQ4ERR (28,300 f) and VS1RS (28,060). The transmitter is an HT-4 running at 450 watts, the receiver is an SX-28 with 6AG5 preselector, and the antennas are a *stacked* rhombic for the States and a four-wire Vee beam combination that gives three other directions. Don says that South America can be worked from almost any direction, depending on the time of day, and the band is open from 7 A.M. to 2 A.M.!

W6TZB/K6 listened on 80 just before dark during a return flight from China and, 350 miles east of Iwo Jima, heard W3KBT/K7, W6TI and W6TT. To make it tougher, they were in the middle of an electrical disturbance, and the signals were copied through S8 QRN. At Hawaii, Bob is using a $4\frac{1}{2}$ -wavelength-per-leg rhombic that is better, on the nose, by about two S points than the four-element rotary. When the K6s get 80, he'll be on with a kilowatt

W6UYQ (28,640 f) is mobile marine in the Pacific and would like the gang to look occasionally for his powerful 10-watter

W2JGF has 20 countries with 30 watts input to a 6L6 doubler and a lazy H antenna

W7ABB has a few on 'phone for us: W8RWW/J9 on Kwajelain,

W1HUX/J9 on Eniwetok, W6EOZ/KF6 on Midway, VP6PC, Box 116, Barbados, and HK3AB, Box 1128, Bogata.

Why:

Did you ever stop to think about the "break" these GI DX operators are getting by being DX at some sought-for location? Sure it's tough being stuck on some island away from home and all, but radio-wise they're getting very radio wise. A fellow operating from W gradually picks up a bag of operating tricks, pet ways to raise tough DX stations, but it takes some time to work out these dodges. On the other hand, the DX station gets these tricks thrown at him every time he calls "CQ," and he soon learns which are the effective ones and which aren't. When he gets back to the States he has them all at his command

and is ready to smoke us right out. We plan to devote an entire chapter in our forthcoming book to interviews with these fellows. The book, by the way, is called "DX Psychology, or From Nines to Niue," and is scheduled to appear about September 31st. It should be terrific

W8DST was the first W contact of EP1C. He heard EP1C on 10 calling "CQ 20" and figured it was a harmonic. He called the Iran station anyway and raised him. It developed that EP1C had been calling that way through force of habit! Moral: if you hear 'em, call 'em.

Incidentally, the DX stations could do everybody a favor if they clearly show on their cards whether a contact was made on 'phone or c.w. Cards are assumed to be for c.w. unless otherwise marked, and some of the 'phone boys have a tough time getting proper credit for WAS, WAC, DXCC and the like on 'phone when the cards don't show it

Speaking of cards, you know that the uncalled-for cards for contacts prior to September, 1939, are going to be destroyed next year. So get that envelope to your QSL Manager if you want the precious pasteboards. Some of the stuff runs back years, so it may be there for you under an old call

From no less an authority than W1EH we learn that some of the boys are calling 10 the "Wonder Band." You wonder what's going to happen next!

Predictions:

Speaking of "wonder bands," if you do any wondering about July on 28 Mc., the IRPL charts are not too encouraging. The East Coast should work South America fairly well and maybe a few VKs, and the West Coast can be sure of VKs and possibly South America and Manila, but otherwise the picture is not too good. As in June, North-South stuff is the best bet.

Where no maximum usable frequency is shown it means the 28-Mc. band should be open during the period — a single time indicates when the corresponding m.u.f. is reached.

Path	Max. Usable Freq. (Mc.)	Time (GCT)
Washington — S.F.	25	0200
Washington — Rio		1900-2230
Washington — Paris	22.5	2130
Washington — Manila	21.5	0100
Washington — Sydney	26	0200
Washington — Johannesburg	23	1700
S.F. — Rio	26	2230
S.F. — Paris	20.2	2000
S.F. — Manila	26.5	0530
S.F. — Sydney		0000-0500
S.F. — Johannesburg	22	1730
S.F. — San Juan, P.R.	26.5	0200
N.Y. — San Juan, P.R.	27.6	2330

— W1JPE



MIDSUMMER of 1921 is upon us and in The Operating Department of our July *QST* we read, "C.w. is fast supplanting the spark transmitter, and while this change is being made our message traffic is suffering. . . . There is no use trying to dodge the issue. C.w. is here to stay . . . c.w. will be so far ahead of the spark that messages of unimportance will be left for that means of communication, while the messages of importance will go via c.w. because they will get thru."

All is in readiness for the Static-Puncturing Contest this month and the c.w. men are planning to really demonstrate their wares against QRN. "A Cup For Summer Achievement" is announced, to be presented by ARRL on behalf of a League member, Mr. Seymour Wemyss Smith, of *The Hartford Courant*, "to the amateur performing the most outstanding feat in the interest of Citizen Radio" during the period July 1st to Nov. 1st.

What is the power factor of an oscillating circuit? Is it unity or is it zero? "Few articles in *QST* have started so much deep thinking and so much violent discussion as the 'Wherefores' of Mr. M. B. West in February *QST*." The top authorities on radio matters theoretical are about evenly divided on this question. *QST*'s mail bag is weighted down with correspondence on the subject, and in this issue S. E. Anderson takes up the case for the unity-factor adherents in "Some of the Wherefores of Radio." An enlightening article, for the moment, but there's sure to be lots more written and said by both sides.

R. A. Heising's paper on "Modulation in Radio

Telephony" tells us that we are going to need new techniques, much different from the rules for telegraphy, to handle properly this new medium. "The Ideal Spark Station," by R. C. Denny, 6CS, unfolds many new ideas on spark operation. Charles Kinyon presents an elementary exposition of "Spark Reception on Honeycombs."

E. W. Whittier, 1DH, describes "A Sure-Fire C.W. Circuit" that gives promise of enjoying a bright future. *QST*'s editor has already tried the circuit at three different stations with surprising improvement in every case. The rig uses a pair of UV-202s in parallel with d.c. from a chemical rectifier on the plates. Efficiency is 33 per cent. Certain precautions must be observed in the transmitter's construction, namely, short leads and the inclusion of all by-pass condensers in the vicinity of the oscillatory circuits, not in the power-supply units. A filament voltmeter rather than an ammeter is recommended.

Irving Vermilya of old IHAA is being QRMed. And by the first district's new YL op, no less! She's Eunice Randall, assistant operator at radio-telephone station 1XE. VN's traffic was down last month. He placed second to 1CK, the country's top station. VN has a new call now, 1ZE.

It's a safe bet we're going to attend the First A.R.R.L. National Convention and Show in Chicago in late summer. The committee in charge has promised for attendance at the banquet "at least 500 unattached young ladies who are willing to be talked to about radio."

Some of the gang want to drop the name "Citi-

(Concluded on page 148)

More Stations per Megacycle at Two Meters

An All-Push-Pull 100-Watt-Output Crystal-Controlled Transmitter

BY CALVIN F. HADLOCK,* W1CTW, AND RALPH S. HAWKINS,* W1OEX

OBSERVANT AMATEURS in the crowded areas have noticed that since the shift from $2\frac{1}{2}$ to 2 meters Old Man QRM has been more bothersome than ever. Amateurs using super-regenerative receivers and modulated oscillators find that fewer signals can be accommodated by the 4 Mc. allotted to their use in the new band, because frequency modulation and receiver selectivity are matters of *percentage* of the operating frequency. Consequently, increasing the operating frequency correspondingly increases the frequency modulation of the modulated oscillator and the bandwidth of the receiver.

Hams are prone to think of occupancy of a band in terms of the amount of QRM heard. If a dozen R9+ signals are present at once on the 2-meter band, the band appears to be crowded and the impression is that there are lots of stations operating. By way of comparison, try listening on the 6-meter band with a sharp receiver when a similar-dozen R9+ signals are present. One gets the impression that the band is practically unoccupied, because signals are far apart with lots of empty space around them. A comparison of this sort will drive home the fact that the 2-meter hams are really making very poor use of the

4 Mc. allotted to them.

The obvious step in combatting this QRM situation is to use a sharper receiver. The superheterodyne-superregenerative combinations recently described in *QST*^{1,2} are not beyond the scope of the average amateur and represent a definite improvement. However, the modulated oscillator has difficulty getting through even these relatively-broad receivers, and if that type of transmitter is about the only one in wide use a ham will hesitate to build the sharper receiver. Since a sharp transmitter will come through and even show up to advantage on a broad super-regenerative receiver, it appears that the first move could be to sharpen up the transmitters. Further, as pointed out in April *QST*³, a power amplifier is much more efficient than an oscillator so an increase in signal strength can be expected.

Transmitter stabilization involves two considerations: first, the variation of carrier frequency with modulation (frequency modulation); and second, frequency drift during and between transmissions. Of the two, the second is the most difficult problem in the simple v.f.o. type of 2-meter transmitter. Several two-stage m.o.p.a.s have been heard around Boston recently, and compared to the modulated oscillators they represent a very definite improvement when received on the superhet-superregen receiver, but the frequency drift is such that constant retuning of the receiver is required while listening to them. During long transmissions this drift ranges from 250 to 600 kc. If a transmitter drifts 500 kc., for

*Engineering Dept., National Co., Inc., Malden, Mass.

¹ Goodman, "A Four-Tube Superheterodyne for 144 Mc.," *QST*, November, 1945.

² Hadlock, "A Two-Meter Crystal-Controlled Converter," *QST*, May, 1946.

³ Grammer, "Stabilizing the 144-Mc. Transmitter," *QST*, April, 1946.

The 144-Mc. tanks and mountings are shown in this rear view of the transmitter. An outstanding feature of the unit is the simple, straightforward layout.

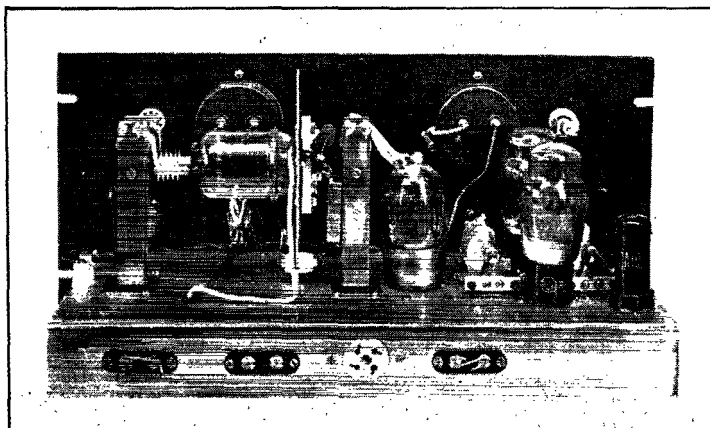

example, it will cause QRM at one time or another to all stations located in the $\frac{1}{2}$ -Mc. strip across which it drifts. In this respect, excessive frequency drift is almost as objectionable as excessive frequency modulation.

Although frequency modulation can be overcome by using several stages, and frequency drift reduced by swamping and compensating methods, we decided to do it the easy way and use crystal control. As soon as a crystal is slipped into its socket at the front end of the transmitter, you can forget about f.m. and drift; the problem is simply to get the required drive for the final with maximum economy in parts and power. Of course, a low-drift crystal should be used; drift is still a consideration with the third-harmonic or high-frequency type of crystal.

Another feature of crystal control is the opportunity it affords to operate very close to the edge of the band. Two crystals in use at W1CTW give frequencies of 144.04 Mc. and 147.98 Mc., and operating this close to the band limits gives the broad receiver a break because only about half of the carrier "blank" extends inside the band.

The Circuit

In planning the circuit, it was decided to use simple, conventional procedure, with trick circuits and methods ruled out. It was desired to multiply as rapidly as possible while still having drive to spare for each stage and operating all tubes well within their maximum limits. If the final stage is to be push-pull, doubling or quadrupling in the exciter requires changing from a single- to a double-ended stage, introducing problems of unbalance. We decided to start out with and use push-pull circuits all the way; this proved to be a very happy choice and produced an exciter that handles as easily as any lower-frequency job we have ever seen. Also, a push-pull tripler from 6 to 2 meters is by far the best way to end up a 2-meter exciter; the efficiency is surprisingly high, running about 30 to 35 per cent if properly driven. By using three push-pull

stages, we multiplied the crystal frequency by 27. This called for a crystal frequency between approximately 5.33 and 5.48 Mc., a range in which low-drift cuts can be obtained and which, incidentally, are quite plentiful as war-surplus stock.

Preliminary Layout

The question of a tube — or tubes — to be used in the final stage was given first consideration. A carrier output of at least 40 or 50 watts was considered desirable and 100 watts about the maximum necessary, since it was felt that at the present time much higher power output than this would not give sufficiently-improved results to justify the increased cost of the power-supply and modulator equipment. Tetrodes were considered preferable to triodes because they require less driving power and we hoped that it would not be necessary to neutralize them. Preliminary checks had shown that most of the common tubes, such as the 6V6 or 6L6, were worthless at 144 Mc., so the field narrowed down to three transmitting types — the 815, 832, and 829.

The 815 has the advantage of low cost and is capable of giving a 40-watt carrier. The 832, while it operates beautifully at these frequencies, is limited as to output and is quite expensive. The 829 in both the A and B versions is capable of considerably-higher output than either of the other two types. While it is quite expensive if bought new, it seems to be quite plentiful since the end of the war. The 829-B is especially desirable as it will take relatively-high inputs and is the sweetest little tube at 150 megacycles that the writers have ever seen. With this tube we have obtained a 100-watt carrier with about 135-watts input.

Two final-amplifier stages were built, and either can be used, depending on whether an 829 or 815 is available. The 829 is more stable than the 815, is relatively easier to drive and will give greater output, but the tubes available are apt to vary in characteristics and be more erratic in operation. The 815 gives a 40-watt carrier with 60-watts input.

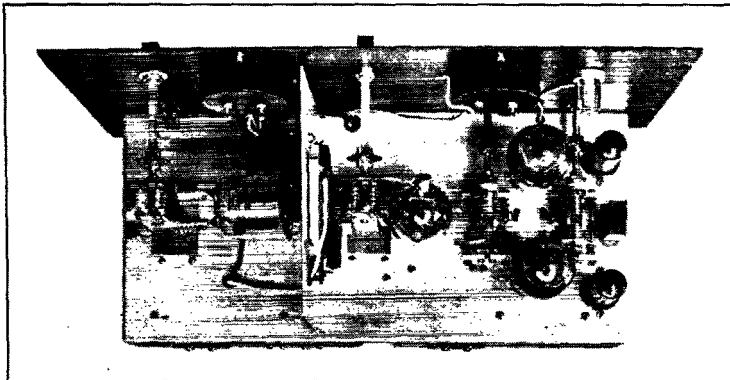

A plan view of the 144-Mc. crystal-controlled transmitter. The set is push-pull throughout, with all frequency multipliers operating as triplers. The crystal oscillator, using 6AG7s, is at the right, the following stages (progressing to the left) being the 6L6Gs as first tripler, 815 as second tripler, and 829 final amplifier.

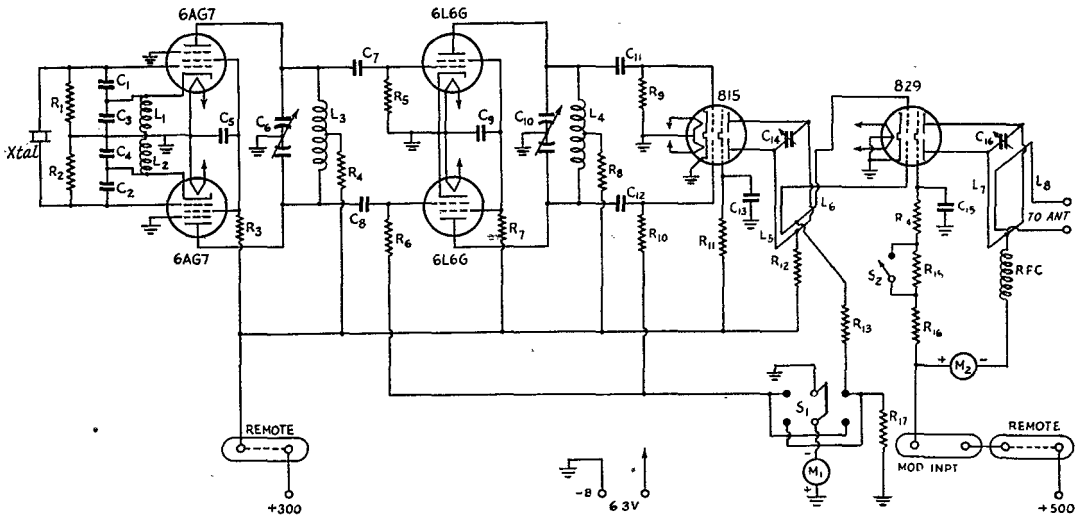

Fig. 1 — Circuit diagram of the 144-Mc. crystal-controlled transmitter.

- | | | |
|--|---|--|
| C_1, C_2 — 5- μ fd. ceramic, 500 volts. | R_7 — 30,000 ohms, 2 watts. | L_4 — 7 turns No. 16 on $\frac{1}{2}$ -inch-dia. form, length $\frac{5}{8}$ inch, center-tapped. |
| C_3, C_4 — 100- μ fd. mica, 500 volts. | R_{11} — 10,000 to 20,000 ohms, 4 watts. | L_5, L_7 — See Fig. 2. |
| C_6, C_9, C_{13}, C_{15} — .001- μ fd. mica, 500 volts. | R_{18} — 5000 ohms, 1 watt. | L_6 — See text. |
| C_8, C_{10} — 50- μ fd. per-section variable (National STD-50). | R_{14} — 5000 ohms, 5 watts. | L_8 — See text. |
| C_7, C_8, C_{11}, C_{12} — 250- μ fd. mica, 500 volts. | R_{15} — 0.1 megohm, 2 watts. | M_1 — 0-10 milliammeter (0-20 ma. may be used, in which case R_{17} is not required). |
| C_{14}, C_{16} — 10- μ fd. variable (National UMA-10; See text). | R_{16} — 5000 to 10,000 ohms, 5 or 10 watts. | M_2 — 0-300 milliammeter. |
| R_1, R_2 — 0.25 megohm, $\frac{1}{2}$ watt. | R_{17} — Resistance equal to grid-meter resistance, if 0-10 milliammeter is used. | RFC — 40 turns No. 26 closewound on $\frac{1}{4}$ -inch-dia. form. |
| R_3 — 15,000 ohms, 2 watts. | L_1, L_2 — 750 μ h. (See text). | S_1 — D.p.d.t. toggle switch. |
| R_4, R_5, R_{12} — 250 ohms, 2 watts. | L_3 — 20 turns No. 22 on $\frac{1}{2}$ -inch-dia. form (National XR-50), closewound, center-tapped. | S_2 — S.p.s.t. toggle switch. |
| R_6, R_6, R_9, R_{10} — 0.1 megohm, $\frac{1}{2}$ watt. | | |

The Exciter

In choosing the 815 for the driver stage, a push-pull tripler, we decided not to be fooled by the low driving-power ratings given in the tube handbooks. We believed that we should figure on about five or six watts output from the driver, especially in view of the type of circuit to be used, for the purpose of avoiding neutralizing the final. In the end, we found that our conservatism was well founded because, although we have ample drive for the final stage, there is not too much leeway.

It is very important that the 815 tripler be driven hard. A tripler stage requires more excitation than the same tube will require operating as a straight-through amplifier, and a high value of grid bias is essential. As shown in the circuit diagram, Fig. 1, we use 100,000-ohm resistors on each grid. About 150 volts of bias should be developed which calls for 1½ ma. per grid.

About two months of experimental work was done in our spare time before we were thoroughly satisfied with the exciter stages. Various tube combinations were used, involving 6AC7, 6AG7, 6V6, 6F6, 6L6, and other types. The experi-

mental chassis now has so many holes in it that it looks like a sieve!

The crystal-oscillator circuit is similar to the one used in the 2-meter converter described in May *QST*.² The 6AC7s are excellent oscillators and multipliers in this circuit, but it was found that enough third-harmonic output could not be obtained to drive the following stage without exceeding the maximum ratings of the tubes, so 6AG7s, which have similar characteristics and which perform equally well, were substituted. The 6AG7s will take about three times as much input as the 6AC7s and are capable of providing full excitation to the second multiplier stage.

This crystal-oscillator circuit is a push-pull grid-plate arrangement with electron-coupled output. The screen grids are grounded for r.f. while a fixed-frequency coil-and-condenser combination is connected between each cathode and ground. The coil and condenser values are not particularly critical, but should be adjusted roughly for optimum oscillation. A 2.5-mh. r.f. choke could be used for the coils, although it might be necessary to remove one or two pies. 5- μ fd. ceramic condensers are connected directly from grid to cathode to increase the strength of oscillation, particularly

with sluggish crystals.

The two tubes are made to oscillate in push-pull by the simple expedient of connecting the crystal from grid to grid. The plate circuit will then triple in push-pull by tuning the plate tank to the third harmonic. One advantage of this circuit is that the crystal will always oscillate regardless of the tuning of any of the controls of the transmitter. Notice that a high value of grid resistor is used on the control grids of the 6AG7s. Quarter-megohm resistors afford strong oscillation and particularly enhance the strength of the harmonics. In operation, the oscillator grid current should develop about 35 to 50 volts per grid. The oscillator should drive the following 6L6 grids to about 125-150 volts of bias.

The second stage uses a pair of 6L6s as a push-pull tripler. Smaller tubes were tried but were found to be inadequate. The rotors of the split-stator tuning condensers used in the first- and second-tripler plate circuits are grounded, and decoupling resistors are used for connecting the B+ to the center of the coils to avoid a second ground connection to the tank. The drive to the following stage should be adjusted by varying the screen voltage rather than the plate voltage, but the screen dissipation should not be allowed to exceed the maximum value specified by the manufacturer. The power supply for the exciter should deliver between 300 and 325 volts at 125 to 150 ma.

The Tank Circuits

The tanks in the plate circuits of the first and second stages use split-stator receiving-type condensers and coils wound on ungrooved National XR-50 coil forms. These coil forms were tried originally with the iron plugs furnished with them for tuning purposes, using fixed ceramic capacitors in place of the variable condensers. The plugs unbalanced the excitation to the following grids when it was necessary to move them away from the center of the coil in tuning, an unbalance which would not occur with slug tuning of single-ended tanks. The variable condensers are mounted above and the coils below the chassis, the two

tank leads passing through holes in the chassis.

The 2-meter tanks for the last tripler and final stage are identical and represent the end result of quite a process of evolution, starting from ordinary condenser-coil combinations and linear tanks. The condenser-coil tanks were not as efficient as the linear circuits, but the latter were too bulky and were not easy to tune from the front panel. Credit for the final form should be given to Marty Oxman, WINYU, who worked it out using material which was readily available. It is made of 1/16-inch copper strip, 3/4-inch wide, as shown in Fig. 2, and uses a National UMA-10 condenser for tuning. This condenser is easily removed from its Isolantite mounting plate and remounted on the ends of the copper strip, after the required holes have been drilled in the latter. A National GS-1 Isolantite insulator is fastened directly below the rotor to make the unit rigid. The inside of the bend at the bottom should be dimensioned to correspond with the length of this insulator. A flexible coupling is mounted on the end of the rotor shaft, which is turned by a knob on the front panel through a 1/4-inch polystyrene rod. The plates of the tubes are connected by thin copper strip to the upper ends of the tank. This arrangement has proved to be very satisfactory both mechanically and electrically, covering the 2-meter band with plenty of leeway.

The grid tank is made of 1/16-inch copper strip, 3/4-inch wide. The bend is made at the bottom to give exactly the same width as the plate tank to which it is coupled. The top ends of this strip are cut back to produce two leads which can be bent around so that they can be rigidly mounted directly on the two grid contacts on the tube socket. The tube socket is mounted with the large hole (cathode prong) toward the top. The loop is placed parallel to the tripler tank to give close coupling. This coil should be made as short as possible while still delivering adequate excitation to the final amplifier; the coil shown in the transmitter is slightly less than two inches long, exclusive of the lead length to the grids. It may be necessary to make two or three of these coils before the best size is obtained, a procedure which

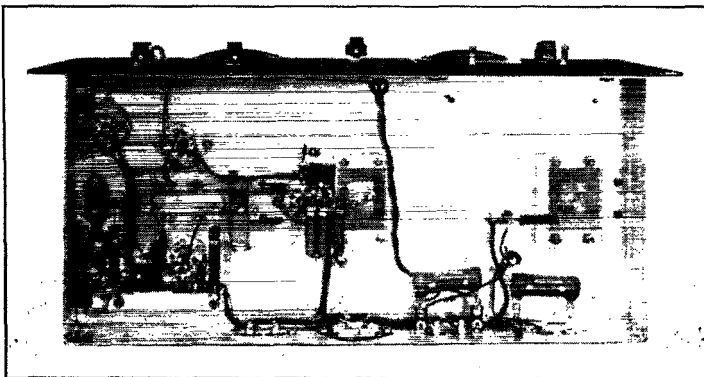

There is relatively little below-chassis wiring, as this photograph shows. Note the oscillator and first-tripler tank coils mounted parallel to the chassis in the section at the left.

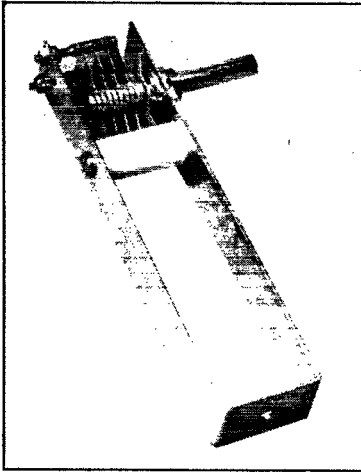

◆
The 144-Mc. tank, using a copper-strip inductance on which a standard midget condenser is mounted for tuning. The cylindrical ceramic stand-off provides mechanical support for the assembly.
◆

is to be preferred to using a larger coil and looser coupling.

The reason for using the small grid coil in place of a resonant one is to avoid neutralizing the final amplifier. It is commonly known that if the grid circuit of an amplifier is tuned to a higher frequency than the plate circuit, oscillation will not occur; this is demonstrated by the fact that a triode crystal oscillator will only oscillate if the plate tank is tuned to a frequency higher than the crystal frequency. By making the grid coupling loop as small as possible the grid circuit is detuned to a higher frequency than the plate circuit, thereby preventing self-oscillation. The result is that the 829 amplifier shows no appreciable need for neutralization. The 815 final stage, which required a larger grid coil, showed a slight degree of reaction on the grid meter when the plate tank was tuned through resonance without plate or screen voltage. However, it would not oscillate, and was very stable under modulation when coupled to an antenna.

The Layout

The entire transmitter is mounted on an aluminum chassis which measures $17 \times 8 \times 2$ inches. It is intended for rack mounting, using a standard panel height of $8\frac{3}{4}$ inches. The plate tank (2 meters) of the 815 tripler stage is placed in the exact middle of the chassis. The components of the three tripler stages are then laid out on one side of the chassis, placing the parts so as to permit the shortest possible leads. The tun-

ing knobs for the two tripler-tuning condensers are balanced on the opposite side of the panel by two switches. The final-amplifier tube is mounted horizontally on an aluminum angle 6-inches high by $7\frac{1}{2}$ -inches wide. On the transmitter shown, the bottom part of this piece is extended horizontally far enough to enable it to contain the entire amplifier stage with its connections. This was done so that more than one amplifier unit could be mounted in place for trying out various tubes and set-ups. If only one final stage is to be used, this expedient is not necessary and the bottom flange need be only about an inch wide. In that case, the best position for the final plate tank should be determined after the tube is in place. The mounting holes in the bottom flange of the aluminum angle can be slotted to allow some movement of the angle for varying the coupling between the last-tripler plate tank and the final-amplifier grid coil. A small antenna-coupling loop is mounted at the end of the chassis next to the amplifier tank.

The meter switch, S_1 , is so wired that in one position it measures the combined grid currents of one section of each of the second and third multiplier stages, and in the other position it measures the grid current to the final amplifier. The other switch, S_2 , is arranged to add 100,000 ohms to the screen-voltage dropping resistance for the final amplifier. The additional resistance prevents excessive screen and plate current (or dissipation) while tuning up.

On the back of the chassis is a four-prong socket to which are supplied (1) the hot 6.3-volt filament connection, (2) the grounded-filament and B-connection, (3) 300- to 325-volts B+ for the exciter stages, and (4) 450- to 600-volts B+ for the final amplifier. Two-terminal strips also located on the back provide for external switching and for connecting to the secondary of a modulation transformer. Wiring is relatively straightforward, and no comment should be necessary except for the usual recommendation to use short, direct leads.

Tuning Up

If the coils have been wound correctly, no trouble should be encountered in tuning up the exciter. The B+ lead to the final amplifier should be disconnected, or else the screen-supply switch S_2 should be thrown to the low-voltage position. When voltage is applied to the exciter, tuning the first stage should produce $1\frac{1}{4}$ to $1\frac{1}{2}$ ma. with the grid meter measuring the current in the exciter

Fig. 2—Dimensional drawing of the 141-Mc. tank inductance before bending. The material is $\frac{1}{16}$ -inch copper strip.

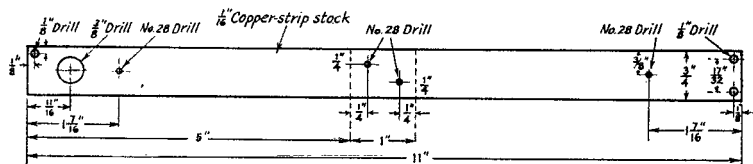

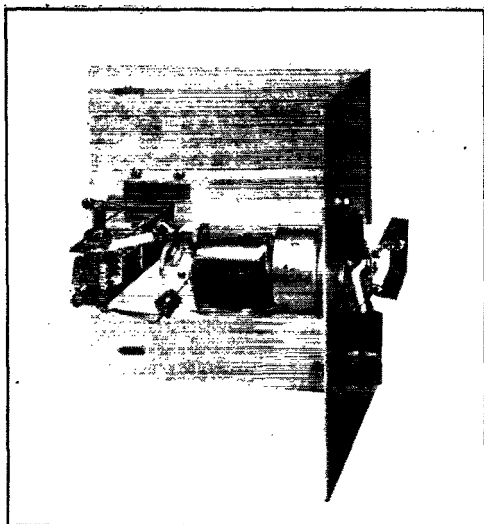

An alternative amplifier unit using an 815. The circuit and general construction are the same as for the 829 unit shown in the transmitter assembly.

stages. Tuning the second stage should develop another $1\frac{1}{2}$ ma. for a total reading of about 3 ma. The meter should then be switched to the final-amplifier grid, in which position it is shunted to read 20 ma., full scale. Tuning the third-tripler tank to resonance should produce about 12 ma. of grid current under load when the grid-coil coupling is correct. At this point the B+ to the final can be applied, if it was previously disconnected, and some antenna loading applied to the final stage, making sure that the screen switch is in the low-voltage position. After tuning to resonance, the switch can be thrown to apply full screen voltage and then the antenna loading can be adjusted to make the plate current rise to 200 or 250 ma. The transmitter is then ready for modulation, which requires no special comment since this problem is not peculiar to two meters.

With a transmitter of this type you can go on the air with a signal which is beyond reproach, and with efficiency and general ease of handling equalling that of transmitters of similar power on the lower-frequency bands. We believe you will find the results well worth the work involved in putting such a rig together.

FEED-BACK

In the circuit diagram of the wide-range test oscillator on page 41 of *QST* for May, the wire shown connecting one side of the a.c. line to the center tap of the high-voltage winding of *T* should be omitted. Otherwise the power plug should be polarized.

WWV Schedules

STANDARD-FREQUENCY transmissions are made available as a public service by the National Bureau of Standards over its standard-frequency station, WWV, on the following schedules and frequencies:

- 2.5 Mc. — 7 P.M. to 9 A.M. EST (0000 to 1400 GMT).
- 5.0 Mc. — Continuously, day and night.
- 10.0 Mc. — Continuously, day and night.
- 15.0 Mc. — Continuously, day and night.

The 10- and 15-Mc. radio frequencies are modulated simultaneously at accurate audio frequencies of 440 and 4000 cycles. 5 Mc. carries both audio frequencies during the daytime but only 440 cycles from 7:00 P.M. to 7:00 A.M., EST, while 2.5 Mc. carries only the 440-cycle modulation. A 0.005-second pulse may be heard as a faint tick every second, except the 59th second of each minute. These pulses may be used for accurate time signals, and their one-second spacing provides an accurate time interval for physical measurements.

The audio frequencies are interrupted precisely on the hour and each five minutes thereafter, resuming after an interval of precisely one minute. This one-minute interval is provided to give Eastern Standard Time in telegraphic code and to afford an interval for the checking of radio-frequency measurements free from the presence of the audio frequencies. Ionospheric disturbance warnings applicable to the North Atlantic path are given at 20 and 50 minutes past each hour. If a disturbance is in progress or is anticipated within 24 hours, the time announcement is followed by 6 Ws; if conditions are quiet or normal, the time announcement is followed by 8 Ns. The announcement of the station's services and of the station's call (WWV) is given by voice at the hour and half hour.

The accuracy of all the frequencies, radio and audio, as transmitted, is better than a part in 10,000,000. Transmission effects in the medium may result in slight fluctuations in the audio frequencies as received at a particular place; the average frequency received, however, is as accurate as that transmitted. The time interval marked by the pulse every second is accurate to 0.00001 second. The 1-minute, 4-minute and 5-minute intervals, synchronized with the second pulses and marked by the beginning and ending of the periods when the audio frequencies are off, are accurate to a part in 10,000,000. The beginnings of the periods when the audio frequencies are off are so synchronized with the basic time service of the U. S. Naval Observatory that they mark accurately the hour and the successive 5-minute periods.

Of the frequencies mentioned above, the lowest provides service to short distances and the highest to great distances. In general, reliable reception is possible at all times throughout the United States and the North Atlantic Ocean, and fair reception over most of the world.



Hints and Kinks

For the Experimenter



FIELD-STRENGTH METER WITH ADJUSTABLE ANTENNA

HERE IS A simple and handy type of field strength meter for use on any frequency up to 1000 Mc.

This unit has only four main components; a 6-foot flexible roll-up type steel rule, a high-frequency crystal, a d.c. microammeter and a copper ground plate in the bottom of a wooden box. The crystal is connected in series with the ruler and the ground plate, and the meter is connected in parallel with the crystal.

As shown in Fig. 1, a small plywood box was constructed with a sloping front panel and with a carrying handle on the top. The flexible roll-up ruler pulls up out of a slot in the top of the box to

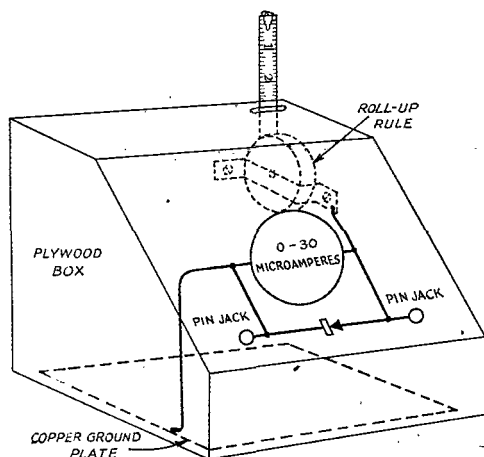

Fig. 1—An X-ray type drawing depicting the connections made in the field strength meter. Note the counterpoise, a copper ground plate in the bottom of the box.

the required height to give a sufficient deflection on the meter. Pin jacks on the front panel permit the easy placement of shunt resistors across the meter to reduce its sensitivity. (A 0-1 milliammeter has been used in place of the 0-30 microampere meter with some sacrifice in sensitivity.)

A meter such as this is very handy for tuning up an u.h.f. antenna or transmitter and also may be used to check relative field strengths and directional characteristics of the antenna.

Its use is not limited to u.h.f., and the unit shown here has received as much use in adjusting

an airplane transmitter on 3150 kc. as it did in connection with a television antenna on 900 Mc.

This simple meter should not be confused with a wavemeter having a tuned circuit as this one is in no way selective as to frequency. It's a mighty handy gadget, just the same. — Philip S. Rand, W1DBM, Harry S. Whittemore, W1BR, and Joseph H. Marchese.

— . . . —

NOTES ON CLEANING CRYSTALS

UNDOUBTEDLY there is hardly an amateur who has not removed the crystal from his transmitter and taken the holder apart for some reason or other. Usually it was because the crystal did not operate properly. The remedy was to wash the crystal with carbon tetrachloride or another cleaning fluid. Nine times out of ten, the rig would then operate correctly and everyone was happy for a few months until the action had to be repeated.

However, in the past five years techniques in the manufacture of quartz crystals for frequency stabilization have changed tremendously, and there will be relatively little need for cleaning a crystal made in these years.

It was learned during the war that crystals changed frequency while resting on the shelves awaiting shipment. The ultimate solution of the fault was to eliminate the use of abrasives as well as carbon tetrachloride in the final finishing. It was observed that abrasives left a broken surface which rearranged itself constantly, and that carbon tetrachloride left a residue which was detrimental to the oscillating qualities of the crystal. Thus was adopted the acid etch or fluoric etch process to finish the crystals, plus the use of warm water and soap to keep them clean. The result is that now, with the use of air-tight and hermetically-sealed holders, it is not necessary or even possible to remove the blank!

If you do happen to have a prewar crystal and it does need cleaning, do it in the following manner: lay the crystal on a piece of clean cheesecloth or kitchen toweling, and using a toothbrush, white castile soap and warm water, scrub both sides of the blank carefully. Then rinse in clean water, and make absolutely sure that the crystal is free from all soap and dirt. Rest the crystal on edge and let dry. While it is drying, wash the crystal electrodes in the same manner, and blow all of the dust and residue from the holder, being

careful not to get any moisture in the holder. After everything is dry reassemble the works. Cleanliness is an important factor, so keep your fingers off the surface of the crystal and electrodes. If you take the extra precaution of sealing the top carefully with shellac, you will probably never have to take the holder apart again. — *H. Edwin Dorr, Little Falls, N. Y.*

UNI-FREQUENCY TRANSMISSION AND RECEPTION

THIS SYSTEM was in use at prewar W5CAT and should appeal particularly to the many 'phone boys who have a receiver containing a crystal filter which is seldom used. The crystal is removed from the receiver and, as shown in the block diagram of Fig. 2, built into the exciter stages of the transmitter. A conventional mixer stage follows and produces a carrier frequency of exactly the frequency to which the receiver is tuned, the necessary heterodyning frequency being obtained by a simple pick-up loop coupled to the local oscillator in the receiver. The resultant frequency is continuously variable, following the receiver automatically up and down the band.

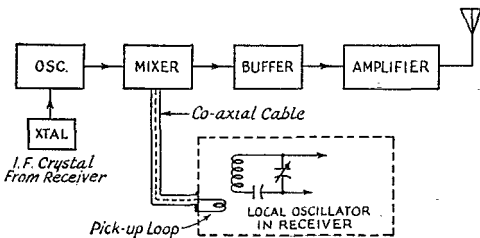

Fig. 2 — W5CAT utilized the i.f. crystal from his receiver in a transmitter frequency-controlling oscillator.

The advantages are obvious: when calling CQ, the operator simply searches for a clear channel on the receiver and when the transmitter is turned on it occupies that channel. Sometimes when making a radical shift in frequency it is necessary to touch up the transmitter amplifier stages but that is to be expected in any v.f.o. system. In answering a CQ the transmitter automatically comes squarely on the calling station's channel and the chances of making a contact are enhanced, especially if the calling station is also using this system.

It is conceivable that interference might be greatly reduced in all bands if this system was used widely, since stations in contact with each other would necessarily be using the same channel.

— *Cecil R. Gray, W5CAT.*

MEASURING GALVANOMETER RESISTANCE

IT IS sometimes necessary to measure the resistance of a deflection galvanometer or microammeter when no other meter is available. This can be done very simply, using the instrument to be measured as its own current indicating device. The other apparatus required consists of a fixed resistor, a calibrated variable resistor or decade box, and a battery cell, connected as shown in Fig. 3.

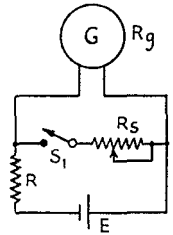

Fig. 3 — Measuring the resistance of a meter by utilizing the meter itself as the current indicating device. See text for component values.

The voltage of the battery should be such that R is large compared with the expected value of R_g , the quantity to be measured. R is then chosen to limit the current through the galvanometer to a safe value, preferably near full scale deflection. R_s must be capable of adjustment to a resistance at least equal to the expected value of R_g . The battery voltage need not be accurately known, but R must be known to the same decimal (not per cent) accuracy by which it is desired to determine R_g .

With S_1 open, read the current through the galvanometer on its scale. Close the switch and adjust R_s until the reading on G is exactly one-half of the first reading.

If R is large, 100 times or more the value of R_g , then the setting of R_s has the same value as R_g with a small error. For the general case where R is not so large, or to determine the exact value, R_g may be found by application of the formula

$$R_g = \frac{RR_s}{R - R_s}$$

— *E. M. Yard, 2 Whittlesey Rd., Trenton, N. J.*

RG-22U CABLE AS MATCHING TRANSFORMER

ONE OF the war-developed polyethylene dielectric cables, RG-22U, provides an almost ideal method for matching a 600-ohm line to a 15-ohm load, such as is represented by a two-element close-spaced beam. This cable, a shielded parallel line, has an impedance of 95 ohms. When it is used as a quarter-wave transformer the impedance is just the right value to effect a match

(Continued on page 148)

Looking over the Postwar Receivers

The Hallicrafters Model S-40

THE moderately-priced communications receiver in the Hallicrafters postwar line is the S-40, a 9-tube superhet with self-contained power supply and speaker. In basic circuit design it is the descendant of the prewar series of Sky Champions, but is now pleasingly styled in the modern manner. The r.f.-i.f.-audio line-up is standard: one stage of r.f. at the signal frequency, converter, two stages of 455-kc. i.f., diode-triode second detector and first audio, and pentode audio power output.

The nine tubes and their functions are as follows:

- 6SG7 — R.f. amplifier
- 6SA7 — Mixer-l.f. oscillator
- 6SK7 — First i.f. amplifier
- 6SK7 — Second i.f. amplifier
- 6SQ7 — Second detector — first audio
- 6F6G — Output audio amplifier
- 6H6 — A.v.c. and noise limiter
- 6J5 — Beat-frequency oscillator
- 80 — Power-supply rectifier

Front-panel controls include main and bandsread tuning, bandsread knob rotation: 5½ turns. Band: 14.0-14.4 Mc.; divisions on bandsread dial: 17; bandsread knob rotation: 2¾ turns. Band: 28.0-29.7 Mc.; divisions on bandsread dial: 80; bandsread knob rotation: 4¾ turns. The headphones jack is on the front panel, but all other external connections are made on the rear of the set.

The complete frequency range is 550 kc. to 44 Mc., covered in four overlapping bands: 550 kc. to 1700 kc., 1680 kc. to 5400 kc., 5300 kc. to 15.8 Mc., and 15.3 Mc. to 44 Mc. The main tuning

dial is calibrated directly in frequency on each range. The oscillator frequency is 455 kc. higher than the signal on the three lower-frequency tuning ranges, but shifts to the low side on the highest range. The antenna input circuit is arranged for either doublet or single-wire input, and transformer coupling is used between the r.f. amplifier and mixer, with additional capacity coupling on the two low-frequency bands to level off the gain over the ranges.

Electrical bandsread is provided by separate low-capacity variable condensers assembled with the main tuning gang; the bandsread dial has a 100-division scale spread over 360 degrees. Amateur bands are covered by the customary method of setting the main dial at the high-frequency end and then tuning with the bandsread dial. Band spread on the various amateur bands is about as follows:

Band: 3500-4000 kc.; divisions on bandsread dial: 95; bandsread knob rotation: 5¾ turns.

Band: 7000-7300 kc.; divisions on bandsread dial: 90; bandsread knob rotation: 5½ turns.

Band: 14.0-14.4 Mc.; divisions on bandsread dial: 17; bandsread knob rotation: 2¾ turns.

Band: 28.0-29.7 Mc.; divisions on bandsread dial: 80; bandsread knob rotation: 4¾ turns.

The r.f. gain control operates on the r.f. stage and the two i.f. tubes, as does also the a.v.c. when used. The i.f. transformers are condenser tuned by compression trimmers, with the i.f. bandwidth specified to be not less than 8.5 kc. at 2 times down nor more than 33.7 kc. at 1000 times

(Concluded on page 149)

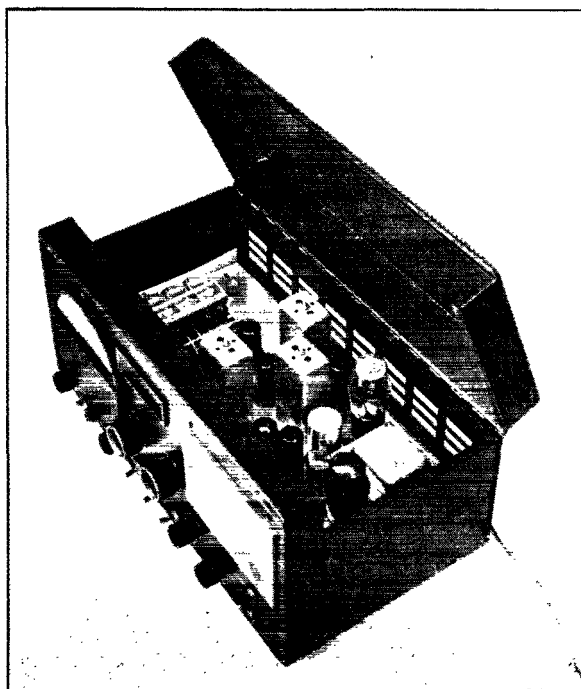

A glimpse inside the S-40. The hinged cane-metal lid not only provides plenty of ventilation but the design is such that it is easy to get at the parts on the chassis.



Correspondence From Members -

The Publishers of *QST* assume no responsibility for statements made herein by correspondents.

CODE PROFICIENCY

19 Merrill Rd., Norwalk, Conn.

Editor, *QST*:

W1AW practice run 10 P.M. today was FB. Keep up the good work!

— Fred Ells, W1CTI

535 Astor St., San Antonio 3, Texas

Editor, *QST*:

Just spent an hour with W1AW and code practice — very FB, and thanks. As you have stressed so many times it is a lot different when you try taking it on a mill. At 15 w.p.m. I got along fine, and at 20 I was still okay except for slight moisture on my brow. Then 25 w.p.m. and th mill ann I and W1AW began to get out of step. When 30 w.p.m. started I mssed th fat three wds and s k l x and then got in step for a couple of lines and then blacked out agn an boy was I swesatng . . . (35 w.p.m. coming up!) . . . "and his loalation is aproceably higher than other a eq has more highest 50 over and his location is cloosr to the — increasing the shad eh — but his spot is still not as dirr ult as that at one . . ."

Whew! Gimme a cigarettel

— Thomas E. G. Abbott, W5DTJ

MICROWAVES

4400 Highland Ave., Bethesda 14, Md.

Editor, *QST*:

. . . I am getting back on the air soon at this location and have my eyes set upon your new OES program as outlined in March *QST*. I am quite convinced that amateurs are going to do much toward converting wartime developments into practical rigs for ham use, particularly the high frequencies — and I hope to be in on the exploration of these new horizons. My present duties as Patent Counsel for Electronics, for the Navy Department, have made it apparent that there are many new fields for the amateur to delve into — and I hope that W1HDQ continues his fine work in *QST*.

More power to ARRL.

— Comdr. Newell A. Atwood, USNR, W3K0X

HAMS IN EIRE

Washington, D. C.

Editor, *QST*:

During the course of my visit to Dublin in March of this year on government business, I arranged to meet Dr. T. D. O'Farrell, EI6F, one of the more important amateurs in Eire and in charge of the X-ray department of St. Vincent's Hospital. Dr. O'Farrell invited me to have dinner at his residence at 40 Wellington Road, Dublin. I gladly accepted and had an extremely-pleasant dinner hour with the doctor, who appears rather youthful for his position, and two other Irish hams, Captain A. C. Woods, EI3L, a youthful member of the military, and Dr. Frank De Burgh-Whyte, EI8G, who served throughout World War II with the United Nations armed forces.

Incidentally, when I telephoned Dr. O'Farrell's residence to confirm my dinner engagement, his servant advised that

the doctor was "up a tree" and that I should wait for a few minutes. In due course the voice of EI6F came over the wire reporting that he had just erected a new Zepp antenna and the situation was under control! The Zepp was intended for 28-Mc. operation in view of the existing regulations in Eire which permit licensed "experimental" stations (operated as ham stations) to transmit and receive on the regular 28- and 56-Mc. bands.

After dinner, we were joined by several other local hams, and exchanged news, opinions, and gossip concerning amateur radio activities, regulations, apparatus, and trends in the United States, Eire, Britain, and the European continent. It appears that most of the amateur activity in Eire at present is on the 28-Mc. band and that contacts with eastern and central U. S. hams are good whenever the Irish signals can get through the American QRM. Many good signals from stations in the states east of the Missouri Valley are regularly heard on 28 Mc. in Dublin, including certain outstanding 'phone stations in the New York area who reportedly produce more than their share of "gabfest" emissions.

Third-party message traffic is permitted when the messages are of a character which would not be sent otherwise over commercial facilities. The Irish hams in general seem to favor a limitation in power to about 100 watts in the antenna and asked that I convey this idea to their American friends. One of the principal difficulties in developing ham radio in Eire is the lack of suitable apparatus and parts. The war brought about a shortage of ham gear which has not yet been overcome. At the present time, there are regulations of the local government which do not permit Irish currency to be used to buy U. S. dollars. It is hoped that within the next few months, currency and import regulations will be liberalized to the extent necessary to acquire some real amateur equipment. With only about 50 licensed hams in Ireland, including 20 in Dublin, there is not much incentive at present for dealers to stock amateur gear. . . .

— W. N. Krebs, W3AE.1

THOSE "Z" CALLS

84 Burrill Ave., Lynn, Mass.

Editor, *QST*:

I was assigned the call W1ZZC in 1928 and ever since the days when five meters opened up I've had one sweet time getting contacts on account of it. I've been called everything; been told to get off the air and several other such insulting remarks; been to the RI in Boston about having it changed but received no satisfaction. He said if anyone doubted the legitimacy of the call, have them contact him and he would set them straight. In the meantime I'm still without contacts. Only two weeks ago on 10 meters I called a fellow — no answer; I called him several more times — no answer. Finally the other night he answered me. He said he had heard me several times but wouldn't answer me on account of the call. The only contacts I get are those locally who know me or who have heard of my plight and take pity on me and give me a call. I know I'm getting out; I have good equipment and am putting out a strong signal to every station that has consented to answer me. So could you run a little article stating W1ZZC is not a bootleg call and explaining how it happens to be in use?

— Ralph H. Wickens, W1ZZC

REPORT ON ESTONIA

Box 2, Norrköping, Sweden

Editor, *QST*:

I suppose you will be rather surprised to get a letter from an Estonian amateur. It seems that most of the world's amateurs have already forgotten that "once upon a time" there was a little, friendly Estonian Free State with very active amateurs and ERAU (Estonian Radio Amateur Union) too. Reading enthusiastic letters from liberated countries in *QST* correspondence gives me the ground to add a little amount of bitterness to the all-around gladness in amateur circles all over the world.

It seems that in gladness about liberation from the Nazi yoke, the fate of the Estonian, Latvian and Lithuanian amateurs (and peoples, too) has been quite forgotten. As early as 1940 our countries were illegally occupied by Russia. All amateur stations were closed down and confiscated. The most active amateurs in Estonia were arrested and deported in unknown directions toward Siberia, like thousands of other Estonian peoples. During the war our country was destroyed first by Russians and then by Germans. We have had to suffer 3 years under German occupation too, and now after the end of the war our country is, instead of enjoying liberation, again occupied by USSR. It means more and more suffering for peoples who do not want any "liberators" from the east and will have their freedom and independence as they have had before.

Only a small part of the former ERAU membership has withstood all the terrors and ordeals of occupations and war and escaped with life. They are now dissipated among the whole of Europe as war refugees and displaced persons. They have lost not only their homes and personal property but also their home country. May all American amateurs, who have self-sacrificingly fought against the aggressors, not forget that all three Baltic States are still victims of aggression, and over 5 millions of people there are suffering without any fault of their own under hard, strange occupation.

— M. Saar, ex-ES3MS

'QSO-CRAZY' HAMS

St. David's Lane, Schenectady, N. Y.

Editor, *QST*:

The report of "QSO-crazy" hams (p. 81, May *QST*) has riled my ordinarily-placid composure. It indeed is fortunate for amateur radio that such stories do not reach the popular press. To my mind the brazen disregard of good taste in interfering with personal communication via amateur radio is a truly-serious offense, legally as well as morally.

If our ethical standards of amateur operating fail to prevent such occurrences why not start invoking FCC regulations against communication interference? A ham deliberately jamming up his neighbor's enjoyment of the Philharmonic soon would lose his license. I advocate some such penalty against those boorish amateurs, far in the minority but always with us, who wreck legitimate and serious amateur communication, much of which is of real value and importance.

— Dallas T. Hurd

P. O. Box 7109, Santurce, P. R.

Editor, *QST*:

I have been quite active on the ten-meter band and have been quite chagrined by certain happenings: first, the results I get from calling a directional CQ. I call "CQ Wichita Kansas," eagerly tune the band for possible results, and lo and behold! — stations are calling me! My mouth waters as I wait for the signing, thinking of talking with the folks, etc. Imagine my letdown when the station signs W2 . . . but wait, he's operating portable . . . but portable W3, and he has lost for me a chance of contacting Wichita. Needless to say, I do not answer him, so his time is lost as well as mine. I have counted as high as eight stations calling me after I put out a directional CQ, and none of them have

been in that direction. Boys, I know you like to get Puerto Rican contacts — I certainly did when I was in the ninth district — but one thing that you evidently do not realize is that you automatically go into my little black book when you call from off-direction. . . .

Second in my list of troubles is the use — or misuse — of e.c.o. Contrary to common belief, we here in Puerto Rico have just as much, if not more, trouble getting good DX QSOs (not contacts) than you fellows in the States. The skip is such that we receive all W districts all the time the band is open. Consequently a DX station in the clear is a rare thing. The other day I was fortunate enough to hook a ZS in the clear — for the first part of his first transmission. Then I heard the e.c.o.s start to move on him, then stations calling him while he was working me, and also stations calling me "OM, I need Puerto Rico for another country — please come back." (Jeeves, the black book!)

I do think that the users of e.c.o. should exercise common courtesy and wait until a DX station signs before calling him. It will pay dividends in more DX worked, and make a better feeling on the part of the DX station. Just put yourself in his shoes, and do unto others as you would have them do unto you. Here's for more good 100 per cent contacts and lots of DX to all, but let's get it the right way!

— J. P. Fitzwilliam, W9KPH/K4

LINE-OF-SIGHT

P.O.B. 49, Athens, Greece

Editor, *QST*:

In the March issue of *QST*, the first to arrive here since the beginning of the war, I have read with great interest the article, "Need there be Line-of-Sight?" by Mr. E. P. Tilton, about positive cases of reception of 2-meter waves "in the electrical shadow of a hill," if I may be allowed to use this expression.

Obviously, the common characteristic of the three cases shown in his Fig. 2 (p. 49) is the fact that the reception of u.h.f. waves was possible immediately behind a hill. This reminds me of a similar observation on the behavior of centimeter waves many years ago, during our first tests of what has been since called radar. (Radar research in Greece started in 1934 on a wavelength of five centimeters, occasionally alternating with a few tests on 60 cm., the upper limit of our magnetron tubes of that time.)

I had a transmitter located at the naval air base in New Phaleron, near Athens. A parabolic reflector of 320-cm. aperture concentrated the energy into a pencil-sharp beam of only 3 degrees, directed toward the open sea. The receiver, built around a similar magnetron tube and connected to a very powerful amplifier, was located in the immediate vicinity of the transmitter. In my first tests I was to utilize the principle of the "obstacle-detector" as installed on the French transatlantic boat *Normandie* (described in the *Bulletin de la Société Française Radio-Electrique*, 1935, No. 4, p. 110), but already universally known a couple of years earlier. The transmitter was to radiate continuously, whereas the receiver was supposed to show only a reflected wave, no pattern appearing on the cathode-ray tube screen when no obstacle was struck by the beam. In spite of the most careful shielding of all imaginable components both on the transmitter and receiver, reception was invariably present, whether an aeroplane crossed the beam or not, obviously on account of the radiation lobes of the reflector and the high sensitivity of the receiver. After a few weeks of unsuccessful attempts, I proposed to our GHQ to move the receiver to Piraeus, in the "electrical shade" of a hill of at least 60 meters in height, the vertical profile being very similar to the top diagram on page 49 of *QST*: the receiver was located just as in the case of W1JLK (Tolland), slightly over the sea level; then came the already-mentioned hill, 200 ft. high, running perpendicularly to the receiver-transmitter path; then a series of bays, separated from each other by hills of minor height; and finally the bay of Phaleron with the transmitter at the naval base, only a few meters above sea level, approximately corresponding to the location of

(Continued on page 150)

Operating News

F. E. HANDY, WIBDI, Communications Mgr.
E. L. BATTEY, WIUE, Asst. Comm. Mgr.

J. A. MOSKEY, WIJMY, Communications Asst.
LILLIAN M. SALTER, Communications Asst.

Leisure is time for doing something useful; this leisure the diligent man will obtain; but the lazy man never.

— Benjamin Franklin.

Useful results as amateurs are achieved through our employment of our leisure for one form or another of amateur radio activity — building, experimenting, planning, testing, organizing, operating! According to Ben Franklin no amateur can be called lazy. With our station workable we're ready to take on the ARRL station or leadership appointments that point up our particular amateur interest. Fun and usefulness are combined in all our projects. A batch of current reports from Section Emergency Coördinators reminds us that in addition to the amateur-service appointments that add to our own enjoyment of our hobby, we are organizing to be ready to do a useful local emergency-radio job for our communities with the ARRL Emergency Corps.

Join the AEC if not now in. AEC members and participating clubs have just returned from an extended week end of station testing, fun and results in the first postwar ARRL Field Day. By fall we would like to see a full-fledged Emergency Coördinator appointed for each city, town, village, and hamlet. Every station owner not already in the Emergency Corps should seek out his local Coördinator at once, or through his SCM obtain membership in the Corps, and insist on drills and other activities dedicated to local ama-

teur radio preparedness in the community. In an early-fall issue we expect to announce a simulated-emergency test with a scoring or rating system that takes local v.h.f. organization, and lower-frequency band tie-ins, both into consideration — a competitive operating activity open to all Emergency Corps Members. Full details will be sent to the AEC through Coördinators. The AEC is open to every active licensed amateur. A card to ARRL will bring Form 7A; if not already in the Corps, we suggest getting your AEC Membership fixed up now.

More SECs Welcomed. A Section Emergency Coördinator appointment is authorized for each of our 71 ARRL Sections. These men whose names we are proud to mention as they are appointed from month to month, devote much of their time to promotion and extension of Emergency Corps coverage. To the score or more on-the-job SECs previously cited, let us add:

Raymond E. Boardman, W1FVL, E. Mass.
L. E. French, W6SID, Utah-Wyoming
George H. Whitfield, W7BWE, Montana
Dana E. Cartwright, sr., W8UPB, Ohio

We are close to 50 per cent SEC coverage if we discount Canadian and Overseas Sections where a slower response is indicated. All amateurs are asked to recommend well-regarded amateurs of the proper leadership characteristics, as SECs, to SCMs in Sections where such appointments

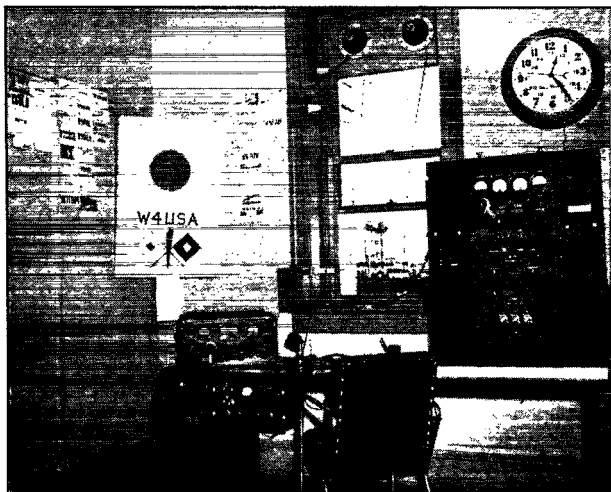

This was one of the first stations to establish regular communication with overseas amateurs after release of the 28-Mc. band. First known as W3USA when activated on January 17th, W4USA works with amateurs in both the European and Pacific Theaters. Conditions permitting, daily schedules are maintained with D4s.

W4USA was constructed in their spare time by amateurs on duty with the War Department, and is available for 24-hour supervised operation by licensed amateur operators assigned to the Army Communications Service, Office of the Chief Signal Officer, Washington, D. C. These operators participate in the operation of station WAR, principal control station in the Signal Corps' world-wide military communications system.

The transmitter at W4USA is a BC610 (500 watts), the receiver an SX-28. Antenna is a three-element rotary atop the WAR transmitting building in which W4USA is located.

are still to be made, to expedite Emergency Corps organization in those regions.

Independence of P. I. Section. We congratulate our P. I. members and appointees on their Independence Day, achieved as of July 4, 1946. The Board at its recent meeting appropriately amended the language of our by-laws so that P. I. members continue to be part of our ARRL field organization by attachment thereto. Attention is invited to SCM Rickard's report under Pacific Division station activities this month. It conveys our first news of relicensing progress, also some measure of the hardships necessarily suffered by some of our P. I. friends and a hint of the degree of amateur station rehabilitation necessary for so many P. I. members. Our admiration for the part they played. Best wishes for the early and successful return to the air of all KAs!

Official Observers Praised; More OOs Needed. At the first official postwar ARRL New England Division Convention (Framingham Radio Club, sponsor), Mr. George Sterling, W3DF, Asst. Chief Engineer of the FCC conveyed a message from the FCC at Washington. He cautioned amateurs concerning the individual and collective results of unauthorized or illegal operations. In the course of his remarks he stressed and lauded the valuable self-regulatory work of ARRL field-organization Official Observers. He suggested extension of their work by early increase of their numbers and activity. We're with him and want to implement this idea! *Official Observers* have assisted many hams currently by mailing them cooperative notices to call attention to spurious radiations, improperly-strong harmonics, bad notes or other difficulties that invite FCC trouble for the individual or the fraternity. Depending on equipment, experience and certification of frequency-measuring test results, OOs engage in the following classes of work: (I) Precise frequency checking. (II) Frequency checks (± 5 kc. at 14 Mc.). (III) Radiotelephone checks of modulation, stability, quality. (IV) Radiotelegraph checks: notes, clicks, chirps, stability.

All members are *eligible* to appointment; even without precise equipment, an amateur with a modern receiver can make excellent use of his time in observing spurious radiations, strong harmonics and other things that rate a Class-III or Class-IV OO appointment. ARRL is glad to renew its invitation to all amateurs who will help to get into this constructive, appreciated amateur program of helping fellow amateurs. We supply the necessary forms for postpaid mailings and reports, once the SCM has given his OK, and has sent ARRL Hqs. the proper appointment form. Hqs. letters point to needed observing as special attention seems required. All new OO frequency-checking appointments are made in Class II terms at this time, pending later opportunities for Class I Observer qualifications as a result of a

Frequency Measuring Test. More OOs of all types are needed in all League Sections. Get an application form from Hqs. on which to indicate your receiving-checking equipment. Helping in this mutual-benefit ARRL program gives you status (certification) as part of the League field organization. We invite you to get our form, and to send it to the SCM promptly to get your OO appointment under consideration. Like other appointments, it is subject to annual review and SCM endorsement; it can stay in effect as long as you can be active in the projected cooperative monitoring program.

Announcing — the July 27th-28th ORS-OPS Parties. It is possible that some additional frequency-band portions will become available by summer, but with 3500-4000 kc. fully returned it is not necessary to postpone plans for the first postwar radio get-together of all ORS and all OPS. Radiograms are still arriving expressing readiness! So here 'tis! All holders of ARRL appointments and offices with active stations may participate and be counted for QSO points; work other ORS, OPS, SCM, RM, PAM, SEC, EC, OES, OBS, OO, and Directors for credit. Stations count once, as worked on each band. No lists of eligible stations are available or will be necessary. A convenient reporting form will be available on request. Scores may be sent to Hqs. in the form of stations-worked lists, and will be checked against each other and appointee records there, as necessary. In general, ORS scores will be compared to those of other ORS; OPS with other OPS.

Starting Time: July 27th: 6 P.M. EST, 5 P.M. CST, 4 P.M. MST, 3 P.M. PST

Ending Time: July 29th: 3:01 A.M. EST, 2:01 A.M. CST, 1:01 A.M. MST, 12:01 A.M. PST

ORS/OPS Party Rules for Scoring.

1) QSO Points: If you are in W6, W7, K6, K7, or KA score 9 points per QSO. If in other districts, score 5 points per QSO. All participants score 1 point for each appointee-station heard but not worked, and reported.

2) Final Scores:

a) Total all QSO points, heard points, and add 30 extra points (or 50 if in W6-7, K6-7 or KA areas) for Code Proficiency credit. Submit copy of July 19th CP qualifying run or the date of earlier CP certification with ORS/OPS score to claim this last.

b) Total different Sections worked; see list p. 6, *QST*.

c) Multiply total points obtained in "a" by "b," the number of different sections worked.

d) Add to result of "c" the number of *different* stations worked, for final score. Mail to ARRL Hqs. promptly.

The above rules for eligible appointees and

ARRL officials working with them provide 33 hours for radio operations. Quite a QSO record is possible in that time. It is sure to be a worthwhile get-together. Some of us with responsibilities may not have that much leisure. In that event part-time operation will bring commensurate results. Even an appointee under vacation portable-privileges should try to make this first ORS/OPS shindig! Fast operating and fraternalism combined! BCNU.

— F. E. H.

UNLICENSED OPERATORS APPREHENDED

Pleading guilty to the operation of unlicensed stations in Belleville, Ontario, Gordon Ling and George Fralick were each fined \$25 and \$5 costs in city police court, Belleville, on April 16th. Their equipment was confiscated by RCMP on March 7th, following charges by Mr. Edward Leslie, inspector for the Department of Radio and Transport. The accused were operating unlicensed stations on the 2½- and 5-meter bands. It was the first such conviction in Canada since the start of the war.

A.R.R.L.-AFFILIATED CLUB HONOR ROLL

All members of these clubs are ARRL members.

The Amateur Radio Club of North Hudson,
Weehawken, N. J.
Amateur Radio Transmitting Society, Louisville,
Ky.
Binghamton Amateur Radio Association, Binghamton, N. Y.
Charlotte Amateur Radio Club, Charlotte, N. C.
Chester Radio Club, Chester, Pa.
Delaware Amateur Radio Club, Wilmington, Del.
Enid Amateur Radio Club, Enid, Okla.
Frankford Radio Club, Philadelphia, Pa.
Garden City Radio Club, Garden City, N. Y.
Glendale Amateur Radio Club, Glendale, Calif.
Grumman Amateur Radio Club, Bethpage, N. Y.
Huntington Radio Club, Huntington, W. Va.
Huron Radio Club, Huron, S. Dak.
The Illinois Ham Club, Chicago, Ill.
Inglewood Amateur Radio Club, Inglewood, Calif.
Intercity Radio Club, Mansfield, Ohio
Iowa-Illinois Amateur Radio Club, Burlington,
Iowa
Jersey Shore Amateur Radio Association, Long
Branch, N. J.
M. A. K. Radio Association, Arlington, Mass.
Norfolk County Radio Association, Norwood, Mass.
The Parkway Radio Association, West Roxbury,
Mass.
Providence Radio Association, Inc., Providence,
R. I.
Radio Association of Erie, Inc., Erie, Pa.
Radio Club of Tacoma, Inc., Tacoma, Wash.
Sunrise Radio Club, South Ozone Park, L. I., N. Y.
West Philadelphia Radio Association, Philadelphia,
Pa.
Wichita Amateur Radio Club, Wichita, Kans.
York Radio Club, Elmhurst, Ill.
York Road Radio Club, Elkins Park, Pa.

"THE A.E.C. IN KINGS COUNTY"

"The ARRL Emergency Corps in Kings County (Brooklyn, N. Y.) embraces some 35 fixed stations, 5 mobile stations, and 3 workable pack sets. Considerable more portable equipment is under construction. We started emergency-net operations in late November. When the revised AEC organization was announced we changed our network operation to conform with the ARRL-outlined procedures.

"Because of the 88-odd square miles of terrain that Brooklyn covers, we have organized the AEC into three subnets, namely Red, White, and Blue, with a subcontrol station for each net and an alternate for each subcontrol. This speeds up roll calls and message handling. Average attendance at drill periods has been always well over 50 per cent. We hold an AEC general meeting once a month and subnet meetings whenever a problem has to be ironed out.

"Our drills have consisted largely of message handling, dispatching mobile equipment to handle hypothetical incidents, originating simulated emergency conditions, and routing requests for assistance. The idea of the three subnets lends itself very nicely to competition within the net. When nets have an unequal number of stations reporting in, the control station usually assigns stations from the subnet having too many stations to the subnet with too-few stations. This is where the fun starts because these temporary assignments usually are made to stations that have difficulty in working each other. Hence it is no easy task to get a message to all stations in a subnet, especially when the other subnets are attempting the same thing, and on a competitive basis.

"Another point of interest is that our AEC network is composed of quite a few of the old-WERS lads. Now that ham tickets are coming through several of the former WERS operators are being licensed and getting into AEC operations. Each drill period sees new stations added. We are going forward and developing a real-effective emergency organization."

— Preston C. Yeomans, W2OHE,
ARRL Emergency Coördinator

BRIEF

Walter A. Keeling, W1OGQ, has been appointed Communications Officer of the Stratford (Conn.) Chapter, American Red Cross. With the cooperation of local amateurs, he has organized a 144-Mc. net for emergency work. There are two "fixed" stations, one in the tower of the Red Cross headquarters, and one in the Stratford Town Hall. Five mobile units are also used. Drills are held each Sunday morning at eleven o'clock. W1OGQ is ARRL Emergency Coördinator for Stratford.

HOW'S YOUR CODE SPEED?

ARRL's Code-Proficiency Program, designed to help all amateurs improve their ability to send and receive radio code, was resumed on May 1st. Have you tried copying the WIAW transmissions to determine how you stand? Did you get in on the first Qualifying Run on June 18th? Every amateur should be familiar with the advantages offered by the CP Program, which was explained fully in June QST.

WIAW conducts practice transmissions nightly, Monday through Friday, 10:00 p.m. EDST, at speeds of 15, 20, 25, 30, and 35 w.p.m. Once each month a special transmission is made to enable you to qualify for a CP certificate or endorsement sticker indicating progress above your first certified speed. See WIAW Schedule for details on frequencies. The next qualifying run will be on July 19th.

In connection with the weekly practice runs, QST lists in advance the text to be used on several of the CP schedules. This makes it possible to check your own copy. It also provides a means of obtaining sending practice since it permits direct comparison of one's fist and tape sending. To get sending help hook up your own key and buzzer and attempt to send right in step with the tape transmissions. Adjust your spacing in the manner indicated as necessary for self-improvement.

Date _____ Subject of Practice Text
From May QST

July 1st: *Noise Limiting in C.W. Reception*, p. 13
July 5th: *A Remote-Indicating Field-Strength Meter*, p. 21
July 9th: *We Have New Regulations*, p. 23
July 11th: *A Two-Meter Crystal-Controlled Converter*, p. 31
July 15th: *A Wide-Range Test Oscillator*, p. 40
July 17th: *Power Control Circuits in Amateur Transmitters*, p. 43
July 19th: Qualifying Run, 10:00 p.m. EDST
July 23rd: *Radio Propagation Work*, p. 45
July 25th: *Operating the 807*, p. 53
July 31st: *The Cliff-Dweller's Antenna*, p. 64

Take advantage of the WIAW practice sessions. Aim to get your CP certificate at an early date. Qualify at your present best speed and go after endorsements for higher speeds as you progress. Dates of all 1946 Qualifying Runs will be found in the Calendar of ARRL Activities, this issue.

BRIEF

Traffic handlers who are looking for a source of messages should not overlook the possibility of establishing contact with the folks at home for lads in military hospitals throughout the country. In addition to such worthwhile message service, beneficial service to those hospitalized would be given by assistance in forming radio clubs at convalescent and other military hospitals. ARRL would be interested in hearing of any such work that may be under way.

M.R.A.C. ACHIEVEMENT AWARD FOR 50 MC. AND ABOVE

At its April 11th meeting, the Milwaukee Radio Amateurs' Club voted to reestablish its offer of a gold-cup trophy to be awarded to the first United States licensed amateur to work two-way between continents in the v.h.f.-u.h.f.-s.h.f. regions. Initially offered in 1937 for work on the 56-Mc. band, the award is now available for the first between-continent contact in the 50-Mc. band or on any amateur band above 54 Mc.



The beautiful cup award is pictured here. It goes to the first United States amateur who qualifies in accordance with the following rules.

RULES

- 1) The licensed United States amateur qualifying must be utilizing transmitter frequencies in the range 50-54 Mc. or in any amateur band above 54 Mc.
- 2) The great-circle distance covered must be in excess of 2000 miles and the terminating stations must be located in different continents.
- 3) Documentary or written evidence from all parties who are principals in this radio communication must prove to the satisfaction of the officers of the ARRL and the MRAC that two-way communication was effected, and show what information was exchanged.
- 4) In the event of any doubt in the minds of the judges or in the event of simultaneous claims based on single inter-continental contacts, it shall be required that the United States station show documentary proof of contact with two different stations outside the North American continent, each at distances in excess of 2000 miles, each confirmed by appropriate and satisfactory written evidence, in claiming the cup award.

CODE AWARDS FOR CLUB MEMBERS

Radio Clubs, Attention! Note herewith a reproduction of a CLUB AWARD (Code Proficiency Certificate). This is independent of the ARRL Hqs. program for awarding proficiency certificates which is described in full in June *QST*. The certificate is devised to enable clubs to extend suitable recognition to individuals over the signatures of officers and witnesses in connection with radio club programs of any nature that will extend code proficiency.



Most forward-looking radio clubs organize 'round-the-table code classes as a sound way to insure new blood in the club, and to increase their memberships. Many clubs have been assisting former WERS to qualify as amateurs to facilitate local emergency organization plans. We suggest that radio clubs continue to do this *and in addition adopt an auxiliary program* to enable those who at present can do 15 and 20 w.p.m. to *increase proficiency* to some 5 or 10 w.p.m. above present levels. Both our sending "fists" and receiving ability need this attention.

CLUB AWARD certificates like that shown will be furnished gratis to *League-affiliated* clubs (1) that undertake to conduct code classes and qualifying tests; (2) that schedule local competitions between large or small groups of amateur operators to stimulate interest in code proficiency. As the blank places on the certificate will indicate, there is considerable latitude in the manner of conducting rating tests. Code or cipher can be used in addition to plain language in qualifying candidates for Club Award certificates.

ARRL-affiliated radio clubs are invited to apply to the League for a suitable supply of Club Award Certificates, after inaugurating such a program as suggested above. A newspaper announcement of the Club program and plans should bring some new faces to your meetings. The Club Award certificates may be given for either sending proficiency or receiving proficiency.

— F. E. H.

WIAW OPERATING SCHEDULE

Official ARRL Bulletins containing latest FCC information relating to amateur operation and reactivation, and other bulletins on matters of general amateur interest are transmitted on regular schedules, as follows:

Frequencies: 3555, 7145, 14,280, 29,150, and 52,000 kc.

Times: 8:00 and 11:30 P.M. EDST, Monday through Friday. (0000 and 0330 GCT, Tuesday through Saturday.)

Starting at the times indicated, bulletins are transmitted by telegraph simultaneously on all frequencies. Bulletins are sent at 25 w.p.m. and repeated at 15 w.p.m. to facilitate code practice. Telegraph bulletins are followed in turn by voice transmissions on each frequency, except that 3950 is substituted for 3555 kc. Changes from this schedule will be announced by the operator.

Code-Proficiency Program: Practice transmissions at five speeds, 15 through 35 w.p.m., are made Monday through Friday, on the above-listed frequencies, starting at 10:00 p.m. EDST (0200 GCT, Tuesday through Saturday). Approximately ten-minute practice is given at each speed. Next certificate-qualification run is scheduled for Friday, July 19th.

General Operation: WIAW engages in two-way work with amateurs, dividing time between 29,150 kc. (voice), 28,060 kc., 3950 kc. (voice), 3825 kc., and other frequencies as bands become available.

BRIEFS

The Pittsburgh Area Radio Club Council will sponsor a hamfest on August 4th, at Spreading Oaks, South Park, Pittsburgh, Pa. Based on the size of similar hamfests held in previous years, this year's attendance is predicted to reach at least 1000. Member clubs of the PARCC are Steel City Radio Club, Pittsburgh; Amateur Transmitters' Assn. of Western Pennsylvania; South Hills Brass Pounders and Modulators, Pittsburgh; Mon-Yough Amateur Transmitting Assn., McKeesport, Pa.; Fort Necessity Radio Club, Uniontown, Pa.; Greensburg Amateur Radio Club, Greensburg, Pa.; Horseshoe Radio Club, Altoona, Pa.; and Wheeling Amateur Radio Club, Wheeling, W. Va.

— —

Do you have *your* ARRL Emergency Corps membership card? Application forms are available from Emergency Coordinators, ARRL-affiliated clubs, SCMs, and Hqs. Among the interesting activities scheduled is an all-member Emergency Corps Test to be held in September. Join the AEC *now* and be ready for this nationwide workout as well as the simulated-emergency drills and tests being lined up by your local EC.

"IN THE PUBLIC INTEREST . . ."

The value of Amateur Radio as a public institution has been demonstrated again by W6PDB and W5JZQ/6 at Douglas, Arizona. These amateurs handled about 600 messages for GIs in the Pacific area during April. Much of this traffic was of an extremely-urgent nature. The service rendered received widespread recognition in the Arizona press.

One urgent message was to a GI's wife on her death bed. The GI husband in the Pacific was notified of his wife's death before contact was broken between the two stations. On another evening five urgent messages were received from W8SHY/J5 on Okinawa. All were delivered by long-distance telephone in approximately ten minutes, and replies returned to the GIs making use of amateur radio.

In addition to Okinawa traffic, many messages have been handled with W6PKP, KG and W6QKB/KG6 on Guam. Most of the traffic has been for the East Coast. The quick delivery service has been possible only through the cooperation of the Mountain States Telephone Company, and Western Union, in giving the amateur traffic highest priority on their wires.

BRIEFS

Pennies for your thoughts: Did you know that the Communications Department runs a continuing Article Contest in which the author of each article printed is awarded a \$10 prize (\$5 in Victory Stamps, plus \$5 in ARRL supplies or publications, except *QST*)? Contributions must be on a subject of general amateur interest, and of not over 500 words. Entries are judged on originality and value to the fraternity. Write on any topic relative to ham operating or organization. Mark your entries "for the CD Contest."

Are you troubled by QRM from local hams? Then you'll appreciate the following, quoted from a bulletin of the Westchester Amateur Radio Association, White Plains, N. Y.: "A very quiet and inconspicuous real estate development recently has acquired a couple of new names. 'Homewood,' nestled serenely atop and on the sides of a wooded ridge in the east part of Yonkers, is now known as 'Harmonic Hollow' and 'Skunk Ridge.' Why? Jack and the Beanstalk have nothing on what has happened over there. Poles have risen, strange assortments of arrays are to be seen swinging from the trees and sparks have been seen flying, but not from the chimneys. . . . Here reside and work out such as W8LO/2, W2JLA, W2CWZ, W9PEI, W2DXT, plus a few others who haven't reported in as yet; all enjoying a communal spirit that QRMs each other, all within a radius of about one-quarter of a mile."

EXPERIMENTERS, ATTENTION!

Applications for the newest ARRL station appointment (OES) are being processed daily through the SCMs. Among the first to qualify for Official Experimental Stations we find W1HDQ, W2OEN/1, W9WNL, W1IID, W9OKF, W1IJ, W9NNX, W9HAQ, W9WHIM/2, W4FKN, W9VET, W9VWU, W9YDX, and W2LXK. As more OES are appointed it is hoped to form groups of those with like interests for experimentation on specific projects.

Available to any licensed amateur operating above 50 Mc., the Official Experimental Station appointment is designed to further the development and experimental operation of v.h.f.-u.h.f.-s.h.f. communications systems and equipment. Of particular interest is the production of data to aid in discussion and knowledge of transmission phenomena peculiar to each of our higher-frequency bands. Attention is called to the article in March *QST*, page 66, wherein the aims and benefits of OES are outlined. Those amateurs who have had experience in electronics, radar, sonar, and technician skills will find the appointment particularly appealing.

There is going to be a whale of a lot of fun connected with development of the frequencies above 50 Mc. The Official Experimental Station appointment opens the way for group cooperation along the lines of special interests, provides medium for exchange of ideas, and enables coordination of data on v.h.f.-u.h.f.-s.h.f. equipment, communication methods, and propagation data.

Every ARRL member operating a station above 50 Mc., who has experimental interests, will find OES right up his alley! Write your SCM or ARRL Hqs. today for application forms.

CALENDAR OF A.R.R.L. ACTIVITIES

July 19th: W1AW CP Qualifying Run
July 27th-28th: ORS/OPS QSO Parties
Aug. 19th: W1AW CP Qualifying Run
Sept. 18th: W1AW CP Qualifying Run
Sept. 21st-22nd: Get-Acquainted Party
(Prewar amateurs to rag-chew with LSPII operators.)
Oct. 12th-13th: Emergency Corps Test
Oct. 17th: W1AW CP Qualifying Run
Oct. 26th-27th: ORS/OPS QSO Parties
Nov. 16th: W1AW CP Qualifying Run
Nov. 15th-17th and 22nd-24th: Sweepstakes Contest
Dec. 15th: W1AW CP Qualifying Run

May 1st-Dec. 31st: 1946 V.I.L.F. Marathon
(complete details in May *QST*)
Mar. 1st-Dec. 31st: WAS Competition
Above 50 Mc. (see page 80, May *QST*)
Started Mar. 1st: Competition for First
WAS on 50-Mc. Band (see page 58,
May *QST*)

HAMS AT HEADQUARTERS

WIAW, ARRL Headquarters Station WIINF, Headquarters Operators' Club

The following calls and personal sines belong to members of the Headquarters' gang:

W1BAW	R. T. Beaudin, "rb"
W1BDI	F. E. Handy, "fh"
W1CEG	H. M. McKean, "mac"
W1DF	George Grammer, "gg"
W1EH	K. B. Warner, "ken"
W1FTX	R. M. Smith, "rs"
W1FWH	W. F. Bradley, "wb"
W1GS	F. C. Beekley, "beek"
W1HDQ	E. P. Tilton, "ed"
W1JB	T. W. York, "tom"
W1JFN	A. L. Budlong, "bud"
W1JJR	J. T. Rameika, "jr"
W1JMY	J. A. Moskey, "joe"
W1JPE	Byron Goodman, "by"
W1LOP	Julius Galin, "jg"
W1LVQ	John Huntoon, "jh"
W1MFA	H. K. Isham, "hk"
W1TS	D. H. Mix, "don"
W1UE	E. L. Battley, "ev"
W9YMV/1	L. T. Waggoner, "roy"

HOW TO DELIVER A MESSAGE

It's all in the way you do it.

I was asked by W8QQN to deliver a message to a friend of his living within telephone range of my station. This recipient never had heard of me. Yet, after my first short sentence over the phone, he came back cordially, "Oh yes; yes; yes sir!" He might have known me all my life. What I had said was, "Do you know Lew Brewer, over in Grand Rapids?" (That's W8QQN.) Sure, he knew Lew, and was all anticipation and interest.

If you want to get a quick, ready, understanding response when you deliver an amateur radiogram over the phone, or in person, open the conversation with a topic with which the addressee is fully familiar, namely, the identity of the person sending the message. If you phone a stranger, or appear at his door, and say, "I'm Bill Bugg, amateur radio station W4QSO," his reaction is likely to be, "Now who is that? Never heard of him. What does he want?" So he says, guardedly, "Yeah?" Then you tell him you have a message for him, and he still wonders what you are selling. Oh, yes, he finally catches on, and is grateful, but I think there is a less painful procedure.

Try this. Without any introduction of *yourself* whatever, start in by saying, "You know Lulu Sheridan over in Hollycourt, Ohio, don't you?" You'll find the ice broken with one quick crash. He knows Lulu and he wants to hear more. *Then* is the time to say, "Well, I have a message for you, from her." The fellow then not only wants to hear what you have for him, but also, he wants to know who you are and how you got the message. So, now you tell him, "I'm Bill Bugg, and I got the message by amateur radio. I operate amateur

radio station W4QSO here in town." Boy, is that interesting! It's wonderful! Here is a little guy right here in my town who talks by radio with somebody over in Hollycourt, who apparently knows Lulu. "Give me the message quick; and tell me all about this amateur radio. It must be wonderful!"

Yep; it's all in the way you do it.

— Harry Fanckboner, W9BPS

A-1 OPERATOR CLUB

All active members of the ARRL A-1 Operator Club are requested to send a postal or radiogram to the Communications Department so that an up-to-date roster may be compiled. This club is aimed at promotion of a high calibre of operating in the amateur bands.

To become a member, one must be nominated by at least two operators who already "belong." A-1 Operators are constantly observing the operating proficiency and characteristics of all amateurs to determine those worthy of nomination to the club. When two nominations are received for an operator, he is added to the roster and receives an attractive certificate.

In choosing candidates for the A-1 Operator Club, members consider the following points:

1) General Keying. Well-formed characters and good spacing are considered above "speed." In nominating 'phone operators, good voice-operating technique, clearness, brevity, coöperation with other operators, careful choice of words, etc., may be used as criteria.

2) Procedure. Use of correct procedure is a natural qualification. Long CQs, unnecessary testing, long calls without signing, too much repetition when not requested, and all other poor practices are grounds for disqualification.

3) Copying Ability. This is to be judged by proficiency in copying through QRM, QRN, and other difficulties, and *accuracy* of copy as well as speed.

4) Judgment and Courtesy. The "CUL 73" type of operator can never make the grade. An operator should be courteous and willing to consider the other fellow's viewpoint. He should QRS or QSZ when requested. He should embrace every opportunity to assist beginners. The matters of "good notes," "sharp" signals, lack of frequency "wobulation," good quality ('phone), use of sound technical arrangement and proper adjustment while not directly points of operating ability are certainly to be considered under Judgment and Courtesy.

In weighing candidates, A-1 Operators consider each of the four required qualifications. Each counts a possible 25 points (of 100 total). No operator nominated should have a rating of less than 15 on any qualification. The total must be 80 or over to warrant a recommendation.

Regarding Disqualification: After an operator has been nominated, if exception shall be taken, or complaint made of faults in his operating work, copy of such complaint shall be sent to him in order that he may profit from constructive suggestions or explain the circumstances. In the event of a number of objections to a nomination, or lacking a satisfactory explanation, the call may be added to a "disqualified" list on record at Headquarters.

The A-1 Operator Club should include in its ranks every good amateur operator who follows standard practice on the air. The new club roster will appear in a later *QST*, when we have heard from a sufficient number of active members so that you may know who has made the grade.

TOLERANCE & COURTESY

We expected QRM to be severe on the 80-meter band until such time as the 40- and 20-meter regions were available to carry some of the load. But we didn't expect the congestion to reach the bedlam stage that it did starting promptly at 3:00 A.M., April 1st! There is no disputing the fact that interference is heavy, throughout the entire 3500-4000-kc. region, both voice and telegraph. None of us particularly enjoys working through interfering signals. As amateurs we have always had the interference problem. It's nothing new. We accept it as a part of operating. We have eased the situation to a considerable extent by using v.f.o.s and crystal filters in our receivers. But that's only part of the solution.

We have in amateur radio an operating condition not common to any other radio service. Each amateur may operate on any frequency he chooses in any amateur band, provided he abides by the existing regulations. No amateur or group of amateurs has any exclusive claim to any frequency in any band. We must work together, each respecting the rights of the other. We know of no case where one amateur has intentionally interfered with another's communication. But QRM is often unavoidable. It is inevitable that we occasionally find ourselves on the frequency used by another station. And the consideration of "who was there first" or "whose communication is most important" doesn't enter the picture. No amateur has prior rights to *any* frequency over and above another. Only in bona-fide emergency communications is the station not engaged in emergency work obliged to move from the frequency, or QRT.

Operating interests in amateur radio vary considerably. Some prefer to rag-chew, others handle traffic, others work DX, others concentrate on working certain areas or states, still others get on for an occasional contact to check a new rig or new antenna. But the point is this — in whatever phase an operator engages, he is doing so as a radio amateur, and he has every right to be on the air, both moral and legal. So we cannot condone such comments as, "Why don't that guy change frequency, he's busting up my rag-chew," or "Where does this bird get off chewing the rag on a traffic-net frequency," "Why do these eggs have to use *my* frequency for their contest QSOs," etc. We have heard such expressions, and many more! All of us have been guilty of breaking up somebody's QSO at some time or other. We didn't intend to do it, but it was just unavoidable.

What to do? There are two attitudes every operating amateur should adopt. First, he should be tolerant of the other fellow's interests. Second, he should exercise the maximum in operating courtesy and common sense. We can't *stop* all interference, but we can help reduce it. And here is the simplest single way to do it — BEFORE

PUTTING THE TRANSMITTER ON THE AIR, LISTEN ON YOUR OWN FREQUENCY. If you hear a trunk line or traffic net in operation on the frequency you intend to use, or if you hear any stations rag-chewing or conducting any form of communication on that frequency, stand by until you are sure no QRM will be caused by your operations, or shift to another frequency. Remember, those other chaps can cause you as much QRM as you cause them, sometimes more! The majority of amateurs own more than one crystal, many have v.f.o. It is not always necessary to stick to one single operating frequency. SPEND SOME TIME LISTENING ON ALL THE FREQUENCIES YOU USE FOR TRANSMITTING. You will soon learn what uses other amateurs are making of those spots. If you find, for example, that a net meets on one of the frequencies you use, or someone uses it for a regular schedule, you will soon learn the time that the net or schedule operates, and will be able to avoid a conflict. It has become quite general operating procedure these days to work stations on or near your own frequency. This practice will automatically assist in reducing interference.

If we will each do our part to operate with tolerance, courtesy, and sane practices, avoiding an attitude of running rough-shod over all other operators, we will do much to make ham operating more productive and enjoyable for ourselves as well as the other fellow!

BRIEFS

The local K4 gang in Santurce, P.R., including K4HLP, K4KD, K4ENT, K4IFO, K4HQU, W4BZA/K4, W6PQE/K4, W3HUN/K4, W8VRD/K4, and W5EVN/K4, holds nightly round tables on 28 Mc. 'phone after the band folds up for DX. W4HVT/PY7, a "non-resident" participant in the round tables on several occasions, was given a grand farewell on March 18th, his last night on the air before decommissioning the station to transfer back to the States. W4BZA/K4 is believed to be the first and last Puerto Rican station to contact W4HVT/PY7.

— . . . —

Upon the opening of the 80-meter band on April 1st, W1DWO's first QSO was with W1MUW, Manchester, N. H. His second contact was with W1JMY, West Hartford, Conn., from whom he requested the QTH of W1MUW. JMY replied, "Sure, I can give you MUW's address. She is my wife!"

— . . . —

Coincidence Department: W8UIY called W7JDB/5 on 28-Mc. 'phone. W7JDB/5 came back to W7EXP/3 and W8UIY simultaneously. Later the same day, W8UIY called K4KD, who answered W7EXP/3 and mentioned that he had heard W8UIY calling at the same time.

Station Activities



REPORT YOUR ACTIVITIES

• All operating amateurs are invited to report to the SCM on the first of each month, covering station activities for the preceding month. Radio Club news is also desired by SCMs for inclusion in these columns. The addresses of all SCMs will be found on page 6.

ARRL members are invited by SCMs to make application for the following appointments: ORS, OES, OPS, OO, OBS. Leaders are needed in several Sections to handle important SEC and EC posts. The SCM would also like to hear of your interest in RM or PAM appointments. Send all inquiries and applications to the SCM for your ARRL Section.

ATLANTIC DIVISION

EASTERN PENNSYLVANIA—SCM, Jerry Mathis, W3BES—3EEW is on 3.5 Mc. with an indoor antenna and low power. He is set for serious OO work. 3AOC has 30 watts on 3.5-Mc. c.w. but will have his half-kw. going soon. 3BRZ is renewing old acquaintances on 3.9-Mc. 'phone. 3HYD, of Columbia, is back from the Navy; he annexed an XYL and a new call, 4HXT, during the war. 8QEW has returned from overseas and QSOed 8SZF, another ex-Pa.-2 net man on 3.5 Mc. 8EU visited 8BQ, who is on 3.5 Mc. He hopes that the FCC will give him 3EU for his new call. He says a letter from 3AQN includes him in the E. Pa. net. 8SNZ has a pair of 35Ts running on 3.5 Mc. with about 450 watts input. 8AIW is on 3.5 Mc. with e.c.o. and 70 watts to T20. 3OP has moved to Friedens, where he has a couple of 55-ft. poles. He has worked twenty-eight states on 28 Mc. 3JPR, Slatedale, is on 28 Mc. with 50 watts and a three-element beam. 8GV has 400 watts to a pair of T55s on 3.5 Mc. where he has worked all W districts and VE1, 2, and 3. GHD worked ZB2A for his twenty-third country on 28 Mc. 3KT delivered a message for 1JTK/SV1 by calling Richmond, Va., on the land line. The Lancaster Radio Transmitting Society has sixty members and has elected the following officers: 3LN, pres.; 3DEI, vice-pres.; 3ADM, treas.; 3DRO, secy.; 3AXT, emergency committee. 3CJI/OA4AK has a four-element beam and is looking for the E. Pa. boys on 28 Mc. 8GSS, 8JHP, and 8VMF are on 3.5-Mc. c.w. 8UWQ is with Mackay Radio. 8UQW is now 3UQW and is on 3.9-Mc. 'phone. 8VD operates 28-Mc. 'phone. 6KCF, second operator at 3HQJ, got 7373S for his car tags without asking. Bud Dahl, active with WKIB, WERS, has his new call, 3KHR. A call-warming party was held at his home and was well attended by the nearby gang. 3AGV got RST599 from LU with an indoor folded dipole, and also worked ZL twice. 3GRS made application for ORS appointment. 3HXA hopes to be KA3HXA soon. 3BXE is back on working in TLAP. 3ILK has a pair of 808s on 3.5 Mc. 3ENX is having trouble with his 3.5-Mc. antenna. Traffic: W3DGM 46, 3BES 3, 3GHD 3, 3BXE 2, 3KT 2, 73. **MARYLAND-DELAWARE-DISTRICT OF COLUMBIA**—SCM, Hermann E. Hobbs, W3CIZ—EQK is QRL as Baltimore police officer with flying and aviation in general as side interests. He expects to be on the air soon on 7, 14, and 28 Mc. ADO, U. S. Naval Academy Amateur Radio Club at Annapolis, Md., is back on the air with 50 watts on 28 and 3.5 Mc. The club has just elected the following officers: A. G. Opitz, 1NWV, pres.; R. M. Bendel, vice-pres.; R. L. Beatty, 9LCI, supply officer; J. E. Deavenport, secy.-treas. During April 6U0U, 3 constructed a four-element rotary beam for 28 Mc. and to date has worked a total of twenty-one countries with only 35 watts input. Since doing that he has rebuilt the rig to work on all bands with a maximum power input of 60 watts. DPA was the speaker at

DARC meeting. DQZ, DRD, IYE, and KAT are heard on 28-Mc. c.w. HGA has FB antenna for 3.9 Mc. KEJ and KEF are new calls in Wilmington and both are active on 28-Mc. 'phone. AKR is back in D. C. and hopes to work 3.5, 7, 14, and 28 Mc. and v.h.f. by this coming winter. At present he is at Walter Reed Hospital, but manages to work on a new radio operating room at home, 412 Quackenbos St., N. W., Washington, D. C. CDG is on 3635 kc. PV has a weekly schedule with K4ENT, Puerto Rico, Saturdays, 3 p.m. Send in ORS/OPS certificates for renewal. Traffic: W9VES/3 32, 3PV 31, ECP 25, CDG 1, 6U0U/3 1, 73.

SOUTHERN NEW JERSEY—SCM, Ray Tomlinson, W3GCU—SEC, BAQ; ECS, ABS and JNZ. At the April meeting of the Delaware Valley Radio Association EED gave an interesting talk on his experiences while in Okinawa as radio operator in the merchant marine. 2CVG is new W2 in Roebling. CHO gave a talk on the proximity fuse at the May meeting of the Trenton Radio Society. New QTH of AXU is J. B. Power, R. D. 5, Trenton. CCC has ordered a new 129-X but in the meantime is using his old ACR-155 BEI has been reporting on harmonic radiation under his Class I OO appointment. 2OXX is first postwar ORS applicant. HTJ, GQX, FBC, EDP, and GCU have HQ-129-Xs. EEQ now sports a Millen "Variarm." ITS has just completed the e.c.o. described in the RCA transmitting tube guide and puts out a swell note on 3.5 Mc. ASQ is doing nice job as Class II OO; also as OBS on 145 Mc. LT is rebuilding his 28-Mc. squirter. ABS reports plans being formulated for first test drill of new 145-Mc. Forest Emergency Net. JWJ is new station signed in for this net operation. New W2 calls: 8VRM/3 now 2OUY; DVC now 2OXX; AKI now 2AKI; EUY now 2EUY; and a brand-new call, 2OSV. 3FTQ has better results on 3.5 Mc. than he had on 28 Mc. GNU, stationed in the wilds of Northwest Canada where he is working on the Loran System, says W1, 2, 4, 5, and 6 come through FB but no W3. ITU has been appointed chairman of the DVRA Hamfest Committee for the gigantic Victory Fest coming up in August. Traffic W2OXX 3, 73. **Ray.**

WESTERN NEW YORK—SCM, Charles I. Otero, W8UPH—BLP's QTH is now Hornell. Usually one of the early morning boys on 3.9-Mc. 'phone, he has worked 6s and 7s with 50 watts input, and K6 and K7 with 100 watts input on 3.5 Mc. c.w. The KBT Radio Club is holding the first hamfest in Buffalo on June 15th at the Hotel Buffalo. Registration starts at 2 p.m. Dinner, prizes and a good time is assured with a line of speakers on deck. NOR gave a very interesting talk on technical advances in Signal Corps fixed station communications before the KBT Radio Club. BCP called "CQ 10" rather anxiously one night when most of us were just listening. Curiously we gave him a call. BCP came back with twenty-three girls! His daughter, Diana, had a sorority meeting at the house. The RARA had three speakers at the last meeting: BAP talked on CAA communications system; Clarence Dinger on Police radio system; and OQC on flying control in England during the war. OCP and UBU visited 2TXB and 2WOW. JARA is having its first hidden transmitter hunt of the season. BDC perfected his 28-Mc. beam. ACK has designed new 500-watt 'phone rig, power supply and all, on one standard chassis. New call in Jamestown is 2OVK. BUT is building new home around ham shack. 8NW put new steel poles up for new antenna. JGX, PCV, and DBI are on the air, GBK and OZV are building remote control station. At the RAWNY Club, PE gave a very interesting talk on radar. New officers of the Niagara Falls Club are: IGI, pres.; FME, vice-pres.; KWS, secy.; and Ed Budd, treas. SJV gave a talk at the Niagara Falls Club on emergency net organization. There is quite a great deal of interest on 144 Mc. in Buffalo and vicinity. Tonawanda and North Tonawanda are hot on 144-Mc. stuff. Consistently on air are NOR, MKB, WHK, TPW, TPY, 2OPZ, 2OUJ, OWT, VCI, MYW, and SJV. SD is in there, too, and PBU was just initiated. The boys at Tonawanda meet at SJV's and after the meeting is adjourned, the fun begins at "2." The Utica Amateur Radio Club is active again. New officers are: PHK, pres.; PFJ, vice-pres.; WQI, secy.-treas.; TQM, public relations manager; PEP, technical and activities manager. Meetings are held at the local YMCA each Monday night. GWP has worked eighteen foreign countries on 28 Mc. PFJ reports working Vermont on 3.9 Mc. with 20 watts! Returned from the services and back on the air are: QXB, QXA, MKA, WME, WPN, WUW, and QJH. PHK, WQI, and WPN are on 144 Mc. 73. **Charlie.**

(Continued on page 82)

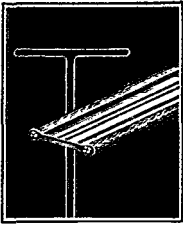

SIGNAL-TO-NOISE ratio is at least as important as sensitivity in a communication receiver, as we mentioned last month. Nearly all good communication receivers have enough gain to get down to the noise level so that the weakest signal that can override the noise is the weakest signal that can be copied.

Various factors influence signal-to-noise ratio and we have discussed them at length on this page from time to time. Of these, the antenna is so very important that we want to remind you again to use a good one for the receiver. Often we find amateurs who have spent days on the antenna for their transmitter and only a few minutes stringing up an odd piece of wire for a receiver antenna. Apparently, the theory is that a fine receiver does not need any help. It is true that a high grade set will perform remarkably well with almost no antenna, but you are throwing money away and missing a lot of fun if you do not provide your receiver with the kind of antenna its designers intended it to have.

The receiver may use the transmitting antenna, or it may have an antenna of its own. In either case, the antenna impedance should roughly match the receiver input impedance. The input impedance of most communication receivers averages between 300 and 400 ohms. There is a type of feeder now available which consists of two conductors spaced apart by a plastic ribbon, as sketched in the small picture at the top of this page. The most common size of this ribbon, with a spacing of about $\frac{5}{16}$ inch, has an impedance of 300 ohms and this will make a very satisfactory feeder for your receiver.

This same feeder will make a good folded doublet antenna, also. A length of ribbon equal to about 82% of a half wave length is shorted at each end. One conductor is cut at the middle and the two ends are joined to another length of ribbon which acts as a feeder. This will provide an excellent antenna system of proper impedance, and with wide enough frequency range to cover an amateur band.

There is a lot to be said in favor of using your transmitting antenna for the receiver. This is particularly true if you are using a directive antenna, for such an antenna will increase the signal as it does in transmitting and at the same time reduce noise and static originating at points outside the beam.

If the feeder from your transmitting antenna has an impedance anywhere between 300 and 500 ohms it will give excellent results with the receiver. Even a 75 ohm feeder is better than the single wire often used. However, much better results will be obtained if the 75 ohm feeder is coupled to the receiver through an impedance matching device. This may take the form of a $\frac{1}{4}$ wavelength section of 150 ohm feeder between the receiver and the 75 ohm feeder. The plastic ribbon mentioned above is also made in 150 ohm characteristic impedance, so it is very convenient for the job. This impedance matching arrangement is the same principle that is used in the familiar "Q antenna."

For more information we refer you to the 1946 ARRL Handbook. The folded dipole described above is covered in a general way on page 225.

JACK IVERS



(Continued from page 80)

WESTERN PENNSYLVANIA — SCM, R. R. Rosenberg, W3NCJ — Section EC, AVY, TOJ, NCS in charge of reactivated W. Penna. ORS net, reports active stations: AXD, CKO, HKU, MJK, KWA, NOJ, PER, PFW, and SZU. CKO, operating on 28 Mc. with three-element beam antenna, has worked fifty-five countries. RAT is active on 28.476 Mc. and reports that VNE is increasing power from his present 55 watts. MJK has daily early morning schedule with 4PL in Tennessee. DXN works out well with new p.p. 100THs in final. MUE/3 has nice signal on 3.5 Mc. UVVM is operating 3.5-Mc. 'phone. MIE has contacted more than 150 stations since 3.5 Mc. was opened. KEW worked California with only 15 watts input. TKU and CA are on 3.5-Mc. c.w. TTD has new SW-3 receiver. 2IAW desires to hear from amateurs near Butler who could schedule his home station. RMU has 150-watt rig on the air at Ginter with T40 final and is using HQ-129-X receiver. The Boys' Club of St. Marys Amateur Radio Society has been reorganized with following members: IFY, IOH, IOI, JZR, KXP, LSH, MUJ, NDE, REE, AIX, QXF, VMX, HRW, KAV, NUN, and CUZ. UVD is running 9 watts on 3711.8 kc. RAS has neat-appearing beam antenna for 28 Mc. WBM has completed new rig with 815 final. TXZ is rebuilding 1-kw. transmitter. KHE is Erie's latest ham. The Conneaut gang, which is always well represented at Radio Assn. of Erie meetings, includes: 9LCL/8, MNJ, BKM, MJM, ABS, SRJ, and PNF. NUG is on 3.5 Mc. with 807. BWP has erected new steel tower for beam antenna. 6PCB/3 and RIS have constructed new transmitter. RIS has HRO receiver with noise limiter built in at factory. MHD is active on 3.5 Mc. IOY is working on design of 28-Mc. antenna. WVJ was heard testing on 28 Mc. after being active on 144 Mc. RM2c Otto Kemper would like to hear from amateurs in Beaver Falls. NUH is running 500 watts input to p.p. T65s final, and received 599X report in Scotland on 28 Mc. RWJ operates from NUH's station. PDP has new transmitter using pair 812s final. KWA and his XYL, 3JSH, are now active on 3.5 Mc. Traffic: W8TOJ 76, HKU 35, MJK 24, AXD 12, CKO 8, RAT 7, DXN 2, 3NCJ 2. 73. Ray.

CENTRAL DIVISION

ILLINOIS — SCM, David E. Blake, II, W9NUX — Hamfesters saluted the ham of the month, Cy Read, AA, and wished him twice the fun in his next thirty years of hamming. Hamfesters is conducting code classes Tuesdays and Thursdays 7:30 to 9:30 p.m. at Viking Temple, 6855 S. Emerald Ave., Chicago. Stations in Chicago area on 144 Mc. are: VEZ, SPQ, 8NU1/9, ULP, AZK, NUX, SH, BYZ, BSE, YBE, LX, QPN, 4HOL/9, 2OGC/9, PSZ, FXB, KKT MXP, STZO/9, LXD, CCH, ARF, LSR, BBK, FFG, EQE, BAY, RHL, CYT, YCP, ZEL, JPZ, IOD, WJM, YQI, 4AVL/9. The CARCC holds its meetings monthly. DBO is on 3754 kc. 6HJP is now known as 9FGZ, located at 10833 S. Ave. F, Chicago, and is on 3.5 and 28 Mc. News from SCH: VYQ has rhombic on 28 Mc. KWN is "doing" all right both with YLs and on 3.5-Mc. c.w. SCH has the old coffee mill back on 3.5-Mc. c.w. and contemplates further studies in wave-propagation on the ionosphere this summer. ODT is on 144 Mc. with a four-element vertical "J" beam. AQP, YWS, and ODT are on 144-Mc. net. From JVI: AZW, FIF, and EJT are active on 3.5-Mc. c.w. YZO ordered an HQ-120. FWE is located in Grand Rapids. ACU is on 3.9-Mc. 'phone. ZAK is replacing blown condenser. NDA is on 3.9-Mc. 'phone. From BGC: The CSRA continues to meet at the La Grange Masonic Temple the 4th Friday of each month. Those active are GY, FVU, CIA, LOJ, GPV, and QLY. FCN is going up to 50, 144, and 224 Mc. MAT was heard on 50 Mc. with a rising response at the low frequency in his modulator — mostly hum. PK's antenna farm is sprouting 50-Mc. beams, arrays, et al. CIA is rolling up a terrific DX score on 28-Mc. c.w. with 807 and folded dipole. 3CEI is now 9HEM. DKM deserted 28 Mc. for 3.9 Mc. GA is working 807s into three elements on 28 Mc. SW and BGC are on 3.5-Mc. c.w. Ex-UPW is copying weather reports for code practice. EJT has 30 watts and doublet in kitchen on 28 Mc., works W6s, and is rebuilding for 3.5-Mc. c.w. AZW has bugs in the rig. KZD, with 807s and beam, knocks off W6s every Sunday. JVI is building fancy power supply with relays and colored lights and 28-Mc. folded doublet. The Twin City Radio Club reorganized with Oran Denhart, No. 1 IAW operator, pres.; YVY, vice-pres.; CCB, secy-treas.; S. L. Bing, public relations; RRY and VGM, directors. Meetings are held at Bondy and Lehmer Radio Co., 711 S. 6th

St., Champaign. 5IGW, of Rt. 1, Greenville Miss., would like to contact the ILN gang to work in as before. GGI and his brother, OH, are building up a ham's paradise in the way of equipment. GGI turned in a very fine report of more than 100 stations outside of U. S. A. and better than thirty countries copied on 14-Mc. c.w. The North West Radio Club meets regularly with a fine attendance and much activity. See LIP, RLW, or TLQ for information. CRR improved his 28-Mc. beam. BEN will try top load antenna on 3.5 Mc. OMA is on 28 Mc. ZHB really is working DX. GNU has antenna trouble. 6NGD worked 3.9-Mc. 'phone contacts while on a recent trip to Arizona and back with 8 watts input. DXL now is RCC, via 5 hours with TUM. On June 9th the Starved Rock Radio Club had an old-fashioned hamfest at Camp Ki-Shau-Wau. BRD has schedules including 6RBQ, 6QKN, YNY, and LAP (Atlantic-Pacific TL). This Trunk Line includes FS (NCS), IHPC, 1VB, 2EC, 3HUM, 3ECP, 4FCU, 5IGW, 6RBQ, 7HSD, 8CBI, TQD, IJB, and IU on 3650 kc. at 9:30 p.m. The following have made application for appointment: ORS: GGI, DXL, BGC, BRD. OPS: IAW, ACU, PSP. RM: AND. OO: IBC, TLQ, PSP. NUX. OBS: AND, IAW, PSP, NUX. EC: TH and Cahokia Amateur Radio Club, NUX. Traffic: BRD 187, DXL 6. 73. Dave.

INDIANA — SCM, Ted K. Clifton, W9SWH — MKU, out of the Army, and ONB, home on 21-day furlough, are on 28 Mc. HTH is LSPH operator who now has a call. FEQ has new 3.5-Mc. Zepp through courtesy of two neighbors. WDV and AB are on 50 Mc. JIW is on 3.5 Mc. with an 807. EUJ is building a 144-Mc. rig. RHL has 150 watts and a superhet converter on "2." 8IUG, at Hammond, has new HQ-129-X. SNF has new HT-9 and 100 ft. of transmission line to his antenna, most of it coiled up on the ground. DNA and WKV are on 144 Mc. in Griffith. EQQ is on 3.5 Mc. with a 144-Mc. antenna. SVZ heard an FOS on 3.5 Mc. AHS worked K7 on 3.9-Mc. 'phone. YDA is on 3.5 Mc. at new QTH, Bloomington. BFW is on 3.5 Mc. DGA is feeding 200 watts into new 28-Mc. rotary beam. QLL has three-element 28-Mc. beam. EHU has pair of 807s in final. HUV built 144-Mc. rig with a hot r.f. stage. ODW, ACW, and ILU are on 3.5 Mc. 8QKB/9 and BKH are on 3.9 Mc. TCZ is advertising for new chimney as he overestimated the mast-supporting abilities of same. UDD is busy making gear for other hams. YQV is building new 28-Mc. antenna. JYU and TJN have new cubical quad 28-Mc. antennas. UUN has been delegated by local hams to act as official checker. GOX has been seen atop his 28-Mc. tower at midnight making adjustments. KCD has a cubical quad antenna more than 40 feet high. MYJ returned from service in the Pacific and has a new T-250 on 3.5 Mc. and is planning on some 28-Mc. work. USU moved away from local QRM by settling down with family at a lake near Ft. Wayne. END, FJT, and FMJ recently were issued their calls. TCZ worked ZL2QM. PMT was responsible for helping put ENB and WOD on 'phone by loaning each a mike. REW, ZEJ, and SRG are on 3.5-Mc. c.w. AET, one of the old-timers, has returned to 3.9-Mc. 'phone. CXJ stays up so late at night that he has to get his sleep on the bus going to and from work. If you don't hear TBM on the air he'll be roller skating. Another newcomer to the air with a Class A ticket is IOL. SBF has one of the Army tank transmitters. PMT and FJT have new receivers. Traffic: W9DGA 9.

KENTUCKY — SCM, Joseph P. Colvin, W5IEZ/4 — 4INC is a new call in Lexington with 60 watts on 35 Mc. MMY has a 276-foot Zepp on 50 Mc. 4IMC has an SX-25 and is building for 28 Mc. More from Lexington: CEZ is mobile on 28 Mc. BNP is on 28 and 3.5 Mc. QLF is active on 3.9 Mc. HGS stays c.w. DPW is on 28-Mc. 'phone. The Central Kentucky Radio Club elected NDY as president. Ultra short skip: KRY, Somerset, worked OEE, Louisville, and YPR, Somerset, and schedules BAZ, Louisville, on 28 Mc. The FCC has honored (?) several Kentucky hams by making them "Three Letter Men." JEL is active after a long illness. NJY has broadcast quality. KYN Net reactivated with BAZ, NCS, on 3810 kc. at 7 p.m. CST temporarily, and the following stations are on: FS, MMY, NEP, YPR, OGY /4, FQQ, EOM, and BAZ. KYF Net is active on 3952 kc. with TXC as NCS, time 7 a.m. Maybe ARU, BOF, DLU, EBG, FXA, HHL, IXN, KQC, LAK, MWR, WMI, YHD, and others could be drafted into it. How about the old 2000-kc. 'phone net getting on 50 Mc.? Known to be active: C.w.: JVK, MMY, OGY/4, TZR, FZV, FKM, FBJ/4, EOM, PWB/4, GTR, FS, 8JVI/4, ZRE, YPR, NEP, FQQ, and KWO. 3.9 Mc.: IXN, JEG/4, FZL, DNY,

(Continued on page 84)

**FOR HAMS -
EXPERIMENTERS - MANUFACTURERS**

NEW PRODUCTS

Small "butterflies" in a convenient variety of capacities for VHF and UHF.

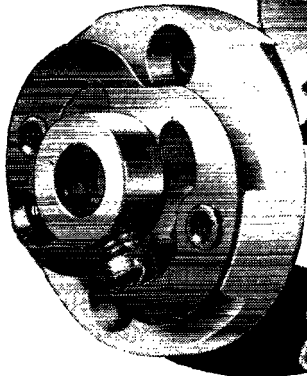
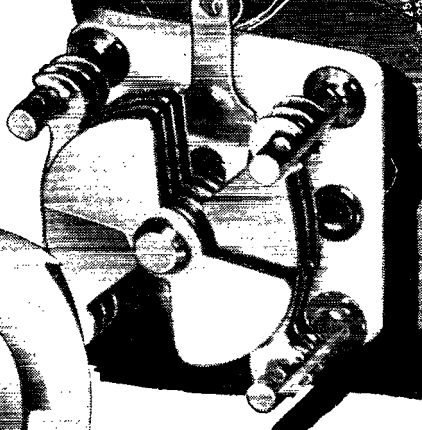

Flexible couplings in two types - insulated and non-insulated.

"RMC," a rugged midget for mobile and other uses requiring great mechanical rigidity.

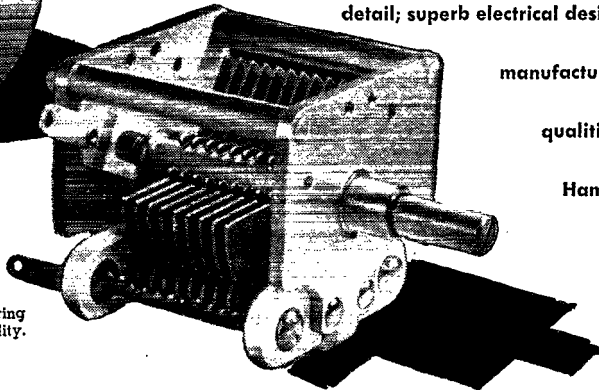

New and improved mechanical detail; superb electrical design; precision manufacturing—Three basic qualities of every Hammarlund product.

Write for technical bulletins.



HAMMARLUND

THE HAMMARLUND MFG. CO., INC., 460 W. 34TH ST., NEW YORK 1, N. Y.
MANUFACTURERS OF PRECISION COMMUNICATIONS EQUIPMENT

(Continued from page 82)

TFK, CMK, UWR, CEK, QLF 4, 2MLN 4, 8AWX 4, TXC, 1ST, ARR, and ELL 28 Mc.: AWN, KRY, YZS, KCZ/4, EYW/4, MRF, RBN, YAL, NJJ, and JEL. FS worked forty-one countries on 28 Mc. before settling down to 3.5-Mc. c.w. He is NCS for trunk line Atlantic-Pacific, 3630 kc., 9:30 p.m. EST. Traffic: W9FS 134, BAZ 48, MMY 7, 5IEZ/4 2. 73. Joe.

MICHIGAN — SCM, Harold C. Bird, WSDPE — 8SWF has new rig and new organization of the QMN has started. He wants all old QMNers to contact him for net on 28 Mc. 8MCV thanks us for bulletin while overseas. 8LXE is back home working for WJBK. The DMRC is holding 10th anniversary outing May 30th. 8TBP is working QMN daily. 8DZ tried for prize given by DARA for most stations worked on QMN. 8UGR is out for ORS appointment again and is building rig for 8YJC. 9GJX received a card from Luxemburg confirming QSO. She is getting the Emergency Corps organized in her community. 8MGG is working hard at public relations appointment. 8DUA reports reorganization of Kalamazoo Radio Club with DUA as president and 8JUQ as vice-president. 8FWU is on with low power. 8NXT is waiting for his 28-Mc. coils to come. 8WVW reports he is working both 'phone and c.w. and organizing a net of amateurs in CAA. He would consider appointment in c.w. traffic net. 8ABH, in Ludington, is running radio shop. He got on the air with parts of an old receiver. 8FX is working with inside antenna and when completed hopes he can run higher power. 8SCW is unable to make QMN early so reports in later; he is out for ORS appointment again. 8WZV installed his new folded dipole beam antenna and it took seven men to get it up to the top of the 42-foot pole. 8HTB, who works us from Ecorse High School, has a nice rig and signal. He handled a message from Okinawa with only two days delay. 8LSF is working the QMN boys regularly. 8CSL is on 28 Mc. 8TIC has 6L6 Tri-tet 6L6 doubled and 807 final with 35 watts input on 28 Mc.; his receiver is S-41. Lt. 9WJV/4 reports from Arlington, Va., where he is working on 28 Mc. He hears 9GJX and the local boys occasionally. 8ONK has renewed ORS appointment. 8KUQ reports that about ten members of QMN Net report in nightly. 8SAY is doing a nice job as Alternate NCS on QMN Net. 8GQZ is working for MSP at The Heights. To be eligible for 'phone appointments in this section, a station must adhere to 'phone procedure and not use c.w. procedure. Two reports are necessary for new appointment or renewal. The QMN Net operates on 3663 kc. EC drills will be held shortly. Traffic: W8SAY 39, 8SWF 18, 8DPE 16, 8FX 9, 9YNY 7, 8SCW 5, 8MGG 2, 8TBP 2, 8JUQ 1. 73. Hal.

OHIO — SCM Carl F. Wiehe, W8MFP — Ex-WAB is now 6QUY/8 in Columbus and is on 3.5 Mc. after putting in three years in Las Vegas and one year in Oak Ridge, Tenn., making atom bombs. DS reports from Cleveland on the usual excellent club activities. OQI owns a Piper Cub. AWF is learning to fly. When the instructor told Joe to take the stick he said, "What do I do now?" ML has another new jr. operator. ALI is out of the hospital and is O.K. EBJ has a brand-new rig. PWY and his XYL are taking a month's vacation. FP, COG, and VBA have rotary beams on 45-ft. telephone poles. TKS reports from Toledo that PCS has returned from the services and is on 28 Mc. BIQ, ARF, NMU, SUL, JLQ, UFN, and QUO have been active on 50 Mc. Newly-elected officers of the Toledo Radio Club are: Ray Lewis, pres.; WEW, vice-pres.; Carl Betz, treas.; Wendell Schnell, secy.; TKS, sergeant at arms. PEG has been discharged and is back at work with the State Highway Patrol at Findlay. MSW has a radio service shop in Toledo. QUO, BHL, K6UOK/NXN, and TLF are fresh out of the services. Carl Betz is reported well satisfied with his new daughter although he expected a third son. LCY/8 reports from Oberlin that KYI is on 3.5 Mc. with 500 watts. JYJ has worked five continents and fifteen countries on 28 Mc. DBD has reenlisted in the Coast Guard and is stationed at Norfolk. AZU has a pair of 35Ts with 350 watts on 3.5 Mc. KKH reports from Dayton that WXT worked a W6 eighteen minutes after receiving his ticket. TYL won a 100-buck rotating mechanism and direction indicator at the Dayton ham club meeting. RGH is burning up 28 Mc. with 75 watts and a three-element beam. KQE, of Bedford, reports he was doing fine on 3.5 Mc. until FCC notified him that he was doing better on 7 Mc. HWE reports from Cincinnati that 1BNL/8 is on 28 Mc. with 60 watts and a fancy automatic band-switching rig complete with push buttons and lights. He came here two years ago from WTAG and is now with W8AL. WVK/8 reports from New Concord that he has

worked thirteen Gs and plans to work from Ashtabula this summer with 150 watts on 28 Mc. APC/8 is on 3.5 Mc. from his new QTH in Columbus with a pair of 807s. TAJ reports from Mansfield that WYN and WXV are two new calls in that area. JEY has a new three-element beam and hopes to work the VKs and KB6s that he is hearing. CHO is moving to Detroit. JMM has abandoned 28 Mc. and is poking big holes in 3.9 Mc. and the intercom system at WMAN. ALC worked 8MJU/KB6 and 9KJW, Saipan. RN reports that he has worked on 28 Mc.: Al — G1, GM, GV, G, D2, D4, ZB, YR, PY, HC, K7, K6, K4, K5, and WE5. A3 — W6, W7, PY7, VE4, and VE5. Traffic: W8EQN 34, RN 24, WE 4 APC 2. 73. Carl.

WISCONSIN — SCM, Emil Felber, jr., W9RH — DIG was off the air because of power supply trouble. BCY, using three-element array on 28 Mc., worked Milwaukee. QHR has worked twenty-two countries on 28-Mc. 'phone. ADK, at Lowell, is on 28 and 3.5-Mc. c.w. IZG, at Juneau, still is talking f.m. with JVV. RCP, at Jefferson, has "V" beam and is getting good reports with low power. KQN, at Stoughton, is working 28 Mc. QVR, at Sussex, is operating 28 and 3.5-Mc. c.w. and still is saying "yessir" from Army habit. ANM has finished a new 28-Mc. beam. Bob also is having receiver trouble. NJT is on 28 and 3.5-Mc. c.w. working DX. OFL, at Waupun, is running high power. ZIE, Geep, now uses "in the shadow of the box factory in Watertown" instead of "shadow of the Knickerbocker in Milwaukee." He is doing orthophonic work in H20-town. MRU lacks a receiver to get on 3.5 Mc. RBI, at Madison, is on 28 Mc. with 150 watts and vertical 2 half-waves in phase. The Rock River Radio Club (RRRC) is meeting at Legion Hall in Beaver Dam monthly and talking about get-together sometime this summer. ILG is on 3.5-Mc. c.w. RHS, at Berlin, is off the air. NRP, at Juda, is with the Monroe Police Dept. QHR and NJT, at Watertown, are ready on 50 Mc. and hope to contact the Milwaukee gang on that band. NPK, at Kenosha, is a new OBS. Look for his official broadcasts on 3907 kc. at 7 p.m. CST daily except Fridays and Sundays. UIT, KCY, and LFK, in Milwaukee, are looking for traffic on 3.5 Mc. c.w. 73. Emil.

DAKOTA DIVISION

NORTH DAKOTA — SCM, Raymond V. Barnett, W9EVP — ZRT has his new HT-4 transmitter on 3.9-Mc. 'phone. PDN, of Fargo, has been heard on 3.9-Mc. 'phone and 3.5-Mc. c.w. using an HT-4 rig. SWC, in Minot, is on 3.5-Mc. c.w. with low power and works regular schedules with his brother, KZL, in Bismarck. PJT has a new HQ-129-X receiver and will be active soon from Ashley. HDD, operating on 3.9 Mc., has moved into a basement and will feed a top loaded vertical. GJJ drove 500 miles to Minneapolis to look for a new receiver and to renew old acquaintances there and at Willmar, Minn. Because of housing shortage, SSW has had to put his rig on the shelf until he can finish a home to move into. EVP is planning on building a house on his basement this summer. We still are waiting for applications for appointment as OBS, ORS, OPS, EC, etc. How about it, fellows: Shall we have nets in North Dakota? 73. Ray.

SOUTH DAKOTA — SCM, P. H. Shultz, W9QVY — QAK is in San Luis Obispo, Calif., with Pacific Tel. & Tel. as transmission man in the toll division. MXB has rebuilt and is on 28-Mc. 'phone. YNW is on 3.5-Mc. c.w. DIY soon will be on 3.9-Mc. 'phone with 500 watts. The Sioux Falls Club is planning a picnic. YMB operated D4AHL while in Germany. ILL reports for the Huron club as follows: YTH is on 28 Mc. with Lazy H antenna. INT is building shack and home. VQC will be on 3.9 and 28 Mc. DZD finds himself 'crowded for space to put up 3.5-Mc. antenna. ZTR is building with dreams of high power. IQD is ready to go on the air, as is LBU, who lacks a receiver. ILL is on 3.9-Mc. 'phone and 3.5-Mc. c.w. with 100 watts. ADJ reports that the Rapid City Club's code and exam classes are off to a good start. Your SCM had a nice visit with GLA and his crew. Let's make a good showing for Field Day. 73. Phil.

SOUTHERN MINNESOTA — SCM, Vernon G. Pribyl, W9OMC — GBZ is on 3.5-Mc. c.w. with a 5-watter. FAJ and JSS are active on 3.5 Mc. JNC sends in a lot of news this month and says he really likes his RME-45 and is increasing power to 300 watts. ZMQ is in the Iowa net and active on 3.9 Mc. IXR, formerly of Rice Lake, Wis., is in St. Louis Park. He is on 3.9 Mc. as well as PTY with 800 watts. KXA, VXH, and JRI all converted to high power.

(Continued on page 86)



Centralab

CERAMIC TUBULAR CAPACITORS

... from the ceramic which houses the capacitor to the silver paint and copper plating, every part of these capacitors is completely fabricated by CENTRALAB.

... no wonder that all Centralab Tubular capacitors hold such fine tolerances.

Always Specify Centralab. Send for Catalog No. 25.



Centralab

Division of GLOBE-UNION INC., Milwaukee

PRODUCERS OF



Ceramic Trimmers
Bulletin 695



Ceramic High Voltage Capacitors
Bulletin 814



Variable Resistors
Bulletin 697

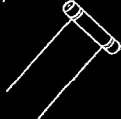

Tubular Ceramic Capacitors
Bulletins 630 and 586

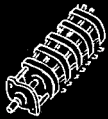

Selector Switches
Bulletin 722

(Continued from page 84)

FUO is active on 3.5 Mc. after returning from Manila, where he served with the Signal Corps. QIN was on the ball the night of the aurora and worked stations east on the 50-Mc. band. NCS is doing a swell job organizing the state net. He holds a drill night every Tuesday on the old net frequency. There still is a lot of activity that is not being reported; we need all those reports, so how about dropping a card? Traffic: W9OMC 24. 73. Vern.

DELTA DIVISION

ARKANSAS — SCM, Ed Beck, W5GED — KXG, a new-comer, is on 28 and 3.5 Mc. with p.p. 807 with 125 watts and is going strong. CEQ is on 3.9-Mc. 'phone down Pine Bluff way with 400 watts using p.p. 805s in final. ABZ is running 100 watts to p.p. T20s on 3.9-Mc. 'phone and from all indications is doing O.K. DGL is coming on 3.5-Mc. c.w. with a bang — every bit of 25 watts. DVM is coming on soon. IAK is putting an 815 on 28 Mc. as soon as he can get the speech amplifier whipped. IVY rang the bell this week with p.p. 807s with e.c.o. on 3.5 Mc. SI is burning up 3.9-Mc. 'phone. JID is on 28 Mc. with a single 807 in the final. JDX has decided that he can spare a little time for ham radio instead of spending all the time chasing bugs out of b.c. sets. HYS is looking over the lay of the land in regards to a sky hook for 3.5 Mc. GTS still is in the building stage. JIC has new p.p. 24G final on 3.5-Mc. c.w. with 150 watts input. He sure had big time on May 2nd when short skip on 28 Mc. lasted until 11-30 p.m. CST. The Fort Amateur Radio Club is building a portable transmitter for Field Day use this year. IWL has e.c.o. rig on 3.5-Mc. c.w. ICS is on 3.5 and 3.9 Mc. with his p.p. HY-51As. 73. W5JIC.

LOUISIANA — SCM, W. J. Wilkinson, jr., W5DWW — BSR has TZ40 p.p. on 3.9-Mc. 'phone and new SX-28A. JFR, AOA, KHC, KTD, KQL, BI, KUZ, JBW, AXS, KZM, IRT/5, KUM, JET, and 9HJF/5 are ready to help give WAS with a Louisiana contact. IBL, SX, AOX, FPO, QH, and KEK are active on 28 Mc. and working DX. DKR says he is looking for a receiver. BPL is on 3.9-Mc. 'phone and ABA is on 3.5-Mc. c.w. ACY is newly-appointed OBS. AVO has new HQ-129 receiver, GUK and EBB are planning new rigs. CEW has worked forty countries on 28-Mc. band. LBA is newly licensed in Shreveport. BZR and UF are in process of building rigs and hope to have them completed by the time 7 Mc. opens. GXO reports the following: The Delta Radio Club holds regular meetings the 2nd and 4th Thursdays in the Delgado Trades School's radio class rooms. All hams are cordially invited to attend. New hams are: KYK, LAE, LAY, and LDH. LAY is sporting a new HT4E and HQ-129-X. K6TTY/5 is in town working 3.5-Mc. c.w. Recent visitors to N. O. were XU1YN and TI2RU. KQL is on 3.5-Mc. c.w. KZM is new New Iberia station on 3.5-Mc. c.w. DWW will appreciate applications from all Louisiana ARRL members for OBS, ORS, OPS, EC, OES. As this is my first report in two years may I express my thanks for the confidence expressed by my election as SCM. Thanks also for all the reports received this month and let's all try to have something newswy by the 7th of next month. Club activities news is invited. Traffic: W5CEW 2. 73 and CUL. "Dub."

HUDSON DIVISION

EASTERN NEW YORK — SCM, Ernest E. George, W2HZL — Newly-appointed EC, BLU, reports he is organizing net around Newburgh area. Contact him if you are interested. Several of those surplus Mark II Sherman tank transmitter and receiver combinations have been seen in the capital district. HZL and MJX have been working mobile on 235 Mc. and report the sets work fine. Too bad 3.5 Mc. cannot be used mobile, as these sets really pull in the stations on this band. Recent appointments: OES, 9WHM/2; OBS, GFH, HCV, HXQ; EC, BLU. Don't forget to send in those activity reports for two months if you want ORS or OPS appointment right away. The Schenectady Amateur Radio Association reports big attendance at meetings now. Have you heard about the latest first for Schenectady; a two way QSO on 2400 Mc. between W9WHM/2 and 6OJK/2 on April 29th? NJF obliges this month with news from Westchester area in the form of issues Nos. 1 and 2 of Vol. 1 of the *WARA News*. Their hamfest of March 1st was well attended and the auction a big success. Invitations are out to attend first and third Thursdays in month at

County Center in White Plains at 9 p.m. Traffic: W2BLU 1.

NEW YORK CITY AND LONG ISLAND — SCM, Charles Ham, jr., W2KDC — BGO, Section EC, reports as follows: JXH is giving up his good 28-Mc. DX and is leaving for the West Coast for sixty days, working mobile en route. In Suffolk, ADW (who was called AVW in error in May activities) is looking for contacts in East Hampton and Amagansett. The regulars on Eastern L. I. continue to be EBT, OQI, ADW, FCH, UX, and DOG. JWO has 225-watt crystal on 144 Mc. and works out well. GAH, EBT, and OQI are active on 28 Mc. OQI, FCH, JWO, DOG, and Guyer attended the Queens Hamfest on April 26th. About a thousand others crowded into a space for 400 and drank up all the refreshments in very short order. In Brooklyn, five mobiles and four pack sets are included in the impressive total of thirty-two stations. Recent additions to the Emergency Corps are: MBZ, ORW, KU, NKO, LPC, KYB, PBH, PFA, ORP, and DZR. ODS and BPV are developing super handie-talkies while DIO, PFA, NSD, NYC, and OHE supply the mobiles. DUS is dreaming of rotating his 144-Mc. beam. The coffee-making exploits of JSJ's XYL are known to hams all over Brooklyn; after Monday night drills they all congregate there. NQQ is active again and 8FLX/2 has overcome his receiver trouble. NXT's beam works FB. From Nassau, FI reports in lieu of CET that regular net operation takes place Monday at 9 with twenty-five to thirty stations reporting each time. On the last Monday in April KNA, mobile at Bayville, originated a message to FI which was handled via OQQ, 4HQW/2, RZ, and 4IHZ/2, all mobile. 9TWS/2 studied contour maps and selected some good high spots. (Other sections note: Highest point on L. I. is 428 ft.) JND has new improved signal. New recruits to the Emergency Corps are ERW, JNT, OZE, HTG, and 1LUU/2. FI uses the official broadcasts each Monday to open the net. In Queens County, BKZ is rebuilding. EC writes and gives an interesting history of TLAP (Trunk Line-Atlantic Pacific) which was started in 1937 by 3HUM and 2EC. Prior to the war twenty-five coast-coast stations participated; ten now are carrying on. They handle much GI traffic originating in Japan. Ferd has rarely been on 'phone, although he is experienced with audio. 1AA/2 called CQ on 3.5-Mc. c.w. and worked 1AQT in Auburndale, Mass., Wally's home town, for his first contact. NFC has very nice recording for calling CQ; only thing, it's for 14 Mc. BDS moved from Massapequa to Asbury Park and is having antenna-height trouble on 28 Mc. However, he did work KDC in Jamaica. HHW left L. I. for Little Silver, N. J., where a new beam puts out a very sharp signal. ADJ is back on 28-Mc. c.w. after a ten-year lapse. 3AIX/2 is losing sleep over his HY75 oscillator, which draws less loaded than unloaded. Lt. Comdr. FIT, just released, and OBU, who was called OBW in error in May activities, became acquainted when both recognized a blowfish breathing in code while on party fishing boat. AFR is on 28 Mc. OJR, NXQ, and MED are applying for Emergency Corps membership. NAZ is running 200 watts on 28-Mc. c.w. She's building modulator and reports the YLRL meets on the third Friday of each month at 8:15 p.m. at the Savoy Plaza, 58th St. and 5th Ave. HMJ worked eleven countries on 28 Mc. Traffic: W2EC 39, HMJ 10, KDC 8.

NORTHERN NEW JERSEY — Acting SCM, John J. Vitale, W2IIN — Because of the pressure of business, CQD has found it necessary to resign as SCM. IIN will take over the SCM duties as Acting SCM until an election is held. The Monmouth County Amateur Radio Association was affiliated with ARRL at the recent meeting of the Board of Directors. At the April 25th meeting of the Livingston Amateur Radio Club, NVK, the following changes in officers were made: MKN was appointed as secretary in place of NCF, who submitted his resignation. EWL was appointed as treasurer to fill the post vacated by MKN. Other officers are: NAP, pres.; BWN, vice-pres.; and LZW, trustee. The club voted to hold meetings the first and third Fridays of each month. The first Friday meetings will be held at the J. O. U. A. M. Hall, where it is expected prominent speakers will be invited to give lectures on matters of interest to amateurs. The third Friday meetings will be held in the basement of the church on Mt. Pleasant Ave., Livingston, until regular quarters can be obtained. At these meetings code and theory classes will be held at 7:30 p.m. The first code class was planned for May 17th, to be conducted by LQN. NAP has requested LQN to handle the publicity department of the club. GC, publicity director of

(Continued on page 88)

Now... a Germanium Crystal Duo-diode

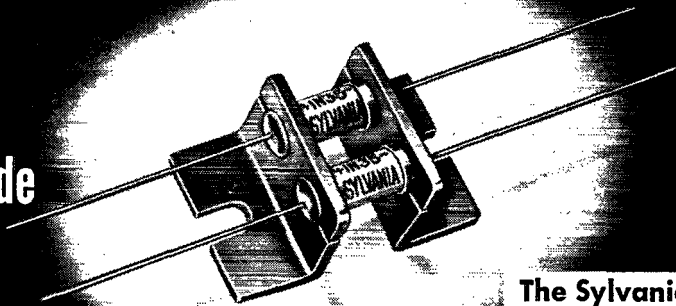

**The Sylvania
1N35
(SHOWN ACTUAL SIZE)**

THE 1N35 CONSISTS OF TWO MATCHED INTEGRALLY MOUNTED CRYSTAL DIODES.
The 1N35 is a precision circuit element, accurately adjusted, ruggedly constructed.

Germanium crystal is cut from 0.6 mm. sheet, optically ground smooth on one side, and silver-soldered to tip of brass screw.

Whisker is formed from tungsten wire 75 microns in diameter, and soldered to screw. Loop provides spring pressure.



Whisker is adjusted for correct forward and back resistance. Isolantite cartridge is wax-filled to maintain correct adjustment and render moisture-proof.

Pigtails are silver-soldered to precision-formed contact cups, and cups are welded over end caps.

CONSTRUCTION DETAILS OF THE 1N35

The 1N35 Duo-diode, a new circuit element developed by Sylvania Electric, consists of two Germanium Crystal Diodes mounted in a single assembly that facilitates mounting.

The two crystal diodes are matched for values of forward and back resistance, under conditions typical of those anticipated in actual use. In addition, the 1N35 is tested for R. F. loading on a tuned circuit.

The 1N35 is valuable wherever full-wave rectification, modulation or demodulation is required in a balanced circuit. Potential applications include FM discriminators, bridge rectifiers, ring modulators, demodulators, and varistors.

TENTATIVE SPECIFICATIONS

Each diode used in the 1N35 has the following tentative characteristics:

Peak Inverse Anode Voltage	50 volts
Peak Anode Current (sine wave)	60 ma max
Average Anode Current	22.5 ma max.
Surge Current (transient peak)	200 ma max.
Back Conduction at 50 volts	2 ma max.
Operating Frequency Range	0-100 mc

Inquiries are invited concerning applications of the 1N35.

TYPICAL CIRCUITS

Full wave rectifier second detector circuit

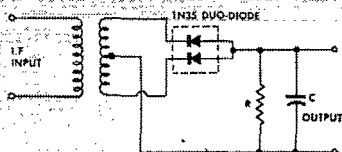

The 1N35 in frequency discriminator circuit

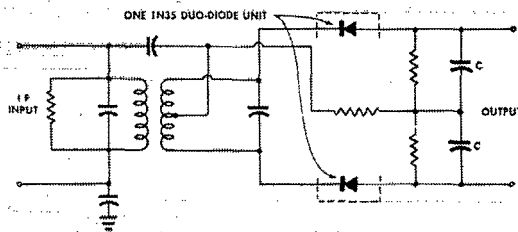

SYLVANIA ELECTRIC

Electronics Division . . . 500 Fifth Avenue, New York 18, N. Y.

MAKERS OF ELECTRONIC DEVICES; RADIO TUBES; CATHODE RAY TUBES; FLUORESCENT LAMPS, FIXTURES, WIRING DEVICES; ELECTRIC LIGHT BULBS

(Continued from page 86)

the Bloomfield Radio Club, JC, reports that the club has been reorganized and meets every Wednesday night in the Boys' Club in the rear of Bloomfield Community House. It has just completed a new 450-watt 'phone rig and is operating on 28 Mc. CMZ, of Caldwell, is in charge of the new class in code practice. George Wright and Harry Kaye, of Bloomfield, helped to put the new outfit into operation. Cross-country contacts have been made. A new antenna is being planned to improve the station range. After a two months' terminal leave from the Navy, JKH is working at Tung-Sol in Newark. GVZ is back on the air with 200 watts. He invested in a surplus Army rig, the ART-13, which has Collins autotune and has variable crystal-control anywhere on 3.5, 7, 14, and 28 Mc. BJO is operating on 3.9-Mc. 'phone and is looking for contacts with the first-district fellows whom he worked prewar in addition to new acquaintances. Frequency is 3934/3955 kc. NIY, ex-1AMZ and ex-8DHU, former Eastern New York ORS, hopes to be on 3.5-Mc. c.w. soon and wants his ORS appointment transferred to Northern New Jersey. Traffic: W2JKH 2.

MIDWEST DIVISION

IOWA — SCM, Leslie B. Vennard, W9PJR — YBV wants to join the Iowa 75 Net. SEF moved to Magnolia for the summer. LDH had hard luck with his main transformer but is doing fine with 40 watts on 3.5 Mc. with portable rig. PDM's tower blew down. UQJ nearly lost his 28-Mc. beam; a six-year-old used the rope for a swing. KNZ made the front page of the paper. He employs only ex-GIs in his shop. JRY has new Super-Pro and DM-36. The Council Bluffs Club met there recently. IFI is a new member of the club. FLI is getting the fever again. VEY wants v.h.f. contacts. SEE says the Emergency Corps gang is getting ready. CCE, on 3836 kc., wants traffic nets going. EOE meets the old gang on 3.5 Mc. ZYS reports that KAH has a new XYL and wants u.h.f. contacts. EPI is putting up 28- and 14-Mc. rotary beam. AMJ is back in Coon Rapids. UVJ is at Denison. UPX, Sioux City, is on the air again. WHG has a lilac bush for an antenna pole. AEP is acting net control of the Iowa 75 Net; AED and KLC are alternates; AHP is deacon. They are handling traffic for the boys in the services and ask the cooperation of all hams operating on 3970 kc. at 12:30 p.m. DIB has his 35-ft. poles painted and holding his antenna. GOK has 500 watts on 3.5 Mc. YKN is building a 28-Mc. job. JZI is building a 3.9-Mc. job. ACL is active on 3.5 Mc. and was Burlington Club's first contact on 3.5 Mc. New tickets in Burlington are: W9FUN and GQI. WNL is having trouble with 3.5-Mc. rig. TLL is back from the Navy and working on 3.5 Mc. again. CWG, Keokuk, and YBS, Council Bluffs, are Silent Keys.

KANSAS — SCM, Alvin B. Unruh, W9AWP — VVU is OES, and reports 50 Mc. open on April 23rd. He is building new 50-Mc. exciter to drive p.p. 812s. Also active on 50 Mc. in Topeka is ICV, who has p.p. 75T final. Both use modified DM-36 converters for receiving. WGM reports NVB acquired a YF, SKW and ANV acquired SX28s, and ICV acquired a Collins transmitter to augment the 28- and 50-Mc. composite job. LCC now is in Topeka and FRC is D4AFC in Germany. The KVRG meets alternate Fridays at Police Headquarters. ESL is active on 28- and 3.9-Mc. 'phone. IWS is building new kw. rig after working Pacific islands on 20-watt rig and rotary beam. TJQ reports RTZ has p.p. TZ40s and HQ-129-X in Garden City. VEL is active on 3.7-Mc. c.w. in Dodge City and has new 28-Mc. three-element beam. SAM has new receiver. G4AB writes from Merry Ole England, requesting W9 cards from stations that will change to W9, for historic interest. VPK/D4AIJ is returning from Germany, where he has been operating D4AIR. KFV/K4 writes from Puerto Rico, where he is making strenuous efforts to work old Kansas friends on 28-Mc. 'phone. OUU is back in Emporia with 75 watts on 3.9 Mc. MDI, IZJ, ZGB, and KGN are active. IFR is interested in 3.9-Mc. 'phone net. He reports LYF is putting on 24G. Traffic: W9UUU 4. 73. Abie.

MISSOURI — SCM, Letha A. Dangerfield, W9OUD — More and better reports are coming in these days as we expected. ARH, Kirksville, worked seven countries on 28 Mc. using a Millen exciter with 65 watts — only QSL to date is a blue one from FCC. WKF is on 3.5-Mc. c.w. ZKY has 200 watts on 3.9 and 28-Mc. 'phone and has worked Z6, KB6, and FA8. YHZ is QRL with physics at St. Louis U. and hoping for time to try more 28-Mc. f.m. KEI sends

in the only traffic report, although he has been busy getting out bugs. TTI has low power on 28 Mc., but is constructing rotary beam and 200-watt rig for that band. WFK is on 3.5 Mc. WXP is ready for 28 Mc. PXH erected 137-foot single-wire antenna for 3.9 Mc. and finds it works perfectly on 28 Mc. TER has a new modulator on 28 Mc. VLQ went to 28-Mc. 'phone after years of c.w. exclusively. PMO, on 28-Mc. 'phone, can't work local St. Louis because of hills. 5KSP/θ and 9MOT/θ, on a farm near Sheldon, have a sky wire but all equipment still is down in Arkansas. HIC, in Yokohama, hears W signals on 3.5 Mc. under military QRM and expects to be back soon. NIP, with nearly all equipment for 500-watt rig for 3.9 Mc., is daydreaming to save extra work. HARC, of Kansas City, had a hidden transmitter hunt on 144 Mc. on May 19th. The prize was the transmitter which was built by TQK and ZJB and the electric companies for which they work. ZJB is making interesting and complicated experiments on v.h.f. BMS and OUD have incorporated an electronics keyer and are building a code monitor. QJP arranged a QSO on 28-Mc. 'phone between a fellow stationed on Guam and his folks in Joplin. Nice going, gang. 73.

NEBRASKA — SCM, Arthur R. Gaeth, W9FQB — OKI has pair of TZ40s and 400 watts. VOM has a half-wave Zepp on 3.5 Mc., National 240 receiver with Fanadapter and BC610 at 375 watts on 'phone. RQK is trying to punch a hole in QRM on 3907 kc. with 180 watts. EXP has a new three-element beam and uses it on 28 Mc. BBS is getting on with BIW's portable generator. Ex-UDJ is now W9GPX. UBN is putting a half-kw. on, with HK54s in the final. BIW, GPX, and PJD are active on 144 Mc. AVX has a brand-new RCA 833A sitting on the shelf. ONH is on 3.5 Mc. TQD, operating TLAP on 3630 kc., reports that DMY is sporting new HQ-129-X. Ex-LTL is now 6UZY and ex-ZNA is 6TSW. Ex-LPA has secured a T-610 Navy rig with parallel 813s in final. CQX is on 3.5 Mc. with HY40Z, 115 watts, pair 46s as modulators, half-wave doublet, and is building beam for 50-ft. pole, consisting of two half-waves-in-phase with two directors and one reflector. ROE has pair T55s at 400 watts on 3.5 Mc. with end-fed Zepp. JED showed ZAR his BC610E and RME 45. EXZ replaced 809s with a pair of HK24Gs at 100 watts input and built a hot Super using 15 tubes with double conversion in the i.f.s and three stages of r.f. JCK is on 3.5 Mc. with 100 watts to TZ40. YPH has 6F6 e.c.o.-6L6 buffer, RK39 on 3.5-Mc. c.w. 8WJV/θ has 829 on 28 Mc. FUV has 829 on 28 Mc. and a new three-element beam. PPY is using Stancor 20P and pair of T40s with 100 watts. NYU has e.c.o. pushing 807 on 3.5-Mc. c.w. and is looking for DNW. VUU and YPH are new members of Ak-Sar-Ben Radio Club. Traffic: W9FQB 13, TQD 12. 73. Art.

NEW ENGLAND DIVISION

CONNECTICUT — SCM, Edmund R. Fraser, W1KQY — 3EHW/1 is permanently located in Putnam using a kw. on 28 Mc. He has worked forty countries. KAT has thirty-seven to his credit and MLT has worked five continents several times with 60 watts, one time in less than six hours. ON is recuperating from recent operation. ITX and MLT, and XYLs, have been spending Sunday nights during the winter ham-shacking in Massachusetts, Rhode Island, and Connecticut. 2HUG/1 is active in Bridgeport operating from YMCA. 8HCO/1, Bridgeport, is handling traffic with Nutmeg Net. ACV reports MRE on way home. GRU is on 3.9-Mc. 'phone with new antenna. MGS was decorated in Germany. The BARA, JHT, is being reactivated and hopes to be on for Field Day. LIG writes that the Bridgeport Radio Amateur Club has been organized, meeting the 1st and 3rd Wednesdays of each month at the "Sons of Italy Hall" with fifty members, including forty-five hams. Officers are BRI, chairman; LIG, secy.; ETC, treas.; and MZZ, sgt. at arms. Former WERS operators in Stratford have organized the Stratford Amateur Radio Club and are studying to obtain ham licenses. ATH reports the code and theory class being held by the NHARA, GB, is making rapid progress with AMM instructing. JMY schedules his XYL, MUW, nightly. VB is Connecticut member on TLAP. UE, VB, and CTI are alternating as Nutmeg Net control stations. CNF attended Tel. Co. school in New Haven renewing ham acquaintances between classes. SF received his old call back from FCC and is again in action. Walter A. Keeling, Stratford, has received the call OGQ and has been appointed EC for that town. He reports that an emergency

(Continued on page 90)

... And now a V.F.O. that is really engineered!

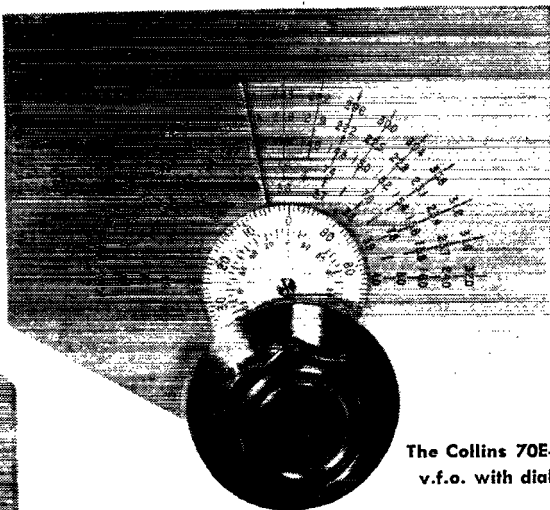
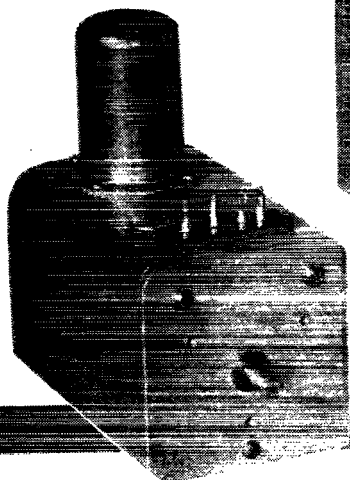

The Collins 70E-8
v.f.o. with dial

The high stability and accurate calibration of the Collins 70E-8 variable frequency oscillator are part of the Collins program to provide amateurs with equipment that is thoroughly engineered from all angles. This unit reflects the years of successful experience at Collins in oscillator research, design, and manufacturing for commercial and military applications.

A frequency range of 1600-2000 kc is covered by the 70E-8. Each dial division represents 500 cycles on the 80 meter band. Frequency deviation and reset accuracy are within 1 dial division under all conditions. Drift due to temperature change and normal voltage fluctuation is practically negligible. Keying is clean and crisp, without a trace of chirp.

The 70E-8 will make an ideal front end for your exciter—will give it professional performance and appearance. Its components are of the same select quality that was specified for wartime use. You can depend on it to give you long service free from trouble—and you always know your frequency.

Get one today. See your dealer, or write to Collins Radio Company, Cedar Rapids, Iowa; 11 West 42nd Street, New York 18, New York; 458 So. Spring Street, Los Angeles 13, California.

FOR RESULTS IN AMATEUR RADIO, IT'S . . .

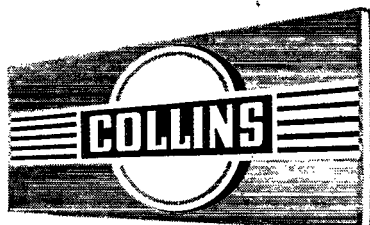

(Continued from page 88)

net of two fixed and five mobile units drills each Sunday morning at 11 a.m. KXB is organizing a radio club in Torrington. EH and BHM have returned to the 3.5-Mc. band. New appointments: OES — HFB; RM — CTI and VB; PAM — EAO and DWP; OO — BHM; ORS — CTI; VB, UE, KQY, 8HCO/1, ITI, HYF, TD, BDI, FMV, JQD, LFK, BHM, and 3EHW/1; OPS — EAO and DWP. Others interested, contact SCM. Traffic: W1JQD 43, VB 39, CTI 36, KQY 34, UE 26, BDI 11, HYF, 19, 3EHW/1 5, FMV 4, TD 2, 73. Ed.

MAINE — SCM, G. C. Brown, W1AQL — To date there has been too little interest shown in the Emergency Corps throughout the section. The Section EC advises that CBV and 2ONP, who is located in Belfast, are the only ones who have made application. LKP is on 3.9-Mc. 'phone and is waiting for his new HRO. ACW reports that the fishing fever has set in up North, but sends in the following items: CPS has his rig permanently installed at his home. HYI is making some tests in the hills with a walkie-talkie. GCB is having antenna trouble. HXQ is having plenty of trouble with his 28-Mc. rig and expects to start from scratch again. His XYL, LYI, is a fine c.w. operator and is patiently waiting to get on the air. QH and AKR are all set to go to Waterville to assist in building up WTVL. KE writes from Bates College; he has had an 807 rig on 28 Mc. and will be on 3680-kc. c.w. and 3925-kc. 'phone. LVY is also a student at Bates. HUT has a 350-watt 'phone rig with a rotary beam on 28 Mc. LOZ and LIZ are both on 28-Mc. 'phone. A short note was received from MXG, radio operator on the SS *George E. Badger*, in which he sends his 73 to the gang around East Millinocket.

EASTERN MASSACHUSETTS — SCM, Frank L. Baker, jr., W1ALP — All ECs in this section, please note the appointment of Raymond E. Boardman, W1FVL, 53 Thurston Road, Newton Upper Falls 64, Mass., telephone Bigelow 6668, as Section EC. My phone number is President 1523. We now have four OOs who are willing to help you if you want any checks on your rigs: BCF, Attleboro; IID, Brookline; HUV, Winchester; BHW, Chelsea. On April 19th the South Shore Amateur Radio Club held its 15th Anniversary and Old-Timers Night with twelve Charter Members present: AAH, AJA, WK, BIO, CPD, VX, UG, ASI, DFE, LK, AKY, and BNU. New officers of the club are: GYZ, pres.; DBH, 1st vice-pres.; DDO, 2nd vice-pres.; Geo Wilson (LSPH), secy.; AKY, treas. KVV gave a talk at the Eastern Mass. Amateur Radio Assn. meeting. MPB gave a talk on "Earning a Class A Ticket." The M.I.T. Radio Club held a small hamfest at Walker Memorial, with Basil Barbee, OCE (ex-2MWX, ex-5FPJ), giving a talk on getting on 28 and 3.5 Mc. MRQ, NYH, 5HQN/1, and 8AQE/1 have applied for ORS appointment. 6MUU/1, Dorchester, says his XYL has the call OBW. Merrill Dawson, of No. Weymouth, is now OAU. BB held a meeting of all Winthrop hams at his QTH. 8VPH, 4GKY, 8QKC, and 9IRK were present. DNL is on 28 Mc. 2OHT has his old call, FFD, back and is on the air. 5DQD/1, Cambridge, is on 28 Mc., as are NYU, NYG, and NZV in So. Boston. OEY in Malden, OET in Jamaica Plain, ODO and NWO in Wellesley, HUP in Weston, and ODF in Milton. OAR, Waltham, is on the air. ODV, Malden, is on 144 Mc. MKX is on 3.9-Mc. 'phone and we heard FVJ on from Portland, Me. CJ, Malden, is on 3.9-Mc. 'phone. MRQ has a 125-watt job on the air. IID is working on mobile rig for car. NKW QSOd 60AN and VE2JO on 3.5-Mc. c.w. JDU, secy. of the Merrimack Valley Amateur Radio Club, says they have twenty-eight licensed members and seventeen SWLs. IQH has a 100TH on 28- and 3.9-Mc. 'phone. JTP is building a pair of 808s final. MQE is on 28 Mc. NZS is call of Bro. Nilus of Central Catholic High School. CBY has 1-kw. Collins rig. JDU will have a pair of 808s final on 28 and 3.9-Mc. 'phone and c.w. AGX says that the Yankee Radio Club had forty-three members present at the April meeting and George Perkins gave a talk on radio tube functions. Meetings are held the 2nd Thursday of each month at the Salem YMCA. BVL advises new officers of the T9 Club are: ITJ, pres.; GGV, vice-pres.; IPK, secy.; IBF, treas. BVL has 200-watt job on 3.5-Mc. c.w. 8DMW/1, Pittsfield, writes that he is on 28-Mc. 'phone and c.w. with 50 watts. KB, Haverhill EC, says that the City has turned over to his group 5 TRAs. He has KQV, KUA, CCF, IWR, and Henry Weber (LSPH) working with him and they are testing every night. CCF is on 3.5-Mc. c.w. with e.c.o. We are sorry to have to report the death of JKR's XYL. CTW and LMU are OBS on 144 Mc. LMU has worked eighty-five hams on

144 Mc. since he got out of the Navy, and will be on 28-Mc. 'phone and 3.5-Mc. c.w. He has entered the V.H.F. Marathon and will be on 50 and 235 Mc. Traffic: W1AAR 3, MRQ 2.

WESTERN MASSACHUSETTS — SCM, William J. Barrett, W1JAH — Ex-KFV is anxious to get his old call back so he can lose the longest call on the band — KF6SJJ/W1. Bob now has twenty-eight countries worked, with 400 watts to a pair of 35TGs. DIZ reports from Shelburne Falls, where JHK, UV, DIZ, HND, and CGY hold nightly round table on 28 Mc. Lee reports FOI and FKN very strong on 28 Mc. and HDQ and CGY on 50 Mc. in Shelburne. BVR has 200 watts on 3.5 Mc. with p.p. 811s. The Pittsfield Radio Club has committees working on preparations for first postwar Field Day. HNE has new HQ-129-X. Seemed like old times to meet so many of the gang again at Framingham Convention. AJ, now located in West Newton, sends his best to the old AARS gang. BJS is working hard at emergency set-up for the section. Ike has named LUD as EC for Pittsfield, and BIV for northern Worcester County. How about some reports, fellows? They should reach here right after the first of each month. JAH is on 3.5 Mc. nearly every night at about 7 p.m., usually near 3715 or 3760, so reports can be handled direct, 73. Bill.

NEW HAMPSHIRE — SCM, John H. Stoughton, W1AXL — Congratulations to CUZ, who announces the arrival of a new jr. operator. MUW has been heard chasing DX on 28 Mc. TA dropped in on BFT/FTJ recently, flying up on a visit. He landed about a half-mile from the shack. BFT won recent QSO Party sponsored by RME and is anxiously waiting for his prize. AVJ has moved to Canterbury. MWI and her OM, JDP, made a visit back to New Hampshire recently. LVG is now working for BFT. MOI is the proud owner of a new RME-45. CEA is back on the air working on 3680 kc. GGV is active on 28 Mc. NQH has an FB 1-kw. rig on 3.9-Mc. 'phone. FTJ was "YL of the Month" in a recent issue of CQ. KPL is back in New Hampshire. He is operating portable at East Jaffery. AXI is on 3.9 Mc. at Exeter. CCM still is doing business at Grafton Center and has just returned to the air with a small rig on 3.9-Mc. 'phone. The New Hampshire 'phone net got off to a weak start. The frequency is 3920 kc. and the net meets once a week on Sunday mornings. How about more of the gang calling in? Let's get the c.w. net going again on 3840 kc., fellers. 73. Jack.

RHODE ISLAND — SCM, Clayton C. Gordon, W1HRC — The following from Rhode Island attended the convention at Framingham: AKA, AWE, BBN, BGA, BIL, BOP, CPV, DTZ, EJ, EWT, HRC, HXS, INU, JMT, JNO, KOG, LFB, LWA, LWB, MRV, MTF, MJL, MWY, MMC, MNC, NUA, NZR, Harry Nicholson and XYL, and Dr. Davenport. ILO is on 3.5 Mc. with 6L6 crystal. QR has worked all districts on 3.5 Mc. except the seventh, has a regular weekly schedule with JOB and has become convinced that condenser input doesn't pay, as his Deforest 566s finally went sour after fifteen years service in that manner. The NAARO has resumed activity and meets every Friday at 122 Elmwood Avenue. The club is planning to take an active part in the coming Field Day as well as sponsor a Rhode Island QSO Party. KOG has e.c.o. and T40 on 3.5 Mc. and has moved shack to basement to avoid QRN. KYK has new e.c.o. and pair T40s on 28- and 3.5-Mc. c.w. LQL has an RME-69 and is on 28-Mc. 'phone and 3.5-Mc. c.w. and put up new Q antenna. MJL is running a 912 on 3.5 Mc. MQF is studying for E.E. Master's Degree at Brown. LWA has e.c.o. and 812s on 3.5 Mc. NCX has kw. on 3.5 Mc. CJH and BFB have new finals and rotaries on 28 Mc. Traffic: W1QR 3, LWA 3, HRC 2.

VERMONT — SCM, Gerald W. Benedict, W1NDL — ELJ is now located in Hartford and will be on 3.5-Mc. c.w. ATZ is in the Army at Fort Belvoir, Va. ELR has been discharged from the Navy. FN is in radio service business and has no time for ham work. EMQ is located in White River Junction. AAK has a radio shop. AVP visited AD, EMQ, MLJ, NDB, and NDL. MLJ has a new 28-Mc. beam, three element. NDB is putting up a 28-Mc. beam. AVP has 144- and 56-Mc. rigs. Montpelier and Barre hams enjoyed a Westinghouse Electronic demonstration by Dr. Thomas.

NORTHWESTERN DIVISION

MONTANA — SCM, R. Rex Roberts, W7CPY — Section EC, BWH. The SMARA Club at Billings is active but has to meet when space is available at Commer-

(Continued on page 92)

More

Quality Components for the Electronic Industries

AMERICAN PHENOLIC CORPORATION

is now completing a sizable addition to its Chicago plant. This means a substantial increase of the already great facilities for production of quality parts for communications and electronics... components that have built the high reputation enjoyed the world over by products bearing the Amphenol name.

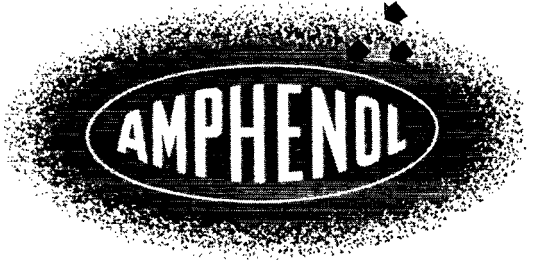

By this timely expansion of facilities American Phenolic Corporation is meeting its responsibility of leadership and specialization in mass production of quality components to better serve the rapidly expanding electronics industry.

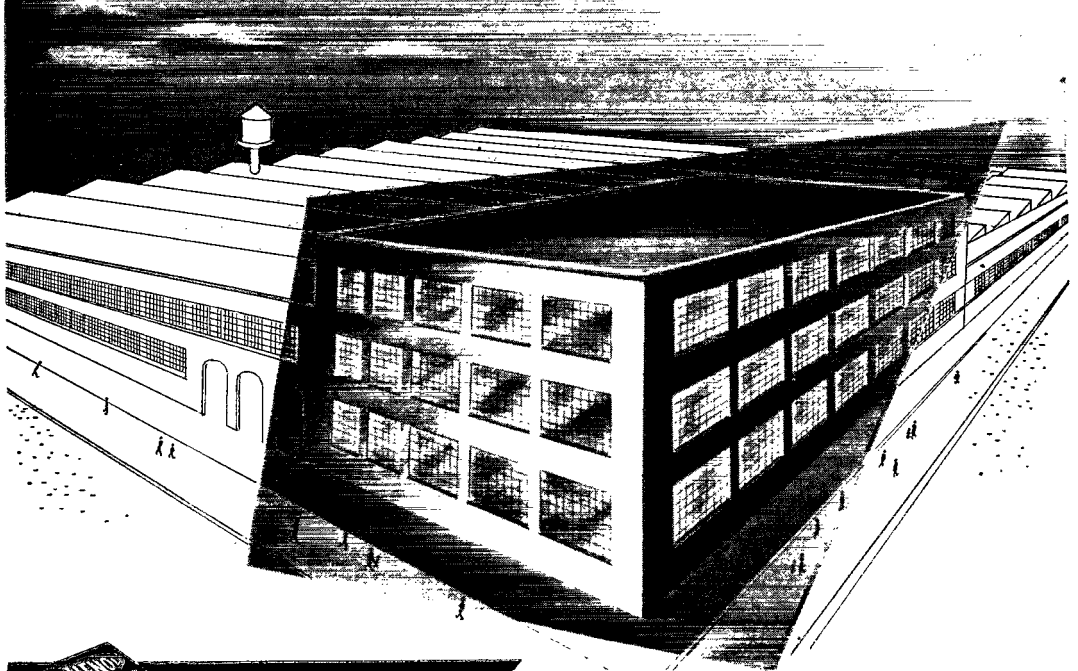

AMERICAN PHENOLIC CORPORATION

CHICAGO 50, ILLINOIS • IN CANADA • AMPHENOL LIMITED • TORONTO

COAXIAL CABLES AND CONNECTORS • INDUSTRIAL CONNECTORS, FITTINGS AND CONDUIT • ANTENNAS • RADIO COMPONENTS • PLASTICS FOR ELECTRONICS

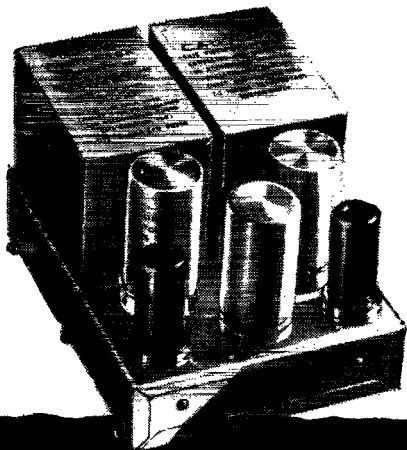

You might as well
GET THE BEST
there is

Inherently superior qualities make Vibrapacks* preferred equipment wherever high voltage is required from a low voltage DC source.

Their efficiency, economy, dependability and ruggedness have been proved by years of service in radio receivers, transmitters, PA systems, direction finders and other electronic apparatus on police cars, aircraft, automobiles, farms and boats, and in military equipment.

Vibrapacks provide instant starting regardless of weather conditions, and their high efficiency means lower battery drain. The only part of a Vibrapack which normally ever wears out or requires replacement is the long-life vibrator. This means minimum cost for service—minimum time out for service.

Get a free copy of Mallory Form E-555, giving complete technical details and application information. Ask your Mallory distributor to show you the complete line of Vibrapacks, or write direct.

P. R. MALLORY & CO., Inc.
 INDIANAPOLIS 6 INDIANA

*Reg. U. S. Pat. Off. for vibrator power supplies

P. R. MALLORY & CO., Inc.
MALLORY

(Continued from page 90)

cial Club. Total membership is thirty with about twenty being ARRL members. The number of potential hams taking exams in Billings in April was an all-time high. JDZ reports from Belgrade, where he is with the CAA. 9HKF/7 reports new call JFF. Montana ECs to date; FGB, Park and Sweetgrass Counties; JDZ, Gallatin County; EMF, Deer Lodge and Silver Bow Counties; JFF, Missoula, Mineral and Ravalli Counties; DSS, Cascade County; and, reported via "grape vine," HVB and/or IRN, Yellowstone County. BCE is home for short visit at Miles City. 9OQE/7, at Polytechnic in Billings, is having some parasitic and spurious radiation trouble. The Butte Club reports seven stations on the air. Pres. Jack Picard now has call JFR. The gang erected a 3.5-Mc. Zepp and a 28-Mc. folded dipole for JFR, who is unable to do such things. Ex-DUZ has passed exams. EQC is rebuilding. DNX, BHB, and CPY report new receivers. BHB is building new rig. BBS is located at Anchorage and his XYL has left for residence there. FOA is on the air again. Thanks, gang, for the FB lot of reports. 73. *Rec.*

OREGON — Acting SCM, Cliff Tice, W7BEE — Some activity is reported from Baker, mainly to try out the 3.5-Mc. band. From Ashland comes news that GLK and FRO, with 6MDI/7, journeyed to Medford for a meeting with the Medford Radio Club. Those present, in addition to the above, were: FMQ, DBZ, FSP, GLK, GUP, FRO, 6RJL, and 6MDI. A report from HHH lists activities of SY, formerly of Salem, Pendleton, and Eugene; he now is the operator of a service station in Bend. There seems to be a decided scarcity of news from the entire State. Whether this is due to "spring fever" or a general disinclination to write is unknown. In this radio serial it is not a question of "who dun it?," but I wish someone would do it — send in some reports to BEE. 73. *Cliff.*

WASHINGTON — SCM, O. U. Tatro, W7FWD — Edgar T. Carter, FPP, 1237 University, Walla Walla, has been appointed EC for Walla Walla, and Robert F. Gleason, IMB, Radio Supply, has been appointed EC for Tacoma. Those desiring to take part in the emergency program should contact these men and register their emergency gear with them. IMB replaces AEA, who is unable to continue with the duties of EC because of illness in his family and added responsibilities. Colfax: ERO has returned from the services and reports working some amateur radio while in the Far Pacific. JHP, another serviceman, has accepted a position with AOA at Presque Isle, Maine, and took his gear with him. DRD is working with 28-Mc. rig and cathode modulation and will soon be on 3.5-Mc. c.w. ERH, a fireman, is on 3.9 Mc.; he tried 28 Mc. with no luck. DP is on 3.5-Mc. c.w. and is working on 'phone rig for cathode modulation. Spokane: EEN, EC, is lining up portable gear and says he has found enough to get by in an emergency; he has been re-elected president of the local club. Everett: K7CZY/7 is on 28 Mc. and is keeping schedule with JBH. CEC and DYD are on 50 Mc. IOQ and CEC are on 144 Mc. JFB is on 3.9-Mc. 'phone and 3.5-Mc. c.w. Walla Walla: FFP, EC, reports a good time on 3.5 Mc. and says DCV is on 3.9-Mc. 'phone. EX is on 3.5-Mc. c.w. and 28-Mc. 'phone and is planning a 300-watt modulator. GW is on 28-Mc. 'phone. EMP and FRM are working mobile to mobile and good DX. Besides working FMJ and GYH in Milton City. GXA and GFU are on 28 Mc. at Vets Hospital. IXR is looking for new QSL cards with lace trimmings. The WWRAC held a raffle; GXA and President Hull took the prizes. Seattle: RT reports the February hamfest was well attended with hams from Tacoma, Bremerton, Everett, Steilacoom, Kennewick, Falls City, Renton, Mercer Island, Port Orchard, and Woodinville as guests. Excess funds left over from the banquet will be turned over to the club when it is re-activated. The meeting was chiefly instigated by IVA, with RT as master of ceremonies. McChord Field: 6TPN/7, on 28 and 3.5 Mc., made some sort of record in taking a message from Guam for New York City and returning the answer to Guam within a period of six hours. 6TRX and 4HNJ have been operating station 6TPN also. Traffic: W7RT 14, FWD 7, FWR 1. 73. *Tate.*

PACIFIC DIVISION

NEVADA — SCM, N. Arthur Sowle, W6CW — Asst. SCM, Carroll Short, jr., W6BYZ. Nevada intercity traffic nets, 3060-kc. c.w., 3980-kc. 'phone, 8 to 10 P.M. PST. MRT and OPP have portable emergency equipment for 3.8 and 235 Mc. RXG operates on 28 Mc. RPU upped

(Continued on page 95)



Enjoy Security and Good Pay! Prepare Now With CREI Technical Home Study Training and Step Ahead of Competition into a Good Radio Job!—CREI Offers You a Proved Program of Self-Improvement to Keep Pace With Modern U. H. F. Advancements and Get That Radio Engineering Job You Want

CREI home study training in Practical Radio-Electronics Engineering can equip you to meet the requirements to hold your job — or advance to a better one. CREI graduates are recognized throughout the Radio-Electronics industry. Your CREI diploma is the best recommendation for a better job. By adding CREI training to your present radio experience you can safeguard your future and keep pace with such new developments as U. H. F. Circuits, Cavity Resonators, Pulse Generators, Wave Guides, Klystrons, Magnetrons and other tubes. Are you equipped to handle them? CREI is equipped to help you, by providing the know-how and ability that is required.

In our proved method of instruction, you learn not only how but why! Easy-to-read-and-understand lessons are provided well in advance, and each student has the benefit of individual guidance and supervision from a trained instructor. This is the basis of the CREI method of training which many thousand professional radio men have completed during the

past 19 years. CREI courses were used during the war to train thousands of Army and Naval radio technicians for the U. S. Signal Corps, U. S. Navy and U. S. Coast Guard.

It's up to you now to decide your course. It costs you nothing to read the interesting facts . . . to learn how CREI can help you enjoy the security you want . . . the better-paying job that can be yours. Write for particulars now! (CREI training for Veterans is approved under the "G.I." Bill.)

WRITE FOR FREE 36-PAGE BOOKLET

If you have had professional or amateur radio experience and want to make more money—let us prove to you we have something you need to qualify for a better radio job. To help us intelligently answer your inquiry—please state briefly your background of experience, education and present position.



CAPITOL RADIO ENGINEERING INSTITUTE

E. H. RIETZKE, *President*

Dept. Q-7, 16th and Park Road, N. W., Washington 10, D. C.

New York City (7), N. Y.
170 Broadway

Chicago (2), Ill.
30 N. LaSalle St.

Branch Offices:
San Francisco (2), Calif.
760 Market St.

San Diego (1), Calif.
316 C Street

MEMBER: NATIONAL HOME STUDY COUNCIL • NATIONAL COUNCIL OF TECHNICAL SCHOOLS

FOR SUPERIOR QUALITY

**THORDARSON
MEISSNER
RADIART**

**AVAILABLE FROM
A SINGLE SOURCE!**

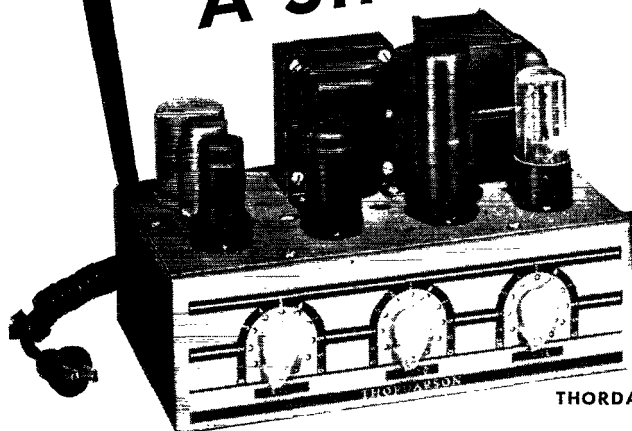

THORDARSON TRU-FIDELITY AMPLIFIER

**ELECTRONIC DISTRIBUTOR AND
INDUSTRIAL SALES DEPARTMENT**

ELECTRONIC PRODUCTS...

THORDARSON

TRANSFORMERS

● For all requirements... communications, sound amplifier, industrial, experimental and amateur.

TRU-FIDELITY AMPLIFIERS

● Advanced tone compensation, conservative ratings, multiple input channels, low hum level, etc.

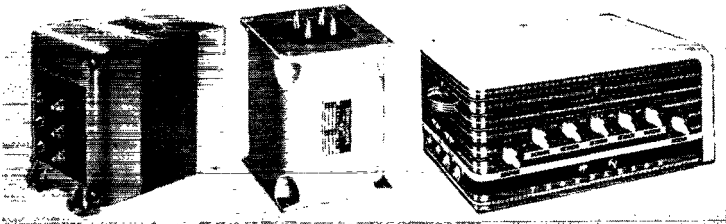

THORDARSON

MEISSNER

COMPONENTS

● Standard, plastic and Ferrocarr transformers; antenna, R. F. and oscillator coils; accessories.

SERVICE INSTRUMENTS

● Meissner Analyst... a complete servicing instrument; Signal Calibrator... self-contained and portable.

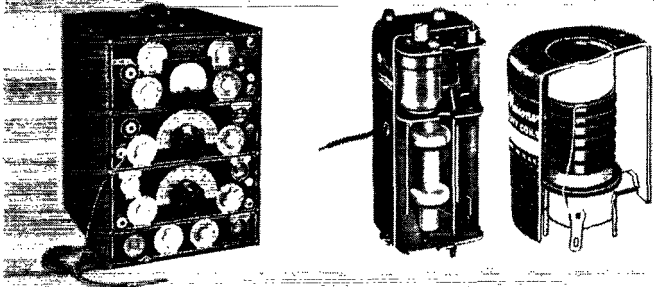

MEISSNER

RADIART

VIBRATORS

● Exact duplicate Vibrators, individually engineered... long life, low noise level, minimum interference.

RUST-PROOF AERIALS

● A complete line, newly designed to fit all cars... cowl, hood and under hood types. Many exclusive features.

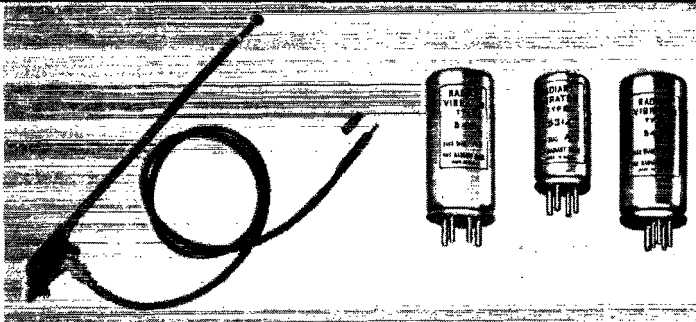

RADIART

MAGUIRE INDUSTRIES, INC.

936 NORTH MICHIGAN AVENUE, CHICAGO 11, ILLINOIS

VARIABLE CONDENSERS

FOR EVERY STAGE OF THE TRANSMITTER

For many years Johnson variable condensers have been the choice of hams who demand the highest quality and latest in condenser design. From oscillator through final amplifier Johnson condensers give outstanding performance and help put your rig "out front."

Shown here are but a few models of the popular line of Johnson condensers, incorporating the most recent advancements of Johnson engineering.

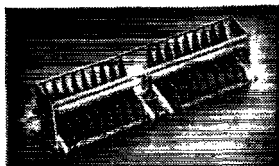

Type C... Single and dual models designed for high power applications. Plate spacing .125—.500

Type D... Single and dual models for high power, smaller than type C. Plate spacing .080—.250

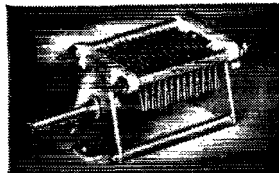
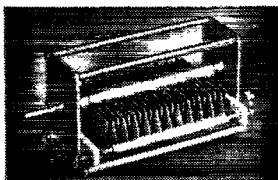

Type E... Single and dual models for medium and low power. Plate spacing .045—.125

Type H... Minimum of weight and size. Medium and low power. Single and dual models. Plate spacing .030—.080



Johnson condensers, inductors, insulators, plugs, jacks, "Q" antennas and ham hardware items are stocked by leading radio-electronic parts jobbers. Watch for new Johnson ham gear to be announced soon; it will be tops.

Write for catalog 968J.

JOHNSON

a famous name in Radio

E. F. Johnson Co. Waseca, Minn.

(Continued from page 98)

his telegraph ticket to 1st. HVY/7 is on 3.9 and 3.5 Mc. at Pioche. GSB reports on 3.9 and 3.5 Mc. TFF is on 3.5 Mc. with 35T at 100 watts. Maichle, of KBNE, has 3.5-, 28-, and 235-Mc. equipment ready to go. BVZ keeps in touch with his part of the section on 3.5- and 28-Mc. c.w. QYK is on 3660 kc. BIC is on 3.9 Mc. F.UO put up a telephone pole for rotary antenna and has new final with p.p. T155. BYR has p.p. 813 on 3.9 Mc. with "V" beam. EEF put three-element rotary on 28 Mc. GYX has portable emergency 3.5- and 224-Mc. rig. PST, GYZ, QYK, UIU, and CW held a round table on 3660 kc. right after it opened up. 73. Art.

SANTA CLARA VALLEY—SCM, Roy E. Pinkham, W6BPT—Asst. SCM, W6TBK. PAM, QLP. The SCCARA held its monthly dinner meeting in April with piano solos by LXW, guitar and "sweet potato" duets by MOV and UGF, and a prize-winning colored movie shown by FBW. The PAARA gave its first dinner meeting of the year at Bertrands in Palo Alto. The meeting ended with a talk on antennas by K6SMP/6, and the matching of feed lines to the antenna. JTQ has a new jr. operator. QLP sports a Panadaper and gives modulation checks to the gang. CRK, 9FAV/6, and KG are using the T-match shown in QST for feeding their close-spaced beams. 9ECA, of Taylor Tube Co., was a visitor at SCCARA meeting. LXA has started his Saturday night get-togethers again. CZX is on 3.9-Mc. 'phone. OVK/6, Redwood City, is looking for stations on 50 Mc. NHO has been heard on 28-Mc. 'phone. 9OFS/6 is rebuilding his 28-Mc. rig through the courtesy of 9FAV/6. SYW has installed a three-element beam for 28 Mc. He would like to hear from HJP and PTO. THV has rig on 3.5-Mc. c.w. 9IHR, using 3 watts while in Chicago, was worked by TBK in Menlo Park. NYS is building new rig and says it will be a kw. 1WV/6 now has forty-four states for WAS. He installed a VR-150 in e.o. PBV is on 3.5-Mc. c.w. with 807 running 30 watts. His 28-Mc. rig uses 250THs p.p. with kw. input. He has receiver on 144 Mc. and expects to be on 50 Mc. soon. 73. Pinky.

EAST BAY—SCM, Horace R. Greer, W6TI—SEC, EE; RM, ZM; EC, QDE; EC v.h.f., FKQ; Asst. EC v.h.f., OJU; OO v.h.f., ZM; OO, ITH; OBS, TT, IDY, ZM, ITH. PB, TI, and BUY are working e.o. on 3.5-Mc. c.w. TT has worked thirty-four countries on 28-Mc. 'phone since the end of the war. LMZ built low-power rig as per March QST. EJA reports best DX on 3.5-Mc. c.w., K7HNG/KC6 on Wake Island. K7 now is off this band due to regulations. BI is back on after five years with 807 in final on 3.5-Mc. c.w. ITH sends in complete detailed reports, and seems to be working everything he hears on 28-Mc. 'phone, which is plenty. Reg worked KUIRO, which is a boat 1000 miles west of San Diego, on 3.9 Mc. IDY is in new QRA with new antennas up with 1 kw. on all bands except 144 Mc., where he uses only 250 watts. TI likes his new Hallicrafters BC-610E transmitter which is now working FB on 3.5-Mc. c.w. using an L antenna. SAN reports he still is sailing as radio operator on *J. L. Hanna*, but has time off to work 144 Mc. with an Abbott TR-4 and 3.5-Mc. c.w. with a 35T in final with 150 watts. PB is new editor-in-chief of *S.A.R.R.O. News*. NPP has his new call letters, VBJ. DDO's best c.w. DX on 3.5 Mc. is Wake, with which he kept a schedule for two weeks. DUB should be on the air any moment with 700 watts with new transmitter with 813s in final. EY attended ARRL Directors' meeting and you can contact him now for all the dope. ZM is active on 28-Mc. 'phone with 807 in final. NO is on the air with new rig with 250THs in final. DON'T FORGET TO SEND IN THAT NO. 10 ENVELOPE, SELF-ADDRESSED AND WITH YOUR CALL LETTERS ON UPPER LEFT HAND CORNER. Who knows maybe you have some QSL cards at the W6 QSL Manager's office? How about sending me a postal card by the fifth of each month giving any information which may be of interest to the gang. From the many letters I receive I note the boys keep informed through the section reports in QST each month. We have a number of boys from this section who still are overseas. Traffic: W6ITH 103, DDO 35, EJA 7, 73. "TI."

SAN FRANCISCO—SCM, Samuel C. Van Liew, W6CVP phone RA 6457—Asst. SCM, Joe Horvath, W6GPB. ECs: DOT, KZP; OO: NJW; OBS, FVK, KNH. IJQ, formerly of Sacramento, now is located in San Francisco. Walt has a pair of 812s on 28 and 3.5 Mc. Ed Ball sends in the following dope: MGL is attending Healds College, cranking up the rig at Sonoma QTH ready for opening of 3.5-Mc. band. LHH is on 28 Mc. from his Novato

(Continued on page 98)

Another SCIENTIFIC Achievement

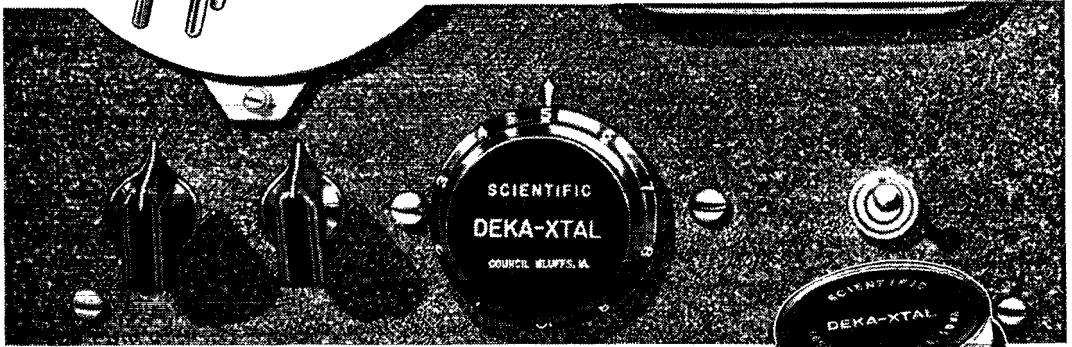

Compact . . . Ten Crystals in a Nutshell



Another Scientific achievement. . . TEN CRYSTALS IN A NUTSHELL, the most useful crystal unit ever designed. In Scientific's new DEKA-XTAL* you have ten of Scientific's fine metalized crystals so arranged that any one of the ten can be connected to the base pins by simply rotating the holder. All ten crystals in one package. No larger than a control knob. This unit plugs into a standard five-prong tube socket on the front panel of your transmitter, giving you ten frequencies with fingertip control.

Compact — rugged — and sealed against moisture and dirt. The DEKA-XTAL plugged into your oscillator gives you crystal control, signal shifting, at less

than the cost of a good ECO. The DEKA-XTAL is useable with any number of crystals from one to ten. You may order the holder with as many crystals as you desire and add other frequencies later.

Your selection of frequencies furnished with the unit and you can purchase additional metalized crystals and easily interchange them with the ones in the unit by following simple instructions.

DEKA-XTAL Holder without crystals. \$6.95 each

Metalized crystals furnished to plus or minus 1 KC, your specifications in the frequency range 3,500 to 9,500 KC.

\$1.50 each



* Patents Pending

SCIENTIFIC



RADIO PRODUCTS COMPANY

738½ W. Broadway - Telephone 3-1412

MANUFACTURERS OF PIEZO ELECTRIC
CRYSTALS AND ASSOCIATED PRODUCTS
COUNCIL BLUFFS, IOWA

SEE OPPOSITE PAGE

For Important News about a new and better

COMMUNICATIONS RECEIVER

This is just the kind of a receiver you would expect Cardwell to build. It's as rugged as a steam roller—yet as smooth to handle and operate as perfectly balanced construction and ball bearings can make it.

We call it the "Cardwell Fifty-Four". And that's more than a mere name. It's a promise of coverage up to 54.0 mcs.!

Read the fifteen outstanding features on the opposite page. These are all combined in a compact seventy-pound unit, designed and developed for the most critical amateur and professional requirements.

Here is everything you could wish for in an amateur ham communications receiver—a band spread dial for five hambands, a built-in crystal calibrator and a newly engineered turret mechanism for changing bands that's really foolproof—just to name a few.

As for styling, one glance at the illustration on the facing page will show you how modern industrial engineers like Henry Rice, Jr., and Henry B. Hoover can add eye appeal to creative engineering.

After you have operated a Cardwell Fifty-Four, I don't believe you could be satisfied with anything else. There'll be lot's more cooking on the hambands for you when you get this fine communications receiver.

Let me send you more complete details. Just drop a card to . . .

Ray Morehouse

W2QA/1

**THE ALLEN D. CARDWELL
MANUFACTURING CORP.**

MAIN OFFICE & FACTORY

97 WHITING STREET, PLAINVILLE, CONN.

(Continued from page 96)

QTH. IUH traded hamming for gears and paints. Traffic nets now are forming as we acquire more bands. RBQ is holding down Pacific end of Pacific-Atlantic Trunk Line, with the assistance of QXN. RBQ also has schedules with KA1AW and KA1ZU. The San Francisco SARO has nets operating Monday nights on 29.4-Mc. 'phone and Thursday nights on 3814-kc. c.w. The SARO holds its monthly dinner meeting the last Monday evening of each month. Those interested please contact NQJ. The club is planning to take part in the coming Field Day Contest and is already testing its equipment on long and short hauls. A test held recently just missed establishing a new record for 144-Mc. work because of receiver failure on one end. However, contact was made one way with ease. The test was checked throughout by a similar 3.5-Mc. hookup. The SARO was the last Pacific Coast prewar Field Day winner and it looks like it means to stay that way. How about some competition, gang? RBQ is using new converter for 144-Mc. work with excellent results. QUC is building a new portable-mobile 100-watt crystal rig and superheterodyne for RBQ to use on 144 Mc. OZC has installed a 144-Mc. three-element beam and has his transmitter ready to go. OZC's son has just returned from service in the China and Japan area. He served as radar technician. ETM3. HEF has fine 28-Mc. beam on 62-ft. tower with complete motor control of rotation and indication. KNH removes BCL trouble by moving antenna away from power lines and increasing height with new tower. Maybe those power lines helped your fine score in the Band Warming Contest, OM. WB is moving location and will be near NYQ and SLD. LES and family are on a vacation trip to Florida. CIS is moving to Los Angeles. The San Francisco Radio Club had an old-timers meeting April 26th with pictures and movies taken as far back as 1926, including some of our previous Field Days. Our forthcoming Field Day was discussed. OZC, publicity director for the Marin Radio Club, extends invitation to any who wish to attend its meetings. The gang has a fine club with swell programs, so drop in. Traffic: W6RBQ 133; KNH, 32; OZC, 24.

SACRAMENTO VALLEY — SCM, John R. Kinney, W6MGC — The Sacramento Amateur Radio Club, which holds meetings on the third Wednesday of each month at the South Side Park Club House, was pleased to present QDT and DGL on May 15th with a report on the use of California State transmitting and receiving equipment used on 152-Mc. operation. MIW exhibited a German high-frequency receiver of unique design. The SARC Field Day outing will be the same date as that of the League. BVK is in charge of refreshments for the F. D. An Old-Timers night will be held on Aug. 23rd. QKJ is the club code instructor. 1JSU/6 won a Vibroplex key. SARC boasts refreshments for each meeting and a membership of 115. Activity: AJD is on 3.5 Mc. with a 35T crystal and a 100TH in the final operating at 350-watts c.w. and an Abbott DK-3 on 144 Mc. PIV and MIW both have 15-tube 204-Mc. Surplus receivers to be made into dandy 144-Mc. jobs. EJC reports FB QSO with 6SKI/VK9, Admiralty Islands, on 'phone. AP has thirty-six FB contacts to the South Pacific and the Aleutians. PNC has two new jr. operators. QKJ, MIW, KME, BVK, CLV, GZY, GAK, MBY, PIV, EJR, and MGC, portable-mobile CLV, and EJR are on 144 Mc. and QDT is on 28 Mc. New amateurs with new calls in the SARC are: VBU, VKM, VLR, VNX, and YKZ. The SCM would appreciate your reports, fellows, and would like to know of any activity that would interest the gang. Traffic: W6EJC 515, AP 72, 73. Jack.

PHILIPPINES — SCM, George L. Rickard, KA1GR — The Philippine Amateur Radio Association held its first meeting December, 1945. However, at that time amateurs were not allowed on the air; could not even get operator licenses. Later we were permitted to secure operator licenses, but not station licenses. Now, however, station licenses are obtainable. We now have twenty-one members, mostly from Manila and vicinity. This number will be increased as hams in the provinces get on the air. We are handicapped for lack of equipment. Most of the hams either turned over their radio equipment to the military in December, 1941, or destroyed it. Such equipment as is available for construction of ham stations is very expensive. However, those who can prove that their equipment was turned over to the Army or Navy at the outbreak of the war will be given, as near as possible, equipment equal to what they formerly had. KA1AF is designated as OBS for KA stations. KA1AF is owned and operated by service men, and will broadcast each Wednesday and Saturday, at 7 P.M., Manila time, on a fre-

(Continued on page 100)

ANNOUNCING . . .

The Cardwell Fifty-Four

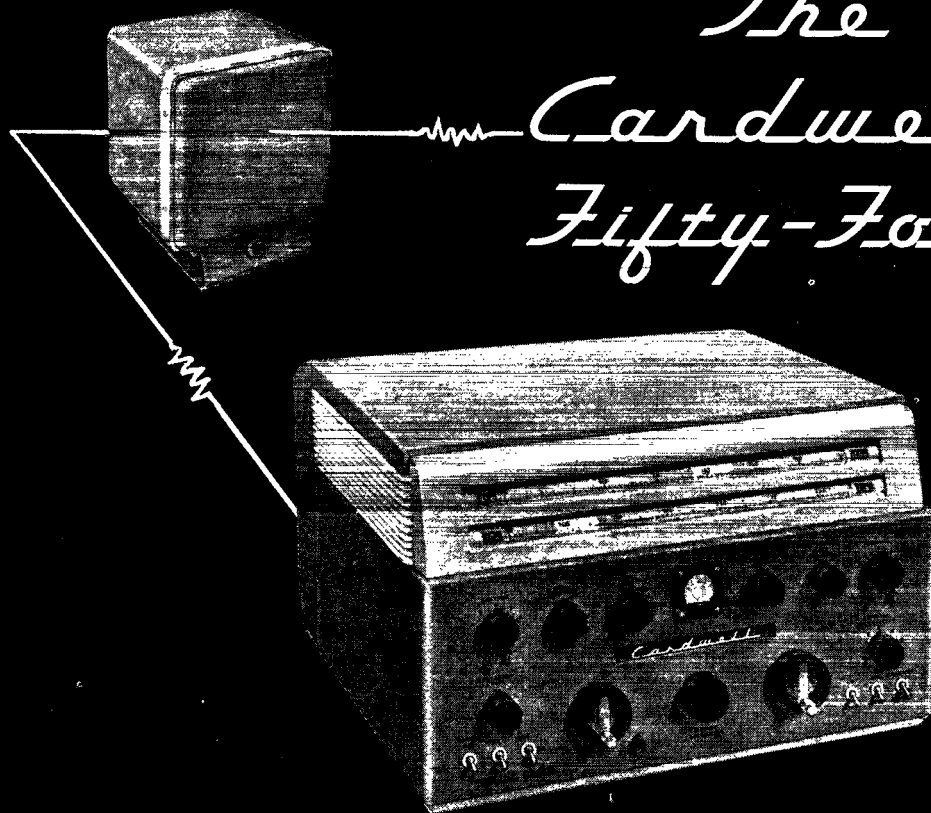

a communications receiver with unusual engineering features

This newly-developed receiver combines many design and engineering refinements within surprisingly compact dimensions. It opens up a whole new area of possibilities for hams. Following are just 15 of its many features. Check them against the things you want in a communications receiver.

1. Full turret type R.F. Section.
(Sturdy turret of original design assures absolute mechanical and electrical stability.)
2. Wide Frequency Coverage.
(Range to 54.0 mcs.)
3. Secondary Frequency Standard.
(Built-in 100-1000 kcs. Calibrator.)
4. High Signal to Noise Ratio.
(Two grounded grid RF Amplifier stages assure actual receiver noise less than 6 db above thermal!)
5. "Custom-built" Gang Condensers.

(Specifically designed by Cardwell for this receiver.)

6. Electrical Band Spread.
(Pointer travel—better than 10½ inches on every range.)
7. Direct reading linear type dials.
(Excellent visibility—only the chosen range and corresponding band spread in view at any band switch setting. Non-Glare dial illumination with dimmer control on front panels.)
8. All miniature Tubes.
(18 including rectifiers.)
9. Mechanical Coupling Provisions.
(Shafts are brought out at rear for linkage to other units.)

10. Threshold Squelch.
(Operating level controllable from 5 to 100,000 micro volts.)
11. Temperature Compensated Oscillator.
(Stability is better than 100 parts per million per degree centigrade.)
12. New Type Noise Limiter.
13. Unit Construction.
(Receiver and power supply combined in one sturdy lightweight unit.)
14. Heavy Duty Speaker.
(Lightweight tilting unit, wall or table mounting.)
15. 8 Watts Audio Output.
(Push-pull class AB—with five available output impedances.)

WRITE FOR COMPLETE TECHNICAL BULLETIN

THE ALLEN D. CARDWELL MANUFACTURING CORP.

MAIN OFFICE
& FACTORY:



97 WHITING STREET
PLAINVILLE, CONN.

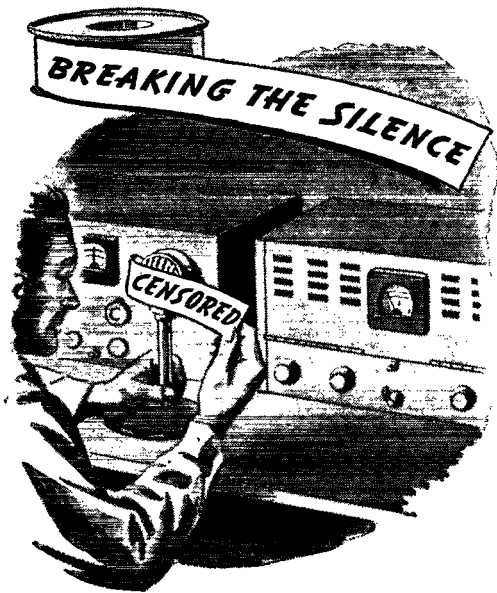

FOR a long time we've been waiting to break the silence and say something to you amateurs. But, for the past four years, for reasons that we all, of course, understand, there hasn't been much that we could say.

Now that you're back on the air, the thing we'd like to say most is that we can supply you with as much radio equipment as you require. Frankly, we're not yet in a position to do that.

But we're getting there. Recently we reconverted our entire Electronic Equipment Division. We've commissioned its personnel to devote all its energies to the design and creation of the kind of equipment we know you want and need. Our designers, who are also HAM operators, are now back at their drawing boards, planning a program that will provide you with maximum gratification from your hobby . . . at lowest cost. Yes, once again Stancor is working for and with the radio amateur.

And when you are able to obtain Stancor equipment for your Radio Shack . . . we're certain you'll agree that it's better and more to your liking than ever. Meantime, remember that our engineering facilities are always at your disposal, that we may both contribute to the progress of our common field . . . communications.

"73"

STANCOR
STANDARD TRANSFORMER
CORPORATION



1500 N. HALSTED STREET, CHICAGO 22, ILLINOIS

Continued from page 98)

quency of 28,380 kcs. KA1AF has direct contact with W61BY which transmits on a frequency of 28,150 kc. KA3CB, Ilagan, Isabela, has been appointed Emergency Coordinator and will have charge of the Emergency Corps in P.I. The PARA desires to continue affiliation with ARRL. We are "up against it" here in many ways but the gang is very enthusiastic and all hams are more than eager to get back on the air. At present we have plenty of food although it is very costly; clothing is on the up; what we lack are radio parts to rebuild our stations. Many of us lost everything during the war; houses, clothing, documents. Some are impaired in health, and while trying to rehabilitate ourselves it is an up-hill job to put in a radio station at present costs. Ed Day, ex-W3CXL/WLM, is now KA1AW and gives address as Hdq. A.S.A. Pacific, APO 358, Care of Postmaster, San Francisco.

SAN JOAQUIN VALLEY — SCM, James F. Wakefield, W6PSQ — NJQ and KPQ gave a demonstration QSO for the Boy Scouts on 28 Mc. Report from QEU says that he is on in Singapore area using the call QEU/VS1. Pete is running a kw. on 14 Mc. and 600 watts on 28 Mc. with thirty-five countries. OWL is on 144 Mc. with an HY-615, both mobile and fixed. FJH is returning to Japan as an interpreter for the OWI and if possible will be on with a J call. PCS is on 28 Mc. running 500 watts on 'phone and 800 watts on c.w. NPI is burning up 3.5 Mc. with a 117N7 combined transmitter and power supply. MYP has opened a new retail store in Fresno and has a swell line-up of stock. EML, of Visalia, is on 3.5 Mc. with a cool kw. into a pair of 204As. PDX has moved to Fairfield to work at Fairfield Suisun Air-base radio and radar shop. HYG received his old call back and is moving to Bakersfield to manage KERO, a new station there. PTF has a new HQ-129 and is on 3.5 Mc. with a Utah 6L6 rig while the big job is in the making. UVN has a new concentric antenna on 144 Mc. and is running twenty watts into his HY-75. Here is some dope from Turlock: SKH has a 85T on 28 Mc. with a new beam. QER has an HK54 on 28 Mc. and has a new beam in the making. 71ZO/6 has a radio shop in Turlock and is on 28 Mc. ONO and AXI are on 28 and 3.9 Mc. RTF, in Ceres, has 150 watts on 28 Mc. into a pair of RK-812a. UBQ has a radio shop in Hughson and is on with a pair of 6L6s in final cathode modulated with a 6L6. 73, gang, and let's hear from y'all. *Jimmie.*

ROANOKE DIVISION

VIRGINIA — SCM, Walter G. Walker, W3AKN — The first postwar meeting of the Peninsula Amateur Radio Club was held at the Hampton U.S.O. on March 29th. The club has elected officers for the year and is working to obtain permanent quarters. New calls issued to amateurs in Virginia are W4GNM replacing K4GNM, 4IJW replacing 3HWT, and 4WO replacing 3WO. 4WO is an airport operator at Washington National Airport and is still a traffic hound rarin' to go on 3.5-Mc. c.w. Lt. Comdr. 3DQB writes in from the M.I.T. Post Graduate School, Cambridge, Mass., to report he is working on 144 and 28 Mc. with a transceiver on 144 Mc. and an 807 and HRO-5 receiver on 28 Mc. 3AKN is rebuilding for higher power on 28 Mc. 3IFJ and 3GGP are active on 28 Mc. with IFJ using a new rotary three-element close-spaced antenna. 9ZUJ at Yorktown, is active on 28 Mc. and 3.5 Mc. 3ICZ and 3GGI are working on rigs to get back on the air for license renewal. 3ESR, the Peninsula Amateur Radio Club station, has sent in for renewal and a club station will be set up in the near future. The following are members of the club: 4GNM, 1NVQ, 2INN, 8RNP, 6UIQ, 8QGN, 3IIF, 8KXC, 3GGI, 3HPW, 1LUF, 3AJA, 3MT, 3ICZ, 5CWX, 2NMG, 3JHC, 4GEZ, 9HLA, XUSWS, 3ATY, 6MG, 3HZU, 9UN, 4FFO, 5JOV, 3CAH, 4DGS, former SCM of Alabama, is located in the Virginia section, working 3.9-Mc. 'phone, also 28-Mc. 'phone on occasion. He suggests a 3.9-Mc. 'phone net and is open for 3.5-Mc. traffic schedules on c.w. every morning. 3MT has completed his 300-watt 'phone and is getting good results on 28-Mc. 'phone. 3GSV is again running a kw. on 28-Mc. 'phone. 3AJA alternates between 3.9-Mc., 28-Mc., and 145-Mc. 'phone bands. 3IIF is rebuilding for higher power and is experimenting with 28-Mc. beams. 8KXC is rebuilding transmitter to work all bands. 3HDD is a new station in Hampton recently heard on 28-Mc. 'phone. 3DRK recently returned to Langley Field from the South Pacific. 3HZU, of Langley Field, is rebuilding to 500-watt all-band 'phone rig. 3PK and 3FQP, of Norfolk, are often

(Continued on page 108)



SINCE

1934

Z-2 80-METER AND 40-METER BANDS— Low temperature coefficient, less than 2 cycles per M.C. per degree centigrade. High activity. Calibrated accurate to within .01% of stated Frequency. Fits octal tube socket. Net\$2.65



Z-3 20-METER BAND— Highly active low temperature coefficient unit, oscillates on third Harmonic. Temperature coefficient less than 2 cycles per M.C. per degree centigrade. Pins spaced for octal tube socket. Net.....\$3.50



Z-5 10-METER BAND—The first and only low temperature coefficient 10-Meter Crystal available to the amateur. Less than 2 cycles per M.C. per degree centigrade drift. When used with 7C5 in (*our circuit) will drive 807 to full output. Calibrated accurate to within .01% of stated Frequency. Holder plugs into octal tube socket. Net.....\$5.00
*Patent Pending.

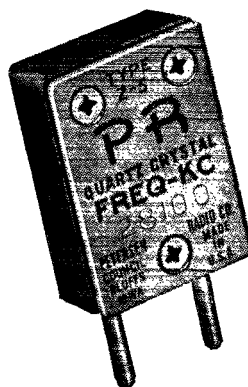

Crystals for all bands can be supplied to exact frequency (integral K.C.) at no extra charge.

Type Z-2 and Z-3 are now available for the 44 and 22-Meter bands to quadruple and double into the New 11-Meter band at same price as 40- and 20-Meter bands.

PR crystals can "take it" and really "put out." Every PR crystal is *unconditionally guaranteed*. See your jobber today — ask him for a copy of the descriptive booklet on PR crystals.

PETERSEN RADIO COMPANY

2800 WEST BROADWAY—TELEPHONE 2760

COUNCIL BLUFFS, IOWA



STATION TESTED*

... an added
proof of Quality!



*Pres. W. A. Kuehl is shown at his amateur radio station W9EZN. With the war over, Walt is again pursuing his favorite hobby.

DRAKE RADIO SOLDERING IRONS

Yes, Drake irons are right for radio. And these sturdy irons have proved their dependability and worth in use on countless other jobs, too, for over 25 years. That's why we say — whatever your needs, you are certain to find a Drake iron that fills the bill exactly!



600-10—the Drake No. 600-10 is ideal for those all important connections when rewiring your rig. Get back on the air fast. Make good dependable connections with this 100 watt $\frac{3}{8}$ " tip.



400—the Drake No. 400 is the perfect iron for work in small places. Only 9 inches long, it is especially designed for tight corners and delicate connections. 60 watt, $\frac{1}{4}$ " tip.



Ask your nearest supplier or write for the name of the distributor nearest you . . . and give yourself the advantages of these superior irons.

DRAKE ELECTRIC WORKS, INC.

3656 LINCOLN AVE.

CHICAGO 13, ILL.

(Continued from page 100)

heard working DX when the 28-Mc. band is open. Try to get news in to me for inclusion in the column by the first of each month. 73. Walt.

WEST VIRGINIA — SCM, Donald B. Morris, W8JM — See WACWV rules following this report. Who'll get WACWV No. 1? SIG, formerly of Ivydale, is now in Cleveland. MOL is back on 3.9-Mc. 'phone with new antenna system. KWVL has thirty-four states on 28 Mc. and six new countries, including KP6. GBF keeps 3770 kc. alive and plans to increase power. Ex-CCN, of Shinnston, has the bug again after twenty years and will be on soon. HOJ has a new rig on 3.9-Mc. 'phone. JIW, of Hamilton, N. Y., would like to work a YL operator in this State. Are there any YL ops in the State? RCU, stationed in Hawaii, has been working the W. Va. boys on 28 Mc. and plans on coming home this summer. PQQ is new OO and OBS. BOK has new HQ-129 receiver. EP, one of West Virginia's oldest hams, is looking for a farm on a high hill, with enough room for a rhombic and "V" beam. QR and NEU have returned to the air and may be heard around 3770 kc. KXC is now at Hampton Roads, Va., working as portable 3, and PGL is working portable from Norfolk. 200S, ex-8CVX, is at Albany, N. Y., and works 3911-kc. 'phone and 3887-kc. c.w. Remember WACWV starting July 1st, and for a tip watch 3770 kc. for weak signals from portables in rare counties. Traffic: W8GBF 3, KWL 1.

W.A.C.W.V.

The Mountaineer Amateur Radio Association, Fairmont, West Virginia, announces a contest for all West Virginia amateurs, to start on July 1, 1946. Only contacts made after that date will count toward WACWV. . . . Worked All Counties in West Virginia.

Attractive certificates will be issued to each West Virginia amateur who works all 55 counties in the state, on either c.w. or 'phone, or both, using any band or bands available to amateurs. Two worthwhile prizes will be given at the end of each six months to the two West Virginia amateurs who have worked the most countries to date. The winner in one such six months period will not be eligible to win in a second period unless a change has been made in the number of counties worked.

Portable operation in any county by a licensed amateur who normally resides in another West Virginia county is permitted provided that a verification card is mailed to each station worked, from the Post Office nearest to the location, confirming the QSO, and provided further that any amateur contemplating portable operation for contest credit shall transmit or have transmitted a general QST (giving date, place, and time of operation) on the WVA Net frequency of 3770 kc., or in the 3.9-4 Mc. 'phone band, at least twice on different days, at least 24 hours before such contemplated operation.

Qualification will be determined by presenting cards from 55 counties to the Contest Committee at Fairmont. The date of arrival of the cards will determine the order of winners and certificate numbers. All cards submitted for awards will be returned if requested. Contest Committee shall consist of the SCM and two members of the MARA. In case of any questions arising, the decision of the Committee will be final. Rules may be changed as found necessary, but no rule change will affect the results of the contest to date of the change.

ROCKY MOUNTAIN DIVISION

COLORADO — SCM, Glen Bond, W9QYT — W8EHC has 500 watts on 3.9-Mc. 'phone down Fort Worth way looking for Colorado contacts. NDM, at La Junta, reports lots of DX on 28 Mc. with 120 watts to a pair 809s. Lewis also is on 3.9-Mc. 'phone and c.w. EEP is on 28 and 3.9 Mc. with a new HT-9 and SX-28. PGX is on 28 and 3.9 Mc. with a 75-T rig. 6JSF/9 is on 28 Mc. at La Junta Army Air Field. The Western Slope Radio Club has a new set of officers. Nate Bale is president and GMB is secretary-treasurer. Most of the boys are back from the services and ham radio is looking up over there. MGX is back in circulation after a period of illness. GTL now has twin jr. operators as well as ham radio to keep him up nights. 9GEW has moved to Grand Junction from down Alabama way. There is some 50-Mc. activity starting in Denver but don't know

(Continued on page 104)

DOLLARS S-T-R-E-T-C-H *far*

when you buy a

TEMCO

75 GA Transmitter

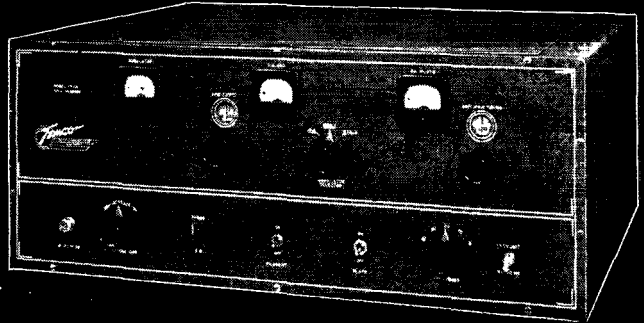

▷ TEMCO 75GA 75 watt output on Phone and 100 watts output on CW.

In addition to the many advanced technical features of the new Temco 75GA Transmitter its ability to perform as both a transmitter and exciter, indefinitely protects your investment against obsolescence when you decide to increase power.

You can start now with a Temco 75GA which is a complete 75 watt phone/100 watt CW transmitter featuring multi-frequency VFO and crystal control — later when you decide to step up to 500 watts output you can do so without sacrificing one cent of your original investment for this higher powered unit utilizes the 75GA as the exciter. Thus when you buy a 75GA you are also acquiring a stake in a Temco 500GA.

The 75GA is designed to operate within the 3.5, 7, 14, 21 and 28 megacycle bands but is also available for operation on any five harmonically related bands for other forms of communication. Unexcelled in craftsmanship, these units feature maximum frequency flexibility and unusual operational simplicity. The only accessories needed to go on the air are a microphone, telegraph key and antenna installation. For further information see previous ads in this publication. Also contact your dealer or write directly to Temco for Bulletin T-5.

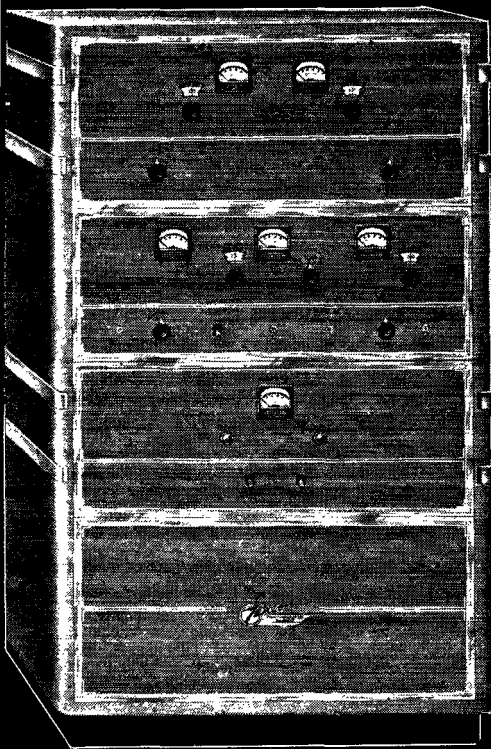

TEMCO 500GA 500 watt output on both Phone and CW incorporating the 75GA as the exciter unit. The final amplifier comprises push pull 100-TH's with a normal input rating of 750 watts modulated by a pair of 100-TH's class B.



TRANSMITTER EQUIPMENT MFG. CO., INC.

345 HUDSON STREET • NEW YORK 14, N. Y.

For CW Only — Get The
HARVEY
 100-T TRANSMITTER
 Without Modulator

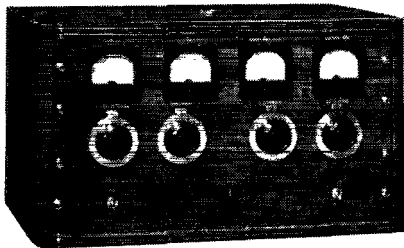

SPECIFICATIONS

Frequency Range—3.5–30 mc.
 Power input—175 watts to final amplifier.
 Radio Frequency Tubes: 6V6 Crystal oscillator,
 6L6 Doubler, 814 Final amplifier.
 Rectifier Tubes: 2–866 Final amplifier supply, 83V
 Oscillator doubler supply.
 Net weight—80 lbs. with cabinet.

...
 Add the **HARVEY**
 100-T Modulator Later

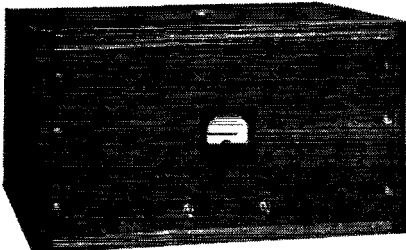

SPECIFICATIONS

Audio Frequency Tubes: 6SJ7 1st Audio amplifier,
 6SF5 2nd Audio amplifier, 6F6 Class B driver, 2–
 807 Class B modulators.
 Rectifier Tubes: 5Z3 Speech amplifier supply, RK-60
 Modulator supply.
 Net weight—100 lbs. with cabinet.

...
 For complete information on the 100-T
 and other HARVEY Transmitters write
 for Transmitter Bulletin.



**HARVEY RADIO
 LABORATORIES, INC.**

451 Concord Ave., Cambridge 38, Mass.

(Continued from page 108)

just who yet. Some of us are dusting off the old 112-Mc. rigs and getting them up on 144 Mc. Look for lots of mobile operating this summer. WYX should be back upon the mountain with something on 144 Mc. I believe all of the Denver clubs will have portable equipment out for the Field Day in June. We sure could use 7 and 14 Mc. then. A lot of the fellows are off the air for lack of receivers and transmitter equipment. 3.9-Mc. has been getting a good workout on both 'phone and c.w. Would like to hear you fellows out in the State with news on what is going on. 73.
Glen.

UTAH-WYOMING — SCM, Victor Drabble, W6LLH — L. E. French, SID, c/o Utah State College, Logan, Utah, is your new SEC. Capt. 9NFX was compelled to resign as SEC because of added work. The Utah Amateur Radio Club has reorganized with the following officers: 6FRI, pres.; 6NXE, vice-pres.; 6QAA, secy-treas.; 9SXI/7, charge of committees; 6NZE, charge of publicity. Each Thursday night at 8 p.m. the club members have a 28-Mc round table with 6DZX as control station. The USAC reorganized and the following officers have been elected: 6SID, pres.; 7IYP/7, vice-pres.; 6RIM, secy.; 6CKI, adviser. 9NFX got his new HQ-129 receiver and has worked some FB DX on 28 Mc. 6DLR, Ogden EC, got a new RME-45 receiver. 6SID reports with a 6L6 oscillator on 3.5 Mc. 7ABO is back on the air with 28- and 3.9-Mc. 'phone. 7GDE is on with very low power. 7JHL gets on 28 Mc. The active 28-Mc. hounds in Cheyenne are 7JET, 9TGU/7, 9HWR, 7BCL, and 9OWZ. On 3.5-Mc. c.w. are 7EUZ, 7ICZ, 7HRM, 7HDS, 7EVH, and 7CEO are on 3.9 'phone. The Shy-Wy Radio Club and Ogden Radio Club are making plans for the June Field Day. The Logan club is expected to participate with the Ogden group. Traffic: W7ABO 4. 73. Vic.

SOUTHEASTERN DIVISION

ALABAMA — SCM, Lawrence J. Smyth, W4GBV — Asst. SCM, Charles L. Herman, jr., W4APJ. GDU opened up the new 27-Mc. band by working France for his first contact. 1QQ is new call in Montgomery. ATF has well signal on 3666 kc.; his rig winds up with pair of T20s. DGS is glad Virginia is moving into the fourth district; he gets to keep his old call. AUP is making big plans for Field Day. EW likes short skip on 28 Mc. so he can work Birmingham. APJ is repairing shack. The Montgomery Club is making plans for another big "feed" with all the "fixin's." 4GBV is active on 28-Mc. 'phone, and 3.5-Mc. c.w. IDZ finally received his rig from California and is having lots of fun. He is running 100 watts on 28 Mc. CYC is on 3.9 Mc. with 807 final and SW-3 receiver. AUS has new rack and panel kilowatt. INZ is new call in Phenix City; he's very active on 3.9 Mc. BYV has 814 final on 3.9 Mc. Ex-HB wants new ticket with his old call. GBR, Fort Payne, is OBS for Alabama. Would like to hear from every active ham in the State. Come on, fellows, write to me care of WMPM, Montgomery, or to Larry. Let's pep up the ole' column.
 73. *Charlie.*

EASTERN FLORIDA — SCM, Robert B. Murphy, W4IP — New hams in St. Pete are 9VJG and 3JKJ. GGJ has a three-element rotary. EPW is first local ham to try 27 Mc. and BQW is trying to locate ANH from Memphis. EYI put the rig on 28 Mc. and enjoys every QSO. HYW, in Georgia, is looking for some weather spotters to work in conjunction with the U. S. Weather Bureau. HKJ is serving as a high-speed operator at Wichita Falls, Tex. I just received some correspondence from IQV asking me to direct him to the nearest QSL center as he is going on 28 Mc. as soon as possible. GIY is crying for someone in the Orlando district to get on the air with him in tests on v.h.f., u.h.f., and s.h.f. so he can get his certificate. Kienlen, in Vero Beach, is also calling for some help. DKA reports working forty-one countries since the war with R8-9 signals in Australia, New Zealand, Europe, and South America. BYF is the local OBS and transmits the official bulletins from Headquarters on 3800 kc. and 28060 kc. at 10 p.m. and noon, respectively, six days weekly. Mao has worked sixteen new countries on 28 Mc. in the last month. 6IRS/4 at Key West reports the following: 5DFZ is a new-comer; 7HIM is on and going strong; 8UXU, 8AAK, and 2LPD have left Key West; 9OCN and 9AQW are on 3.5 Mc.; 6IRS is applying to GVC to act as EC for Key West. AYW is applying for ORS and OO appointments. GVC, Section EC, is

(Continued on page 106)

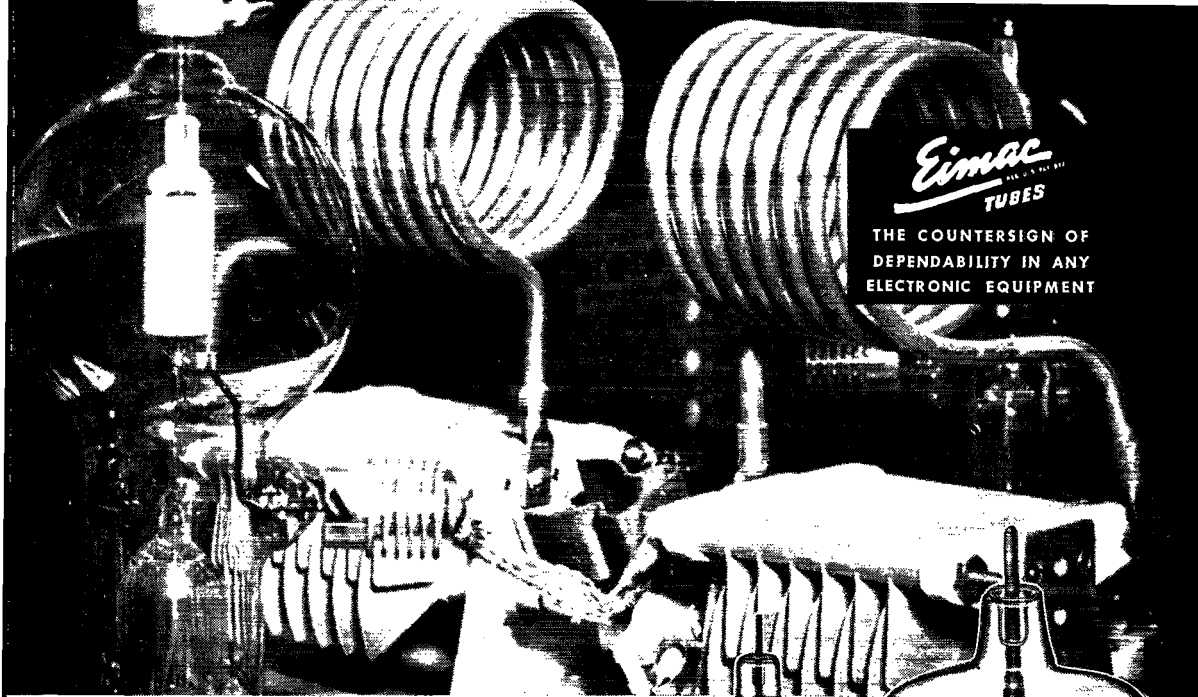

Eimac
TUBES

THE COUNTERSIGN OF
DEPENDABILITY IN ANY
ELECTRONIC EQUIPMENT

HIGH POWER LOW PLATE VOLTAGE

The famous Eimac 75T is now available in both high and low amplification factor types (75TH-75TL). These exceptionally flexible triodes provide a high power output at low plate voltage, and require a minimum of driving power. These Eimac 75T's are suitable for use as oscillators, amplifiers, or modulators. For example: a pair of 75TL's in a class-C amplifier can easily be operated at 500 watts input with only 500 volts on the plate. The required grid driving power for the two tubes would be only 12 watts. In a class-B modulator, two 75TL's operated within 1500 plate volts will deliver 280 watts of audio power, sufficient to more than 100% modulate the above mentioned RF amplifier.

The Eimac 152T has twice the power handling capacity and twice the transconductance of the 75T, but less than twice the already low grid-plate capacity. At 1500 plate volts, 500 watts input can be run to a single 152TL, or a full kilowatt can be run to a pair of 152TL's in a class-C amplifier. For class-B audio, a pair of 152TL's will deliver 560 watts with 1500 plate volts. Eimac 152T's are also available in high and low amplification factor versions. Literature giving full technical information on these triodes available now. Write today, or contact your nearest Eimac representative.

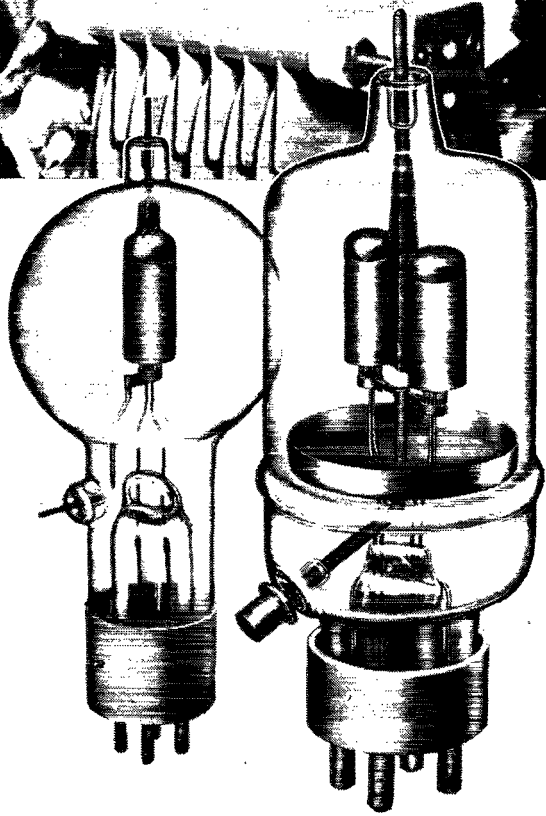

EIMAC 75T
POWER TRIODE

EIMAC 152T
POWER TRIODE

Follow the leaders to



TELE-McCULLOUGH, INC. 1243 San Mateo Ave., San Bruno, Calif.
Plant Located at San Bruno, California

Export Agents: Frazar and Hansen, 301 Clay Street, San Francisco 11, California, U.S.A.

CALL IN AN EIMAC REPRESENTATIVE FOR INFORMATION

ROYAL J. HIGGINS (W9A10), 600 S. Michigan Ave., Room 818, Chicago 5, Illinois. Phone: Harrison 5948.

HERB. B. BECKER (W6QD), 1406 So. Grand Ave., Los Angeles 15, California. Phone: Richmond 6191.

VERNER O. JENSEN, Verner O. Jensen Company, 2616 Second Ave., Seattle 1, Washington. Phone: Elliott 6871.

TIM COAKLEY (W1KKP), 11 Beacon St., Boston 8, Massachusetts. Phone: Capital 0050.

M. B. PATTERSON (W5CI) Patterson & Company, 1124 Irwin Keasler Bldg., Dallas 1, Texas. Phone: Central 5764.

RONALD C. BOWEN, 1886 So. Humboldt St., Denver 10, Colorado. Phone: Spruce 9468.

ADOLPH SCHWARTZ (W2CN), 220 Broadway, Room 2210, New York 7, New York. Phone: Courtland 7-0011.

JAMES MILLAR ASSOCIATES, J. E. Joyner, Jr. (W4TO) 1000 Peachtree St., N. E., Atlanta, Georgia.

Your Equipment
Deserves the Best...

C.T.C. CRYSTALS

Your sending and receiving apparatus represents a considerable investment in time and money. It makes good sense, then, to insist on the finest when considering Crystals.

C.T.C. Crystals are tops in quality and performance. Mathematical dimensioning, X-ray orientation, mechanical lapping, etching to final frequency are among 21 vital checks and tests that assure high activity and low drift in every C.T.C. Crystal.

You'll find C.T.C. Crystals for amateur frequencies in the 20, 40 and 80 meter band. Kilocycle spreads include 14,000-14,750 kc. in the 20 meter band; 7000-7300 in the 40; 3500-4000 kc. in the 80. "C" holders to fit octal sockets, HPB holders for 5- or 6-prong sockets.

For complete information on C.T.C. Crystals write for free Crystal Bulletin.



CAMBRIDGE THERMIONIC CORP.

451 Concord Avenue
Cambridge 38, Massachusetts

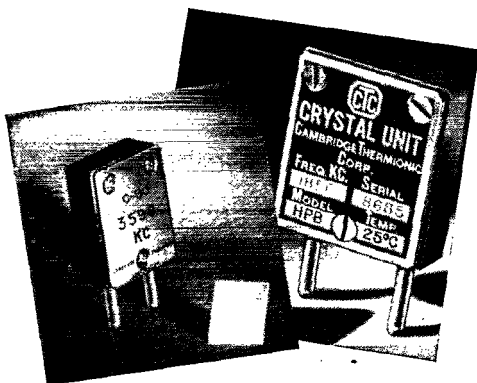

(Continued from page 104)
getting the gang lined up for the Emergency Net. FWZ has been appointed EC for Jacksonville, and RQ has accepted his renewal as EC for Upper Pinellas County. GVC had a hamfest in Rook Springs with thirty-two other guys and gals. IE is active in 3.5 Mc. according to NB. June 1st marks the end of my term as SCM. I hope I have satisfied you, and should you care to place me again I will do my darndest to keep things rolling. Traffic: W4BYF 34. 73. Merf.

WESTERN FLORIDA — SCM, Lt. Comdr. Edward J. Collins, W4MS — CNK received his old call back from the FCC. DXZ is on 3.5-Mc. c.w. JV is really working the DX on c.w. Our newest call is IPV. HJA has an HT-4 ordered. DAO has his four-element beam perking and worked OQ5AE. HIZ has an FB four-element beam perking. EGN is heard working DX twenty-four hours a day. AXP is working on bigger and better 3.5-Mc. antennas. KB is on 3.9 Mc. again. HHX is putting out a swell signal from Tally. ACB had trouble with his SX-28. FHQ is on 3.5 Mc. 7IQJ gets out FB with indoor antenna, as does IDBT/4 on 28 Mc. 3HNX/4, in Foley, has his big rig on 4 Mc. MS made a trip to Philadelphia and was royally entertained by 3IOU, 3GNA, and 3JOO. AXF enjoys West Coast schedules on 28 Mc. 9MN/4 is looking for QTH to set up his 4-Mc. rig. LT is heard on 4 and 28 Mc. HYB is enjoying 4-Mc. c.w. DX cards are starting to pour in at QSL Manager's desk. 73.

GEORGIA — SCM, Thomas M. Moss, W4HYW — The hamfest sponsored by Amateur Radio Club of Savannah will be held on July 21st at Savannah Vocational School, 214 West Bay Street, Savannah. Program includes demonstrations, prizes, sports, refreshments and barbecue. Special prizes to lucky holders of advance tickets. Tickets are \$2.00. Write club at P. O. Box 1942, Savannah. HDC/3 is at Ft. Belvoir, Va. DYG/K4 is at N. A. S., San Juan. DNY is KA. CFJ is at Ft. McPherson. We welcome back to civilian life and ham radio: FHM, Brunswick; EN, Hapeville, CIE, Columbus; GUN, Canton; IAO, Jakin; AGI, Augusta; CNV, Decatur; BIN, Marietta; DYK, Gainesville; BOC, EFS, EJJ, FER, FIJ, FIN, FKN, FOO, FVI, FZE, GMP, GPD, GYA, HAS, HDM, HII, HKQ, HUP, IEO, IRA, KU, MV, SREJ, 8SYW, 9BMC, Atlanta. 9TDT is now in Atlanta. 2JEH is now 4IPF. DXI is new ORS and OPS. Our first OES appointment went to FKN. 9GZR is at Savannah. FCV, BB, DX, EEZ, and DIZ were visitors at FDJ. ERS, enroute to Pennsylvania to visit jr. in the Navy, also visited Pop. Pop is now out of the swamps and in Lyons. Now that the Emergency Corps has replaced the WERS, we wish to thank IKJ, FWD, ERT, FBH, and ILG for a nice job. New ECs: OBR, Evans; FBH, DeKalb FDJ, acting for Toombs; CIE, Muscooge; and DBM, Burke. New Emergency Corps members: DXI, FKN, HPR, and IKJ. We are in need of OPS and ORS. Your inquiries are invited. Activity reports are solicited. 73. Tom.

WEST INDIES — Acting SCM, E. W. Mayer, K4KD — W6FFP/K4 was on with ex-W9MDQ/K4 rig. W3ICS/K4 was heard in San Juan on short skip. W6MUG/K4, W3JGG/K4, W5JAC/K4 are active on 28-Mc. 'phone. W4BZA/K4 and W9KFH/K4 are keeping W4EEB's son, U. S. Navy, in contact with W4EEB. On short skip recently VP6YB was worked on 28-Mc. 'phone by W9KFH/K4, K4KD, W4BZA/K4, W8VRD/K4, and W3HUN/K4. W8VRD/K4 has new brass tubing doublet coaxial-fed and LM7 frequency meter. K4HEB worked VO18 and XE1KE. K4HLP is on c.w. W4BZA/K4 and W4FAY/K4 worked VP2LU and a PZ on 3.5-Mc. c.w. K4KD was on 3625 kc. for band opening. W3HUN/K4 worked eight countries and nine U. S. districts on 'phone during month. W4GJM/K4 worked fourteen countries and twenty-six states on 'phone. KB4HTX/K6 is heard in P. R. W4DYX/K4 worked his first ZS on c.w. K4FKC made postwar debut on 28-Mc. 'phone. Isn't anyone interested in ORS and OBS appointments? Traffic: K4KD 2, W8VRD/K4 2, K4HEB 1. 73. Ev.

SOUTHWESTERN DIVISION

LOS ANGELES — SCM, Ben W. Onstenk, W6QWZ — All stations, please note the new reporting dates listed at the beginning of these columns. Lack of reports are cause for cancellation of appointments. Also no reports, no column. The Citrus Belt Radio Amateurs' Club has applied for affiliation. A new club heard from is the Tri-County Radio Amateurs' Club, which meets on the second Wednesday of the month at the Boy Scout Headquarters in Pomona, on Gary St., two blocks south of Holt. The Inglewood Club meets

(Continued on page 108)

External Beauty FOR "SHOWMANSHIP"

It will grace any 1000-Watt
Broadcasting Station!

Expertly Engineered
"Internally" for Performance



THE Gates 1-KILOWATT TRANSMITTER—

Has Everything!



... "oomph" and showmanship—thanks to good designing—that makes your station "super" in appearance and impression. But here beauty is more than skin deep. This Unit is engineered for super performance also. A peek inside reveals those modern circuits and mechanical improvements that make the statement, IT HAS EVERYTHING a "built-in" fact. Write for complete specifications.

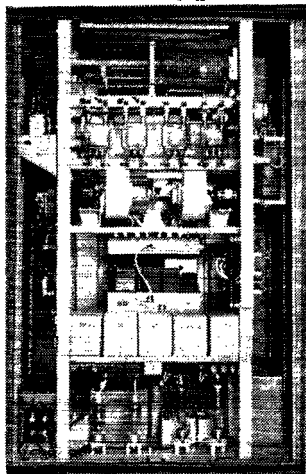

NEW YORK
OFFICE:
9th Floor • 40 Exchange Place



SOLD IN CANADA BY:
Canadian Marconi Co.,
Ltd., Montreal

RADIO CO.
QUINCY, ILLINOIS

Exclusive Manufacturers of Radio Transmitting Equipment Since 1922

CONDENSED SPECIFICATIONS

FREQUENCY RANGE: 530 to 1600 K. C.

FREQUENCY STABILITY: Plus or minus 10 cycles maximum.

POWER OUTPUT: 1000 Watts. May be operated as 500 Watt Transmitter. Power reduction for night operation may be incorporated to suit requirements.

POWER SUPPLY: 230 Volts, 60 cycles, single phase—Regulation not to exceed plus or minus 5%.

FREQUENCY RESPONSE: Within 1½ DB. from 30 to 10,000 cycles.

DISTORTION: Less than 3% from 50 to 7500 cycles. 0-95% modulation.

NOISE LEVEL: 60 DB. below 100% modulation.



ANNOUNCES—



MODEL 800 • 144-148 and 235-240 mcs. U. H.F. receiver. E. P. Tilton's Feb. 1946 QST design modified by Byron Goodman's inductive r.f. tuning, built-in PM speaker, 88" band-spread, all in new "ATOM-X" construction. Factory built or kit for easy home construction, compact.

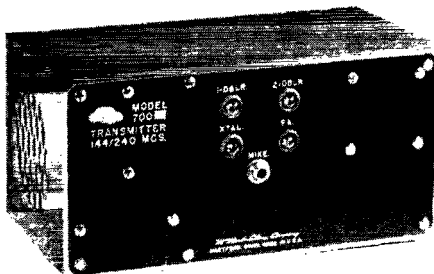

MODEL 700 xtal controlled transmitter. 144-148 and 235-240 mcs. 6AQ5 Tritet drives 6C4 doubler, 6C4 doubler/tripler, 832 long-line push-pull final. Built-in 14 watt 6AQ5 push-pull voice modulator. New "ATOM-X" construction, size only 5" x 10" x 5 1/4". Matches MODEL 800. Makes serious home-station or mobile rig. Factory built or kit.

• • •

Illustrated and high spotted above are but two of many fresh, post-war receivers, transmitters, factory built or kits and parts designed by and for serious amateurs. Prices are as low as quality is high. A penny post-card will bring you catalog of what's new . . . your favorite jobber will have them soon.

OVER 35 YEARS OF RADIO ENGINEERING ACHIEVEMENT

McMurdo Silver Company

1249 MAIN ST., HARTFORD 3, CONNECTICUT

In Canada—McMurdo Silver Division, General Radionics Ltd.
465 Church Street, Toronto, Ontario

(Continued from page 108)

at the Inglewood Women's Club on the first and third Wednesdays. Will club secretaries please send me club news and meeting dates? New OES appointee is 3IVZ/6. BUK reports that he is rebuilding his rig. AM has 105 acres on top of rolling hills with eight rhombics and two "V" beams already installed, and plans to use a half kw. IWU moved from the San Joaquin Valley Section to Chino. VCX has an 807 on 3.5 Mc. 4EJQ is the new EC in the San Bernardino area. Give him a hand, boys. We need emergency stations in and around Santa Barbara and San Luis Obispo. The Section EC, UXN, will send you applications on request. His address is 618 E. Buckthorne, Inglewood. NGK has been selected by the Wilmington boys to be their EC. UYG is the PAM in Riverside and is putting on a pair of 4-125As. SEY and SET are working together trying to get that DX record on 144 Mc. The Inglewood AEC net is now operating on one frequency. K4HTU/6 has come back from his vacation and is looking for traffic schedules on 3664 or 3810 kc. OQB is beating the quiet hours by using his MBF that has been converted to 28 Mc. SCQ took a handie-talkie on his vacation so he could find out if he was a grandpa or not. NAT reports that Mt. Wilson is the spot for working mobile on 28 Mc., he has worked all districts with 5 watts. SGZ will be mobile OO, being ship operator on a coastwise run. SET won 1N34 crystal at the Colton club and wondered what the frequency was. Traffic: K4HTU/6 12, W6IWU 6, W6AM 2. 73. Ben.

ARIZONA — SCM, Gladden Elliott, W6MLL — QLZ reports a new crystal-control rig from 160 to 2 meters complete with modulator on a 3X3X10 chassis. KTJ has 50 watts on p. p. HY75. LKK has a TR-4 and a four-element beam. 3DMV/7 has a four-element beam that works about everything in DX. He also reports hearing PDB on 28 Mc. 8VLT/7 has a rig at his bedside through the courtesy of the Phoenix gang. QJL is on the air at Mesa. LXC will operate from Prescott. HBA is on 28 Mc. OAS and PUM are on 3.9 Mc. PDB and 5JZQ/6 handled 600 pieces of G. I. traffic this month. The Phoenix picnic was attended by sixty and OZM reported all had a grand time. New calls: 7JIW, Fulton; 7JHB, Beechner; 7JGZ, Marston; 7JFG, Trembley; 7JDX and JGW. 5JGY/6 and 9UPT/6 took exams before the R. I. at Tucson. QAP is hunting a 50-Mc. contact. UPW is on 3.9 Mc. at Morenci; 9ORY/6 is on 28 Mc. 144-Mc. stations are: Verde Valley: RLC, SNI, SQN, LJJ. Phoenix: QLZ, KTJ, LKK, MAE, LSK. Tucson: OWX, TXM, JHP, UPY. Safford: ONC. Best DX; QLZ-KTJ, 75 miles. MLL has an antenna through the courtesy of the Tucson gang. RLC and SNI have applied for OES appointment. More applications are wanted. 73. GC.

SAN DIEGO — SCM, Ralph H. Culbertson, W6CHV — LKC reports handling traffic from XU1YT, XU1YO, W1MXX/KA6, W2CJ/J2, and KA1JM. W6OEZ/KM6 is located on Midway Island running about 25 watts. TZO is keeping regular schedule with W9WFW/KG6 on Guam. LKC reports working a CO2 in Cuba with his new mobile rig and antenna on the floor of the shack with only 25 watts input. 3IXF/6 has received his new call, 6VEA. He is keeping schedules with W9GQO/KG6 on Guam semi-weekly. SIG has a new FB three-element rotary beam on 28 Mc. and reports activity on 3.5-Mc. c.w. BALE handled traffic with W6MZZ/J5, W6PUZ/Tinian, W2ILE/KP4; he also worked FK8AN, VP2AT, and FM8AC. LDJ is on the air from Santa Ana. W9LLM/6 worked JRM and ANN on 50 Mc. CAV is on 28 Mc. at Grossmont. OUQ reports the Helix Radio Club is organizing all the fellows and equipment for a big Field Day. QNM has new tower and keg of dynamite to raise so gather around fellows and give him a hand. W9LLM/6 is sporting a new four-element 28-Mc. beam. MMV has a new rig consisting of two gallon jugs with necessary filaments, etc., but in planning the rig he neglected to locate suitable modulator tubes so he is covering Army Surplus carefully. TLT is active on 3.5-Mc c.w. OUQ reports lots of activity on 28-Mc. 'phone on the East Side with the following heard regularly: JRM, OUQ, QNM, CAV, RPJ, and W9LLM/6. The San Diego Amateur Radio Club is getting under way with the following temporary officers: KW, chairman; MLB, secy.; and QNM, events chairman. The Palomar Club is completing plans for a bigger and better Field Day. CHV is rebuilding. APG has a new folded doublet on 28 Mc. made from the new 300-ohm coax and reports it works FB. I want to thank all of you fellows who sent in reports this month. Traffic: W6LKC 22, SIG 13, BAM 13, OUQ 11, CHV 10. 73. Ralph.

(Continued on page 110)



BOTH FILLED and IMPREGNATED with

KVO
 KILO-VOLT-OIL
 REG. U. S. PAT. OFF.

THE FAMOUS SPRAGUE WARTIME RESEARCH OIL DEVELOPMENT

TYPE CR—KVO rectangular transmitting types, 600 to 7500 Volts. Equipped with handy adjustable flanges for mounting in any position. All ratings are conservative to allow ample safety margin. Unconditionally guaranteed against breakdown when used as specified.

Oil-filled capacitors are essential for high-voltage use. And in KVO-Kilo Volt Oil, Sprague brings you the very best! Developed for wartime use, this oil has proved its superiority, under all conditions. KVO retains its dielectric efficiency at low temperatures to a greater extent than any other type of oil in common use. It maintains high insulation resistance and low power factor over a broad range of operating temperatures.

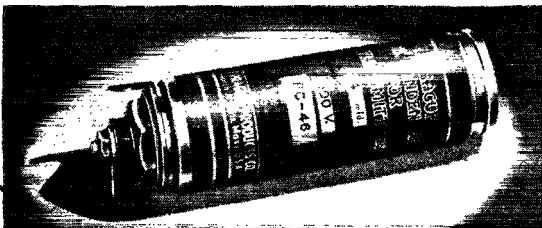

TYPE PC—KVO inverted round screw can transmitting types, 600 to 1500 Volts. These units include spade washer and insulating lug to insulate the round metal can containers from the chassis. Like the famous Sprague CR condensers, they are conservatively rated for ample safety, and labelled according to A.R.R.L. standards.

TYPE OT—KVO's popular, inexpensive round can transmitting types, 600 to 3000 Volts. A favorite with amateurs the world over. Rated to conform to tube and circuit design requirements. Unconditionally guaranteed when used as specified.

SAVE MONEY!

Here's an inexpensive cardboard-cased transmitting type capacitor at about one-third the price of conventional high voltage units, yet gives excellent service for practically any transmitting or similar use from 400 to 1000 volts as rated. Popular with beginners—and also with old-timers who want to save money without sacrificing efficiency. These capacitors are oil impregnated, wax filled, fully cased and sealed in durable cardboard containers. Handy mounting flanges may be cut off when not needed. Unconditionally guaranteed when used at rated voltages.



SPRAGUE PRODUCTS CO., North Adams, Mass.
 Jobbing Distributing Organization for Products of the Sprague Electric Co.



SPRAGUE

TRANSMITTING CAPACITORS

WEST GULF DIVISION

NORTHERN TEXAS — SCM, Jack T. Moore, W5ALA — BHZ is having difficulty getting back on the air so probably will wait until 7-Mc. c.w. is available before he gets going. Ross sends the following news: GFL is back at work on his old job; AAO is building a swell 28-Mc. 'phone rig; AVJ has moved to Lubbock. DQV is building a new home. TW is now working for WRR. ALA has an HT-9 and a two-element beam. AJG, the 5th district QSL Manager, says that he sure has some swell DX cards on hand, dated as far back as 1937 and asks that you fellows please send him stamped self-addressed envelopes with your call in the upper left-hand corner so that he can send them to you. ILJ is now living in Sweetwater, but expects to enter S.M.U. in June. Joe sends the following news: HTH is at Texas A.&M.; IWE was married recently and is living in San Antonio; JEB is located in Ft. Worth. Joe would like to know the QTH of IWR. BSY is aboard ship again and is working mobile-marine on 28 Mc. traveling between the U. S. and Europe. NW visited the Dallas and Ft. Worth clubs en route to the ARRL Board Meeting. JIZ/K7, in Kodiak, reports hearing DXR and IJJ and working IYJ on 3.9-Mc. 'phone. Luther is anxious to arrange a schedule with Dallas so he can talk to his folks. The Dallas Amateur Radio Club held a Field Day outing the first week end in May at Lake Dallas with headquarters at the camp of DAS. 73. Jack.

OKLAHOMA — SCM, Ed D. Oldfield, W5AYL — 3.9 Mc. is almost a mass of heterodynes in Tulsa and there are prospects of a large increase in the amateur rolls. The R. I. was really busy giving exams. The TARC expects to do a good job on Field Day. FJ, at Enid, has returned from the Navy after about five years continuous active duty. FJ has been very active in NCR for quite a number of years. CPC is working up schedules and doing traffic work. ADC, CRM Navy, returned to civilian life after three years service. He says it's a lot more enjoyable operating your own rig and is pleased with the good job ARRL did during the war. HLD, EZK, GVS, and CPC operate on 28 Mc. GFT is moving to Twin Cities. CYM is stationed at Camp Crowder. The Enid Club is renovating its constitution. BGR puts out a fine third harmonic, as evidenced by the receipt of a "pink ticket." HUM visited Muskogee on leave from Panama. 3.5-Mc. operation has spirited the Muskogee boys and a number of them broke open the band at 3 A.M. starting day. The MARC will be in action on Field Day. FAB, AEC for Oklahoma, is on 3.9 Mc. and is interested in receiving applications for the Emergency Corps from you fellows. His plan is to have at least one appointee in each county with groups of counties under a community EC. Write FAB, 2712½ N. Military, Oklahoma City, for information and blanks. We need your cooperation! Contact FAB on 3.9 Mc. and listen for his official broadcasts on Mon., Wed., Fri., 7:30 P.M., 3940 kc., A-3 emission. Traffic: W5CPC 10. Regards. Ed.

SOUTHERN TEXAS — SCM, James B. Rives, W5JC — Major KDA, formerly of Wink, Tex., is on Okinawa and reports the fellows there are working WAC in five hours. He would like to QSO San Antonio. HIF reports the Corpus Christi club has reorganized and elected the following officers: BEY, pres.; 9BDL/5, vice-pres.; HP, secy.; EUO, treas.; 6ODE/5, activities mgr. There are about eighty members and a large number are active on 28 and 3.5 Mc. GEL is working some nice DX on both c.w. and 'phone. KHH worked VP9F. EWZ has 20 watts input on 3.5 Mc. Director Soupy Groves attended a meeting of the San Antonio club to get some firsthand information for the ARRL Board Meeting. IKY is active in Austin and KSB is rebuilding with a kilowatt on 3.5 Mc. Major FXZ is the signal officer at Goodfellow Field and is assisting in the organization of a club which includes GCJ, BVG, JNP, HDY, and KTP. JC enjoyed a good rag chew with ZA and AOT on a recent trip to New Mexico. EIS is code instructor at San Antonio Military Training Center. 73. Jim.

NEW MEXICO — SCM, J. G. Hancock, W5HJF — DER is building a new shack and fixing up the rest of his place swanky. ENI does not plan to be active until he has a new shack. HJF is having barrels of fun with an 807 on 3.9 and 28 Mc. while DER revamps his big rig. More dope on the new rig will come. David Erwin (LSPH) is now 5KXX and is building a TZ40 on 3.9- and 28-Mc. 'phone. Harold Wheeler (LSPH) is now 5KYL and is building a TZ40 for

(Continued on page 114)

The MINILOG

THIS POCKET-SIZE LOG BOOK has been designed by the American Radio Relay League to answer the special needs for compactness and convenience in portable and portable-mobile amateur operation. Taking maximum advantage of all short-cuts permitted by the regulations this log still meets all of the requirements of the Federal Communications Commission. The F.C.C. regulations are as binding on portable and portable-mobile stations as on fixed ones.

This log has a page size of 4 x 6 inches and consists of 60 log pages, leatherette-paper cover and spiral-bound at the end. The whole book has been designed with thought to utmost convenience.



THE PRICE
IS TWENTY-FIVE CENTS PER
BOOK FROM
YOUR LOCAL DEALER
OR DIRECT FROM A.R.R.L.
WEST HARTFORD
CONNECTICUT

What HAMS Say About GRAPHITE ANODES * Ⓢ

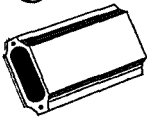
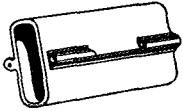

"Graphite anodes stand three to four hundred percent overload without puncturing or warping . . . frequency stability is assured."

"... Undeniably heat resisting . . . little or no danger of plate warping from high inputs . . . superior heat dissipation, cooler transmitter, and greater over-all efficiency."

"... plate current is perfectly steady, no rise indicating tube capacity drift-off resonance. On 5 meters, loss of power output cannot be tolerated thus making use of graphite anodes really necessary"

"... I find I get the lowest cost per watt . . . that means money in my pocket."

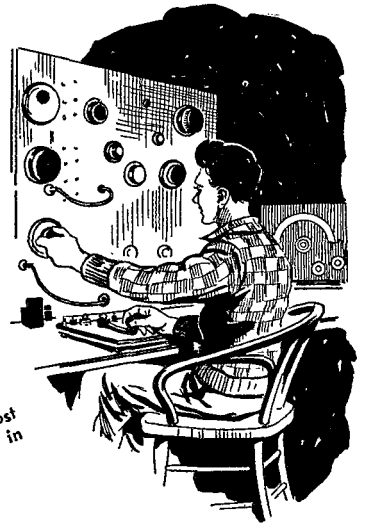

Performance of transmitter and power tubes having Speer Graphite Anodes is repeatedly demonstrating their superior characteristics under normal and unusual operating conditions.

Check over all the advantages listed below — then you'll realize why hams — old and young — are so enthusiastic about graphite anode tubes:

SPEER GRAPHITE ANODES . . .

- Increase allowable plate power dissipation.
- Lower temperatures of associated tube parts.
- Withstand severe overloads.
- Defy warping.
- Prevent hot spots or fused holes.
- Minimize bulb darkening and insulator leakage.
- Improve degassing qualities.
- Decrease gas troubles.
- Enhance tube appearance.

- Provide precise anode dimensions.
- Produce uniform tube characteristics.
- Retain original dimensions in service.
- Maintain normal tube characteristics.
- Allow wide latitude of anode design.

* Excerpts of letters from enthusiastic hams. Many more on file.

CHICAGO • CLEVELAND • DETROIT
MILWAUKEE • NEW YORK • PITTSBURGH



HAM GEAR

at Newark Electric

The new HY-Q 75 vhf linear oscillator unit, just released by Hytron, provides a swell illustration of the benefits of high equipment efficiency measured in terms of useful power output. When operated in the 2-meter band, the HY-Q 75 gives a modulated carrier output of approximately 11 watts. And this is useful power delivered to the antenna lead.

But, you ask, isn't the power output very much lower than that listed in the HY75 application bulletin?

This useful power output of 11 watts is really quite compatible with the rated power output of 19 watts.

To begin with, tube manufacturers commonly rate tubes on the basis of the plate power output obtainable under certain specified operating conditions. The rating is a figure of merit of the tube alone — not of the tube plus the associated circuit. Special attention should be paid to the descriptive adjective "plate" (power output), for it means exactly that!

Many amateurs rate their transmitter power output in terms of the manufacturer's rated output for the tube, or by some value of power which they arrive at by multiplying their plate power input by a rule-of-thumb efficiency factor. Few amateurs have the means of accurately measuring the useful power output actually delivered from transmitter to load circuit; whether this load is a dummy load or a radiating system.

Hytron, through precise power measurements, has determined the amount of useful power output obtainable with the HY-Q 75, when using an average HY75 tube. The manufacturer lists the apparent discrepancies between tube power and transmitting power output as follows: Grid driving power, 3 watts; grid bias loss, 2 watts; circuit losses, 1 watt; and direct radiation losses, 2 watts.

When a tube is used as a self-excited

oscillator, rather than as a driven amplifier, the plate circuit obviously must furnish the required driving power to the grid and bias supply or resistor. Thus any tube, when used as an oscillator, will have its useful power output reduced by the amount of the total power required by the grid circuit.

Losses which occur in the circuit are determined primarily by the Q of the circuit. Radiation losses depend largely upon the geometry of the tank circuit and the physical relationship of the tank circuit to other metallic objects. In any given transmitter, very much higher circuit losses and slightly higher radiation losses could exist.

Most hams have found that the tubes they use become harder to drive as they have gone higher and higher in frequency,

and that plate circuit efficiency becomes lower. High-frequency tubes, when operated in the 2-meter band, have an extremely low plate circuit efficiency, and require very high

grid power — with the result that the useful power output obtainable at 2 meters may be only a small fraction of that obtainable at 10 meters.

From preliminary demonstrations, Hytron reports that the performance of the HY-Q 75 kit is so phenomenal that operators of stations being worked could not believe that a plate power input of only 32 watts was being used. They thought they had been listening to a much higher powered transmitter!

It should be noted that as a master oscillator without modulation, the HY-Q 75 is capable of delivering 14 watts of useful power — sufficient to drive fairly husky bottles in the final stage, or with reduced oscillator output, a pair of HY75's.

There's a big story to tell about the new HY-Q 75. So why not stop in or write your nearest Newark store for the complete dope?

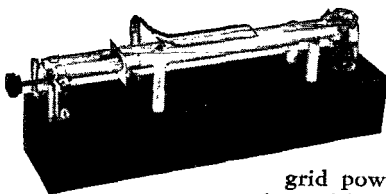

Chicago

Newark **ELECTRIC** Company New York

115-117 W 45th St.
NEW YORK 19
BRyant 9-4735
(ADOLPH GROSS)

212 Fulton St.
NEW YORK 7
BRyant 9-4735
(HY KAHN)

323 W. Madison St.
CHICAGO 6
DEArborn 0083
(SAM PONCHER)

Address N. Y. C. Mail to 45th St.

REGULATION



§12.136. LOGS. Each licensee of an amateur station shall keep an accurate log of station operation, including the following:

(a) The date and time of each transmission. (The date need only be entered once for each day's operation. The expression "time of each transmission" means the time of making a call and need not be repeated during the sequence of communication which immediately follows; however, an entry shall be made in the log when signing off so as to show the period during which communication was carried on.)

(b) The signature of each licensed operator who manipulates the key of a radiotelegraph transmitter or the signature of each licensed operator who operates a transmitter of any other type and the name of any person not holding an amateur operator license who transmits by voice over a radio-telephone transmitter. The signature of the operator need only be entered once in the log, in those cases when all transmissions are made by or under the supervision of the signatory operator, provided a statement to that effect also is entered. The signature of any other operator who operated the station shall be entered in the proper space for that operator's transmission.

(c) Call of the station called. (This entry need not be repeated for calls made to the

same station during any sequence of communication, provided the time of signing off is given.)

(d) The input power to the oscillator, or to the final amplifier stage where an oscillator-amplifier transmitter is employed. (This need be entered only once, provided the input power is not changed.)

(e) The frequency band used. (This information need be entered only once in the log for all transmission until there is a change in frequency to another amateur band.)

(f) The type of emission used. (This need be entered only once until there is a change in the type of emission.)

(g) The location of the station (or the approximate geographical location of a mobile station) at the time of each transmission. (This need be entered only once provided the location of the station is not changed. However, suitable entry shall be made in the log upon changing the location. Where operating at other than a fixed location, the type and identity of the vehicle or other mobile unit in which the station is operated shall be shown.)

(h) The message traffic handled. (If record communications are handled in regular message form, a copy of each message sent and received shall be entered in the log or retained on file at the station for at least 1 year.)

The

Convenient ▼ ▼ ▼ Complete

ARRL LOG BOOKS

Regular Log, 8½ x 11, 35 cents each • Three for \$1.00

Mini-Log, 4 x 6¼ • 25 cents each

American RADIO RELAY LEAGUE

WEST HARTFORD, CONNECTICUT, U. S. A.

WHEN MAXIMUM EFFICIENCY IN
FREQUENCY CONTROL
 IS DEMANDED

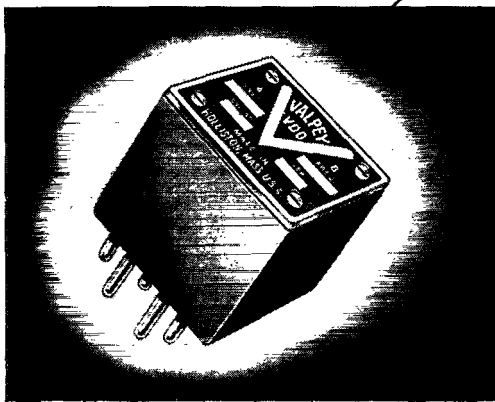

Invariably
 it's **VALPEY**

Type VDO — a compact unit utilizing two crystals in the same holder with or without temperature control — is a 5-pin mount designed to fit the standard 5-prong tube socket. Particularly adaptable for use in transceiver equipment where both transmitter and receiver channels are crystal controlled.

Send for Bulletin No. 8, giving complete specifications and details of various applications.

VALPEY CRYSTAL CORP.
 HOLLISTON, MASS.

Valpey
CRYSTALS
 Craftsmanship in Crystals Since 1931

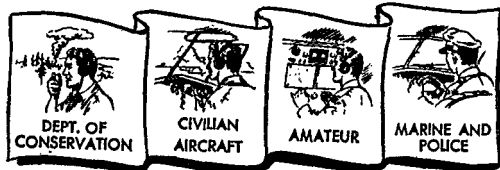

(Continued from page 110)

3.5-Mc. c.w. 5KXB is a new station in Albuquerque and 5LAQ is new in Portales. Please, you LSPers, send us your new calls and tell us about your activities on the air. 73. Jake.

CANADA

MARITIME DIVISION

MARITIME — SCM, A. M. Crowell, VE1DQ — EP still continues to be leading DX man in this section. HJ handled traffic during emergency when lines were down because of storm, and also put through messages for FQ through G8MN. The HARC and VARC will arrange a VE1 Hamfest for the Labor Day week end. It is hoped to make this event a Maritime Division Convention. Contact JH for registration and additional information. ET, after a whirl on 28-Mc. DX, has taken to 3.8-Mc. 'phone to work locals. CW gives us the dope on the P.E.I. gang. Wylie was quite active with emergency traffic during the bad storm; he also reports traffic from Italy. CO, who has been ill, is back on 28 and 3.5 Mc. BD still is building and FR still is in blueprint stage. IM and EA both worked HB9BX on 28 Mc. DR gets frantic calls for QSL on his 28-Mc. 'phone. KJ, recently back home from VO-Land, is on 3.8-Mc. c.w. KY just finished the final ticks to a high-power all-band rig and will work mostly on 28 and 3.8 Mc. ET renewed old friendship by QSOing VO1I on 3.8-Mc. 'phone. Traffic: VE1EJ 51, LZ 20, OM 15, EY 12.

QUEBEC DIVISION

QUEBEC — SCM, L. G. Morris, VE2CO — Newly-elected MARC officials are: BU, pres.; KS, vice-pres.; LV, secy.; BR, treas.; and executive committee, MW, GE, DR, CO, and IE as past-pres. The club now has a membership of 150, of which 124 are licensed, and includes the following from other sections: 4JK, 5JB, 3KH, 3ZV, 4YT, and W5HEI, who is a CSM in the RCCS. HP is located in Stamford, Conn., and listens enviously to the gang on 3.5 Mc. DR has worked all VE districts on 3.5 Mc and is active in traffic work scheduling 1HJ in Halifax thrice weekly. He handled numerous messages from HMCS *Uganda* while cruising off the coast of South America. SM is assisting in the local organization of the Air Force Amateur Radio System. Stations so far enrolled are AX, LV, BE, DR, DX, LC, and SM. BU is working on details of a similar set-up for the Army. XR and FK are up and about after a session in the hospital. KM expects to return to Montreal and ham radio this summer. KX is working in Boston. JO and AR have been demobbed from the Army. Ex-OI is operating from Uplands under call 3BFW, while ex-IN is now 3BDR at Chalk River. Activity on 3.5 Mc. is increasing with over fifty calls being logged, including PJ, at Beauharnois, and GZ, at Rouyn. Gang, this will be my last report as your SCM as I have tendered my resignation. It has been a pleasure to have represented the section and I trust that you will give my successor your full cooperation. 73 and SK.

VANALTA DIVISION

ALBERTA — SCM, C. S. Jamieson, VE4GE — 6AO keeps traffic schedule with LQ nightly. Ed says BW and LQ are most consistent 'phone stations heard there. 6MO keeps 3.9-Mc. 'phone busy these days. 6RH, ex-4ALL, is on 3.9-Mc. 'phone with all of 4 watts input. 6RP, ex-4ACP, is on the air from N.W.A.C. in Edmonton. 6NT has half-kw. on 3.9-Mc. 'phone. 6AA has his 3.9-Mc. 'phone rig on the air again. 6EO is heard on 3.5-Mc. c.w. 6AZ, ex-4AAZ, is on 3.5 Mc. most evenings. 6JP has feeder trouble, as evidence by flash-overs on modulation peaks. 6HM keeps 3.5-Mc. schedule with 7FG whenever he is home. 6CE holds his own with 12 watts input on 3.9-Mc. 'phone. 6LG handled broadcast from turret of "Staghound" Armoured Car in Edmonton recently. 6BY, ex-4ADD, is on 3.5 Mc. with a 2A5 crystal oscillator. 6HM handles traffic for Vancouver from 6CE. 6EA says the new rig will use 813 final with input up to 100 watts. 6US pounds brass on 3.5 Mc. 6EL has FB signal on c.w. 6CY works W9s on short skip 28-Mc. QSOs. 6AO is managing Calgary Hamfest. 6EY and 6WS are keeping up 28-Mc. activity in Edmonton, ably assisted by 6SZ and 6AE. 6HM rebuilt final on steel chassis. 73. VE6LQ

PRAIRIE DIVISION

MANITOBA — SCM, A. W. Morley, VE4AM — First report of traffic reached me this month. A lot more was
 (Continued on page 116)

A TAYLOR Rectifier for Every Purpose ... and LONGER LIFE!

Taylor Rectifier Tubes have been **Sales Leaders** for many years because of their record of unusual service in Amateur, Broadcast and Police Transmitters.

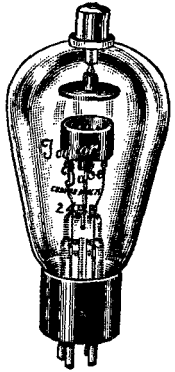

866 JR. —for 1000 Volts —250 MA.....	\$1.00
866A —for 3000 Volts —500 MA.....	\$1.50
249B —for 3200 Volts —750 MA.....	\$5.00
872A —for 3200 Volts —2.5 Amps.....	\$7.50
TT-17 —Grid Control for 2500 Volts —500 MA.....	\$6.00
873 —Grid Control for 3000 Volts —2.5 Amps.....	\$17.25



Taylor Rectifiers, like all Taylor Tubes, are backed by the broadcast guarantee in the entire tube industry.

AVAILABLE NOW
At All Leading Parts Distributors



**“MORE
WATTS
PER
DOLLAR”**



Taylor HEAVY **CUSTOM BUILT** DUTY **Tubes**

TAYLOR TUBES INC., 2312-18 WABANSIA AVE., CHICAGO 47, ILL.

Try
Walter Ashe
 for fast
 delivery of

RECEIVERS

- GENEROUS TRADE-IN ALLOWANCES
- DELIVERING ALL MAKES

Ashe delivers the goods! We're delivering all makes of receivers constantly now—giving the best service possible! Trade in your old receiver—get immediate shipment on some models!

SEND IN YOUR ORDER NOW FOR

Hammarlund HQ 129-X.....	\$168.00
RME 45 with Cal-O-Matic Dial.....	186.00
Hallcrafters S-40.....	79.50
Hallcrafters S-38.....	39.50
National HRO 5TA, 1.7 mc to 30mc with Band Spread and Noise Limiter, less Speaker and Power Supply.....	274.35
Speaker type MCS.....	10.95
Power Supply type 697.....	17.70

SIZZLING SPECIAL!

Amertran Primary Controls

A limited supply—but a once-in-a-blue-moon chance to pick up a real buy! A Primary Control that will enable you to adjust your input voltage, made by Amertran—magic name in the industry! Get your order in fast!

Primary from 95 to 130 V at 9½ Amps. Type 32415 @.....

\$14.95

Primary from 102 to 128 V — 16 Amps. Type 31970 @.....

\$17.95

Get 'Em While They're Hot!

Sola Plate Transformers, pri. 110 V., sec. 3600 VCT @ .4 amps.....	\$17.50
Vomax, the famed vvm.....	59.85
Radio Operating Ques. & Ans.....	3.00
Xtal Adapter for using new type holder in old sockets.....	.35
Rectifier Crystals, Silicon, 2 MA peak current.....	.75

Write for Our Monthly Flyer . . .

Snappy Mail Order Service

WØIYD W9ZJP W9ULH W9QDF

WALTER ASHE RADIO CO.
 1125 PINE STREET ST. LOUIS 1, MO

(Continued from page 114)

heard being handled, but — no report, no credit. Things are shaping up for a swell provincial network, so how about it. JM and JN are new AEC members. HS wants more emergency drills. Anyone else? II uses ADO's power supply for his 6L6. PA is on at Dauphin. ACD is on 'phone. CJ is new call there. XP has rebuilt exciter. AP, at Brandon, is heard on c.w. as well as 'phone. MM and AN are active at Portage. JN, at Waskada, uses 807 final. AD, ex-AAI, finally got time out from getting everyone else on to get his own rig going, and is making up for lost time. BQ is working everything on 3.5 Mc. SO is using both phone and c.w. on 3.5 Mc. with a pair of 809s. AC has been heard on c.w. WH is making recordings, so watch out. SR uses 28-Mc. antenna for 3.5 Mc. and gets away with it. Visitors to Winnipeg included IF, GE, and AP, from Brandon, JN, from Waskada, and 3AFH, from Dryden. AM finally got going. Traffic: VE4SO 5, AM 2. 73. Art.

Strays

Theme song of the 75-meter 'phone "band":
 "Patience and Fortitude."

"Senator Claghorn," the BCL radio-program character who hates the north so much he has sworn never to use a compass "because it points north," has been presented with an east-west compass by the engineering staff of the General Electric Co. Made of a new alloy called silmanal, the compass needle is magnetized across its width, rather than along its length.

It Seems to Us

(Continued from page 118)

mum assignment under which amateurs could be expected to make an effective contribution to the relief of disasters would be three 10-kc. channels in this range, and a much more effective organization can be planned if the whole range 1,750-1,800 is made available.

When the Commission reaches the stage of drafting its regulations for this operation we request that adequate provision be made both for testing of the apparatus and for drills of the personnel engaged in a communications plan. Apparatus cannot be counted upon to work in an emergency if it is never tested, nor can networks be counted upon to give the expected performance unless the personnel is drilled in the actual establishment of communication between the necessary points. The League, drawing upon its long experience in this field, offers its consultative services to the Commission when this stage in the development of the matter is reached.

The Commission hasn't answered yet. It hasn't answered us or anybody else interested below 25 Mc. because it hasn't had time to complete its studies. The matter still rests in just that fashion and the League not only still rests on its brief but believes increasingly in it. Yet "rests" isn't the right word, either, for the loran situation has never been quiescent and the League has never stopped working. For our part, we have been buttonholing people in Washington for a year, and writing further letters of argument, and collecting

(Continued on page 118)

Motorola

RADAR RESEARCH

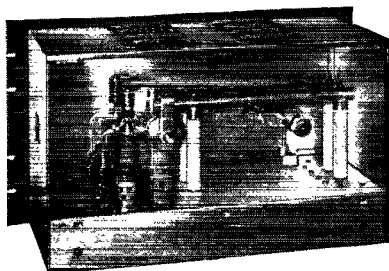

Push-Pull Final Amplifier

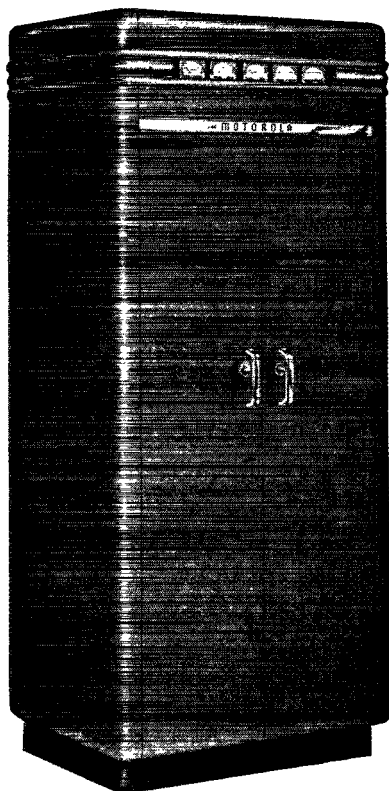

Leads the way in 152-162 MC 2-Way Radiotelephone Equipment

Motorola's extensive RADAR development and productive activity is reflected in the new line of 152-162 mc. equipment. The use of cavities, lines and microwave techniques provide exceptional performance and trouble-free service in the new bands.

The new 152-162 mc. equipment has been field-tested and proved before being released. Recently, field tests were conducted at the Motorola factory before a group of APCO members. The tests included comparison of 250-watts 162 mc. and 30-40 mc. equipment using a 150-ft. tower for antenna support. The Central Station power was reduced to 15 watts. Two cars using 15-watt transmitters were cruised over a radius of 20 miles including areas like the loop, lower level of Wacker Drive and Lake Shore Drive with tall buildings between the cars and Central Station, in addition to the normal territory encountered in a large city. Solid 2-way coverage with marvelous fidelity and very high signal-to-noise ratio was reported. Comparison with 30-40 mc. over the same area showed marked superiority of 162 mc.

Motorola proudly announces its 152-162 mc. equipment with the Model FSTRU-250-BR 250-watt Central Station Transmitter-Receiver unit.

WRITE TODAY for full details showing how Motorola Radiotelephone will solve your communications problem

GALVIN MFG. CORPORATION • CHICAGO 51
COMMUNICATIONS AND ELECTRONICS DIVISION

F-M & A-M HOME RADIO • AUTO RADIO • TELEVISION • "HANDIE TALKIES" • POLICE RADIO • AIRCRAFT RADIO

XTALS • XTALS • XTALS

Mounted Low-Drift

3.5 M.C. and 7.0 M.C.

XTALS

± 5KC your specified frequency anywhere in 3.5 and 7.0 MC bands. Fits octal socket — has stainless steel electrodes — moisture resistant phenolic case and neoprene gasket seal.

Send cash or money order. No C.O.D. accepted.

①

Only

\$1.50

EACH

Postpaid in U. S. A.

COMMERCIAL EQUIPMENT CO.

1416-18 McGee St., Kansas City 6, Mo.

XTALS • XTALS • XTALS

(Continued from page 116)

data on the D4 and G use of this band and relaying them to Washington, and doing everything else we can to advance an enlightened reexamination of this subject when FCC and IRAC dig into it again later this year.

For it is now apparent that loran will never realize the great destiny that its creators envisaged for it. It is an American invention. The British don't go for it. They have several other systems of their own, and even in this country one Government agency advocates changing from loran to a competing system which it sponsors. The employment of loran is going to be chiefly by the United States — and chiefly by civilian enterprises, since loran has now lost its military value for wartime use. The principles of hyperbolic navigation are invaluable but they must find embodiment in new secret apparatus for the next war. Admittedly even this peacetime American use can be of considerable proportions. Our manufacturers are equipping ships and planes with loran receivers, and the Coast Guard is preparing to rebuild and relocate the entire transmitting system at a cost of several million dollars. It involves eight installations, and fifty officers and 604 enlisted men are required for its operation. It seems probable, then, that loran will remain part of the American radio picture for five or ten years to come.

Yet in these smaller dimensions it is no longer the world boon whose "transcendental usefulness" warrants taking an amateur band. It is just one more radio device, and one that is on the way out. The League therefore feels more strongly than ever that the band should be returned to amateurs, and its continuing representations in Washington are to that effect. What are our chances, recognizing that loran is in there now and that some loran is to exist for years to come? It is quite impossible to say at this time but there are two angles worth examining:

1) If loran stays where it is, it may be possible to share on a geographical basis. What is technically feasible in this respect is not yet known to anyone. Technical studies must first be made. The League is urging them. Also, with loran destined to be only a small American institution, the needed frequencies should not be as large as when a great worldwide system was believed in prospect.

2) But loran is in the wrong part of the spectrum for a device of its type and it may be moved, vacating the greater part of our band. Nobody yet knows whether it will be moved, or to what frequencies, or when. If it is moved, obviously we want our band back as exclusively amateur frequencies. We are told that such an outcome is by no means assured. If loran goes to lower frequencies, for instance, it invades the oldest and best-organized part of the spectrum, and it is said that a place could be made for it there only by displacing

(Concluded on page 120)

Compare!

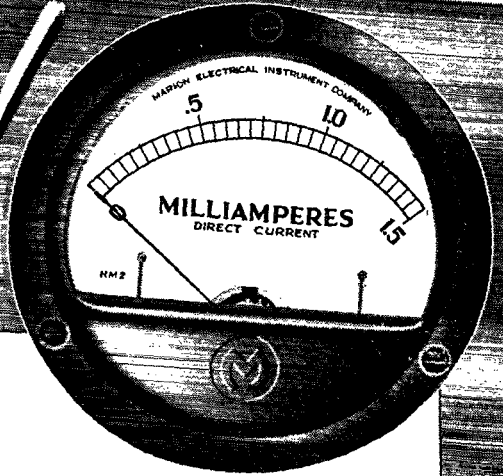

MARION

gives you all this and sealing, too !

- Magnetic shielding
- Interchangeable round and square flanges
- Alnico magnet and full soft iron pole pieces
- Tough "Bulldozer" moving system with beryllium copper frame
- 100% guarantee covers everything
- Modern, 1947 design and coloring
- Competitive prices

***Marion Glass-to-Metal Truly Hermetically Sealed
2½" and 3½" Electrical Indicating Instruments***

Dealers: Write for details of the "4 for 1"
advantage of stocking Marion "hermetics."



MARION ELECTRICAL INSTRUMENT CO.
MANCHESTER, NEW HAMPSHIRE

EXPORT DIVISION

458 BROADWAY • NEW YORK 13, N. Y., U. S. A.

CABLES: MORHANEX

IN CANADA: THE ASTRAL ELECTRIC COMPANY, SCARBORO BLUFFS, ONTARIO

Entirely **NEW**

FOR THE AMATEUR

★ **We Have Them!**

PANADAPTOR



MODEL PCA-2

including 10 tubes and accessories \$99.75
for 115V 60 cycle operation.....

**NAVY SURPLUS
RCA LONG WAVE RECEIVER**

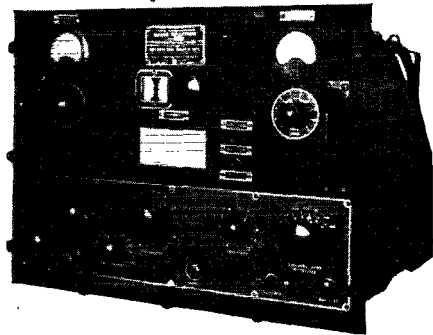

15-600 KC CONTINUOUS. Complete with tubes
... including AC pack and case (not shown in photo above). \$500 value for .. **\$49.50**

MAIL ORDERS SHIPPED IN 24 HOURS

RADIO ELECTRIC

SERVICE CO. OF PENNSYLVANIA, INC.

N. W. Corner 7th and Arch Streets
PHILADELPHIA 6, PA.

Camden, N. J.; Allentown, Pa.; Wilmington, Del.; Easton, Pa.

Send for **FREE flyer TODAY!**

(Continued from page 118)

some old service that would then have to be moved where loran is now. Again it is your League's position that there is no longer any justification for such a decision. There has just been an international conference on navigation aids at London and the course of this country will become clearer. The future frequency assignments of loran will probably be decided within the next few months.

In other words, although the outcome is still decidedly uncertain the League is continuing to fight for this band. The rejection of loran by the other important countries of the world makes it impossible for us to concede any great permanent importance for it, and we think it should either be wound up as soon as possible or moved to such frequencies that it does not invalidate an amateur band.

No discussion of 160 is complete without confessing that we used to misuse the band and without recognizing that there is a goodly segment of amateur opinion that the band was more of a liability to us than an asset. The 160-meter 'phone man sighs for the good old days — but that is quite likely to be the wish, as someone has said, that things should be again as they never quite were. It wasn't all ice cream. That band caused us more BCI and a worse press than all other amateur activities combined, and indeed there are some case-hardened c.w. men who question whether what went on there was amateur radio at all. "Loran is a blessing in disguise; the hell with 160." The League does not at all hold that view. We think it might well be that we'd be better off to use the band for c.w. or at least confine 'phone there to Class A men, who supposedly know better how to avoid such troubles, but those are internal problems that we can always work out among ourselves when the time comes. Meanwhile our point of view is that these are amateur frequencies, they have never in the history of radio in this country before the war been anything but amateur frequencies, and we need them for the orderly accommodation of the growing postwar amateur population. We therefore continue the fight.

Asbury

Strays

Anyone knowing the present whereabouts of the prewar holders of the following calls is requested to get in touch with ARRL Hqs.: KB6AA, EDC, ILT, RVN; KC6CKM, BVL, IDB; KD4HHS, HOC; KD6FOU, OPJ, QHX, RF, XU; KE6QAC; KF6DHW, JEG, OWR, ROV; KH6KKR, RZQ.

*Here's the
true operator's
transmitter*

-----BACKED BY THE
OPINIONS OF FM OPERATORS
IN 56 CITIES IN 22 STATES

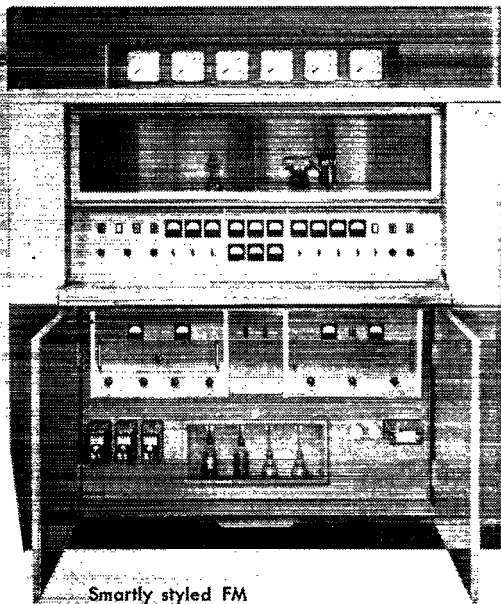

Smartly styled FM transmitters (in two-tone blue and grey) are built in light-weight aluminum cubicles to facilitate portability and rapid installation.



Here's the answer to many of your hopes . . . an FM transmitter packed with the features you want most, as revealed by an extensive survey among station owners and operators throughout the country.

In this survey, 96% wanted a roomy transmitter . . . one with complete, fast and easy accessibility. This important feature shows up in many ways in the Westinghouse FM transmitters:

Example: you can service any tube quickly from easily-opened front panels.

Example: high-voltage rectifier tubes can be checked visually, any time, through glass panels.

Example: oscillator-driver-audio and center frequency control units are built on standard relay rack chassis and equipped with plug-in connectors for easy removal.

Making your job easy is a keynote of the Westinghouse FM design. Meters and indicating instruments are at eye level. All overload protection is fuseless. And to place the transmitter in operation it is only necessary to connect the audio input, r.f. transmission line and input power supply.

This improved design is the product of another important fact: the unmatched experience of Westinghouse engineers in actual station operation of five FM and six AM stations. Get the facts from your nearest Westinghouse office. Westinghouse Electric Corporation, P. O. Box 868, Pittsburgh 30, Penna.

J-02082-B



This new book gives you the complete picture story of the operating advantages built into Westinghouse transmitters and the way operators approved them. Ask for your copy of B-3829.

Westinghouse
PLANTS IN 25 CITIES . . . OFFICES EVERYWHERE



Electronics at Work

For the latest in RECEIVERS and SUPPLIES Call the RADIO SHACK

WHATEVER YOU WANT — WHENEVER YOU WANT IT — that's the Radio Shack motto. And today that means new items all the time — transmitters, receivers, meters, tubes, condensers, transformers — everything needed for amateur radio construction and operation. Prices are "right" on all leading lines — and amazingly low on the many "specials". Write for our 108-page catalog — and get on our mailing list for "hot buys".

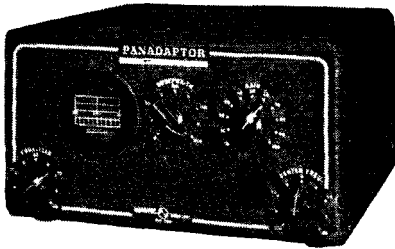

PANADAPTOR

... gives eyes to your receiver ... lets you watch any 200 KC section of the band at any time, find holes in crowded bands, locate weak sigs, see quick answers to your CQ's. Add the PANADAPTOR to your receiver — any receiver — and operate the modern, visual way. In stock for immediate delivery, complete with 10 tubes and full operating instructions.

Net price **\$99.75**

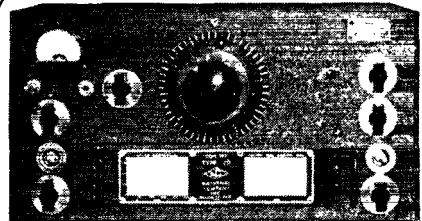

NEW . . . NATIONAL HRO-5TA1

This latest HRO gives you all the regular HRO operating features . . . plus a new noise-limiter circuit that works equally well on phone and CW. Table model, complete with 11 tubes, power supply, and speaker . . .

Net price **\$274.35**

Time payment plan . . . only \$91.45 down; balance, including small service fee, in 12 monthly payments.



80 METER XMTR — 25 WATTS BC-223-A for phone, CW, or ICW

Here's a real bargain you can use either as a regular xmtr or as an exciter; 5-tubes include 801 osc, 801 PA, 46 speech amp, and two 46's class B mod; panel switch selects MOPA or any of four crystal frequencies; small enough for mobile or marine use; simple modification required for 80-meter operation; for use with external 500 volt dynamotor (not included); variometer tuning unit; plate and r-f meters. Net Price (complete with tubes)

\$37.50

And all these Standard Receivers!

NATIONAL	
<input type="checkbox"/>	NC-2-40-C \$225.00
<input type="checkbox"/>	NC-46 ac/dc with speaker 107.50
<input type="checkbox"/>	NC-1-10 56.10
HAMMARLUND	
<input type="checkbox"/>	HQ-129-X complete 139.50
New Super-Pro's	
<input type="checkbox"/>	SPC-400-SX 310.05
<input type="checkbox"/>	SPR-400-SX (Rack Model) 320.55
<input type="checkbox"/>	SPC-400-X 334.05
<input type="checkbox"/>	SPR-400-X (Rack Model) 344.55
<input type="checkbox"/>	Speaker, in Cabinet 18.45
R. M. E.	
<input type="checkbox"/>	RME-45 complete 186.00
HALLICRAFTERS	
<input type="checkbox"/>	S-22R Skyrider Marine 74.50
<input type="checkbox"/>	S-36A VHF FM-AM 307.00
<input type="checkbox"/>	S-38 39.50
<input type="checkbox"/>	S-39 Sky Ranger 110.00
<input type="checkbox"/>	S-40 Complete 79.50
<input type="checkbox"/>	S-41G Complete 33.50
<input type="checkbox"/>	SX-25 Super Defiant 109.50
<input type="checkbox"/>	SX-28A Super Skyrider 238.00

All prices net FOB Boston



ABBOTT TR-4A

You all know this famous transmitter-receiver for 2-meter work. Order it today from the Radio Shack.

Net price **\$43**
 Kit of tubes for TR-4 **\$8.30**

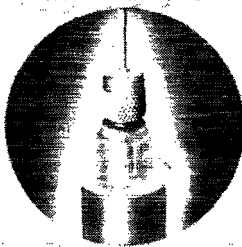

COAXIAL DIPOLE

For the 144-148 mc. band. For fixed-station or mobile use — matches 50-55 ohm co-ax cables — continuously adjustable — immediate delivery from Radio Shack only.

Net price **\$12.50**

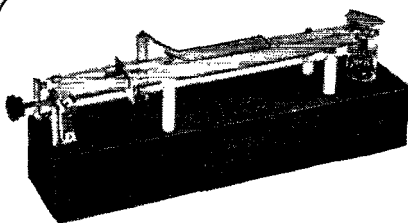

HYTRON VHF XMTR KIT

HY-Q 75 . . . for 1/4 and 2 meters

Here's an efficient linear oscillator you can quickly put on the air for vhf work. Engineered for reproducible results on 1/4 and 2 meters, this rig utilizes the HY75 in a stable, parallel-line circuit with no fancy plumbing or tricky parts. Tunes 135 to 250 mc; useful power at 144 mc is 14 w on c-w; 11 w on phone. Build-your-own-kit — **\$9.95**; ready-wired, assembled, and tested kit — **\$11.95**. HY75 tube for this kit — **\$3.95**.

HIGH FREQUENCY SUPERHET

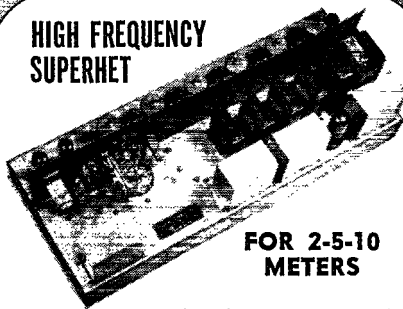

FOR 2-5-10 METERS

For that "super" sensitivity in the high-frequency bands, use this famous radar-type BC-406 receiver, easily adaptable to amateur use as described by Henry Geist, W3AOH, in February CQ. Designed for "super" service, with super-quality components, this outfit gives you a superhet for high-frequency use, at very low cost. Complete BC-406 superhet, including broadband IF's, power-supply with 4-section filter, and 15 tubes including 5 acorns.

Net price **\$29.75**

HERE'S A 500-VOLT DYNAMOTOR for your mobile rig.

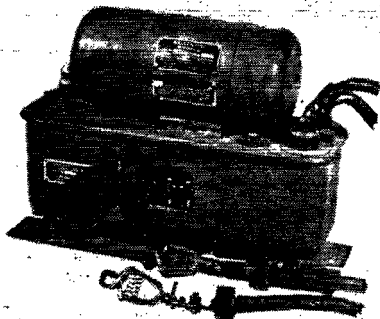

Delivers 160 mills at 500 volts d-c from d-c input of 6 or 12 volts; shock-mounted assembly includes circuit breakers, relays, and interference filters; heavy-duty cables for battery connection. Units slightly used but fully guaranteed.

Net price only **\$14.95**

UFH ACORN TUBES — Types 954-955

Six tubes same type or assorted **\$2.95**

Isolantite socket for acorn tubes **48c ea.**

SUPER SPECIAL TUBE VALUES

Type 832—JAN inspected **\$5.95 ea.**

Type 3C24/24G Eimac **1.95 ea.**



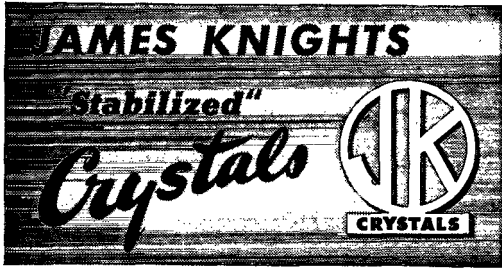

GOOD QSO'S AT BAND ENDS

BAND end operation often results in better QSO's but it also places critical reliance on your crystal. JK "Stabilized" Crystals are especially processed to prevent drift due to aging in service or on the shelf. Their low temperature-drift characteristics (usually less than 1 P.P.M. per degree centigrade) plus their vibration, moisture and dust proof mountings, make band edges as safe as center-of-the-band operation. Listed below are three of the most popular types of JK "Stabilized" Crystals.



H43 — Any frequency between 2000 KC and 30000 KC. Dimensions: 1.4" x 1.2" x .5". Pin spacing: 3/4". Pin diameter: 3/16".



H23 — Any frequency between 2000 KC and 9000 KC. Dimensions: 1.3" x .7". Pin spacing: 3/4". Pin diameter: 3/16".

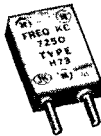

H73 — Any frequency between 2000 KC and 30000 KC. Dimensions: 1.8" x .5" x .8". Pin spacing: 3/4". Pin diameter: .093".

BUY JK "STABILIZED" CRYSTALS FROM YOUR JOBBER. ANY AMATEUR FREQUENCY BELOW 18,500 KC
*10 KC — \$2.80



HOW OFTEN HAVE YOU NEEDED A FREQUENCY STANDARD?

To check band edges, transmitter frequency, received signal frequency, signal generator for aligning receiver? With a frequency range from 100 KC to 500 MC in convenient steps, the JK FS-344 covers the whole range of generally useful bands. Continuous frequency stability is maintained with two JK "Stabilized" Crystals. The FS-344 will become one of the most used pieces of equipment in your shack. Price complete with tubes and JK "Stabilized" Crystals. **\$79.50**



JAMES KNIGHTS
"A Radio Researcher Since the Early Days"

The men of the James Knights Company have grown up with Ham Radio. Because of their work with piezo quartz since it first came into use as a frequency control, they know what is expected of a good Ham Crystal. You can depend on JK "Stabilized" Crystals.



LEON A. FABER
W9DAX — "An Active Ham Since 1913"

The JAMES KNIGHTS Co.
SANDWICH, ILLINOIS

Write for New Illustrated Folder

Crystals for the Critical

Audio-Modulated Detection

(Continued from page 16)

made at 4.6 Mc. with a 0.6-microvolt input signal. With the LC audio output filter mentioned above, a signal-plus-noise to noise ratio of better than 200 to 1 was easily obtained, with a.f. and r.f. receiver gain controls at maximum. With the conventional b.f.o. method of reception, the best signal-plus-noise to noise ratio that could be obtained was about 8.

The selective a.f. filter accounts for much of the improved signal/noise ratio obtainable with A.M.D. It is not practicable to use such a filter with the b.f.o. method of reception, because the audio beat frequency varies with every slight change in the frequency of the transmitter, of the receiver's high-frequency oscillator, and of the b.f.o.

There are four types of selectivity which can be employed in a c.w. telegraph receiver, as follows:

- 1) R.f. and i.f. (tuned circuits, quartz-crystal filters)
- 2) Electrical a.f. (band-pass filter)
- 3) Mechanical a.f. (resonant reproducer)
- 4) Aural (the human ear)

With the first three types, the only limit is the width of the pass-band required to pass the modulation component of the r.f. signal, which is a function of the keying speed. The significance of this statement can perhaps better be understood when we put it this way: with A.M.D. and a highly-selective receiver, it is possible to separate completely two signals which are only 20 cycles apart and yet modulate either at any desired audio frequency. This would not be possible, of course, with the b.f.o. With A.M.D., there can be no audio-image interference and true single-signal reception in the fullest meaning of the term is achieved.

The A.M.D. adapter previously mentioned has several desirable features. It provides a continuously-variable audio tone from 330 to 1150 cycles, adjustable upper-gate and lower-gate bias voltages, adjustable square-wave modulating voltage, and an unique type of selective filter developed especially for use with A.M.D. This unit will be described in a subsequent issue of *QST*.



AC3SS is a legitimate station run by Bob Ford in Sikkim. He got his license by politely asking the Maharaja if it met with his approval for an amateur station to be opened up in his country. The Maharaja had an HRO and considerable interest in the subject, so Bob became the only station in this country. I visited him in February; and also had a long chat with the world-famous AC4YN, only station in Tibet, actually located at Lhasa, the capital. Reg Fox, AC4YN, is keen to get in touch with W9HLF, Claude Moore, or anyone who can help.

— G8NV, VS7PS

HARRISON HAS IT!

* HSS

24G TUBES (3C24/VT204) An FB triode for VHF, 90 Watt rated, Class C output, 6.3 Volt, 3 amp filament. Small bulb. Made by H & K, Gov't inspected, fully guaranteed! Regular amateur net price was \$9.00, reduced to \$6.00, Harrison sells them (in lots of 3 or more) for only, each..... **\$1.48** (Less than 3, at \$1.69 each.)

The last time we offered these popular tubes, orders and reorders came in so heavy, we had to ration them. But this time, we think we have plenty — so order as many as you want — spares — presents, etc.!

PRECISION RESISTORS
1 Megohm, 1 watt, 1% accuracy, IRC WWS. Use as a thousand volt multiplier with 1 ma meter. List Price \$5.25. HSS in lots of **98¢** THREE at each.... (less than three — \$1.19 each)

RC4 955-A Acorn Tubes
New, standard, boxed stock. Reg. net price \$6.95. HSS... **\$1.90**

LINEN LACING \$2.25
CORD, 1-lb. spool

HSS OIL CONDENSERS
G.E. 4 MFD 600 VOLT. Rectangular case with stand-off insulators. **\$3.47** THREE for...

Round metal case, single hold mount. 2 Mfd. 1000 Volt. **FOUR \$2.34** for.....
Bathtub type. 2" x 2" x 1 1/4" 2 Mfd. 600 Volt. **FOUR \$2.12**

LONG WAVE RECEIVERS

Navy Model RAK-7. New, in original crates. A real commercial job for marine, aviation, etc. use. 15 to 600 KC. Two tuned RF stages, Band switching, precision dial, AVC noise limiter, Band pass filter, tuneable audio filter, Db output meter, filament voltmeter. Six tubes plus three in 115 Volt 60 cycle regulated power supply. Complete with tubes and instruction **\$64.50** manual.

Steel chest 12" x 12" x 18" containing 50 pounds of spare parts — transformers, chokes, condensers, sockets, coils, switches, etc. All new, with specifications! **\$12.00.**

DYNAMOTORS

Just the thing for that mobile amplifier, Xmitter, etc. 12 volt. input, gives 680 volts at 210 ma; 6 volt input delivers 300 volts at 210 ma, or 265 volts at 300 ma. Compact, well-constructed unit for Military use. Weighs only 6 1/2 lb. with mounting. Ball bearings for good efficiency! Brandnew! **\$8.95** HSS Special!...

TEST EQUIPMENT

Our TEST EQUIPMENT DEPT. can furnish practically all makes and models of instruments, with many in stock for immediate shipment. Send in your orders NOW for best delivery!

ANTENNA TUNING UNIT

Signal Corps Model BC-939-A. Designed to efficiently couple the HT-4E (or almost any transmitter up to 1 KW) to any short or long wire antenna. Has three rotary coils with cyclometer crank tuning, Isolantite switches, 3" RF ammeter, in black metal cabinet. Covers 2 to 18 MC with proper plug-in vacuum condensers, available separately. Brand new! HSS... **\$32.50**

22 mmf condenser to cover 10 to 18 MC.....\$9.75
50 mmf condenser to cover 2 to 10 MC (or almost any frequency on long antenna).....\$11.50

* Harrison Select Surplus

Your assurance of good, usable, guaranteed surplus material at sensationally low prices — top value always! Come in and browse through our large, entirely separate HSS Department (Harrison Select Surplus).

HARRISON HAS IT!

ALL STANDARD LINES

RECEIVERS

As one of the world's largest distributors of Communication Equipment, we are delivering plenty of receivers — right now! All makes — practically all models. If you want your new set in the quickest possible time — send your order to HARRISON!

NATIONAL
HRO-5TA-1. New model with noise limiter, metal tubes, ham bandspread coils. Complete with pack, speaker and coils 1.7 to 30 Mc..... **\$303.00**
NC-240-C..... **225.00**
NC-46. AC-DC Receiver..... **97.50**

HAMMARLUND
New Super-Pro. SPC-400 SX. 1.25 to 40 Mc. **310.05**
HQ-129-X. With speaker..... **168.00**

HALLICRAFTERS
FM-AM-CW. Peak performance on 10 and 6 meters, a swell police job, a beautiful high-fidelity FM receiver (old and new bands), an excellent piece of Lab equipment — all in one Acorn tube RF section, noise limiter, 15 tubes, 27.8 to 143 Mc.
Model S 36-A. \$415.00, reduced to only..... **\$307.50**
S-41. Skyrider, Jr..... **33.50**
S-38. New Sixy Buddy..... **39.50**
S-40. 1946 Sixy Champion..... **79.50**
SX-28-A. Super Skyrider..... **223.00**

RME 45. New, revised model with calibrated ham bandspread. With speaker..... **\$186.00**
RME 84. New eight tube receiver. Complete... **98.70**

Literature on any receiver gladly sent upon request. Write today! (All prices subject to change without notice.)

ELECTRIC DRILLS

THOR — one of the best quality makes. Compact, sturdy, a good lifetime tool. Jacobs chuck.
1/2", 2500 RPM free. Model UI4AP... **\$32.50**
1/4", 500 RPM, with removable dead handle for extra leverage on heavy jobs. Model U44. **\$59.50**

Our **TOOL DEPT.** also has pliers, cutters, soldering irons, steel work benches, screw drivers, etc. — in stock!

INTERCOMMUNICATION SYSTEMS

TALK-A-PHONE
LP-5. Master for up to five remote stations... **\$19.95**
RS-3. Remotes (can call master)..... **\$7.25**

BOGEN

12-C. For up to 12 station multiple master system. **\$28.74**
(Many other models in stock)

[This space is reserved for all the new items announced by the manufacturers in their ads in this magazine. Send us your orders, NOW, because just as soon as it is available — HARRISON HAS IT!]

DUMONT Oscilloscope

Model 208-B. An excellent 5" scope for **\$235.00** Lab, Service Bench, or Ham Shack!....

We are **FACTORY AUTHORIZED DISTRIBUTORS** for the top quality manufacturers and we now have in stock lots more new, latest improved production Ham gear! Visit our stores today, for everything you need. We promise you fresh, clean material — quicker — at the lowest current prices — and, above all, our sincere desire to be of friendly, helpful service.

MAIL ORDERS? — Certainly! Just list everything you want (items in this ad, or any ad, magazine or catalog) and include deposit.

73 de

Bill Harrison, W2AVA

HAM HEADQUARTERS
Since... 1925!



HARRISON RADIO CORPORATION

12 WEST BROADWAY • NEW YORK CITY 7

BARCLAY 7-9854

JAMAICA BRANCH — 172-31 Hillside Ave. — REPUBLIC 9-4102

TYPE--951C Transformer Relay

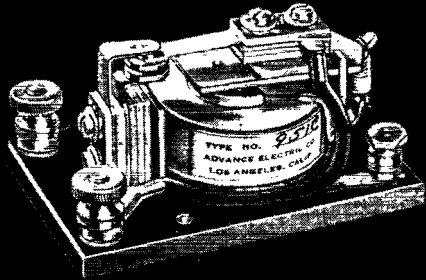

by **ADVANCE**

The Advance type "951C" relay is designed for use in the primary circuit of the power transformer. It is an exceptionally sturdy unit mounted on a 3/16-in. black Bakelite base. Contacts are 3/8-in. diam., pure silver, rated at 20 amps. on 110 v.a.c.

A similar relay is made in 30 amps. capacity (Type 961C), also with base but with double contacts banded together.

A lighter, unmounted relay of 10 amps. capacity (Type 950) is widely used on general circuit control within its range. Amateur Net Price (At Your Jobber) TYPE 951C \$3.60; TYPE 961C \$4.20;

TYPE 950 \$2.10

Advance Relay Catalog free on request.

Advance Relays



**ADVANCE
ELECTRIC & RELAY CO.**

1260 West 2nd Street
Los Angeles 26, Calif., U. S. A.

Phone Michigan 9331

RECEIVING SENDING
CODESPEED *without strain*

CHAMPIONS ENDORSE CANDLER WAY

Get skill, accuracy, speed with the highly endorsed Candler System. Learn to send and receive by telegraph or radio code. Government service and commerce need thousands of better trained operators. Air commerce, mail, freight, etc., demand expert, reliable operators. Good pay. Get the Candler System, the maker of champions. It teaches you the "knack" of sound sense, alertness, speedy sending and receiving without strain. Adventure—good pay. Learn at home or wherever you are. Rush name today for free book.

FREE! **CANDLER SYSTEM CO.**
Dept. 4-H, Box 928, Denver 1, Colorado, U.S.A.
and at 121 Kingsway, London, W.C. 2, England

Beginners Transmitter

(Continued from page 88)

operated from heavy-duty B-batteries, a filtered vibrator pack or a d.c. generator.

The connections to the 5-prong emergency power-cable plug follow:

Pin 1 — No connection.

Pin 2 — "Hot" filament, 6-volts a.c. or d.c. at 1.2 amps.

Pin 3 — No connection.

Pin 4 — Plate supply, B+, 250-350-volts d.c. at 70-100 ma.

Pin 5 — "Cold" (grounded) side of filament supply and B-.

An Alternate and More Versatile Connection for Emergency Use

Just in case it is desired to provide for all-round emergency or portable usage of the "Metal Longfeller," a substitution may be made in the power plug thus permitting the connection of (a) the built-in a.c. supply (plug P_{10}), (b) an unfiltered d.c. supply, such as some types of vibrator packs (plug P_8), and (c) a filtered d.c. supply, such as B-batteries, a filtered vibrator pack or generator (plug P_9).

A six-prong chassis power socket P_7 is substituted in the transmitter in place of the five-prong socket P_1 shown in Fig. 4. By wiring the transmitter power supply as shown in Fig. 5, the built-in filter components are made available when required and eliminated if not needed, to the junction of R_7 and R_8 in Fig. 4.

Normal operation is obtained through the use of the shorting plug, P_{10} , and either filtered or unfiltered supplies may be connected when properly terminated by plugs P_9 or P_8 , respectively.

Happenings of the Month

(Continued from page 30)

League, similar in tenor to that for the 1938 national convention.

Mr. Kiener called the attention of directors to By-Law 15, on the duties of directors, pointing out that this included the duty of being informed on the desires of their members on allocation matters. Mr. Davis associated himself with this opinion.

On motion of Mr. Davis, unanimously VOTED that the League shall promote the economical use of available phone frequencies by an educational program of good operating technique and constructional design to minimize the channel width required for transmission of intelligence, in order that maximum employment of available frequencies may be realized.

On motion of Mr. Acton, seconded by Mr. McGargar, unanimously VOTED that the Board commends the article on amateur radio appearing in the April 6, 1946, issue of "Collier's" and expresses the hope that there may be more such articles in magazines of nation-wide circulation in the coming year.

Moved, by Mr. Kirkman, that By-Law 42 be amended by adding the following words: "Provided, however, that the adoption of the Working Code shall not prevent the mover of a debatable question from speaking in support of his motion for lack of a second." The yeas and nays being ordered, the said question was decided in the negative: Whole number of votes cast, 15; necessary for adoption, 10; yeas, 8;

(Continued on page 138)

CELEBRATING OUR TENTH ANNIVERSARY

Won't you join us?



To our many friends and customers we express our sincere thanks for helping us complete a decade of service. We're still going strong and are just as eager to please the large number of "Hams" who have found Terminal to be a good place to shop for radio supplies. To those who have already "discovered" Terminal and to those who during our next year will join our growing family of satisfied customers, "THANK YOU."

NEW! HYTRON'S HY-Q 75 VHF KIT 1/4 AND 2 METER XMITTER

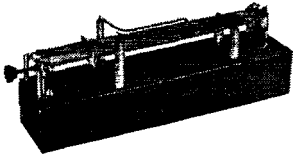

See Hytron's ad in this issue for tech specs. Add tube, power supply and a-f unit to really perk on VHF!

HY-Q 75 Kit—Fancy plumbing, etc. Net **\$ 9.95**

Assembled, wired and tested. Net **11.95**

Hytron HY-75 tube. Net **3.95**

BUY YOUR NEW RECEIVER—NOW!

HALLICRAFTERS

SX-25	\$94.50
S-38	39.50
S-40	79.50
S-41½G or W	33.50

NATIONAL

HRO-5TA-1, latest model, complete	306.71
NC-46, with speaker	107.40

R M E

RME-45, complete	186.00
RME-84, complete	98.50

Note — Prices subject to OPA approved changes.



HAMMARLUND

HQ-129X	\$129.00
SPC-4005X, complete	323.25

PANADAPTOR **99.75**

FOR THAT NEW RIG! BARKER & WILLIAMSON Coils and Condensers

Terminal carries the complete B & W line of Air Inductors and Capacitors!

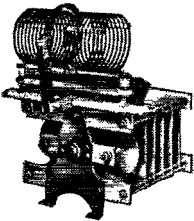

Whether building a new rig or rebuilding, you'll want the extra efficiency of a Barker & Williamson tank assembly. Let us help you select the B & W coils and variable condensers for your requirements. Our friendly counter-men are experienced hams eager to serve you—or write us for complete B & W catalog and prices.

OUR "BIRTHDAY SPECIAL"!

4 Mfd.—2000 Volt CAPACITORS

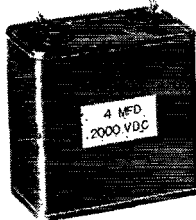

Oil-impregnated, oil-filled condensers made by the country's leading manufacturer of quality capacitors. Conservatively rated and a real buy for the value-wise ham!

ONLY 2 TO A CUSTOMER! **\$1.75** EACH NET

KENYON UNIVERSAL MODULATION TRANSFORMERS

TYPE NO.	AUDIO WATTS	NET PRICE
T-489	15	\$3.81
T-493	40	5.55
T-494	75	8.34
T-495	125	18.45
T-496	300	28.02

Famous KEN-O-TAP transformers never grow obsolete! Will match any Class B tube or tubes to any Class C load!

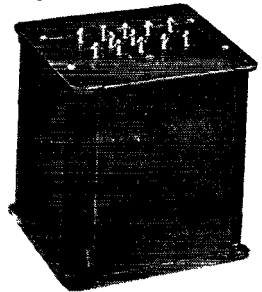

TERMINAL RADIO CORP.

Home of Sound Radio Values

85 CORTLANDT STREET · NEW YORK 7, N. Y. · WOrth 2-4415

Now—a really
high-powered



RADIO ENGINEERING LIBRARY

5 VOLS.
3319 PAGES,
2289
ILLUSTRATIONS

- especially selected by radio specialists of McGraw-Hill publications
- to give most complete, dependable coverage of facts needed by all whose fields are grounded on radio fundamentals
- available at a special price and terms

THESE books cover circuit phenomena, tube theory, networks, measurements, and other subjects — give specialized treatments of all fields of practical design and application. They are books of recognized position in the literature — books you will refer to and be referred to often. If you are a practical designer, researcher or engineer in any field based on radio, you want these books for the help they give in hundreds of problems throughout the whole field of radio engineering.

1. Eastman's Fundamentals of Vacuum Tubes.
2. Terman's Radio Engineering.
3. Everitt's Communication Engineering.
4. Hund's High Frequency Measurements.
5. Henney's Radio Engineering Handbook.

Free Examination • Special Low Price • Easy Terms

McGraw-Hill Book Co., 330 W. 42nd St., New York 18
Send me Radio Engineering Library, 5 vols., for 10 days' examination on approval. In 10 days I will send \$2.50, plus few cents postage, and \$4.00 monthly till \$26.50 is paid, or return books postpaid. (We pay postage on orders accompanied by remittance of first installment.)

Name.....
Address.....Company.....
City and State.....Position.....QST 7-46

Ted McElroy
World's Largest Manufacturer of
Wireless Telegraphic Apparatus
COMPLETE CENTRAL OFFICE EQUIPMENT
McElroy Manufacturing Corp.
82 Brookline Avenue • Boston, Massachusetts



Founded in 1909

RADIO TELEPHONY RADIO TELEGRAPHY

Courses ranging in length from 7 to 12 months. Dormitory accommodations on campus. Advanced students eligible for practical training at KPAC, 1 KW broadcast station owned and operated by Port Arthur College. New students accepted monthly. If interested in radio training necessary to pass F.C.C. examinations for first-class telephone and second-class telegraph licenses, write for details.

PORT ARTHUR COLLEGE PORT ARTHUR TEXAS
Approved for G.I. training

(Continued from page 186)

nays, 7. Those who voted in favor are Messrs. Bickel, Davis, Groves, Kiener, Kirkman, Markwell, Noble and Raser. Those who voted opposed are Messrs. Acton, Caveness, McCargar, Norwine, Reid, Shelton and Weingarten. So the by-law was not amended. Ruled, by the Chair, that the desired practice is already permitted by our rules of order.

Moved, by Mr. Kirkman, that, in order to prevent a generally unavoidable type of interference under existing frequency allocations, and thereby to protect the good name of amateur radio, FCC be urgently requested to change the amateur allocation of 28 to 29.7 Mc. to 25 to 27 Mc. for the purpose of shifting the second-harmonic radiation from the television band 54 to 60 Mc. After discussion, including hearing Technical Director Grammer, on motion of Mr. Noble, unanimously VOTED that the motion is amended by changing the words "FCC be urgently requested to change" to "the Board appoint a committee to study the desirability of requesting FCC to change." The question then being on the motion as thus amended, the same was unanimously ADOPTED.

Moved, by Mr. Kirkman, that an amateur call book be prepared forthwith, the first edition of which shall sell for seventy-five cents, and further that this action shall be deleted from the minutes as published in QST until the November, 1946, issue, at which time it shall be published in full; this action shall be held confidential until published. But, after discussion, the motion was rejected.

Moved, by Mr. Norwine, that the Federal Communications Commission be requested to sanction the use of one long dash in lieu of the customary five dashes as an alternate for the numeral 0 in amateur calls. But, after discussion, unanimous consent being given, Mr. Norwine withdrew the motion.

Moved, by Mr. Noble, that the League set up a fund to be used for scholarships in the following manner: an outstanding secondary school or trade or vocational school senior, holding an amateur license, be selected each year for one year's practical experience in the A.R.R.L. laboratory, following his graduation from school, his salary to be determined by the General Manager. But, after discussion, the motion was rejected.

Moved, by Mr. Noble, that the League set up a fund to be used for scholarships in the following manner: each year an outstanding high school senior, holding an amateur license, be granted by A.R.R.L. a scholarship of \$500 a year for a four-year radio engineering course at a college or university of his own selection. But, after discussion, the motion was rejected.

Moved, by Mr. McCargar, that, in view of the imminent independence of the Philippine Islands, By-Law 5 (a) be amended by striking out the words "the Philippine Islands," and that By-Law 6 be amended by adding at the end thereof a new item, "Philippine Islands — attached to the Pacific Division," and that By-Law 8 be amended by inserting, after the words "its island possessions and territories" the words "the Philippine Islands." He pointed out that the remaining language of By-Law 5 continues the Philippine Islands as an actual part of the Pacific Division until the date of their independence. The yeas and nays being ordered, the said question was decided in the affirmative: Whole number of votes cast, 15; necessary for adoption, 10; yeas, 15; nays, 0. Every director present voted in the affirmative, except the President who abstained as required. So the by-laws were amended.

Moved, by Mr. Caveness, that the League request the Federal Communications Commission to permit Class B operation on the proposed 3850-4000 kc. 'phone band. But, after discussion, the motion was rejected, 5 votes in favor to 10 opposed.

On the further motion of Mr. Caveness, VOTED, 8 votes in favor to 7 opposed, that the League shall request the Federal Communications Commission to make the frequencies 7200-7300 kc., for which 'phone authorization is being requested, open to Class B amateur operators instead of being confined to Class A as previously voted.

By request, Mr. Markwell read a letter from the Denver Radio Club, about the danger to amateur radio in the sale of surplus radio equipment to the lay public. The Secretary and General Counsel reported the awareness and activities of FCC in this respect.

Mr. Shelton brought up the question of phonetics in calls. After discussion, although no action resulted at this time, he requested that the minutes show that the subject was discussed.

(Continued on page 180)

HARVEY... has the cream of the surplus crop...

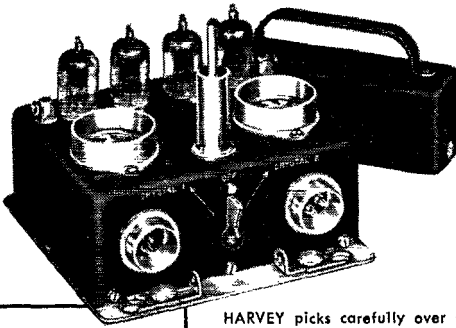

CRYSTAL OSCILLATOR UNIT O-4/ARC-5

Consisting of 2 Pierce oscillators and modulator; complete with four 9002 tubes.....\$6.95

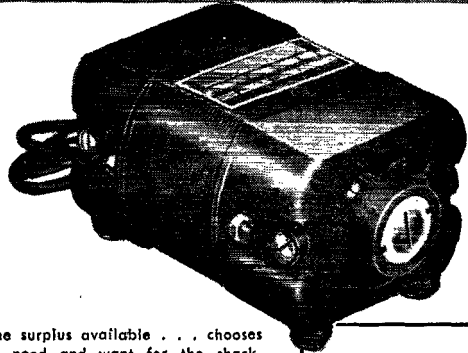

CARTER DYNAMOTOR

5.5 volt input; output: 350 volts at 150 mts. Brand new.....\$14.95
Same unit, mounted on chassis with two 4 mfd. oil-filled 600 v. filter capacitors, hermetically sealed choke, and push-to-talk relay. New.
\$29.50

HARVEY picks carefully over the surplus available... chooses only the things we think you need and want for the shack. (Quantities are often too limited to permit advertising, so drop in if you're in the neighborhood to see what's on hand.) Surplus items we procure can be put to immediate use as is... or easily converted. They're all in excellent condition... all "buys" we couldn't afford to offer otherwise

ARMY TYPE 6C-221 FREQUENCY METER

Complete with crystal, original calibration chart, and tubes. Frequency—125 kc. to 20 Mc.; battery operated or can be operated on AC by constructing small power supply, 135-160 v. DC at 18 ma. Used, in good condition.
HARVEY SPECIAL, \$39.50

**Quantities limited.
Order at once!**

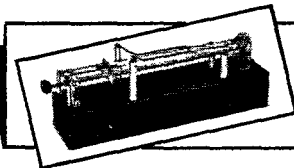

HARVEY'S HIT OF THE MONTH

Hytron HY-Q 75 1 1/4 and 2 Meter Kit. Completely assembled, wired and tested.....\$11.95
HY-75 tube.....\$3.95

HARVEY'S HAMFESTIVAL OF VALUES...

Electro-Voice 950 Cardax Mike—High impedance; high level; rising output at speech frequencies to approximately —48 db, minimizes rf feedback....\$22.00

Having trouble getting coils for the new rig or the new frequencies? Harvey has a complete selection of B & W coils, mounts and condensers in stock.

Hard-to-get, **National ACN dial** for that new ECO, etc.....\$3.00

National Type N dial.....\$4.50

Special! **5000 kc. precision crystal**, mounted in dustproof holder with neoprene gaskets.....\$1.95

Gordon No. 1000 heavy duty 1 KW rf relay.....\$10.80

Dynamic throat mike—High impedance, no polarizing voltage required, \$4.95

Johnson ceramic socket for 829 and 832.....\$1.05

New Gross Ultraphone, Model USP-2-144-148 Mc., 30 watt input to oscillator TUF-20. Uses 6AK5 detector; complete with tubes.....\$89.50

For the HT 9 and HT 6 transmitters, **Hallcrafters coils** in stock.

Millen 90800 50-watt exciter-transmitter with coils for one band.....\$37.50

New Cardwell v.h.f. oscillator—Uses 6F4 tube; complete with coils for 141-151 Mc., 215-230 Mc., 415-455 Mc.....\$10.80

Single button carbon mike, desk stand type, with push-to-talk switch, 7 ft. cable, and PL 68 plug.....\$4.95

Having trouble with BCI due to rf in your line? Harvey has **Ohmite Z 20 and Z 22 rf line chokes**, Z 20—14 μ h, 5 amps., .15 ohms DC.....99¢

Z 22—18 μ h, 20 amps., .045 ohms DC.....\$2.40

Telephone:  Longacre 3-1800

HARVEY RADIO COMPANY INC.

103 West 43rd St., New York 18, N. Y.

PRE-EXAM TESTS

For Commercial
Radio Operator

FCC LICENSE EXAMINATIONS



Don't Take A Chance!

Avoid Failure On FCC Commercial Radio Operator License Examinations!

Use **NILSON'S COMPLETE PRE-EXAMINATION TESTS AND COACHING SERVICE**

Enables You To

REHEARSE the FCC license examinations • **PRACTICE** the procedure • **PRACTICE** the multiple-choice examination methods used by FCC • **CHECK** your knowledge • **LOCATE** your weak points • **CORRECT** your weak points before taking the actual examination

Prepared by **Arthur R. Nilson, Famous Co-Author of Nilson and Hornung's Radio Questions and Answers.**

Use Coupon or write for Descriptive Folder
No obligation—no salesmen

CLEVELAND INSTITUTE OF RADIO ELECTRONICS

Successors to Nilson Radio School, founded 1939;
Smith Practical Radio Institute, founded 1934.

QT-7 TERMINAL TOWER CLEVELAND 13, OHIO

Approved for Veteran Training under GI Bill of Rights

CLEVELAND INSTITUTE OF RADIO ELECTRONICS

QT-7 Terminal Tower, Cleveland 13, Ohio

Gentlemen: Please send information about Pre-Exam Tests.

Name..... Address.....

City..... Zone..... State.....

ALUMINUM

ALL SIZES OF
TUBING for Beams
and Vertical Antennas

SHEETS and ANGLES
for CHASSIS and PANELS
BUILT — CUT — DRILLED

Send your requirements
for a quotation

• **TRIEX TOOL WORKS**
429 BROOME ST., N. Y. 13

**Complete
MACHINE
SHOP
Service
for HAMS**

A.L. MOSS • W2EUZ

Telephone
CAnal 6-1382

HAM SPECIALS

4 mfd. 600 v. OIL Sq. Can Condensers..... \$1.45
6 mfd. 600 v. OIL Sq. Can Condensers..... 2.30
2 mfd. 1000 v. OIL Sq. Can Condensers..... 2.30
1 mfd. 2000 v. OIL Sq. Can Condensers..... 1.65

Standard Brands — Fully Guaranteed at Rated Voltages

IN STOCK — New Hycon HY-Q-75 Kits \$9.95. HY-75 Tubes \$3.95. HY-615 Tubes \$2.25. 2E30 Tubes \$2.25. Complete Stocks of RCA-HYTRON-UNITED Power Tubes.

HAMMARLUND-NATIONAL-RME Receivers — Complete Line of Aerovox-Milten-Radiart-Hammarlund parts. Write for our latest list of Specials.

CHIEF ELECTRONICS

"Mid-Hudson Valley's Only Distributor"

104 MAIN ST. POUGHKEEPSIE, N. Y.

(Continued from page 138)

Moved, by Mr. Shelton, that the League petition the Federal Communications Commission to permit amateur mobile operation on 3500-4000 kc. But, after discussion, the motion was rejected.

On the question of elections in Canada, Mr. Reid made an oral report on the trend of recent amateur developments in that country. After discussion, on his motion, unanimously VOTED that elections for Canadian General Manager and alternate thereto are postponed until such time as he is in position to give the Board or the officers a further report on the wishes and intentions of Canadian amateurs.

Moved, by Mr. Reid, that By-Law 2 be amended by inserting, after the words "of the United States," the words "or Canada." The yeas and nays being ordered, the said question was decided in the affirmative: Whole number of votes cast, 14; necessary for adoption, 10; yeas, 14; nays, 0. Those who voted in favor are Messrs. Acton, Bickel, Caveness, Davis, Groves, Kiener, Kirkman, Markwell, McCargar, Noble, Raser, Reid, Shelton and Weingarten. So the by-law was amended.

During the foregoing action the Board was in recess for dinner from 6:36 to 8:07 P.M., reassembling with all directors and other persons hereinbefore mentioned in attendance except General Counsel Segal.

Moved, by Mr. Reid, that By-Law 30 be amended by striking out the words "to be known as the Canadian Radio Relay League." But, after discussion, unanimous consent being given, Mr. Reid withdrew the motion.

On motion of Mr. Caveness, after discussion, the following resolution was ADOPTED by unanimous vote:

RESOLVED: that QSL cards on file in the ARRL QSL Bureau System confirming contacts prior to September 1, 1939, may be disposed of on January 1, 1947, if not applied for in the prescribed manner before that date; and that meanwhile in QST extensive publicity shall be given this policy so that every amateur may be fully aware of the opportunity to obtain such cards as there may be on file for him.

On the question of a building fund, after discussion, moved, by Mr. Kirkman, that there be segregated from the general funds of the League the sum of one hundred thousand dollars (\$100,000), the same to be separately invested as a Building Fund and subject to the order of the Board for the construction or acquisition of a permanent building as offices of the League. After further discussion, on motion of Mr. Groves, seconded by Mr. McCargar, unanimously VOTED that the motion is amended by changing the figure therein to read one hundred fifty thousand dollars (\$150,000). The question then being on the motion as thus amended, the same was unanimously ADOPTED.

On the request of members of the FCC staff for a League recommendation in the matter of the indicator to be signed by amateur mobile stations on the high seas, after discussion, on motion of Mr. Shelton, unanimously VOTED that the League recommends to the Commission that such amateur stations indicate maritime-mobile status by signing the designator /MM as part of the call, and that the name of the vessel be required to be transmitted once in each transmission but not as part of the call.

On the question of modernizing the authorizations to the Treasurer concerning investments, after discussion, on motion of Mr. McCargar, the following resolution was unanimously ADOPTED:

RESOLVED: that the Treasurer is hereby fully authorized and empowered, with the approval of the Finance Committee of the Board, (1) to invest and reinvest the surplus funds of the League in securities of the variety in which a life insurance company is empowered by law to invest, and (2) to transfer, endorse, sell, assign, set over and deliver any and all shares of stock, bonds, debentures, notes, evidences of indebtedness, or other securities now or hereafter standing in the name of or owned by the League, and to make, execute, and deliver, under the corporate seal of the League, any and all written instruments necessary or proper to effectuate the authority hereby conferred. And be it further resolved that all previous instructions and authorizations in the matter of investments are hereby rescinded.

(Continued on page 138)

The easy sure-fire way

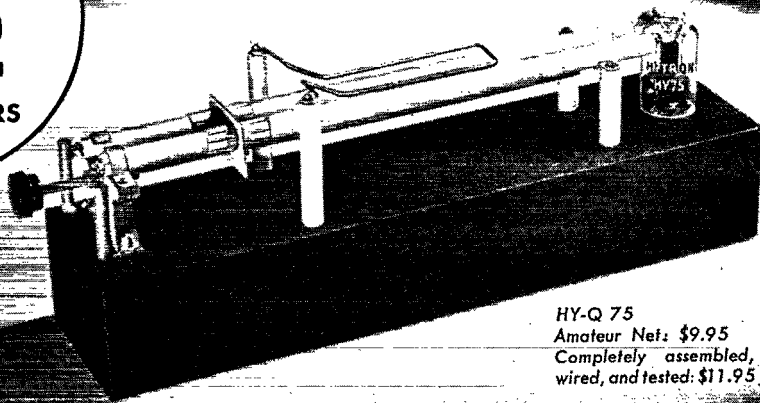
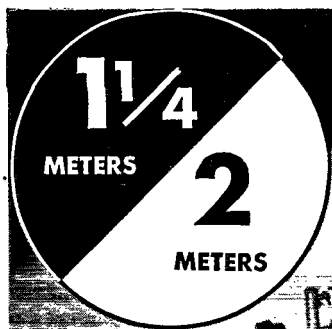

HY-Q 75
Amateur Net: \$9.95
Completely assembled,
wired, and tested: \$11.95

ASSEMBLE THIS EFFICIENT HY-Q 75 KIT IN AN HOUR

Like most amateurs you may prefer to "roll your own." If your leisure time is limited, however, you will welcome the HY-Q 75. Long hours of engineering have ironed out the "bugs"—have assured easily reproducible maximum efficiency on $1\frac{1}{4}$ and 2 meters with the popular HY75. Fancy "plumbing" and tricky parts are prefabricated. With screwdriver, pliers, and soldering iron, you can quickly put this efficient linear oscillator on the air. Check the many features. Ask your jobber to let you see the HY-Q 75.

HY-Q 75 KIT HAS MANY FEATURES

CAREFULLY ENGINEERED to make it easy for you to duplicate results on $1\frac{1}{4}$ and 2 meters.

NO CUT AND TRY—chart assures quick location of amateur bands.

MICROMETRIC TUNING (135 mc to 250 mc) by finely adjustable lead screw.

SILVER-PLATED TANK CIRCUIT means permanently low r-f losses.

PRECISION-MACHINED SHORTING BAR with multi-fingered silver-plated contacts for low resistance.

LOW-LOSS INSULATORS with extremely long leakage paths.

SPECIAL R-F CHOKES—filament, plate, grid—assure peak operation of HY75 at vhf.

NON-INDUCTIVE PLATE BLOCKING CONDENSER is concentric with the plate line.

QUICK BAND CHANGING from $1\frac{1}{4}$ to 2 meters by adjusting the positions of shorting bar and coupling loop.

ADJUSTABLE ANTENNA COUPLING LOOP matches efficiently either concentric or parallel line feeders.

BETTER FREQUENCY STABILITY is obtained from the rugged parallel-line construction.

COMPLETE VHF TRANSMITTER—a-c or d-c, fixed or mobile. Add only tube, power supply, and a-f unit.

LABORATORY POWER OSCILLATOR for special measurements and classroom vhf demonstrations.

USEFUL POWER TO LOAD at 144 mc (less at 225 mc) is 14 w on c-w; 11 w on phone.*

PEAK PERFORMANCE OF HY75—but readily adaptable to other vhf tubes.

PICTORIAL WIRING DIAGRAM and easy-to-understand instruction manual.

**Useful power output equals total power output minus radiation losses, circuit losses, and grid drive.*

SPECIALISTS IN RADIO RECEIVING TUBES SINCE 1921.



HYTRON

RADIO AND ELECTRONICS CORP.



MAIN OFFICE: SALEM, MASSACHUSETTS

PREMAX

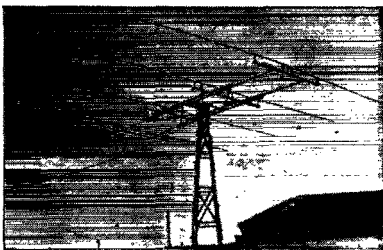

For Better Reception

Premax Tubular Antennas in steel, aluminum or monel . . . and Corulite Steel Elements will give better reception on any wave length. Send for new catalog showing Premax Antennas and Mountings.

Premax Products

Division Chisholm-Ryder Co., Inc.

4615 Highland Avenue

Niagara Falls, N. Y.

High Forward Gain, Wide-Spaced, 4-Element,
All-Aluminum

10 METER BEAM

Weights only 13 lbs. Puts terrific sig. *where* you want it. No insulators, no adjustments of any kind! Just attach 2-inch line or twin 300 ohm line and use! Easily supported and rotated with a 1 1/2 inch round wood pole. Up to ten times power gain over 1/4 wave ant. Greatly reduces ignition and other QRM. Package has elements; hor. sup. member; delta or folded dipole term. panel; all hardware; complete instructions and clear print. Amateur net price \$50.

Send for literature on the above, our beams for 50, 144, 235 and 425 MC., and High-Q tuned circuits for the U.H.F. bands

U.H.F. RESONATOR CO.

GUION ROAD, RYE, N. Y.

Telephone Rye 2030

EASY TO LEARN CODE

It is easy and pleasant to learn or increase speed the modern way — with an Instructograph Code Teacher. Excellent for the beginner or advanced student. A quick, practical and dependable method. Available tapes from beginner's alphabet to typical messages on all subjects. Speed range 5 to 40 WPM. Always ready, no QRM, beats having someone send to you.

ENDORSED BY THOUSANDS!

The Instructograph Code Teacher literally takes the place of an operator-instructor and enables anyone to learn and master code without further assistance. Thousands of successful operators have "acquired the code" with the Instructograph System. Write today for full particulars and convenient rental plans.

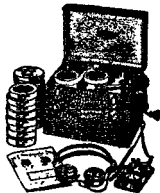

INSTRUCTOGRAPH COMPANY

4709 SHERIDAN ROAD, CHICAGO 40, ILLINOIS

132

(Continued from page 130)

At this point Mr. Reid rendered an oral report on behalf of the Finance Committee, expressing satisfaction with the financial position of the League. He complimented Communications Manager Handy on the efficiency and appearance of W1AW, and Secretary Warner on the rehabilitated headquarters. He recommended reaffirmation of the special authorizations to the President. On his motion, seconded by Mr. McCargar, unanimously VOTED that the Board, having examined its actions at the 1940 meeting at which it granted the President extraordinary powers to act as a committee of one in all aspects of protecting amateur operation, and in which it made an open authorization of ten thousand dollars (\$10,000) available to him for the defense of amateur frequencies, now reaffirms those actions.

Moved, by Mr. Klener, that in order to divide the present Central Division in such manner that the Central Division may in future consist of the states of Illinois, Indiana and Wisconsin, and that a new Great Lakes Division may be established consisting of the states of Kentucky, Michigan and Ohio, By-Laws 5 (a) and 22 be amended to read respectively as follows:

5. For administrative purposes the United States & Possessions and the Dominion of Canada shall be partitioned into divisions as follows:

(a) In the United States and Possessions —ATLANTIC DIVISION, those portions of the states of New York and New Jersey not included in the Hudson Division, the states of Pennsylvania, Maryland and Delaware, and the District of Columbia; CENTRAL DIVISION, the states of Wisconsin, Michigan, Illinois, Indiana, Ohio and Kentucky, but, effective at noon, C.S.T., January 1, 1947, and also for the purpose of 1946 elections to choose a director whose term begins January 1, 1947, only the states of Illinois, Indiana and Wisconsin; DAKOTA DIVISION, the states of Minnesota, North Dakota and South Dakota; DELTA DIVISION, the states of Louisiana, Mississippi, Arkansas and Tennessee; GREAT LAKES DIVISION, effective at noon, C.S.T., January 1, 1947, and also for the purpose of 1946 elections to choose a director whose term begins January 1, 1947, the states of Kentucky, Michigan and Ohio; HUDSON DIVISION, the counties of New York, Bronx, Richmond, Kings, Queens, Nassau, Suffolk, Westchester, Rockland, Putnam, Orange, Ulster, Dutchess, Columbia, Green, Albany, Rensselaer and Schenectady of the state of New York, and the counties of Bergen, Passaic, Essex, Union, Middlesex, Monmouth, Hudson and Ocean of the state of New Jersey; MIDWEST DIVISION, the state of Nebraska, Iowa, Kansas and Missouri; NEW ENGLAND DIVISION, the states of Maine, New Hampshire, Vermont, Massachusetts, Rhode Island and Connecticut; NORTHWESTERN DIVISION, the states of Washington, Oregon, Montana and Idaho, and the Territory of Alaska; PACIFIC DIVISION, that portion of the state of California not included in the Southwestern Division, the state of Nevada, the Territory of Hawaii and the United States Possessions in the Pacific; ROANOKE DIVISION, the state of Virginia, West Virginia, North Carolina and South Carolina; ROCKY MOUNTAIN DIVISION, the states of Colorado, Wyoming and Utah; SOUTHEASTERN DIVISION, the states of Georgia, Florida and Alabama, and the United States Possessions in the Caribbean; SOUTHWESTERN DIVISION, the counties of Imperial, Inyo, Los Angeles, Mono, Orange, Riverside, San Bernardino, San Diego, San Luis Obispo, Santa Barbara and Ventura of the state of California, and the state of Arizona; WEST GULF DIVISION, the states of Texas, Oklahoma and New Mexico.

22. In the year 1946 a Director shall be elected in the Great Lakes Division for a term of one year or until a successor is duly elected and qualified. Also in the year 1946, and in each even-numbered year thereafter, a Director shall be elected in each of the following divisions, to serve for a term of two years or until a successor is duly elected and qualified: Central, Hudson, New England, Northwestern, Roanoke, Rocky Mountain, Southwestern and West Gulf. In the year 1947, and in each odd-numbered year thereafter, a Director shall be elected in each of the following divisions, to

(Continued on page 134)

LEO'S Sensation of the Year

IT'S EXCLUSIVE READY NOW

WRL Globe Trotter TRANSMITTER KIT

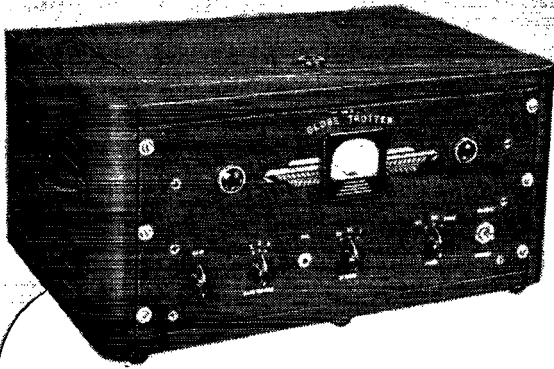

Complete kit including all parts, chassis, panel, streamlined cabinet, less tubes, coils and meters. Cat. No. 70-300 **\$59⁹⁵**

Kit Same as above. Wired by our engineers — Cat. No. 70-312..... **\$75.**

ACCESSORIES

Complete kit of 8 Tubes
 Cat. No. 70-314 \$5.95
 3 in. Meter Cat. No. 70-318 4.95
 Cells per set (any band)
 Cat. No. 70-316 2.95
 Crystals 40-80 Meters Mts.
 Cat. No. 70-322 ea. 2.65
 Quality Crystal Mike and Stand
 Cat. No. 70-320 9.45

Transmitter kits are almost impossible to get, but Leo, W6GFQ, now offers amateurs the WRL Globe Trotter, destined to become one of the most popular kits on the market. The WRL Globe-Trotter is capable of 40 watts input on C.W. and 25 Watts input on phone on all bands from 1500 KC through 28 Megacycles. Incorporates the proven Tritet Oscillator using a 20 meter X-tal and providing sufficient drive at 10 meters for the 807 final. Helmsing choke modulation is incorporated which gives excellent results and good tonal quality. Look this

over! It has everything! Three bands are all pretuned and available at the turn of a switch, 10, 20, and 80 meters. Metering is provided for both oscillator and final stages. The transmitter uses two power supplies, one furnishing power to the 807 final and modulator tubes, and the other supplying the speech amplifier and oscillator stage. Tube Line Up: RF-6L8 OSC, 807 final amplifier; Audio-6SJ7, 6N7, 2-6V6's-Rectifiers, 2-5U4G.

Look Fellows: TEN CRYSTALS IN A NUT SHELL

New Deke X-tal Holder, no larger than ordinary control knobs, holds one to ten crystals. Attached to front panel of transmitter it gives you ten frequencies at your fingertips. Cat. No. 13-185 \$6.95 Holder less crystals, Cat. No. 13-181 ea. 1.50 Metallized crystals, with ten crystals 21.95 COMPLETE.

For early delivery on your favorite receiver write World Radio now! All of the latest makes and models—

Available Now—the new BC348Q Surplus Receiver, 9 Tubes, 200 to 500 Kilocycles. Weather, aircraft, and all ham bands except 10 meters. Cat. No. 33-01 Less speaker, only\$85.00

TRANSMITTING OIL FILLED CONDENSERS

2 mfd 600 VDC—Cat. No. 19-359 \$0.59
 1.0 mfd 1000 VDC—Cat. No. 19-465 1.57
 4.0 mfd 1000 VDC—Cat. No. 19-573 0.80
 2.0 mfd 1000 VDC—Cat. No. 19-595 1.29
 8.0 mfd 2000 VDC—Cat. No. 19-581 1.74
 3 mfd 4000 VDC—Cat. No. 19-469 2.49
 5 mfd 4000 VDC—Cat. No. 19-675 5.95

Nationally Known Moulded Mica Condensers

.00022 mfd 2500 VDC Working, 5000 VDC Test Cat. No. 19-425 \$0.29
 .00025 mfd 2500 VDC Working, 5000 VDC Test Cat. No. 19-599
 .001 mfd 2500 VDC Working, 5000 VDC Test Cat. No. 19-429
 .002 mfd 2500 VDC Working, 5000 VDC Test Cat. No. 19-611
 .005 mfd 2500 VDC Working, 5000 VDC Test Cat. No. 19-687
 .01 mfd 2500 VDC Working, 5000 VDC Test Cat. No. 19-653
\$0.69 ea. Lots of six 65c

IN HIGH WATTAGE RESISTORS

50 Watts, 1000 ohms. Cat. No. 27-819, Price.... **\$0.15**
 Most All Values New—Some Used—All Guaranteed
 100 Watts, 10,000 ohms. Cat. No. 27-823
 100 Watts, 15,000 ohms. Cat. No. 27-821
 100 Watts, 50,000 ohms. Cat. No. 27-821
 100 Watts, 100,000 ohms. Cat. No. 27-103
ea. 39c. Lots of Six ea. 35c
 100 Watts, 50 ohms. Cat. No. 27-109
 100 Watts, 100 ohms. Cat. No. 27-831
 100 Watts, 200 ohms. Cat. No. 27-105
 100 Watts, 425 ohms. Cat. No. 27-107
ea. 29c Lots of Six ea. 25c

WRL MULTITESTER

Sturdy Steel Case. Cat. No. 16-491—Less Leads \$18.75
 Range: DC Volts—0.5/5/50/250/500 V. AC Volts—0.10/100/500/1000 V. DC Mills—0/10/100 Ohms. High Range—0-500 Ohms. High Range—0-100,000—1 Meg. 3" Meter with sturdy D'Aronval movement. Size 5 1/2x3x3 1/4.

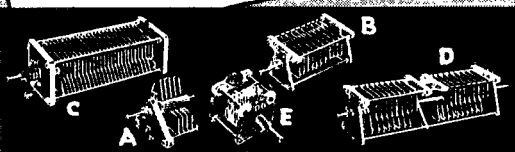

CONDENSER SPECIAL

A—7 to 50 MMFD; 5 plates; full shielded rotor; 1/4" shaft; chassis or panel mounting. Cat. No. 31-197 49c

FAMOUS JOHNSON CONDENSER SURPLUS VALUES

B—5.3 to 12 MMFD. High voltage neutralizing condenser, Johnson 12G70. Cat. No. 31-285 \$1.95
 D—200 MMFD. Johnson 200P20 Cat. No. 13-1029 2.95
 E—250 MMFD. Johnson 250H15. Cat. No. 31-325 1.65
 C—150 MMFD. Johnson 150H15. Cat. No. 31-199 .95

Address Dept. Q-7
 Council Bluffs, Iowa

Formerly Wholesale
 Radio Laboratories



NATIONAL HEADQUARTERS FOR HAM EQUIPMENT

Quality PRODUCTS
Since 1923



**CERAMIC—
PORCELAIN & STEATITE
INSULATORS**

for every
purpose

BIRNBACH RADIO CO., Inc.
145 HUDSON ST. NEW YORK, 13, N. Y.

RADIO CHASSIS PUNCH



cut in radio chassis

Saves hours of work cutting clean, accurate holes in radio chassis—for connectors and other receptacles. Simply insert cap screw in hole to be enlarged (drill small hole if necessary), turn with ordinary wrench to force punch through the metal. No reaming or filing—hole is smooth and clean. No distortion—die supports metal. Ten sizes from $\frac{3}{4}$ " to $2\frac{1}{4}$ "; also up to $3\frac{1}{2}$ " for meters. Write for free folder S-119 to Greenlee Tool Co., 1867 Columbia Ave., Rockford, Ill.



(Continued from page 132)

serve for a term of two years or until a successor is duly elected and qualified: Atlantic, Dakota, Delta, Great Lakes, Midwest, Pacific and Southeastern.

The yeas and nays being ordered, the said question was decided in the affirmative: Whole number of votes cast, 14; necessary for adoption, 10; yeas, 13; nays, 1. Those who voted in favor are Messrs. Acton, Bickel, Caveness, Davis Kiener, Kirkman, Markwell, McCargar, Noble, Raser, Reid, Shelton and Weingarten. Mr. Groves voted opposed and the President abstained as required. So the by-laws were amended.

At this point the Board heard a supplementary oral report from Communications Manager Handy.

On motion of Mr. Kiener, unanimously VOTED that the appropriation for the administrative expenses of the directors in 1947, previously voted, is amended to change the appropriation for the Central Division Director to two hundred and fifty dollars (\$250), to add a new appropriation of two hundred fifty dollars (\$250) for the Great Lakes Division Director, and to increase the total sum appropriated for that purpose to three thousand eight hundred dollars (\$3800).

On motion of Mr. Kirkman, after discussion, VOTED with one dissenting voice, that the Board respectfully requests the Federal Communications Commission to rescind the prohibition, in the last sentence of Sec. 12.82 (d) of the amateur rules, of the use of the names of countries, states or cities as phonetic aids in the identification of calls.

Mr. McCargar pointed out to the Board that, in order for amateur radio to participate effectively in the disaster-relief networks contemplated for the vicinity of 1750 kc., the operation of organized amateur nets in ordinary amateur communication must be permitted on such frequencies, to provide the necessary constant testing of apparatus and training of personnel; and he urged that the League work to that end.

Mr. Davis proposed that the Planning Committee study various methods of taking membership referenda and analyzing the data thus yielded, reporting a recommended method to the Board at its next meeting. With unanimous consent the Chair so ORDERED.

Mr. Groves brought up the question of obtaining Government surplus apparatus for amateurs who gave or sold their apparatus to the military services. The Chair reported his many discouraging experiences with this matter in Washington. No feasible method being found, no motion resulted.

Moved, by Mr. Groves, that the League request the Federal Communications Commission to open the frequencies 3800-4000 kc. to Class A 'phone operation. But the motion was rejected, 6 votes in favor to 8 opposed.

On motion of Mr. Davis, unanimously VOTED that the Board shall now proceed to the election of President and Vice-President. On motion of Mr. McCargar, two-thirds concurring, Special Rule A was SUSPENDED. The Chair APPOINTED Messrs. Brotherson, Grammer and Huntoon as tellers.

Nominations for President being in order, Mr. Reid nominated Mr. Bailey. On motion of Mr. McCargar, unanimously VOTED that the nominations are closed. On motion of Mr. Davis, the Secretary was unanimously ORDERED to cast one ballot for the unanimous election of Mr. Bailey. Which done, Mr. Bailey was declared reflected for a two-year term. (Applause.) Mr. Bailey spoke briefly in appreciation.

Nominations for Vice-President being in order, Mr. Shelton nominated Mr. Caveness, Mr. Davis nominated Mr. Bickel, Mr. Acton nominated Mr. Groves, Mr. Kirkman nominated Mr. McCargar, Mr. Raser nominated Mr. Noble. On motion of Mr. Acton, unanimously VOTED that the nominations are closed. On motion of Mr. Noble, after discussion, unanimously VOTED that, 15 directors being present, 8 votes shall be necessary for election to Vice-President. The vote having been taken, the result of the ballot was announced by the tellers as follows:

Whole number of votes cast.....	15
Necessary for election.....	8
For Mr. Caveness.....	4
For Mr. Bickel.....	2
For Mr. Groves.....	3
For Mr. McCargar.....	5
For Mr. Noble.....	1

(Continued on page 136)



RME Owners Say!

HOUSE OF REPRESENTATIVES, U. S.
CLERK'S OFFICE
WASHINGTON, D. C.

May 14, 1946

Mr. L. A. Morrow, Sales Mgr.
Radio Mfg. Engineers, Inc.
Peoria 6, Illinois
Dear Mr. Morrow:

Such a receiver as the RME 45 deserves all the credit it has earned. A true example of excellent workmanship, planning and electronic achievement.

Enclosed please find registration card for the RME 45 — serial number EG4 purchased April 2nd, 1946.

Vy FB es have heard many DX stations es most stable recr ever owned. With vernier knob, can overcome 98% local QRM. Even on 10 meters with auto QRM ¼ block away noise level is abt nil. Hope to have one of your preselectors before very long.

Vy best of 73's

(Signed) John C. Page W4INA
1313 21st Street, South
Arlington, Virginia

.....

Vernon, Texas
April 4, 1946

Gentlemen:

Enclosed find registration card for my RME 45. Wouldn't have bought an RME if I hadn't run onto a demonstration. I sure like the 45. It is a real receiver (no drift). Perfectly balanced on all bands. Darn well calibrated on all bands. Perfect broadcast receiver. Good sensitivity. Single dial control.

D. Estes, W5AEM

.....

Radio Mfg. Engineers, Inc.
Gentlemen:

Please mail me literature on the RME 45, and please advise me where I could purchase one. I now have a ---, which I should like to trade in if possible. I would like to go RME, because not alone for the receiver, but my experience with you in the past has been that your service is most outstanding,

Sincerely,

G. Bergen Naylor
New Market, New York



FINE COMMUNICATIONS EQUIPMENT
RADIO MFG. ENGINEERS, INC.
Peoria 6, Illinois U. S. A.

THE MILLEN 90800 50 WATT XMITTER-EXCITER

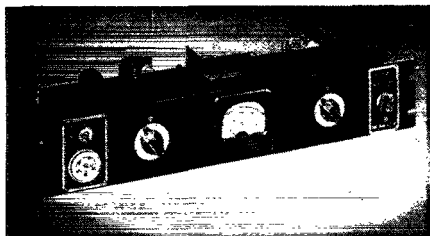

Compact relay rack mounting uses 6L6 and 807 output for 10, 40, or 80. When ordering state band in which xtal operates and band in which output is desired. 90800, less tubes, but including one set of coils—net. **\$37.50**

W. D. BRILL CO.

198 TENTH ST • OAKLAND 7, CALIFORNIA

W6KLO

W6SSN

W6FJX

The Radio Amateur's License Manual

Before you can operate an amateur transmitter, you must have a government license and an officially assigned call. These cost nothing — but you must be able to pass the examination. The examinations are based on the multiple-choice type of questions. The "License Manual" has been written to make it as easy as possible for the individual to acquire the necessary knowledge to pass the examination with flying colors. Whether you are going up for your Class C, B or your Class A ticket, "The License Manual" will provide the most direct path to getting that ticket. If you are one of the thousands who always want a "License Manual" around the shack for ready reference for amateur regulations, it will please you to know that the regulations are very thoroughly indexed.

25¢

POSTPAID ANYWHERE

(No Stamps, Please)

**AMERICAN RADIO
RELAY LEAGUE**

WEST HARTFORD • CONNECTICUT

(Continued from page 154)

No candidate having received a majority, a second ballot was ordered, the result of which was announced as follows:

Whole number of votes cast	15
Necessary for election	8
For Mr. Caveness	5
For Mr. Bickel	2
For Mr. Groves	2
For Mr. McCargar	6
For Mr. Noble	0

Messrs. Bickel, Groves and Noble withdrew their respective names as candidates. No candidate having received a majority, a third ballot was ordered, the result of which was announced as follows:

Whole number of votes cast	15
Necessary for election	8
For Mr. Caveness	5
For Mr. McCargar	10

Mr. McCargar, having received a majority of the votes cast, was thereupon declared by the tellers to be elected Vice-President of the League for a term of two years. (Applause.) Mr. McCargar spoke briefly in appreciation.

Whereupon, on motion of Mr. Caveness, the Board adjourned, *sine die*, at 9:56 p.m.

(In the course of its deliberations the Board also discussed, without formal action, Government surplus apparatus, *QST* advertising policy on surplus, the licensing situation, contents of *QST* and the *Handbook*, headquarters representation at conventions, League finances, the next world conference, and training aids. Total time in session, 9 hours, 11 minutes. Total appropriations, \$160,000.)

Edward Warner

Secretary

Strays

We heard an interesting piece of work the other morning but one which unfortunately violates the FCC rules. A local station, which we will call A, on 10-meter 'phone, was working cross-band with a station that we'll call B on 80-meter c.w. A was receiving on a loudspeaker and permitting B's signal to modulate his carrier as room background. Thus B could hear his own sending by a remote keying monitor. Then an amateur that we'll call C barged into this activity on the 10-meter band, fired up his e.c.o. dead on B's frequency, and crashed the party. With occasional interpolations in voice by A, B and C worked each other on c.w. by means of A's 10-meter 'phone. They had perfect break-in on their own frequency, something otherwise difficult to attain. It was also interesting as an elementary example of automatic relaying, and one could just imagine nationwide chains of such stations on v.h.f.

Unfortunately, though, such operation is a violation of FCC rules. § 12.134 prohibits leaving an unmodulated carrier on the air either during so-called duplex or crossband contacts or for the purpose of "retaining the channel." There has been some suggestion that the restriction might be evaded by modulating the carrier by means of the incoming signal, but that would not be "for the purpose of communication" by the transmitting station, and FCC regards it as a violation. It is OK above 144 Mc. and also on the 11-meter band, however.

electrical pipe-line →



Microwaves make their journey from apparatus to antenna not by wire, cable, or coaxial—but by *waveguide*.

Long before the war, Bell Laboratories by theory and experiment had proved that a metal tube could serve as a pipe-line for the transmission of electric waves, even over great distances.

War came, and with it the sudden need for a conveyor of the powerful microwave pulses of radar. The metal waveguide was the answer. Simple, rugged, containing no insulation, it would operate unchanged in heat or cold. In the radar shown above, which kept track of enemy and friendly planes, a waveguide conveyed microwave pulses be-

tween reflector and the radar apparatus in the pedestal. Bell Laboratories' engineers freely shared their waveguide discoveries with war industry.

Now, by the use of special shapes and strategic angles, by putting rods across the inside and varying the diameter, waveguides can be made to separate waves of different lengths. They can slow up waves, hurry them along, reflect them, or send them into space and funnel them back. Bell Laboratories are now developing waveguides to conduct microwave energy in new radio relay systems, capable of carrying hundreds of telephone conversations simultaneously with television and music programs.

EXPLORING AND INVENTING, DEVISING AND PERFECTING FOR CONTINUED IMPROVEMENTS AND ECONOMIES IN TELEPHONE SERVICE



BELL TELEPHONE LABORATORIES



Get the extra dependability and longer life, inherent in ElectroX Rectifiers—full and half wave low capacity copper oxide rectifiers, for test sets, instruments, and other electronic applications which must stand up under exacting service.

Made by one of the oldest manufacturers of dry disc rectifiers — time proven — trouble-free — they cost no more!

At your parts supplier,
or write for descriptive
Circular 446



Georgia Hams!!

You can now buy your Hammarlund Super Pro's and HQ 129-X from Henry Reid, W4KU. Orders now being filled.

Phone or write:

HENRY L. REID COMPANY
1103 Peachtree St., N.E., Atlanta, Georgia

TRANSMISSION LINE SPACER

- Low Loss
- Easily Attached
- No Metal Contact



PATENT APPLIED FOR

Type LX-2 (2 in.) Type LX-6 (6 in.) Type LX-4 (4 in.)

- Fabricated from Amphenol 912-B (low moisture absorption—low power factor—low loss factor)
- Easily attached to line wires without threading through holes
- No metal contact between line wires and spacer to cause noise or changes in line characteristic

SEE THEM AT YOUR DISTRIBUTORS!

THE **Arthur L. Munzig**
MANUFACTURING COMPANY

The Arthur L. Munzig Mfg. Co., Redlands, Calif.

Converting Your Converter

(Continued from page 49)

inductance-adjusting procedures described above can be used. We were able to get the r.f. coil to track perfectly, after considerable careful adjustment.

If there is trouble with regeneration, careful shielding of the input leads will be necessary. We found, however, that with the twisted-pair held close to the shield box by the clamps that the manufacturer put there, regeneration was not a problem. With the leads dangling free or with anything but the twisted-pair in use, the stage oscillated over at least half of the dial.

After all circuits track to your satisfaction, replace the set in its cabinet and readjust the trimmers. Slight readjustment is needed for maximum performance.

Upon completion of the job, the converter was tried out by W1HDQ and gave performance comparable to that of the NHU that he uses regularly, with no trouble experienced from oscillation. In operation with a communications receiver having a 456-kc. i.f., a strong unmodulated signal may show up at about 52 Mc. This is a harmonic of the oscillator in the communications receiver, and it cannot be eliminated without using an entirely different intermediate frequency for the converter output. Since this would require almost complete rebuilding of the converter, including the 10-meter section, it was not deemed worth while. This harmonic did not show up in the old 5-meter band, but unfortunately it falls within the new tuning range. The exact frequency of this "signal" depends upon the intermediate frequency used in the communications receiver, but it should not prove troublesome once you have grown accustomed to its presence. It is a relatively small sacrifice to make for the saving in time and money effected by the conversion of an existing piece of gear instead of having to start from scratch building a new converter or a complete receiver for the 6-meter band.

World Above 50 Mc.

(Continued from page 53)

the detector, and adjust the detector regeneration carefully. The signal will be heard, usually with much better quality than that of the superregen, in the speaker of the low-frequency receiver.

This novel method of reception, as used in the converter built by W3KIL, has two important defects, both of which might be overcome with some experimentation. First, being an ordinary superregenerative detector, it causes the usual severe interference at the signal frequency. This can be overcome by a properly-designed r.f. stage.¹ Second, in self-quenched detectors particularly, the quench frequency changes considerably as the receiver is tuned and as the re-

(Continued on page 140)

¹"A Non-Radiating Superregenerative Receiver for Two Meters," Feb., 1946, QST.

Western Electric

New 25B Speech Input Console really rates the spotlight!

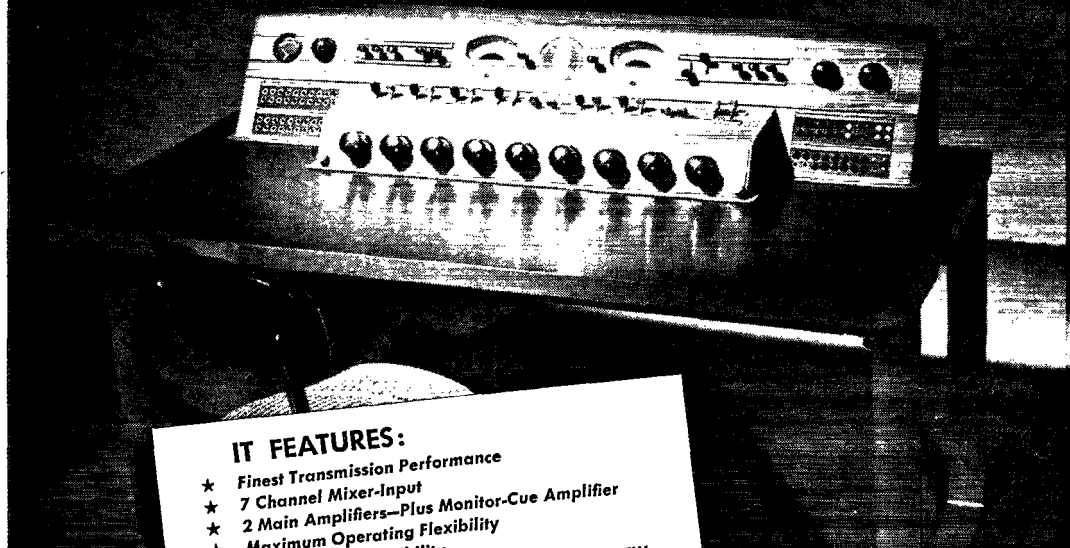

IT FEATURES:

- ★ Finest Transmission Performance
- ★ 7 Channel Mixer-Input
- ★ 2 Main Amplifiers—Plus Monitor-Cue Amplifier
- ★ Maximum Operating Flexibility
- ★ Exceptional Accessibility
- ★ Complete Unit Design—including Table and NEW Plug-in Cables
- ★ Sparkling Style and Beauty

The new 25B is a honey! Designed by Bell Telephone Laboratories and made by Western Electric, it handles two programs simultaneously. It's compact—easy to install—provides great flexibility at moderate cost. Whether your station is large or small, AM or FM, the 25B will give you the highest quality studio control. Ask your nearest Graybar Broadcast Equipment Representative to tell you what a top number the 25B really is!

You can open it up for inspection and maintenance almost as easily as you turn the pages of a book!

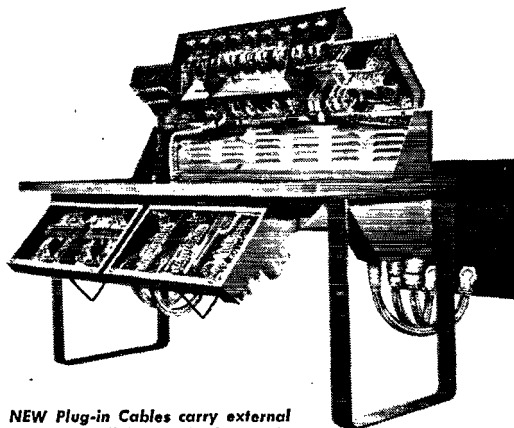

NEW Plug-in Cables carry external leads to wall boxes—further facilitate installation and maintenance.



Tops for FM

—YOU can hold a
New, Better Job in
RADIO ELECTRONICS



... Use Cleveland Institute home study courses for professional self-improvement

THREE OUTSTANDING COURSES—
Advanced Radio and Communication Engineering
Master Course in Radio Communication
Specialized Television Engineering
 with
The Remarkable Workbooks of Instructional Aids,
 prepared by the instructing staff of Cleveland Institute

Write for descriptive literature

CLEVELAND INSTITUTE OF RADIO ELECTRONICS

Successor to NILSON RADIO SCHOOL, Founded 1939

SMITH PRACTICAL RADIO INSTITUTE, Founded 1934

QT-7 Terminal Tower Cleveland 13, Ohio
 Approved for Veteran Training under G-1 Bill of Rights

Cleveland Institute of Radio Electronics
 QT-7, Terminal Tower, Cleveland 13, Ohio

Gentlemen: Please send information about your home study courses in Radio Electronics.

Name.....Address.....

City.....State.....

Here's a New **POWER CUTTER KIT**
 with a cutting range of 5/16" to 2 1/2"



Two Bruno Adjustable Hole Cutters in one convenient kit. High speed steel blades cut clean, fast holes in metal, wood, plastics. Quickly adjustable and easily sharpened. Designed by tool engineers to operate efficiently in bench drill, drill press or portable drill. Ask your jobber, or write Dept. Q-7

Only **\$785** complete

MODEL	SHANK SIZE	EXPANSION	PRICE
100	1/4" straight shank	3/8"—1 1/2"	\$3.00
101	3/8" straight shank	1"—2 1/2"	\$5.00
		5/8"—2 1/2"	\$8.00*

*Full Trade Minimum \$7.35

BRUNO TOOLS 9330 Santa Monica Blvd. Beverly Hills, Calif.

ELECTRICITY
 FOR RADIO AND ELECTRONIC APPLICATIONS

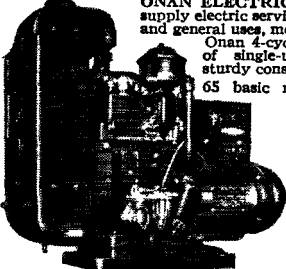

ONAN ELECTRIC GENERATING PLANTS supply electric service for electronics applications and general uses, mobile or stationary. Driven by Onan 4-cycle gasoline engines, they are of single-unit, compact design and sturdy construction.

65 basic models ranging in capacity from 350 to 35,000 watts. Standard A.C. models, 115-volt, 60-cycle, single-phase. Standard D.C. models, 32 to 115 volts. Special voltages to 660 A.C., and 6 to 4000 volts D.C. 5 KW to 35 KW units available in 3-phase. High frequencies to 300 cycles. Combination A.C.-D.C. types. Write for detailed literature or engineering assistance.

D. W. ONAN & SONS 2638 Royalston Ave. Minneapolis 5, Minn.

(Continued from page 138)

generation adjusted. This makes the tuning and regeneration adjustments extremely critical when a simple triode detector is used in this manner. Though we've not yet had time to try it, we have the idea that the use of a screen-grid tube (such as the 954 or 6AK5) in an electron-coupled circuit, perhaps with a separate quench oscillator and screen injection, would stabilize the quench frequency. The harmonics of the quench oscillator (modulated by the audio on the received signal) could then be coupled off the plate of the detector. Mind you, we haven't tried it yet — we merely think it an interesting idea. If anyone wants to give it a whirl, W3KIL and your conductor will be interested to learn of your results. A long-wave receiver which would permit the use of lower-order harmonics of the quench oscillator, or even the fundamental, for that matter, might give better results.

First Activity on 10,000 and 21,000 Mc.!

The month of May saw the first amateur work on two more of our new s.h.f. bands, on frequencies hardly dreamed of before the war. On Sunday, May 5th, W1LZV/2, James A. McGregor, at Verona, N. J., and Charles K. Atwater, W2JN/2, at Caldwell, N. J., worked over a distance of two miles on 10,300 Mc. The transmitters used 723-A/B oscillators, modulated with 6J7s. Power output of both rigs was about 25 milliwatts. For receiving, 3-centimeter crystal mixers were used, the transmitting oscillators serving as local oscillators also. Mixer output was on 30 Mc., and this was fed into two i.f. stages and then into communications receivers operating on 30 Mc. The antenna systems consisted of 36-inch parabolic reflectors, waveguide feed, and the dipole-and-reflector technique similar to that employed in radar work. A.c. power was used at W1LZV/2, and the communications receiver employed was an SX-28-A. W2JN/2 was operated from a gas-engine-driven generator, and the receiver, which served as i.f. and audio system, was an S-29 portable.

Minor alterations are being made in the equipment, to make it more adaptable to portable use, and soon the boys expect to take it to elevated locations in an attempt to extend the distance record. Both have crystal-controlled 144-Mc. mobile units, using 832-As in the final stages, and these will be used for liaison in projected DX attempts on the microwaves.

Word has been received from Schenectady, N. Y., of work on a still higher frequency. On May 18th, A. H. Sharbaugh, W1NVL/2, and R. L. Watters, W9SAD/2, worked on 21,900 Mc. over a distance of 800 feet. No details of the equipment used have been received, but descriptions and photographs are on the way.

SWITCH TO SAFETY!



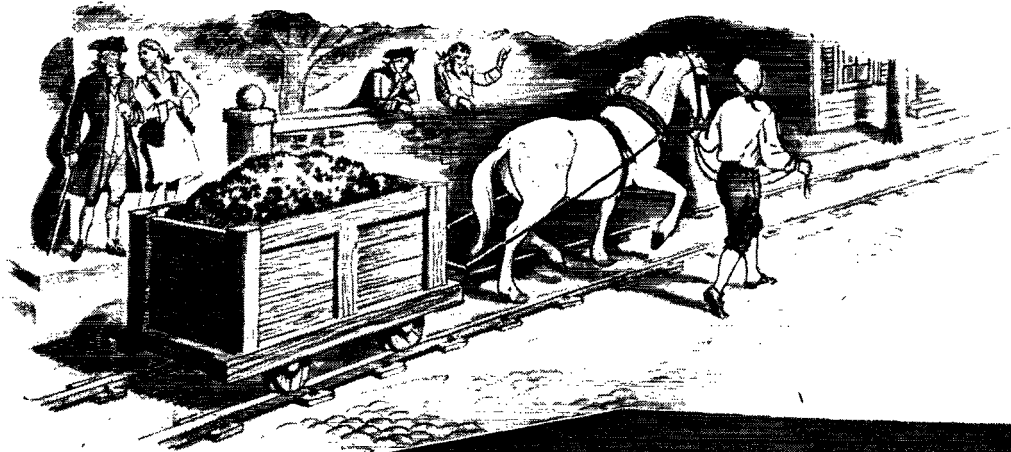

When T. Leiper raised the eyebrows of Philadelphians with his cart-on-wheels . . . he introduced our first modern network of railroads.

PANORAMIC RECEPTION

makes "blind" operation for the radio amateur as out-dated as stagecoach and wagon train.



SEE all that Panoramic Reception offers...

SEE a band up to 200 kc wide as you tune . . . SEE all activity within that band . . . phone, c.w., f.m., at a glance . . . SEE weak signals, short calls, dx. . . . SEE the characteristics of your own signal as well as others . . . SEE phone modulation or key clicks . . . SEE all these and much more with the PANADAPTOR.

ASK THE LUCKY MAN WHO OWNS ONE!

New Panoramic Handbook contains complete operating, maintenance, installation and application data. Answers all questions about the PANADAPTOR. 50c at your jobber or by mail.

Panadaptor, featuring Panoramic Reception, is the exclusive and original design of Panoramic Radio Corp.

Panadaptor Model PCA-2

now available at leading radio parts jobbers. Amateur net price, complete with ten tubes and accessories, for 115 V., 50-60 cycle operation,

\$99.75

One Year Guarantee

PANORAMIC

CABLE ADDRESS
PANORAMIC, NEW YORK



RADIO CORPORATION

242-250 WEST 55TH ST. New York 19, N.Y.

Exclusive Canadian Representative: Canadian Marconi, Ltd.

Now!
A Better Soldering Tool...

THE **KWIKHEAT**
THERMOSTATIC SOLDERING IRON

Has Built-in
Thermostat
Control!



6 TIP STYLES

- #0—\$1.25
- #1—\$1.25
- #2—\$1.25
- #3—\$1.25
- #4—\$1.25
- #5—Soldering Pot for Tinning—\$1.25

HOT, READY FOR USE ONLY 90 SECONDS after plugging in! Kwikheat is the only soldering iron with a thermostat built into the tool itself—maintaining the proper level of heat for most efficient, economical operation. **SAFE!** ... **Cannot overheat—ECONOMICAL!** ... Lasts longer—saves tips and requires less retinning. **POWERFUL!**—225 watts—yet exceptionally light weight (14 oz.). Well-balanced with cool protecting plastic handle. Modern streamlined design. Six interchangeable tip styles adapt one Kwikheat Iron to all your soldering jobs. You will be proud to own America's finest and most versatile soldering tool... from tip to plug Kwikheat is in a class by itself. Ask your dealer to demonstrate the quick-heating feature now!

Kwikheat Iron complete with #1 tip... \$11.00
Set of 5 tips consists of #0, 2, 3, 4 and 5 \$ 5.50



Dept. Q-77, Kwikheat Division of
SOUND EQUIPMENT CORP., 3903 San Fernando Rd., Glendale, 4 Calif.

COMPLETE RADIO TRAINING!

Prepare now to accept a responsible position in Commercial Radio. New developments will demand technicians with thorough basic training, plus a knowledge of new techniques discovered during the war. Training open to high school graduates or those with high school equivalency. Courses 6 to 18 months' duration in **RADIO AND ELECTRONICS**. Approved Veteran training in Radio. Write for Particulars.

VALPARAISO TECHNICAL INSTITUTE
Dept. TN Valparaiso, Ind.

A MATEUR GEAR

8 CONNECTICUT AND MASSACHUSETTS HAM STORES

CONNECTICUT: Hartford, New Haven, Bridgeport, New London, Stamford, Waterbury. **MASSACHUSETTS:** Boston and Lawrence

HATRY & YOUNG
The Elect in Electronics

25 Years Ago

(Continued from page 60)

zen Wireless" that we have been using when referring to our hobby, in favor of the designator "Amateur Wireless." Editorially, *QST* asks for a full and open discussion of the matter and suggests that we continue to use the names interchangeably. There is a certain prestige to being known by the former name, says *QST*, especially at Congressional Hearings.

New radio legislation is in the offing and we want our wavelengths written into the law. Commercial interests are getting stronger and more numerous. To protect our large investment in gear which "would be made virtual junk if we were given a wavelength appreciably different from our present," the League is asking our friends at the Department of Commerce to amend their new bills to afford us full protection.

Mr. O. Pshaw, the lackadaisical operator, who "gets along with any old antenna current," sleeps through club meetings and never gets time to repair his tuner, and Mr. Jay Wattburner, head of the National Union of Tireless Senders, are both introduced in "Who's Who in Amateur Wireless." Stations described are 1XM, MIT Radio Society, and 5XA, Alabama Polytechnic Institute.

The Strays tell us that tragedy has befallen 9AK — all 13 tubes in his radiophone burned out at the same time! Our sympathy to OM Klaus. David Sarnoff, communications manager of the Radio Corporation of America since its inception, has been promoted to general manager. A new c.w. record — 8LF has been heard by 6AOY! H. P. Maxim's 1AW and H. H. Carman's 2EL did notable work in relaying news when the AP wire between Hartford and New York went out because of auroral influence. A calibrated receiver is now in use at 9YA and wavelength reports will be supplied gladly to stations worked.

Strays

"In view of the fact that the divorce columns in the 'papers are longer than the marriage lists now'days," writes *Brazos Bill*, "how 'bout bringin' our list of ham terms up to date; how 'bout *XXYL* to describe the Reno-voted ex-partner?"

CONVENTION DATES TO REMEMBER

- Aug. 31st, Sept. 1st-2nd: Maritime Division, Kentville, N. S.
- Sept. 14th: Rocky Mountain Division, Denver.
- Sept. 21st-22nd: West Gulf Division, Oklahoma City.

READY
for you NOW

ALLIED'S NEW 1946 CATALOG

of Radio Parts and Equipment



Everything for the Veteran and the Beginner!
Includes Latest Communications Receivers

Here's your latest, most complete Buying Guide for everything in radio! Includes newest receivers, Ham gear, code apparatus, parts, kits, tubes, tools, books, test instruments, public address and other equipment. Over 10,000 items available from the largest and most complete stocks under one roof. Nationally known makes. Finest values. Fast, efficient service from one reliable central source. Our experienced staff of licensed radio amateurs is glad to help you.

Free... Send for it today

Communications Equipment

Now from **ALLIED** Time-Payments • Trade-ins Accepted

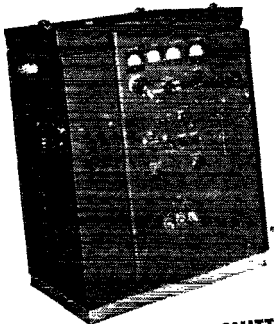

BC-610 (HT-4) TRANSMITTER

Available for immediate delivery from Allied stock. Net \$535
Including coils for 3 amateur bands

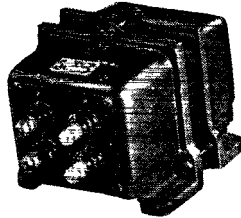

**350 WATT
MODULATION TRANSFORMER**

Brand new units as used in the BC-610 transmitter. Primary for class "B" 100-TH Modulators. Secondary 8300 ohm class "C" load at 250 ma. Special, Net..... **\$21.50**

Hallicrafters S-38.....	\$39.50
Hallicrafters S-40.....	79.50
SM-40 "S" Meter.....	15.00
RME-84.....	98.70
Panadapter PCA-2.....	99.75
RME DB-20.....	59.30
RME VHF-152 Converter.....	86.60
National NC-46.....	97.50
Speaker for NC-46.....	9.90
Hallicrafters SX-25.....	94.50
Hammarlund HQ-129X.....	129.00
RME-45.....	186.00
National HRO.....	197.70
National NC-2-40C.....	225.00
Hallicrafters SX-28A.....	223.00
Hallicrafters S-36A.....	307.50
Hammarlund 400X.....	318.00
Hammarlund 400SX.....	318.00
Hallicrafters S-37.....	591.75
HT-9 Transmitter.....	250.00

and other models
Net, F.O.B. Chicago

*Prices Subject to
Possible Change*

ALLIED RADIO

Everything in Radio & Electronics
833 W. Jackson Blvd., Chicago, Ill.

ALLIED RADIO CORP., D. L. Warner W91BC
833 W. Jackson Blvd., Dept. 27-GG-6
Chicago 7, Illinois

- Enter order for.....Model.....
- Enclosed \$..... Full Payment Part Payment (Balance C.O.D.)
- Send literature on Receivers and Time Payment Plan.
- Send FREE new 1946 Allied Catalog.
- Send special Amateur bulletins on Surplus Equipment.

Name.....

Address.....

City.....Zone.....State.....



Burlington

'DONUT' TRANSFORMERS



These transformers are designed for use with vane type ammeters which are used on frequencies from 25 to 133 cycles.

Maximum accuracy is obtained at 70% of full scale value and is dependent upon the number of primary turns used. Accuracy is directly proportional to the number of primary turns.

These transformers are designed for a capacity of two volt-amperes and the secondary windings are of such size as to allow in excess of 800 CM/ampere at maximum rating.

Insulation resistance is such that 4500 volts can be applied without breakdown.

BURLINGTON BULLETIN DT GIVES FULL INFORMATION
WRITE FOR A COPY TODAY

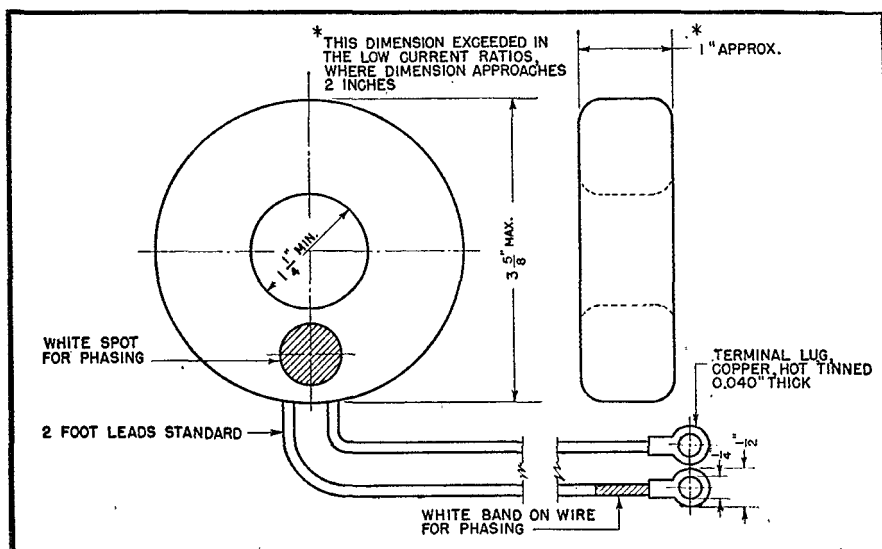

BURLINGTON INSTRUMENT COMPANY
808 FOURTH STREET, BURLINGTON, IOWA



ARMY-NAVY Official HEAD PHONES

\$249



**EXTRA
SPECIAL
VALUE**

Limited quantity of these head phones. Highly sensitive, 8000 ohms impedance. Bi-polar magnets, bakelite shell and cap. Adjustable head band. Cord connects from one side out of the way. One of our many special features. Write today for complete catalog.

BURSTEIN-APPLEBEE CO.
1012T McGee, Kansas City 6, Mo.



RCA INSTITUTES, INC.

Offer thorough training courses
in all technical phases of

RADIO and TELEVISION

WEEKLY RATES

DAYS—EVENINGS

VETERANS, RCA Institutes is approved
under G. I. Bill of Rights

For Free Catalog write Dept. ST-45

RCA INSTITUTES, INC.

A Service of Radio Corporation of America
75 Varick Street, New York 13, N. Y.

CONNECTICUT HAM HEADQUARTERS

Complete stocks of nationally known
amateur gear — radio electronic parts
— tubes — sets and equipment.

Wholesale Only

R. G. SCELİ & CO.

Pete De Pasquale, W1GUC Roger Amundson, W1HYF
George Lappe, W1LWW Roy Watson, W1MHH
Porter Noe, W1LWZ Ernie Johnson, W1FSY
Art Lundeen, W9PZJ John Yacovelli, W1KKB

317 Asylum St.
Hartford 3, Conn.
Tel. 2-1144

84 Elm St.
Bridgeport, Conn.
Tel. 63-1811

ASK FOR OUR BARGAIN BULLETIN

Hints and Kinks

(Continued from page 68)

between 600 ohms and 15 ohms. The flash test on this cable is 2000 volts r.m.s. at 60 cycles, and the loss is only about 2 db. per hundred feet at 100 Mc. The writer has used it successfully on 29 Mc. with a power output of 100 watts, completely modulated, with excellent results and no heating whatsoever.

The physical length of a quarter-wave matching transformer is only 65 per cent of the length of a quarter-wave open-wire line because of the lower velocity of propagation in the solid dielectric. A quarter-wave transformer at 29 Mc. will be approximately 5-feet six-inches long. A three-quarter- or five-quarter-wave line is usually more convenient from the standpoint of rotating the antenna. The shield around the transformer is left floating in this application.

A two-element beam constructed entirely to theoretical dimensions using the RG-22U matching transformer was tried here, and with no adjustments whatsoever the standing-wave ratio on the feed line was found to be less than 1.6 to 1. — E. G. Jones, W4BBR.

Postwar Receivers

(Continued from page 69)

down. The diode section of the 6SQ7 serves as the second detector, with the b.f.o. voltage coupled to the diode plates through a small condenser from the grid of the beat-oscillator tube. The noise limiter is the shunt-diode type which short-circuits the audio input to the triode section of the 6SQ7 when noise peaks exceed a level determined by the amplitude of the rectified carrier being received.

The headphone jack is connected in the output of the first audio stage (actually in parallel with the grid circuit of the 6F6G output tube) and is arranged so that the circuit from the secondary of the output transformer to the speaker voice coil is opened up when a 'phone plug is inserted in the jack. The tone control, a three-position affair giving high, medium and low-frequency response, uses the conventional condenser-resistor circuit and shunts the plate of the output tube.

Like its predecessors, the S-40 has a socket for connection to an external S-meter, which can be purchased separately in a case with an adjustable divider for zero setting. It likewise has a socket enabling the receiver to be used with a battery or battery-vibrator power supply for portable work or in fixed locations where a.c. is not available. Power requirements for d.c. operation are 5 amperes at 6 volts for the filaments and 70 ma. at 270 volts for the plates. On a.c. the power consumption is about 75 watts. Although the receiver is normally furnished for 115-volt 60-cycle operation, a universal model for operation on 25 to 60 cycles and 115 or 230 volts is also available.

(Continued on page 160)

LOOK

What SUN RADIO Has

**FOR
IMMEDIATE
DELIVERY!**

**IMMEDIATE
DELIVERY**

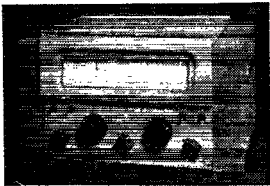

NATIONAL NC-46 RECEIVER

Tuning Range: .54 to 30 mc in 4 bands. Calibrated band spread on ham frequencies. 10 tubes. Push-pull audio output. AVC. BFO. Series valve noise limiter. Separate PM speaker. AC or DC input. 2 tone cabinet.

net, less speaker \$97.50
speaker \$ 9.90

**IMMEDIATE
DELIVERY**



ULTRAPHONE MODEL UHP-2

30W. 2 meter receiver-transmitter. Complete with 3 tubes including Taylor TUF-20. Operates up to 230 mc from either dynamotor, vibrator, or standard AC power supply. Separate receiver-xmitr circuit makes retuning unnecessary.

net \$89.70

Act NOW And Be One Of The Lucky Hams To Get These Receivers And UHF Equipment

We're not kidding. Every item featured on this page is ready for immediate shipment to you. *Yes—we mean the NC-46 Receiver and Ultraphone too.*

Don't wait. The early birds will strike it rich. You know how difficult it is to buy new receivers today. Sun Radio has gotten them for you, and we expect a minor stampede. Write or call *now*. Make sure you get yours. The supply won't last long.

THESE ARE ALL BRAND NEW, STANDARD, NATIONALLY ADVERTISED ITEMS.

10% deposit must accompany all C.O.D. orders.

NEW! These two UHF Kits!

Follow the crowd to the higher frequencies. Life up there is getting more active and interesting every day.

Here are two kits which fill the exacting requirements of UHF operation. They're compact and rugged. They're as new as tomorrow's headlines. Sun Radio has them for **IMMEDIATE DELIVERY.**

**IMMEDIATE
DELIVERY**

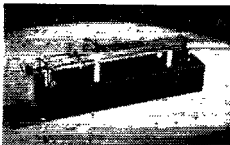

HIGH POWERED HYTRON HY-Q 75

Useful power to load at 144 mc (less at 225 mc) is 14 w on CW, 11 w on phone. Micrometric tuning (135 mc to 250 mc) by finely adjustable lead screw. Silver-plated tank circuit means permanently low r-f losses. Adjustable antenna coupling loop matches efficiently either concentric or parallel line feeders. Assembles in an hour.

kit net, without tube \$ 9.95
completely assembled, \$11.95
wired, tested \$ 3.75

**IMMEDIATE
DELIVERY**

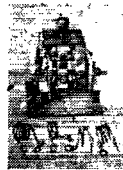

CARDWELL VHF OSCILLATOR KIT

Assemble this 3 band kit yourself. Furnished with coils for 144-148 mc, 220-225 mc, 420-450 mc. Will deliver pure CW signal whose stability and drift characteristics equal the best low frequency ECO's available. Can easily be made to cover "Citizen Radio" band. Uses 6F4 tube, delivering approx. 1 1/2 w drive. See front cover and page 13, Feb. QST.

net, without tube \$10.80
tube \$ 5.00

SUN RADIO & ELECTRONICS CO., INC.

122-124 DUANE ST. · NEW YORK 7, N. Y. · BARCLAY 7-1840

CHOICE OF VETERAN HAMS

Famous Turner Model 22X - 22D Crystal or Dynamic

Engineered for smooth response to both voice and music pickups, Turner 22 cuts feedback to the minimum. Crystal model has built-in wind-gag permitting outdoor operation. Crystal is impregnated against moisture and protected from changes in barometric pressure. Range 30-7000 cycles. Level -52DB. 22D Dynamic has high level dynamic cartridge. Takes rougher handling and severe climatic conditions. Dependable indoors or out. Range 30-8000 cycles. Level -52DB. Available in all standard impedances. Both models equipped with 90° tilting head and 7-ft. removable cable set. Smartly styled chrome finish case.

ASK YOUR DEALER OR WRITE

Licensed under U. S. Patents of the American Telephone and Telegraph Company, and Western Electric Company, Inc.

THE TURNER COMPANY
917 17th Street N.E.
CEDAR RAPIDS, IOWA



TURNER



TURNER

Pioneers in the communications field

Microphones

Complete Microphone Catalog
Write for Your Free Copy

Crystals licensed under patents of the Brush Development Co.

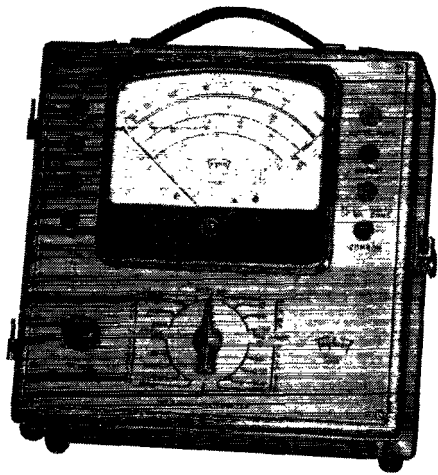

MODEL 2405

Volt • Ohm • Milliammeter

25,000 OHMS PER VOLT D. C.



SPECIFICATIONS

NEW "SQUARE LINE" metal case, attractive tan "hammered" baked-on enamel, brown trim.

- PLUG-IN RECTIFIER — replacement in case of overloading is as simple as changing radio tube.
- READABILITY — the most readable of all Volt-Ohm-Milliammeter scales — 5.6 inches long at top arc.
- RED-DOT LIFETIME GUARANTEE on 6" instrument protects against defects in workmanship and material.

NEW ENGINEERING • NEW DESIGN NEW RANGES • 30 RANGES

Voltage: 5 D.C. 0-10-50-250-500-1000 at 25000 ohms per volt.
5 A.C. 0-10-50-250-500-1000 at 1000 ohms per volt.
Current: 4 A.C. 0-.5-1-5-10 amp. 6 D.C. 0-50 microamperes—
0-1-10-50-250 milliamperes—0-10 amperes.
4 Resistance 0-4000-40,000 ohms—4-40 megohms.
6 Decibel -10 to +15, +29, +43, +49, +55.
Output Condenser in series with A.C. volt ranges.

Model 2400 is similar but has D.C. volts
Ranges at 5000 ohms per volt.
Write for complete description

Triplet

ELECTRICAL INSTRUMENT CO.
BLUFFTON, OHIO



R. C. (Dick) Hall
W5EIB

R. C. & L. F. HALL, INC.

"THE HAM SHACK"

HOUSTON: 1015-17 Caroline St. • Telephone C-9731

DALLAS: 2123 Cedar Springs Ave. • Telephone

**TWO GREAT AMATEUR STORES
TO SERVE YOU**

Amateurs living in Dallas and nearby will be interested to learn that a "Ham Shack" is now located near them at 2123 Cedar Springs Avenue, Dallas. Equipped with the most modern fixtures and stocked with the finest amateur gear, this "Ham Shack" will be a real convenience to Amateurs living in Dallas and vicinity. Formal opening, arrangements, will probably be in July and will be announced to those on our mailing list. Mail orders should generally continue to come to Houston for the time being.



L. F. (Lillian) Hall
W5EUG

with door prizes and refreshments, will probably be in July and will be announced to those on our mailing list. Mail orders should generally continue to come to Houston for the time being.

THE NEW MECK TRANSMITTER MODEL T-60-1

Efficient performance on any Amateur Band. 10 to 80 Meters. Phone or CW. 60 Watts.....\$160.00

SPECIAL

UHF Navy Glidepath Receiver. Operates on 12 volts DC.....\$14.95

RECEIVERS

HALLICRAFTERS

S-38.....	\$ 39.50
S-40.....	79.50
S-22 R Marine.....	74.50
S-37 (130-210 MC) FMAM.....	591.75
S-36A (28-143 MC) FMAM.....	307.50
Speaker for S-36, S-37.....	15.00
HT-9 transmitter (less coils, crystals, mike).....	250.00

HAMMARLUND

HQ-129X — less speaker.....	\$168.00
Speaker.....	10.50

SUPER PRO

SPC-400-X (540 KC to 30 MC) cabinet model.....	\$334.05
SPC-400-SX (1250 KC to 40 MC) cabinet model.....	310.05
SPR-400-X (540 KC to 30 MC) rack model.....	344.55
SPR-400-SX (1250 KC to 40 MC) rack model.....	320.55
PS-CW-10 — 10-inch PM speaker.....	13.20

NATIONAL

NC-2-40C — less speaker.....	\$225.00
Speaker.....	15.00
NC-2-40D (Amateur Band Spread).....	97.50
NC-40, less speaker.....	97.50
Speaker.....	9.90
1-10 less tubes, speaker and power supply.....	56.10
5886 tube supply for 1-10.....	19.50
Tubes for 1-10 (954, 955, 6CS, 6F6).....	9.57
HRO-5TA — 4 sets coils (less speaker and power supply) table model.....	197.70
Speaker for HRO-5TA.....	10.95
Power supply for HRO-5TA.....	17.70
HRO-5RA — 4 sets coils (less speaker and power supply) rack model.....	211.20
Speaker for HRO-5RA.....	19.85
Power Supply for HRO-5RA.....	33.00

RME

RME-45 with crystal, meter and speaker.....	\$186.00
RME-84 with self contained speaker.....	98.70
DB 20 Preselector.....	59.30
VHF-152 (2, 6, & 10 Meter Converter).....	86.60

Wire, write or phone your order. We will ship C.O.D. with a \$5.00 deposit. We also offer easy terms and trade-in allowances for used equipment. State tax not included in above figures.

PANADAPTER GIVES YOU EYES FOR YOUR RECEIVER

Panadapter PCA-2 Complete.....\$99.75

PUBLICATIONS — NOW IN STOCK

Amateur Radio Relay League Publications:	
Radio Amateur Handbook — 1946 Edition.....	\$1.00
Hints & Kinks — 3rd Edition.....	.50
How to Become a Radio Amateur.....	.25
License Manual — Postwar Edition.....	.25
Learning the Radiotelegraph Code.....	.25
Log Books.....	.35

PANEL METERS

SUPREME

Square Case — DC Milliammeters, DC Microammeters, DC Voltmeters

DC MILLIAMMETERS

2" Range: 0-1.....	\$ 5.84
2" Ranges: 0-10, 0-25, 0-50, 0-75, 0-100, 0-200, 0-250, 0-300, 0-500, 0-700.....	5.68
3" Range: 0-1.....	6.17
3" Ranges: 0-10, 0-25, 0-50, 0-75, 0-100, 0-200, 0-250, 0-300, 0-500, 0-700.....	5.84
4" Range: 0-1.....	6.94
4" Ranges: 0-10, 0-25, 0-50, 0-75, 0-100, 0-200, 0-250, 0-300, 0-500, 0-700.....	6.60

DC MICROAMMETERS

3" Range: 0-50.....	\$14.34
3" Range: 0-100.....	12.50
3" Range: 0-200.....	11.00
4" Range: 0-50.....	15.00
4" Range: 0-100.....	13.17
4" Range: 0-200.....	11.67

DC VOLTMETERS

4" Range: 0-50.....\$ 8.17

SIMPSON

Square or Round Cases — DC Milliammeters, DC Voltmeters, AC Voltmeters

DC MILLIAMMETERS

2" Ranges: 0-10, 0-50, 0-100, 0-150, 0-200, 0-250, 0-500, 0-700.....	\$ 4.30
3" Ranges: 0-10, 0-50, 0-100, 0-150, 0-200, 0-250, 0-500, 0-700.....	5.14

DC VOLTMETERS

3" Ranges: 0-2000, 0-3000, 0-4000.....	\$11.00
3" Range: 0-5000.....	14.34

AC VOLTMETERS

Model 57: Range 0-10.....	\$ 5.14
Model 57: Range 0-150.....	6.24

TEST EQUIPMENT IN STOCK

Silver "Vomax".....	\$59.85
Monitor "Crystalliner," Signal Generator.....	57.50
Robson-Burgess V-O-M MT-100 0-1 Megs, 0-1000 Volts.....	18.75
Robson-Burgess V-O-M MT-200 0-10 Megs, 0-1500 Volts.....	22.95
Superior Signal Tracer.....	18.75

Ask for other brands and models, since we carry practically all of them and are getting shipments regularly.

CRYSTALS

BILEY

80 Meter.....	\$2.80
40 Meter.....	2.80

PETERSEN

80 Meter.....	\$2.65
40 Meter.....	2.65
20 Meter.....	3.50

A FEW OF THE MANUFACTURERS WHOSE PRODUCTS WE DISTRIBUTE

Aerovox	Clarostat	GE	Kaar	Meissner	Pioneer	Setchell-Carlson	Trim
Amphenol	Drake	Hallcrafters	Kainer	Millen	Precision	Silver	Triplet
Astatic	Dumont	Hammarlund	Keinor	Mueller	Premax	Simpson	Turner
B&W	Echophone	Hytron	Kwikheat	National	Radial	Speed-X	Yaco
Belden	Eimac	Instructograph	Leach	Newcomb	Raytheon	Stancor	Vibroplex
Billy	Electronics Lab.	Insonline	Lectrohm	Ohmite	RCA	Supreme	Walco
Bud	Erie	Jensen	Les Logan	Panoramic	Robson-Burgess	Taylor	Ward
Centralab	Gammatron	JFD	Littelfuse	Peerless	RME	Thermador	Weller
Cinacudagraph	General Cement	Johnson	John Meck	Petersen	Sangamo	Thordarson	Weston

NOW IN STOCK AT ALL LEADING RADIO DISTRIBUTORS

CODE PRACTICE

OSCILLATOR TONES

WITH
**ADJUSTABLE
RESONATOR**

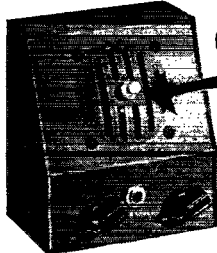

For Greater and Better **VOLUME
TONE!**

Adjustable Resonator (optional) increases volume five times. Tone frequency variable from 600 to 1500 cycles. Volume control from 0 to FULL ON. "DM" DYNAMIC speaker may be disconnected during headphone operation. Up to 300 headphones may be used. Has phone jack for headphones. Optional built-in key. 110 V. AC or DC. Uses a 117N7GT tube. Gray crackle finish.

MS 710PR • DeLuxe Master Oscillator with resonator and built-in key. Amateur net price... \$13.00

MS 710P • With built-in key but less resonator. Amateur net price... \$11.50

MS 710R • With resonator but less built-in key. Amateur net price... \$10.50

MS 710 • Less resonator and less built-in key. Amateur net price... \$9.00

Designed by
**THE WORLD'S
CHAMPION
RADIO
TELEGRAPHER**

TELEGRAPH
Apparatus Co.

412 SOUTH GREEN ST

CHICAGO 7, ILLINOIS

RADIO

RADIO Technician and Radio Communications courses. Register now for new classes starting first Monday of each month. Day and Evening Classes.

AMERICAN RADIO INSTITUTE
101 West 63d St. New York 23, N. Y.

Approved under GI Bill of Rights

RADIO INSTRUCTORS ●

Receiver servicing experience. College degree preferred. \$3600 a year to start. \$4200 after four months. Work in the heart of the Radio Industry. We will teach you practical television. Write Raleigh G. Dougherty, 158 Market Street, Newark 2, New Jersey, c/o New York Technical Institute of New Jersey. America's foremost Television school.

TRANSMITTING TUBES RECTIFIERS CATHODE RAY TUBES

We have been appointed a sales agent by Defense Supply Corporation of Government surplus tubes and rectifiers. All are first grade Government tested and inspected tubes—not rejects.

The following types are immediately available:

826 (HF Triode)	Cathode Ray Tubes
VT 127A (HF Triode)	8AP1
304 TL	8BP4
872A M. V. Rectifier	3AP1

Trade discounts to dealers on standard packages • Write for prices

LEWIS ELECTRONICS 16 Lyndon Avenue
Los Gatos, California

(Continued from page 146)

An operating feature which we understand is being incorporated in other Hallicrafters receivers as well is the use of red indicators on all controls to show the proper settings for broadcast reception so the non-ham members of the family can make use of the set when the OM isn't around. With the "follow the red mark" technique the receiver becomes as easy to tune for music as any ordinary b.c. set. The bandswitch, incidentally, has a special knob that really allows you to get a grip on it — an improvement that will be appreciated by anyone who has had to struggle with a small-size smooth knob and a switch that takes some turning.

We don't know whether it's an indication of a future trend or not, but the instruction book furnished with the set is done up in Army-Navy technical-manual style and really provides information: how the circuit works, alignment instructions, socket voltages, trouble shooting, and a complete list of replaceable parts.

— G. G.

Correspondence

(Continued from page 71)

your W1EPC. The reflector of the receiver was pointed toward the open sea, as was also the case with the reflector of the transmitter, both being at right angles to the direct path receiver-transmitter. Under these conditions and with the hill as a "perfect shielding screen," I was almost certain that no reception pattern would appear on the screen as long as no aeroplane would cross the radiated beam. But, contrary to expectations, reception was still invariably present, with no obstacle in the beam, and this for any orientation of the beam — the height of the tragedy appeared in its full measure when it appeared that it was possible to plot even the radiation pattern of the transmitting reflector with the receiver behind the hill! In spite of this last fact, constituting a quasi-proof against the theory of line-of-sight propagation of microwaves, I proceeded to further test in order to eliminate any possibility of stray r.f. fed through the cables of the power station serving both localities. To this end a battery-powered transmitter using a triode tube working on 60 cm. was substituted for the magnetron, and a similar triode receiver was connected to the amplifier. But again reception was always present, no matter which was the orientation of the transmitting reflector, and even

(Continued on page 158)

AMATEUR EQUIPMENT

Distributors for
HALLICRAFTERS — NATIONAL CO.
HAMMARLUND — R.M.E.

and
All other leading manufacturers

20 years in Providence supplying amateur gear

W. H. EDWARDS CO.

94 Broadway Providence, Rhode Island

Write or phone your orders!

THE RADIO AMATEUR'S LIBRARY

These are the publications which every Amateur needs. They form a complete reference library for the Amateur Radio field; are authoritative, accurate and up to date.



<i>Title</i>	<i>Price</i>
QST.....	\$2.50 per year*
Operating an Amateur Radio Station	Free to members; to others 10c
The Radio Amateur's Handbook.....	\$1.00**
The Log.....	35c each; 3 for \$1.00
How to Become a Radio Amateur.....	25c
The Radio Amateur's License Manual.....	25c
Hints & Kinks for the Radio Amateur.....	50c
Lightning Calculators:	
a. Radio (Type A).....	\$1.00
b. Ohm's Law (Type B).....	\$1.00
A.R.R.L. Antenna Book.....	50c
The Minilog.....	25c
Learning the Radiotelegraph Code.....	25c
A Course in Radio Fundamentals.....	50c

* In the United States and Possessions—
other Countries \$3.00 per year.

** Postpaid in Continental U. S. A.—
\$1.50, postpaid, elsewhere. (*No stamps, please*)



THE AMERICAN RADIO RELAY LEAGUE, INC.

WEST HARTFORD 7, CONNECTICUT

A Super Selection of Surplus

• Collins T47/ART 13

New transmitters, 811's modulate 813, 12 tubes, Autotune and Frequency Standard **\$240.00**

• Hallicrafter HT-4E

Latest model with tubes, speech amplifier, coils for 10-20-40-80 meter bands..... **\$535.00**

• Navy TBY-8—\$49.00

A complete RADIO-TRANSMITTER for 28-80 Mc range. (5 & 10 M. Bands) with phones, mike, 8 tubes, carrying case. Storage battery. Vibrator pack for above \$30.00.

• New Panadaptors PCA-2 \$99.00

VAN SICKLE RADIO SUPPLY CO.
34 W. Ohio Street Indianapolis 6, Ind.

For quickest delivery, send us your order now for any of the new model receivers.
W9KJF • W9VEK • W9TE • W9OEK • W9IEE • W9GHE

COMMERCIAL RADIO INSTITUTE

A RADIO TRAINING CENTER FOR 26 YEARS

Resident Courses Only • Broadcast, Service, Aeronautical, Television, and Marine telegraphy classes now forming for fall term Oct. 1. Literature upon request. Veteran training

Dept. B, 38 West Biddle Street, Baltimore 1, Maryland

THE EXPERTS' CHOICE

GENUINE
EASY-WORKING
"ORIGINAL"

VIBROPLEX

Reg. Trade Mark: Vibroplex, Lightning Bug, Bug

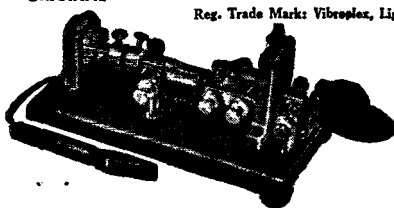

DeLuxe
Model

WITH
PATENTED
JEWEL
MOVEMENT

\$19.50

Yes, the "ORIGINAL" DeLuxe Vibroplex is the experts' choice—because it cuts sending effort in half, saves the arm and develops the highest degree of sending skill attainable. Equipped with the sensational Patented Jewel Movement—exclusive with DeLuxe Vibroplex keys, it provides watch-like precision, feather-touch action, lifetime service and ease of operation unapproachable by any other key. Chromium finished base. Bright machined parts. Colorful red switch knob, finger and thumb piece. 3/16th contacts. Circuit closer, cord and wedge. DeLuxe finish also available in the "Blue Racer" and "Lightning Bug" models. Prompt shipment. Order yours to-day! Money order or registered mail. FREE catalog.



The "BUG" Trade Mark identifies the Genuine Vibroplex. Accept No Substitutes

THE VIBROPLEX CO., Inc.

833 Broadway

New York 3, N. Y.

(Continued from page 160)

its minor lobes could be estimated (in the headphones used in this case in order to avoid the cathode-ray tube with its high voltage).

Thus the conclusion appeared to me in the hypothesis that microwaves were diffracted by the top of the hill, this constituting the new center of radiation of spherical waves, reaching any point located in direct sight of the top, behind the hill. . . .

The purpose of the above lines is to point out the similarity of the cases exposed by Mr. Tilton in his article and to recall the explanation I put forward when we came across the same phenomenon, together with the practical advice: don't worry about a hill or a mountain in the path to your correspondent, but bravely point your beam towards its top and let it do the rest. Making the beam as narrow as possible will increase the energy striking the hill and provide a more economic solution than erecting high towers or using mobile equipment.

— Dr. Paul Santorini

HANDS ACROSS THE BORDER

Palma Norte No. 518, Mexico, D. F

Editor, *QST*:

The writer believes that hams in the States could do a great deal to cement a bond of friendship here in Mexico.

These fellows here are a pretty fine gang, and most speak some English. If amateurs in the States would continue to try and understand them it would help so much, but occasionally the wrong one gets a QSO, and it does so much harm. Also, when a QSL is promised, be sure it is sent. Call books are rare down here, and for this reason, many have to wait for a card before reciprocating. . . .

— Allan D. McLean, W2HFG

BOUQUETS

Room 3C264, Pentagon, Washington 25, D. C.

Editor, *QST*:

I was formerly licensed as W8CPG, operating in Michigan. However, I have been on duty with the Signal Corps for about five years and have not kept up with the doings of the Headquarters gang (had some doings of my own to keep up with). I notice that lots of former hams had some doings, too, that kept them pretty busy. Thank God, that's over with for a while and we all can get back to the friendliest hobby in the world.

Enclosed is my check for a membership-subscription. This check is also an indication of my appreciation for the fine work done by the staff of ARRL during the war years and for the good fight put up in protecting the interests of the radio amateurs. Carry on! . . .

— Major J. D. Flewelling

P.O. Box 1036, Tyler, Texas

Editor, *QST*:

Congratulations on the swell job you fellows did during the war and are still doing. Keep *QST* coming my way. We are encouraging all Tyler Radio Club members to send in their subscriptions.

— Frank Sewell, W5IZU

31 Trinity Ave., Lowville, N. Y.

Editor, *QST*:

Just returned home after being discharged from the Army. My *QST*'s have piled up and I'm getting a great kick out of reading them. I want to compliment you on the fine job you have been doing while the war has been going on. Going to rebuild and *QST* will help me do it.

— Owen E. Shedd, W8WRC

SWITCH TO SAFETY!



QST for

SUN RADIO — The Home Of Nationally Known Radio Parts

**WAR SURPLUS
EQUIPMENT--**

**At A Fraction of
Their Original
Government Cost!**

• AEROVOX • AMPHENOL • A.R.R.L. • ASTATIC • B. & W.

• CAROSTAT • HALICRAFTERS • HAMMARLUND • INSULINE • JENSEN • MEISSNER • R. C. A. • HYTRON

• J. F. RIDER • WALSCO • STANCORE • TRIPLETT • U.T.C. • VALPEY • VIBROPLEX • RADIART • R.C.P.

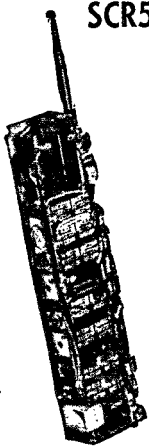

**SCR536-B1 HANDIE
TALKIE CHASSIS**

Complete including tubes, antenna coils, output tank and crystals for 3885 KC, uses 1 — 1R5, 2 — 3R4, 1 — 1T4 and 1R5 tubes. As pictured

\$14.95

SCR536-B2, same as above less antenna coil, output tank and crystals. . . . **\$9.95**

SCR536-B3, same as SCR536-B2, less antenna. . . . **\$7.95**

Ideal for a low powered phone or C.W. Receiver and Transmitter or foundation-kit for portable broadcast receiver.

BATTERIES FOR HANDIE TALKIES. Complete set **\$2.50**

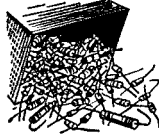

25 ASSORTED POPULAR CONDENSERS. Mica and silver mica condensers. An \$8.00 value. **YOUR COST.....\$1.99**



500 ASSORTED BOLTS, NUTS, AND WASHERS. Assorted brass and nickel plated, some solid brass, in these sizes only: 6/32, 8/32, 10/32. **\$1.99**



100 ASSORTED RESISTORS. Insulated, carbon, 5, 10, and 20% tolerance. I.R.C. Color-code-chart. No-capacity, non-inductive. \$8.00 value. **YOUR COST.....\$1.99**

**LOTS OF 12 OR MORE
OF ANY OF THESE THREE OR
COMBINATIONS THEREOF
\$1.89 EACH**

*Net F.O.B. Washington, D. C. — 25% Deposit Must Accompany All C.O.D. Orders

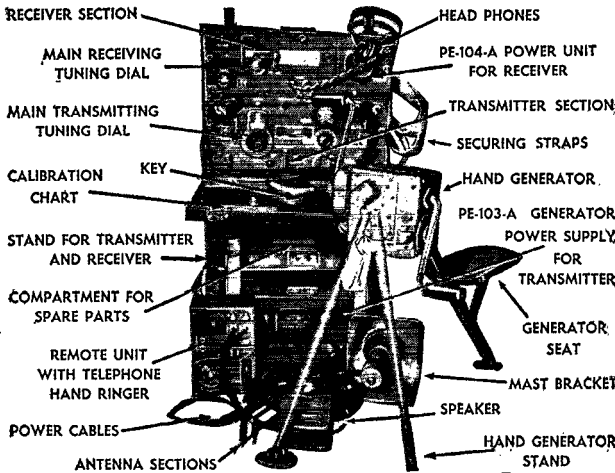

**READY TO GO
ON THE AIR!**

**New Complete
Receiver &
Transmitter**

SCR284A

\$97.50

7 Tube Receiver
8 Tube Transmitter, 25
watts phone, or 35 watts
CW

Portable or Fixed Station
Operates 6 or 12 volts D.C.
Frequency Range Continuous
3800 to 5500 KC

Crystal Controlled
Complete with PE 103
Genemotor, PE 104 Vibro-
pack and Hand Generator
G-N45

Packed for overseas shipment.

SUN RADIO

OF WASHINGTON, D. C.

938 F STREET, N. W. WASH. 4, D. C.



World's Largest DISTRIBUTOR OF SHORT WAVE RECEIVERS

Do business with the biggest and one of the best in the field. Enter your orders for the following:

Skyrider Jr. S41.....	\$33.50
Hallicrafters S38 complete.....	39.50
Hallicrafters SX-25.....	94.50
Hallicrafters SX-28A.....	223.00
Hallicrafters S36A.....	307.50
Hallicrafters S37.....	591.75
Hallicrafters S40.....	79.50
National N-2-40C.....	225.00
National One-Ten.....	56.10
National HRO Sr.....	197.70
RME-45.....	186.00
Hammarlund HQ129X.....	129.00
Hammarlund SP-400-SX Super Pro complete.....	318.00
Hammarlund SP-400-X Super Pro complete.....	342.00
HT-9 transmitter.....	250.00
Harvey 100T transmitter.....	583.00
Temco 75/100GA transmitter.....	495.00

Some models are available for immediate shipment. As more and more receivers become available Bob Henry will be able to serve you better and better. By dealing with the world's largest distributor of short wave receivers you are assured of the fastest delivery possible and the best of service.

Enter your reservation now. You can trade in your present receiver. You can order on our 6% terms. You can depend on Bob Henry also for a wide assortment and the best values in crystals, transmitting tubes, microphones, test equipment, etc. Your inquiries welcomed.

Bob Henry
W9ARA

BUTLER, MISSOURI

HENRY RADIO SHOPS

LOS ANGELES 25, CALIF.

"WORLD'S LARGEST DISTRIBUTOR OF SHORT WAVE RECEIVERS"

PLASTICON* CAPACITORS

*PLASTICONS—plastic film dielectric capacitors.

OBSOLETES

PAPER CONDENSERS!

Smaller, lighter, more economical. Specified by Signal Corps, Air Corps and Navy for more severe operating conditions than oil-paper capacitors. Closer tolerances, wider temperature range, greater safety factor, longer life.

Condenser Products Company 1375 NORTH BRANCH STREET
CHICAGO 22, ILLINOIS



WHAT!

THERE'S NO ONE
ON THE ENTIRE FORCE
CAN SERVICE OUR NEW
WRIST RADIOS? WE MUST
SUBSCRIBE TO RADIO
MAINTENANCE
AT ONCE!



Let
Radio
Maintenance
Magazine
help you
keep up
with new
developments

"More of
everything
you want!"

Articles monthly on:

- Television — AM — FM
- Public Address Systems
- Test Equipment — Tools — Service Kit
- Shop Layout — Service Bench
- Trouble Shooting — Alignment
- Business News

Radio Maintenance
is not sold on newsstands

RADIO MAINTENANCE MAGAZINE

460 BLOOMFIELD AVE.,

MONTCLAIR, N. J.

Special offer to Radio Servicemen

Please send me
RADIO MAINTENANCE

For 1 year 2.00 For 2 years 3.00

NAME _____

OCCUPATION _____

ADDRESS _____

CITY _____

ZONE _____ STATE _____

CHECK ENCLOSED* BILL ME LATER

*NOTE: By enclosing payment,
thus eliminating billing expense

WE WILL ADD ONE ISSUE FREE!

HAM-ADS

(1) Advertising shall pertain to radio and shall be of nature of interest to radio amateurs or experimenters in their pursuit of the art.

(2) No display of any character will be accepted, nor can any special typographical arrangement, such as all or part capital letters be used which would tend to make one advertisement stand out from the others.

(3) The Ham-Ad rate is 30c per word, except as noted in paragraph (6) below.

(4) Remittance in full must accompany copy. No cash or contract discount or agency commission will be allowed.

(5) Closing date for Ham-Ads is the 25th of the second month preceding publication date.

(6) A special rate of 7c per word will apply to advertising which, in our judgment, is obviously non-commercial in nature and is placed and signed by a member of the American Radio Relay League. Thus, advertising of bona fide surplus equipment owned, used and for sale by an individual or apparatus offered for exchange or advertising inquiring for special equipment, if by a member of the American Radio Relay League takes the 7c rate. An attempt to deal in apparatus in quantity for profit, even if by an individual, is commercial and all advertising by him takes the 30c rate. Provisions of paragraphs (1), (2), (4) and (5), apply to all advertising in this column regardless of which rate may apply.

Because error is more easily avoided, it is requested signature and address be printed plainly.

Having made no investigation of the advertisers in the classified columns, the publisher is unable to vouch for their integrity or for the grade or character of the products or services advertised.

QUARTZ—Direct importers from Brazil of best quality pure quartz suitable for making piezo-electric crystals. Diamond Drill Carbon Co., 719 World Bldg., New York City.

AMATEUR radio licenses. Complete code or theory preparation for passing amateur radio examinations. Home study and resident courses. American Radio Institute, 101 West 63rd Street, New York City.

WRL Transmitting kits—15, 35, 70, and 150-watt units—low priced. All makes of receivers, both new and reconditioned. Leo offers best trade-in deal, and easy time payment plan. One of the country's largest part supply houses. Write today for free catalog, special radio map offer, tube-base calculator offer, and other items. Leo, at World Radio Labs, Dept. HA, Council Bluffs, Iowa.

RADIO tubes, parts, condensers, free bargain lists. Potter, 1314 McGee, Kansas City 6, Mo.

YOUR station call plate beautifully cast in aluminum, size 2" x 5 1/2". Two styles, Type P, with tapped bosses for panel mounting. Type D for desk use. Price either type, \$1.50. Duplicates of same type, 75c each. Print your call plainly. P & H Sales Co., 619 Jasper Street, Kalamazoo 31, Mich.

HAM crystals: \$2.50 within 10 kc. of specified frequency; excellent oscillators guaranteed. 3500 kc. to 8000 kc.; Army type, FT 243 holders. L. Kipp, 277 Broadway, N. Y. C. 7.

CRYSTALS: Precision low drift x-ray oriented units manufactured by latest and most scientific methods. Optional holder mounting type 400A for five prong socket or type 100A of which plug in a single octal socket. Your specified frequency: 3500 Kc to 4000 Kc, \$2.60; 6250 Kc to 7425 Kc, \$2.60; 12,500 Kc to 14,850 Kc, \$3.30. Rex Bassett, Inc., Ft. Lauderdale, Fla.

CO-AXIAL cable available RG 8/U (new material) in 29' lengths, with end fittings, \$3, per length. C. F. Moretti, Boulevard, Peekskill, N. Y.

QSL samples. H. L. Carter, Jr., W8JOT, 749 S. Plymouth, Rochester 8, N. Y.

QSLs. Samples. Glenn Print, 1042 Pine Heights Ave., Baltimore 29, Md.

COMMERCIAL radio operators examination questions-and-answers. One dollar per element. G. C. Waller, W5ATV, 6540 E. Washington Blvd., Tulsa 15, Okla.

PERSONALIZED QSL cards. Your photo on your card, price: 500 cards, \$7.50; 1000 cards, \$10. Samples on request. Albraun Studio, 1742 N. Palmer St., Milwaukee 12, Wis.

QSLs. Samples free. Radio Headquarters, 1217 So. Calhoun Street, Fort Wayne 2, Indiana.

CRYSTALS, 40-80 meters, 5 kc. of desired frequency, calibrated, holder fits 5-prong socket. \$2.85 postpaid. Immediate delivery. Borri Electric Co., Granville, Ill.

KAIAP will QSL all his QSOs. Any station not receiving a QSL should notify KAIAP by QSL or postal, giving call and QSL QTH. Thanks very much. Address: KAIAP, c/o E. Julius M. Hofer, W8UHF, 3217 Leslie Avenue, Detroit 6, Michigan.

CO-AXIAL cable RG8/U, RG13/U and RG59/U available 50 feet to 1,000,000 feet at ridiculously low prices. See QST April p. 51 for detailed description. 5" oscilloscopes BC-412 complete, \$40; Thordarson T19C44 chokes; 12H, 400 ma. \$6.50; National HRO receivers complete with coils, \$110. Coaxial Cable Co., Box 19, Woodside, N. Y.

CASH for 350 to 500-watt phone and cw xmtr, 80, 40 and 20 meters. S. E. Bowers, W5EAY, Boyce, La.

CRYSTALS: low-drift high activity, 80 and 40-meter units, airgap mounted in dustproof holders. Within 5 Kc. \$2.50. Exact, \$3.50. Nebel Laboratory, 1104 Lincoln Pl., Brooklyn 13, N. Y.

SX-28 Hallicrafter receiver and speaker. Perfect. Excellent 100-watt transmitter. New 125 high-frequency transmitter. Station equipment, power supplies, tubes, back QSTs. Write Lee B. Forte, W9ZHY, Neosho, Mo.

OLD amateur, commercial radio sets, parts, catalogs, wanted. Will trade new gear or pay cash. McMurdo Silver, Simsbury, Conn.

ELECTRICAL Instrument Service, 15 Howard Avenue, Vallejo Calif. Send us your meters and instruments for fast and reasonable repair, calibration and conversion. Write for estimates.

WALKIE-Talkie wanted, or small transceiver. Hulse, 1547 Cole St., Baltimore 23, Md.

HEADQUARTERS in the Pike's Peak region for amateur gear. Write for catalog and free IRC Resisto-O-Guide. Mail orders given special attention. Large stock Ham parts, R.M.E., Taylor, Elmec, etc. Complete stock Petersen Crystals, Don (W8HJD) at Murray Radio Co., 502 West Colorado Ave., Colorado Springs, Colo.

FOR Sale: NC44, four tube TRF, transmitting parts. Harold A. Darata, W8SQI, 3216 West 132 Street, Hawthorne, Calif.

FOR Sale: 250-watt phone xmtr. Millen exciter, 813 final, Brentwood speech amp, PR 811s, Class B. Xtal mike. Meissner Deluxe signal shifter. \$250. S. Hack, 81-85 Utopia Pkwy, Jamaica, N. Y.

WANTED: commercially built medium power transmitter, 'phone-cw. Must be in perfect condition. (Veteran). Blaszczyk, 2233 Letterly St., Phila. 25, Penna.

SALE: Hallicrafters S-39 Sky Ranger. Never used much. Good as new. Make offer. Luby Jernigan, Dunn, N. C.

BAKELITE panels machine engraved. Neat professional work. Six cents per character, base price. Meter, shaft holes machined to specifications. Inquiries invited. Wm. E. Gilpin, W8GDT, Box 425, R.R. Mt. Clemens, Michigan.

WANTED: 80-meter, 10-meter coils and National power supply for FBX. G. Hunsath, W2CMR, 708 Third Ave., Asbury Park, N. J.

OSL. New designs. Also army surplus radio equipment. Dossett, W9HUC, 857 Burlington, Frankfort, Indiana.

SELL electronic products V.T.V.M. New. \$43. Like RCA voltmovmt. Wanted: used Millen exciter. C. Sloanaker, 65 Bow Rd., Belmont 78, Mass.

QSLs-SWLs. Meade, WØKXL, 1507 Central Avenue, Kansas City, Kansas.

QSL? **QSL**? No cheap trash! 10c for stamps. Biley, "PR" crystals? Sackers Printery, (Russ, W8DED) Holland, Mich. (Veteran.)

144-148 Mc. coaxial dipole—fixed or mobile use. Adjustable, \$6.00 complete with coaxial feeder. Engineering Electronics Co., Montclair, N. J.

NEW RME, National, Hammarlund receivers. Rotobeams, Conklin Radio, Bethesda, Md.

SALE or trade: Western Electric K55211 with D88651 control cabinet. 110 volts 60 cycles to 400 volts, 300 mills. New condition. Suitable for BC station. Want pair of Elmec 250s. O. W. Lummis, 3009 Magee, Phila. 24, Penna.

125-WATT phone-cw transmitter: 7C5, 7C5, RK-4D32. Modulated by a pair of 809s, B & W coils, 10, 20, 40, and 80 meter. Four power supplies; 2 VR tubes, 866A, 866 negative peak speech clipper. 7 M. high fidelity speech pre-amplifier 6S7, 6C5, 6N7, P-P 6A3s. Just completed, and it's a honey on 10 & 80. Complete with 300-ohm Amphenol folded dipole 10-meter antenna; three crystals and Shure 7068 crystal microphone; a real buy at \$210. Also new S-20R receiver at \$60. Price, W9OQB, 545 No. Franklin, Decatur 7, Ill.

WILL trade: 2500 v. power supply; various high power RF equipment; several transmitting tubes, including 4 813s; 5 832s, 811s, TZ40s, 211s, etc. Want complete medium power 'phone rig, Jimmy Moss, Roseville, Miss.

WANTED: 300-watt multi-tap modulation transformer, cash. Milton Savada, 115 CPW, NYC 23, N.Y.

CRYSTAL blanks: 4 for \$1.00, low drift, x-ray oriented, FT-243 for 7 Mc. range, complete with 2 holders, abrasive and instructions. 3 for 7 Mc. mounted crystals. 5 Kc. specified frequency \$2.50; 500 cycles, \$3.00. Holder pin spacing 1/4 or 1/8 in. Breon Laboratories, Williamsport, Penna.

AMPLIFIERS: Signal Corps VO-3-B audio oscillator amplifiers. 1 6J5, 1 6SN7, 2 6L6s, 1 5UA tubes included. Completely metal encased. Four to five hundred OHM tapped output. Inverse feedback. Makes fine phonograph and speech amplifier or P.A. system with little change. Original cartons, instructions and schematic enclosed. \$20. Radio Hospital, 1021 King St., Alexandria, Va.

SELL new MRT-3 with tubes, \$27.50. Gowen, Effie, Minn.

FOR Sale: National one to ten receiver, new, with powerpack and tubes. Strite, 31 No. Grant, Waynesboro, Penna.

EXCELLENT serviceable surplus: SCR-211 frequency meters, original tubes and xtal for perfect calibration. Contains spare matched tubes to maintain calibration, \$39.95; 100 Kc xtals, \$5; Loran indicators, complete with 26 G.3v tubes and 5" ray tube. Has 100 Kc. xtal-hi-voltage condensers, resistors, controls in steel cabinet, \$49.95; Loran tuners, complete with 16 tubes, 4 channel fixed tuner has transformers, chokes, 2500 v. condensers, etc., \$39.95; Dandy dynamos, 1000 v. 350 Ma., \$7.50; 375v.-150 Ma., \$5. Quantity limited. First come first served. Cyril F. Hoffman, Box 762, Uvalde, Texas.

ABBOTT TR4 transceiver now on 2 meters. FB rig, \$27. Leo V. Liebl, Whiteside, Wis.

BC-221 frequency meter with calibration chart and crystal, \$65. P. Buyak, W8OXL, 1456 Lakewood St., Toledo 5, Ohio.

WANTED: Hallicrafters Sky Buddy, new or slightly used. Walter Camp, Jr., 236 Emerson St. NW, Washington 11, D.C.

SELL new and used ham equipment. Write for list. Doersam, W2BZB, Fallsde, N. J.

WANTED: National SW-3 with coils. Write Maddox, W5DGV, 2311 Valmont St., New Orleans, La.

SELL: National SW-5; 14 coils, some bandspread. Power pack, tubes, A-1 condition. \$30. O. R. Kreimeier, W3FIM, Woodstown, N. J.

PARATROOP all-metal folding antenna in original triple-packed dehydrated container as used in War. New. Real buy for Ham-to-ant experimenter. 18" to 15 ft. Opens with a snap of the wrist. Worth \$10. Prepaid, \$1.49. Western Electric fixed xtal detector, 26-S. No adjusting, constant loud signal, rare buy, very scarce. Coast Govt. \$6.00. Prepaid 99c. Free list. War surplus bargains. Radio City Labs, 30 Church St., New York City 7.

RARE coin collection. Catalogs \$250. Trade for xmtr. Some bear full uncirculated, mostly American. Write for description. Arnold, W6VFFH, Box 634, Rosewood, Calif.

EXPERIMENTAL ham surplus bargains. Selsyns, xtfrs, xta receptors, 100 Kc xtals, Lectronic, 5832 Hegerman & Howell, Phila. 24, Penna.

WANTED: Thordarson T-82M10 modulation transformer, or equivalent. Will buy or swap. State condition and price or what you need. W3KNF, 1066 Fernside, Detroit 4, Michigan.

5G Selsyn motors, 110AC 60 cycle, 3 1/2" x 5 1/2" Ideal antenna or wind speed indicator. Diagrams furnished. \$12 per pair. New in boxes. Low prices. Write for lists, Westchester Electronic Products, 29 Milburn St., Bronxville 8, N. Y.

SALE: Complete set QSTs in binders, 1943-44-45. Like new, at cost \$12. Parrott, 120 South 37th, Apt. 3, Louisville 12, Ky.

SELL: two complete 2-meter rigs. Improved Abbott TR-4. Pair of new 8005 tubes. Want National 1-10. Must be late model and complete. WHIL, Mitchell, 4 Sidney, Wakefield, Mass.

IN STOCK: New BC342s for 110 Volt AC operation, \$79.50; new BC348Qs for 110 Volt AC operation, \$85; BC312Ns, \$45; BC223s, \$37.50; new Triumph pocket volt-ohm-milliammeters, \$9.95; HT-4s reconditioned and converted to 10 meters by Hallcrafters, \$53.5; large stock of amateur receivers, transmitters, parts. Terms, Trade-in. Write for lists. Henry Radio, Butler, Missouri and Los Angeles 25, California.

SELL Precision 870 volt-ohm-milliammeter. Excellent condition. \$13. Bedell, W2HFM, Merrick, N. Y.

WESTINGHOUSE Generators: brand-new operated from 6 or 12 volt battery or gas engine. Max. output 1000 vdc at 0.4 amps. \$25. John Zubas, 173 Warburton, Yonkers, N. Y.

BEST Offer: RCA police radio phone transmitter, type MI-78, 6 volt mobile, 30-40 meg. 8 watt output; RCA police radio transmitter, type MI-7801-A, 115-volt AC 30-40 Meg. 15 watt output. RCA MI-7802A receiver, 30-40 Meg. Fixed tuned, 6 volt operation; RCA MI-7803A, 110-volt AC receiver, 30-40 Meg. Fixed tuned. Also available accessories to make complete installation. This equipment is used but in first-class operating condition. Joe's Radio, Eagle Bldg., Bridgeton, N. J.

SELL: Collins 32F transmitter, complete; 60 watts phone or cw, 80, 40, 20, 10, \$65. f.o.b. Cedar Rapids, Iowa. W9WCY, Vernon Perry, 207 27th St., N. E.

FOR SALE: One Hallcrafters HT 9. Practically new. Only about 10 hours in use. What am I offered? You pay express or freight charges. Tully Brady, WSHAD, Brookhaven, Miss.

SELL: Complete 450-watt phone transmitter, using in RP-HK54s 2033s modulators. In fine steel rack with no bay-wire. Works all bands. Miller, W9DTL, 1218 No. Academy St., Galesburg, Ill.

WANTED: SX-25 receiver (used). Wass, W1VI, 20 Danforth St., Jamaica Plain, Mass.

FOR SALE: Hammarlund Comet Pro receiver. Complete with coils for 9 to 550 meters. Brush model BR2S xtal mike, RCA velocity mike. W2ETQ, W. Slinkanks, 536 East 27th St., Paterson 4, N. J.

ENGRAVING panels, nameplates. Neat, professional service. Finest equipment. Small jobs welcome. Inquiries invited. W. E. Gilpin, Box 425R6, Mt. Clemens, Michigan.

HAMS: any circuit built or designed or both to your specifications. Free estimates. Electronic Laboratories, Box 252, East Oak St., Basking Ridge, New Jersey.

HALLCRAFTERS S-39 Sky Ranger. Like new. Batteries included, \$90. 100-watt Thordarson multiband transmitter. Phone and cw. \$75. Write for details. W3KON, 522 So. 46th St., Phila., Penna.

STORAGE battery, new, 24-volt, 34 ampere-hour, rubber mounted in 1/2" aluminum container, shielding it against interference with radio circuits by Brackets, etc. of Boston to rigid standard specifications. Excellent for either 50 Mc or 144 Mc band. Complete with power supply which operates from either 6 volts DC or 110 volts AC. Write to George J. Cronin, State Purchasing Agent, Commissioner and Purchasing Agent, State House, Boston, Mass.

WANTED: commercially built transmitter, Collins, Hallcrafters preferred. Phone. Also receiver. Cash. Must be in perfect condition. What have you? Ralph Geer, W9GLR, Mason City, Iowa.

FOR Sale: Collins broadcast amplifier, 7R-9. Complete with tubes. 7-watt output. Rack panel mounting grey finish. Original carton. Never been used. Test data and schematic included. Price \$125.00. Chas. W. Boegel, Jr., P.O. Box 224, Cedar Rapids, Iowa.

PORTABLE radio telephone and telegraph transmitter-receiver, units used by Navy. Model TBV designed for knapsack walkie-talkie purposes. Operates on 56 volt dry batteries. Frequency 23 to 30 megacycles in four bands covering two amateur bands changed by revolving coil turrets with solid silver inductances. Built-in frequency calibrator with crystal. Super-regenerative receiver, push-pull transmitter, 7 tubes, key, microphone anti-noise aircraft type push-to-talk button. Filament-plate meter, antenna, canvas case, instruction book with wiring and complete specifications. Beautiful construction by Westinghouse and others. Ideal for boats, autos, camps, etc. Price with 7 tubes less batteries, \$65. Shipped in Navy trunk weight, 45 lbs. Arrow Appliance and Radio Co., 385-391 Broad St., Lynn, Mass.

TELEPLEX, like new, complete coils, \$15. Blanchard, 1104 E. Adams St., Syracuse, 10, N. Y.

IDENTIFY your station with original "Call O' the Wild" cartoon. Printed nice buff paper 8 x 10, suitable framing or hanging in your shack. Individual call entered by hand, india ink. Copyrighted. Created by professional cartoonist, ex-navy, commercial, aviation wireline operator. Send call letters, 50¢, to Chas. Merchant, Box 1592, Rapid City, So. Dakota. No stamps.

FOR Sale or swap: Abbott MRT-3 with vibrapak; AN/TRC 10-; 2-12 Mc. xtal transmitter-receiver with 40, 80, mtr xtals and AC power supply. H. Meltzer, 1 West 85th St., NYC.

NORTHWOOD hams! We have excellent surplus equipment. Sherman tank transmitter-receivers, B-29 Collins Autotune transmitters, BC-342s, BC-610 similar to HT4, frequency meters. Get on our mailing list. Range-Electric 224 Norfolk, Ironwood, Michigan.

NEW surplus tubes 829B @ \$4.50; 802 @ \$1.75; 813 @ 9.50; 828 @ \$6.50; cable RG13T @ .08; RG11U @ .07; RG8U @ .96, 100 ft. or more; transformer 500 vdc. ct. @ 250 mils @ \$16; other bargains J. A. Zebrowski, 631 Broadway, Bayonne, N. J.

SPEED X model 515 speed key, new. \$5. Superior Volt-ohmeter, AC-DC, 50.00 per volt. Make offer. John C. Bobbitt, 885 So. Cox Street, Memphis, Tenn.

VETERANS! Complete your QST files. Years 1942, 1943, 1944, 1945, each \$1.50. All \$5.00. Estes, W9FYM, Brunswick, Missouri. QSLs to please you. Samples free. Dossett, W9BHV, 857 Burlington Ave, Frankfort, Ind.

FOR Sale: Western Electric 6C/4 modulator receiver. 832 final. Output frequency 100-156 Mc. 6r6 transmitters, 2-1852 mixers, 3 IF stages. Noise limiter. 2-12A6s audio. Primary power 26 volts. Ideal mobile rig, 2 meter or 6, 10 meter with some conversion. Price, \$125, with cabinet and shock mount platform less tubes f.o.b. Glendale, California. W6UBT, D. Dapp, 611 E. Garfield Avenue.

SELL transmitter, 150-watts phone and cw. Michael, W2MNR, 9 Prospect Park West, Brooklyn, N. Y.

WANTED: 33 plate rotary variable receiver condensers. Honeycomb coils. Inside panel honeycomb mount. W8QLX, MacDonald, 12314 East Outer Drive, Detroit 24, Mich.

QSLs. Samples. Patterson, W6OKK, Box 133, Escalon, Calif.

QSLs: Fritz, 1213 Briargate, Joliet, Ill.

NEW 50P1 cathode ray tubes, \$7.95 each. 12 pin socket for same. 434 limited quantity. Shipping weight 4 lbs. include postage in your money order. Write for free electronic bargain list. Olmeyer Engineering Dept. A, Fairview Blvd., Hempstead, N. Y.

CRYSTALS: low drift, each finished to your exact frequency, 40 and 80 meters. The new FT-243 with socket, \$2.50. Regular ham size to fit 5 prong socket, \$2.80. 24 hour service. Tedford Crystal Labs (Ted, W8AKW) 1626 Chase St., Cincinnati 23, Ohio.

SALE 400-watt fone-cw transmitter. Millen exciter with power supply, Lafayette communications receiver. Write W3EVT, Box 182, Clementon, N. J.

All electric reversible 10 meter beam mount. Finger tip control. Selsyn indicated. Weighs 11 pounds. Rotates 300 pounds. Surplus. Immediate delivery. Write to W9UJ 2768 South 13th St., Omaha 9, Nebraska.

SELL new HQ 129 X receiver. Will give reason for selling. T. Clarke, 609 Birch St. Fall River, Mass.

SELL new NC-240C with speaker, perfect. Highest offer or trade movie camera. Write Walter Eng, 4435 N. Racine, Chicago, Ill.

WANTED: dynamotor Input 12 or 14 vdc. Output 250 to 375 vdc. 100 to 150 Ma. W/MD, 1833 Armacost Ave., Los Angeles 25, Calif.

HIGH voltage dynamotor power supply and v-o-m. Will sell or trade for other radio equipment. Pete Sorsen, 3312 Noyes St., Evanston, Ill.

"LICENSE holder", Plex-O-View, shows both sides. Neat wall mounting. Dollar postpaid. Delos P. Trim, W6QKI, 245 Los Alamos Drive, San Diego 2, Calif.

250-watt plate modulated transmitter, an S-40 Hallcrafters receiver. Trade for excellent still camera equipment. All replies answered. H. K. Howe, Box 185, Tonkawa, Okla.

SW3 6 sets, general coverage coils. National power supply, \$25. WIKMR, 8 Willard, Medford 53, Mass.

SELL several 829Bs, one 813, one MOD. transformer for PP 811 to 813. Hoefle, Box 22, Parsons, Kansas.

SIGNAL shifter coils, new additions to our line as follows: 3900-4000 kc. Direct output \$5. 11 meters by doubling; 6 meter output on 12.5 to 13.5 Mc. 2 meter output on 9 to 9.25 Mc or 18 to 18.5 Mc. Price \$4 per set. Rodgers Harris, 127 Main Street, Mt. Carmel, Ill.

HALLCRAFTERS SX-18 Sky Challenger for sale. Very good condition. \$35 or best offer. Joe Novak, 2535 Highland Ave., Berwyn, Ill.

QSLs SWLs, 200 \$1.50. Samples. Calabrese, W1LRV, 16 Sanger, Medford, Mass.

O. A. Wise (W9VCF) is now in charge of our Ham Department. Write or come in and let him help you. We are distributors for the leading manufacturers: Hallcrafters, Hammarlund and RME receivers. Eimac, Taylor and Hytron tubes. Simpson meters. Johnson and Bud condensers, coils and components. Our bargains this month include: An 813 with modulation transformer — \$14.75; this transformer alone, \$4.95; A-N HI-impedance fones, rubber cushions and long cord — \$2.95; 954, 958 and 956 tubes, 98; VT-127 tube (500 watts input) 5 volt fil. \$4.75; BC-610 (HT-4E) transmitter, \$485; 50-ohm coax, 76 per foot; Amphelon twin-lead in stock. Write for our Bargain Bulletin. Gifford-Brown, Inc. 106-108 First St. SW, Cedar Rapids, Iowa.

TRANSMITTER receiver tank set 19 mark II — Ultra short wave, 80 and 40 meter phone and cw. Complete for operation including antenna, cables, spare tubes, etc. New \$65, plus boxing. Grey Automatic Keyer, variable tape-puller, amplifier, electric eye reader, large reels; assembled cracked cabinet. Used in Army code classes \$70, boxed. W8RRD, C. H. McKnight, 1123 Carlisle St., Tarentum, Pa.

SURPLUS used Police radio equipment: 2 only, RCA MI-7821 station transmitters, \$250 ea.; 1 only LINK No. 8 UA receiver (less cables and speaker) \$15; 2 only LINK A-NR complete two-way units, \$100 ea.; 3 only Motorola No. P-69-17A receivers, \$25 ea.; 1 only RCA No. 205A frequency monitor, \$100; 8 only, RCA No. 7603-C receivers, \$15 ea.; 3 RCA AC power supply for No. 7603-C receiver, \$10 ea.; 7 only RCA No. 7814 transmitters, \$50 ea.; 1 only RCA No. ET 5004 transmitter (revised) \$50; 1 only RCA No. ET5004 transmitter (sep. crystal exciter) \$50; 3 only RCA D.C. power supply for No. 7603-C receiver, \$10 ea.; 1 only RCA No. 7829 receiver and power supply, \$25; 3 only AR 5019A receivers, \$10 ea.; 1 only Stancor No. 10 M mobile transmitter, \$75. Some items will require new cables, all in working order when removed from cars. Terms cash, f.o.b. Richmond, Va. Write or wire the Arnold Company, 2349 West Broad Street, Richmond, Va.

QSLs to please you. Samples free. Dossett, W9BHV, 857 Burlington Ave, Frankfort, Indiana

TOWERS: for your rotary beam, full lattice-work spruce construction. Priced for the amateur. Write for Bulletin T-101, Sky-Lane Products, Ironwood, Mich.

Designed for



Application

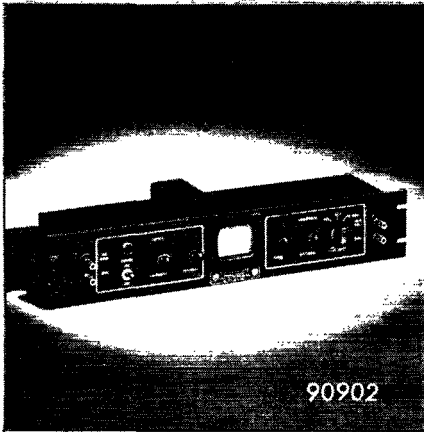

90902

**90900 Series
Cathode Ray Oscilloscopes**

The No. 90902 and No. 90903 Rack Panel (3½") Oscilloscopes, for two and three inch tubes, respectively, are inexpensive basic units comprising power supply, brilliancy and centering controls, safety features, magnetic shielding, switches, etc. As a transmitter monitor, no additional equipment or accessories are required. The well-known trapezoidal monitoring patterns are secured by feeding modulated carrier voltage from a pick up loop directly to vertical plates of the cathode ray tube and audio modulating voltage to horizontal plates. By the addition of such units as sweeps, pulse generators, amplifiers, servo sweeps, etc., all of which can be conveniently and neatly constructed on companion rack panels, the original basic scope unit may be expanded to serve any conceivable application.

**JAMES MILLEN
MFG. CO., INC.**

MAIN OFFICE AND FACTORY

**MALDEN
MASSACHUSETTS**



Index to Advertisers

	Page
Advance Electric & Relay	126
Allied Radio Corporation	143
American Phenolic Corporation	91
American Radio Institute	150
Ashe Radio Co., Walter	116
Astatic Corporation, The	2
Bell Telephone Laboratories	137
Birnbach Radio Company	134
Brill Co., W. D.	136
Bruno Tools	140
Burlington Instrument Company	145
Burstein-Applebee Company	146
Cambridge Thermionic Company	106
Candler System Company	126
Capitol Radio Engineering Institute	93
Cardwell Mfg. Co., Allen D.	98, 99
Centralab	85
Chief Electronics	130
Cleveland Institute of Radio Electronics	130, 140
Collins Radio Company	89
Commercial Equipment Company	118
Commercial Radio Institute	152
Condenser Products Company	154
Crystal Research Laboratories	144
Drake Electric Company	102
Edwards Company, W. H.	150
Eitel-McCullough, Inc.	105
Galvin Manufacturing Company	117
Gates Radio Company	107
General Electric Company	1
Greenlee Tool Company	134
Hall, R. C. & L. C.	149
Halicrafters Co., The	4, 5
Hammarlund Manufacturing Co., Inc., The	9, 83
Harrison Radio Company	125
Harvey Radio Company	129
Harvey Radio Laboratories	104
Hatry & Young	142
Henry Radio Shop	154
Hytron Radio & Electronics Corp.	131
Instructograph Company	132
International Resistance Company	8
Johnson Co., E. F.	96
Knights Co., The James	124
Kwikheat Soldering Irons	142
Lewis Electronics	150
Maguire Industries	94, 95
Mallory & Co., F. B.	102
Marion Electrical Instrument Co.	119
McElroy, Ted	128
McGraw-Hill Book Co.	128
Millen Mfg. Co., Inc., Jas.	158
Munzig Manufacturing Co., Arthur L.	138
National Co., Inc.	81, Cov. III
Newark Electric Co.	112
New York Technical Institute	150
Onan & Sons, D. W.	140
Panoramic Radio Corporation	141
Petersen Radio Company	101
Port Arthur College	128
Premax Products Company	132
Radio Electric Service Co. of Penna.	120
Radio Maintenance Magazine	155
Radio Manufacturing Engineers	135, 159
Radio Product Sales Company	144
Radio Shack, The	122, 123
Reid Co., Henry L.	138
RCA Institutes	146
RCA Mfg. Co.	Cov. IV
Sceli & Co., R. G.	146
Schauer Machine Company	138
Scientific Radio Products	97
Silver, Company, McMurdo	108
Solar Capacitor Sales Corp.	160
Speer Carbon Company	111
Sprague Products Co.	109
Standard Transformer Corporation	100
Sun Radio & Electronics Co.	147
Sun Radio of Washington, D. C.	153
Sylvania Electric Products Co.	87
Taylor Tubes Company	115
Telegraph Apparatus Company	150
Terminal Radio Company	127
Transmitter Equipment Mfg. Co.	103
Triex Tool Works	130
Triplet Electrical Instrument Co.	148
Turner Co., The	148
UHF Resonator Co.	132
United Electronics	7
United Transformer Corporation	Cov. II
Valparaiso Technical Institute	142
Valpey Crystal Corporation	114
Van Sickle Radio Supply Co.	152
Vibroplex Company, The	152
Western Electric Company	139
Westinghouse Electric Corporation	121
World Radio Laboratories	133

Announcing the RME 84

High in Quality — Low in Cost



HERE'S the new RME 84 you'll be hearing a lot about during future QSO's. It's a precision instrument built to RME's tradition of expert engineering and quality components.

No compromise has been made with quality. An all gear and planetary tuning mechanism is used—no strings, no pulleys! Tubes are the new "lock-ins" resulting in high signal to noise ratio and exceptional performance in the higher frequency ranges.

For sensitivity and selectivity, the RME 84 out-performs anything in its price class.

NET PRICE \$98.70

Features

- Four tuning ranges .54 to 44 MC.
- One Preselection Stage
- Smooth Vernier Tuning Control
- Bandspread Scale, arbitrarily calibrated from 0 to 100
- Bandspread, positively geared to main tuning control for accurate logging—no backlash!
- Automatic Noise Limiter
- Beat Frequency Oscillator—continuously variable by panel control
- Self Contained Shock Mounted PM Speaker
- Headphone Jack
- Standby, Receive & B F O Switch
- Antenna Input Terminals, provision for doublet or single wire
- Cabinet of heavy prime furniture steel beautifully finished in two-tone grey
- Plug connection provided for low drain battery operation.
- Eight tube superheterodyne circuit

K 99695-M

Specification Sheet
on Request



RME

FINE COMMUNICATIONS EQUIPMENT

RADIO MFG. ENGINEERS, INC.

Peoria 6, Illinois U. S. A.

QUALITY SURE TELLS



"Quality Sure Tells" is what "QST" means to hams who use Solar capacitors. Why? Simply because Solar sticks to its by-word "Quality Above All" year after year, giving hams capacitors that stand up under heavy duty in all climates.

Where every penny counts, as it does with most amateurs, Solar capacitors are the logical choice for the "most for your money"

Solar now has for you a NEW easy-to-use 36-page catalog, SC-1, showing the most complete line of capacitors for ham use—every type of capacitor from tiny tubulars to compact high-voltage oil papers. Slide your postcard request into the post box today, OM. We'll shoot your copy of the SC-1 back to you by return mail.

SOLAR CAPACITOR SALES CORP.
285 MADISON AVENUE • NEW YORK 17, N. Y.



ELECTROLYTIC, PAPER AND MICA CAPACITORS

1252

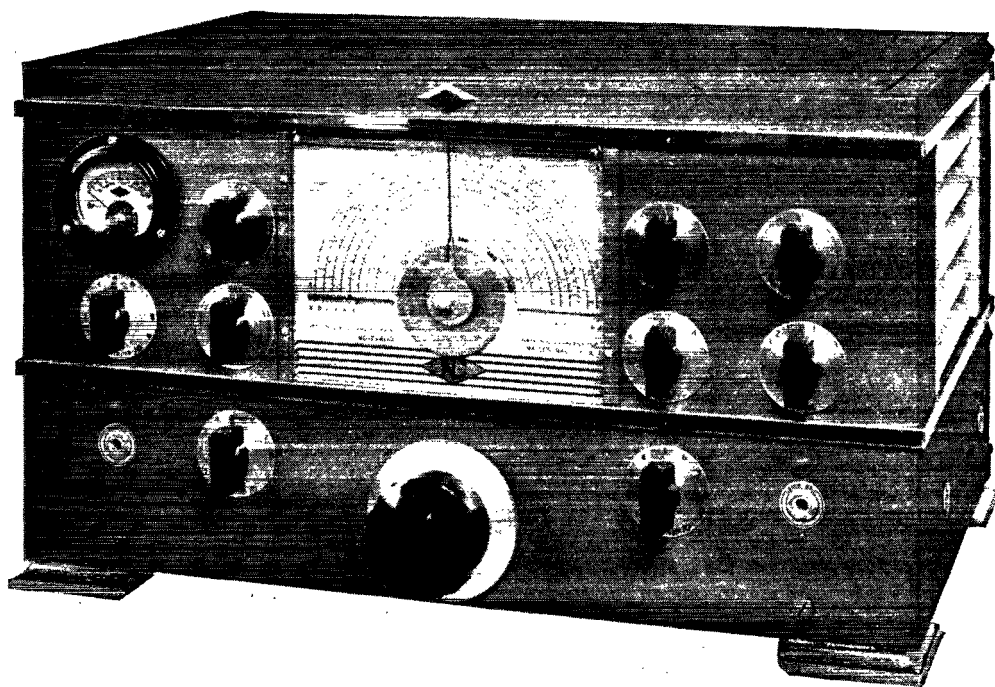

THE NC-2-40D

... WITH AMATEUR BAND COVERAGE

Every feature the amateur needs is found in the superb NC-2-40D receiver. Special expanded coil ranges for the 10, 20, 40 and 80 meter bands are included in addition to general coverage from 490 Kc. to 30 Mc. Each amateur band is spread over 80% of the dial range and the full vision dial shows your location in the band at a glance. Stability and sensitivity are outstanding. A wide range crystal filter gives optimum selectivity under all conditions. The series-valve noise limiter, the AVC, beat oscillator, tone control and S-meter are among the many auxiliary circuits that contribute toward the all-around excellence of the NC-2-40D. See it at your dealer's.



NATIONAL COMPANY, INC.

MALDEN, MASSACHUSETTS, U.S.A.

MALDEN
MELROSE

WHAT'S BETTER THAN AN RCA-807?

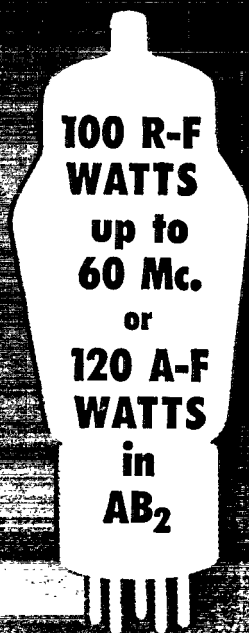
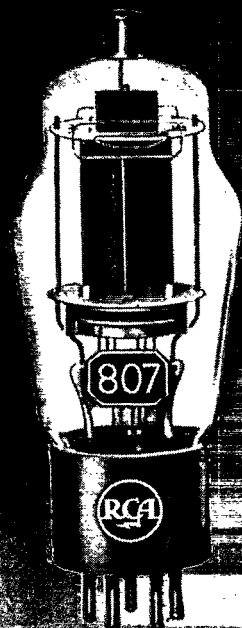

\$230

+

\$230

=

\$460

TWO OF 'EM!

RCA-807's are still tops in watts-per-dollar value. They will operate without neutralization and they provide high efficiency at low plate voltage.

1. Two RCA-807's push-pull in ICAS Class C telegraph service can deliver 100 watts RF output with 750 volts on their plates.

2. Two RCA-807's push-pull in ICAS Class C telephony service can deliver 85 watts RF output with 600 volts on their plates.

3. Two RCA-807's push-pull in ICAS Class AB₂ modulator service can deliver 120 watts audio output with 750 volts on their plates.

4. Two RCA-807's push-pull in RF service can be driven by an inexpensive receiving type tube, such as the 6V6, used as a doubler.

5. Two RCA-807's push-pull will take full input and operate at high plate-circuit efficiency at frequencies up to 60 Mc.

For further details, see your local RCA Tube Distributor or write RCA, Commercial Engineering Department, Section A-21G, Harrison, New Jersey.

**THE FOUNTAINHEAD OF MODERN
TUBE DEVELOPMENT IS RCA**



TUBE DEPARTMENT

RADIO CORPORATION of AMERICA

HARRISON, N. J.