

QST

march, 1946

25 cents

35c In Canada

devoted entirely to

amateur radio

A Simple 10-Meter Rig

An 829 Amplifier

New Panoramic Reception

Microwave Antennas

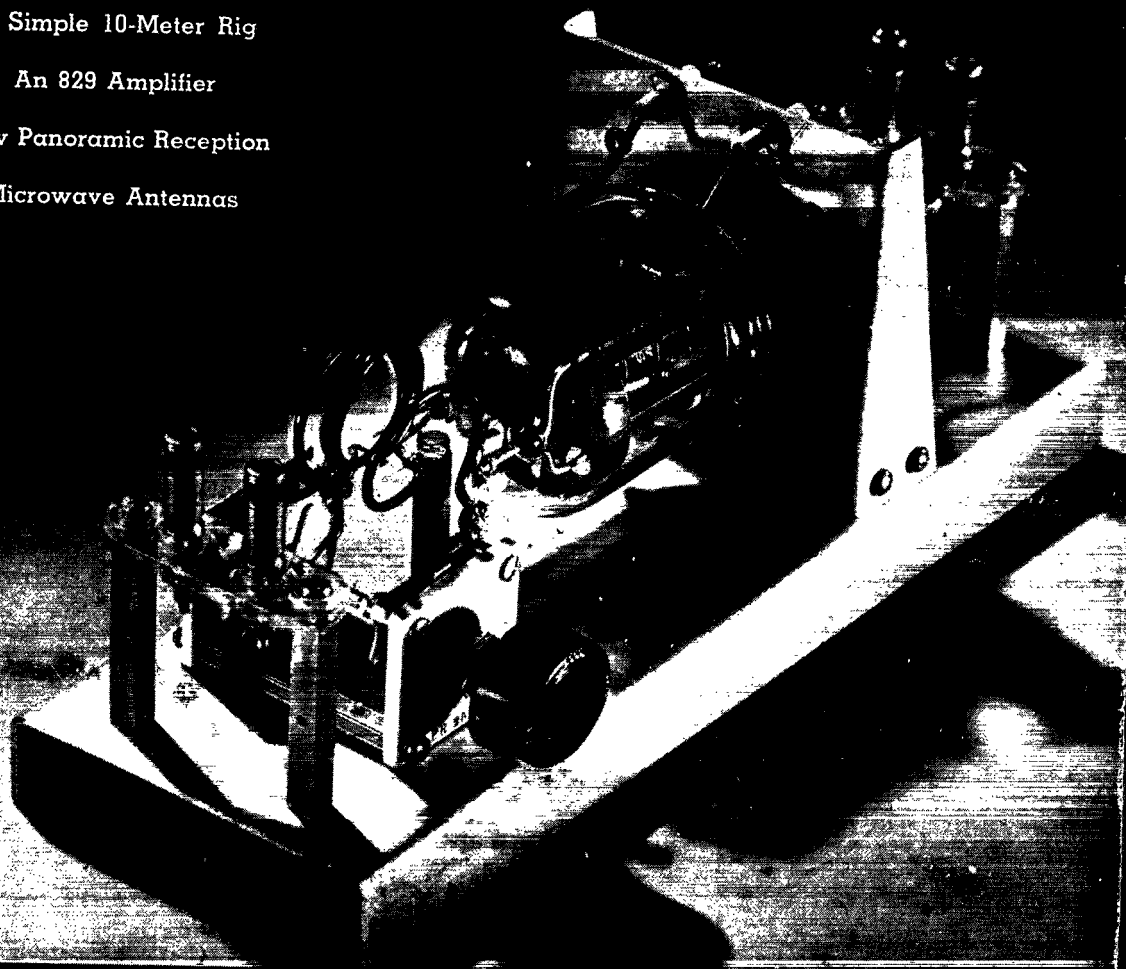

Published by the American Radio Relay League, Inc., 2215 Broadway, New York, N. Y.

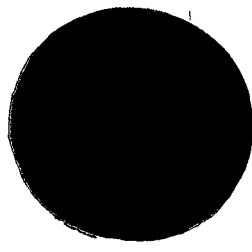

FOR
HEARING AIDS
VEST POCKET RADIOS
AIR BORNE DEVICES

UTC SUB-OUNCER SERIES

UTC Sub-Ouncer units are 9/16" x 5/8" x 7/8" and weigh only 1/3 ounce. Through unique construction, however, these miniature units have performance and dependability characteristics far superior to any other comparable items. The coil is uniform layer wound of Formex wire . . . On a molded nylon bobbin . . . insulation is of cellulose acetate . . . leads mechanically anchored (no tape) . . . core material Hipermalloy . . . entire unit triple (waterproof) sealed. The frequency response of these standard items is 3 DB from 200 to 5,000 cycles.

Type	Application	Level	Pri. Imp.	D.C. In Pri.	Sec. Imp.	List Price
SO-1	Innut	+ 4 V.U.	200 50	0	250,000 62,500	\$5.00
SO-2	Interstage 3:f	+ 4 V.U.	10,000	0	90,000	3.00
SO-3	Plate to Line	+ 23 V.U.	10,000 25,000	3 mil. 1.5 mil.	200 500	5.00
SO-4	Output	+ 20 V.U.	30,000	1.0 mil.	50	5.00
SO-5	Reactor 50 HY at 1 mil. D.C. 3000 ohms D.C. Res.					4.50

UTC OUNCER SERIES

The standard of the industry for seven years. The overall dimensions are 7/8" diameter by 1-3/16" height including lugs. Mounting is effected by two screws, opposite the terminal board side, spaced 11/16". Weight approximately one ounce. Units not carrying D.C. have high fidelity characteristics being uniform from 40 to 15,000 cycles. Items with D.C. in pri. are for voice frequencies from 150 to 8000 cycles.

Type	Application	Pri. Imp.	Sec. Imp.	List Price
0-1	Mike pickup or line to 1 grid	50, 200, 500	50,000	\$11.60
0-4	Single plate to 1 grid	8,000 to 15,000	60,000	\$ 9.25
0-5	Single plate to 1 grid, D.C. in Pri.	8,000 to 15,000	60,000	\$ 9.25
0-6	Single plate to 2 grids	8,000 to 15,000	95,000	\$10.45
0-8	Single plate to line	8,000 to 15,000	50, 200, 500	\$11.60
0-9	Single plate to line, D.C. in Pri.	8,000 to 15,000	50, 200, 500	\$11.60
0-12	Mixing and matching	50, 200	50, 200, 500	\$10.45
0-13	Reactor, 200 Hys-no 0 G., 50 Hys-281A D.C., 6,000 ohms			\$ 8.10

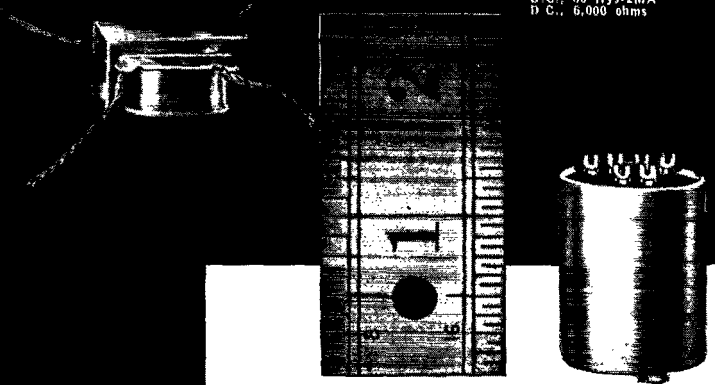

United Transformer Corp.
 150 VARICK STREET NEW YORK 13, N. Y.
 EXPORT DIVISION: 13 EAST 40th STREET, NEW YORK 16, N. Y., CABLES: "ARLAB"

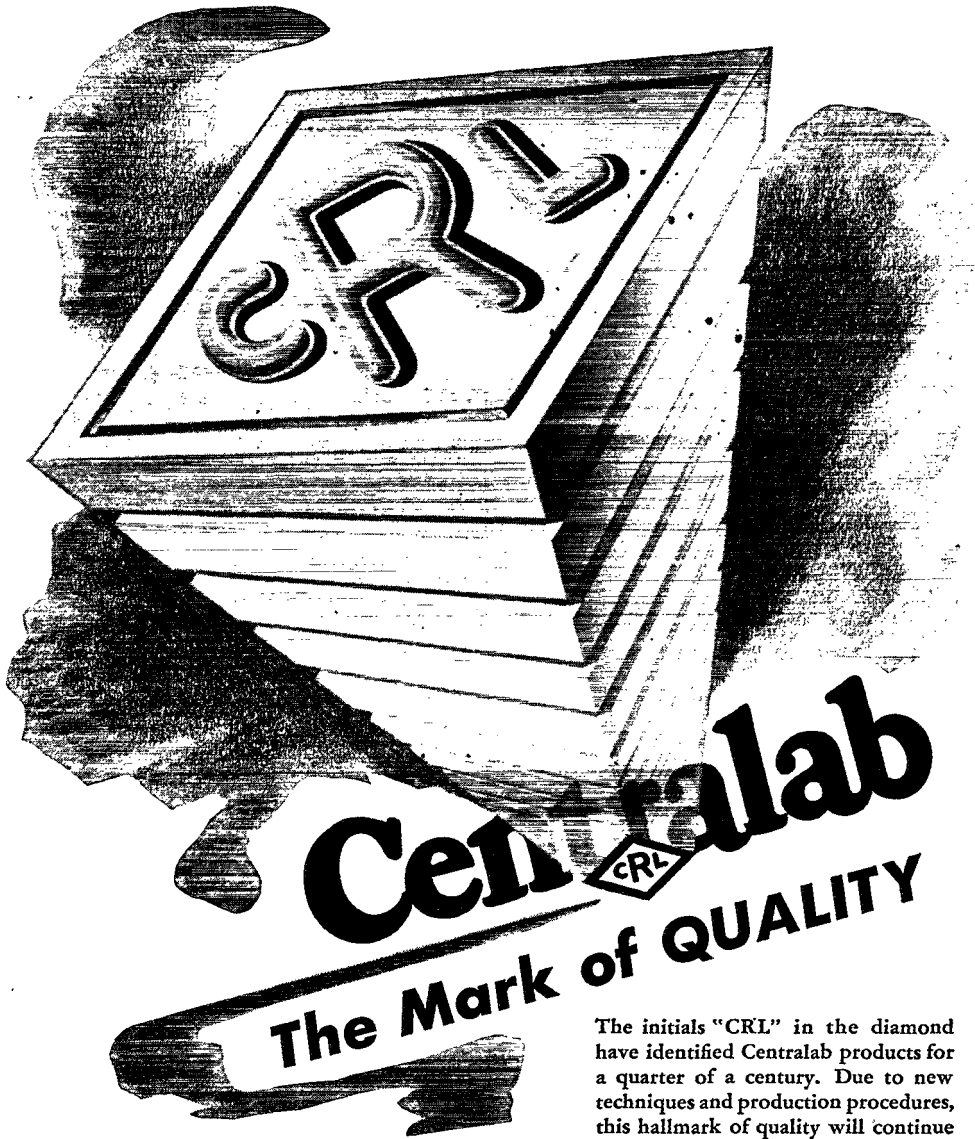

Centralab

The Mark of QUALITY

The initials "CRL" in the diamond have identified Centralab products for a quarter of a century. Due to new techniques and production procedures, this hallmark of quality will continue to represent the latest developments in components for the electronic field . . . *always specify Centralab.*

Centralab

Division of GLOBE-UNION INC., Milwaukee

PRODUCERS OF



Ceramic Trimmers
Bulletin 695



Variable Resistors
Bulletin 697

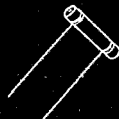

Tubular Ceramic
Capacitors
Bulletins 630 and 586



Selector Switches
Bulletin 722



Ceramic High Voltage Capacitors
Bulletin 814

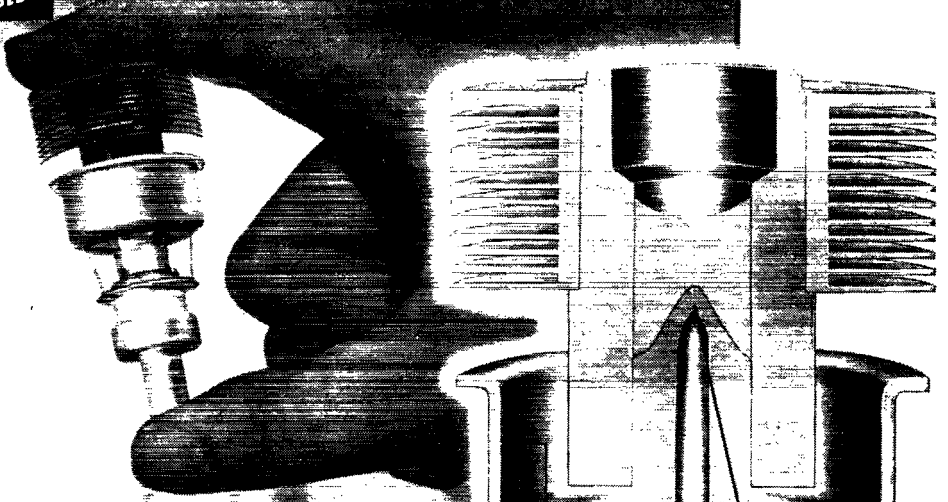

**PRECISION ENGINEERING
ON A MASS PRODUCTION SCALE**

... that's the basic achievement of Eimac engineers in providing typically outstanding Eimac performance in these tiny triodes. Observe the many functions of the Eimac developed 3X100A11/2C39 triode—cross section view. Note actual size shown in photo above.

Designed for special military purposes—these tiny triodes will find valuable application in commercial fields. An indication of their high efficiency is their ability to operate on frequencies up to 2500 megacycles and their high plate dissipation (100 watts) despite the extremely small effective plate area—about the size of a dime.

By developing and improving the performance of this tiny triode Eimac has again demonstrated an extraordinary ability to accomplish outstanding results in Electronic vacuum tube engineering—an ability which has established Eimac as first choice of leading Electronics engineers throughout the world.

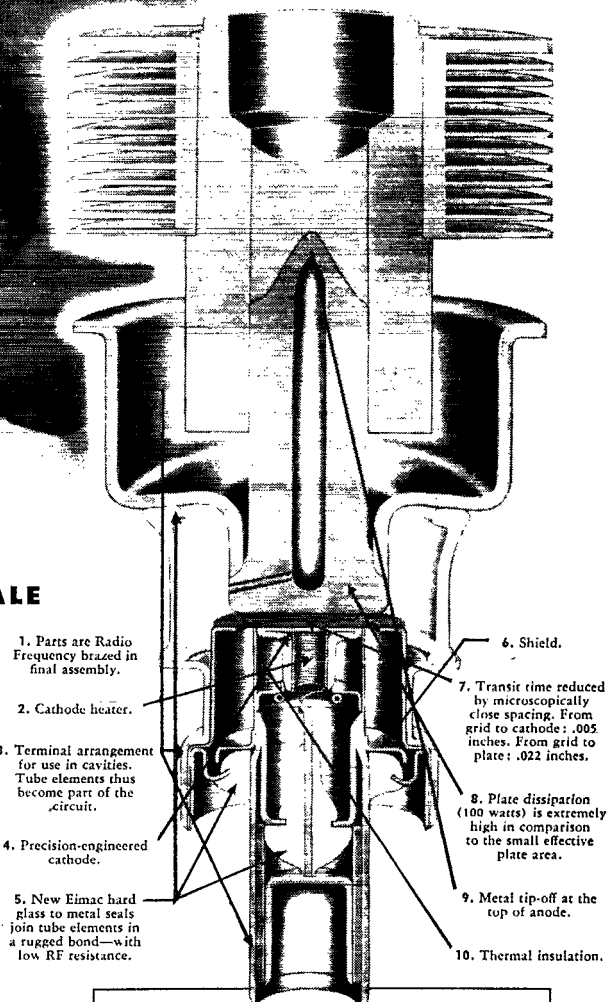

- 1. Parts are Radio Frequency brazed in final assembly.
- 2. Cathode heater.
- 3. Terminal arrangement for use in cavities. Tube elements thus become part of the circuit.
- 4. Precision-engineered cathode.
- 5. New Eimac hard glass to metal seals join tube elements in a rugged bond—with low RF resistance.
- 6. Shield.
- 7. Transit time reduced by microscopically close spacing. From grid to cathode: .005 inches. From grid to plate: .022 inches.
- 8. Plate dissipation (100 watts) is extremely high in comparison to the small effective plate area.
- 9. Metal tip-off at the top of anode.
- 10. Thermal insulation.

FOLLOW THE LEADERS TO



EITEL-McCULLOUGH, INC., 1148 San Mateo Ave., San Bruno, Calif.
Plants located at: San Bruno, Calif., and Salt Lake City, Utah
Export Agents: Frazor and Hansen, 301 Clay St., San Francisco 11, Calif., U. S. A.

TYPE 3X100A11/2C39 EIMAC TRIODE GENERAL CHARACTERISTICS	
ELECTRICAL	
Cathode: Coated unipotential	
Heater Voltage	6.3 volts
Heater Current	1.1 amps
Amplification Factor (Average) 100	
Direct Interelectrode Capacitances (Average)	
Grid-Plate	1.95 μ fd
Grid-Cathode	4.50 μ fd
Plate-Cathode	0.030 μ fd
Transconductance ($i_b=75$ ma., $E_b=600$ v.) (AV.)	20,000 μ mhos
Maximum Plate Dissipation	100 watts
MECHANICAL	
-Maximum Overall Dimensions	
Length	2.75 inches
Diameter	1.24 inches

CALL IN AN EIMAC ENGINEER FOR RECOMMENDATIONS

ROYAL J. HIGGINS (W9AIO)... 600 South Michigan Avenue, Room 818, Chicago 5, Illinois. Phone: Harrison 5948. Illinois, Wisconsin, Michigan, Indiana, Ohio, Kentucky, Minnesota, Missouri, Kansas, Nebraska and Iowa.
VERNER O. JENSEN, General Sales Co., 2616 Second Avenue, Seattle 1, Washington. Phone: Elliott 6871. Washington, Oregon, Idaho and Montana.
M. B. PATTERSON (W5CI)... 1124 Irwin - Kessler Bldg., Dallas 1, Texas. Phone: Central 5764. Texas, Oklahoma, Arkansas and Louisiana.

ADOLPH SCHWARTZ (W2CN)... 220 Broadway, Room 2210, New York 7, N. Y. Phone: Cortland 7-0011. New York, Pennsylvania, New Jersey, Maryland, Delaware and District of Columbia.
HERB B. BECKER (W6QD)... 1406 South Grand Avenue, Los Angeles 15, California. Phone: Richmond 6191. California, Nevada and Arizona.
TIM COAKLEY (W1KPP)... 11 Beacon St., Boston 8, Mass. Phone: Capitol 0050. Maine, Vermont, New Hampshire, Massachusetts, Connecticut, Rhode Island.

CAUTION! Look for the latest serial numbers on Eimac Tubes. Be sure you get the newest types.

MARCH 1946

VOLUME XXX

NUMBER 3



STAFF

Editorial

KENNETH B. WARNER, W1EB
(Managing Secretary, ARRL)
Editor

GEORGE GRAMMER, W1DF
(Technical Director, ARRL)
Technical Editor

DONALD H. MIX, W1TS
BYRON GOODMAN, W1JEE
Assistant Technical Editors

A. DAVID MIDDLETON, W2OEN
Department Editor

EDWARD P. TILTON, W1HDQ
V.H.F. Editor

WALTER E. BRADLEY, W1FWH
Technical Information Service

Production

RALPH T. BEAUDIN, W1BAW
Superintendent

ELSIE C. HOCHMEISTER
Assistant

Advertising

F. CHEYNEY BEEKLEY, W1GS
Advertising Manager

Circulation

DAVID H. HUGHSON
Circulation Manager

RALPH T. BEAUDIN, W1BAW
Assistant Circulation Manager



OFFICES

33 La Salle Road
West Hartford 7, Connecticut

Subscription rate in United States and Possessions, \$2.50 per year, post-paid; all other countries, \$3.00 per year, post-paid. Single copies, 25 cents. Foreign remittances should be by international postal or express money order or bank draft negotiable in the U. S. and for an equivalent amount in U. S. funds.

Entered as second-class matter May 29, 1919, at the post office at Hartford, Connecticut, under the Act of March 3, 1879. Acceptance for mailing at special rate of postage provided for in section 1103, Act of October 3, 1917, authorized September 9, 1922. Additional entry at Concord, N. H., authorized February 21, 1929, under the Act of February 23, 1925.

Copyright 1946 by the American Radio Relay League, Inc. Title registered at U. S. Patent Office.

QST

devoted entirely to

AMATEUR RADIO

PUBLISHED MONTHLY, AS ITS OFFICIAL ORGAN, BY THE AMERICAN RADIO RELAY LEAGUE, INC., AT WEST HARTFORD, CONN., U. S. A.; OFFICIAL ORGAN OF THE INTERNATIONAL AMATEUR RADIO UNION



CONTENTS

It Seems to Us	11
Feedback	12
A Low-Power 28-Mc. Phone-C.W. Transmitter <i>Donald Mix, W1TS</i>	13
Panoramic Reception, 1946 <i>J. R. Popkin-Clurman, W2LNP and B. Schlessel</i>	22
The Opening of the Band <i>R. B. Bourne, W1ANA</i>	28
A Band-Switching V.F.O. Exciter Unit <i>Walter E. Bradley, W1FWH</i>	29
High-Gain Microwave Antennas <i>William G. Tuller, W2BPZ/1</i>	34
Military Television Cameras — and the Amateur <i>A. David Middleton, W2OEN</i>	41
Happenings of the Month	44
Foreign Notes	46
Need There Be Line-of-Sight? <i>E. P. Tilton, W1HDQ</i>	47
A 4.3-Mc. F.M./A.M. I.F. and Audio Amplifier <i>James W. Brannin, W6OVK/6</i>	51
A V.H.F. Amplifier Using the 829	55
How's DX?	57
Technical Topics	
Single Signal C.W. Reception and Crystal Filters	59
Wave and Wave Guides (Part III)	61
Hints and Kinks	
<i>Quiet Break-in Operation — Reducing No-Carrier Noise in F.M. Receivers — A Simple Bias Isolator</i>	65
Official Experimental Station <i>F. E. Handy, W1BDI</i>	66
The World Above 50 Mc.	68
In QST 25 Years Ago This Month	70
Simple Capacitance and Inductance Measurements <i>Dr. T. A. Gadwa, W2KHM</i>	71
New Tubes	73
Correspondence from Members	75
The Crystal Ball	77
Operating News	80
Station Activities	84
Silent Key	148
Ham-Ads	156
QST's Index of Advertisers	158

hallicrafters

New design, new utility in a great new communications receiver . . .

Here is Hallicrafters new Model S-40. With this great communications receiver, handsomely designed, expertly engineered, Hallicrafters points the way to exciting new developments in amateur radio. Read those specifications . . . it's tailor-made for hams. Look at the sheer beauty of the S-40 . . . nothing like it to be seen in the communications field. Listen to the amazing performance . . . equals anything in its price class. All around, up and down, through and through it's a true Hallicrafters-built ham job.

See your local distributor about when you can get an S-40—the up and coming leader in the popular price field.

INSIDE STUFF: Beneath the sleek exterior of the S-40 is a beautifully engineered chassis. One stage of tuned radio frequency amplification, the S-40 uses a type 6SA7 tube as converter-mixer for best signal to noise ratio. RF coils are of the permeability adjusted "micro-set" type identical with those used in the most expensive Hallicrafters receivers. The high frequency oscillator is temperature compensated for maximum stability.

From every angle the S-40 is an ideal receiver for all high frequency applications.

\$79⁵⁰
(APPROXIMATELY)

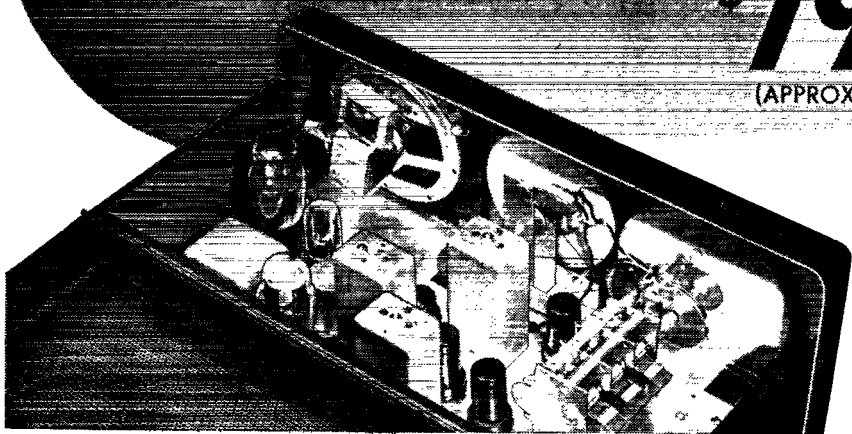

Interior completely accessible. Entire top turns back on piano hinge.

COPYRIGHT 1945
THE HALLICRAFTERS CO.

new Model S-40

Tuning range from 550 kc to 42 Mc continuous in four bands

Separate electrical bandspread with inertia flywheel tuning

New beauty and perfect ventilation in the perforated steel top

Self-contained, shock mounted, permanent magnet dynamic speaker

Standby receive switch

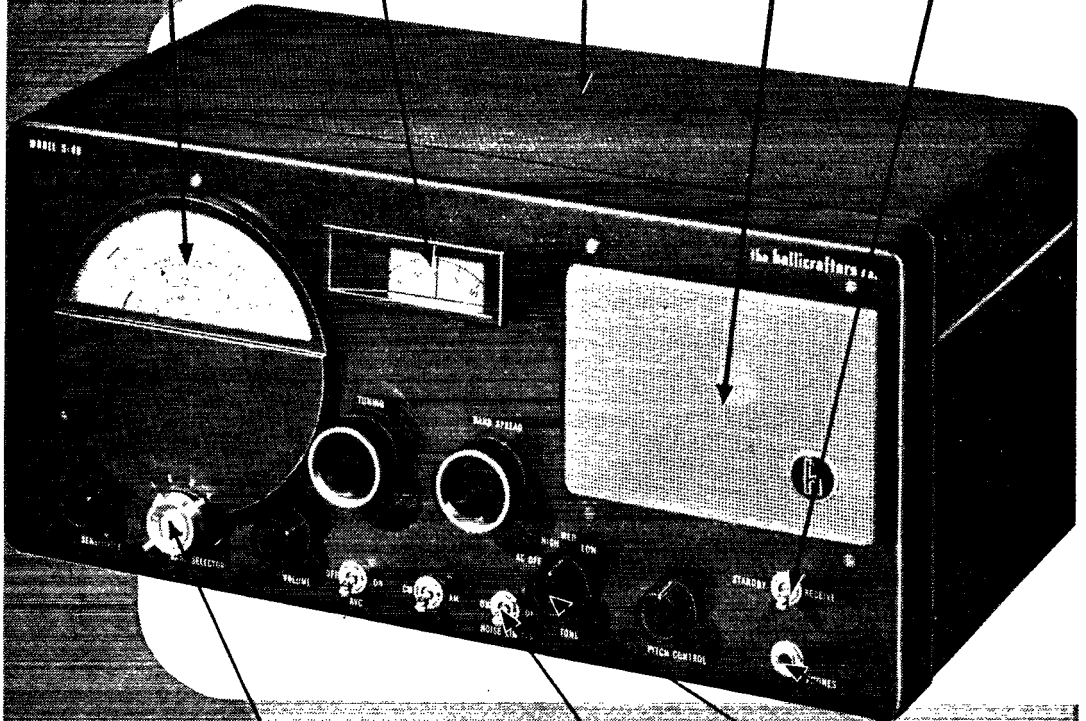

All controls logically grouped for easiest operation. Normal position for broadcast reception marked in red, making possible general use by whole family.

Automatic noise limiter

3-position tone control

Phone jack

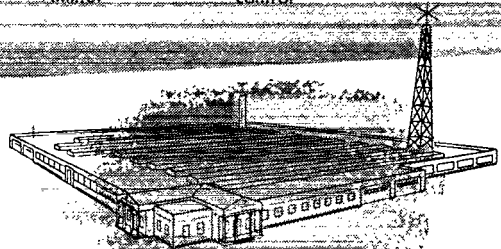

hallicrafters RADIO

THE HALLICRAFTERS CO., MANUFACTURERS OF RADIO AND ELECTRONIC EQUIPMENT, CHICAGO 16, U. S. A.

Sole Hallicrafters Representatives in Canada: Rogers Majestic Limited, Toronto-Montreal

Section Communications Managers of the A.R.R.L. Communications Department

Reports Invited. All amateurs, especially League members, are invited to report station activities each mid-month (16th of the month for the last 30 days) direct to the SCM, the administrative official of ARRL elected by members in each Section whose address is given below. Radio Club reports are also desired by SCMs for inclusion in QST. New ARRL Field Organization appointments, with the exception of SEC, OES, EC, OBS, and OO are not at present being made. See Operating News.

ATLANTIC DIVISION				
Eastern Pennsylvania	W3BES	Jerry Mathis	623 Crescent Ave. 9701 Monroe St. Silver Springs P. O.	Glenside Gardens
Maryland-Delaware-District of Columbia	W3CIZ	Hermann E. Hobbs	633 E. Brown St.	Linden, Maryland
Southern New Jersey	W3CCU	Ray Tomlinson	4158 Ridge Road, West	Trenton 10
Western New York	W8T1PH	Charles I. Otero	927 East 23rd St.	Spencerport
Western Pennsylvania	W8NCJ	R. R. Rosenberg		Erie
CENTRAL DIVISION				
Illinois	W9NUX	David E. Blake, II	4501 N. Malden St.	Chicago 40
Indiana	W9EGC	Herbert S. Brier	385 Johnson St.	Gary
Kentucky	W5IEZ/9	Joseph P. Colvin	1653 Beechwood Ave.	Louisville 4
Michigan	W8DPE	Harold C. Bird	R.F.D. 2, Box 228	Pontiac 2
Ohio	W8MFP	Carl F. Wiehe	122 St. Albert St.	St. Bernard 17
Wisconsin	W9RH	Emil Felber, Jr.	1625 N. 18th St.	Milwaukee 5
DAKOTA DIVISION				
North Dakota	W9EVP	Raymond V. Barnett	406-17th St.	Bismarck
South Dakota	W9QVY	P. H. Schultz	118 N. Yankton Ave.	Pierre
Northern Minnesota	W9FUZ	Arnold D. Brattland	3435 S. Western	Los Angeles, Calif.
Southern Minnesota	W9YNQ	Millard L. Bender	608 N. Huron Ave.	Spring Valley
DELTA DIVISION				
Arkansas	W5CED	Ed Beck	2503 Bishop St.	Little Rock
Louisiana	W5DKR	Eugene H. Treadaway	P. O. Box 44	LaPlace
Mississippi	W5HAV	P. W. Clement	524 Santini St.	Bloom
Tennessee	W45P	James B. Witt	R.F.D. 6, Shady Dell Trail	Knoxville
HUDSON DIVISION				
Eastern New York	W2HZL	Ernest E. George	2044 Lexington Parkway	Schenectady 8
N. Y. C. & Long Island	W2KDC	Charles Ham, Jr.	151-06 84th Drive	Jamaica, L. I., 2
Northern New Jersey	W2CQD	Winfield G. Beck	617 Spruce Drive	Roselle
MIDWEST DIVISION				
Iowa	W9FJR	Leslie B. Vennard	2712 Washington St.	Burlington
Kansas	W9AWP	A. B. Unruh	1617 S. Seneca St.	Wichita 12
Missouri	W9OUD	Mrs. Letha A. Dangerfield	411 Moffett Ave.	Joplin
Nebraska	W9FQB	Arthur R. Gaeth	6105 N. 37 St.	Omaha 11
NEW ENGLAND DIVISION				
Connecticut	W1KOY	Edmund R. Fraser	48 Willow St.	West Haven 16
Maine	W1AOL	G. C. Brown	379 No. Main St.	Brewster
Eastern Massachusetts	W1ALP	Frank L. Baker, Jr.	91 Atlantic St.	North Quincy 71
Western Massachusetts	W1JAH	William J. Barrett	239 Columbia St.	Adams
New Hampshire	W1FTJ	Mrs. Dorothy W. Evans	P. O. Box 312	Concord
Rhode Island	W1HRC	Clayton C. Gordon	70 Columbia Ave., Gaspee	Plateau, Providence 5
Vermont	W1NLO	Burtis W. Dean	P. O. Box 81	Burlington
NORTHWESTERN DIVISION				
Alaska	K7GNN	James G. Sherry	P. O. Box 486	Homer
Idaho	W7AVP	Don D. Oerbillig	Box 1088	Boise
Montana	W7CPY	Rex Roberts	1137 Federal	Glendive
Oregon	W7GNJ	Carl Austin	513 N. Central	Bend
Washington	W7FWD	O. U. Tatro		Olympia
PACIFIC DIVISION				
Hawaii	K6RLG	Howard S. Simpson	2068 Wells St.	Wailuku, Maui
Nevada	W6CW	N. Arthur Sowle	Box 2025	Reno
Santa Clara Valley	W6LUZ	Earl F. Sanerson	600 Acacia Ave.	San Bruno
East Bay	W6TI	Horace R. Greer	414 Fairmount Ave.	Oakland 11
San Francisco	W6RBO	William A. Ladley	200 Naylor St.	San Francisco 12
Sacramento Valley	W6MDI	Vincent N. Feldhausen	113 South Quincy St.	McCloud
Philippines	KA1GR	George L. Rickard	Box 849	Manila
San Joaquin Valley	W6PSQ	James F. Wakefield	1548 L St.	Fresno
ROANOKE DIVISION				
North Carolina	W4CVB	W. J. Wortman	c/o Duke Power Co.	Charlotte 1
South Carolina	W4BOE/ANG	Ted Ferguson	3022 Rosewood Drive	Columbia 25
Virginia	W3KEN	Walter G. Walker	217-51 St.	Newport News
West Virginia	W8JRL	Kenneth M. Zinn	P. O. Box 132	Clarksburg
ROCKY MOUNTAIN DIVISION				
Colorado	W9VGC	H. F. Hekel	2743 Julian St.	Denver 11
Utah-Wyoming	W6LLH	Victor Drabble	1024 Oak St.	Ogden, Utah
SOUTHEASTERN DIVISION				
Alabama	W4GBV	Lawrence J. Smyth	808 Winona Ave.	Montgomery
Eastern Florida	W4IP	Robert B. Murphy	3302 S.W. Grapeland Blvd.	Miami 33
Western Florida	W4MS	Lt. Edward J. Collins	1409 N. 10th Ave.	Pensacola
Georgia	W4HYW	Thomas M. Moss	570 Oak Drive	Hapeville
West Indies (Cuba)				
(Puerto Rico-Virgin Islands)*	K4KD	Everett Mayer	P. O. Box 1061	San Juan 5, P. R.
SOUTHWESTERN DIVISION				
Los Angeles	W6OWZ	Ben W. Onstenk	9631 3rd Ave.	Inglewood
Arizona*	W6MLL	Gladden Elliott	P. O. Box 424	Tombs-tonc
San Diego	W6CHV	Ralph H. Culbertson	7172 Eads St.	La Jolla
WEST GULF DIVISION				
Northern Texas	WSALA	Jack T. Moore	4529 Fairway Ave.	Dallas 4
Oklahoma	WSAYL	Ed Oldfield	2141 N.W. 35th St.	Oklahoma City 6
Southern Texas	WSJC	James B. Rives	1721 Kentucky Ave.	San Antonio 1
New Mexico	WSHJF	J. G. Hancock	110 S. E. Nevada St.	Portales
MARITIME DIVISION				
Maritime	VE1DQ	A. M. Crowell	69 Dublin St.	Halifax, N. S.
ONTARIO DIVISION				
Ontario	VE3EF	Dr. Donald R. Gunn	1007 Lakeshore Road	New Toronto, Ont.
QUEBEC DIVISION				
Quebec	VE2CO	Lieutenant L. G. Morris	4114 Hingston Ave.	Montreal 28, Que.
VANALTA DIVISION				
Alberta	VE4GE	C. S. Jamieson	581 W. Riverside Drive	Drumheller, Alta.
British Columbia	VE5DD	C. O. I. Sawyer	2634 West 31st Ave.	Vancouver
PRAIRIE DIVISION				
Manitoba	VE4AW	A. W. Morley	26 Lennox St.	St. Vital
Saskatchewan	VE4SY	Arthur Chesworth	1084 Redland Ave.	Moose Jaw

*Officials appointed to act temporarily in the absence of a regular official.

BUILD REAL ARMY-NAVY EFFICIENCY INTO YOUR NEW RIG

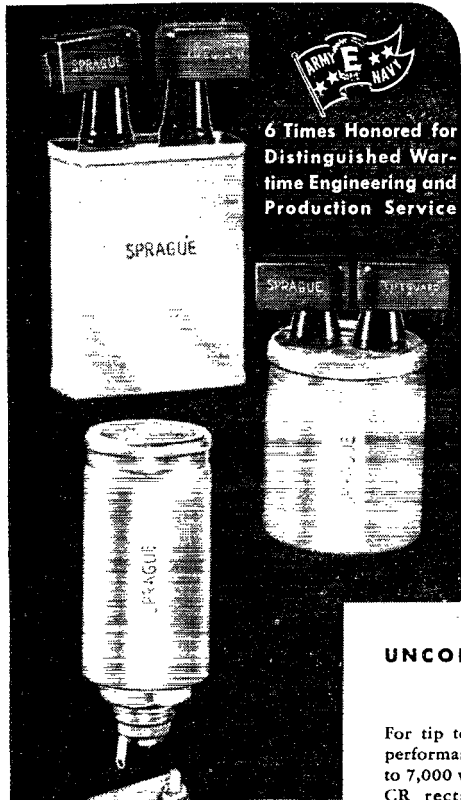

6 Times Honored for Distinguished War-time Engineering and Production Service

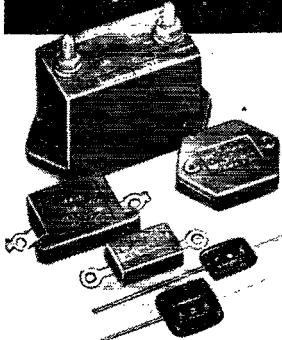

FIXED MICA CAPACITORS

... all shapes, all types—each one constructed of the finest materials, to unsurpassed quality standards.

SMALLER

INEXPENSIVE

MADE WITH NEW SPRAGUE K.V.O.

A WARTIME RESEARCH IMPROVEMENT

(KILO VOLT OIL)

Those who were in communications and similar services during the war found plenty of their old friends, Sprague Capacitors, in all types of equipment—from radio to radar, from the VT radio-controlled fuze to the atom bomb. And they found many new and unusual types—types whose unique engineering features are reflected in every Sprague Transmitting and Mica Capacitor now offered to put real efficiency into your new peace time rig. See them at leading distributors' stores. Write for new catalog, just off the press.

UNCONDITIONALLY GUARANTEED—EQUIPPED WITH LIFEGUARD TERMINAL CAPS

For tip top Transmitting Capacitor performance on any circuit from 600 to 7,000 volts, the new Sprague Type CR rectangulars with universal mounting feature will beat anything you ever tried before—at any price. The OT round can types ranging from 600 to 3,000 volts are smaller, better than ever before, and give you a whale of a lot of capacitor for surprisingly little money. Where the call is for inverted round can units, you'll be more than pleased with the compactness, all around efficiency

and low cost of the Sprague PC Type which comes in all popular capacities and in voltages from 600 to 1500 volts.

All are unconditionally guaranteed against breakdown when used as specified—because all are filled (not just impregnated) with **K. V. O.**

All are supplied at no extra cost with famous Sprague LIFEGUARD SAFETY CAPS on the terminals for your physical protection. No chance of getting hold of a "hot one" here. It pays to play safe!

SPRAGUE

SPRAGUE PRODUCTS CO., North Adams, Mass.

Member Sales Organization for Products of Sprague Electric Co.

...100% Guaranteed

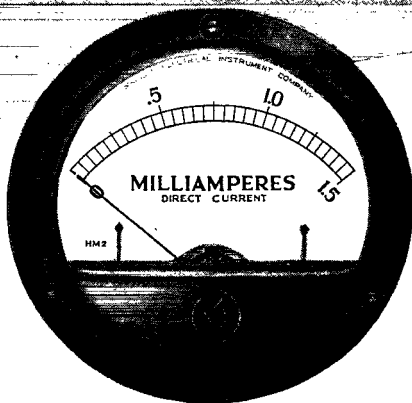

Marion Glass-to-Metal Truly Hermetically Sealed Electrical Indicating Instruments are 100% guaranteed for six months. After this period we will replace any 2½" or 3½" type, ranging from 200 microamperes upward, for a flat fee of \$1.50, regardless of whether the instrument has been overloaded, burned out, or in any way mistreated, provided the seal has not been broken. We will replace, for a flat fee of \$2.50, any 2½" or 3½" instrument, with sensitivity greater than 200 microamperes, under similar circumstances.

An important blanket guarantee...

For the user of electrical indicating instruments, this guarantee is highly significant. It precludes the need for him to maintain his own repair department, and it minimizes the correspondence and red tape that formerly enmeshed most replacement transactions. Moreover, he is assured of receiving his replacement within a reasonably short period at a saving of considerable time and money. It is our faith in the quality and performance of Marion "hermetics" that prompts us to make this guarantee which is offered to customers in all parts of the world. You can buy and use them with confidence.

**Marion Glass-to-Metal Truly Hermetically Sealed
2½" and 3½" Electrical Indicating Instruments**

Ready soon — the new Marion Catalog, containing information of value to all users of electrical indicating instruments. Reserve your copy now.



MARION ELECTRICAL INSTRUMENT CO.
MANCHESTER, NEW HAMPSHIRE

EXPORT DIVISION

458 BROADWAY • NEW YORK 13, N. Y., U. S. A. CABLES: NORMANEX

NEW RAYTHEON SUB-MINIATURE TUBES for Pocket Receivers

Since 1938 Raytheon has pioneered in the design, development, and production of small, low drain, long life tubes. These have helped to make possible the modern extremely compact hearing aid.

Now for Radio Receivers — Now Raytheon announces a physically similar kit of flat style, sub-miniature tubes for radio receiver applications. Included is a shielded RF-pentode amplifier, a triode-heptode converter, a diode-pentode detector-amplifier and an output pentode for earphone operation.

Much Smaller Radios Possible — These tubes make it possible to construct radios a fraction the size of prewar "personals," with sensitivity rivaling much larger sets.

The ratio of performance to battery drain is maintained very high, thus assuring the maximum possible operating life from the small size batteries now available.

The line consists of tubes approximately $1\frac{1}{8}$ " long x 0.3" x 0.4" in cross section. Each type is available with pins for use with small commercially available sockets as illustrated, or may be had with long flexible leads for wiring the tube directly into the circuit.

No progressive radio manufacturer will overlook the tremendous possibilities inherent in the small pocket receiver — built around the new Raytheon sub-miniature tubes. But call on Raytheon for every tube need — large or small — for the finest in engineering, production and performance.

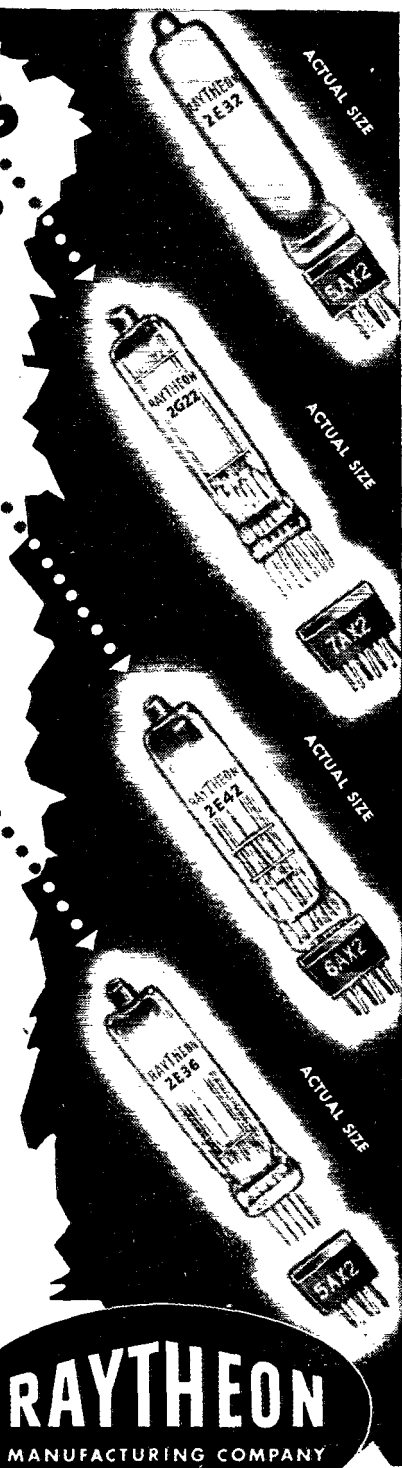

ELECTRICAL CHARACTERISTICS

	2E31†	2G21†	2E41†	2E35†
	2E32*	2G22*	2E42*	2E36*
	Shielded RF Pentode	Triode-Heptode	Diode-Pentode	Output Pentode
Filament Voltage	1.25 V	1.25 V	1.25 V	1.25 V
Filament Current	50 ma	50 ma	30 ma	30 ma
Max. Grid-Plate Capacitance	0.018 μuf	0.065 μuf†	0.10 μuf	0.2 μuf
Plate Voltage**	22.5 V	22.5 V	22.5 V	22.5 V
Screen Voltage	22.5 V	22.5 V	22.5 V	22.5 V
Control Grid Voltage*	0	0	0	0
Osc. Plate Voltage	—	22.5 V	—	—
Plate Current	0.35 ma	0.2 ma	0.4 ma	0.27 ma
Screen Current	0.3 ma	0.3 ma	0.15 ma	0.07 ma
Osc. Plate Current	—	1.0 ma	—	—
Transconductance	500 μmhos	60 μmhos (Gc)	400 μmhos	385 μmhos
Plate Resistance	0.35 meg	0.5 meg##	0.25 meg	0.22 meg

*With 5 megohm grid resistance connected to F—. **Higher voltage operation is possible, as shown on engineering characteristics sheet available by request.

†Flexible lead Types.

##Plug-in Types.

##Approximate conversion Rp.

‡Signal grid to mixer plate Capacitance



Radio Receiving Tube Division
NEWTON, MASSACHUSETTS • LOS ANGELES
NEW YORK • CHICAGO • ATLANTA

EXCELLENCE IN ELECTRONICS

THE AMERICAN RADIO RELAY LEAGUE, INC.,

is a noncommercial association of radio amateurs, bonded for the promotion of interest in amateur radio communication and experimentation, for the relaying of messages by radio, for the advancement of the radio art and of the public welfare, for the representation of the radio amateur in legislative matters, and for the maintenance of fraternity and a high standard of conduct.

It is an incorporated association without capital stock, chartered under the laws of Connecticut. Its affairs are governed by a Board of Directors, elected every two years by the general membership. The officers are elected or appointed by the Directors. The League is noncommercial and no one commercially engaged in the manufacture, sale or rental of radio apparatus is eligible to membership on its board.

"Of, by and for the amateur," it numbers within its ranks practically every worth-while amateur in the nation and has a history of glorious achievement as the standard-bearer in amateur affairs.

Inquiries regarding membership are solicited. A bona fide interest in amateur radio is the only essential qualification; ownership of a transmitting station and knowledge of the code are not prerequisite, although full voting membership is granted only to licensed amateurs.

All general correspondence should be addressed to the Secretary at the administrative headquarters at West Hartford, Connecticut.



Past Presidents

HIRAM PERCY MAXIM, W1AW, 1914-1936
EUGENE C. WOODRUFF, W8CMP, 1936-1940

Officers

President.....GEORGE W. BAILEY, W1KH
Washington, D. C.

Vice-President

Secretary.....KENNETH B. WARNER, W1EH
West Hartford, Connecticut

Communications Manager.....F. E. HANDY, W1BDI
West Hartford, Connecticut

Treasurer.....DAVID H. HOUGHTON
West Hartford, Connecticut

General Counsel.....PAUL M. SEGAL
1026 Woodward Building, Washington 5, D. C.

Directors

President
GEORGE W. BAILEY.....W1KH
1530 P St., N.W., Washington 25, D. C.

Vice-President

Canadian General Manager

ALEX REID.....VE2BE
240 Logan Ave., St. Lambert, P. Q.

Alternate: Leonard W. Mitchell.....VE3AZ
78 Raglan Ave., Toronto, Ont.

Atlantic Division

EDWARD G. RASER.....W3ZI
315 Beechwood Ave., Trenton 8, N. J.

Alternate: J. Victor Brotherson.....W8BHN
1743 Ottawa Drive, Erie, Pa.

Central Division

JOHN A. KIENER.....W8AVH
3462 Edison Rd., Cleveland Heights,
Cleveland 21, Ohio

Alternate: Earl S. Nelson.....W8DS
22551 Hadden Rd., Euclid 17, Ohio

Dakota Division

TOM E. DAVIS.....W9VVA
915 W. Becker Ave., Willmar, Minn.

Alternate: Harold B. Love.....W9ZRT
Box 426, Mandan, N. D.

Delta Division

GEORGE S. ACTON.....W5BMM
Plain Dealing, La.

Alternate: Samuel H. Dowell.....W5ERV
1057 Mildred St., Shreveport 15, La.

Hudson Division

ROBERT AKERIDGE KIRKMAN.....W2DSY
Werah Pl., R.F.D. No. 1, Box 61, Long Branch, N. J.

Alternate: George Rulffs, Jr.....W2CJY
38 Brookwood Drive, Manhasset, L. I., N. Y.

Midwest Division

FLOYD E. NORWINE, JR.....W9EFC
7405 Hlawatha Ave., Richmond Heights 17, Mo.

Alternate: C. A. Colvin.....W9VLR
C. Omaha & Council Bluffs St. Railway Co.,
Omaha 2, Nebr.

New England Division

PERCY C. NOBLE.....W1BVR
37 Broad St., Westfield, Mass.

Alternate: Clayton C. Gordon.....W1HRC
70 Columbia Ave., Warwick, R. I.

Northwestern Division

KARL W. WEINGARTEN.....W7BG
3219 N. 24th St., Tacoma 7, Wash.

Alternate: R. Rex Roberts.....W7CPY
110 W. Brennan St., Glendive, Mont.

Pacific Division

J. L. McCARGAR.....W6EY
66 Hamilton Pl., Oakland 12, Calif.

Alternate: Elbert J. Amarantes.....W6FBW
1875 Dale Ave., San Jose, Calif.

Roanoke Division

H. L. CAVENESS.....W4DW
2607 Vanderbilt Ave., Raleigh, N. C.

Alternate: J. Frank Key.....W3ZA
Box 707, Buena Vista, Va.

Rocky Mountain Division

Acting Director:
HOWARD R. MARKWELL.....W9TFP
355 Monroe St., Denver 6, Colo.

Southeastern Division

WILLIAM C. SHELTON.....W4ASR
527 Revilo Blvd., Daytona Beach, Fla.

Alternate: William P. Sides.....W4AUP
Fleming Road, Montgomery, Ala.

Southwestern Division

JOHN E. BICKEL.....W6BKY
1834 E. Whittier Blvd., Whittier, Calif.

Alternate: Eldridge E. Wyatt, Jr.....W6ARW
P. O. Box 3597, Long Beach 3, Calif.

West Gulf Division

WAYLAND M. GROVES.....W5NW
c/o Humble Pipe Line Co., Odessa, Texas

Alternate: Jennings R. Poston.....W5AJ
P. O. Box 848, Curundu, Panama Canal Zone

"It Seems to Us..."

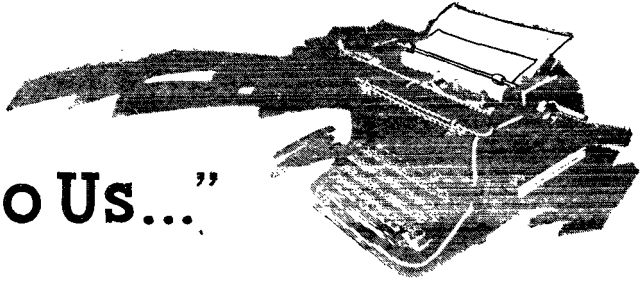

LICENSING RESUMES!

A GAIN WE have the feeling that what we are writing for this page may seem very much "old stuff" by the time it reaches print. But in these closing days of January we have been filled with new pep and fresh enthusiasm by the good news, so long awaited, that FCC is now beginning the issuance of new amateur station licenses.

It has been a long, hard struggle. Both the Commission and ARRL have wanted to see this job done since August, when we first went back on the air. Lack of personnel and funds has made it impossible before this. FCC has had a depleted staff during the war, a condition made doubly difficult by the great growth on which civilian radio immediately embarked with V-J Day. Even when they were given emergency funds, late in the year, they found it impossible to get additional people. It is a sad fact that the war agencies in Washington have done little or nothing toward releasing personnel, and a good stenographer-clerk is almost impossible to obtain at a Government salary. Meanwhile all the peacetime agencies want more and more people: the Veterans Bureau 60,000 of them, the General Accounting Office 3,000, and so on. Much reconversion work is held back by the shortage of help. FCC has earnestly desired to do something for the amateur but their whole establishment is still suffering for adequate people and it promises to be many months before their situation is normal. The relaxation of the proof-of-citizenship order, reported in another column, made enough people available in the FCC offices to make a start on the amateur licensing job. Badly needed as they were throughout the Commission's departments, FCC has permitted them to be diverted as a block to the amateur unit, and so a beginning is made. And that, it seems to us, is a very pretty testimonial indeed to the genuine wish of the Commissioners and their staff to take care of us amateurs!

As all old station licenses that were valid between Pearl Harbor and September 15, 1942, have been temporarily reinstated, first attention will be given *new* applicants. If you have a pending application for new operator and sta-

tion licenses, it will now be acted upon. If you are an LSPH op-only, you may now apply for a station license — write your district inspector for an amateur application form. If you have been standing by for the resumption of licensing, you may now appear at any field office or other examination point and take the operator exam and apply for a station license, too. If you are one of those unhappy hams whose licenses expired shortly before Pearl Harbor, holding you off the air until now, the way is opened for you to get going again quickly — with your old call, if you're still entitled to it.

Huzzahs, then, and whoops! We're off again! The doors are open, the blanks are in the inspectors' offices. Help us to spread the good word.

As *new* licenses are issued, their calls will be in terms of the new call areas. Thus the first WØ calls you hear will probably be those of brand-new licensees. But the calls of existing stations that are slated to be altered by the new areas will be changed only as the station licenses are *renewed*. Renewing 60,000 licenses is a very big job. It is going to take many months, possibly all this year. It is additional to the task of licensing the many thousands of new applicants who have been waiting for the doors to open. It must be done piecemeal, probably on a geographical basis, state by state. If you are on the air now, you are asked not to rush in with a renewal application, even though you need modification. You're being permitted to operate, so QRX and give the other fellow a break. Our temporary authorization until May 15th unquestionably will be extended. Wait until the Commission indicates that it can entertain your renewal application — which word we shall expect to carry to you in *QST* and via *WIAW*.

But such an indication comes right now for the first two groups of fellows. FCC wishes its first renewing activities to be applied to those whose calls are scheduled to be changed under the new areas — so as to make the new call system effective as soon as possible. We have consulted the FCC staff and find that they are able to entertain renewal applications from the following areas at the following times:

1) During the month of March: Amateurs living in Colorado, Iowa, Kansas, Minnesota, Missouri, Nebraska, North Dakota and South Dakota. In other words, the group whose calls are to be changed, upon renewal, to WØ.

2) During the month of April: Amateurs living in the other areas where calls are to be changed upon renewal, i.e., Alaska, Arizona, Hawaii, Kentucky, W9 Michigan, Nevada, W3 New Jersey, W8 New York, the Pacific possessions, W8 Pennsylvania, Puerto Rico, Utah, Virginia, Virgin Islands.

We suggest that amateurs in the areas enumerated now write their RI for an amateur application blank, Form 610, and file renewal application early during the month indicated. They are asked to pass the word along to other hams in their areas. The rest of us are requested to continue to stand by until further word.

Slowly, bit by bit, the pieces fit together, and the postwar shape of amateur radio begins to be visible. The resumption of licensing was a key piece. Now we have it!

OUR GOOD FREQUENCIES

WE WISH we could say the same thing about our 3.5-, 7- and 14-megacycle bands. They, too, have been dangling just beyond our reach for many months. One has only to live a little on 28 Mc. and up, fun though they be, to realize how utterly handicapped we are in most of our useful work by the delay of the military services in returning our reliable and useful frequencies.

It is a tremendous thrill to hear our friends in allied countries again, particularly the Gs, but we yearn for bands that support something more than an occasional sporadic contact. And we haven't anything yet that permits solid domestic communications at reasonable distances.

The officers of your League are maintaining constant and close contact with this situation under policies laid down by your Board as the result of studies by its Planning Committee. We want you to know that. We also want you to know that in our opinion the military services are doing their level best to cooperate with us. We are not in danger of losing anything, despite the rumors going around, and there is no evidence of deliberate delay or imperialistic aspirations. This has been a very huge war and the situation is not at all a simple one. It is not the mere matter of vacating amateur bands; the military have occupied the channels of many commercial services as well, and they too must be returned. The structures that have been built up are very large and it takes time to tear them down in an orderly manner. The military systems are world-wide and the military arrangements between the

allied nations leave no country free to move alone. On the contrary, they must make joint determinations on many continuing problems throughout the world — problems that require the continued use of frequencies. Yes, we know that things seem to move awfully slowly, that there seems to be too much duplication, and that by listening in you can't gather that any important use is being made of our bands. It's just a question of timing, OM. Our Navy is reported substantially ready to return our frequencies, and Canada is said to be ready to join the United States any instant. Our Army's position has been more difficult, both because of its bigger structure and because of the overwork and confusion introduced by too rapid demobilization. But progress is being made, definitely. The attitude of the services toward us is all you could wish. They are working hard, shifting frequencies, shipping crystals around, scheduling dates by which they move out of hunks of our bands and blocks of commercial channels. Remember that the League is working on this problem every day and is doing everything it is desirable to do at this stage. It may seem a long, long time but the bands are coming back, and in fact we hope to have some good news for you — via WIAW — by about the time this *QST* reaches you. To get good news fast, make it a habit to tune in WIAW nightly. And shove along your station plans — get that rig ready!

Asbury



Lieutenant Arthur G. Bauernfeind, W8SWG, tells us that he found W8WNN's 1943 *Handbook* on the old transport *SS Alamo* when he decommissioned that vessel recently near Manila.

— — —

FEEDBACK

McCormick, "A Small Oscilloscope Using the 913," January, page 33. In Fig. 1, the lead from R_{15} should go to point 3 of S_2 instead of to point 4 as shown, and the lead from C_{12} to the arm of S_2 should not connect to point 4 of S_2 but only to the rotor arm of S_2 .

Our draftsman slipped a notch in labeling the ordinates in Fig. 1, "Premodulation Speech Clipping and Filtering," February *QST*, with the result that the articulation curves rise above 100 per cent. The ordinates should start at zero, ending with 100 per cent at the top. W6BCX also writes that the rectifier in the clipper circuit is a 6AL5, not a 6AL6 as indicated in Fig. 2 and in the text.

A Low-Power 28-Mc. 'Phone-C.W. Transmitter

Complete Equipment for the Beginner on 10

BY DONALD MIX, * W1TS

• The various units pictured in this article, together with the simple receiver described in the preceding issue of *QST*, constitute a complete 10-meter station from power supply to antenna. The equipment was designed primarily from the viewpoint of the beginner. While it is not the least expensive, nor the simplest which might be built, it is considered to represent minimum requirements for satisfactory performance in the hands of the average inexperienced operator.

The modulator is built as a separate unit which may be omitted if c.w. operation only is desired, or its addition may be deferred until later. The transmitter power-supply unit is terminated in such a way that it may be used to operate the receiver as well, through the switching system shown. With the power supply described, the transmitter will handle an input of 40 watts or more, 'phone or c.w.

IT IS MORE or less to be taken for granted that equipment for the beginner's first venture into the ham game ought to be designed to keep the cost at a minimum, since most neophytes are from the younger group to whom ready cash does not come too easily. Also it is assumed that the average youngster in his teens is not equipped to undertake a complicated job of assembly and wiring; therefore the apparatus should be kept as simple as possible constructionally. However, it has always seemed to us that these considerations can too easily be stressed disproportionately, overlooking the perhaps even more important point that the gear should be capable of satisfactory performance in inexperienced hands. The two-tube regenerative receiver and the simple

one-tube crystal-oscillator transmitter, often suggested for the beginner's station, are examples of equipment from which even an experienced operator sometimes has considerable difficulty in obtaining more than mediocre results, particularly at 28 Mc. where tolerances are much narrower than at lower frequencies.

While there are, of course, such things as 10-meter crystals, they are none too reliable and because they are relatively fragile, oscillators using them must be very limited in power output. In addition, even at lower frequencies, a simple crystal oscillator is not an easy thing to adjust so that it will deliver a reasonable amount of power to an antenna. To obtain reliable starting of the crystal and anywhere near decent keying characteristics, the plate circuit must be loaded lightly and detuned critically to a point so far off

* Assistant Technical Editor.

Panel view of the transmitter. The upper knob to the left controls the metering switch and the one below it is the control for the oscillator plate tuning condenser, C_2 . Below the meter at the center is the doubler tuning condenser, C_3 . The knob for tuning the 807 output circuit and the key jack are to the right. The 807 plate blocking condenser, C_{14} , may be seen in this photograph between the 807 plate r.f. choke and the output coil, L_4 .

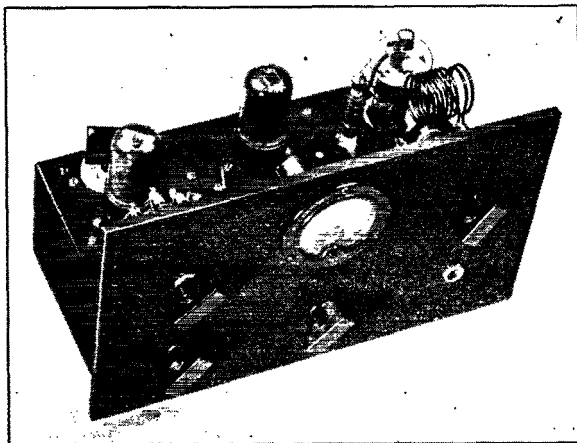

resonance that relatively little power output is obtained. The more complicated circuits, such as the Tri-tet and the grid-plate arrangements, constitute improvements only when a well-screened tube can be used. Another disadvantage is that the simple oscillator cannot be modulated satisfactorily.

An oscillator-amplifier arrangement solves most of these problems, of course. The amplifier may be keyed readily, eliminating fussy oscillator adjustment. Furthermore, the amplifier will handle considerably more power than any crystal oscillator of comparable tube rating. While a few more components are required, construction need not be beyond the capabilities of the average high-school student.

The Transmitter Circuit

The transmitter shown in the photographs is quite straightforward both in circuit and construction. The diagram appears in Fig. 1. It is a three-stage affair consisting of a 6V6GT Tri-tet oscillator controlled by a 7-Mc. crystal, a 6V6GT frequency doubler and an 807 output stage operating as a straight amplifier. The 7-Mc. band was chosen as the starting point since it is the highest frequency for which rugged and reliable ham-band crystals are readily obtainable. L_1C_1 is the customary Tri-tet cathode tank circuit. Its tuning is fixed at a frequency somewhat higher than that of the crystal and, if the coil dimensions given are followed carefully, no ad-

justment should be necessary. Grid bias for the oscillator is obtained from a combination of cathode resistor, R_1 , and grid leak, R_2 . Experience has shown that this arrangement results in better crystal starting and lower crystal current than with either biasing method alone. The oscillator plate tank circuit, L_2C_2 , is tuned to 14 Mc., the second harmonic of the crystal frequency.

The output of the oscillator is coupled to the grid of the frequency-doubler stage by the capacitance of the coupling condenser, C_3 . Bias for this stage is obtained from the grid leak, R_6 . The doubler plate tank circuit, L_3C_3 , is tuned to 28 Mc.

Capacitance coupling is used also between the doubler and final-amplifier stages, C_{12} being the coupling condenser. The v.h.f. choke, RFC_2 , in conjunction with the resistor R_{12} in the screen lead of the 807 is used to suppress undesired parasitic oscillation in this stage. Grid bias is obtained from the grid leak, R_{10} . The output tank circuit, L_4C_4 , is tuned to the same frequency as the doubler circuit, 28 Mc., of course. Coupling to the antenna transmission line is provided by the link winding, L_5 .

Both the doubler and final stages are keyed simultaneously in the cathode circuits, which makes it unnecessary to provide fixed bias for the two tubes to hold the plate current to a safe value in the case of removal of excitation as would occur with oscillator keying.

Parallel plate feed through r.f. chokes is used in

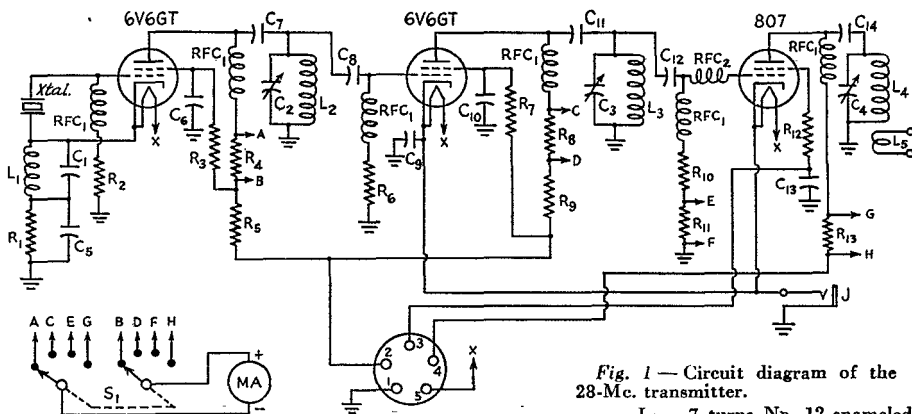

Fig. 1 — Circuit diagram of the 28-Mc. transmitter.

- C_1 — 100- μ fd. mica.
- C_2, C_3 — 35- μ fd. (National ST35).
- C_4 — 35- μ fd. variable, 0.07-inch spacing (Hammarlund MC-35SX).
- C_5, C_6, C_9, C_{10} — 0.01- μ fd. paper.
- C_7, C_{11}, C_{14} — 0.001- μ fd. mica.
- C_8, C_{12} — 0.0001- μ fd. mica.
- C_{13} — μ fd. mica.
- R_1 — 200 ohms, 1 watt.
- R_2 — 50,000 ohms, $\frac{1}{2}$ watt.
- R_3 — 12,000 ohms, 1 watt.

- $R_4, R_5, R_{11}, R_{12}, R_{13}$ — 50 ohms, $\frac{1}{2}$ watt.
- R_6, R_9 — 5000 ohms, 5 watts.
- R_7 — 40,000 ohms, $\frac{1}{2}$ watt.
- R_8 — 40,000 ohms, 5 watts.
- R_{10} — 15,000 ohms, $\frac{1}{2}$ watt.
- L_1 — 9 turns No. 20 d.c.c., 1 inch diameter, 1 inch long.
- L_2 — 13 turns No. 20 d.c.c., 1 inch diameter, 1 inch long.
- L_3 — 5 turns No. 12 enameled, $1\frac{1}{2}$ inch diameter, turns spaced the diameter of the wire.

- L_4 — 7 turns No. 12 enameled, $1\frac{1}{2}$ inch diameter, turns spaced the diameter of the wire.
- L_5 — 5 turns insulated wire $1\frac{1}{2}$ inches in diameter, close-wound.
- RFC_1 — 2.5-mh. r.f. choke (National R100U).
- RFC_2 — Parasitic choke, 11 turns No. 20 bare, $\frac{9}{16}$ inch diameter, $\frac{3}{4}$ inch long.
- S_1 — 2-gang, 4-position rotary switch (Mallory).
- MA — Milliammeter, 100-ma. scale, 2-inch.
- J — Closed-circuit jack.

This photograph shows the top of the chassis from the rear with the 807 and its plate tank circuit to the left, the doubler tube in the center and the oscillator tube and crystal to the right. The 807 plate choke may be seen just to the right of the 807. The blocking condenser, C_{14} , is behind the tube. It is soldered directly between the stator terminal of C_4 and the top terminal of the r.f. choke.

The meter and metering switch are mounted on the panel. The plug at the rear is for power connections.

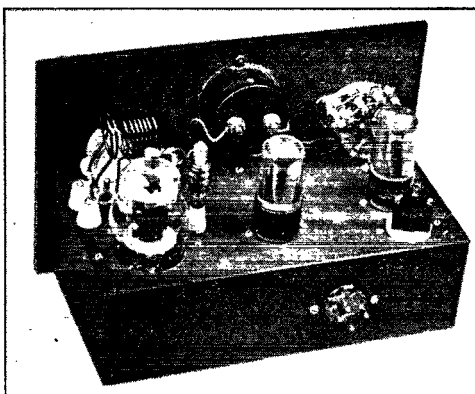

all stages of the transmitter so that the tuning condensers, C_2 , C_3 and C_4 , may be mounted directly on the metal chassis without insulation. The unit operates from a single 475-volt power supply. This voltage is dropped to 250 for the plates of the 6V6GTs by the resistors R_6 and R_9 . Additional drop for the screens, which are operated at 200 volts, is obtained from the screen resistors, R_3 and R_7 .

The milliammeter may be switched to read oscillator plate current, doubler plate current and final-amplifier grid or plate current by means of S_1 . Instead of inserting the milliammeter in series with each lead, which would require a complicated switch, the meter is connected successively across a 50-ohm resistor in each lead. These resistors, R_4 , R_8 , R_{11} and R_{13} are sufficiently low in value to cause negligible voltage drop and yet the resistance is high enough to have no appreciable effect upon the meter reading when connected in shunt.

Transmitter Construction

Metal construction has become practically universal in amateur equipment building. Assemblies on standard metal chassis have the advantages of greater mechanical strength, good appearance and, of more importance, shielding and the means for making good ground connections — both of which are essential for modern high-gain tubes — are provided.

Most of the details are visible in the photographs and the chassis-plan sketch of Fig. 2. The large holes are most easily made by means of socket punches, one of the most useful of tools in radio-equipment building. Two types are on the market. One operates by the turning of a pressure bolt with a wrench while the other type works by a blow from a hammer. The first type usually is considered preferable. If the beginner does not wish to purchase one or two punches, often it is possible to borrow them from a radio service shop, or the service man may be induced to do the job for a reasonable sum. If a punch for the larger

hole for the 807 is not available, it can be made by filing out after using the socket punch. Large holes also may be cut with an adjustable circle cutter, sometimes called a fly cutter, clamped in a carpenter's brace. This also is the best way to cut the meter hole in the panel. Small holes are made easily with a hand drill. The only holes not shown in Fig. 2 are those for fastening the tube sockets in place. These may be marked simply by placing the sockets in position after the large center hole has been punched. The oscillator socket is mounted with the keying notch to the right, while the doubler socket notch is to the left, both as viewed from the top.

The oscillator stage is at the left and the doubler stage is at the center. The tuned tank circuits of both of these stages are mounted underneath the chassis, while that of the output stage is on top. In this way good shielding between the input (L_2C_3) and output (L_4C_4) circuits of the output stage is provided. This is necessary to prevent this stage from operating as a tuned-grid tuned-plate self-excited oscillator, since both circuits are tuned to the same frequency. Since the tank circuits of the two preceding stages are not tuned to the same frequency, complete isolation is not necessary. However, it is usually advisable to take the precaution of good separation between coils to prevent couplings which might be the cause of self-oscillation at other frequencies or other erratic behavior of the circuits. It will be noted from the bottom-view photograph that the doubler coil, L_3 , is mounted at right angles to the oscillator plate and cathode coils, L_2 and L_1 . Both tuning condensers, C_2 and C_3 , are fastened directly to the chassis.

The socket for the 807 is spaced below on brackets to bring the bottom of the socket just inside the lower edge of the chassis. In the case of the Millen socket which was used in this instance, the brackets are $2\frac{1}{4}$ inches long. The socket is lowered to provide shielding between the input and output sections of the 807. The socket is orientated so that the No. 3 terminal is at the top

as viewed in the bottom-view photograph. The tank condenser for the final stage is mounted on top of the chassis on $\frac{1}{4}$ -inch metal spacers to bring its shaft even with the shaft of the meter switch, S_1 , on the panel. In addition to the coil, the only other output-stage components mounted on top of the chassis are the 807 plate-circuit r.f. choke and the blocking condenser, C_{14} . The latter is soldered directly between the top terminal of the r.f. choke and the nearest stator terminal of the tank condenser. A short lead connects the plate cap of the 807 to the upper terminal of the r.f. choke.

The panel shown in the photographs is made of $\frac{1}{4}$ -inch crystalline-finished Presdwood, but it may be made of $\frac{1}{16}$ -inch steel if desired. Important dimensions are shown in Fig. 2. The shafts of

all tuning condensers extend through to the front of the panel, of course, so that the holes for the shafts of C_3 , C_4 and the jack, J , in the front of the panel must be duplicated in the chassis.

The bottom-view photograph may create an impression of complication underneath the chassis, but the constructional problem is chiefly that of assigning suitable space to the several small components. One end of each by-pass condenser should connect to the terminal to be by-passed with as short a lead as possible, while the other should connect to the chassis at the nearest convenient point. Soldering lugs fastened under the socket-mounting screws are useful for this purpose. All 2.5-mh. r.f. chokes are of the type which mounts vertically from the chassis on small stand-off insulators since they fit better into the avail-

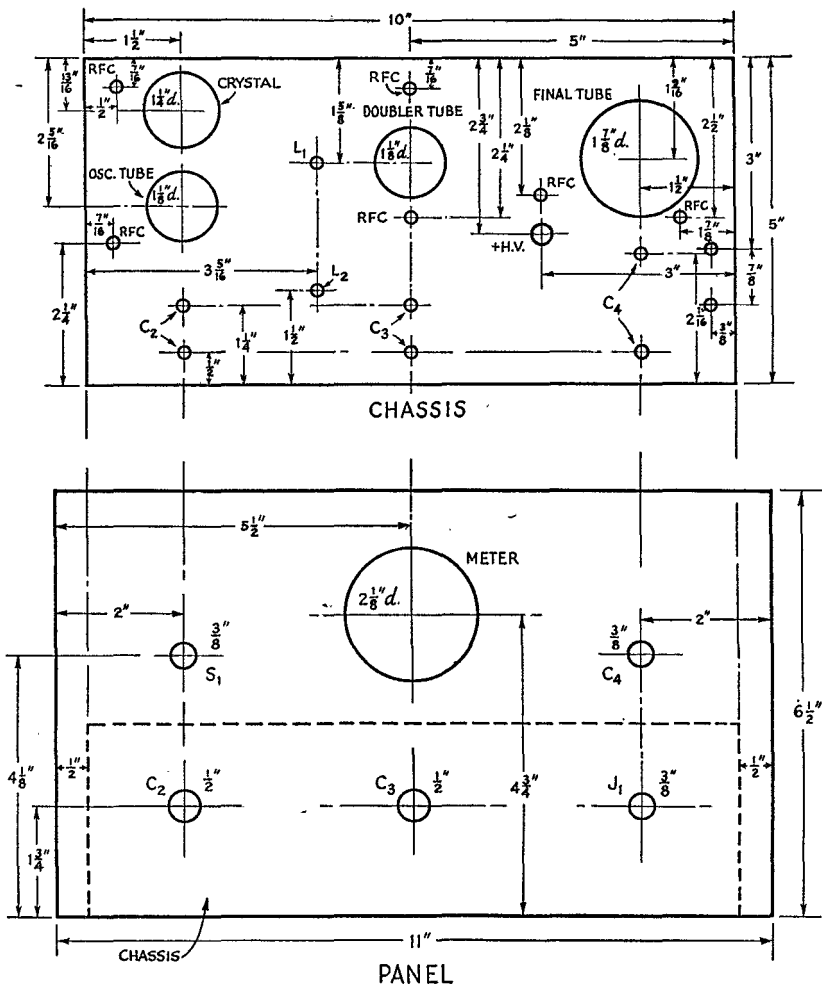

Fig. 2 — Panel and chassis layouts for the 10-meter transmitter. The upper sketch shows the top of the chassis, the lower sketch the front of the panel with the chassis outlined in dashed lines.

able space than the unmounted type which is usually suspended horizontally. The coupling condenser, C_8 , should be connected as directly as possible between the preceding tank circuit and the grid of the following tube. Likewise, the plate blocking condensers, C_7 and C_{11} , should be connected with the shortest leads between the plate terminal of the preceding tube and the following tank circuit. The only exception to this is in the last coupling condenser, C_{12} , where the parasitic r.f. choke, RFC_2 , must be inserted in series in the grid lead. This choke is wound around a $\frac{1}{4}$ -inch diameter form. When the coil is removed from the form, it should expand to the correct diameter. The turns are then spaced out to the required length by stretching the coil slightly. The dimensions given are fairly critical. The parasitic suppressor resistor, R_{12} , in the screen lead is important. It should be placed close to the 807 screen terminal with the by-pass condenser, C_{13} , connected with short leads.

The placement of resistors is not so important, since they are not a part of the r.f. circuit and therefore the length of their connecting leads is not important. In cases where it is necessary to support their terminals to prevent contact with the chassis, fibre soldering-lug strips, some of which may be seen in the bottom-view photograph, may be used. The metering resistors, R_4 , R_8 , R_{11} and R_{13} , are most conveniently mounted on the meter switch, S_1 , where they may be seen in the rear-view photograph.

The oscillator coils, L_1 and L_2 , are wound on Millen 1-inch diameter forms. After the turns are spaced out to the correct length, they should be

cemented in place with Duco waterproof cement, or preferably with a good low-loss coil cement. The cathode tank condenser, C_1 , is soldered directly across the terminals of the cathode coil. A hole is drilled in the center of the bottom of the coil form and the form is fastened to the chassis by a brass machine screw, spacer and nut to space the bottom of the form $\frac{1}{2}$ inch away from the chassis.

The doubler plate coil, L_3 , and the output tank coil, L_4 , are wound with heavy wire both to reduce the r.f. resistance and to provide mechanical strength so that the losses of coil forms need not be introduced. Both are wound around a 1-inch form so that the diameter expands to $1\frac{1}{2}$ inch after they are removed from the form. The forms for the oscillator coils may be used for this purpose before they are wound. Sufficient length of wire should be left at the coil ends so that they may be soldered directly to the tuning-condenser terminals. L_3 should be equally spaced from the tuning condenser and the sides of the chassis. The antenna-coupling coil, L_5 , is wound in the same manner as L_3 and L_4 , and is mounted on half-inch stand-off insulators.

Push-back wire is used for the power-supply circuits, which include the wiring to the meter and switch. Wherever possible, the wiring should be bunched together and kept down close to the chassis. The high-voltage line for the 807 is brought up through the chassis through a $\frac{1}{4}$ -inch hole, lined with a rubber grommet, to the lower terminal of the r.f. choke. Care should be taken in wiring the switch so that the meter is switched in logical order to read in succession, from left to

Bottom view of the transmitter. To the left in line are the oscillator tuning condenser, C_2 , tube and crystal socket. The grid-circuit choke is to the left of the crystal socket and the plate choke to the left of the tube socket. To the right are the two oscillator coils, L_1 below and L_2 above. The plate blocking condenser, C_7 and the coupling condenser, C_8 , are on edge with C_7 just below the tuning condenser and C_8 just below L_2 .

The doubler tuning condenser and coil, C_3 and L_3 , and the doubler tube socket are at the center.

The blocking condenser, C_{11} , is soldered between the tube plate terminal and the stator of C_8 . The plate r.f. choke is below the tube socket and the grid choke just below the tuning condenser.

The 807 socket is in the lower right-hand corner, mounted on spacing brackets. The parasitic choke, RFC_2 , is connected directly to the grid terminal with the coupling condenser, C_{12} , and the grid r.f. choke connecting to the other end of RFC_2 . The 807 grid leak is in the upper right-hand corner, supported on fibre lug strips.

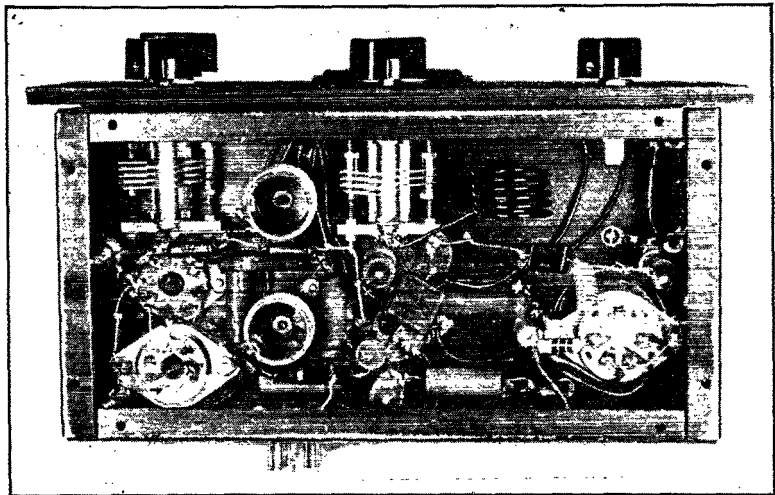

right, oscillator plate current, doubler plate current, final-amplifier grid current, and plate current.

The r.f. wiring — that is, the wiring connecting the coils and condensers and the grid and plate

choke input. R_1 is a bleeder resistor whose chief function is that of discharging the filter condensers. R_2 is a voltage divider for obtaining 250 volts for the screen of the 807, while R_3 is a voltage-dropping resistor for the receiver. Cables

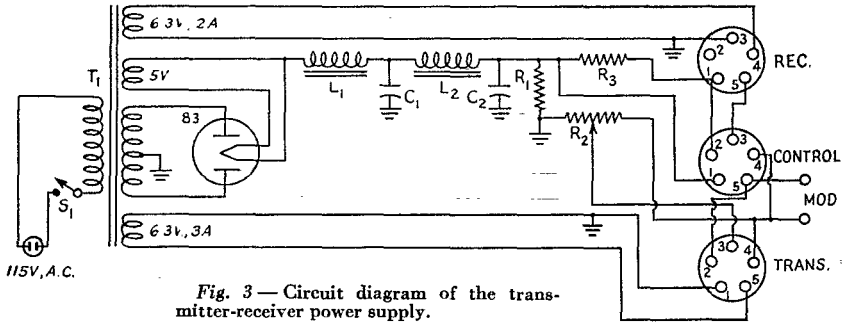

Fig. 3 — Circuit diagram of the transmitter-receiver power supply.

- C_1, C_2 — 8- μ fd electrolytic, 600-volt, high-surge.
- R_1 — 50,000 ohms, 10 watts.
- R_2 — 20,000 ohms, 75 watts, tapped at 4000 ohms from positive end.
- R_3 — 12,000 ohms, 25 watts.
- S_1 — S.p.s.t. toggle.

- T_1 — Transformer, 600 volts each side of center, 200 ma., 5 volts, 3 amp., 6.3 volts, 2 amp., 6.3 volts, 3 amp. (UTC S41).
- L_1 — 5/25-h. swinging filter choke, 200 ma. (UTC S32).
- L_2 — 15-h. smoothing filter choke, 200 ma. (UTC S31).

terminals of the tubes — is done with No. 14 wire run as directly as possible between terminals. This part of the wiring should be kept well spaced from the chassis and from other wiring.

Power Supply

The circuit diagram of the power supply appears in Fig. 3. The transformer, T_1 , has two 6.3-volt filament windings so that separate windings may be used for the receiver and transmitter. L_1C_1 and L_2C_2 comprise a two-section filter with

to the receiver, transmitter and control panel plug into the power-supply unit as indicated in Fig. 3.

The unit is built on a 6 by 14 by 3-inch chassis. The power transformer, filter chokes and condensers are mounted in an inverted position with their terminals protruding through cut-outs in the chassis. Those for the choke terminals are made by punching two overlapping holes with a socket punch. The larger opening for the transformer is made by using the socket punch in the four corners and cutting out the center with a hacksaw. Socket-punch holes are required also for the rectifier-tube socket and the three output sockets in the front edge of the chassis.

The placement of components is not at all critical and no particular care in wiring is required other than to make sure that there are no exposed spots in the wiring which might cause an accidental short-circuit. The three resistors should be mounted so as to allow plenty of air space around each unit. The two screw terminals at the left-hand end of the chassis are for connecting the output of the modulator.

The Modulator

The modulator and its power supply are combined on an 8 by 17 by 3-inch chassis. The modulator components occupy the right-hand end of the chassis, the left-hand end containing the power supply. In the diagram of Fig. 4, a 6J5 speech amplifier for the single-button carbon microphone is transformer-coupled to a pair of 6L6s operating as Class- AB_1 amplifiers. The output will run about 20 watts maximum normally. Potentiometer, R_1 , in the grid circuit of the 6J5 con-

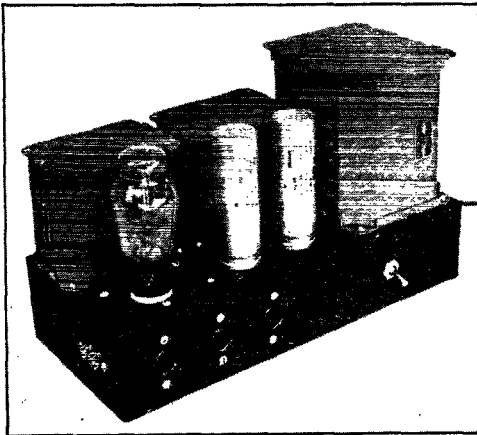

The power supply for the transmitter and receiver. The transformer, T_1 , is to the right, with the filter chokes, L_1 and L_2 , along the rear and filter condensers, C_1 and C_2 , and the rectifier tube in front. Along the front edge of the chassis are the three outlets and the on-off switch, S_1 , Fig. 3. The terminals at the left are for modulator-output connections.

Bottom view of the transmitter-receiver power supply, showing the terminal cut-outs and the voltage-dropping resistors. The filter-condenser terminals are in the lower center.

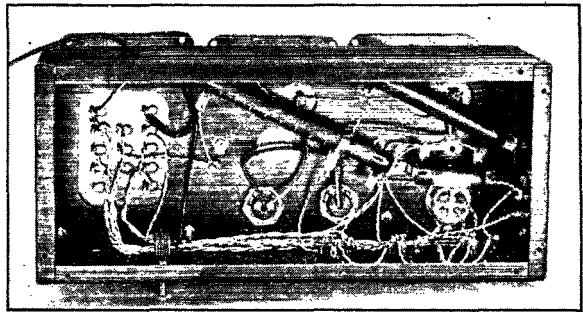

trols the gain. R_2 and R_3 are biasing resistors. A screen voltage of 270 for the 6L6s is obtained from a voltage divider consisting of R_4 and R_6 . The voltage is further reduced to 250 volts for the plate of the 6J5 by R_5 which acts also as a decoupling resistor.

The modulator power supply is similar to the one for the transmitter, except that the output voltage is lower, 360 volts under load. S_1 is the power switch.

At the right-hand end of the chassis in line are the microphone transformer, T_1 , the 6J5 and the interstage transformer, T_2 . The 6L6s are in line to the left with the output transformer, T_3 , alongside. The microphone jack and gain control are mounted in the front edge of the chassis. The input and output leads of each transformer are passed down through the chassis via $\frac{3}{16}$ -inch

holes lined with rubber grommets. The leads from the gain control to the grid of the 6J5 should be kept as short as possible and should be shielded with a short length of copper braid. Plenty of room will be found underneath the chassis for resistors and by-pass condensers. A 4.5-volt dry battery is required for the microphone.

In the power-supply section, a cut-out similar to those made in the transmitter power-supply chassis is required for the transformer. The filter chokes are mounted underneath against the front and back edges of the chassis. A line switch in front and audio output terminals at the rear complete the construction of this unit.

Control Box

The control system, whose diagram appears in Fig. 5, is arranged so as to take care of, with one

control, all of the required circuit changes in shifting from transmitting to receiving positions. With the switch thrown to the left, plate voltage is applied to the transmitter, the modulator output is short-circuited for c.w. operation and the plate voltage is removed from the mixer stage in the receiver to reduce the sensitivity for good monitoring of the transmitter signal. Simultaneously, the antenna transmission line is switched from the receiver to the transmitter. When the switch is thrown to the right, the same applies, except that the short-circuit is removed from the modulator output for 'phone work. In the central position plate voltage is removed from the transmitter, voltage is applied to the mixer for full receiver operation, and the antenna is connected to the receiver.

The switch, together with the necessary terminals for

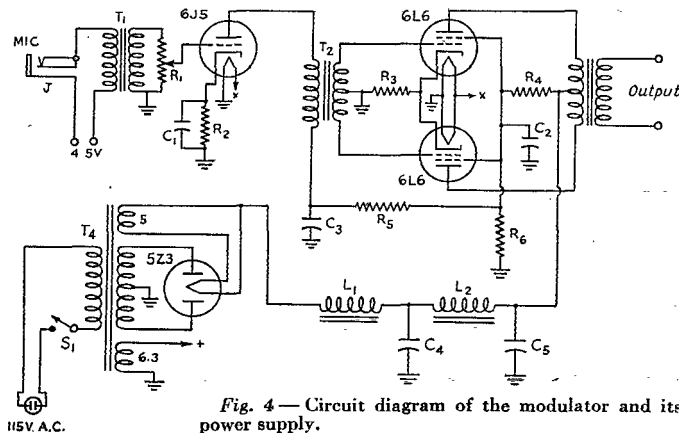
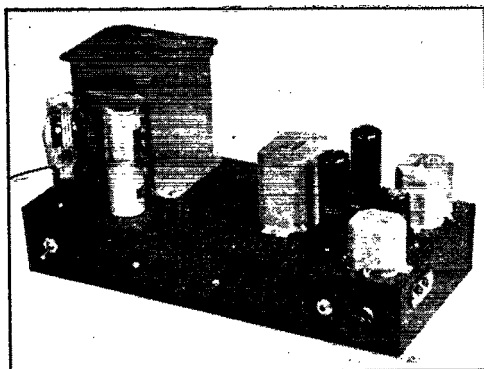

Fig. 4—Circuit diagram of the modulator and its power supply.

- C_1 — 25- μ fd., 25-volt electrolytic.
- C_2, C_3 — 8- μ fd., 450-volt electrolytic.
- C_4, C_5 — Section of dual 8- μ fd., 600-volt electrolytic.
- R_1 — 500,000-ohm potentiometer.
- R_2 — 1500 ohms, 1 watt.
- R_3 — 250 ohms, 10 watts.
- R_4 — 2500 ohms, 10 watts.
- R_5 — 10,000 ohms, 1 watt.
- R_6 — 10,000 ohms, 10 watts.
- L_1 — 5/25-h. swinging filter choke, 225 ma. (UTC S32).
- L_2 — 15-h. smoothing filter choke, 225 ma. (UTC S31).

- T_1 — Single-button microphone to grid transformer (UTC S6).
- T_2 — Single plate to push-pull grids interstage transformer (UTC S7).
- T_3 — Universal output transformer, 30 watts (UTC S19).
- T_4 — 490 volts each side of center, 175 ma., 5 volts, 3 amp., 6.3 volts, 4 amp. (UTC S39).
- J — Open-circuit microphone jack.
- S_1 — S.p.s.t. toggle.



The modulator and its power supply are assembled as a single unit on an 8 × 17 × 3-inch chassis. The microphone jack and gain control are to the right and the power switch is to the left.

connection to the antenna, transmitter output and receiver input, and a plug for the power connections are mounted in a 3 by 4 by 5-inch steel box. Connections between the receiver and transmitter and the control box should be made with the transmission-line material used in the construction of the antenna. The leads should be as short and direct as possible and should be kept away from the power-control cable.

The Antenna

While any of the more-complicated 28-Mc. antenna systems described in *The Radio Amateur's Handbook* and the *ARRL Antenna Handbook* might be used with this equipment, one simple type which requires no tuning or other adjustment will be described. This antenna is known as a folded doublet and is made of Amphenol twin-lead 300-ohm transmission line. A length of 18 feet plus the length of line required to extend from the center of the antenna to the control box will be required.

First, the antenna should be prepared by cutting a length of line 18 feet long. This measurement, and those to follow, should be made accurately. If most of the operation is to be c.w., the insulation should be removed from each end for a distance of 9½ inches, or 12 inches if chiefly 'phone operation is contemplated. This will leave two bare wires at each end of the antenna. These wires should be passed through the hole in the antenna insulator in opposite directions, forming a loop. The ends should now be drawn up until the hole in the insulator is one inch from the end of the insulation. The loop should then be completed by wrapping the ends around the loop wire a few times, soldering and clipping off the excess wire. Thus, the total length of the antenna, when an insulator is attached at each end as described, should be either 16 ft., 7 inches for the c.w. part of the band, or 16 ft., 2 inches for the

'phone portion, including the 1-inch length of loop which fastens the antenna to the insulator.

Next, the exact center of the antenna should be found and *one* (not both) of the wires should be cut at this point. The cut ends should be pulled out carefully for a distance of about an inch on each side. In the gap thus formed, the ceramic pillar of a National type GS-1 stand-off insulator should be inserted. Each end of the insulator should be fitted with a heavy soldering lug (a lamination of two or three ordinary tinned lugs will do the job) and the cut ends of the antenna wire fastened to these lugs. The bared ends of the transmission line also should be fastened to these lugs and the joint soldered. The line should be brought away from the antenna as nearly as possible at right angles and some slack should be permitted so that there is little direct strain upon the center of the antenna.

Tuning the Transmitter

Providing the coils have been wound reasonably close to the dimensions given, no difficulty should be experienced in adjusting the transmitter for proper operation. If it was not done at the time of construction, the slider on the voltage divider, R_2 , Fig. 2, should be set at 16,000 ohms from the grounded end. The transmitter power-supply unit should be connected through cables to the change-over switch and to the transmitter. The modulator terminals on the power-supply unit should be connected to the modulator output terminals. If no modulator is used, these terminals on the power-supply chassis may be left open, since the switching arrangement completes the circuit for c.w. operation when the switch is turned to the correct position. If c.w. operation is contemplated the crystal frequency should be between 7000 and 7025 kc. For 'phone operation, the frequency should be between 7025 and 7425 kc. The change-over switch should be set to the center or "off" position and the switch on the power-supply unit turned on. This should

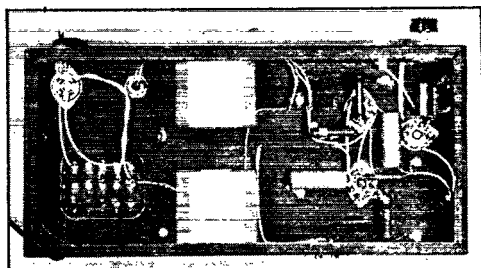

Bottom view of the modulator unit. The power-transformer terminals protrude through the cut-out in the chassis to the left. The filter chokes are at the center. Although the placement of parts in this unit is not as critical as with r.f. circuits, the resistors and by-pass condensers are mounted in groups around the associated tube socket. The terminals at the right-hand end of the chassis are for the microphone battery.

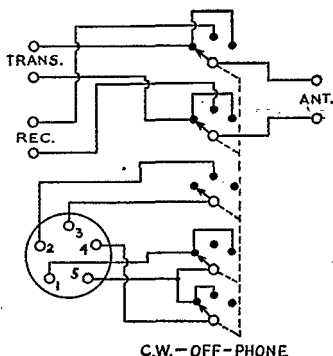

C.W.—OFF—PHONE

Fig. 5 — Wiring diagram of the switching system in the control box. The switch is a 5-gang, 4-position, ceramic rotary switch (Centralab 2546) only three positions of which are used.

turn on the heaters of all tubes in the transmitter. If the receiver is connected, both heater and plate voltage will be applied.

With the change-over switch turned to transmit, the power-supply switch turned on and the metering switch turned to the first position, the meter should read about 40 ma. As C_2 is turned, the meter reading should dip at some point within the range, indicating resonance at 14 Mc. The tuning should be adjusted to the point of minimum plate current which should be at about 35 ma. If the receiver is working, the signal should be heard at the proper point on the dial.

The next two stages should be tuned up with the key closed for short intervals only until tuning is complete. When the key is closed, with the switch in the second position, the meter should read about 60 ma. When the doubler plate tank circuit is tuned to resonance by C_3 , the plate current should dip to about 40 ma. At this point, the meter should be shifted to the third position for reading grid current to the 807. Again closing the key, a reading of 5 or 6 ma. should be obtained. It may be necessary to retune the two preceding circuits slightly to bring the grid-current reading up to maximum. The 807 output circuit should be tuned up with the meter switched to the last position. When the key is metering switch turned to the first position, closed, the 807 plate current should run 100 ma. or more and drop to about 20 ma. at resonance.

The transmitter is now tuned up and ready for the feeder connections as shown in Fig. 5. With the change-over switch thrown to the c.w. position, the plate current to the 807 should run above 30 ma. The position of the antenna coupling coil, L_5 should be adjusted until the plate current is about 80 ma. with C_4 adjusted for minimum plate current. In other words, when the output stage is loaded by the antenna, the plate current should dip to about 80 ma. at one point

and increase when C_4 is tuned to either side. The minimum plate-current point is the correct point.

With a supply voltage of 475, the plate voltage of the oscillator and doubler should be approximately 250 volts and the screens both 200 volts. The 807 screen voltage should be 250 and the plate voltage 475. A variation of 10 per cent or so in oscillator and doubler plate and screen voltages about the values given should have little effect upon the operation of the transmitter. The screen voltage on the 807 should be set to the correct figure by adjusting the slider on R_2 , bit by bit. This adjustment should be made with the final stage loaded to rated plate current.

'Phone

For 'phone operation, the output terminals of the modulator should be connected to the "MOD" terminals on the power-supply unit. After the transmitter is tuned up, the control switch should be turned to the 'phone position. This removes the short-circuit which is necessary across the modulator output for proper c.w. keying. Then, the modulator power supply may be turned on. The modulator should never be operated with the control switch in the c.w. position. The modulator gain control, R_1 , Fig. 4, may now be advanced until the pointer on the meter switched to read 807 plate current starts to fluctuate when

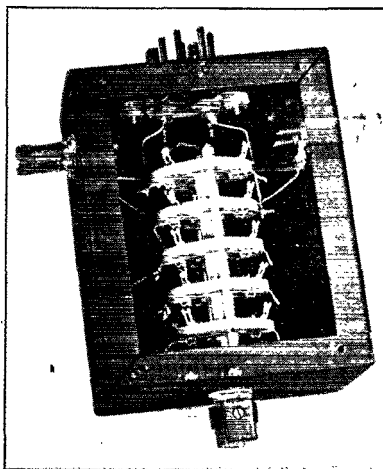

The control box with the bottom plate removed. In this picture, the receiver-input terminals are to the left, transmitter output terminals to the right and the transmission-line terminals and power-control plug at the rear. The terminal strips are National type FWG.

speaking into the microphone at a normal level. The gain control then should be backed off until the fluctuation is negligible. To conserve the microphone battery, the microphone plug should be removed when the modulator is not in use.

Panoramic Reception, 1946

The Latest in Visual Aids to Amateur Operation

BY J. R. POPKIN-CLURMAN,* W2LNP, AND B. SCHLESSEL*

PANORAMIC instruments provide visual reception of all signals simultaneously within a given band. Each signal in order of frequency appears as an individual vertical "pip" (or inverted V) at a definite location along the horizontal calibrated baseline of a 'scope screen. The horizontal location of a "pip" indicates the frequency of its respective signal, and the amplitude or height of the "pip" reveals signal strength. The appearance and behavior of a "pip" divulges the characteristics of its associated signal. The visual bandwidth, commonly called "sweepwidth," is continuously selectable from a broad band of frequencies down to zero. Under conditions of reduced sweepwidth the number of signals or "pips" visible is decreased, but those which are seen are magnified and more clearly resolved.¹

Panoramic adaptors can be made to operate in conjunction with a standard communications superheterodyne receiver, and they provide visual and aural reception of either all signals simultaneously or single signals within a band that extends equally above and below the frequency to which the receiver is tuned. As the receiver is tuned, the "pips" pass across the screen and "walk off" on one side while new "pips" enter on the opposite side. However, for any setting of the receiver tuning dial, the "pip" appearing at the center of the screen represents the signal to which the receiver is tuned.



A panel view of the modern panoramic adaptor. The "equalizer" control at the lower left-hand corner allows compensation for the variation in receiver front-end selectivity on the various bands.

Panoramic reception was originated before the war. During peace time, government agencies using standard direction finders for intercept and counter-espionage monitoring found it virtually impossible to follow illegal stations which changed frequencies at random intervals. Panoramic reception proved to be a more than satisfactory solution of this problem. Since the panoramic indicator could show at one time all signals within a given band in any portion of the radio spectrum, the disappearance and subsequent reappearance of a suspicious signal on another frequency was immediately detectable. In addition, the signal could be "fixed" quickly by watching the nulls and maxima on the panoramic screen without tuning in the signal aurally. Thus, no time was lost in locating and tuning in any suspected transmission. The panoramic indicator assisted direction finding even further by obtaining null points with greater accuracy. The panoramic system provided a visual aid in which the signal "pip" rode above the noise, or "grass," and consequently the "pip" was visible despite noise level. This feature of panoramic reception is invaluable to the amateur. Weak signals which normally might be passed by while tuning the band aurally stand out prominently on the panoramic screen, showing clearly *through* the noise.

As the possibility of our entry into the war became more likely, the activities of the anti-espionage services were augmented considerably, and panoramic equipment was pressed into service in greater numbers. Panoramic instruments are reported to have been credited for the eradication of at least one spy ring.

Military Applications

With the advent of the war the importance of radio interception and monitoring soared. Panoramic reception was put to innumerable new uses, with gratifying results. For some time there was in the United Kingdom a bank of more than one hundred panoramic monitors operating simultaneously at one location. They were particularly valuable in monitoring normal distress and other emergency frequencies. It was not uncommon to

*Panoramic Radio Corp., 242 West 55th Street, New York 19, N. Y.

¹ Miller, "The Panoramic Radio Spectroscope," *QST*, March, 1942. Grammer, "A Compact Panoramic Radio Spectroscope Adaptor," *QST*, July, 1942. Pollack, "Panoramic Reception," *QST*, March, 1945.

receive distress signals which were not on designated frequencies, and this was frequently true of transmissions originating from m.o.p.a.-type transmitters. Without panoramic equipment it would have been extremely difficult, if not impossible, to detect such off-frequency transmissions. An operator of a single panoramic instrument not only was capable of doing the work of at least twenty operators using other means of monitoring, but he could operate more efficiently and with less fatigue.

Panoramic reception also played a unique role in helping to integrate communications between aircraft carriers and carrier-based planes. Of necessity, the duration of communications between such craft was kept at a minimum to prevent the enemy from locating either the plane or carrier. The extreme brevity of communications made it imperative to have a rapid means for locating signals whose exact frequencies were unknown and for spotting transmissions which were unscheduled. Panoramic was ideally suited for showing signals of this nature, and it was immediately utilized for rapid unhampered tuning by visual observation of the oscilloscope screen. In a similar manner, panoramic reception found usage in monitoring communications between land-based aircraft and aircraft control towers. The fact that these craft often returned in large groups from bombing and reconnaissance missions resulted in a large volume of messages which panoramic aided in handling in the briefest possible time. Through the use of panoramics, control towers were prepared to pick up calls from either scheduled or itinerant aircraft which were slightly off the normal control-tower calling frequency.

One of the most spectacular applications of panoramic was its use in radar countermeasure work. The use of the panoramic receivers enabled us to set our jammers exactly on the enemy radar frequencies and to match the characteristics of the enemy radar with the most effective type of jamming.²

Panoramic equipment also helped to combat effectively enemy jamming of point-to-point communications on the lower frequencies. All that

• With the relaxation of wartime restrictions, it becomes possible to reveal to some extent the "panoramic" techniques and circuit details which were developed and employed during the war. This article discusses those techniques which find ready application to amateur operation, and a typical post-war panoramic adaptor circuit is described. For the thousands of amateurs planning to use "panoramic" in their post-war stations, this is strictly "must" reading.

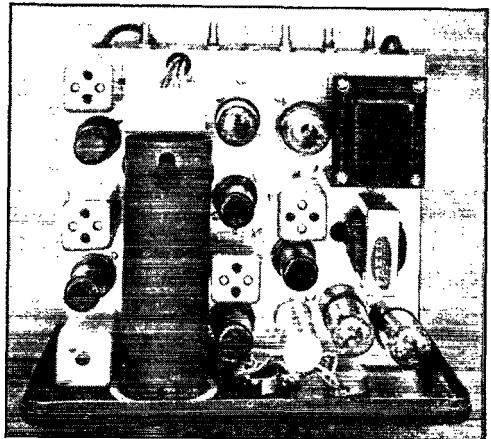

A top view of the adaptor shows the arrangement of parts. The additional controls at the rear of the unit are "focus," "intensity," "horizontal centering," "vertical centering," and "sweep pad."

was required was that both points be equipped with panoramic receivers. At the receiving end, the operator could see, on the panoramic screen, the jamming QRM of the enemy wash out the signal from the transmitting end. By rapid observation of the screen, the operator could locate a clear channel and advise the transmitting end how far and in what direction the latter should shift frequency to ease into the clear area. Through the use of this technique, the necessity for setting up specific pre-arranged operating channels was eliminated. Without any modification whatever, the same procedure is applicable to amateur operation. There is no simpler way to avoid QRM which might cut into a QSO.

Even the famous "walkie-talkie" and "handie-talkie" sets were used in conjunction with panoramic instruments for net operation. The small equipments were grouped into nets on a series of frequencies watched by panoramic adaptors. The presence, absence and behavior of any members of the nets were quickly shown on the panoramic screen. When roll was called in such nets, it was determined, by counting the number of "pips," how many net operators in advanced positions were still operating.

Special panoramic equipment was also designed in which the sweep through the band was slower than in the equipment discussed in the preceding paragraphs. The output of these instruments provided an audible as well as a visual presentation. Some were connected to a warning bell circuit and any time a station was swept through, the bell sounded automatically. Many of these automatic-monitoring panoramics incorporated unique features. They were capable of showing

² Robbiano, "QRM — The Electronic Life Saver," *QST*, January and February, 1946.

frequencies from 20 to 6000 Mc. as panoramic displays, and in some cases marked the frequency position of the unknown station!

Circuit Development

Upon the basis of wartime experience and demands, it has become possible to construct panoramic equipment adaptable to almost all communications receivers. It was recognized that since the flatness of response over a given visual bandwidth is dependent upon the selectivity characteristics of both the panoramic and the receiver preselector, one of the greatest obstacles toward adaptability was the matter of compensating for the discrepancies in front-end selectivity among various communications receivers. Furthermore, within the receiver itself, this selectivity is less when operating on the higher frequencies. To meet these problems, "variable equalization" was developed. Its earlier forms were so complicated that its use in amateur equipment was prohibitive because of the cost. Toward the end of the war a far simpler equalizer was finally developed, and it has since been incorporated in new amateur equipment, with excellent results.

Great strides were made during the war in extending the visual bandwidths (sweep width) so that it is possible now to obtain a variety of commercial panoramics which provide maximum sweepwidths of 50, 100, 200, 500, 1000, 3000, 6000, 10,000, 15,000 and 20,000 kc. It is of interest to note at this point that as the sweepwidth rises, the "visual selectivity," or resolution, falls off. For amateur work, it is desirable to secure maximum "visual selectivity," in order to see the many individual signals which are crowded into the amateur bands, but at the same time to be able to observe a healthy slice of the band. For most amateur needs a 200-kc. sweep-width represents a satisfactory compromise. All the sweeps mentioned above are obtained by electronic means and can be reduced at will down to zero. At zero sweep, it is easy to determine the percentage of amplitude modulation and also to detect non-linear modulation and distortion of any received signals.

Immediate operation, without idle "warm-up" periods, was made possible by the addition of an electronic "center-frequency" tuning control. With this control, the "pip" representing the signal audible in the receiver can be kept centered on the screen until the equipment reaches its final operating temperature. In addition, this tuning control facilitates visual investigation of any signal "pip" on either side of the center or aural frequency, without tuning the receiver to the particular signal in question. The "pip" under investigation is centered by rotation of the center-frequency control, and upon reduction of sweepwidth it is ready for detailed examination.

The installation of a phone jack connected to

the output of the video amplifier enabled the panoramic to act as an additional aural receiver, providing two types of operation, "panoramic aural" or "uni-signal aural." In panoramic aural reception a band is swept electronically, and the presence of one or more signals in the visual band is indicated by a clear buzz in the audio output from the video amplifier. The pitch of the buzz rises as the number of stations swept through increases. In this capacity the panoramic serves as an automatic monitor. In uni-signal aural reception the panoramic is operated at zero sweepwidth, and any station within the bandwidth covered by the instrument is tuned in through the use of the center-frequency control and can be monitored at the phone jack. This type of operation is invaluable for three-way rag chews and auxiliary nets. Aural investigations of a "pip" can be performed in exactly the same manner as the visual check mentioned previously. By learning one's letters in terms of the rhythm of a bobbing "pip" — similar to reading blinker signals — amateurs can readily see and tune in either calls or replies to CQs while listening to the center-frequency station coming through the conventional receiver.

Finally, pulse automatic gain control was incorporated to compress the stronger signals and leave the weaker ones unaffected. Pulse a.g.c. made its appearance in panoramic long before it was incorporated in radar receivers.

A Typical Adaptor

The "panadaptor" shown in the photographs has been designed primarily for amateur use. It incorporates the basic design and all of the circuit refinements discussed above.

The circuit, shown in Fig. 1, is basically a superheterodyne in which the r.f. section is fixed-tuned to the i.f. of the companion receiver, and the local oscillator is tunable through 200 kc., either manually or by frequency modulation at a definite rate.

The input is connected through the isolating resistor, R_1 , to the converter plate in the receiver. In the plate of the converter there may be many signals on either side of the i.f. because of the relatively poor selectivity of the receiver preselector. The band pass transformers are peaked on both sides of the receiver i.f. so that a relatively flat overall response of 200 kc. is obtained. The peaking of T_2 is controlled partially by the equalizer control, R_6 . As more of the resistance of R_6 is thrown into the secondary circuit, the double peaks of T_2 become less pronounced and, therefore, the r.f. section of the adaptor compensates less for the preselector selectivity. This is desirable when the receiver front end offers low selectivity either through design or high-frequency operation. See Fig. 2.

The r.f. section is a straight amplifier employing a 6SG7. Manual gain control is provided by

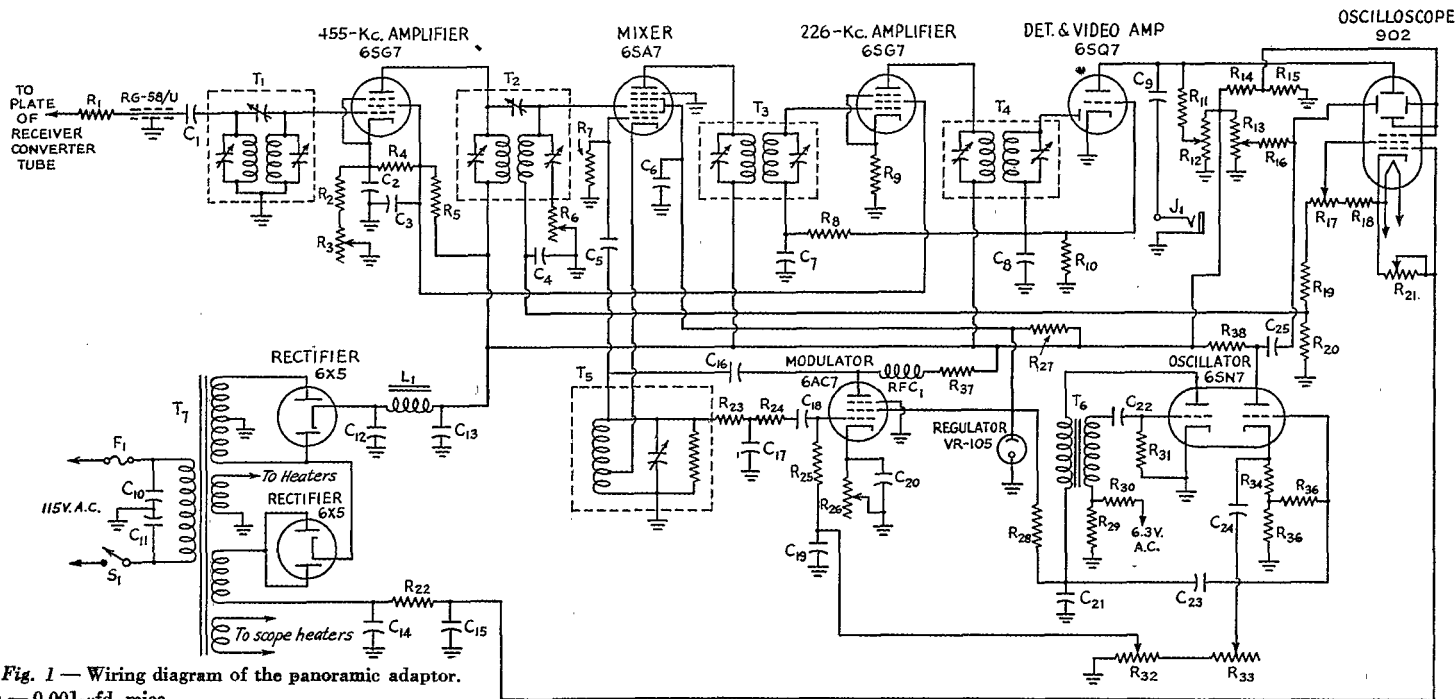

Fig. 1 — Wiring diagram of the panoramic adaptor.

- C₁ — 0.001- μ fd. mica.
- C₂, C₃, C₄, C₆, C₉, C₂₀, C₂₂ — 0.01- μ fd. mica.
- C₅, C₇, C₁₈ — 100- μ fd. mica.
- C₈, C₁₆ — 500- μ fd. mica.
- C₁₀, C₁₁ — 0.05- μ fd. paper, 200 volts.
- C₁₂, C₁₃ — 15- μ fd. electrolytic, 450 volts.
- C₁₄, C₁₅ — 0.01- μ fd. paper, 600 volts.
- C₁₇ — 10- μ fd. mica.
- C₁₉ — 250- μ fd. mica.
- C₂₁ — 0.1- μ fd. paper, 400 volts.
- C₂₃, C₂₅ — 0.05- μ fd. paper, 400 volts.
- C₂₄ — 0.25- μ fd. paper, 400 volts.
- F₁ — 2-ampere fuse.
- J₁ — Open-circuit phone jack.
- L₁ — 12-henry, 55-ma. choke (Panoramic L15209).
- R₁, R₄, R₈, R₁₄, R₁₅ — 50,000 ohms.
- R₂ — 200 ohms.
- R₃ — 10,000-ohm potentiometer.
- R₅ — 25,000 ohms, 1 watt.

- R₆ — 5000-ohm potentiometer.
- R₇, R₂₃, R₂₄ — 20,000 ohms.
- R₉ — 1000 ohms.
- R₁₀, R₂₂ — 0.1 megohm.
- R₁₁ — 0.15 megohm.
- R₁₂, R₃₂ — 0.1-megohm potentiometer.
- R₁₃, R₂₁ — 0.25-megohm potentiometer.
- R₁₆, R₂₈ — 3 megohms.
- R₁₇ — 0.5-megohm potentiometer.
- R₁₈, R₂₃ — 0.5 megohm.
- R₁₉ — 1 megohm.
- R₂₀ — 10,000 ohms.
- R₂₅ — 0.2 megohms.
- R₂₆ — 3000-ohm potentiometer.
- R₂₇ — 15,000 ohms, 10 watts.
- R₂₉ — 2000 ohms.
- R₃₀ — 500 ohms.
- R₃₁ — 1.5 megohms.

- R₃₃ — 1-megohm potentiometer.
- R₃₄ — 15,000 ohms.
- R₃₅ — 5000 ohms.
- R₃₆ — 2 megohms.
- R₃₇ — 3000 ohms.

All fixed resistors $\frac{1}{2}$ watt unless otherwise indicated.
 RG-58/U — 30 inches of RG-58/U cable. See text.

- S₁ — S.p.s.t. toggle switch.
- T₁, T₂ — Overcoupled 455-kc. transformer (Panoramic T115215-L1114; T15216-L1114A).
- T₃, T₄ — 226-kc. transformer (Panoramic T115217-L1115; T15218-L1115A).
- T₅ — Oscillator assembly (Panoramic T15219).
- T₆ — 2:1 audio transformer or special pulse transformer (Panoramic T15114).
- T₇ — Power transformer. 325-0-325 v. at 60 ma., 200 v. at 10 ma., 6.3 v. at 4 a., and 6.3 v. at 0.6 a. (Panoramic T15115).

R_8 . The output of this section, containing signals up to 100 kc. above and below the receiver i.f., is fed to the 6SA7 converter tube. The converter receives a signal from its local oscillator in addition to signals from the r.f. section. The frequency of the local oscillator is determined by the tuned circuit in T_5 and by the reactance modulator tube. The modulator tube acts as a variable inductance shunted across the tuned circuit. The magnitude of the inductance is dependent, in part, upon the amplitude of the plate current through the tube. The center-frequency potentiometer, R_{26} , controls the plate current through the

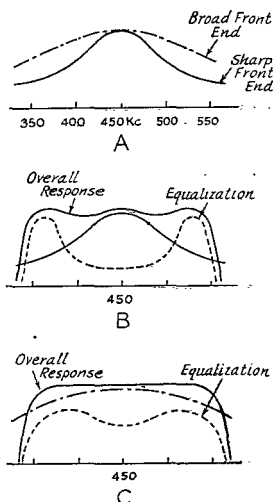

Fig. 2 — The effect of variable equalization in maintaining a flat pass band for the panoramic adaptor. The curves at A show typical front-end selectivity curves, at the intermediate frequency. The curves at B show how extreme double-peaked compensation must be used with a selective front end, and C shows the necessary compensation with a broad front end.

modulator tube and therefore the frequency of the local oscillator. Thus, manual tuning of the oscillator within a range of 200 kc. is accomplished. In a similar manner, the oscillator frequency is also controlled by a linear saw-tooth voltage taken off the sweep width control, R_{32} , and applied to the control grid of the modulator tube. The oscillator is thus frequency modulated and the extent of frequency deviation is proportional to the amplitude of the applied saw-tooth voltage.

It is important for the oscillator frequency excursion to follow linearly the saw-tooth voltage.

³ A finite time must be allowed for the signal to build up in the 226-kc. amplifier, if maximum sensitivity is to be obtained. The bandwidth of this amplifier must therefore be increased as the product of sweep width times sweep rate is increased, with a resultant loss of resolution. — Ed.

The special phase net made up of R_{23} , R_{24} and C_{17} provides linear operation. The construction of this circuit is critical, but once it is properly adjusted its operation is stable.

The i.f. of the adaptor is set at 226 kc., and for a 200-kc. sweepwidth the modulated oscillator excursion is 100 kc. either side of 681 kc., for a 455-kc. receiver i.f. During uni-signal operation the slide arm of R_{32} is at ground, so the center-frequency control becomes the tuning control. During panoramic operation, the arm of R_{32} is brought to the "hot" end of the potentiometer for a 200-kc. excursion of the oscillator. As the oscillator swings through 200 kc. it beats progressively and periodically with one incoming signal after another to produce an i.f. of 226 kc. The oscillator mean frequency is maintained at 681 kc. by use of the center-frequency control.

The i.f. amplifier uses a 6SG7 in a typical stage as found in most receivers, except that its selectivity is made as high as is consistent with the sweep width and sweep rate.³ The detector is the diode section of a 6SQ7. Its output is directly coupled to the grid of the triode section of the same tube so that the lowest possible frequency — in this case d.c. — appearing across the diode load resistor will be amplified by the triode video amplifier. During panoramic operation, pulses of i.f. are fed to the detector and appear, rectified and filtered, across the diode load resistor, R_{10} . These negative voltage pulses are fed back through the filter, R_8C_7 , to the control grid of the i.f. amplifier. A strong signal produces a high negative voltage and hence reduces the gain of the i.f. stage. In this way the amplitude of strong signals is automatically decreased, and it becomes possible to present simultaneously signals which differ considerably in strength. The time constant of the filter is sufficiently short so that a strong signal does not reduce the gain for an adjacent weak signal. The output of the video amplifier is directly coupled to the vertical deflection plate of the 'scope so that a flat video response down to zero frequency with minimum distortion is possible. The potentiometer, R_{12} , controls the difference of potential between the upper and lower vertical deflection plates, and, therefore, the vertical position of the electron beam. The audio output is taken from the plate of the video amplifier, through a blocking condenser, to a phone jack at the rear of the chassis. The audio level is more than adequate for headset operation, and crystal headphones are recommended because of their high impedance.

The saw-tooth voltage applied to the modulator is obtained from a "blocking-grid" oscillator. As the grid of the 6SN7 oscillator tube — the half connected to T_6 — is driven positive, the grid blocking condenser, C_{22} , is charged highly negative by grid current, and as the grid makes its negative swing, the voltage across C_{22} keeps the grid at a high negative potential that blocks the

The parts are arranged under the chassis for best electrical performance. Note that the "equalizer" potentiometer is mounted directly under its transformer and is driven by an extension shaft. The phone jack at the rear of the chassis is for aural reception.

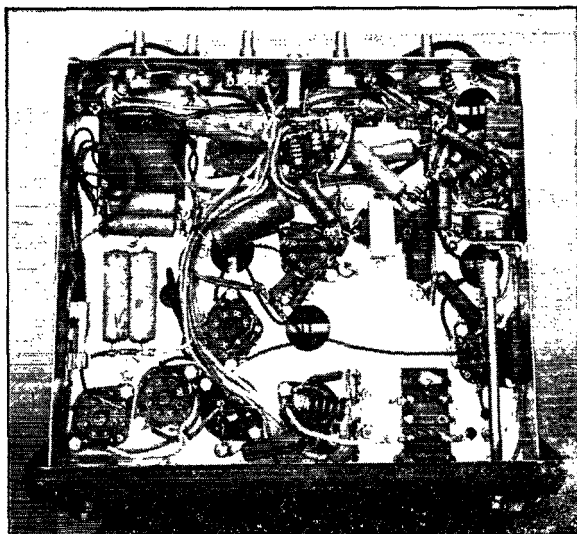

tube. The negative charge on the condenser — the blocking voltage — slowly leaks off through the grid resistor, R_{31} . In the meantime, while the tube is blocked the plate condenser, C_{21} , charges slowly through the linear portion of the charging curve, until the charge on the grid condenser has decayed sufficiently to allow the tube to conduct. In the process of conduction the plate condenser is rapidly discharged and the whole process is repeated so that a saw-tooth voltage appears across the plate condenser. The frequency of the saw tooth is dependent upon the rate at which the grid blocking condenser discharges through the grid resistor, and R_{23} and C_{21} also affect the frequency. The values are chosen so as to produce a saw-tooth frequency of approximately 25 to 30 cycles per second. By introducing the power-line frequency into the grid input circuit, through divider resistors R_{29} and R_{30} , the saw tooth is locked or synchronized to one-half the power-line frequency.

The saw-tooth voltage developed across C_{21} is applied to and amplified by the other half of the 6SN7. The output at the plate of this section is capacitively coupled to the horizontal deflection plates of the 'scope. The application of the saw-tooth wave to the horizontal deflection plates causes the electron beam to sweep in one direction across the fluorescent face of the 'scope as the saw-tooth voltage rises, and then snap back with the rapid decay of the saw-tooth. Because of the persistence of vision, a horizontal baseline is apparent. Another output is taken off the cathode of the section and this is applied through potentiometer R_{33} , the sweep pad, to the sweep width control, R_{32} . The function of the sweep pad is to proportion the proper amount of saw tooth across the sweep width control so that a 200-kc.

oscillator excursion is obtained when the sweep width control is set at maximum.

Horizontal positioning of the baseline is possible through the use of potentiometer R_{13} which controls the d.c. potential difference between the left and right horizontal-deflection plates.

The fact that the same saw-tooth voltage is used to swing both the electron beam and oscillator frequency simultaneously is necessary for understanding the development of the panoramic display. Since any given instantaneous value of saw-tooth voltage will correspond to one particular horizontal location on the 'scope face and to one particular frequency of the oscillator, signals across the band being examined will be spread across the face of the 'scope, in exactly the same manner that the signals would be spread across the range of a tuning dial. Deflections caused by constant carriers will be open at the base line but c.w. signals will be closed at the base, since the beam in the momentary absence of the c.w. signal will sweep through the location of the c.w. deflection. An amplitude-modulated carrier appears as a deflection which bobs up and down due to the varying modulation. Sideband deflections appear as the modulation frequency increases.

When the sweep width control is at zero a constant carrier causes the baseline to shift upward, since under such conditions the voltage across the diode load is predominantly d.c. Carrier fading is indicated by the baseline moving up and down. A c.w. signal will cause the baseline to bob up and down in step with the signal. The modulation frequency of an a.m. signal will appear on the screen when the sweep is zero, since the modulation frequency appears across the diode load.

The power supply consists of a positive supply

(Continued on page 116)

The Opening of the Band

BY R. B. BOURNE, * WIANA

The end of hostilities. The thoughts of ham radio. The more careful reading of *QST*. The gossip at the store. The rumors of opening. The "confidential" dope. The official announcements.



The look at the rig. The trip to the cellar. The cobwebs. The return to the shack. The feeling of frustration. The search for old notes. The incomplete notes. The wrong notes. The superseded notes. The decision to fire up. The decision not to fire up. The trip to the back yard. The forgotten lengths of feeders. The standing around. The cold feet. The return to the shack. The consulting of the *Handbook*. The design for the antenna. The lack of insulators. The lack of wire. The trip to the store. The laying out of the antenna. The building of same. The lousy solder. The rotted rope. The robbing of the clothesline. The pruning of interfering bushes.

The changing of coils. The connecting up of the oscillator. The closing of the switch. The brightness of the plate. The indifference of the crystal. The search for a neon. The cleaning of the crystal. The soup in the tank. The soup in the doubler. The lack of soup in the driver. The open grid leak. The dirty contacts. The shorted filter condenser. The grid mils in the final. The soup in the final.

The lengthening of the feeders. The shortening of the feeders. The return of memory. The amps in the feeders. The tightening of the coupling. The loosening of the coupling. The proper plate mils.



The check of the note. The blocking of the receiver. The scrapy condensers in the receiver. The carbon tet. The pipe cleaner. The listening to the

* Maxim Silencer Co., Hartford 1, Conn.

note. The chirp of the oscillator. The hum on the note. The wobble in the note. The boiling of electrolytics. The molten wax. The replacement of parts. The sweet note.

The calling of CQ. The second calling of CQ. The third calling of CQ. The intensive listening-in. The calling of a local. The answer of the local. The entry in the log. The working of the second local. The renewal of acquaintances. The same old baloney.

The decision to get on 'phone. The lack of speech power. The investigation of the S.A. The molten wax. The open grids. The lack of bias. The replacement of parts. The failure of same. The suspicions of the mike. The borrowing of a mike. The power in the Class B. The feedback. The monkeying around. The feedback. The grounding of this. The grounding of that. The



feedback. The shielding of this. The carefully-found mike position. The "one-two-three-four." The changing of the coupling. The feedback. The lengthening of the feeders. The shortening of the antenna. The final adjustment. The calling of a local. The answer by a W5. The same old baloney. The thrill of the same. The first QSL card. Boy, we're in business!



The Hon. James Lawrence Fly, former Chairman of the FCC and the BWC recently paid amateurs the following tribute — "All of us owe much more than most of us realize to the radio amateur for the superb job he has done in peace and war."

— W2ASN

In a June, 1945, *Stray* we incorrectly credited W9FLA with the item about placing Scotch tape over *QST* binder labels. This clever idea was contributed by W-Eight-FLA. Sorry, OM!

A Band-Switching V.F.O. Exciter Unit

Calibrated Band-Spread for 80, 40, 20 and 10 Meters

BY WALTER E. BRADLEY,* W1FWH

WITH amateur operation on the lower-frequency and DX bands looming on the near horizon, and memories of prewar sweepstakes, ORS and OPS parties, DX contests and Field Day competition fresh in mind, plans for a v.f.o. on these frequencies just naturally form a part of the postwar picture. This is particularly true for those of us who in the past have never made a decent score in any contest nor won a WAS or WAC certificate, mainly because we had no v.f.o. and too few crystals. What we really needed was a self-excited oscillator with frequency stability comparable to the best of "rocks," that could put our frequency just where we wanted it. The importance of a v.f.o. is fully recognized by old timers and should not be overlooked by those who are about to join our ranks for the first time.

Recorded in many past issues of *QST* are numerous descriptions of e.c.o. and v.f.o. exciter units — articles which in themselves constitute a tribute to the importance of the v.f. exciter unit in amateur radio. Excellent strides have been made toward frequency stability, ease of operation, simplicity of design and flexibility, all of which constitute basic requirements for a good variable exciter. Similar strides in tube design by the manufacturers making high-power tubes with very low driving power requirements have considerably eased the power-output needs from such a unit. With these things in mind as well as a few ideas of our own, the exciter here described was constructed.

The single-dial control as shown in the front-view photograph is directly calibrated in frequency for each of the four bands covered — 3.5, 7, 14 and 28 Mc. The dial is a National Type ACN, particularly suited to this application because calibration points can be marked directly on the scale. Just under the tuning dial is the band-changing switch; no plug-in coils are used in this unit. The key jack is on the left and on the right is the frequency-monitoring switch for parking the rig on the desired frequency while listening on the receiver.

Circuit Details

Any band-changing exciter is essentially a good oscillator with doubler stages added to give output frequencies

* Technical Information Service, *ARRL*.

¹ Robinson, "A Search for V.F.O. Stability." *QST*, May, 1945, p. 18.

in the desired bands. The 160-meter 6J5 oscillator, as shown in the circuit diagram, Fig. 1, is isolated from the 2E25 80-meter output tube by two intermediate stages, the first being an 1853 Class-A r.f. amplifier working straight through on the oscillator frequency and the second an 1852 doubler. Up to this point the set-up is the same as Robinson used in his v.f.o.¹ except for the bandspread coils, L_1 to L_{12} , and the use of parallel feed to the oscillator and 1852 doubler. Parallel feed was used to permit grounding the rotor plates of both C_2 and C_{15} and thus simplify construction.

A 2E25 is used in the 3.5-Mc. output stage, which operates as a straight amplifier and therefore requires a well-screened tube. The three following stages are frequency doublers using 6L6s. Since the tuning of these stages is fixed, the output over a band varies somewhat. It is ample at any point, however, to drive an 807. Because the output of an 807 will remain essentially constant over a wide excitation range, its use is recommended as a power-leveling stage between the v.f.o. and a high-power stage.

Capacitive coupling is used between each successive stage from the 6J5 oscillator to the last 6L6 doubler. Driving voltage for the 1853 is taken from the grid of the oscillator rather than from its plate to minimize reaction on the tuned plate tank, which is the frequency-determining circuit. Link coupling from the

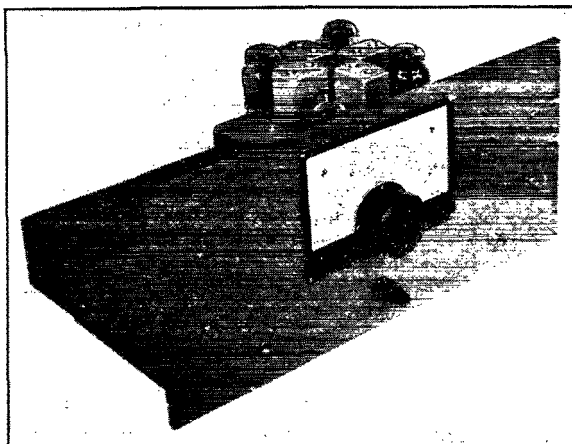

Panel view of the v.f.o. exciter. The key jack is to the left, band-switch at the center and the monitor-transmit switch to the right. The chassis measures 12 × 7 × 3 inches.

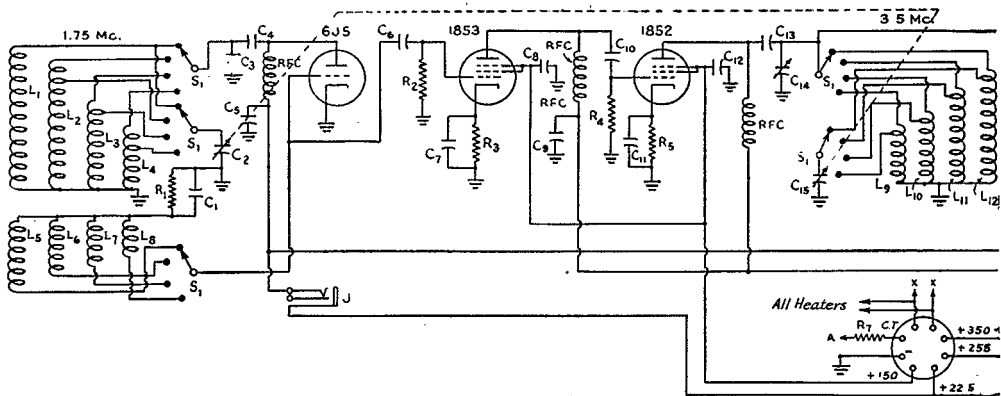

Fig. 1 — Circuit diagram of the bandswitching v.f.o. exciter.

- C₁ — 200- μ fd. zero-temp. mica.
 C₂ — 200- μ fd. variable (Bud MC-1858).
 C₃ — 500- μ fd. zero-temp. mica.
 C₄, C₁₃ — 0.002- μ fd. mica.
 C₅, C₇, C₈, C₉, C₁₁, C₁₂, C₁₇, C₁₈, C₁₉, C₂₀, C₂₂, C₂₃, C₂₄,
 C₂₆, C₂₇, C₂₈, C₃₀, C₃₁, C₃₂ — 0.01- μ fd. paper.
 C₆, C₁₀, C₁₆, C₂₁ — 100- μ fd. mica.
 C₁₄ — 50- μ fd. variable (Cardwell ZR-50-AS).
 C₁₅ — 35- μ fd. variable (Hammarlund MC-35-S) ganged
 with C₂.
 C₂₅, C₂₉ — 50- μ fd. mica.
 R₁ — 50,000 ohms, $\frac{1}{2}$ -watt.
 R₂, R₄ — 150,000 ohms, $\frac{1}{2}$ -watt.
 R₃, R₅ — 500 ohms, 1-watt.
 R₆ — 20,000 ohms, $\frac{1}{2}$ -watt.
 R₇, R₉, R₁₁, R₁₃ — 400 ohms, 1-watt.
 R₈, R₁₀, R₁₂ — 100,000 ohms, 1-watt.
 RFC — 2.5-mh. r.f. choke.
 J — Open-circuit jack.
 S₁ — Sections of 6-pole 4-position tap switch, ceramic
 insulation.
 S₂ — 4-point short-circuiting switch ganged with S₁ on
 single control.
 S₃ — D.p.d.t. toggle switch.

- L₁ — 3.5-Mc. bandspread — 26 turns, no tap.
 L₂ — 7-Mc. bandspread — 28 turns, tapped 14 turns
 from ground end.
 L₃ — 14-Mc. bandspread — 29 turns, tapped 14 turns
 from ground end.
 L₄ — 28-Mc. bandspread — 28 turns, tapped 18 turns
 from ground end.
 All above coils are wound on Millen 1-inch-diameter
 forms with No. 24 enameled wire, turns spaced to an
 approximate length of 1 inch, then adjusted by spreading
 turns to give full dial-scale bandspread.
 L₅, L₆, L₇, L₈ — 19 turns No. 28 enameled, close-wound.
 L₉ — 28-Mc. bandspread — 39 turns, tapped at 20
 turns from ground end.
 L₁₀ — 14-Mc. bandspread — 42 turns, tapped 18 turns
 from ground end.
 L₁₁ — 7-Mc. bandspread — 41 turns, tapped 19 turns
 from ground end.
 L₁₂ — 3.5-Mc. bandspread — 35 turns, tapped 33 turns
 from ground end.

All above coils wound on Millen 1-inch-diameter forms with No. 24 enameled wire, turns spaced to an approximate length of 1 inch, then adjusted by spreading turns to give proper tracking.

tank circuits, T_1 to T_4 , of each power stage feeds power to the output terminals through a section of the gang switch, S_1 .

Tuning System

Of major importance to frequency stability in any self-excited oscillator is a high-Q tank circuit. For this reason a 500- μ fd. fixed capacity, C_3 , is maintained across the tuned circuits, L_1 to L_4 , of the 6J5. Frequency drift from temperature changes is reduced by using a zero-temperature-coefficient condenser at C_3 . Since any change in the capacity of C_1 , the grid condenser, also will affect frequency it, too, is a zero-temperature coefficient type. C_2 is the band-spread condenser to which the tuning dial is connected. To tune the oscillator from 1750 to 2000 kc., as is required to cover the 80-meter band, a variable capacity of 200 μ fd. is used at C_2 ; this capacity range makes a few extra kilocycles at both the high and low ends available on the dial.

To simplify the tracking problem and to reduce the number of ganged tuning condensers, the

1853 stage is untuned and each of the output stages is fixed-tuned. Because the 1852 doubles to 3.5 Mc. its tank circuit should have a lower capacity-to-inductance ratio than the oscillator in order to do an efficient job of producing second-harmonic output. The tank padding capacity, C_{14} , is therefore only 50 μ fd. A variable condenser is used in order to facilitate tracking adjustment, as explained later. To cover 3.5 to 4 megacycles in this stage the bandspread condenser, C_{15} , need only be 50 μ fd. C_{15} and the oscillator bandspread condenser are ganged together, as indicated in the circuit diagram and shown in the top-view photograph.

It was doubtful at first whether reasonably constant output over each band could be obtained with fixed-tuned output circuits and no loading resistors to broaden their tuning, but the power output over each band was surprisingly uniform. Stagger tuning is a means to this end and its use to a mild degree improves performance over the higher-frequency bands. Because the 28-Mc. band is quite wide, constant-level

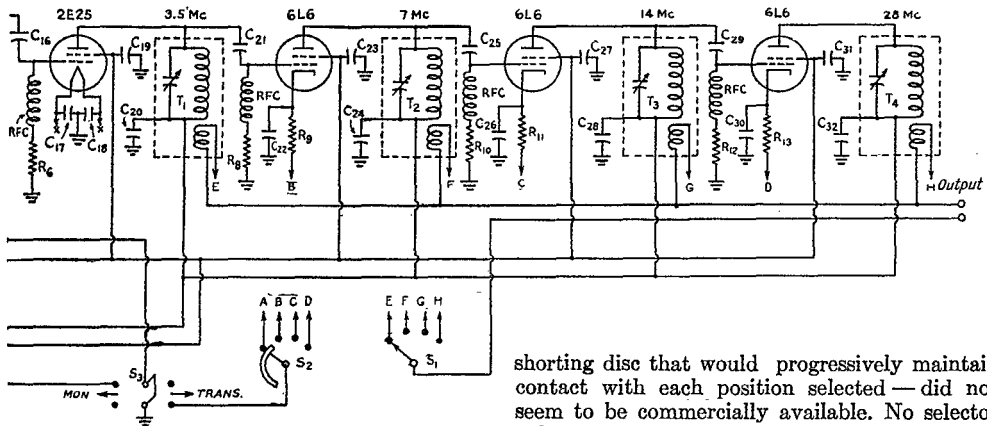

output could not be expected from end to end on this band. With one setting of the tuning condenser on T_4 about 60% of the band can be covered with good results. This means that the 28-Mc. output tank should be peaked for the particular portion of the band that promises the most returns.

Switching

A major consideration in the design of any all-band exciter such as this one is the switching arrangement. Over a period of several days many pencils were worn out and innumerable sheets of paper were completely covered in an effort to come up with a brand-new switching system that would require only one switch in the oscillator and first doubler, permit the same coil to be used on all bands, and give the same bandspread scale length on each. The system having the fewest disadvantages turned out to be the one used here. Maybe someday someone will invent a gear-shifting dial that will be the answer to a ham's prayer, but until that day comes it will be necessary to wind separate coils for each band to accomplish this end.

The oscillator takes three single-pole, four-position rotary switches. The first throws C_3 across the entire coil in use, the second throws C_2 to the proper tap for bandspread, and the third connects the grid to the proper tickler coil. The doubler takes two more switches to connect C_{14} to the various coils and C_{15} to the bandspread taps. These switches, which are ganged, are labeled S_1 in the diagram. The sixth section of the gang switch shifts one of the output terminals to the link winding on the output coil in use. The other terminal has a common connection to all links.

The exact type of switch needed for S_2 — a rotary job having a half-round

shorting disc that would progressively maintain contact with each position selected — did not seem to be commercially available. No selector pole was necessary. The nearest thing to it was a Centralab Type GG which had one selector pole, ten positions, and an almost complete-circle shorting disc that shorted out all unused contacts. This was converted to the type of switch needed by cutting the shorting disc to a half circle and discarding the selector pole. The ground connection to S_2 through S_1 is actually made to the No. 1 finger contact that continuously touches the rotating shorting disc. S_2 progressively cuts in the doubler stages as required, by connecting their cathode resistors to ground.

All rotary switches with the exception of S_2 are Centralab Type RR ceramics having two poles and five positions each. The four wafers needed are ganged together in a multiswitch assembly measuring approximately $6\frac{1}{2}$ inches in length, made from the parts of a Centralab switch kit.

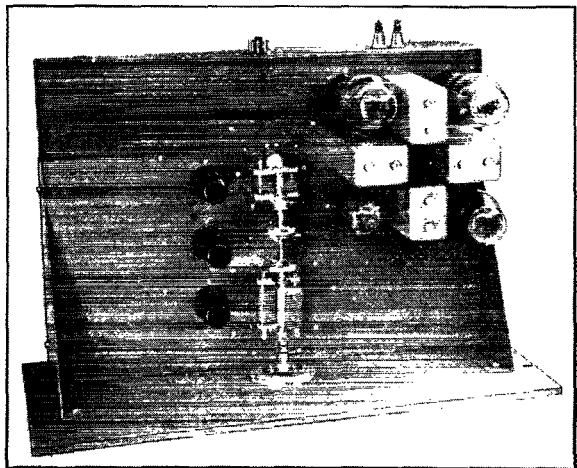

Top view of the v.f.o. exciter behind the panel. The shield cover for the condenser gang has been removed. In line from front to rear at the left are the 6J5, 1853 and 1852. In the upper right-hand corner from lower left clockwise are the 2E25, the 7-Mc. 6L6 doubler, the 14-Mc. 6L6 doubler and the 28-Mc. 6L6 doubler.

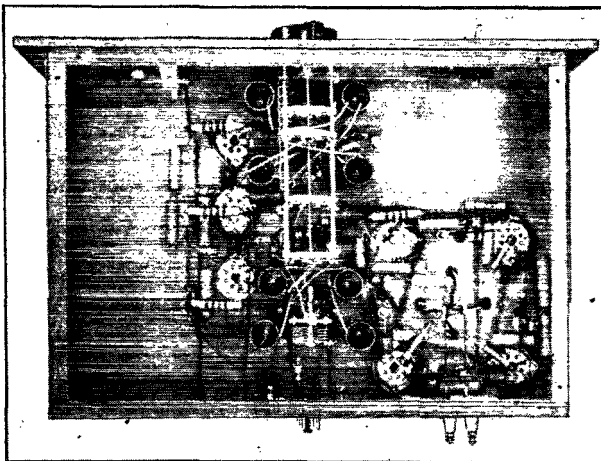

Bottom view of the v.f.o. exciter. The ganged band switch is at the center. Toward the front are grouped the four oscillator coils with the four corresponding 1852 buffer coils and padder to the rear.

When in the monitoring position, S_3 opens the cathodes of all output stages so the final amplifier will be inactive when monitoring the v.f.o. frequency on the receiver. At the same time it shorts the key jack, keeping the oscillator, its Class-A amplifier, and the doubler running.

Construction

The whole unit is mounted on a 17 by 12 by 3-inch chassis whose front panel measures 19 by $8\frac{5}{8}$ inches. Parts are mounted in the usual fashion, holes marked and then drilled before starting assembly and wiring. The general layout can be seen in the photographs.

A minor difficulty was encountered in the mounting of the National ACN tuning dial as a result of the $\frac{1}{4}$ -inch thickness of the masonite front panel. After cutting the $1\frac{1}{8}$ -inch hole for the dial drive it was discovered that the pointer could not clear the front-plate mounting screws unless stand-off spacers were used. Two $\frac{3}{8}$ -inch metal spacers did the trick. Fortunately the dial shaft is long enough to permit mounting the knob firmly.

The long band-changing switch, connected as it is to the oscillator coils, must be made absolutely rigid. Four mounting angles, one at each end of the assembly bolts, are fastened to the chassis.

A piece of $\frac{1}{16}$ -inch aluminum $6\frac{3}{8}$ inches wide and $7\frac{1}{2}$ inches long is bent to form a cover shield $2\frac{1}{8}$ by $2\frac{1}{8}$ by $7\frac{1}{2}$ inches for the tuning condensers. At each corner and the bottom center of both sides threaded mounting bolts hold the cover down.

The tuning dial is mounted on the front panel before the band-spread condensers are fastened in place. Since this dial must come high enough on the panel to give plenty of clearance for the

band-switch knob directly beneath it, the condensers will hang above the chassis when lined up with the dial shaft. Husky half-inch diameter metal spacers hold C_3 and C_{15} firmly above the chassis and in line. The spacers were approximately a half inch high, but careful filing was necessary to make the alignment as perfect as possible. The two condensers are actually about six inches apart in order that they might be placed just above the center of the oscillator and doubler coil groups. The stator connections to the bandswitch go through National polystyrene feed-through bushings in the chassis.

The first three tubes are lined up alongside the tuning condensers and the doubler stages are arranged in a cluster in the rear right-hand corner of the chassis. The 2E25 is the glass tube with the plate cap on top. Its plate connection goes through a special hole drilled in the National ETU-80 coil shield permitting a short direct lead to the coil inside.

Some self-oscillation trouble was encountered in the next 6L6 doubler stage. This was cured by making the coupling leads to its grid come out another specially drilled hole near the bottom of the ETU-80 coil shield, just above the chassis.

Coil Winding and Adjustment

All coils are wound on one-inch Millen coil forms. The lowest-frequency oscillator coil is wound first. The oscillator bandspread condenser is set to within 10 per cent of minimum capacity by placing the pointer line on the dial over "10" on the 0-100 calibration scale provided. The last two or three turns on the coil are then adjusted until the oscillator frequency hits 2000 kilocycles. Other coils are similarly adjusted to track at the high-frequency end of each band.

The most accurate frequency-checking device available should be used for calibrating the dial. We used the bandspread calibration of a good communications receiver carefully checked against a 1000-kilocycle secondary frequency standard previously adjusted for zero beat against WWV. The receiver was warmed up for several hours before frequency-checking operations were begun.

No bandspread tap is required on the first oscillator coil, because the capacity of the tuning condenser gives the required amount of dial coverage, 80 divisions. The remaining oscillator coils are adjusted, with the tuning condenser connected to the recommended taps, for their highest frequencies first. The highest frequency with the second coil is 1825 kc., with the third it is 1800 kc., and with the last, 1856.25. This explains the peculiar fact that the 14-Mc. oscillator coil has more turns than the 7-Mc. coil.

If the bandspread is too great, the number of turns between the ground end and the tap should be increased, and vice versa. Should any change in the position of the taps be necessary, realignment of the coils at their highest frequencies is imperative.

In order to align the 1852 doubler coils accurately it was necessary to have C_{14} variable. If the minimum capacity across the coil in use is too great, the fixed maximum capacity of C_{15} will tune the coil to too low a frequency. Several coils had to be wound before the correct capacity of C_{14} was found to give the proper tracking.

The setting of C_{14} is found by winding the specified coil for L_{12} , setting the oscillator on 2000 kc. and adjusting the spacing of the last few turns for maximum grid drive to the 2E25. A second check on the grid drive or grid current as measured with a 0-10 milliammeter must be made at the low-frequency end of the band. If increasing the capacity of C_{14} at this point shows increased grid drive, more inductance in the coil is required and may be obtained by squeezing the turns closer together. Checking and rechecking at both the high- and low-frequency ends will eventually bring the coil and condenser combination into exact alignment.

Compared to the adjustment of this coil, adjustment of the others is simple. After they are wound, line them up at the high-frequency ends and then change the taps at the low frequency ends if necessary.

Each of the doubler output coils is lined up for the center frequency of its band by tuning the condenser for maximum output, as indicated by a 6.3-volt dial light connected across the output terminals.

Performance Data

The plate current of the oscillator operating from a 22.5-volt battery is 0.5 milliamperes. Plate current of the 1852 with 150 volts on the screen and 255 volts on the plate is 6 ma. constantly, whether the oscillator is on or off. If the plate current in this tube changes, it is not running strictly Class-A as it should. The plate current of the 1852 was 6 ma. also and did not change with oscillator keying. The plate current of the 2E25 with the 6L6 doubler running was 12 milliamperes.

An abundance of excitation for the 2E25 was available from the 1852 doubler and, in spite of the fact that the tank of the 2E25 was fixed-tuned, the excitation did not vary over ten percent for the widest range covered. Plenty of excitation to each of the 6L6 doublers is evidenced by the fact that each of their grid leaks becomes perceptibly warm over a period of extended operation.

The total current drain from the 400-volt power supply recommended is 175 milliamperes

including the current through the VR-105 and VR-150 regulator tubes.

Power Supply

The power transformer should be capable of delivering 400 volts d.c. at 200 milliamperes. A separate filament transformer should be used to take care of the 4.9 amperes drawn by the filaments of all the seven tubes used. Voltage regulation of the 150 volts to the screens of the 1852 and the 1853 is taken care of by the VR-150 which is in series with the VR-105. The two in series regulate the 255 volts applied to the plates of the 1853 and 1852 as well as to the screens of the 2E25 and the 6L6s.

Stability

Frequency stability of the oscillator as checked on ten meters was all that Robinson said it would be for an oscillator of this type. Over a period of ten minutes listening on ten meters, the beat note did not change more than 800 cycles. Divide this by 32 and you have the number of cycles the oscillator itself drifted in that time.

A nasty parasitic reared its ugly head in the last 6L6 doubler stage, but an r.f. choke, consisting of 18 turns of No. 20 enameled wire wound on a $\frac{1}{4}$ -inch form, with the turns spaced the diameter of the wire, inserted in series with the grid coupling condenser at the grid, plus a 0.05 μ fd. by-pass condenser for the screen, eliminated it.

Keying is clean and the note on ten meters is good d.c.

Strays

D. F. Taylor, VE4QV, and Douglas E. Kerr found this item in Canadian newspapers —

“Rationing officials in some parts of the Maritimes would like very much to meet that fellow, whoever he is, who first gave radio amateurs the nickname of ‘hams.’

“As you will recall, the newspapers a few weeks ago published stories with headlines to the effect that restrictions on radio ‘hams’ had been relaxed.

“Some dear old ladies apparently read only the headings, didn’t stop to consider what the ‘radio’ reference could mean, and immediately besieged their butchers with a demand that he wrap up a ham for them without benefit of coupons and no more fooling about it.

“The Prices Board asserts, just in case anyone doubts the butcher’s word, that authentic ham of every type is still rationed.”

High-Gain Microwave Antennas

Operational Features of Radar Beams

BY WILLIAM G. TULLER, * W2BPZ/1

• Haven't you often wondered, like the rest of us, what antenna developments were coming out of the war, particularly in the hush-hush field of radar? Here is a story of the basic types used in radar between 20 and 20,000 Mc., complete with performance data and a description of some of the tricks involved.

ALTHOUGH opinion seems to be divided on whether we will all be building microwave rigs within the next ten years, communicating by means of pulses bounced off the moon, using cathode-ray tubes instead of the usual pair of cans, and downspout instead of the usual pair of No. 12 wires spaced with pieces of Shears and Wards best towel racks, two things seem to be pretty clear; first that we will all still be using receivers, some part of which will be like the ones we use today, and second, that we will be using antennas. In the dear, dead, hectic days just before the war the beam antenna was just getting to be a recognized must for 10- and 20-meter DX, with a few happy souls putting them up at 40 and even longer wavelengths. Almost all the really significant work at long ranges on 5 meters and below was being done with beams, and in some cases with beams of fairly good gain and high complexity. All this adds up to the fact that a

* Old Connecticut Path, RFD, Cochituate, Mass.

good beam antenna really isn't just a luxury, but represents either a good way of beating the 1-kw. maximum power limitation or of making those thirty struggling watts sit up and fight for attention like several hundred, depending on which way your taste and pocketbook dictate.

During the last several years of radar development a great many man-years of time and labor and a few megabucks have been poured into the problem of getting good reliable beam antennas at frequencies ranging anywhere from twenty-two to more than that many thousand megacycles. Of course much of that work has been on special applications that don't apply at all to amateur work, but enough of the principles and techniques evolved do apply and apply directly to make those of us who have been involved in the work do a lot of paper-scratching to see how an antenna built after radar antenna designs can help us out in the next few years. With that in mind, let's take a look at the general kinds of antennas that have been developed, the specifications they had to meet, and the performance they could give if used for amateur communication.

Early Developments

The earliest radar antennas started right out where the ham-designed jobs left off. The frequencies used were the same, 20 to 120 Mc., and the antenna designs might have been copied for the most part out of the *Handbook* or other simi-

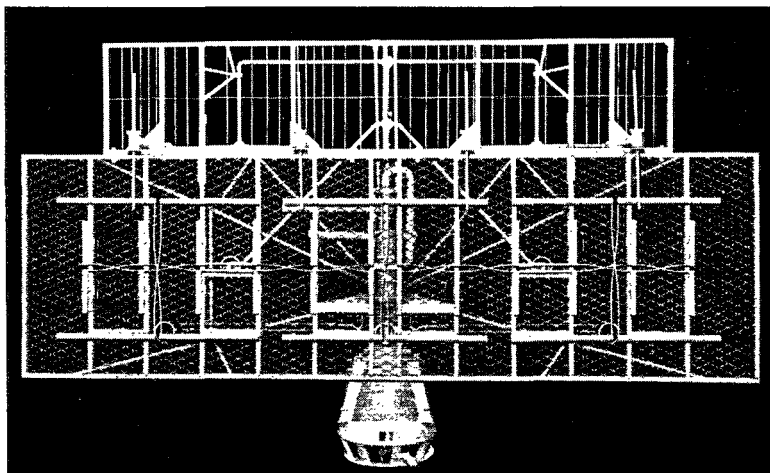

◆
A 200-Mc. radar antenna, illustrating the use of three separate antenna systems working against one reflector. The six horizontal dipoles are for the radar, the twelve short vertical dipoles near the uprights in the main reflector form another antenna system, and the four top vertical dipoles form still a third. All are connected by coaxial line within coaxial line to cables at the base of the antenna.
◆

lar references. One of the simplest of these, for example, consisted of a half-wave dipole backed up by a reflector, cut the usual few per cent longer than the radiator, and spaced about 0.2 wavelength from the radiator. The radiator was fed with a two-wire line, matched with a single matching stub, and the whole affair was rotated with a drive motor in quite familiar fashion, even to having rotation limited to a little over one full revolution in any one direction at any time, since the feeders wrapped around the mast supporting the structure! The device did work, though, and work well, as could be attested by the reports of several hundred Nazis, were they not all now dead. Variations of this scheme were used up to 6-element arrays, sometimes stacked vertically in two layers to improve vertical directivity. They consisted of a driven antenna plus a reflector and up to four directors, the number of directors being determined by operational requirements and what, or sometimes who, had to carry the thing around under fire. Performance figures for these types will not be given, since the curves in the *Handbook* apply. In general, the only difference between these antennas and the one you may have or wish you had in your back yard for 10-meter work is that they were very carefully tested and adjusted for best pattern, compromising between gain, side lobes, and best impedance match in the entire frequency band over which they were to be used. This is quite important, since surprising things can happen to antenna gain, side lobes, and input impedance over a band of frequencies whose width is 10 per cent or so of the center frequency. This order of bandwidth is common both in radar and amateur work, and the variation in performance over the band is something whose importance should not be forgotten in the design of a good antenna system.

V.H.F. Radar

As the frequencies used in radar went higher, into the 200- to 500-Mc. region, the Yagis, or linear arrays, used previously began to pale. In the first place, a 6-element beam of this type is

TABLE I

Performance of Representative 200 Mc. Antennas							
Antenna	Number of Dipoles		Beam Widths		Gain (db.)	Height (feet)	Width (feet)
	High	Wide	Vert.	Horiz.			
1	2	6	55°	20°	15	5.5	13.5
2	2	3	50°	30°	12	5.3	8.7
3	2	2	60°	40°	12		
4	2	6	60°	20°	13.5	4.5	15
5	6	6	20°	20°	19.7	17	18

about all that can be used over any reasonable band width, and in the second place the gain of such a small array is definitely limited. The answer to these troubles was the now familiar "mattress" or "bed-spring" array, seen at a spot near the top of the mast of most of our warships, atop masts or trucks on the ground, and even along the side of a large aircraft in some obsolete installations. These arrays are almost all basically broadside arrays, stacked vertically and horizontally. The basic array used is almost always bidirectional and, contrary to amateur practice, is generally backed up by a screen made up of rods parallel to the antenna or mesh, the screen being mounted about 0.2- to 0.25-wavelength behind the driven antennas. The reason for using a reflecting screen rather than another string of dipoles is simple; if there is a relatively large number of dipoles, it is a lot easier, cheaper, and better over a broad band to put up a nonresonant mirror than a resonant one such as a group of dipoles. The screen should overlap the dipoles on all sides by a bit, say a half wavelength or so, but this does not make it very large when that half wavelength is only 20 inches. Further, we can now make this mesh our main support for the dipoles instead of stringing them on the feeders. This is done by supporting the dipoles on metallic insulators, or sections of parallel-wire line 0.25-

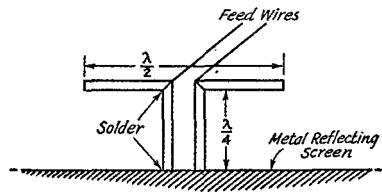

Fig. 1 — A single dipole element of a "mattress" array. The half-wave radiator is supported by a "metal insulator" — the familiar quarter-wave section that can be grounded at the short-circuited end.

wavelength long (also luckily the distance from screen to dipoles) and short-circuited at the screen. Now if each half of the dipole is supported on one wire of this quarter-wave line, it will be effectively insulated from the other half dipole because the impedance seen looking into a line 0.25-wavelength long, short-circuited at its far end, is an open circuit. This makes it possible for the screen, and the dipole to be bonded solidly together, even though there is considerable r.f. potential difference between the screen and the radiator. A photograph of a mattress array is shown in one of the illustrations, and Fig. 1 is a sketch of the dipole support. This metallic insulator is one of the most useful gadgets to be brought into prominence by the war, and although it is certainly nothing new, it is safe to say that it will be widely

used in the future. One of the great advantages of such a scheme is that we can now make our dipoles big and fat, since they are supported on rigid rods rather than hung on wires. All other things being equal, a fat dipole is a broad-band

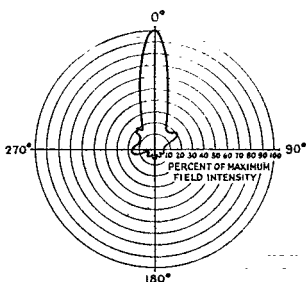

Fig. 2 — Polar diagram of the radiation pattern of Antenna No. 4 in Table I.

dipole; that is, the impedance seen looking into its center does not change very much with frequency. The dipoles used in radar work have a ratio of length-to-diameter of between 2 and 40 as compared to about 2500 for a No. 12 wire at 10 meters. This means that they show nearly constant impedance over a broad band — a great help in getting a complex antenna system to work equally well from one end of the band to the other, since many things besides the dipoles individually are at work making the input impedance to the antenna change with frequency.

Before going into the performance, shapes and sizes of such antennas, a word about the method of feed is in order. The arrays themselves have generally been constructed with parallel-wire lines internally, since a dipole is inherently a balanced device and operates most easily from a balanced line. However, such a line has high radiation losses at a few hundred megacycles, and this is not only inefficient but productive of much QRM when a few hundred kilowatts are going into the line. Therefore a coaxial line is generally employed between antenna and transmitter. The shift from balanced to unbalanced line is usually made between the antenna and its pedestal by means of a "bazooka" or line-balance converter.¹ Inasmuch as wrapping the feeder around the mast can no longer be tolerated, the coaxial output of the "bazooka" is led to a rotary joint. This usually consists of two pieces of air-dielectric

coaxial line arranged end-to-end, one piece having spring fingers which make a good wiping contact between the two sets of conductors. It is often desired, for one reason or another, to have a second antenna atop the same pedestal, and if this feature is included the rotary will have a coaxial within a coaxial to feed the second antenna. A typical joint, for example, might have a 3-inch diameter tube as the outer conductor of the radar line, a 3/4-inch diameter conductor as the inner conductor of the radar line and outer conductor of the auxiliary line, and a 1/4-inch diameter conductor within this as the center conductor of the auxiliary line, all three conductors being broken somewhere along their length and wiping-contact joints inserted. During the early days of radar, the transmission line from antenna pedestal to transmitter might have been air-dielectric copper tubing coaxial line, fitted with ceramic insulating beads every so often and filled with dry nitrogen at a pressure of a few pounds per square inch. However, the beads in such a line crack under military usage, the line leaks nitrogen and then fills up with water vapor if it is in the tropics, immediately arcing over under the high power of the transmitter. These troubles occurred too frequently to be neglected, so a splendid job of research and development was done by the services and the cable manufacturers, culminating in very excellent solid-dielectric flexible coaxial line with high power-handling capabilities and low losses. This will probably be one of the great

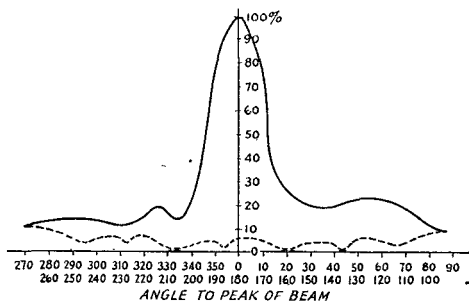

Fig. 3 — The pattern of Fig. 2 presented in rectangular coordinates. To save space, the dotted line is used with the lower set of ordinate values.

boons of the war to the ham who is fortunate enough to be able to purchase it, since its characteristics leave little to be desired in the v.h.f. and u.h.f. range.²

Performance

The above discussion may give an idea of what the mattress arrays look like in detail, and of some of the constructional kinks, but the factor of main interest after all is just what do we get from this floppy bed-spring? Table I gives beam

¹ See A.R.R.L. Handbook, 1945 edition, Chapter Ten.

² Some of the cable produced early in the development of the new RG series has reached the hands of the surplus dealers and is giving the whole cable picture a bad name. The early cable was markedly inferior to the presently-available material, aged rather badly, and was used extensively by the services only because nothing better was available. Therefore beware of surplus solid-dielectric coaxial cable unless you are familiar with the good and the bad.

widths at half power and gains (as referred to an isotropic radiator) of several typical antennas. A typical pattern from one of them (No. 4) is drawn in polar coordinates in Fig. 2 and in rectangular coordinates (the way most radar antenna designers draw them) in Fig. 3. The quantity plotted as a function of angle in the patterns is field intensity, or voltage out of a linear receiver. Some antenna patterns are plotted in terms of power relative to power on the nose of the beam, or voltage out of a square-law receiver, but the system used is believed to be most convenient since it shows all the lobes without making it necessary to resort to semi-log paper. All patterns are for the antenna used either as a transmitter or as a receiver, since the same pattern will always be observed in both cases.

A word about the general shape of patterns obtained from these dipole arrays might be in order. The "beam width" usually spoken of is that of the 0.707 intensity, or half-power, points; that is, the total beam width between the two points on the pattern at which the field intensity is 0.707 of the intensity at the peak of the beam. In general, the beam width between points at 0.31 of the peak intensity will be double the half power width. Side lobes on a well-designed array of this type can be kept below 20 per cent in intensity (-14 db.) and the front-to-back ratio of 17, or 25 db., is by no means exceptional.

The gains, as mentioned above, are referred to an isotropic radiator. This is a convenient fictitious radiator that radiates equally well in all directions. Compared to such an antenna a theoretical dipole has a gain of 2 db., and a half-wave antenna³ a gain of 2.7 db. These numbers should be subtracted from the values given in Table I if you prefer to use either dipole as a gain reference.

Microwave Antennas

So far, the picture has not seemed too different from that found in a back yard of the late 1930s. There have been a few refinements, notably in the rotary joints and broadbanding, but now here come microwaves, with their optical systems, and anything can and does go. By way of introduction, let us consider two types of antennas which really don't operate on microwaves, but are built somewhat like microwave antennas and have much more in common with such antennas than with the mattresses talked about above.

Suppose we place a collinear broadside array along the focal line of a cylindrical parabola. Let's

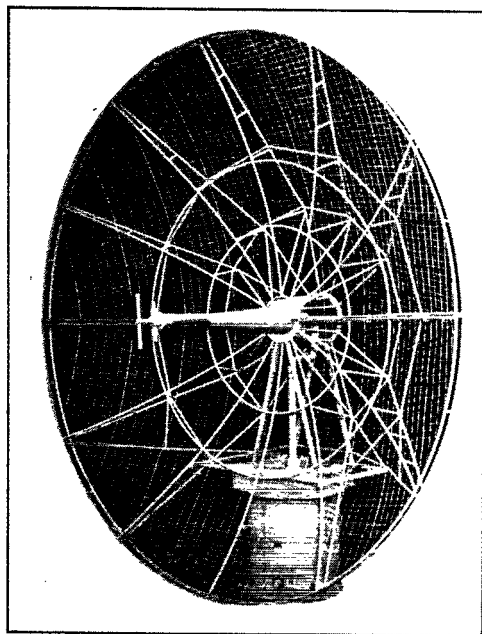

Another 200-Mc. radar antenna, using a parabolic dish reflector and dipole-plus-one-reflector illumination. This dainty little job is only 17 feet in diameter!

place the array and the focal line horizontally, so as to give horizontal polarization. Now considering the horizontal plane only, we know that the array will give us a beam of width determined by the number of elements we use, and that the paraboloid behind the antenna array will make the radiation unidirectional rather than bidirectional. Were it not for the curvature of the parabola this would give us a vertical beam width of about 90 degrees. By placing the collinear array at the focal line of the cylindrical paraboloid, we focus the radiation in the vertical plane down into a narrow beam, one whose width is determined by the height of the paraboloid and the way in which we illuminate it. This last phrase simply means that we can spray our energy in all directions, in which case some will hit the paraboloid and be reflected, but much will miss our dish and just be wasted side-lobe energy. Or we can go to the other extreme and shoot radiation at the dish from a highly directive array so that only a small section of the dish has any energy striking it. Obviously those portions of the dish which are not irradiated by the array are wasted in this case and might as well be cut off. Or, and this is what one tries to do in designing an antenna using a parabolic reflector, the directivity of the array — or "feed" — can be matched to the size and shape of the dish and the position of the feed in the dish, so that almost all of the radiation from the feed hits the dish and none spills over to be

³ A theoretical dipole is a short section of antenna, so short that it has uniform current along its length. This shows gain over the isotropic radiator because the radiation pattern is a cosine function and the radiation in the direction of the element is zero. A half-wave antenna, which is made up of a very large number of these elements, shows still more gain because it might be considered to be a collinear array of these elements. — Ed.

TABLE II

Performance of Representative 3000 Mc. Antennas						
Antenna	Height	Width	Feed	Beam Widths		Gain (db.)
				Vert.	Horiz.	
1	15"	48"	Horn	15°	5°	23
2	24"	24"	Dipole with Reflector	11°	12°	23
3	48"	48"	"	5°	5°	29
4	72"	72"	"	4°	4°	31
4	36"	84"	Box Horn	10°	3°	28

wasted nor creeps in too far from the edges of the dish. Obviously then our simple collinear array won't be the best feed, since it radiates in all directions normal to itself equally well. However, we can do the best job with the tools at hand by putting the collinear array deep down within the paraboloid; that is, by making the focal length of the paraboloid small compared to its width. A typical antenna of this type is three feet high and twelve feet long, operates on about 770 Mc. and has within it a 16-element collinear array. It has a horizontal beam width of 6 degrees between points of 0.707 intensity, and a vertical beam width of 30 degrees. Its gain is 22 db. over an isotropic radiator. Another antenna of the same general type is 6 feet high by 7 feet wide, and has an 8-dipole array backed up by eight reflector-dipoles to reflect the energy into the dish. Its gain is also 22 db. and both horizontal and vertical beam widths are 12 degrees. The side lobes on these antennas are generally lower than those of the mattress type, largely because of the increased size of the antenna as measured in terms of operating wavelength. For the antennas mentioned above, they are never over about 10 per cent of the intensity of the main beam. The front-to-back ratio is about 33 db.

Some of the mattress arrays are being replaced by arrays of this type or by the next logical step in antenna development — a paraboloid of revolution fed by a single dipole, or dipole-plus-reflector, in place of the collinear array. In this type of antenna the dish focuses the beam in the vertical and horizontal planes (as well as all others) and feed directivity is only used to put all the radiated energy on the dish, not partly to shape the final beam as in the antennas just previously described. An antenna of this type is shown in one of the photographs. A typical antenna is seventeen feet in diameter, operates on about 200 Mc., has a beam width of 20 degrees in both the vertical and horizontal planes, and has a gain of 19.8 db. Another similar antenna has a 10 foot diameter dish, works on 600 Mc., has a gain of 34 db. and beam widths of about 12 degrees. These antennas have side lobes close in to the

main beam of about 10 per cent intensity, and a front-to-back ratio of about 34 db.

This same type of antenna is used at frequencies up to 10,000 Mc. At 3000 Mc. a typical unit, using only a 4-foot diameter dish, has a gain of 29 db., and beam widths of 5 degrees in both horizontal and vertical planes. All lobes may be kept below 26 db. below the main beam, and all lobes outside of 10 degrees beyond the main beam below 30 db. Front-to-back ratios of 40 db. are not uncommon in antennas of this size. A typical antenna pattern from a microwave antenna is shown in Fig. 4. The gaps in the pattern were caused by the measuring equipment, which would not go below 45-db.-down lobes.

For many applications one wishes a beam which is fan-shaped; that is, wider in one plane than another. Inasmuch as the beam width is inversely proportional to the dish width (assuming a constant type of illumination and constant wavelength), we might think that one could simply cut top and bottom, or each side, off our parabola and thereby get a wider beam. That statement, so far as it goes, is true, but strict adherence to it will not produce a very efficient antenna. The reason for this is that the energy formerly striking the now cut-off portion of the antenna will be wasted. However, we may recover this wasted energy by shaping the radiation from the feed so that the beam from the feed, our primary radiator, just covers the dish, or secondary radiator. If we have cut off the top and bottom of the dish so as to get a wide vertical beam, we must narrow our primary beam in the vertical plane. At long waves — v.h.f. is long wave in this business — a primary radiator to produce a narrow beam would be a large and bulky device. However, at microwaves we can use a horn for a primary radiator and easily shape the primary beam

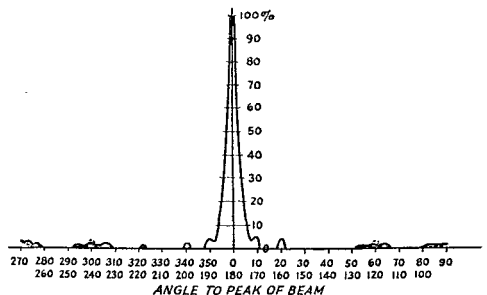
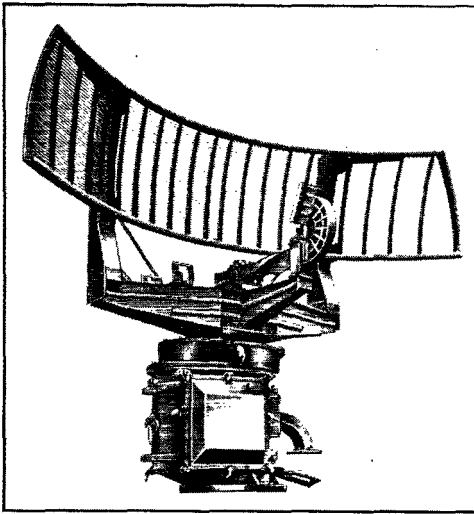

Fig. 4 — A typical pattern of a microwave radar antenna, clearly demonstrating the sharpness of the beam and the attenuation of the minor lobes.

by varying the size and shape of this horn. This works fine if the vertical beam is about four times the width of the horizontal beam, but gets into trouble if the vertical beam width grows as high as ten times the horizontal beam width, as it



This "cut dish" antenna was used at 3000 Mc. and illustrates the use of wave guide and the "box horn" feed. The horn is set just below the dish, to reduce minor lobes.

sometimes does at the higher frequencies. Such antennas have been built, one in particular being 4.4 inches high and 48 inches wide. The focal length of this parabola is 12 inches, which puts the feed out 12 inches from the center of the dish. Consequently the majority of the radiation from the feed, in any vertical plane that meets the reflector, must be confined to a 4.4 by 12-inch triangle. This, as can be figured out with a few

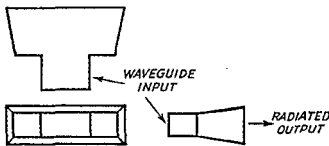

Fig. 5 — A "box horn" radiator, used on the end of a piece of wave guide to illuminate a "cut dish" reflector. The output pattern is controlled so that very little of the radiation misses the reflector.

groaning swipes at high-school trig, means the primary feed alone has to have a beam width of 21.6 degrees, and not between 0.707 intensity points, but between 0.32 intensity points if too much of the precious soup is not to leak over the edges. This makes a primary radiator with a beam width between 0.707 intensity points of about 11 degrees, narrower than some of the big antennas put out at v.h.f. A normal horn to give this narrow a beam would be a rather long and bulky item, so a box horn as used in this, and other similar antennas. The theory behind the opera-

tion of a box horn, illustrated in Fig. 5, is a little too complex to go into here, involving as it does the calculation of the effects of high-order waves in wave guides, but the device itself is quite simple, and the picture self-explanatory.

Since even the box horn is a fairly large obstacle to put in the way of a nice optical mirror like a paraboloid antenna, it scatters radiation coming at it from the dish and spreads this radiation out in the form of side lobes. The cure is to get the feed out of the way of the beam, and this is done by placing the feed at the lower edge of the dish and shining the radiation up into the dish at a slight angle. The dish is then so shaped as to radiate straight out as usual. This trick has generally been good for from 6 to 10 db. in the suppression of far-out side lobes, although it leaves the ones close in to the main beam substantially unaffected.

It will be noted from the various photographs that no antennas use a solid continuous sheet of metal for the dish, but instead use some form of grating, lattice, screen, or punched metalwork. The use of such materials prevents the antenna from behaving like a sail, which it will in great style if left solid. The effect of the shift of material on the beam cannot be detected if the design is adequate, as the mesh

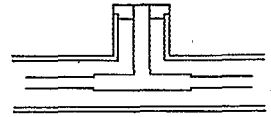

Fig. 6 — A cross-sectional view of stub-supported coaxial line. The stub is a quarter wavelength long and hence does not short circuit the inner conductor. The slight increase in diameter of the inner conductor at the support is for "broadbanding."

or grating used can be made to reflect more than 99.9 per cent of the energy striking it.

Feeding the Antenna

Three types — really two members of one family and one member of another — of transmission lines have generally been used in radar work. These are rectangular wave guide, solid-dielectric flexible coaxial line, and stub-supported coaxial line. The first two can pass without mention, since they are quite plain and uncomplicated, but the last deserves some comment. It makes use again of the quarter-wave metallic insulator described earlier in this article. A cross-section of the stub support is shown in Fig. 6. It again consists of a piece of line, this time coaxial, one-quarter wave long and short-circuited at one end. The other end has its inner and outer conductors respectively connected to the inner and outer conductors of the main transmission line so that the short rigid stub — about seven-eighths of an inch long at 3000 Mc. — supports the line's center conductor. Although the stub itself is good at only one frequency, the half-wave matching network consisting of the bump on the center con-

ductor makes it very nearly perfect — standing wave ratio of 1.05 or so — over a 20 per cent band width.

Rotary joints for the microwaves have generally been of the so-called "capacity" type, shown in Fig. 7. Actually the name is very misleading, since the two sections of line, fixed and rotating, are electrically coupled by a transmission line

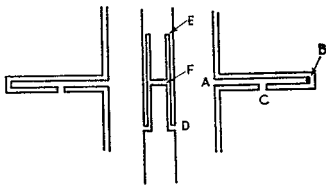

Fig. 7 — Cross section of a rotary joint in coaxial line. Distances *A-B* and *D-E* are a half wavelength long at the operating frequency, and effectively short circuit the inner and outer conductors at *D* and *A*, although there is no solid connection at any point.

network and not by a capacity. This is because no piece of metal over a quarter inch long can be considered to be a lumped circuit element at microwaves, but must be dealt with as a transmission line — an easy enough process once one recovers from the initial shock. We simply have to remember that the current flowing along the inside of our transmission line will not jump a gap, but must be led around it by a transmission line of the right length so there will be no reflection of energy. Mathematical or physical purists will probably shudder at that statement, but it represents an extremely useful viewpoint when dealing with this type of rotary joint. In the case of the joint shown in Fig. 7 there are two gaps, one in the inner conductor and one in the outer, although we may leave out the inner conductor and have, for our purpose, an entirely adequate picture of a wave guide. The distance from *A* to *B* and that from *D* to *E* in this figure is made equal to a half wavelength. That makes these regions half-wavelength transmission lines, short-circuited at the far, or *B* and *E* ends, when viewed from the inside of the main transmission line. Simple transmission-line theory tells us that a half-wave line short-circuited at its far end looks like a short circuit, so our lines are effectively transferring the short circuits from points *B* and *E* to points *A* and *D*, allowing the waves to go by the gap unimpeded. But how about the little gaps we have left at points *C* and *F*, and carefully avoided mentioning? Well, there we pull a little trick. In the first place, these points are a quarter wavelength from points *B* and *E*, so if we stand on the edge of the gap nearest, say, *B* and look toward *B*, forgetting what is behind us, we

see a quarter-wave line short-circuited at its far end, or an open circuit at *C*. Now if we back up an infinitesimal distance and across the gap, we still see our open circuit, since we haven't moved very far, but in series with it is the gap, another open circuit. Obviously an open circuit in series with another open is still a very good open circuit. So we haven't changed the impedance at this point, and therefore we can regard the line between *A* and *B* as continuous, making our previous statement about its effect on the main transmission line true. We may fold the line from *A* to *B* in many shapes to get it to fit into our antenna pedestal, but it will still work in much the same way if we are careful. This joint works equally well in wave guide or coax, if we use a mode in the round wave guide which has circular symmetry so that it will not be affected by displacing one end of the joint angularly with respect to the other, or if we use an asymmetrical wave and arrange the antenna system to take whatever polarization comes out. Either method will work, and has been used.

Other Types of Antennas

The antennas described above have formed the backbone of the radar picture during the war. A string of variations, entered into for one reason or another, could be listed in microwave antennas but most of these break down into some form or other of the types listed. In particular the collinear array has been made up, either for a feed or as a radiator, by exciting a series of dipoles from probes, entering a short way into either a coax line or a wave guide. It has also been made by cutting half-wave long slots in the wall of coaxial line or wave guide in such an orientation that the slots will radiate. Further, the collinear array has been made by exciting one end of a dielectric rod with a wave guide. Such a rod acts as an end-fire array, since it is a leaky wave guide, transmitting some power and allowing the rest to leak off into space. Combinations of arrays with phase-shifting schemes have been used to rapidly rotate the antenna beam through about ten beam widths, or to scan it from side to side. Combinations of rotary joints, up to three per antenna, have been used to give complete freedom of motion for the antenna, so that it might be placed on a stable platform and its beam remain aimed at a distant target regardless of the motion of whatever vehicle carried the platform. The special types could be listed by the book rather than the column but, as has been said above, the antennas described in detail are the basic types, the ones from which almost anything else can be developed, and these are the ones which the ingenious ham can build in his cellar and mount in his back yard.

A word on impedance tolerances is in order, just to wind up performance data. Almost all the

(Concluded on page 122)

Military Television Cameras – and the Amateur

The Story of the Radio Amateur's Part in the Development of Missile-Borne Television Cameras

BY A. DAVID MIDDLETON,* W2OEN

GUIDED-MISSILES have long been a dream of the fighting services. One obstacle in the path of their research was the lack of a suitable and effective "eye" in the controlled missile that could scan the scene and transmit this intelligence to the control operator who could then correct for any possible deviation in direction.

Such an "eye" was finally supplied in the form of compact, light-weight, expendable television camera units which could be attached to or installed in a remotely-controlled missile such as a robot bomber, a glide bomb or a high-angle bomb.

Two outstanding facts become evident in an analysis of the background of one such equipment. The first includes the inquisitiveness and ingenuity of the radio amateur that led him to delve into the mysteries of television. The second demonstrates the foresight and courage shown in *QST's* program to present amateur television in a manner designed to stimulate the radio amateur's activities along these lines.

These two features combined to produce the type of compact, light-weight military missile-borne television camera equipment shown in the photographs.

From the radio amateur's laboratories came the incentive, the original designs, applications and construction technique and radio amateurs initiated, nurtured, developed and carried through a program of research, development and production of television camera equipment in the Electronic Division of Remington Rand at Middletown, Conn.

Among the first amateur television transmission experiments were those made by W1BCR, about 1932. This station transmitted television

pictures on 160 meters utilizing a 48-hole scanning disc. These signals were received by various New England amateurs including Philip S. Rand, W1DBM. Television transmissions were directed to definite stations and these stations answered back on 160-meter 'phone and described the character of the picture received. In those days it was considered an exceptional feat if the receiving station could identify and describe any details of the received images. Rand said recently, "I'll never forget the thrill when, at the end of a Falmouth Radio Club meeting at my shack, we tuned in on 160 meters for a few QSOs. Upon hearing the characteristic buzz-saw note I switched in the neon tube and after synchronizing the scanning disc we saw through a magnifying glass, my call, W1DBM, spelled out in big characters. W1BCR was 'calling' me by television! I answered on 160-meter 'phone and he replied by televising some Mickey Mouse cartoons in black and white."

In the latter part of August, 1940, while Rand was in Washington, he made inquiries on the possibility of controlling, by radio, bombs and other missiles so that they might be directed to their targets more accurately than with a bombsight. W1DBM had read Sherman's article in *QST* on a new electronic television transmitting system for the amateur and also Lamb's article on a new iconoscope for amateur

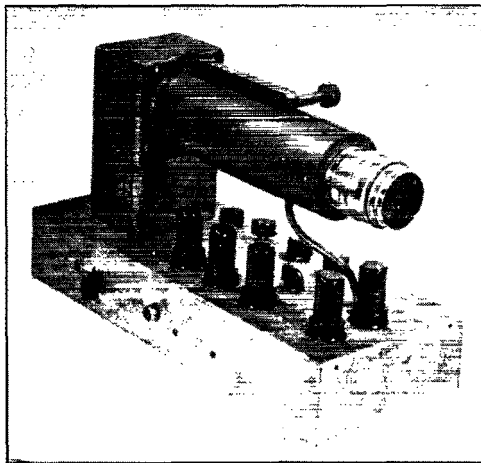

One of the original 2-inch Iconoscope amateur television camera units. Circuit details were almost identical to those described in October, 1940, *QST*.

television cameras. During a discussion with a naval officer concerning the possibility of guiding a bomb by radio remote control, Rand was told "that this would not be feasible due to the difficulty in seeing the falling bomb from a plane and hence the difficulty of estimating its probable striking point." This original opinion later proved incorrect. (The Army recently announced

* Department Editor.



Left to right — Philip S. Rand, W1DBM, James J. Lamb, W1AL, and Joseph Brustman, ex-OE134. Rand's arm rests on the first model of the 4-inch Orthicon television camera developed by this trio. W1AL is holding the latest model incorporating a 2-inch Vericon pick-up tube. This unit, combined with the pulse box held by Brustman, makes up the "latest word" in compact television camera equipment.

successful remote-controlled bombs known as the Azon and Razon. The difficulty in seeing bombs fall from the plane was overcome through the use of a smoke flare in the bomb.)

As Rand sat there having his remote-controlled bomb idea picked to bits he recalled his amateur television interest and amateur television's recent publicity in *QST*. He countered that if a television camera could be built small enough to be put in the nose of the bomb then the bombardier would not have to worry about visually following the bomb in its fall but could see, on a television screen in his plane, the exact spot at which the bomb was hitting.

Rand returned home, approached company officials, and was assigned the job of building an amateur television outfit to test the feasibility of building television cameras small enough to fit into a bomb. Due to the military secrecy surrounding such projects, Rand was unaware that research groups, having vast resources and engineering personnel, were also engaged in the development of television camera equipment for missile-borne use. In true amateur fashion Rand started on the project without the aid of outside sponsorship and satisfactory equipment was actually developed before any agency was sufficiently interested to offer any aid.

A project had been started by H. J. Rand (W1DBM's nephew) utilizing a two-inch amateur "ike" for picking up objects through fog and darkness by infrared rays. Experiments determined that the two-inch amateur "ike" was not particularly sensitive in the infrared region and therefore was of no value for this purpose and this equipment was made available and the television camera project got under way in September, 1940 with W1DBM and H. J. Rand as co-workers.

Tests disclosed that the two-inch amateur

"ike" lacked sensitivity and definition for high-quality pictures. This operating defect was brought home forcefully late one afternoon when demonstrating the equipment. There was insufficient light outdoors to get a decent pick-up. However, upon tuning in NBC's television they saw an excellent outdoor picture of a football game. Upon investigation it was learned that NBC was using an Orthicon type of pick-up tube. Samples of these tubes were procured and work started on a small camera utilizing this more sensitive pick-up. By now, the project had grown considerably and additional personnel was required. J. J. Lamb, W1AL, of *QST*, had been working on amateur television and was a logical choice. He was engaged on a consulting basis and later secured a leave of absence from the ARRL to devote full time to the project. Next came Joseph Brustman, ex-OE134, a native of Vienna, Austria, a man with wide television experience. H. J. Rand dropped out to begin work on another project. Later he joined the Army Air Forces. Toward the end of the war, with the rank of major, Rand actually controlled television-guided missiles in the ETO.

The first model utilizing a four-inch Orthicon was completed in the spring of 1941 and given vehicular tests transmitting back to the laboratory on 105 Mc. This camera unit weighed about 65 pounds as compared to the then existing "portable" commercial equipment comprised of six or seven large-size suitcases weighing a total of some 700 pounds.

This midget television equipment was demonstrated to the armed forces but they did not appear particularly enthusiastic about such a "fantastic idea." However, the OSRD and the NDRC thought it worth while. They could not sponsor a *completed project* but if a smaller and lighter camera could be made it would be a *new development* which NDRC could sponsor.

A new type of Orthicon pick-up tube had been experimentally made by Dr. H. B. DeVore of RCA, and this tube was used in a considerably smaller television camera subsequently developed for and demonstrated to the NDRC by the Middletown group.

Early in 1942, Vernon Chambers, W1JEQ, obtained a leave of absence from *QST* and joined Rand and Lamb, as did Harry Whittmore, W1BR.

By late spring it became apparent that more of the two-inch Orthicons would not be available from RCA, so it became necessary to manufacture them and Marshall P. Wilder, W2KJL, started the production of the desired pick-up tubes, assisted by Frank Norman, W1JZB. Daniel Smithwick, jr., W1NKA, went to work on construction of the cameras as did Calvin Bennett, W1KHL. August, 1943 brought George Grammer, W1DF (obtained on leave of absence from *QST*) and later Milton Bloomquist, ex-

W2BAI, joined Wilder's vacuum-tube section. John S. Muskatallo, W1BFW, and Thomas S. Pugarelli, ex-W2LWL, also were included in the project. Approximately fifty workers, men and women, were finally engaged in the manufacture and development of this equipment.

After the Germans began using their robot bombs the Army and the Navy became intensely interested in remotely-controlled guided missiles and the Middletown group was given contracts by both services to develop still *smaller* and *lighter* weight units.

Various models built concluded with the latest and smallest model comprised of two pieces; one, a long slim box containing the camera and the video amplifier and a smaller square box housing the pulse and synchronizing signal generator. The outstanding characteristics of these units are their small, compact and light-weight construction and features such as the automatic iris control and the automatic focusing control. These units will stand temperatures from -50° to $+50^{\circ}$ C. as well as centrifugal force up to 10 Gs. Circuit details are still shrouded in military secrecy.

Both the Army and Navy have disclosed some of the uses to which equipment of this type has been subjected, including details on the high-angle television bomb, the glider bomber, (called a "Glomb") and the television-equipped robot-plane.

One actual use of the equipment might be as follows: A suitable bomb (maybe 2000 pounds) has a streamlined housing strapped under it. This contains the camera head. A wing of sufficient lifting capability, to maintain a glide of possibly 6 to 1, is strapped on top. Fastened to the rear of the bomb is a fuselage containing the pulse box, transmitter and a remote-control receiver together with motors and solenoids for controlling the rudders and fins which project from the rear of the fuselage. This is the so-called "glide bomb" which is carried to within gliding range of the target. The bombardier switches on the television apparatus and when he is within gliding range of the target he releases the glider. At this time the bomber circles away and gets out of range of enemy AA fire and fighter planes. The operator in the bomber synchronizes his television receiver with the transmitter and holds it synchronized while the bombardier, looking at a separate monitor 'scope in a darkened part of the cabin, throws switches on his remote-control apparatus and changes the glide bomb's path — up or down or right or left so that the target is centered on the crosshairs on his picture 'scope. Meanwhile the bomb, gliding at a speed of some 200 or 300 m.p.h., approaches the target. The target looms larger and larger on the 'scope in the plane and the bombardier makes minute corrections as various cross winds throw the bomb off course. Suddenly the ground seems to leap up and hit the observer in the face. The scene disappears in

an enlarging close-up as the camera is destroyed. And so is the target!

The camera unit can be installed in the nose of a robot plane, complete with motors and all the necessary controls. The robot is flown off the ground by remote radio control or by a pilot who parachutes to earth after flying the plane off the ground. The two planes now fly hundreds or even thousands of miles until they come to the target area. Then the operator flies the robot plane, carrying a heavy charge of explosives, right into the target, guiding the robot by the view of the area ahead as received over the television circuit.

Television may also be used in the so-called high-angle bomb carrying a television camera in front of the "war head" and with the associated equipment in the bomb's tail portion. This bomb has no wings but has controlling devices on the tail. The bomb is dropped from 25,000 to 30,000 feet by a standard bomb sight and theoretically would hit the target without any remote control. However, unknown cross winds and unknown temperatures at lower levels often cause high-elevation bombs to miss their target, therefore the bombardier utilizes television to see in what direction the bomb deviates and then corrects its trajectory by remote control.

Many amusing incidents occurred in connection with the development and testing of this equipment. One day when parked on a hill about five miles away from the lab, W1DBM tried frantically to raise the lab on the 112-Mc. talk-back circuit. However, those viewing the images had become so engrossed that they paid no atten-

(Continued on page 124)



Phil Gildersleeve, W1CJD, city editor of the Middletown Press and famous QST cartoonist, holds one of the 2-inch Vericon cameras during a recent demonstration of the equipment to the press. The cord stretched along the unit is part of the automatic iris control system.

Happenings of the Month

NEW FREQUENCIES

We have two new bands! The 1215-1295-Mc. band, and the first ten megacycles of the 420-450 band, were made available to amateurs by FCC on January 16th by means of its Order 130-B. That order amended the second ordering clause of Order 130-A so that Paragraph 2 (a) (6) now reads as follows:

(6) 420-430 Mc., 1215-1295 Mc., 2300-2450 Mc., 5250-5650 Mc., 10,000-10,500 Mc., and 21,000-22,000 Mc., using on these six bands A1, A2, A3, A4 and A5 emissions and special emissions for frequency modulation (telephony and telegraphy). Peak antenna power on the band 420-430 Mc. shall not exceed 50 watts.

This is all of our 1200 band but is only the first third of our 400 band, the remainder being delayed a while longer during international discussions about navigational aids in this part of the spectrum. That question, which is also delaying the opening of our 220-225-Mc. band, is expected to be settled soon.

The unusual method of stating the power limitation for the new 420-430 band arises from the need to protect the navigational devices with which we share this assignment. A peak power of 50 watts means that if A3 telephony is used, with Class B modulation in the final in the usual manner, the carrier power may not exceed $12\frac{1}{2}$ watts. For f.m. telephony, the carrier power of course is the peak power, permitting the use of 50 watts f.m., which mode, considering its other advantages, is therefore certainly indicated as preferable. Unlike all our other bands, this power limitation is in terms of antenna power, not plate input to the final. We haven't much experience with this band. We would guess that we would have efficiencies of only 15 or 20% to a dummy load when using a voice-modulated a.m. oscillator, perhaps as much as 50% from the final of an oscillator-amplifier transmitter. The power being specified as antenna power, the losses in the feeders do not enter. They of course will vary widely with different installations. A self-excited oscillator on A3 may well be running 200 watts input for this permitted antenna power, and 800 watts for c.w.; and the final of an f.m. transmitter, at relatively high efficiency, but with a mode without peaks, may also well be running 200 watts input. So we seem to have no great handicap from this temporary power limitation.

Who will be the first amateurs to establish communication on these two new bands?

WHAT BANDS AVAILABLE?

Below is a summary of the presently-authorized U.S. amateur bands as of February 1st. Changes are announced by W1AW broadcasts. Figures are megacycles. A1 means c.w. telegraphy, A2 is m.c.w., A3 is a.m. phone, A4 is facsimile, A5 is television; FM means frequency-modulated 'phone or telegraphy.

28.00-	29.7 -	A1	
28.10-	29.5 -	A3	
28.95-	29.7 -	FM	
56.0 -	60 -	A1, A2, A3, A4	
58.5 -	60 -	FM	[only
144.0 -	148 -	A1, A2, A3, A4, FM; except band is	
146.5 -	148 -	within 50 mi. of Washington, Seattle, Honolulu	
420 * -	430 *		
1,215 -	1,295		} A1, A2, A3, A4, A5, FM
2,300 -	2,450		
5,250 -	5,650		
10,000 -	10,500		
21,000 -	22,000		

* Peak antenna power must not exceed 50 watts.

CITIZENSHIP PROOF ABANDONED

FCC on January 23rd adopted Order 75-D, modifying the extensive requirements of Order 75, originally adopted in 1940 as part of the Commission's national-emergency program. Order 75 required holders of and applicants for radio operator licenses, both commercial and amateur, to submit responses to questionnaires, together with fingerprints and documentary evidence of citizenship. Order 75-D eliminates the requirements of Order 75 except with regard to the submission of fingerprints on FCC Form 735-A.

Since January 23rd, an applicant for an operator license, commercial or amateur, is not required as a general rule to submit documentary evidence of citizenship. He must, however, continue to certify in his application that he is a citizen of the United States and must also furnish fingerprints. In particular cases, the Commission may make specific requests for documentary evidence of citizenship and for information concerning qualifications to hold operator licenses.

REVISED REGULATIONS

Over the last several months, FCC has been looking over the amateur regulations to modernize them in terms of our additional bands and to clear up a few doubtful points. Gradually the job has extended until our regulations have received a fairly thorough overhaul in polishing up the

language for greater understandability. The principles and the scope remain unchanged, although there will be a few small new features. ARRL has been consulted and our representatives have sat in with FCC people during the discussions. At the present writing, the draft is ready to go before the Commission itself for adoption and issuance as our postwar regulations. As soon as that occurs, *QST* will publish the full text and any necessary explanations. Watch for it.

SAMUEL H. DOWELL

Samuel Hamilton Dowell, W5ERV, the well-known alternate director of the Delta Division, died suddenly at his home in Shreveport on the evening of January 24th while operating his station. He was 74 years old.

Mr. Dowell was a prominent figure in the lumber business, being secretary-treasurer and a director of Frost Lumber Industries and of several of its subsidiaries. He was born in Pike County, Mo., and as a young man worked as a telegrapher for the "Cotton Belt" railway.

He has served as alternate director of the Delta since the autumn of 1943 in a term of office that was due to expire this past January 1st. Because of the failure of Delta members to nominate for alternate, he was continuing in office until his successor was chosen, and we hear was in the process of being renamed for this position by Shreveport amateurs at the time of his death. He will be greatly missed by his many friends on the air lanes.

CANADIAN MEMBERSHIPS

ARRL operates in both the United States and Canada. Since 1941 our by-laws have provided, in the case of the United States, for Full Membership, open only to licensed amateurs, and Associate Membership, open to any interested person. At the time of the adoption of this arrangement, Canada was at war and her amateurs closed down. It was accordingly provided that in Canada it would become applicable only three months after the resumption of licensing.

The Canadian Government resumed the issuance of amateur licenses when it reopened amateurs on November 15th. Since February 15, 1946; therefore, new and renewing Canadian members are also being classified according to license status. Only Full Members have the right to hold office or vote in ARRL affairs. Memberships in effect before February 15th continue in the enjoyment of full rights for the period for which dues were then paid, but not beyond February 15, 1947.

CANADIAN NOTES

Amateur call areas are being changed in western Canada, effective April 1st, to provide three

additional districts. The new set-up will be:

VE1 — Maritime Provinces
VE2 — Province of Quebec
VE3 — Province of Ontario
VE4 — Province of Manitoba
VE5 — Province of Saskatchewan
VE6 — Province of Alberta
VE7 — Province of British Columbia
VE8A-L — Yukon Territories
VE8M-Z — Northwest Territories

Except in Yukon and Northwest Territories, the only changes will be in the digit in Saskatchewan, Alberta and British Columbia, the rest of the call remaining unchanged.

Canada will move the amateur 5-meter band simultaneously with the United States. The full width 50-54 Mc. will be available for A-1, A-2 and A-3 emissions, and 52.5-54 for f.m.

G. I. OPERATION

Although amateur operating is not permitted in the AFPAC area, the Navy has authorized it in the Mariannas area, including Guam, Saipan, Tinian, Iwo Jimo and Peleliu, as well as several smaller islands. The Guam Radio Amateurs League has about 75 U. S. hams, the president being Major Mel Jackson, W3AIM, the secretary R. J. Morrow, W5CQ. There are ten chapters around the island, mostly at Army bases but including the NOB Amateur Radio Society. Upon individual authorization, licensed amateurs there are authorized to sign their own calls plus a portable indicator, which is KB6 for Guam and is the name of the island in other cases. An input of 500 watts is authorized. Frequencies begin at 28 Mc. and in general resemble FCC allocations on the mainland.

In Germany, Signal Operation Instructions authorize FCC-licensed amateurs under military control to operate amateur stations, with 25 watts to the antenna. There is an examination in three elements paralleling FCC, the third element on regulations relating to the rules of this command as given in these Instructions. Any signal officer can certify an applicant. That certification, plus his license or an affidavit that he possesses one, and a simple application form get him a D4 call. Authorized frequencies include 21-21.5, 29-30 and 58.5-60 Mc. There are no D4 Germans.

ELECTION NOTICE

To all Full Members of the American Radio Relay League residing in the Delta Division:

You are hereby advised that no eligible candidates for alternate director of your division were nominated under the recent second call. By-Law 21 provides that if no eligible nominee be named, the procedure of soliciting and nominating is to be repeated. Pursuant to that by-law, you are again solicited to name Full Members of your division as candidates for alternate director thereof. See the original solicitation published on

(Concluded on page 188)

Foreign Notes

CZECHOSLOVAKIA

Czech amateurs played a vital role in the early reconstruction period of their country. Accepting the amateur's traditional responsibility for emergency communications, at the end of war OKs built ingenious little rigs from almost nothing and communicated important state and private news for several months until official telecommunications facilities were again in order. During the first two months over 10,000 messages were handled, mostly on the 80-meter band although not in actual amateur status. C.A.V. knows that this performance capitalized the amateurs' war service, for they have a promise from authorities to reactivate amateur radio soon. Probably 56 and 112 Mc. will come first, lower frequencies later.

The society was "dissolved" by German occupation authorities in 1939, and funds confiscated. During the war period 24 members were executed, 40 imprisoned in concentration camps. But spirit is still strong: three-fourths of the former mem-

bership has returned, and there are nearly 1000 new members. There is great shortage of radio literature, and several Handbooks brought back by Czech army personnel returning from England were avidly read.

DENMARK

OZ amateurs fared better during occupation years than their Czech compatriots, apparently. E.D.R. managed to retain most of its regular membership and even added to its roster. Their magazine appeared monthly without interruption. There were even hidden transmitter hunts! Amateur operation has not yet been permitted, but an early release of the v.h.f. bands is hoped for.

GREAT BRITAIN

Our G friends are being re-opened on 28-29 and 58.5-60 Mc., as rapidly as the depleted staff of the Post Office department can issue licenses.

(Concluded on page 130)



These hams gathered in Cairo on November 24th to visit Moustapha Waley, SU1MW, who provided some thrills with many splendid W contacts on ten meter 'phone. Left to right, front row: DeLake Bowen, W5CUB; Mario Motter; Walter Gordon; Kenneth Ellis, SUIKE; Henry Bourne; John Davis, W8RFO; A. Varenick. Middle row: Bill Speechley, SU1SP; B. Bassiouni, FR548; S. Knight, G2DFL; C. Alway, W8UNF; R. Houseworthe, W9SAJ; J. Gillson, W3GAW; D. Uptegrove, W3JQS; E. Shaw, W5SH; F/O Taylor, G4RY. Back row: T. Tice, W8UBW; Tim Heffenen, G8HW; D. Buckland, SU1DB; D. Myer, SU1RO and SU1MR were also present but not in picture.

Need There Be Line-of-Sight?

Breaking Down Some Popular Fallacies Regarding V.H.F. Coverage

BY E. P. TILTON,* WIHQ

• "Work 2 meters in my location? What chance would I ever have of getting over those hills?" More chance than you think, perhaps, and you may not need a mile-high antenna to do it, either!

FROM THE earliest days of activity on 5 down to present-day efforts on the new 2-meter band, the horizon has been the v.h.f. worker's most formidable enemy. Frequent examples of consistent work over distances up to 100 miles and more and occasional contacts up to 350 miles on both 56 and 112 Mc. have served to prove the falsity of this idea, but still many would-be v.h.f. enthusiasts are deterred from making any serious effort by the thought that hills lie between their locations and those of other potential workers.

The almost standard approach employed by the more incurable addicts has included the use of the highest possible antennas as the means of getting out of difficult locations or, failing that, resorting to portable or mobile gear which can be taken to the highest hill in the area in order to work over as wide an area as possible. Our whole thought on v.h.f. problems has been predicated on the worship of altitude as the most potent factor in the picture.

We have no quarrel with these techniques; we like our antennas high in the air, of course, and we agree that work from the mountain-tops can be one of the most enjoyable adventures in all of amateur radio, but the results of almost nightly tests since November 15th have convinced us that many so-called "impossible" locations are not as difficult as they seem, and that a highly-elevated antenna is not necessarily the best way to conquer certain geographical difficulties.

Then there is the matter of polarization. For years this writer has been between two fires in this connection. In areas other than the Atlantic Seaboard the trend has been toward horizontal polarization, and pressure from various groups — particularly the gang in the Middle West — has been strong for us to come out for standardization on horizontals for all v.h.f. work. But the existing records for both 56 and 112 Mc. were made with

vertical polarization, over distances which have never been approached with horizontal. What, then, are the true facts regarding polarization in v.h.f. work?

The 144-Mc. tests mentioned above included the use of dipoles which could be used in any position and at varying heights above ground. Results were at variance with data collected on 56 Mc. recently and in two years of work with both horizontal and vertical antennas in the period prior to the outbreak of war. On 56 Mc. it has always been a matter of vertical or horizontal; good results were obtained with both, but only when the same polarization was in use at both ends. Except for paths involving skip, we have never seen any consistent example of improved reception with polarization opposite to that of the transmitting station. On 144 Mc., however, in work with stations located behind intervening hills it appears that *either* type of polarization may be used almost at will, and the man you want most to work (that fellow on the other side of the hills) will often be unable to tell which polarization you are using.

For some time after the changeover from 112 to 144 Mc. was made on November 15th, we were unable to hear anything beyond the numerous stations in the Hartford area. Most of these stations are virtually line-of-sight, because our Selden Hill location is considerably elevated above the surrounding countryside. The first signal heard from beyond the hills on the other side of the Connecticut Valley was from W1EJI near Tolland, Conn., 23.6 miles distant. He was in contact with W1JLK, Tolland, and W1BEQ, Coventry, both of whom remained little more than unintelligible murmurs until we improved our receiving facilities.¹ When we began to hear the latter two well enough to know when they were on or off, we began trying various antennas, horizontal and vertical, though previous tests had demonstrated that W1EJI was heard best with vertical polarization. All three stations were using similar vertical dipoles and, fortunately for the sake of comparisons, about the same power level — approximately 15 watts input.

Trying a 125-foot "V" on W1JLK, we were amazed to hear his signal jump from bare audibility to a husky S8, though W1EJI, in nearly the same direction, had dropped slightly when the "V" had been used. W1BEQ was also found to be louder on the "V," though not to such a marked

* V.H.F. Editor..

¹ "A Non-Radiating Superregenerative Receiver for Two Meters," Feb., 1946.

degree as JLK. A simple dipole which could be used either vertical or horizontal gave similar results. A 3-element horizontal array similar to the one shown in Fig. 1 was then tried and a further improvement in reception of JLK and BEQ resulted. All three were now received at about the same signal level, though EJI, with the easiest path, was slightly weaker unless the array was turned up to a vertical position.

A glance at the accompanying vertical contours for the three paths will show why this is so. Although EJI is the most distant, he has considerably less in the way (and consequently less polarization shift) and his location is appreciably higher than the others'. BEQ has more hills to climb over (or around) and his location is closer to them, increasing the shadow effect, but his spot is still not as difficult as that of JLK. At exactly one mile from his home JLK has a hill which is 280 feet higher than his elevation, directly in the path to the Hartford area. It was his location, therefore, which was selected for further tests.

In such a location, where high ridges are the limiting factor, it seemed that height above ground would be of little importance and that increasing antenna gain and reducing line losses would net a far greater improvement than raising the antenna. We had this idea under consideration for some time when a visit from W8CIR, who has a fine 56-Mc. mobile rig, provided a good chance to investigate further. Enroute to Boston, Ed passed the home of W1JLK, so some impromptu comparisons were made. With the car in front of JLK's home W8CIR/1 was only 5 db. down from W1JLK, despite the fact that the mobile unit ran only 12 watts compared to 60 watts for the 56-Mc. home rig of JLK. There was a difference of nearly 50 feet in antenna height! Numerous checks showed that this was no isolated freak, because the signal from W8CIR/1 remained nearly constant all through the area around Tolland. Incidentally, it was necessary to use vertical polarization matching the verticals of W1JLK and W8CIR/1, to obtain these levels on 56 Mc., whereas it has appeared that unlike polarizations are equally effective on 144.

These observations encouraged JLK to try low indoor antennas for 144. A 3-element horizontal array which could be used at the operating position, only a few feet above ground, netted stronger signals than had ever been received with a vertical extended double-Zepp which is 50 feet

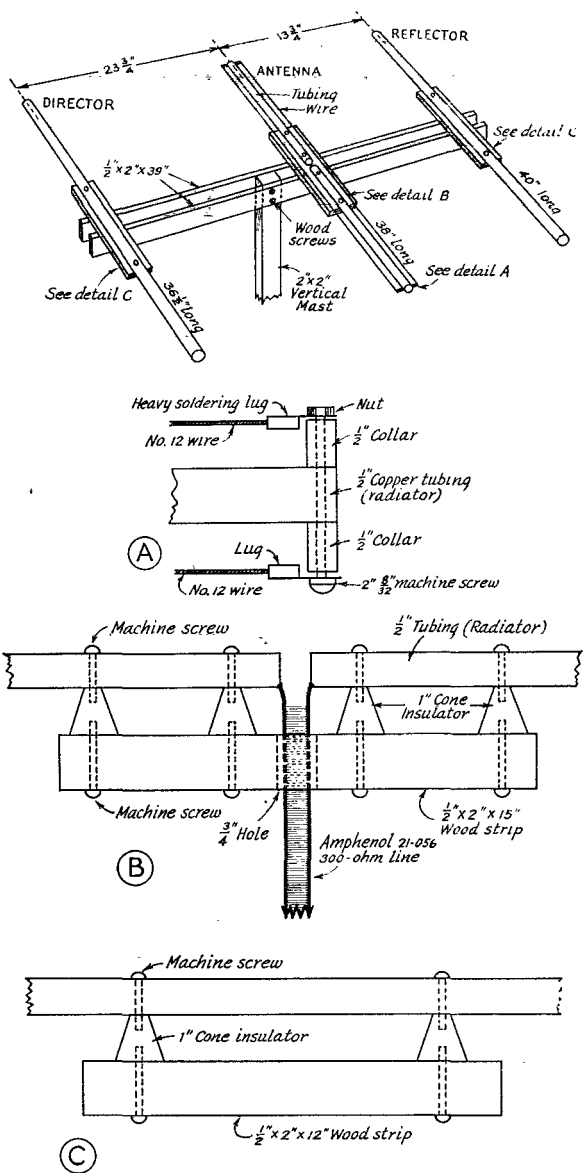

Fig. 1 — The 3-element horizontal array discussed in the text. The driven element is a multi-wire dipole consisting of two sections of half-inch tubing paralleled fore and aft by lengths of No. 12 wire. Parasitic elements are one-inch duralumin tubing, though any material one half-inch or larger may be used. Use of the wide spacing shown permits feeding the array with a 300-ohm line. Amphenol 21-056, a flexible polystyrene-insulated line, is ideal for this purpose.

Detail A shows the method of attaching the wires to the dipole in the driven element, mounting of which is shown in detail B. Detail C applies to both parasitic elements.

The two lateral supports are screwed to the mast in such a position as to result in mechanical balance.

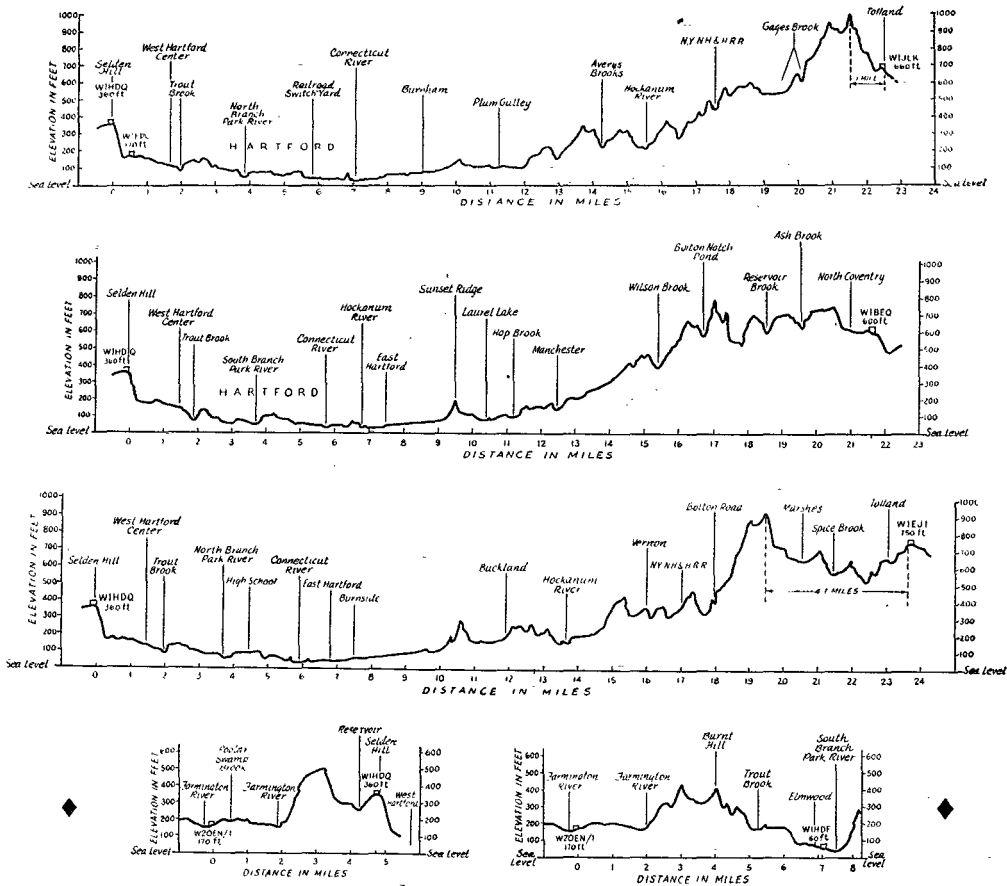

Fig. 2 — Vertical contours of indirect paths over which 144-Mc. work is being done regularly. The upper contour represents the path from WIHDQ and WIEPC, West Hartford, to WIJLK, Tolland. The second shows the line between Selden Hill and the Coventry location of WIBEQ. The longest path is the relatively easy hop to WIEJI, near Tolland. The two lower contours show the difficult terrain between Farmington and WIHDQ and WIHDF. Signals over all these paths show evidence of multipath reflections.

Earth curvature is disregarded as relatively unimportant at these distances. Vertical scale is 1/2400, horizontal 1/63360.

above ground, and disclosed that the signal from WIHDQ was reaching Tolland not by direct path but by reflections from various surrounding hills. In the case of the hilltop location of WIHDQ, height above ground is of practically no importance in v.h.f. antenna design, as evidenced by the fact that the signal from WIJLK can be heard equally as well at a few feet above ground as with the highest antenna we've ever used. Indoor antennas, with feeders only long enough to permit rotation, have given best results in this spot to date.

There are several types of locations where there is no substitute for height above ground, of course. The fellow who is directly behind a slight rise in ground will improve his range by raising his antenna sufficiently to clear such a rise. Sta-

tions situated in congested city areas, especially those having steel-frame buildings, must have antennas "in the clear" to cover much territory. Signals are attenuated rapidly in dense forest areas, so raising the antenna above heavy foliage concentrations may often be necessary. But there are countless other locations, such as the examples shown in the accompanying graphs, where the high line losses present in the average amateur antenna system make it doubtful whether there is any advantage in increasing the antenna height above that which permits the use of a feedline not more than a few feet long. Surely the man who plans to erect a high antenna will do well to make a careful investigation of the terrain he will have to cover, to see whether the added height will pay him an appreciable

dividend. A few cents invested in topographical maps, and a few hours devoted to their study,² may save large amounts of both time and money in the end.

Getting Out of a Hole

Every v.h.f. enthusiast dreams of having a home on the top of the highest hill in the county miles from the nearest b.c.l. and with acres of land on which to erect his dream arrays, but few of us realize this ambition, especially in these days of housing shortages. The difficulties of house hunting in the Hartford area, still feeling the effects of wartime expansion, forced our Department Editor, W2OEN, into one of the worst v.h.f. locations ever conceived by the mind of man. Just the name, "River Glen, Farmington," gives some idea. There is nothing lower for miles around which is not actually under water, and less than 200 feet distant is an embankment which is higher than any antenna at W2OEN/1; yet Mid has had his share of fun on 112 and 144 Mc. If you are a v.h.f. man at heart, but have given up trying because of your poor location, take a look at the vertical contours over which W2OEN works with 8 watts input, and take heart. All is not lost!

W2OEN has had his moments of thinking about 100-foot towers, but consideration of the fact that, even with this height, he would still be far from line-of-sight to the Hartford area has kept him from taking the step. Hours on end have been spent examining the effect of various antennas on the indirect path between W2OEN/1 and W1HDQ. Because of the relatively short path, approximately five miles, communication can be carried on with almost any sort of antenna. Indoor dipoles at both ends give approximately equal signal strength, regardless of polarization. There is some evidence of the necessity for matching the polarization at the other end, but it is not nearly so pronounced as with line-of-sight paths of the same length. With the transmitting antenna (a folded dipole) at W2OEN/1 located only a few feet above ground the signal was found to be practically equal to that heard when a similar antenna was used at about 25 feet, though the polarization was more easily discernible when the higher antenna was used. The really interesting thing about these tests was disclosed when we had a call from W1HDF, who had heard every transmission from W2OEN/1 during the evening's testing, regardless of antenna height. W1HDF was listening with a vertical dipole about 20 feet above ground in one of the poorest locations in the Hartford area!

Would 100-foot towers have helped any over this path? They might have raised the signal one S unit — but an increase of four S units could result from the use of high-gain antennas at each end!

² "Choosing U.H.F. Sites," Rand, Sept., 1945, page 161

What Sort of Beam?

The usual type of parasitic array will give very good gain but its frequency response is too sharp for a 4-Mc. bandwidth, hence it may turn out to be a liability when used for receiving over the whole 144-Mc. band. Furthermore, it is usually difficult to tune up properly, with the result that although considerable "front-to-back" may be in evidence there actually may be little forward gain over a good dipole. Sacrificing a little front-to-back ratio by using wider spacing permits the use of a multi-wire dipole and a close-spaced line in conjunction with a 3-element system. The array shown in Fig. 1 is now in use at W1BEQ, W2OEN/1, and W1HDQ. Its frequency response is sufficiently broad to permit operation over most of the band with the dimensions shown, the close line spacing keeps down radiation losses, the forward gain, while not quite up to the theoretical limit for 3-element arrays, is decidedly worth while, and the performance on receiving is superior to any other parasitic system tried to date. Best of all, it can be cut to size and erected without elaborate adjustments, though the serious experimenter will seldom be satisfied with this method. The installation of this array at W2OEN/1 has resulted in improved signal reports from the various stations in the Hartford area, all of whom are on the other side of the high ridge of hills shown in the two lower contours in Fig. 2, even though practically all of them were using vertical antennas for reception. The array is less than 25 feet above ground, and is somewhat below the level of the embankment mentioned above.

The information relating to the degree of polarization shift and the direction of arrival of signals so affected, was gathered during the period between November and mid-January, when New England's hills are devoid of foliage and covered with a blanket of snow. It will be interesting to see whether or not there will be some change in propagation characteristics as the foliage returns and the season of greater temperature-inversion effects rolls around.

Let no one draw the conclusion that we are recommending the abandonment of tower construction or standardization on indoor antennas. Far from it! We merely wish to emphasize that there are many locations in which there are factors other than great height. We offer the examples given as convincing evidence that there are few "impossible" locations, and that the fellow who is willing really to work on the problem can get results on 144 Mc. even though his location may not appear favorable at first glance. Very few of us ever get to live in the "good" locations; it is by making the most of what we have that we draw the greatest measure of satisfaction from v.h.f. endeavor.

A 4.3-Mc. F.M./A.M. I.F. and Audio Amplifier

Universal Amplifier for V.H.F. and U.H.F. Converters

BY JAMES W. BRANNIN, * W6OVK/6

It is generally conceded that superheterodyne reception offers the best overall results on v.h.f. and u.h.f. bands as well as on the lower frequency bands. An all-band receiver that will cover the 50- to 22,000-Mc. bands does not seem very practical when we consider the problems of maximum sensitivity, bandswitching and bandspreading, and therefore it seems more practical to use one standard i.f./audio combination and

is used for the b.f.o., and a fixed-tune 30-Mc. converter using a 9001 mixer and a 9002 oscillator allows 30-Mc. input to be converted to the lower i.f. of 4.3 Mc. The lower i.f. of 4.3 Mc. seems desirable for converters at a signal frequency of 28, 50, 144 and 220 Mc., while the 30-Mc. i.f. is a more logical choice for higher frequencies.

Most of the circuit is more or less conventional and will be familiar to the average amateur, with the possible exception of the limiter and discriminator circuits. The limiter circuit using two resistance-coupled 6SJ7s is used in most f.m. broadcast receivers, with the exception of the tap for a.m. reception and the signal meter. The variable shunt across the meter, *M*, allows the sensitivity to be adjusted to accommodate different signal levels, although the meter — and receiver — can be calibrated for any particular setting of this control. Local stations will run the meter well off scale, and the sensitivity must be reduced under such conditions. The meter indication is not affected when switching from f.m. to a.m. or vice versa. The limiter-control potentiometer, *R*₂₈, is used to set the limiting point of the first limiter and during f.m. reception is normally set to the lowest voltage consistent with good audio output.

No a.v.c. is used in the i.f. amplifier, but a manual gain control, *R*₄, is included in the first i.f. stage to accommodate various signal levels during a.m. reception. It is run wide open for f.m.

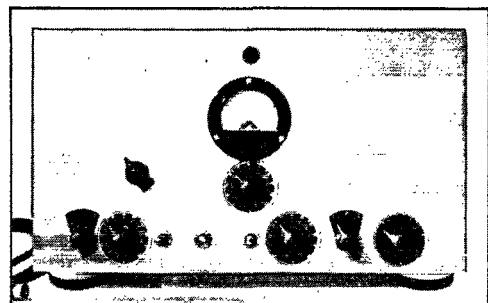

A combination a.m./f.m. i.f. amplifier for either 4.3, or 30-Mc. output converter. The auxiliary cable is needed when a 30-Mc. output converter is used.

feed individual converters for each amateur band into such a unit. The amplifier should be capable of either a.m. or f.m. reception, should include a b.f.o. for c.w. operation, and should be able to accept either 5- or 30-Mc. signals, so that some freedom of converter design is possible. The unit to be described is the result of an attempt at such a combination, and has proved to be quite satisfactory in the bands where it has been used.

The Circuit

As can be seen from the wiring diagram in Fig. 1, three stages of i.f. amplification are used, followed by a two-stage limiter, a discriminator and two stages of audio amplification. Type 6AC7 tubes are used in the i.f. amplifier, 6SJ7 in the limiter stages, and the discriminator and two audio are 6H6, 6SF5 and 6V6 respectively. The i.f. amplifier is loaded to give a pass band of 200 kc., and a switch, *S*₄, connects the discriminator to the audio for f.m. reception, the first limiter grid circuit to the audio for a.m. reception, and in a third position the audio amplifier can be used with a phonograph pickup. A 9001 miniature tube

* Room 909, 65 Market St., San Francisco, Calif.



A top view of the a.m./f.m. i.f. amplifier. The small aluminum chassis in the center is the b.f.o. unit, and the aluminum chassis near the power transformer at the left is the fixed-tune 30-Mc. converter.

reception. A b.f.o. injection control, R_{35} , allows various levels of b.f.o. voltage to be fed to the a.m. second detector — the first limiter stage — and is useful not only for c.w. reception but for spotting weak a.m. carriers.

The discriminator is the conventional Foster-Seeley type, and this feeds into the audio system through a de-emphasis network, $R_{40}C_{31}$. This network is not strictly essential for amateur work only, but it serves as a "tone control" on a.m. reception and decreases the high audio frequencies and the noise.

The audio amplifier uses negative feedback, through C_{34} and R_{45} , and the audio volume level is set by the gain control, R_{41} . A jack, J_4 , is included for headphone operation, and this cuts off the 6V6 stage when the phones are plugged into the circuit. It was found necessary to shield the leads in the input of the audio circuit to reduce hum pickup, although this might not be necessary in some rigs.

Construction

The amplifier was built on a 7 by 14 by 2-inch cadmium-plated chassis — the only one available

at the time — and the crowded chassis accounts for the use of miniature tubes in the 30-Mc. converter and 4.3-Mc. b.f.o. circuits. The front panel controls can be seen in the photograph and they are, from left to right: f.m./a.m./phono switch, audio gain, power switch S_1 , standby switch S_2 , 30-Mc. converter switch S_5 , limiter control potentiometer R_{28} , b.f.o. on-off switch S_3 , and i.f. gain control R_4 . The signal-strength meter shunt potentiometer, R_{25} , is directly under the meter, and the control to the left is the b.f.o. injection control, R_{35} . Amphenol jacks on the right-hand end of the chassis provide connections for either the 30- or 4.3-Mc. input circuits.

The 30-Mc. converter is built on a single piece of aluminum bent into a shape that might be described as a square cross section with the closing side bent away instead of closing the square. This chassis mounts the two tubes and all of the necessary components, and it is mounted on the end of the main chassis next to the power transformer. The b.f.o. is built in a small aluminum can, and the tuning adjustment is available at the top.

As mentioned previously, the i.f. transformers

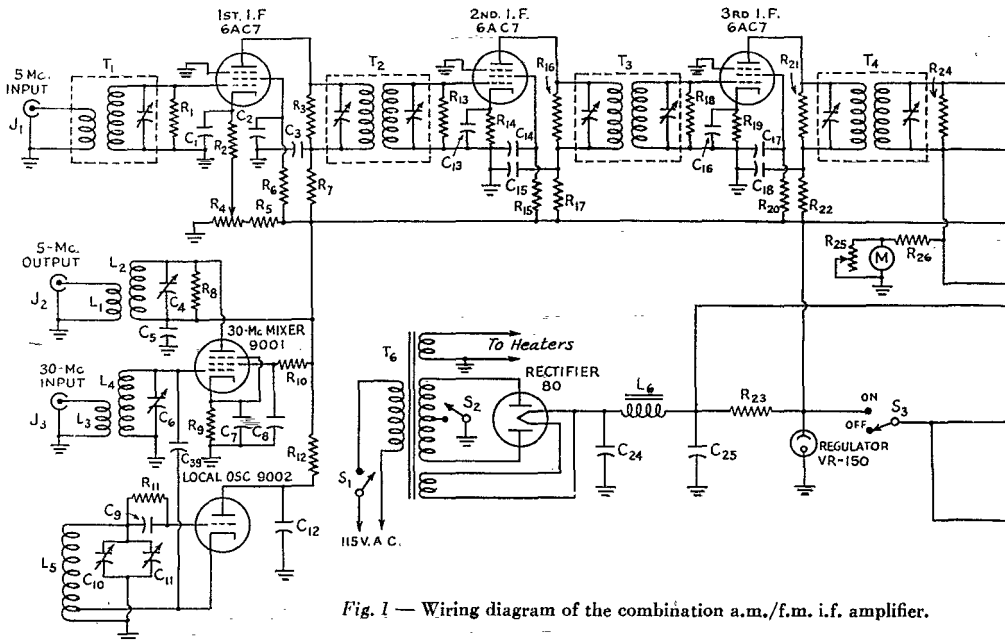

Fig. 1 — Wiring diagram of the combination a.m./f.m. i.f. amplifier.

- | | | |
|---|--|---|
| $C_1, C_2, C_3, C_5, C_{13}, C_{14}, C_{15}, C_{16}, C_{17}, C_{18}, C_{26}, C_{37}, C_{38}$ — 0.01- μ fd. small mica | C_{12} — 0.001- μ fd. mica | J_1, J_2, J_3 — Microphone cable jacks (Amphenol 80-C) |
| C_4, C_6, C_{29} — 125- μ fd. mica adjustable padder | C_{22} — 25- μ fd. mica | J_4 — Midget closed-circuit jack |
| C_7, C_8 — 500- μ fd. mica | C_{24}, C_{25} — 16- μ fd. 450-volt electrolytic | M — 0.100 microammeter |
| C_9, C_{27}, C_{30} — 100- μ fd. mica | C_{28} — 25- μ fd. midget variable | $R_1, R_3, R_8, R_{13}, R_{16}, R_{18}, R_{21}, R_{24}$ — 20,000 ohms |
| C_{10} — 3 — 30- μ fd. mica trimmer | C_{31} — 0.002- μ fd. mica | R_2, R_{14}, R_{19} — 200 ohms |
| $C_{11}, C_{19}, C_{20}, C_{21}, C_{23}$ — 50- μ fd. mica | C_{32}, C_{35} — 0.02- μ fd. 400-volt paper | R_4 — 5000-ohm potentiometer |
| | C_{33}, C_{36} — 25- μ fd. 50-volt electrolytic | R_5 — 0.25 megohms |
| | C_{34} — 250- μ fd. mica | $R_6, R_{11}, R_{15}, R_{20}, R_{26}, R_{36}, R_{37}$ — |
| | C_{39} — Two twisted wires. See text. | |

are broadened by loading them with 20,000-ohm resistors, and by increasing the coupling between the primary and secondary windings on each transformer. This latter alteration in the physical make-up of the transformers was done more for the purpose of boosting the gain of the i.f. channel than for broad-banding it, since considerable loss in gain was experienced when the windings of each transformer were loaded heavily enough to give a pass band of 200 kc. The windings were moved up to $\frac{5}{8}$ -inch spacing by scraping the wax from both sides of the lower coil and then moving the coil into the proper position. This was done to T_2 , T_3 , and T_4 . The input transformer, T_1 , was treated with even less respect. Approximately half of the bottom coil was unwound and removed, and the remaining half coil was moved up tight against the top coil, in the manner described above. The modified coil was reconnected to the proper terminals but the tuning condenser was left at minimum capacity. It is recommended that each transformer winding be tested for continuity after the above alterations. Short leads from the trans-

formers to grid and plate socket connections is a "must," and short leads and a single common ground at each socket for the cathode, screen, plate and grid returns should be used.

The small coupling condenser, C_{39} , between mixer and oscillator, is made by twisting together for a distance of about $\frac{1}{2}$ -inch two pieces of No. 20 insulated hook-up wire.

Alignment Procedure

For all practical purposes the whole i.f. system can be lined up on noise reception; however, if one wants to get everything exactly "on the nose" and to make accurate bandpass measurements through the i.f. and discriminator stages, then an oscillator and 20,000-ohms-per-volt voltmeter will be necessary. Both procedures will be described.

Connect a 10-foot piece of wire into the input jack, J_1 , and with the set switched to "a.m.," tune the condensers on the first four i.f. transformers for maximum noise output in the speaker or headset. As mentioned above, the input padder in T_1 should either be set at minimum capacity or

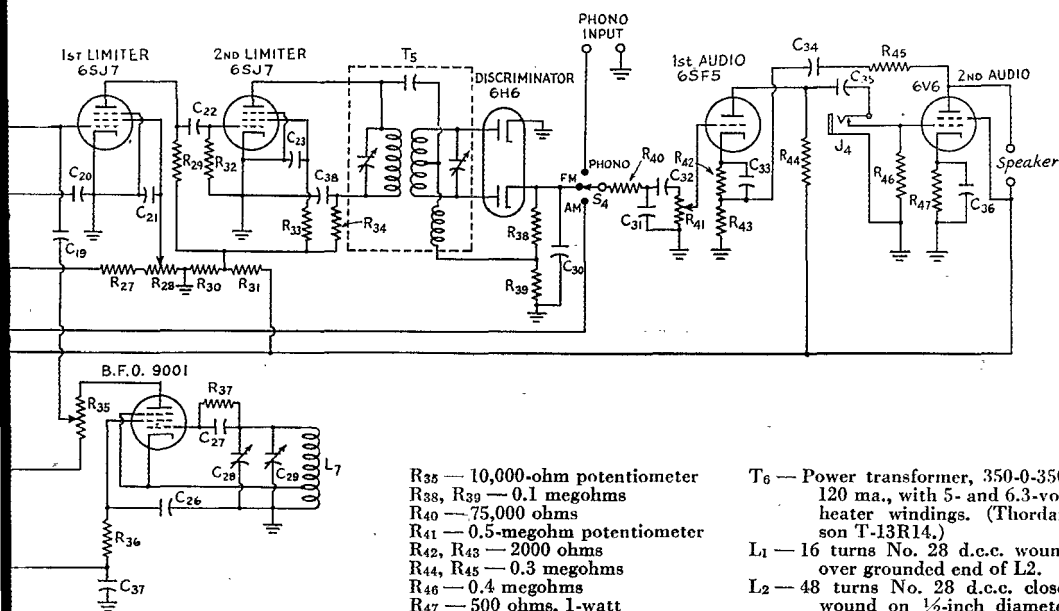

- 50,000 ohms
 R_7 , R_{17} , R_{22} — 500 ohms
 R_9 — 3000 ohms
 R_{10} , R_{12} , R_{20} — 10,000 ohms
 R_{23} — 3000 ohms, 25-watt
 R_{25} , R_{28} — 50,000-ohm potentiometer
 R_{27} — 0.2 megohms
 R_{30} , R_{31} — 45,000 ohms, 2-watt
 R_{32} — 0.15 megohms
 R_{33} — 15,000 ohms
 R_{34} — 1000 ohms

- R_{35} — 10,000-ohm potentiometer
 R_{38} , R_{39} — 0.1 megohms
 R_{40} — 75,000 ohms
 R_{41} — 0.5-megohm potentiometer
 R_{42} , R_{43} — 2000 ohms
 R_{44} , R_{45} — 0.3 megohms
 R_{46} — 0.4 megohms
 R_{47} — 500 ohms, 1-watt
 All resistors $\frac{1}{2}$ -watt unless otherwise specified.
 S_1 , S_2 , S_3 — S.p.s.t. toggle switch
 S_4 — Single-circuit 3-position wafer switch
 S_5 — S.p.s.t. toggle switch, at point "X" in diagram.
 T_1 — Modified 4.3-Mc. i.f. transformer. See text. (Meissner 16-6664.)
 T_2 , T_3 , T_4 — 4.3-Mc. i.f. transformer. (Meissner 16-6664.) See text.
 T_5 — 4.3-Mc. discriminator transformer (Meissner 17-3483 or 17-3482).

- T_6 — Power transformer, 350-0-350, 120 ma., with 5- and 6.3-volt heater windings. (Thordarson T-13R14.)
 L_1 — 16 turns No. 28 d.c.c. wound over grounded end of L_2 .
 L_2 — 48 turns No. 28 d.c.c. close-wound on $\frac{1}{2}$ -inch diameter form.
 L_3 — 4 turns No. 28 d.c.c. wound over grounded end of L_4 .
 L_4 — 14 turns No. 28 d.c.c. close-wound on $\frac{3}{8}$ -inch diam. form.
 L_5 — 10 turns No. 28 d.c.c. close-wound on $\frac{3}{8}$ -inch diam. form. Cathode tap at 2 turns from ground end.
 L_6 — 10-henry 110-ma. filter choke (Thordarson T-57C53).
 L_7 — 48 turns No. 28 d.c.c. close-wound on $\frac{1}{2}$ -inch diam. form. Cathode tap at 5 turns from ground end.

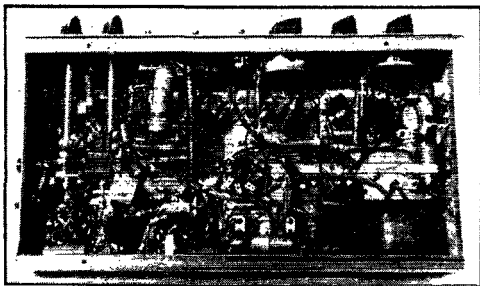

A bottom view of the amplifier shows that short leads was a major consideration in the design of this unit. Note J1 on the right side of the chassis — J2 and J3 are mounted on the aluminum chassis of the 30-Mc. converter. The two pin-tip jacks at the left are for phonograph input, and the two telephone jacks on the rear of the chassis are for 'phones and loud speaker. The latter is shown in Fig. 1 as binding posts.

disconnected. When the i.f. channel is aligned, switch to "f.m.," detune the secondary padder on the discriminator to maximum capacity and then tune the primary padder for maximum noise output. The final step in the lineup is to tune the secondary discriminator padder to resonance, which is indicated by a very sharp null or decrease in noise. The length of wire used in the input circuit for noise pick-up may have to be changed in length depending upon surrounding conditions. During this procedure the limiter control, R28, should be advanced to put maximum screen voltage on the limiter stage.

The b.f.o. can best be tuned to the i.f. frequency after a converter is fed into the unit and a stable signal is tuned in on the converter.

If it is desired to use an oscillator for alignment purposes, the signal strength meter may be used as an indicator for tuning the i.f. stages. The discriminator is then detuned in the secondary circuit and the primary tuned to resonance, as indicated by maximum deflection of the 20,000-ohm-per-volt voltmeter connected from the ungrounded cathode of the 6H6 to ground. The secondary of the discriminator is then tuned to resonance as indicated by zero voltage on the test voltmeter. Band pass measurements can be made by tuning the external test oscillator to first one and then the other side of resonance and plotting the voltage readings against frequency. When the i.f. amplifier is properly aligned, the curve should be reasonably symmetrical. Use only as much signal as is necessary to give a good reading, since overload or limiting in the amplifier will give a distorted picture of the bandwidth.

A local ten-meter station or a test oscillator will serve as a means for tuning the 30-Mc. converter. It is suggested that this converter be tuned just outside either one end or the other of the 30-Mc. band, to prevent i.f. interference from local ham stations.

This unit has been used for quite some time in conjunction with a 42- to 50-Mc. converter for standard f.m. broadcast reception, and with a 112-Mc. converter for listening to amateurs on that band. More recently it has been used with a converter on the 144- to 148-Mc. band and the results have been very satisfactory on all three of these bands. The unit does discriminate against the very poorly modulated oscillators, but all have been readable, on either a.m. or f.m.

Strays

The receiver shown resting on top of the HRO is the German version of this well-known American receiver. Made by Körting-Radio and modeled after the HRO the Germans employed the same circuit and layout and used identical mouldings and die castings. Even the front panel arrangement was copied. But the superiority of American craftsmanship is demonstrated clearly by the inferior components and workmanship contained in the set. The presence of substitute materials and signs of rush production are evidence of the pressure on German manufacturing facilities.

"New Electronic Term" Department

Q — For the best reception, what should my headphones be, 1000, 1500, or 2000 ohms?

A — Greater reception will result from the use of more ohm power.

— *Sunday Call* (Newark, N. J.) via W2NHX



A V.H.F. Amplifier Using the 829

THE GADGET on this month's cover is there primarily because it seemed to offer possibilities in the highlight and shadow field. But like most gear that gets pictured on our covers it has its strictly utilitarian aspect, too. Built in conjunction with some experiments with m.o.p.a. transmitters for the 144-Mc. band, it is an amplifier using one of the 829-type tubes that seem to be in the pockets of every ham that had any connection with radio during the war. It is designed for link-coupled input, and so can be used with any sort of driver arrangement that will deliver a couple of watts. The circuit is shown in Fig. 1.

The unit is built on an aluminum chassis formed by bending the long edges of a 5 by 10-inch piece of aluminum to make vertical lips $\frac{3}{4}$ inch high, so that the top-of-chassis dimensions are $3\frac{1}{2}$ by 10 inches. The tube socket is mounted on a vertical aluminum partition measuring $3\frac{1}{2}$ inches high by $3\frac{1}{4}$ inches wide on the flat face, with the sides bent to provide bracing. The socket is mounted with the cathode connection at the top, the cathode prong being directly grounded to the nearest mounting screw for the socket. The heater by-pass condenser, C_6 , is mounted directly over the center of the tube socket, extending between the paralleled heater prongs at the bottom and the cathode prong at the top. The screen by-pass is connected with as short leads as possible between the screen prong and the nearest socket mounting screw.

The grid coil, L_2 , is supported by the grid prongs on the socket. The two turns of the coil

are spaced about one-half inch to allow room for the input coupling coil, L_1 , to be inserted between them, the coupling being adjusted by bending L_1 into or out of L_2 . The grid tuning condenser, C_1 , is mounted between the socket prongs; although the condenser has mica insulation it is used essentially as an air-dielectric condenser since the movable plate does not actually contact the mica at any setting inside the band. The coupling link is soldered to lugs on a binding-post strip, the strip being mounted on metal pillars $1\frac{1}{2}$ inches high to bring the link to the same height as the grid coil.

Although the shielding between the grid and plate of the tube is sufficiently good so that the circuit will not self-oscillate, tuning of the plate circuit will react on the grid circuit to some extent, and to eliminate this reaction it is necessary to neutralize the tube. The neutralizing "condensers" are lengths of No. 12 wire soldered to the grid prongs on the socket. The wires are crossed over the socket and then go through small ceramic feed-throughs at the top of the vertical shield, projecting over the tube plates on the other side.

Connections between the plate tank condenser, C_7 , and the tube plate terminals are made by means of small Fahnestock clips soldered to short lengths of flexible wire. The tank coil, L_3 , is mounted on the same condenser terminals to which the plate clips make connection. The plate choke, RFC_1 , is mounted vertically on the chassis midway between the plate prongs of the tube; the mounting means being a short machine screw threaded into the end of the polystyrene rod. The "cold" lead of the choke is by-passed by C_5 underneath the chassis, directly below the point where the lead passes through.

In adjusting the amplifier, the plate and screen voltages should be left off and the d.c. grid circuit closed through a milliammeter of 0-25 or 0-50 range. The driver should be coupled to the amplifier input circuit through a link (Amphenol Twin-Lead is suitable, because of its constant impedance and low r.f. losses). Use loose coupling between L_1 and L_2 at first, and adjust C_1 to make the grid circuit resonate at the driver frequency, as indicated by maximum grid current. The coupling between L_1 and L_2 may then be increased to make the grid current slightly higher than the rated load value, 12 ma. If the driver is an oscillator, the coupling between L_1 and L_2 should be kept as loose as possible so long as the proper grid current is obtained.

Neutralization can be checked by rotating C_7 through resonance. A flicker in grid current as C_7 is rotated indicates that the neutralizing capacity is not correct. The neutralizing wires should be

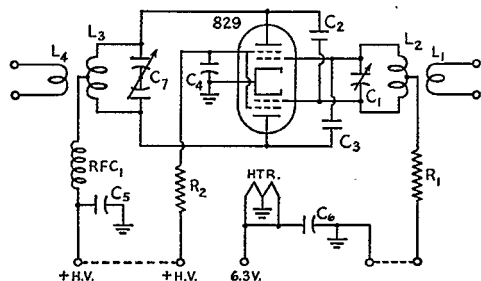
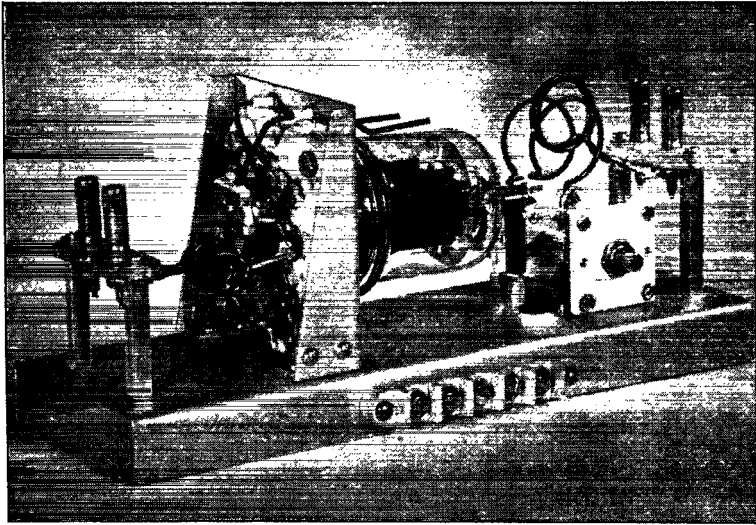

Fig. 1 — Circuit diagram of the 829 amplifier.

- C_1 — 3-30- μ fd. ceramic trimmer.
- C_2, C_3 — Neutralizing condensers; see text.
- C_4 — 500- μ fd. mica, 1000-volt.
- C_5 — 500- μ fd. mica, 2500-volt.
- C_6 — 500- μ fd. mica.
- C_7 — Split-stator, 15 μ fd. per section (Cardwell ER-15-AD).
- L_1 — 2 turns No. 12, diameter $\frac{1}{2}$ inch.
- L_2 — 2 turns No. 12, diameter $\frac{1}{2}$ inch, length $\frac{1}{2}$ inch.
- L_3 — 2 turns No. 12, diameter $1\frac{1}{4}$ inches, length 1 inch.
- L_4 — 2 turns No. 12, diameter 1 inch.
- R_1 — 5000 ohms, 1 watt.
- R_2 — 10,000 ohms, 10-watt.
- RFC_1 — 1-inch winding of No. 24 d.s.c. or s.c.c. on $\frac{1}{4}$ -inch diameter polystyrene rod.



◆
A rear view of the 829 amplifier shown on the cover. The input circuit is designed for link coupling to the driver stage.
◆

bent in relation to the tube plates until the grid current remains constant when C_7 is tuned through resonance. Care should be used to keep the wires symmetrical with respect to the two sections of the tube.

At a plate voltage of 400 it is readily possible to secure a power output of 50 watts with the plate current in the vicinity of 200 ma. With no antenna load the plate current should dip to about

80 ma. at resonance. With the A and B varieties of the 829 higher plate voltages can be used, but since the tube ratings call for a corresponding reduction in plate current (the power input being about the same with any model) the chief difference is in the fact that the modulating impedance changes with the plate voltage/plate current ratio.

— G. G.

Hams Needed

THE Interservice Radio Propagation Laboratory at the National Bureau of Standards, Washington, D. C. is the group that prepared the world chart illustrated in Commander E. H. Conklin's article, "The Bright New World of Sun Spots" in January, 1946 *QST*, and in William R. Foley's article, "Forecasting Long Distance Transmissions" in February, 1946 *QST*.

The construction of these charts whereby it is now possible to predict usable frequencies over any path anywhere in the world during any month was accomplished by the coordination of data from about 45 ionosphere stations throughout the world.

The whole story of the I.R.P.L. will appear in a subsequent issue but we have been asked to make an announcement right now of an immediate need for men to operate some of these stations.

During the war the Department of Terrestrial Magnetism of the Carnegie Institution of Washington and the Army and the Navy maintained a number of these stations. Now the National Bureau of Standards is taking over operation of these stations.

Men with appropriate engineering and administrative experience are needed immediately to fill the positions of engineer-in-charge and assistant engineer. Other men will be required as station operators. It is expected that personnel will serve a minimum of 18 months on the job at the overseas location and that living quarters and transportation for families will be available at some locations.

Here is a chance for hams (and others) to get in on some interesting work. For further details write Radio Section, National Bureau of Standards, Washington 25, D. C.

How's DX?

How:

The stock answer this month to that cheery old greeting we use for the name of this column is another question. That's right — substitute "What" for "How's" and you have it. However, the conditions we are not enjoying at this time are normal for the band at this time of the year, and about all we can do is adopt the old football policy of "kick and wait for the breaks."

Now that W4ERI holds the official DX record — to the moon and back — there isn't much left anyway, unless Jeeves can come up with an idea for bouncing the stuff off of the other side of the moon! "No, Jeeves, backspin won't do it, and put away my nine iron!"

What:

Conditions haven't been impossible — they've just been a little tougher than anyone likes to see them. Some parts of the world, however, don't suffer as much as the Ws do. For example, W4CMR, writing from Calcutta, India, on January 1, says ". . . the boys are being heard on 10 meters out in this neck of the woods, especially 'phone stations. The Brazilians are also coming through very nicely. . . ." This refers to December activity, though, and isn't quite fair W6ITH has been grabbing off a few 'phones that represent good DX for these trying times: LU4AC (28,140), LU7AZ (28,190), W9QMD/KB6 (29,100), W9QCJ/KB6 (28,260), W2MUC/KB6 Tinian (28,740), W6MBA/KB6 Tinian (28,410), and a number of K6s and K7s W7EYN worked LU3AQ (28,030 f), who requests QSL via LU1AH, and Bob heard W1KSF/KB6 (28,400 f) and KA1JB (28,700 f) W1NVO/1 worked W2KMZ/EL (28,040) on c.w., and W1KMY raised TI2DX (28,300 T9c) W1UE reports hearing TG9RAC and VP2AT on c.w. and W6RNJ/PY7 and ZS4AA on 'phone.

Why:

That story by K4FEC on "Forecasting DX Transmission," in the February *QST*, has a lot more in it than might appear in casual reading. In the first place, if you follow the instructions and draw out the great circle path from your station to any part of the world with a choice bit of DX, the bearing of the line leaving your station is the correct direction for a beam on the DX station. For the fellow without a globe or one of those fancy projection maps, this is a handy device.

Another thing that shows up in studying the

charts is how locations in different parts of the world vary. From a study of Figs. 7 and 8 and an understanding of the prediction process, it immediately becomes apparent that stations near the equator enjoy a terrific advantage, 10-meter wise, over us poor guys in the alleged temperate zone. So, if you have made your million bucks and are planning to retire to some good radio location in your declining years, you would do well to take along a few of the charts when you see your real estate agent.

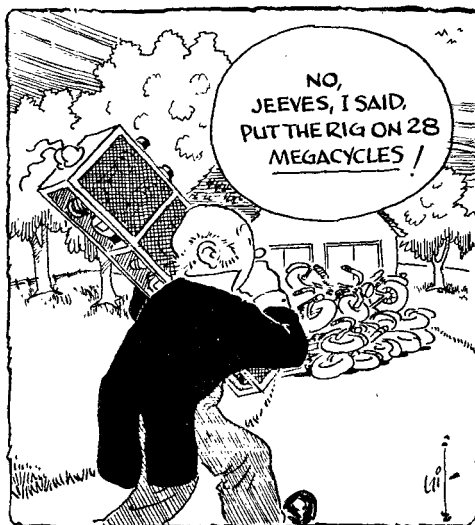

Who:

The English came back on with a bang on Feb. 3, to be welcomed with open logs by many eager and anxious Ws. Their new regulations require them to call "CQ" instead of the old familiar "TEST," but a few of them couldn't break the habit. Their regs also require that they sign their calls not faster than 20 w.p.m., a boon to us fellows without a code proficiency certificate The following calls have been officially assigned to the European theatre: D4ABA, to W9OEN; D4ABB, to W8JTW; and D4ABC to W1JZJ According to the *T&R Bulletin*, AC4YN and AC3SS have both been heard in England, on 14 Mc. . . . W1GH has 14 countries on 28 Mc. so far, which proves that it can be done but not by everybody W8ROV was XUSROV at Lanchow on 14 Mc. during October and part of November, and needed only North America for WAC. There's a switch!

W6JWT has been quite active on 10, and scared up XE1AM, XE1CM, TI2RC, LU7AZ, LU9AX, LU3DH, W9TQD/J and KB4AL/Marshall on c.w. and W6MVL/KB6 and W5JXM/KB6 on 'phone K4KD and son K4HEB worked all night to get the rig on for the Nov. 15th opening W8PMJ worked W2KMZ/CR6, when KMZ was in port at Luanda Angola, and also YSUJ8 (28,100) in San Salvador. The latter sounds like the same fellow who was signing HJ8 one weekend W2LBB was with W8SJA at Tsingtao, and they were on 10 with XU3LBB and XU3SJA respectively. They worked a handful or two of Ws, and say that W6NMJ and W6AM had the best signals over there. LBB is back but SJA is still there and looking for contacts.

DXCC:

In the January issue something was said about the plan to start a post-war DXCC, with everyone starting from scratch, and we asked for any ideas on the subject. Among the letters received were a few by fellows who were opposed to the idea, and since some of these seem to stem from an incomplete understanding of the motives behind the plan, we'll take a little time to discuss it once again.

In the first place, a few fellows seem to think that something is being taken from them. Frankly this is an attitude we can't see, since how can anyone eliminate the fact that one station worked another at a particular time, especially if the contact has been confirmed? Personally, we like to boast about DX as much as the next fellow, and we plan to include on our QSL card a pre-war total, a post-war total, and an all-time total of countries worked. This is something that revising the DXCC rules can't take away from us, except in revising the post-war total if the countries list is changed radically. Even if the list is changed radically — which won't happen — we won't suffer any more than anyone else who has worked the same countries.

Some seem opposed to "working all their DX over again." We don't see how this is much of a factor, since they would undoubtedly do this in the course of a DX Contest or two, or just during the day-to-day renewing of old friendships and making of new ones. Several writers suggested that the strain of QSLing would be too great on some of the one-station countries. We quite agree with this, but the intention is to get lists of contacts from these stations, as was done in the past, so if one has had a QSO he can certainly get DXCC credit for the contact. If one hasn't got a card from that country already, he is naturally going to use his full persuasive powers anyway, so what's the difference?

Another point seems to be that now we may never know what station in the world has the highest all-time total of countries worked. This

is, of course, a direct insult to the writer of this column, and while we admit all of the indictments of the past and future, we resent the implication that we don't realize stuff like that there is newsworthy and hence should appear in the column from time to time. While it may not be mentioned every month, you can rest assured that we will keep an eye on the all-time high totals and pass along the information. However, the official monthly listings in *QST* will only show what has been done since reactivation.

On the other hand, the large majority who were in favor of the idea liked it because it gives everyone a chance to participate on an equal basis. Further, most of these fellows are ones who were well up in the old DXCC but who are willing to give the newcomers an even break. Personally, we're betting that after the list settles down we will find a large majority of old-timers at the top, simply because their experience gives them an edge over the new upstarts.

There is one possibility that cannot be overlooked. If for some reason less than 100 countries show up within the next few years it may be necessary to reduce the 75-or-more figure to a lower one, in order to get any stations to qualify for a listing. However, this is a hekuvva time to be *that* pessimistic.

Predictions:

The predictions for March shape up better than February for Washington-Rio, Washington-Sydney, S. F.-Rio, S. F.-Sydney, S. F.-S. J. and N. Y.-S. J. The open circuit to Australia is the most promising, what with the VKs back on. S. F.-Manila should be open but spotty. Transcon stuff in northern latitudes should be in but erratic, with slightly better consistency farther south.

We would welcome any suggestions about these predictions: other routes that might be interesting and easy to check, different forms in which the predictions might be presented, or just if anyone is following them over a period of time.

Where no maximum usable frequency is shown, it means the 28-Mc. band should be open during the period shown — a single time indicates when the corresponding m.u.f. is reached.

Path	Max. Usable Freq. (Mc.)	Time (GCT)
Washington — S. F.		1900-0100
Washington — Rio		1300-2330
Washington — Paris	24.5	1800
Washington — Manila	23	2230
Washington — Sydney		2000-0100
S. F. — Rio		1630-0130
S. F. — Paris	22	1800
S. F. — Manila		2230-0130
S. F. — Sydney		1945-0330
S. F. — San Juan, P. R.		1630-2400
N. Y. — San Juan, P. R.		1400-2330

— W1JPE

● Technical Topics —

Single Signal C.W. Reception and Crystal Filters

ANY MODERN communications receiver worthy of the name will provide single-signal c.w. reception, yet the number of operators who do not take advantage of this essential feature is surprising. Some amateurs, who confine most of their operating to traffic handling and net operation, claim they do not want the selectivity that is inherent in s.s. reception because all of the stations are not on exactly the same frequency,

Heterodyne C.W. Reception

Every amateur is familiar with the heterodyne or "beat-note" reception of c.w. signals, where the local oscillating detector (or beat-frequency oscillator in the superheterodyne) combines with the incoming signal to form an audible "beat" note. As the receiver is tuned into a c.w. signal, one first hears a high-pitched beat which, as the dial motion is continued, becomes lower and lower in pitch until it reaches inaudibility or "zero beat." Further dial motion produces an audible beat again, first of very low tone but gradually increasing in pitch until it is lost to the ear. This tuning process is illustrated in Fig. 1.

Of course, this beat note actually exists far beyond the range through which it is heard, as shown in Fig. 2-A, but because of the upper audio limits of response in the receiver and headphones, the *audible* portion of the beat is limited, as shown in the selectivity curve of Fig. 2-B, peaked where the response of audio amplifier and headphones is a maximum, and dropping off in the high- and low-frequency ranges. Additional sharpness of these peaks is obtained in the superheterodyne by increased r.f. and i.f. selectivity, as shown in Fig. 2-C.

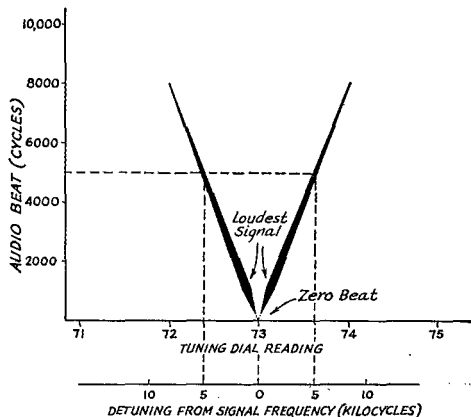

Fig. 1 — Representation of heterodyne tuning. The thickness of the tapering line is proportional to the strength of the audio signal heard. Notice that there are two points of maximum signal strength.

but many more seem to avoid its use because they do not understand the principle involved or realize the consequent advantages. However, the fact that s.s. reception makes possible QRM-free reception under many otherwise difficult circumstances should be sufficient incentive for every amateur to acquaint himself with the theory and practice of this very useful device.

One popular misconception seems to be that "single-signal reception" is synonymous with "crystal filter." Such is not the case — the only requirement for s.s. reception is sufficient selectivity, either r.f. or i.f., and a separate beat-frequency oscillator which is coupled into the receiver *after* the high-selectivity stage or stages. It is true that a quartz-crystal filter is the best device to date for obtaining the necessary high selectivity, and it is equally correct to say that a superheterodyne with a selective i.f. amplifier is at present the most popular system for obtaining s.s. reception at amateur frequencies, but s.s. reception is a *principle*, and a crystal filter is a *circuit element*.

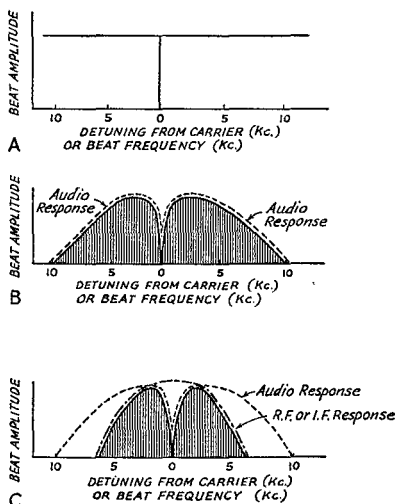

Fig. 2 — The effect of audio and r.f. or i.f. selectivity on a heterodyne beat note.

- (A) Amplitude of beat note with no r.f. or audio selectivity.
- (B) Amplitude of the beat note as modified by the audio response of the receiver.
- (C) Amplitude of the beat note in (B) further modified by r.f. or i.f. selectivity.

The important thing to notice — and the inherent disadvantage of plain heterodyne reception in a crowded band — is that although we may tune in only one incoming signal, it can be heard *twice* at any one audio frequency: once on either side of zero beat. Hence no amount of audio selectivity will eliminate the “two-spot” tuning that exists in straight heterodyne reception. If every signal occupies two spots on the tuning dial, it is obvious that there is considerable room for improvement.

Nothing much can be done with an ordinary regenerative — actually “oscillating detector” — receiver, but let us consider what happens in the case of the superheterodyne if the relation between intermediate frequency and beat-oscillator frequency is changed. Fig. 3-A shows the effect of tuning through a signal when the b.f.o. is set exactly to the mid-frequency of the i.f. amplifier. This is, in effect, the same as tuning through a signal with a simple regenerative receiver, and

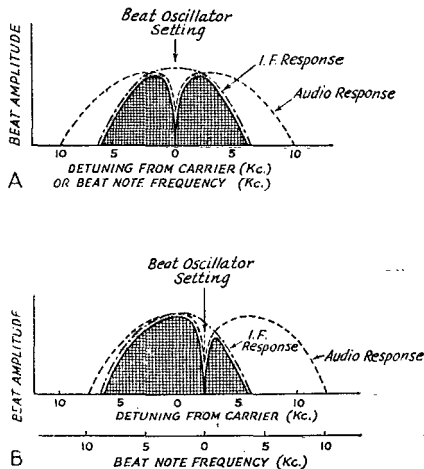

Fig. 3 — The principle of s.s. reception.

(A) Same as Fig. 2-C, showing superheterodyne reception with the b.f.o. tuning to the center of the i.f. pass band. There are two points of maximum signal response, one above and the other below the zero-beat point.

(B) Same as above but with the b.f.o. tuned to one side of the i.f. maximum. There is now only one point of maximum response. By increasing the i.f. selectivity, the response on the right-hand side of zero beat, as well as at the higher audio frequencies, can be made negligible.

two signals are heard, each of equal intensity. If the beat oscillator is tuned *off* the mid-frequency of the i.f. amplifier, however, as in Fig. 3-B, the signal on one side of zero beat is not so loud as the signal on the other side, depending upon the selectivity of the i.f. amplifier. Thus simply detuning the b.f.o. from the center of the i.f. pass band to one side results in unequal amplitude signals on either side of zero beat.

By carrying this process to its next logical step, we have the key to s.s. reception! If the i.f. ampli-

fier can be made selective enough or if one side of the selectivity curve can be made steep enough, and the b.f.o. is set correctly in relation to the i.f. amplifier, the signal on one side of zero beat

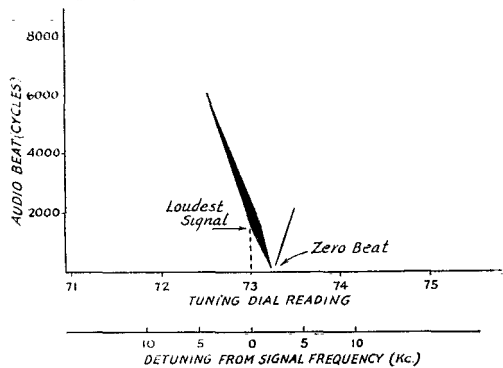

Fig. 4 — A representation of Fig. 3-B in the manner of Fig. 1. Notice that the signal now appears at only one point on the tuning dial, except for a slight trace of image signal which can be eliminated by even better selectivity.

will be eliminated or greatly attenuated. Thus the signal tuning effect will be as represented in Fig. 4, and each signal is tuned in at only one spot on the dial for any particular audio frequency. Compare this with Fig. 1, the effect obtained when tuning through a signal with straight heterodyne reception, and it immediately becomes apparent that we now have twice as much room on the dial for signals and hence at least twice as much chance of tuning in a signal without QRM.

Crystal Filters

The most satisfactory type of selective element for use in a narrow-band i.f. amplifier is a quartz-crystal filter. For the same reason that a crystal forms an excellent frequency-control unit — its extremely high *Q* — it can be used to give an extremely sharp amplifier in the vicinity of 500 kc. and below. Its inherent stability is, of course, excellent, and it has the additional advantage that a “rejection notch” — a very narrow band of practically zero response — occurs in its characteristic quite close to the point of maximum response, as shown in Fig. 5. The position of this rejection notch, with respect to the maximum,

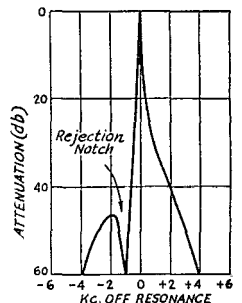

Fig. 5 — Selectivity curve of a modern crystal filter. With this degree of selectivity, excellent s.s. reception can be obtained. Note the rejection notch, which can be shifted to any spot within the pass band by adjustment of the “phasing” control.

can be shifted by means of the "phasing control," and thus, the operator can usually drop his QRM into this notch or else position the notch to reject any vestigial remains of "the other side of zero beat." The "selectivity control" changes the width of the pass band and allows the filter to be made narrow for c.w. reception or broad enough for 'phone reception under QRM conditions. Early models of crystal filters were too sharp for 'phone reception, but later types are adjustable in steps from a narrow position good only for c.w. work to a broad condition entirely adequate for anything but amateur high-fidelity 'phone reception.

Some amateurs are discouraged in using their crystal filters for s.s. reception because the noise level drops when the crystal is switched in, and they think the receiver has lost some sensitivity. The truth is, of course, that the noise has been reduced because the bandwidth has been decreased, but any properly-tuned signal will not be attenuated, and the result is an increase in signal-to-noise ratio. Given a good receiver in other respects, it is quite possible to hear weaker signals with a crystal filter "in" than "out."

There are, of course, other ways to obtain the selectivity necessary for s.s. reception. A regenerative amplifier at 465 kc. — and even at 1600 kc. — when operated close to the point of oscillation will have a pass band sufficiently narrow to give a high degree of s.s. reception. It has the disadvantage, however, that the dynamic range is not too wide, since the stronger signals will tend to broaden the amplifier characteristic, and the selectivity is needed most in the presence of strong signals. However, with proper use of a gain control ahead of the regenerative amplifier, very useful and inexpensive s.s. reception can be obtained.

By using a large number of loosely-coupled high-Q tuned circuits in an ordinary i.f. amplifier it is possible to obtain an i.f. selectivity characteristic with sufficiently steep sides and narrow pass to give good s.s. reception and excellent dynamic range. An amplifier of this type is likely to be unstable unless extreme care is exercised in its design, and optimum performance is not obtained unless all of the circuits are tuned and stay tuned "right on the nose."

— B. G.

Wave and Wave Guides (Part III)*

THE WAVE described in the preceding discussion was assumed to be one in which there is but a single half-period variation in electric field strength between the side walls of the guide. However, it was brought out in Fig. 9 (November

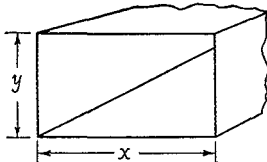

Fig. 14— In the standardized nomenclature for rectangular wave guides, the larger cross-sectional dimension is labeled "x" and the smaller "y".

QST) that any number of half-period variations can exist, provided the walls of the guide are far enough apart to accommodate them — or, to put it another way, provided the wave frequency is high enough in comparison with the guide cut-off frequency. If a guided wave is to be completely identified it becomes necessary to include in the nomenclature some means for indicating the number of half-period variations, in addition to the TE and TM designations that tell whether or not the wave has a component of magnetic or electric field in the direction of propagation.

In standards recently adopted by the Institute of Radio Engineers, the cross-sectional dimensions of a rectangular guide are labeled as shown in Fig. 14, the larger dimension being known as the x dimension, and the smaller as the y dimen-

sion. The particular type of wave that may be going through the guide is identified first as either TE or TM, and the half-period variations are then indicated by numerical subscripts. The first subscript gives the number of half-period variations along the x dimension, and the second the number of such variations along the y dimension. The subscripts refer to variations in the electric field in the case of TE waves, and to variations in the magnetic field in the case of TM waves.

Up to this point, in order to simplify the discussion as much as possible, we have avoided

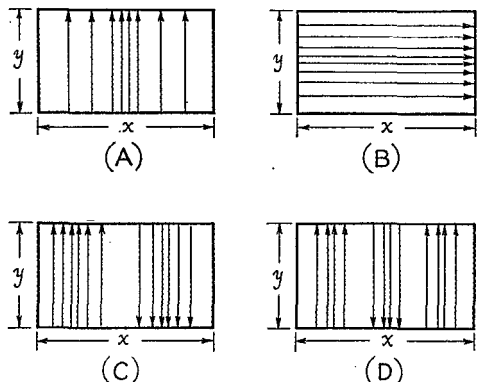

Fig. 15 — Simple TE waves having variations in only one dimension in a rectangular guide. (A) the $TE_{1,0}$ wave; (B) $TE_{0,1}$; (C) $TE_{2,0}$; (D) $TE_{3,0}$.

* Continued from December, 1945, QST

introducing the thought that there could be variations along *both* dimensions. However, we found that a half-period variation along at least one dimension was necessary if the wave was to travel through the guide, and was possible just so long as the width of the guide was at least equal to a half wavelength in space. Now if the distance from the top to the bottom of the guide also is at least equal to a half wavelength in space, it seems reasonable to expect that similar variations can exist along this *y* dimension. They can and do. But first let us dispose of the nomenclature for the simpler cases we have considered already.

Fig. 15-A is a cross-sectional view of the electric field distribution in a wave of the type shown in top view in Fig. 13 (December *QST*). It is our "standing wave in space" disposed laterally in the guide. There is one half-period variation along the *x* or largest dimension of the guide, so the first numerical subscript is 1. Along any line drawn perpendicularly from top to bottom of the guide

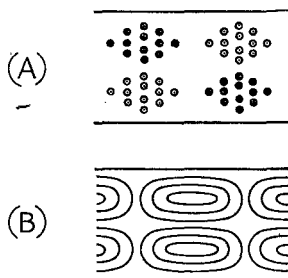

Fig. 16 — Top view of a $TE_{2,0}$ wave, showing at (A) the instantaneous electric field and at (B) the corresponding magnetic field.

— that is, along the *y* dimension — there is no variation in field strength. Consequently the numerical subscript for the *y* dimension is 0. The wave is therefore known as a " $TE_{1,0}$ " wave (the two subscripts are separated by a comma). It is of interest to note that a wave *could* fit into the guide in such a way that there is no variation along the larger dimension, as in Fig. 15-B. In such a case the wave would be a " $TE_{0,1}$ " wave, because the larger guide dimension always is labeled *x* and the variations along the *x* dimension always are listed first.

Cases where there is more than one half-period variation are labeled by the same method. In Fig. 15-C there are two half-period variations along the *x* dimension, and in Fig. 15-D there are three. In neither of these cases is there any variation along the *y* dimension. The wave in Fig. 15-C consequently is a $TE_{2,0}$ wave, and that in Fig. 15-D is a $TE_{3,0}$ wave. The various wave configurations are called "modes."

In the "higher-order" modes — that is, modes having more than one half-period variation along one or both dimensions — the magnetic lines of force form loops associated with each variation. The magnetic field for the $TE_{n,0}$ mode (where *n* represents any whole number) can be visualized by imagining drawings such as are shown in Fig.

Fig. 17 — The $TE_{1,1}$ wave. Field variations exist along both dimensions of the guide.

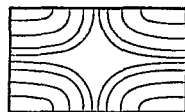

13-B placed side by side but with the directions of the lines reversed in alternate rows. This is because the electric field direction is reversed in each half-period variation. A top view of the $TE_{2,0}$ mode is given in Fig. 16.

The field distributions become more complicated as the order of the mode becomes higher. A cross section of the electric field of the $TE_{1,1}$ mode is shown in Fig. 17. The field intensity is maximum at the center of each of the four walls, as shown by the spacing of the lines, and decreases to zero at the corners. The lines are all perpendicular to the walls at the point of contact, and in addition must obey the ordinary laws which say that lines of force must be continuous in a dielectric and must not cross each other. In still higher-order modes some of the lines of electric force may form closed loops which do not touch the guide walls at any point. Fortunately, there is little need to be concerned about such field configurations because in practice the higher-order modes are little used — in fact, they are definitely not wanted. It is quite sufficient if the operating principles of the simpler modes are understood; once these are grasped it is easy to appreciate that they can be extended to cover more difficult cases.

The only limit to the number of modes that can exist in a given wave guide is the frequency of the wave being transmitted. We may start out with a wave of such length that the guide is only wide enough to accommodate one half-period variation; that is, a $TE_{1,0}$ wave. Let us say that the *x* dimension of the guide is $2\frac{1}{2}$ times the *y* dimension. As we raise the frequency, the wave eventually will become short enough so that two half-period variations can be accommodated along the *x* dimension; in other words, when the wave frequency is slightly greater than twice the guide cut-off frequency, the $TE_{2,0}$ mode becomes possible. At this frequency the *y* dimension is still too small to permit a half-period variation from top to bottom, but if the frequency is raised still more — up to the point where the wavelength is smaller than the cut-off wavelength for the *y* dimension — the wave can be of the $TE_{0,1}$ type. Actually, any of three TE types — $TE_{1,0}$, $TE_{2,0}$, or $TE_{0,1}$ — could exist at this wavelength.

As a matter of fact, still another mode — of the TM type — could appear in the same wavelength range. In contrast to electric lines of force, mag-

Fig. 18 — The $TM_{1,1}$ wave in a rectangular guide. The magnetic field goes through the same variation in both dimensions.

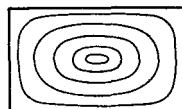

netic field lines must be continuous and closed on themselves, and as a consequence of this neither of the subscripts can be zero in TM transmission in a rectangular guide. The simplest TM mode is shown in Fig. 18, and it is easily appreciated that the variation in field strength that occurs across one dimension likewise must occur across the other. For this reason the lowest-order TM mode is the $TM_{1,1}$. Each dimension of the guide, therefore, must be at least equal to one-half wavelength in free space before a TM mode becomes possible. However, this does not mean that a guide of square cross section will have a cut-off wavelength equal to twice the length of either dimension. The situation is not quite so simple as in the case of $TE_{n,0}$ waves, because to have variations in both dimensions the reflections must take place from all the walls of the guide. This means, in general, that in a guide of given dimensions the cut-off wavelength is smaller than in the case of the $TE_{1,0}$ wave.

The cut-off wavelength in a rectangular guide for either TE or TM waves is given by the equation

$$\lambda_c = \frac{2}{\sqrt{\left(\frac{m}{x}\right)^2 + \left(\frac{n}{y}\right)^2}}$$

where m and n are the subscripts associated with the x and y dimensions, respectively. If either m or n can be zero, we come out with the simple relation that the cut-off wavelength is equal to twice the width of the guide, but this can occur only in the case of TE waves. For the same thing to be true in the case where both m and n are not zero, one guide dimension would have to be infinitely large so that one of the terms under the radical would approach zero.

Whether or not a particular mode comes into being, when more than one is possible, depends principally upon the way in which the wave is introduced into the guide. This is the reason why, in the practical case, operation on higher-order modes is undesirable; it is usually difficult to maintain complete control of the type of mode that is "excited" in the guide, with the result that the operation is likely to jump from one

mode to another. This may lead to poor power transfer either because the termination is designed for a mode other than the one that happens to be in existence, or because undesirable reflections may take place at joints or other discontinuities in the guide. The situation is much the same as though the load on a matched transmission line suddenly decided to change its impedance (or if the line impedance itself shifted to a new value) or as though a shorted matching stub somewhere along the line quite unexpectedly turned into an open stub.

Guide Dimensions

To avoid this, the guide dimensions usually are chosen so that only one mode, the one having the longest cut-off wavelength, can be transmitted. This is called the "dominant" mode of the guide. In a rectangular guide the $TE_{1,0}$ is the dominant mode. To permit only the dominant mode to exist the x dimension of the guide must be greater than a half wavelength in space but must not be as large as a full wavelength, while the y dimension must be smaller than a half

wavelength. On the other hand, the attenuation in the guide decreases when the dimensions are fairly large compared to the length of the wave being transmitted, so it is desirable to make the dimensions just as large as possible without exceeding the limits at which the next higher-order mode can come into being. As a practical compromise the x dimension of the guide can be made about 0.9 wavelength and the y dimension approximately 0.45 wavelength (an x/y ratio of 2 to 1), for the shortest wavelength to be transmitted. The guide can be used, of course, over quite a range of wavelengths without running into danger of exciting higher-order modes at the short-wavelength end and without getting too much attenuation at the long-wavelength end.

Fig. 19 shows a typical curve of attenuation for the $TE_{1,0}$ mode in a rectangular copper guide, in terms of the ratio of the transmitted frequency to the cut-off frequency. Although minimum attenuation occurs when the dimensions of the guide are greater than dictated by the above considerations, the higher attenuation is accepted in order to eliminate the possibility of higher-order modes.

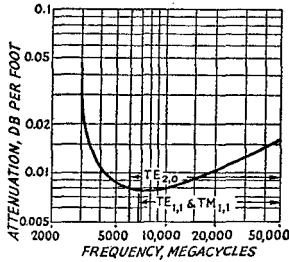

Fig. 19 — Theoretical attenuation curve for the $TE_{1,0}$ mode in a 1 by 2 inch rectangular copper guide. Other modes can exist at all frequencies above the cut-off frequencies indicated.

TABLE I

Band	Largest (Optimum)	Smallest	Usable Standard Size
1215-1295 Mc.....	$4\frac{1}{4}'' \times 8\frac{1}{2}''$	$2\frac{1}{4}'' \times 5\frac{1}{2}''$	$\left\{ \begin{array}{l} 1\frac{1}{2}'' \times 3'' \\ 1'' \times 2'' \\ 3\frac{1}{4}'' \times 1\frac{1}{2}'' \\ 1\frac{1}{2}'' \times 1'' \end{array} \right.$
2300-2450 Mc.....	$2\frac{3}{4}'' \times 4\frac{3}{8}''$	$1\frac{1}{2}'' \times 3''$	
5250-5640 Mc.....	$1'' \times 2''$	$3\frac{1}{4}'' \times 1\frac{1}{4}''$	
10,000-10,500 Mc.....	$\frac{3}{8}'' \times 1''$	$1\frac{1}{8}'' \times 1\frac{1}{4}''$	
21,000-22,000 Mc.....	$\frac{3}{8}'' \times \frac{1}{2}''$	$\frac{3}{16}'' \times \frac{3}{16}''$	

From this curve we may assume that the optimum frequency range would be from approximately 1.15 times the cut-off frequency, where the attenuation is about 0.013 db. per foot, to about 1.8 times the cut-off frequency, allowing a little margin of safety for the next-higher mode. In terms of the amateur microwave bands the wave-guide dimensions shown in Table I could be used.

The dimensions above have been rounded off to appropriate fractional parts of an inch, and in the limiting sizes represent the inside dimensions of the guide. The standard sizes of rectangular tubing are given in terms of *outside* dimensions; wall thicknesses vary from 0.064 to 0.081 inches, depending upon the size of the guide.

Circular Guides

Waves can be guided through a pipe of circular cross section just as readily as through a rectangular guide. While the mechanism of transmission is similar in principle to that already discussed in connection with rectangular guides, it is practically impossible to visualize it in detail. In the rectangular pipe it was relatively easy to visualize reflections taking place in rather simple fashion, one from each of two walls of the guide, but in a circular guide there is no straight wall to reflect plane waves. Instead, an infinite number of reflections occur all around the periphery. It is still true, of course, that the TEM wave cannot go through the guide; the wave must be either of the TE or TM type just as in rectangular guides. Similarly, the number of modes of transmission is limited only by the operating frequency in relation to the cut-off frequency.

Circular wave guides are little used, despite obvious advantages in fabrication, because it is more difficult to maintain a given mode of transmission than it is in a rectangular guide. This is because there are three modes having cut-off

frequencies fairly close together, a situation that restricts the frequency range over which a guide of given diameter can be used without danger of exciting an unwanted mode. Furthermore, when the diameter is chosen so that only the dominant mode can be excited at the desired wavelength, the attenuation is higher than it is in a rectangular guide similarly operated.

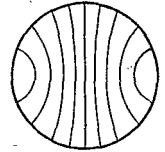

Fig. 21 — Cross-section of electric field of the TE_{1,1} mode in a plane perpendicular to the axis of a circular wave guide.

TE_{1,1}

Designations for the different modes in circular wave guides resemble those used for rectangular guides in that they consist of the letters TE or TM followed by two numerical subscripts. However, the subscripts have a somewhat different significance. If the first subscript is 0, the wave is circular; that is, the lines of electric force in the TE wave form a series of concentric circles lying in planes perpendicular to the axis of the guide, or the lines of magnetic force in the TM wave similarly are in concentric circles in planes perpendicular to the axis. In this case the second subscript gives the number of half-period variations encountered in going from the center to the circumference of the guide along a radius. The TE_{0,1}, TE_{0,2}, TM_{0,1} and TM_{0,2} modes are shown in Fig. 20. The cross-sections of the TE and TM modes having the same subscripts are similar except that the electric and magnetic fields are interchanged.

If the first subscript is other than zero, interpretation becomes more difficult — enough so that, in view of the fact that there is only one case of practical importance, an attempt at explanation would only complicate a picture that we have tried to keep as simple as possible. The one practical case is the TE_{1,1} mode, which is the dominant mode in a circular guide. A cross-section of this mode is shown in Fig. 21; in a way, it can be considered to be equivalent to the TE_{0,1} mode in a rectangular guide when the lines of force are deformed to be fitted to a circular boundary. The cut-off wavelength for the TE_{1,1} mode is

$$\lambda_c = 3.41r$$

where r is the radius of the guide. The cut-off wavelength for the circular electric wave, the TE_{0,1}, is

$$\lambda_c = 1.64r$$

and for the circular magnetic wave, the TM_{0,1}, is

$$\lambda_c = 2.61r$$

(Concluded on page 154)

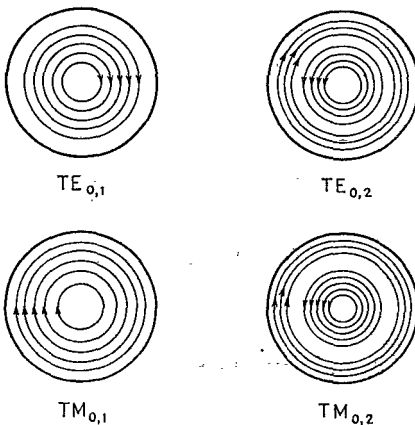

Fig. 20 — Circular modes in a cylindrical wave guide.



Hints and Kinks

For the Experimenter



QUIET BREAK-IN OPERATION

IN THE "Crystal Ball," November, 1945, *QST*, I SCM Clayton C. Gordon asks for a way to eliminate the annoying racket in the receiver when working break-in on spot-frequency nets. There are undoubtedly many others who have wrestled with the same problem who may be

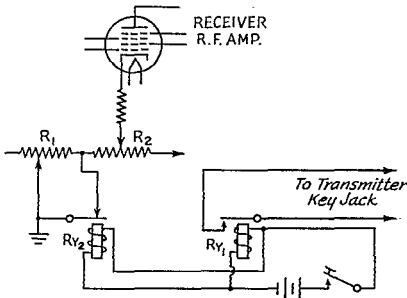

Fig. 1 — A system for obtaining quiet operation when working break-in on spot-frequency nets. R_{y2} is similar to R_{y1} except that it is normally closed.

interested in the system shown in Fig. 1. This was in use at W8BLO in the period prior to the war, working out very nicely in AARS work.

An auxiliary gain control, R_1 , is inserted at the ground end of the normal receiver r.f. gain control, R_2 . Relay R_{y2} is connected across R_1 shorting it out when the key is up. This relay and R_{y1} (the keying relay) operate from the same source of power. The normal receiver gain control R_2 is adjusted for satisfactory reception of incoming signals, then with the key down and the transmitter running R_1 is adjusted for the desired level of reception of the signal from the transmitter. This system does not produce the loud clicks which result when the receiver is switched off entirely when the key is pressed, and in addition it gives one a continuous monitoring of his own signal. To protect the receiver, in case it is desired to use the transmitting antenna for receiving, an additional relay should be used to remove the antenna from the receiver when the key is pressed.

Another idea I found useful in conjunction with this system was to feed the output of my monitor into the grid of the first audio tube of my receiver, enabling me to monitor my transmissions while working someone not on my own frequency.

— Elwyn Guest, W8BLO

REDUCING NO-CARRIER NOISE IN F.M. RECEIVERS

TO KILL noise in f.m. receivers when no carrier is being received, try adding fixed bias to the limiter tube. Sufficient bias should be used to cut the tube off, plus enough to keep the noise voltage from drawing limiter grid current. — Robert G. Hester, W9TYQ/4.

A SIMPLE BIAS ISOLATOR

A COMMON trouble encountered when using bias supplies is the rise in voltage as the rectified grid current flows to ground through the bias supply bleeder. The circuit shown in Fig. 2 in effect disconnects the bias supply when bias due to rectified grid current reaches a value equal to or higher than that supplied by the bias rectifier.

When excitation is applied additional voltage is developed across the grid leak, R_1 . When this voltage reaches or exceeds that of the bias supply the rectifier stops conducting, no current flows

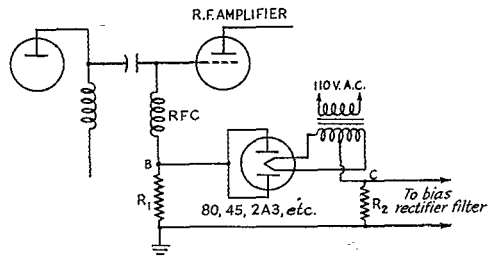

Fig. 2 — Bias isolating circuit.

in the circuit CB, and bias to the r.f. stage is supplied solely from the voltage developed across AB by the flow of rectified grid current through R_1 .

The rectifier may be any non-gaseous tube having low R_p . An 80 is ideal, but 45s, 2A3s, etc. may be used with grid and plate connected together. Pentodes and tetrodes may be used by tying all grids to the plate.

A single-ended r.f. amplifier stage is shown, but the system works equally well with push-pull. Additional stages may be supplied by connecting the bias isolator cathodes to point C.

— Wesley M. Bell, W9FEG/7

Official Experimental Station

New ARRL Appointment Available

BY F. E. HANDY,* W1BDI

EFFECTIVE immediately, geared to postwar amateur radio needs, ARRL announces the availability of a new field organization appointment. The Official Experimental Station appointment is available at once to League members operating licensed amateur stations with definite experimental objective, anywhere in our amateur world above 50 Mc., in any U.S.A. or Canadian Section.¹

The OES group is charged with development of v.h.f.-u.h.f.-s.h.f. communications systems and equipment and trying them out experimentally. OES operation and reporting of results will assist amateur operating progress from 50 Mc. through the Microwaves, as methods and equipment applicable to use of these frequencies for various amateur purposes are evolved. The broad group aim will be immediate production of data to aid in discussion and knowledge of transmission phenomena peculiar to each of our higher frequency bands. The correlation of reports of QSOs and other results on the broadest possible scale will assist us in knowing how best to use antenna structures. This will contribute to our knowledge of the performance of these radiations in different terrain and circumstances as regards polarization, absorption, refraction and reflection. Other

ARRL appointments² are established to assist particular kinds of amateur interest which serve amateur radio or help individual amateurs. OES appointment is especially for the experimentally inclined operator.

Advantages in OES

A primary benefit in Official Experimental Station appointment will be that of getting the names or calls of individuals who are interested in the same experimental problems. With these in hand tests can be lined up between operators with like problems, and letters written that will expedite common progress. OES will receive an informal bulletin as, if, and when we can do it. The appointment gives formal recognition and point to experimental activity of any type in our higher frequency family of amateur bands.

* Communications Manager, ARRL.

¹ Communications Department field organization Sections are designated for each part of the League's operating territory. See page 6, *QST*, for the complete list of ARRL Sections with addresses of the officials who make the appointments in each jurisdiction.

² Types of ARRL-SCM appointments and the field of each:

- SEC Section Emergency Coördinator. Promotes and administers Section Emergency-Radio Organization.
- EC Emergency Coördinator. Organizes amateurs of a community or other area for radio emergency service; liaison with officials of agencies served and with representatives of other communication facilities locally.
- ORS Official Relay Station. Traffic Service, operates nets and trunk lines.
- OPS Official Phone Station. Voice operating, assists in establishing high operating standards.
- OES Official Experimental Station. Experimental operating, collects reports v.h.f.-u.h.f.-s.h.f. propagation data or contacts, some engage in fax, f.m., t/v, etc. experiments.
- OBS Official Broadcasting Station. Transmits ARRL Bulletins to amateurs.
- OO Official Observer. Sends mail (or radios) cooperative notices to amateurs to assist in frequency observation, insure high quality signals, and prevent FCC trouble for the individual or the fraternity.
- RM Route Manager. Organizes traffic nets and coördinates schedules.
- PAM Phone Activities Manager. Organizes activities for OPS.



* *QST*'s Technical Editors will collaborate with OES and are especially interested in transmission and QSO reports for possible over-all analysis. Outstanding transmission reports will be mentioned in "The World Above 50 Mc." Papers on any subject of sufficient general interest resulting from completed experimentation will be given consideration for article space, since the OES bulletin will be distinctly on the informal. Other operating reports of course will appear in "Station Activities."

Like all other ARRL appointments, regular reporting of operating and other results will be required of OES to keep the appointment active. The super-duper certificate shown herewith can be obtained by a showing of your operating and experimenting intentions on an application form or letter sent your SCM. To keep an appointment

effective requires annual SCM-endorsement like most other ARRL posts. To earn that endorsement will take a monthly report to the SCM, stating current operating results and experimental progress. Besides using notes reported, SCMs are requested to forward all OES reports in full detail to ARRL Hq. to permit analysis and special *QST* reports as, if, and when justified.

Have you followed us thus far? Are you interested in OES appointment? Before we outline the qualifications in detail, a few remarks about appointments in general: We recommend that *all* amateur operating be undertaken *with a purpose*. That way takes your work out of the haphazard, makes results more certain, definite and interesting. "Appointment" is just the ARRL way to try to improve individual results and the benefit to the nation and ourselves from a given activity. General high respect of others for the amateur service and for ARRL as an institution flows from full past participation in constructive, purposeful work, not in the casual fun-with-radio approach alone.

Requirements for OES

So here it is! The principles of the old "X Section" have been combined with a modern CD appointment. We hope you like it. We welcome your application. Note in paragraph "4" of the following requirements that good technical and operating practices are prescribed, and applicants for appointment are pledged to follow same. SCMs will strive to appoint member station owners who will live up to the best traditions of the fraternity in this respect.

1) Official Experimental Station appointment is limited to member-amateurs with operative stations who can receive-transmit on one or more frequencies in amateur bands above 50 Mc.

2) Applications for OES appointment will indicate specific experimental problems in which the applicants have a continuing interest, showing primary and secondary interest.

3) Applicants will describe their equipment, and state their intention to report their contacts, observations and progress on these problems at monthly and additional intervals via field organization channels.

4) In the course of experimental station operations the appointee agrees to employ equipment in accordance with good technical practice, where feasible in producing the desired results. Insofar as the state of the art permits, stabilized signals, non-radiating receivers and the like will be used, as appropriate to the frequency and mode of emission, in accordance with the highest amateur ethics.

5) OES appointees will cooperate with all amateur operators and experimenters to promote the most rapid progress and results for all members of the particular project groups to which they may subscribe. It is understood that all constructive results will be reported for the benefit of those amateurs working on the same or allied problems.

6) Reports: Continuing appointment depends on regular reports at prescribed monthly intervals. Such reports will include with the results to-the-point experimental data, detailed descriptions of unusual conditions, distances worked or signals and effects observed, identifying station calls, system performance, equipment operating conditions or other pertinent information. Note requirement for annual endorsement on certificate.

7) Problems: Applicants will indicate their interest in projects involving experimentation on any amateur frequencies above 50 Mc. Problems of current general interest shown on the application form may be indicated. Subjects such as the following are listed on the present form:

56 Mc. Propagation
144 Mc. Propagation

Transmission characteristics and ranges (prediction factors):

- (a) v.h.f. bands (30 to 300 Mc.)
- (b) u.h.f. " (.3 to 3 Kmc.)
- (c) s.h.f. " (3 to 30 Kmc.)

Equipment for frequencies above 1000 Mc.

F.m. 'phone, for amateur band use.

Facsimile, for amateur band use.

Television, for amateur band use.

Antenna types and modifications,

— frequency band:

- (a) Antenna applications for Fixed Locations
- (b) Antennas suited to Portable and Mobile applications
- (c) Omni-directional
- (d) Directive Patterns
- (e) Antennas for Broad and Narrow Band tuning (tunable and non-tunable)

Polarization of signals

Pulse Time Modulation

Automatic Relaying

When the by-products of experimentation can be reported in completed form these results will be reported to the appropriate editors of *QST* for consideration. The Communications Department field organization thus provides a new group medium for fostering experimental operating activity. The high standards and aims of service to fellow amateurs that have always inspired field organization appointees equally will benefit v.h.f.-u.h.f.-s.h.f. amateur operators.

Apply for OES Now

OES appointment should appeal to every experimentally minded amateur. Also it is hoped the many new folks coming into amateur radio who have had experience with electronics, radar, sonar, and technician skills and who follow their technical bents by investigating pulse, time-modulation, fax, or television techniques will find the microwaves and the near microwaves, and OES appointment just the ticket.

In summary, Official Experimental Station work is dedicated to progress in developing successful communications systems and equipment applications, and in collecting propagation data applicable in the v.h.f., u.h.f., and s.h.f. amateur bands. ARRL makes a special effort to coordinate OES reports on problems of interest to large numbers of amateurs by over-all analysis of data reported. This appointment is available only to ARRL members operating stations on one or more bands above 50 Mc.

If you are an ARRL member, experimentally minded, and operating a station above 50 Mc., drop a line to your SCM or ARRL Hq. to-day for the application form, and get lined up for OES appointment.



The World Above 50mc.

CONDUCTED BY E. P. TILTON,* WHDQ

IS THERE DX to be worked on 2 meters? We have always assumed that the maximum distance to be spanned on 144 Mc. would be in the vicinity of 350 miles, with perhaps 100 miles as the consistent working radius of an advanced station in a good location. This had been the sum of our experience on 112 Mc., and it probably represents about the top accomplishment for 144 also. There was a time, however, when we felt the same way about the 5-meter band. Contacts over 100 miles furnished the thrill supreme, and we gave no thought to the possibility of working skip DX until signals from W8 and W9 began pinning back the ears of astounded listeners in W1, back in the early 30s. Could we be similarly in error in our estimates of the potentialities of 144 Mc.?

Some time ago the reception of 127-Mc. signals over a 1000-mile path was reported in this department, and several other instances have come to light since which indicate that skip DX is at least within the realm of possibility for 144-Mc. workers. Two AAF officers, visiting Hq. recently, told a story of reception of 127-Mc. signals from Alaska while flying the Hump in China! As all this sort of thing took place during the war period it was incidental to much more important business, and details are lacking. If any reader can site other such instances or shed more light on the ones already reported such information will be most welcome.

The rather haywire nature of most amateur work on 112 Mc. tended to prevent us from realizing the full potentialities of that band, and the condition on 144 is much the same; yet at least one case of DX reception which appears to be authentic has been reported. On the evening of January 1st, at about 7:00 P.M., three Baltimore stations, W3CRB, W3CGF and W8NWA/3, were in QSO when a weak fading signal was heard near 144 Mc. Several checks by the three operators served to identify the station as W3JLU/4. The signal faded out before more information could be obtained, so W3CRB wrote to W3JLU (Camden, N. J.) for confirmation. His reply, now in our hands, shows that at the time of reception of his signals by the Baltimore stations, W3JLU was operating on 144 Mc. at Lake Worth, Florida, a distance of some 850 miles!

Such reports demonstrate that our v.h.f. bands are deserving of more careful attention than

*V.H.F. Editor.

U.H.F. RECORDS

Two-way Work

- 56 Mc.: W1EYM-W6DNS
2500 miles — July 22, 1938
- 112 Mc.: W1BJE-W3FYB
355 miles — September 6, 1945
- 144 Mc.: W6OIN/6-W6UID
100 miles — January 10, 1946
- 224 Mc.: W6IOJ/6-W6LFN/6
135 miles — August 18, 1940
- 400 Mc.: W6IOJ/6-W6MYJ/6
60 miles — September 14, 1941
- 5250 Mc.: W2LGF/2-W7FQF/2
31 miles — December 2, 1945

many operators normally give them. Intelligent operating, alone, would serve to extend our useful working range. Here are a few rules, observance of which would help us all to get more out of the time we spend in v.h.f. work.

- 1) Speak distinctly, especially when signing calls. Use identifying words for your call letters whenever concluding a QSO. Sign your call and give your location and the call and location of the station being worked at the beginning and end of each transmission.
- 2) Listen carefully. Many long-haul contacts are missed because of rapid tuning of the band and insufficient attention to weak signals.
- 3) Rig up a system for tone modulation, and use it regularly for CQs and calling other stations. Tone will attract attention of operators at distant points in a way that voice never will.
- 4) Arrange transmitting and listening schedules with fellows at points beyond your normal range. Contacts are made in this way which would never result from random operation.

— . . . —
Since November 15th we've been waiting for someone to send in a report of two-way work over a considerable distance so that we could list it as the 144-Mc. record. Ray Jacobs, W6OIN, gave us a good starter on January 10th, when he worked W6UID, Long Beach, from a hill near San Diego, a distance of 100 miles. Ray expects to have 250 watts, crystal controlled, and a 4-element horizontal array on at his home location soon. Then he will be out for some real DX!

W6CAN, Napa, Calif., writes that activity around San Francisco is coming along gradually, though it has not reached the proportion of pre-war doings on 112 Mc. Stations operating from Mt. Diablo work into Sacramento quite regularly, and work over 100-mile paths is expected before long. W6CAN works San Francisco stations regularly, a 30-mile path over hilly terrain. Several of the fellows in that area have improved their receiver performance by the installation of r.f. stages using 6AK5s.

From his old stand at North Harwich, Cape Cod, W1BBM is hearing stations in Fall River and New Bedford on 144, and hopes to do better when weather conditions permit the erection of some good outdoor antennas. Bates is also interested in developing some activity on 420 Mc., now that the first third of that band is open to amateur use. Other stations reported to be active on 2 meters on Cape Cod include W1ARC, West Harwich, W1DJK, West Dennis, and W1FZH, Marston Mills. These boys, like those on Narragansett and Buzzards Bays, should be in a fine position to work some nice DX up and down the Atlantic Seaboard, come spring and temperature inversions.

Still in the Army at Lake Charles, La., Hank Keene, W2CTK, is looking forward to getting back home to try out some of his antenna ideas on 144 Mc. Hank used vertical rhombics with good results on 112 before the war, and feels that they should be even better on 144. A vertical rhombic one wavelength on a leg, with 60-degree angles top and bottom, would be only about 10 feet high. Several of these in a line would not be too difficult to construct, and should provide considerable gain without the sharp frequency response which is the limiting factor with most parasitic arrays.

While most of the work on 144 Mc. is being done with simple oscillator rigs, the number of stations using stabilized equipment is on the increase. The results these fellows are getting demonstrate that the effort necessary to put such a rig on the air is well repaid. Stabilized rigs reported by W1MGW, Bridgeport, Conn., include those of W2JWO, Patchogue, L. I. (826's crystal controlled); W9JL/1 and W2IQI/1 of Milford, W1KPN, Stratford, and W9BYJ/1, Bridgeport, all with 829 m.o.p.a. rigs. In the Hartford area W1LIH was the first to have crystal control. George has a walloping signal with his HK-54 on 145920, yet he uses up about one-fourth the territory occupied by modulated-oscillator rigs running but a fraction of the power. W1HDF, Elmwood, starts on 9 Mc. with an 802 ECO, followed by three 807 doublers and an HK-24 doubler, driving a pair of 24Gs in the final.

We hear frequently from fellows who are interested in v.h.f. work, but who are situated in a section of the country where there is no v.h.f.

activity. W9PKD, Salina, Kansas, wonders what he can do other than talk to himself. He would like to enlist the cooperation of others in promoting the use of v.h.f. for the local contacts which so often clog up lower-frequency amateur bands. Such work could be carried on on 2 meters, for instance, with a freedom from interference never found on any low-frequency band. The new Official Experimental Station appointment, announced elsewhere in this issue, should be a good medium for furthering v.h.f. activity where it is now low or nonexistent.

One way to develop activity which has been found to work time and again is the setting aside of one night each week to be devoted to work on whatever band you are interested in promoting. Get all the fellows who are known to have equipment for that band to use it on that night. Spread the word around (we'll be glad to list your schedule in this department) and talk it up on other bands. The Minute-Men in Eastern New England, the Horsetraders in the Connecticut Valley, the various nets in the Middle West, the Desert Rats of Arizona, the Monday-nighters (now active in the Hartford area on 144 Mc.), and the Wednesday-night Five-meter Roundup in W2, are but a few examples of the successful use of this system. Not only does it produce activity on the appointed night, but it usually boosts the occupancy of the band on other nights as well.

Helpful Hints Department

If you have an HRO here's a simple means of checking frequency in the 144-Mc. range. With the HRO operating on the 28-Mc. range, listen for the 5th harmonic of the HRO oscillator in the 144-Mc. receiver. Add 2275 to five times the frequency indicated on the HRO dial and there you are. It goes like this:

$$V = 5H + 2275$$

$$H = \frac{V - 2275}{5}$$

where V = frequency in the 144-Mc. band
H = frequency of HRO as indicated by dial calibration.

This system will work with other communication receivers having reliable dial calibration and a 455-kc. i.f. Some receivers may run the oscillator on the other side of the mixer frequency, in which the signs are reversed in the above equations.

For a long time now there has been a smattering of interest in the use of f.m. for amateur communication. It has always been a matter of one or two stations taking the necessary steps to get on and then spending the next few months trying to browbeat others into doing the same. The advantages of f.m. (noise-free reception, high quality, simplicity and low cost of transmitters) have been extolled in print and over the air for

years; yet amateur use of f.m. remains in the "something-ought-to-be-done-about-this" category.

One hitherto unpublicized point in favor of f.m., discovered quite by accident recently at W1HDQ, is the fact that it is a sure-fire cure for v.h.f. broadcast interference. When we set up for operation on 56 Mc. at our present location, we soon found out that we were making plenty of noise in four broadcast receivers which were in use within twenty feet of our antennas. By use of chokes, wavetraps, and shielding, we managed to get the interference down to satisfactory levels, but when we fired up on 144 it was worse than ever. Quiet hours seemed the only solution until we went on f.m. A check of our own broadcast receiver showed no interference, so we made the rounds of "our public" hopefully, with the 250-watt f.m. rig running 1000-cycle tone with plenty of deviation. No interference was noted in any of the receivers, and the signal could be heard only at tiny places on the dial, where, apparently, harmonics of the receiver oscillator beat the signal in at sharply-tunable spots.

Practically every station worked on 144 Mc. uses a superregenerative receiver, yet we manage to work everyone we can hear, though the reports indicate "low modulation but good quality." The signal, on all types of receivers, is vastly sharper than would be that of an amplitude-modulated oscillator of comparable power, and reception by the few who have f.m. superhets is superb. In any event, we are able to blaze away to our hearts' content, with little more than half the normal load on the a.c. line, and with the very comforting feeling that we are not spoiling anyone's evening by blotting out his favorite broadcast programs!



MARCH, 1921, *QST* reports the big news of new transcontinental relaying records. On four nights in mid-January a series of selected crack stations — our best ones — relayed messages coast-to-coast and returned an answer to the starting point, in several cases breaking our prewar record of one hour twenty minutes. On the final night the start was delayed until 3 A.M. and the routes checked through before the test began. Four round-trip messages were handled, in elapsed times of 23 minutes, $13\frac{1}{2}$, $7\frac{3}{4}$, and finally $6\frac{1}{2}$ minutes! 6ZK was the terminal for one of these messages but 6JD was on the other three. The record-breaking chain was 1AW-9ZN-5ZA-6JD and back the same way. Coöperation in maintaining silence made this test possible. "From 3 o'clock until 4:45 not a signal was aud-

ible at 1AW when 9ZN was silent except two times when 5ZA was barely readable, yet hundreds upon hundreds of stations were QRX with eager ears, and the very air was tense. . . . The eastern part of the country was silent as the grave, for probably the first time since Marconi invented spaghetti."

"6JD and Its Operator" are news from their part in the Transcons. Bitz says the test "will let the East know that there are a few amateurs in the West." His spark transmitter is unusual, being remarkably compact and having the novel feature of cutting a single-turn primary in the oscillation transformer at both top and bottom to introduce the condenser and gap with minimum lead-length. Other famous stations described in this issue was 6ZK, the station of our Pacific Division Manager, A. E. Bessey, at Sunnyvale; and 4XB at Savannah, a notable c.w. station using six VT2s in parallel in a Hartley circuit.

Although all the Transcon stations were spark, c.w. is forging ahead rapidly, with a very successful net of Z stations operating on about 350 meters. The editor hails it as "the berries" and says that the c.w. 10-watters completely outclass a kilowatt spark set in actual work. Thus it is great news that power tubes have finally reached the amateur market. RCA announces the UV-202, rated at 5 watts output but good for 10, 350-400 volts, price \$8. A 50-watter is coming up at \$30, a 250-watter at about \$110.

The trans-Atlantic tests which we took over from *Everyday Engineering* have failed, a radiogram having just been received from Phillip R. Coursey in London: "No signals received from States." . . . A new operating stunt is the CQ Party planned for April Fool's Day, in which "everyone is invited to take part and open up on high power and any old speed and call CQ as per scheduled below — and get CQ out of his system for all time." . . . "The Log of an Amateur at Sea" reports many calls heard in a trip from East to West Coast via the Canal Zone, 2EL being the star. . . . We begin a new department which publishes reports from listening stations listing the best, second and third-best stations from each district, both as regards their steadiness and reliability and as to the signal strength. It is remarkable how the same stations stand out.

On the technical side, McMurdo Silver reports on "Some Experimental Regenerative Tuners," while "New Apparatus" describes the deForest OT-3 "Midget" radiophone and the Clapp-Eastham ZRFD receiver, actually two regenerative receivers covering 175-625 meters with the aid of a detector and two-step amplifier. Reginald Denny, 6CS, a power engineer in Fresno, describes his indoor 6-wire antenna in the attic, loading being accomplished by an inductance coil of 40 feet of the same wire added at the free end of each antenna wire. He has been heard 250 miles.

Simple Capacitance and Inductance Measurements

Using the Frequency-Variation Method

DR. T. A. GADWA, * W2KHM

ALMOST every radio amateur, experimenter or designer has had an occasion to measure the capacitance of a condenser and the inductance of a coil. Since most methods require laboratory equipment, empirical formulas or trial and error usually are employed. The proposed frequency-variation method is attractive because of its simplicity, since the only equipment required is an oscillator, a frequency meter or frequency-calibrated receiver and a standard capacitance or inductance. None of the usual requirements of elaborate Wheatstone bridge, alternating-current power with some form of detector and calibrated resistances are necessary.

Fig. 1 — Typical oscillator circuit for measuring inductance or capacitance by the frequency-variation method.

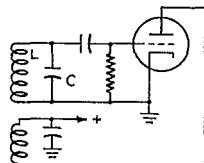

The voltmeter-resistance method is unreliable for small values of unknown because of input-capacitance and resonance effects of the vacuum-tube voltmeter at radio frequencies or lack of sensitivity at audio frequencies.

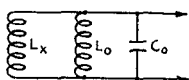

Fig. 2 — The coil is connected in parallel with the oscillator tank circuit if its inductance is small.

The principle of the proposed frequency-variation method is the measurement of the change in frequency of an oscillator when the unknown capacitance or inductance is inserted in an oscillating circuit. Almost any self-excited oscillator may be employed, such as that shown in Fig. 1. The frequency of oscillation is essentially established by the value of the inductance L and the capacitance C , according to the usual formula

$$f = \frac{1}{2\pi} \sqrt{LC}, \quad (1)$$

where f = frequency in cycles per second
 L = inductance in henrys
 C = capacitance in farads
 $\pi = 3.1416$

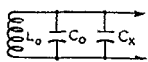

Fig. 3 — Small values of unknown capacitance are connected in parallel with the oscillator tank circuit.

The choice of frequency will depend upon the accuracy required and the value of capacitance or inductance to be measured. The method is limited to those values of capacitance and inductance to which the oscillator and frequency detector are capable of response. For small values of capacitance and large values of inductance, they should be connected in parallel with the

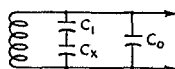
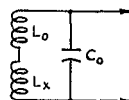

Fig. 4 — Large values of unknown capacitance, C_x , are connected in series with a known capacitance, C_1 as shown.

resonant oscillator circuit as shown in Figs. 2 and 3. Large values of capacitance are connected in series with the oscillator capacitance as in Fig. 4, while small values of inductance are connected in series with the oscillator inductance as in Fig. 5. Since it is more convenient to connect in parallel than in series and also, because of the disturbing effects of connecting leads if in series, a different choice of inductance, capacitance and frequency for the oscillator may be desirable.

Fig. 5 — Small values of inductance are connected in series with the oscillator tank circuit.



Formulas

The usual variation method requires a calibrated variable condenser to measure the change of capacitance necessary to restore the oscillator to the original frequency when the unknown condenser or coil is inserted in the oscillator circuit. Such a condenser is not readily available to most radio amateurs. Lacking the calibrated frequency meter, a broadcast receiver may be used as a substitute. Here the frequencies are known to a high degree and are available at almost any time.

Consider the case for capacitance measurement where

- L_o = inductance of oscillator before test, appropriate units,
- C_o = capacitance of oscillator condenser, any units,
- C_s = capacitance of standard condenser, same units,
- C_x = capacitance of unknown condenser, same units,
- f_o = frequency of oscillator before test, any units,

* 214 Hillcrest Rd., Mt. Vernon, N. Y.

f_o = frequency of oscillator with standard condenser in circuit, same units,
 f_x = frequency of oscillator with unknown condenser in circuit, same units.

Then from Fig. 6,

$$\text{Circuit diagram: } L_o \text{ in series with } C_o \text{ and } f_o \text{ in parallel.} \quad f_o = \frac{1}{2\pi\sqrt{L_o C_o}} \quad (2)$$

From Fig. 7,

$$\text{Circuit diagram: } L_o \text{ in series with } C_o \text{ and } C_x \text{ in parallel.} \quad f_x = \frac{1}{2\pi\sqrt{L_o(C_o + C_x)}} \quad (3)$$

Combining (2) and (3)

$$f_o^2 C_o = f_x^2 (C_o + C_x) \quad (4)$$

Solving,

$$C_o = \frac{C_x}{(f_o/f_x)^2 - 1} \quad (5)$$

From Fig. 8,

$$\text{Circuit diagram: } L_o \text{ in series with } C_o \text{ and } C_x \text{ in parallel.} \quad f_x = \frac{1}{2\pi\sqrt{L_o(C_o + C_x)}} \quad (6)$$

Combining (2) and (6), solving for C_o and equating to Eq. (5),

$$C_o = \frac{C_x}{(f_o/f_x)^2 - 1} = \frac{C_o}{(f_o/f_x)^2 - 1} \quad (7)$$

Solving,

$$C_x = C_o \frac{(f_o/f_x)^2 - 1}{(f_o/f_s)^2 - 1} \quad (8)$$

For example, assume that

- $f_o = 100$ kc., reference frequency,
- $C_o = 250$ $\mu\text{fd.}$, standard capacitance,
- $f_s = 90$ kc. frequency with standard capacitance,
- $f_x = 95$ kc. frequency with unknown capacitance,

From Eq. (8),

$$C_x = 250 \frac{(100/95)^2 - 1}{(100/90)^2 - 1} = 250 \frac{(1.110 - 1)}{(1.235 - 1)}$$

$$C_x = (250) \frac{0.11}{0.235} = 117 \mu\text{fd.}$$

For accuracy, C_o , the fixed oscillator capacitance, should be as small as practicable and the unknown and standard capacitances approximately equal. The fixed capacitance will include that of the condenser and wiring. Small capacitances of the order of 1 $\mu\text{fd.}$ can be measured if a minimum fixed capacitance is employed in the oscillator. Any reference frequency may be chosen but the capacitance range will be limited by the frequency range of the frequency meter. For instance, if $f_o = 700$ kc. and $f_x = f_s = 1400$ kc., then $C_x/C_o = C_x/C_o = 3$. If any frequencies are below that of the frequency meter, then harmonics can be observed and the capacitance range increased. For instance, a 100-kc. oscillator with

a broadcast receiver is an ideal arrangement for a wide-range capacitance meter.

Greater Accuracy

For improved accuracy when using harmonics, establish the number (order) of harmonic and calculate the value of fundamental frequency instead of using the difference of adjacent harmonics. For example,

Harmonic Frequency	Harmonic Number	Calculated Fundamental Frequency
895 kc.	10	89.5 kc.
805	9	89.5

Difference 90 kc.

89.5 Average

The number of any harmonic can be identified by division of the harmonic frequency by the difference of adjacent harmonics and using the closest integer. Thus $895/90 = 9.94$ or the 10th harmonic is the closest integer.

If the frequency change is small, the following equation will give more exact results:

$$C_x = C_o \left[\frac{f_s}{f_x} \right]^2 \left[\frac{(f_o - f_x)(f_o + f_x)}{(f_o - f_s)(f_o + f_s)} \right] \quad (9)$$

Either Eq. (8) or (9) may be plotted as a curve, f_x vs. C_x , and the unknown capacity read directly from the frequency with the unknown in the circuit. Such a curve is shown in Fig. 9 and applies only to the author's apparatus where the following conditions hold:

$$f_o = 1400 \text{ kc.} \quad L_o = 38.8 \mu\text{h.} \quad C_o = 333 \mu\text{fd.}$$

(Continued on page 134)

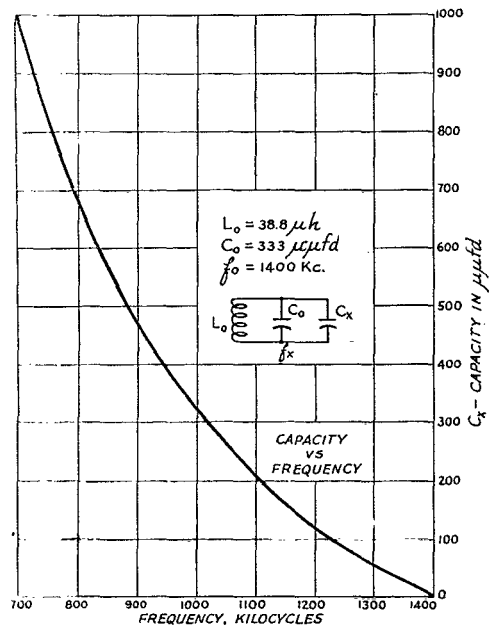

Fig. 9 — Capacity calibration curve.

New Receiving and Transmitting Tubes

MAJOR amateur transmitting-tube developments to date have been beam-power tetrodes, working well into the v.h.f. range and requiring little driving power as well as no neutralization, improved triodes that also go into the v.h.f. region, and more powerful "lighthouse" tubes for the ultrahigh frequencies.

The trend in receiver-tube design is definitely swinging toward miniature, glass-button based types. Even sub-miniature tubes are being manufactured that will permit construction of really tiny "personalized" receivers.

RK-4D32

This is a Raytheon beam power tetrode amplifier or oscillator tube designed to give 100 watts output on frequencies up to 60 megacycles when operating from a 600-volt power supply. No neutralization is necessary up to the 60-megacycle limit. A pair in Class AB₂ will deliver 125 watts of audio.

The 4D32 has a 6.3-volt heater that takes 3.75 amperes. Its glass button base is exactly the same as the 829-B and fits the same socket. The large guide pin is No. 4. It and the No. 5 pin connect to the cathode, the beam-forming plates, and to the internal shield. Pins 1 and 7 are the heaters, 6 is the control grid, 2 is the screen which is internally by-passed to cathode, and the No. 3 pin has no connection. The plate connection is on top of the tube.

Direct Interelectrode Capacitances

Grid to plate (with external shield)	0.27 μ fd. (max.)
Input	28.0 μ fd. (max.)
Output	13.0 μ fd. (max.)
Screen-cathode capacitance (including internal screen by-pass condenser)	40.0 μ fd. (approx.)

R-F Power Amplifier or Oscillator — Class C

Typical Operation

	Telephony *		Telegraphy or Frequency Modulation	
	Plate and Screen Modulation	Modulation	Telephony	Telephony
D.c. plate voltage	550	600	600	750 volts
D.c. screen voltage			300	300 volts
Series screen resistor	15,000	10,000		ohms
D.c. grid voltage	-100	-100	-100	-100 volts
D.c. plate current	175	220	215	240 ma.
D.c. screen current	17	28	30	26 ma.
D.c. control grid current	6.0	10.0	10.0	12.0 ma.
R.f. grid driving power (approx.)	0.6	1.25	1.25	1.5 watts
Carrier power output (approx.)	70	100	100	135 watts

* Carrier conditions per tube for use with a maximum modulation factor of 1.

A.F. Power Amplifier — Class AB₁ and Class AB₂

Typical Operation *

	Class AB ₁	Class AB ₂
D.c. plate voltage	600	600 volts
D.c. grid voltage	-37.5	-25 volts
D.c. screen voltage	350	250 volts
Peak a.f. input voltage (grid to grid)	74	70 volts
D.c. plate current (zero signal)	100	100 ma.
D.c. plate current (max. signal)	350	365 ma.
D.c. screen current (max. signal)	45	23 ma.
Effective load resistance (plate to plate)	3000	3000 ohms
Maximum signal driving power (approx.)	0	0 45 watts
Maximum signal power output (approx.)	112	125 watts
Maximum plate dissipation (per tube — approx.)	49	47 watts
Maximum screen dissipation (per tube — approx.)	8	3 watts

* Unless otherwise specified, values are for two tubes.

The RK-4D22 is a 25-volt counterpart of the 4D32 except that it has a center-tapped heater for alternative 12.6-volt operation.

2E25

Hytron developed this beam power amplifier tube especially for portable work as an r.f. or modulator tube. It is capable of generating 22 watts output up to 100 megacycles as an r.f. amplifier running on a 450-volt power supply. Up to this frequency no neutralization is needed and maximum ratings can be used. Singly, it will give 6 watts of audio while a pair in Class AB₂ will deliver 40 watts.

The filament takes 6 volts at 0.8 amperes. Its octal-base pin connections are as follows: No. 1, no connection; 2, filament; 3, no connection; 4, screen; 5, control grid; 6, no connection; 7, filament; 8, beam-forming plates. Plate connection is at top.

Direct Interelectrode Capacitances

Grid to plate (maximum)	0.15 μ fd.
Input	8.5 μ fd.
Output	6.0 μ fd.

R.F. Power Amplifier and Oscillator — Class-C Telegraphy and Frequency Modulation *

Maximum Ratings:

D.c. plate voltage	450 max. volts
D.c. screen grid voltage	250 max. volts
D.c. control grid voltage	-125 max. volts
D.c. plate current	75 max. ma.
D.c. control grid current	4.5 max. ma.
Peak positive r.f. control grid voltage	60 max. volts
D.c. plate input power	33.5 max. watts
D.c. screen grid input power	4 max. watts
Plate dissipation	15 max. watts

* Key-down conditions per tube without amplitude modulation.

Typical Operation — Average Characteristics:

D.c. plate voltage.....	450	450 volts								
D.c. screen grid voltage.....	250	250 volts								
D.c. control grid voltage	<table border="0"> <tr> <td>{ a.....</td> <td>-45</td> <td>-70 volts</td> </tr> <tr> <td>{ b.....</td> <td>15,000</td> <td>23,000 ohms</td> </tr> <tr> <td>{ c.....</td> <td>480</td> <td>750 ohms</td> </tr> </table>	{ a.....	-45	-70 volts	{ b.....	15,000	23,000 ohms	{ c.....	480	750 ohms
{ a.....		-45	-70 volts							
{ b.....		15,000	23,000 ohms							
{ c.....	480	750 ohms								
Peak r.f. control grid voltage.....	90	120 volts								
D.c. plate current.....	75	75 ma.								
D.c. screen grid current.....	15	15 ma.								
D.c. control grid current.....	3	3 ma.								
Control grid driving power.....	0.27	0.36 watts								
Plate power output.....	20	22 watts								

a = Fixed bias; b = Grid leak; c = Cathode resistor

A.F. Power Amplifier — Class AB₂

*Typical Operation — Average Characteristics:**

D.c. plate voltage.....	450 volts
D.c. screen grid voltage.....	250 volts
D.c. control grid voltage.....	-30 volts
Peak a.f. control grid to control grid voltage....	142 volts
Zero signal d.c. plate current.....	44 ma.
Max. signal d.c. plate current.....	150 ma.
Zero signal d.c. screen grid current.....	10 ma.
Max. signal d.c. screen grid current.....	40 ma.
Max. signal d.c. control grid current.....	3 ma.
Effective load resistance (plate to plate).....	6000 ohms
Max. signal control grid driving power.....	0.9 watts
Max. signal plate power output.....	40 watts

* Unless otherwise specified, values are for two tubes.

HD59

Another Hytron beam power tetrode, this time in miniature. It doesn't sound reasonable that a tube so small can deliver 3.5 watts of audio or 6 watts of r.f. from a 250-volt plate supply, but the HD59 is rated to do just that. As a Class-C doubler it can give about 4 watts output up to 80 megacycles. Its size and performance are admirably suited to mobile v.h.f. work.

The 6-volt filament draws only 0.7 amperes. The No. 1 pin on its glass button base is the control grid, 2 is the beam-forming plates, 3 and 4 are filament connections, 5 is the plate, 6 is the screen, and 7 is the filament center tap.

Direct Interelectrode Capacitances

Grid to plate.....	0.3 μ fd.
Input.....	10 μ fd.
Output.....	7.0 μ fd.

R.F. Power Amplifier and Oscillator — Class-C Telegraphy and Frequency Modulation

Typical Operation

D.c. plate voltage.....	250 volts
D.c. screen voltage.....	150 volts
D.c. grid voltage.....	-75 volts
D.c. plate current.....	37 ma.
D.c. screen current.....	9 ma.
D.c. grid current.....	2.8 ma.
R.f. grid driving power (approx.).....	0.35 watts
Carrier power output (approx.).....	6 watts

A.F. Amplifier, Class A₁

Typical Operation

D.c. plate voltage.....	250 volts
D.c. screen voltage.....	250 volts
D.c. grid voltage.....	-20 volts
Zero sig. plate current.....	40 ma.
Max. sig. plate current.....	42 ma.
Zero sig. screen current.....	2.5 ma.
Load resistance.....	4500 ohms
Max. sig. plate power output.....	3.5 watts

TB-35

Taylor adds this high-voltage, 130-watt output beam power tetrode to the field. Good for full input ratings up to 250 megacycles and half power input to 400 megacycles, this tetrode will be very welcome to the v.h.f. gang. It's about the size of a 24-G and has a four-pin medium ceramic base. The plate-supporting rod runs through the glass at the top for the external plate connection. Its filament takes 6.3 volts at 3 amperes.

Direct Interelectrode Capacitances

Grid to plate.....	0.2 μ fd.
Input.....	6.5 μ fd.
Output.....	1.8 μ fd.

R.F. Amplifier, Class-C Telegraphy

Typical Operation

D.c. plate voltage.....	1500 volts
D.c. screen voltage.....	375 volts
D.c. grid voltage.....	-300 volts
D.c. plate current.....	110 ma.
D.c. screen current.....	22 ma.
D.c. grid current (approx.).....	15 ma.
Plate dissipation (max.).....	35 watts
R.f. grid driving power (approx.).....	4.5 watts
Carrier power output (to 250 Mc.).....	130 watts

R.F. Amplifier, Class-C Telephony

Typical Operation

D.c. plate voltage.....	1000 volts
D.c. screen voltage.....	300 volts
D.c. grid voltage.....	-200 volts
D.c. plate current.....	85 ma.
D.c. screen current.....	14 ma.
D.c. grid current.....	10 ma.
R.f. grid driving power.....	2 watts
Carrier power output.....	60 watts

3D23

Lewis Electronics announces this beam power tetrode, the same in physical appearance and electrical characteristics as the TB-35.

4E27

This is another beam power tetrode manufactured by several concerns and better known as the 257B or 8001.

TUF-20

Similar in appearance to the HY-75 is Taylor's latest low-power, v.h.f. triode that can be operated at full ratings up to 250 megacycles. A tantalum plate is an outstanding feature. Plate and grid caps are on top and filament leads come out to pins on the octal base. Primarily the tube is designed for portable and mobile v.h.f. applications. Its filament draws 2.75 amperes at 6.3 volts.

Direct Interelectrode Capacitances

Grid to plate.....	3.5 μ fd.
Input.....	1.8 μ fd.
Output.....	0.9 μ fd.

R.F. Oscillator, Class-C Amplifier

Typical Operation

D.c. plate voltage.....	300	750 volts
D.c. plate current.....	100	80 ma.

(Continued on page 140)



Correspondence From Members -

The Publishers of *QST* assume no responsibility for statements made herein by correspondents.

ATOMIC SIGS

P.O. Box 192, Pomona, Calif.

Editor, *QST*:

Well, it looks now that about all that has to be done is to get the atoms tied across the sky hook, pour on a little turpentine, get 'em fighting, and when they get good and mad and start up a heavy smoke they will go places unless they make up and start to skip and get grounded! Anyway it all leads up to getting a sig out of here — this valley of dead holes and spots makes a sponge look like a piker.

And there is talk of running the 2600 v. main lines into ham shacks and going back to gas for midnight oil, due to lack of No. 22 and 24 d.c.e. wire. The only juice one can get here now is out of an orange and that has the wrong polarity for the tubes.

My kingdom for 10 lbs. No. 22 or 24 wire. Have you seen any up that way?

— "Old Jim" Porter, W8CBF

THE NEWCOMERS

Eng.-Guard Co., Base Depot, Camp Elliott,
San Diego, Calif.

Editor, *QST*:

Your editorial in the September, 1945, issue of *QST* on the subject of enrolling service-trained radiomen into the amateur fold is a timely and vital one. At no time in the history of amateur radio has such a vast, untapped store of potential hams existed, and new methods of recruitment must be evolved if we are to reach them. It is a big task. The service operating and technical schools have turned out trained men by the hundreds of thousands. How are we to acquaint them with the fascinating realm of amateur radio? Obviously ARRL Hq. cannot contact so many by itself, with no means of locating the veteran in his movements back from the war zone, through a separation center, and along the road to home and civilian life. It is a job for thousands of *field workers* living in the cities, the towns, the countryside throughout the land, where word-of-mouth, the newspaper and personal contact bring the returning serviceman under his observation. The field worker must possess an active interest in amateur radio; he must be unselfishly energetic in fostering interest in others — in short, he must himself be a typical ham.

Accordingly, I urge that every active amateur be enlisted in a planned and sustained program to seek out the service-trained veteran and present to him the full possibilities that hamming provides. Direct appeal to those who apply to the FCC for new and renewed licenses, in the form of pamphlets along with ample monthly space in *QST*, should bring a response that will more than justify the effort, for these applicants have demonstrated their interest in hamming. They should be urged to form clubs in their community for the purpose of adding others, with emphasis upon seeking out the veteran with wartime radio experience. We should suggest newspapers as a prime source of information; they announce the return of the serviceman to his home, and often tell the kind of work he has been doing. It is a simple matter to see him personally and present the future that hamming offers.

This initial contact should be considered only a first step in the program. Local clubs are important. They provide a common meeting place where interested persons can discover the comradeship and high ideals of our fraternity and receive group aid in mastering license requirements. Think of the enormous possibilities of a gathering which already possesses the necessary technical training, already intrigued by radio's

unique position as a communication medium that knows no terrestrial boundaries, needing only to be shown the way to acquiring a license and a station to become hams. The results cannot but be overwhelmingly successful.

No, we do not lack for eminently qualified future hams, nor should the task of converting them to our numbers be difficult. What we must have is an enthusiastic corps of "missionaries" to broaden our comparatively narrow sphere of activities to encompass these potential amateurs. We must enlist the aid of every ham, summoning every means at our disposal to convey to him the importance of his help. Appeal to his imagination: picture a vast expansion of the amateurs' prestige and authority with increased membership. Appeal to his patriotism: the war record of the amateurs will inspire him. Call upon his sense of obligation: whom of us was not helped by another? — he should pass on that "good turn." Cater to his own interest: he needs others to QSO in his neighborhood if he contemplates u.h.f. work.

My personal observations lend strong corroboration to all you have said. I have met and worked with the men of whom you speak. Their backgrounds and postwar plans are varied. Many will not make radio their vocation. School, their dad's business, their old job will absorb them. It is these men that we must seek out, or their wartime training will be forever lost to themselves, to us, and to their country, for radio is a swift-moving art. Amateur radio has an enormous potential in the veteran today. Let us not forget him.

— Stanley W. Jeffcoat, W5KPY, ex-W4EFP

STILL WITH US

Mattapoisett, Mass.

Editor, *QST*:

Twenty-five years ago this summer I wrote a little skit for *QST*, which I have just re-read, called "QRX for a New OW." In those days there was no YL; every female was an OW just as OM was old man whether you were nine or ninety years old. In those days, even as today, QRM was a problem — but we have no spark coils today to pester. Twenty-five years ago Eunice Randall in Mattapoisett, Mass., let go with the worst old scratch box spark coil you ever heard, and man! — I'm still here to tell you it was as wide and broad on my tuner as both of her barn doors, over on her farm. I only lived five miles away at the time.

Well, to make a long story short, the upshot of it all was that I fussed and fretted and fumed at my new source of QRM till the Wouff-Hong seemed like a child's toy instead of the terrible instrument of torture that it was. Imagine my surprise when, at long last, I made out "ER" for a call, and was about to murder the bootlegger when I suddenly discovered it was a girl! I think in all America there were only three other girl operators at that time. "ER" made a quick date with me, and we met up in the Mattapoisett town hall at a dance. I soon discovered that here was really an original female tinkerer — a regular "Willie Westinghouse Edison Randall." She could dance (and believe me, she took some long steps — we were both over six feet tall) but gosh darn! — what did she talk about during the dance? The moon? The music? The weather? Any small talk? No, definitely not — she wanted to know what made the wheels go round at my ham station, and she was laying plans for her station.

Just think of it — here we are — twenty-five years later and here's Eunice right in our midst, still batting 'em out at her own station, W1MPP, now in Watertown, Mass. Let it be known, too, she is no sissy; c.w. is her favorite, and she has the nicest, cleanest fist. I'm really astonished, for I never would have believed that she would still be a ham

twenty-five years from then. Now all I can say is, she's good for life — I must have given her a good start or something. Maybe she's waiting to see if I quit. Well, Eunice, I'm going to take a set with me, so hook on for another twenty-five years.

If you want any art work done, any blueprints made and plans drawn up, or if you want to see a work of art — get one of her QSL cards. Eunice is a draftsman for none other than the New England Light and Power Company of Boston. No ordinary ribbon clerk job for her! During the war, same thing — teaching code, civilian defense WERS, sold her nice RCA ham receiver to be patriotic. Now she's scratching again, not with a squeak box but for a new super-duper receiver. She told me last November that she heard W1AW back on the air, and it felt as tho someone was urging her, gently pushing.

I'd better sign off and get to bed, cause back there in 1921 when Eunice came to life I had already been fussing around for nineteen years as a ham. I don't want my whiskers to get caught in the final tank circuit, or get any atomic dust in them.

— Irving Vermilya, W1ZE

PROS AND CONS

SS Brookfield, Persian Gulf

Editor, QST:

What in heck is holding those FCC members up in regards to opening the ham bands? The war was over in August, and here it is January and no important ham bands are open yet. I know that the ARRL is doing all it can to get us back on the air, but it's sure a heck of a lousy deal! After so many hams did their stuff to win the war, they come back to find out that Washington red tape is the real victor!

I bet that our wartime Silent Key members are turning in their honorable graves at this very moment. (The FCC may have "seen the lite" by time you get this, if so please disregard.) Hi!

— J. C. Nelson, W8FU

Editor's Note. — FCC, of course, is powerless to return any amateur frequencies until their release by the military.

Overseas

Editor, QST:

I would like to take this opportunity to praise and thank the ARRL for the splendid manner in which the name of amateur radio was held in high esteem and their cause so well presented throughout the entire emergency. Only through your efforts have the amateurs been able to take up their activities again.

— Joseph C. Duncan, W4ECW

404 W. Ely St., Alliance, Ohio

Editor, QST:

"Onions" for your page in December QST, "It Seems To Us." I quote: "Of course we're not really back on until we get 80, 40 and 20 but it will seem no time at all until things are like they were in the good old days."

Evidently you forget that in the so-called good old days there was a 160-meter band, and also then were a few hundred amateurs who worked that band. The writer being one of those, I here and now am protesting to the chairman of the committee appointed by our organization for their negligence in losing this band for our use.

I also condemn KBW for his article; it smacks as propaganda, for regardless of what KBW may write if 160 meters are not returned to us ham radio will never be what it was prior to the war. So what say, you fellows of the old 160 gang — make yourself heard. We've never been licked yet.

— Glenn Dallas, W8SBS

3910 Bruce St., Alexandria, Va.

Editor, QST:

I feel compelled to write you people after listening to the W1AW broadcasts since their inception. After a 4-year wait I don't believe anything will ever sound better to me than

"QST de W1AW." I listen to all broadcasts on all of the yet-forbidden frequencies, just to hear that famous old hain call pounding away down there. I have worked that call over 16 years ago when The Old Man himself was at the key and never hear it without being flooded with memories of the days gone by in this, the most magnificent of all hobbies.

I am connected in the Washington, D. C., area and know something of what the League has done for the amateur these past four years and of the things that are now being done to get us back on all our old bands. You gentlemen deserve a most profound vote of thanks from the whole 60 thousand of us for providing the American amateur with the most complete and prolific representation enjoyed by any amateur group in the world. . . .

— William Davis, W8NOA

147 Worthington St., Boston 15, Mass.

Editor, QST:

The return of amateur frequencies appears to be slow. Probably you are fencing for them with plans to step on as few toes as possible. It is suggested that these bands be monitored by the gang so as to give you a complete report of activities. Unfortunately, I cannot sit for any length of time due to injuries received in the Pacific, so have only observed practice circuits, V-wheel stuff, aviation use and many holes showing no activity. And then there are those BC programs who are going great guns.

It is felt that if we do not keep at it without getting too nasty about it, the authorities will feel that we hams do not really want to get back on the air.

— Walter S. Rogers, W1DFS

112 S. Orchard, Madison, Wis.

Editor, QST:

Having postponed my membership application to the League for some years, I feel it is time enough to acknowledge that you do represent the voice of ham radio in the U. S.

Rather a "touchy" subject with me before hostilities — whether ham radio should be organized as a body — in the ensuing arguments between myself and my sponsor into the game, W6GG, I'm afraid the League took a little name-calling at my hands.

Now — and with the subsequent pressure put forth on the part of the League as to the resumption of ham activity — my opinions and ideas have been altered completely.

Let us hope that I am one of the many that will come to realize that ham radio, to endure, must have organization, and the League on the basis of its accomplishments, is the group behind which we should organize.

— William Hess, W6SIQ

PAGE REPORTS

(Editor's Note. — The following are excerpts from a letter to W2CSS, reproduced with his permission):

Da van Dykweg 20, Doetinchem, Holland

Dear OM:

. . . I understand I still owe you a long story about my experiences during the war. Well, here it goes: After the capitulation of the Dutch army in May, 1940, I went after my xmitter which in the autumn of 1939 had been requisitioned by army authorities. The people in charge did not dare, however, to give the stuff free, so the only thing I could do was to say goodbye to the thing. Till April this year the xmt, with those of other hams of this district, has been in the postoffice of a nearby town, and as soon as this town came in the frontline the Germans took the stuff with them and very probably destroyed it.

In 1943 we had to bring our receivers to a depot, and listening was prohibited, except to Germans and nazi party members. The sets of the latter were "amputated," however — that is, the shortwave section was put out of action, to prevent listening to the shortwave transmissions of the "enemy." The Germans did not trust their Dutch political coöperators very far! I did not feel inclined to give up my

(Continued on page 148)

The Crystal Ball

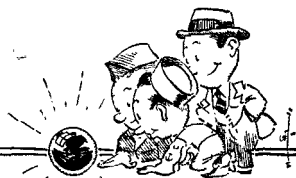

CONDUCTED BY A. DAVID MIDDLETON,* W2OEN

CRYSTAL-BALL gazing has become almost a national pastime since the press and various popular magazines have adopted the term in dealing with prognostication concerning such diversified subjects as politics and women's hats.

But to radio amateurs it has a more specific meaning. It is a combination of day-dreaming, wishful thinking and plans for future designs based on a desire for improvement in operating or construction technique.

This month we present a group of ideas that demonstrate the outstanding ability of the radio amateur as a Crystal-ball Gazer, first class.

LOW-DRAIN BATTERY TUBES IN V.F.O.

MY ANTIQUE Crystal Ball, although cracked and battered by years of use, reveals a new type of v.f.o., a three-stage affair using the new Raytheon CK510AXs. These little tubes, with their 0.625-volt 50-ma. filament should run cool and should drift little due to temperature changes. Also, being battery operated, my v.f.o. will have no voltage variation. The three CK510AXs will be gang-tuned with the second and third stages band-switched. The unit will have output on the 80-, 20- and 15-meter bands, and will be followed

*Department Editor.

An Announcement

• With this issue the Crystal Ball is returned to its velvet-lined case and packed away with other souvenirs of the recent conflict. Inspired by the obvious desire of key- and mike-hungry hams to dream a bit about the shape of things to come, it has served its purpose now that the visions are becoming realities. Our thanks to the many hams and hams-to-be whose contributed ideas made it possible.

The final contest winners, chosen by the conductor of the department and "guest judge" F. E. Handy, WIBDI (Communications Manager, ARRL), are T/Sgt. Wm. Parrott, first prize; Thomas N. Pauley, K7HNG/6, second prize; J. W. Sikorski, third prize; Wm. Kawai, W6MNQ/9; Geo. M. Williams, W4EYK.

by two band-switching rigs, the first having output on 80 and 40 and the second working on 20 and 15.

It sounds good to me!

— George M. Williams, W4EYK

STATION PLANNING

CRYSTAL BALL columns published so far have included more or less high powered, or super-technical rigs, but how about us — the boys who are just starting in — the "amateur amateurs"?

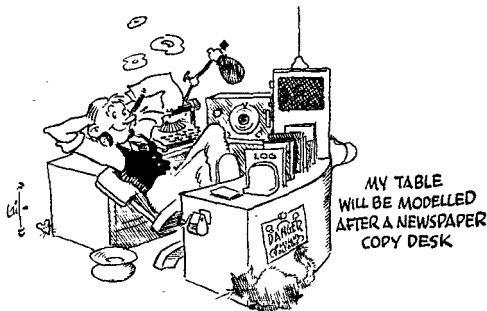

My "crystal ball" is something of a reality, — a fruit jar on the kitchen cabinet, into which goes all my spare change. Now, a look in my "crystal ball" shows me enough for my first rig.

A lot of the high-power boys and the old-timers will get a laugh out of my ambitions for my first outfit, but in time maybe the "crystal ball" will fill up again, and I can spread out a little.

My first transmitter is going to be the midget job described in July, 1944, *QST*. Fifteen or twenty watts will be plenty to start with, and the outfit seems easy to build. I know, of course, that in a relatively short time, I'll be wanting to park it on the shelf, and build an outfit with more "posh."

I'm going to buy my first receiver. Three friends have highly recommended three different receivers, so I guess I'll have to draw straws. I may build one some day, but at present, I'm too lazy and don't know enough about it.

My shack is going to take more of my time than the rest of the installation. I have long had an idea of the kind of shack I was going to have when I got around to it.

Fig. 1—This advanced type of keyer was suggested by K7HNG/6. A keyed tone is fed into an amplifier and then rectified. This rectified voltage offsets the high bias on a keyer tube which actuates the crystal oscillator. The RC combination of R_2 and the $0.04 \mu\text{fd}$. condenser eliminates the possibility of modulation reaching the crystal.

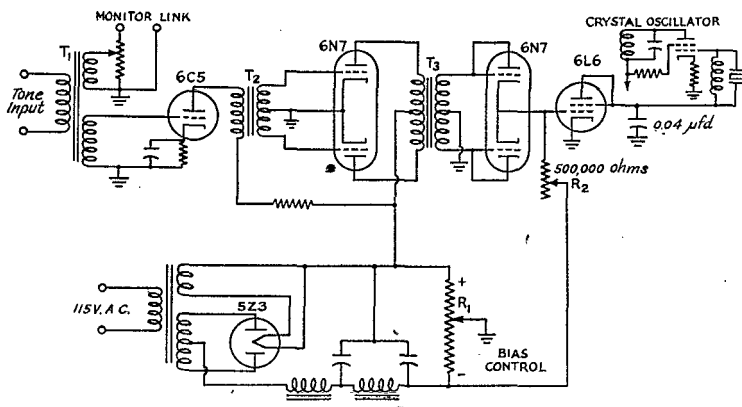

a) It's going to be well-lighted—I've been in a half dozen ham shacks and not one of them was properly lighted. Every one has a lone sixty-watt bulb in a drop from the ceiling.

b) My table will be modelled after a newspaper copy desk, with my receiver in the center, my transmitter to the right, and a mill on the left wing of the "slot." That leaves the right wing for books and assorted operating desk junk. A good swivel chair will complete the picture.

I realize this is probably a very amateurish job to some of the boys who have been pushing out the kilocycles for many years, but I believe it will be the modest beginning of something better to come. Probably a lot of the old-timers started out in even a smaller way.

— J. W. Sikorski, Centerville, S. Dak.

ator on the same pair of 'phones—which of course is most desirable.

Adjustment? It's very simple. Adjust the bias control tap on R_1 until the rated bias is applied to the 6L6, using enough resistance in R_2 that the bias may be counteracted by the keying tone. The 6L6 should be cut off—and no more.

A local oscillator may be used to key the transmitter, a remote signal may be used to do the same, and any received signal without too much noise on it may be retransmitted by feeding it into the keyer unit. The unit will key the transmitter on anything from a Morse telegraph line to a teletypewriter signal.

I would like to give credit to Chet Murphy (call unknown) of Platinum, Alaska, for his part in helping me iron out the details of the circuit.

— Thomas N. Pauley, K7HNG/6

AN ADVANCED TYPE OF KEYER

HERE IS my idea for a keying system for my postwar ham rig. It offers freedom from clicks and chirps, a monitor signal, and *no* large amount of current to be broken.

A code practice oscillator, such as a Hartley with a '99 tube, is keyed and the output fed into this unit. The keyed tone is then amplified (Class B) and rectified, and applied as positive bias which is supplied through a 500,000-ohm variable resistor. This, of course, places a fairly large positive voltage on the grid of the keyer tube during "key down" conditions, allowing it to pass all the current drawn by the oscillator. The components should not be critical, the input transformer may be of the split secondary push-pull type used for inverse feedback, the others may be taken from the junk box. T_3 should be selected to give a large secondary voltage. The monitor line is fed into the audio channel of the receiver, to provide a preset monitor of the tone that actually keys the transmitter. This will give the monitor signal and the received signal to the oper-

"— A LOT LESS AND STILL MUCH MORE"

CRYSTAL-BALL gazing comes close to day-dreaming as far as I'm concerned. It brings a picture of a neat row of racks and panels, with a multitude of dials and meters, an operating table with diversity receivers, and rows of

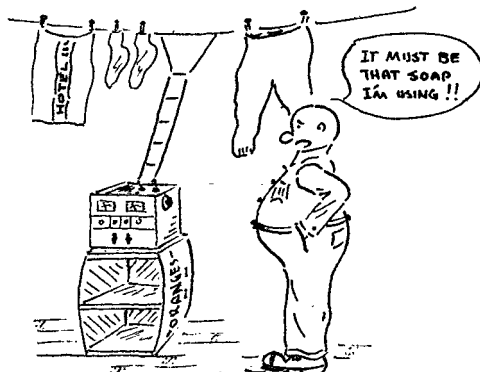

switches within easy reach to go from 'phone to c.w., to change bands or antennas, plus a visual indicator for that rotary beam which rotates so majestically on a tall mast atop the peak of the highest knoll in the county — all this and Lana Turner, hubba, hubba!

However, after a hitch of five years in the Army, and a constant change of QTH, what with "carry this and carry that," the once-beautiful vision of the above-mentioned amateur gear appears as if viewed through the wrong end of the telescope. Instead of the original layout of vastness, my new compact rig reposes atop an orange crate. It has about one cubic foot displacement, I'd say. It's for both c.w. and 'phone. From the meter readings and the size of the bottle, it must come close to a quarter kilowatt. Two leads on the top of the cabinet will light up even a clothes line when connected to same. Three switches marked "Band," "AM-FM," and "Power" complete the rig. Wait a minute! I missed the dial on the side of the rig — that must be the v.f.o. crank.

And there you have it, my postwar rig — a lot less commercial appearance and still a lot more hamming.

A receiver to match this one-foot transmitter? Well, my crystal ball is growing hazy but I'll get another look one of these days!

— Bill Kawai, W6MNQ/9

AN AMATEUR'S PLAN POSITION INDICATOR

HERE'S an idea that might appeal to some of the boys who have plenty of "lettuce" to spend on their rigs.

Purpose — To provide, at a glance, the direction and relative signal strength of all signals on a given frequency. This system is probably more applicable to the v.h.f. bands.

Components — The system consists of a rotatable beam having sharp unidirectional characteristics. Its output is fed into a receiver and then amplified to furnish excitation for the magnetic coils on an oscilloscope. The antenna and the deflection coils are rotated in synchronism by means of selsyns. The 'scope, having long persistence, will retain the received trace furnished by the incoming signal. The driving motors have both high and low speed.

Operation — The receiver is tuned to the desired frequency and the beam is rotated at high speed. The incoming signals leave a trace on the 'scope, as the trace is deflected outward from the center of the face of the 'scope. The pattern on the 'scope would probably look something like Fig. 1-C.

After a choice has been made of the signal to be "worked" the beam is rotated at slow speed

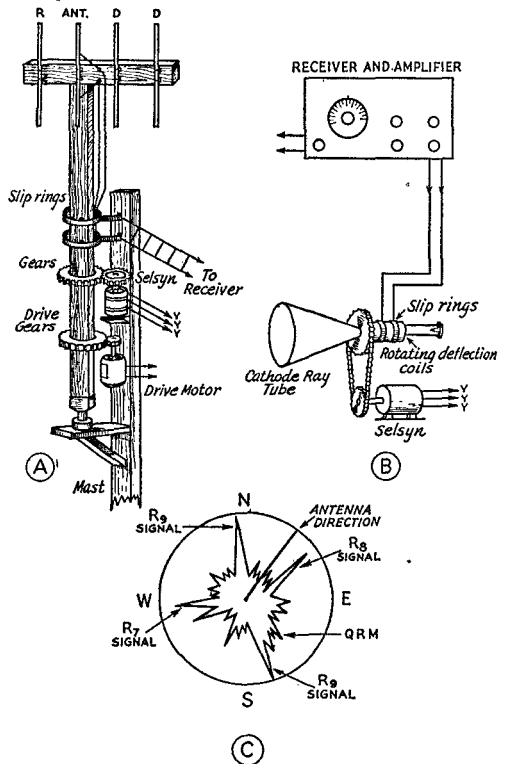

Fig. 2 — One version of a plan position indicator for amateur use. Slip rings connect the antenna feeders to an appropriate receiver. The output of the receiver is fed into deflection coils on a cathode ray tube. The rotating antenna rotates in synchronism with the deflection coils controlled by selsyns on the PPI and the antenna. A depicts the general layout of the antenna system while B shows the arrangement inside the station at the receiving location. The face of the long persistence PPI 'scope might look like the sketch at C after the antenna has made a few rotations.

until maximum signal has been received. As signals over a certain strength would operate the squelch relay in the receiver, the audio signal would be heard, thus identifying the station tuned in. A QSO is then effected in the normal manner with the beam antenna connected to the transmitter by means of a changeover relay.

— T/Sgt. Wm. Parrott, Ft. Leonard Wood, Mo.

**SWITCH
TO SAFETY!**





Operating News

F. E. HANDY, W1BDI, Communications Mgr.
E. L. BATTEY, W1UE, Asst. Comms. Mgr.

J. A. MOSKEY, W1JMY, Communications Asst.
LILLIAN M. SALTER, Communications Asst.

28 Mc. Precautions Necessary. Have you been on "10"? By all means get in on what this band has to offer! But a note of warning. Certain amateur stations have been cited by FCC for spurious 14 Mc. radiations. When these occur at the sub-harmonic frequency it is usually because of the leakage of 14-Mc. energy from multiplying stages just ahead of the final amplifier, through the final. Look also for an antenna-feeder-ground set-up that can radiate twenty-meter r.f. in addition to the frequency for which it was designed. If the final itself is a frequency multiplier, with excitation by capacity coupling from a preceding stage, you should by all means investigate your output thoroughly for possible trouble.

This can happen to you even without this exact arrangement. The FCC monitoring stations have been very active. ARRL's Technical Information Service gets the resulting inquiries of what to do to the specific transmitters to prevent further embarrassment. Some amateurs are receiving official citations right now. What to do? Every operator of a 28-Mc. amateur transmitter should check and re-check its output. Look for any spurious radiations. Search particularly at the appropriate sub-harmonic frequency.

Don't mistakenly think you are safe because of your low power. Less than a watt in a conductor acting as radiator of spurious frequencies has got hams into trouble in these frequency ranges. In one case we know, an East Coast station was logged by the FCC in Oregon. In another case the citation originated at Grand Island . . . real low-power DX in every case, but not the kind of DX we are proud of! To insure that transmitted energy is confined to a band on which operation is legal, and that no spurious radiations bother fellow hams or other authorized communication, all amateur operators are urged to check their transmitter outputs. Listening checks should be made locally in addition to utilizing absorption-type frequency meters with sensitive indicators, so as to pick up and work on any conceivable spurious radiation. The requirements for prevention of interference are included in the amateur service regulations, paragraph 12.133, which is well worth re-reading before putting any postwar outfit on the air. When one finds trouble the logical solutions will suggest themselves, or one may have recourse to the *Handbook* where everything from Faraday screens between coupling coils to the protection of additional 28-Mc.-tuned stages ahead of the final can be tried to put the

station in shape for operation. Some precautionary experimentation will avoid this kind of FCC trouble. We hope these few paragraphs and the suggestion for a careful check of your transmitter output will make your 28-Mc. amateur operation free from FCC-citations.

ARRL Appointments. With the announcement of the new OES appointment elsewhere in this issue, mention is included of other types of appointments available from ARRL SCMs. Each kind of appointment is described briefly.

It long has been ARRL policy to assist each group interest in amateur radio along the lines of natural interest, by activities and appointments. Each appointment caters to a particular kind of amateur interest. Each kind of appointee renders some special service to amateur radio as a whole, or a service to an individual brother amateur at the same time the appointee enjoys the radio aim of his choice. By group work with fellow amateurs of like interest, definite benefits come back to the appointee. There's more fun and point to operating with special status, responsibility and purpose. Also appointees receive bulletins from ARRL Hq. at intervals. Amateur radio is made even more interesting and progressive for the individual holding an ARRL appointment and living up to the letter of such appointment.

A more detailed description of each ARRL appointment will be provided, if desired. In any request to ARRL please specify which appointment you are interested in. League members are eligible for all appointments, when they meet the qualifications, on expression of their interest and intention to perform the functions of the appointment. Theoretically one amateur may hold several appointments. In practice, any one appointment can be a sufficient challenge to deserve the full time and attention of the appointee. SCMs therefore entertain and invite new applications for a single appointment objective. All amateurs are invited to report all their operating work to SCMs each month, whether holding appointment or not.

Invitation is extended to all earnest amateurs now operating actively, to consider the basic appointments, ORS, OPS, and OES. If not already holding one of these appointments, note which is in line with your operating inclinations. Get any further information you wish from Headquarters. Then send the appropriate application form to your SCM. As mentioned in January *QST* (p. 72) ORS and OPS appointments will be reactivated

later when SCM activity reports show a sufficient monthly number of activity and traffic reports to justify resumption of bulletins and a general opening of trunk lines and 'phone activities. But your SCM will entertain your application for ORS or OPS now, even though he cannot act on it until he has received one or two monthly reports that demonstrate your activity, and has the word from Hq. that ORS-OPS appointment cards can be entered. OES applications can be acted on at once! So look into ORS-OPS-OES. Your *inquiry* on any appointment will be welcomed, and you can make application without delay . . . and quite likely be among the first to receive a new appointment.

New SECs. In addition to the SECs listed last month more appointments have now been received. Application blanks for the ARRL Emergency Corps have been distributed widely, and the first are being returned in different localities, as Emergency Coördinators hold meetings of local amateurs to get organized for possible communications emergencies in late winter and spring. We welcome the following Section Emergency Coördinators, and want to say that nearly all of them have a record of contributing notably to the organization of amateur facilities for emergency radio readiness in the past — so we know that work in the Sections represented is in good hands!

Isaiah Creaser, W1BSJ, W. Mass.
 Raymond W. Woodward, W1EAO, Conn.
 Vincent T. Kenney, W2BGO, NYC-LI
 Theodore T. Torretti, W3BAQ, S. N.J.
 George J. Nichols, MD, W3JAY, E. Pa.
 Chester A. Murgatroyd, W5BUD, S. Tex.
 Wilfred E. Varley, W5FAB, Oklahoma
 G. R. Devore, W8BIU, Michigan
 James M. Coulson, W9ALC, Iowa
 A. E. Swanberg, W9BHY, Minnesota
 William F. Burch, W9NFX, Utah/Wyo.
 Frank A. Swaniund, W9WYX, Colorado

These SECs will promote organization of all radio amateurs in their Sections for possible communications emergency. In the absence of an EC in your community, contact the SEC (or the SCM if you don't know the SEC's address). He knows the proper steps to take for emergency readiness, and can advise you of your place in the now fast-growing ARRL Emergency Corps.

DXCC. Have you taken advantage of the new privilege extended to DXers with over-75 accredited countries to get official ARRL letter-certification of prewar confirmed-countries? If you have prewar cards not presented for CC credits, and had a listing of 75 countries or more, send these along so we can give you this special credit. The certification can be framed to show your standing if you were "75 or above" even if there are no cards to *add* to prewar credits. Postwar DXCC rules will be published after consideration of all suggestions received relative to rules, so if you write, send along your ideas.

F. E. H.

W1AW OPERATING SCHEDULE

Official ARRL Bulletins containing latest FCC information relating to amateur operation and reactivation, and other bulletins on matters of general amateur interest are transmitted on regular schedules, as follows:

Frequencies: 3555, 7145, 14,280, 29,150, and 56,968 kc.
 Times: 8:00, 9:00, and 10:00 P.M. EST, Monday through Friday. (0100, 0200, and 0300 GCT, Tuesday through Saturday.)

Starting on the hour, bulletins are transmitted by telegraph simultaneously on all frequencies. Speeds used are 15 and 25 w.p.m. Telegraph bulletins are followed by voice transmissions on each frequency in turn. Changes from this schedule will be announced by the operator.

The station is not operated on legal national holidays.

ADDITION TO CD STAFF

Introducing Mr. Charles D. Parmelee, W1LFK, a new member of the Communications Department staff. "Dan" will be attendant at the Headquarters station, W1AW, as well as a regular operator. On telegraph he will be recognized by his personal "sine," CP.

At present, in addition to handling the Monday through Friday transmissions of bulletins, he is busily engaged in the rehabilitation program for equipment at W1AW. Top priority projects are: (1) Replacement of the final tank of the 7-Mc. rig to take 100 per cent modulation in view of the special FCC authorization for W1AW to use A1/A3 on that band. This transmitter was originally designed for c.w.t. only. (2) Erection of the 1400 foot rhombic, which was a wartime casualty. (3) Implementing plans for new frequency measuring gear and replacement speech equipment to bring W1AW in line with the most modern practice.

"Dan" hails from North Haven, Conn., where he was licensed as W1LFK in 1938. The last rig in use at his home station had 812s in the final with 300 watts input on c.w. and 250 watts with cathode modulated 'phone. He is holder of Class "A" ham ticket, and 2nd-class telegraph and 1st-class radiotelephone commercial licenses. Be-



sides his first-love hobby, ham radio, he is a private flier, owning his own plane.

With five years of military service behind him, CP joins the Headquarters staff as both a competent technician and proficient operator. Enlisting in the Army at the age of 18 in August 1940, "Dan" spent 14 months in the infantry, followed by work with AACCS at Presque Isle, Maine. D-Day found him assigned to the 9th Tactical Air Force, with which he served in UK, France, Belgium, and Germany. At time of separation in August 1945, he was communications technician.

You are assured of an enjoyable contact when you work "Dan" from W1AW or W1LFK, whether by voice or telegraph.

MEET THE SCMS

The handsome (or should we say "Hamsome"?) fellow pictured here was elected recently to serve for two years as SCM of the New York City-Long Island Section.

Charles M. Ham, jr., W2KDC, was born in Brooklyn on August 23, 1912. After graduating from high school he attended Cornell University, Ithaca, New York; Antioch College, Yellow Springs, Ohio; and Brooklyn Polytechnic, Brooklyn, New York. He is presently employed as production engineer by the Sperry Gyroscope Co., and has had some commercial radio experience as part time operator of broadcast and police stations. Although his interest in amateur radio dates back to 1929, his first license was not received until 1935. In addition to W2KDC, the calls W8PVD and W9KJM have been

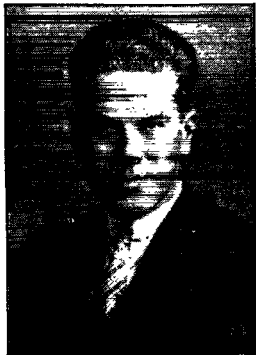

held. Mr. Ham took part in the 1939 and 1940 Field Days, did noteworthy work in the Ithaca Flood of 1936 and the New York Hurricane of 1944, and was active in the War Emergency Radio Service until its discontinuance, being one of the organizers of Queens WERS and director of Queens Boro control station.

KDC started high power early, with 400 watts on 40-meter c.w., and still has the high-power bug. Before the war he worked 75 countries on 20-meter 'phone and c.w., from Jamaica, L.I., and Joplin, Mo. It is believed that he was one of the first users of a fish pole car antenna in late 1935. At the present time he is manufacturing custom-built h.f. coaxial antennas as a sideline. Equipment at W2KDC includes a main transmitter for 40, 20, and 10 meters consisting of 304TLs in final modulated by two 50Ts; 829 for 144 Mc.;

PP 812s for 28 Mc.; and PP 812s portable for all bands. Receivers owned are SX28, S36, and an HRO. The antennas in present use are a three-element beam on 28 Mc. and a $\frac{1}{2}$ -wave vertical fed with coaxial cable. His mobile 144-Mc. crystal-controlled rig with 60 watts input worked 43 miles when on 112 Mc.

His favorite sports are table tennis, swimming, and outboard motoring. Automotive servicing is a second hobby, and many articles on the subject have been written by him for automotive technical magazines. He claims that he plans to initial male offsprings "C.W." so that they will be real "Hams"!

Charlie's ambition is to gain more experience on c.w. before all the low-frequency bands are open, and to improve his traffic. The New York City and Long Island gang is to be congratulated on having selected such a fine all-around "Ham" to direct the affairs of the Section.

W3QR OPERATOR ON WORLD'S RECORD FLIGHT

The world record for non-stop flight was made by an AAF B-29 plane, designated "Dreamboat" on November 19, 1945 when it landed at the Washington National Airport after a flight from Guam of 8,198 miles. Lieutenant Colonel Frank J. Shannon, AC (W3QR) acted as radio operator of the ship on this and some subsequent record-breaking flights. To get necessary flight information it was necessary that W3QR remain awake 22 consecutive hours of the 35-hour flight! Here are some additional "Dreamboat" records: (1) 2,464 miles in five hours, twenty-seven minutes (451.08 m.p.h.) from Burbank, California, to Floyd Bennett Field (NYC). (2) Hartford, Connecticut, to Seattle, Washington, flight in ten hours against a 70-mile-an-hour headwind. (3) West Coast to Honolulu, then non-stop official course Honolulu to Guam direct.

In the course of the above travels, it was a pleasure to welcome W3QR at ARRL Headquarters. He has now returned to his duties as Wing Communications Officer, Headquarters, 315th Bomb Wing.

BRIEFS

In January *QST* we asked for reports on traffic "firsus." What seems to be the first traffic handling on 28 Mc. since our return to the air is reported by K4KD, as follows: K4HEB at the key of K4KD during QSO with W8FYF at 1714 GCT, November 15, 1945, sent a message for relay to W8JIW.

Reliability is not the word for 28 Mc., but we are wondering if anyone finds it possible to maintain regular schedules on that band. We would like to hear of any successful schedules in progress for traffic handling or other purposes, exclusive of normal local contacts.

ELECTION NOTICE

To all ARRL Members residing in the Sections listed below:

You are hereby notified that an election for Section Communications Manager is about to be held in your respective Sections. This notice supersedes previous notices.

Nominating petitions are solicited. The signatures of five or more ARRL full members in good standing, residing in the Section concerned, are required on each petition. No member shall sign more than one petition.

Each candidate for Section Communications Manager must have been a licensed amateur for at least two years and similarly a full member of the League for at least one continuous year immediately prior to his nomination.

Petitions must be in West Hartford, Conn. on or before noon on the closing dates specified. In cases where no valid nominating petitions were received in response to previous notices, the closing dates are set ahead to the dates given herewith. The complete name, address, and station call of the candidate should be included with the petition.

The following nomination form is suggested:

Communications Manager, ARRL (Place and date)
38 La Salle Road, West Hartford, Conn.

We, the undersigned full members of the ARRL residing in the Section of the Division hereby nominate as candidate for Section Communications Manager for this Section for the next two-year term of office.

Elections will take place immediately after the closing dates specified for receipt of nominating petitions. The Ballots mailed from Headquarters to full members will list in alphabetical sequence the names of all eligible candidates.

You are urged to take the initiative and file nominating petitions immediately. This is your opportunity to put the man of your choice in office.

— F. E. Handy, Communications Manager

ELECTION RESULTS

Valid petitions nominating a single candidate as Section Manager were filed in a number of Sections, as provided in our Constitution and By-Laws, electing the following officials, the term of office starting on the date given.

Kentucky	Joseph P. Colvin, W5IEZ/9	Jan. 15, 1946
Los Angeles	Ben W. Onstenk, W6QWZ	Jan. 15, 1946
San Joaquin Valley	James F. Wakefield, W6PSQ	Jan. 15, 1946
Georgia	Thomas M. Moss, W4HYW	Jan. 16, 1946

EMERGENCY CORPS

Organization of the ARRL Emergency Corps is going on apace. Have you sent *your* application to the Emergency Coördinator for your community? If you don't know who he is, write direct to the SCM (address page 6 this issue), who will send you application blank and further information. Every active amateur is needed in the AEC!

Attention Emergency Coördinators: Which community will be first to complete organization under the new plans announced in December 1945 QST? Will your group be first to report regular emergency drills and tests? Drop us a line direct, if you think your group drill is a "first."

CANADIAN 28 MC. CONTEST

Sam Trainer, VE3GT, sends announcement of a VE QSO contest to be held during March under the auspices of XTAL, publication of the Canadian Amateur Radio Operators' Association. He writes, "XTAL thinks something like a colossal hamfest should be held to mark the return of some of our bands. Transportation difficulties and distances involved make such an event impractical, but communication does make possible a real stupendous get-together. Here is how we will do it."

Put: A shooting match for those operators who are ready to squirt signals on 28 Mc. They will have their battle with *watts* as weapons!

Take: A scramble for the fellows who have only a receiver on 28 Mc. These lads can joust with *sensitivity* as a weapon!

Times: 9 A.M. to 7 P.M. EST, Sunday, March 17th and March 24th.

Scoring: Transmitting ("Put" section) 5 points for each QSO, multiplied by number of Canadian provinces, states in U.S.A., and countries.

Receiving ("Take" section) 5 points for each station heard, multiplied by number of Canadian provinces, states in U.S.A., and countries.

Rules: Frequency limits must be strictly observed. Off-frequency operation will result in disqualification. Contestants in "Put" section will not be eligible for a prize in the "Take" section. Copies of logs must be sent to CAROA, 2498 Yonge St., Toronto 12, Ontario, bearing date stamp no later than March 30th. Be sure your call, name, QTH, and times of contacts or "heards" are listed. 'Phone-c-w., 'phone-'phone, or c-w.-c-w. contacts are permissible. Only one contact with a station counts.

Official Call: "CQ XTAL." Three times three, of course!

Dust off those receivers and crank up the old rig. The prizes, open to VEs only, are worth going after. What's more, you're going to be able to make new contacts, and remember, DX counts just as much. There's just one kitty in the woodpile — *not more than one station worked or heard within 20 miles will count in the final score.*

Section	Closing Date	Present SCM	Present Term of Office Ends
Eastern Mass.	Mar. 15, 1946	Frank L. Baker, jr.	Apr. 2, 1945
Sacramento Valley	Apr. 1, 1946	Vincent N. Feldhausen	June 15, 1941
New Hampshire	Apr. 1, 1946	Mrs. Dorothy W. Evans	Sept. 1, 1942
West Indies	Apr. 1, 1946	Mario de la Torre	Deceased
Idaho	Apr. 1, 1946	Don D. Oberbillig	Apr. 15, 1944
Arkansas	Apr. 1, 1946	Edgar Beck	Aug. 17, 1944
Virginia	Apr. 1, 1946	Walter G. Walker	Oct. 15, 1944
Tennessee	Apr. 1, 1946	James B. Witt	Nov. 15, 1944
Mississippi	Apr. 1, 1946	P. W. Clement	Apr. 1, 1945
Rhode Island	Apr. 1, 1946	Clayton C. Gordon	Apr. 15, 1945
North Carolina	Apr. 1, 1946	W. J. Wortman	May 3, 1945
Arizona	Apr. 1, 1946	Douglas Aitken	Deceased
Northern Minn.	Apr. 1, 1946	Armond D. Brattland	June 15, 1945
Northern N. J.	Apr. 1, 1946	Winfield G. Beck	Sept. 23, 1945
San Diego	Apr. 1, 1946	Ralph H. Culbertson	Apr. 15, 1946
Missouri	Apr. 1, 1946	Letha A. Dangerfield	Apr. 17, 1946
Colorado	Apr. 1, 1946	H. F. Heikel	Apr. 17, 1946
Philippines	May 1, 1946	George L. Rickard	Oct. 15, 1938

Station Activities

• Report your activities for these columns. All amateurs, especially ARRL members, are invited to report station activities each mid-month (16th of the month for the last 30 days) direct to the SCM, the administrative official elected by League members in each Section. The addresses of all SCMs will be found on page 6, QST. Radio Club reports are also desired by SCMs for inclusion in Section activity reports.

Is your station actively aligned with the ARRL Field Organization? Applications are invited for the following appointments: SEC, EC, OBS, OO, and the new Official Experimental Station (v.h.f.-u.h.f.-s.h.f.) announced elsewhere in this issue. Send your inquiries and applications to the SCM for your Section.

ATLANTIC DIVISION

EASTERN PENNSYLVANIA — SCM, Jerry Mathis, W3BES — OBS for E. Pa. are: 3AOC, AOJ, AQN, FMF, IOU, IU, and 8AFV. E. Pa. SEC will be 3JAY. Philadelphia EC is 3KD. Other appointments and details will be worked out at a general meeting to be held in Philadelphia. 3DPU has his frequency-measuring equipment ready to renew his OO activities. 3PB is on 28-Mc. c.w. 3IU uses long-wire antennas to work out well on 28 Mc. 3DGP is experimenting with compact indoor beam antennas. The Delco Radio Club is going full blast again and is building a club rig. 3AJS, club president, is back from the Navy. 3GYV and 3EON have been released from the USN. 3GMK is building an elaborate transmitter in an 82-inch cabinet. 3GHM is stuck over in the wilds of China. A very "blue" letter says that his 32 points did well to keep him there indefinitely. The members of the York Road Radio Club are whooping it up on 28 Mc. 3FQG, just returned from a world-tour with the merchant marine, will sail again, 3IRS, who was reported very ill in the Valley Forge Hospital, has recovered, secured a medical discharge, and is making a big noise on 28-Mc. 'phone and c.w. with a pair of 813s. 3AQN reports plenty of AEC activity in York. When the low-frequency bands are opened the members of the E. Pa. Traffic Net are requested to contact 3AQN. 3HFD's new four-element beam works out to the DX in great fashion. 3HXA is trying his hand at 'phone for the first time. 3JBC telegraphs that he is in the U.S.A. 3EPC is stationed at Johnsville with the Navy and is building a high-powered transmitter. 3GYV is building a new rig with two of the new Eimac 4-125As. 3KT built a new rig using 808s in the final for 3ILK. 3IXN put up an 8JK beam. 3AGV and 3KT are working hard for 28-Mc. WAS, having twenty cards each. 3ENX has his new 18-tube exciter perking. 3GHD entertained the Frankford Radio Club. Bob has a nice shack and shop and his new rig is nearing completion. 3EVT boasts a new Super-Pro. 3FPW is on 28-Mc. 'phone and c.w. with an 815 3QV is on the air from China using the call XU1YV on 28 Mc. 3IKW is stationed at the Philadelphia Navy Yard. 3FED is on 28-Mc. f.m. 3DMQ is out of the merchant marine and is vacationing in Florida. When he comes back he will put a pair of T55s at 300 watts on 28-Mc. c.w. How about reporting traffic? 73. Jerry.

MARYLAND-DELAWARE-DISTRICT OF COLUMBIA — SCM, Hermann E. Hobbs, W3CIZ — Word recently was received from GEB that he is located at Tampa, Fla. as chief radio officer on the SS *Freeport Seam*, after serving four months in the same capacity on the *Felipe De Neve*, which operated as a troopship between the U. S. and Europe. PV has a regular schedule on 28 Mc. with 6ANN and frequent contacts with Buenos Aires. CRB has a por-

table-mobile located on a hill in Baltimore. He and GKP, at Silver Spring, Md., near D. C., established the first Baltimore-Washington 144-Mc. portable-mobile contact on Dec. 26, 1945. GKP had a portable-mobile with 15 watts and the rigs still contacted with the power reduced to 7 watts. FAM and FT supply code practice for the Baltimore gang on 144 Mc. BR has bought, in a Baltimore suburb, a farm 700 feet above sea level and is rebuilding for 1 kw. on all bands. 1IIN has a new XYL. FBB has a new S-20R with 40 watts on 30 Mc. HC has been appointed reporter for the Delaware Amateur Radio Club. The club meets the first Tuesday of each month in the Chamber of Commerce rooms in the Mullen Building, Wilmington, Del. All amateurs in the Wilmington vicinity are cordially invited. At a recent DARC meeting, GAU, HBE, and FNI, discharged from the armed forces, spoke of their war experiences. DQ, BTQ, DQZ, DNN, DPA, CGV, and HC are active on 28 Mc. CGV also is working on 144 Mc. and 56 Mc. PV reports six messages handled on 28 Mc. during the past month. Traffic: W3PV 6.

SOUTHERN NEW JERSEY — SCM, Ray Tomlinson, W3GCU — Section EC, BAQ; ECs, ABS and JNZ. BAQ, new SEC, will carry on with the reorganization of the ARRL Emergency Corps. Co-operation with your EC is requested. If you do not know who he is, contact BAQ, 804 Chestnut Ave., Trenton, or your SCM. ECs are needed. Contact your SEC, if you can qualify. Send applications for appointment as OO and OBS to your SCM. JTR, FIM, and BEI are on 28-Mc. c.w. BEI says that in his vicinity every district is represented operating "portable 3." IDY is using a new skywire on 28 Mc. AXU is doing OK with the new beam. EEQ landed a Super-Pro. ASQ and BAQ are OBS and Class 1 OO. EDP, JND, AFH, FTU, GQX, HYC, IOW, ARZ, GNM, 1KIQ/3 are on 28 Mc. GNM snared an SX-28A. ABS is only station on 144 Mc. in Somerville area. The former Hamilton Twp. WERS organization has been reorganized into a local radio group and classes in theory are conducted weekly by ARN. HAZ has his new shack in the cellar of 777 Chambers St., Trenton. 2MMN is engineering officer aboard a merchant ship. The DVRA Bond Wagon wound up with \$2000 toward the club house. EED, on Okinawa, says if he had a rig he could work his "J" and be WAC. At the January meeting of the DVRA everyone enjoyed the talk on a.m./f.m. comparison given by Tony Rura. BGP is back among the gang. After the January meeting of the SJRA an auction, with IIC as auctioneer, was held. Ed Clammert, of RCA, gave an interesting and instructive talk on r.f. amplifiers as applied to receivers. 73. Ray.

WESTERN NEW YORK — SCM, Charles I. Otero, W8UPH — Your SCM is certainly having a lot of trouble getting organized, but the trouble is with time only. Anyhow, we will keep plugging until the machine runs smoothly. Meantime, visited some of the boys and had a lot of fun watching them operate and getting ourselves a crack at the mike. The blessings of the rotary beam are being demonstrated daily in a way that should convince even the most skeptical. AFQ, NOL, PPR, JIC, RDX, and RTX are consistent DX-beam swingers in this neck of the woods. With the hamming of "ten" when it is good, it is not impossible to visualize that some day contacts between amateurs on this particular band will be made in a sort of "private" way. Many of us have long realized that the rotary beam is the "open-sesame" to greater enjoyment of the 28-Mc. band. There is probably not one radio amateur who does not know that he can get more signal strength in a desired direction with a 3- or 4-element beam without jacking up the power one watt. Yet, shouting out the audio is still practiced "to get out" and the guy who happens to be stuck nearby is the fellow who really has to get out of the way to keep sane and sound. Amateur radio is a fascinating, interesting, and delightful hobby, so there should not be any reason to wish to throw the whole darned thing out the window. The shack is having more of the attention of the postwar amateur. Apparently we have come to the conclusion that to invite friends and neighbors, and BCLs too, to the shack seems to be a good-neighbor policy. If we intend to practice this policy for the good of amateur radio, let us not lose sight of the fact that the shack can be a reflection of the guy who

(Continued on page 86)

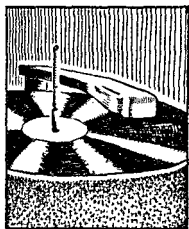

★ ★ ★

OFF and on for some months past we have been talking about high quality phonograph reproduction on this page. The letters we receive show us that we still have some questions to answer.

One of the most frequently asked questions is "What pickup did you use?" We used our own. When the war started, we were about to tool up on a new type of phonograph pickup. We had to abandon the tooling and concentrate on war work. However, we took the model home and had a lot of fun with it, experimenting with circuits and playing records. It was this "homework" that resulted in our series of articles.

The pickup should be on the market sometime this year, and we will tell you all about it when the time comes. In the meantime, you may be interested to know that it is not the "magnetic," "moving-coil" or "crystal" type. It uses a new principle. No more than one-fourth of an ounce is needed for good tracking. The frequency response is uniform within 1 db for frequencies up to about 15,000 cycles, with fair response up to much higher frequencies. It is a velocity type pickup.

We have often been asked to give a complete wiring diagram of the amplifier used in the experiments described on this page in earlier issues of *QST*. We promise to do so shortly. Before publishing a circuit on this page, we have always made sure that all the bugs were out of it and that it gave good performance. We do not wish to change this policy, so before giving the diagram we will have to renovate the design and test it thoroughly.

We do have an amplifier at home and this was the basis of the articles you have read on this page. However, we never polished off this unit. We experimented with it for fun, we changed the circuit a score of times and we learned a lot. But after a hard day's work we had neither the time nor the inclination to do the extra hard work it takes to make a finished design. We never bothered to get it absolutely hum-free. We never checked to see if any make of tubes worked equally well. We used whatever parts we found in the junk-box. We don't apologize and amateurs will not expect us to. They work the same way we did, for fun. And it was fun, because the results were encouraging. We believe that they will lead to a very satisfactory amplifier and we are sure that you will like the pickup.

WILLIAM A. READY



(Continued from page 84)

handles the gadgets in it. To be judged correctly by our visitors, the very first shock must be the right one and that shock comes from the shack. Speaking of shacks, RGA's new modern shack is something to be proud of. MBW, CBK, and BOA are active in Dryden. BOA worked K6XE. EOL, QJT, and ADM are active in Ithaca. TVO, IY, REI, and FEJ, who works Geneva on ground wave, are on. DST hears Binghamton stations on ground wave. The Dryden gang is trying to get Syracuse stations on ground wave. How about more news, fellows? Drop this SCM a card. The address is on page 6 QST. And, this is important, join the EC for public service and send in your applications soon. 73. *Charlie.*

WESTERN PENNSYLVANIA — SCM, R. R. Rosenberg, W8NCJ — Section EC, AVY. All qualified amateurs in this section are invited to enroll in the new ARRL Emergency Corps. For details see page 49, Dec. QST. If you reside in an area without an EC, please write direct to the SEC, AVY, 3577 Elmhurst St., N. S., Pittsburgh, for membership application. T/Sgt. KXS, operating portable from near Sante Fe, N. Mex., reports hearing YK2AHP on 28.05-Mc. c.w. TUV is very busy with radio work. OKU is installing ship-to-shore radio equipment. VZA is operating on 28 Mc. after trouble with parasitic oscillations. DNO is completely rebuilding, including new shack. RZC has 100-watt 'phone rig on the air. OKP is working out fine on 28 Mc. OJL would like to hear from amateurs interested in Coast Guard Temporary Reserve unit in this area. AVY, secy. Pittsburg Area Radio Club Council, reports that the ATA of W. Pa. and the Steel City Radio Club are reactivated. From Camp Butner, N. C., T/3 NTJ writes that PHC and KYW are pounding brass in the Air Corps. TOJ, EC for Warren, already has signed up seven full members in new AEC. Four transmitters are now in operation on 144 Mc., and first contact on that band was made with BOZ on Jan. 12th. UVD is putting finishing touches on new rig with 809 final. NUH has 807 rig ready to go on 28-Mc. c.w. AXD is the only ham in Smethport. BWP is in full operation on 28 Mc. AOE reports following Mercer County hams active on 28 Mc.; OIY, OAJ, IYQ, BVP, WDC, and AOE. KCV, RBO, TVA, VNE, and VUJ are civilians again. OAJ and IYQ managed to contact a K6 on 28 Mc. with special loop antenna. BVP is being heard on 28-Mc. 'phone. QCN, GEG, and WDC are rebuilding. IKIU/8 remains on 144 Mc. working DX. The Mercer County Radio Association holds meetings on the second and fourth Friday of each month at station WPIC. AG gave an excellent demonstration of a signal tracer at recent meeting. The following Erie amateurs are active on 28-Mc. 'phone: GU, QJ, NMP, RHK, VHP, and TXZ. NBV has been conducting experimental contacts using low-power u.h.f. transmitters. NTE is in Arcata with the FCC. 73. *Ray.*

CENTRAL DIVISION

ILLINOIS — SCM, David E. Blake, II, W9NUX — New officers of Hamfesters are: AA, pres.; HLB, vice-pres. TAL, recording secy.; OFZ, financial secy.; Al Gross, treas.; QGG, sgt. at arms; FWU and DXU, directors. A very distinguished visitor, Camille Buysse, ON4LIM, of Belgium, was in Chicago for a short time. Those who wish to contact ON4LIM in this country may address him, c/o Dr. Ronald Carroll, Loew's International Corp., 1540 Broadway, New York 19, N. Y. MSS is back in Chicago. News from Dixon via AND: GNU, AHV and UNG are discharged. AWA and AND are equipment mad, both work for the State of Illinois and will have two-way radio in their cars. 6RGN, ETM2c, is at Bldg. 312, USNTC, Great Lakes, Ill., and wants to make a schedule with the gang in Los Angeles. QKJ's operating location should be 1504 E. Prairie Ave., Decatur 9. He wants information as to HPG and the rest of the AARS gang; also ILH and ICN. Lt. James C. Miller, NTV/FA8, 3156th Sig. Svc. Co., APO 497, c/o Postmaster, New York, N. Y., sends his regards to the gang and would like very much to hear from ERU, AIC, AGV, FFQ, GXQ, and ZRB. He is at present officer in charge of one of the Army radio stations, JDJD, near Algiers. He has heard thirty-three countries on 14 Mc. and a great number of 28-Mc. 'phone stations. 6EJP, a captain in the Air Corps,

who for the past fourteen years has been a member of the San Francisco section, has married a Chicago girl and plans to make his home there. He is stationed at Chanute Field. The Cahokia Amateur Radio Club, of East St. Louis, Ill., organized in 1938, meets the 2nd and 4th Wednesdays of each month at the City Hall. Members are: APX, EBX, CD, END, ENI, ERA, FIN, FOI, GFF, GUF, JUM, NMY, NRF, NVW, OAW, PDR, QNK, SMY, TCK, TZI, VLT, WPC, WQC, ZYP, 5DTL/9, Fred Cooper, P. Hogan, and C. Rogers. EBX, of 7040 Vogel Place, is secy. and treas. Bill Ziske, of the Milwaukee Radio Amateur Club, now is located at 6431 N. Rockwell Ave., Chicago, and is waiting for his call from FCC. ODT reports the Joliet Amateur Radio Society's new officers are: HVZ, pres.; MWI, vice-pres.; R. L. Whitmer (LSPH), secy.-treas. 73. *Dave.*

INDIANA — SCM, Herbert S. Brier, W9EQ — IUM has a new custom-built transmitter, TIY is operating portable in Texas. DLI plans to use a 202 to drive his 815 on 144 Mc. OOG was home on furlough for Christmas. LG reports that ZYK has a receiver as large as a transmitter. OJM is on the air in Germany — if he isn't home now. ILL had one contact while on Attu: TQD/J. He is in the Aleutians. EGV is going to "sulk" until 75 meters is opened for hams. HUV has trouble from a doubler radiating on 14 Mc. VW is building a very special e.c.o. CTK is working in Ft. Wayne. PQL and EUJ are studying radio at Valparaiso Tech. SNAF will build custom-built ham equipment in Ft. Wayne when the Navy releases him. HJJ and FFN are amazed at the tremendous signals emitted from a 6V6 on u.h.f. ARI has a new HRO. ARI, HJJ, DOK, JDW, and FFN, all of Muncie, are on 28 Mc. OMD is out of the Army. EZ/MDJ is cleaning up his equipment in preparation for the opening of 80 meters. Gary has a new radio club with thirty-five members. WWG and MVZ are officers. Meetings are held the first Tuesday of the month. Visitors are welcome. TBM visited EGV. WWG is building for 144 Mc. PUB has a four-element beam on 28 Mc. I have resigned as SCM, so nominate your candidate as soon as possible. I have enjoyed the work, but the press of other work takes up all my time. 73. *Herb.*

KENTUCKY — SCM, Darrell A. Downard, W9ARU — The number of letters received by the SCM from "out-in-the-State" hams is very gratifying. JML is dividing his time equally between antennas and the "flu." FS reports hearing BAZ on 28-Mc. c.w. EX-IJT reports from the Mountains that FRI, JJS, JWV, KUY, and KLO have 28-Mc. rigs getting rusty from inactivity on account of not being able to "get out." They live in the valleys. MMY writes that the Owensboro gang have formed a radio club which meets on the 2nd and 4th Monday nights of each month. KRY is on 28 Mc. How about 50 Mc. for those local contacts — also for your emergency communication station? The ARTS now boasts seventy-three members! HZL is shopping for civvies. Yunk still is asking for a treasurer's report. *D.A.D.*

MICHIGAN — SCM, Harold C. Bird, W8DPE — 8NOH says look for QAM, RKE, RFW, 9OAM/8, and OAT on 28 Mc. He reports his new beam and transmitter are working fine. 8JO reports 9EXT is working portable on 28 Mc. from Roscommon. 8CFQ is back with the conservation department as radio engineer, after serving with the Signal Corps for over three years. 9YNY, a civilian again, is building a new rig using 6SK7-6L6 e.c.o. 8MV is back in civvies and is living at 15737 Tuller Ave., Detroit 21. 8TPV has been mustered out of the services and is back home. 8VYI will be home soon. 8WBZ listens on 28 Mc. for the boys for contacts. 8ECZ is building a new rig. 8NNE is working 28-Mc. 'phone. 8MYZ and TRB can be heard on 28-Mc. 'phone nightly. 8WOJ has added new prewar Meissner e.c.o. and crystal mike and new SK-25 to the shack equipment. 8TNO, PDB, SJH, WIK, NIT, and DIV can be heard working 28 Mc. on 'phone and c.w. regularly. On Jan. 10th the DARA held its monthly meeting at the home of Ed Hait. After the regular business meeting, the following directors were elected for the regular term of two years: 8BIU, 8FX, 8GP, 8MCOB, 8DPE, and 8DYH. Your SCM and Asst. Director would be pleased to hear from you fellows on your plans for the Emergency Corps, now in the in the process of organization with 8BIU, G. R. Devore,

(Continued on page 88)

AVAILABLE NOW!

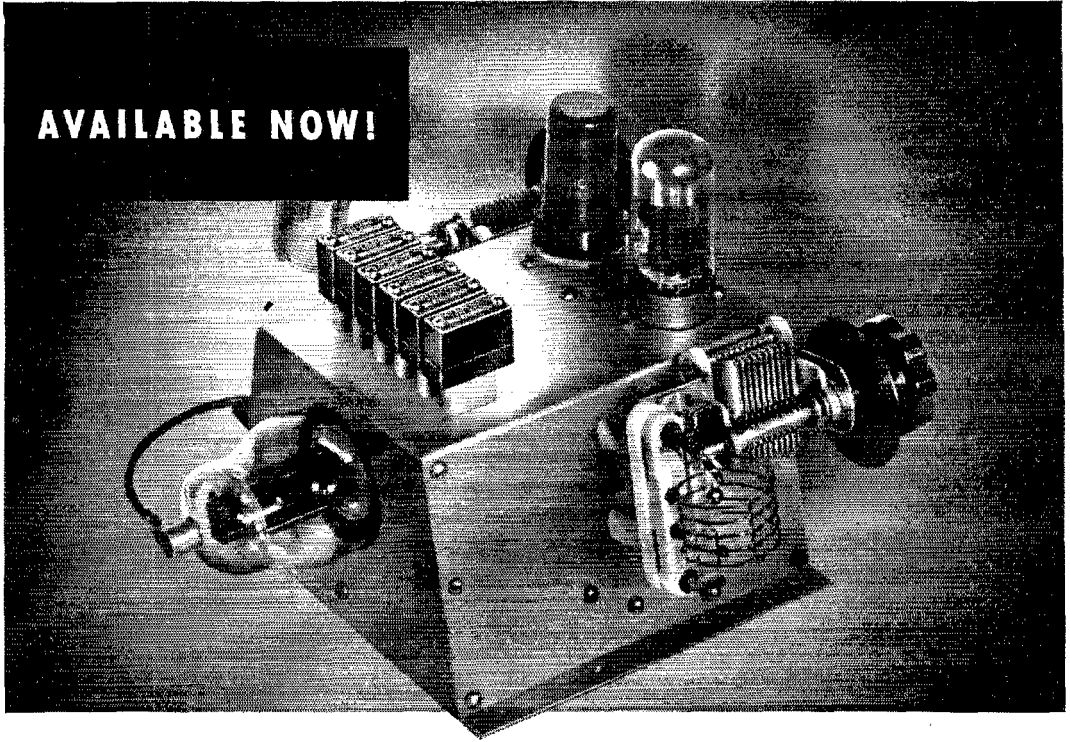

TYPE AX2, THE NEW BLILEY CRYSTAL FOR AMATEUR FREQUENCIES

Just one look at the many features that make up this new type AX2 and you'll understand why we say it's a worthy successor to a long, famous line of Bliley Crystals for amateur frequencies:

- 1 To prevent "aging" it is acid etched to frequency by Bliley's patented process.
- 2 Nameplate calibration accurate to $\pm .002\%$ at 25°C . in factory oscillator.
- 3 Temperature stability better than $\pm .02\%$ between -10°C . and $+60^{\circ}\text{C}$.
- 4 Activity level tested between -10°C . and $+60^{\circ}\text{C}$.
- 5 Stainless steel, coined electrodes, contact plates and spring.
- 6 Solid, stainless steel pins.
- 7 Welded contact between pins and contact plates.
- 8 Neoprene gasket seal.
- 9 Moisture resistant, molded phenolic case and cover.
- 10 Small, compact size permits easy stacking. Two units may be mounted back to back in standard octal socket.

Not a thing has been overlooked to insure top performance under any conditions encountered in amateur equipment. All our wartime experience is reflected in this new model, engineered specifically for amateur frequencies.

Frequency selection from your Bliley distributor's stock

TYPE AX2

3500-4000kc . . . \$2.80 ea.

7000-8222kc . . . 2.80 ea.

Prices on 20-meter and special order crystals to be announced shortly. Keep in touch with your Bliley distributor for latest information.

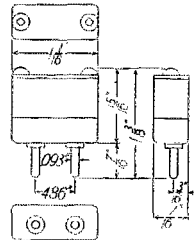

Bliley CRYSTALS

BLILEY ELECTRIC COMPANY, UNION STATION BUILDING, ERIE, PENNSYLVANIA, U.S.A

(Continued from page 86)

your Section EC. 8DED, Holland, recently was discharged from the Army after serving nearly two years in the heart of the jungles and equatorial section of New Guinea and the Philippines. He is known as the Ham Print Shop in his printing business, and will resume his QSL printing as a civilian. Let's have reports on your activities. Traffic: W8NOH 10. Thanks and 73. Hal.

OHIO — SCM, Carl F. Wiehe, W8MFP — TRX, his XYL and daughter, have returned to Waverly after his honorable discharge from the Navy after forty-four months as a radio technician. 9UYP is working at Wright Field and will soon be operating from his new home in Osborn. NAF spent Christmas and a 30-day leave with his family. He intends to go into custom building of ham equipment at his old QTH in Mt. Vernon. PZA reports from Cleveland — the first postwar hamfest, sponsored by CRA, was a huge success with nearly 300 attending. Morrie Pierce, of WGAR, told of his interesting experiences in the psychological warfare branch of the U. S. Army, and his part in helping to capture the Italian fleet. PWG and partner put on a swell juggling act. Lt. Comdr. BAH, recently returned from the Pacific, told of his 4½ years in the services. Lt. Comdr. GD, who had just arrived, was welcomed back in the usual style. Hams from the 2nd, 3rd, and 4th districts were present, the most distant being 40Y of Edgewater, Fla. BXR won an RME-45 communications receiver, the main prize of the evening. Several other prizes were won by the gang and the ladies each received a carnation for bringing the OM to the party. Proceeds of a raffle netted enough to buy an up-to-date receiver for the CRA club station. WOI received his discharge after two years of service as aerial radio operator in both the Atlantic and Pacific theaters. SSJ has just returned from the Army. WV, a captain in the USNR, expected his discharge from the Navy late in December. EFW is reported back in the U. S. after contracting a serious foot infection in the Pacific area. UNA likes his Signal Corps work in Oahu, Hawaii. TKS reports from Toledo that at the December meeting of the TRC, 2MYF and 6IR, G. E. tube engineers, talked on the "Phasatron," a new tube development. QUO, who received a commission in the field, is back after three years service. WHA has his former position with the Spitzer Rorick Bank after service as CPO in the Navy. TLF was in town on an eleven-day furlough. PEG is stationed at the Toledo Naval Armory. SMN has been discharged after two years in France as a 2nd Lt. VDV has returned from the Army after flying around the world a couple of times as a flight radio operator. The Toledo gang reports great activity on 28 Mc. PNQ reports from Cincinnati that during a busy and well-attended meeting in January, the following officers were elected: TQS, pres.; VAV, vice-pres.; 9NRA, secy.; and MEU, treas. It was announced that the new QCEN club station, located in the Red Cross Bldg., was almost ready for operation on all bands. Code classes will be held Monday and Wednesday evenings at the Vocational High School under the direction of Mr. Moorman. Radio repair instruction is also available at no cost. Capt. MFN is out of uniform after service in the British and later the U. S. Armies. MFV, after three years in the AACS, is in civvies and says he'll be on the air as soon as he can find a suitable QTH. SVI committed matrimony just after arriving home from the Pacific. He expects his discharge after a seventy-day terminal leave. Various groups took occasion to thank and commend WERS men again for their excellent wartime work. LZE's transmitter is in storage awaiting low frequencies. ROX has 300 watts in working order for 10-, 20-, 40-, 80-meter bands. UZJ has 500 watts ready to go. RN is active. AVH, nearly through revamping, is awaiting low frequencies. AQ is ready to go and awaiting low frequencies. Traffic: W8RN 11. 73. Carl.

WISCONSIN — SCM, Emil R. Felber, jr., W9RH — The following were present at the Northern Wisconsin Radio Club, Eau Claire: HMX, GIT, YPU, ASQ, NBN, ARJ, VSG, MUM, and 8VGC. Tentative plans for a banquet were made. For meeting dates get in touch with the secretary, MUM, 639 Fleming Ave., Eau Claire. The Four Lakes Amateur Radio Club, Madison, met to get the fellows acquainted and to form opinions as to whom they want elected. For other meetings get in touch with UFX, Route 1, Box 72a, Stoughton. MRY and JLM are out of service. MRY is awaiting re-

newal for license. HZS has to go to Chicago for his renewal. 5CEE returned to Wichita Falls, Tex., after spending three years at Navy School. FZC is in the oil business at Wausau. UFX has been forced to move to his lake cottage while looking for a new business. PCX in Brazil says to pass on his 73 and to look for him on 14 and 7 Mc. when the ban is lifted. MFR has a deluxe kw. At Milwaukee the MRAC has an average of over 100 attending its weekly meetings. This club is in the midst of planning an MRAC QSO PARTY for May 11th. SYT, the EC, is organizing a new emergency net. Any hams that happen to be in Milwaukee on a Thursday night are invited to drop in at the Club meeting place, Conference Room, Milwaukee Public Library, 8th and W. Wisconsin Ave. 8:00 p.m. 73. Emil.

DAKOTA DIVISION

NORTH DAKOTA — SCM, Raymond V. Barnett, W9EVP — The Bismarck Radio Service has almost completed a new 812 transmitter for DXC, of Mandan. OKM is out of the Navy and back as transmitter engineer at KLPK in Minot. AZV is located at Minot. ZGR, formerly of Washburn, is now with Gilfillan in Los Angeles as electronic engineer. EVP and KZL made a trip to Stanton to overhaul the rig and Premax three-element beam for KOY. SSW claims a K6, nineteen states in eight call areas, and VEs 2, 3, and 4 with an input of less than 15 watts since Nov. 15th. GJJ has his pair of 809s fired up on 28 Mc. and EVP is adding the pair of HY30z he got in 1941 to his rig. Our Section EC urges all to write for AEC application blanks. I would like to have reports from more of you fellows not later than the 16th of each month. After all, this is YOUR column and can only be what you help me make it. 73. Ray.

SOUTH DAKOTA — SCM, P. H. Schultz, W9QVY — DNV and STI paid a visit to your SCM on January 4th. They are now located at Murdo and Presho respectively. The Sioux Falls Amateur Radio Club has been reorganized and reactivated. EKT is secretary and sends in news regularly. Clubs and individuals please note, send in your dope by the 16th of each month as it must reach Headquarters by the 20th. KQO is back on the air at Conde running 5 watts to a 6V6 from Vibropack but has gone high power to 25 watts now. TXK was at home from O'Reilly Hospital at Springfield, Mo. MNI, also from Conde, is on 28-Mc. c.w. The following are active on 28 Mc.: ADJ at Rapid; AKX, of Sioux Falls; ORE, at Gary; EOJ, Aberdeen; DB, of Milbank; also TI and CJS, of Bryant. Please send more news items if you want to keep the column going. 73. Phil.

NORTHERN MINNESOTA — SCM, Armond D. Bratland, W9FUZ — BCT is operating at WTCN. OMC moved to Hutchinson. OCN, USNR, Key West, will be on 28 Mc. FUZ is on the way to Manila, Leyte, and Japan. LAE and CUE are now civilians. ORJ is radio repairman at Wadena. RPT, president of new Fairmont Radio Club, built three-wire folded doublet. HBI is taking up E. E. at U. of M. HZM is back at radio servicing. ORT has a jr. operator. TOA, TEF, and YKV are back at the Falls. JNC/4 keeps us informed on his monitoring for the locals. HKF was heard from Missoula, Mont. with a nice signal. TOZ, FEW, UCA, and BHY put up a folded dipole for OPA. ZWW is getting f.m. gear all set for his car. ORA has kw. steamed up. YCR got his 28-Mc. rig sounding respectable. JIE, president of St. Paul Club, reports a rapidly-increasing membership. BHY has two-element stacked folded dipole array. BMX is now Super-Pro. LIL puts out fine 28-Mc. signal. URQ is known as the St. Paul authority on transformer winding. DZM's beam works in great shape. BHY is taking applications for AEC. A net on 28 Mc., for procedure training, is suggested. Any interest? The St. Paul Radio Club will soon begin theory and code sessions. 73.

SOUTHERN MINNESOTA — SCM, Millard L. Bender, W9YNQ — This is ZT pinch-hitting for the SCM. Since my return from the Navy I have scanned each issue of QST for news from So. Minnesota, with no luck. I finally contacted our Director, VVA, and offered to substitute for the SCM until his return. Tom accepted my offer so from now on there will be a report each month if all you fellows will help out with plenty of news and traffic reports. That shouldn't be too hard with so many of the gang getting home

(Continued on page 90)

RK-6D22

BEAM TETRODE POWER TUBE

Typical Tetrode Operation*

Plate volts = 3000 volts
Screen volts = 400 volts
Plate current = 500 ma
Power output = 1100 watts

Typical Class B Operation

Plate Volts = 4000 volts
Grid bias = 0 volts
Power output = 2200 watts
(2 tubes)



5/8 OF ACTUAL SIZE

RAYTHEON

MANUFACTURING COMPANY

Excellence in Electronics

POWER TUBE DIVISION

WALTHAM, MASSACHUSETTS

● The Raytheon RK-6D22 is a newly developed, compact, 450 watt plate dissipation beam tetrode for communication use. It is so designed

that it may be used either as a highly efficient Class C amplifier, or, with screen grid and control grid tied together, the tube makes an ideal 0 bias Class B amplifier.

When connected as a tetrode, the RK-6D22 delivers at least 1100 watts at frequencies up to 60 megacycles with less than 22 watts drive. This low drive and high efficiency is ideal for the operator who wants to put out a kilowatt or better with a minimum of associated equipment. Under Class C conditions this tube is rated at a maximum of 3500 volts.

As a 0 bias Class B triode, a pair of tubes will easily deliver 2500 watts of audio with only 100 watts drive; rated for a maximum of 5000 volts.

(Continued from page 88)

and making great plans for getting on the air again. My address is Medicine Lake, Rt. 14, Minneapolis 12. How about it? VVA tells me he soon will be on 28 Mc. with 200 watts if his pals will lend some muscle to get the antennas up again. As for yours truly, there is hope of banging out a CQ soon but at present all my gear is in packing cases and boxes where it has rested for the past five years. Now don't forget the news, gang, and let's have it by the 16th of each month, 73. *Burt.*

DELTA DIVISION

ARKANSAS—SCM, Ed Beck, W5GED—The following report was written by JIC. The Fort Smith Amateur Radio Club soon will hold its first meeting since Dec. 1941. 1IGD/5, stationed at Camp Chaffee, has been experimenting with long-wire antennas on his 15-watt 807 rig. 9VIP/5 is active on 28 Mc. with about 20 watts with an 807. GAS is on 28 Mc. ICS has a single 807 on 28 Mc. and is building a converter for auto operation. IWL is operating PP 807 with about 75 watts, and is perfecting an e.c.o. ARX is on with an 807 and is making plans for a half-kw. IYW is on 28 Mc. with an RK39 and is laboring on a mobile 807 job. GWT has PP T40s on 28 Mc., but is revamping the doubler stages. DQV/5 is accumulating parts for a 200-watt band switching affair, and is on the lookout for that HQ-129. DXJ, formerly of Marble City, Okla., has a new S-20-R and a new 807 rig. HOT, down Paris way, has been heard here, 40 miles distant. Ex-HNU is assembling a cool kw. with PP 806s. JPY has plans for a half-kw. Heard KJB, Selman City, Tex., recently. Also heard ALA some time back. Had a one-and-one-half hour QSO with GNV/1 recently. HYS is awaiting new receiver. JIC is also waiting for a new HQ to go with the 812s.

HUDSON DIVISION

NEW YORK CITY AND LONG ISLAND—SCM, Charles Ham, jr., W2KDC—The appointment of BGO as Section EC caught some of the ECs by surprise. They now should send monthly reports to him, not the SCM, by the 16th of each month. In Suffolk, DOG lists five fixed, three mobile, and one pack on 144 Mc. covering the south shore from Riverhead to west of Patchogue. Six new stations are expected shortly. Brooklyn's new Bay Ridge Termit League boasts nine stations. Eleven more report to the net, all fixed. Mobile and pack sets are badly needed. NQQ, EGI, NWK, NXT, DUB, NNX, AUF, and QHE are active with OHE as EC. In Nassau, FI reports gradually increasing activity on 144 Mc. with RZ, AES, ADT, 8VFR/2, 3AIX/2, NDQ, IDJ, ER, and CMU active. The latter shows great resistance to the elements in his mobile forays to Little Neck Hill night after night. The SEC reports he believes 144 Mc. should be concentrated on for local EC operation, although in Suffolk large areas must be covered, there being five Red Cross chapters, each with four branches. CET could assist DOG in organizing the west end of Suffolk. 28-Mc. stations should be enrolled to cover the eighty-mile length of this County. All readers holding station licenses are urged to contact the ECs in each county: DOG, CET, BKZ, OHE, JXH, and LKP. GAH and NMP keep 28 Mc. busy. JNU is back again and LUD is back from the Navy. LVN now is located at Sag Harbor. CET and others got good publicity in local rag with three-column spread. NRL writes from Japan that he should be home in Freeport in January. KUH and KAI are still there. MHD has been discharged from the Army after four years as radar instructor in the Signal Corps. He's on 28-Mc. c.w. with 60 watts awaiting 40 and 80. IXZ had usual troubles changing from 112 to 144 Mc. He's tech. Sgt. in Washington, D. C., and hopes to be home by March. MFR, discharged from the Coast Guard and living permanently in Miami Beach, is on 28 Mc. and wants contacts with W2s. 2EC has all equipment ready for reopening Atlantic-Pacific trunk line on 3.5-Mc. c.w. BGO, as SEC, has started a very informative questionnaire to all ECs calling for much valuable information. Let's all get behind Vince in his new job as Section EC. KKK/2, formerly of L. I., replaced 812s with 813s. GH beams from his attic. MJLL, afraid of ladders, sends his six-

year-old up to replace halyards, etc., on his plumber's delight. IOT coils spare coax. around his feet to keep them warm. MDQ removed his 28-Mc. elements from his 10/20 beam and now regrets it. JIH is very active on 28 Mc. KDC was off for three weeks due to change in location from attic to sunporch. AD and LK are getting out on 28 Mc., as are JEP, JXH, and AIQ. KDC tried hard to relay press report to Boston for *Boston Globe* during telephone strike but no luck. How about a 28-Mc. net with stations every 40-50 miles for night work?

MIDWEST DIVISION

IOWA—SCM, Leslie B. Vennard, W9FJR—EC FDL is back in Muscatine and will be on 28.5 Mc. soon POY has new 60-ft. tower with a beam on top driven by T-200. OSO is on 28 Mc. with pair 100Ts. FNF is on 28 Mc. and has RME-45 ordered. UPL wants 1500-volt supply to get on. CVU, SEG, MNA, TVD, WQQ, LRS, CPR, and DIZ are on 28 Mc. FYF has 500 watts on 28 Mc. and is really getting out. MEI is using 4EZT and wants Iowa contacts. FNW is on 28 Mc. at Keokuk. QFD is out of the services and plans on Iowa State for engineering. Ex-SCM LEZ hopes to contact Iowa with a W3 call soon. Ames hams on 144 Mc. are: NWF, ZDS, ZRC, NTB, and CYL. ALC is Section EC. Write either her or SCM for EC wallpaper. QAQ is EC for Council Bluffs again. QUF, REV, QUQ, and CCY are back from the services. YYP has revamped 20P on. JRY has a kilowatt going with plumber's delight on roof. PGG is in service business for himself. WHG reports TIO, Slater; DTI, Ames; CHI, Grand Junction, and TVD, Ogden; working Des Moines using vertical antennas. NMA, at Corpus Christie, Tex., will be home in April. CCE is repairing a smashed transmitter. AHP reports plenty of activity on 28 Mc. around Quad Cities. AEP has a new ham shack and AED and DIB are on 28 Mc. WML, Newton club, is on 28 Mc. also. OZO and OZL are on 28 Mc. AS is on 28 Mc. waiting for 20 meters to open up. DIZ is on 28 Mc. and working in town. The Burlington club meets every Friday evening and is sending code on 58 Mc. five nights per week. Let's have more EC applications. 73. *Les.*

KANSAS—SCM, A. B. Unruh, W9AWP—Typical layouts in Wichita range from 5DIW's 6L6 modulated with 6L6, to CVN's PP 100THs. In the medium-power class are rigs like DMF's PP T40s, IGJ's PP 800Ss, DJL's PP 813s, AWP's single-ended 100TH; while in the lower-power class typical rigs are UNQ's PP 10s, FET's 807, PGL's T20s. Antennas range from half-wave doublets fed with EO-1 cable to three-element rotary beams and fixed arrays. PAH is on 28 Mc. and has new SX-25 receiver. He reports YUQ, OTV, and CMY are active. New officers of KVRG, Topeka, are: VWU, pres.; ICV, vice-pres.; WGM, secy. Col. FRC, Signal Corps, has returned to Europe. Reported back from the wars are: FKD, VWU, WPN, NVB, TPF, KXB, OZF, UFA, KSY, and AGC. Active on 28 Mc. are: ICV, VWU, FMR, KKR, KXB, WKV, RZF, and WGM. ESL is teaching electronics, algebra, calculus, and physics at St. Benedict's. IWS, at Mawr Hall, also in Atchison, is on the air. ONB is S1c ARM, stationed at Hutchinson Naval Air Base, and reports a radio club active in that city. New officers of Wichita club are: QEF, pres.; BGY, vice-pres.; DMF, secy.; ABJ, treas.; and AWP, publicity director. FER writes from Hays that he longs for reactivation of the lower-frequency c.w. bands. Also in Hays is HJM, ex-Navy operator. QKS/K6PIT and brother, KXL, are back in Kansas City, Kans., with KXL on 28 Mc. 5KSF/9 also is active there. OKD is radio maintenance man at KGPZ, Wichita. Also on the staff is OZN, a c.w. operator. Traffic: W9IGJ 1.

MISSOURI—SCM, Mrs. Letha A. Dangerfield, W9OUD—There is no trick at all in keeping this column within the allotted space. The trick comes in making it even resemble a column. But the thing to worry about is that unless we have enough news to use our allotment we may be cut further, and we must not let that happen. PUV has been back in civvies since November. He has remodeled the 112-Mc. rig to work on 114 Mc., built a 28-Mc. transmitter using HY75, and has been working over a 5-inch oscilloscope. MBE was in a hospital in Japan for several weeks and expects to be sent home after fifteen months in the Pacific

(Continued on page 92)



Follow **YOUR INTERESTS TO YOUR RADIO PARTS JOBBER STORE**

An excellent way, during this transition period, to become familiar with new and available devices and parts in the field of radio and electronics, is to visit your local Radio Parts Jobber Stores frequently. You will find the management and salespeople in these stores helpful and courteous . . . talking your language . . . interested in you and your problems. Regardless of whether your interest is in radio amateur activities, public address and communications systems, phonograph or other electronic installations, your Radio Parts Jobber is in a position to offer helpful cooperation and supply most of your requirements.

*Astatic Crystal Devices
manufactured under Brush
Development Co. patents.*

THE
Astatic
ASTATIC CORPORATION
CONNEAUT, OHIO
IN CANADA: CANADIAN ASTATIC LTD., TORONTO, ONTARIO

(Continued from page 80)

area. He said the boys out there were working on 14 Mc. KIK has been trying to stir up AEC interest in St. Louis. The husband of OWQ — he was not a ham himself — died in November. OUD and BMS copy W1AW regularly and have the Stancor transmitter down from the loft and find it will still oscillate on 3.5 Mc. Do send some news along. And how about the AEC? The new cards are very attractive. 73.

NEBRASKA — SCM, Arthur R. Gaeth, W9FQB — EWO, appointed OBS, has Super-Pro. OKI, Bellevue, has a 12-tube homemade receiver with converter for 28 Mc., and an 807 with 100 watts input. QNP has been appointed OBS and EC for district 9. KEB, Omaha, has 829 push-push final with 50 watts input. RFQ is with FCC at Grand Island. OCB and OCC, Omaha, are active on 28 Mc. ZNI has a homemade version of Stancor 60-P on 28 Mc. EWO is a civilian again. EKK reports CME now a civilian; BYR in Seattle hospital with broken leg; ZYE active on 28 Mc.; DMQ has a plumber's delight antenna on 28 Mc.; and RWV at KMMJ. EXZ has 809s on 28 Mc. QXR is building rig for 809s. VHR on 28 Mc. has 6 half-waves in phase, rotatable and stacked, and 250 watts to a pair of HK254s. DKV has 120 watts to 6L6-6L6-35T rig, grid modulated. DYG has 30 watts to 807 final. EZV has a TZ40 on 28 Mc. JHN has 250 watts to 813 final. EUT has 150 watts to 6L6-RK39-T55 rig. YDC has NC-100A and an XH array on 28 Mc. QQN built a 28-Mc. Twin Three Beam antenna. RUH built new power supply and 6N7 modulator. SHH built new crystal oscillator for Stancor 20-P and is on 28 Mc. YMU put up a long wire antenna for 28 Mc. HTE is back on the job as detective. GTC, RQS, and FQB purchased new HT9s. UPC is building 150-watt rig with 809s in final. OYB is a civilian. RQW is radio operator on Clipper between U.S.A. and Honolulu. Traffic: W9EKK 15, FQB 1. 73. Art.

NEW ENGLAND DIVISION

CONNECTICUT — SCM, Edmund R. Fraser, W1KQY — GDG completed 144-Mc. 5-element beam. BQQ raises chickens when not on 28 Mc. NFG, Hamden, is rebuilding rig. 2FUO, of New Brunswick, N. J., works at WNHC. N. H. KDK moved to Wollaston, Mass. NPE is Taftville EC. LFK is new 1AW operator. ON is Putnam EC and OO Class 2. CTI built exciter unit; is designing kw. final. BIH, using 807 modulated by 6L6 on 28 Mc., worked 8KAY/KB6, ship seventy miles from Wake Island; he took and delivered two messages. 4HVH/1 is engineer at WSRR, Stamford. MBK has emergency rig on 144 Mc. KKS QSOd 7BOH using ship's blinker lights. NOA, Kessler Field, Miss., met 2MRH, 71QR, and 6EAV, Mississippi SCM. EAO is OO Class 1 and Section EC. Lt. NEA sends 73 from Kakota Army Air Base, Tokyo. ERM and LEI are 144-Mc. additions. Bryan Taylor, Brentwood, Essex, England, heard AW and HXU on 28 Mc. Heard around Conn. on 28 Mc.: JPE, HDQ, EH, UE, 2OEN/1, NCL, MEM, 4FFD/1, MIC, LTL, ILG, KPN, MIQ, NNL, EUG, FMV, BQQ, KAT, HYF, LUL, KGE, BVS, JLL, KXB, WR, DPY, UZ, HXU, JJR, HWH, LOP, ITI, NMZ, NMP, ANA, AW, BTU, DNQ, MTX, JVE, NJS, ITM, LZR, DTJ, DEF, GZC, DBM, KHL, BFH, BEQ, DVO, NNP, NNQ, AYY, LEP, NAI, JOS, DHS, MYB, JLK, AOK, KIO, JPB, JSE, ANC, FPP, 9DPV/1, and 9YMV/1. FWH is on 144 Mc. (Newwalk Amateur Radio Assn., NDS, elected officers: 4HVH/1, pres.; A. Ciarletto, vice-pres.; Martin Lee, ex-WJQA-31, secy.; MRP, trustee. LRT is chairman NARA Anniversary Celebration in March; MRP is chairman Field Day planning committee. NHARA, GB, reports: NGQ received Class A ticket. JAK has new HT-9 and Comet-Pro. KUK, Tsintao, China, writes that he and 9PWZ listen in on 28 Mc. MVH completed 144-Mc. beam with unique method of rotation. Fred Burkle, MEF, and DDP have been arranging code classes at GB. IGT is working with N. H. Chapter Red Cross setting up emergency communications. CTC and ILG are new GB members. MEM completed 28-Mc. beam. AMM, JQK, LZM, LTZ, NGQ, FMV, KQY, Cohen, Burkle, and Bates painted four of GB's club rooms. DDP was released as warrant officer after five years service. Our sympathy to MSB in the loss of his mother. KAT is leading the club in countries contacted on 28 Mc. MMN and Ann Stevenston, OPLO, sister of KRV, were married Oct. 13.

1945. Traffic: W1BIH 2. 73. Ed.

MAINE — SCM, G. C. Brown, W1AQL — UP, the newly-appointed Section EC, is formulating plans for the line-up of the Emergency Corps program and expects to get letters out to the ECs in the very near future. A nice letter was received this month from AMR, who is in Orlando, Fla., with the Air Corps as flight chief and has had six years' service, two of which were spent at K6NXXD. MXT writes that he is about ready to get on the air with 300 watts. KEZ is rebuilding and will be on 28 Mc. soon. NIV is having his troubles but expects to get them ironed out and get going. 6SVR who has been stationed at Dow Field, Bangor, has been released and has left for his home in Lemon Grove, Calif. Bob says he hopes to QSO the Maine gang from there. DAS is out of the Navy and has his postwar transmitter nearly completed. Ex-HB has completed his duties with the FCC and is working in Ellsworth. There is considerable interest and comment floating around this area relative to the organization of a club and no doubt a meeting of the gang will be forthcoming soon. CBU is working with the FCC. BPX and DLC have gone into the radio repair business. DPJ is building a beam for 28 Mc. ERO is in the oil burner business. HTZ is with the Navy recruiting service.

EASTERN MASSACHUSETTS — SCM, Frank L. Baker, jr., W1ALP — HKK is again a civilian and is living in Belmont and working for Sylvania as a sales engineer. He is now OBS. KEF is married and has a family. LVY is out of the Coast Guard. LSD sends in news about the Waltham Amateur Radio Assn. Weekly meetings are held Tuesdays at 8 P.M. in Waltham Watch Co. rooms. New officers are: JCI, pres.; LSD, vice-pres.; Arline Berry, secy.-treas. The club station, MHL, is going to be on 28 Mc. The club has a weekly column in a local paper. JCI just got out of the Army and is building for 144 and 28 Mc. JCB is on 28 Mc. and is looking for a new car. HIL delivered a message from Guam which was relayed by HCH/KG and he got a nice note from the lady whose son sent the message. LVV is out of the Navy and will be on 28 Mc. soon. MDH also is on 28 Mc. EKT and MJ are on 56 Mc. MIZ, NDA, NID, and FWK are working for Watson Lab in Cambridge. Lt. Comdr. ZV is now living in Braintree. RP is living in Waltham and is on 28 Mc. 9UQP is living in Weymouth and still working for Raytheon. CTR is working for the New Haven R.R. as a signal station operator. JBH is a civilian again and back in the mechanical dentistry line. JCB is out of the Navy, as is JAC, who is taking it easy for awhile. IVI is out of the Navy and back at WBZ in Hull. IOO is out of the Signal Corps, and has a jr. operator. ADB is back in civilian life and is a benedict. LNC is out of the Navy and working in a lab in Washington with DEL. KAG is out of the Navy and taking life easy; he may go to college to continue studies in radio. IOG is a department head at Raytheon. DDM was active on 112 Mc. while it lasted. The Framingham Radio Club had a get-together at the Hotel Kendall to formally start their activities. Plans are being made for a hamfest to be held in the spring. MEG is now an officer in the above club. Norman Gillin, a W8, is working for Valpey Crystal Corp. We understand that a radio club has been started at the Raytheon Mfg. Co. MX. M.I.T. Radio Society, has a rig on 28 Mc. DRL is living in Hingham and has his own radio store. H. P. Hatch, who had a ham station in W. Bridgewater back in 1915, writes from the Vets Mountain Home, Tenn. Any of you old-timers who remember him, drop him a line. KMY, secy.-treas. of the Lowell Radio Operators Club, says the club is not quite ready to go yet. AKE and AGB are rebuilding. MKX is on 28 Mc. KMY is on 28-Mc. c.w. OQ, DBE, and COX are on 144 Mc. QF, QM, BTW, and IYT are rebuilding. LMT and MQV are due home soon. Traffic: W1HIL, 6.

WESTERN MASSACHUSETTS — SCM, William J. Barrett, W1JAH — FOI reports MQK out of the services and recently married. JLL is on terminal leave as captain in the Signal Corps after fifty-nine months service. Chris is back at WMAS. Dick Atwood reports from Worcester that 144 Mc. is about dead, pending completion of plans for hams to take over former WERS net operations. Holdup on issuance of calls to the LSPH gang is slowing up operations. CH has worked thirteen countries, using 3-element rotary. MVF checks in from Oahu, where he, 2LPV/6DTC, and 9QWMM are operating MVF/K6, using HT-4 trans-

(Continued on page 84)



RME Owners Say!

"Incidentally — we like the RME-45 very much. The writer spent about 4 years in front of an old RME-69, have also used the RME-70, and had five RME-99s in my communication class. The 45 seems to have all of the sensitivity and selectivity we've dreamed about — a crystal circuit that really works, a real single dial tuning unit with no back-lash — and stability. On CW we notice the receiver has that desirable "hard" sound that operators prefer. I have been personally sold on RME receivers for over ten years, and during that time I have owned four receivers made by other manufacturers. In addition I was a radio instructor in a government school for two years during the war, where we used many makes and models of receivers. As an amateur I have been in many of the DX contests using an RME-69 with a DM-36 converter and on ten meters have 65 countries confirmed, WAC many times on both phone and CW and WAS on ten meters. In my own opinion, speaking as an amateur, I believe that the true test of a communications receiver is how it performs under the trying conditions of a DX contest. Many receivers perform well so long as they are not working with a transmitter, but immediately start developing bugs when loaded with stray RF from the rig. The old RME-69 was tops, so far as I am concerned, and having used the new RME-45 on ten meters, I can truthfully say it is much better than even the old RME-69."

DON B. MURRAY
W9HDU

"Time Will Tell." . . . Four years ago prior to debarkation to Africa, I purchased an RME-99. This receiver landed at Casablanca with the Second Armored Division. After a year's commendable service in North Africa it went with me to Great Britain for the invasion and then on to Normandy, Holland, Belgium and Germany. It was still giving satisfactory service in Berlin during the days of the Potsdam Conference. Before being redeployed to the United States, I managed to ship this receiver home. The set is now a very much battle scarred veteran of four years outstanding service. I am interested in keeping this set for the future Ham years and am wondering if it would be possible to have it reconditioned. From this information I'm certain that the receiver speaks for itself in proving the validity of your slogan "Time Will Tell."

JACK BURROUGHS
Ex. Bn. Communication Sgt.
Second Armored Division



FINE COMMUNICATIONS EQUIPMENT
RADIO MFG. ENGINEERS, INC.
Provia 6, Illinois U. S. A.

(Continued from page 98)

mitter and S-27 receiver. QRM from nearby Navy stations is tough, but the boys have worked twenty-three states, plus most of the Pacific outposts. George reports WIAW RST 569X when local c.w. interference lets the 14-Mc. signal through. HCH is active on 28 Mc. from Ft. Shafter. T. H. MVF wants to be remembered to the Fitchburg and Leominster gangs. BSJ, our new Section EC, will be glad to hear from any hams interested in furthering emergency communications in the section. Correspondence concerning this work will reach him at 76 Cortland St., Springfield 9. The North Adams gang has resumed meetings after a long layoff. How about some news? 73. *Bill*.

NEW HAMPSHIRE — SCM, Mrs. Dorothy W. Evans, W1FTJ — EAW is back on 28-Mc. phone. HOV is home from China and expects to be on the air in the spring. LVG is sporting a new RME-45 receiver. EWF expects to be on 28 Mc. soon with one of the new Eimac 4-125As. BAC, from the top of Mt. Washington, is covering the State very well on 28-Mc. phone and can be heard almost nightly. KYG and GWY have been representing Manchester on 28-Mc. phone. AXL is installing an 8JK beam. HOU expects to be on "10" as soon as his new receiver arrives. IVU has taken over his new duties with the Hytron Radio & Elec. Corp. in their Amateur Division. MMG expects to be out of the Navy and home in Milford by the time this goes to press. Traffic: W1BFT. 4.

RHODE ISLAND — SCM, Clayton C. Gordon, W1HRC — The newly-elected officers for 1946 of the Providence Radio Association are as follows: KKE, pres.; EOF, vice-pres.; AEI, treas.; Mr. Atherton, secy.; AFO and LYE, directors. LDL is back from Japan. KYK is out of the Marines. KOG is back. JRY visited the PRA on Jan. 8th. BIL is the acknowledged leader of the movement to get 144 Mc. alive. LFB joined the PRA Jan. 8th. A card from ILO says his QTH is 1164 S. W. 17th Ave., Miami, Fla. Had a phone call recently from FAA, who now is in Newark, N. J. saying he had a new HRO. CNZ, LCH, DQ, HJB, BFB, GTH, and GVH are all very active on 28 Mc. HRC was active on 28 and 14 Mc. at the same time, but the FCC caught up with him. Moral — isolate the antenna tuning unit plenty far away from the final amplifier tank circuit.

NORTHWESTERN DIVISION

MONTANA — SCM, Rex Roberts, W7CPY — HFZ is back on the ranch at Melville and will be active in both traffic and emergency work. He acquired a plane while he was gone. GZA is building and will be on the air by spring. W9HFK/7, FOM, and FEG are on the air at Missoula. New officers of the Butte Club are: Jack Picard, pres.; Orval Hill, vice-pres.; and Leslie Blewett, secy.-treas. The Butte and Anaconda Clubs held a joint dinner in January at which new officers of both clubs were installed. FL, CT, and GDB are home from the service. BWH and FGB are in Livingston and active; they are in radio business for themselves. 73. *Rez*.

OREGON — SCM, Carl Austin, W7GNJ — QP built a 20-watt for 28 Mc., and with an 8JK is doing well. He says he is going to try and get the local gang to go on 144 Mc. A letter from IIX mentions that he is home again after thirty months in the Aleutians, and is starting at Portland U. He was on 28 Mc. three days after getting home, and worked IAC at Guam, who has since returned to the States. He also reports that IIH is on the way home from Japan. HAL has his new receiver, now to get the rig on 28 Mc. SY, of Eugene, reported in person recently and says he is having fun on 28 Mc., and that at least ten of the locals are working that band. Jerry plans on installing his rig, a Karr, in the car later. We were glad that ASG's Christmas card came from Salem instead of India this year. AOY is still in charge of Navy radio lab, but finds time to listen in on 28 Mc. occasionally. 5IYI, of Texas, has moved to Bend, and will soon get the rig assembled. LI, of Klamath Falls, captain in the Coast Guard, is out and thinking about tuning up his kw. again. AME, of Bend, a ham since 1928, was seen measuring around on his roof. ARZ has ordered tubing for 3-element rotary. A letter from ITZ and FTA, CAA operators at Unalakleet, Alaska, mentions that they will probably be able to dig up enough parts to get on 28-Mc.

c.w., if the wind ever lets up enough to get an antenna up 73. *Carl*.

WASHINGTON — SCM, O. U. Tatro, W7FWD — More ECs are wanted, particularly in Seattle, Spokane, Walla Walla, Wenatchee, Vancouver, Bellingham, and Aberdeen. Recent appointments: JBH, former radio aide of KFEY, as EC for Burlington and vicinity; FLQ, as OBS in Spokane. Chet has 300 watts on 28 Mc. now. At a meeting held in FWR's shack thirteen hams and nine interested non-hams expressed their desire for a reactivation of the Olympia Radio Club. SARC elected LeRoI Rusland, pres.; FXD, vice-pres.; JBH, secy.-treas.; and Lawrance Morrission, chief squelecher. FXD is getting out well with his 150 watts on 28 Mc. and EYS, ILR, and FOK are also active. Lt. Comdr. BCV is back in Walla Walla after five years in the Navy and is waiting for 20 and 40 to open up. DET is on terminal leave at Seattle after service in London, Londonderry, Normandy, and Paris as electronics officer, and is on 28 Mc. receiving with a new SX-28A. 6TZW/7 just returned from overseas and is looking for the 144-Mc. gang around Seattle. He is building a transceiver using a 9002 superregen, and a 6V6 Hartley osc. Of the Aberdeen gang AQB, FLD, GEX, and CKZ are reported on 28 Mc. HNP, with the Navy Yard, is pruning for 144 Mc. but talks in terms of 3000 to 10,000 Mc. HCE, EC, reports GMC is locating in Yakima with s.h.f. ideas and is taking his HK-24 rig out of storage; HEA of five-meter DX fame is back; YARC is active and experimenting with amateur chemistry; ALH has a big pole but no erecting crew and he wants a receiver; AWX is now a parts jobber catering to ham's needs; AYO denies 2½-meter or YL activity as previously reported; CAM finds his prewar exciter strictly modern; NWA's job keeps him busy when the band is open; LV is returning to Yakima; the new FCZ v.f.o. is beautifully constructed and rock steady; AWX and HCE are getting the feel of revamped frequency meters and are rebuilding 144-Mc. equipment; HRU is working hard on his 144-Mc. equipment and is interested in EC work; GR is repairing b.c. sets. IOQ is on 28 Mc. and back handling traffic; Miriam Brown (LSPH) is building a 6L6 doubler to hook on to Leo's Meissner Signal Shifter and plans to add an 815; she has given up Jergens for a mixture of dirt, coil dope, and solder burns, and is remodeling and enclosing the front porch for a shack and wants a high pole for her antenna support. AIU, FWD, and GKY have added Signal Corps b.c. 342NS to their shacks. HPJ is the only local that has whipped 28 Mc. via GEV. Traffic: W7JBH 40. 73. *Tate*.

PACIFIC DIVISION

HAWAII — SCM, Howard S. Simpson, K6RLG — FAZ has left for Hilo to install new police radio for Island of Hawaii. All Hawaii's hamdom plus the commercial interest threw a big farewell party in Honolulu for the coast-bound RI Homsey. QLG is back on 28 Mc., using a single 35T in the final to his prewar three-element beam. PHD, along with his police radio work, writes a ham column for the local paper. W7HNH is now portable K6 and has just received his rig from the mainland. Rebirth of Maui Amateur Club occurred in August 1945. A code machine has been ordered from the Coast, code classes are being started, and a portable generator is being built up for emergency work and future Field Day activities. A club house has been donated. New officers are: QLG, pres.; THA, vice-pres.; PHD, secy.; BJJ, treas. BJJ and his young op., TTT, pulled down their three-element beam during the war so now they have a two-section flat top on 28 Mc.

NEVADA — SCM, N. Arthur Sowle, W6CW — Asst. SCM, Carroll Short, W6BVZ. IAJ, OPP, RPU, GGO, TJI, QYK, and TNA have been welcomed home from the services. TKV went into the air; he is a private airplane pilot now. GSB has 500 watts on 28 Mc. RXG is supervising installation of county-wide police radio in Vegas. MRT is grinding crystals for 500-watt rig. BVZ is fighting bugs in 28-Mc. rig. QXH left for California. PGD, TFF, PZY, CDM, and SXD report rig-building or ready for the lower frequencies. 1MSP/6 has 100 watts cathode modulated and indoor antenna. EEF built a very hot superhet. TQZ is building airtight cabinet for his big rig. UTZ, QAY, and

(Continued on page 96)

McELROY "400" SERIES

COMPLETE AUTOMATIC RADIO AND TELEGRAPH TRANSMITTING AND RECEIVING EQUIPMENT

New designs, new features, new low prices. Immediate delivery, in any quantity. Illustrated catalog and technical manuals available in all commonly used languages.

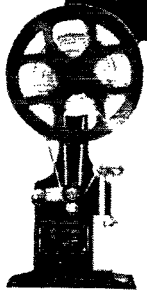

McELROY TAPE PULLING HEAD

TPH-400

Admits tape from any angle from the right; prevents breakage; permits tape to come from any level on receiving table. \$45.00

McELROY WHEATSTONE CODE TAPE PERFORATOR

PFR-400

Designed to modernize small stations, at sea, ashore or on the air. For 110-120 volts, AC or DC. \$95.00

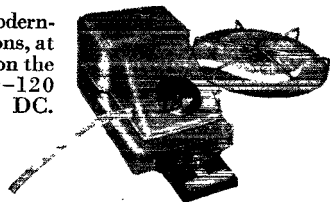

McELROY UNIVERSAL DRIVE

MSD-400

Permits rapid interchangeability of keying head and tape pulling head. Save money on maintenance and spares. \$195.00

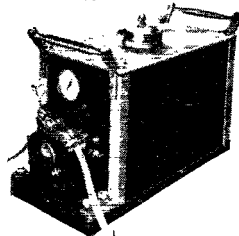

McELROY KEYING HEAD

HED-400

Complete with built-in polarized relay. Made without a Star Wheel opening in contact case; this assures clean contacts. \$240.00

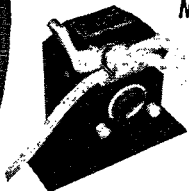

McELROY INK RECORDER

REC-400

Capable of speeds up to 700 words per minute. Tape holder, which is part of equipment, may be attached to right or back of case. \$195.00

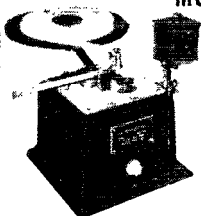

McELROY RECORDER AMPLIFIER

MRD-400

Designed to drive the Ink Recorder at speeds to 300 words per minute. Cabinet or rack mounting. \$195.00

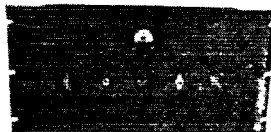

McELROY PHOTOTUBE KEYS

PTK-400

Delivers a tone code signal to from 1 to 50 headphones for operator training, and runs at low or extremely high speeds. \$45.00

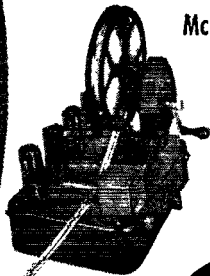

McElroy engineers never copy, never imitate. We create, design, build . . . we are never satisfied with mediocrity.



McElroy MANUFACTURING CORPORATION

82 BROOKLINE AVENUE

BOSTON, MASSACHUSETTS

two BIG favorites



MALLORY DRY ELECTROLYTIC CAPACITORS

First manufacturer of commercial high voltage dry electrolytic capacitors, Mallory has applied its skill to the continued perfection of this product. Mallory developments have culminated in the now-universally adopted—and copied—FP and WP capacitors. Use them both for replacement and for the construction of new apparatus—no other capacitors can compare with them.

MALLORY CONTROLS

Mallory pioneered and still leads the field in wire-wound controls including rheostats, potentiometers and pads. For low resistance circuits, or where a higher wattage rating control is required, choose a Mallory wire-wound control. It will pay you every time!

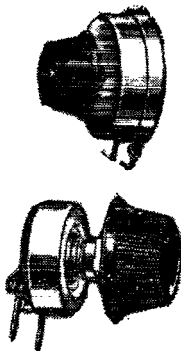

Do you have a copy of the latest Mallory Approved Precision Products Catalog? It's a must for every radio man! Get one from your nearest Mallory distributor, or write direct to

P. R. MALLORY & CO., Inc.
INDIANAPOLIS 6 INDIANA

P. R. MALLORY & CO. Inc.
MALLORY

(Continued from page 94)

CW have rotary beams on 28 Mc. QJF is a newcomer in Nevada. DLA moved to the Coast. UCA is hunting a good QTH. VE2DU visited us while in Reno. BYR, TQZ, PST, TJJ, and QYK are on 28 Mc. All are urged to contact BVZ or CW for AEC applications. This is a very important activity. 73. Art.

EAST BAY — SCM, Horace R. Greer, W6TI — Section EC, EE; EC, QDE: EC v.h.f., FKQ; Asst. EC v.h.f., OJU; OO v.h.f., ZM. The East Bay Section regrets to announce the passing of one swell guy and a real credit to ham radio. W6SFT, Loyd Litton, passed away in Oakland on December 31, 1945. His many friends say 73 but not good-bye. The following are on 28-Mc. 'phone, and the figures after calls show input to final: ZM 80, NO 1000, NPP 300, PB 980, OCZ 450. RCE, when not on the air, is teaching Cross Bar School for Pac. Tel. & Tel. BUY has new e.c.o. CHE has one 4-125 Eimac tube in final. AEX bought new Western Electric 10A BCL receiver. The Oakland Radio Club is sponsoring a 144-Mc. contest on the week ends of March 23rd-24th and March 30th-31st for mobile and fixed units. Points will be figured at one point per mile and there will be prizes for this East Area Contest that will be awarded at a hamfest on April 7th, place to be decided at a later date. The following SARO members can be heard each Thursday evening on 29,400-ke. 'phone, where the net meets: EHS, control; QWX, PB, NPP, BUY, NQJ, PSN, KQ, CHE, VX, OZC, and RCE. More members are planning to get rigs going on 28 Mc. Let's all get signed up in the Emergency Corps. DUB is counting on his new jr. operator to keep the rig on the air. Can anybody find someone to dig out GEA's basement so he can get on the air? The Richmond boys are quite active. HVP, QDE, OJU, NJX, and 7EVL/6 are on 28-Mc. 'phone. LMZ, SAD, and EJA are on 28-Mc. c.w. In El Cerrito CTL, RMNI, and KEK are on both c.w. and 28-Mc. 'phone with IUF on 'phone only. EJA reports working 9TQD and NSL, both portable in Tokyo, and PUZ and 5LLN, both portable on Tinsan. The Richmond club meets the first and third Fridays of each month and all visitors are welcomed. How about sending those traffic reports each month? Traffic: W6AOY 5. 73. "TI."

SAN FRANCISCO — Acting SCM, Sam C. Van Liew, W6CVP — Address: 215 Knowles Ave., Daly City, San Francisco. Phone RA. 6457. Asst. SCM, 6GPB; ECs, DOT, KZP; OO, NJW; OBS, FVK, KNE. This is my first report as Acting SCM since RBQ's term expired. RBQ will continue to be active in section affairs. WB addressed the Marin Radio Club on Jan. 11th at San Rafael. This club has been reorganized with GPB as new president. The following are active on 28-Mc. c.w.: MZ, CIS, RBQ, DOT, CVP, WN, WB, LV, DJI, and ATY. On 'phone: PGF, NYQ, OZC, AHH, and TMV. On 144 Mc.: SLD, RBQ, 4TZ, KZP, and NJW jointly with pair of 85Ts. CIT and PM are on 144 Mc. ERS expects to return to the air soon. ATY just returned to the air, his son is radio operator in Signal Corps in Tokyo. CVP's son has returned after three years overseas with the armed forces. RBQ is rebuilding 28-Mc. beam and also repairing roof. Capt. HJP is now a married man and will reside in Chicago with expectations of a return to the air this summer as a W9. All amateurs interested in joining the new AEC are requested to contact me. The first official meeting of the new San Francisco Radio Club was held on Feb. 15th with good attendance. The new officers are: WN, pres.; NYQ, vice-pres.; BUJ, secy.-treas.; LV, sgt. at arms. Capt. SRT is back home after thirty-months duty in the South Pacific and soon will be on 28-Mc. c.w. He is married and is taking a special course in radiology at the U. C. Hospital. Would appreciate receiving a postal card monthly from you fellows with news of interest. Traffic: W6RBQ 60, NYQ 35, OZC 36. 73. Sam.

COLORADO — SCM, H. F. Hekel, W9VGC — ZLH is holding down a good job with CAA in Alaska. OMZ just returned from Italy. 7GYE reports the arrival of a second jr. operator Dec. 30th. UTK, formerly of Lawrence, Kans., is located in Denver. OWP was discharged from the Navy Dec. 20th. He was attached to the USS *Basitan*, AG 68, an electronics repair ship in the Pacific. He says his ship carried a few spare parts, but there were times when they needed things which they could not get by mail so they carried about \$35,000,000 worth of spares and out of that they were expected to help out friends who might find themselves in a pinch for a few feet of wire or perhaps a new tube. His travels were somewhat limited and the best he could do was the waters along the East Coast and down to Cuba then

(Continued on page 100)

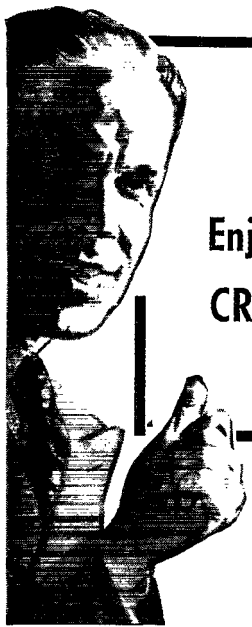

Where Will YOU Be in 1950?

**Enjoy Security and Good Pay! Prepare Now With
CREI Modern Technical Training and Step Ahead
of Competition into a Good Radio Job!**

**CREI Offers You a
Proved Program of Self-
Improvement To Keep
Pace With Modern U.H.F.
Advancements—and En-
ables You to Go After—
and Get . . .
A Secure Radio Job!**



YES, there are GOOD JOBS . . . for GOOD men! The easy jobs are gone and once again knowledge and ability are the requirements for the good-paying jobs. Competition is opening up. Employers once again can afford to be "choosy" . . . to select the best man for the best job. In the face of this show-down situation — *where do YOU stand?*

By adding CREI training to your present radio experience you can safeguard your future and keep pace with such new developments as U.H.F., Circuits, Cavity Resonators, Pulse Generators, Wave Guides, Klystrons, Magnetrons and other tubes. Are you equipped to handle them? CREI is equipped to *help you*, by providing the know-how and ability that is required.

In our proved method of instruction, you learn not only *how*, but *why!* Easy-to-read-and-understand lessons are provided well in advance, and each student has the benefit of personal guidance and supervision from a trained instructor. This is

the basis of the CREI method of training for which many thousand professional radiomen have enrolled since 1927.

What you do today will be the answer to where you will be in 1950 and the years after. It costs you nothing to read the interesting facts . . . to learn how CREI can help you enjoy the security you want . . . the better-paying job that can be yours.

WRITE FOR FREE 36-PAGE BOOKLET

If you have had professional or amateur radio experience and want to make more money—let us prove to you we have something you need to qualify for a better radio job. To help us intelligently answer your inquiry—please state briefly your background of experience, education and present position.



CAPITOL RADIO ENGINEERING INSTITUTE

HOME-STUDY COURSES IN PRACTICAL RADIO-ELECTRONICS
ENGINEERING FOR PROFESSIONAL SELF-IMPROVEMENT

Dept. Q-3, 3224—16th Street, N. W., Washington 10, D. C.

Contractors to U. S. Navy—U. S. Coast Guard—Canadian Broadcasting Corp.
Producers of Well-trained Technical Radiomen for Industry

MEMBER: NATIONAL COUNCIL OF TECHNICAL SCHOOLS

wartime

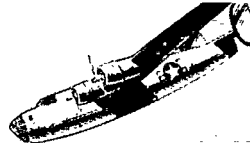

served with the AACCS

BC-779-B

WHEREVER AIRPLANES FLEW THE SKIES

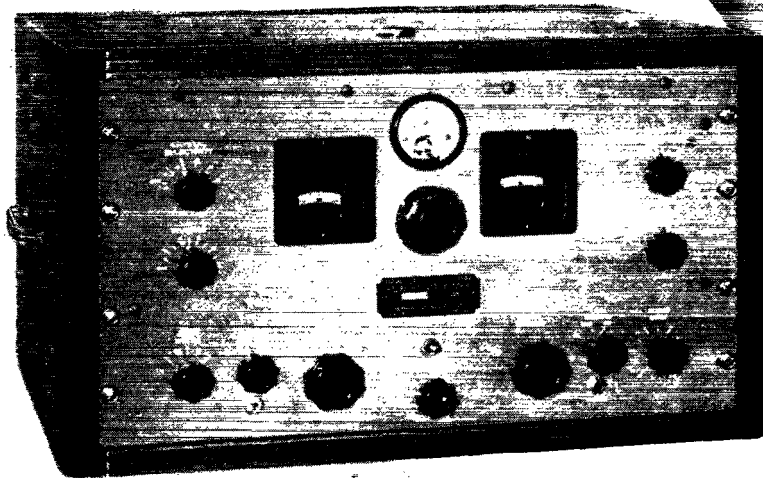

The BC-779 made countless thousands of friends in the AACCS and other branches of the military. Many of the men in the AACCS who did such an outstanding job in keeping our planes safely in the air, have written to us praising the performance of the war-time "Super-Pro" under the most unbelievable operating conditions. There could be no more positive test of the basic design of the "Super-Pro."

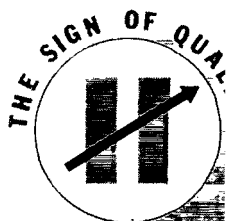

ESTABLISHED 1910

peacetime

SP-400-X

FOR THE MAN WHO PREFERENCES THE BEST



Super-Pro .54-30 MC.

The Series 400 "Super-Pro" is the latest in communications equipment. Both the old "Super-Pro" with over eight years of service in commercial and government installations, and the BC-779 with its matchless military record with the AACCS, have contributed to the design of this new postwar receiver. Meets every need of the most critical professional or amateur operator...

Write for technical details.

HAMMARLUND

THE HAMMARLUND MFG. CO., INC., 460 W. 34TH ST., NEW YORK 1, N.Y.
MANUFACTURERS OF PRECISION COMMUNICATIONS EQUIPMENT

**A CARDWELL
CONTRIBUTION TO
IMPROVED V. H. F. PRACTICE**

P. L. 20,024

\$10.80

AMATEUR NET
Inc. 3 sets of Coils
covering 144-148M.C.
220-225 M. C.
420-450 M.C. bands.
Less 6F4 tube

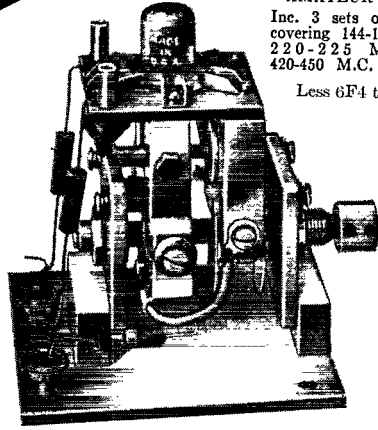

**THE NEW CARDWELL V. H. F.
OSCILLATOR KIT
DESCRIBED IN FEB. Q. S. T.**

Just the thing for hams who are experimenting with Very High Frequencies. Some suggested uses; local oscillator for super het receiver; as plate modulated oscillator for low power transmitter; driver unit for amplifier tube in higher powered transmitter; V. H. F. signal generator.

Cardwell Catalog No. 46, FREE, upon request



**THE ALLEN D. CARDWELL
MANUFACTURING CORP.**

Main Office: 81 Prospect St., Brooklyn 1, N. Y.
Factories: Plainville, Conn. — Brooklyn, N. Y.

(Continued from page 98)

through Panama and west to the Philippines, Okinawa, Korea, Uluthi Isles, and Shanghai, China, his last stop. He now has his feet back on dry land again and his new QTH is Ramon S. Walker, Box 266, Brush, Colo. YXS is getting back into the game again; he opened his store in Denver and may have some real buys in surplus radio equipment. EHC is on his own again and will have to work for his keep from here out. His new job is with CAA as radio engineer and most of the others on the job with him are hams and are itching to get back on the air as soon as 20 and 40 are opened up. Have any of you noticed the 28-Mc band lately? A lot of nice Big rigs floating through the air at night with 400 and 500 watts and better just for a local rag chew. 73. *By Heck.*

UTAH-WYOMING — Victor Drabble, W6LLH — The following hams are enrolled at USAC: 6SID, 7IYP/6, 6MAV (6CKI faculty), 6RWM. The USAC's club is on 28 Mc. with an HT-9 with 100 watts using a 12-wave antenna. 7BCL is building a new all-wave band rig. 7ICZ has just been released from the hospital. 7HRM's new 300-watt rig will work c.w. on the 28-Mc. band. 6DJT, formerly of Salt Lake City, has returned from his Canadian job and works for the Western Air Lines in Cheyenne. 6TVN is building a new 12-tube receiver, two i.f. stages and a 9002-9003-6AK5 in the front end. His new rig has a pair of HK24Gs modulated by a pair of 6L6s. M. W. Brechet (LSPH) is awaiting his station license so he can get on the air. 7FLO is making a reputation on 28 Mc. with only 50 watts input. 7GSQ says his rig is not built to get on 28 Mc. and is waiting for the new rigs to get on the market. 7FLO and 7GSQ got on 144 Mc. and had very good results up to eight miles; one rig was portable, the other fixed. 6IWY is building an FB rotary beam antenna for his 28-Mc. 'phone rig. 4IHV/6 is finishing his transmitter with an 815 in the final and has trouble getting out without a good antenna. 73. *Vic.*

SOUTHEASTERN DIVISION

ALABAMA — SCM, Lawrence J. Smyth, W4GBV — Asst. SCM, Col. Fred J. Elser, 6ANM/4. The Montgomery Amateur Radio Club holds meetings every Wednesday night and is 100 per cent ARRL. New officers are: ECF, pres.; EW, vice-pres.; AUP, secy-treas.; GSQ, membership chairman; EIB, program chairman. Code and theory classes are conducted Wednesday and Friday nights and the club has several emergency stations available. The following stations are active in Montgomery on 28 Mc.: AUP worked the Belgian Congo; EW has a new 3-section rotary beam; FVS is proud of his new homemade e.c.o.; GBV is very busy with his state police f.m. v.h.f. stations; GDU is hauling them in on his converter; GGC worked Argentina; HEG is an old Morse Operator; 3GME/4 likes to work code; 6ANM/4 worked Brazil. FSW, in Birmingham, is often heard in Montgomery on 28-Mc. short skip. FYB, now a colonel, writes he expects to be back on the air from Dothan soon. Many stations are waiting for receivers to get back on. Write in if you don't see your call listed. Let's let 'em know Alabama is in there pitching! 73. *Fred.*

EASTERN FLORIDA — SCM, Robert B. Murphy, W4IP — Let me hear from you who are interested in the ARRL Emergency Corps program. We need someone to accept Section EC appointment. GVC, at Orlando, sends in the following fine report: OQ is coming out on 28 Mc.; 8BRL/4 works a K6 with 12 watts; ASE will be on 28 Mc. shortly; QN is still working his pet theme, "Antennas"; Miami and St. Pete stations have been heard in Orlando R3-5; DWI has a vertical erected by QN; CLW will be on 3910 kc. when it pops open; GIY engineers WDBO and is working a rotary beam on 28 Mc. 1BRA/4 has sent out his QSLs for 112-Mc. work from Delray. That was that 50- to 60-mile stretch we made with the highest antenna being not more than 50 feet above sea level. 1PAN writes from Raytheon Plant and Jones says hello to the old FAA net. HXM, from Sanford, says CPG is going to locate in California, which leaves Lloyd Boyle (LSPH) as the only ham in Sanford. HXM, GVC, and QN are working the "Ragbag Net." PT dropped by to say hello to HXM. GIB has a new RME and it has encouraged him to get on 28 Mc. IR is again writing his owl juice for QST. The following from EYI: DHD was home on two-weeks leave; DBA had a beam party on 28-Mc. job with FZW, EPW, and EYI assisting; EPW is using a 60-foot windcharger on his new 28-Mc.

(Continued on page 104)

OHMITE

RITEOHM PRECISION RESISTORS

Non-Inductive... Pie-Wound... 1% Accurate

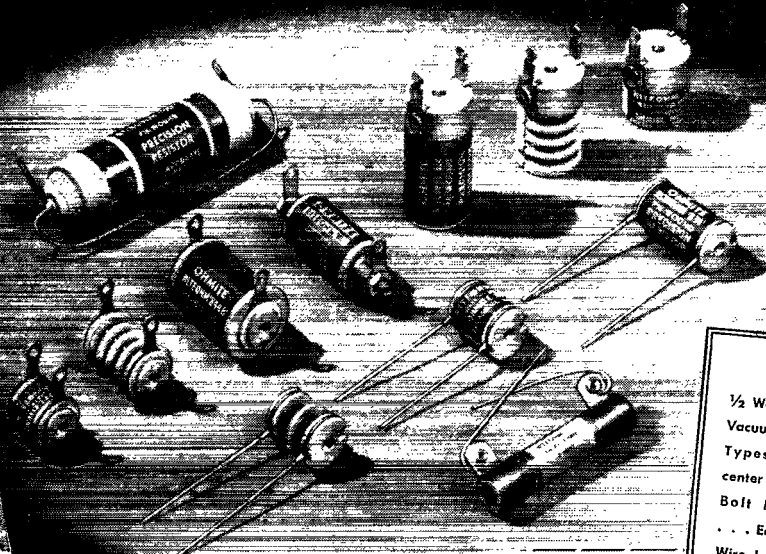

NEW
 1/2 Watt and 1 Watt
 Vacuum Impregnated
 Types... Hole in
 center for Through-
 Bolt Mounting
 ... Equipped with
 Wire Leads or Lugs

Available from Stock . . . or Made to Order

OHMITE presents a *new* line . . . a *full* line . . . of finer precision resistors! Every type, every size, ready for every need! Each Riteohm is designed and built with all the specialized skill and experience that have made OHMITE units the standard in this field. However critical the application . . . consistent accuracy and reliability are assured. In these Riteohms, you get *time-proved protection against humidity, temperature and corrosion.*

AVAILABLE FROM STOCK in 1/2 watt and 1 watt units in a wide range of values, in various types of mountings and terminals . . . or made to order. Complete line of 6 different series includes non-inductive pie-wound vacuum impregnated units . . . single-layer wound vitreous enameled units . . . and non-inductive pie-wound hermetically glass sealed units. Some units in range of 0.1 ohm to 2,000,000 ohms.

AUTHORIZED DISTRIBUTORS EVERYWHERE

OHMITE MANUFACTURING CO., 4865 Flournoy St., Chicago 44, U.S.A.

**Send for
 Bulletin No. 126**

This handy Riteohm Bulletin makes it easy for you to select the exact units for your needs. Gives complete data . . . lists stock units and made-to-order units . . . includes dimensional drawings. Write for it now.



Be Right with **OHMITE**

RHEOSTATS • RESISTORS • TAP SWITCHES • CHOKES • ATTENUATORS

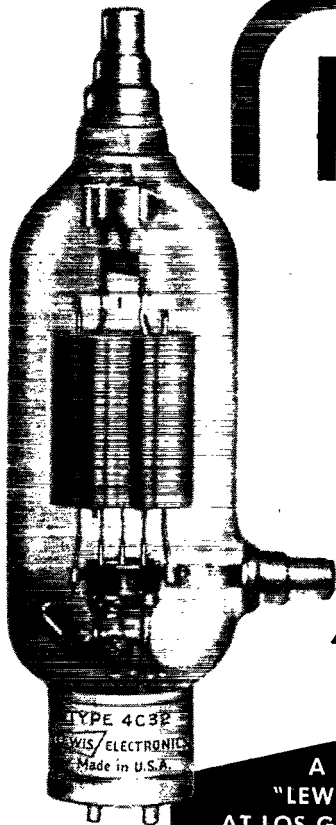

1000 WATTS FONE

ON 60 MCS.

Using the New

4C32 \$24⁵⁰
LIST

**At Your Dealers'
Everywhere**

A
"LEWIS
AT LOS GATOS"
Transmitting
Tube

TWO 4C32 tubes operating at CCS rating can be your final amplifier at 60 mcs. Two more can then deliver 500 watts of audio for modulators while operating well below CCS rating; plate voltage, either case, is at 2000 volts.

Heavy copper terminal seals, heretofore used only on large water-cooled tubes, make the 4C32 capable of handling without excessive heating, large circulating currents

found on the high frequency bands.

Extra cooling surface and lower bulb temperature so vital at high frequencies, is provided by an ample 3-inch diameter bulb.

The 45-watt filament, 10.0 volts, 4.5 amperes, supplies reserve emission for high peak demands.

A special LEWIS processed graphite plate assures long and useful life with plenty of reserve for the dissipation rating of 200 watts.

Lewis

Subsidiary of **Aireon**
MANUFACTURING CORPORATION

ELECTRONICS
LOS GATOS • CALIFORNIA

An example of Cinaudagraph Speaker Engineering—the fifteen-inch electrodynamic speaker of Aireon's Electronic Phonograph, most perfect of commercial music machines.

There's a better

Aireon

Cinaudagraph Speaker

for every
electroacoustical application

Aireon Cinaudagraph Speakers, Inc., has the facilities, experience and engineering ability to design and produce better speakers for any purpose. Whether it is a two-inch unit for table model radios, or a fifteen-inch for commercial phonographs, the same research, precision construction and superior materials are employed. All Cinaudagraph PM Speakers use Alnico 5, the "miracle metal" which gives you four times the performance without size or weight increase.

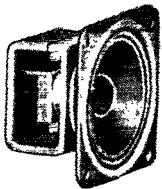

← Aireon Cinaudagraph Speaker for small radios—remarkable fidelity reproduction within a two-inch cone. The magnet structure is of Alnico 5.



In Aireon's scientific laboratories individual and special problems of electroacoustical reproduction are under constant study, so that the finest and truest tonal reproduction may be combined with unusual stamina and long service life.

As a result, electronic perfection never before achieved has been incorporated in Cinaudagraph Speakers—for public address systems, radio, commercial phonographs and many special purposes.

Cinaudagraph Speakers, Inc.

Subsidiary of **Aireon** Manufacturing Corporation

3911 SOUTH MICHIGAN AVENUE, CHICAGO





(Continued from page 100)

beam; FZW has been discharged from the Navy and is working in Miami; FRE, in Washington, has a new rating of "electronic technician's mate"; HUY is looking for you guys on 28 Mc. with a new rig and beam; GGJ and GFE report distant QSOs on 28 Mc.; DVT is in San Juan with PAA as a combination aircraft and airport radio mechanic. AAO, of old AARS days, also is in San Juan with PAA as an operator at WMDU. Let me hear from fellows as to what you want in the way of a communications set-up in this section. I need an SEC and several OOs and OBS. 73. *Merf.*

WESTERN FLORIDA — Lt. Eddie Collins, W4MS — EQR received a pair of TZ40s for Christmas from his XYL. BKQ has his four-element pouring signals all over the globe. EZT, now out of the Navy, is returning to the U. of Fla. UW is busy at WCOA. VR and FHQ are awaiting opening of 7 Mc. DXZ is about ready to get on 28 Mc. FJR is thrilled over her 28-Mc. c.w. QSOs. JV is very hot on 28 Mc. AXP says 28 Mc. is not like 7 Mc. EPT/K6 has been QSO the gang. 3IHC/4 is increasing power on c.w. 5AX and 5ZV visited the gang. DAO has put NU40TZs in the modulators. MS is installing PP 100TLs in the final. ECT is pounding 28-Mc. c.w. 6OHN/4 is very active on 28-Mc. phone here. 7IQJ/4 is having exciter trouble. QK is getting the rebuilding job done in great shape. AXF is waiting for 14 Mc. to open. HIZ is back and ready for 28-Mc. operation. How about sending envelopes for DX QSL cards? 73.

GEORGIA — SCM, Ernest L. Morgan, W4FDJ — West Coast stations have been heard working Georgia stations consistently on 28 Mc. BB is ready to go. DSF, DX, FAP, ACQ, AMX, GMA, AUF, and COD are known to be in Savannah. CBR, CRJ, CZQ, DAA, and WZ were visitors in Savannah. DLW is rebuilding. ESE and ETI have XYLS. FOL and Cookie are back from T.H. and are glad to see Chatham County. The Savannah Radio Club has been reactivated and that means one of those good hamfests in August this year. FCW returned to practice at Cordele after five years and will be on 28 Mc. pronto. GFF got another stripe and now is EM3c. CBR is home at Claxton. FWD has a new jr. operator. FDE and FFI are at Jax. DNY is doing a tour in the Pacific. EWY is on 28 Mc. This is the last column from the writer and he wishes to thank all who have aided in carrying on. HYW, unanimously elected SCM, will take up the tasks with youth and enthusiasm and to him I offer the wholehearted efforts of all of us so that the usefulness of the League in Georgia will be outstanding. 30 and 73. "Pop."

WEST INDIES — Acting SCM, Everett Mayer, K4KI — December saw a number of prewar K4s come back on the air on 28 Mc. ENT, ESH, FSP, HQU, IFO, and JA are active. ESH has home-built e.c.o. working FB. JA uses vertical dipole with coaxial feed. WINCU/K4 and W8VRD/K4 are on at Rio Piedras. FAB is checking and double checking rig preparatory to going on air at old QTH. W4DAN/K4 and HLP installed three-element beams. KD installed 3/4-wave vertical and plans beam. HEB is designing new 200-watt rig. W9MDQ/K4 made contact with his XYL in Chicago and is active daily on 28 Mc. KD visited W4AAO/K4 and W4IP/K4 and had FB hamfest. Indications are that P. R. will soon have a ham headquarters supplier where needed parts can be obtained at fair prices. Watch the papers and listen to the grapevine for further news on this. W8UAK/K4 and W8NDU/K4 have returned to States. Drop us a line, fellows. 73. *Ev.*

SOUTHWESTERN DIVISION

LOS ANGELES — SCM, H. F. Wood, W6QVV — QKT writes that he has his own barber shop at Atwater. Orville Car, in Key West, is moving to Banning and wants to contact hams in that area. TZD, of South Gate, wrote from Pres. Grant at Shanghai and sent in a list of stations heard, including all W districts. SLE, who is flying C-47s in troop carrier service, wrote from Korea and is worried about expiration of his 1st-class 'phone ticket as he doesn't expect to get back until summer. Visited the Inglewood Radio Club, where a very large number of the fellows were in attendance and a good raffle was held. They have done a swell job in keeping the club going during the war and the organization is larger and better than ever. The Pasadena club is becoming activated again as well as the Foothill Radio Club, now guided by FFN, with DTS, vice-pres., ON, secy.; and CQG, treas. RIU advises that the Mike and Key Club of Santa Monica has resumed meetings under

(Continued on page 108)

Order Your Amateur X-Tal Kit Now before our supply is exhausted!

ONLY \$1.00 POSTPAID
(IN UNITED STATES ONLY)

Each Kit Contains

3 CRYSTAL BLANKS

These crystals are approximately 50 to 100 kc. below fundamental frequency of 7,000 kc., but can be ground to 7,000 kc. or over (with enclosed abrasive) to any desired frequency within the amateur band. The fundamental frequency can be doubled and redoubled to become operative at 14 mc. or 28 mc. or up.

2 HOLDERS

Complete with both regular electrodes and springs.

2 ADDITIONAL SETS OF ELECTRODES

1 BAG ABRASIVE

for grinding crystals to desired frequency together with folder of instructions for the most efficient method of grinding crystals.

Additional crystals, holders and electrodes may be secured.

QUALITY GUARANTEED

by a Company that has made more than two million crystals for the Armed Forces.

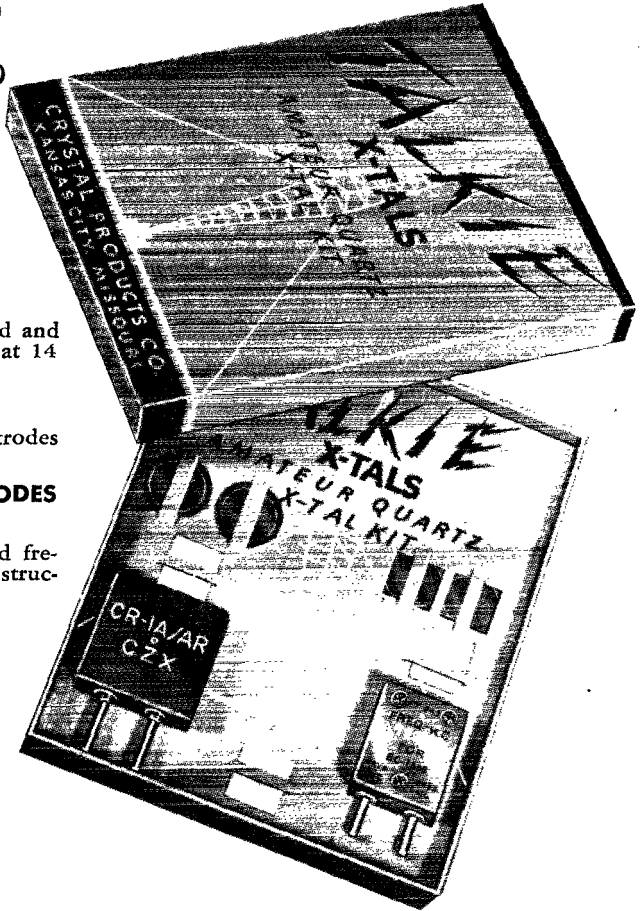

Crystal

PRODUCTS COMPANY

Main Office: KANSAS CITY, MO.

Canadian Distributors: MEASUREMENT ENGINEERING
104 Lombard St., Toronto 1, Canada

Special Prices to Jobbers

USE THIS ORDER-BLANK TODAY!

CRYSTAL PRODUCTS, INC., 1519 McGee, Kansas City, Mo.

Send me-----Quartz Crystal Amateur Kits as advertised, Postpaid.

Cash Enclosed. C. O. D.

NAME-----

ADDRESS-----

CITY-----

STATE-----

Order from HARVEY if you want that receiver soon!

HARVEY stocks are rapidly growing. Those receivers, transformers, meters, microphones and other things you waited for are here now, in their postwar packages. But the supply is being gobbled up quickly! So, to avoid unnecessary delay in obtaining what you want, HARVEY advises you to send in your order as soon as possible.

Orders are filled in sequence of arrival. In this way, you'll be sure of receiving your equipment with a minimum of delay. And you'll have the satisfaction of dealing with a responsible organization that has won a place in many ham hearts.

The items below are typical amateur necessities in stock in limited quantities.

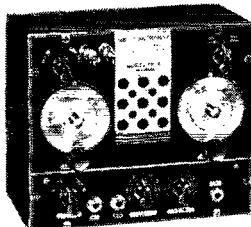

NEW ABBOTT TR-4

Postwar model; Frequency range: 144-148 Mc.....\$43.00
6 volt power supply \$13.50
Kit of tubes..\$ 8.30

SINGLE BUTTON CARBON MICROPHONE

In desk stand, with tiltable head, press-to-talk switch. Complete with 6 ft. of three-wire cable and Signal Corps type PL-68 3-contact plug. Specially priced.....\$4.95



Weston Model 301 3 1/2" D.C. VOLTMETER

Bakelite case, 1000 ohms per volt, range: 0-4000 volts, complete with precision 4-meg-ohm multiplier, \$10.95

Note: These items are subject to prior sale.

Telephone: Longacre 3-1800

HARVEY RADIO COMPANY

103 West 43rd St., New York 18, N. Y.

(Continued from page 104)

NSC, with TSN as secretary, while activities are under the able guidance of PTR. The Glendale Club and the Valley gang are going strong. Let's hear from other clubs. Considerable interest is being shown by various groups in the conversion of their WERS work into Emergency Corps work and appointments have been made and others are being considered. The Los Angeles gang has moved its headquarters and is now located in the swimming stadium at the Coliseum where the AEC gang used to hold forth. Walt Matney, as EC, did a swell job in promoting this spot and getting the equipment moved. UQL finally got on 28 Mc. and had someone answer a CQ. He was of considerable help to QVV in the matter of making up the new rack at the new QTH. SSU is working for a radio parts house. MFJ kept twenty-seven transmitters going on board ship but it has taken months for him to get his own rig. QCE dropped in to see me but as usual I was out. PPW phoned that he had gotten his little rig fired up on 28 Mc. after its fall from the rafters in his garage. NEW is living out in the Valley and putting in his usual FB signal most every night. SCQ is going to town with his new rig. NAT been very busy on 28-Mc. mobile and MBD seems to be doing a swell job with his four-watt mobile rig. KEI sold his big transmitter to some Mexican Airline and is just getting on with a "little 100-watt or so" until he can build up another job. Capt. HJP writes that he is stationed at Mitchell Field, N. Y., with the 52nd Group. UFJ, ex-5BED, is with the CAA and is in Santa Monica at 1625 Fourth St., Apt. C. Had a swell letter from K4HTU, assistant communications officer at the VAAF, who now is portable "six" at Victorville. He has a rig at the field and is having a swell time handling traffic for the fellows when the "skip" is right. BUK writes offering his help and applies for membership in the Emergency Corps. The Glendale club meets the first and third Thursdays of each month instead of the first and third Wednesdays, as previously reported. Lt. Col. UUP is back from Europe, where he was officer in charge of the radio section of the European Theater of Operations until he was transferred after V-E Day to Military Government for Germany at Berlin to head up radio with the Allied Control Commission. He has been awarded with the Legion of Merit, the Order of the British Empire, by the King of England, and made an honorary member of the French Signal Corps. Get your reports in by the fifteenth. Ted.

SAN DIEGO — SCM, Ralph H. Culbertson, W6CHV — Asst. SCM, Gordon W. Brown, W6APG. LYF has just returned from Los Angeles after attending a month's course given by the telephone company. BOS has completed the modification of one of the Army surplus transmitters for TZO. TZO's first contact with the new transmitter on 28 Mc. was with 9QMD/KE6 with an FB report. EOP has just been elected president of the Helix Radio Club. GYV has returned to San Diego after several years in the services. EPM has returned home after spending four years in the East on the engineering staff of a large tube manufacturing company. OCJ has a new transmitter and FB four-element rotary beam running about 500 watts to pair of 813s. He has a daily schedule with 9TQD/J4. OZH is reported to have worked LU7AZ. KSE has a new rig ready to go on 28-Mc. 'phone. LRU has just completed a new rotary beam and is getting some FB reports. New stations operating on 28 Mc. are BLZ, RBY, RCD, SYA, 9LLM, 9UXZ, 5GHU, and K6RVF/6. At the January meeting of the Palomar Radio Club it was decided to hold the Annual Birthday Party about the 16th of March at Oceanside. All amateurs in Southern California are welcome. There was an FB attendance of about sixty amateurs at the meeting, including old-timers EPM, EPW, and KW. SIG walked away with the main raffle prize. The Palomar Club is preparing for Field Day and hopes ARRL will sponsor one. All amateurs in the San Diego section interested in ORS, OPS, or OBS appointments are urged to get in touch with the SCM. 73. Ralph.

WEST GULF DIVISION

NORTHERN TEXAS — SCM, Jack T. Moore, W5ALA — The Navy is sending JIZ to Kodiak Island for a ten-month tour of duty and he is taking an HT-9 transmitter with him. Luther intends to build a rhombic beamed at the center of the U. S. so be on the lookout for him — his frequencies are 28,320 and 28,768 kc. AJG is in charge of the 5th district QSL Bureau. BAM is communications officer at the Naval Air Station at Grand Prairie with the rank

(Continued on page 110)

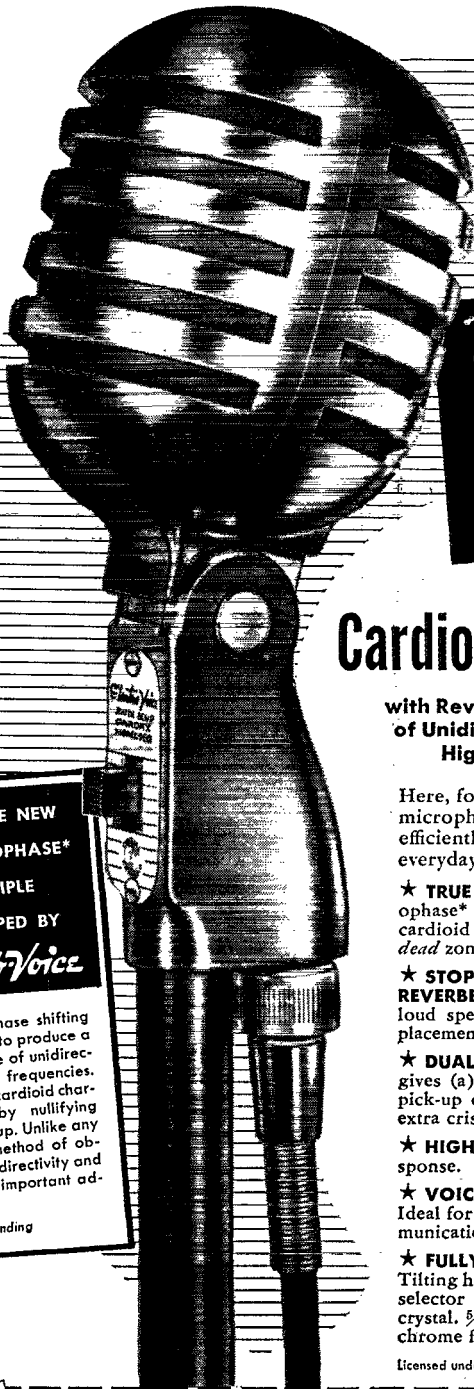

Electro-Voice
ANNOUNCES THE
CARDAX

A NEW
Cardioid Crystal Microphone

with Revolutionary New **MECHANOPHASE*** Principle of Unidirectivity . . . Dual Frequency Response . . . High Output . . . and other big features!

Here, for the first time, you get *all* these features in *one* microphone! With amazing flexibility, new CARDAX efficiently serves many applications . . . easily solves everyday problems of sound pick-up and reproduction!

★ **TRUE CARDIOID POLAR PATTERN** New E-V Mechanophase* principle gives wide-angle front pick-up in true cardioid pattern over wide frequency range. Sound at rear dead zone cancels out and is not reproduced.

★ **STOPS FEEDBACK—CUTS BACKGROUND NOISE AND REVERBERATION PICK-UP** Permits nearly double usable loud speaker volume. Simplifies microphone and speaker placement. Assures finer reproduction of just the sound wanted.

★ **DUAL FREQUENCY RESPONSE** Screw control on back gives (a) Wide range flat response for high fidelity sound pick-up or (b) Wide range with rising characteristic for extra crispness of speech or high frequency emphasis.

★ **HIGH OUTPUT LEVEL** —57 db for flat frequency response. —48 db for rising frequency response.

★ **VOICE AND MUSIC PICK-UP EXACTLY AS DESIRED** Ideal for public address, recording, remote broadcast, communications . . . indoors and outdoors.

★ **FULLY EQUIPPED FOR CONVENIENT OPERATION** Tilting head. Built-in "On-Off" switch. Dual frequency range selector switch. Cable connector. 20 ft. cable. Bimorph crystal. $\frac{5}{8}$ "-27 thread. New modern functional design. Satin chrome finish. CARDAX Model 950, List Price \$37.00

Licensed under Brush Patents. Electro-Voice Patents Pending.

EXCLUSIVE NEW
MECHANOPHASE*
PRINCIPLE
DEVELOPED BY

Electro-Voice

Utilizes a phase shifting diaphragm to produce a high degree of unidirectivity at all frequencies. Gives true cardioid characteristic by nullifying back pick-up. Unlike any previous method of obtaining unidirectivity and has many important advantages.

*Patents Pending



SEND FOR BULLETIN NOW

Get full facts about amazing new CARDAX! Describes *Mechanophase*. Shows how dual frequency response selector works. Includes diagrams and response curves.

NO FINER CHOICE THAN

Electro-Voice
M I C R O P H O N E S

ELECTRO-VOICE, INC., 1239 South Bend Ave., South Bend 24, Indiana
Export Division: 13 East 40th St., New York 16, N. Y., U.S.A.—Cables: Arlab

FOR
**PRECISION-BUILT
 ELECTRONIC
 PRODUCTS!**

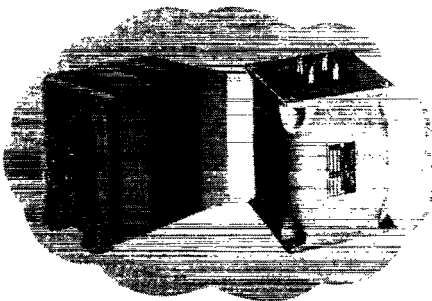

THORDARSON TRANSFORMERS

Over fifty years experience in the manufacture of quality-built transformers for all applications—replacement, communications, sound amplifier, industrial, experimental and amateur. Thordarson also originated Tru-Fidelity Amplifiers.

MEISSNER COMPONENTS

The Meissner reputation, gained and maintained by furnishing high quality components, including antenna, R.F. and oscillator coils; standard and Ferrocart transformers; windings, chokes and accessories. Meissner also makes the finest in service equipments.

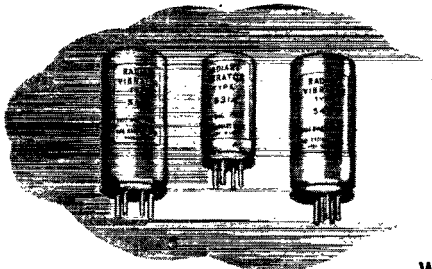
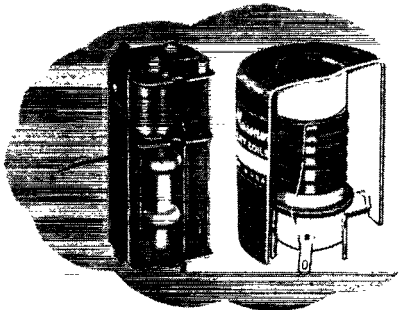

RADIART VIBRATORS

Radiart Exact Duplicate Vibrators are individually engineered to meet the physical and electrical requirements of each application. This assures longer life, minimum R.F. interference, low hum level, etc. Radiart also makes rust-proof aerials to fit all cars.

WRITE FOR COMPLETE INFORMATION TODAY!

MAGUIRE INDUSTRIES, INC.

936 NORTH MICHIGAN AVENUE, CHICAGO 11, ILLINOIS

THE RIGHT COMBINATION

THORDARSON

TRANSFORMERS

TRU-FIDELITY AMPLIFIERS

MEISSNER

COMPONENTS • KITS

SERVICE EQUIPMENT

RADIART

VIBRATORS

RUST-PROOF AERIALS

ONE
SALES
SOURCE

●
ONE
RESPONSIBILITY

BETTER
FASTER
MORE
COMPLETE
SERVICE

ELECTRONIC DISTRIBUTOR AND
INDUSTRIAL SALES DEPARTMENT

JAMES KNIGHTS

"Stabilized" *

Crystals



Quality
for the Amateur!

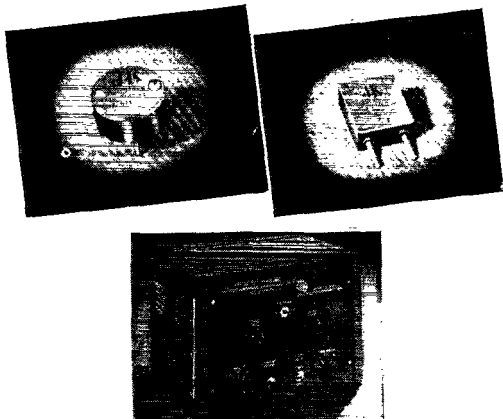

*JK "Stabilized" Crystals are made by the latest known methods of precision crystal manufacture. Our process known as "Stabilizing" absolutely prevents frequency shifts due to aging, either in operation or on the shelf.



JAMES KNIGHTS
"A Radio Researcher
Since the Early Days"

The men of the James Knights Company have grown up with Ham Radio. Because of their work with piezo quartz since it first came into use as a frequency control, they know what is expected of a good Ham Crystal. You can depend on JK "Stabilized" Crystals.



LEON A. FABER
W9DAX — "An Active Ham Since 1913"

The JAMES KNIGHTS Co.
SANDWICH, ILLINOIS

Write for New Illustrated Folder

Crystals for the Critical

(Continued from page 108)

of Lt. commander. Gene advises that Bill Green, former West Gulf Division Director, is located in Quonset Point, R. I. ISD is back home, according to CDU. AZN reports that, besides himself, the following hams are at Western Union in Dallas: JHR, GTL, AZC, DMR, ZC, and ATC. JFF has been transferred back to El Paso. ALA has a new SX-28A. ICB purchased an SX-25 and is on 28 Mc. GTL reports that he has a radiotelephone 1st-class ticket and an XYL, who he met in the Yukon Territory, where they both were radio operators in the AACSS. GML is out of the Army and is working for the FCC as a radio inspector at Galveston. SH is out of the Army and home again. 73. Jack.

OKLAHOMA — SCM, Ed Oldfield, W5AYL — Most urgent at present is the formation or rejuvenation of the Emergency Corps. FAB, 2712 1/2 N. Military, Oklahoma City, has been appointed Section EC. We owe him our cooperation in joining and supporting the Emergency Corps. His job is no small one and will require a lot of work. You are urged to contact FAB for membership applications. "Let's put it over!" HFX was discharged December 10, 1945 from the Navy after seeing service with a submarine repair unit on the west coast of Australia. JKS writes that he has made residence in Tulsa. He is an old timer (since 1919), having held calls 8UG, 8BMZ, 9QCT, and is ready to operate on 80 and 40 meters. He also was active in AARS and NCS and is traffic minded. "How about EC, Tom?" HQM returned from radio operating in the merchant marine, and expects to attend college. He has a new SX-25 receiver and is ready for 40 meters. "JOIN THE EC!" 73. Ed.

SOUTHERN TEXAS — SCM, James B. Rives, W5JC — EIS has returned to San Antonio on terminal leave from the Marines. CGW is stationed at Victoria in the signal office. DUQ has a nice rig on 28 Mc. in the bus station at Wharton. 9ZZS/5 is now assistant chief, communications engineering section, at Kelly Field. The following are active on 28 Mc. in Galveston: AFP and XG have a pair of 35Ts. DDJ has an HK24 on c.w. and 3IVT/5 is using an 813. JKZ has a new RME-45 receiver. BVF fell from a ship and broke his back. Capt. BUV has been appointed Section EC and those interested in emergency work are requested to contact him for AEC membership. DTJ is in the merchant marine and enjoys operating WQUU. EVK and BHM are active on 28 Mc. in San Antonio. NW has moved to Odessa. AXI is chief radioman in the merchant marine and is back from seven months at sea, where he covered 55,000 nautical miles to all parts of the world. HJY has an 813 on 28 Mc. and is in the amateur supply business in San Antonio. 2KGI/5 is active in Texas City. BKE has received his discharge from the Army and is assistant station manager for Braniff at Alamo Field. Maj. FTU has returned from India. JVF is in Peiping, China, operating XONE. HDK has purchased a twin-engine Cessna airplane with plenty of radio gear aboard. 73. Jim.

NEW MEXICO — SCM, J. G. Hancock, W5HJF — JJJ, who is experimenting with frequency-multipliers, sends the following report from the gang in Albuquerque: JYZ is running 200 watts to a 203A and is also on 144 Mc. FAG has 100 watts to an 829, and is planning a pair of 8005s final. 7GOH is building a 35T 200 watts final to add to his 807. 9SPN is looking for a power supply to run his 1000 watts Eimac 250Ts final, he also is sporting a 28-Mc. Signal Shifter and a pair of windchanger towers to hang his antenna on. BEZ, EWM, HGV, 3IGO, 3JSD (ex-5GGX), 6UNW, 6UQD, 9BEZ, and 9DDU are other stations active on 28 Mc. in Albuquerque. These fellows are organizing a club and plan to erect a club house with transmitters and receivers installed. HJF and IESZ are on 144 Mc. as well as 28 Mc. from Portales. ICD is in Los Angeles. David Erwin (LSPH) is home from the Navy awaiting his station license. Bozo, the faithful mascot at HJF, died of poison early in January. 73. Jake.

CANADA

MARITIME DIVISION

MARITIME — A. M. Crowell, VE1DQ — The HARC elected the following: EK, pres.; ET, vice-pres.; JH, secy.; and OB, treas. The club will make application for the call VE1FO, in memory of F/O Doug Smith, well-known former EC and ardent HARC worker. Famous first — Ron's new RME-45. All Maritime clubs are asked to send in their news items to the SCM by the 16th. All applications

(Continued on page 118)

TINY* *but* TERRIFIC!

Impossible . . . yet here it is!

A complete radio tube . . . slim as
a pencil, short as a paper-clip!

Built for high and ultra-
high frequencies.

So rugged it will bounce!

Developed by SYLVANIA!

Short leads, inside and
outside the tube, mean
FLAT response in the new
high frequency bands.

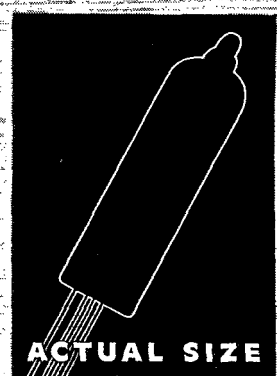

* The size of this tube, designated
as T-3, will permit cigarette-
pack size portable radios.

SYLVANIA ELECTRIC

Emporium, Pa.

MAKERS OF RADIO TUBES; CATHODE RAY TUBES; ELECTRONIC DEVICES; FLUORESCENT LAMPS, FIXTURES, WIRING DEVICES; ELECTRICLIGHT BULBS

NOW You CAN HAVE Mathematically Dimensioned CRYSTALS

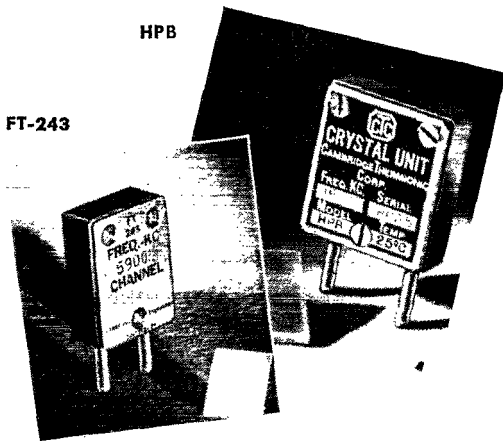

Mathematical dimensioning, C.T.C.'s brilliant wartime discovery which assures low drift and high activity, is now one of the many important features of C.T.C. Crystals for amateur use. This important development plus X-ray Orientation, mechanical lapping, etching to final frequency and other exclusive C.T.C. features make C.T.C. Crystals the amateur's best bet.

Ready for immediate delivery for amateur frequencies in the 20, 40 and 80 meter band, C.T.C. Crystals come in two models, the HPB to fit 5 or 6 prong sockets and the FT-243 to fit octal sockets.

For complete information on C.T.C. "Crystals You Can Count On" write for free bulletin



CAMBRIDGE THERMIONIC CORP.
451 CONCORD AVENUE
CAMBRIDGE 38, MASSACHUSETTS

(Continued from page 110)

for EC appointment and AEC membership will be given prompt attention. Lt. BK, home on leave from England, says that the greatest efficiency in the T/S base in England was obtained by retaining hams in the key positions wherever possible, and that the work of VE hams was outstanding. He mentions 4AIN, 4AJV, and 4VX. DM is gathering parts for new rig. AO is in radio work in N. Ontario. New HARC members are 2FF and 3AYC. Halifax calls heard on 28 Mc.: DB, LZ, MZ, OB, NW, HB, HJ, EF, OM, PQ, JS, LY, QM, OK, OE, and NO. VO2KJ, formerly VE1KJ, now at Gander, Newfoundland, reports there are two other Canadian hams who also operate the station, VE1GI and VE3DN. VE1HH and VE1FU are nearby. Also active are: VO2N, VO2H, VO1Y, VO1I, VO1A, VO1D, and VO4A. VO2O works in the American transmitter station. VO2W soon will be on. 73. DQ.

QUEBEC DIVISION

QUEBEC — SCM, L. G. Morris, VE2CO — Ex-GA, who was transferred to the Bell Telephone Co. in Toronto, writes that his new call is 3BDA. In a ceremony at Buckingham Palace, IO was awarded the M.B.E. for his meritorious service in the RCAF. Congrats to Mr. & Mrs. GE on the arrival of their first jr. operator — a boy. Additions to the 28-Mc. gang include MT, PZ, and DR on c.w. and KC, DG, EM, and AX on 'phone. 6UI, VP5AG, and DG (who is ex-3ACN) are students at McGill. W2NZU visited BK, FK, and CO while on furlough from the USN. The McGill Radio Club has been reorganized and is planning to set up its own station again.

VANALTA DIVISION

ALBERTA — SCM, C. S. Jamieson, VE4GE — The following report was written by LQ. BW, LQ, EY, ALO, EA, HM, UP, XE, ASX are gradually getting rigs working on "ten." ALO is Edmonton's "standout" 28-Mc. station. HM put pair of 807's into his final. ANQ is back in Camrose after a few years at CJCA, Edmonton. Cpl. ANS, RCMP, is stationed in the Edmonton Barracks. MO is back at the old stamping ground. SW moved to Camrose. BW gets out FB on 28 Mc. HA was in BW's joint picking up a few necessary parts for his heap. EO says ALI and ALH, of Lethbridge, are on 28 Mc. Frank Duval, still in uniform, has returned to his old haunts. AF was in the Army when last heard of, stationed in Vancouver. ASX and JJ are on 28 Mc. BV is hot on the trail of a private pilot's license. BW and ALO went to "The Fort" to help GY get the heap going again. UT has returned after his tour of duty with the RCAF. LQ rebuilt his frequency meter and installed a VR tube therein; also has modulator rebuilt. AC is back on the air; he's rebuilding his frequency meter. AEV, TM, GD, and AW got together for a little "bull-session." AEV managed to scrounge a few feet of coaxial cable for his 28-Mc. antenna.

PRAIRIE DIVISION

MANITOBA — SCM, A. W. Morley, VE4AAW — AEE has opened radio shop in Roblin. 5DV left Flin Flon and went back to B.C. AEO has been discharged from the Navy. OB and AEQ finished supers. YM and AFF now are at Flin Flon. NO is in tower at Stevenson's. AFV, who was in Europe for a few years, is home. HC is discharged and working in Peg. AAE and ADC are back. ACP and 2BS are in Edmonton. RO, KF, SO, YZ, IU, SEI, SR, EK, ABV, QV, ACR, AJC, EF, AFE, VD, AAV, ZK, IS, MN, and IK are Winnipeg stations on 28 Mc. IF/AMS, of Brandon, and AIX, of Binscarth, are also on 28 Mc. ABE is on 56 Mc. ADG and APE were seen buying parts. It is time to start thinking of traffic work. Will anyone interested please get in touch with me? 73. Art.

**SWITCH
TO SAFETY!**



PRECISION MOVEMENTS

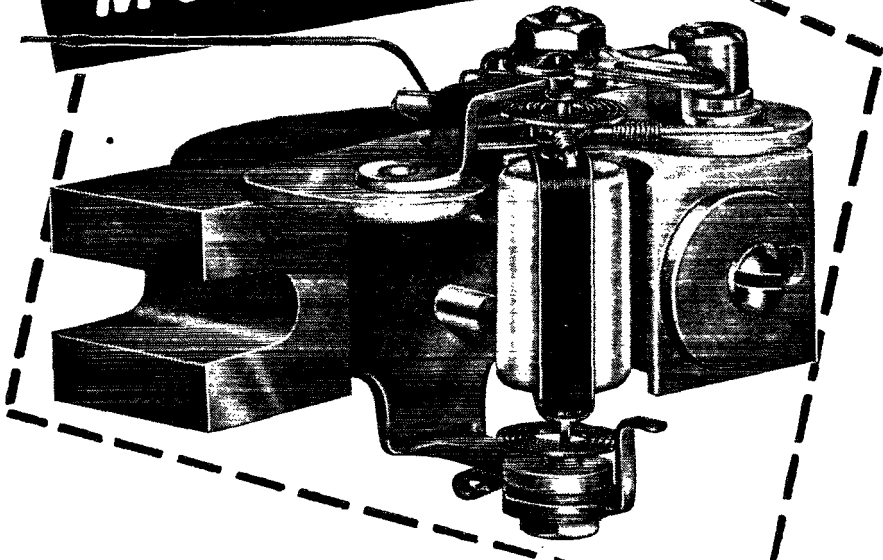

Burlington PANEL INSTRUMENTS

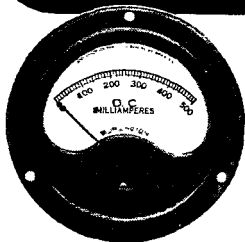

The heart of every Burlington Instrument — and the reason for its high degree of dependability — is the Burlington Precision Movement.

Design, material, and manufacturing processes are selected in such a manner that Burlington gives you a rugged instrument — which may be subjected to rough usage — and still retain its original calibration characteristics. All DC instruments employ Alnico magnets which are known to be more highly resistant to shock, heat, vibration, and stray fields than any other magnetic material. All ranges AC and DC are available in 2½", 3½" and 4½" sizes, both square and round, flush mounting.

Engineering Service Furnished for Specialized Applications. No Obligation

Write Today for Further Information

BURLINGTON INSTRUMENT COMPANY • 804 Fourth Street, Burlington, Iowa

**Still Your BEST CHOICE for
ALL INPUTS...ON ALL BANDS!**

TAYLOR TUBES

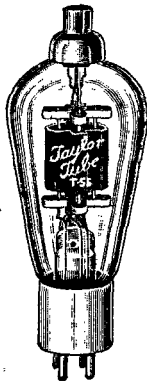
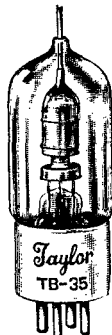
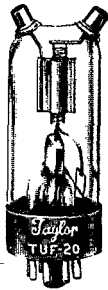

- ★ CLASS C RADIO FREQUENCY
- ★ FREQUENCY MULTIPLYING
- ★ CRYSTAL OSCILLATOR
- ★ CLASS B AUDIO
- ★ POWER SUPPLIES

TAYLOR TUBES are the choice of Amateurs who insist on "More Watts per Dollar." With TAYLOR TUBES, they get the greatest possible "Safety Factor" which means protection against loss of tubes due to temporary overloads.

In rectifiers, the 866 Jr. and 866 A are the standard of comparison . . . more in use than all other makes combined.

The TZ-40 has been the leader in the medium power field for 8 years . . . it's still the tops in performance and value for both Class C RF and Class B Audio. Proof can be heard on the air daily.

The "Tuffy" TUF-20 has set a new standard in the portable mobile field — a tube that can take it and put it out!

The new TAYLOR TB-35 Beam Tetrode has quickly established itself as a most popular type for ease of drive and for band-change rigs.

That's just high-lighting a few of the famous TAYLOR TUBES. Others — the T-55 — the T-200 and the T-125 — the T-20 and TZ-20 — the 805 and 203 Z and the big 822 are again enjoying deserved popularity.

Most Hams know that they are safer with TAYLOR TUBES because they are protected by the generous TAYLOR GUARANTEE.

**SOLD BY ALL LEADING
RADIO PARTS DISTRIBUTORS**

ALL AMATEUR TRANSMITTER CONTEST

For the best interests of all Amateurs, the contest closing date has been extended to May 15, 1946. You can still secure your entry blank at your radio parts distributor or by writing directly to TAYLOR TUBES, INC.

**"MORE WATTS
PER DOLLAR"**

Taylor HEAVY **CUSTOM BUILT** DUTY **Tubes**
TAYLOR TUBES INC., 2312-18 WABANSIA AVE., CHICAGO 47, ILL.

For tubes of Uniform Performance . . .

BEAT THE HEAT

with SPEER GRAPHITE ANODES

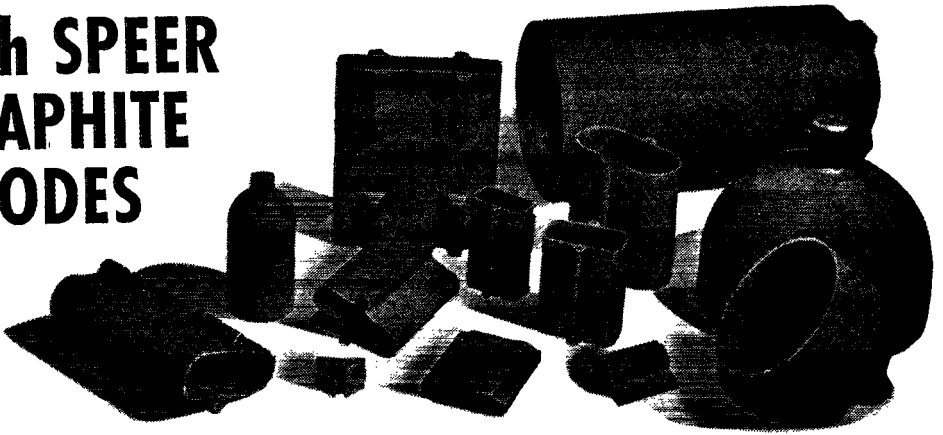

In manufacturing transmitter and rectifier tubes that are truly uniform in performance, the high heat dissipation value of SPEER Graphite Anodes is an important factor. It's one of the many reasons why SPEER Anodes are consistently specified by so many leading tube manufacturers and tube users.

Tubes containing SPEER Graphite Anodes can handle greater plate power dissipation as they disperse the heat of operation faster, and because SPEER Anodes minimize heat transfer to other component parts of the tube. SPEER Graphite Anodes will withstand any temperature up to 3500 F. without warping—temperatures at which many anode materials may soften and distort.

SPEER Anodes are carefully processed and are 99.9% pure electro-graphite. They can be machined to extremely close tolerances to conform with your tube design. Internal face spacings of SPEER Graphite Anodes can be held to .002 inch.

The many advantages of SPEER Graphite Anodes listed here are available to manufacturers and users of almost every type of electronic tube. Write today for further details, without obligation.

Do You Know?

SPEER GRAPHITE ANODES

- Lower temperatures of associated tube parts.
- Withstand severe overloads.
- Defy warping.
- Prevent hot spots or fused holes.
- Minimize bulb darkening and insulator leakage.
- Improve degassing qualities.
- Decrease gas troubles.
- Enhance tube appearance.
- Provide precise anode dimensions.
- Produce uniform tube characteristics.
- Retain original dimensions in service.
- Maintain normal tube characteristics.
- Allow wide latitude of anode design.

595

CHICAGO • CLEVELAND • DETROIT
MILWAUKEE • NEW YORK • PITTSBURGH



SPEER

CARBON COMPANY
ST. MARYS, PA.

STATION TESTED*

*an added
proof of Quality!*

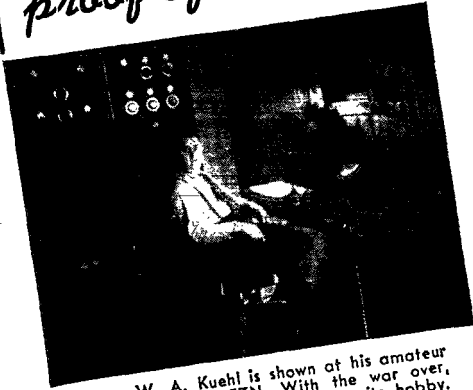

*Pres. W. A. Kuehl is shown at his amateur radio station W9EZN. With the war over, Walt is again pursuing his favorite hobby.

DRAKE RADIO SOLDERING IRONS

Yes, Drake irons are *right for radio*. And these sturdy irons have proved their dependability and worth in use on countless other jobs, too, for over 25 years. That's why we say — whatever your needs, you are certain to find a Drake iron that fills the bill. exactly!



600-10—the Drake No. 600-10 is ideal for those all important connections when rewiring your rig. Get back on the air fast. Make good dependable connections with this 100 watt $\frac{3}{4}$ " tip.



400—the Drake No. 400 is the perfect iron for work in small places. Only 9 inches long, it is especially designed for tight corners and delicate connections. 60 watt, $\frac{1}{4}$ " tip.



Ask your nearest supplier or write for the name of the distributor nearest you . . . and give yourself the advantages of these superior irons.

DRAKE ELECTRIC WORKS, INC.

3656 LINCOLN AVE.

CHICAGO 13, ILL.

Panoramic Reception

(Continued from page 27)

used for all of the tubes and to furnish part of the 'scope voltage, and a low-current negative supply makes up the rest of the 'scope supply. The intensity control, R_{21} , varies the brightness of the trace and the focusing control, R_{17} is necessary to set the beam to as small a spot as possible. A VR-105 regulator tube is used to stabilize the screen voltage on the modulator and oscillator tube.

Alignment Procedure

About half a minute after the power switch is turned on, the baseline should appear on the screen. If not, the intensity and focus controls may be adjusted. Should it be found that the baseline does not appear but the screen glows, the vertical-position control should be adjusted until the baseline comes into view. Reduction of the intensity and proper adjustment of the focus control produces a sharp baseline. The horizontal position control is adjusted so that the baseline is approximately centered along the horizontal axis.

The 226-kc. channel is first aligned by introducing a 226-kc. signal on the grid of the 6SG7 and adjusting the trimmers on T_4 for maximum vertical deflection on the 'scope. The signal can then be transferred to pin 8 of the 6SA7 mixer tube and T_3 aligned in a similar manner. The signal-generator output must be kept low to avoid overload.

Next a 455-kc. signal — or whatever the receiver i.f. is — is introduced at the grid of the first 6SG7 amplifier. The gain and sweepwidth controls are turned to maximum, and the center-frequency control is adjusted until the signal "pip" is approximately centered on the 'scope. The sweepwidth should then be slowly reduced, and as this is done the "pip" will broaden out. At all times the center-frequency control may require readjustment to keep the broadening "pip" centered. Finally, when the sweepwidth is at zero, the center-frequency control should be adjusted for maximum deflection. Maximum deflection is more easily recognized if the gain is reduced slightly. The sweepwidth control is then turned back to maximum, and the horizontal-centering control is adjusted to bring the "pip" to the exact center.

The signal generator is then set to 100 kc. higher, or about 555 kc. With the sweep pad, R_{33} , set the "pip" to the extreme right of the calibrated scale. When the frequency is now reduced 200 kc., the "pip" should move over to the extreme left-hand side of the 'scope face. If it doesn't, the oscillator trimmer on T_5 should be turned slightly and the process in this and the above paragraph repeated. With a little care, it is possible to adjust the system to have less than 10 kc. discrepancy at either end of the sweep.

Now set the signal generator to 90 kc. lower

(Concluded on page 118)

Two New HYDROGEN THYRATRONS

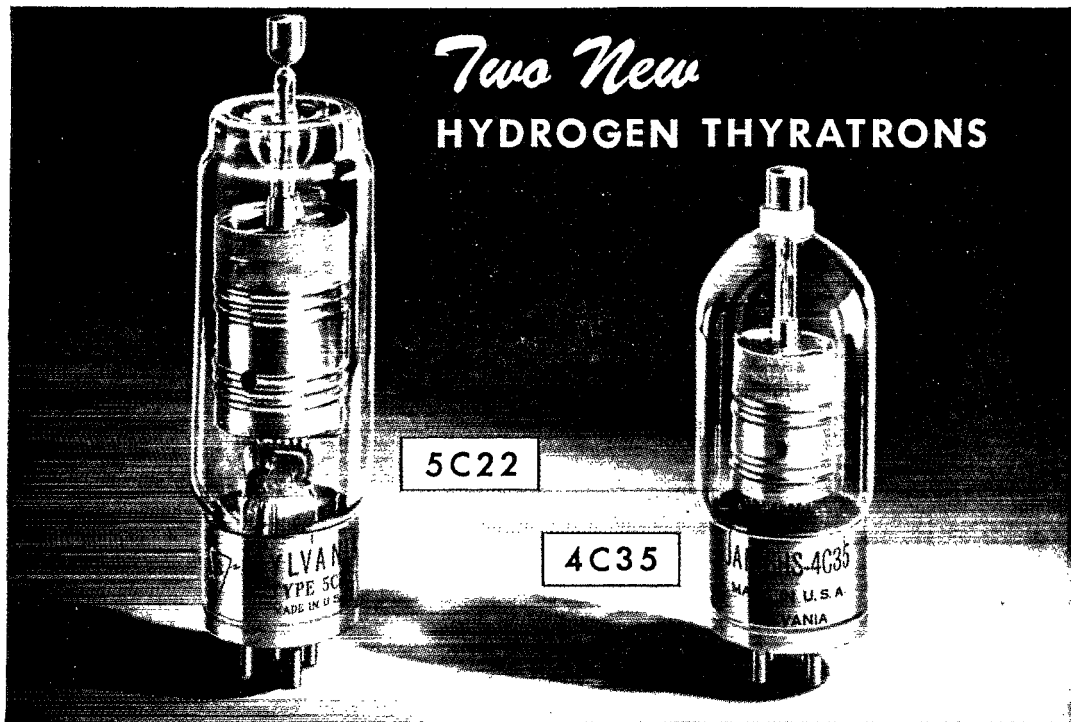

These Hydrogen Thyratrons are hot-cathode grid-controlled gas rectifier tubes especially designed for zero bias pulsing service at high repetition frequencies, high peak currents, and high voltages.

An outstanding feature of Hydrogen Thyratrons is the short deionization time required to convert the gaseous ions to neutral molecules when the tube is shut off. This permits operation at exceptionally high repetition frequencies. Also, an outstanding advantage is that they may be operated over a wide range of ambient temperatures without significant change in electrical characteristics.

APPLICATIONS

Applications suggested by the character-

istics of these two Hydrogen Thyratrons are:

1. Switching in welding circuits, particularly of the capacitor discharge type.
2. Shock excitation of tuned circuit.
3. Excitation of piezoelectric crystals.
4. Use in induction heating circuits to replace spark-gap heaters, resulting in trouble-free and quieter performance.
5. Pulser for pulse time modulation circuits in which signals are produced by modulating the pulse repetition rate.
6. Servomechanisms and control circuits where relatively high a-c supply frequencies are used.

CHARACTERISTICS	5C22	4C35
Peak anode voltage	16 KV	8.0 KV max.
Peak anode current	325 amps. max.	90 amps. max.
Peak inverse anode voltage	16 KV	8.0 KV max.
Average anode current	200 ma. max.	100 ma. d-c max.

SYLVANIA ELECTRIC

Electronics Division, 500 Fifth Ave., New York 18, N. Y.

MAKERS OF ELECTRONIC DEVICES; RADIO TUBES; CATHODE RAY TUBES; FLUORESCENT LAMPS, FIXTURES, WIRING DEVICES; ELECTRIC LIGHT BULBS

When BYRD Flew South . . .

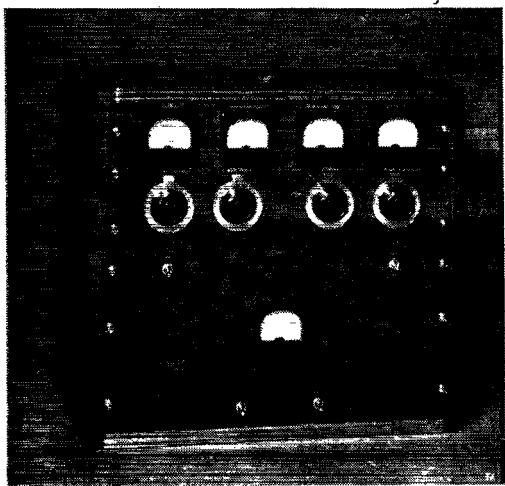

A HARVEY 100-T TRANSMITTER

Like This Went With Him

Admiral Byrd's Antarctic Expedition is but one of many important pre-war and wartime missions on which HARVEY Model 100-T Transmitters have proven their worth.

These plate modulated units have the power and range to provide real performance. They have everything you want—5 band operation, quick frequency shift, easy tuning, efficient appearance and low cost.

Write for free Transmitter Bulletin. It has the whole story on the HARVEY 100-T and the UHX-25 in which you may be interested.



HARVEY RADIO LABORATORIES, INC.

451 CONCORD AVENUE
CAMBRIDGE 38, MASSACHUSETTS

(Continued from page 116)

than the nominal frequency and peak the signal by adjusting the two top trimmers of T_2 . During this process the equalizer, R_6 , is set at minimum resistance and the coupling capacitor, on the side of T_2 , is set at minimum capacity. Then setting the signal generator to 90 kc. higher than the nominal frequency, the side trimmer — the coupling capacity — is adjusted for maximum signal at the 90 kc. higher point.

The signal generator is then connected to the free end of R_1 and ground, and the steps in the above paragraph repeated for T_1 .

It is also possible to align the r.f. section — T_1 and T_2 — by feeding a broad band of frequencies in through R_1 and examining the entire pass band of the r.f. section at one time. Suitable sources for this signal are a 3-ke. multivibrator, a saw-tooth generator, a square-wave generator, or any other source of high-frequency steep wave fronts. The same tuning procedure is followed, except that the resultant 'scope picture will be a group of vertical "pips" with their top outline following the configuration of the compensation curve in Fig. 2-B.

The isolating resistor, R_1 , must be connected as close as possible to the plate of the receiver converter tube, to avoid detuning of the receiver i.f., and as close as possible to the shielded cable, RG-58/U, to avoid pick-up of external signals.

Once the panoramic adaptor is in use in an amateur station, it will be found to be an invaluable tool in many ways.

About the Authors

• Ray Clurman broke into amateur radio in 1933, with the call W1EPI. For his S.B. at M.I.T., in 1938, his thesis was on a tricky "speech-music discriminator." It could be used on broadcast receivers to turn down the volume automatically as soon as the announcer came on, and this angle made it an overnight sensation in the Boston papers. However, Ray frankly admits that the broadcasters licked him with the introduction of singing commercials. Since getting an M.B.A. from Harvard in 1940, he has done consultant work on f.m. stations, radar development for the Signal Corps which included working on one of the first megawatt radars, and currently his work for Panoramic involves engineering and liaison. His ham interests are DX, television and circuit design.

Bernard Schlessel waited until 1944 to get his ham license and hence is in the "LSPH" no-call predicament, a condition that will be remedied very shortly. His B.S. was granted at Brooklyn's St. Francis College, and since then he has been an AAF Instructor at Scott Field and Sioux Falls and a Coordinator at Yale O.C.S. His present work at Panoramic includes writing of instruction books and advertising, and finding more applications for panoramic equipment.

**A rugged performer with
a big voice and keen ear!**

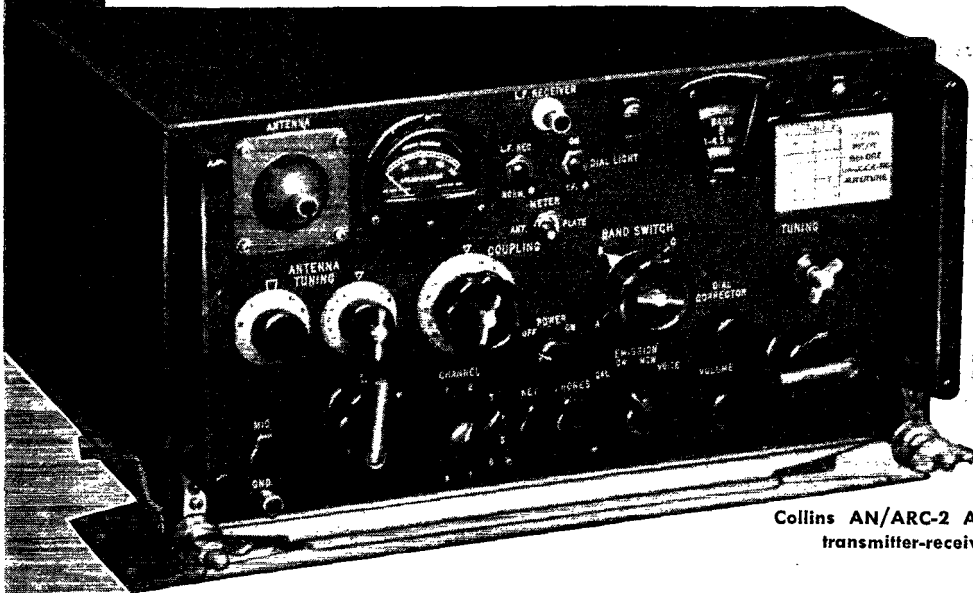

**Collins AN/ARC-2 Autotune
transmitter-receiver**

**Remote
Control
Box**

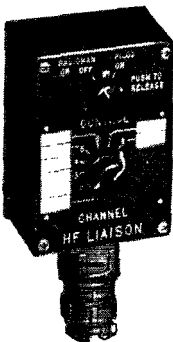

The AN/ARC-2 Autotune transmitter-receiver was designed and is built by Collins for two place and larger military aircraft. It is an example of the experience, design ingenuity and manufacturing skill also available, in the Collins organization, to commercial users of communication equipment.

Transmitter, receiver and dynamotor are all contained in the same case. The weight and space requirement of the AN/ARC-2 is considerably less than that of the equipment it replaces. Any one of eight pretuned channels is immediately and automatically available by means of the Collins Autotune, operated either at the main panel or by remote control. The transmitter and receiver are tuned simultaneously by a single set of controls.

This equipment, including its Autotune mechanism, functions reliably at all temperatures from -58° to $+140^{\circ}$ F, all altitudes from sea level to 40,000 feet, and all conditions of humidity up to saturation.

The Collins organization specializes in fulfilling exacting requirements. We will welcome an opportunity to make recommendations regarding your needs in the field of radio communication equipment. Collins Radio Company, Cedar Rapids, Iowa; 11 West 42nd Street, New York 18, N. Y.

IN RADIO COMMUNICATIONS, IT'S...

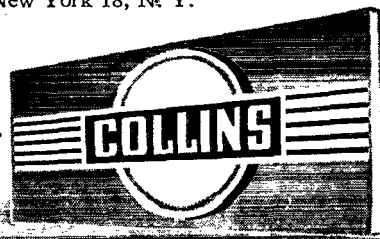

HAM GEAR

at Newark Electric

Another month, another issue of *QST* and we're back at the same old corner. Can't say it has exactly become a habit because this is only our second crack at this HAM GEAR column.

Just in case you missed the January issue, it is our intention to devote this space each month to ham gear — the components that make it up and sometimes about the people and the brainwork they put into it. If you can drop in at a Newark store and tell us what interests you, please do. Otherwise write us a card. We'd like to hear from you.

Our subject for discussion this month is the RCA 2C43 tube, a Lighthouse triode. During the war the armed forces used this little electronic gem in ways that can't be disclosed as yet. Amateurs planning to go into the new u.h.f. bands will find that RCA designers have engineered out of the 2C43 the usual frequency-limiting factors found in most triodes. This Lighthouse tube can be used in suitable circuits at frequencies up to about 3,000 megacycles.

The features of the 2C43 that make it of such great value in high frequency applications as an amplifier or oscillator include very close interelectrode spacing combined with low interelectrode capacitances, rf and multiple D.C. cathode connections, and unique arrangements for connections to the plate and grid.

Design-center ratings, always useful in considering tube features best adaptable to your gear, are shown below:

Plate voltage.....450 max.
 Plate current ma..... 36 max.
 Plate Dissipation watts..... 10 max.
 Maximum potential difference between
 heater and cathode, volts ± 90
 Plate seal temperature 150 deg. C max.

The high value of transconductance, the virtual absence of lead inductance, and the rigid construction of the active elements in the 2C43 make it a very

stable and highly efficient oscillator. Its mechanical design makes it adaptable to electrical and mechanical circuit design in a variety of ways. All in all, the amateurs who try to use the tube will most probably be gratified with the ease that excellent results are obtained.

Let's now consider the installation of the 2C43 Lighthouse tube. After all that is important. Starting at the bottom (pardon the pun), the base pins fit an octal socket. The mounting should support it by the metal shell (rf cathode terminal) rather than by the base or other terminals. Connectors for the grid disc and for the plate disc and post must make firm, large-surface contact. In addition, the plate connector must be capable of conducting heat so that the plate-seal temperature will not exceed 150° C under any conditions of operation.

The heater of the 2C43 is designed to be operated at 6.3 volts. The transformer winding supplying the heater power should be designed to operate the heater at the rated voltage under average line-voltage conditions. To make possible the reduction of circuit inductance, the cathode is brought out to three base pins. In addition, a capacitor of approximately 70 μf is connected between the cathode and the metal shell. Connection to the shell provides a low-impedance path for the u.h.f. currents to the cathode.

A bias of not more than 90 volts is permissible between heater and cathode. Operation of the 2C43 is recommended with self-bias rather than with fixed bias.

We'd like to tell you a lot more about the 2C43 Lighthouse tube — such as the great job RCA did in putting it into production early in the war, but that would take us right off the page. If all this interests you, and if you'd like to "get into" the exciting new u.h.f. bands, drop us a line and we'll send you more dope. And that just about winds up this QSO. We'll be back next month, though, so be watching for us.

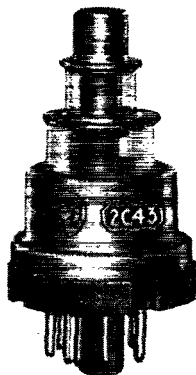

CHICAGO

Newark ELECTRIC Company

NEW YORK

115-117 W. 45th St.
 NEW YORK 19
 BRyant 9-4735
 (ADOLPH GROSS)

"Service is the
 Foundation
 of our Business"

323 W. Madison St.
 CHICAGO 6
 DEARborn 0083
 (SAM PONCHER)

HAMS ... here are all the things you've been waiting for in **NEWARK'S** two big stores. Order from the store nearest you for fast service.

THIS MONTH'S FEATURES

The famous Newark bargain oil-filled, oil-impregnated

FILTER CONDENSERS

Fully guaranteed at rated voltages

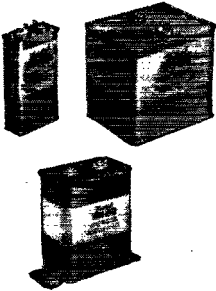

Capacity	Working Voltage	Height	Width	Depth	Wt.	Price
1 mfd.	1500 V. D.C.	2 3/8	1 3/4	1 1/2	4 oz.	\$.79
4 mfd.	1000 V. D.C.	3 1/4	2 1/2	1 1/4	12 oz.	1.50
4 mfd.	3000 V. D.C.	3 3/4	1 3/4	3 3/8	1 1/4 lbs.	3.75
5 mfd.	2000 V. D.C.	4	3 3/4	1 1/4	1 lb. 4 oz.	2.15
8 mfd.	2000 V. D.C.	4 1/2	3 3/4	2 1/2	2 1/2 lbs.	2.75
.15 mfd.	4000 V. D.C.	2 1/2	1 3/4	1	8 oz.	.89
.25 mfd.*	2000 V. D.C.	3 3/4	1 3/4	1	6 oz.	.69
*Special Porcelain Insulators						
1.5 mfd.	1000 V. D.C.	2 1/2	1 3/4	1	8 oz.	.59
10 mfd.	3000 V. D.C.	4 1/2	3 3/4	3 1/4	3 lbs. 8 oz.	4.75
13 mfd.	1000 V. D.C.	3 3/4	3 1/2	1 3/4	1 3/4 lbs.	2.25
15 mfd.	3000 V. D.C.	4 1/2	4 1/4	3 1/2	5 lbs.	5.25
8 mfd.	3000 V. D.C.	7 3/4	6 1/2	3 3/4	7 lbs. 4 oz.	3.95
2 mfd. and 4 mfd.	600 V. in metal can	4 1/2	2 1/2	1 1/4	14 oz.	.80
5-5-15 mfd.	1000 V. in metal can	4 1/2	3 1/2	3 3/4	4 1/4 lbs.	1.75

McELROY KEY

The Deluxe — Model CP 810 \$9.75

G.E. METERS

O-500 D.C. MA. 2" round Bakelite case..... \$3.50

O-8 RF ammeter, 2" round Bakelite case..... \$4.00

ABBOTT TR-4

Compact, efficient 2 1/2 meter transmitter-receiver less tubes and power supply \$39.00

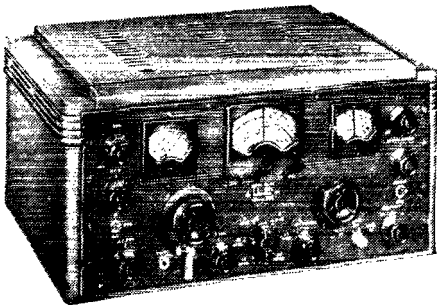

HALLICRAFTERS

SX-28A	Super Skyrider with crystal, less speaker.	\$223.00
S-20R	Sky Champion with built-in speaker.....	60.00
S-22R	Skyrider Marine with built-in speaker...	74.50
SX-25	Super Defiant with crystal, less speaker...	94.50
S-39	Sky Ranger portable, AC/DC and battery	110.00
SX-36	FM/AM receiver.....	415.00
S-37	V.H.F. FM/AM receiver.....	591.75
PM-23	10" PM speaker in cabinet for use with SX-25, SX-28A.....	15.00

TUBE BARGAINS • Many famous makes, popular types at ridiculously low prices! Write for list!

NEWARK TRANSFORMER BARGAINS

45556	778 V.C.T. at 200 M.A. 115 V. 60 Cycle 6.3 V.C.T. at 5A. 5 V. at 30 amp. 9 lbs.....	\$3.95
45557	15 H. 150 MA. 200 ohm 2000 V. Insulation 5 1/2 lbs.....	\$1.95

CLOSE OUT ON METERS. \$4.95 EACH

Western Electric Micro-ammeter. Bakelite case fits 3 3/4" hole. Radium dial 150-0-150. Can be used with 0-200 micro and amp scale costing 15¢ additional. Excellent as a 5,000 ohm-pervolt meter or null, sound level and galvanometer indicator. Instruction included. No priority required.

4 1/2" square 0-200 Micro-ammeter.
4 1/2" square 100-0-100 Micro-ammeter.

NEWARK GUARANTEE

All merchandise advertised carries the usual Newark Electric guarantee of complete satisfaction!

HAMMARLUND

HQ-129X (with tubes).....	\$129.00
ASP-210X.....	318.00
ASP-210SX.....	318.00

Available for rack mounting at same prices

NATIONAL

NC-2-40C and speaker..... \$240.00

RME

RME-45 and speaker..... \$166.00

Get Your Name on Our Mailing List

Be first to get announcements of merchandise available, special bargains, etc., etc. Send name and address on post card. State whether amateur, engineer, school, industrial or service man. Address orders and inquiries to Dept. Q, at NEWARK store nearest you.

ALL PRICES SUBJECT TO CHANGE WITHOUT NOTICE

NEW YORK
Newark ELECTRIC Company
CHICAGO

115-117 W. 45th St.
NEW YORK 19
BRYant 9-4735
(ADOLPH GROSS)

"Service is the Foundation of our Business"

323 W. Madison St.
CHICAGO 6
DEARborn 0083
(SAM PONCHER)

In this NEW WORLD OF ELECTRONICS

Will you go *Forward-*
or *Backward?*



TO GET AHEAD YOU
MUST STUDY NOW

NEW ELECTRONIC TECHNIQUES—War-born developments equivalent to 20 years of research are here. Your future demands that your technical knowledge be modernized to keep pace with these new developments.

THE EXACTING DEMANDS OF POST-WAR EMPLOYMENT require that you "deliver the goods." Employers can afford to be "choosy"—only the technically qualified can expect to pass the screening tests for the better jobs. "What Do You Know?" will be the hurdle you will have to leap. Pulse shaping techniques—cavity resonators—single sideband multitone multiplex transmission—These are commonplace terms in this New World of Electronics. Do you know these or similar new techniques?

MORE THAN EVER BEFORE a sound basic knowledge of up-to-date, fundamental engineering of radio electronics is an essential to a better job—promotion—increase in pay.

LET CIRE TAKE OVER YOUR PERSONAL UP-GRADING PROBLEM. Qualified, competent instructors, ample, personalized instructional aids, orderly, progressively arranged study assignments in recognized, approved technical texts—these are only a few of the many superior advantages of CIRE'S plan of personalized spare-time home study training for professional self-improvement.

CIRE HOME STUDY COURSES COVER THE FIELD OF RADIO-ELECTRONICS—TELEVISION, ULTRA-HIGH FREQUENCY TECHNIQUES, AM AND FM BROADCASTING, COMMUNICATIONS ENGINEERING—from simple treatment of fundamentals, through preparation for FCC commercial radio operators' license examinations, up to and including complete high level quantitative treatment of advanced radio-electronics and communications engineering. **Choose the course best suited to your needs, and start with the section you are qualified to enter. You pay for only the section or sections you need. Use the "Pay-as-you-go plan" patterned after ethical, educational practice.** These features are unique with Cleveland Institute, and represent the best in the modern, post-war concept of home study training.

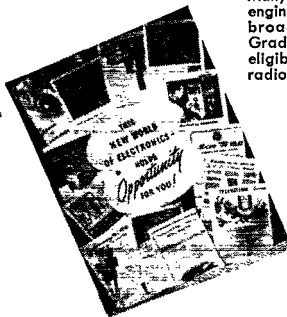

Many CIRE students of advanced engineering courses today are broadcast chief engineers. Graduates of CIRE courses are eligible for the top jobs in radio-electronics.

Write today for free, descriptive booklet—"THIS NEW WORLD OF ELECTRONICS HOLDS OPPORTUNITY FOR YOU."

No obligation—no salesman.

CLEVELAND INSTITUTE OF RADIO ELECTRONICS

Successors to

NILSON RADIO SCHOOL, Founded 1939

SMITH PRACTICAL RADIO INSTITUTE, Founded 1934

QT-3, Terminal Tower

Cleveland 13, Ohio

Radar Beams

(Continued from page 40)

v.h.f. and u.h.f. antennas have a voltage standing-wave ratio at the base of the pedestal of two-to-one or less over their band of frequencies, which is generally about 3 per cent wide. The microwave antennas usually have a voltage standing-wave ratio measured at the base of the pedestal of 1.5 to one or less over their band of frequencies, from 3 to 10 per cent wide. This is not because microwave antennas are inherently better matched, but because microwave magnets must be worked into a flatter line.

Don't let the fancy pictures frighten you. The antennas shown were designed for military use, to take tremendous shock and vibration, and to give extremely reliable operation. The electrical performance can be duplicated, if the sizes of the antennas as measured in wavelengths are duplicated, without a great deal of effort providing care and a little time are given to tuning up. There isn't much excuse for being smothered by QRM with a good beam—and really good beams, as shown by the patterns above, can be built. (Photographs courtesy of General Electric Company and Raytheon Manufacturing Company.)

About the Author

• W2BPZ is new to the pages of *QST* but not to amateur radio. He obtained his license in 1931, at the tender age of thirteen, and his Class A (then "unlimited 'phone") a year later. A commercial telephone first, picked up for his seventeenth birthday, has never been used. His B.S. and M.S. from M.I.T., granted in 1942, were a little late, thanks to the war. While at Tech he did cooperative work at Western Electric and Bell Telephone Labs, and was Research Assistant, M.I.T. E.E. Dept., 1939-1941. A staff member of Radiation Lab, 1940-1944, he was a senior engineer at Raytheon in charge of the microwave laboratory from 1941 to 1945. Since November he has been a Research Associate in the E.E. Dept. at M.I.T., working in the Research Laboratory for Electronics and studying for his D.Sc. in E.E. In his spare time he hams on the low frequencies around 144 Mc.



Coincidence: At the same time our ITS department was answering a letter from W9OPA a similar letter was being written to a Roger Wilco!

For the Finest . . .

IN ACCESSORIES

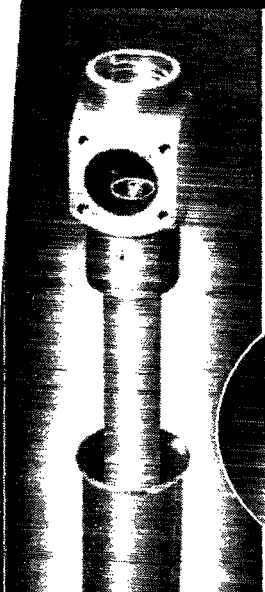

COAXIAL

Dipole

MODEL 105

For best results in the 144-148 mc. band. Vertically polarized antenna ideal for fixed-station and mobile operation . . . matches 50-55 ohm co-ax cables . . . low losses . . . easy installation . . . continuously adjustable . . . durable construction. **LOW COST** . . . only \$12.50 net F.O.B. Boston Immediate delivery . . . order now . . . sold only thru the Radio Shack.

U H F ACORN TUBES

Types 954-955-956

Six tubes . . . \$2.95

same type or assorted

These tubes are not suited to military use but fine business for experimental and commercial use. Isolantite sockets for acorn tubes . . . 48c each.

Pls incl. 10c packing & postage chg.

**SEND FOR OUR FREE
108-PAGE CATALOG**

IN RECEIVERS



Check your preference . . . and order **TODAY!**

- HRO-W **NATIONAL** Military type \$217.35
- N-2-40Cabout 225.00
- RME-44 **R. M. E.** 166.00

- HQ-129X **HAMMARLUND** 129.00
- Super-Proto be announced

- EC-1A **ECHOPHONE** 29.50

- S-20R **HALLICRAFTERS** Sky Champion 60.00
- S-22R Skyrider Marine 74.50
- S-39 Sky Ranger110.00
- SX-25 Super Defiant 109.50
- SX-28A Super Skyrider 238.00

All prices are for *complete* receivers and are net FOB Boston.

The RADIO SHACK

★ 167 WASHINGTON ST. ★
BOSTON, MASS., U.S.A.

EVERYTHING FOR THE HAM

WRITE

Leo, W9GFQ

For Fast Delivery!



Get Leo's own personal, sudden-service on your radio needs. Leo will help you get back on the air quickly with first delivery on anything in radio.

HAM NEEDS

Transmitting tubes, condensers, mikes . . . everything for the Ham. One of the country's largest stocks of Ham equipment. Write Leo, W9GFQ, today, and be first with the latest. We invite inquiries for special equipment of all kinds.

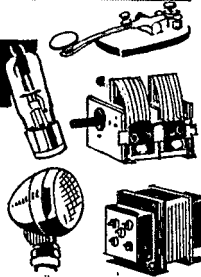

TRANSMITTERS

For peak performance and more dollar for dollar value, get a WRL Transmitter Kit . . . designed in Leo's own laboratories . . . tested and proven. Available in 15, 35, 70, and 150 watt kits as well as kits custom built to your own specs. Write Leo today for complete details, prices and terms.

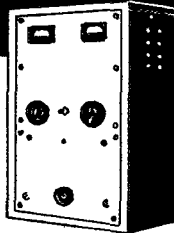

RECEIVERS

Here are just a few of the many well-known receivers offered by Leo:

Hallicrafters SX-25\$ 94.50
Hallicrafters S-20R\$ 60.00
Hallicrafters SX-28A\$223.00
Echophone EC-1A\$ 29.50
Hammarlund HQ-129X\$129.00
National NC-2-40C\$225.00

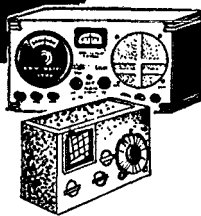

Free!

NEW POST WAR 52 PAGE FLYER

52 pages packed with real buys in radio, electronic, and general merchandise. Write for your free copy today.

- Send for these exclusive items:
- Tube and Circuit Book10c
 - Giant Radio Reference Map (size 3 1/2" x 4 1/2")15c
 - Handy Tube-Base Calculator25c

Write for details of our trade-in plan and easy terms.

Address Dept. GST-3
Council Bluffs, Iowa



**Wholesale
RADIO LABORATORIES**

Television Cameras

(Continued from page 43)

tion to the voice circuit. Rand then thought of a simple way of "raising" them. He got out of the truck, walked around to the front and pointed first at the camera and then at his ear, meanwhile making talking motions with his mouth. The lab called him before he could get back into the truck!

Another day while demonstrating the equipment WIDBM was driving with the camera turned on. The television camera, mounted inside a station wagon, had its lens about two inches away from the windshield. Suddenly it began to rain so hard that the windshield wipers were ineffective. Rand stopped because he couldn't see beyond the radiator cap and the talk-back speaker barked, "Don't stop there! Continue to your location." Rand informed his base that he couldn't see where he was going due to the rain. They replied, "That's funny, we can see all right."

The windshield, so close to the lens that it was out of focus, acted more like a neutral density filter and while it cut the light in half, it still permitted vision outside the windshield.

On one occasion during a flight in the Connecticut valley the test plane seemed to be losing altitude so the pilot was ordered to climb back up to his original altitude. The pilot radioed back that he couldn't see the ground through the haze and so would continue to come down until he could establish his position. But he halted his descent when he learned that a good picture of the Connecticut River was being transmitted to the ground and the men on the ground could give him instructions as to his course.

Many problems had to be solved and serious difficulties overcome before a television camera could be made as small and as light-weight as the final models shown in the accompanying photographs. One of the tough problems was that of automatically adjusting the iris in the lens to the various changing light conditions encountered by an airborne television camera. Another serious problem was the constant battle to reduce size and weight. This was so vital that one of the slogans of the lab was, "Cut it in half!" The engineers were constantly on the watch for smaller tubes, resistors, condensers and other components and searching for new layouts which could reduce the physical size and weight. Another important detail was that of maintaining the right temperature range. It was necessary to install thermostatically-controlled heated jackets on the lens and on some of the other components before the temperature problem was licked. The equipment was required to withstand all the abuse put upon airborne radio through the severe vibration and high noise levels. Extensive tests on vibration tables and in acoustical boxes were conducted and, one by one, the offending parts or circuits were eliminated.

Probably the most important problem was that of dispensing with the usual three or four tele-

(Continued on page 128)



E-L MODEL 2606

INPUT: 6VDC at 8 amps.

OUTPUT: 300VDC at 100 ma.

DIMENSIONS: 4¼" x 4¾" x 5¼"

WEIGHT: 5 lbs. 2 ozs.

Amateurs!

use a **VIBRATOR POWER SUPPLY** in your portable rig

No matter what the particular power requirements of your rig may be, there is an *E-L* Vibrator Power Supply built to fill your needs. *E-L* Vibrator Power Supplies deliver constant output voltage despite wide variations of input; have power outputs up to 1000 watts; and can furnish any wave form including a pure sine wave. Units are available with multiple input and multiple output. All are lightweight, sturdy, and are superior in performance and dependability.

The latest *E-L* post war model, No. 2606, pictured above, is ideal for supplying plate and grid voltages in re-

ceivers and transmitters. It delivers up to 300 V DC at 100 ma and power output up to 30 watts, from a 6 V DC supply. Its great usefulness is indicated not only in radio, but in P. A. systems and in test equipment, as well. Completely filtered, the output is hum-free. Model 2606 is ideal for stationary, mobile or portable communications applications such as used by amateurs, police, coast guard, and in marine and farm applications where battery power is all that is available. It will pay you to investigate the advantages of *E-L* Vibrator Power Supplies. Catalog sent on request, or see your dealer.



**AMATEUR
POWER SUPPLIES**

Electronic

LABORATORIES, INC.

INDIANAPOLIS

VIBRATOR POWER SUPPLIES FOR LIGHTING, COMMUNICATIONS, AND ELECTRIC MOTOR OPERATION, ELECTRIC, ELECTRONIC AND OTHER EQUIPMENT

FOR BETTER BROADCASTING

AM or FM

More and more broadcasters are turning to Western Electric for better broadcasting equipment. From microphones through amplifiers and transmitters to antenna coupling units—AM or FM—Western Electric has a complete line of products to serve the broadcasting industry.

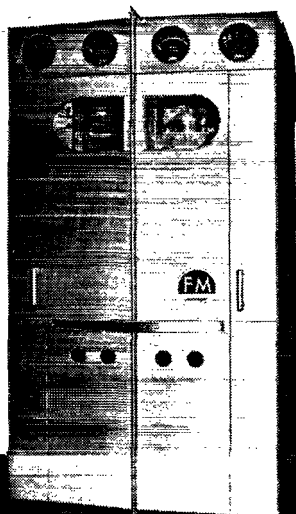

FM TRANSMITTERS—A complete line of FM transmitters to meet the most exacting standards.



AM TRANSMITTERS—A complete line from 250 watts to 50 KW for all AM broadcasting needs.

COMPONENTS—Many miscellaneous elements such as plugs, jacks, condensers, thermistors, relays and vacuum tubes to help you "roll your own."



AMPLIFIERS—For pre-mixing, line, program and monitoring. A complete line to fulfill every requirement.

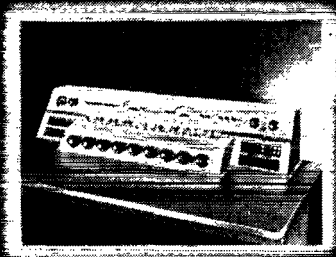

AUDIO FACILITIES—For all studio applications including standard console, remote, and special "custom" designed studio and master control equipment.

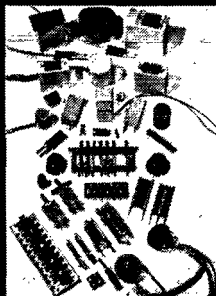

ANTENNA EQUIPMENT—including phasing, coupling, and monitoring equipment.



MICROPHONES—that will continue to set the standard for better broadcasting.



Western Electric

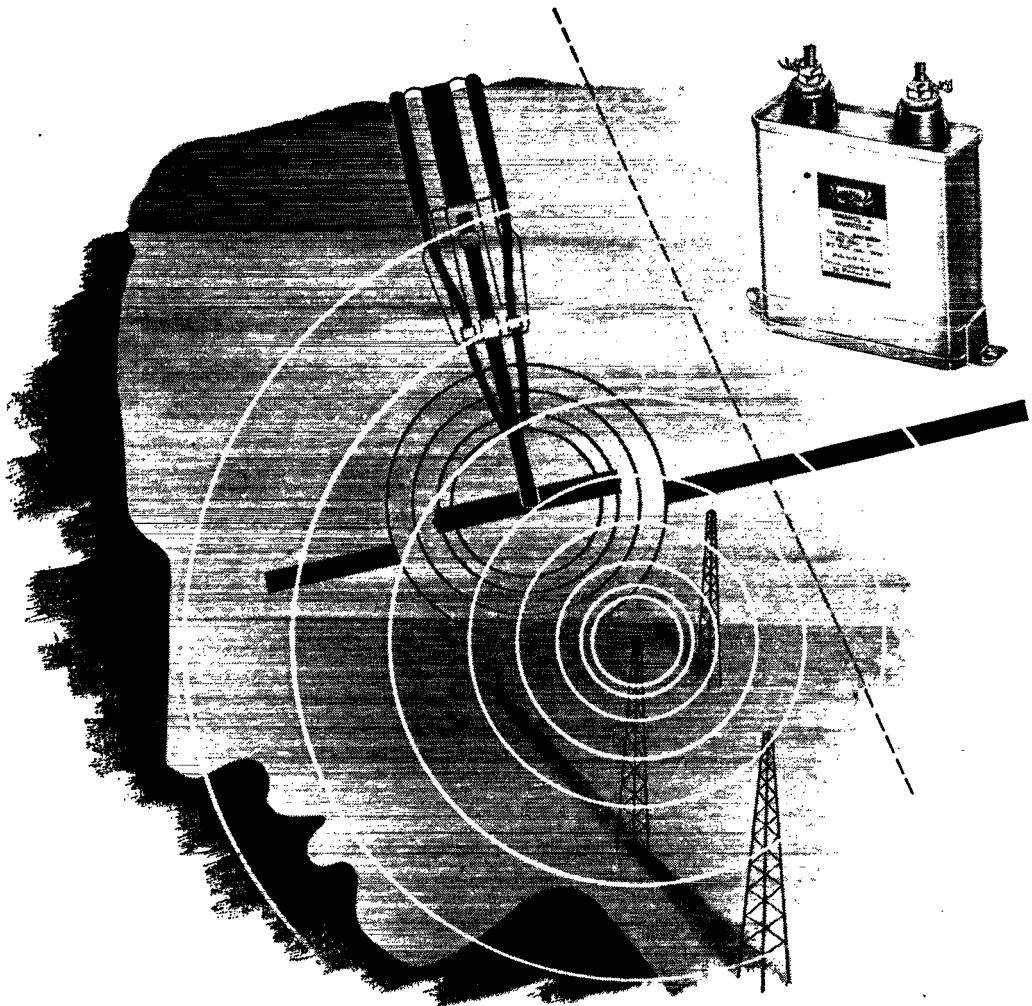

... Like being born again

A while back, you tucked the set away — said goodbye to CQ's and 73's. You didn't know then for how long . . . but, you probably took an oath, that once the air waves were free again: "Nothing would keep you off!"

We, here at C-D, also made a pledge. We promised — once the war was over — nothing would keep us from meeting our obligations to the hams. You've been a special class of customers with us. And that means everybody . . . you fellows who own the latest wrinkle in radio equipment, and you who are riding the waves in old rigs.

There'll be no war-weary surpluses for you; no shortages of quantity or quality. Whatever you need in capacitors . . . whenever you need it . . . trust C-D to have it for you. We want our C-D hams back on the air faster. And we never want it said that a single ham missed out on a thrilling 88 for want of C-D Capacitors.

. . . DON'T JEOPARDIZE your standing or spoil the fun with inferior parts. Send for Catalog #195, a ready reference of the complete C-D line of capacitors. It's FREE. Write Dept. Q3, Cornell-Dubilier Electric Corporation, South Plainfield, New Jersey.

NAME.....

ADDRESS.....

CITY.....

STATE.....



MICA • DYKANOL • PAPER • ELECTROLYTICS



Premax Antennas

Available in Aluminum,
Monel and Steel

The tested and approved types which achieved such a fine war-time record. Send for complete details — or see your dealer.

Premax Products

Div. Chisholm-Ryder Co.
4615 Highland Av., Niagara Falls, N. Y.



RECEIVING SENDING
CODE Speed *without strain*

CHAMPIONS ENDORSE CANDLER WAY

Get skill, accuracy, speed with the highly endorsed Candler System. Learn to send and receive by telegraph or radio code. Government service and commerce need thousands of better trained operators. Air commerce, mail, freight, etc., demand expert, reliable operators. Good pay. Get the Candler System, the maker of champions. It teaches you the "knack" of sound sense, alertness, speedy sending and receiving without strain. Adventure — good pay. Learn at home or wherever you are. Rush name today for free book.

FREE!

CANDLER SYSTEM CO.

Dept. 4-C, Box 928, Denver 1, Colorado, U.S.A.
and at 121 Kingway, London, W.C. 2, England

TRANSMITTING TUBES RECTIFIERS CATHODE RAY TUBES

We have been appointed a sales agent by Defense Supply Corporation of Government surplus tubes and rectifiers. All are first grade Government tested and inspected tubes — not rejects.

The following types are immediately available:

826 (HF Triode)	Cathode Ray Tubes
VT 127A (HF Triode)	5AP1
304 TL	5BP4
872A M. V. Rectifier	3AP1

Trade discounts to dealers on standard packages • Write for prices

LEWIS ELECTRONICS 16 Lyndon Avenue
Los Gatos, California

(Continued from page 124)

vision engineers and operators that, in the past, accompanied so-called "portable" apparatus. This camera unit had to be fully automatic as the only adjustment permitted was that of turning on the power supply.

But these perplexing problems were overcome by this group of radio amateurs in their development of television camera equipment. Inspired by amateur television experiments, developed and "followed-through" by amateurs, this type of equipment may well prove to have many useful functions in a peacetime world, in spite of the fact that it was originally conceived to aid our country in battle. It is truly another worth-while contribution made by the radio amateur in the battle of the laboratory and the production floor.

Happenings

(Continued from page 46)

page 23 of August *QST*, page 21 of September *QST*, which remains in full effect except as to dates mentioned therein: Nominating petitions must now be filed at the headquarters office of the League in West Hartford, Conn., by noon EST of the 20th day of February, 1946. Voting will take place between March 1st and April 20, 1946, on ballots to be mailed from the headquarters office the first week of March. The new alternate will take office as quickly as the result of the election can be determined after April 20, 1946, and will serve for the remainder of the 1946-1947 term. You are urged to take the initiative and file nominating petitions.

For the Board of Directors:

K. B. WARNER,
Secretary

January 1, 1946

NOTICE TO MEMBERS DISCHARGED FROM THE MILITARY SERVICES

The requirement of continuous membership in the League for eligibility to ARRL offices has been waived for members serving in the uniform of the United States. See particulars on page 39 of *QST* for July last. Those desirous of taking advantage of this arrangement are asked to claim the right when renewing membership, stating the beginning and ending dates for their military service.

ARE YOU LICENSED?

• When joining the League or renewing your membership, it is important that you show whether you have an amateur license, either station or operator. Please state your call and/or the class of operator license held, that we may verify your classification.

**READY
for you NOW**

ALLIED'S NEW 1946 CATALOG

of Radio Parts and Equipment

**Everything for the Veteran and the Beginner!
Includes Latest Communications Receivers**

Here's your latest, most complete Buying Guide for everything in radio! Includes newest receivers, Ham gear, code apparatus, parts, kits, tubes, tools, books, test instruments, public address and other equipment. Over 10,000 items available from the largest and most complete stocks under one roof. Nationally known makes. Finest values. Fast, efficient service from one reliable central source. Our experienced staff of licensed radio amateurs is glad to help you.

Free... Send for it today



**FOR EARLIEST DELIVERY... ORDER YOUR
Communications Receiver**
Now from ALLIED Time-Payments • Trade-ins Accepted

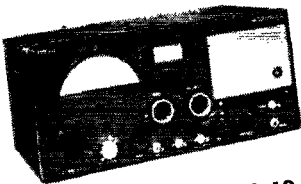

NEW HALLICRAFTERS 5-40

Simple to operate. Frequency range 550Kc. to 44Mc. in 4 bands. Wide vision main tuning dial accurately calibration main tuning dial accurately calibrated. Separate electrical band-spread dial, inertia flywheel tuning. Beat frequency oscillator. Automatic noise limiter. Separate RF and AF gain controls. Three position tone control. "Micro-set" permeability adjusted coils in RF section. Internal dynamic speaker. Net. **\$79.50**
(Subject to OPA approval)

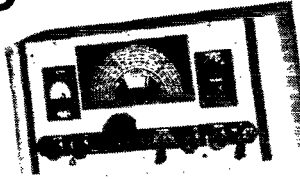

NEW PRECISION RME 45

Delivers peak reception on *all* frequencies—500 to 33,000 Kc. Full vision calibrated dial using one control for two-speed tuning. Five Amateur bands with ample band spread. DB calibrated signal level meter, 5 step variable crystal filter. Automatic Noise Suppression. Stable, variable pitch beat oscillator. **\$166**
Net, with Speaker

Other Models

Hallicrafters SX-25	\$94.50
RME DB-20	59.30
Hammarlund HQ-129X	129.00
National NC-2-40C	225.00
National HRO	197.70
Hallicrafters SX-28A	223.00
Hallicrafters S-36A	415.00
Hammarlund 400X	318.00
Hammarlund 400SX	318.00
Hallicrafters S-37	591.75
Hallicrafters HT-6	110.00
Hallicrafters HT-9	225.00

Net F.O.B. Chicago
Prices Subject to Possible Change

ALLIED RADIO

Everything in Radio & Electronics
833 W. Jackson Blvd., Chicago, Ill.

ALLIED RADIO CORP., D. L. Warner W91BC
833 W. Jackson Blvd., Dept. 27-CC-6
Chicago 7, Illinois.

Date.....

Enter order for..... Model.....

Enclosed \$..... Full Payment Part Payment
(Balance C.O.D.)

Send literature on Receivers and Time Payment Plan.

Send FREE new 1946 Allied Catalog

Name.....

Address.....

City..... Zone..... State.....

Foreign Notes

(Continued from page 48)

Postwar operation will take place under an entirely new set of license conditions, some of which are interesting:

"Sending shall not commence without listening on the frequency which is to be used in order to ascertain, as far as possible, whether interference is likely to be caused thereby with any other station which may be working." (Bravo!) A station without crystal control must possess an accurate frequency meter. In telegraphy, call signs must not be transmitted at a speed greater than 20 words per minute. In telephony, phonetic words identifying call letters "must not be of a facetious character nor be capable of undesirable misinterpretation." (Bravo again!) An amateur must cease transmitting at the request of a commercial or government station, if interference is caused. It is understood the power limits will be 100 watts on ten meters, 25 watts on five. The artificial aerial license is no more. And, after all these years the Gs may now call CQ (instead of TEST).

ITALY

A.R.I. is reinstated as of January 1st, as well as its official organ, "Il Radio Giornale." President Montú describes the Italian post office authorities as "well disposed" toward amateurs, although they are unable to take any favorable action without approval of the communication staff of AMG.

LUXEMBURG

Before the war, LX amateurs were permitted to operate despite a good deal of government sentiment against the policy of allowing radio communication by private parties. When Germany invaded the Grand Duchy in 1940, they imprisoned most of the members of R.L. and stole all radio equipment they could. Nevertheless, with typical infatigable spirit, amateurs are rebuilding for a great day of re-opening, even though authorities give them little encouragement. Good luck, OMs!

NEW ZEALAND

The opening of 3500-3960 kc. to New Zealand hams on December 8th brought "a night of heterodynes!" Also, 58-60 Mc. was opened. No date has been set yet for the release of the 10-meter band, but N.Z.A.R.T. reports authorities very favorably inclined toward the society's proposals.



SEATTLE

HEADQUARTERS FOR
AMATEUR - PROFESSIONAL RADIO
INFORMATION
CATALOGS
COMPETITIVE
PRICES



HQ-129-X \$129*
AMATEUR NET
LESS SPEAKER

COME IN - BROWSE
WRITE FOR OUR BULLETIN

RADIO PRODUCTS SALES CO.

1214 1st AVENUE
SEATTLE 1, WN. MAin 1035

EASY TO LEARN CODE

It is easy and pleasant to learn or increase speed the modern way — with an Instructograph Code Teacher. Excellent for the beginner or advanced student. A quick, practical and dependable method. Available tapes from beginner's alphabet to typical messages on all subjects. Speed range 5 to 40 WPM. Always ready, no QRM, beats having someone send to you.

ENDORSED BY THOUSANDS!

The Instructograph Code Teacher literally takes the place of an operator-instructor and enables anyone to learn and master code without further assistance. Thousands of successful operators have "acquired the code" with the Instructograph System. Write today for full particulars and convenient rental plans.



INSTRUCTOGRAPH COMPANY

4709 SHERIDAN ROAD, CHICAGO 40, ILLINOIS

Representative for Canada:

Radio College of Canada, 54 Bloor St. West, Toronto



CUT ANY SIZE HOLE IN METAL · WOOD · PLASTICS

One Bruno Adjustable Hole Cutter replaces many fixed-radius cutters. High speed steel blade cuts clean, fast holes. Fits drill press, portable drill or hand brace. Easily set for any diameter from 3/8" to 1 1/2" or 1" to 2 1/2". Ask your jobber, or write Bruno Tools, Beverly Hills, Calif., Dept. QST-3

Model No. 100

\$2.95

Model No.	Shank Size	Cutter Expansion Capacity	User's Price
100	3/4" straight shank	3/8" - 1 1/2"	\$2.95
100-B	Square Bit Stock	3/8" - 1 1/2"	\$2.95
101	1/2" straight shank	1" - 2 1/2"	\$4.95
101-B	Square Bit Stock	1" - 2 1/2"	\$4.95

BRUNO TOOLS Beverly Hills California



SWITCH TO SAFETY!





Eliminate the "Hide and Seek" element from amateur operations with the

PANADAPTOR



... featuring Panoramic Reception — the simultaneous visual observation of many radio signals, continuously selectable from a broad band of frequencies down to a single frequency.

as only the PANADAPTOR can eliminate

Hiding

- ... of stations whose exact frequencies are unknown
- ... of calls to you
- ... of auxiliary nets
- ... of signals masked by synchronous noise
- ... of intermittent transmissions
- ... of modulating parasitics

Seeking

- ... for replies to your CQs
- ... for stations down in noise
- ... for QRM-free spots for sending and listening
- ... for calibration points from a standard
- ... for stations whose frequencies drift

By showing up to 200 kc. of the band at once

Enjoy These Other Exclusive Features of the PANADAPTOR

- Three-way QSOs . . . additional aural channel
- Automatic aural and visual monitoring over broad band
- Frequency setting and station monitoring
- Checking signal characteristics of Phone, FM and CW
- Adjusting transmitters and antennas
- Instantaneous "S" meter for CW and Phone
- Checking percentage of modulation

The PANADAPTOR operates in conjunction with any receiver having an IF between 450 kc. and 470 kc. Normal operation of the receiver is not affected. The Panoramic picture, which is presented on the 'scope screen through a specially processed green light filter, appears bright and sharp . . . in a normally lighted room. There are just four simple operating controls. Six types of operation are provided: Panoramic — visual . . . aural . . . visual-aural; Tunable-Unisignal—visual . . . aural . . . visual-aural.

Panel and cabinet finished in standard black or grey wrinkle to harmonize with the rest of your rig. Non-walking feet protect the surface on which it rests. Overall dimensions: 11" wide, 9 3/4" deep, 6 3/16" high. Gross weight: approximately 16 pounds. Manual containing full installation, operating and maintenance instructions furnished with each PANADAPTOR.

TEN TUBES

- One 65G7 — Special RF Bandpass Amplifier
- One 65A7 — First Detector and FM Oscillator
- One 6AC7 — Reactance Modulator
- One 65G7 — IF Amplifier
- One 65Q7 — Second Detector and Video Amplifier
- One 6SN7 — Sawtooth Generator and Amplifier
- One 902A — Cathode Ray Tube Indicator
- One OC3/VR105 — Voltage Regulator
- One 6X5 — High Voltage Rectifier
- One 6X5 — Low Voltage Rectifier.

NOW AVAILABLE AT LEADING RADIO PARTS JOBBERS
MODEL PCA-2, amateur net price, complete with tubes and accessories, for 115 V. 50-60 cycle operation.

\$99⁷⁵

WITH ONE YEAR GUARANTEE

... against defects in workmanship or materials (excluding tubes) during normal operation.

Ask your dealer for free demonstration or write to us for descriptive booklet.

PANORAMIC

CABLE ADDRESS PANORAMIC, NEW YORK



RADIO CORPORATION

242-250 WEST 55TH ST. New York 19, N.Y.



Wave Makers

"A leaping trout awakens the still pool to life in waves that move in silent rhythm."

In the same way, when you speak over the telephone, vibrating electric currents speed silently away with the imprint of your voice over the wire and radio highways of the Bell System.

Tomorrow, the vibrations will be the living pictures of television. All are examples of wave motion.

How to produce, transmit and receive

electrical wave motion is the basic problem of the communication art.

Bell Telephone Laboratories, which exist primarily to invent and develop better communications for the Bell System, devote the teamed efforts of physicists and mathematicians to the production and control of electric waves in all forms.

Out of these studies have come discoveries which keep the Bell System at the forefront of the communication art.

BELL TELEPHONE LABORATORIES

EXPLORING AND INVENTING, DEVISING AND PERFECTING,
FOR THE CONTINUED IMPROVEMENT OF TELEPHONE SERVICE



PLASTICON* CAPACITORS

*PLASTICONS—
plastic film
dielectric capacitors



★ OBSOLETES PAPER CONDENSERS! ★

Smaller, lighter, more economical. Specified by Signal Corps, Air Corps and Navy for more severe operating conditions than oil-paper capacitors. Closer tolerances, wider temperature range, greater safety factor, longer life. Now available at the following prices:

PLASTICONS TYPE AOC

Mfds.	DC-WV	Dimensions	List Price	Your Price
4.....	600.....	4" x 2" x 1 1/4".....	\$ 2.80.....	\$ 1.68
1.....	1000.....	2 3/8" x 1 3/4" x 1".....	3.65.....	2.19
2.....	1000.....	3 1/2" x 2" x 1 1/4".....	4.70.....	2.82
4.....	1000.....	4 5/8" x 2 1/2" x 1 3/16".....	5.85.....	3.51
6.....	1000.....	4 5/8" x 3 3/4" x 1 1/4".....	7.65.....	4.59
8.....	1000.....	4 5/8" x 3 3/4" x 1 3/4".....	8.40.....	5.04
1.....	2000.....	2 3/8" x 2" x 1 1/4".....	5.20.....	3.12
2.....	2000.....	3 1/2" x 2 1/2" x 1 3/16".....	6.10.....	3.66
3.....	2000.....	3 1/2" x 3 3/4" x 1 1/4".....	7.50.....	4.50
4.....	2000.....	3 1/2" x 3 3/4" x 1 3/4".....	8.40.....	5.04
1.....	3000.....	4" x 2 1/2" x 1 3/16".....	11.00.....	6.60
2.....	3000.....	4" x 3 3/4" x 1 1/4".....	14.00.....	8.40
4.....	3000.....	4 5/8" x 3 3/4" x 1 3/4".....	19.35.....	11.60
1.....	4000.....	4" x 3 3/4" x 1 1/4".....	25.00.....	15.00
1.....	5000.....	4" x 3 3/4" x 1 3/4".....	30.00.....	18.00
2.....	5000.....	3 1/2" x 3 3/4" x 4 9/16".....	37.50.....	22.50
1.....	7500.....	3 1/2" x 3 3/4" x 4 9/16".....	45.00.....	27.00
1.....	10000.....	4" x 3 3/4" x 4 9/16".....	80.00.....	48.00

ALL PLASTICON CAPACITORS are guaranteed for six months.
Order from your distributor. If he cannot supply you, write direct.



Condenser Products Company

1375 NORTH BRANCH STREET • CHICAGO 22, ILLINOIS

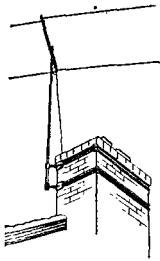

TRYLON BEAM ANTENNA SUPPORTS

Also Rhombic, Doublet, Flat Top, Vee, and Dipole Antenna Systems, Ladder Towers, etc.

• Give your new rig full benefit of a modern, scientifically-designed antenna system! Trylon supports, available in types for every need, are inexpensive, easy to install—and permit quick, easy adjustment of antennas. All are packed in convenient knock-down form, complete with hardware, guys cut to desired lengths, and with full installation instructions. Trylon also offers a complete line of AM, FM or Television antenna supports in bracket types for chimney, window, roof or eave mounting; tripods, self-supporting and guyed ladder towers. Write for details.

Give full data as to your requirements, for accurate recommendation by Trylon antenna engineering specialists.

TRYLON TOWER & ANTENNA DIV.
WIND TURBINE CO. WESTCHESTER, PA.

WANTED ↓

Radio and Electronic Engineer

Nationally known Radio Parts Manufacturer, Long Island City, N. Y., requires a radio and electronic engineer; preferably, one who has had experience in the manufacture of components and parts for service field and manufacturers, as well as short wave and amateur field. Must be conversant with designing of coils, condensers, FM, television, auto antennas, etc. Permanent position. Submit detailed record of experience and salary requirements. Application will be treated in strict confidence. Address

BOX 148 • QST
WEST HARTFORD 7, CONNECTICUT



ELECTRICITY FOR RADIO AND ELECTRONIC APPLICATIONS

ONAN ELECTRIC GENERATING PLANTS supply electric service for electronics applications and general uses, mobile or stationary. Driven by Onan 4-cycle gasoline engines, they are of single-unit, compact design and sturdy construction.

65 basic models ranging in capacity from 350 to 35,000 watts. Standard A.C. models, 115-volt, 60-cycle, single-phase. Standard D.C. models, 32 to 115 volts. Special voltages to 660 A.C., and 6 to 4000 volts D.C. 5 KW to 35 KW units available in 3-phase. High frequencies to 800 cycles. Combination A.C.-D.C. types. Write for detailed literature or engineering assistance.

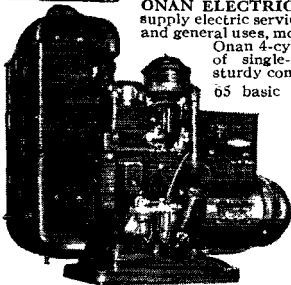

D. W. ONAN & SONS 2634 Royalston Ave.
Minneapolis 5, Minn.

134

Technical Topics

(Continued from page 64)

Thus, in a circular guide the $TM_{0,1}$ mode can exist when the wavelength is reduced to $2.61/3.41 = 77.5$ per cent of the cut-off wavelength for the dominant $TE_{1,1}$ mode. In the rectangular guide having an x/y ratio of 2 to 1, the wavelength must be reduced to 50 per cent before the second mode can exist. This provides a larger range of wavelengths in which to work without danger of exciting the wrong mode.

— G. G.

Measurements

(Continued from page 72)

For large values of unknown capacitance, the circuit may stop oscillating if the parallel connection is used. In such case, the unknown capacitance is connected in series with a known value of capacitance as in Fig. 4. The unknown capacitance can be calculated from the value of the resultant capacitance of the unknown and known fixed condensers in series.

Inductance Measurement

For the determination of known inductances by this method, the conditions for accuracy are limited. In general, if a pure inductance is connected in parallel with an oscillator coil, the frequency will be increased. Since all coils have distributed capacitance, they behave as parallel-resonant circuits. If such a coil is connected in parallel with an oscillator at the fundamental frequency of the coil, no change in frequency will result. Such coils act as a capacitance at frequencies above their fundamental, as a pure resistance at the fundamental, and as an inductance at frequencies below the fundamental. Therefore all measurements must be made at frequencies below the fundamental which may be in the audio-frequency range for large inductances. Audio frequencies may be difficult to measure, although the method is ideal for most radiofrequency coils.

If the unknown inductance is much larger than the oscillator inductance, the change in frequency may be too small for accurate results. A larger oscillator coil and lower frequency is in order. If the unknown inductance is much smaller than the oscillator inductance, the increase in frequency may be too great and be outside the range of the frequency meter. In this case, it is desirable to put the unknown in series with the oscillator coil, as in Fig. 5.

The oscillator inductance, L_o , and condenser, C_o , can be calibrated from either a standard capacitance or inductance. In lieu of a standard capacitance, a standard inductance can be constructed easily from a single-layer solenoid coil and its value calculated from appropriate equations or the ARRL Lightning Calculator with an accuracy is satisfactory for most uses. However, multilayer and universal-wound coils of unknown turns can not be evaluated, hence the proposed

(Continued on page 136)

HARRISON HAS IT!

HARRISON HAS IT!

ALL STANDARD LINES

We are Factory Authorized Distributors for the top quality manufacturers and we now have in stock lots more new, latest improved production Ham gear! Visit our stores today, for *everything* you need. We promise you fresh, clean material — quicker — at the lowest current prices — and, above all, our sincere desire to be of friendly, helpful service.

MAIL ORDERS? — Certainly! Just list *everything* you want and include deposit or full amount. (Please add postage if you want parcel post shipment.)

73 de

Bill Harrison, W2AVA

NEW! HALLICRAFTER SKY CHAMPION

Here's the first *completely* new post-war model. As usual, Harrison will be among the very first to have these receivers in stock for immediate delivery! So rush in your order right now. Model S-40. Complete **\$79.50**

HT-9 TRANSMITTERS

We've already delivered lots of these fine new 100 watt *output* (75 watts phone) Xmitters and they're getting FB reports. Excellent value at. **\$225**

Accessories needed: Coils for one band — \$10.50, Crystal — \$2.65, Microphone — \$5.95 to \$21.45, Key — \$1.05 to \$2.40 (Vibroplexes) — \$9.95, \$13.95, \$15.95, \$17.50, \$19.50)

HALLICRAFTER

SX-28A	\$223.00
PM-23	15.00
S-20R	60.00
S-22R	74.50
SX-25	94.50
S-36A	415.00
S-37	591.75
S-39	110.00

SEND FOR HALLICRAFTER CATALOG

TRANSFORMERS

- THORDARSON • UTC
- STANCOR • UTAH
- KENYON • H-A

Harrison has it!

Practically *all* types in stock

RESISTORS

Fixed — Adjustable — Controls. Composition — Wire — Metalized. From 1/4 watt to 1000 watts!

Harrison has it!

MILLEN TRANSMITTER-EXCITER

Four bands on one crystal! Up to 50 watts output. 6L6-807. On standard 19" x 3 1/2" rack panel. Requires up to 50 V DC at 250 MA for plates. Meter switches into either plate circuit. Can be used as transmitter or as driver for hi power final.

No. 90800, with one set of coils. **\$37.50**

Tubes \$3.46

WESTON PANEL METERS

3 1/2" Flush Bakelite cases.

Model 301 0-1 DCMA. Round case. \$7.35. 0-200 DC Volts. 1000 ohms per volt. Square. \$10.29.

Model 476 0-15 AC Volts. \$6.61.

Other ranges and types in stock at all times.

IF YOU WANT

to be among the very first to get any new, or not immediately available equipment, put your name on our "Preferred List." The factories owe us plenty — and as it comes in we rush it right out!

You can make sure of getting yours quicker by telling us now what you want. (Naturally, orders with deposit come first.) If you change your mind you can cancel at anytime before shipment without obligation.

H S S

HARRISON SELECT SURPLUS

Your assurance of good, usable, guaranteed, surplus material at sensationally low prices — *top value* always! Come in and browse thru our large, *entirely separate* HSS Department (Harrison Select Surplus).

MULTI-TEST METER

Even when good test equipment is scarce, Harrison brings you this special value in a general purpose multi range test meter!

AC and DC Volts: 3, 15, 150, 600, 3000 (all at 1000 ohms per volt)

DC Current: .6, 6, 60, 300 MA, 15 Amps.

Ohms: 0-10,000; 100,000; 1 meg; 10 megs; 100 megs (with external battery)

Output: -20 to +64 DB in five ranges.

Made by Triumph (Model 333-S) for the Signal Corps (BC1052-E). Large 4 3/4" square meter with laboratory type mirror back scale. In sturdy black metal case 9 1/4" x 9 1/4" x 4 3/4" with leather handle, tool compartment, and removable cover. Comes with needle chuck **\$30.98** test leads, batteries, and instruction book.

UHF RECEIVER

Signal Corps BC-1068A. Tunes 155 to 200 MC. 14 tubes. Two RF, five IF, two amplifier stages. Separate dials for RF, Det., and Oscillator. 110 Volt. 60 cycle operation. In metal cabinet. New, perfect, with tubes. **\$44.50**

HSS METERS

All round, flush mounting bakelite cases.

0-200 DC microamp, 3 1/2" Western Electric. Radial pointer (clock type) **\$4.75**

0-150 DC microamp, 2 3/4" White scale and pointer. **\$2.97**

0-20 microamp, 3 1/2" Weston model 301. 45° sweep. **\$3.45**

A POST CARD will put your name on our mailing list to receive new catalogs, bulletins, additional HSS bargains, and details of how you may obtain, without cost, a copy of "Electronic Parts and Equipment," our new 800-page Buyers' Guide. **PLEASE SEND IT TODAY!**

HSS CONDENSERS

All new — perfect — high quality makes — guaranteed to be satisfactory for use in transmitters, amplifiers, etc., at full rated DC working voltage.

Compact, cylindrical metal case type. Conveniently mounts in 1/4" hole, 1 1/2" dia. x 4 1/2" high. 2 MFID. 1000 VOLT.

FOUR for \$2.34 (Regular price of one)

Standard rectangular type with standoff insulator terminals.

10 mfd., 600 Volt. List \$10.80. Two for \$2.47.

4 mfd., 1000 Volt. 2.45 ea.

4 mfd., 1500 Volt. 2.80

2 mfd., 1500 Volt. 1.95

8 mfd., 1500 Volt. 3.25

4 mfd., 2000 Volt. 2.35

2 mfd., 600 Volt (Lug type terminals)

THREE for \$1.67

HSS TUBES

All new, fully guaranteed, top quality makes.

24G (3C24/VT204) An FB tube for VHF. 90 watts Class C output. Gov't inspected.

Regular amateur net price was \$9.00, reduced to **\$6.00**, but Harrison sells them for only. **\$1.48**

CO-AXIAL CABLE

RG-13/U. 74 Ohm. .420" dia. List 52¢, HSS — 14¢ per foot! (Other types in stock at special prices.)

HSS MICA CONDENSERS

Transmitting type. Standard tolerance and test voltage rating.

5000 Volt: .002, .005

2500 Volt: .01

1000 Volt: .02, .03

SPECIAL 1/3 for \$3.85 (any values)

HAM HEADQUARTERS
Since... 1925!



HARRISON RADIO CORPORATION

12 WEST BROADWAY • NEW YORK CITY 7

BARCLAY 7-9854

JAMAICA BRANCH — 172-31 Hillside Ave. — REPUBLIC 9-4102

WE'RE NOW SHIPPING RESISTORS



• We are now shipping service type resistors from stock . . . no delays. You have learned to count on Ward Leonard Resistors for years. Send for Resistor Bulletins today.

WARD LEONARD

RELAYS RESISTORS RHEOSTATS

Electric control devices since 1892

WARD LEONARD ELECTRIC COMPANY

Radio and Electronic Distributor Division

53B WEST JACKSON BLVD.

CHICAGO, ILL.

COMMERCIAL RADIO INSTITUTE

A RADIO TRAINING CENTER FOR 26 YEARS

Resident Courses Only • Broadcast, Service, Aeronautical, Television, and Marine telegraphy classes now forming for July 1st.
Literature upon request. Veteran training

Dept. B, 38 West Biddle Street, Baltimore 1, Maryland

ASK FOR OUR BARGAIN BULLETIN

Phone, Wire or Write

WHOLESALE

Radio-Electronic Parts

Tubes, Sets and

Equipment

R. G. SCALI & CO.

317 Asylum St. Hartford, Conn.

Telephone 2-1144

BRANCH: 83 ELM ST., BRIDGEPORT, CONN.

(Continued from page 134)

method which follows will find application.

Assume that the oscillator coil is to be calibrated from a standard inductance.

Let L_s = inductance of standard in appropriate units.

Then,

$$\frac{L_o}{L_o L_s / (L_o + L_s)} = (f_s / f_o)^2 \quad (10)$$

Solving,

$$L_o = L_s [(f_s / f_o)^2 - 1] \quad (11)$$

Let L_x = inductance of unknown in appropriate units.

From Fig. 2,

$$\frac{L_o}{L_o L_x / (L_o + L_x)} = (f_x / f_o)^2 \quad (12)$$

Solving,

$$L_o = L_x [(f_x / f_o)^2 - 1] \quad (13)$$

Equating Eq. (11) and (13) and solving for L_x ,

$$L_x = \frac{L_s (f_s / f_o)^2 - 1}{(f_x / f_o)^2 - 1} \quad (14)$$

If the calibration is by standard capacitance, first obtain C_o from Eq. (5), then L_o from Eq. (2). Solving Eq. (13),

$$L_x = L_o [(f_x / f_o)^2 - 1] \quad (15)$$

Similarly for capacitance measurements only, if calibration is by standard inductance, first obtain L_o from Eq. (11) then C_o from Eq. (2). Combining Eqs. (2) and (6).

$$(f_x / f_o)^2 = C_o / (C_o + C_x) \quad (16)$$

Solving for

$$C_x = C_o [(f_o / f_x)^2 - 1] \quad (17)$$

The mathematical derivations may be confusing to some, but one need only apply Eq. (1) for oscillator frequency and the laws of series and parallel connections for inductances and capacitances. For those who shy away from all mathematics, the following proposed frequency-variation method can be readily adapted. In this case, one needs only a number of standard condensers and coils. The frequency when each is individually inserted in the oscillator circuit is noted. A plot of frequency vs. capacitance or inductance will permit interpolation and extrapolation to other values.



This department recently received a long hand-sent tape which read —

"CQ CQ CQ GREETINGS FROM THE HAMS IN THE 89TH SIGNAL BN TO ARRL WITH BEST WISHES FOR A QUICK REUNION ON THE ETHER SIGNED W8LRA W8ULO W9MPS CO B 89TH SIGNAL BN FORT BENNING GA"

Modernize your rig with G-E VACUUM CAPACITORS

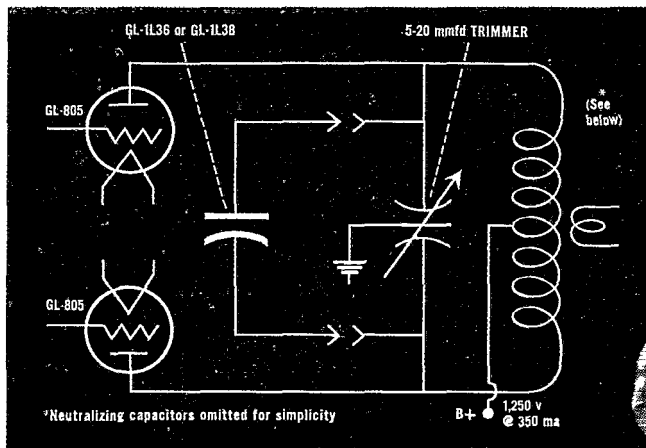

16-kv type
shown above

With this circuit you can operate on 10, 15, and 20-meter phone or C.W. without changing the tank-coil. Two G-E vacuum capacitors will do the job: GL-1L38 for 20 meters, GL-1L36 for 15 meters, trimmer capacitor alone for 10 meters. Coil details: 7 turns No. 12 wire, 2½" diameter coil form, winding 2" long.

G-E vacuum capacitors help you to bring your circuit up-to-date, by handling efficiently jobs like the one diagrammed above. Small, space-saving, these capacitors occupy the least possible area. Moreover, you can rely fully on their performance at peak voltages—ratings are conservative. And your pocketbook will welcome the economy of the low prices!

Another key advantage . . . G-E vacuum capacitors, by reason of ultra-compact design, add less inductance to your circuit, thus minimizing parasitic oscillations. 10 types—a full range—are available, as listed at the right. See your nearest G-E tube distributor for further facts, or write direct to *Electronics Department, General Electric Company, Schenectady 5, N. Y.*

Check these low prices!

Type	Peak voltage, volts (a-c, d-c, or r-f)		Capacitance, micromicro- farads	Price
	CCS	ICAS		
GL-1L32	7,500	9,000	6	\$8.50
GL-1L21	7,500	9,000	12	8.50
GL-1L36	7,500	9,000	25	8.50
GL-1L38	7,500	9,000	50	8.50
GL-1L33	7,500	9,000	100	10.00
GL-1L31	16,000	20,000	6	9.25
GL-1L25	16,000	20,000	12	9.25
GL-1L22	16,000	20,000	25	9.25
GL-1L23	16,000	20,000	50	9.25
GL-1L24	16,000	20,000	100	11.00

GENERAL ELECTRIC

161-EG-8850

ELECTRONIC TUBES OF ALL TYPES FOR THE RADIO AMATEUR

137



CRYSTAL KIT No. 1

- 15 blanks to precision tolerances
- 5 between 7005 and 7050 KC
- 5 between 7050 and 7220 KC
- 5 between 7220 and 7240 KC
- 10 Holders — CRL-16
- 10 Complete sets of springs, electrodes, covers, gaskets and screws
- 10 additional electrodes for slight freq. changes
- 10 pieces of lintless cloth
- 1 box of fine abrasive for finishing
- 1 box of medium abrasive for rough lapping
- 1 piece of plate glass for lapping
- Blueprints of selector switch
- Photographs of selector switch

INSTRUCTION BOOKLET giving complete details for selector switch, and complete instructions for lapping of your crystals.

All components suitably boxed.



CRYSTAL KIT No. 2

- 7 blanks to precision tolerances
- 2 between 7005 and 7050 KC
- 3 between 7050 and 7220 KC
- 2 between 7220 and 7240 KC
- 5 Holders — CRL-16
- 5 complete sets of springs, electrodes, covers, gaskets and screws
- 10 pieces of lintless cloth
- 1 box of fine abrasive for finishing
- 1 box of medium abrasive for rough lapping
- 1 piece of plate glass for lapping
- Blueprints of selector switch
- Photographs of selector switch

INSTRUCTION BOOKLET giving complete details for selector switch, and complete instructions for lapping of your crystals.

All components suitably boxed.

THESE KITS WERE DESIGNED FROM YOUR SUGGESTIONS IN CRYSTALAB'S HAM CONTEST *

Thank you, HAMS, for your suggestions. Now, you don't have to stay in ORM. You can move along to a quieter spot. With these kits, you can pick your own freqs, and be sure of getting there. Grind your own crystals to any freq you want . . . you get FB blanks and all other supplies needed for making complete crystals . . . for "net" freqs or your own "spot" freqs.

*WINNERS will be announced shortly.

See your Local Radio Dealer.



CRYSTAL RESEARCH LABORATORIES INC.

29 ALLYN ST., HARTFORD, 3, CONN., PHONE 7-3215

QRG?



Crystalab

TRADE MARK REG. U.S. PAT. OFF.

CALIBRATION SERVICE FOR HAMS

A SPECIAL SERVICE OF
CRYSTAL RESEARCH LABORATORIES

60¢
per crystal

Pack shipments carefully and insure . . . C. R. L.
not responsible for damage in transit to us.

Have your crystals checked for exact frequency at room temperature. Crystals are calibrated on representative "ham" equipment to $\pm .5$ KC. Calibrating circuits are featured in Figures 403, 404, 406, 407, and 408 of the 1945 ARRL Radio Amateur Handbook.

Further tests may be made to meet your special requirements. Upon inquiry, please state exact desired temperature. For further tests, prices will be quoted. Mailing charges back to you are included.

**CRYSTAL RESEARCH
LABORATORIES INC.**
29 ALLYN ST., HARTFORD, 3, CONN., PHONE 7-3215

Send money order or check
— please do not send cash.

★ ★ ★

Crystalab

TRADE MARK REG. U.S. PAT. OFF.

★ ★ ★

I am enclosing..... Crystals for Calibration at room temperature.

Please Calibrate in circuit Figure No.....

Name.....

Address.....

CITY..... STATE.....

Quality PRODUCTS
Since 1923



**CERAMIC—
PORCELAIN & STEATITE
INSULATORS**

for every
purpose

BIRNBACH RADIO CO., Inc.

145 HUDSON ST. NEW YORK, 13, N. Y.

RADIO COURSES

- RADIO OPERATING
- RADIO SERVICING
- REFRIGERATION SERVICING
- CODE
- ELECTRONICS

REFRIGERATION SERVICING

Personal Counselling Services for Veterans
Write for Latest Trade & Technical Catalog

Y. M. C. A. TRADE & TECHNICAL SCHOOLS
4 W. 64th Street New York City

**Your RED CROSS
must carry on!**



New Tubes

(Continued from page 74)

D.c. grid voltage.....	-60	-150 volts
D.c. grid current.....	15	15 ma.
Plate dissipation.....		20 watts

3C28

A worthy addition to the HK-24(3C34) and 24G(3C24) tube class is the Lewis 3C28, v.h.f. triode. By careful design and the use of two external grid leads, its interelectrode capacities are reduced and full power input may be used up to 100 megacycles while half power input may be used up to 350 megacycles. The two grid leads protrude on opposite sides of the glass bulb. The plate connection comes out the top. The base is a small 4-pin ceramic.

Direct Interelectrode Capacitances

Grid to plate.....	1.8 μ fd.
Input.....	2.1 μ fd.
Output.....	0.1 μ fd.

Typical operating conditions are the same as for the 3C24.

4C34

This is the latest version of the well known HF-300 power triode. Operating conditions and electrical characteristics of the 4C34 are identical to those of the HF-300. Sixty megacycles is the maximum frequency for full input.

4C32

Lewis announces this high-mu triode in the 200-watt plate dissipation class. It uses copper-to-glass plate and grid connection seals and has its graphite plate specially treated to reduce the possibilities of gassing under heavy overloads. The 4C32 is equally adaptable to r.f. amplifier or modulator service. The upper limit for full ratings is 60 megacycles.

Direct Interelectrode Capacitances

Grid to plate.....	5.8 μ fd.
Input.....	5.5 μ fd.
Output.....	1.1 μ fd.

R.F. Power Amplifier or Oscillator, Class-C Telegraphy

Typical Operation

D.c. plate voltage.....	2000 volts
D.c. grid voltage.....	-165 volts
D.c. plate current.....	275 ma.
D.c. grid current.....	20 ma.
R.f. grid driving power (approx.).....	10 watts
Carrier power output.....	400 watts

A.F. Power Amplifier, Class-B

Typical Operation Two Tubes

D.c. plate voltage.....	2000 volts
D.c. grid voltage.....	-50 volts
Peak a.f. input voltage (grid to grid).....	380 volts
Zero-signal plate current.....	60 ma.
Max.-signal plate current.....	460 ma.
Max.-signal driving power.....	15 watts
Effective load resistance (plate to plate).....	10,000 ohms
Max. signal power output.....	650 watts

GL-592

GE's high-power v.h.f. triode, good for 600 watts input up to 100 megacycles, is representative of a new style of transmitting-tube construc-

(Continued on page 148)

MAKING TUBES IS EASY

If YOU KNOW HOW!

● On this automatic grid winding lathe, the two heavy side-post wires — drawn from two large spools — are pulled taut over a mandrel form. A cutting wheel nicks these support wires, as the mandrel, wires, and spools revolve on the lathe. Very fine lateral wire is simultaneously wound from another spool into these nicks, with the mandrel providing the proper cross-sectional shape. A swedging wheel presses the side-post rods, thus anchoring each lateral turn firmly into place. Finished grid strips approximately twelve inches long are then cut to the required lengths. Excess turns are removed from each end of these short lengths preparatory to assembly. The completed grid is finally micro-gaged and micro-inspected.

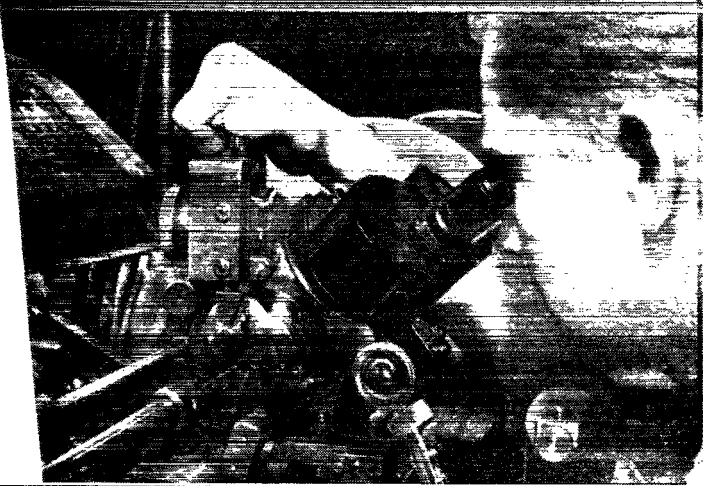

HERE'S AN EXAMPLE OF HYTRON KNOW-HOW.

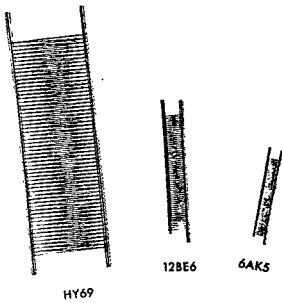

NOTE THE SMALL DIMENSIONS OF THESE GRIDS

Tube	Grid	Turns Per Inch	Length of Winding	Width of Winding
HY69	Screen	30	1.417 in.	0.570 in.
12BE6	Control	76	0.776 in.	0.135 in.
6AK5	Control	200	0.322 in.	0.100 in.

12BE6 and 6AK5 grids cannot successfully be illustrated, because of their minute size.

MASS production and a watchmaker's precision usually are strangers — especially if unit cost is low. Here you see a job setter adjusting a precision lathe on which tiny grids are wound to tolerances as tight as .0005 inch. Keen eyesight, patient perseverance, and the skill of a fine toolmaker, are his requisites. Pitch, turns per grid, inside and outside diameters, cross-sectional shape must be right on the nose. Furthermore, they must be kept there despite engineering changes in specifications, variances in materials, and wear and tear of the machine.

With this lathe turning up to 1000 rpm, grids form faster than the eye can travel. It is amazing to watch the tiny parts take shape — to examine with a microscope the rugged manner in which each lateral turn is swedged into the side-post rods.

Yet as you see these grids produced at top speed, it all looks easy. Nothing to it — *if you know how*. Then you stop to think. You realize skilled hands and precision machines are part of the Hytron know-how which makes tough jobs easy — which gives you tubes of dependable, jewel-like precision at prices absurdly low.

OLDEST MANUFACTURER SPECIALIZING IN RADIO RECEIVING TUBES



HYTRON

RADIO AND ELECTRONICS CORP.



MAIN OFFICE: SALEM, MASSACHUSETTS

Now! A Better Soldering Tool... THE KWIKHEAT

Has Built-in Thermostat Control!

THERMOSTATIC SOLDERING IRON



6 TIP STYLES

- #0—\$1.25
- #1—\$1.25
- #2—\$1.25
- #3—\$1.25
- #4—\$1.26
- #5—Melting Pot for Tinning—\$1.25

HOT, READY FOR USE ONLY 90 SECONDS after plugging in! Kwikheat is the only soldering iron with a thermostat built into the tool itself—maintaining the proper level of heat for most efficient, economical operation. **SAFE!** ... Cannot overheat—**ECONOMICAL!** ... Lasts longer—saves tips and requires less retinning. **POWERFUL!**—225 watts—yet exceptionally light weight (14 oz.). Well-balanced with cool protecting plastic handle. Modern streamlined design. Six interchangeable tip styles adapt one Kwikheat Iron to all your soldering jobs. You will be proud to own America's finest and most versatile soldering tool... from tip to plug Kwikheat is in a class by itself. Ask your dealer to demonstrate the quick-heating feature now!

Kwikheat Iron with choice of any one tip . . . \$11.00
Set of 5 tips, consisting of #0, #2, #3, #4, and #5 . \$5.00

6 TIP STYLES—QUICK HEATING ELEMENT—BUILT-IN THERMOSTAT—WELL BALANCED—COOL PROTECTING HANDLE—LIGHT WEIGHT

Dept. Q-S, Kwikheat Division of
SOUND EQUIPMENT CORP., 3903 San Fernando Rd., Glendale, 4 Calif.

ATTENTION HAMS!

Excess inventory, no war surplus. Warehouse of tubes, resistors, relays, condensers, transformers, chokes, chassis, cabinets, hardware—everything you need. Real ham prices. Come to plant every day or Saturday, "ham day."

MAGUIRE INDUSTRIES • Electronics Division
Post Road Greenwich, Connecticut

IN A CLASS BY ITSELF! . . .

GENUINE EASY-WORKING "ORIGINAL"

VIBROPLEX

Reg. Trade Mark: Vibroplex, Lightning Bug, Bug

CHROMIUM FINISHED BASE

PATENTED JEWEL MOVEMENT

\$19.50

Deluxe Model

America's finest radio key—the deluxe performer that sets new standards of sending excellence and operating ease. The jewels used in Delux Vibroplex keys are the same as those placed in the finest made watches and precision instruments, providing watch-like precision, feather-touch action, lifetime service and ease of operation unapproachable by any other key. Chromium finished base, Bright machined parts. Colorful red switch knob, finger and thumb piece. **DIE CUT** contacts and main spring. 3/16th contacts. Circuit closer, cord and wedge. Delux finish also available in "Lightning Bug" and "Blue Racer" models. **Order NOW!** Money order or registered mail. **FREE** catalog.

THE VIBROPLEX CO., Inc.
833 Broadway New York 3, N. Y.

The "BUG" Trade Mark identifies the Genuine Vibroplex.
Accept No Substitute

(Continued from page 140)

tion. The 200-watt anode is surrounded by the major portion of the glass envelope, at the top of which is the plate connection. The lower section of the envelope is of reduced diameter and forms a stubby extension to the end of which is sealed the glass button supporting the three filament leads. The two grid terminals come out opposite sides of this extension.

The amplification factor of the GL-592 is 24.5, and its filament draws 5 amperes at 10 volts. Forced-air cooling is required.

Direct Interelectrode Capacitances

Grid to plate	3.3 μ fd.
Input	3.6 μ fd.
Output	0.41 μ fd.

R.F. Amplifier and Oscillator, Class-C Telegraphy

Typical Operation

D.c. plate voltage	2600 volts
D.c. grid voltage	-240 volts
D.c. plate current	230 ma.
D.c. grid current (approx.)	45 ma.
R.f. grid driving power (approx.)	18 watts
Carrier power output	425 watts

2C39

Both Eimac and GE announce this "lighthouse" tube that, with 100 watts plate dissipation and 1000-volt maximum ratings, is able to generate 25 watts of carrier power at 500 megacycles. The tube is only 2 1/4 inches long and 1 1/4 inches in diameter. This particular lighthouse tube has an unusually high grid-plate transconductance of 19,000 μ mos. The amplification factor is 85. The cathode is indirectly heated by a 6.3-volt heater drawing 1.1 amperes. Forced-air cooling sufficient to keep the seal temperature to 175 degrees Centigrade allows the full 100-watt plate dissipation rating.

Direct Interelectrode Capacitances

Grid to plate	1.95 μ fd.
Input	6.5 μ fd.
Output	0.035 μ fd.

Maximum Ratings and Typical Operating Conditions

C.W. Oscillator

	Typical	Maximum
(Grid separation circuit)		
D.c. plate voltage	1000	1000 volts
D.c. grid voltage	-48	-150 volts
D.c. plate current	58	100 ma.
D.c. grid current	8	ma. (approx.)
Plate input	50	watts
Plate dissipation	25	watts
Carrier power output	25	watts

2C43

RCA and GE manufacture this lighthouse triode with a maximum plate voltage rating of 500 volts and plate dissipation of 12 watts. It has an amplification factor of 48, a grid-plate transconductance of 8000, and takes 6.3 volts at 0.9 amperes to operate the heater. Its six-pin octal base has the following connections: No. 1, internal connection; 2, heater; 3, cathode; 5, cathode; 7, heater; 8, cathode.

Direct Interelectrode Capacitances

Grid to plate	1.7 μ fd.
Input	2.9 μ fd.
Output	0.05 μ fd.

(Concluded on page 146)

IT'S ENGINEERED...



to MEET the EXACTING DEMANDS

of the MODERN BROADCASTING STATION-

THE GATES 1-KILOWATT TRANSMITTER

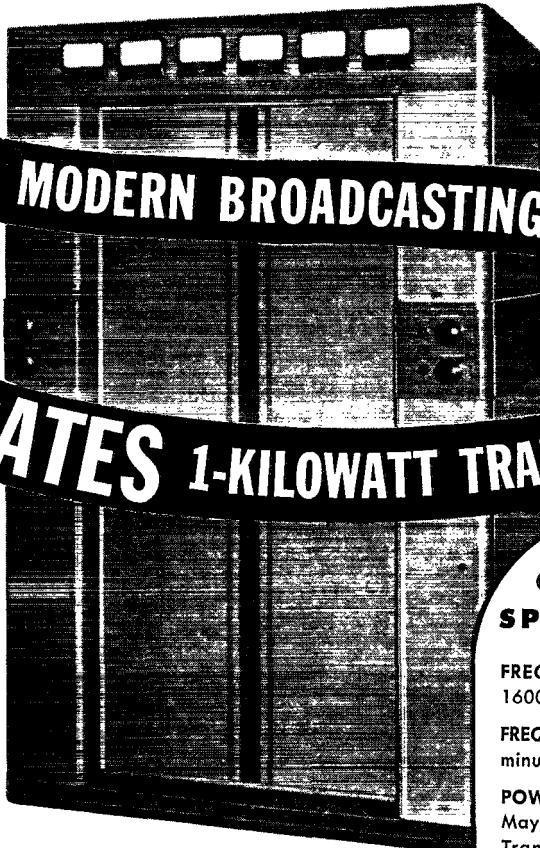

CONDENSED SPECIFICATIONS

FREQUENCY RANGE: 530 to 1600 K. C.

FREQUENCY STABILITY: Plus or minus 10 cycles maximum.

POWER OUTPUT: 1000 Watts. May be operated as 500 Watt Transmitter: Power reduction for night operation may be incorporated to suit requirements.

POWER SUPPLY: 230 Volts, 60 cycles, single phase. Regulation not to exceed plus or minus 5%.

FREQUENCY RESPONSE: Within 1½ Db. from 30 to 10,000 cycles.

DISTORTION: Less than 3% from 50 to 7500 cycles. 0-95% modulation.

NOISE LEVEL: 60 Db. below 100% modulation.

WRITE FOR COMPLETE SPECIFICATIONS

Combines

EFFICIENCY • VERSATILITY • DEPENDABILITY

The GATES Model 1-E Transmitter is the most modern installation for the 1-Kilowatt broadcasting station. It combines modern circuit developments, which are the results of strict laboratory tests, with other mechanical improvements that will make your Station outstanding in operating efficiency and showmanship. All parts are accessibly located for simple operation. The streamlined pressure-type cabinet assures dustless, cool performance. Investigate the 1-E Transmitter before considering any other.

NEW YORK OFFICE:
9th Floor • 40 Exchange Place

GATES
RADIO CO.
QUINCY, ILLINOIS

SOLD IN CANADA BY:
Canadian Marconi Co.,
Ltd., Montreal

EXCLUSIVE MANUFACTURERS OF TRANSMITTING EQUIPMENT... SINCE 1922

HAMS! You're on the air at amazingly Low Cost with New V.H.F. and U.H.F.—



Mail Coupon Below for

NEW CONCORD CATALOG—FREE

Order **PARTS**
EQUIPMENT—SUPPLIES
at TREMENDOUS SAVINGS from
CONCORD

America salutes the radio ham, and gives thanks for amateur pre-war experimenting. This constant search and striving for new and better methods, equipment and results paved the way for phenomenal war-time radio and radar progress in the V. H. F. and U. H. F. bands. Now these war-born developments are available from Concord for you to build ultra-modern V. H. F. and U. H. F. rigs at a fraction of the cost of pre-war high frequency equipment. Concord stocks

are huge and complete—and Concord's buying of termination inventories released by war-equipment contractors permits us to list the finest standard, nationally-known radio and electronic equipment, all built to high and rigid government standards, at amazingly low prices. Mail the coupon now for your FREE copy of CONCORD'S new RADIO PARTS Bargain Book.

Typical Catalog Values—A Few of Hundreds

★★★★★★★★★★★★★

★
★
★ **FREE**
★ This is the new CONCORD catalog supplement, just off the press! It lists thousands of money-saving bargains in radio parts and electronic equipment—most of them items of nationally-known make, representing the most famous names in radio.
★
★
★
★
★
★
★



Mod. Transf.
 Pri: 5000 ohms
 P.P. plates, 100 M.A. Sec: 3000 ohms, 100 M.A.
 5B5063. Each....\$1.49

Mica Capacitor. .0005 Mfd., 3000 volts D.C.
 5B3035. Each....\$2.95

Selsyn Motor.
 25 volt, 60 cycle Selsyns.
 Ideal for antenna position indicators.
 5B9523 Per pair...\$7.90

- Pwr. Trans.** Pri: 105-125 volts, 60 cycles. Sec: 2260 volts C.T. @ .5 amp.. 5B5114. Ea. \$17.95
- Filter Choke, 8.8 henry,** 500 M.A. 50 ohms D.C. resistance.....5B5113. Ea. \$8.95
- 6.3 volt, 9 amp. Filament Trans.** Pri: 105-125 volts, 60 cycles.....5B5105. Ea. \$1.95
- Headset and Chest Plate Mike.** Phone 300 ohm impedance. Mike 200 ohm carbon type.5B7059. Ea. \$5.95
- Upright Telephone Set.** Carbon 200 ohm mike. Push to talk switch in handle of stand.... 5B7057. Ea. \$5.95
- 200 M.A. G.E. Milliammeter.** 2½-inch flange mount.....C10650. Ea. \$3.95
- Thermocouple Milliammeter.** 0-500 M.A. 2½-inch flange mount.....5B4121. Ea. \$3.95
- .001 Mfd. 3000-volt Mica Capacitor.** 5B3037. Each..... \$2.95
- Filter Condenser.** Dual 8.5 Mfd. 1000 volt. Oil filled. Porcelain stand offs. 5B3165 Ea. \$3.95

CONCORD

RADIO CORPORATION
LAFAYETTE RADIO CORP.
 CHICAGO 7 ATLANTA 3
 901 W. Jackson Blvd. 265 Peachtree Street

CONCORD RADIO CORP.

901 W. Jackson Blvd., Dept. ST-36
 Chicago 7, Ill.

Please send me FREE a copy of your latest Catalog of Radio Parts, Accessories, and Equipment.

Name.....
 Address.....
 City..... State.....

T.A.C. ANNOUNCES THE NEW CODE PRACTICE OSCILLATOR WITH ADJUSTABLE RESONATOR

for Greater Volume
Better Tone

ADJUSTABLE
RESONATOR

MS 710, less resonator and less built-in key. Amateur net price, \$9.00
MS 710R, with resonator but less built-in key. Amateur net price, \$10.50
MS 710P, with built-in key but less resonator. Amateur net price, \$11.50
MS 710PR, DeLuxe Master Oscillator with resonator and built-in key. Amateur net price, \$13.00

Adjustable Resonator (optional) increases volume five times. Tone frequency variable from 600 to 1500 cycles. Volume control from 0 to FULL ON. "PM" DYNAMIC speaker may be disconnected during headphone operation. Up to 300 headphones may be used. Has phone jack for headphones. Optional built-in key. 110 V. AC or DC. Uses a 117N7GT tube. Gray crackle finish.

NOW IN STOCK AT ALL LEADING RADIO DISTRIBUTORS

TELEGRAPH Apparatus Co.

325 WEST HURON STREET • CHICAGO 10, ILL.

Adson RADIO CO.

Dept. Q - 221 FULTON ST. N. Y. 7, N. Y.

EVERYTHING FOR AMATEURS AND SERVICEMEN
COMPLETE LINE OF ELECTRONIC EQUIPMENT

TELEVISION TECH CORRESPONDENCE COURSE

WANTED: Qualified radiomen to take a specialized television course. Instructions begin and end with television. Course has been written for the experienced radioman (amateur, serviceman, operator, or technician) who wishes to prepare for this new field. Course covers reception and transmission in detail. A knowledge of basic radio is assumed.

PREPARATION: Authors of a large portion of this course are Edward M. Noll and O. J. Jimerson. Mr. Noll is a former member of the television department of a major radio corporation and author of the practical math series in QST and television series in Radio News; Mr. Jimerson, a former senior radar inspector and member of same television staff.

TELEVISION TECH ENTERPRISES

Box 94 Dept. A HATBORO, PA.

(Continued from page 148)

Maximum Ratings and Typical Operating Conditions

C.W. Oscillator	# Tubes	Max. Per Tube	
D.c. plate voltage	360	470	500 volts
Grid leak resistance	1000	1000	ohms
D.c. plate current	28	38	40 ma.
Plate input	10	17.9	watts
Plate dissipation	5.3	8.9	12 watts
Cathode current			.55 ma.
Frequency	350	350	1500 Mc.
Power output	4.7	9	watts

117Z3

Tung-sol announces this miniature half-wave rectifier. The 7-pin glass button base has the following connections: No. 1, internal connection; 2, no connection; 3, heater; 4, heater; 5, plate; 6, cathode; 7, no connection.

Tung-Sol announces a complete set of new miniature 7-pin glass-button based tubes comprising two types of pentode r.f. amplifiers, a pentagrid converter, a duplex-diode hi-mu triode, a beam power audio tube that is capable of 4.5 watts output and even a full-wave rectifier tube.

There are two complete sets, one for 6.3-volt heaters and the other for 12-, 35- and 50-volt heaters. Thus the needs of both a.c. and a.c.-d.c. receivers are taken care of. All tubes can be operated from a plate supply of 250 volts. The list is as follows:

6AU6 Sharp cutoff r.f. pentode	6.3-volt heater
6BA6 Remote cutoff r.f. pentode	6.3-volt heater
6BE6 Pentagrid converter	6.3-volt heater
6AT6 Duplex-diode high-mu triode	6.3-volt heater
6AQ5 Beam power amplifier tetrode	6.3-volt heater
6X4 Full-wave rectifier	6.3-volt heater
12BA6 Remote cutoff r.f. pentode	12.6-volt heater
12BE6 Pentagrid converter	12.6-volt heater
12AT6 Duplex-diode high-mu triode	12.6-volt heater
50B5 Beam power amplifier tetrode	50-volt heater
35W4 Half-wave rectifier	35-volt heater

Ratings

Max. peak inverse voltage	330 volts
Max. peak plate current	540 ma.
Max. d.c. plate current	90 ma.
Max. surge plate current	1800 ma.
Average tube voltage drop at 180 ma.	22.5 volts

Typical Operating Conditions

Heater voltage	117 volts
Heater current	0.04 amp.
A.c. plate voltage (r.m.s.)	117 volts
D.c. output current	90 ma.

A new series of sub-miniature tubes similar to the hearing aid types has been announced by Raytheon for use in pocket-size radios. The line includes all the requisite types required for a superheterodyne receiver as here listed:

Type	Base	Description
2E32	Pins	Shielded sharp cutoff r.f. pentode
2G22	Pins	Triode-heptode converter
2E42	Pins	Diode-pentode, detector-amplifier
2E36	Pins	Pentode amplifier for earphones
2E31	Flexible leads	Shielded sharp cutoff r.f. pentode
2G21	Flexible leads	Triode-heptode converter
2E41	Flexible leads	Diode-pentode, detector-amplifier
2E35	Flexible leads	Pentode amplifier for earphones

*Ask Your
Jobber for*

PR

The Standard Crystal For the Amateur Bands

☉ P R, the standard crystals for the amateur bands, are now available at your favorite supply jobber. Ask him for P R—they're the best—accurately calibrated, low drift over wide temperature range. Write for your copy of our descriptive booklet on P R amateur crystals.



PETERSEN RADIO COMPANY

2800 WEST BROADWAY—TELEPHONE 2760

COUNCIL BLUFFS, IOWA



RADIO CHASSIS PUNCH



Saves hours of work cutting clean, accurate holes in radio chassis—for connectors and other receptacles. Simply insert cap screw in hole to be enlarged (drill small hole if necessary), turn with ordinary wrench to force punch through the metal. No reaming or filing—hole is smooth and clean. No distortion—die supports metal. Ten sizes from $3/4''$ to $2 1/4''$; also up to $3 1/2''$ for meters. Write for free folder S-119 to Greenlee Tool Co., 1863 Columbia Ave., Rockford, Ill.



RCA INSTITUTES, INC.

Offer thorough training courses in all technical phases of

RADIO and TELEVISION

WEEKLY RATES

DAYS—EVENINGS

VETERANS: RCA Institutes is approved under G. I. Bill of Rights

For Free Catalog write Dept. ST-46

RCA INSTITUTES, INC.

A Radio Corporation of America Service
75 Varick Street, New York 13, N. Y.

AMATEUR GEAR HATRY & YOUNG

8 Connecticut and
Massachusetts Ham Stores

Hartford	C	Stamford
New Haven	O	New London
Bridgeport	N.	Waterbury

BOSTON—MASS.—LAWRENCE

The ELECT in Electronics

Silent Keys

It is with deep regret that we record the passing of these amateurs:

W2DPN, Major Jacob Ludwig, Kingston, N. Y.

W5HTQ, RM 2/c John Walters Booth, USNR, San Antonio, Texas.

W9NLR, Clarence E. Brownson, Brookings, S. Dak.

W9ZDJ, Fred W. Friess, Chicago, Ill.

W9ZQP, Frank A. Baughman, Wichita, Kans.

PAØON, Harry Obreen, Zaltbommel, Netherlands.

CORRESPONDENCE

(Continued from page 76)

sets, so I stowed away the biggest one between two lavatories in my house, which were just one over the other with ample space between them. When we had German soldiers living in the house afterwards, they often were sitting under or over the radio set when using the lavatory, without having any notion of a hidden revr so nearby! My little BCL set (5" x 6" x 10") was hidden in a briefcase, and was used everyday to hear the latest news from the Allies, and the Germans, tho often billeted in the house, never put their noses into the briefcase.

Dutch amateurs have done a lot of underground work, and many of my colleagues fell victim to the German SS and gestapo. Due to my work in the regional water supply company I had not much time left for such work, but at the same time my job served as a perfect screen behind which I was able to do several forbidden things. As far as radio relay work is concerned, I served a while as operator in the eastern sector of Holland, and maintained contact with the Dutch government in London. The gestapo hounds had a fine nose, however, and found my QRA. They just missed me by a hair! By diving under the surface and changing my face a bit I misled them, but I had to discontinue my operating activities for the time being.

You will be interested to know, I guess, how our system operated. The messages from London were received in the Hague on the Bureau of the Radio Control Commission, its members being "OK." The chief of our organization put up a series of xmtrs in the whole country in such a way that each point was at least 25 miles from the next nearest. An army of special messagmen (and girls) kept up contact between HQ and xmitting points. The messages to be xmited were then brought around in such a manner that the succeeding xmissions jumped around over the whole country, thus preventing the Huns from making an exact location of each station. Of course, xmitting periods had to be limited to a few minutes per station. The system proved to be okay, but due to failures made and the high activity of the gestapo hounds, many an operator fell in their hands.

Our chief was caught too, and shot a few weeks before our liberation in March of this year. Our government tried to prevent his shooting by offering to change him for a high ranking "garry," but the Germans knew too well who they had in their hands and prevented the greatest radioman we had from ever telling his story. A few months ago we commemorated him, and the street in which his house was has been named Jan Thyssen Street after him. Furthermore, the three amateur organizations we had in Holland, in commemoration of their fallen co-hams in the underground work, have decided to stop arguing over differences of

(Continued on page 158)

TERMINAL IS YOUR BEST BET FOR BETTER BUYS!

**HEADQUARTERS
FOR AMATEUR
EQUIPMENT**



Fresh Stock! 20 AND 40 METER MOUNTED CRYSTALS

Wide selection of frequencies. Plug into octal tube socket. Low temperature coefficient versus temperature change less than two cycles per megacycle per degree centigrade. Calibration accurate within .01 percent. Mtg. space less than 1/2 x 3/8 inch.
14001 to 14399 Kc.—Type Z-3 **\$3.50 net**
7001 to 7399 Kc.—Type Z-2 **\$2.65 net**

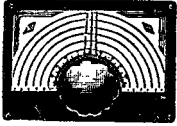

**NATIONAL ACN DIALS
IN STOCK!
\$3.00 net**

Other National dials in stock!
Write for "Specials" lists!

**WESTON 301
METERS**

0-1 MA. D.C.
Graduated scale 0-100
Special **\$5.95**
**G. E. 3 1/2" METERS
SQUARE CASE**
0-150 MA. D.C.
Special **\$3.95**

**STRUTHERS-DUNN
TIME-DELAY RELAY**

SPECIAL! For use in preheating your 866's, etc. 30 second delay, coil voltage 120 volts AC, 20 amp contacts. Rugged construction throughout. This is one of the best relay buys ever offered. Net price **\$4.65**

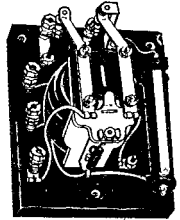

NEW TUBES NOW IN STOCK

Taylor TB-35... **\$10.00 net** Eimac 4-125A.... **\$20.00 net**
Taylor TUF-20... **\$ 4.95 net** Eimac 4-250A.... **\$30.00 net**

Visit our Communication RECEIVER DEPT. All sets on demonstration. Prompt Deliveries!

TERMINAL Radio Corporation

85 CORTLANDT STREET • NEW YORK 7, N. Y. • WOrth 2-4415

**TURNER
Model 33
CRYSTAL OR DYNAMIC**

Here's a rugged TURNER Unit you can depend upon for all-around recording, communications and P.A. work. Built to stand up under difficult operating conditions. Precision engineered to faithfully deliver accurate reproduction of desired sound without harmonics or distortions in a choice of crystal or dynamic models.

33X CRYSTAL with high capacity crystal to permit extra long lines. Range 30-10,000 cycles free from peaks. Moisture, blast and mechanical-shock proofed. Automatic barometric compensator. 90° tilting head. 20 ft. removable cable set. Level -52DB.

33D DYNAMIC has high level dynamic cartridge. Same style and rich chrome finish as 33X. Can take plenty of punishment in all kinds of climate. Level -54DB. Range 10-10,000 cycles. Furnished in 30-50 ohms, 200 ohms, 500 ohms or high impedance.

Ask Your Dealer or Write

Licensed Under U. S. Patents of the American Telephone and Telegraph Company and Western Electric Company, Incorporated

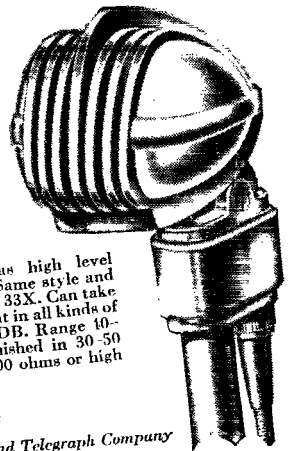

TURNER

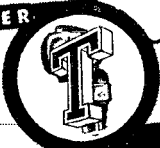

TURNER
Pioneers in the communications field

THE TURNER COMPANY
917 17th Street N. E.
CEDAR RAPIDS, IOWA

Microphones

Complete Microphone Catalog
Write for Your Free Copy

Crystals licensed under patents of the Brush Development Co.

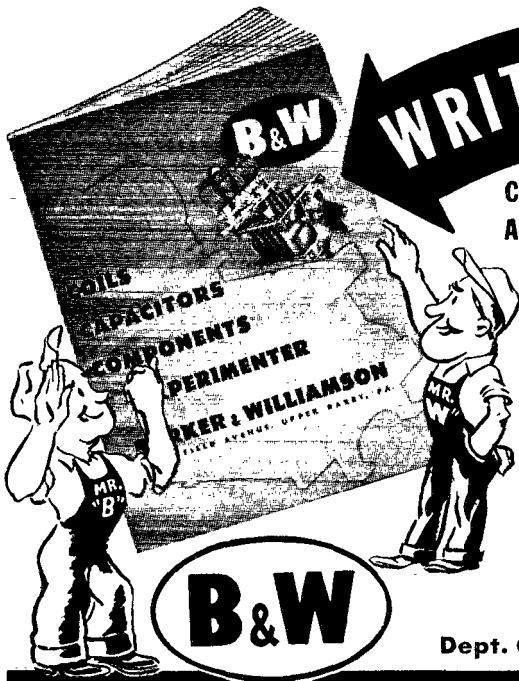

WRITE FOR YOURS

COMPLETE DATA ON THE LATEST B & W AIR-WOUND INDUCTORS, CAPACITORS, ETC.

INCLUDES HELPFUL CIRCUIT HINTS

Write today for your copy of the new B & W catalog. Lists coils, turrets assemblies and accessories for every amateur radio need—also famous B & W Type CX Heavy-Duty Variable Capacitors. Includes installation hints, circuit suggestions and data every ham should know about inductors and variable capacitors.

BARKER & WILLIAMSON

Dept. Q-26, 235 Fairfield Ave., Upper Darby, Pa.

INDUCTOR HEADQUARTERS

HAM HEADQUARTERS FOR Equipment and Information

EXTRA SPECIALS

- 24 G Tubes. Limited Supply..\$1.90 net
- Pyrex Feed Thru Insulator with 2" Mounting Ring. 69¢ net
- Leach Relay. Low Loss D.P.D.T. 6V. D.C. Coil. \$1.75 net
- Ceramic Caps for 866s and 807s. 19¢ net

Mail Orders Promptly Filled

Amateurs To Serve You

Write Dept. Q5T

W6SCQ • W8WLG/6 • W6NAT • W6SSU

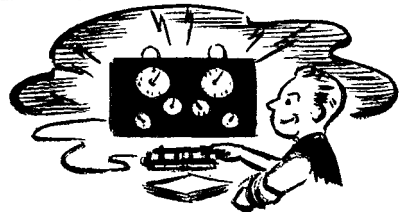

FOR YOUR NEW RIG

Monitor Crystals. 7 MC. Band. Type 43B.....\$2.85 net

Also Complete Line of:

- | | | |
|----------|---------|--------------|
| National | Eimac | Barker- |
| Johnson | Jones | Williamson |
| Ohmite | Amperex | Hallcrafters |
| Taylor | Advance | |

Radio Product Sales Company

238 WEST 15TH STREET
LOS ANGELES 15, CALIFORNIA PRSpec# 7471

REPAIR ANY KIND OF RADIO EQUIPMENT

PREPARE NOW FOR A BETTER JOB AT HIGHER PAY IN THE RADIO-ELECTRONIC FIELD.

Complete Basic Radio-Electronic Training for Beginners... FOR ONLY \$5

EASILY WORTH \$50 IF YOU BOUGHT IT AS A COURSE

No sir! Radio-Electronic Training doesn't have to be expensive to be good. Actually, A. A. Ghirardi's famous 772-page RADIO PHYSICS COURSE book gives you just the training you need—ALL YOU NEED—easier, better, faster—AT A TOTAL COST OF ONLY \$5 (\$5.50 foreign). No previous training is necessary. RADIO PHYSICS COURSE book carries you rapidly

through Basic Electricity (over 300 pages) to the latest Radio-Electronic developments. Nothing is omitted or condensed. Each step is made crystal clear by thorough explanations and by more than 500 illustrations. Each section contains Self-Testing Review Questions so you can check your progress every step of the way. There are no lessons to wait for—no monthly payments to make.

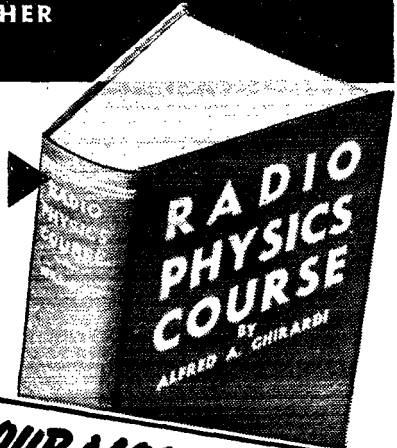

★ **More universally used for home study, by more Signal Corps, Navy and civilian schools and colleges than any other book of its kind!**

All you need is a little spare reading time plus a desire to get started NOW to make more money in the rapidly expanding fields of broadcasting, aviation radio, F-M, Television, radio servicing, electronic manufacturing—or any other of Radio-Electronic's fast-growing branches. RADIO PHYSICS COURSE is famous for making it easy for beginners to learn Radio-Electronic fundamentals—at home without an instructor.

You can understand every word without previous training. You'll be pleasantly surprised how easily you'll master the subjects that other books and courses make seem very complicated. Our 5-Day Money-Back guarantee enables you to examine this great book for five full days—and get every cent of your money back if you're not more than satisfied. Send coupon today!

YOUR MONEY BACK
in 5 Days if Ghirardi's RADIO PHYSICS COURSE doesn't teach you EASIER, FASTER, and AT LESS COST than any other Radio-Electronic book or course!

HERE'S HOW TO LEARN MODERN SERVICE WORK

without an instructor!

Ghirardi's MODERN RADIO SERVICING (see below) is the only single, inexpensive book giving a complete course in modern radio repair work. Written so you can understand it without an instructor! Read from the beginning, it takes you step by step through all phases of the work. Used as a reference book, it serves as a beautifully cross-indexed work for "brushing up" on any job that puzzles you. Explains ALL test in-

struments, how they should be used and why (it even gives all data for constructing your own test equipment); "Troubleshooting Procedure and Circuit Analysis; Testing and Repair of Components; Installations; Adjustments, etc., etc.—ALSO How to Start a Successful Radio-Electronic Service Business. 1300 pages; 726 Illus. Only \$5 (\$5.50 foreign). 5-Day Money-Back Guarantee!

HERE'S HOW TO REPAIR RADIOS THE EASY WAY

Ghirardi's big 744-page manual size RADIO TROUBLESHOOTER'S HANDBOOK (below at right) isn't a "study" book. You simply turn to it whenever you want to fix a particular trouble in a particular model and make of radio. Its 404-page Case History Section gives full details on common trouble symptoms, their causes and remedies for practically every Radio in use—over 4000 of them! It describes the trouble exactly—tells you exactly how to fix it—without any elaborate testing whatever!

If you like to tinker with radios the HANDBOOK is your "Open, Sesame!" to fast, efficient work. If you are already a radio man it will help you fix two sets in the time normally required for one—repair cheap sets profitably—train new helpers—substitute parts properly, etc. Also, hundreds of pages devoted to I-F alignment peaks; transformer troubles, tube substitutions and dozens of charts, graphs, helpful hints, etc.—all indexed so you can find them fast. Only \$5 complete (\$5.50 foreign) on our 5-Day Money-Back Guarantee



MONEY-SAVING OFFER

See coupon for special combination offer on MODERN RADIO SERVICING and TROUBLESHOOTER'S HANDBOOK—over 2040 pages representing a complete service library for only \$9.50! (\$10.50 foreign)

JUST LOOK UP the model radio you want to fix. The Handbook tells exactly what to do—exactly how to do it!

RADIO & TECHNICAL DIVISION

Murray Hill Books, Inc., Dept. Q-36, 232 Madison Ave., New York 16, N. Y.

Enclosed find \$_____ for books checked; or send C.O.D. (U.S.A. only) plus postage. If not fully satisfied, I may return books within 5 days and receive my money back.

RADIO PHYSICS COURSE \$5 (\$5.50 foreign)

MODERN RADIO SERVICING \$5 (\$5.50 foreign)

RADIO TROUBLESHOOTER'S HANDBOOK \$5 (\$5.50 foreign)

MONEY-SAVING OFFER: Modern Radio Servicing AND Troubleshooter's Handbook \$9.50 for the two (\$10.50 foreign)

Name _____

Address _____

City & Dist. No. _____ State _____

QST

YEARLY BINDERS



Are We Right?

You should have at least two of them—one for your complete 1945 file of copies, and one for each 1946 issue as published.

With each Binder is furnished a sheet of gold and black gummed labels for years 1927 through 1947. The proper one can be cut from the sheet and pasted in the space provided for it on the back of the binder.

Price **\$1.50** postpaid

Available only in United States and Possessions

THE AMERICAN RADIO RELAY LEAGUE
West Hartford, Conn.

152

(Continued from page 148)

opinion and have joined together in a new organization called V.E.R.O.N.

The apparatus we used for our underground work was of two types. One type was dropped by Allied planes. It consisted of a little "cigar box" containing xmtr and revr, xtal; metal tubes could be easily attached. The other type was a little "cigarette box" to which a 6L6, tank coil, xtal and control bulbs were attached. The thing had an input of 60 watts and was operated in combination with an ordinary BCL-revr. With such an xmtr I obtained excellent results on approximately 7000 kc., when operating to London. My antenna, believe me or not: 15 feet long, 2 feet over and parallel to the top of the house, attached to two lightning conductors. Notwithstanding the theoretical antenna height of two feet my signals came in R9 in London!

Before signing off I'll tell you what happened to my home town. After the liberation of the southern part of Holland, we were for half a year approximately 25 miles behind the front line. The air warfare in our region changed from over flying bombers into fighter attacks on German targets, as cars, AA posts, Hq., etc., in and around my town. In February a "Typhoon," at which I was looking from the top of my office where I happened to be on air raid duty, turned his nose in our direction and let loose his four rockets, one of which hit our office. I can tell you I never felt so near to the end. Shells and bullets flew all around me in the building as we could ascertain afterwards from holes in the walls and pieces of metal. I came out of it unhurt, but my best friend, who stood beside me, got a bullet thru the head. In March we were bombed twice by tactical bombers, the front line then being 15 miles from here. The inner town went up in flames and 2% of the inhabitants were killed. Two weeks later on April 1st, the Canadians took our town.

Now that the war is over for half a year, living conditions have become much better. We are glad over every little improvement. This week the cigarette rations have been raised from 60 to 80 per two weeks. From now on we will have 3 ounces of chocolate or sweets every two weeks. At the end of next year everybody in Holland will have been supplied with one pair of shoes. The light rations are this month 3 units (kwh) per week. It may seem poor to you, but we are very glad with it.

With best greetings and thanks, I am,

— G. H. Pieterse, PAQGE

A PLUG FOR F.M.

Editor, QST: 322 E. 18th St., Covington, Ky.

Just a word concerning f.m. or phase modulation on ten meters. I for one have a full kw. using Armstrong's method of phase modulation. . . . If the fellows on the air now will tune up to the high end of ten they will hear either my station or one of a few others. If they don't have an f.m. receiver but do have a good communications receiver, if they will turn off the a.v.c. an f.m. signal will be understandable. This I have tried with a number of locals, and it works. It is also to all hams' advantage to try f.m. as the local BCL trouble is not bad at all, even with high power, and is much less expensive to operate. . . . I use a total of 30-kc. swing and the exciter can be used for both mobile and fixed. I use a pair of T-200 tubes in the final, with variable control of input. I can also prove that with f.m. communications can be more solid than with a.m. with the same input.

I have a pet gripe that the average ham does not tune to the high end of the band, and as long as we have these frequencies let's get some stations on them. . . . I am on the air almost every afternoon and would appreciate any activity that you may be in a position to start. Please explain that even a very sharp receiver can be used for f.m. if it is narrow-band transmission, and that a simple f.m. converter is easy to construct and will reduce man made noise, even when receiving a.m. I have a home built superhet f.m. and a.m. receiver which works. Thanks for any support you may give.

— J. E. Dickerson, W9PKU

COTO CONTROL WHEELS

Are Again Available

Prompt Delivery

of the Coto Bakelite Control Wheel may again be had in the familiar 2 1/4" and 3 1/4" diameters—at the same old prices!

Supplied with aluminum scale complete or wheel only as desired.

Separate name plates in a wide choice of titles are also available for attachment on scale as shown, or for use over meters.

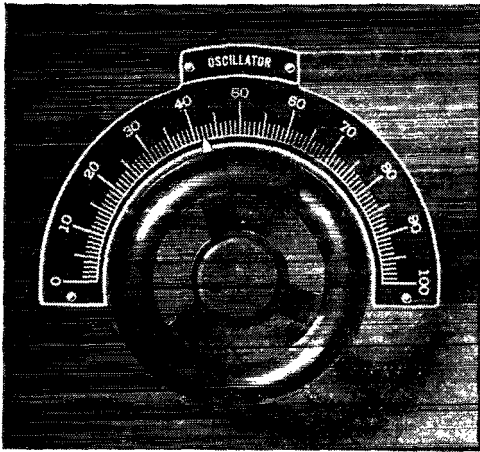

Coto
RADIO PRODUCTS

COTO-COIL CO., INC.

65 Pavilion Avenue

Providence 5 • Rhode Island

COMPLETE RADIO TRAINING!

Prepare now to accept a responsible position in Commercial Radio. New developments will demand technicians with thorough basic training, plus a knowledge of new techniques discovered during the war. Training open to high school graduates or those with high school equivalency. Courses 6 to 18 months' duration in RADIO AND ELECTRONICS. Approved Veteran training in Radio. Write for Particulars.

VALPARAISO TECHNICAL INSTITUTE

Dept. TN

Valparaiso, Ind.

Now—a really
high-powered



RADIO ENGINEERING LIBRARY

5 VOLS.
3319 PAGES,
2289
ILLUSTRATIONS

- especially selected by radio specialists of McGraw-Hill publications
- to give most complete, dependable coverage of facts needed by all whose fields are grounded on radio fundamentals
- available at a special price and terms

THESE books cover circuit phenomena, tube theory, networks, measurements, and other subjects—give specialized treatments of all fields of practical design and application. They are books of recognized position in the literature—books you will refer to and be referred to often. If you are a practical designer, researcher or engineer in any field based on radio, you want these books for the help they give in hundreds of problems throughout the whole field of radio engineering.

Free Examination • Special Low Price • Easy Terms

McGraw-Hill Book Co., 330 W. 42nd St., New York 18
Send me Radio Engineering Library, 5 vols., for 10 days' examination on approval. In 10 days I will send \$3.00, plus few cents postage, and \$3.00 monthly till \$24.00 is paid, or return books postpaid. (We pay postage on orders accompanied by remittance of first installment.)

Name.....
Address..... Company.....
City and State..... Position..... QST 3-46

1. Eastman's Fundamentals of Vacuum Tubes.

2. Terman's Radio Engineering.

3. Everitt's Communication Engineering.

4. Hund's High Frequency Measurements.

5. Henney's Radio Engineering Handbook.



Founded in 1909

RADIO TELEPHONY RADIO TELEGRAPHY ANNOUNCING

Courses ranging in length from 3 to 9 months. Dormitory accommodations on campus for men and women students. Advanced students eligible for practical training at KFAC, 1 KW broadcast station owned and operated by Port Arthur College. New students accepted each month during year. If interested, write for details.

PORT ARTHUR COLLEGE PORT ARTHUR TEXAS

HELPS FOR HAMS

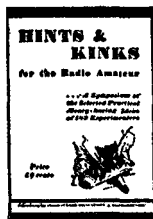

★ ★ ★

Hints & Kinks

Amateurs are noted for their ingenuity in overcoming by clever means the minor and major obstacles they meet in their pursuit of their chosen hobby. An amateur must be resourceful and a good tinkerer. He must be able to make a small amount of money do a great deal for him. He must frequently be able to utilize the contents of the junk box rather than buy new equipment. Hints and Kinks is a compilation of hundreds of good ideas which amateurs have found helpful. It will return its cost many times in money savings — and it will save hours of time. Newly revised.

Price 50 cents

The Radio Amateur's License Manual

To obtain an amateur operator's license you must pass a government examination. The License Manual tells how to do that — tells what you must do and how to do it. It makes a simple and comparatively easy task of what otherwise might seem difficult. In addition to a large amount of general information, it contains questions and answers such as are asked in the government examinations. If you know the answers to the questions in this book, you can pass the examination without trouble.

Price 25 cents

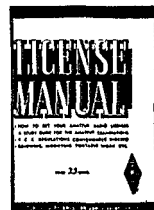

How to Become a Radio Amateur



Universally recognized as the standard elementary guide for the prospective amateur. Features equipment which, although simple in construction, conforms in every detail to present practices. The apparatus is of a thoroughly practical type capable of giving long and satisfactory service — while at the same time it can be built at a minimum of expense. The design is such that a high degree of flexibility is secured, making the various units fit into the more elaborate station layouts which inevitably result as the amateur progresses. Complete operating instructions and references to sources of detailed information on licensing procedure are given.

Price 25 cents

Lightning Calculators

RADIO, Type A — This calculator is useful for the problems involving frequency, wavelength, inductance, capacity, etc. It has two scales for physical dimensions of coils from one-half inch to five and one-half inches in diameter and from one-quarter to ten inches in length; a frequency scale from 400 kilocycles through 150 megacycles; a wavelength scale from two to 600 meters; a capacity scale from 3 to 1,000 micro-microfarads; two inductance scales with a range of from one microhenry through 1,500; a turns-per-inch scale to cover enameled or singlet silk covered wire from 12 to 35 gauge, double silk or cotton covered from 0 to 36 and double cotton covered from 2 to 36. Using these scales in the simple manner outlined in the instructions on the back of the calculator, it is possible to solve problems involving frequency in kilocycles, wavelength in meters, inductance in microhenrys and capacity in microfarads. Gives the direct reading answers for these problems with accuracy well within the tolerances of practical construction. \$1.00

OHM'S LAW, Type B — With this concentrated collection of scales, calculations may be made involving voltage, current, and resistance, and can be made with a single setting of a dial. The power or voltage of current or resistance in any circuit can be found easily if any two are known. This is a newly-designed Type B Calculator which is more accurate and simpler to use than the justly-famous original model. It will be found useful for many calculations which must be made frequently but which are often confusing if done by ordinary methods. All answers will be accurate within the tolerances of commercial equipment. \$1.00

ABOVE PRICES ARE POSTPAID ■ PLEASE DO NOT REMIT IN STAMPS

AMERICAN RADIO RELAY LEAGUE, INC., West Hartford, Connecticut



Bob Henry is Delivering Receivers

I am delivering these models:

Skyrider Jr. 541.....	\$ 33.50
Hallicrafters 520R.....	60.00
Hallicrafters 522R.....	74.50
Hallicrafters 539.....	110.00
Hallicrafters 5X-25.....	94.50
Hallicrafters 5X-28A.....	223.00
Hallicrafters 536A.....	415.00
Hallicrafters 537.....	591.75
ECTA.....	29.50
National N-2-40C.....	225.00
National One-Ten.....	56.10
National HRO Sr.....	197.70
RME-45.....	166.00
Hammarlund HQ129X.....	129.00
Hammarlund Super Pro.....	318.00
HT-9 transmitter.....	225.00
T350XM transmitter.....	850.00
HT4E BC-610 transmitter.....	695.00

Demand for some models exceeds supply. Some models I ship at once. You can trade in your receiver. You can order on my 6% terms. Write for information. I specialize in receivers and transmitters but also have crystals, transmitting tubes, microphones, test equipment, amateur parts, etc. Your inquiries welcomed.

Bob Henry
W9ARA

BUTLER, MISSOURI

HENRY RADIO SHOPS

LOS ANGELES 25, CALIF.

"WORLD'S LARGEST DISTRIBUTOR OF SHORT WAVE RECEIVERS"

RADIO

RADIO Technician and Radio Communications courses. Register now for new classes starting first Monday of each month. Day and Evening Classes.

AMERICAN RADIO INSTITUTE

101 West 63d St. New York 23, N. Y.

Approved under GI Bill of Rights

Buy Direct from Indiana's Most Exclusive "HAM-GEAR" Supply House

New Models Now at Lowest Prices

- National
- Hammarlund
- Hallicrafters

• RME • RCA • HK • B & W • Aerovox • Astatic • Biley • Presto • Stancor • Taylor • Triplett • Temco • Vibroplex

and 100 other top lines to choose from. Rush us your order now with a \$5.00 deposit for quickest possible delivery.

We're making deliveries **NOW!**

W9KJF, W9LVI, W9MMJ, W9OEK, W9VEK, W9TE

VAN SICKLE

RADIO SUPPLY CO.

34 W. OHIO ST. • INDIANAPOLIS 6, IND.

Extras
at No Extra Cost!

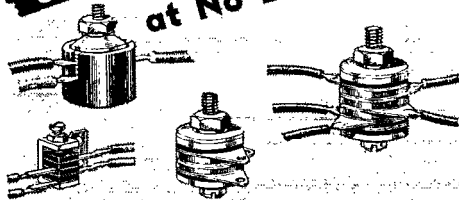

ELECTROX RECTIFIERS

Get the extra dependability and longer life, inherent in ElectroX Rectifiers—full and half wave low capacity copper oxide rectifiers, for test sets, instruments, and other electronic applications which must stand up under exacting service.

Made by one of the oldest manufacturers of dry disc rectifiers — time proven — trouble-free — they cost no more!

At your parts supplier,
or write for descriptive
Circular 446

ELECTROX DIVISION **SCHAUER MACHINE CO.**
2049 Reading Rd. Cincinnati 2, Ohio

HAM-ADS

(1) Advertising shall pertain to radio and shall be of nature of interest to radio amateurs or experimenters in their pursuit of the art.

(2) No display of any character will be accepted, nor can any special typographical arrangement, such as all or part capital letters be used which would tend to make one advertisement stand out from the others.

(3) The Ham-Ad rate is 30c per word, except as noted in paragraph (6) below.

(4) Remittance in full must accompany copy. No cash or contract discount or agency commission will be allowed.

(5) Closing date for Ham-Ads is the 25th of the second month preceding publication date.

(6) A special rate of 7c per word will apply to advertising which, in our judgment, is obviously non-commercial in nature and is placed and signed by a member of the American Radio Relay League. Thus, advertising of bona fide surplus equipment owned, used and for sale by an individual or apparatus offered for exchange or advertising inquiring for special equipment, if by a member of the American Radio Relay League takes the 7c rate. An attempt to deal in apparatus in quantity for profit, even if by an individual, is commercial and all advertising by him takes the 30c rate. Provisions of paragraphs (1), (2), (4) and (5), apply to all advertising in this column regardless of which rate may apply.

(7) Because error is more easily avoided, it is requested signature and address be printed plainly.

Having made no investigation of the advertisers in the classified columns, the publishers of QST are unable to vouch for their integrity or for the grade or character of the products or services advertised

QUARTZ — Direct importers from Brazil of best quality pure quartz suitable for making piezo-electric crystals.
Diamond Drill Carbon Co., 719 World Bldg., New York City.

AMATEUR radio licenses. Complete code or theory preparation for passing amateur radio examinations. Home study and resident courses. American Radio Institute, 101 West 63rd Street, New York City.

WRL Transmitting kits — 15, 35, 70, and 150-watt units — low priced. All makes of receivers, both new and reconditioned. Leo offers best trade-in deal, and easy time payment plan. One of the country's largest parts supply houses. Write today for free catalog, special radio map offer, tube-base calculator offer, and other items. Leo, at Wholesale Radio, Dept. HA, Council Bluffs, Iowa.

CRYSTALS: complete units mounted in holders $\frac{3}{16}$ " pin spacing to fit 5-prong socket 3.5 mc., 14 mc. bands within 5 kc. your selected frequency, \$3.30 ea. Blanks: large $\frac{3}{16}$ " by $\frac{1}{8}$ " oscillating blanks, 3.5 mc. and 7 mc. bands, \$1.00 each. Immediate shipment. No priority required. Rex Bassett, Inc., Ft. Lauderdale, Fla.

CRYSTAL plus holder, BT cut, mounted, 5 kc. of desired frequency, \$2.75. Exact frequency, \$3.75. Borri Electric Co., Granville, Ill.

WANTED: QST, September 1919 and September, 1921. Dick Dunham, W1EWF, River Ridge, Hanover, N. H.

750-1000 watt phone and bug transmitter, 2 racks, 42" x 72" complete, including oscilloscope, mikes, 2 receivers, IRME 66 remote control, etc. Make reasonable offer. Estate Wm. W. Birney, W2LVE, 319 Parkville Ave., Brooklyn, N. Y.

BRETTING 12 wanted in good condition, with speaker, for cash. W6SN, 525 So. Westgate, Los Angeles 24, Cal.

COAX cable, Type RG-34U. Handles a kw, with ease. Loss 2 db. per 100 ft. at 100 Mc. Special price, 15c per ft. Limited quantity. Willard S. Wilson, 405 Delaware Ave., Wilmington, Del.

NEW low loss antenna transmission line RG59U polystyrene insulated 70 ohm $\frac{1}{4}$ " coaxial cable, weatherproofed, 8¢ per ft. BC 406 Signal Corp surplus 205 mc. 15 tube superhet (6 Acorn tubes) easily adapted, 10-2 meter reception, \$30. BC 224 surplus 7-tube superhet, 200-500 kc., 1.5-18.3 mc., xtal less power supply, \$69.50. Triplett 2 square Bakelite 0-150 Ma. meters, 2 for \$6.50. New Meters, all types, low prices. List. Westchester Electronic Products, 29 Milburn St., P.O. Box 231, Bronxville 8, N. Y.

QSLs. Samples, prices for hams. W2AEY, Groebe, 338 Elmora, Elizabeth, N. J.

SELLING: Guaranteed used 304 TLs, 250 TL, \$9.80 each. $\frac{1}{4}$ µd, 20,000 volt, Cornell-Dubilier condenser, \$27. Amertran choke, 1 h, 8 amp, \$17. Send for parts list. Charles Johnson, 705-9th Street, Manhattan Beach, Calif.

WANTED: good ham receiver. Will swap DeVry Type G projector and Stewart-Warner FC 5 camera, 16 mm. H. Hohl, 1305 Pearl, Sandusky, Ohio.

CONDENSERS: New: rectangular cans. GE Pyranols, 4 µd, 1000 v., \$1.75; 2 µd, 1500 v., \$1.75; 8 µd, 1500 v., \$3.75; 4 µd, 2000 v., \$3.00; 4 µd, 3000 v., \$6.75; 2 µd, 400 v., \$8.50; C-D Dykanols: 8 µd, 1000 v., \$2.75. HV micas, screw terminals, bakelite cased: Sprague 0.0015 µd, 5000 v., \$1.50; C-D 0.005 µd, 5000 v., \$1.75. 10% discount on orders over \$15. Les Dubin, W2AQN, 147 Elm Ave., Mt. Vernon, N. Y.

UTAH, Jr., transmitter for sale. Complete with 80 and 40 meter coils, tubes, and 0-150 Ma. Triplett meter. \$25. Marquez, 116 Delgado, Las Vegas, New Mexico.

VIBRATOR supply, EL606B, 6 v.d.c. to 400 v, 200 Ma. New, \$17.50 or exchange for h-voltage 6 or 12 v. dynamotor. Harry Sherwood, 35-05-87 St., Jackson Heights, N. Y.

SPECIAL: General Electric plate transformers, 800 v., c.t. 250 mls. \$4. Gilbert E. Miller, Electronic Equipment, 516 Fifth Ave. N.Y.C.

HAM crystals: \$2.50 within 10 k.c. of specified frequency; excellent oscillators guaranteed; 3500 k.c. to 8000 k.c.; Army type, FT 243 holders. L. Kipp, 277 Broadway, N.Y.C. 7

CRYSTALS: Ham and commercial. Low TC. Fast service on 80 and 40 = 1 kc. \$2.65; 20 meter + 2 kc., \$3.50; 100 kc. standard crystal, \$12.50; 1000 kc. standard crystal, \$6.50; 465 & 456 filter crystals at \$4.50. Filters: 80, 40, & 20 ft. octal sockets. Standards fit 5-prong socket. Write me your crystal problems. Al Scientific Radio Products Co., 738 $\frac{1}{2}$ W. Broadway, Council Bluffs, Iowa.

QSLs. Outstanding values! Fritz, 1213 Briargate, Joliet, Ill.

BARGAINS in war surplus radio parts for hams. Standard parts. Guaranteed new. Send for list. R. A. Smith, 43-39 147th St., Flushing, N. Y.

QSTs for sale. Best offer. 1930-40 inclusive. Also Grebe GR-9, Burton Waldron, W9ZT, Medicine Lake, Rt. 14, Minneapolis 12, Minn.

QSLs. Samples. Glenn Print, 1042 Pine Heights Ave., Baltimore 29, Md.

TRANSCEIVER. Navy type ARC4, complete, control boxes, dynamotor, tubes and crystals. V.h.f. 140 to 144 Mc. Trade for Dumont scope 5". F. M. Rice, 312 No. Mawmee St., Tecumseh, Mich.

QSLs, SWLs, new designs, first class printing. Free samples. Franzen, W3DEE, Box 103, Maple Shade, N. J.

BLILEY crystals? RME-45s? QSLs? SWLs? Pre-war stock! Order now! Samples? Sakkers, W3DED, Holland, Mich.

WANTED: #4 and #5 Utah kits, either new or used. Will pay top price. Donald Hathorn, 208 Broadway, Bangor, Me.

SELL: Howard 438, like new; older HRO, service manuals, Meissner noise silencer, 2" Supreme Oscilloscope. J. Ridgway, Milledgeville, Ill.

TRANSFORMERS. Kenyon 866A, filaments 2.5 v., 10 amps., 10,000 test volts, 115 v. a.c. primary, \$3.89. Kelvin Electronics, 72 Cortlandt St., New York 7, N. Y. Dep. with order.

TRADE: 2 new RCA #814 tubes, unused. Wanted: 8 mm. movie camera, good condition. Cash for difference. K. W. Grinde, 4234 Gateway, Los Angeles 27, Calif.

SCR-211 frequency meter with modulator, unused. Best cash offer or trade for National revr. E. Harris, W8SJB, 3319 Catalpa, Chicago, Ill.

RECEIVER headquarters: RME, National, Hammarlund, Hallicrafters. Conklin Radio, Bethesda, Md.

QSLs, 2 colors, special design, samples, prices on request. Royal Printing, Malden (R), Mass.

FOR SALE: Shortwave revrs, army surplus. Contact John Melhorn, Herrin, Ill., for particulars.

WANTED: High power parts. Crowell, W3AJO, 4203 Rosemont Ave., Drexel Hill, Penna.

SELL: Old issues of QSTs, good condition, from December 1926 through April 1934. Make offer. Major H. A. Stadermann, 4120 Arkansas Ave., N.W., Washington, D. C.

8MM movie projector, Eastman model 60 a.c. only, for sale, \$40 or trade for Precision E200 signal generator and cash. W2OHE, 1156 East 40th St., Brooklyn, N. Y.

SINGLE button microphones. Compact, fine for portable use or on mike stand. \$1.39 ea., R. R. McFarland, W5PKS, Little Silver, N. J.

QSLs-SWLs. Meade, W9KXL, 1507 Central Ave., Kansas City, Kansas.

GUARANTEED 813 tubes, \$10. Wise, 424 20th NE., Cedar Rapids, Iowa.

WANTED: QSTs: July, Aug., Sept., Oct. 1932; Jan., Feb. 1932; Feb., April, Oct., 1936. State condition and price. Gerry Corrigan, W9BBB, 1102 State St., Guthrie Center, Iowa.

FOR SALE: Onan 2000-watt a.c., 110 volt gasoline driven power plant, with remote control relay, starter. New 809, 866, 804, power transformer, relays 1-100 watt transmitter, 10-20 meters. W. S. Felt, Wellington, Kansas.

METERS repaired, rebuilt, and calibrated. Factory accuracies. Springfield Testing Laboratory, 2931 East Enos, Springfield, Ill.

WANT NC200, also RCA AR-77. Sell or trade Kodak 35, special coupled range-finder. W. M. Mead, Chico, Texas.

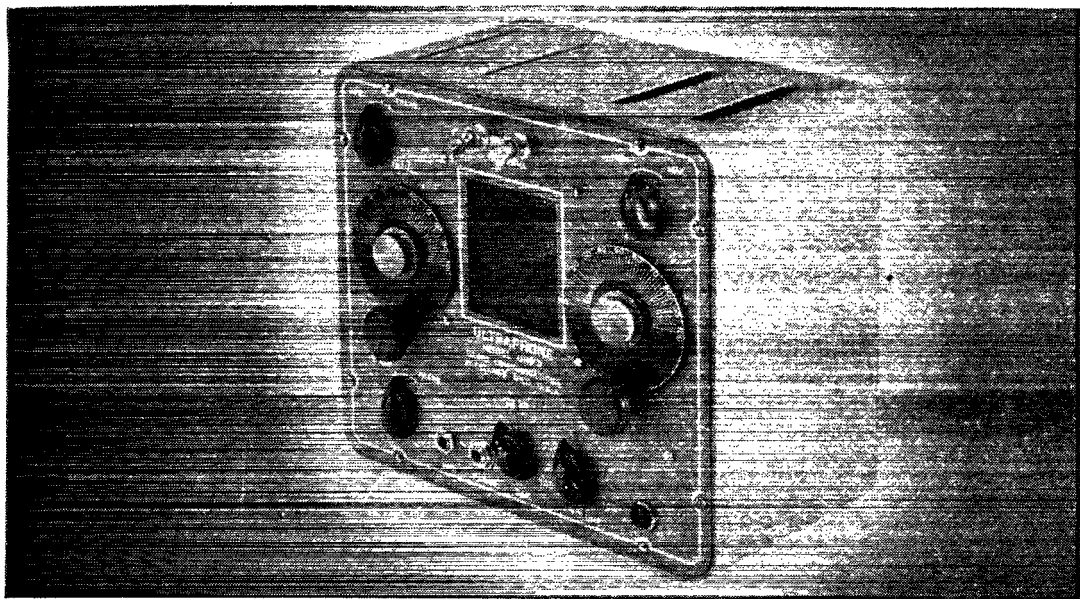

Introducing the **ULTRAPHONE**

Copyright and Patent Applied for

MODEL UHP-2

Get on the air with this high quality 144-148 megacycle transmitter-receiver—designed for portable, mobile or fixed station use—

✓ **Check these important features . . .**

- ✓ Commercial appearance and performance.
- ✓ Newly designed 6AK-5 detector circuit.
- ✓ Expanded band spread and increased sensitivity.
- ✓ Transmitter will handle 30 watts input continuously.
- ✓ Operating capabilities up to 250 mc.
- ✓ Transmitter features the Taylor TUF-20 tube.
- ✓ Other tubes include 6AK-5, 7B4 and 7C5.
- ✓ Provisions for crystal or magnetic headphones and metering.

Comes complete with matched set of tubes, but less power supply. Will operate from 6-volt vibrator pack, genemotor or a-c power supply.

Specially Designed "Amphenol" Hi-Q Antenna Kit Optional

ORDER NOW FROM YOUR LOCAL JOBBER

Manufactured by

GROSS COMMUNICATIONS PRODUCTS

Division of The Mills Company — Cable Code: Millsmetal

1514 PROSPECT AVE. • CLEVELAND 14, OHIO

Telephone: PProspect 0782

Designed for



Application

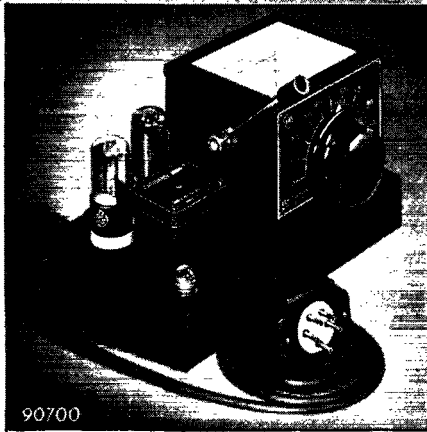

90700

The No. 90700

MILLEN "ECO"

A favorite pre-war frequency shifter is again available. Plugs in, in place of crystal for instant finger tip control of carrier frequency. Low drift. Chirpless keying. Vibration immune. No hand capacity. Big band spread. Accurate calibration. Easy to read curve. Built-in power supply. Ideal for use with 90800 Millen 50 watt Transmitter-Exciter.

**JAMES MILLEN
MFG. CO., INC.**

MAIN OFFICE AND FACTORY
**MALDEN
MASSACHUSETTS**



Index of Advertisers

	Page
Adson Radio Co.	146
Aireon Manufacturing Corp.	102, 103
Allied Radio Corporation	129
American Radio Institute	155
Astatic Corporation, The	91
Barker & Williamson	150
Bell Telephone Laboratories	132
Birnbach Radio Co.	140
Biley Electric Co.	87
Bruno Tools Co.	130
Burlington Instrument Co.	113
Cambridge Thermionic Corp.	112
Candler System Co.	128
Capitol Radio Engineering Inst.	97
Cardwell Mfg. Co., Allen D.	100
Central	1
Cleveland Inst. of Radio Electronics	122
Collins Radio Company	119
Commercial Radio Institute	136
Concord Radio Corp.	145
Condenser Products Co.	133
Cornell-Dubilier Elec. Corp.	127
Coto Coil Co., Inc.	153
Crystal Products Co.	105
Crystal Research Laboratories	138, 139
Drake Electric Co.	116
Eitel-McCullough, Inc.	2
Electro-Voice Corp.	107
Electronic Laboratories	125
Gates Radio Co.	144
General Electric Co.	137
Greenlee Tool Co.	148
Gross Communications Products	157
Hallcrafters Co., Inc.	4, 5
Hammarlund Mfg. Co., Inc.	98, 99
Harrison Radio Co.	35
Harvey Radio Co.	118
Harvey Radio Laboratories	106
Hatry & Young	148
Henry Radio Shop	155
Hytron Elec. & Radio Corp.	141
Instructograph Co., The	130
Knights Co., James	110
Lewis Electronics	103, 128
Maguire Industries	108, 109, 142
Mallory & Co., P. R.	96
Marion Elec. Instrument Co.	8
McElroy Mfg. Co.	95
McGraw-Hill Book Co.	153
Millen Mfg. Co., Inc., The James	158
Murray Hill Book Co.	151
National Co., Inc.	85, Cov. III
Newark Electric Co.	120, 121
Ohmite Mfg. Co.	101
Onan & Sons, D. W.	134
Panoramic Radio Corp.	131
Peterson Radio Co.	147
Port Arthur College	153
Premax Products	128
Radio Manufacturing Engineers	93, 159
Radio Product Sales Co.	150
Radio Products Sales Co.	130
Radio Shack Corp., The	123
Raytheon Mfg. Co.	9, 89
RCA Institutes, Inc.	148
RCA Mfg. Co.	Cov. IV
Seeli & Co., R. G.	136
Schauer Machine Co.	155
Solar Capacitors	160
Sound Equipment Corp.	142
Speer Carbon Co.	115
Sprague Electric Co.	7
Standard Transformer Corp.	104
Sylvania Elec. Products Co.	111, 117
Taylor Tubes Co.	114
Telegraph Apparatus Co.	146
Television Tech. Ent.	146
Terminal Radio Co.	149
Turner Co., The	149
United Electronics	143
United Transformer Co.	Cov. II
Valparaiso Technical Institute	153
Van Sickle Radio Supply Co.	155
Vibroplex Co., The	142
Ward Leonard Electric Co.	136
Western Electric Co.	126
Wholesale Radio Laboratories	124
Wind Turbine Co.	134
Yaxley (P. R. Mallory & Co.)	96
YMCA Trade & Tech. Schools	140

RME GETS WAC*



So many letters telling us how well RME receivers are performing were received the other morning, we thought we'd see if we had heard from each continent. We had—and quickly made a new kind of WAC without even turning on the transmitter. Excerpts from these letters tell the story of peak performance the world over—the kind of performance the new 45 is rendering.



EUROPE (From England)

... "possessed models of your manufacture and they were the height of engineering as applied to short wave receiver design. The keynote was reliability and the amazing sensitivity." ...



AFRICA (From Union of South Africa)

... "My wartime position of Communications Officer has brought me in touch with your products, and so it has become my ambition to own a really fine communications receiver of your type." ...

THE NEW RME 45 — ALWAYS A BETTER RECEIVER!

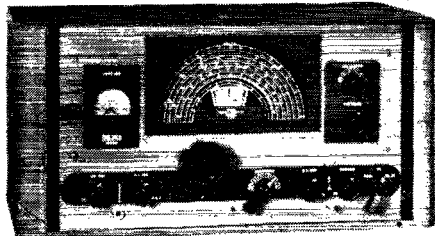

OCEANIA (From Australia a VK3)

... "Back in 1935 I was fortunate enough to be able to acquire an RME. This set has performed marvelously." ...



ASIA (From Ceylon)

... "and the technical world outside of Ham-Dom should be told about your receivers." ...



SOUTH AMERICA (From Brazil a PY7)

... "I have an RME 69 that I consider the best receiver I have seen any time." ...



NORTH AMERICA (From the Aleutians)

... "I have one of your 43 receivers here and the reception on it is excellent. I am 3000 miles from Seattle and" ...

*Worked All Continents



RME

FINE COMMUNICATIONS EQUIPMENT

RADIO MFG. ENGINEERS, INC.

Provia 6, Illinois U. S. A.

NEW!

JUST OUT!

RADIO AMATEURS

Before choosing capacitors
for all rigs, large and small —

SOLAR MANUFACTURING CORPORATION
285 Madison Avenue, New York 17, N. Y.

Gentlemen:
Sure, I want the new Solar Capacitor Catalog SC-1.
Please send it along.

Name _____
(Please Print)

Address _____

City _____ Zone _____

State _____
RAC

get the new



catalog!



CAPACITORS

Every size, every type—from tiny tubulars for
vest-pocket receivers to high-voltage solder-sealed
oil papers for that 1-kw dream transmitter—are
shown in this new 36-page book that belongs in
every ham shack... Remember SOLAR Capacitors
are reliable in every climate.

FREE

Get your catalog from your SOLAR dis-
tributor or clip coupon, paste on penny
postal card and mail today.

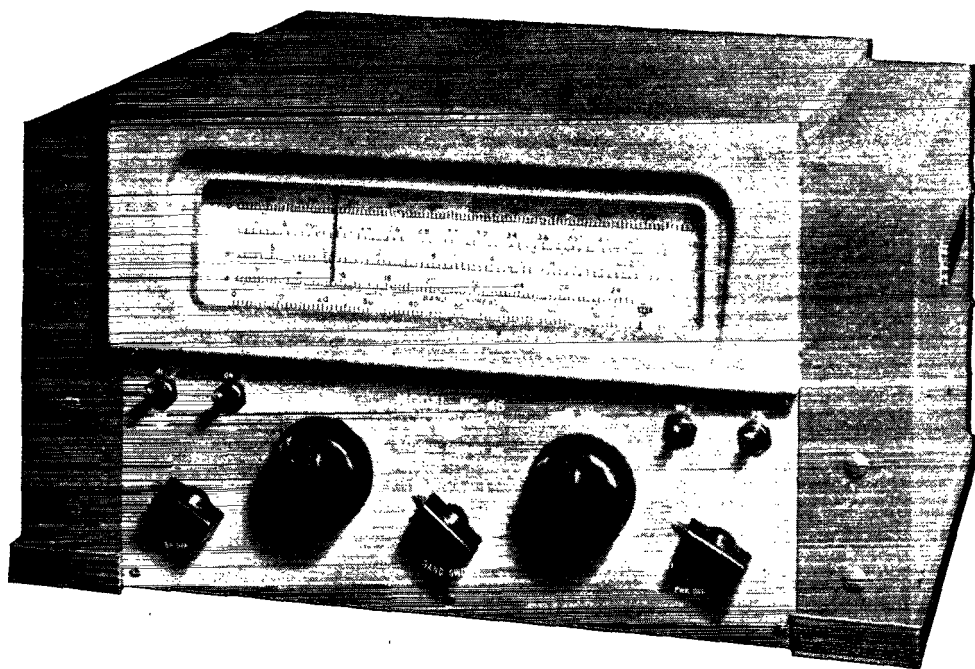

THE NC-46

The New National NC-46 Receiver is a fine performer at a moderate price. Ten tubes in an advanced super-heterodyne circuit provide excellent sensitivity throughout the receiver's range from 550 KC to 30 MC. Circuit features include an amplified and delayed AVC, series valve noise limiter with automatic threshold control, CW oscillator and separate RF and AF gain controls. The push-pull output provides 3 watts power, and the AC-DC power supply is self-contained.

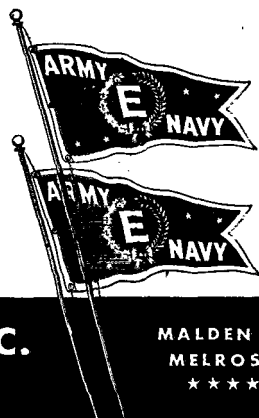

NATIONAL COMPANY, INC.
MALDEN, MASSACHUSETTS, U.S.A.

MALDEN
MELROSE
★★★★



6C4 HF POWER TRIODE

Delivers 5.5 watts at moderate frequencies, 2.5 watts at 150 Mc. Its 150 ma. heater makes it ideal for mobile rigs.



6BA6 REMOTE CUT-OFF PENTODE

As an r-f or i-f amplifier in communication receivers it provides high gain at the upper frequencies.



6J6 TWIN TRIODE

Delivers one watt at 250 Mc. Especially suitable for transmitter and receiver applications at 450 Mc.

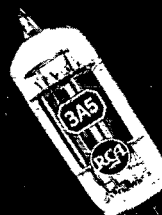

3A5 HF TWIN TRIODE

A battery type for portables. Filament draws 220 ma. at 1.4 v. Will deliver 2 watts at 50 Mc., about 1/2 watt at 144 Mc.



6AK6 POWER PENTODE

Has same heater rating as 6C4. In push-pull, modulates a 6C4 or 6J6 final. Fine as a crystal or electron-coupled oscillator.



3A4 POWER PENTODE

Two 3A4's connected in push-pull will plate-modulate a 3A5 final. The 3A4 filament draws only 200 ma. at 1.4 v.



6AU6 SHARP CUT-OFF PENTODE

A high-gain, general-purpose tube for speech amplifiers, frequency meters, monitors and other "ham" gear.

7 RCA MINIATURES

that offer unusual operating possibilities in the VHF Bands

THE high performance characteristics of these RCA Miniature Tubes at very high frequencies stem from their lower inter-electrode capacitances and reduced lead-inductance values, and the low-loss glass button base. The small dimensions of the tubes permit the design of equipment which is neat and compact.

The low price of the RCA Miniatures illustrated makes them particularly attractive for amateur use.

There are 36 RCA Miniature types. You will find many of these ideally suited to amateur transmitter and receiver designs. For further details, see your local RCA Tube Distributor.

THE FOUNTAINHEAD OF MODERN TUBE DEVELOPMENT IS RCA



TUBE DIVISION

RADIO CORPORATION of AMERICA

HARRISON, N. J.