

QST

december, 1944

25 cents

35c in Canada

devoted entirely to

amateur radio



In This Issue: Why Low-Level Microphones?
Carrier Current F. M. • Video Amplifier Design
The Cathode Follower • Cross-Over Networks

LOW PASS (TYPE L.P.I.)
HIGH PASS (TYPE H.P.I.)

FILTERS

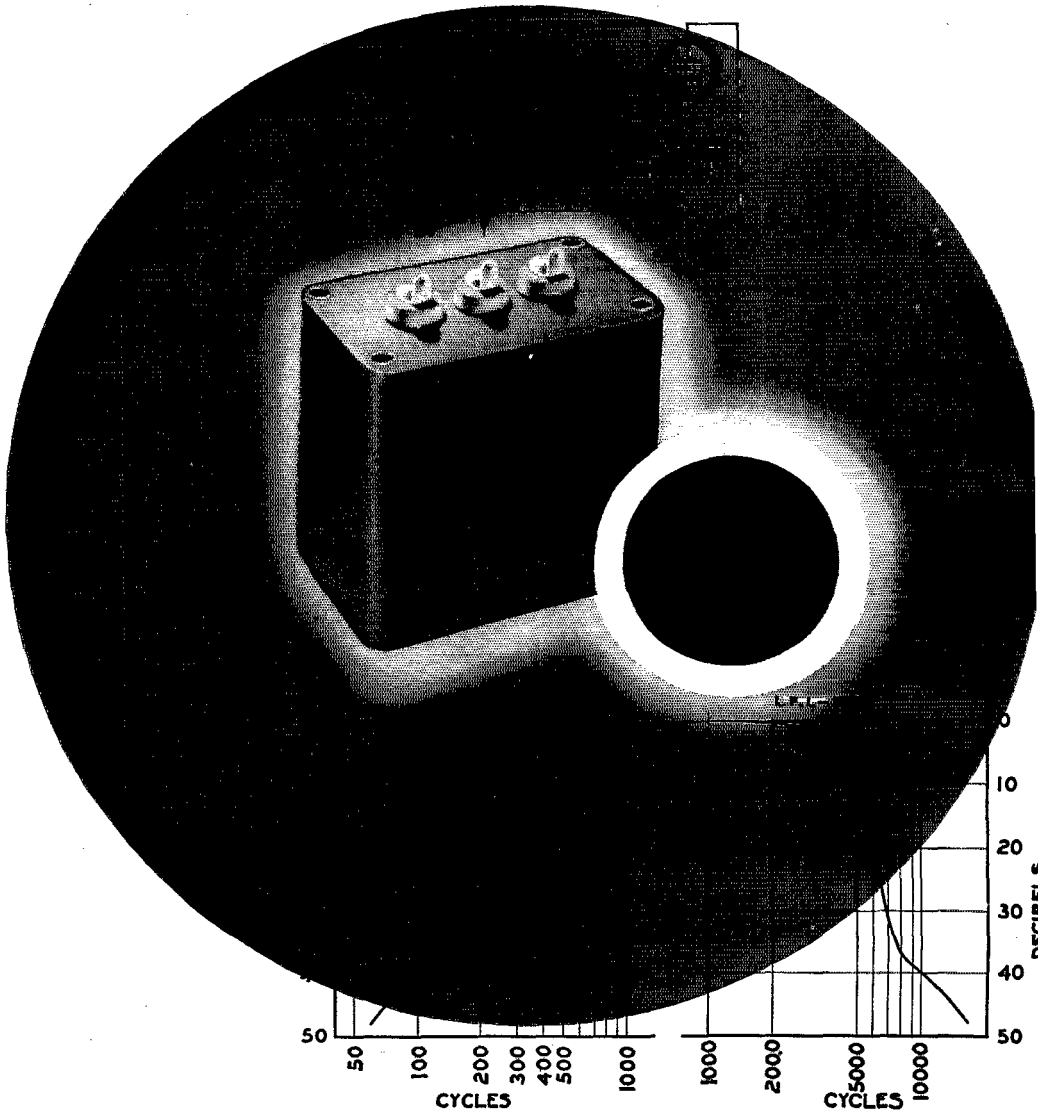

New additions to the UTC Interstage Filter family are now available in the type HPI and LPI units, respectively high pass interstage and low pass interstage filters.

The units are designed with a nominal impedance of 10,000 ohms to be used in a circuit as illustrated. Typical curves obtainable are shown above. Loss at cutoff frequency is less than 6 DB. At .75 times cutoff or 1.5 cutoff frequency respectively, the attenuation is 35 DB, and at one-half or twice cutoff frequency respectively, the attenuation is 40 DB.

These units employ a dual alloy magnetic shield which reduces inductive pickup to 15 Mv. per gauss. The dimensions in hermetically sealed cases are $1\frac{1}{2}'' \times 2\frac{1}{2}'' \times 2\frac{1}{2}''$. Filters of the HPI and LPI type can be supplied for any cutoff frequency from 200 to 10,000 cycles. Specify by type followed by frequency, as: LPI-2500.

May we cooperate with you on design savings for your application . . . war or postwar

150 VARICK STREET

NEW YORK 13, N. Y.



“They filled a gap—”

The following is quoted from a letter received from a Chief Radio Mechanic in the U.S. Navy and is one of a series of real life stories of Hallicrafters radio equipment in action . . .

“During the early days of the South Pacific offensive the cruiser on which I was serving was called upon unexpectedly to maintain a watch on five extra frequencies. All of our regular receivers were already in use and it was impossible to use any of them for this emergency.

“Some thoughtful predecessor in peace time had purchased eight Hallicrafters S-20-R receivers with ship’s service funds for use as broadcast receivers in the crew’s quarters. We dug them out of the lockers and tested them.

All were in excellent condition after months of vibration, humidity and tropical heat. We stacked them on an operating table in the radio room and set them on the specified frequencies.

“The first call on all frequencies was heard S-5 and voice signals came through clear as a bell. These receivers required no attention other than volume adjustment and the volume was sufficient to over-ride the noise of guns on our own ship. Their reliability in a tough spot amazed us. They filled in a big gap in the chain of command and filled it well.”

The S-20-R mentioned above is known to thousands as Hallicrafters famous “Sky Champion.” It has a frequency range of 550 kc. to 43 mc., continuous in 4 bands and 9 tubes.

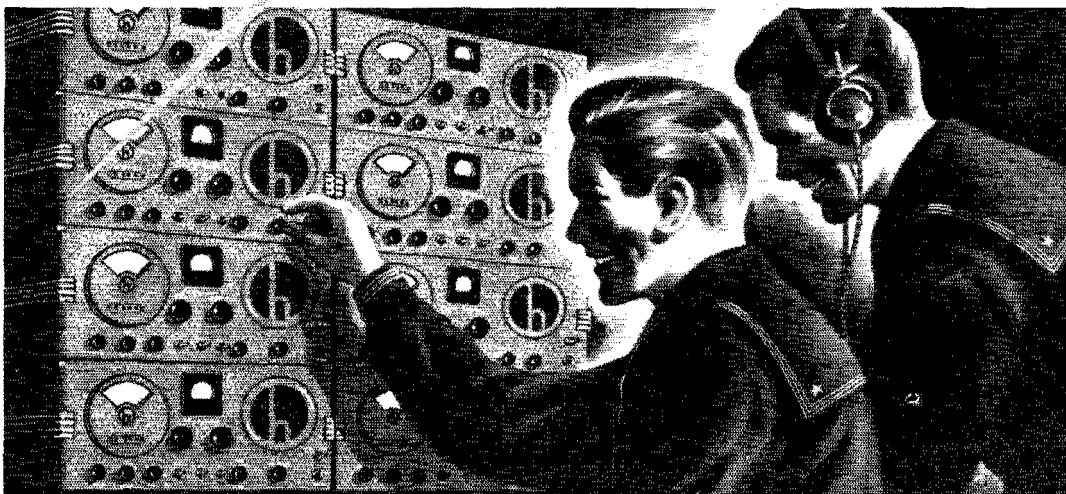

BUY A WAR BOND
TODAY!

hallicrafters RADIO

THE HALLICRAFTERS COMPANY, MANUFACTURERS OF RADIO AND ELECTRONIC EQUIPMENT, CHICAGO 16, U.S.A.

THE SET THAT

never slept

10,800 Continuous Hours

Fifteen months of continual service, 10,800 continuous hours, night and day with the switch never once turned off—and no repairs or replacements needed. That's the record established by a Hallicrafters SX-28 in use testing crystal standards at Scientific Radio Products Co., Council Bluffs, Iowa.

Equal to Five Years' Use

Witness to this amazing performance was Myron C. Jones, resident inspector in charge. Day after day he watched "the set that never slept" in continuous action between January 5, 1943 and April 10, 1944.

Inspector Jones writes:

"This is what I call punishment. It surpasses five years of ordinary use, with no new parts needed. This war plant had many more Hallicrafters receivers, all performing outstandingly. You can't beat Hallicrafters for endurance, sensitivity, selectivity, tone, ease of operation and all around performance."

"The Radio Man's Radio"

This is only one more significant notch in Hallicrafters' record. Men who know radios inside out, men who depend on them when life itself is at stake and when there can be no compromise with quality, specify Hallicrafters, "the radio man's radio."

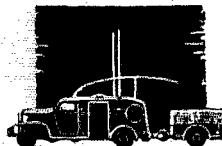
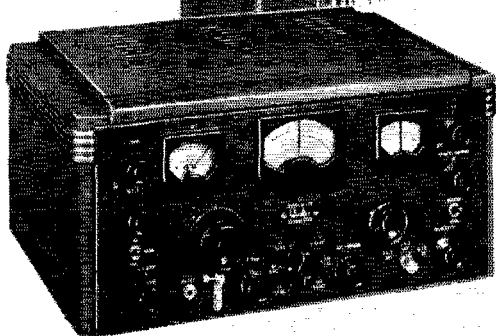
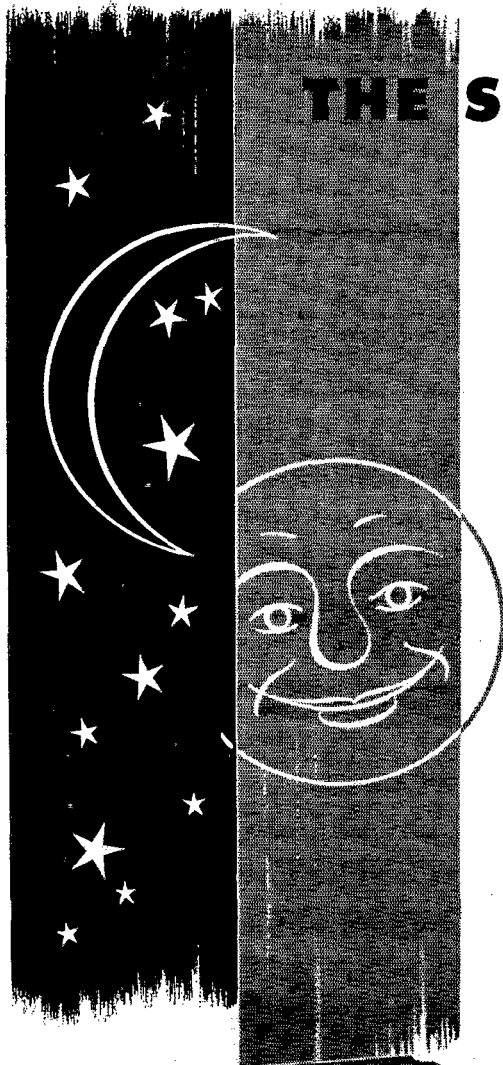

BUY A WAR BOND TODAY!

hallicrafters RADIO

THE HALLICRAFTERS COMPANY, MANUFACTURERS OF RADIO AND ELECTRONIC EQUIPMENT, CHICAGO 16, U.S.A.

DECEMBER 1944

VOLUME XXVIII

NUMBER 12



STAFF

Editorial

KENNETH B. WARNER, W1ER
General Manager of A.R.R.L.
Publications

CLINTON B. DeSOTO, W1CBB
Editor

GEORGE GRAMMER, W1DF*
Technical Editor

DONALD H. MIX, W1TS
Acting Technical Editor

J. VENABLE FITZHUGH, W5VL
HOLLIS M. FRENCH, W1JK
BYRON GOODMAN, W1JPK*
Assistant Technical Editors

EDWARD P. TILTON, W1HDQ
Contributing Editor, V.H.F.

WALTER E. BRADLEY, W1FWH
VERNON CHAMBERS, W1JEQ*
Technical Information Service

LOUISA B. DRESSER
Editorial Assistant

JAMES J. LAMB, W1AL*
Research Engineer, A.R.R.L.

Advertising

F. CHEYNEY BEEKLEY, W1GB
Advertising Manager

Circulation

DAVID H. HOUGHTON
Circulation Manager

RALPH T. BEAUDIN, W1BAW
Assl. Circulation Manager

*On leave of absence



OFFICES

38 La Salle Road
West Hartford 7, Connecticut

Subscription rate in United States and Possessions, \$2.50 per year, postpaid; all other countries, \$3.00 per year, postpaid. Single copies, 25 cents. Foreign remittances should be by international postal or express money order or bank draft negotiable in the U. S. and for an equivalent amount in U. S. funds.

Entered as second-class matter May 29, 1919, at the post office at Hartford, Connecticut, under the Act of March 3, 1879. Acceptance for mailing at special rate of postage provided for in section 1103, Act of October 3, 1917, authorized September 9, 1922. Additional entry at Concord, N. H., authorized February 21, 1929, under the Act of February 28, 1925. Additional second-class entries to cover sectional editions authorized March 20, 1935.

Copyright 1944 by the American Radio Relay League, Inc. Title registered at United States Patent Office.

QST

devoted entirely to

AMATEUR RADIO

PUBLISHED, MONTHLY, AS ITS OFFICIAL ORGAN, BY THE AMERICAN RADIO RELAY LEAGUE, INC., AT WEST HARTFORD, CONN., U. S. A.; OFFICIAL ORGAN OF THE INTERNATIONAL AMATEUR RADIO UNION



CONTENTS

It Seems to Us	7
Splatter	8
A Mobile Installation for WERS Robert W. Carter	9
Silent Keys	13
Happenings of the Month	14
The Cathode Follower	
<i>Captain William H. Minor, SC, W9DSN</i>	18
In the Services	20
Video-Amplifier Design	
<i>Charles H. Merritt, ART1c, USNR, W6OMH</i>	24
In QST 25 Years Ago This Month	28
F.M. for Carrier-Current Communication	
<i>George M. Guill, jr. W8VAN</i>	29
Gold Stars — VE5NV, W. Robinson	31
Why Low-Level Microphones? McMurdo Silver	32
The Ham Shack on the Boulevard	34
Design of Cross-Over Networks for Loudspeaker Units	
<i>Major E. N. Sieder, SC, W2AHN</i>	35
Free Radio Training Available to Ex-Service Men	38
A Plan for Tomorrow "Helix"	39
Practical Applications of Simple Math — Part VIII	
<i>Edward M. Noll, ex-W3FQJ</i>	40
The Troubles of a Wandering Ham	
<i>Major James W. Hunt, W5TG-W5CCU</i>	43
Strays	44
Anglo-American Hamfest	45
Hints and Kinks	
<i>Variable Voltage Tap for Power Supply — Self Bias Applied to the TR-4 — Renewing Burnt-Out Tubes — B.C. Receiver Adapted for Shipboard P.A. — Improved Autotransformer — Voice-Controlled Transmitter Switching — Thinner for Coil Cement</i>	46
Correspondence from Members	49
Operating News	52
The Month in Canada	56
Amateur Activities	57
Ham-Ads	96
QST's Index of Advertisers	98
QST Index for 1944	101

Ⓢ All material appearing in QST conforms with the "Code of Wartime Practices for the American Press" of the U. S. Office of Censorship.

Ⓢ All material involving military security has been reviewed by appropriate military, naval or other competent authority.

Section Communications Managers of the A.R.R.L. Communications Department

Reports Invited. All amateurs, especially League members, are invited to report communications activities, training plans, code classes, theory-discussion groups, civilian-defense building or planning each mid-month (16th of the month for the last 30 days) direct to the SCM, the administrative official of ARRL elected by members in each Section whose address is given below. Radio Club reports and Emergency Coordinator reports representing community organized work and plans and progress are especially desired by SCMs for inclusion in **QST**. ARRL Field Organization appointments, with the exception of the Emergency Coordinator and Emergency Corps posts, are suspended for the present and no new appointments or cancellations, with the exception named, will be made. This is to permit full efforts of all in Emergency Corps plans.

ATLANTIC DIVISION			
Eastern Pennsylvania Maryland-Delaware-District of Columbia	W3BES W3CIZ W3GCU W8MCO W8CKO	Jerry Mathis Hermann E. Hobbs Ray Tomlinson William Beller E. A. Krall	623 Crescent Ave., 9701 Monroe St. Silver Springs P. O. 623 E. Brown St. 186 Dorsey Rd. 703 Broadway
Glenide Gardens Linden, Maryland Frenton 10 Rochester East McKeesport			
CENTRAL DIVISION			
Illinois Indiana Kentucky Michigan Ohio Wisconsin	W9NUX W9EGQ W9ARU W8DPE W8MFP W9RH	David E. Blake, II Herbert S. Brier Darrell A. Downard Harold C. Bird Carl E. Wiebe Emil Felber, Jr.	4501 N. Malden St. 385 Johnson St. 116 N. Longworth Ave. R. F. D. 2, Box 228 127 St. Albert St. 1625 N. 18th St.
Chicago 40 Gary Louisville 12 Pontiac 2 St. Bernard 17 Milwaukee 5			
DAKOTA DIVISION			
North Dakota South Dakota Northern Minnesota Southern Minnesota	W9YVF W9QVY W9FUZ W9YVQ	John W. McBride P. H. Schultz Armond D. Brattland Millard L. Bender	620 North Merlo Ave. 118 N. Yankton Ave. 2802 So. Western 608 N. Huron Ave.
Sions Falls, South Dakota Pierre Los Angeles 7, Calif. Spring Valley			
DELTA DIVISION			
Arkansas Louisiana Mississippi Tennessee	W5GED W5DKR W5RAV W4SP	Ed Beck Eugene H. Treadaway P. W. Clement James B. Witt	2503 Bishop St. P. O. Box 44 524 Santini St. R. F. D. 6, Shady Dell Trail
Little Rock LaPlace Biloxi Knoxville			
HUDSON DIVISION			
Eastern New York N. Y. C. & Long Island Northern New Jersey	W2HZL W2AZV W2CQD	Ernest E. George E. L. Baunach Winfield G. Beck	2044 Lexington Parkway 102 Central Ave. 617 Spruce St.
Schenectady 8 Massapequa, L. I. Roselle			
MIDWEST DIVISION			
Iowa Kansas Missouri Nebraska	W9AED W9AWP W9OUD W9FOB	Arthur E. Rydberg A. B. Unruh Mrs. Letha A. Dangerfield Arthur R. Gaeth	1617 S. Seneca St. Box 123 6105 N. 37 St.
Mitchellville Wichita 12 Butler Omaha 11			
NEW ENGLAND DIVISION			
Connecticut Maine Eastern Massachusetts Western Massachusetts New Hampshire Rhode Island Vermont	W1KOY W1AOL W1ALE W1IAH W1IFT W1HRC W1NLO	Edmund R. Fraser G. C. Brown Frank L. Baker, Jr. William J. Barrett Mrs. Dorothy W. Evans Clayton C. Gordon Burtis W. Dean	48 Willow St. 379 No. Main St. 91 Atlantic St. 239 Columbia St. P. O. Box 312 70 Columbia Ave., Gaspee P. O. Box 81
West Haven 16 Brewer North Quincy 71 Adams Concord Plateau, Providence 5 Burlington			
NORTHWESTERN DIVISION			
Alaska Idaho Montana Oregon Washington	K7GNN W7AVP W7CPY W7GNJ W7FWD	James G. Sherry Don D. Oberbillig Rex Roberts Carl Austin O. U. Tatro	P. O. Box 486 Box 1088 1137 Federal 513 N. Central
Homer Boise Glendive Bend Olympia			
PACIFIC DIVISION			
Hawaii Nevada Santa Clara Valley East Bay San Francisco Sacramento Valley Philippines San Joaquin Valley*	K6ETF W6CW W6IUZ W6TI W6RBO W6MDI KA1GR W6BXB	Francis T. Blatt N. Arthur Sowle Earl E. Sanderson Horace R. Greer William A. Ladley Vincent N. Feldhausen George L. Rickard Edward H. Noack	837 16th Ave. Box 2025 600 Acacia Ave. 414 Fairmount Ave. 200 Naylor St. 113 South Quincy St. Box 849 811 West Magnolia St.
Honolulu Reno San Bruno Clarendon II San Francisco McCloud Manila Stockton			
ROANOKE DIVISION			
North Carolina South Carolina Virginia West Virginia	W4CVB W4BOE/JANG W3AKN W8JRL	W. J. Wortman Ted Ferguson Walter G. Walker Kenneth M. Zinn	P. O. Box 366 3422 Rosewood Drive 217-51 St. P. O. Box 132
Morganton Columbia 25 Newport News Clarksburg			
ROCKY MOUNTAIN DIVISION			
Colorado Utah-Wyoming	W9VGC W7DIE	H. F. Hekel John S. Duffy	2743 Julian St. 938 "D" St.
Denver 11 Rock Springs, Wyo.			
SOUTHEASTERN DIVISION			
Alabama Eastern Florida Western Florida Georgia West Indies (Cuba) (Puerto Rico-Virgin Islands)	W4GBV W4IP W4AXP W4FDJ CM20P K4KD	Lawrence J. Smyth Robert B. Murphy Oscar Cederstrom Ernest L. Morgan Mario de la Torre Everett Mayer	808 Winona Ave. 3302 S.W. Grapeland Blvd. 408 S. Pine St. R. F. D. 4 Escobar 110 (Altos) 24 Lindberg St.
Montgomery Miami 33 Warrington Lyons Habana, Cuba Santurce, P. R.			
SOUTHWESTERN DIVISION			
Los Angeles Arizona San Diego	W6QVV W6RWW W6CHV	H. F. Wood Douglas Aitken Ralph H. Culbertson	429 So. Fairview 341 S. Mt. Vernon Ave. 7172 Eads St.
Burbank Prescott La Jolla			
WEST GULF DIVISION			
Northern Texas Oklahoma Southern Texas New Mexico	W5ALA W5AVL W5MN W5HJF	Jack T. Moore Ed Oldfield Horace E. Biddy J. G. Hancock	5712 Berkshire Lane 2141 N.W. 35th St. 1746 Schley Ave. 110 S. E. Nevada St.
Dallas 9 Oklahoma City 6 San Antonio Portales			
MARITIME DIVISION			
Maritime	VE1DQ	A. M. Crowell	69 Dublin St.
Halifax, N. S.			
ONTARIO DIVISION			
Ontario	VE3EF	Flying Officer Donald R. Gunn c/o Canadian Bank of Commerce	New Toronto, Ont.
QUEBEC DIVISION			
Quebec	VE2CO	Lieutenant L. G. Morris	211 Bolton St.
Ottawa, Ont.			
VANALTA DIVISION			
Alberta British Columbia	VE4GE VESDD	C. S. Jamieson C. O. I. Sawyer	581 W. Riverside Drive 2634 West 31st Ave.
Drumheller, Alta. Vancouver			
PRAIRIE DIVISION			
Manitoba Saskatchewan	VE4AAW VE4SY	A. W. Morley Arthur Chesworth	932 Dorchester Ave. 1084 Redland Ave.
Winnipeg Moose Jaw			

*Officials appointed to act temporarily in the absence of a regular official.

THE AMERICAN RADIO RELAY LEAGUE, INC.,

is a noncommercial association of radio amateurs, bonded for the promotion of interest in amateur radio communication and experimentation, for the relaying of messages by radio, for the advancement of the radio art and of the public welfare, for the representation of the radio amateur in legislative matters, and for the maintenance of fraternalism and a high standard of conduct.

It is an incorporated association without capital stock, chartered under the laws of Connecticut. Its affairs are governed by a Board of Directors, elected every two years by the general membership. The officers are elected or appointed by the Directors. The League is noncommercial and no one commercially engaged in the manufacture, sale or rental of radio apparatus is eligible to membership on its board.

"Of, by and for the amateur," it numbers within its ranks practically every worth-while amateur in the nation and has a history of glorious achievement as the standard-bearer in amateur affairs.

Inquiries regarding membership are solicited. A bona fide interest in amateur radio is the only essential qualification; ownership of a transmitting station and knowledge of the code are not prerequisite, although full voting membership is granted only to licensed amateurs.

All general correspondence should be addressed to the Secretary at the administrative headquarters at West Hartford, Connecticut.



Past Presidents

HIRAM PERCY MAXIM, W1AW, 1914-1936
EUGENE C. WOODRUFF, W8CMP, 1936-1940

Officers

President.....GEORGE W. BAILEY, W1KH
Washington, D. C.
Vice-President.....CHARLES E. BLALACK, W6GG
Yuma, Arizona
Secretary.....KENNETH B. WARNER, W1EH
West Hartford, Connecticut
Communications Manager.....F. E. HANDY, W1BDI*
Chevy Chase, Maryland
Treasurer.....DAVID H. HOUGHTON
West Hartford, Connecticut

General Counsel.....PAUL M. SEGAL
1026 Woodward Building, Washington 5, D. C.

*On leave of absence. Address correspondence to the Acting Communications Manager, Carol K. Witte, West Hartford 7, Connecticut.

Directors

President
GEORGE W. BAILEY.....W1KH
1530 P St., N.W., Washington 25, D. C.

Vice-President
CHARLES E. BLALACK.....W6GG
Box 108, Yuma, Ariz.

Canadian General Manager
ALEX REID.....VE2BE
240 Logan Ave., St. Lambert, P. Q.
Alternate: Leonard W. Mitchell.....VE3AZ
78 Raglan Ave., Toronto, Ont.

Atlantic Division
WALTER BRADLEY MARTIN.....W3QV
Address correspondence to the Acting Director:
HERBERT M. WALLEZE.....W8BQ
P. O. Box 18, Drums, Pa.

Central Division
GOODWIN L. DOSLAND.....W9TNS
11831 Longwood Drive, Chicago, Ill.
Alternate: Everett H. Gibbs.....W8AQ
405 Broad St., Wadsworth, Ohio

Dakota Division
TOM E. DAVIS.....W9VVA
915 W. Becker Ave., Willmar, Minn.
Alternate: Aaron E. Swanberg.....W9BHY
1487 Breda St., St. Paul 4, Minn.

Delta Division
E. RAY ARLEDGE.....W5SI
340 N.E. 20th Terrace, Apt. 7, Miami 37, Fla.
Alternate: Samuel H. Dowell.....W5ERV
1057 Mildred St., Shreveport 15, La.

Hudson Division
ROBERT AKERIDGE KIRKMAN...W2DSY
Werah Pl., R.F.D. No. 1, Box 61, Long Branch, N. J.
Alternate: George Ruffis, Jr.....W2CJY
38 Brookwood Drive, Manhasset, L. I., N. Y.

Midwest Division
FLOYD E. NORWINE, JR.....W9EFC
7405 Hlawatha Ave., Richmond Heights 17, Mo.
Alternate: C. A. Colvin.....W9VHR
e/o Omaha & Council Bluffs St. Railway Co.,
Omaha 2, Nebr.

New England Division
PERCY C. NOBLE.....W1BVR
37 Broad St., Westfield, Mass.
Alternate: Clayton G. Gordon.....W1HRC
70 Columbia Ave., Warwick, R. I.

Northwestern Division
KARL W. WEINGARTEN.....W7BG
3219 N. 24th St., Tacoma 7, Wash.
Alternate: R. Rex Roberts.....W7CZY
110 W. Brennan St., Glendive, Mont.

Pacific Division
J. L. McCARGAR.....W6EY
66 Hamilton Pl., Oakland 12, Calif.
Alternate: Elbert J. Amarantes.....W6FBW
1675 Dale Ave., San Jose, Calif.

Roanoke Division
H. L. CAVENESS.....W4DW
2607 Vanderbilt Ave., Raleigh, N. C.
Alternate: J. Frank Key.....W3ZA
Box 707, Buena Vista, Va.

Rocky Mountain Division
C. RAYMOND STEDMAN.....W9CAA
925 So. Gaylord St., Denver 9, Colo.
Alternate: Willard C. Wright.....W9BQO
2641 S. Race St., Denver 10, Colo.

Southeastern Division
WILLIAM C. SHELTON.....W4ASR
527 Revillo Blvd., Daytona Beach, Fla.
Alternate: William P. Sides.....W4AUP
Fleming Road, Montgomery, Ala.

Southwestern Division
JOHN E. BICKEL.....W6BKY
1834 E. Whittier Blvd., Whittier, Calif.
Alternate: Eldridge E. Wyatt, Jr.....W6ARW
P. O. Box 3597, Long Beach 3, Calif.

West Gulf Division
WAYLAND M. GROVES.....W5NW
Box 1314, Seagraves, Texas
Alternate: Jennings R. Poston.....W5AJ
Box 246, Mabank, Texas

welding with a paint brush?

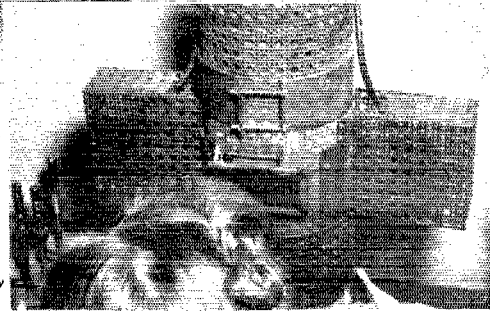
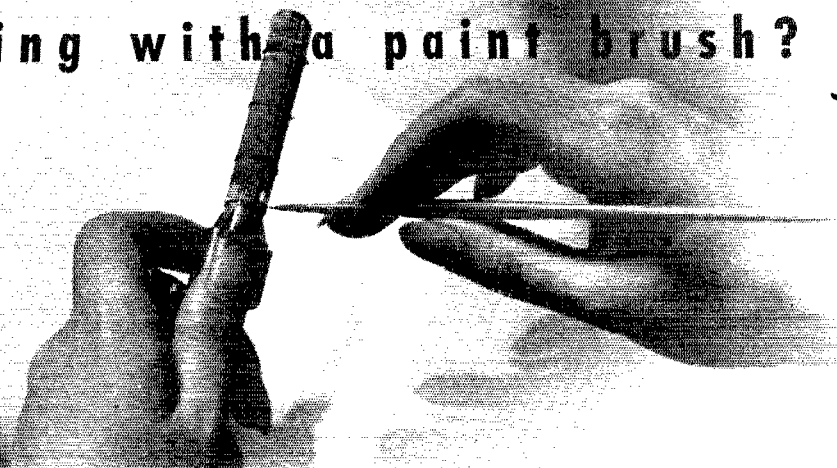

Alloy flows easily and weld is quickly completed under arc

The Science Behind the Science of Electronics

is the focusing of all branches of science upon the development and improvement of electron vacuum tubes

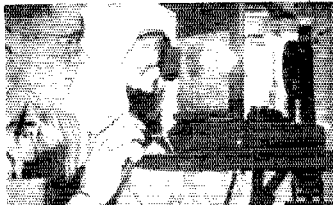

SPECTROGRAPH... Analysis determines exact characteristics of metals to be joined



METALLURGY... Compounding special alloys of metals

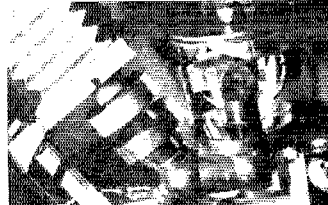

OPTICS... For studying the effects of processing



ELECTRONICS... Welded elements in electron vacuum tubes withstand tremendous heat

To solve a difficult welding problem, Eimac laboratory technicians compounded a welding alloy that could be applied with a paint brush. The alloy flows easily under an arc to complete the weld, yet subsequent heating to temperatures as high as 2900 degrees Centigrade will not destroy the weld.

Such is but an example of the application of the Science of metallurgy in the "science behind the science of electronics." The extent to which Eimac Engineers went to solve this relatively small problem reveals two important facts:— (1.) The thoroughness of Eimac Engineering, and (2.) The completeness of their engineering facilities. The leadership which Eimac tubes enjoy throughout the world in all phases of electronics is attributable to the soundness of this engineering.

Performance of any electronic equipment is a direct reflection of the performance of its vacuum tubes. Hence it is advisable for users and prospective users of electronics to look first to the vacuum tube requirements. Because Eimac makes electron vacuum tubes exclusively their advice to you is unbiased and can be of great value. A note outlining your problem will bring such assistance without cost or obligation.

EITEL-McCULLOUGH, INC., 870 San Mateo Ave., San Bruno, Calif.
Plants located at: San Bruno, California and Salt Lake City, Utah
Export Agents: **FRAZAR & HANSEN**,
301 Clay St., San Francisco 11, California, U. S. A.



Write for your copy of *Electronic Telesis*—a 64 page booklet fully illustrated—covering fundamentals of Electronics and many of its important applications. Written in layman's language.



Follow the leaders to

Eimac
REG. U. S. PAT. OFF.
TUBES

"IT SEEMS TO US—"

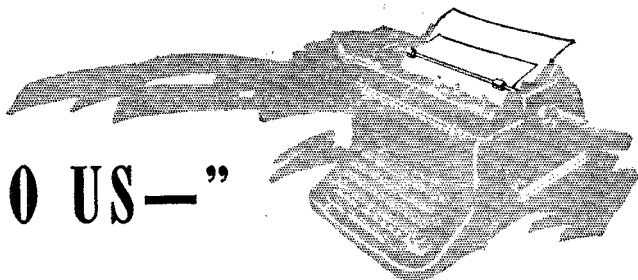

ONE HUNDRED MEGACYCLES & UP

CLINT DESOTO gave the name *Two Hundred Meters and Down* to his history of amateur radio, in which is recounted the story of our progression to successively shorter wavelengths. There are many indications that the radio world is preparing to create, in early postwar days, its own brilliant sequel to that work as the region above one hundred megacycles is occupied and put to work. The FCC hearings have shown that a large number of radio interests intend to establish a considerable variety of services in that part of the spectrum, all the way up to the tens of thousands of megacycles. There are the various kinds of broadcasting, including television and facsimile and their links and relays. There are Government services, including various aids to navigation. Many kinds of communication services are contemplated. They include in particular some ambitious plans for a public service for hire based on wide-band multi-channel automatic relaying, plans that envisage the possible ultimate investment of billions. Engineers and hams and manufacturers are talking u.h.f. and microwaves. The allocation studies concentrate on the v.h.f. and u.h.f. The hopes of the industry for big-volume business are largely pinned to f.m. and television in the v.h.f.

As we see it, there are some good reasons for this commercial preoccupation with this part of the spectrum. First, most of it represents the opening of new territory, the only part of the spectrum where there's possibility of room for new services. Second, it's the only place where bandwidths exist for the wide-band methods of emission, such as television, f.m. broadcasting, facsimile and multi-channel relays. Third, the short range permits frequent duplications of frequency assignments, accommodating a vast number of stations.

But we emphatically do not see the waves below ten meters displacing the kind of amateur radio we have known on lower frequencies. We expect that message-handling and DX rag-chewing and emergency relief will remain the major operating activities of the American amateur. When FCC finally blows that magic whistle at 3 A.M. EWT some fine day, we suspect that most of us of prewar experience will streak it like mad for "80, 40 and 20." Why, then, so much harping in *QST* on the higher frequencies?

We do it because we perceive that this is the new world, which also must become a part of the amateur establishment. Not all of us are absorbed in DX. Many of us are experimenters, interested in staying out in front in new fields, and for us it has been many a year since there was anything so fascinating as microwaves. And when Joe and Mac come home and become hams — fellows who were never on the lower frequencies and whose interest comes from wartime experience with "secret devices" — we think they'll make for these higher frequencies by instinct and preference, as representing their kind of radio. Certainly the experimenter, both old-timer and newcomer, will find this a most intriguing new world, for here is where the new techniques and the new gear exist. Yet it is a realm of which all too little is known, with unlimited experimental opportunities for adding to knowledge both of technique and of performance. There is the appeal of working with utterly new apparatus and circuits. There is the ever-present possibility of interesting DX under proper circumstances and the opportunity to extend our ranges by automatic relaying if the DX doesn't come naturally. We suppose we'll start out with i.c.w. and voice and some day work ourselves into our own particular versions of fax and television, things for which we haven't had room in our l.f. bands. We foresee the expansion of the Experimenter's Section, with task groups signing up for the investigation of particular problems. We wish they were already coming up with some of the answers, for we've been going around with our head in the clouds, sketching microwave installations for our own home shack, and have we got questions to which we don't know the answers! But we do know that we want the chance to make our own personal comparison of lighthouse tubes and klystrons and magnetrons and whatever else there may be, and to have the fun of fiddling with butterflies versus cavities versus pots versus long lines. We get as itchy as only a ham can get when we think of little paraboloids and horn antennas with a power gain of a cool million, where one watt theoretically will do the work that one expects of a thousand kilowatts in a dipole. And if you'd had our troubles with long spaced feeders in the old days, you'd be plenty eager to get going on waveguides and coax of negligible losses. (The copper downspouting on our

house is of precisely the dimensions used for waveguides in some interesting installations. We feel the compulsion to find some way of taking advantage of that fact.) And, by the way, we are waiting for the surplus sales to start. We want to buy a submarine's periscope. We want to mount it in a well in our back yard. It is to support our beam above the tree-tops. When we press a button it is to lower to table height while we install new gear or shoot trouble, and then go neatly upstairs again when we press the other button. We suppose we'll wind up by continuing to risk our neck climbing the old chestnut pole but it's a nice thought. And any way you look at it, we experimenters are going to have both a lot of fun and some good communication on these frequencies after the war.

We've got an additional reason for getting up a little steam. There is a fighting chance that we'll be let loose on such frequencies between V-E day and the cleaning up of the Japs. If the latter job is well in hand and 5000 miles away, and if the military services agree that there are no security worries about amateur communication on microwaves, and if the administration remains eager about new markets that make employment, why not? Could be.

There used to be a few amateurs who could boast that they possessed equipment to work on every band open to amateurs. That's going to be a much more comprehensive job to accomplish in the postwar period. Wonder who will be the first to do it?

CORRESPONDENTS WANTED

WE'RE getting practically no news about communications from any of the fighting fronts, only dribbles of items coming from any of the war areas. For weeks there hasn't been a mention of radio in the War Department's own *Army News*. We tried hard to arrange to get our own editor over to the European Theatre as a technical correspondent but didn't quite succeed. It isn't right that there should be this dearth of communication news when communication plays the vital part that it does in the war. The explanation is that, under present policy, the war correspondents do "general coverage" work and have neither special knowledge of communications nor special interest in it. It isn't censorship; it's just that there's nobody there doing the job.

You hams overseas: This is your magazine. Do you care to send us some stuff? Since we can't get overseas to get the news ourselves, you're our only chance. Naturally there is much you cannot write about but there are many items of interest that will pass, if you can find the time to help make *QST* more interesting both to yourselves and to the gang back home. Though we would welcome full-length articles and more Hams-In-Combat yarns, we speak more particularly of the little things that are easy to do, human-interest items about yourselves and other hams, anything that would be of interest to other amateurs and about which they would rag-chew if they got together. Willing? TU vy.

K. B. W.

★ SPLATTER ★

OUR COVER

CAROL K. WITTE, acting communications manager of ARRL displays the service flag presented to the League by the Hamfesters Radio Club of Chicago in honor of the thousands of amateurs who are now employing their radio skills in the various branches of the armed forces. Incidentally, the figure representing the number of amateurs in the services is a conservative one, no authentic recent official count being available.

...—

FOOTNOTES

TO ROUND out the current volume of *QST* we present in the last issue for this year five new authors and four old-timers. First alphabetically as well as in appearance in the issue is Robert W. Carter. While not an amateur, Bob has long been associated with ham radio and plans to apply for his ticket and operate his own station after the war. Through his ham friends and associates, he has kept abreast with amateur radio, developing several types of unusual mobile

power supplies that will be immediately available to hams when hostilities cease. Such a power supply is included in the mobile WERS installation he describes on page 9.

In response to a request for biographical data, George M. Guill, jr., W8VAN — ex-W3BIW, replies that he is a typical ham. He received his first license, W3BIW, in 1932 when attending high school, and went through the usual rebuilding stages — 45s TNT to 450-watt 'phone and c.w., all-band job. He holds ORS, OBS, ROWH and 25 w.p.m. certificate, his chief interest being in DX, rag-chewing and experimenting. For the past eight years he has been employed by the Appalachian Electric Power Company, the last two and one-half years in their carrier current department of the Charleston Division — which makes it only logical that he should write the article appearing on page 29. . . . Charles H. Merritt, ART1c, USNR, W6OMH (p. 24), before enlisting in the Navy in 1942, was a radio instructor at Arizona State Teachers College at Tempe, Arizona. He holds a Class A amateur license and a radiotelephone first. Since joining the Navy he has attended the Navy radio school at Texas A & M College, and the Naval Air Technical Training Center at Corpus Christi.

(Continued on page 80)

A Mobile Installation for WERS

Separate Receiver and Transmitter in a Compact Unit

BY ROBERT W. CARTER*

With the gradual easing up of the parts-supply situation, it is reasonable to expect that we shall see a corresponding improvement in WERS gear. In the mobile unit described in this article, a receiver refinement in the form of an acorn r.f. stage takes a long step toward the reduction of two common receiver weaknesses — superregen radiation and antenna tuning effects. The author also discusses other features which will find ready application in plans for improved emergency gear.

IT SEEMS that the urge to build ham radio gear is not curtailed, even by war. After getting our feet wet in war work, which has been keeping us busy morning, noon and night, there came a time when a little slack left us wondering if we couldn't do a bit of ham radio even though the war still was going full blast. So, we joined the WERS and soon began to lay plans for some sort of gear. The illustrations show the final results.

We have always been particularly interested in mobile work, probably because this lies more closely to our business of producing power units for installations of this type. The complete equipment consists of four units. The largest of these contains the transmitter and receiver which operate independently. Thus only power-supply switching is required. Two small enclosed units are included for power controls and interconnection of units. The fourth unit is the dual dynamotor which supplies plate voltages for both transmitter and receiver. Space for all four units was found under the dashboard of the car, a spot which makes long battery leads unnecessary, and yet leaves plenty of room for the XYL's feet.

The Receiver Circuit

The circuit diagram of the installation is shown in Fig. 1. A superhet receiver was rejected in favor of the simpler superregenerative type with lower power requirements. However, to reduce radiation and antenna effects, as well as to provide some gain, a ganged acorn r.f. stage is used ahead of the superregen detector. It seems incongruous, yet nevertheless it is true, that while we had no difficulty at all in obtaining acorn tubes, the scarcity of such garden varieties as the 6C5 and the 6V6 made

it necessary to revert to the older types 76, 42 and 6A6 in the audio stages. An HY615 was selected for the detector.

Tests showed that two stages of audio were not quite sufficient for the amount of speaker output expected, so a second 76 stage was added. The full gain of this stage is not required, however. If a 6C5 and a 6V6 are available, this additional stage may be eliminated. The headphone jack is connected permanently across the output of the 42, while the speaker may be silenced by opening the voice-coil circuit by means of S_4 .

The Transmitter and Controls

An HY75 was chosen for the transmitter oscillator since tubes of this type are readily available and may be operated conservatively at the maximum power permissible. The circuit is standard and inductive antenna coupling is used.

The modulator portion consists of a 6A6 dual triode with the sections connected in parallel as a speech amplifier, and another tube of the same type in the Class-B output stage. Microphone voltage is obtained from the car storage battery through the series resistance, R_{15} . The condenser C_{23} provides feed-back to produce audio oscillation for i.c.w. work. It is connected from output to input of the audio section when a plug fitted with a key is inserted in J_3 .

Two relays are used to perform the necessary switching in changing between transmitting and receiving. The push-to-talk switch, S_1 , at the microphone controls these relays. Ry_2 takes care of the antenna change-over, while the power-supply switching is done by Ry_1 . When S_1 is open, Ry_1 is in the normal position shown in Fig. 1 with

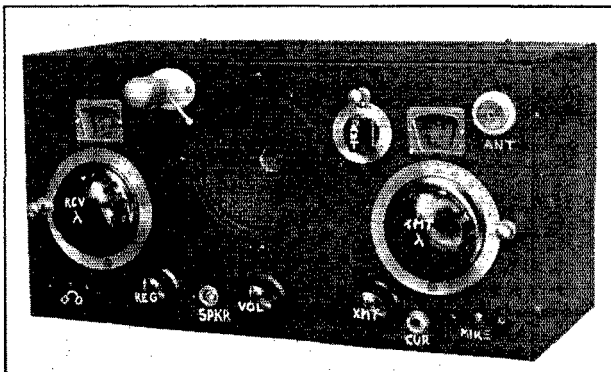

The transmitter and receiver are housed in a single cabinet. The various controls on the panel are marked. The 'phone-tip' jacks are provided for connecting the microphone and headphones for testing purposes, although they are not used normally when the unit is installed in the car.

*Carter Motor Co., 1608 Milwaukee Ave., Chicago, Ill.

the bottom contacts closing the plate-voltage circuit to the receiver. When S_1 is closed, the bottom contacts open, removing "B" voltage from the receiver, while the center contacts close the high-voltage circuit to the oscillator and modulator tubes and the top contacts complete the filament circuit of the HY75. Thus, the 3.5-ampere load of the HY75 filament is removed from the battery except when transmitting.

S_2 is the filament switch for the receiver and modulator, while S_4 cuts the plate voltage from

the transmitter when this is desirable. J_2 is a metering jack.

The power unit is a dual-winding dynamotor delivering 235 volts for the receiver and 335 volts for the transmitter. The receiver voltage is filtered by L_3 , C_{30} , L_7 and C_8 . L_7 is the speaker field winding which may be omitted in case a p.m. speaker is used. C_{27} , C_{28} and RFC_4 are for the purpose of filtering out commutator hash. C_{22} and C_{29} are all that is required to provide satisfactory filtering for the transmitter.

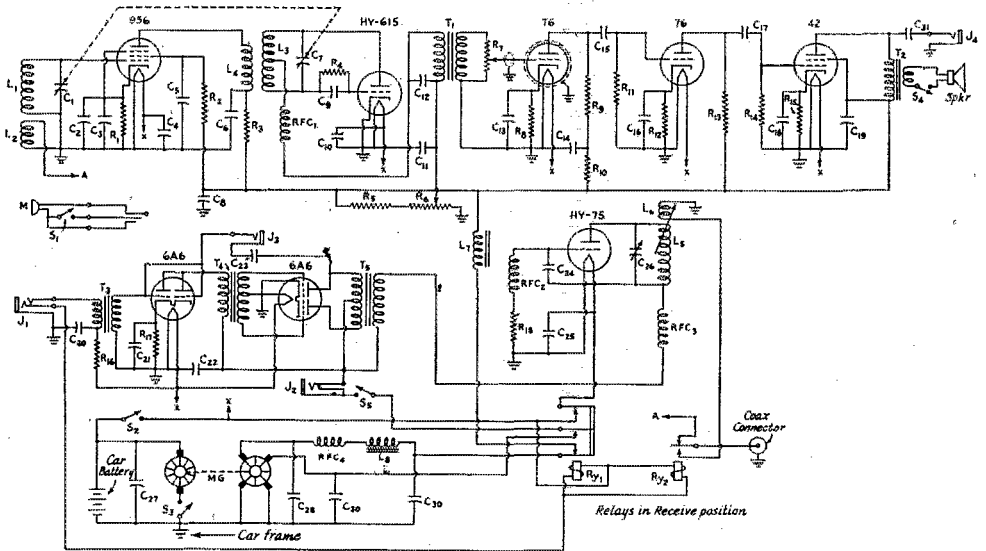
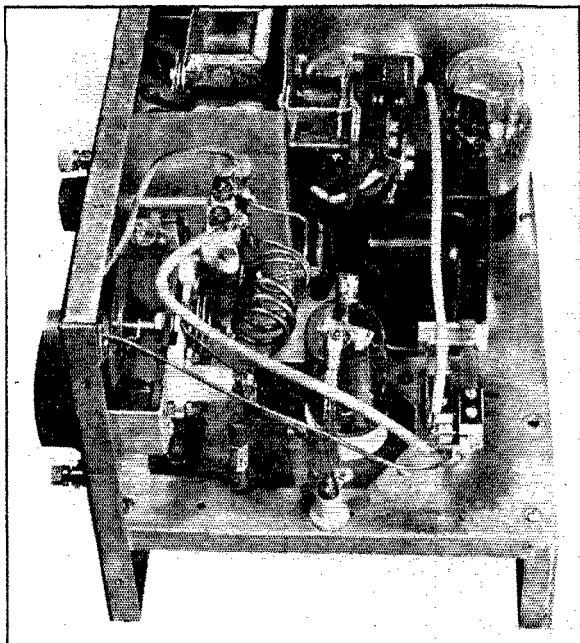

Fig. 1 — Circuit diagram of the combined transmitter and receiver unit for mobile WERS service.

- | | | |
|---|--|--|
| <p>C_{11}, C_7 — 15-μfd., variable with all but 2 plates removed.</p> <p>C_2 — 100-μfd. midget mica, connected directly at socket.</p> <p>C_3, C_6, C_{10}, C_{25} — 0.002-μfd. midget mica.</p> <p>C_4, C_5 — 250-μfd. mica.</p> <p>C_8, C_{22}, C_{29} — 8-μfd. 450-volt electrolytic.</p> <p>C_9 — 100-μfd. mica midget (silvered preferred).</p> <p>C_{11} — 0.25-μfd. paper.</p> <p>C_{12}, C_{19} — 0.004-μfd. mica.</p> <p>C_{13}, C_{27} — 20-μfd. 50-volt electrolytic.</p> <p>C_{14}, C_{30} — 4-μfd. 450-volt electrolytic.</p> <p>C_{15}, C_{17} — 0.05-μfd. paper.</p> <p>C_{16}, C_{18}, C_{21} — 10-μfd. 25-volt electrolytic.</p> <p>C_{20} — 0.5-μfd. paper.</p> <p>C_{23}, C_{31} — 0.1-μfd. paper.</p> | <p>C_{24} — 100-μfd. 500-volt mica.</p> <p>C_{26} — 15-μfd. variable (National).</p> <p>C_{29} — 0.001-μfd. 500-volt mica.</p> <p>R_1 — 200 ohms, $\frac{1}{2}$ watt.</p> <p>R_2 — 125,000 ohms, $\frac{1}{2}$ watt.</p> <p>R_3 — 30,000 ohms, $\frac{1}{2}$ watt.</p> <p>R_4 — 5 megohms, $\frac{1}{2}$ watt.</p> <p>R_5 — 25,000 ohms, 2 watts.</p> <p>R_6 — 100,000-ohm potentiometer.</p> <p>R_7 — 500,000-ohm potentiometer.</p> <p>R_8 — 1000 ohms, 1 watt.</p> <p>R_9, R_{13} — 50,000 ohms, 1 watt.</p> <p>R_{10} — 15,000 ohms, $\frac{1}{2}$ watt.</p> <p>R_{11}, R_{14} — 500,000 ohms, $\frac{1}{2}$ watt.</p> <p>R_{12} — 2500 ohms, 1 watt.</p> <p>R_{15} — 500 ohms, 2 watts.</p> <p>R_{16} — 250 ohms, 2 watts.</p> <p>R_{17} — 1000 ohms, 2 watts.</p> <p>R_{18} — 5000 ohms, 2 watts.</p> <p>T_1 — Interstage audio transformer.</p> <p>T_2 — Output transformer, 7000 ohms to 4-6-ohm voice coil.</p> | <p>T_3 — Microphone transformer, 50-100 ohms to grid.</p> <p>T_4 — Driver transformer, type 6N7 parallel-connected to 6N7 Class-B (30,000 ohms to p-p. grids).</p> <p>T_5 — Modulation transformer, 8000 ohms primary to 4000 ohms secondary.</p> <p>S_1 — Push-to-talk switch (on mike handle).</p> <p>S_2, S_3, S_4 — S.p.s.t. toggle switch.</p> <p>S_5 — Rotary s.p.s.t. switch.</p> <p>RFC_1, RFC_2, RFC_3 — 112-Mc. r.f. choke (Ohmite Z-0).</p> <p>RFC_4 — 150 turns No. 31 s.s.c., lattice-wound on $\frac{3}{8}$-inch dowel to $\frac{1}{2}$-inch wide, $\frac{3}{8}$-inch deep (Carter).</p> <p>M — Single-button carbon microphone.</p> |
|---|--|--|
- RY_1 — Relay with 6-volt d.c. coil, 2 normally-open sets of contacts, 10 amp.; one normally closed set of contacts, $\frac{1}{2}$ amp.
- RY_2 — Antenna change-over relay, 6-volt coil, Isolantite insulation.
- J_1 — 3-terminal jack.
- J_2 — Closed-circuit midget jack (insulated from panel).
- J_3 , J_4 — Open-circuit midget jack (J_3 insulated from panel).
- L_1 — 5 $\frac{1}{2}$ turns No. 18 bare, $\frac{3}{8}$ -inch diameter, spaced to tune, wound in same direction as L_1 .
- L_2 — 1 $\frac{1}{2}$ turns No. 18 bare, $\frac{3}{8}$ -inch diameter.
- L_3 — 6 turns No. 18 bare, $\frac{3}{8}$ -inch diameter, spaced to
- tune, tapped 2 turns from plate end.
- L_4 — 2 turns No. 18 push-back, $\frac{3}{8}$ -inch diameter, wound in same direction as L_3 .
- L_5 — 3 turns $\frac{1}{8}$ -inch copper tubing, $\frac{3}{4}$ -inch diameter, $\frac{3}{8}$ -inch between turns.
- L_6 — 2 $\frac{1}{2}$ turns No. 12 bare, $\frac{3}{4}$ -inch diameter, $\frac{1}{2}$ -inch between turns.
- L_7 — Speaker field, 3000 ohms (omit if p.m. speaker is used).
- L_8 — 8.2-hy. filter choke (Carter).
- MG — Dynamotor, dual output, 215-volts, 100 ma.; 315 volts, 175 ma.; 5.5 or 11-volt motor (Carter MMVX-312).



The transmitter end of the chassis, showing the HY75, its tank circuit and the relays. The tubes in the background are used in the modulator. The speaker transformer is at the upper left.

Receiver Construction

Part of the constructional work was avoided when we found an old TR-7 5-meter rig in the attic. After trying unsuccessfully to make the set work at $2\frac{1}{2}$ by chopping the coils, the chassis was stripped of everything except the dials and speaker and a new arrangement started from scratch. Almost any old chassis of similar general shape and size which may happen to be on the shelf can be put to work by following the arrangement shown in the illustrations. The transmitter and receiver sections are separated by zig-zag shields both above and below the chassis.

Most of the components for the receiver r.f. circuits are mounted on a plain baffle shield behind the receiver tuning dial. The detector components are on the front of this shield while the r.f. stage components are mounted on the rear. In both cases, the various parts should be grouped to make the shortest leads possible. This is especially important in the r.f. stage where only miniature-type parts should be used; it is useless to try to make this stage operate properly with "standard-size" components. "Ground" connections should be made to a single

The receiver section. The r.f. stage components are assembled on the rear face of the baffle shield in the center of the picture, while the HY615 detector tube and associated components are mounted in front.

short wire which is soldered to the chassis proper, since sufficiently low-resistance contacts to the aluminum shield cannot be made, no matter how tight the mounting screws are drawn up.

The acorn tube is mounted horizontally with its plate terminal protruding through a hole in the shield to provide good isolation between its input and output circuits. The separate suppressor and cathode by-pass condensers, C_2 and C_3 , which appear to be in parallel in Fig. 1, are necessary because the connections between these two tube terminals are too long to permit a single condenser to do a satisfactory job of by-passing both electrodes. Each condenser should be connected directly between the socket and the ground wire.

The coupling between the r.f. stage and the detector is very loose. The socket for the HY615 is placed in front of the shield with its grid and plate terminals close to the small ceramic stand-off insulators which support the air-core coils, L_3 and L_4 . As shown in the photograph of the receiver end of the chassis, the detector tuning condenser, C_7 , is mounted on a strip of low-loss insulating material supported by a pair of metal U-shaped brackets fastened to the panel so that

the shaft of the condenser is lined up with the dial. An insulated shaft coupling is required between the condenser and the dial. A second insulating coupling is required between the detector tuning condenser and the r.f. tuning condenser which is mounted on an insulating strip set in the aluminum shield.

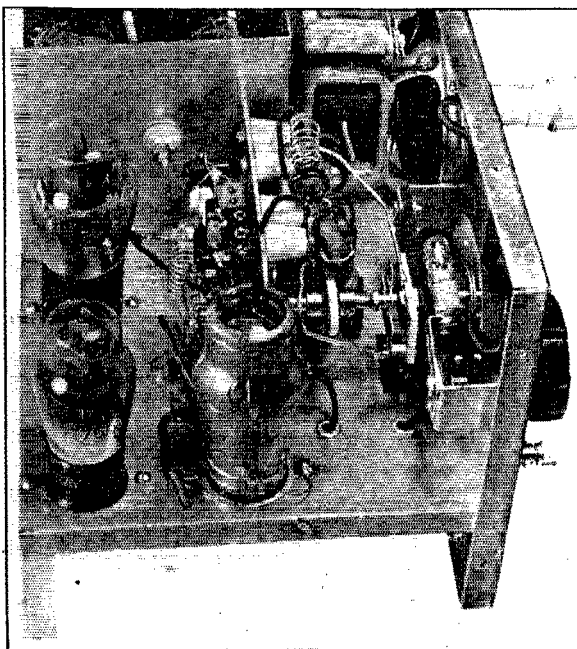

The placement of the audio components is not critical, of course. As indicated in Fig. 1, the first audio tube as well as the lead between its grid and the volume control, R_7 , must be shielded.

Transmitter Construction

The transmitter tank condenser, C_{26} , at the other end of the chassis is mounted by the same method used in mounting the detector tuning condenser. The metal brackets also support the stand-off insulators on which the copper-tubing tank coil, L_5 , is mounted. The HY75 is placed so that the grid and plate caps are close to the coil terminals. The antenna-coupling coil, L_6 , is fastened to a pair of small stand-off insulators which are mounted on a bakelite strip. This strip then is attached to a shaft held in place by a bearing standard panel so that the degree of coupling may be varied by the knob on the front of the panel.

The antenna relay is mounted on the chassis behind the HY75, while the power-supply relay is fastened to the zig-zag shield immediately behind the speaker. The modulation transformer and the two tubes in the modulator occupy the remainder of the chassis space. Space for the Class-B input transformer is found underneath the chassis.

The various panel controls are marked in the front-view photograph. The dials are friction-type verniers on which plain dials have been sub-

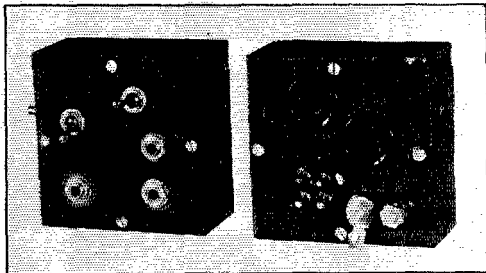

The control and junction units. The heavy terminals in the lower right-hand corner of the junction box are for the storage-battery connections.

stituted for the customary small control knobs. Both dials are fitted with locks to prevent movement by vibration once they have been set at the desired frequencies. A cable connector in the upper right-hand corner of the panel serves for making connections to the antenna transmission line. The metering jack below the transmitter dial must be insulated from the panel. For night work the panel lamp above and to the right of the speaker is provided.

The Antenna

A single 84-inch steel rod is used as the antenna both for receiving and transmitting. It is fed by connecting the center conductor of a 48-inch length of Amphenol 73-ohm concentric cable to the bottom end, with the excess left over after installation carefully coiled up. The outside conductor is left free at the antenna but is grounded at the connector on the transmitter panel. By using the four feet of cable a reasonably close match is obtained at the antenna and good transfer of energy takes place. The antenna is mounted on a large stand-off insulator which is fastened to a metal L-shaped bracket with triangular bracing mounted on the car.

Controls

A single steel box, 3 inches square and 2 inches deep, is used to house the dynamotor and filament-control switches and the jacks for the microphone, key and headphones. It is mounted on the dash of the car in a central position where it is directly under the hand of the operator. This unit is connected to the rest of the equipment through an 11-pin socket at the rear.

The other small box of similar size shown in the photograph is a junction box which contains sockets for the plugs of all interconnecting cables. Thus each unit may be removed for servicing simply by removing the single plug without disturbing other units. An 11-pin socket is provided for the plug from the control box, a 9-pin socket for the cable from the transmitter and receiver unit and a 4-pin plug for connections to the dynamotor. The main connection to the car battery is made at two places. No. 9 wire or larger should be used for these connections to prevent excessive voltage drop.

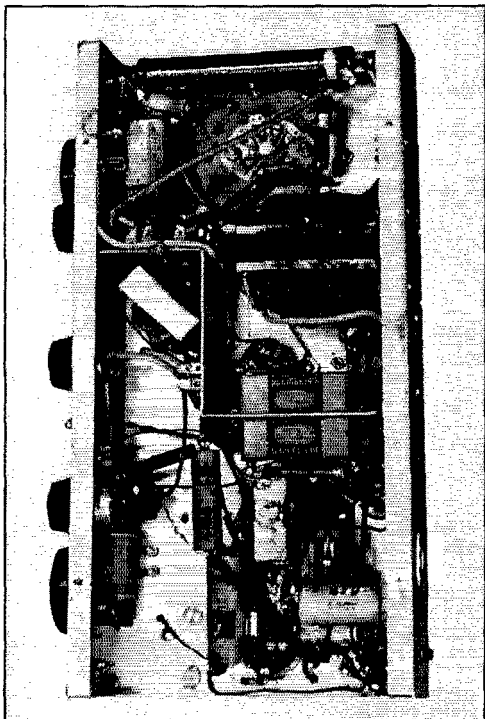

Bottom view of the mobile unit. A zig-zag shield separates the transmitter section on the right and receiver section at the left. The two transformers are in the modulator circuit.

The complete mobile installation ready for WERS work. The dynamotor is mounted on the floor board to the left of the transmitter-receiver unit. The control unit is suspended from the bottom edge of the dashboard where it can be conveniently operated by the driver or passenger operator.

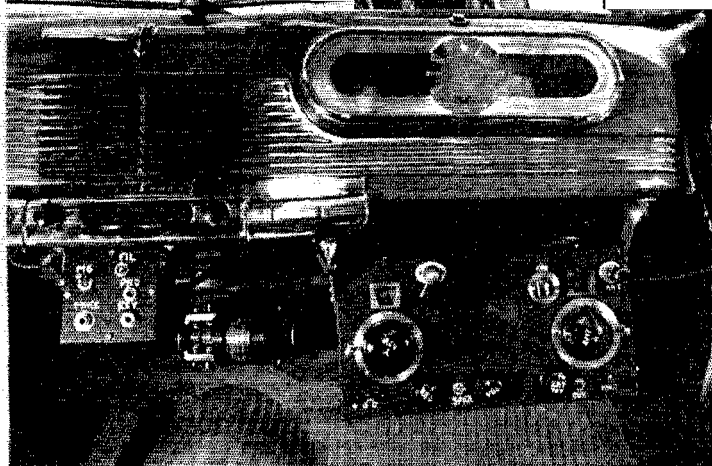

Power Supply

As mentioned previously, the transmitter and receiver are supplied by a dynamotor which operates from the 6-volt storage battery. It has dual windings which supply a maximum of 100 ma. at 215 volts for the receiver and 175 ma. at 315 volts for the transmitter. Both dynamotors and vibrator-transformer supplies have their proponents and each type fits certain applications better than the other. For the heavier-duty work we prefer the dynamotor. Both ripple and hash are easily filtered. Dynamotors do not need to be mounted remotely from the receiver; they are often mounted directly on the units which they supply. To supply both transmitter and receiver would require the use of two vibrator-transformer units of the usual power-handling capacity and thus the dynamotor is more compact. Voltage regulation also is better than that which a single vibrator pack with a voltage divider would provide. In addition, a well-built dynamotor usually operates over longer periods without servicing.

The main connection to the car battery is made at two points to reduce voltage drop to a minimum. The first connection is made from the junction box directly to the ungrounded terminal of the battery, while the other runs from this terminal directly to the dynamotor. All unit controls are activated through the "ground" connection and grounds which are used from the various frames of the respective units, as well as those which carry current from the battery are made of half-inch copper braid.

Both ripple- and hash-filter components are mounted inside the base which supports the dynamotor. A 4-prong output socket also is mounted on the base to receive the plug of the cable connecting to the junction box.

The installation has seen considerable service around the Chicago area and its performance has lived up to all expectations. As a result of its capacity to take full legal power input, the transmitter packs a real wallop. Needless to say, operators of other units within the area appreciate the reduction in receiver radiation provided by the r.f. stage and after having experience with receivers which tune to the other end of the band

whenever someone walks past the antenna, we like the idea, too. For those interested in the new emergency police and aircraft bands, the receiver will be found to cover 107 to 128 Mc., and the transmitter 110 to 127 Mc.

Strays

The United States isn't the only place where the great value of amateur radio is recognized by government authorities. The following paragraph is taken from a recent publication of the South African Government Information Office:

"There is no knowing what you can do until you try.' . . . That thought ran in the minds of the production engineers who sat down to plan production of radio sets in the Union (of South Africa). Never before had anything in this line been attempted, except by those enthusiasts, the amateurs, who graduated from crystal sets and cats' whiskers to the elaborate sets of modern radio. It was indeed from among these men that a great many of the skilled staff was recruited for the newly planned production."

Silent Keys

It is with deep regret that we record the passing of these amateurs:

- W3IKG, Pfc. Alvin T. Friend, USA, Phillipsburg, N. J.
- W5DNE, James M. Chambliss, Ft. Worth, Texas
- W8MAD, Lt. Donn F. Harrington, AC, Clinton, N. Y.
- W8OD, Lt. Cyril J. C. Schmidt, USA, Cincinnati, Ohio
- W8TNI, Clifford Morrow, Canton, Ohio
- W9SX, James Czarnecki, RT, Chicago, Ill.
- ex-W9VPC, Willy Hess, Chicago, Ill.
- CO2DE, Ignacio A. Ruz, Habana, Cuba
- Lt. John Denney, Chicago, Ill.

HAPPENINGS OF THE MONTH

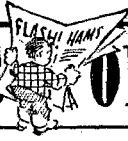

ALLOCATION WORK

THIS would be a progress report if there were any net progress to report, but there isn't. The State Department committee has been QRX while the FCC hearings held the spotlight. In endless days of testimony, the various radio services have been parading before FCC and stating their cases. Not until the hearings are completed can FCC formulate its allocation ideas. At the end of the hearings RTPB is to file its allocation recommendations. RTPB Panel 2 is at work as we write, with this end in view, but with no final decisions and so far with only the frequencies above 30 Mc. under study.

Another month should bring more definite news.

ELECTION RESULTS

IN THIS year's ARRL elections, the incumbent directors and alternate directors were the only candidates named in the Hudson, North-western, Roanoke and Southwestern Divisions, and consequently have been declared reflected without voting by the membership. (In the North-western, a petition for director also was filed naming H. W. Johnston, W7DXF, but was found invalid for want of sufficient signatures.) Similarly in the New England and West Gulf Divisions, the incumbent alternate directors were the only ones named and were declared reflected without membership balloting.

The Central Division has a new alternate director in the person of Earl S. Nelson, W8DS, of Euclid, Ohio, who, being the only candidate named and being found eligible, was declared elected without balloting. Mr. Nelson is by profession an industrial safety engineer and special agent for an indemnity insurance company. He was the organizer of the Cuyahoga Radio Association and its president for its first five years. He helped to organize the Cleveland WERS, under W8AVH, and has been his chief deputy radio aide since WJH was licensed. In ARRL he is OPS, OBS and AEC.

In the Central, New England and West Gulf Divisions, balloting is occurring to elect a director, and, in the Rocky Mountain Division, both a director and an alternate, the results of which will be reported in February *QST*.

EDITORIAL ASSISTANCE REQUIRED

DURING the war this column has brought hundreds of men into contact with the jobs where their services were needed. We wonder if it isn't possible for *QST*, through this means, to do something now for *QST* itself.

QST's editorial staff has immediate need for highly qualified amateurs with experience in both technical and editorial fields, men who can

write literately and lucidly, who can edit capably and sympathetically, and who can design and construct model radio apparatus. Ability to work either on original projects or under direction is desirable, as are intelligent curiosity, amenability to working as a member of an organization, and keen interest in amateur radio. Applicants must be draft-exempt and not now employed at their highest skill.

If interested and available, write, stating age, education, experience, present and previous employment, family and draft status, physical condition, and minimum salary. Examples of previous technical or other writings will be helpful. Address: Editor, *QST*, 38 LaSalle Rd., West Hartford 7, Conn.

CANADIAN PLANNING

To Canadian amateurs, from Canadian General Manager Alexander Reid, VE2BE:

The United States is not the only place where postwar radio planning is going on. Although I do not often have an opportunity to address myself to you, I have been maintaining contact with our officials in Ottawa and am pleased to tell you that there is every evidence that they propose to continue their prewar sympathetic attitude toward amateur problems.

Now a Canadian Radio Technical Planning Board is being set up, and the Canadian Section of ARRL is to be one of its sponsors and a participant in its work. As in the case of RTPB in the United States, this is a temporary nonprofit organization sponsored by the various noncommercial groups in Canadian radio and having for its purpose the preparation of technical recommendations to the Government and the radio industry. On behalf of the Canadian Section, ARRL, I attended the initial organization meeting in Ottawa, with Commander N. N. Wright, RCN, VE2DU, as my technical adviser, and it was decided that we would have membership in the same fashion that ARRL itself is a member of the American RTPB on behalf of the W-K amateurs. The League of course is financing the participation of the Canadian Section in this matter, which I am sure will be a source of gratification to VE amateurs. When the CRTPB gets down to work it is expected that most of the meetings will be in Montreal. At an appropriate time I intend to appoint amateur representatives to the various committees or panels in whose work we shall have a particular interest and I have no doubt that we shall be able both to make some contribution to the work and to take care of the interests of the amateur.

You will understand that the CRTPB will not have the power to settle any important matters, particularly the question of frequencies. It will

make recommendations to the authorities in Ottawa, where we are assured of sympathetic consideration. I hope to be able to advise you from time to time of the favorable progress of this work, through further notes in *QST*.

WAR SERVICE RECORDS

Do you see that "coupon" at the bottom of this page? It is the means for bringing to ARRL headquarters the names of the licensed amateurs of the United States and Canada who are working in the war effort, so that we can compile a statistical record of the amateur's participation. It also serves as the "raw material" for the individual mentions in our department, "In the Services," which you see in each issue.

We want to hear particularly from amateurs in the armed forces but we have equal interest in all the other categories of service listed. If you are employing your ham know-how in any phase of communications or electronics and have not yet registered with us, please do so at once. (If you don't want to cut your copy of *QST*, you may reproduce the essentials of the form on a post card.) It will help us all, so thanks.

THAT I.R.A.C. PROPOSAL

PUBLICITY restrictions having been removed, we give you now the amateur provisions in the proposal of the Interdepartment Radio Advisory Committee for the revision of the Cairo allocations. This proposal is the base for the frequency discussions in the study committees set up by the Department of State. It is not associated with either the FCC hearings or the RTPB studies. But, because it reflects the point of view of the military services, it inevitably colors the discussions by all agencies; and in the higher reaches of the spectrum it has pretty well become the pattern for thinking. It has not been adopted and no decisions about it have been made. It is simply one of many proposals that are being advanced during this complex study but it is the first and most famous one.

The amateur allocations proposed below 30 Mc. consist of:

3,500 to 3,900 kc.
7,000 to 7,400 kc.
14,000 to 14,400 kc.
21,000 to 22,000 kc.
28,000 to 30,000 kc.

with the military using the 100-kc. frequencies of the last two bands for mobile service on a secondary noninterference basis. No 160-meter band is proposed. With broadcasting going to 1605 kc., IRAC proposes 1605-1800 for mobile 'phone (except aero), 1800-2000 for that secret navigational aid which we mentioned in our FCC testimony reproduced last issue, and 2000-2050 as part of a new organization of the mobile service that would involve a calling frequency at 2055 and a new distress frequency at 2070. Intense congestion reigning in the lower end of the h.f. range, IRAC proposes a swap or exchange in our next two bands, taking 100 kc. off at 4 Mc. and adding it to the 7-Mc. band. Then they propose a new and wide band for us from 21 to 22 Mc., interesting both because we could triple to it from 7 and because the frequencies are more useful than 28. The ARRL position on these proposals can be seen from our FCC testimony, appearing in this department last month.

Above 30 Mc. IRAC proposes, for amateurs:

144 to 149 Mc.
218 to 225 Mc.
420 to 460 Mc.
1,125 to 1,225 Mc.
2,500 to 2,700 Mc.
5,200 to 5,750 Mc.
10,000 to 10,500 Mc.
21,000 to 22,000 Mc.

There is no provision for a 5-meter band. IRAC started out with a complex organization for the aeronautical service involving an aggregation of bands for navigation aids and mobile communication reaching from 108 to 132 Mc. as an immov-

AMATEUR WAR SERVICE RECORD

Name

Call, present or ex; or grade of op-license only

Present mailing address

SERVICE

- Army
 Navy
 Coast Guard
 Marine Corps
 Maritime Service
 Merchant Marine
 Civil Service
 Radio industry, 100% war

Rank or rating

*Branch or bureau: Signal Corps, AAF, BuShips, WAVES, etc.
If civilian industry, give title and company.*

ARE YOU LICENSED?

When joining the League or renewing your membership, it is important that you show whether you have an amateur license, either station or operator. Please state your call and/or the class of operator license held, that we may verify your classification.

able "must" for the future. From the other end they got up to 42 Mc. with essential provisions. That left 42 to 108 available in their plan to be divided between f.m. and the present sort of television. They considered that provision so tight that the amateur band would have to be omitted, and they suggested the division between f.m. and television at 54 Mc. Above 132 they have what is labeled as a Government "must" for military aviation and control circuits, covering 132-144. Then they put in the amateur band, displaced and widened. Similarly in the 200-range the ham band would be widened but displaced and again would adjoin a Government band.

No change in the power of amateur stations is contemplated until the 218-225 band is reached, which IRAC proposes be limited to 500 watts because all the services from 150 to 460 would observe that as a top limit. The band 420-460 is a special case and is intended to be temporarily shared. The IRAC language reads, "Air Navigation Aids and Amateur. Power up to 500 watts. Government and non-Government; cannot be moved. Amateur power limited to 50 watts. Band to be exclusively amateur when no longer required for air navigation aids." At that time the 50-watt amateur limit supposedly would be removed. No power reduction is specified in the higher bands. No amateur band is proposed between 460 and 1125 because the 800-region, where it would normally fall, lies in the band 460-956 which IRAC proposes as the major assignment for television. Above 956 Mc. IRAC has spotted in only the amateur and navigation-aid bands, the rest being left subject to regional agreements, with above 30,000 Mc. as experimental. For the ARRL comments on amateur allocation above 30 Mc. we again refer you to our FCC testimony as published here last month.

FCC ORDER 123

IN ORDER to ease the present shortage of qualified operators for ship radiotelegraph stations, FCC Order 123, effective October 9, 1944, establishes a new class of commercial license entitled "Temporary Emergency Radiotelegraph Second Class Operator License." This is not to be confused with the Temporary Limited Radiotelegraph Second Class Operator License, familiarly known as the T.L.T.

Stripped of its legal language, this license contains the following points of interest, in brief:

1) The license authorizes the user to operate radiotelegraph equipment aboard cargo vessels,

exclusively for the transmission of emergency signals directly related to the safety of life and property at sea.

2) It is issued to any person who passes the Commission's code test of at least 16 coded groups per minute, in addition to obtaining a rating of 50% or better in Elements 1 and 6 of the commercial radio-operator examination, and who is found to be otherwise qualified to hold a radio operator license.

3) It is valid only for operation of a ship station on board a vessel that carries at least one operator with a T.L.T. or higher grade of license, who maintains at least an eight hour watch, or one-third of the required watch, per day, and supervises the operation of the transmitter.

4) Finally, this license expires one year from date of issue unless previously terminated by the Commission; and, unless otherwise provided by the Commission, will not be renewed.

It is a temporary expedient to provide operators for emergency communications on U. S. cargo vessels but when the need is no longer acute, the Commission may be expected to cancel these licenses. Take heed, therefore, and if you qualify for a T.E.T. ticket, start studying for a T.L.T. or 2nd class commercial without delay.

"AMATEUR RADIO AND ITS CONTRIBUTIONS TO THE SECURITY & WELFARE OF THE NATION"

LAST month we gave you, in small type, the testimony offered by Secretary Warner at the FCC hearings and dealing with "The Frequency Requirements of the Amateur Service." That statement followed extensive testimony by President Bailey on the nature of amateur radio and its contributions to the national life.

We believe that you are interested in reading what your League has said in your behalf at Washington, and that you will find in such a document much helpful "ammunition" in case you get into any local arguments. You'll be interested, too, in our prophesy of future amateur growth. Here is Mr. Bailey's testimony:

I appear before you as president of the American Radio Relay League, representing the radio amateurs of our country.

I request you to return to us the frequencies assigned to us before December 7, 1941, together with certain additional frequencies above 300 Mc.

In support of this request I shall outline to you how radio amateurs contribute to the security and welfare of our country. I propose to submit a brief summary of the categories into which radio amateurs may be divided, and then enlarge upon these categories. In conclusion I shall outline briefly the history of amateur radio and venture an estimate of the future.

From the standpoint of security, there are four major categories of amateur radio:

The first is the existence of a huge reservoir of skilled amateurs. From this pool there are immediately available thousands of operators who are experienced in communication through terrific interference and thousands of technicians who are skilled in the building, operation and maintenance of radio gear.

The second point is the availability for military use of amateur frequencies, free from interference, immediately upon declaration of war.

The third is the huge supply of up-to-date gear available for communication purposes to the military services when suddenly needed.

The fourth point is the support of manufacturers of gear who find a wide market among amateurs and who must keep abreast of the times to fill that demand. Thus, in time of war, manufacturers' designs and facilities are ready to take care of the sudden demands for military use.

From the standpoint of welfare, there are five salient points to be noted:

The first is the fact that amateur radio is a vast training school for the radio art.

The second is the contribution of amateurs to the technique of radio.

The third point is the availability of amateurs for nationwide assistance in large-scale investigations and experiments.

The fourth is the ability of amateur radio to supply communications in time of emergency, caused by natural disasters.

And fifth is the sociological importance of amateur radio.

Security

The Reservoir of Skilled Operators & Technicians

It is of the utmost significance that in this most technical of all wars, with its heavy dependence upon communication and electronic devices, we should have had available in this country a body of many tens of thousands of skilled radio people, available for the needs of the military services and for the vastly expanded research, development and manufacturing programs. The practice of amateur radio has given the free citizen of a democracy an invaluable skill which he is eager to apply to the defense of his country. Though amateur numbers are inadequate for the nation's whole radio needs in modern warfare, many thousands of them are instantly available to step into the early desperate situations of a war, before there is time to organize training schools. This organization has been told many times by competent officials of both the Army and the Navy that, except for the speed with which the American amateur stepped forward and volunteered in our armed forces, with a skill that was already sufficient for the task, the story for America might have been very different. There are also many wartime personnel needs outside the military services. The training schools are one such. Amateur radio itself being a great training school, it lends itself almost automatically to the vast programs that are necessary to a war effort, with teaching personnel and instruction apparatus immediately available from amateur circles. Many amateurs possess admirable qualifications as research workers and development engineers, and many of them have contributed significantly in the laboratories of this nation in the development of the complicated electronic devices which have meant so much to the prosecution of the war. It is a matter of record that in all these fields of work the amateur, because of the training he has given himself and perhaps frequently because he has learned things the hard way, is a very valuable person and of much greater value than those who have been given emergency training, necessarily brief and hurried, for the sudden demands of war.

All amateurs engage in two-way communication and a great many of them so specialize on communicating activity that they develop exceptional competency. Since 1914 our organization has maintained a voluntary field organization to coordinate the practical communicating activities of amateur stations and has operated an elaborate network of trunklines and relay routes for the handling of unpaid amateur message traffic. Although many of these messages were in themselves of considerable public value, where they were received through amateur supplementation of existing communication systems as in the case of emergency work, they are of most value in the training in operating procedure which they afford the amateur operators concerned; that is to say, these messages, like amateur conversations, are the raw material of training.

One valuable communication service rendered by amateurs which has particular appeal to the imagination is the maintenance of contact with scientific expeditions and exploring parties. It began in 1923 when the amateur organization selected one of its most skillful members and, paying his salary, contributed his services as radio operator on an Arctic expedition. Amateurs all over the country joined in the work of keeping the expedition in contact with the homeland. So successful was this demonstration that there has scarcely been an expedition since that time that did not plan on contact with home via amateur radio. Frequently the apparatus has been amateur made and generally the operators were amateurs. Our association has record of over a hundred such expeditions to unknown scientific or geo-

graphical frontiers, in all continents, from the equator to both poles, where amateurs have been instrumental in maintaining the contact with civilization.

Amateurs Contribute to the Technique

The amateur is an experimenter and his contributions to the technique of radio have been manifold. When the amateur was first banished to 1500 kc. to accomplish his gradual extinction, he astonished the world by developing apparatus and methods to communicate at considerable distances on these despised frequencies. The whole discovery of the value of short waves and their opening for government and commercial work, in a diversity of services embracing the world, was purely an amateur accomplishment. The first published explanation of the ionospheric transmission of high frequencies was by an amateur. The first exposition and demonstration of the extended ranges obtained on very high frequencies by virtue of the bending of the waves in the lower atmosphere was by an amateur. The most selective "communications type" receiver in existence, the so-called single-signal crystal-filter receiver, is an amateur development. Amateurs were the first to develop simple and reliable equipment for operation in the v.h.f. region, first to occupy this territory in large numbers, and first to comprehensively record and evaluate its fundamental characteristics. Throughout the years the amateur has been a pioneer, working out the apparatus necessary for his peculiar problems in a fashion that the scientific and commercial branches of radio have followed with great interest. Organized amateur radio acts as a clearing house for ideas, and the restless curiosity of these many experimenters, individualistic and unfettered by hidebound ideas, leads to a perpetual flow of new ideas to enrich the art. The amateur has the habit of talking complicated concepts and stripping them of unessentials, to meet his own limitations of facilities and pocketbook, in a process that we have come to call "the reduction to amateur practice" — frequently to the benefit of the technique generally.

These qualifications of the amateur as a technical worker have been of priceless value to the nation during the present war. The Commission is aware that the military services are employing many secret and complex devices of an electronic nature. In the laboratories and engineering departments where these devices have been developed, and where work on their improvement continues, a great many hundred skillful amateurs have found an outlet for their talents. In the manufacturing companies which produce and install this apparatus, some of it of unbelievable complexity, many hundreds of additional amateurs are serving as expert technicians. In the military services the genius of the amateur has similarly been indispensable. Both in the employment of special devices and in communication work there are recorded instances where a desperate situation has been saved only by the incredible improvisation of an amateur, a faculty that cannot be imparted by wartime schooling and which exists only as the result of years of the ardent pursuit of amateur radio.

This basic spirit of amateur radio — this heart-interest in the art — has been carried by radio amateurs from their own avocation to all the other fields of radio, and is said by many to be the fundamental reason for America's leadership in technological radio. We submit it as a fundamental argument for the amateur that the status of the art today, and our country's position in it, derive fundamentally from the institution of amateur radio.

The Amateur Frequencies Are a Military Reserve

It is a stark fact in allocation history that the frequencies retained by the military services during time of peace are insufficient for their needs in time of war. If there were no radio amateurs, the difficulty of the military services in finding frequencies for their additional wartime needs would be very great. But during war, amateur stations are traditionally closed down for security reasons and the amateur frequency bands thereby become available to the military services. Thus at the very time when frequencies are most needed for the country's preservation, there comes into the Government's hands priceless additional blocks of frequencies. If there were no amateur assignments, these bands would be filled with the signals of every nation, including essential American services, and their recapture for military needs would be difficult or impossible in blocks of any appreciable width.

(Continued on page 74)

The Cathode Follower

A Simple Mathematical Discussion of Design Factors

BY CAPT. WILLIAM H. MINOR, SC,* W9DSN

DESIGN consideration for the cathode follower has often been slighted by the average radio amateur and mechanic since little or no use of it has been seen heretofore. There will be, however, increasing use of this simple degenerative amplifier as video and isolation principles are called for in the future of radio and television.¹

It is well to consider the uses of the cathode follower first. Primarily, the circuit is used as an isolating stage to prevent loading of an amplifier by the network which is to follow. Secondly, it is used to match a high impedance to a low impedance.

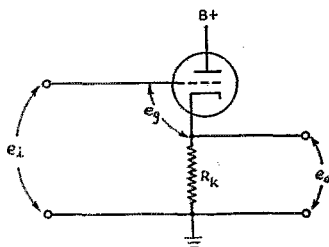

Fig. 1 — The cathode-follower circuit.

Fig. 1 shows the extreme simplicity of the cathode follower. In developing mathematically the design formula involved, the following identifying symbols are used:

- e_i = instantaneous value of input voltage
- e_g = instantaneous value of grid-cathode voltage
- e_o = instantaneous value of output voltage
- i_p = instantaneous value of plate current
- r_p = plate resistance of tube
- μ = amplification factor of the tube

It can be seen that:

- 1) $e_i = e_g + e_o$
- 2) $e_g = e_i - e_o$, solving (1) for e_g .

*Chief Radio Repair, Radio Repair Branch, Maintenance Division, AOASC, Newark, N. J.

¹ The material contained herein is in no way to be construed as an official statement by the U. S. Army.

The cathode follower is an electronic device which has many applications in stage isolation and impedance matching. With this circuit, the output is taken from the cathode circuit instead of the plate. In this article the author discusses the conditions which must be met for optimum performance.

- 3) $e_o = i_p R_k$
- 4) $i_p = \frac{\mu e_g}{R_k + r_p}$
- 5) $e_o = \left(\frac{\mu e_g}{R_k + r_p} \right) R_k$, substituting (4) in (3).
- 6) $e_o = \left(\frac{\mu R_k}{R_k + r_p} \right) (e_i - e_o)$, substituting (2) in (5).

Solving algebraically for $\frac{e_o}{e_i}$ gives the value of voltage gain.

$$7) \text{ Voltage gain} = \frac{e_o}{e_i} = \frac{\mu R_k}{r_p + R_k(1 + \mu)}$$

It must be remembered that this is the *no-load* gain.

By simple manipulation the equality may be thrown into the form:

$$8) \frac{e_o}{e_i} = \left[\frac{\mu}{(\mu + 1)} \right] \left[\frac{R_k}{R_k + \frac{r_p}{(\mu + 1)}} \right], \text{ or}$$

$$9) e_o = \left[\frac{\mu}{(\mu + 1)} \right] (e_i) \left[\frac{R_k}{\frac{r_p}{(1 + \mu)} + R_k} \right]$$

Without further proof the reader will see that this is the mathematical expression for the voltage from a voltage divider whose resistance values

are $\frac{r_p}{(1 + \mu)}$ and R_k and whose voltage source equals

$$\left(\frac{\mu}{\mu + 1} \right) e_i.$$

This then can be pictured graphically as shown in Fig. 2.

The impedance looking into the output circuit is Z_o and

$$10) Z_o = \frac{R_k \left(\frac{r_p}{\mu + 1} \right)}{R_k + \frac{r_p}{\mu + 1}}$$

Solving (10) for R_k ,

$$11) R_k = \frac{-Z_o r_p}{Z_o(1 + \mu) - r_p}$$

It will be noted again that the cathode follower is used to match high and low impedances. There is a limit to the maximum value which a given set of tube parameters may be made to match. If, in equation (11), R_k is differentiated with respect to Z_o and the first derivative set equal to zero, that maximum may be shown. It is easier to

see, and the answer is the same, if equation (11) is examined and consideration given to the physical limitations of R_k .

R_k must be finite. Therefore, $Z_o(1 + \mu) - r_p$ must never reach the value of 0 or, mathematically, $Z_o(1 + \mu)$ should not equal r_p .

R_k must be positive. Therefore r_p must be greater than $Z_o(1 + \mu)$

The absolute limit of R_k is:

$$12) Z_o(1 + \mu) = r_p$$

$$13) Z_o(\text{max.}) = \frac{r_p}{(1 + \mu)}, \text{ solving (12) for } Z_o(\text{max.}).$$

In studying equation (8), the disadvantages of this amplifier will be seen. The value of $\frac{\mu}{(\mu + 1)}$

is less than 1 and $\frac{R_k}{R_k \left[\frac{r_p}{(1 + \mu)} \right]}$ is less than 1.

The product of two numbers smaller than 1 is less than 1; therefore, the voltage gain of the stage will never exceed unity. A small r_p or large μ , or both, will raise the amplification closer to the limit 1. It is well to design the circuit such that $Z_o(\text{max.})$ and the impedance of the load are close to the same value. In such cases the value of R_k increases and when the voltage gain under load is computed the *effective* value of R_k will approach the value of the load resistance. This, then, will bring the value of voltage gain to maximum.

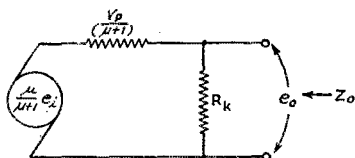

Fig. 2 — Equivalent voltage-divider circuit of the cathode follower.

A Practical Problem in Design

A given line represents a load of 400 ohms. It is desired to match a high impedance output to the 400-ohm load.

Choose a tube such as the 6C5. From the tube characteristics,

$$\mu = 20 \quad r_p = 10,000$$

The maximum Z_o that can be matched is

$$Z_o(\text{max.}) = \frac{10,000}{20 + 1} = 476 \text{ ohms.}$$

The tube parameters are satisfactory, since 400 ohms is less than the maximum calculated above.

The value of R_k needed to match $Z_o = 400$ is

$$R_k = \frac{(-400)(10,000)}{(400)(1 + \mu) - 10,000} = \frac{-4,000,000}{8400 - 10,000} = \frac{(-4)(10)^6}{(16)(10)^3} = 2500 \text{ ohms.}$$

To compute the gain under load it must be remembered that the load resistance is in parallel with R_k . In this instance the 400-ohm line is matched and represents a pure resistive load of 400 ohms.

The formula becomes

$$\frac{e_o}{e_i} = \frac{\mu R_k^1}{r_p + R_k^1(\mu + 1)}$$

where

$$R_k^1 = \frac{R_L R_k}{R_L + R_k} = \frac{(400)(2500)}{2500 + 400} = 345 \text{ (} R_L = \text{load resistance).}$$

Under load

$$\frac{e_o}{e_i} = \frac{(20)(345)}{10,000 + 345(20 + 1)} = \frac{6900}{17245} = 0.4$$

gain without load

$$\frac{e_o}{e_i} = \frac{(20)(5000)}{10,000 + 5000(20 + 1)} = 0.8$$

The signal is impressed from grid to ground, while the load is taken from the voltage drop across the cathode resistance. A rise in grid-to-ground potential will cause an increase in plate current. This plate current flowing through R_k will cause the potential of the cathode end of R_k to rise above ground making the increment in voltage from cathode to ground *in phase* with the increment in grid voltage.

At the same time the rise in potential at the cathode end of R_k is equivalent to lowering the bias on the grid. This action of the cathode following the grid is degeneration of the current feed-back type, and is the basis for the name given to this circuit.

Strays

W9NBE contributes the following copy of a memorandum found in a field engineer's notes:

"It has been brought to our attention that one cause of failure of fuses F-201 and F-202 may well be the carelessness on the part of a field engineer in allowing his arm or other part of his body to short out the 12,000-volt supply.

"Such practice is to be avoided because the bureau frowns upon excessive fuse failures and is especially to be avoided when one's hands are damp because the transformer is apt to be burned out.

"On second thought, however, we feel that undoubtedly our complaint is really not well-founded inasmuch as component failures would not exceed one per engineer and could, therefore, be tolerated.

"The only point which now remains to be settled is whether or not field engineers come under 'guarantee replacements' or are to be considered expendable items."

IN THE SERVICES

RETURNS from the In the Services post-card insert in September *QST* have been so good we hope to repeat it in an early issue, hoping to catch the lazy ones and those on foreign service who do not get *QST* regularly. For the benefit of many men not conversant with latest FCC regulations, who have given their calls on the post cards as "ex," under the impression that their tickets have lapsed, we offer the following information.

FCC Order 115, dated May 25, 1943, automatically extends all amateur operator licenses expiring between December 7, 1941, and December 7, 1944, for an additional three year period beyond the normal expiration date of the license. While the Commission has taken no action on operator licenses expiring after December 7, 1944, we expect there will be a similar extension at the appropriate time. Under this order, therefore, it is unnecessary that an amateur apply for operator license renewal for the present.

While amateur station licenses have not been extended and many have technically lapsed,

since the Commission has not issued new or renewed station tickets since September 15, 1942, all calls are "frozen" and will not be reassigned new men 'till the former owners are given an opportunity of renewing them after the war.

Under the circumstances, any station license which has expired due to present regulations should not be considered an "ex" but simply in a state of suspended animation. More properly, an "ex" call is one formerly held by an amateur, which has voluntarily lapsed and has not been renewed due to lack of interest or death of the licensee. Please take this into consideration when sending us your amateur war service record.

NAVY - AERONAUTICS

- 1ILU, Parker, ART3c, Corpus Christi, Texas
- ex-1LOW, Livingstone, ARM1c, foreign duty
- 2DDU, Berger, ART1c, Terminal Island, Calif.
- 3DOB, Sinkez, ART3c, Corpus Christi, Texas
- 3HUZ, Jacobsen, ART1c, foreign duty
- 2IQM, Moore, ART1c, Willow Grove, Pa.
- 3MBB, Costello, RE, foreign duty
- 3FPB, Di Lorenzo, CRM, Corpus Christi, Texas
- 3GTV, Uhlhorn, ACRT, Minneapolis, Minn.
- 3JKK, Haimbach, ART1c, Corpus Christi, Texas
- 4CMT, Starnes, ART1c, Corpus Christi, Texas

- 4CTT, Jennings, ART1c, Corpus Christi, Texas
- 4DBT, Elias, ART1c, foreign duty
- 4DJJ, Williams, ART1c, Corpus Christi, Texas
- 4DVQ, Marks, Sp(T)2c, Memphis, Tenn.
- 4EPY, Wimberly, ART1c, Corpus Christi, Texas
- 4FMJ, Harrell, ART2c, Corpus Christi, Texas
- 4GSU, Stout, ART3c, Corpus Christi, Texas
- 4HLO, Cannon, ACRM, Hertford, N. C.
- 4HPC, Siler, Sic, Corpus Christi, Texas
- 4HRQ, Hattaway, ART1c, foreign duty
- 5CYK, Moore, Lt. (jg), Corpus Christi, Texas
- 5DGE, Palmer, ACRT, Corpus Christi, Texas
- 5DWJ, Speer, ART1c, Corpus Christi, Texas
- ex-5EOD, Sullivan, CEM, Jacksonville, Fla.
- 5FBS, Webster, ACRT, Corpus Christi, Texas
- 5FLJ, Leach, ART2c, Corpus Christi, Texas
- 5GGS, Gullberg, ART1c, Corpus Christi, Texas
- 5GYG, Polchow, ART1c, Corpus Christi, Texas
- 5HKA, Dodds, ART1c, Great Lakes, Ill.
- 5HNF, Glover, RE, Corpus Christi, Texas
- 5HYA, Parker, ART1c, Corpus Christi, Texas
- 5HZY, Shelton, ACRT, Beauford, S. C.
- 5IFA, Burns, ACRT, foreign duty
- 5IQR, Brown, ART1c, Corpus Christi, Texas
- 5IW, Cline, ART1c, Corpus Christi, Texas
- 5JBK, Martin, ARM1c, Corpus Christi, Texas
- 5JPF, Schwappach, ACRT, foreign duty
- 5KPV, Kollman, ART1c, Corpus Christi, Texas
- ex-5MU, Seligmann, Sic, Corpus Christi, Texas
- 5OB, Murphree, ART1c, Corpus Christi, Texas
- 6HLL, Tuers, ARM1c, Alameda, Calif.
- 6ISA, Butler, ART1c, Corpus Christi, Texas
- 6JEZ, Paul, ACRT, Corpus Christi, Texas
- 6LQZ, Bailey, Lt., Patuxent River, Md.
- 6LIX, Guyot, Ens., Patuxent River, Fla.
- 6MKJ, Jordan, ART1c, Corpus Christi, Texas
- 6MSL, Kirkpatrick, ART1c, Corpus Christi, Texas
- 6OAK, Galloway, ART1c, Corpus Christi, Texas
- 6PHW, Cox, Lt., Corpus Christi, Texas
- 6BQLX, Gillispie, Lt., Terminal Island, Calif.
- 6RGJ, Dotta, ART1c, Corpus Christi, Texas
- 6RGH, Simpson, ACRT, foreign duty
- 6RWP, Maass, ART1c, Corpus Christi, Texas
- 6SIT, Grain, ART2c, Corpus Christi, Texas
- 6TPJ, Edmisten, ART3c, Corpus Christi, Texas
- 6UKE, Jackson, ART1c, Johnsville, Pa.
- 7ART, Talen, ACRT, Pasco, Wash.
- ex-7AXH, Pritchard, ARM1c, Willow Grove, Pa.
- 7DUP, Stacy, ACRT, Corpus Christi, Texas
- 7GMF, Levenzon, ART1c, Moffett Field, Calif.
- 7GSZ, Scovill, A/C, Seattle, Wash.
- 7GWN, Vause, ART1c, Corpus Christi, Texas
- 7IDJ, Quinn, ART1c, Brunswick, Me.
- 7IGN, Bander, ART1c, Corpus Christi, Texas

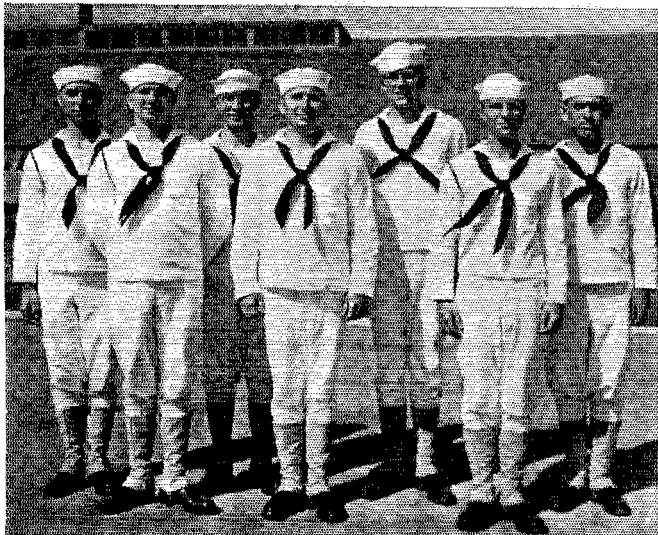

Great Lakes Naval Training Station has graduated many thousands of radio men during World War I and II, who are now doing duty on vessels and at shore stations throughout the world. This is a recent group, the hams of Company 1476, all Seaman 1c (RT). *Left to right:* L. T. Thomasson, W9UQH; P. W. Schuster, W8SWY; W. E. Clayton, W7EDH; J. O. Mackinder, W9DVT; A. R. Hutson, W8WMM; N. A. Hontz and G. H. Robertson, operator licenses only.

71IQ, Ketchum, ART1c, Corpus Christi, Texas
 8BKJ, Klein, ART1c, Corpus Christi, Texas
 8KW1, Burkhamer, ACRT, foreign duty
 80EA, Schauer, ART1c, Corpus Christi, Texas
 8OMB, Smith, ARM1c, foreign duty
 800M, Fischer, ART2c, foreign duty
 80ZC, Sockel, ART2c, Corpus Christi, Texas
 8PBF, Watson, ART1c, Corpus Christi, Texas
 8PTP, Kellogg, ART2c, Corpus Christi, Texas
 8RGZ, Boggs, ARM1c, Terminal Island, Calif.
 8TPK, Anne, ARM1c, foreign duty
 8VNI, Martich, ART1c, Corpus Christi, Texas
 8WOM, Magill, ART2c, Norfolk, Va.
 9AZG, Stepro, ART1c, Corpus Christi, Texas
 9CLK, Glover, ACRT, San Diego, Calif.
 9DYS, Szedziewski, Lt., San Diego, Calif.
 9EOS, Burden, ART2c, Patuxent River, Md.
 9FGP, Louden, ACRT, Corpus Christi, Texas
 91LM, Wenzel, ART2c, foreign duty
 91YK, Johnson, ACRT, Washington, D. C.
 9KVO, Tretter, ART1c, Corpus Christi, Texas
 9LBH, Ford, ART2c, Corpus Christi, Texas
 9ME1, Rinehart, ART1c, Pensacola, Fla.
 9NEC, Kramer, ART1c, Corpus Christi, Texas
 9NER, Mayer, S1c, Corpus Christi, Texas
 9NMA, Wight, S1c, Corpus Christi, Texas
 9NYZ, Fouts, ART1c, foreign duty
 9PAG, Smith, ART1c, Corpus Christi, Texas
 9X-9RUP, Linda, Lt., Washington, D. C.
 9SQU, Lucey, ART2c, Corpus Christi, Texas
 9TBW, Armstrong, Lt., Arlington, Va.
 9UKN, Wise, Willow Grove, Pa.
 9VEF, Lehner, Ens., Corpus Christi, Texas
 9VXT, Holtman, ART3c, Corpus Christi, Texas
 9YIL, Hoff, ACRT, Corpus Christi, Texas
 9YYW, Yarborough, ART3c, foreign duty
 9ZPF, Sorensen, Ens., Gainesville, Ga.

ARMY—SIGNAL CORPS

1APQ, Heddemon, S/Sgt., foreign duty
 KA1BB, Chapman, Pvt., Camp Crowder, Mo.
 1BEK, Holderness, Pvt., Camp Van Dorn, Miss.
 1BK0, Bradley, Pvt., Camp Crowder, Mo.
 ex-1FQC, Reyen, M/Sgt., Pataluma, Calif.
 1GJF, Simonsen, S/Sgt., Camp Pickett, Va.
 1GVY, Giddings, Sgt., foreign duty
 1HEK, Adler, Capt., Camp Bowie, Texas
 1JPH, Sladky, T/5, Kelly Field, Texas
 1KAG, Greim, foreign duty
 1KEI, Ferla, Lt., Ufitea, N. Y.
 1MLV, Klein, Cpl., Ft. Monmouth, N. J.
 1MMN, Chandler, Pvt., Camp Crowder, Mo.
 1NNA, Audet, Pvt., Ft. Monmouth, N. J.
 ex-2BTH, Sess, Lt. Col., Philadelphia, Pa.
 2CTO, Ehrler, Cpl., foreign duty
 2CWM, Miller, Lt., Dayton, Ohio
 2DTK, Schmidt, T/Sgt., foreign duty
 2EYZ, Ehrmann, T/Sgt., foreign duty
 2GJM, Colaguri, M/Sgt., Ft. Monmouth, N. J.
 2GVH, Kimmel, Capt., Tinker Field, Okla.
 2IDX, Schreiber, T/5, Camp Crowder, Mo.
 2IHU, Cangialosi, Pvt., Camp Crowder, Mo.
 2IUK, Lasnik, Cpl., Camp Crowder, Mo.
 2JYV, Thompson, Pvt., Camp Crowder, Mo.
 2KNS, Weber, Pvt., Camp Crowder, Mo.
 2KTD, Poulos, Pvt., Ft. Jackson, S. C.
 2KXG, Stonitsch, Pvt., Camp Crowder, Mo.
 2LMO, Tafaro, Cpl., Newark, N. J.
 2LOP, Cooke, T/5, Camp Crowder, Mo.
 2LUQ, Kavanaugh, 2nd Lt., Ft. Dix, N. J.
 2LYQ, Applegate, Capt., Washington, D. C.
 2NOM, Allen, Pvt., Ft. Monmouth, N. J.
 2CGG, Thomas, Pvt., Camp Crowder, Mo.
 ex-3DNJ, Johnston, Pvt., Camp Crowder, Mo.
 3FDO, Gilkey, 2nd Lt., Ft. Monmouth, N. J.
 3FGF, Watts, Lt., Washington, D. C.
 3FGY, MacMillan, T/5, Kelly Field, Texas
 3HFW, Culzer, Pvt., Camp Crowder, Mo.
 3ICD, Bellan, S/Sgt., address unknown
 3IJR, Hall, T/4, Washington, D. C.
 3IPB, Pigula, T/4, Robins Field, Ga.
 3JLS, Bell, Pvt., Camp Crowder, Mo.
 3JRG, Pallies, Pvt., Baltimore, Md.
 4ALT, Winstead, Major, Washington, D. C.
 4CDV, Ruple, Capt., Camp Stewart, Ga.
 ex-4DSG, Smith, Lt., Philadelphia, Pa.
 4EJS, Berry, 2nd Lt., Ft. Monmouth, N. J.
 4FGU, Leathers, Capt., Arlington, Va.
 4FQR, Metcalfe, 2nd Lt., Ft. Monmouth, N. J.
 4GNO, Wyatt, Pvt., Camp Crowder, Mo.



With pardonable pride we present a former member of the ARRL Headquarters Staff, 2nd Lt. Julius Galin, W1LOP, now the navigator on a B-29 superfort. Formerly our lab technician, he left in December, 1942, to study electrical engineering at the University of Connecticut, and eight months later commenced intensive AAF training which ended August, 1944, with a commission and his present assignment. Happy landing, Julius!

4HFU, Denton, Lt., foreign duty
 4HRW, French, Sgt., Wright Field, Ohio
 5BAY, Whitaker, Capt., Manchester, N. H.
 5EDC, Easterwood, Pvt., Camp Crowder, Mo.
 5EGC, Brown, Lt., Half Moon Bay, Calif.
 5ERM, Long, Lt., address unknown
 5ERR, Hannan, T/Sgt., Oklahoma City, Okla.
 5EYH, Rips, Lt., Wright Field, Ohio
 5EZA, Blake, T/Sgt., foreign duty
 5FRH, Beatty, Lt., foreign duty
 5GQH, Bates, T/5, foreign duty
 5HCE, Michaelson, Capt., Wright Field, Ohio
 5HTH, Harrison, Cpl., Kelly Field, Texas
 5JFA, Roddy, 2nd Lt., Camp Chaffee, Ark.
 5KQY, Woddy, Lt., foreign duty
 6HLE, Lunge, T/5, Robins Field, Ga.
 6JQX, Shaw, Pfc., Camp Crowder, Mo.
 6KHU, Nettell, Major, San Francisco, Calif.
 6LWE, Baird, T/Sgt., foreign duty
 6MTN, Johnson, 2nd Lt., foreign duty
 6PQP, Honnold, Pfc., Camp Crowder, Mo.
 6RJV, Becker, 2nd Lt., Hicksville, N. Y.
 6RZU, Harris, Pvt., Camp Crowder, Mo.
 6SCO, Kemper, Pfc., Ft. Lewis, Wash.
 6SLC, Hannum, 2nd Lt., Camp Edison, N. J.
 6TPO, Arnold, Pvt., Camp Crowder, Mo.
 ex-7AHC, Cote, Lt., Camp Kohler, Calif.
 7BW, Allen, Pvt., Camp Crowder, Mo.
 7EHN, Clark, Capt., Los Angeles, Calif.
 ex-7EPE, Nofiri, Sgt., Ft. Hayes, Ohio
 7FTO, Penkake, Lt., Drew Field, Fla.
 7FVH, Gunther, Sgt., Douglas, Ariz.
 7GCA, Wright, Pvt., McClellan Field, Calif.
 K7JJC, Nelson, S/Sgt., Seattle, Wash.
 ex-8BNE, Prehn, Major, Arlington, Va.
 ex-8BQY, McTighe, Lt., Alexandria, Va.
 8DLB, Burbridge, Pvt., Camp Crowder, Mo.
 8JRY, Bramley, Pvt., Camp Crowder, Mo.
 8JLS, Aiken, Pvt., Camp Crowder, Mo.
 8LKT, Horvath, S/Sgt., Wright Field, Ohio
 8ODS, Ohmart, Lt., Washington, D. C.
 8OJR, Boehmig, Pvt., Camp Crowder, Mo.
 8OJS, Borelli, Lt., Pittsburgh, Pa.
 8OOT, Lipton, Pvt., Camp Crowder, Mo.
 8QDS, Chapman, Pfc., Camp Beale, Calif.
 8QGH, Carr, 2nd Lt., Ft. Monmouth, N. J.
 8QOC, Hmel, Pfc., Camp Crowder, Mo.
 8RPG, Prykan, T/4, foreign duty
 8RPS, Coffey, Cp., Camp Crowder, Mo.
 8RRE, Latter, 2nd Lt., Ft. Monmouth, N. J.
 8SKK, Humphrey, Pvt., Camp Crowder, Mo.
 ex-8SKJ, Chmielewski, T/4, Ft. Myer, Va.
 8UNX, Sommer, Pvt., Camp Crowder, Mo.
 8UOD, Mullaney, T/5, Warrenton, Va.
 8VUV, Walck, Pvt., Camp Crowder, Mo.
 8WLL, Dezio, Pvt., Camp Crowder, Mo.
 9ARP, Rickman, Pvt., Camp Crowder, Mo.
 9ASO, Hansen, 2nd Lt., Ft. Monmouth, N. J.
 9BNV, Stone, T/4, Ft. Monmouth, N. J.

ex-9COM, Landgraf, Pfc., foreign duty
 9DYG, Phillips, Pvt., Camp Crowder, Mo.
 9EXD, Shull, Pvt., Camp Crowder, Mo.
 ex-9FSC, Scott, Lt., Camp Crowder, Mo.
 9FZW, Allen, Pvt., Camp Crowder, Mo.
 9FZZ, Sebestik, Pfc., Kelly Field, Texas
 9HMU, Hanson, T/4, Kelly Field, Texas
 9IUZ, Eppley, Pvt., Naperville, Ill.
 9JXU, Thomas, 2nd Lt., Ft. Monmouth, N. J.
 9KXZ, Brown, 2nd Lt., Washington, D. C.
 9LIH, Gabrielson, Cpl., Camp Crowder, Mo.
 9LS, Smith, Lt., Pendleton Field, Ore.
 9MFY, Payne, T/5, Camp Crowder, Mo.
 9MKU, Graham, Cpl., Ft. Monmouth, N. J.
 9MTR, Olson, 2nd Lt., Ft. Monmouth, N. J.
 9MYW, Wolman, Pvt., Camp Crowder, Mo.
 9NQS, Ervin, Sgt., Chicago, Ill.
 9NRL, Pechter, Pfc., Dallas, Texas
 9NSK, Marx, Sgt., foreign duty
 9OAG, Steinmetz, Capt., foreign duty
 9OUC, Mehl, Lt., Omaha, Neb.
 9QWN, Shepherd, T/5, Ft. Monmouth, N. J.
 9NRI, Aurzada, Pvt., Camp Crowder, Mo.
 9SIS, Kulwitz, T/3, foreign duty
 9X-9TOH, Davidson, Major, Red Bank, N. J.
 9VAK, Busch, T/Sgt., foreign duty
 9WXE, Alexander, Lt., Arlington, Va.
 9XP, Nidlinger, Pvt., Camp Crowder, Mo.
 9YSM, Skyles, Cpl., Camp Howze, Texas

MARINE CORPS

1EUZ, Colpitts, CEM, foreign duty
 1JPA, Turner, Cpl., Corpus Christi, Texas
 1MJX, Messimer, 2nd Lt., Cambridge, Mass.
 2APU, Hoffman, Ens., Cranford, N. J.
 3HDM, Sinclair, W/O, foreign duty
 3IAN, Morewitz, 2nd Lt., Cambridge, Mass.
 ex-K4FOV, Lillie, Major, Cherry Pt., N. C.
 4GXI, Lacy, Sgt., Port Blakely, Wash.
 5HFD, Nichols, Pvt., Clarksville, Ark.
 5LDR, Cunningham, MT/Sgt., San Diego, Calif.
 5JAG, Cummins, S/Sgt., Corpus Christi, Texas
 5KND, Kneese, T/Sgt., Corpus Christi, Texas
 6TYD, La Baine, S/Sgt., foreign duty
 6UEP, Hueckins, address unknown
 6UML, Laurence, S/Sgt., Paris Island, S. C.
 6VY, Pierce, Col., San Diego, Calif.
 80LJ, Charbeneau, Kinston, N. C.
 8VRJ, Misic, S/Sgt., Camp Le Jeune, N. C.
 8WQH, Yerkey, T/Sgt., San Diego, Calif.
 9CUG, Lockman, T/Sgt., foreign duty
 9HNO, Meyers, Lt., foreign duty
 9OYN, Sumner, Sgt., foreign duty

Operator's license only:
 Drossel, Cpl., Klamath Falls, Ore.



Pfc. Bob Ehrler, W2CTO, has been in the Tunisian, Sicilian and Italian campaigns with a signal company and now has the problem of winning friends and influencing people well in hand. This picture was snapped in Palermo and the pleasant looking gentlemen are Italian cops.

ARMY—AIR FORCES

1JYV, Lubke, S/Sgt., Great Bend, Kan.
 1KKN, Ballou, Lt., Eglin Field, Fla.
 1LOX, Tabor, 2nd Lt., Boca Raton, Fla.
 1MKN, Francis, Cpl., Boca Raton, Fla.
 1NJJ, Tibbetts, T/5, Quantico, Va.
 1NJM, Hart, O/C, San Antonio, Texas
 ex-1WT, Moore, Pvt., Greensboro, N. C.
 ex-2HFK, Reynolds, Pfc., Geiger Field, Wash.
 2HIN, Lahullier, Cpl., foreign duty
 2JFY, Spear, Sgt., Santa Maria, Calif.
 2JUA, Johnston, 2nd Lt., New Haven, Conn.
 2JUJ, Wotton, S/Sgt., Gainesville, Fla.
 2KGV, Leggett, 2nd Lt., foreign duty
 2KSL, Martin, Pvt., Boca Raton, Fla.
 2MKK, Sewart, Cpl., foreign duty
 2NLR, Butler, A/C, Bainbridge, Ga.
 2NQW, Keeler, Cpl. MacDill Field, Fla.
 2NYP, Beakley, 2nd Lt., address unknown
 3AII, Baldwin, Capt., Boston, Mass.
 3AXP, Hudson, address unknown
 3BXD, Harold, Pfc., Sioux Falls, S. D.
 3BNG, Parks, Major, foreign duty
 3FSA, Smelser, T/Sgt., Tinker Field, Okla.
 3FXJ, Duff, foreign duty
 3GRD, Hee, T/Sgt., Atlantic City, N. J.
 3GRS, Weiler, Pfc., Scott Field, Ill.
 3HAN, Beard, Pvt., address unknown
 4DOP, Colvert, Cpl., Reno, Nev.
 4FDP, Boles, Pfc., Kessler Field, Miss.
 4HOF, Cooper, S/Sgt., Memphis, Tenn.
 4IAN, Coleman, Capt., Ft. George G. Meade, Md.
 4IBR, Finger, M/Sgt., foreign duty
 5DZM, Kelly, Major, foreign duty
 5GFO, Manning, Capt., Kelly Field, Texas
 5GJX, Thaxton, Sgt., Independence, Kan.
 5ILN, Harton, 2nd Lt., Grand Island, Neb.
 5IXN, Adams, Cpl., San Antonio, Texas
 5IZN, Halm, A/C, Pecos, Texas
 5KBE, Rutramel, Cpl., address unknown
 5KPT, Mundell, Col., Washington, D. C.
 6SH, Shaw, Cpl., Greensboro, N. C.
 6AAI, Parry, Capt., foreign duty
 6DLV, Hanson, Sgt., Chandler, Ariz.
 6DZF, Barrows, Capt., foreign duty
 6PHF, Kennedy, M/Sgt., Camp Daly City, Calif.
 6PWT, Wakeman, Sgt., Great Bend, Kan.
 6QCF, Pattison, Pfc., Long Beach, Calif.
 6QOC, McKinniss, M/Sgt., Washington, D. C.
 6RCR, Loest, A/C, Carlisle, N. M.
 6RIH, Overstreet, Lt., foreign duty
 6SPQ, Earnstein, Sgt., Truxav Field, Wis.
 6SVR, Lucas, Sgt., Presque Isle, Me.
 6SZG, Martin, Lt. Col., foreign duty
 6TLD, Dalton, Pvt., Selfridge Field, Mich.
 6TUA, Tuell, Cpl., McClellan Field, Calif.



An ardent fisherman in prewar days, S/Sgt. Wm. Roy Breen, WIJSC has laid aside his bass rod and is now putting out bait for the biggest fish in the world. His present duty is with a coast artillery mine planter battery at Fort Story, Va.

7EJN, Mulcahy, Pfc., Las Vegas, Nev.
 7YJAT, Wolters, Major, Seattle, Wash.
 8AFK, Trevarthen, Pvt., Truxav Field, Wis.
 8BDM, Whitaker, Major, Middletown, Pa.
 8KHN, McKnight, Sgt., Barksdale Field, La.
 8LLB, Dittenberger, 2nd Lt., Boca Raton, Fla.
 8OYB, Cerney, 2nd Lt., Muskogee, Okla.
 8PHP, Stowell, 2nd Lt., Malden, Mo.
 8QKL, Bredesen, Lt., Robins Field, Ga.
 8QWR, Holloway, M/Sgt., foreign duty
 8TIR, Mossar, A/C, San Antonio, Texas
 8TWW, Kraft, Cpl., Pratt, Kan.
 8UCP, Strasburger, T/Sgt., Dalhart, Texas
 8UEP, Whalen, S/Sgt., foreign duty
 8UUC, Hoffman, Sgt., foreign duty
 8UZH, Mende, Capt., Majors Field, Texas
 8VLI, Papp, Pfc., Columbus, Ohio
 8VLL, Kasproski, Pfc., Brookley Field, Ala.
 8VQL, Ksen, S/Sgt., Romulus, Mich.
 8VUX, Garrison, Pvt., Madison, Wis.
 8VYZ, Dolvin, A/C, Waco, Texas
 8WHK, Fuller, Cpl., Boca Raton Field, Fla.
 8YJK, Wood, Pvt., Truxav Field, Wis.
 9CEV, Snyder, 2nd Lt., Hendricks Field, Fla.
 9CTD, Hayward, T/Sgt., George Field, Ill.
 9FOF, Macy, S/Sgt., McClellan Field, Calif.
 9GTD, Edel, Sgt., Reedsburg, Wis.
 9IZA, Uigaard, 2nd Lt., Boca Raton Field, Fla.
 9JFA, Mossman, Capt., foreign duty
 9JGR, Johnsen, T/Sgt., Salina, Kan.
 9KZM, Boyd, Cpl., MacDill Field, Fla.
 9MGE, Trinko, S/Sgt., foreign duty
 9MJO, Nichols, Sgt., Chicago, Ill.
 9MWK, Crowell, S/Sgt., Wilmington, Del.
 9OMF, Strouhal, A/C, Santa Ana, Calif.
 9PFT, Swearingen, T/Sgt., foreign duty
 9PJM, Grigsby, Cpl., Boca Raton Field, Fla.
 ex-9PR, Williams, Sgt., MacDill Field, Fla.
 9QCJ, Raffel, 2nd Lt., Cambridge, Mass.
 9QKS, Mende, Capt., foreign duty
 9RKF, Sullivan, 2nd Lt., foreign duty
 ex-9SDG, Brooks, 2nd Lt., Anchorage, Ky.
 9TRR, Sayers, Capt., foreign duty
 9YIV, Klawuhn, Lt., Coral Gables, Fla.
 9VFP, Sarnowic, S/Sgt., West Hampton Beach, N. Y.
 ex-9VWM, Barnes, Lt., Brownsville, Texas
 9WEB, Langford, M/Sgt., foreign duty
 9YID, Tebow, T/Sgt., Presque Isle, Me.
 9ZOG, Olson, S/Sgt., Brookley Field, Ala.
 Operator's license only:
 Baxter, Sgt., Love Field, Texas
 Birnell, Pvt., Selfridge Field, Mich.
 Benstock, Sgt., La Junta, Colo.
 Boyd, 2nd Lt., Victoria, Kan.
 Boyd, 2nd Lt., Ft. Sumner, N. M.
 Brunow, M/Sgt., Kansas City, Mo.
 Brunage, Pvt., Truxav Field, Wis.
 Chase, S/Sgt., Eglin Field, Fla.
 Chrapkiewicz, Cpl., foreign duty
 Dombert, Cpl., Boca Raton, Fla.
 Gier, W/O, Long Beach, Calif.
 Gillis, Sgt., Nashville, Tenn.
 Gobba, Pvt., Selfridge Field, Mich.
 Hardenburg, Pfc., Sioux Falls, S. D.
 Hillstrom, Pvt., Sioux Falls, S. D.
 Holmberg, Cpl., St. Paul, Minn.
 Hunt, Sgt., Peterson Field, Colo.
 Jasut, Cpl., Rapid City, S. D.
 Jolgran, Sgt., Salina, Kan.
 Kenney, Pvt., Scott Field, Ill.
 Kiblinger, Pfc., Dodge City, Kan.

NAVY—GENERAL

ex-1AGH, Murphy, Lt.(jg), foreign duty
 1CV, Corish, Lt.(jg), Somerville, Mass.
 1DOT, Maloof, Lt.(jg), Quonset Pt., R. I.
 1JXT, Tucker, CRM, Port Blakely, Wash.
 1KAA, Colletti, CRM, foreign duty
 1KAG, Greim, CRM, Winter Harbor, Me.
 1KMW, Pike, RM3c, foreign duty
 1KPY, Begrin, Y3c, Manchester, N. H.
 1KQM, Josephson, S1c, Brooklyn, N. Y.
 1LBZ, Paladino, RM1c, foreign duty
 1LEW, Jette, CRM, foreign duty
 1MGR, Sprague, S1c, Chicago, Ill.
 1NRJ, Daitch, A/S, New Haven, Conn.
 1NTN, Cadman, Lt., foreign duty
 1NVA, Laffin, EM2c, San Diego, Calif.
 1RZ, Snow, Lt. Comdr., foreign duty
 ex-2CBX, Clendinnen, CRM, Port Blakely, Wash.
 2GAC, Sullivan, RM1c, Bronx, N. Y.
 2IHL, Kroupa, RE, foreign duty



Ed Kirchner, W2KJY, whose description of his civilian travels and experiences in the South Pacific appears in Correspondence from Members, page 51 in this issue, has returned to the Philadelphia Signal Depot, where he thinks city life is composed of noise, indoor work and beautiful women. Could he!

2IXQ, Florance, CRE, Arlington, Va.
 2IYC, Fulhamus, Ens., Paterson, N. J.
 2IZX, Slavin, Ens., foreign duty
 2JGR, Freundlich, Ens., New York, N. Y.
 2JJO, Wright, RM3c, Norfolk, Va.
 2JRE, Richard, RM1c, Madison, Wis.
 2KCL, Loughlin, S1c, New York, N. Y.
 2KYI, Judge, MOMM2c, Sampson, N. Y.
 3LAF, Sharman, RE, Chicago, Ill.
 3NAP, Gasparik, Ens., foreign duty
 ex-3AU, duPont, Lt. Comdr., Wilmington, Del.
 3BIZ, Corson, Lt.(jg), Washington, D. C.
 3BSM, Hucklestep, S2c, Madison, Wis.
 3DRH, Brown, Lt., Princeton, N. J.
 3DXK, Hood, CRM, Port Blakely, Wash.
 3GUQ, Derr, RM1c, foreign duty
 3HFM, Lee, RM2c, foreign duty
 3HLL, Rhoads, Lt., Treasure Island, Calif.
 ex-3HLP, Baker, RE, foreign duty
 3ITB, Bullock, S1c, Jacksonville, Fla.
 3JXF, Farmer, A/S, address unknown
 3SWL, Young, S2c, Bainbridge, Md.
 4AGO, Van Sleet, Lt.(jg), Washington, D. C.
 ex-4BXQ, Furr, RM1c, Memphis, Tenn.
 4BZX, Lambert, Lt.(jg), Brunswick, Me.
 ex-4CU, Farr, RM3c, Memphis, Tenn.
 4DRO, Moore, S1c, Madison, Wis.
 4EYX, Woodard, RM1c, Port Blakely, Wash.
 4FL, Hardy, EM2c, Mare Island, Calif.
 4FTG, Ford, Lt.(jg), Washington, D. C.
 4HTK, Yandle, S2c, foreign duty
 4IAG, Danner, S2c, Bainbridge, Md.
 ex-4TE, Pinkston, Lt., Jacksonville, Fla.
 5DGB, Hidalgo, CMMR, Camp Parks, Calif.
 5HFX, Wheeler, CMM, Mare Island, Calif.
 5IGZ, Smith, Ens., Washington, D. C.
 5ILT, Frauenthal, S1c, Great Lakes, Ill.
 5INP, Brewer, RM2c, Oceanside, Calif.
 5JKC, Montemayor, RM2c, Great Lakes, Ill.
 6DXG, Miller, Lt. Comdr., Washington, D. C.
 6GTM, Zierman, RM1c, Oceanside, Calif.
 6GXV, Cookson, RM1c, Oakland, Calif.
 6HLR, Craig, Lt.(jg), foreign duty
 6KQK, Cooper, CRM, Port Blakely, Wash.
 6MTH, Collier, RE, Port Blakely, Wash.
 6NJI, Cleaver, RM1c, Alameda, Calif.
 ex-K6ODJ, Bradford, CRM, Port Blakely, Wash.
 6OUV, Shilzons, Ens., Washington, D. C.
 6PGM, Michaels, Ens., foreign duty
 6PXR, Methven, RM1c, Philadelphia, Pa.
 6PYV, Munzig, Ens., New London, Conn.
 6QCG, Bright, CRM, Mare Island, Calif.
 ex-6QPG, Kile, RE, foreign duty
 6TAW, Shull, KM2c, Long Island, N. Y.
 6TCM, Raulston, RM3c, Schememaker, Calif.
 6TFT, Russell, RM2c, foreign duty
 6TJL, Tatarsky, RM1c, Chicago, Ill.
 6TJX, McCrary, CPC, foreign duty
 6TRO, Pessly, MOMM2c, Cleveland, Ohio
 6TNS, Sjoberg, S1c, Great Lakes, Ill.
 7AXD, Webster, Ens., Oakland, Calif.
 7BRS, Wandling, Ens., Port Blakely, Wash.
 7BWD, Harvey, RE, Treasure Island, Calif.
 7BWX, Smith, EM3c, foreign duty
 7FBX, Nichols, Ens., foreign duty

7FOG, McClure, Ens., Brunswick, Me.
 7FTR, Johnson, RM1c, Mare Island, Calif.
 7GOU, Homad, CRM, Port Blakely, Wash.
 7GOZ, Callahan, Lt.(jg), address unknown
 7HQB, Lind, S2c, Camp Gilmore, Idaho
 7HZG, Bennett, A/S, Pasadena, Calif.
 7IEV, Howe, Lt., Chickasaw, Ala.
 7YTUC, Rackliff, CRM, Port Blakely, Wash.
 7IXU, Chinn, S1c, Madison, Wis.
 8AVB, Schneider, Lt., foreign duty
 8RRB, Garnhausen, Lt.(jg), Cambridge, Mass.
 8CRY, Frost, W/O, Philadelphia, Pa.
 8DUI, Kuehner, CRM, Port Blakely, Wash.
 8LXA, Manning, CRM, Port Blakely, Wash.
 8LZH, Weimer, S1c, Brooklyn, N. Y.
 8MIB, Bryson, S1c, Greensburg, Pa.
 8MSS, Alexander, Ens., Cambridge, Mass.
 ex-8NNH, Williams, S1c, Chicago, Ill.
 ex-8ODD, Challis, Lt.(jg), Washington, D. C.
 8OID, Mullins, FM2c, Ames, Iowa
 ex-8OQL, Essenwine, Lt., San Diego, Calif.
 8OYY, Schneider, Ens., Princeton, N. J.
 8PCL, Miller, Ens., Washington, D. C.
 8QAX, Kost, RM2c, foreign duty
 8TMP, Ewenschied, RM2c, Port Blakely, Wash.
 8UCU, Stout, RM1c, foreign duty
 8UDT, Mumaw, A/S, Cleveland, Ohio
 8WQW, Frank, S1c, Chicago, Ill.
 9AQK, Cronemeyer, A/S, Lawrence, Kan.
 9AQW, Buchanan, Ens., Logansport, Ind.
 ex-9BFP, Gelineau, RE, Port Blakely, Wash.
 9BNL, Hill, Lt. Comdr., Puyallup, Wash.
 9DNF, Strother, S1c, Norfolk, Va.
 9EKL, Rohrer, Ens., Peoria, Ill.
 9EZW, Fogelsanger, RM1c, Port Blakely, Wash.
 9FKS, Carson, A/S, Ann Arbor, Mich.
 9GWH, Hill, S2c, Farragut, Idaho
 9GZQ, St. Amant, S1c, Chicago, Ill.
 9HQX, Samson, S2c, Farragut, Idaho
 9HQY, Staebler, RM2c, Port Blakely, Wash.
 9IQZ, Mitchell, S1c, Madison, Wis.
 9JKI, Moore, Ens., Ft. Schuyler, N. Y.
 9KJ, Baker, A/S, Lawrence, Kan.
 9KAT, Dudak, S2c, Norfolk, Va.
 9MJN, Strom, CRM, foreign duty
 9MMY, Taylor, FM2c, Ames, Ia.
 9MRT, McLaughlin, S1c, Brooklyn, N. Y.
 9MTT, Bertas, CRM, Vero Beach, Fla.
 9MUS, Newcomb, S2c, foreign duty
 9NHR, Sumner, RM2c, foreign duty
 9PIC, McDermut, Mid., Annapolis, Md.
 9QI, Barregeray, EM1c, San Diego, Calif.
 9QVZ, Kelley, Ens., Daly City, Calif.
 9QXG, Young, A/S, Parkville, Mo.
 9RID, Svendsen, Lt., Riva, Md.
 9RJS, Zwaaska, Ens., Gainesville, Ga.
 9RPU, Kyle, A/S, Boulder, Colo.
 9SCU, Alam, S1c, Chicago, Ill.
 9SQC, Lear, Ens., Middlesboro, Ky.
 9UYO, Howard, S1c, Great Lakes, Ill.
 9WBK, Horwitz, S1c, Great Lakes, Ill.
 9WEO, Lytle, Ens., Schenectady, N. Y.
 9YEB, Howard, SOM3c, foreign duty
 9ZGU, Trimmer, RM1c, foreign duty

HAM HOSPITALITY

“APPARENTLY the lads do read *QST* as we had three visitors off a U. S. warship who read in *QST* to ring up VK2TI. They didn't ring — they just arrived — and we were all the gladder to see them this way. Any ham not having a good time in VK2 just hasn't contacted any VK2 hams.” So writes J. B. Corbin, VK2YC of Mascot, N.S.W.

That sentiment is corroborated by many letters we have received from W amateurs ashore in Australia and New Zealand. Apparently there is something like home in the brand of hospitality and cordiality offered our men by the Aussies and Zedders. For the benefit of those who do not have a complete file of *QSTs*, we again list VK and ZL amateurs and organizations who favor the open door policy.

R. Anderson, VK3WY, Sec'y, Wireless Inst. of Australia, 191 Queen St., Melbourne

H. W. Batty, ZL1HQ, Hinemoa St., Birkenhead N5, Auckland

J. Freeman, ZL3FB, 164 Aldwins Rd., Christchurch

W. D. Gorman, ZL2IY, 27 Kenwyn Terrace, Newtown, Wellington; bus. phone 47-800, ext. 854

C. A. Hughes, ZL3CA, 28 Thomas St., Linwood, Christchurch E2

Roy P. Jonasson, VK3ND, Farnsworth St., Castlemaine, Victoria

L. Petrie, ZL2OV, 127 Cor-

mandel St., Newtown, Wellington; bus. phone 46-000

W. Ryan, VK2TI, Sec'y, N.S.W. Division, Wireless Inst. of Australia, 21 Tunstall Ave., Kinsford, N.S.W.

F. Sellens, ZL2MY, Sec'y, N. Z. Assn. of Radio Transmitters, Box 489, Wellington

R. T. Stanton, ZL3AZ, 193 Ashgrove Terrace, Christchurch S. W. 1

James M. Strachan, ZL4AF, 60 Searells Road, Papanui, Christchurch

CRM John R. Haley, K4FAY, made his first Brazilian QSO in person by the unoriginal but effective method of chartering a taxi in Recife and cruising until he spied a likely looking mast and rotary beam. Its owner, PY7CW, extended a cordial welcome and invited Haley to attend a meeting of other Brazilian hams, many of them members of the Liga de Amadores Brasileiros de Radio Emissao, the national amateur radio society and member of the IARU.

Limited space unfortunately does not permit our printing K4FAY'S enthusiastic report of the meeting, the kindness shown him by many prominent amateurs and their interest in our activities and technical developments in North America. It is a pleasure, however, to reproduce this picture of some well-known hams at the meeting, who have had numerous U. S. QSOs in prewar days and are looking forward to many more in the future.

Brazilian hams who met CRM John R. Haley, K4FAY, at Recife. Left to right: Francisco V. Sobrinho, PY7AX; Asziz F. Elhimias, PY7AP; Joaquim S. Netto, PY7AY; Francisco B. Carvalho, PY7AQ; Otavio de Moraes, PY7CW; Lourival Fernandes, PY7CF; Capt. Vantuil Camargo, chief of the Transmitting Services, Seventh Military Region; Sergio Alcantara, PY7CY; Jose V. Araujo, PY7AN; Joao B. de Carvalho, delegate of the L.A.B.R.E. in Pernambuco, Paraiba and Alagoas; Fte. Adavio Oliveira, PY7CV; and Antonio A. Caldas, PY7AG.

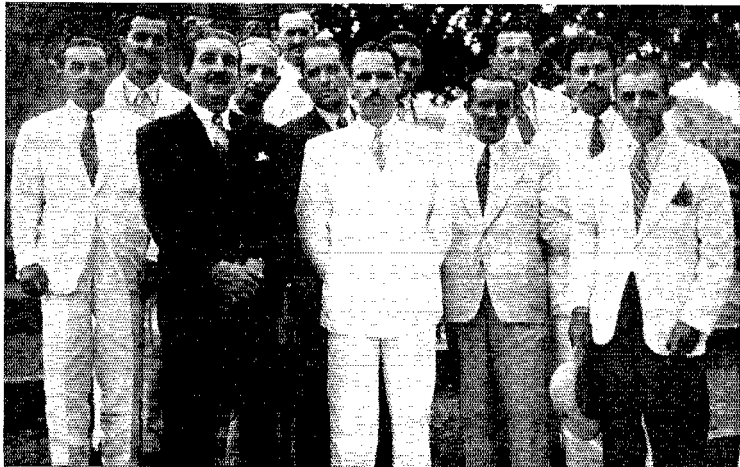

Video-Amplifier Design

A Discussion of the Basic Principles of Wide-Band Amplifiers

BY CHARLES H. MERRITT,* ARTIC, USNR, W60MH

THE pride and joy of any audio-minded ham is to build an amplifier which is "flat" from 30 to 5,000 cycles. The more particular hams want it flat clear out to 10- or 15,000 cycles. Then perfection is said to be achieved. But is it? Most loudspeakers give non-uniform reproduction, and the human ear itself normally responds better to low tones than to the highs. Added to this is the usually uneven frequency characteristics of the air and room in which the listener is located. All of these factors raise the question of whether purely flat response in an amplifier is so good after all. In sound movies, some thought has been given to possible modifications of equipment along these lines, but it still is standard practice to design amplifiers with flat frequency-response characteristics.

In television there can be no argument on this point. Here, the upper frequency limit must be extended to perhaps as much as four megacycles, and the amplifier response must be flat all the way so that the complex series of pulses which modulate the television carrier will be reproduced faithfully at the receiving end. At the transmitter, the bandwidth of the carrier must be kept within FCC limits, which is another way of saying that not too many pulses per second can be mixed with the carrier, or else excessive sidebands will be produced and there will be "slopping over" into adjacent channels. For this reason, the upper frequency limit necessarily may be somewhat less than four megacycles. Whatever it is, distortion of the pulse modulation occurs when the video amplifier at either the receiver or transmitter is unable to pass the

* Lomita Flight Strip, Lomita, Calif.

New horizons are opening to hams on the design of resistance-coupled amplifiers. No longer is an amplifier which is flat from 30 to even 10,000 cycles considered to be a very wide-band amplifier. For example, video amplifiers used in television must amplify uniformly frequencies from almost zero cycles to four megacycles — the top edge of our 80-meter band! Tuned circuits are not used, and the equipment required is nothing new and phenomenal. It is in the design of the circuit that the wide band-pass is made possible. Engineering publications treat video amplifiers in highly mathematical terms. This article, however, explains the subject almost without any math, in terms that the average ham can readily understand.

pulses with equal fidelity of waveform, phase, and amplitude. In practical language, this means that an amplifier is required which really is flat out to anywhere from one to four megacycles.

Not by any means is television the only place where wide-band amplifiers are used. In square-wave signal generators, they are used to boost the output of the initial source of square-wave voltage to a value which is suitable for test work under various conditions. An ordinary amplifier cannot do this job because it will not begin to pass the signals in the high-frequency range, and it also may be weak on the lows. Just why a square-wave signal is used can be explained by the fact that the individual square-wave pulse is composed of sine-wave voltage at a fundamental frequency, plus many harmonics thereof. These harmonics extend into the tens of thousands of cycles. Therefore the input waveform of the square-wave signal may be observed on an oscilloscope, and any changes from stage to stage mean that the amplifier under test is not responding uniformly at the point of distortion.

F.m. receivers do not require video amplifiers, but the much-advertised tone "color" from f.m. will be lost if the audio circuit fails to cover a wider band of frequencies than that provided in the usual receiver audio circuit. Therefore some of the same techniques in the design of video amplifiers can be applied profitably to f.m. circuits.

These design techniques are not hard to apply. They are interesting to work with, even though certain very mathematical articles have appeared on the subject in various publications which make the job seem like super-engineering. If the math side of it is bothering you, a little reading on Noll's article in the September issue of *QST* should make things easier in this respect.¹ Surely the equipment is not complicated. Fig. 1-A shows a basic video circuit, and it contains only the usual run of resistors, condensers, tubes, and r.f. chokes. They are, of course, arranged to provide the benefits which this type of amplifier should possess.

Technical Requirements

For convenience in the discussion of circuit details, the technical requirements of video amplifiers are listed as follows:

- 1) In general, frequencies from 30 to 4,000,000 cycles must be amplified uniformly, and with a minimum of phase shift.
- 2) Input and output impedances must be matched properly.

¹ Noll, "Practical Applications of Simple Math," *QST*, Sept., 1944, p. 65.

3) Input and output circuits must be isolated from one another.

4) Ample output power must be obtainable.

5) The over-all voltage gain of the amplifier must be obtainable with a minimum of distortion.

6) In special cases, the input circuit must be able to handle large variations of signal voltage without distortion.

7) Thermal agitation and harmonic distortion must be kept at a minimum.

Choice of Tubes

Much video-amplifier tube research has been carried on by leading manufacturers, with the result that such tubes as the 1851, 1852/6AC7, 1853/6AB7, and 6AG7 have appeared on the market. These tubes have exceptionally high mutual conductance, or transconductance (G_m). In usual practice this constant is taken as a criterion of the gain of a tube, both at high and low frequencies. Therefore this would indicate that a tube with the highest possible mutual conductance should be chosen for video-amplifier-circuit applications.

As far as low and medium frequencies in the band between one and four megacycles is concerned, this is all right, but not so for the high-frequency portion of the band. As the upper limit is approached, other factors have to be considered. One is the input and output capacitances of the tube, considered along with the size of the coupling capacitor, C_c . The combination of these capacitances determines the useful high-frequency limits of satisfactory amplifier performance as a whole. In general practice, it has been found that roughly one-third of the total shunt capacity in a circuit is contributed by the internal capacity of the tube itself while the remainder comes from the stray capacitance of wiring and other components.

It is this shunt capacity, along with any external shunt capacitances which appear in parallel, which limits the low-frequency response of the amplifier. From this it can be seen that the lower the tube capacitance, the better the tube will work as a video amplifier. Mathematically, this fact is apparent from the value of the capacitive reactance in a circuit as the frequency increases. From experience with r.f. circuits, it is known that leakage paths form readily through even very small capacitive effects, according to the following basic formula.

$$X_c = \frac{1}{2\pi f C}$$

where X_c = capacitive reactance in ohms,
 f = frequency in cycles, and
 C = capacity in farads.

In the high-frequency portion of the video-amplifier range, leakages become noticeable and

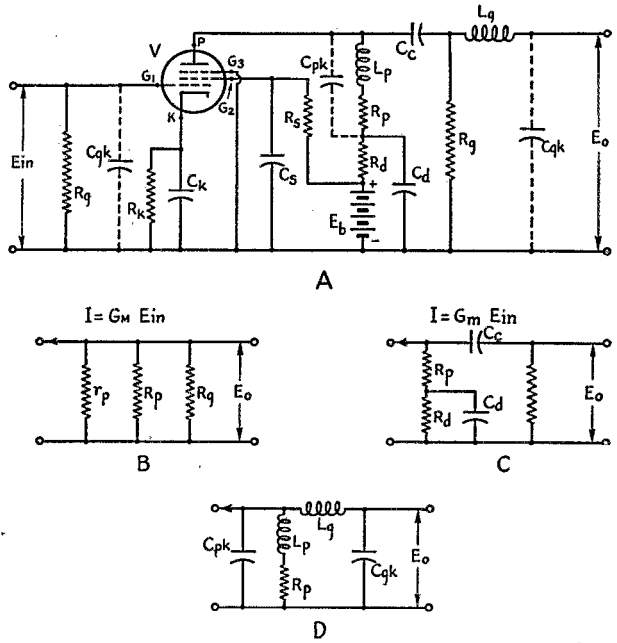

Fig. 1 — Basic video-amplifier circuits. A — One-stage video amplifier. B — Equivalent circuit at mid-frequencies. C — Equivalent circuit at low frequencies. D — Equivalent circuit for high frequencies. *

must be avoided, if flat response is to be provided. The same is true of the admittance capacity, C_{pk} , according to the amount of gain and plate current. These factors not only determine the high-frequency limits of the tube but also the type and amount of compensation required for satisfactory operation.

Pentodes are used almost universally in video-amplifier circuits because of their high-gain characteristics. When the tube plate resistance, r_p , is much higher than the total effective load impedance, Z_o , the over-all gain of the stage, G , may be computed from the expression,

$$G = G_m Z_o$$

Since G_m is independent of frequency, the phase and frequency responses of the stage are affected only by Z_o , which consists of components of resistance, inductance, and capacitance, so chosen that a value of impedance as constant as possible is obtained for any frequency within the range of the amplifier in which the tube will be used. If the load impedance thus can be kept nearly constant over this frequency range, then the gain over the entire band will be nearly uniform, and the phase shift will remain at a low minimum.

The points at which low- and high-frequency cut-off occur in the circuit must be shifted either way so that the required wide band of frequencies may pass through without attenuation. The cut-off frequency may be defined as that frequency at which the gain is 0.707 times the mid-frequency gain. Between these two limits, the

average gain, G , of the stage depends chiefly upon the transconductance, G_m , of the tube and the value of R_p , the load resistor, which composes the principal component of the total load impedance, Z_o .

High-Frequency Compensation

A basic difference between the video amplifier and the usual resistance-coupled amplifier is that the video equipment must pass uniformly frequencies which are very much higher than those passed through the usual circuit. This is where the stray capacities need to be watched, because they attenuate the higher frequencies. One way of

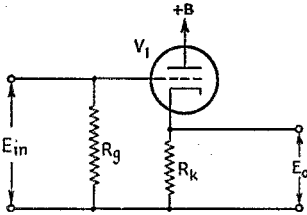

Fig. 2 — Basic cathode-follower circuit.

counteracting such losses is to design the plate load circuit so that a higher impedance is presented to the higher frequencies. One method of doing this is to insert an inductance, L_p , in series with the load resistor, R_p . This method is known as *shunt compensation*, and is shown schematically in Figs. 1-A and D. A circuit thereby is formed, including the shunt capacitances of the circuit, C_s , which is resonant at some particular frequency. The values of these circuit constants should be adjusted so that this resonant frequency is above the upper frequency limit of the amplifier. Otherwise an unwanted "hump" will show up in the response curve for the amplifier, in the upper-frequency range, and the desired flatness of response will be lost. On the other hand, this resonant circuit has a definite advantage. Its presence helps to compensate for the loss of response at high frequencies and provides a sharp cut-off for frequencies higher than the desired high-frequency limit. It will be found that smaller values of R_p will be required as the frequency-response requirements are increased. For most video requirements, R_p will range from 500 to 5,000 ohms.

Another type of compensation is called *series compensation*. By this method, an inductance, L_c , is placed in series with the coupling capacitor, C_c , and the grid of the following stage, as shown in Fig. 1-A. The advantage of this method is that the input circuit of a given stage is isolated from the output circuit of the previous stage, as far as the capacitances, C_{pk} and C_{pk} , are concerned. C_{pk} represents the plate-to-cathode capacity of the tube, and C_{pk} represents the grid-to-cathode capacity.

A comparison of the series- and shunt-compensation systems shows that C_{pk} and C_{pk} are additive in the shunt circuit but are isolated and

usually can be neglected in the series arrangement. Also, shunt compensation affords a gain of 1.414 over the uncompensated resistance-coupled amplifier, while the series method affords an additional gain of approximately 1.5 over the *shunt* system.

At mid-frequencies, where the amplifier response is uniform for a wide range, the circuit acts like a set of parallel resistors, as shown in Fig. 1-B. No compensation therefore is required because there are no components acting to cause phase shift or other undue losses.

The art of compromise can be applied to definite advantage through the use of a combination of series and shunt compensation. Such circuits form the best and most commonly-used high-frequency compensation methods, which is not hard to accept when they provide a gain of approximately 1.8 over the simple shunt system. Circuits of this type have become very standardized, and many good ones can be found in the popular handbooks and magazines which are available on the bookstands.

Low-Frequency Compensation

Low-frequency compensation in a video amplifier usually is necessary only from the consideration of phase shift which does not become serious until frequencies of 30 cycles or less are reached. The human ear accommodates itself to this type of distortion but the cathode-ray oscilloscope is not so easily satisfied. It is not hard to make the low-frequency gain the same as that at high frequencies, but phase distortion, if sufficiently severe, can cause circuit instability.

A chief offender in the circuit is the combination of the coupling condenser, C_c , and the grid resistor, R_g , shown in Figs. 1-A and C. The phase angle introduced by these components often is great enough to distort the waveform of the signal which is being amplified. If a rectangular-shaped signal is fed into the amplifier, then the time constant of $R_g C_c$ must be longer than that of any single half-cycle of the input signal. Otherwise, phase shift will take place. Generally, it is considered best to make this time constant about ten times greater than the time required for a half-cycle of the lowest frequency to be passed. A rectangular-shaped waveform is composed of an infinite number of frequencies, so that it is possible only to approach a reproduction of the original waveform. Especially is this true of rectangular waves in the region of 30 to 60 cycles, unless very large values of C_c and R_g are used. On the other hand, high-frequency response is adversely affected by the resulting increase in shunt capacity, C_s , so that low-frequency compensation is obtained better through the use of an impedance-isolating circuit, $R_s C_s$, in series with the plate high-voltage lead. Each stage then is isolated effectively from the others by keeping the plate power supply from becoming a common impedance between the various stages of the amplifier. In order to keep phase-shift near zero below 30 cycles per second, the time-constant of $R_s C_s$ should be between 0.1 and 0.5 second.

Practical Design Considerations

The control-grid bias in a video-amplifier stage may be obtained from the voltage developed across a resistor placed between the cathode and chassis, as shown at R_k in Fig. 1-A. R_k then is by-passed by C_k . The capacity of this condenser is made large enough to provide a reactance of only about one-tenth that of R_k at the desired low-frequency cut-off point. In the usual video amplifier, C_k has a value of approximately 100 to 200 μfd . This arrangement further improves the over-all frequency response by providing current feed-back at low frequencies. Compensation for phase shift in the $R_k C_k$ combination is taken care of by making R_d and C_d of larger than usual values.

Screen-grid-voltage variations cause corresponding changes in the amplification factor of the tube. Therefore, in a pentode amplifier, this voltage should be kept constant so that there is no distortion of the output waveform. Therefore particular attention should be paid to screen bypassing. It is desirable to use two by-pass condensers in parallel. One of low capacity, say about 100 μfd ., should be connected between screen and chassis right at the tube socket. The larger one, usually about 0.01 to 0.1 μfd ., may be mounted at some more convenient place away from the socket. The purpose of this arrangement is to provide an easy path for the higher frequencies from screen to chassis through the small condenser which may be ineffective at low frequencies, while an easy path for the lows, when they come along, is provided by the large condenser. The time-constant of R_s and C_s is large enough to prevent voltage variations and to isolate the screen from the impedance of the power supply.

The video amplifier also must be isolated from low-frequency magnetic fields. This may be accomplished by proper placement of components, by adequate and properly designed shielding of the several stages, and through isolation of the power supply from the other circuits. When low frequencies are being passed through the amplifier, the heaters of the tubes may introduce undesirable 60-cycle hum into the cathode circuits, and so the heaters should be by-passed. Instead of the familiar flexible shielded wire, coaxial cable should be used for the control-grid leads, where they are long. This will minimize high-frequency attenuation — something we don't often bother about to this extent in the ordinary audio amplifier.

In matching impedances between stages, obviously a transformer is undesirable because of its limited frequency response and disastrous phase shift over the wide band of frequencies to be amplified. A band-pass filter might be used, but it would suffer from the disadvantages of small power output and drastic attenuation. An arrangement called the *cathode follower* fills this job very well. By using such tubes as the 6L6, 6AG7, or 807, large power output with very little attenuation and wide frequency-response with no phase-distortion, can be obtained.

The Cathode Follower

The cathode follower is simply a one-stage inverse feed-back amplifier in which the output voltage is taken from the cathode circuit of the tube, as shown in Fig. 2. The gain of this circuit always is less than unity, and the input capacitance is less than that of the ordinary amplifier. One advantage of the circuit is the fact that the output impedance across the cathode acts like a pure resistance, and can be made of any value between 100 and 1,000 ohms. This low impedance often is desirable in coupling links between the cathode follower circuit and an amplifier stage which follows.

Another advantage of the cathode follower circuit in visual work is the fact that the phase relationship between the input and output signals is the same. A signal, therefore, which appears upright on a 'scope screen at the input circuit also will appear upright at output of the cathode follower circuit. This is not the case when the output voltage is taken from the plate.

In the design of a video amplifier, the cathode-follower arrangement is used to isolate the input circuit from the signal source. A voltage-divider, such as that shown in Fig. 3, is used to attenuate the signal if it is of greater magnitude than the amplifier will handle without distortion. An ordinary type of voltage divider can not be used to attenuate signals of rectangular or square waveform, because the stray capacity, C_t , will not allow a true voltage-divider action. To offset this disadvantage, a small capacity, C_x , is added in the section between the top of the voltage divider and the grid connection. This small capacitor may be a small variable type, and in operation it may be adjusted with a known signal in such a way that the ratio of the reactances of C_x and C_t will correspond to the desired voltage division. A very neat arrangement can be worked out using this type of voltage divider which allows the amplifier to be used with rectangular-shaped signals of very short time duration, and with no distortion at the leading-edge or flat-top portions of the wave. Because the capacitors C_x and C_t are of very small value, input impedances of the order of one to two megohms may be obtained.

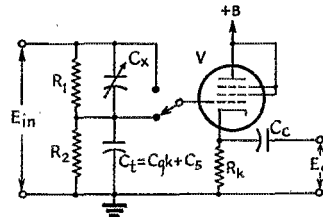

Fig. 3 — Capacity voltage divider.

When larger power output and higher signal voltage are desired from the cathode-follower circuit, two, three, or even four tubes may be connected in parallel. If tetrodes and pentodes are used, which is the usual case, the screen and suppressor grids should be connected to the

plate. Naturally, the capacity, C_{pk} , will be additive, and the admittance capacity to the cathode follower will be increased. This means that the high-frequency cut-off point will be at a lower frequency than if a single tube were used.

Testing

It was suggested at the beginning of this article that a test signal of square- or rectangular-shaped waveform should be used to test a video amplifier. In this connection, it is well to be sure that a good oscilloscope is used — one which contains vertical and horizontal sweep-circuit amplifiers which themselves are flat over as wide a band as possible. It is assumed that the 'scope used will have the proper number and type of controls for flexible adjustment of the images on the screen. For the square- or rectangular-shaped test signal, a simple multivibrator followed by an amplifier will serve for rough checking, if a refined unit is not available. With a multivibrator, any radical phase shifting or amplitude distortion of the original signal in the final output circuit can be detected. With a little experimentation, even a simple multivibrator can be made to give acceptable results for the purpose at hand.² In addition to phase shift from stage to stage in the amplifier under test, an approximate test of the gain also may be made. The relative heights of the test patterns on the 'scope screen will tell the story, provided that the input signal level is kept constant and the circuit under test is not loaded down by the 'scope connection.

To one who has been through the job of making a common audio amplifier flat throughout its useful frequency range, the task of making a video amplifier flat clear up to 4,000,000 cycles per second must seem impossible. The fact that it has been done shows that the subject is not a purely theoretical one. Satisfactory color television has been produced in the laboratory, with a complex pattern of pulses passing through video amplifiers built in principle along the lines suggested in this article. The same is true, as was pointed out, of actual amplifiers in use with oscilloscopes and square-wave signal generators. In the future, with pulse technique entering the picture of radio communications and requiring uniform amplification over a wide frequency range, we may expect more and more applications of the principles of video-amplifier design.

Bibliography

Ultra-High Frequency Techniques, by Brainerd, Koehler, Reich, and Woodruff. D. Van Nostrand Co., Inc. 1942.

Cathode-Ray Tubes and Instruments, by Allen B. DuMont Laboratories, Inc. 1943.

Principles of Television Engineering, by Donald G. Fink. McGraw-Hill Book Co., Inc. 1943.

Radio Engineers' Handbook, by F. E. Terman. McGraw-Hill Book Co., Inc. 1943.

² Gardner and Page, "New Electronic-Key Circuits," *QST*, March, 1944, p. 15. *The Radio Amateur's Handbook*, 1944, pp. 77 and 397.



December, 1919: Before we were opened up, little more than a month ago, everybody seemed ready to go, but we are finding that it takes time to get fixed up, particularly in the erection of masts and heavy antennas. There is a terrible lot of CQing from the few who can transmit and precious little answering. However, Traffic Manager Smith reports that already some of the routes are open to traffic and some of our Midwestern stations are working the Atlantic Coast with ridiculous ease, showing the wartime improvement in equipment. Broadly speaking, traffic is open from New York to Topeka and from Duluth to Little Rock. Licensing has been resumed in all districts and *QST* devotes five pages to a directory of new calls, as well as publishing the first postwar lists of Calls Heard. Some trouble is being encountered in the fact that the United States and Canadian second districts adjoin and the calls are identical, so that one cannot distinguish nationality. It is suggested that Canadians use *v* for an intermediate, while the Yanks use *de*. The League is examining the possibility of extending organization into Canada, if the Canadian amateurs wish it.

The lead article, by Don F. Alexander, W1BK, of Bangor, describes an easily-built short-wave regenerator covering 150-700 meters. It uses a fixed tickler feed-back, with the regeneration ingeniously controlled by a variable by-pass condenser which acts as a throttle. Signals have been heard from Cuba to Labrador. The major article on transmitters is by R. H. G. Mathews on "Transmitter Resonance" — how to tune up a spark set. John M. Clayton has a short article on "How to Make a Simple Variometer"; he means how to make a variometer simply. M. B. Sleeper contributes "An Audion Oscillator & Tone Circuit," with drawings in the author's w.k. style, while Lou Pacent begins a series on "Wave Meter Construction & Operation." Irving Vermilya, of "Amateur No. 1" fame, has his first postwar story, "S. O. L.," on his happy days in the Navy. Bowden Washington, chief engineer of Cutting & Washington, explodes our hopes of amateur impulse excitation on 200 meters by a letter to the editor in which he shows that very special apparatus is necessary for this type of set. Effective with this issue of *QST*, "The Junior Operator" department, devoted to nontechnical instruction in radio for the novice, is taken over by Guy R. Entwistle, of the Massachusetts Radio & Telegraph School, who ought to know how.

Considerable new apparatus makes its first appearance in our advertising pages this month. Included is the Grebe CR-4 regenerative, tuning 170-580 meters; the Benwood gap, Amrad's \$5 wavemeter, the deForest receiving equipment in units, Acme transformers, the Tresco tuner and knock-down condensers, and the first small motor-generators for vacuum tube work.

F.M. for Carrier-Current Communication

Noise Reduction with a Narrow-Band System

BY GEORGE M. GULL, JR.* W8VAN

ALL AMATEURS who have used carrier-current communication on distribution power lines are familiar with the high noise level which limits the pleasure and range of communication. Random noise, caused by corona and various types of arcs, sometimes can be overcome by an increase in transmitter power. This method of improving the signal-to-noise ratio, however, is not always practical because of the increased cost of equipment and the possibility of exceeding the permissible radiation field strength, thereby increasing the danger of interference with other radio services. On the high-voltage power lines used by commercial power companies another type of noise is found on carrier signals. This noise is heard only while the carrier is being received and is probably caused by a change in the impedance of the power line to the flow of the carrier-current signal as a result of corona. Increasing the transmitting power in this case does not help the signal-to-noise ratio, because the percentage of "corona modulation" remains the same.

* R.F.D. 1, Box 281, Poca, W. Va.

One of the greatest obstacles encountered by the ham who tries carrier-current communication is the discouraging amount of line noise. In this article W8VAN describes narrow-band f.m. gear used in tests on high-voltage lines. The resulting reduction in noise on domestic-service lines should be even more marked.

Since one of the outstanding features of high-frequency f.m. is noise reduction, it was decided to try f.m. on the low frequencies used in carrier-current communication. The results of tests made at 69 kc. exceeded all expectations. The same improvement should be obtained over the 160-200-kc. range recommended for amateur operation.

A deviation ratio of one-to-one is used in the narrow-band f.m. system, which results in the best possible signal-to-noise ratio where readability and distance are concerned.¹ Audio-frequency

¹ Crosby, "Band Width and Readability in Frequency Modulation," *QST*, March, 1941.

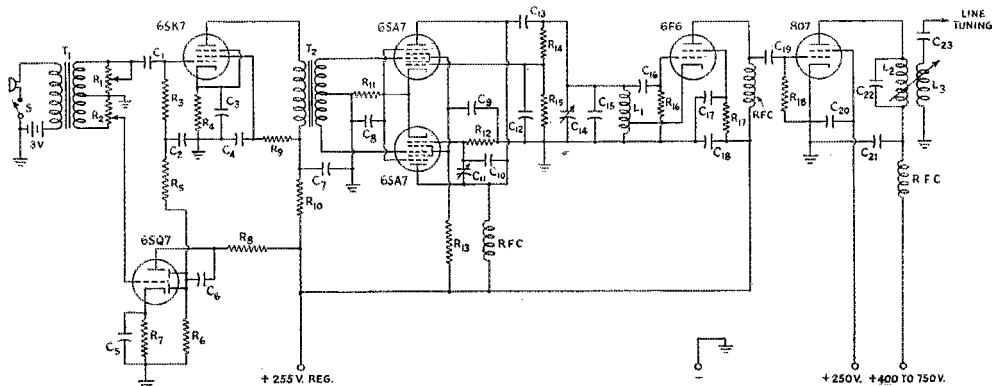

Fig. 1 — Circuit diagram of the f.m. carrier-current transmitter.

- C₁, C₈ — 0.01- μ fd. 450-volt paper.
- C₂, C₃, C₄, C₆ — 0.1- μ fd. 600-volt paper.
- C₅ — 10- μ fd. 25-volt electrolytic.
- C₇ — 8- μ fd. 450-volt electrolytic.
- C₉ — 0.1- μ fd. 600-volt paper.
- C₁₀, C₁₂ — 200- μ fd. mica (two 100- μ fd. units in parallel).
- C₁₁, C₁₄ — 100- μ fd. midget variable.
- C₁₃, C₁₇, C₁₈, C₂₀ — 0.002- μ fd. 600-volt mica.
- C₁₅ — 550- μ fd., mica for 69 kc. (approx. 300- μ fd. for 170 kc.).
- C₁₆ — 0.001- μ fd. mica.
- C₁₉ — 500- μ fd. 600-volt mica.
- C₂₁, C₂₂ — 0.002- μ fd. 2500-volt mica.
- C₂₃ — 0.005- μ fd. 2500-volt mica.

- for 69 kc. (approx. 0.002- μ fd. for 170 kc.).
- R₁, R₂ — 500,000-ohm potentiometer.
- R₃ — 1 megohm, $\frac{1}{2}$ watt.
- R₄ — 400 ohms, 1 watt.
- R₅, R₆ — 500,000 ohms, $\frac{1}{2}$ watt.
- R₇ — 5000 ohms, 1 watt.
- R₈, R₉ — 100,000 ohms, 1 watt.
- R₁₀ — 10,000 ohms, 1 watt.
- R₁₁ — 175 ohms, 1 watt.
- R₁₂ — 1000 ohms, 1 watt.
- R₁₃ — 10,000 ohms, 10 watts.
- R₁₄, R₁₆, R₁₈ — 50,000 ohms, 1 watt.
- R₁₅ — 500,000 ohms, 1 watt.
- R₁₇ — 15,000 ohms, 2 watts.
- T₁ — Single-button microphone transformer (Thordarson T-83A78).

- T₂ — Class-B driver transformer (Thordarson T-54D63).
 - L₁ — 8-mh. r.f. choke, tapped above first pie from ground end for 69 kc. (Meissner) (2.5-mh. r.f. choke tapped between first and second pies from ground end for 170 kc.).
 - L₂ — Two 1.5-mh. universal-wound coils connected in series, fields opposing, coupling adjustable for 69 kc. (Two 0.4-mh. coils for 170 kc.).
 - L₃ — 1-mh. universal-wound coil.
 - RFC — 80-mh. r.f. choke.
 - S — S.p.s.t. toggle switch.
- Note: Only frequencies between 160 and 200 kc. should be used by amateurs.

response is limited to 3000 cycles, therefore the bandwidth or swing of the f.m. transmitter is 6 kc. — the same bandwidth which would be required by an a.m. carrier modulated by a 3000-cycle signal. All equipment associated with a.m. — line traps, line tuning systems and receiver pass-band characteristics can be used in the f.m. system without change.

The Transmitter

The transmitter circuit, shown in Fig. 1, uses conventional f.m. circuits with values suitable for low-frequency operation. The tube line-up consists of a 6SK7 speech amplifier, 6SQ7 automatic gain control,² 6SA7s in a balanced reactance modulator, 6F6 e.c.o. and an 807 Class-C amplifier.

Output from the single-button mike is more than sufficient to drive the modulator directly. However, without a.g.c., it was found that the gain control setting was too critical. Voice peaks caused excessive swing, which resulted in distortion in the output of the narrow-band f.m.

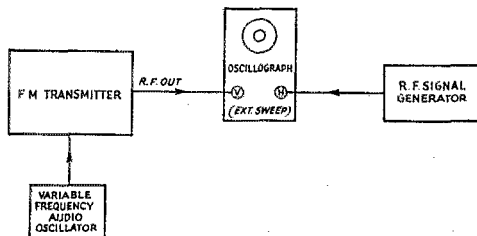

Fig. 2 — Arrangement of apparatus for checking the performance of the f.m. carrier-current transmitter.

receiver. When the gain was reduced to limit the voice peaks, the "modulation percentage" dropped, which resulted in low audio output from the receiver. The 6SK7 speech amplifier controlled by the 6SQ7 a.g.c. circuit solved the gain problem very nicely. When the a.g.c. circuit is adjusted properly, the speech peaks are compressed below the point of excessive swing and the average speech level is raised resulting in maximum output from the receiver. Response over the desired frequency range, 300 to 3000 cycles, is good because of the transformer coupling between the 6SK7 and 6SA7s.³

Operation and adjustment of the balanced reactance modulator was described some time ago in *QST*⁴ and will not be repeated here. The values shown for the phase-shifting networks of the 6SA7s and the *LC* ratio of the oscillator grid circuit are suitable for 3-kc. deviation at 69 kc. With regulated voltage on the modulator and oscillator, center-frequency stability is unusually good and always returns to within a few cycles of the selected frequency after modulation is removed, so any form of center-frequency stabilization is unnecessary. When operating on higher

carrier frequencies, always use the maximum *C* in the oscillator tank which permits the desired frequency deviation.

The 6F6 e.c.o. and 807 circuits are standard and are tuned up in the usual way without modulation. Of course, any change in the balancing condenser *C*₁₁ will make it necessary to readjust the oscillator tank condenser *C*₁₄. A VR-105 and a VR-150 connected in series furnish the regulated voltage. Input to the 807 can be run as high as 75 watts.

Deviation Check

For a simple accurate frequency-deviation check on carrier frequencies, the equipment as connected in the block diagram of Fig. 2 was used. The r.f. signal generator should be accurately calibrated every kilocycle and should operate over the same fundamental frequency range as the transmitter. For example, suppose the center frequency selected is 170 kc. Set the frequency of the signal generator on 170 kc. and, with transmitter unmodulated, tune *C*₁₄ until a circle is obtained on the screen of the cathode ray tube. The frequency of the transmitter is exactly the same as the r.f. signal generator. Now tune the signal generator to 173 kc. (deviation plus 3 kc.) and modulate the transmitter with a 3000-cycle sine wave. Adjust the speech amplifier gain (a.g.c. control set at ground end) until a circle is seen superimposed on the solid pattern produced on the screen by the two r.f. voltages. Tune the r.f. signal generator to 167 kc. and another circle, like the one described above, should be seen indicating the minus-3-kc. deviation point. If it is necessary to change the speech-amplifier gain setting for the minus-3-kc. deviation point, audio distortion is indicated. Check the modulator balance and audio excitation to each 6SA7 grid and change the oscillator grid *LC* ratio if necessary, so that the frequency deviation is plus or minus 3 kc. with the same audio gain setting. With the values shown, deviation in excess of 3 kc. at 69 kc. (the test frequency) resulted in a swing in the 6SA7 plate current and considerable a.m.

To put the a.g.c. circuit into operation, increase the input to the 6SQ7 to the point where a reasonable change in the audio-oscillator input to the speech amplifier does not change the frequency deviation. The speech-amplifier gain will have to be changed, but the adjustment is simple and should result in good speech quality when checked on the f.m. receiver. Too much compression will cause distortion.

When a lower modulation frequency, such as 500 cycles, is used it is possible to see the beat between the r.f. from the signal generator and the sidebands produced by the f.m. If the center frequency is *F*, beats will occur when the r.f. signal generator is set at $F \pm 500$ cycles, $F \pm 1000$ cycles, $F \pm 1500$ cycles, etc. When the modulation frequency is raised to 1000 cycles, beats will be seen at $F \pm 1000$ cycles, $F \pm 2000$ cycles, etc.

If an accurate deviation check is unnecessary, adjust the speech-amplifier gain and a.g.c. control

² A.R.R.L. Handbook, 1944 Edition, p. 280.

³ *QST*, September, 1944, p. 87.

⁴ Crosby, "Reactance-Tube Frequency Modulation," *QST*, June, 1940.

for maximum undistorted audio output from the narrow-band f.m. receiver.

The receiver used in the tests consisted of a 2-stage standard r.f., a.m. receiver equipped with an f.m. adapter using a 6SJ7 limiter and a 6H6 demodulator, which could be switched in and out of the circuit, f.m. to a.m., with one switch. A discriminator transformer of the three-coil type was constructed using r.f. chokes for coils. Other circuit values were standard. Experienced hams should have no difficulty in converting a.m. receivers for narrow-band f.m. reception.

All tests were made on a 44,000-volt power-line system on a frequency of 69 kc. **CAUTION:** For amateur use, be sure to stay above 160 kc. to avoid possible interference with vital public utility services.

Results

The f.m. signal was compared with the signal from a 100-watt (output) a.m. transmitter located 30 miles by line from the a.m.-f.m. receiver. For convenience in testing, the f.m. transmitter, whose power output was limited to about six watts, was located at a point 10 miles by line from the receiver. Under normal operating conditions the quality of the f.m. signal was considerably better than that of the a.m. signal. One reason for the quality improvement is the more favorable signal-to-noise ratio in the absence of the effects of "corona-modulation" noises, which are completely eliminated in the f.m. receiver.

For a real noise test, a continuous arc was produced on the 44-kv. system by letting the charging current to the bus-side bushings of an oil circuit breaker arc between the 44-kv. bus and the OCB bus disconnects. The noise produced by this arc (an inch or so long) was tremendous. It was impossible to read the 100-watt a.m. signal through this terrific noise level. When the limiter was adjusted properly, the f.m. signal pushed the noise down in the background. Speech came through with good, crisp quality. Signal-to-noise measurements were not made, but the improvement shown by f.m. over a.m. in this case was remarkable.

When a carrier is not being received the output of the receiver is noisy, therefore if it is desirable to have the receiver quiet when no signals are present, some type of silencing squelch circuit should be used.

For QRN-free carrier communication and more miles per watt or less power per mile try f.m. Remember the QRM and summer QRN on the 75- and 160-meter 'phone bands? Well, narrow-band f.m. has wonderful possibilities there, too!

Strays

Lt. (jg) Charlie Floring, W8EBR, even though in the service can't get away from ARRL. He works for the ARRL—the Aircraft Radio and Radar Laboratory of the Naval Air Experimental Station in the Philadelphia Navy Yard.

★ ★ ★ ★ ★ ★ ★ ★

Gold Stars

T. GUY K. HOBSON, RCCS, VE5NV, died on August 9, 1944, from severe head wounds received in action in the Caen-Falaise sector of France on the previous day. For three weeks prior

to his death he had been signal officer in a Canadian armored regiment.

VE5NV attended the King Edward High School Radio Training Centre in Vancouver, B. C., and received his commercial license in November, 1939. He then worked as radio operator for the Consolidated Mining and Smelting Co. of Canada, at Yellowknife, N.W.T., for a year. Following his

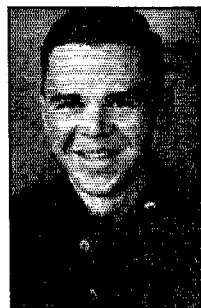

enlistment he was stationed at Ottawa and Debert, N. S., before being sent to England in October, 1942. The following year he was recommended for a commission and graduated second place in his class in July, 1944.

Guy operated his station, VE5NV, jointly with Len Hoover, VE5PE, during the time both were attending the Radio Training Centre in Vancouver. Although Canada entered the war shortly after their station went on the air, they had made many contacts on the 7-Mc. band.

T. WESLEY ROBINSON, III, AC, Class B operator licensee, was killed in action over France on December 31, 1943. He was first reported missing in action when the B-24 Liberator on which he was a bombardier failed to return from a bombing mission, but the International Red Cross advised the War Department on June 3, 1944, that he had been killed.

Enlisting in the Air Corps as a cadet in January, 1942, Lt. Robinson received training at Maxwell Field, Ala.; Albany, Ga.; Santa Ana, Calif., and Deming, N. M., where he received his wings. His



squadron was sent overseas in October, 1943.

Although Lt. Robinson held no station license, he helped his brother, Lt. James W. Robinson, now a communication officer in the AACCS, build his station, W4DDD, and shared the operation of it, mostly on 3.5- and 7-Mc. c.w.



Why Low-Level Microphones?

Some Advantages of the Neglected Carbon Microphone

BY McMURDO SILVER*

TWENTY years ago, when today's old-timers were young squirts, the basic components needed for a radiotelephone transmitter were vacuum tubes and a carbon microphone. The first were necessarily acquired by the cash route, the second by what might be termed the "filch" route, as from an abandoned (?) telephone. Today, crystal, velocity and dynamic microphones appear to be acquired by the cash route, but with the order of cost in relation to vacuum tubes markedly reversed.

The old dependable carbon microphone appears to be unjustly frowned upon by the aspiring amateur — unfairly so, for today's best carbon microphone is about as far ahead of its grandfather of twenty years ago as are today's vacuum tubes. This neglect may conceivably be explained by the logical trend of broadcast-station services away from carbon microphones in the search for finer tone quality — for *musical reproduction*. It would appear that the amateur fraternity has presumed, therefore, that it necessarily follows that the carbon mike should be relegated to the junk box in ham stations. Only rather recently has general amateur cognizance been taken of the fact that the problems of high-quality broadcasting and those involved in attaining the most efficient transmission of intelligence via speech are quite separate and distinct.

Concerned as he has been over the past five years only with radio equipments to be used by the naval and military services, the author has yet to see a serious government specification accepting anything but carbon microphones for land, sea or air services. It would seem that what is good enough for Uncle Sam's services, where cost is sacrificed to all-essential dependability under conditions of very rigorous service with emergencies the presumed rule, should be worthy of more serious amateur consideration.

Microphones for Speech

The wise amateur is not interested in a wide audio-frequency range in his speech equipment, as is the broadcaster — quite the reverse if he desires to obtain the greatest amount of effective power output at the least cost. Today's land-line telephone could quite properly serve as his criterion of excellence — good, clearly intelligible speech, with no waste of power or money through transmission of frequencies which are of no importance to the conveyance of intelligence. This is not suggested from the standpoint of that order of unselfishness (which should always be the other fellow's!) of minimizing interference in crowded 'phone bands. Quite the contrary, it is

dictated by the strictly selfish desire to put out more power — to waste nothing in effective modulation capability through the transmission of those low frequencies, hogs for power that they are, which contribute little except modulator overload and background noise.

Accepting the above assumption as reasonable, it might be narrowed down to the statement that available amateur power would get out farther, would convey greater intelligibility, and would cause less interference if the audio tone range of amateur equipment were uniformly limited to a band of 200 to 3,000 cycles, or even to a range of 400 to 2,000 cycles. These are not at all unreasonable extremes. To such ranges today's best carbon microphones are admirably suited. General recognition of something along this line seems to be dawning, since for some time past the so-called "communications-type" microphones have been gaining popularity. But microphones of this sort are usually of the crystal type, which do not fit amateur requirements ideally because they still are "low-level" as compared to a fine carbon microphone.

Output Levels

A good, high-quality, wide-frequency-range microphone, such as is eminently fitted for fine broadcast or public-address work, is "low-level" — averages perhaps minus 70 db. which means it puts out about 0.00032 volt r.m.s., or mighty little indeed. The "communications-type" crystal microphones put out about 0.032 volts r.m.s., and are "down" at about an average of minus 30 db. Contrast this with a good modern carbon microphone which will put out 0.3 volts or more. Reduced to terms of ultimate simplicity, the "communications" microphone requires ten times more amplification to bring it up to the equal of the carbon microphone; the high-fidelity broadcast type requires 1,000 times as much audio amplification as does the good carbon microphone, or, in decibels, the carbon microphone is plus 20 db. better than the "communications" microphone, and plus 60 db. better than the wide-range microphone used in broadcasting.

True it is that audio gain as such is not very expensive today. A voltage gain of 10 easily can be obtained with almost any resistance-coupled, single-stage triode amplifier. A db. gain of 60 or a voltage gain of 1000 can be had by the same simple triode audio stage plus a good high-gain pentode stage. But — every time gain is added, even at small expense, troubles from hum, noise and r.f. pick-up multiply while the possibility of failure of some innocent-looking little part at some inconvenient moment increases in propor-

*Box 91, Plainville, Conn.

tion. It has aptly been drummed into all school-boys that the shortest distance between two points is a straight line. Hence, why do amateurs buy inefficient microphones at a comparatively high price, then buy amplification in an attempt to make them the equal of the simple "straight line" provided all in one little package by a good carbon microphone? Certainly it is not to ape the broadcasters — or is it?

Noise

But this is not the whole story — not at all. For about one dollar the carbon microphone can be lifted roughly another 25 db. in output by the essential microphone-to-grid coupling transformer. The fact that the transformer is a small, cheap unit should be pleasing in amateur application. With the use of this transformer little is required in the way of audio amplification before small modulator tubes. A transformer of this type is relatively insensitive to hum pick-up because of the low gain which follows it. At worst, a little "wiggling" will suffice to determine the physical position in which the microphone transformer should be placed to eliminate a.c. hum pick-up from a filter choke or power transformer which may happen to be near it. This is really inconsequential, since the desirable audio speech system will be poorly responsive to 60- and 120-cycle hum frequencies in any case, and the input is high-level, where induction effects are not serious.

The handbooks state that carbon microphones are noted for their "hiss." This is only too true if they are followed by considerable amplification, such as would be necessary with a low-level, double-button, broadcast-type microphone. This is one of the reasons for the desertion of such microphones by broadcasters. But it is extremely doubtful indeed if the noise from a good present-day, single-button carbon microphone will ever be noticed in use, since it may be operated with little amplification before the modulator tube or tubes. In many low-power applications no amplification at all is needed. In any event, a "sure-fire," simple modulator showing at worst a slight trace of hiss when an exceptionally poor microphone is used seems preferable to the poor quality which frequently gets on the air from some supposedly "super-deluxe" modulators starting with a fine low-level microphone, getting all tangled up in unstable high-gain pre-amplification and r.f. pick-up, and coming out rather sourly at the antenna.

But hiss is unnecessary, for today fine carbon microphone "buttons," diaphragm and shell with spring contactors all included, can be purchased for a very few dollars — so few that one can replace them without wrecking the family budget. The possibility of damage through dropping or "packing" of carbon granules can be avoided by the use of a negligible amount of care in keeping the microphone-button current down within the bounds of reason, or the manufacturer's rating.

Perhaps the most distinct benefit of those already mentioned which accrues to the user of the carbon microphone is freedom from r.f. pick-

Experience with microphones in equipment used in vital military communications prompts the author of this article to pose the question set forth in the title. Through logical reasoning he arrives at the answer that the most expensive audio equipment may not always be the most efficient when the effective transmission of speech alone is considered.

up from the transmitter proper by a long line of sensitive, high-impedance, high-gain pre-amplifier circuits. There just isn't much trouble on this score with the simple speech-amplifier stage needed for even a high-power modulator when a carbon microphone is employed. What little may be present can be killed by 0.002 μ f. across the microphone itself, across the microphone transformer primary, or by an r.f. choke in the input grid lead, followed by 0.0001 μ f. from grid to ground if both microphone and its transformer are remotely located. But why bother, when the microphone circuit proper is low-impedance, and can be run in a two-wire cable 20 or 30 feet without any trouble?

Microphone Supply

Mike current can come from a couple of dime-store flashlight cells at a few pennies each. If one wants to be independent of batteries, microphone voltage often may be obtained from a connection between ground and the variable arm of a potentiometer used to provide automatic cathode bias for the modulator tube. Plenty of steady voltage develops across this resistor. A by-pass of about 1 μ f. will keep low-frequency response down where it belongs in a speech system, and no trouble will be encountered in getting button current, adjustable from zero up to the specified microphone current, from this source. A voltmeter or milliammeter should be used to set the voltage or current within safe limits. Of course, button current should be cut off when not in use, but any microphone housing for a single-button carbon microphone worth its salt has a combined "push-to-talk" and button-circuit switch incorporated in its design.

It is the author's hope that, bringing as he does something of the military viewpoint to this question of which microphone to use, he may have indicated that, for all-around economy, simplicity and that always sought-for maximum of efficiency, the wise amateur will no longer neglect the carbon microphone, for it may be his most logical choice.

Strays

When you hear the singing guitar of a name band look up W6RDX's name in a copy of the *Call Book*. — W1KKS/6.

The Ham Shack on The Boulevard

ON October 16th the Hamfesters Radio Club of Chicago presented a service flag, representing the thousands of radio hams who are now using their abilities in the various branches of the armed forces, to the American Radio Relay League. The presentation was made by Chet Horton, W9YQH, for the Hamfesters and the flag was accepted by Carol K. Witte, W9WWP, acting communications manager of the League. The occasion was the official opening of Hallicrafters' new display rooms at 643 North Michigan Boulevard, Chicago. This exhibit of typical amateur equipment, known locally as "The Ham Shack on the Boulevard," was dedicated to the hams in the presence of about thirty-five of Chicago's leading amateurs who afterward went to the usual Monday amateur luncheon at the Fair Store as the guests of Bill Halligan, W9WZE.

The new "shack" is a truly interesting place. Of most unusual design, it is finished in gleaming white and pastel gray enamel and when illuminated by floodlights at night it can be seen far down the Boulevard. The front room contains a display of receivers and transmitters including some new v.h.f. and u.h.f. equipment. The next room is furnished as a library or den and contains an SX-28A and an S-36A (f.m.), either of which can be connected to a large bass reflex speaker.

The point of greatest interest to amateurs, however, is the small rear room which is fitted out as an ultra-modern ham station. Complete with an HT-4E transmitter, similar to the unit which powers the Signal Corps' SCR-299, this layout gave most of the visiting hams an almost uncontrollable desire to sit down and start pounding brass. The building is surmounted by a rotatable 10- and 20-meter beam antenna supported on a white enameled steel tower. For the time being the beam's mechanism will be controlled by clockwork in order to create the impression of actual operation.

(Continued on page 86)

Top — The "shack" "... when illuminated by floodlights at night it can be seen far down the Boulevard. *Left above* — A few of the Chicago gang who were present. YLs in the front row are: Winifred Wadsworth, editor of "Hamgab," the monthly publication of the Hamfesters, Carol K. Witte, W9WWP, acting communications manager of the ARRL, and Alice R. Bourke, W9DXX, who operates one of Chicago's best-known amateur stations. *Left* — The layout in the back room "... gave most of the visiting hams an almost uncontrollable desire to sit down and start pounding brass." *Lower left* — The north window of the ham "shack" "... a Pacific island invasion scene complete with landing craft, jeeps, tanks, ducks, and two SCR-299 mobile radio stations." *Lower right* — The south window "... A typical American countryside ... more than ordinarily interested in radio."

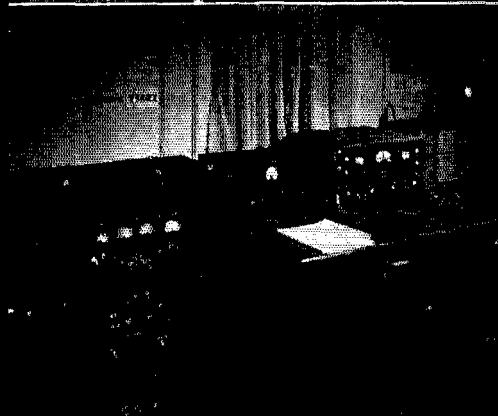
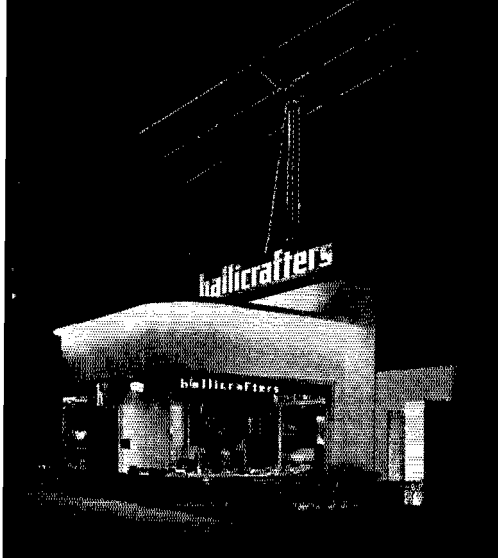

Design of Cross-Over Networks for Loudspeaker Units

Dividing Filters for "Woofers"- "Tweeter" Combinations

BY MAJOR E. N. SIEDER,* SC, W2AHN

The use of dual loudspeakers in any high-fidelity reproducing system has come to be a recognized necessity. Getting the most out of such a system, however, involves something more than the simple connection high- and low-frequency speakers in parallel.

This article treats the design and construction of networks which are used to obtain proper division of the audio-frequency range between the "woofer" and the "tweeter" and provide an essentially constant load for the output stage.

BECAUSE of wartime restrictions on transmitting, many amateurs and experimenters have directed their efforts toward building high-fidelity amplifiers for a.m. and f.m. broadcast reception. Often they find themselves up against it when it comes to obtaining a speaker or speakers having a satisfactory audio-frequency range. Single speakers may be obtained which give sufficiently broad response to be satisfactory for a.m. broadcast reception with a superheterodyne receiver, since the radio-frequency bandwidth limits the sideband response to about 5000 cycles. However, well-designed tuned-radio-frequency a.m. receivers will provide good response up to 7000 or 8000 cycles and f.m. receivers will go up to 12,000 or 15,000 cycles. To make the most of high-fidelity receivers and amplifiers, dual-speaker combinations are almost a necessity.

Advantages of Dual Speakers

Some of the more important advantages claimed for the use of multiple-speaker combinations, in which the speakers cover complementary frequency ranges are:¹ (1) improved frequency response, since each type of unit covers a moderate range; (2) higher system efficiency, for the same reason; (3) improved directivity characteristics, since the diaphragm (or horn mouth) for the highest-frequency range may be made relatively small; (4) improved transient response, because many of the artifices used to obtain extended fre-

quency ranges in single units tend to make the transient response worse, particularly at high frequencies; (5) reduced intermodulation, since large amplitudes are confined to the speaker reproducing low frequencies; and (6) reduced frequency modulation which occurs when a single diaphragm moves with large amplitude with respect to the listener, thereby altering the frequency (Doppler effect). Furthermore, properly designed cross-over networks will insure that each speaker will present a load to the amplifier only over the frequency range in which it is working.

Fig. 1 is presented to show the impedance-vs.-frequency characteristics of two typical speakers, one of the "woofer" type and the other of the crystal "tweeter" type. A curve also is presented to show the combined impedance of the two speakers operating with the inputs of their speaker transformers in parallel without the use of cross-over networks. It will be noted that at the normal design point of 400 c.p.s. only half of the amplifier output is being delivered to the low-frequency speaker. The combined impedance curve of these speakers when used with suitable cross-over networks will be approximately that of the individual speakers with the transition point occurring at the cross-over frequency.

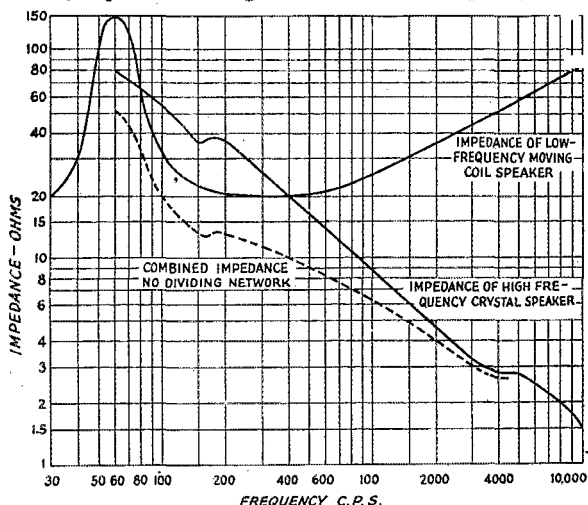

Fig. 1 — Impedance vs. frequency characteristics of two typical speakers and the resulting impedance curve when they are connected in parallel with no dividing network. The combined impedance characteristic is flattened out when the dividing network is added as shown in Fig. 3.

* Waterloo St., Warrenton, Va.

¹ Henney, *The Radio Engineering Handbook*, 3rd ed., p. 893, McGraw-Hill, N. Y., 1941.

Cross-Over Frequency

In cross-over networks, sometimes called dividing networks, the frequency at which the power delivered to the two speakers is equal is termed the cross-over frequency. *Terman*² states: "Experience indicates that the dividing network should provide at least 12 db. attenuation one octave away from the cross-over frequency, as compared with the cross-over attenuation, whereas attenuations of more than 18 db. per octave are not necessary "or desirable."

Suitable dividing networks may consist of complementary high- and low-pass filters connected with inputs either in parallel or in series. Networks of this type, providing an attenuation of between ten and twelve db. for the first octave beyond cross-over frequency, are shown in Fig. 2. Necessary design formulas are included. The network recommended by the writer and which will be considered in examples given herein is the parallel network shown in Fig. 2-B.

The choice of a cross-over frequency will, of course, depend upon the characteristics of the speakers involved. It seems generally agreed that a satisfactory cross-over frequency lies between 1500 and 2000 c.p.s. If we select the latter value with an output-tube load resistance of, say, 5000 ohms, then substituting in the formulas given in Fig. 2-B,

$$L_o = \frac{R_o}{2\pi f_c} = \frac{5000}{(2)(2000)}$$

$$L_2 = (\sqrt{2})(L_o) = 0.56 \text{ hy.}$$

$$C_o = \frac{1}{(2\pi)(2000)(5000)}$$

$$C_2 = \frac{C_o}{\sqrt{2}} = 0.13 \text{ } \mu\text{fds.}$$

Inspection of these circuit values indicates that the only problem is the design of the inductance L_2 . It can be seen from the circuit diagram in Fig. 2 that the inductance in the low-pass filter carries the d.c. plate current to the output tube and any design method for calculating the inductance must take into consideration this magnetizing current. Although the inductance in the high-pass filter does not carry direct current, it may be considered expedient to make it similar to the inductance in the low-pass filter.

Inductance Design

Where no direct-current component is present, an iron-core inductance may be made using interleaved laminations, in which case the inductance is given by the formula

$$L = \frac{(3.2)(10^{-8})(N^2)(\mu A)}{l} \text{ hy.} \quad (1)$$

where N is the number of turns, μ is the incremental (a.c.) permeability, A is the effective cross-section of the core in square inches, and l is the length of the path of the magnetic circuit in

inches. In this formula, no allowance has been made for any gap in the magnetic circuit. The value of μ depends upon the type of iron used in the laminations as well as upon the a.c. and d.c. flux densities. The length of the magnetic path is the distance travelled in the complete circuit of the core. The path taken will be along the center line of each leg, except that when there are two windows each path through the center leg will be along a line one-quarter way across the leg. Note that in the latter case only a single circuit around one window is considered in the calculation of the length of the magnetic path. For low flux densities, an incremental permeability, μ , of 1200 might be used for commercial silicon-steel transformer-core material.

However, where the direct current is considerably greater than the peak a.c. current, a different method must be used in calculating the inductance of an iron-core choke. The more exact methods require cut-and-try types of calculations. However, a simple method can be used in calculating the inductance of chokes or transformers with fairly large air gaps. This method is given in the following formula:

$$L = \frac{3.2 A N^2}{(a)(10^8)} \quad (2)$$

where the symbols have the same meaning as for the preceding case. For accuracy, a should be calculated as the actual air gap plus the air gap equivalent of the iron core, or

$$a = (\text{air gap}) + \left(\frac{l}{\mu(ac)}\right) \quad (3)$$

The flux density, B , in lines per square inch will be given by the formula:

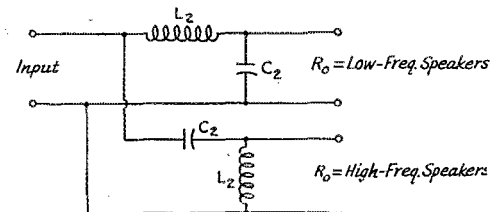
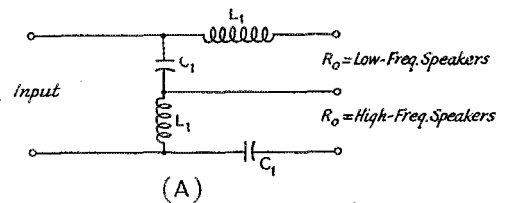

Fig. 2 — Cross-over networks.

$$L_1 = \frac{L_o}{\sqrt{2}} \text{ hy.} \quad C_1 = \sqrt{2} C_o \text{ fd.}$$

$$L_2 = \sqrt{2} L_o \text{ hy.} \quad C_2 = \frac{C_o}{\sqrt{2}} \text{ fd.}$$

$$L_o = \frac{R_o}{2\pi f_c} \quad C_o = \frac{1}{2\pi f_c R_o}$$

² *Terman, Radio Engineers' Handbook*, 1st ed., p. 249. McGraw-Hill, New York, 1943.

$$B = \frac{3.2 NI}{a} \quad (4)$$

Selection of the proper air gap is dependent upon several factors, but primarily upon the ratio of peak alternating current to the d.c. component. Terman³ gives a chart showing the variation in inductance versus length of air gap for several values of direct current through the inductance. This particular chart indicates that for a direct current of 40 milliamperes and an alternating current of 10 milliamperes the inductance in henries increases rapidly as the air gap is increased from zero to about 4 mils. From that point on, to an air gap of about 14 mils, the inductance decreases slowly. This curve also shows that with an air gap greater than 10 mils the inductance does not change greatly with a 4-to-1 change in d.c. component. Thus we see that if a total air gap of over 10 mils thickness is chosen, the inductance as calculated from formula (2) will be approximately correct. It should be borne in mind that in using the shell-type core the total air gap will be twice the thickness of the material used as a spacer. (For those who do not have a micrometer on hand, we might say that an ordinary manila file folder has a thickness of about 10 mils, whereas the thickness of your QST cover is approximately five mils. Usually the standard 3 x 5 filing card has a thickness of eight mils. A standard penny postcard has a thickness of eight mils.)

Let us assume that we have available sufficient core material from an old audio transformer to give us two cores each of 0.28 square inches net area (measured area times 0.90), and that the magnetic path, l , measures 4.25 inches. Then substituting in formula (2) and solving for the required number of turns needed to give us an inductance of 0.56 henries,

$$L = \frac{3.2 A N^2}{(a) (10^8)}$$

Rearranging we get

$$N = \sqrt{\frac{(L) (a) (10^8)}{3.2 A}} \quad (5)$$

Then assuming an air-gap spacer thickness of 0.008 inches (8 mils) and an incremental (*a.c.*) μ of 500, the equivalent gap

$$a = 0.016 + \frac{4.25}{500} = 0.024,$$

³ Terman, *Radio Engineers' Handbook*, 1st ed., p. 101, McGraw-Hill, New York, 1943.

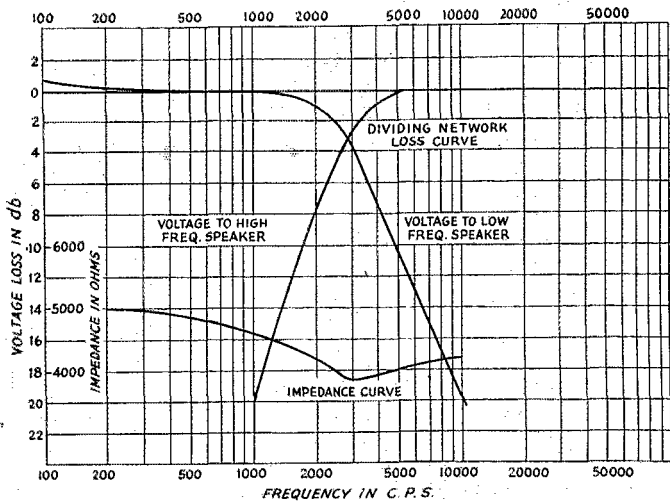

Fig. 3 — Characteristics of a dividing network designed according to data presented in the text. The cross-over frequency in this case is 2800 cycles.

we have

$$N = \sqrt{\frac{(0.56) (0.024) (10^8)}{(3.2) (0.28)}} = 1222 \text{ turns.}$$

The turns may be scramble-wound on a cardboard form made to fit the available window space. No. 30 or 32 wire will be found satisfactory for most applications.

Network Characteristics

The actual characteristics of a dividing network built by the writer were determined experimentally and are shown plotted in Fig. 3. This curve shows that at the actual cross-over frequency of 2800 c.p.s. the output from each of the filter networks will be down 3 db. on a voltage basis or about half on a power basis. Fig. 3 also shows a plot of the impedance characteristics of the network viewed from the input end when each of the networks is terminated by a load resistance of 5000 ohms. This particular dividing network shows a drop in impedance at the cross-over frequency but it is felt, however, that the 20-per-cent reduction in impedance at this point, although undesirable, may be tolerated. A perfect network would be expected to show a flat frequency-vs.-impedance curve. As a matter of fact, slight changes in the values of the air gap and of the capacitors, C_2 , may be found to change the shape of the impedance curve to a noticeable extent. For example, a particular combination of air gap and capacity tried by the writer showed a voltage loss of 4.2 db. at cross-over and an abrupt change in impedance to 7000 ohms at this frequency. Loss data on the dividing network also were taken with no d.c. component through the inductance in the low-pass filter. These data indicated that there was little if any change in the position of the attenuation curve and, therefore, we can conclude that the d.c. magnetization

caused by the 40 milliamperes of plate current did not appreciably change the inductance of L_2 . The physical characteristics of the components in the dividing network for which the characteristic curves are shown are indicated in the table below:

$A = 0.25$ square inches net
 $l = 4.25$
 $N = 1000$
Gap-spacer thickness = 8 mils
 $a = 0.024$ (equivalent)
 $L_2 = 0.34$ hy. (calculated)
 $C_2 = 0.01$ μ fd.
 $I_{max} = 40$ ma. d.c.
 $R_o = 5000$ ohms

Checking Network Characteristics

It is very desirable that any network built by the amateur experimenter be checked for loss and impedance characteristics. The only instruments needed are an oscilloscope or output meter, a variable-frequency audio oscillator covering the range from 100 to 10,000 c.p.s. and an ohmmeter.

The network may be connected to the amplifier for which it was designed and suitable load resistors inserted in the outputs of the network to replace the speaker load. The resistors should have a value equal to the reflected impedance of the speakers at 400 c.p.s. This should correspond closely to the rated load resistance of the power-amplifier tube. The resistor used in place of the low-frequency speaker-matching transformer should be capable of passing the full plate current of the power tube. The audio oscillator can, of course, be coupled to the input of the amplifier in any convenient manner.

To measure the attenuation characteristics of the network, it is only necessary to measure the audio voltage across the input and again at the load for any given frequency setting of the oscillator. If an output meter is used for measuring the audio voltages, sufficient resistance should be inserted in series with the meter to insure that the meter does not represent any appreciable additional load to the circuit. A high-impedance measuring device, such as an oscilloscope, insures against such a possibility.

Impedance measurements may be made on the network by using the simple but satisfactory substitution method. With this method, it is only necessary to couple a load of unknown impedance across the output of a high-impedance audio oscillator. The voltage across the unknown impedance is then observed with an oscilloscope. A variable resistor is then substituted for the unknown load and adjusted until the voltage reading is the same as was noted for the load of unknown impedance. The variable resistor can then be removed and its resistance measured with an ohmmeter. The resistance so measured can be considered to be equal to the impedance of the load under test.

It should be well understood that attenuation characteristics and impedance curves plotted from data taken as described above do not represent the actual characteristics that would be

obtained if "woofer" and "tweeter" speakers, with their respective matching transformers, were used as loads in the network. The variable-impedance characteristics of the speakers with frequency will, of course, reflect back through the networks and present a similarly variable load on the amplifier. Curves similar to those of Fig. 3 could, of course, be run using the speakers as loads. Such curves would, however, be of little use in checking the design of the cross-over networks and are, therefore, not necessary.

Free Radio Training Available to Ex-Servicemen

IN ANSWER to an increasing number of inquiries from men in the service interested in continuing their radio studies after return to civil life, we have extracted the following information from the Servicemen's Readjustment Act of 1944 (G. I. Bill of Rights), Public Law 346, from the Veterans Administration and from other sources, which will answer most questions. According to the provisions of the G.I. Bill, an eligible veteran, man or woman, may obtain:

1) One year of full-time education or training, or the equivalent in continuous part-time study, at any approved school or institution of his own choice, in any subject or subjects for which he is fitted.

2) An additional period of education, not to exceed three years, equal to the veteran's length of active military service and subject to the condition that the veteran was not over 25 years of age at time of entering the service or, if over 25, that he can prove his civilian education or training was interrupted by military service.

3) Payment of tuition and other expenses by the government, including books, laboratory supplies, health and infirmary fees, not exceeding \$500 per year.

4) A subsistence allowance of \$50 per month if without dependents, \$75 per month with dependents.

5) Part-time attendance in a course of education or training, if desired, at a reduced subsistence allowance, but with payment of tuition and incidental expenses.

6) The right to have released to him books and equipment furnished upon satisfactory completion of the course or training.

Practically any course of training in radio is open to the veteran, from part-time work in a service shop to a college course leading to a degree. He is not limited to instruction in his home State, but may choose any commercial school or college in the United States approved by the State Office of Education or Veterans Administration. While the list is not complete, it now includes most reliable institutions.

The provisions of the Bill and the assignment of veterans to training or rehabilitation courses are administered by the Veterans Administration.

(Continued on page 48)

A Plan for Tomorrow

Announcement of a Proposed Radio-Model Meet

BY "HELIX"

According to the author, the accompanying article is the result of a lot of wishful thinking and some flights of fancy, but he hastens to add it is not fantasy. The events portrayed undoubtedly will take place sooner or later, so, if the suggestions appeal to you, start a little advance planning.

DATE: Labor Day week-end, V year plus two (Victory plus two years).

PLACE: Lakeland Model Port.

SPONSORS: The Municipal Model Engineering Society and the Lakeland Chapter, Hams, Inc.

CONTESTANTS: Any individual or club may enter one or more model radio-controlled aircraft — plane, glider or helicopter.

EQUIPMENT:

AIRCRAFT: Wing spread, 15 feet or less. No weight limitations. All craft must be radio-controlled so that model may be launched, flown and landed under radio control from the ground. Any type or means of propulsion may be employed. Gliders may be entered and will participate in their own class of events.

RADIO: All transmitters must be capable of maintaining an assigned center frequency of plus or minus 10 kc. Assignments will be made in the 112-116 Mc. band. Power input to the final stage must not exceed five watts. Any type of modulation may be employed with a deviation on f.m. permitted up to plus or minus 25 kc. Receivers must be of the non-radiating type. Antenna systems for ground use must be enclosed in a space not to exceed a cubed area ten feet on each side. Antennas on the aircraft must be contained on or in the aircraft and must not protrude from the craft for a distance of over five feet. Power source must be furnished by contestant. Power plant must be of non-interfering type (suppressed, etc.).

FREQUENCY ASSIGNMENTS: Assignments will be made consecutively upon receipt of applications received after noon July 1st, V plus two. Assignments will be made in multiples of 100 kc. For example, the first application to be received will be assigned 1112.1 kc. and No. 1. The second would receive 112.2 kc. and No. 2. These frequencies and numbers would be used by all aircraft flying under auspices of that particular registrant.

ENTRIES: Multiple entries may be made by an individual or club. However, no entrant may enter more than one aircraft in any one particular event.

PARTICIPATION: Any registrant may select any licensed amateur to control his craft. Awards will be made on the basis of performance by the aircraft regardless of who controls it.

PRIZES AND AWARDS: Many thrilling prizes have been secured by the committee. These prizes range from model kits to a standard light plane complete with a year's supply of gasoline and oil, from model handbooks to a four-year course in aircraft engineering at a nationally known school. Model supplies, radio kits and sets, parts, and many other worth-while prizes are in store for the winners of the events. Points also will be awarded to the winner of each event and the group or individual collecting the most points will be awarded special bonus prizes.

EVENTS PLANNED:

- 1) **BALLOON BUSTING.** Several aircraft will go aloft and attempt to burst five-foot balloons which are floating free in the air. A time limit will be set, and the winning plane will be the one bursting the most balloons in that time.
- 2) **SPOT LANDINGS.** Craft will attempt landing near a flag located in a 10-foot circle. Helicopters barred.
- 3) **FORMATION FLYING.** A special award will be made to each individual or club participating in formation flying involving two or more aircraft performing simultaneous aerobatics.

ANY INDIVIDUAL
OR CLUB MAY ENTER
ONE OR MORE —

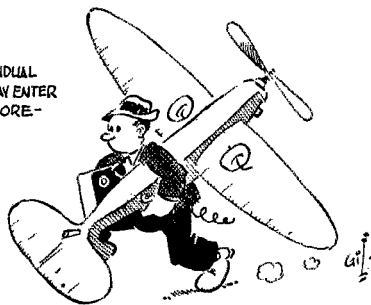

- 4) **DIVE BOMBING.** Dive bombing with non-explosive bombs at a target located on the ground.
- 5) **HIGH-LEVEL PRECISION BOMBING.** Bombing with non-explosive bombs from heights of over 500 feet.
- 6) **DEAD-STICK LANDINGS.** Helicopters barred. Power-free landings with propelling element dead will be made, with contestants attempting to land near a flag located in a target area.

(Continued on page 88)

Practical Applications of Simple Math

Part VIII—Class-B Amplifier Design

BY EDWARD M. NOLL,* EX-W3FQJ

THE Class-B amplifier or modulator is the most efficient audio amplifier. Large outputs can be obtained using small tubes and low electrode potentials. The use of Class-B modulators permits 100 per cent modulation of considerable r.f. power output using small tubes.

Types of Class-B Amplifiers

Class-B amplifiers are almost never operated strictly Class-B. By definition a Class-B stage is one in which the tube draws plate current for only 50 per cent of the complete excitation cycle. This means there would be no overlap of the composite push-pull characteristics and the distortion at low plate-current values would appear in the output. Consequently, what is termed a Class-B amplifier is in most cases operating at the very extremes of Class-AB₂ operation, so there is sufficient overlap of the two curves at low plate current to prevent serious distortion. Class-B amplifiers are of three types:

1) The amplifier is biased negative and the grid is permitted to swing positive. The general-purpose triode falls into this classification when it is operated Class-B. Special consideration is given to the driver-stage design to prevent distortion when the Class-B grids swing positive.

2) An amplifier in which the tubes are biased far negative and grids swing only to the grid-current point. A stage operated in this manner does not deliver as much output as one operated under conditions of the first example. However, the driver-stage requirements are not so strict and the power required from the driver stage is at a minimum. Distortion at the peak of the grid cycle because of grid-current flow does not occur.

3) The amplifier uses special tubes designed for Class-B operation. These tubes operate at zero bias and with this bias draw only a small amount of plate current. Efficiency is high and there is no problem of bias-supply regulation.

Power-Output Calculations

The following procedure is used in designing a Class-B amplifier.

1) Draw the Class-B load line using the same general procedure as covered in the previous installment. One point is always located on the plate-voltage coordinate at the supply-voltage point. A number of considerations, such as the power output desired, driving power available, and limitations of the tube itself, govern the choice of the second point. In all cases the manufacturer's recommendations for plate voltage, plate current, and plate dissipation must not be exceeded. If a set of the manufacturer's operat-

* 300 Fifth Ave., Asbury Park, N. J.

ing characteristics is not suitable, a number of trial load lines may be drawn as shown in Fig. 1.

Line *AB* represents a load per tube of 4000 ohms or 16,000 ohms plate-to-plate, while line *AC* represents a load per tube of 2500 ohms or 10,000 ohms plate-to-plate. For a given plate voltage, the lower value of plate load resistance represents the greatest output and highest efficiency, if the *applied signal swings the grid to its most positive bias lines*. However, the distortion increases, plate dissipation increases, and driver requirements are stricter. Consequently it is preferable to design the Class-B stage to meet the requirements with only a little to spare. For example, if 200 watts of audio are needed, design the amplifier to supply this amount, not 300 watts. Distortion in the Class-B stage will be covered a little later.

2) Having made the trial load lines, the power output can be estimated. In no case should the grid signal be permitted to swing to a positive value which exceeds the minimum plate voltage at that instant (180-degree phase shift in a vacuum tube). Thus for load line *AB* the peak of the positive alternation of the grid cycle must not drive the grid any further positive than 125 volts, which is the minimum plate voltage at the same instant (point *D*). For load line *AC* the maximum value is 175 volts (point *G*). With maximum signal the power output for the load line *AB* is

$$P_o = I^2 R_L = [(0.590)(0.707)]^2 (4000) = 696 \text{ watts, or } 348 \text{ watts per tube.}$$

Now if the grid swings only to 100 volts, the power output becomes

$$P_o = I^2 R_L = [(0.550)(0.707)]^2 (4000) = 608 \text{ watts, or } 304 \text{ watts per tube.}$$

Now if we estimate the power output for the second load line (*AC*) we find that it has jumped tremendously.

$$P_o = I^2 R_L = [(0.920)(0.707)]^2 (2500) = 1056 \text{ watts.}$$

Plate Dissipation and Plate Current

However, as will be proved later, the plate-dissipation and plate-current ratings of the tube have been exceeded.

3) Calculate the plate dissipation and plate current to see if the manufacturer's ratings have been exceeded. The ratings of the Amperex HF-200 have been taken as a typical example. They are as follows:

$$\begin{aligned} \text{max. plate current} &= 200 \text{ ma. per tube} \\ \text{plate dissipation} &= 160 \text{ watts per tube.} \end{aligned}$$

Other operating characteristics are:

$$\begin{aligned} \text{grid bias} &= 130 \text{ volts} \\ \text{zero-signal } I_p &= 60 \text{ ma.} \end{aligned}$$

As explained in the previous article, a good approximation of tube plate current is obtained using the following formula:

$$I_b + \frac{I_{max}}{2}$$

The plate currents, in order, for the three examples given previously in the second step are:

$$1) I_{dc} = \frac{0.06 + \frac{0.59}{2}}{2} = 178 \text{ ma. per tube}$$

$$2) I_{dc} = \frac{0.06 + \frac{0.55}{2}}{2} = 168 \text{ ma. per tube}$$

$$3) I_{dc} = \frac{0.06 + \frac{0.92}{2}}{2} = 230 \text{ ma. per tube}$$

Plate Load Resistance

The last example eliminates the possibility of using the AC load line, since the plate-current rating would be exceeded. The d.c. component of plate current can be reduced by decreasing the grid swing. However, for a given grid signal a greater power output can be obtained with a higher plate load resistance. Likewise, the d.c. component can be reduced by increasing the grid bias and decreasing the zero-signal plate current.

A reduction in plate current, I_b , means an increase in distortion. Thus it seems that the best plan for obtaining maximum output is to construct the load line in the following manner. Draw the load line with just the right slope to have the applied signal swing the grid to the highest bias line (to the $E_g = E_p$ line) and, at the same time, to cause the maximum permissible value of plate current (d.c. component) to be drawn. Do not reduce the zero-signal component of plate current to a value which will introduce serious distortion. The plate dissipations for the first two examples are:

$$1) IE = (0.178)(2500) = 445 \text{ watts}$$

$$2) IE = (0.168)(2500) = 420 \text{ watts}$$

Since the power output is known, the power dissipated on the plate of each tube is:

$$\begin{aligned} 1) P_d &= P_i - P_o \\ P_d &= 445 - 348 = 97 \text{ watts} \\ 2) P_d &= 420 - 304 = 116 \text{ watts} \end{aligned}$$

Driver Considerations

Both of these values are well within the maximum permissible value.

4) The peak grid signal per tube is:

$$\begin{aligned} 1) E_{max} &= (130 + 125) = 255 \text{ volts} \\ 2) E_{max} &= (130 + 100) = 230 \text{ volts} \end{aligned}$$

5) The peak grid current per tube is found on the $I_g E_p$ curves shown in Fig. 1.

1) $I_g = 185$ ma. (peak)
(Point A represents peak grid voltage and minimum plate voltage.)

$$2) I_g = 65 \text{ ma. (peak)}$$

6) Since the greatest load is placed on the driver stage when the grid signal is at the peak of its positive alternation, the value of the peak grid power is an important item in determining the driver requirements. The peak grid power for both examples are

$$1) P_g = I_g E_g = (255)(0.185) = 47.2 \text{ watts per tube (peak)}$$

$$2) P_g = (230)(0.065) = 14.95 \text{ watts per tube (peak)}$$

It is evident that the driver power required increases rapidly as the grid is driven farther positive (driven positive to the point where the positive grid voltage approaches the value of the minimum plate voltage). Driver power requirements also increase as the load is decreased and the grids are driven farther positive.

7) The grid resistance at the peaks of the grid cycle becomes

$$R_g = \frac{255}{0.185} = 1372 \text{ ohms}$$

$$R_g = \frac{230}{0.065} = 3538 \text{ ohms}$$

Thus, in the first example, the driver must be capable of delivering 47.2 peak watts into 1372 ohms and, in the second example 14.95 peak watts into 3538 ohms. It is apparent that the

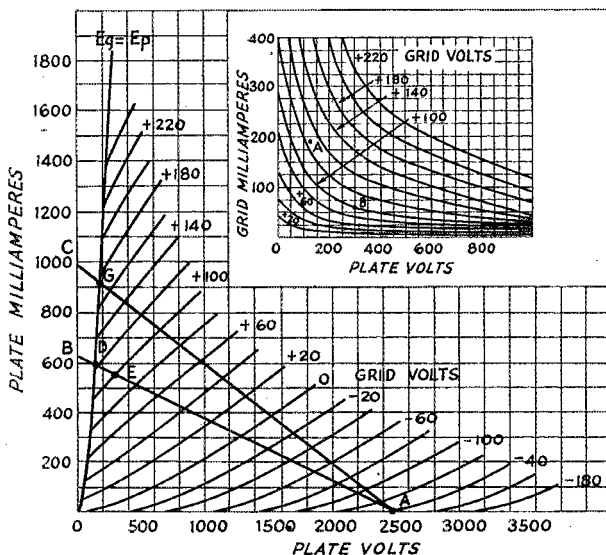

Fig. 1 — $I_p E_p$ and $I_g E_p$ characteristic curves for the Amperex HF200 tube upon which calculations discussed in the text are based.

regulation of the driver must be good to deliver a linear voltage to the grid circuit of the Class-B amplifier which has an infinite impedance when no grid current is drawn and a very low impedance when current flows. In fact, the power requirements and very low impedance in the first example would require exceptional driver regulation and bias-supply regulation if excessive distortion were to be prevented. The value of the grid-current flow itself may exceed the grid rating of the tube. Driver-stage regulation can be improved by the use of zero-bias tubes, which start to draw grid current at a linear rate as soon as the grid signal begins to rise, or by using tubes which are driven barely to the grid-current point at the peak of the grid cycle.

8) The turns ratio of the transformer is dependent upon the load required for the driver tube. Thus, as in the second example, if a 230-volt peak signal at 14.95 peak watts is required, the turns ratio of the transformer must be chosen to furnish this voltage from the plate load of the driver when the driver tube is developing the required wattage (due consideration to be given to the efficiency of the transformer).

$$T = \frac{E_p(\text{max}) \text{ (driver)}}{E_g(\text{max}) \text{ (Class-B grid)}} = \frac{\text{turns ratio, total}}{\text{primary to one-half secondary}}$$

To obtain the best regulation, a driver tube should be chosen which will require a step-down ratio from primary to one-half secondary. This means that the driver should appear as a low impedance to the Class-B grids so that variations in grid impedance will not affect the output of the driver so readily. Likewise, distortion is minimized by the use of a triode driver which, compared to a pentode, is less critical in regard to load variations.

Output Matching

9) To match the output of a Class-B stage to a modulated r.f. stage, transformer output is necessary. The turns ratio of the transformer is calculated in the same manner as in the case of a transformer coupling a speaker to an output stage. In the case of the modulated amplifier, the secondary impedance is actually that represented by the current drawn, and voltage applied, to the radio-frequency amplifier to be modulated. If the stage to be modulated draws 400 ma. with 3000 volts applied the secondary impedance is

$$Z_s = \frac{3000}{0.4} = 7500 \text{ ohms.}$$

Since the primary impedance is the load required by the Class-B stage, or 16,000 ohms plate-to-plate,

$$N = \sqrt{\frac{16,000}{7500}} = 1.46 \text{ primary to secondary}$$

With a transformer of a given ratio it is sometimes possible to vary the load presented by the modulated stage and, in this way, more properly match the Class-B stage. This can be accom-

plished by changing the antenna loading over a limited range.

10) Distortion in a Class-B stage is caused by poor driver regulation at the peak of the grid cycle and by the non-linear characteristic composite curve at the low plate-current cross-over point. Grid-current distortion is increased as the grid is driven more positive; low level (cross-over) distortion increases as the zero-signal plate current is reduced, or the amplitude of the applied signal is reduced to a low level. It is evident that the more the grid swings positive, the lower the grid impedance becomes and the greater the required peak driving power. Thus the driver and bias regulation must be excellent. Low-level distortion increases as the cross-over period (overlap of the two plate currents) becomes longer. Thus, for *strictly Class-B* operation, the distortion is at its highest. Since the low-level distortion is of the same amplitude regardless of signal amplitude, the actual *percentage of distortion* increases as the signal is reduced in amplitude. Thus it appears that for operation with the least distortion, for a given signal amplitude, the Class-B stage should be operated at the highest zero-signal plate current (toward AB₂) permissible without driving the grids excessively positive or exceeding the manufacturer's ratings for the tube. This rule does not apply strictly to the zero-bias tube which may have slightly less distortion when operated with a small amount of negative bias and a corresponding increase in grid signal voltage. In this case we are not so much changing the type of operation as we are causing the tubes to overlap a little more at low plate-current values.

Free Radio Training Available to Ex-Servicemen

(Continued from page 38)

Since the length of training for which a veteran is qualified depends on the length of his active military service, the Veterans Administration cannot undertake to advise a man on this point prior to his discharge.

When a man in the service receives his discharge, he is furnished a booklet describing in detail government benefits to which he is entitled, including vocational training and instruction, and he may then file V.A. Rehabilitation Form 1950 with the regional office of the V.A. of his own State; or with a regional office in the State in which the school or college he wishes to attend is situated; or with the school or college itself. He must meet the usual entrance requirements of the institution he selects.

Before picking a school far from home, it is well to note that transportation, meals and lodging to and from school are paid by the veteran and not by the government. He must also begin his course of study within two years from date of discharge, or two years after termination of the war, whichever is *later*.

The Troubles of a Wandering Ham

An AACS Man Finds Further Adventures in Asia

BY MAJOR JAMES W. HUNT,* W5TG-W5CCU

EVERY so often, I guess, a ham gets the yen to report his amazing experiences to his fellow hams. Well, sir, the last report I sent in was about the fabulous Kee bird of the Arctic.¹ Everytime I think of that bird I shudder and look under the tables and behind me. Thank goodness I am safe over here in the Himalayas.

I am glad now that I have always considered truthfulness one of life's greatest virtues; otherwise I am afraid there are some who would doubt my veracity.



Asia is a perfectly wonderful land and I recommend it highly to every ham. In fact, I think it would be nice if every ham could bring his mother-in-law over here for a few months, say from May to September. The people are very friendly — just disregard the hungry look in the eyes of some of them. The tigers, cobras, hyenas, elephants, etc., even though very thick all over India, are of very little trouble. Not a single one of our boys has been eaten in three days now. Carelessness is the usual cause of the fellows getting eaten up like that. They all know better than to go from building to building in groups of less than ten and with less than two machine guns. But you know how careless Americans get.

As I believe I mentioned once before, radio communications is my specialty. The Army Airways Communication System is responsible for the radio safety of all our aircraft in flight over our world airways systems. We get the aircraft to the combat zones where they go over on their own combat frequencies and use their own combat personnel. We just get them there, get the supplies and men there through helping the ATC, and we collect the weather data for them. We run the ranges and homing beacons, we run the direction finding equipment and find the planes when they

are lost and lead them into a safe runway. We even can bring them in safely when they cannot see the runway ten feet above it. We give them any information they desire while in flight, and we get them out to the runway and into the air safely as well as get them out of the air and onto the ground safely.

Besides doing all that, we have great nets of radioteletype circuits that gargle away and send more traffic than has any right to be sent even on good equipment. In addition we have lots of other equipment that causes hams to drool at the mouth and get wild looks in their eyes. Truly, a ham is as near Heaven as he ever expects to be when he is in the AACS.

Now, you can imagine that we get into very peculiar fixes and see many new things. I have been very fortunate in being able to study the near impossible radio conditions along the North Atlantic route. The story of our experiences along that route will make very interesting reading whenever the full details can be told. Such things as using a mobile relay station between two fixed stations — this station 25,000 feet high and half way between the two ground stations.²

Now I find another land with its peculiar conditions. Here in Asia we have pretty bad sandstorms, terrible heat and it even gets damp at times. The sand is so bad that it caused us great embarrassment at one station. We do not like to talk about it much. However, this station, Butchbehas, was only a small station of a few thousand

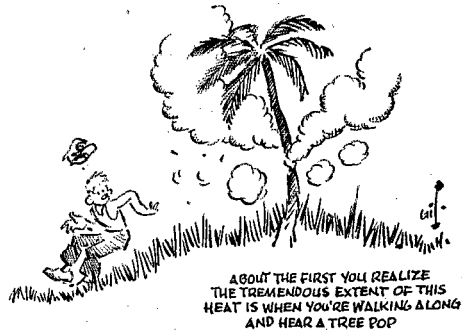

soldiers. The runways were short, being only about 15,000 feet long each (ten of them). It was built one afternoon by the engineers. Naturally, we put up the control tower over operations, put in the point-to-point circuits, installed the d/f and the remote receivers, and the various power plants that seem to pop up under every bush

(Continued on page 88)

* APO 885, c/o Postmaster, New York, N. Y.

¹ Hunt, "The Wail of the Kee Bird," *QST*, October, 1943, p. 50.

² DeSoto, "Hams and the AACS," *QST*, August, 1944, p. 12.



STRAYS



Prompt and numerous have been the challenges to the claims of W2JA and W2RB that they are the only hams with two-letter calls in the second call area who operated under their existing calls before World War I and who are still in the game under their original calls. (Strays, *QST*, October, 1944, p. 57.) The challengers to date include: W2BO, 1912; W2EC, 1913 (2NX, 1911); W2GC, 1913 (DV, 1908); W2IW; W2KR; W2KU, 1913 (MA-QX-ILG, 1907-1910); W2NV; W2PC, 1916 (license No. 5157, 1913).

A number of functions of the Signal Corps relating to aviation communications are being taken over, effective November 1st, by the Office of the Air Communications Officer. The transfer includes the research and development functions of the Signal Corps connected with aviation radio, radar and electronics and, in particular, the Aircraft Radio Laboratory at Wright Field, Ohio. However, the procurement of aviation communications equipment and the current critical items of air-borne radar will remain with the Signal Corps' Procurement and Distribution Service until after Victory in Europe. Both the functions and personnel of the Signal Corps connected with the aviation communications functions will be transferred, as will all fixed communications plants in the AAF airfields and other AAF bases and camps. Besides the Aircraft Radio Laboratory at Dayton, the functions and personnel in the Office of the Chief Signal Officer handling research and development and equipment planning under the Engineering and Technical Service, including the Aircraft Radio Division, Air-borne radar and certain sections of the Electronics Division, will be transferred.

It has been reported that over 50,000 radio transmitter crystals have been salvaged from battle-damaged U.S. military planes and put back into service with the help of a crystal tester invented by T/Sgt. James T. Hohmson, a radio technician at an aircraft repair and modification depot in England. The tester gives an instant visual picture of the exact frequency of the crystal, and at the same time indicates the crystal's ability to stand up under the vibration of a plane in flight.

Lt. Alan N. Houghton, the son of ARRL Treasurer David H. Houghton, was awarded the Distinguished Flying Cross on October 18th. The bombardier on a B-24 Liberator with the 8th Air Force, Lt. Houghton also has received the Air Medal with three Oak Leaf Clusters. Dave's face is beaming these days and everything's just fine in *QST*'s Circulation Department!

Ripley's "Believe it or Not" column in the Washington, D. C., *Times-Herald* for August 28, 1944, featured this item: "Ollie Ross, Vallejo, Calif., radio DX champion, has tuned in and verified every known station in the world — 1367 radio stations in 76 countries." We hope even Ripley doesn't believe that one!

Signal equipment which weighed 97,000 pounds and which was urgently needed by troops in France recently was transported by planes of the Air Transport Command from New York to the battlefields in approximately 30 hours. It was one of the biggest air lifts ever accomplished in the European Theater of Operations.

A new television transmitter to be procured for the Columbia Broadcasting System by the Federal Telephone and Radio Corporation will initiate broadcast application of the principle of sending sight and sound signals on a single carrier. The transmitter will permit a high degree of definition in black and white and in full color. The sound and picture signals are combined at the studio, then broadcast as a composite signal.

Combining video and audio transmission on the same carrier is a technical innovation of great advantage both in the construction and maintenance of the station and in benefits to the radio audience. Lower first cost of the station, less power consumption, less space requirement and fewer high-power tubes are advantages deriving from the fact that this system uses a single transmitter in place of two independent transmitters formerly required for television transmission.

Receiver design is simplified by a reduction in the total number of tubes required. More than twice the detail heretofore possible can be seen, and a larger home screen can be used. Greater focal depth will provide more lifelike images, and objects in motion will be screened with greater clarity.

The greater sharpness of the television image in this fine-screen reception arises from the ability of the equipment to transmit an image on a broad band of frequencies. Special vacuum tubes had to be developed for this purpose. The advent of color television is thereby facilitated.

The station will be located in the Chrysler Tower, in New York City, nearly 1000 feet above the street, and will serve an area with an estimated eleven million people. Programs originating in the studios of WCBW, in the Grand Central Terminal, will be broadcast.

Extension of the new type of picture service to other localities is being planned, but will be paced by public acceptance of the fine-screen pictures and by the availability of new intercity transmission facilities.

For the feat of capturing the powerful Luxemburg radio station, Robert M. Pierce, an Office of War Information employee and former chief engineer of WGAR, has received a second citation: Pierce entered Luxemburg with the American armored vanguard and, commandeering a group of tanks, he surrounded and took the radio station before its German occupants had a chance to damage it. His first citation was received last year when he helped bring about the surrender of the Italian fleet. When Allied authorities were at a loss for a way to get a surrender appeal to the Italian fleet, Pierce recalled that all ships listen to the international distress frequency. Resurrecting some old radio gear, he tuned it to 500 kc., broadcast the appeal, and the fleet gave up.

According to the Navy's Incentive Division, a modern battleship requires more than 1600 electronic tubes to make her a great fighting mechanism, while an aircraft carrier requires approximately 1550 tubes.

Anglo-American Hamfest

THE first Anglo-American hamfest was held in England on September 23, 1944, in conjunction with the Radio Society of Great Britain. Arranged by Major Joseph D. Andrew, W4EFG; F/Lt. John Clarricoats, G6CL, and Lt. Col. David Talley, W2PF, the meeting was held in the dining room of the Mostyn Red Cross Club near the Marble Arch in London. Of the seventy hams present one was Canadian, twenty-one British and the rest U. S., every U. S. radio call district being represented. Those attending included: U. S.: W1APQ, 1BMV, 1DJC, 1DTS, 1DUJ, 1KMH, 2ERS, 2HGP, 2LR, 2NC, 2NJC, 2OHG, 2PF, 3USA, 4EFG, 4FKR, 5EEB, 5HXL, 6BLX,

6DCT, 6OCA, 6RPE, 7GZI, 7IDZ, 7IXV-600V, 7IXX, 8FFK-SURA, 8IZG, 8KCG, 8KFZ, 8OMM-8GYO, 8QBU, 9CCS, 9DPU, 9FVQ, 9FET, 9LPO, 9IVB, 9IWH-9ESQ, 9KOW, 9LTX, 9MFD, 9SNW, 9SYX, 9VUD, 9YKA, and 9YNX. Great Britain: G2IG, 2MI, 2TJ, 2YL, 3ST, 3SU, 3UH, 3UQ, 3YY, 4KY, 5LN, 5PY, 5QF, 6CL, 6GR, 6WN, 8KZ, 2APH, 2CBB, 2FWA and 2PXL. Canada: VE3DG.

The meeting was called to order by the prime mover, Chaplain Andrew, followed by introductory remarks by Major Talley as acting chairman. E. L. Gardiner, G6GR, president of RSGB, spoke briefly and John Clarricoats, secretary of RSGB, gave a talk on the RSGB and amateur radio in England prior to the war.

During the open forum part of the meeting discussions of postwar plans and activities brought forth these views concurred in by almost everyone present:

1) An international conference of amateur radio interests should be held prior to the International Telecommunications Conferences to exchange views and agree on the ham point of view.

2) The 20-meter 'phone band should be at one end of the band or the other and not in the center, the same to apply to any other 'phone bands that may be allocated in the future.

3) Encourage the full use of frequencies of all amateur bands and discourage crowding together at one end of the band.

4) International exchange of non-commercial messages should be permitted (more of a British amateur matter).

5) Greater attention should be paid to antenna design instead of high-power operation.

6) Amateur frequency allocations should be the same width internationally, especially on the DX 10-, 20- and 40-meter bands.

The hamfest concluded with refreshments and rag-chewing, and with the prospects of another meeting to be held on October 28th.



The group of British, Canadian and American amateurs who attended the first Anglo-American hamfest held in London, England, September 23, 1944. Every U. S. radio call district was represented.



HINTS AND KINKS FOR THE EXPERIMENTER

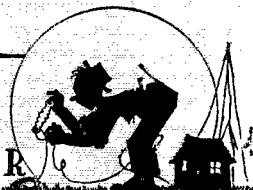

VARIABLE VOLTAGE TAP FOR POWER SUPPLY

A SOMEWHAT unconventional means of obtaining an adjustable voltage tap for a power supply is shown in Fig. 1. Any voltage from zero to maximum is made available if R_2 equals or, preferably, is slightly less than the total resistance of the potentiometer, R_1 . Since R_2 shares some of the voltage drop, the power-dissipation rating required for the potentiometer is reduced. Since the voltage per degree of rotation has been reduced by half by the introduction of the series fixed resistor, the setting of the potentiometer to a desired voltage will be less critical than would be the case if a potentiometer of adequate power rating were employed alone.

By inserting another fixed resistor, R_3 in the circuit, the device becomes useful as a signal attenuator. The voltage per degree of rotation is spread greatly for large values of R_3 . Values giving an output from zero to one tenth of the input and, with reversal of the d.p.d.t. toggle switch, from one tenth to two tenths of the input, are given in the caption for Fig. 1. Of course, other ratios of resistance may be employed.

SELF BIAS APPLIED TO THE TR-4

THE Syracuse Squadron, New York Wing, CAP, uses three Abbott TR-4 transmitter-receivers operating from planes in its WERS network. "Close-talking" microphones are used to minimize response to flight noise. These require greater speech amplification than that available in stock models of the TR-4.

Sgt. David Foote, assistant communication officer of the squadron, observed from the published wiring diagram of the TR-4 that the $4\frac{1}{2}$ -volt microphone battery also is employed as a source of bias for the 7F7 amplifier stage. From the tube-data sheet he noted that a 2-volt negative bias is recommended for the 7F7 when operated at a plate voltage of 250.

Sgt. Foote then made the necessary changes in the TR-4 circuit to free the microphone battery

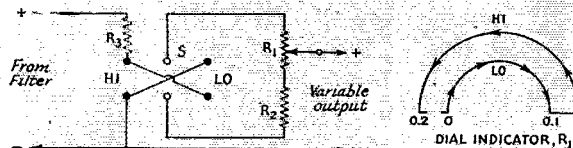

Fig. 1 — The circuit of a variable voltage control for the output of a power supply.

R_1 — 0.1 megohm potentiometer. R_3 — 0.8 megohm, 2-watt.
 R_2 — 0.1 megohm, 10-watt. S_1 — D.p.d.t. toggle switch.

from bias service and provide for self bias on the 7F7, as shown in Fig. 2.

The 7F7 grid return at the transformer, T , was disconnected from the negative terminal of the

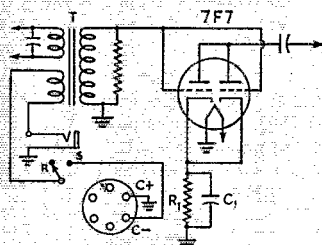

Fig. 2 — Diagram of the revised audio circuit for the TR-4, to substitute self bias for the microphone battery connection to the 7F7 tube. C_1 is a 0.1- μ fd. paper condenser, R_1 is a 1000-ohm, $\frac{1}{2}$ -watt resistor.

microphone battery and grounded. The cathode of the 7F7, originally grounded, was disconnected from ground and a 1000-ohm, $\frac{1}{2}$ -watt resistor, R_1 , shunted by a 0.1- μ fd. paper condenser, C_1 , was inserted in series with the cathode and ground. The microphone transformer remains connected to the battery when the change-over switch is in the "S" position.

These simple changes resulted in a considerable increase in amplification in both receiving and transmitting. — Jerome Blaisdell, 2nd Lt. CAP, 5323 So. Salina St., Syracuse, N. Y.

RENEWING BURNT-OUT TUBES

MANY, though not all, high-voltage tubes of the type used in a.c.-d.c.-type broadcast receivers may be restored to normal operation when the cause of their "going west" is a burned-out heater. The method is that of snapping high voltage across the heater pins on the base of the tube.

The voltage applied should be of the order of some 500 to 800 volts or more, and may be either a.c. or d.c. A simple means of getting at the high voltage available from any transformer-operated receiver is to pull out the rectifier tube and take the voltage from the plate connections of the rectifier. The d.c. output from a high-voltage power supply may serve the purpose just as well. Of course well insulated leads, together with considerable caution, must be used for personal safety.

Before turning on the high-voltage switch, one lead should be connected to

one of the heater pins. Then the power is turned on and the other lead is snapped across the unused heater pin three or four times in succession. The higher the voltage rating of the tube under repair, the greater will be the number of times this must be done. With metal tubes whose heaters cannot be seen when they light up, a little experience undoubtedly will be required before the exact number of flashes may be determined. With glass tubes the job is simpler.

Observing the brilliance of the cathode in a tube of the glass type as it is heated by the surges of current pumped into the heater during the flashing, the intervals of flashing and the number of flashes should be timed to bring the heater approximately 25 percent above normal. Keep it at this temperature for about a half minute to allow a good welding job to be made internally.

If such a rejuvenated tube continues to operate for a period of one-half hour when replaced in the receiver from which it came, it is practically certain that the tube will be good for at least six more months of service. Not all tubes will respond to this treatment, but the percentage of "cures" is amazingly high and well worth the effort to restore in this manner. — *Joseph S. Ferland, W1CKZ.*

B.C. RECEIVER ADAPTED FOR SHIPBOARD P.A.

MANY ships use a Scott broadcast receiver connected to speakers in the various mess rooms below. The Scott may be used as a public-address amplifier, for making announcements to the ship's company.

There is a terminal board in the rear of the receiver with connections for a crystal phonograph pick-up for record playing. A crystal microphone may be connected to these terminals or even a pair of magnetic headphones. The switch on the front panel of the receiver is set at "PHONO," and the announcer talks into the mike or the headphone substitute. — *Jack C. Nelson, W8FU.*

IMPROVED AUTOTRANSFORMER

A SUGGESTION is offered which may be considered an improvement on the design for an autotransformer described by W9TUJ on page 59 of October *QST*.

It will be observed that his transformer must be designed to carry the total current consumption of the applied load whereas with the design shown in Fig. 3 the power-handling capacity required is only sufficient to withstand the desired difference in line voltage. As an example, assume a line voltage of 120 in which a reduction to 110 volts is desired. In W9TUJ's transformer, the total core, diameter of winding, and number of turns must provide a total inductance and current-carrying capacity to satisfy the requirements of the 120-volt primary source, and it must be capable of delivering 110 volts at the current rating demanded by the load.

In the suggested design, the secondary, tapped for various voltages, must supply only the difference between the voltage requirements. In the case of a 120-volt line, reduction to 110 volts would require a transformer capable of supplying only 10 volts at the load-current rating.

By placing a switch in the primary of this autotransformer it is made equally useful for raising voltage as well as lowering it, by shifting the polarity of the primary connection of the transformer to the supply line.

The secondary must have a wire size capable of carrying the current demanded by the load, but in most cases a suitable transformer can be made by winding a tapped secondary of No. 12 soft-drawn copper wire over the windings of a large-size receiver power transformer. Such a transformer when wound with the proper number of turns will either increase or decrease the line voltage, depending on whether the secondary is bucking the line voltage or adding to it.

When the transformer is used in a voltage-bucking position it has a tendency to stabilize line-voltage variation inasmuch as a drop in line voltage will be reflected back to the primary of the transformer. This will in turn lower the voltage in the secondary, resulting in a lessening of the bucking effect on the load side. Yet the ratio of voltage correction will still depend upon the secondary output voltage of the transformer. With a line voltage of 120 and a secondary bucking voltage of 60, the load side of the transformer would have only one-half the voltage variation of the primary. In other words, the voltage regulating ability of the transformer is inversely proportional to the primary/secondary ratio of the transformer.

It should be noted that the effect just described is reversed when the transformer is used with the secondary voltage additive to the line voltage.

The writer's transformer is assembled within an old radio-analyzer case to give it portability. It is constructed with a selector switch on the panel. The points of the switch are given dual markings, i.e., the point marked 105-125 is the one at which with a normal line voltage of 115 volts, the output of the transformer will be 105 volts on the low or bucking side, and 125 on the high or additive side, depending on the position of the primary-reversing switch. — *Jack R. Zeckman, W7DVK.*

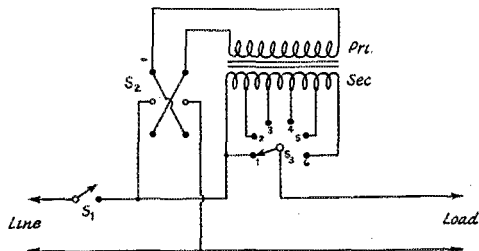

Fig. 3 — Circuit of autotransformer.

- S₁ — S.p.s.t. toggle switch.
- S₂ — D.p.d.t. toggle switch.
- S₃ — Multipoint rotary selector switch, single gang.

VOICE-CONTROLLED TRANSMITTER SWITCHING

BEING a very lazy person, I want to eliminate as much work as possible in the operation of my postwar rig. Here is a system to eliminate all the drudgery of pushing a button or moving a toggle switch to turn on the transmitter! (There are some other advantages to be pointed out.)

The circuit is shown in Fig. 4. The controlling elements of the device are the two potentiometers, R_1 and R_2 . Together with C_2 , R_1 is the time-delay control. It can be set to hold the transmitter in operation from zero to a maximum of about 5 seconds after the operator stops talking.

R_2 is the threshold control which allows the operator to adjust the input level to suit his own particular requirements. Experience proves that this control can be set from a point where shouting into the microphone will not turn on the transmitter to another point where the sound of steps in another room will actuate the device. Somewhere between these points a setting will be found where normal speech from a distance of one inch from the microphone will throw the transmitter into operation.

The original circuit employed two 6C5 triodes as shown in the diagram. One is used as a rectifier, with grid and plate tied together. The other is used as the control tube. One of the new dual-triode tubes, such as the 6SN7 or the 6SL7, having separate cathode terminals for each section, may be used instead of two separate tubes.

The operation of the circuit follows. Audio voltage from the driver plate of the speech amplifier is fed through a 0.01- μ f. condenser, C_1 , to the plate and grid of the rectifier. Rectified voltage from the cathode of this tube is direct-coupled to the grid of the control tube. Thus the flow of current through this tube and through the relay connected in its cathode circuit is speech controlled. There is no time lag between the time the first word is spoken and the time the relay closes, thus starting the rig.

Two disadvantages appear in the use of this method of transmitter control. It requires that

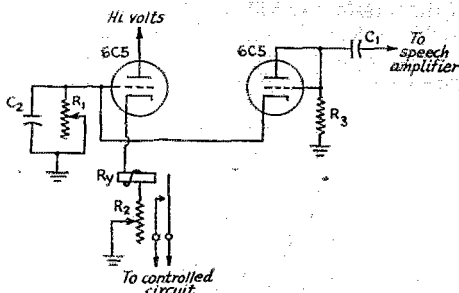

Fig. 4 — Diagram of circuit for voice control of transmitter switching.

- C_1 — 0.01 μ f., 600 volts.
- C_2 — 1 μ f., 200 volts.
- R_1 — 5 megohm potentiometer.
- R_2 — 25,000-ohm potentiometer.
- R_3 — 1 megohm, $\frac{1}{2}$ -watt.
- R_7 — 2500-ohm s.p.s.t. relay.

the speech amplifier as well as the control unit be in continuous operation. Further, if the threshold control is set too high, excessive volume from the loud speaker may operate the device during receiving stand-by periods. If headphones are used the latter disadvantage is removed.

Advantages would seem to equal or outweigh the disadvantages. It makes possible break-in operation comparable to the best c.w. practices. With the high-speed change from transmitting to receiving, operation is as natural and pleasant as with the outlawed "duplex" 'phone operation. The operator who has formed smooth speech habits will not be bothered by the clacking of the relay, but the "Ah — er" operators will be rebuked by the interruptions of the relay, a possible aid to reformation! Properly adjusted this speech-control circuit will be very helpful. It will be black magic, or at least a source of wonder, to uninitiated visitors to the shack. If used at both stations in communication it will produce a favorable impression of amateur radiotelephone operation in the minds of some who find it hard to understand why the party at the other end, in many amateur stations, does not come right back in reply to questions and remarks, as in land-wire telephone conversations. — "Lazee Bones."

— — —

THINNER FOR COIL CEMENT

A STATEMENT on page 421 of the 1944 edition of *The Radio Amateur's Handbook* suggesting the use of acetone as a thinner for Duco cement seems to be misleading.

The use of acetone as a thinner in reducing lacquers or cements is not a good policy. Although acetone is an excellent solvent, it evaporates very rapidly. Under certain conditions this will cause "blush" or white spots to appear in the finish. "Blushing" also is caused by improper proportions between solvent and cement. It usually may be removed by painting the spots with butyl acetate or amyl acetate.

However, a much safer thinner to use would be one of the commercial brushing-lacquer thinners, butyl acetate or amyl acetate. The latter is sometimes referred to as "banana oil."

Acetone, chemically classed as a ketone, is distinct from amyl acetate (banana oil) which is an ester. — Garrett E. Brown, 179 Harrison St., East Orange, N. J.

Strays

Instructor: "What kind of a tube is this?"
(Pointing to the schematic symbol for a triode.)
RT3c: "RCA, I guess." — W. T. W.

— — —

There's one of them there Kee birds flying around Hq. these days. Every time we receive a letter with no return address on it, he starts squawkin', "Kee-kee-rist, why doesn't the sap put his address on it?" It's surprising how much squawking he's been doing lately.



CORRESPONDENCE FROM MEMBERS

The Publishers of *QST* assume no responsibility for statements made herein by correspondents.

DESIRABLE CITIZENS

597 Fifth Ave., New York 17, N. Y.

Editor, *QST*:

I strongly feel that you and Mr. Bailey are indeed to be congratulated on the extremely clear, forceful, and persuasive presentation of the case of the amateur, a copy of which you were so kind as to send me. Certainly the amateur fraternity could not desire or hope for a more competent and devoted team.

I have an additional reason why the radio amateur is a most desirable citizen. It is because he represents an example of liberty of action, freedom of thought, and opportunity for self-instruction and growth. His work encourages enterprise, originality, and lack of slavish acceptance of principles laid down by others. Thus he preserves a fine scientific and human tradition — and one from which the people of many nations have of late increasingly deviated to their vast detriment and the great hurt of the world. As a matter of fact, I would rarely find cause for worry about a nation which encouraged its citizens to enter the highways and byways of individual experimentation.

— Dr. Alfred N. Goldsmith

THE VKs EXPRESS APPRECIATION

90 Railway St., Cottesloe, West Australia
Editor, *QST*:

We wish to express our thanks for the timely aid rendered the Commonwealth of Australia by American arms in the Pacific. The days after Pearl Harbor brought this country face to face with the danger of imminent invasion by an inhuman foe flushed with the results of victory throughout the Far East. They were indeed dark days for Australia, and we would like you to know that the tide was turned by British Naval power in the Indian Ocean and by immediate Naval and air aid from the United States. We feel that every citizen of the United States can feel justifiable pride in the magnificent assistance given to this country in her great hour of need.

The prewar Australian amateurs are mostly scattered far from home in the fighting services or other essential work, but they will be with us in thanking you of the United States.

We have been privileged to meet some Ws far from their homes who have been out to meet the Japs in planes and ships and subs, and we know at first hand what a magnificent job they are doing. We cannot say more now.

Let us hope that in the postwar period the British Commonwealth and the United States will cooperate in bringing peace and sanity to the world. We see in such cooperation our great hope for the future.

— M. S. Urquhart, VK6MU
S. E. Austin, VK6SA

BURNING DESIRE

AP0 957, c/o Postmaster, San Francisco, Calif.
Editor, *QST*:

After four years of this bloody mess and finally returning minus a lung and assorted parts to comparative civilization in Hawaii, I find myself with a burning desire regarding the present status of *QST* and the amateur world in general. . . . My license, under the call of W2HUH, expired in November, 1940, but my interest and love for the game most positively did not!

The nights were many "down under" when I wished the hell I were back home pounding brass in front of the rig and the blessed Super Pro! Those were the days, and with your help, I may see them again.

— Capt. J. Schwyler, ex-W2HUH

THE ORGANIZATION ELECT

AP0 608-M, c/o Postmaster, Miami, Fla.
Editor, *QST*:

QST is slow in getting out here, but when it does arrive it is a big day in the rag-chew corner.

As things are looking brighter on all fronts we are inclined to think and do more than a little talking about postwar amateur radio. The conclusions indicate that the ARRL will be the organization elect to insure the return of the amateur gang to the air. That idea, I am sure, is the general one. Hats are off to all who have worked and worked well in keeping the ARRL intact. I can assure you that the AACs gang has many in its ranks who are at this time, or will be in the very near future, lined up behind the ARRL. . . .

Congratulations on the fine job you have done in giving the boys over here a chance to keep in touch with the old hands in the amateur radio game. The gang has been off the air for some time, but many a good QSO has been accomplished through the medium of *QST*. At this point it seems only proper to give a vote of thanks to the SCMs who have done a grand job in keeping in contact wherever and whenever possible with the members of their respective districts. . . .

In conclusion, I would like to make appreciative mention of the fine account of WERS activities that *QST* has maintained since the beginning of this field of radio operation.

— *S/Sgt. Francis X. Martin*

N.C.R. FOGIES

India

Editor, *QST*:

Regarding "NCR Fogies," page 8, in the August, 1944, issue of *QST*.

It might interest you to know that NCR time helped me get my first foggy eleven months ahead of schedule. So, your friend isn't the only one — I thought of it, too — and was pleasantly surprised!

Went on active duty with NCR in January, 1941, but bounced out due to color blindness. The cadets — a quick promotion — China — and now back in India "sweating out" rotation — is the rest of the story.

— *Lt. S. R. Rose, AC, W9VKC*

RE: "A TRIBUTE"

Editor, *QST*:

Regarding the letter from Captain James H. Rose, AC, W8PDU, in the October issue of *QST*, page 60.

Paragraph 1: Takes offense because some officers in the Navy are of the opinion that some amateurs are not measuring up. Comment: Is he implying that all amateurs are perfect?

Paragraph 2: Presents military history. Comment: None. My military history: Enlisted man in the Army Air Forces from 1930 to 1942, officer in the Army Air Forces since that time. Have worked with, for, and taught thousands of communications personnel from the brand new ham, to the GI school graduate, radio serviceman and engineer. All have their faults, the amateur not excepted. The ham is not necessarily outstanding from any standpoint.

Paragraph 3: No comment other than when his ham in OCS graduates, he no longer will have "the best radio-operator-mechanic."

Paragraph 4: Operators? Captain Rose has worked with hundreds. I have worked with thousands — aircraft, ground and field operators — both former hams and the GI radio school graduates. Have noted nothing outstanding in either as a class, except that the ham usually had a background upon which to base his military operating.

Paragraph 5: Use of abbreviations. Captain Rose must have an exceptional individual if his chief op has never used them. In peacetime operating these help clear traffic, and lend a touch of life to straight 8-hour tricks at the bug. Certainly, many GI radio ops have picked them up and in many cases used them. However, both the GI op and the ex-ham op are guilty. The shave-and-a-hair-cut routine, I must admit, is strictly GI. It has no part in wartime communications,

but during peacetime on the graveyard shift when traffic was slow, it certainly felt good to know that someone else was with you, and on some circuits the last "dit" would go all over the country.

Paragraph 6: Agreed.

Paragraph 7: So your nets are run on a 20-word basis. Well, that is necessary due to mass production of operators. Circuits are much slower than they should be. Before the war, our circuits were 35 w.p.m. and up. We broke in our ops on 20 w.p.m., and held them on the lazy shifts until speed was attained. I'd hate to think of what might have happened if we had a 20-w.p.m. man on one of our fast circuits during the hours when traffic was heaviest. Heck, I remember when time for relief came, the ops would have to switch headsets and continue without a break in copy. The fast men, without exception are considerate of the others in the net if they cannot copy at their speed. That was a dirty dig at the old Army op, and was uncalled for. I have seen many men try to snow other ops under, and both hams and GI ops are guilty.

Paragraph 8: There are all types of communications officers. Preventive maintenance and "tinkeritis" are as different as day and night. A liberal interpretation of technical publications in regard to maintenance is necessary to keep a rig in operation with a minimum of off-air time. A good communications officer will encourage this if it does not work to the detriment of the equipment. In one of my outfits we have had no off-air time for as much as two and three years. This is not due to the fact that the men operating and maintaining the equipment were former hams, and this particular unit had tropical conditions to battle.

Paragraph 9: The ham needs no tribute, not any more than any other man who has been drafted or enlisted to serve his country. This is not a tribute to the GI op either, but it is in rebuttal for some of the remarks made regarding the old Army operator.

— *S. A. L., Major AC, ex-K6KTF-K5AX*

201 So. Balliet St., Frackville, Pa.

Editor, *QST*:

Captain Rose's letter reads pretty good to me, but holy caramba, a good operator from the "old Army" never sort of shows-off just to be a hot-shot. Personally, I think Capt. Rose does not know the difference between a "ham" and a "regular" — for most "regulars" are hams as well and are of the "old Army" school, or "old Navy" school as the case might be. I personally would take that crack at the "regulars" as a direct insult to some good Army men whom I know.

Lots of traffic can be moved on a 20-w.p.m. circuit, but there are many times when an operator would block the circuit if he couldn't take and do 35 or more. . . .

— *Bern Felsburg, W8VD*

REGARDING A COMMON LANGUAGE

1717 University Ave., Madison 5, Wis.
Editor, *QST*:

The correspondence section of *QST* for October contained a letter from W8UPH which, in my opinion, presents a suggestion worth consideration. I have always been a firm believer in the theory that it is easier to settle differences between countries with the same language than where all discussion or correspondence must be carried on through an interpreter. I think the possibility of the amateur learning enough Spanish, or any other language, to enable him to carry on a limited conversation via ham radio should be given serious consideration.

— Jerry L. Dame, W9TPS

HE SAW "THEM"

3105 Midvale Ave., Philadelphia, Pa.
Editor, *QST*:

Just received my first copy of *QST* since my return from the Southwest Pacific area. . . . Want my story? Here 'tis.

Left the Philadelphia Signal Depot right after Pearl Harbor. Flew to the West Coast, boarded a ship and sailed with a task force to destination "X." Sailed around for a very long time and finally landed in Brisbane, Australia. When I left the States I was radio repairman (principal) and when I landed I was a radar expert — it said so in my orders!

I had W2FOB with me. We set out to fix up all of the radar sets in New Guinea and Australia. [A photograph of W2KJY taken in New Guinea appears on p. 22 in this issue. — Ed.] The invasion of Australia was very probable at that time so we really had a job cut out for us. Lou, 2FOB, and I worked like busy beavers for ten months *all* over the place. Equipment was in pitiful condition, and to make the job harder spare supplies were nil. We made some of the funniest substitutions ever heard of. Tin signs made transformer cores. Shellac was our best insulator against moisture. We painted everything with it to keep the gear working.

After the first year the Japs gave up trying to advance and started "straightening their lines." Lou went to Perth and settled down with a coast artillery outfit and I went to Sydney to study airborne radar. I got "so good at it" they sent me up with each load of equipment to set it up in the front lines. I got close enough to see "them" and that's *too* close for a civilian. The funny part of the deal was the fact that I had to wear insignia on my arm to tell the Japs I was a civilian. I was told I would not get hurt if I wore the patch, but just in case "here's a .45, learn to use it." I found out it made a good weapon if thrown forcibly, but was very hard to point.

Lou came up again and we had malaria together. After that dengue, yellow jaundice and trench mouth. Then we got transferred to the 5th Air Force. Six months later we were sent via medical ship to Frisco.

Never did I cram so much work and experience into two years. We did animal husbandry, slit-trench diggery, and many other things I didn't learn at Brooklyn Tech. After returning to the Depot I hit the jack pot, and was installed as foreman of the "tropicalization" shop where we fungus-proof all signal equipment for shipment to the many war fronts.

The only things about this city life I don't like are the noise, indoor work, and the women — have to wear blinders most of the time. Hi!

— Ed Kirchner, W2KJY

HIS RÉSUMÉ

c/o Fleet Post Office, New York, N. Y.
Editor, *QST*:

I have been threatening to get this to you for some time, but it took three issues of *QST* to give me the boost.

Just a short résumé of myself to let you know my status. Amateur radio since '35. Finally got my license in '41, and was a member of the National Research Council — which started the ball rolling for the Commission in late '41 — through the questionnaire sent me by President George Bailey. After coming in as an ensign, spent a tour of duty on the beach, then the U.S.S. *Bristol*, and then here where I am communications officer. At present I do not have even an operator's license to show that I'm really a ham — having lost it when we lost the *Bristol* last October. But I shall have it renewed in time — never fear. . . .

Your fight for the hams is up to snuff — and haven't you always been! I'll be meeting you on the hot spot of 40 one of these days.

— Lt.(jg) E. E. Rains

MUTUAL TIES

Key Field Air Base, Key Field, Miss.
Editor, *QST*:

. . . . Although through neglect this Ham is not a ham, I've a strong interest and hope to get a license and a rig one day. Still have my Breting 14AX, which is now distributing all-wave reception to the wards of this station hospital which I command.

Have contacted hams all over the world personally during the 4½ years since I ceased being a civilian. I find a strong tie of mutual respect and friendship wherever I meet one.

— Lt. Col. George H. Ham, MC

BEST SELLER

RAF, BNAF

Editor, *QST*:

. . . . For upward of three years now I have been commanding British radar units and you may be interested to know in what high esteem your *Handbook* is held by the men. I feel that I can safely say that in all the Eastern (not Far East) countries — and I have operated in many — the longest waiting lists at all booksellers were for *The Radio Amateur's Handbook*.

— F/Lt. W. M. Marshall



OPERATING NEWS



CAROL K. WAITE, W9WWP
Acting Communications Manager

LILLIAN M. SALTER
Communications Assistant

WERS — To Be Or Not To Be? With increasing frequency, letters of inquiry keep coming in to us concerning the maintenance of the War Emergency Radio Service after the war. While some of the letters advocate that we turn over an entire amateur v.h.f. band to WERS operation, other letters suggest that definite portions of the amateur bands be assigned exclusively for WERS operation, with the continued requirements of the present WERS operator permits as a basis for operating eligibility.

Strangely enough, not all these letters come from holders of WERS operator permits only, who are very active in WERS work, but they also come from licensed amateurs with prewar experience in amateur operation. In one locality, a licensed amateur of long standing started a movement to get the required support for continuance of an emergency service on the amateur bands, allowing WERS operator permit holders to continue as operators.

We reply that the American Radio Relay League has never advocated the maintenance of WERS, as such, after the war. Amateurs have always been capable of doing a top-notch job in emergencies in normal times, using their own networks on their own bands. It was these same amateurs who became the backbone of the War Emergency Radio Service, when the government established it for civilian protection reasons, after Pearl Harbor. It gave thousands of amateurs the opportunity to put their skill and their idle equipment to work in doing a valuable wartime job.

The WERS was based on the fundamental organization existing in the American Radio Relay League's Emergency Corps, which was a peacetime service in which amateurs participated, and which served much the same purpose as the WERS. The experience many amateurs had

obtained in the Emergency Corps was found invaluable when administrators, technicians, operators and instructors to train other civilians to qualify as operators in WERS, were needed.

When many of the amateurs serving in WERS were called into the armed forces, it was then that the greatest need arose for training of civilian persons for WERS operating assignments. These trained persons have since become very proficient operators, frequently excelling their more technically informed amateur brethren. However, in most cases, the WERS civilian operators have been trained chiefly in operating procedure, lacking all technical instruction except that which is required to operate the switch that puts their WERS unit on and off the air. Thus, it would be easy to imagine the rightful resentment that would rise up among our amateur membership, if they were confronted with the announcement that individuals holding only third class restricted licenses would be permitted to operate on the amateur bands. Nine amateurs out of ten probably would feel that it was not only illogical but unfair to require a high grade of technical proficiency of amateurs to operate on amateur frequencies, and, at the same time, permit WERS operators with such limited radio knowledge to operate on the same bands.

Since it is expected that the already swollen amateur ranks will increase to some tremendous number immediately after the war, it seems impossible to suggest that there would be room for any other type of operator except amateur, on the amateur frequencies.

Strictly speaking, the *WERS is a federal service and not an amateur organization.* ARRL has provided the liaison between OCD and the radio amateur, by carrying articles in *QST* on v.h.f. equipment and WERS administration, and by devoting *Operating News* space chiefly to dis-



This happy group includes the members of the Chicago Radio Traffic Association (CRTA), and their families. The occasion was their annual picnic held at Kiwanis Park in Chicago. Sgt.-at-Arms Sando, W9QV, is standing second from the left; Secretary Haller, W9HPG, is standing third from the left; President Ahlborg, W9AYL, is standing at the extreme right, and Treasurer Taylor, W9ADF, is kneeling at the extreme left. The CRTA is Chicago's oldest amateur radio club

cussions and suggestions concerning the operational aspects of this service. This should not be construed to mean that ARRL advocates perpetuation of WERS after the war, however.

After the war, the AEC or an organization of similar form will undoubtedly exist. It is in this organization that WERS operators, who also hold ham tickets, will be needed. Many WERS operators, not satisfied with training in non-technical matters only, already have enrolled in radio code and theory classes which will prepare them to take the amateur license examination. When they receive their amateur licenses, they will be a desirable addition to the ever-growing amateur family, and they will find rich satisfaction in the continuance of their radio interests as an avocation.

To those WERS operators who are not interested in amateur radio operation after the war, or who find it too difficult to master the code and theory required, we would suggest an investigation into the possibilities of operation of other type radio stations, which would be possible with the licenses they now hold.

It should also be added at this time, that the OCD and ARRL appreciate the fact that many long hours have been put into WERS training, and into WERS operating, by civilian and amateur operators alike. We hope that each one has felt the rewarding satisfaction that comes from doing a job well on the home front. To the amateurs, the "bonus" award will come in the restoration of operating privileges on the amateur frequencies. The door is open to civilian WERS operators to share in this award. An amateur ticket is the stairway leading to the door.

— C. K. W.

WJHH Assists In Cleveland's Gas Explosion Catastrophe

ON THE afternoon of Friday, October 20th, Cleveland, Ohio, suffered one of the worst disasters in its history. The holocaust, with its staggering amount of property damage and loss of life, will long linger in the memories of every Cleveland citizen, and especially in the memory of every WJHH operator in action that afternoon.

Late in the afternoon of that day, John A. Kiener, W8AVH, the radio aide of the WJHH WERS network, was standing on a corner talking to a friend when the first explosion occurred. Although he did not know at the time that it was the first explosion of the liquefied gas tanks of the East Ohio Gas Company, he saw a sheet of flame shoot up about a mile and a half into the air, and immediately rushed to the scene. Realizing that the fire-explosion was of a serious nature, he immediately telephoned the main control center from the fire area and found that preparations were being made to alert and assemble the chiefs of staff. WJHH radio aides and operators were also alerted, less than ten minutes after the first blast.

The immediate response of the personnel of WJHH to the call to serve during this emergency was very gratifying to Radio Aide Kiener. To quote him, "The many months of constant testing, training and practice really paid off that night." Mrs. Mildred Wildman, W8PZA, put the main control center (WJHH-1) on the air, as soon as alerted, and George Lister, W8NVV, rushed over to get the Terminal Tower control station, WJHH-40, in operation. Cliff Noel, W8AXQ, was the first operator to appear at the scene of



W8GW and W8PWY, deputy aides, are shown here on the scene of the Cleveland gas blast, operating WERS unit WJHH-55. The walkie-talkies were found invaluable for use in areas where fallen debris prevented use of car units.

the explosion, operating WJHH-68. Shortly thereafter, a dozen more mobiles and a half-dozen walkie-talkies were put into operation.

The regular and auxiliary public safety services were on the job also from the very first, and it was soon discovered that an auxiliary means of communication was needed to handle the heavy demands for medical, police, fire and utility services. The police radio was functioning smoothly, but was greatly overloaded. WERS was then worked into the operations to give the greatly needed assistance in dispatching of equipment and personnel. In addition to relieving the police radio operators, this service by WERS also released several of the regular, phone stations for additional traffic.

All CD and Red Cross units were on the scene, and communication was furnished for them by the units of WJHH. The Red Cross and other relief agencies had set up four emergency medical and casualty stations to care for the many injured persons. Mobile WERS units were assigned to each of these stations, and other units were deployed in the area and reassigned as needed. Some of the points at which mobile units served were casualty centers, schools used to care for evacuees and injured persons, and hospitals. In several cases, radio units acted as ambulances to carry walking cases from casualty stations to regular hospitals, and in this way, the casualty stations were kept cleared to receive the new cases constantly arriving.

Inasmuch as there was still plenty of danger from further explosions of gas tanks during that afternoon and evening, the rescue work was extremely hazardous. Many injuries were caused by the explosion of manhole covers and sewer lines located as far as two miles from the actual explosion-fire scene. In every instance, WJHH operators stuck with their units at their posts in the face of these dangers. Several units were able to give at-the-spot descriptions of manhole covers blowing several hundred feet into the air just alongside them or in front of their cars. Fortunately, of the fifty operators who served during the emergency disaster, not one was hurt.

In summary, it can be said that several hundred messages were handled during the seven-hour period that WJHH was in operation. The services of WJHH had been made available to the Ohio Bell Telephone Company, all of the gas, light and water utility services, the Red Cross and the entire disaster relief organization in the field during the catastrophe. Twenty-five two-way radio equipped cars, six walkie-talkies and ten fixed report center stations were used, and over forty two-way equipped units were held in reserve during the entire period, but were never used. In anticipation of greater need, the radio aide of the WODF network in Akron, Ohio, Rex Brown, generously offered the services of the entire WERS net there. Fortunately, the

fire was brought under control and the explosions ceased before additional equipment was required.

After the fire had abated, James McArthur, a captain of the Cleveland Police Force who is also chief of plant protection for the local CD, said to the radio aide, "Every part of Civilian Defense showed its real mettle during the disaster. Your WJH group displayed splendid cooperation and performed a very fine service during this terrible catastrophe. You can be proud of their performance."

Additional tribute was paid to the WJH operators, for their work in the explosion-fire, on the news broadcasts from WTAM, WGAR and WHK. The fact that most of the operators were radio amateurs was noted by these news commentators. (Among the amateurs who deserve special commendation for their activity in the field following the rescue movements are: Earl S. Nelson, W8DS, chief deputy aide; Bill Irwin, W8GW, deputy aide, and J. R. Wildman, W8PWY, deputy aide.)

— W8AVH and W8GW

Ham Yarn No. 2

BY MEADE W. POWELL,* W6GS

DURING the many years that I have been an amateur radio operator, my hobby has been a great source of pleasure and full of surprises. Some of my most thrilling experiences have resulted while I assisted others, such as the time that I used my amateur station to help the radio operator on the dirigible "Shenandoah" to find his bearings, and others have resulted while I have been engaged in tinkering and experimenting. The ham yarn I have to tell comes under the latter classification.

My friend, Dell Isabell, and I were avid radio experimenters back in the good old days. One evening, while we were listening to commercial broadcast stations in Nebraska and Los Angeles, we hit upon the idea of going down below the surface of the earth to see what DX we could get.

After some thought, we decided to make the Junction copper mine of the Calumet and Arizona Mining Company, at Warren, Arizona, our site of action. We could get down to 2,200 feet there, and if we chose a Sunday night, we could be free from the reception interference which might be

* 620 East First Street, Tucson, Ariz.

Ham Yarns

What is the most unusual experience you have ever had in connection with ham radio? Have you ever had a QSO that took place under peculiar circumstances, or that resulted in an exciting adventure? Have you ever been surprised, terrified, or highly amused at some incident that occurred during the good old days when you were operating your ham rig?

CD invites you to submit your story of the most unusual ham yarn you know of, whether experienced by yourself or a fellow amateur, for possible publication in Operating News. All stories should contain approximately 500 words, must be true, and must center about the subject of ham radio.

Each winning "Ham Yarn" will be published in this department, and the author may select a bound *Handbook* (Defense or regular edition), *QST* binder and League Emblem, Lightning Calculators, or any other combination of ARRL supplies of equivalent value (\$2.00), as his prize.

All entries should be marked "Ham Yarns" and addressed to the Communications Dept., ARRL, West Hartford 7, Conn.

caused by the running of the electric trolley cars which were used to bring out the ore, in the daily operations.

In that year, which was 1925, the 200-meter wavelength was used by Navy stations, amateurs, commercials, and almost every other type of station that transmitted. This meant that our possibilities of hearing anything, below the earth, would be greater if we could hear it on that wavelength. Accordingly, we primed up two receivers — one of which was a three-tube regenerative set, and the other of which was a five-tube tuned radio-frequency receiver. When all was ready, we selected a Sunday night for the test, and then went out to the mine.

As we descended into the mine, we found that it was extremely damp. Not wanting to risk damage to our equipment, we decided to ascend, and to try the experiment on another Sunday night. In the meantime, we obtained some canvas, and covered it with linseed oil. This canvas was to serve as a protective covering for our equipment from the mine dampness, in future tests.

The time for our second descent into the mine arrived, and we eagerly assembled our equipment for the test. Upon arrival at the mine, we found a mine operator ready to help us. We loaded our equipment and ourselves into a push-car down the mine, which ran along the tunnel track. Using 100 feet of lead-covered, number 14 copper trolley wire for an antenna, we then prepared to begin our listening test.

We listened for awhile, as we moved from spot to spot along the track, but had no results. Then, we stopped to cover the receivers with the canvas protective, but this seemed to have no effect. Thinking our antenna length was at fault, then, we broke the trolley wire with circuit breakers until we had about 60 feet of antenna. Again and again we listened and anxiously tuned the receivers. Still no luck. Then, thinking that perhaps our ears had become too accustomed to hearing the static in the receivers, we passed the headphones over to the mine operator. He could hear nothing beside the static, either.

At this point we were all feeling uncomfortable and disgusted enough to want to give up the test for that night. However, with characteristic amateur persistence for that "last listen across the band," I put on the headphones once more, and gave the dials of the regenerative receiver what was to be their last twirl of the evening.

All of a sudden, although almost imperceptible, a slight whistle sound came through the headphones. Hardly daring to breathe, I listened intently, and found that my fondest hopes had been realized. The whistle was broken up into dots and dashes! I immediately passed the headphones to my friend, and he too confirmed the presence of the signal. *There, 2,800 feet below the earth, we were hearing the Navy radio station at Point Loma, Calif., 400 miles away!*

Moving up to the 1,400-foot level, we found that we were able to hear, in addition to the Navy radio station, two ships on the Pacific. We continued to copy the Navy radio station for one half hour solid, to make sure that we could hold the signal at that depth.

The word of our accomplishment soon spread. Among the organizations which took interest in our experiment was the Bureau of Mines, in Washington, D. C. Their first reaction to the experiment was that "some amateur was having a day dream." However, our exploit must have piqued their curiosity, for a short time later, government officials issued a report stating that a Louisville broadcast station had been heard on a receiver down in Mammoth Cave in Kentucky.

While they were skeptical, and inclined to believe that the results were due to freak reception, they later admitted that the experiment had established the fact that powerful radio waves penetrate to great depths in the earth where they can be heard on a receiver.

BRIEFS

Queens WERS code classes have been resumed. The present rate of speed used is 9 w.p.m. After the class reaches the "perfect copy" stage at 13 w.p.m., part of the class time will be devoted to complete review of the ARRL *Radio Amateur's License Manual*. Additional information may be obtained by writing Athan Cosmas, 7250 Kessel St., Forest Hills, L. I., N. Y.

Two of the most regular attending members of the Hamsters Radio Club in Chicago are blind hams — Lawrence Buroker, W9GPS, and Wynne Davies, W9YKJ.

ELECTION NOTICES

To all ARRL Members residing in the Sections listed below:

The list gives the Sections, closing date for receipt of nominating petitions for Section Manager, the name of the present incumbent and the date of expiration of his term of office. This notice supersedes previous notices.

In cases where no valid nominating petitions have been received from ARRL full members residing in the different Sections in response to our previous notices, the closing dates for receipt of nominating petitions are set ahead to the dates given herewith. In the absence of nominating petitions from full members of a Section, the incumbent continues to hold his official position and carry on the work of the Section subject, of course, to the filing of proper nominating petitions and the holding of an election by ballot or as may be necessary. Petitions must be in West Hartford on or before noon on the dates specified.

Due to resignations in the San Joaquin Valley and Utah-Wyoming Sections, nominating petitions are hereby solicited for the office of Section Communications Manager in these Sections, and the closing date for receipt of nominations at ARRL Head quarters is herewith specified as noon, Friday, December 15, 1944.

Section	Closing Date	Present SCM	Present Term of Office Ends
Oregon	Nov. 15, 1944	Carl Austin	Nov. 22, 1944
Georgia	Nov. 15, 1944	Ernest L. Morgan	Nov. 29, 1944
Southern Texas	Dec. 1, 1944	Horace Biddy	Dec. 15, 1944
Kentucky	Dec. 1, 1944	Darrell A. Downard	Dec. 15, 1944
San Joaquin Valley	Dec. 15, 1944	Antone J. Silva (resigned)
Utah-Wyoming	Dec. 15, 1944	John S. Duffy (resigned)
Hawaii	Dec. 15, 1944	Francis T. Blatt	Feb. 28, 1941
Sacramento Valley	Dec. 15, 1944	Vincent N. Feldhausen	June 15, 1941
Alaska	Dec. 15, 1944	James G. Sherry	June 14, 1942
Southern Minn.	Dec. 15, 1944	Millard L. Bender	Aug. 22, 1942
New Hampshire	Dec. 15, 1944	Mrs. Dorothy W. Evans	Sept. 1, 1942
West Indies	Dec. 15, 1944	Mario de la Torre	Dec. 16, 1942
Western Fla.	Dec. 15, 1944	Oscar Cederstrom	Oct. 1, 1943
Idaho	Dec. 15, 1944	Don D. Oberbillig	Apr. 15, 1944
South Dakota	Dec. 15, 1944	P. H. Schultz	May 18, 1944
Alabama	Dec. 15, 1944	Lawrence Smyth	May 22, 1944
Iowa	Dec. 15, 1944	Arthur E. Rydberg	May 26, 1944
Los Angeles	Dec. 15, 1944	H. F. Wood	July 1, 1944
Arkansas	Dec. 15, 1944	Edgar Beck	Aug. 17, 1944
North Dakota	Dec. 15, 1944	John McBride	Aug. 17, 1944
Virginia	Dec. 15, 1944	Walter G. Walker	Oct. 15, 1944
New Mexico	Dec. 15, 1944	J. G. Hancock	Oct. 15, 1944
Santa Clara Valley	Dec. 15, 1944	Earl F. Sanderson	Oct. 15, 1944
Tennessee	Dec. 15, 1944	James B. Witt	Nov. 15, 1944
Michigan	Jan. 15, 1945	Harold C. Bird	Feb. 3, 1945
Western New York	Feb. 1, 1945	William Bellor	Feb. 15, 1945

1. You are hereby notified that an election for an ARRL Section Communications Manager for the next two-year term of office is about to be held in each of these Sections in accordance with the provisions of the By-Laws.

2. The elections will take place in the different Sections immediately after the closing date for receipt of nominating petitions as given opposite the different Sections. The Ballots mailed from Headquarters will list in alphabetical sequence the names of all eligible candidates nominated for the position by ARRL full members residing in the Sections concerned. Ballots will be mailed to full members as of the closing dates specified above, for receipt of nominating petitions.

3. Nominating petitions from the Sections named are hereby solicited. Five or more ARRL full members residing in any Section have the privilege of nominating any full member of the League as candidate for Section Manager. The following form for nomination is suggested:

(Place and date)

Communications Manager, ARRL
38 La Salle Road, West Hartford, Conn.

We, the undersigned full members of the ARRL residing in the.....Section of the..... Division hereby nominate.....as candidate for Section Communications Manager for this Section for the next two-year term of office.

(Five or more signatures of ARRL full members are required)

The candidates and five or more signers must be League full members in good standing or the petition will be thrown out as invalid. Each candidate must have been a licensed amateur operator for at least two years and similarly, a full member of the League for at least one continuous year, immediately prior to his nomination or the petition will likewise be invalidated. The complete name, address, and station call of the candidate should be included. All such petitions must be filed at the headquarters office of the League in West Hartford, Conn., by noon of the closing date given for receipt of nominating petitions. There is no limit to the number of petitions that may be filed, but no member shall sign more than one.

4. Members are hereby invited immediately, filing petitions for the officials of each Section listed above. This is your opportunity to put the man of your choice in office to carry on the work of the organization in your Section.

— Carol K. Witte, Acting Communications Manager

ELECTION RESULTS

Valid petitions nominating a single candidate as Section Manager were filed in a number of Sections, as provided in our Constitution and By-Laws, electing the following officials, the term of office starting on the date given.

Northern Texas	Jack T. Moore, W5ALA	Oct. 15, 1944
Nebraska	Arthur R. Gaeth, W9FQB	Oct. 15, 1944
Eastern New York	Ernest E. George, W2HJL	Oct. 15, 1944
Wisconsin	Emil R. Felber Jr., W9RH	Oct. 16, 1944
South Carolina	Ted Ferguson, W4BQE	Oct. 16, 1944
Kansas	Alvin B. Unruh, W9AWP	Oct. 29, 1944

SCM of the Month

EASTERN FLORIDA'S newest SCM, Robert Bourne Murphy, W4IP, of Miami, Florida, is the featured SCM for this month.

Born in Chicago, Ill., on September 16, 1901, W4IP has managed to lead a very adventuresome life. From 1919 to 1922, he served with the U. S. Navy and attended the Navy radio school at Cavite in the Philippines. He also attended Miami University.

In May, 1929, the ham bug bit W4IP, and in July of that same year he received his first license. Since that time he has held the calls of W4IP, W4NE and W4PFK. He operated 'phone on 75 meters, and c.w. on 40 and 80 meters, laying claim to 35 w.p.m. receiving speed on a typewriter. (He ascribes much of his success on a mill to AARS net operation.) Among his other activities he lists the Florida National Guard, from 1930 to 1939, serving in the Hurricane Net of that organization. He also was a WWV observer in 1938.

At the present time W4IP is active as an aircraft radio mechanic and radio operator for Pan American Airways. He formerly was employed as a foreman for the Florida Power and Light Company at St. Augustine, Florida.

When he finds some spare time, W4IP swims and fishes, but he admits that his greatest skill and interest lie in the field of radio operating.

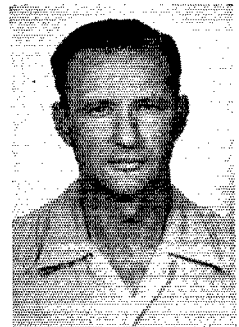

BRIEFS

U.S.M.S. Ensign P. H. Stevens, W8JTH, adds two more press schedules to the transmissions listed for code practice purposes on page 71 of QST for July, 1944:

Time (GMT)	Call	Frequency (kc.)	Origin	Speed
0900 to				
1130	KMH	8346	Los Angeles	16
0415	WSL	109/5555/11115	New York	20

In addition, Arthur Erdman, W8VWX, writes, "... there is a station, namely WEV, that transmits code every evening except Sunday, from 7 P.M. to 10 P.M. E.W.T. The speed varies from 30 to 40 w.p.m., and the frequency is just a stone throw higher than WWV on 5000 kc."

Sgt. Sheldon Shalett, W9TDQ, and Lt. Walt Riddeogh, W3FZX, stationed at an overseas base, decided to get a "blinker flashlight net" going to see whom they could contact in their locality. They find "DX" pretty fair, for they have already "worked" some W2s, W3s and a W7.

After five years of inactivity, the Halifax (Nova Scotia) Amateur Radio Club has been fired up again. The new officers for 1944-1945 are: Webb, VE1DB, president; Bishof, VE1OB, vice-president; MacLaughlin, VE1JH, secretary-treasurer; Street, VE1EK, membership and program chairman.

The Month in Canada

MARITIME — VE1

From Ed S. MacLaughlin, VE1JH:

THE Halifax Amateur Radio Club was reorganized Feb. 28, 1944, having been inactive since 1939. Officers elected at that time were: president, Gordon Phalen, 1KG; vice president, Don Sutherland, 4FK; secretary-treasurer, Ed MacLaughlin, 1JH. The old HARC annual meeting used to be in September every year, so on Sept. 20th we had our annual meeting and election of officers for 1944-45, who are: president, Fritz A. Webb, 1DB; vice president, Harold Bishop, 1OB; secretary-treasurer, Ed S. MacLaughlin, 1JH; membership and program chairman, A. E. W. Street, 1EK. So far as I know this is the only Maritime Province club in operation and we are drawing members from all over Canada.

Visitors and members of our club from other parts of Canada include: 2FR, 3ABT, 3ASX, 3AWR, 3AXX, 3AME, 4BH, 4FK, 4MF, 4UZ, 4ADZ, 4AFG, 4ALT, 5AJU, 5AGJ and 5IN.

QUEBEC — VE2

From Lt. L. G. Morris, VE2CO:

ERNE MILLER, 2AF, has been discharged from the RCAF for medical reasons, after having seen five years' service, and is now in Montreal studying engineering at McGill University. Through a previous mention in this column, 2AF was able to contact an old friend, Bev. Miles, 2QH, a lieutenant commander stationed at H.M.C. Signal School, Ste. Hyacinthe, P. Q. Lt. Bill Lore, 2NQ, is now serving overseas.

ONTARIO — VE3

From L. W. Mitchell, VE3AZ:

A. H. K. RUSSELL, 9AL, whom everyone knows as our former CGM, and who has been on active service with the RCAF since September, 1939, has retired from that service and resumed the practice of law. At the time of his retirement he held the rank of air commodore. 3AB, Al Tomlinson, who is still in the RCAF, has been posted to the Pacific Area and is on his way East.

The Wireless Association of Ontario, Canada's only radio club which has been carrying on continuously since 1913, is still holding regular meetings. They have undertaken to supply this column with a monthly letter giving news of their members. In spite of the war, the paid-up membership of the WAOO is 95. The Association is affiliated with the ARRL and applications for membership in the ARRL are solicited at each meeting. During the past season 1943-4 the executive of the Association secured some excellent speakers whose papers were very entertaining and educational. Many of the papers were enhanced by practical demonstrations, movies and slides. Some of the speakers heard during the season were:

G. E. Adamson, B.Sc., Canadian General Electric Co. Ltd., "Plastics at War."

Dr. Maxwell Krasno, Chief Eng., Electronic Labs. of Canada, "Development and Design of Vibrator Power Supplies."

H. L. Sheen, B.Sc., Canadian General Electric Co. Ltd., "Radio & Television Today."

Frank Bowkett, Production Engineer, Addison Ind. Ltd., "Modulation Design of Class-C Amplifiers."

Paul M. Brand, Rogers-Majestic Ltd., "British & French Television up to 1939."

R. C. Jacobsen, Meteorological Div., Department of Transport, "Radio & Radiosondes serving Meteorology & Flying."

Gordon J. Irwin, Chief Engineer Philco Corporation of Canada, "Design of Small Power Transformers."

At the meeting on October 19th, the speaker was Capt. C. L. Richardson, RCCS, whose paper, "I have a Message for You," covered the development of radio communication since its inception to present day war requirements. This paper also included descriptions of certain Army receivers and transmitters which are now off the "secret" list.

The Secretary of the WAOO has sent in the following news letter: "One of the Notice of Meeting cards of the WAOO was mailed to the home of 3LT, Ted Sheppard. It was readdressed to him, and secretary 3APA, Bill Winter, received a letter from Italy saying Ted could not attend the meeting as the card was received two months too late. His 3LT is now in Italy doing good work with Sigs. A chat with some of the boys in a prominent war plant reveals that 3MT, 'The Major,' has been able to contact a fair number of hams who are still interested in radio. Most of them are keeping their equipment in moth balls waiting for the *great day*. On the survey it was found that many had built equipment that would be of great help in the days ahead such as amplifiers, vacuum-tube voltmeters, crystal calibrators, short-wave sets, etc. 4TO, Nick Salome, from Winnipeg, is on testing. He tells us his brother, 3AHN, has been flying bombers over the occupied countries and also had some exciting experiences on D day. 3OO, that old familiar 10-meter hound from Newmarket, is also on the test benches. 3ASV, Al Valler, is on repair work and testing in very useful war radio work. 3MF, Eric Kerohan, is a lieutenant in the Canadian Navy, doing some fine work and hopes to get leave, soon. 3ZY, Jack Kinch, also has been hard at it at the same plant. He is collecting equipment for the *day*, also turning a commercial super into a short-wave set. He is taking part in dramatics and developing his own sound equipment and musical background. Andrew McGowen, an old commercial op., may get back on the air after V day. 3ALC, Bob Humphreys, has been very active in ham radio and holding the presidency of the WAOO. He is very keen on u.h.f. and has a fair amount of equipment lined up for the future. 3AAK, Bob Burland, is employed as supervisor of testing at a war plant, and also has quite a connection with the public in repair work. 2AX, Frank Bowkett, now is electrical engineer with a war plant in Toronto. He was a prominent ham in Montreal. 3TC, Fred Reynolds, who is with the Canadian Press, has been working on speech amplifiers and all types of electrical equipment, including carrier current, etc. 3ATB, Bert Bouckley, recently visited 3KV, Jack Hamilton, who is a sergeant in the RCAF, now stationed at Clinton, Ont., and discovered he is raising chickens. 3YY, Art Vivian, is looking forward to a trip to the Signals School at Vimy. More next month. 73."

ALBERTA — VE4

From W. W. Butchart, VE4LQ:

A REMINDER in the August issue of QST brought quick response from our old pal 4AOZ, Slim Marsden, of Milo. It appears that Slim hopped into his car and visited 4HK, Tony Jensen, of Standard, finding him very busy combining his wheat crop. After lunching with Tony he dropped in on 4APA and 4AHZ, Maude and Glenn Phillips, of Chancellor, and spent a very PB time rag-chewing and looking over their fine home. At that time Glenn and Maude were very busy with harvest, too.

I had the pleasure of a second visit from 4IN, Bill Lawrie, of Kirkcaldy, High River, Vancouver, etc., on Sept. 15th. He has been very busy installing new antennas at stations on the NWSR north and west of Edmonton. This time IN had his XYL along with him, and a few minutes after they arrived at LQ's shack, along comes 4JP, Reid Elliott, at Alliance, and we had a very interesting evening. By the way, 4IN imparted the information that he was on his way to Winnipeg to attend a school for signal officers (RCAF) and to collect that long-awaited commission. Bill also informed us what while in Calgary and Strathmore a week or two ago

(Continued on page 70)

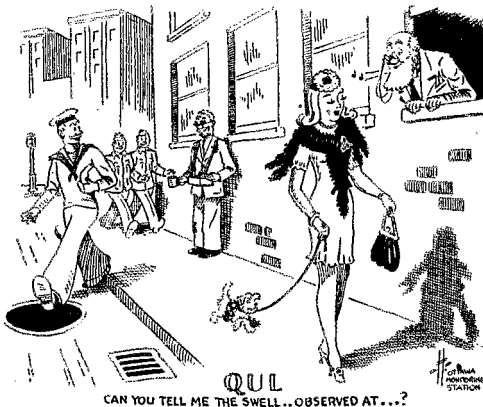

AMATEUR ACTIVITIES

ATLANTIC DIVISION

EASTERN PENNSYLVANIA — SCM, Jerry Mathis, W3BES — 3JBC now has a Postmaster, N. Y. C., address so he will have to wait a bit to see his new transmitter. 3GEM is due home for a furlough any time now. 9RQM, well-known c.w. contest ham, dropped in to say hello. 3JUC and 3JSU were home for a visit. They have about completed their course at Bellevue, D. C. 3CYC is working for the Dept. of Commerce station with the Bureau of Standards at Beltsville, Md. We learn via 9KEH that 3FRY is improving in health and is raring to get back to work. 3EMJ is back from Hawaii. Your SCM, 3BES, has moved to a new QTH: 623 Crescent Ave., Glenside Gardens, Pa. The new location has excellent possibilities for radio but, outside of SWLing, the proof will have to wait until V-day. Fellows, please send along more dope for our column. 73, Jerry.

SOUTHERN NEW JERSEY — SCM, Ray Tomlinson, W3GCU — Regional EC for So. N. J., Technical Radio Advisor for N. J. State Defense Council, State Radio Aide for N. J. WERS and Radio Aide for Hamilton Twp. WERS, ASQ. EC for Somerville and vicinity, including South-branch, and Radio Aide for Hillsboro/Branchburg Twps. WERS, ABS. Reports from various parts of the State, as reported by ASQ, have shown that where WERS is in use those organizations made a very excellent showing during the recent hurricane. Some took active part, while others were on stand-by duty for several hours. Hamilton Twp. units were not actually in operation, but stood by ready to go immediately upon receipt of request, as did WKXQ in Hillsboro Twp. Leonia Council placed their units in operation at 7:00 p.m. Sept. 14th and maintained continuous operation until 12:32 a.m. Sept. 15th, and the Director of Public Works for the Boro of Leonia reported that WERS in that locality proved extremely valuable throughout the boro during and following the storm. The director says that, in the first real emergency in which they were called upon to serve, the many hours of practice and training have proven well worth the effort. Hamilton Twp. license has been approved for amendment for operation of 32 active units, under which several of the unit location numbers have been altered to comply with the new amendment. The new transmitter for emergency control, using an 815 final, has proven itself beyond any doubt under rigid tests, and has been copied consistently at WKXQ and WJMN, an airline distance of approximately 32 miles. T.r.f. stages are being added to existing receivers as material is received for this. The personnel of WKXQ held a WERS-feat on Oct. 1st at the home of Stan Case, which was attended by several operators from WKPX, including ASQ, ITS and AXU. Also several of the WJMN personnel were present, including Ray Cassell, radio aide for Bridgewater Twp. Photographs of the individual groups were taken, as well as the cutting of the birthday cake, which was in celebration of the first anniversary of WKXQ. On Oct. 13th, WKXQ and the Hillsboro Twp. Civilian Defense Council gave a public demonstration, operating in conjunction with fire, police and all CD units. Among the visitors were Alexander Milne, deputy air raid administrator for Morristown area; ASQ; Sgt. Bencer of the N. J. State Police; GCU, all CD and twp. officials, as well as ITS and AXU of the WKPX organization and ATF, at home on furlough from the So. Pacific. The WKXQ WERS organization was praised very highly by Mr. Milne, Mr. Fogg and Sgt. Bencer and, as SCM for So. N. J., I wish to congratulate the staff and personnel of WKXQ, especially ABS and ACC, on the efficiency and cooperation shown during this demonstration. Stan reports all except three of their eleven units, which operated under their new amended license for the first time in the demonstration, are either superhets or have t.r.f. stages for elimination of receiver re-radiation. Restricted radiotelephone examinations have been given to five applicants. The WKXQ license has also been modified to permit finer performance of the network. Radio aide for Bridgewater Twp., Ray Cassell, reports installation of two new antennas and the installation of two new units, one in

Martinsville fire headquarters and one in the fire headquarters in Raritan. A letter from Cpl. JTR, formerly of Phillipsburg, now somewhere in Luxemburg, requests news of WERS activity in and around his home town. I am very sorry to have to tell him that there is either no activity at all or his former associates have not reported anything into this office since I have been SCM. Our state aide is making every effort to contact the proper parties in that area and there may be something to report at a later time. Carney's Point reports six new units being added there. This set-up covers two very important industrial plants and had five mobile units in addition to control ready and waiting during the recent hurricane. Radio Aide BCC is very fortunate in having several licensed amateurs, including 3AVC, IDP, FAX, CKA and IMY, on the staff of WJYD. Frank reports that several of the Upper Penns Neck Twp. civilian defense body have really gotten interested in radio through the WERS activities there. New classes have been instituted and are going along nicely. IKG, formerly reported missing in action in Italy, must now be reported as killed in action. Cpl. JTR is somewhere in Luxemburg. His full address may be obtained by contacting your SCM. ITU has a medical discharge and is again among the boys at home. ATF is enjoying a 30-day furlough at home after two years in the So. Pacific area. BWR has purchased a new home at 42 Laurel Ave., Linwood, N. J. Larry is on instrument maintenance at Atlantic City Electric and does remote work for WEPG, Atlantic City Steel Pier, one shift a week. ACX is still with WEPG, where Blair Thron is chief engineer. Let's have your call, Blair, please. CVK is with Bell Tel., and his new hobby for the duration is an outboard motor boat, while BWR's hobby for the duration is model railroading. ACX is not doing bad at golf as his hobby. For the first time since the inception of WERS, and after many discussions pro and con, the Delaware Valley Radio Association has, according to appearances, decided to get on the band wagon. The *DVRA News* cover on the Oct. issue carries a swell "plug" for WERS urging everyone to join up and do his bit. We will certainly welcome the DVRA into the WERS fold after so long an absence. 73, Ray.

WESTERN NEW YORK — SCM, William F. Bellor, W8MC — S2B again sends us a nice batch of dope. TEP was seen entering the local movie show — after two years with the AATC at Romulus, Mich. QOT is back home after being honorably discharged for a back injury. Bill had earned his m/sgt. stripes. RCJ is connected with the service division of Sears-Rosbuck. LLZ is busy as chief projectionist at the picture house where he works. Where is OSA? We have a fine letter from Sgt. Archie Foster, late of Russell, N. Y., and more recently of Anzio beachhead, but he forgot to sign his call. We wish Arch the best of luck in his work with his SIAM Co., a most important branch of Army service. We hear that VYT has been laid up in an Army hospital. He wants particularly to say hello to VJO and UXU in the Navy, and VIU and RRJ in the AAF. The RARA opened a new season Sept. 28th, under the gavel of ACY, president. A fine program of speakers and entertainment has been announced for the year. Syracuse WERS, WKBS, put on a successful stunt by using their units for communication between the sheriff's office and the jail and several other points, and handled traffic simulating an emergency. We were sorry to hear that our old friend and 28-Mc. contact, 9VGC, has been in the hospital with a bum ticker and hope that he now finds himself well on the road to health. 73, Bill.

CENTRAL DIVISION

INDIANA — SCM, Herbert S. Brier, W9EGQ — EHT is planning to go to the base radio school to take up "slip-page" in code speed. TIY installed a p.a. system for a hula show. He is studying Japanese. NXU has a jr. operator, and is studying Grammer's radio course. YWE is working at WHOT, So. Bend, and is getting married! DHJ reports no traffic this month. SVH and AB are feuding again. FDS is building an oscilloscope. DEE has finished communications officer training at Yale. EBB and EGQ have been designing a rotary beam to revolve at 10,000 r.p.m., but are meeting with a few design problems. ZNC is on his way overseas. DNQ remains at Camp Crowder. HKP, who has been a radio instructor for 2 years at Camp Rucker, Ala., is now radio technician. He wishes to know the whereabouts of HJW. KBQ is in radio operations as section chief. He has a seven-month old son whom he is afraid will be old enough to operate the rig before he gets home. KBQ wishes information about ACW. ABB is on a "ham's paradise," sign roll in

from all over the world. He sends regards to the AARS gang. HUV still doesn't like Pierce oscillators. 9VLL-5KRT is a warrant officer. He built a 20-watt speech amplifier, which he dreams of using as a modulator. He is now Class A. SNF expects a furlough soon. He is constantly dreaming about his postwar transmitter. DUT now has 1st-class radio-telephone license. MTL and WKN have a radio shop in Gary. AHJ is first assistant operator on his ship. He went to Normandy and back without much excitement. YMV, an ensign in the Maritime Service, is in San Francisco waiting for another ship. ILL gets the urge to build something regularly, but the Army keeps him too busy to do anything about it. MVZ is collecting the parts for a field strength meter for Gary WERS. PBS has completed several lessons of his Spanish course. LMO does radio service work in his spare time. PUB is ARM1c. His suggestion to the Naval chief of staff that he arrange a six-day week for fighting the war has not been given much consideration. 73, *Herb*.

KENTUCKY — SCM, Darrell A. Downard, W9ARU — Lt. ALR, USNR, paid the SCM a visit while on a 10-day leave. The CD station at Curtis Wright should be on the air at this writing. WJKK-200, ARU's handie-talkie, is covering the city — contrary to DFW's statement that it's "99 per cent handie and 1 per cent talkie." From the voices on the WJKK stations Monday nights, YLs must be standard equipment. WJKK-22 says he has an AAA-1 priority for a blonde. According to chief radio aide BAZ, the entrance to station No. 22 is as neat a booby trap as has been developed. The prize at the last meeting of the ARTS, a plane ride, was won by DFW. Does anyone have a spare 'chute? While we haven't heard anything from the "Admiral," we understand he, ELL, is getting used to terra firma in Frisco. The ARTS now has the largest membership since its organization. AHL has moved to Mt. Sterling and wants to contact hams in that city. His QRA is the Montgomery Hotel. Ralph Albers always pays us a visit at the club when in from the briny. WJKK-1 moved from the City Hall to the Court House. ARU and CNE entertained (?) at the last meeting, the program being devoted to "ye olde days" of spark, quenched gaps, Benwood, E. I. Co., Duck, etc. Even LR's wavering note out in Anthony, Kans., was discussed. For the benefit of any of the gang at Ft. Knox, the ARTS meets the second Sat. of each month at 6:30 p.m. at the Canary Cottage. Come in and meet the gang.

MICHIGAN — SCM, Harold C. Bird, W8DFE — At a recent meeting of the DARA we were fortunate to have with us Capt. George Goldstone, back from the European campaign. George now is located at Ft. Monmouth. He related some very interesting experiences with the Signal Corps. Capt. George also took his place in the round-the-table QMN net sending and copying a few messages. Capt. 8KNP writes that he still is teaching down in Texas. Capt. Jimmy says there is quite a bunch of hams there. Out of seventeen officers in the department only four are not hams. Capt. Jimmy is also getting the urge to get back with the old gang and pound brass again. He reports we may see him soon. We are pleased to report that our friend and QMNER, SGP, has almost completely recovered from his recent attack of infantile paralysis. 8LHH writes us from a local point that he has just returned from No. Michigan and found three DARA Bulletins waiting. Ed has been at his location for a year now. He has many hours on B-24 as radio operator. For you fellows who would like to contact him, his address is Ed Mort, 4863 Winnifred, Wayne, Mich. The Pontiac WERS gang tried using i.c.w. instead of voice at a recent test and it met with such a response that they have decided to use it in all their drills. There are quite a few potential hams in the group and they realize that it is important right now to gain all the knowledge of the code and radio they can. A test message was transmitted in c.w. then the control asked each station in voice to repeat the message or as much as they received of it. The WERS group has also signed up for a course in electronics which is to start very soon and run for ten weeks. They feel that this knowledge will be very beneficial to them in future radio work. Hope to hear from other WERS groups next month. Hope that you men receiving the next QMN bulletin will take advantage of the card enclosed and get it off to your SCM with a nice bunch of news at your earliest convenience. Each one writing to us says that he turns to the Michigan news as soon as he receives his copy of QST. Remember no news from you, no news to print. How about it, gang? 73, *Hal*.

OHIO — SCM, Carl F. Wiehe, W8MFP — CBI reports Dayton WERS active, drills enjoyable and turnout good.

TOZ, now assigned to personnel work at Selfridge Field, was home on furlough. ENH completed special radio training at Chicago and now is seaman 1st class stationed at Corpus Christi. QDI has been assigned to Naval Research Lab. at Washington after graduating from special Navy radio training. IX, after 18 months in the So. Pacific, is now Lt. comdr. assigned to a battleship. BI is now a major assigned to Dayton. TDI, t/sgt. in a Marine artillery outfit, writes of his experiences in the So. Pacific with Japs and of their radio equipment. CBI is a new grandpop. The new mobile rigs of RGH and IJ are working swell. Dayton WERS will miss Deputy Radio Aide Hal Jones, who received a promotion and a new job with his company and will leave soon for N. Y. SDO's new home in Miamisburg now takes all of his time. IBQ is again active after a tough siege of flu. TDY's new "J" is giving his mobile sigs a new punch. NXJ reports club and WERS activities progressing in Canton in spite of difficulties because of war plant shifts. ADQ is radio aide for WHNE, licensed to Stark County Commissioners, and has all mobile units working directly with control station. VUS reports 100 per cent activity in WERS group at Middleport. AVH reports his ARRL directorship campaign progressing. John, an old-timer in radio, has proven his ability by the very efficient operation of Cleveland's WERS outfit, of which he is radio aide. The Cleveland fire department sponsored a fire demonstration program at the Ohio State Safety Council convention held in Cleveland in Sept. LEX, JNF and Bill Carter demonstrated walkie-talkies and point-to-point WERS communication aid. When the Coast Guard fireboat which was taking part in the drill received a call the WERS operator on board was treated to a thrilling if impromptu ride. AVH says, "Intercity relays furnish a possible interesting WERS activity. At present Erie, Pa., Cleveland and Akron are perfecting a relay. We'd like to see Youngstown in on it and down through Columbus, Dayton, Hamilton and Cincinnati. Erie perhaps can work through to Buffalo and, who knows, maybe to N. Y. C. or West Hartford." Fifty-five attended the Sept. meeting of the Cuyahoga Radio Association. JNF was elected vice-president to succeed GW who found it necessary to resign. PBZ, in the Army, was there. TQS, radio aide for Cincinnati Metropolitan Area, reports Hamilton Co. CDC has discontinued all civilian protection activities. WERS is being continued under the jurisdiction of Hamilton Co. chapter of Red Cross. Control station WKHO-3 is located in Red Cross Chapter House. Some equipment under the control of Hamilton Co. has been transferred to the Red Cross. Direction-finding drills are a major activity. The WKHO area covers more than three counties and finding a cleverly hidden unit is quite an achievement. The Queen City Emergency Net, under President PNQ, is contemplating the establishment of a memorial station named in honor of the first Greater Cincinnati casualty of the present war. JIN, who is pounding hi-speed brass for the Army, was home on furlough. VUV writes from Fort Bliss, Tex., that he is an Army 'phone man but hopes to be assigned to the big c.w. rig. Several Dayton WJTW WERS units are being heard regularly in Cincinnati. The Cincinnati gang has begun sending QSL cards to operators of WERS units worked. VVS took unto himself an XYL on Aug. 12th.

WISCONSIN — SCM, Emil Felber, jr., W9RH — VD has just completed 25 years as a member of ARRL. He was SCM of this State for many years and was one of the founders of the Milwaukee Radio Amateurs Club and now is one of the operators of WMFI-10. GSP has added jr. operator No. 2 to his family. CRG visited HRM in Milwaukee and reports that he is a radio engineer with Western Electric in Chicago. DIJ has been gathering the crop from his victory garden. QIH, RM1c, wrote to GPI, still located around the So. Pacific. ADI, ARM1c, has had one year of combat duty flying in the Aleutians and out of Guadalcanal as aviation radio man. DYO, ARM3c, is located in Tennessee and hopes to visit Milwaukee some time in January. SYT dropped us a card from Belmar, N. J.; he has his uniform and is waiting for further instructions. Lt. (jg) Louis A. Wollaeger, USNR, wrote HRM a long letter from the S.W. Pacific. ULE is in California, where he is attached to an overseas processing squadron in the aircraft radio division. Anyone knowing Pfc. Steve Rukavina's address, please notify HRM. DC has been transferred by his company to Lake Geneva, Wis. Capt. ZBP is located in England. Don Merten, who is an expert consultant to a major general and has the simulated rank of a colonel, is now on a long flight in

a converted B-17. Capt. KVX, Signal Corps, is stationed in California when not traveling around the world setting up communications systems for the Army. Ray Charney, RT3c, is now overseas. Sgt. James Fischer sends greetings from France. Cpl. John Rashinsky, a radio operator on a B-24 bomber, is at present located in Colorado. Comdr. Fred Catel, USNR, in Alaska, says that if he stays up there with the Army much longer, he'll soon become GI. VKC, 1st Lt. ATC, wrote from the China-Burma-India wing that he is counting the days when his two years will be up and he will be rotated back to the mainland. IZQ, USNR, is located at a Naval air station in Texas. RVB of Little Chute, is working for WISN at Milwaukee. The WERS-WMFI of Milwaukee County has added a new mobile unit, No. 27, operated by ACM, which makes five completed mobile sets now taking part in drills. Units 14 and 6 are again on the air. Our Wed. drills consist of handling messages, replete with names, numbers and problems. It improves operating skill, gets the boys acquainted with procedure, besides keeping them alert. All units are on one frequency operating as a controlled net. Recently Mrs. Ruth Isham, WERS operator of a station in Mansfield, Ohio, traveled around the city and visited various units with mobile unit No. 13, which was operated by CDY. Your SCM wishes you all Season's Greetings. 73, *Emil*.

DAKOTA DIVISION

SOUTH DAKOTA—SCM. P. H. Schultz, W9QVY— Even BZU laments the fact that he has nothing to offer except that TXK has been transferred from Topeka to Springfield, Mo. and is still hospitalized. YBX, formerly of Yankton on the WNAX staff, is 100 per cent in war work and permanently located at Redwood City, Calif. He does crystal manufacturing and takes care of the operation and maintenance of police radio for the sheriff's office. He says WPA is senior flight communications officer with Pan-American Airways in Texas. A very welcome letter from VOD, former SCM, says he is now on overseas duty. It sounds as though he likes the Navy first-rate. I know Doc would appreciate a line from the old gang. Please write me for his address. BJV is now a 1st. col., somewhere in Italy. Reports coming in state that Stan is doing an FB job over there. 73, *Phil*.

NORTHERN MINNESOTA—SCM, Armond D. Brattland, W9FUZ—Wally Lamb (operator license) reports locating a couple of other hams in his boot training radio tech. company at Great Lakes, indicating that the supply of hams is not yet exhausted. HQX reports from RM School, Camp Gilmore, Farragut, Idaho. While on a voyage as chief radio officer on a Liberty ship, FUZ's first assistant was 6TDO. Recently FUZ was invited down to the harbor to visit a Victory ship on which 6TDO was shipping as first assistant and the chief turned out to be 6SJT, who had personally delivered traffic via street car for FUZ from Bemidji, Minn. It also turned out that 6TDO and his brother, 6SHE, had both worked 6SJT. It goes without saying that 6TDO and 9FUZ will be pawing through logs in the future to see if the circle of QSOs is complete. DPU reports from England that Minnesota was the best represented state at a hamfest held in London recently. Other Minnesota radio GIs besides Bill, who hails from Crookston, were KOW of So. St. Paul and SNW and IPO of Minneapolis. Any of you fellows knowing of other such hamfests, please send the dope to this SCM or to QST. The fellows away from home cling to the hope that someone back home will carry on and keep the column alive and that now and then there will be a bit of news in it that stirs up memories of the past and dreams for the future. Don't let them down! Get in the news and it will appear, otherwise it just can't be made up "out of thin air." 73, *Army*.

HUDSON DIVISION

NEW YORK CITY AND LONG ISLAND—SCM, E. L. Baunach, W2AZV—The following was sent in to Headquarters by BGO: By 2 P.M. on Sept. 14th all key members of New York City's WERS group had been alerted. For an hour they contacted all other operators by telephone, telling them to stand by for a later call. At 8 P.M. there still wasn't an alarm from the officials, but the rain was coming down heavily and the wind was gaining velocity with each passing minute. At 8:20 the radio aide answered the telephone to hear a Fire Department official say, "Are your operators on the job? All our alarm boxes in Staten Island are out!" A call was then put through to Police Headquarters to instruct that office to contact the

chief and obtain an okay for WERS to open the net. Permission was granted in three minutes. Telephone lines were dead in many localities of New York City's 319 square miles. As soon as it was determined that many 'phone lines were out in all boroughs except Manhattan (where most all communications wires are underground), the local broadcasting stations were called upon to put on a spot announcement asking all WERS operators to report to their posts immediately. While this did help in some instances, power lines also went out with the telephones in all but Manhattan Borough. By 9:10 P.M. 72 WERS-units were in operation, including 6 fixed units that had antennas replaced by that time. The engineering staff in Queens and Brooklyn were having a busy time, dashing from one fixed unit location to another, climbing to the roofs of the buildings housing the equipment, and while the storm was at its height erecting temporary sky wires. Their progress from point to point was greatly hampered by fallen trees and power lines. By 9:30 P.M. 87 units were in operation and 117 operators were working. Traffic was moving rapidly—important traffic! Flushing Hospital had no telephone service. A mobile unit, was rushed there and, until telephone connections were again made, handled many calls for ambulances from police precincts in Queens. The Queens Net was exceptionally busy handling all kinds of traffic, but mostly police communications, for virtually all police precinct headquarters were without telephone service. The headquarters of the Fire Department in the Bronx sent a call to City Control saying there were three large areas in that borough where fire alarm boxes were out. Mobile units were immediately dispatched to the Bronx from Manhattan. These units patrolled areas in the stricken territories, passing a given fire alarm box at least every five minutes. The mobiles sent from Manhattan operated on the Manhattan net frequency, all their traffic being relayed by a Manhattan fixed unit located close to the Bronx, thereby permitting two nets to operate in one borough without interference. Then units in Brooklyn started heading traffic to City Control. Many mobile units were forced to detour frequently because of blocked streets to reach their assigned posts. The first two to three hours' work was accomplished in darkness, except for the light furnished by flashlights and the lights on the mobile units. Emergency power at many of the fixed units was used. One operator, who was fortunate in having a pair of insulated gloves in the car, removed more than two dozen cables in his travels, but later his car was stopped quite suddenly when a tree crashed on the turret of the car and a cable draped across the hood. In the 70th precinct in Brooklyn, WERS was the only means of communication to and from the precinct headquarters from the time the storm started until 3:30 A.M. Friday. A water pumping station was reported to be without telephone service, which could have led to disastrous results had WERS not been on the job to furnish a means of communication to control the flow of water from the reservoir to distribution points. The chief electrician of LaGuardia Airport was transported from his home to the airport after the storm had cleared away, in order to repair damage to the flood light system used to permit planes to land. This call came to WERS and a mobile unit was dispatched to finish the job. Forty-five minutes after the request was made the lights were working again. All operators who participated have received a letter of commendation for their splendid work during the emergency. In New York City the War Emergency Radio Service has definitely justified its existence.

NORTHERN NEW JERSEY—SCM, Winfield G. Beck, W2CQD—Pat Jessup writes from Glen Rock to say that he's been seriously ill for four months following an operation but is OK now. C.M.Y., who works for a government agency overseas, is really getting around over there and looking for DX cards! 3EFM, who used to be a frequent visitor in the N.N.J. net, is living in Plainfield and doing war work. LMB, secretary of the Jersey Shore Amateur Radio Association, writes that club meetings have been resumed. MWW and her OM were hosts at the Sept. meeting. The recent storm had the a.c. cut off at MWW but ham ingenuity and an emergency generator provided light for the meeting. The next meeting is scheduled to be held at the home of GMR. EUJ now has "admiral" rating for suggestions submitted to Eastern Aircraft. He's still busy operating WWCB and WNEK base control stations at Linden Airport. CQV, with an eye to the future, has rebuilt his kilowatt from stem to stern and is still plugging along at Western Electric. CHQ is holding forth at Western Electric. AU is engineering at Link Radio and spending spare hours

with the Coast Guard. AZL is still with "PRU" and the Coast Guard. GOH is involved with those very high frequencies at W.E.; he has a jr. operator too. KHQ is busy bone-cracking and sending CQ on diathermy. LI and company still have the best WERS set-up. ZB is in on it too but busy at Public Service. LCR is at Phelps Dodge, Elizabeth. LXV is keeping the home fires burning at the coal and lumber business in Elizabethport. CSL is going strong on WERS and Fredericks Tavern! HWZ is keeping those traffic lights in the municipality going in addition to his Coast Guard work as communications officer. The UCARA is considering a meeting in the near future. FUP, radio inspector at Eastern Aircraft, is keeping 'em flying for the U. S. Navy. CNP is in Hopewell; ditto FUP. Otto Gruss just finished his Rutgers radio course. George Carey is building for the future and Joe Trembulak is diddling too. Major Bill Schweitzer, ex-JKQ, reported in France. BCX is still at the Schweitzer Paper Mill shopping around for new ideas on transmitters. BYD, EC and radio aide for Cranford, is going strong with WERS, radio service work and Standard Oil. HFP is busy making them that 'now radios work at ole' Eastern Aircraft. IVP, c/o Fleet Post Office, New York, would like to hear from IMX. 73, W/tn.

MIDWEST DIVISION

KANSAS—SCM, Alvin B. Unruh, W9AWP—RQF was home on furlough from the West Coast air base where he is stationed as a radio maintenance man. RQF reports that GUY completed boot training at Great Lakes and will go into radar. RBX is a sergeant stationed in California, as is PLN, who is in the medics. Ex-UQX, now a W6, and formerly president of the Wichita club, is a lt. col. and has transferred to radar. FRC, a colonel in the Signal Corps, writes on German stationery from France, and says he is seeing some of the same old places he saw in World War I. He has chewed the fat with a great number of Gs and Fs and says he believes in ham radio more than ever. This scribe ventures to guess that Bill will have some good yarns to tell when they can be told. DSD, formerly of KFH in Wichita, and later with a station in Denver, was home on a visit after service in the European and Mediterranean sectors. He is a warrant officer, USMS, and will report to the Pacific Coast for his new assignment. QQT is preparing a list of Boeing-Wichita hams for QST, as the many hams employed there are all in 100 per cent war work producing the B-29. ICV and his YF attended the meeting of the Associated Police Communication Officers in Toledo. ICV is in charge of radio at KGZC, Topeka. AMD is at Corpus Christi Navy school, working with secret radio. NOF writes from the West Coast, where he is stationed as an ensign in the Navy after a year and a half of schooling on the East Coast. He states he has been too busy to think about radio, but expects to be a radio officer aboard ship. RAT is radio engineer with TWA in Kansas City. He returned to Coffeyville on his vacation "to visit the family and look in the junk box." RUE is co-owner of the *Caney Chronicle*. TKF was home on leave from Chicago Radio Materiel School after 30 months in the Pacific area. Mike is wearing four Asiatic battle stars. 5EAK is running a radio service business in Coffeyville. When last heard from PSE-VWT was teaching ground subjects in a Texas airbase. YLY has joined the merchant marine and when last heard of was in New Guinea. Thanks to RAT for the Coffeyville dope. IJK writes a very interesting letter from India, where he is radar officer at an airbase. He longs for Kansas weather and asks the SCM to pass along his APO number to his friends. JXT has been added to the staff of the Boeing-Wichita Electronics-Confidential shop. *Abte*.

MISSOURI—SCM, Mrs. Letha A. Dangerfield, W9OUD—FYD, of Independence, who is in a ranger field in New Caledonia, asked for the addresses of DDX, IDK and QZA. We were able to furnish the first and would appreciate it if anyone can furnish the others. QDQ is back in the U. S., in radio down at Corpus Christi with the Navy. He sent us some souvenir cat eyes he picked up in the Fiji Islands. We saw KG at the highway patrol station at Lee's Summit recently and he said WOC was still with the FCC in Washington. How about more news of the K.C. gang? Pat Sullivan (LSPH) wrote from the Naval station at Port Blakely, Wash. to ask for the QTH of REA, MFN, the Old Judge of the Mo. net, is with the merchant marine since leaving the FCC monitoring service. GHD says there have been some changes made up in the Aleutians and he hopes for a leave before long. ZXX is completing his radio course with the Navy at the College of the Ozarks. NSU is selling

real estate, mainly farms, down in the Ozarks. It was almost homecoming time for the Joplin gang—except that the boys just missed each other. PRO, who does something with photography for the Air Corps, came first, then TGN had that long-awaited leave from the Navy. Next PQS was back from Alaska, and finally, our brother 4HLN, ex-9IGW, whom we naturally find very fascinating with lieutenant's stripes, a mustache and two campaign ribbons, came home. BMS put a squeelch circuit in the SX-23. It works beautifully. OUD thanks you for your letters, and would appreciate more news, addresses, etc. The best of luck to you all. 73.

NEBRASKA—SCM, Arthur R. Gaeth, W9FQB—Douglas County, including Omaha, with 64 units, was licensed for WERS with the call KHKN on Apr. 5th. YDC is radio aide with EKK and YMU as assistants. Unit No. 1 is crystal-controlled and is located in the county sheriff's office. KHKN units stood by during the Elkhorn Valley flood but were not activated. ZPZ is trying/crystal control on 2½. As a result of WERS activity the Omaha gang are on the verge of organizing a radio club. We hear that Lincoln has been licensed as KAAJ and that Fremont has applied for a WERS license. Rumor also has it that Lincoln intends to have a unit in the State House tower (which is over 400 ft. high) with a beam directed towards Omaha. In turn EKK, KHKN-2, will beam at Lincoln. If this can be accomplished it will give the state radio aide an outlet into Omaha. You guys elsewhere in the State, tune in and send in a report if you hear so much as a twerp. KGLZ, Ashland, and also various points in Iowa, especially the Sioux City gang, should take heed. 5ABI has moved to Omaha and is active in WERS. UFD has a pair of HY75s ready to go on 2½. EW has moved to Lincoln. Loyal B. Brison, HTE, APO, c/o Postmaster, San Francisco, Calif., has been promoted to captain and CO of his unit. Congratulations to VHR on his election. Thanks to EUT (the politician) now located at the WOW transmitter. EXZ is repairing autos and radios now that the marine radio school has closed. HGV is warming up the T40s between railroad trips. UEW sold most of his equipment and is concentrating on photography. FQB was promoted to inspector on the OFD. As your new SCM I will do my very best to carry on the good work of my predecessor. Good luck to Pop, and I hope that soon we will be reporting in on the AARS net. I have observed that very few of the gang in Omaha belong to the ARRL and wish to urge that all members do some campaigning if you want some representation in Washington, and more especially if we are to protect what we have for the fellows in the services. Out-state gang, please send in your reports regularly and we will attempt to keep this section interesting for all. Holiday Greetings, Art.

NEW ENGLAND DIVISION

MAINE—SCM, G. C. Brown, W1AQL—Received a nice letter from DTS. He was reading the July issue of QST when he wrote. Bill went to a hamfest in London and met DUJ, BMY and APO. He says that hams from Britain, Canada, Australia and New Zealand were present. G2YL was also in the group. Many of the gang will remember her as the YL from London on 'phone a few years back. BX was in town recently; he has a son in the Navy. AWN was a visitor in this vicinity recently. HNS is driving a school bus. JSY is building up a portable generator for postwar use. What say, gang, let's have some news other than what your SCM is able to pick up locally. 73, "G. C."

EASTERN MASSACHUSETTS—SCM, Frank L. Baker, jr., W1ALP—JXZ is now EC for Milton and has WJYM-29 on the air. ALP has been on at WJYM-1, LZW at WJYM-6 and HHU and Jack Donnelly at WJYM-7. DBH writes from Selfridge Field, Mich., that he is a pfc. in the AACS. BTL writes from Oahu, T. H., where he is stationed. Sorry to have to report the death of another ham from this section. AFQ, AHG is working in Newport, R. I., all the time. LVB is working at Sub Signal Co. and living in Winthrop. We hear by the grapevine that LBY is back in these parts again and is working for Sub Signal Co. ALP had breakfast one morning with 9SYT, DYT and 4CFT in Belmar, N. J.; he also visited BDI and KH in Washington, D. C. AME has moved his family to Watertown. FSL is stationed at M.I.T. for awhile. LCV, 7IGY, 6AIQ and 8SBA are working at M.I.T. MPT has a new jr. operator that he hasn't seen yet, as he is still on the high seas. KBS has a new baby daughter. Ex-UG is back selling the old oil again. LID gets home weekends from Camden, N. J. He expects to go back to Wright Field. HXK, CBW and LVC

are working at Bedford. Arthur Jones of Stoneham has his Class B ticket. The South Shore Amateur Radio Club held its regular meeting with these hams present: LZW, CPD, MD, IS, CT, AKY, FWS, KBS, FKV, HHU, MMH, MMU, ALP and CCL. KNZ, who spent 31 months overseas and just finished a month's furlough, is now located at Grenier Field, N. H. KCF is now a CPO and is located at Panama City, Fla. KXU is overseas with the Supreme Command Headquarters. EJU is helping out in WERS in Dorchester. MME writes all the way from Burma and says he would like to hear from any of the gang. If you want his address drop me a line. 73, Frank.

WESTERN MASSACHUSETTS — SCM, William J. Barrett, WIJAH — The biggest news of the month is the successful WERS message relay from Pittsfield to Boston and return. After many attempts, the circuit clicked with WKHW-2 in Pittsfield, WKHW-16 on Mt. Greylock, WLSO-1 in Fitchburg and WJQH-4 in Newton. The relay took place Oct. 9th at 10:25 p.m., with immediate reply from Boston. NDE dropped in to the Pittsfield club meeting and related his experiences in the Air Corps. Ranny is now stationed at Carlsbad, New Mex. While in Boston, AZW visited HPC and KCT. Prent also visited WERS stations in Dedham and Newton. JLT is building 112-Mc. m.o.p.a. of Sept. QST. NJZ is now a Signal Corps lieutenant stationed in Africa. Pittsfield WERS was alerted for the recent hurricane with 15 stations ready, but, fortunately, the storm missed this part of the state. The North Adams gang was also on the job. Moira Sheehan of WKHW-10 has joined the Air WACs as a radio operator at Westover Field. Her sister, Gerry, will keep unit No. 10 on the air. How about some news from the gang? 73.

NEW HAMPSHIRE — SCM, Mrs. Dorothy W. Evans, WIFTJ — HJI tells us that he has met lots of hams from every district there in Washington. FGC, TA and BFT had a miniature N. H. hamfest in New York recently. AOO is the proud father of a baby daughter. We understand that HOV has returned to Camp Crowder. TA is living in single blessedness no longer; he has taken unto himself a YF and is living in New York. GKE is doing FB at his own new shop at Manchester. MWI and JDP were recent visitors at BJJ's shack.

RHODE ISLAND — SCM, Clayton C. Gordon, WHRC — HRC took his annual trip to the White Mountains in Sept. and met JYJ and Bill Mrs. ex-9VBG, there, and a miniature hamfest took place. Visited WMTW but the clouds were so thick you would swear it was raining. Anyhow, got some mighty nice Kodachromes. Had a mighty nice note from BVR, who has started a nominating petition for yours truly for another term as alternate director for New England. No word from the gang in the services this month — guess they are too busy. But we think of them and wonder how and where they are. The following was sent in to Headquarters by BEH: On Sept. 14th at 3 p.m. the Civilian Defense Council placed the WJWN network on the alert. By 3:30 p.m. all personnel had been instructed as to their posts of operation. Three stations were to be ready for service, one at Disaster Relief Headquarters, located in the Varnum Armory, one at Red Cross Headquarters and the third at the control center of Civilian Defense. At 7 p.m. the radio aide ordered the three stations manned and tested for operation. At 7:50 p.m. mobilization orders were received from CD Headquarters. Each station was ready with emergency power. Each unit had one 6-volt storage battery available. The first use of WERS came at 8:45 p.m., when communication was lost between Red Cross Headquarters and Disaster Relief. Knowing the 115-volt service would not last long and realizing that one storage battery per unit would be insufficient, a call went to CD Headquarters and the Red Cross Motor Corps for more storage batteries. Both agencies responded immediately. Within 20 minutes there were 8 batteries available for our use. At 9 p.m. 115-volt service was lost. All stations went on emergency power. At 9:45 p.m. the Police Department reported no communication with Disaster Relief. Within 15 minutes a unit was in operation at this point, which made a total of 5 units, including a mobile unit patrolling the shoreline, in operation. The network handled messages for the State Guard, Civilian Defense, Red Cross, Police Department and Fire Department. A total of 84 messages were handled between the 5 units. WERS facilities were not required after the storm had subsided so orders from CD Headquarters to close down came at 1 a.m. on Sept. 15th. The following amateurs were on the job during the emergency: BFB, CJH, NCX and CIU. Carl King, a totally-

blind WERS operator, did an excellent job operating the control center unit.

VERMONT — SCM, Burtis W. Dean, W1NLO — BD and Prof. Whittemore Littell, of Dartmouth College, are instructors in radio theory for Co. K, at Norwich. Roy reports that the State Guard lost out on radio equipment from the government as they were not licensed to operate on the frequency of the sets. Nine more members of the VSG have their WERS permits: From Co. K, Norwich: Whittemore Littell, William D. Carter, Frederick Ladd, Carl Ladd, William DeVaux and Fred Waterman. From Co. E, Barre: Lt. Langdon Cummings, Sgt. Angelo Rossi and Wendell Walker. HPN, LWN and NLO have been busy installing coaxial cable in the swamp at Colchester. KXP has bought a new HRO and has sold his S-23 to LWN. Your SCM met ATF on the street in Burlington recently. Harry reports the apple crop was poor this year so there won't be any cider for the boys when they drop in on him this winter. GM visited LWN and NLO at Colchester on his annual tour of inspection. How about a line from some of the Vt. gang? 73, Burt.

NORTHWESTERN DIVISION

MONTANA — SCM, R. Rex Roberts, W7CPY — DXQ vacated at his old home in Minnesota. CBY is again in Butte. BEB is active as scoutmaster of an active troop of Boy Scouts. Notes from the Butte Amateur Radio Club: BDP is conducting weekly code classes at his home. Harry Meyer, of Rocker, is a new member. The members of the Club recently visited KGR and a pleasant and instructive time was reported. CPY and DZQ recently spent a Sunday with FLT and HYD — a near hamfest for Eastern Montana. 73, gang. Rex.

OREGON — SCM, Carl Austin, W7GNJ — ENC reported personally to GNJ this month. Ed is a s/sgt., in charge of a transmitting station in the Aleutians. He has five gold bars on his sleeve, each of which signifies a six-month overseas "hitch." Ed mentions that there are numerous hams in his outfit, among them IM and GLF. The flight out was very interesting, and after visiting around for his 19-day leave, he expects to fly back. IVJ is back home in Portland, having been discharged from an instructor job in Colorado because of spotted fever. He mentions that DWG is now a lt. (jg.) in the So. Pacific. Also AMX is still doing double duty-b.c. transmitter and installing radio on new boats. A letter from QP, now chief electrician's mate, says that things are smooth with him at present, that HKO and his XYL are at TI, and that LI is a captain somewhere in the So. Pacific. Word comes that GOC was made chief technician at Pearl Harbor recently. IIK, instructor at Corpus Christi, is now chief aviation radio technician. An FB letter from FHB, an instructor at Eugene Vocational School, contained the following information: FBO reports that FHM received the rating of chief radioman; FQO is still busy selling sawmill equipment; SO is back in Albany at the old radio service shop; DNB is carrier-current expert for Bonneville, at Vancouver, Wash.; AHX is about a year behind on his plumbing calls; ILQ, school station, has had some good results from the 18-watt 180-kc. c.c. rig. HAL says he has sort of lost contact with the Pogang because he now is working 12 hours per day. CZJ, now in Chicago, is thinking of trying c.c. with a nearby 9. Pop says the last letter from FTA and ITZ mentioned that they were about to fly to Alaska, where they will take up their CAA work. ARZ has acquired one of those complicated high-cap and high-powered little cameras, and produces some FB pictures. BS is the daddy of a brand-new harmonic, which makes the third. 73, Carl.

WASHINGTON — SCM, O. U. Tatro, W7FWD — AEA, of Tacoma, has been appointed EC for this area. Max is an active ham and will aid in initiating amateur activity in his locality. KV, former director, is in Seattle on furlough. Ralph is now a colonel, commanding officer, ATC, Fairbanks, Alaska. AW is now in South Tacoma but will be heading south shortly. Vee has been in the Northwest with his rail detector car for several weeks. OWN is working in a defense plant in a motor coach division and wants to write to some of the old hams. His QTH is 15610 Ambaum Rd., Seattle 66, Wash. An "air letter" from a sister of G2DF states that Fred is now in Belgium. He is OK and very busy. BG left his QSL card on a V-8 coupe. It found its way to Captain Patrick, who wrote, "The car used to be mine. I worked a two-letter call from Tacoma on 40 c.w. in 1940 but don't remember if it was you." The captain is IDZ of Asotin and is with a bomb group. We have his full QTH.

6SBV of Santa Ana, Calif., now at Ft. Lewis with a signal company, was a recent visitor. He was active in the old days on 160, 40 and 10 c.w. and 'phone. EHQ is attending a distributors' convention in Chicago. EXG is regaining his health and BG admits to over twenty years in amateur radio by joining the 20-Year Club. IGM advises that Manila is the name of his new XYL and "the same old welcome" will prevail at his shack for his many ham friends. Your SCM sent a recording of Radio Tokyo Prisoners' Hour to a war prisoner's mother in Brooklyn, N. Y. I wish you could know the gratitude she expressed in her letter. 73, *Tate*.

PACIFIC DIVISION

NEVADA — SCM, N. Arthur Sowle, W6CW — Asst. SCM, Carroll Short, jr., W6BVZ — CDM, formerly of So. Calif., now is working in Boulder City for the Bureau of Power and Light of the City of Los Angeles, as a power house operator at Boulder Dam. Rudy Ganser, an ex-W9, is also working for the Bureau as a radio operator. He has just returned from three years in Alaska with PAA and CAA. Before that he worked police radio in the Midwest. S. A. Curley of Boulder City, now a radioman in the Navy, has been heard from recently from the So. Pacific. BVZ recently had a letter from SWL Mark Churton of Auckland, New Zealand. They have been corresponding since 1931. Mark has 1500 QSLs from the States and asks to be remembered to the gang who knew him here. PZY has been testing the ol' rig on a dummy antenna after re-vamping it. He figures we may get the "go ahead" signal one of these days! He is still servicing radios when not on duty at KIKH-KJK. MRT and GSB are also servicing in their spare time. BTJ, assistant Naval architect in S. F., just completed a five-tube a.c. receiver. His address is 2406 Dana St., Berkeley 2, Calif. JSH, the old sagebrusher, now in the Navy, last reported from New Guinea. QVP, formerly of California, now in Reno, is civilian director of personnel at the Reno Army Air Base. TJI dropped in en route to his new assignment after a couple of hot months in Texas. His new address is 3247th Signal Base Maintenance Co., Ft. Monmouth, N. J. Let's hear from more of you! 73, *Art*.

SANTA CLARA VALLEY — SCM, Earl F. Sanderson, W6IUZ — RM: LLW. Congrats to CFK and his XYL on the arrival of a YL jr. operator. A V-mail from MOV indicates postwar planning for new rig. LIP, whose new QTH is 990 Lincoln Ave., Palo Alto, reports interesting experiences as flight radio operator with ATC; he has been commuting "down under" for two years. He would appreciate contact with anyone in his area active in WERS. Lt. Charles L. Holdiman, S&F EMS, Ft. Monmouth, N. J., would like contact with DMY. RBM, recuperating at Mare Island Hospital, reports that his father is now the proud possessor of a Class B ticket and is working with WERS. 73, *Sandy*.

EAST BAY — SCM, Horace R. Greer, W6TI — EC, QDE; EC v.h.f., PKQ; Asst. EC v.h.f., OJU; OO v.h.f., ZM. I would like to take this opportunity to extend the Season's Greetings to everyone, everywhere. I know that everyone has hopes that the coming year will see the last of war and that once again we can all enjoy our hobby, AMATEUR RADIO. LBC is now in this area; he used to be chief engineer at R.C.A. but is now chief engineer at KRBU, California highway patrol. The WERS meeting was held at the Oakland City Hall on Oct. 20th. BUY is going to town on his new farm at Walnut Creek — all set for a new home and an FB DX location after the war. At present he is raising rabbits and chickens. EE is still doing an FB job with WERS and is planning a big postwar rig. SQ is building up a fixed 112-Mc. rig using some of the newer type tubes for his home location. IKQ is still in the East on an important war project. BGY is working hard at the telephone company. PB is starting to rebuild the old rig for postwar use and at present is on 112 Mc. WERS. SFT is very active in WERS and is keeping the dust off the old rig. He is still running the picture machine at Oakland Fox. RCE is working evenings at the telephone company, spending most of his spare time dreaming of his new rig. GPY hopes to be back on the Coast soon. Another day closer to victory. 77.

SAN FRANCISCO — SCM, William A. Ladley, W6RBQ — ECs: DOT, KZP. OO v.h.f., NJW. Radio Aide DOT held a meeting of WERS zone aides on Sept. 27th. Present were NJW, KZP, EVI, LFZ and RBQ. Matters pertaining to WERS drills and plans for the future were discussed. We have two new appointments this month:

KZP as EC and NJW as OO on the very-highs. Both are technicians at KYA and active in WERS. DAV has a new portable mobile unit installed in his car; a TR4 push to talk. EVI's son is serving in the So. Pacific. RH's address is 1st Lt. Wm. Overstreet, APO A0610, c/o Postmaster, N. Y. 9YQS, formerly an S.F. WERS operator, is teaching radar for the Navy at Chicago. HJP writes in stating that all goes well. His address is 1st Lt. Arthur M. Monsees, APO 241, c/o Postmaster, San Francisco, Calif. 9EKY of ERC, St. Louis, is back at Honolulu. RAH is back in S. F. as a permanent resident field engineer for Raytheon. DUC writes in from home. Vic underwent a severe operation but has since been to sea as radio operator. 5FDR visited RBQ this month on his way to Washington to receive the Congressional Medal of Honor for his part in sinking three Jap ships. Bill is a CA pilot and is ex-WLJR of Houston, Tex. SZ lost his wife recently. NJW has constructed a new type noiseless super for WERS use. A new portable mobile unit is in use at zone 2 and manned by Miss Frances Jessin, who holds a restricted 'phone license. CWH has completed a new 10-meter crystal frequency meter. Word comes from NLL, who was liaison officer for 9th C.A. of AARS. It is reported that 6LFZ will soon be moving to the Santa Clara section. Make it your business to get a new member for the League each month. We need all the help we can muster until our frequencies are won back. Please drop a card each month with activities of yourself or of other amateurs. 73, *BUU*.

SAN JOAQUIN VALLEY — Acting SCM, Edward H. Noack, W6BXB — JIN and DXL called on the Acting SCM. JIN went into the Navy recently and is in charge of P.T. boats at Miami, Fla. DXL is stationed at Samon, near Eureka, Calif., and is in charge of all radio communications. HIP is stationed at Treasure Island and is warrant officer in charge of radio. DTJ is also in charge of radio equipment and is an instructor. Fresno, Merced, Modesto and all other hams, please send in reports. We would like to see all districts of the San Joaquin Valley section represented in this column.

ROANOKE DIVISION

VIRGINIA — SCM, Walter G. Walker, W3AKN — M/Sgt. Dan Lake, ex-GON, was a recent visitor at his old Langley Field post. Dan is now stationed at an Army Air Base in Mississippi. Bob Vernon, ex-IFJ, is now stationed at Camp Stoneman, Calif. IKT is still in India. HOC is now in the AAF in Texas. Your SCM had as a recent visitor, IAN, who is now a lieutenant in the Marine Corps stationed at Quantico. IED is now a lieutenant and an instructor at Ft. Monmouth, N. J. NE is again radio operator in the merchant marine, operating in the West Coast to South Pacific service. Ens. HAE reports his new address as 541 Boylston St., Apt. D1, Boston 18, Mass. Buster is now in the Navy program at M.I.T. Your SCM heard from the following: Capt. A. P. Marsh, ELA, 2117th AAF, B.U. Section C-1 B, AAF, Ft. Myers, Fla. M/Sgt. W. H. Kiblinger, RCAC-5, 1244 SCSU, T.T.S., 673 Broadway, New York 12, N. Y. 1JEC, APO 512, Postmaster, New York, wishes to know the whereabouts of his old buddy, IQL, formerly of Ocean View, Va. Anyone knowing about Bill is urged to write to Stuart, who is laid up for a spell. Major 4BC reports from HQ ATC, Washington, D. C., that he has been all over the globe and would like to hear from some of the old gang. According to the grapevine, Col. HWJ has been transferred to Florida. Wikstrom, ex-IIF and HJW were last reported to be working together in Brooklyn, N. Y., for Raytheon. II is still with the FCC in Washington, D. C. To all you fellows who have written to me, I hope to get a letter out soon, but it is hard to find the time to write. 73, *Walt*.

ROCKY MOUNTAIN DIVISION

COLORADO — SCM, H. F. Heikel, W9VGC — EHC reported from Washington, D. C., again, which means that he has stayed put in one place for about three months. During that time he was promoted to the rank of captain and is now living on this side of the tracks at 326 Raymond Ave., Alexandria, Va. Harrison Goff and his wife had a nearly-fatal accident in New York. They were on their way to Radio City with friends in a car and a street car plowed through the intersection against the red light and hit the automobile amidship. They landed in Roosevelt Hospital, each with a broken hip. The baby was not with them, as Dona left her with her grandmother in Denver. The Radio

(Continued on page 64)



"HIGH FIDELITY" has come to mean the same thing as wide frequency range to most radio men. This can lead to a lot of grief, because wide range is only one of the requirements that must be met. In our experience it is not even the major requirement.

We take it that fidelity refers to the ability of a sound system to reproduce the original sound faithfully. The more the reproduction sounds like the original, the higher the fidelity. We think there is not much argument here.

For the reproduction to be a perfect replica of the original nothing must be added and nothing can be taken away. Unless the system can reproduce a wide range of frequencies, something is taken away. The "highs" are missing. Unless the system is free from distortion, something is added. Harmonics are present. In our experience, distortion is more important, and much more difficult to control than frequency range.

As an experiment, we once "souped up" a phonograph so that the upper limit of its range was extended from about 5000 cycles to about 10000 cycles. We substituted a wide range speaker for the previous one, and added compensation by means of filters to extend the range of the pickup and amplifier. It sounded awful, much worse than before we made the changes in fact. This must be a fairly common experience, because a number of people who heard it remarked "That is what you always get when you go in for high fidelity."

As a sequel to this experiment, we rebuilt the amplifier. Triode tubes, operating Class A, were used throughout. The last two stages were push-pull. Transformers of the highest grade were employed, and the output transformer in particular was a husky affair having lots of iron and copper. Great care was taken to make sure that the amplifier was absolutely stable and that the speaker was adequately damped. The pickup was of a special type having linear response to 15000 cycles. Having done all this, we then inserted a filter with a cut-off at about 5000 cycles.

With such a cut-off, the system clearly could not be called "high-fidelity," yet the reproduction was so realistic that it approached the spectacular. The attenuation of high frequencies was similar to the loss caused by distance, or by draperies. Someone hearing the system for the first time, without warning, was apt to say, "Who is playing the piano *in the next room?*" The italics are ours.

We are not arguing against wide frequency range. On the contrary, we think that only a wide range system can do a first class job. A phonograph pickup will introduce a lot of distortion as it approaches the limit of its range. So if you want to reproduce 7500 cycles, do not use a pickup that just reaches this range. Use one that goes an octave higher, to 15000 cycles. Then use a filter that cuts off just low enough to take out the distortion in the record, at the limit of *its* range. The same thing goes for radio tuners, speakers, and amplifiers. It may seem wasteful to buy frequency range and then throw it away with a filter. Actually you buy fidelity, and throw away distortion. You will hardly believe how good such reproduction can be until you try it.

WILLIAM A. READY



Amateur Activities

(Continued from page 82)

Widow's Club has headed into its big season. Margaret Swanlund had a birthday in Sept. and her OM, WYX, had another year hung on him Oct. 15th. The Swanlunds and the Hawleys celebrated their wedding anniversaries Oct. 28th and the second regular meeting for Oct. and a Halloween Party was scheduled for the 28th. I wish to thank TFP for filling in for me the past two months. I was told (unofficially) that CAA helped him, with the understanding that TFP would sign the report and send it in and assume all responsibilities and pay all claims for damage. And don't think that AA-1 priority will get you through the Pearly Gates; you will have to get back in line and take your turn with the rest of them. I asked an old man at the end of the line how long I would have to wait and he said that he didn't know, he had been there since the Fourth of July, so I decided to come back home. The following was sent in by TFP: BQO is building a new WERS receiver, using a 615 tube; also a new transmitter, using an HY75. He is also considering some monitor and frequency measuring equipment, too. CAA says that since reading about the New England hurricane he has tightened up all his guy wires. Incidentally, he has that new rig working now. ESA is still working on his WERS equipment, but hopes to be on with it soon. He says that he is too busy with industrial equipment to get much done with his own. CNL is now settled in his new job at Weickers and will soon have his receiver done and on the net. KFND-31, Paul Kirkpatrick, is building a new transmitter. ACB and TFP, who went deer hunting the first of Oct., came home without having found any of the four-legged kind. BVZ is somewhere in the West Pacific with the Navy. VIK was in Denver on a 5-day furlough during the middle of Oct. KFND-27 is now one of the most consistent signals on the WERS net. His antenna system is a constant topic among the hams. Looks like he will have to either write an article or make a speech on it. 7GYG has located another one of his bugs, an 83 tube causing a bit too much hash. KFND-24 and 26 are engineering what they call a special WERS stove pipe antenna and when completed 24 will have an antenna raising bee with beer and pretzels. BQO and TRR have entered the radio parts and service business. WERS in Denver has some newcomers; Wm. Newton, KFND-16; 6SSA, KFND-5; Wm. Thoes and Al Zambakian have licenses but no call yet. 73, by Heck.

SOUTHEASTERN DIVISION

ALABAMA—SCM, Lawrence J. Smyth, W4GBV—EOX has been promoted to ensign and is working overseas for the Navy. He was in Birmingham for a visit and saw EDR. He passed through Washington and visited DGS. EBZ was promoted to 1st lieutenant and is still in the Signal Corps in Ceylon. He says among the hams he works with are G3WH, VU2FS, Y12GQ and Y11DH. He would like to hear from the gang. His address is Lt. F. N. Thompson, APO 432, o/o Postmaster, New York, N. Y. AHQ is in charge of the AACB high-powered radioteletype transmitters sent to Europe. He is stationed in Maine. HDI, who used to be with highway patrol radio and is now at Auburn, Ala., has just received a notice to come up for his physical. Good luck, Jack. 73, Larry.

EASTERN FLORIDA—SCM, Robert B. Murphy, W4IP—The hurricane of Oct. 15-20 passed Miami like the adopted stepchild and we were glad we had to clean up only a few limbs and leaves. MacArthur, from a sick bed, directed his Dade County 112-Mc. net sending a portable to Homestead, 29 airline miles south. Operators Petruff and Mennitt manned the equipment and kept in constant touch with control. Jerguson did the same thing with a car portable. Mac thinks he has a record with Jerguson; he worked 29 miles from control station to a car unit with 100 per cent QSO all the way. "Prof." Longsmith and Browne are doing very good work with their new ideas in Mac's net too. ANP is still resting and has an SW3 on the air. He says FLZ is back in Miami after a tour of duty as an aircraft RM1c at Corpus Christi, Tex. A letter from ACZ shows he is very active in our Fla. State Guard, holding the rank of 1st Lt., P & T officer. Tony is an old 2 1/2-meter man. I would like to hear from Tony about his activities around Lake Worth. Good old EYI comes through with the following: JM was home on a short visit. ATB is with WSUN. FRE is still based at Washington. When last heard from FZW was out Calif. way. HPM is still with the police

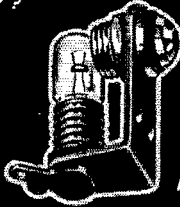

Is it Off?
High or Low?
Thermostat Working?
Is it On?
Generator Charging?
What Door?
What Band?
Stand-by?
Microphone On?
Monitor Running?

Don't Guess!
USE
MALLORY
310 SERIES
Pilot Lights

BANISH confusion from your radio room and laboratory. Have instant visual indication on the condition or adjustment of transmitters, receivers, and all electronic or electrical apparatus with Mallory 310 Series Pilot Lights. Police, fire and sheriff departments use them for "cars in service" indicators and for illuminated maps. They are ideal, too, for civilian defense applications and signaling where the sound of bells or buzzers can not be tolerated.

Mallory 310 Series Pilot Light Brackets are available with faceted jewels in six colors—white, amber, green, red, blue and opal, and with two types of sockets—miniature screw base and miniature bayonet.

See these Mallory 310 Series Pilot Light Brackets today at your authorized Mallory Distributor.

P. R. MALLORY & CO., Inc.

INDIANAPOLIS 6

INDIANA

For Quicker Victory—Buy War Bonds



P. R. MALLORY & CO. Inc.
MALLORY

RESEARCH



Continual research in chemistry, metallurgy and effects of various atmospheres on different plating finishes assures you that your Hammarlund variable capacitor will stay on the job.

HAMMARLUND

THE HAMMARLUND MFG. CO., INC., 460 W. 34TH ST., N. Y. C.
MANUFACTURERS OF PRECISION COMMUNICATIONS EQUIPMENT

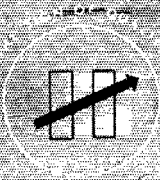

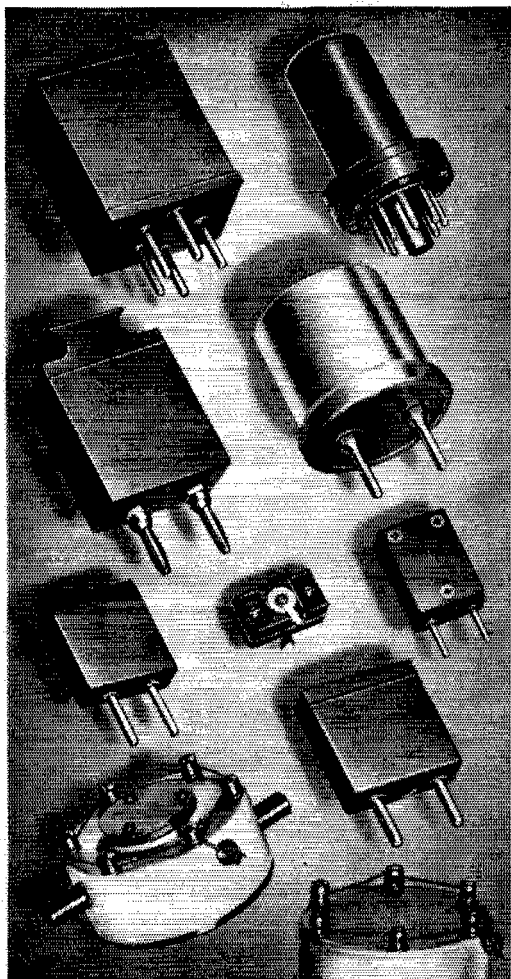

In **QUARTZ**
CRYSTALS
 the most significant
 advancements have been
 introduced by **BLILEY**

Do more than before . . .
 buy extra War Bonds

Bliley
 CRYSTALS

BLILEY ELECTRIC COMPANY
 UNION STATION BUILDING • ERIE, PENNSYLVANIA

(Continued from page 64)

department. IK is Frigidaire distributor in St. Pete. EYI is a good corresponding secretary and really keeps in contact with you fellows. GGL is back from a tour of duty with PAA as a maintenance man at Natal, Brazil. He is now going through school to become a flight radio officer (GEE please note). Ray Russell, one of BYF's active WERS men, is in the hospital with a fractured skull received in a motorcycle accident. BYR, ex-SCM, writes that he has left for Chicago on a business trip and reports the following activity in Tampa: KM is doing nicely with his new Tampa jobbing outlet. He owns his plane with full radio equipment. CCC, of Winter Haven, has pin feathers showing and will be flying shortly. DES sold his home in Haines City and has moved his family to a newly-purchased home on Prospect Rd. in Tampa. DRX has married and is flying with AAC. KM and BYR attended Electronic Parts and Equipment Industry Conference held in Stevens Hotel at Chicago in Oct. KK has become active again after extensive repairs to his receiver. Doc keeps his code speed up with a little copy each day. We all extend our sympathies to Doc on the death of his father. CPG called and is working as a Raytheon engineer for the Navy here in Miami. CNZ is still at the PAA school as a code and procedure instructor and is a very busy man. We extend our sympathies to Tiny on the passing of his father. ES and wife are enjoying a prolonged business trip to New York. Well, fellows, drop me a one cent government post card with some news. 73, Merf.

WESTERN FLORIDA — SCM, Oscar Cederstrom, W4AXP — EPT is in the Army now. George's radio talent should be a welcome addition to the services. FIO says he has a new home with plenty of room for ham radio gear when the boys go on the air again. A/C 9ZVJ, of St. Louis, is now in training here and visited AXP for a personal rag-chew. Leo's sister is 9ONW, and they have a swell QSL card, one of which he gave the OM. Leo ran into 4ABB, who is at Corry Field; UV, who is an instructor at Ellyson, and 6DIS and 8TJI, who are at Whiting. 9ZVJ and 9ONW worked nearly all the bands and used 'phone on 10 and 20. Some of the Pensacola gang have worked him in the past on 'phone. ECT and FJR are the proud parents of a brand-new 1944 model YL. Congrats from the section. One of our radio boys, Horten E. Whaley, who is in one of the code rooms, composed a poem which he called "The Song of a Radioman." It's some poem and fits the situation pretty well. Dr. R. E. Smith, ex-ham, has returned from a well-earned leave and is now back on the job at the Naval Hospital. Hinshaw, one of our instructors, has left on a trip, some of which he will make via plane. The OM would like to hear from all hams at this air base. We run into quite a few off and on. So let's hear from you. The OM wishes all of you a Merry Christmas and a Happy New Year. 73 to all from *The Old Maestro*.

GEORGIA — SCM, Ernest L. Morgan, W4FDJ — CCJ has had an interesting time in India. FXG, a lieutenant in the Navy, was in Sicily for a considerable period. ACR is in Augusta with Ordnance in a civilian role and has a son somewhere in the services. VX is teaching radio at Columbus and keeps up a great correspondence with his graduates in the services. Stevens, of Columbus (call not available), is in Australia. CIE and his XYL are hosts to a jr. operator. Scotty made a few trips with the merchant marine and came home with a luxuriant beard. EGT is at sea in the Pacific. The hams of Georgia were thrilled to see the picture and to learn of AGI's whereabouts. 73. Pop.

SOUTHWESTERN DIVISION

LOS ANGELES — SCM, H. F. Wood, W6QVV — Had a nice letter from Wally Newman, RM1c, who finally arrived home from duty in the So. Pacific. He had a chance to visit some hams on Funifute, Elice Islands, American Samoa and New Zealand. On Funifute he ran across ZL2DI, whom he had worked many times, and really had a good long rag-chew. He says he had to pay ninety cents for a used four-prong socket. He would like to hear from all his friends. The SCM will be glad to furnish his address. SML has been studying at Cornell but has been transferred back to our Coast and is interested in building a carrier current transmitter. His friends can reach him at 10933 Ayers Ave., Los Angeles 34. A report has just come in that "Wittle Daniel Cupid" has done his stuff again with the help of QKP, who is now a Seabee. He introduced RLX of Los Angeles and SPX of Fresno and darned if they didn't become engaged. RLX is a t/sgt. with the Signal Corps in

"SUPER-PRO"

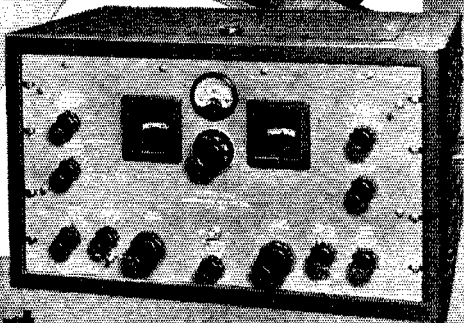

RIGHT . . . from the start

A good product is no accident. From the very beginning the "Super-Pro" was planned right—for seven years it has been the world's finest communications receiver. Watch this page for new and superior Hammarlund products.

HAMMARLUND

THE HAMMARLUND MFG. CO., INC., 460 W. 34TH ST., N. Y. C.
MANUFACTURERS OF PRECISION COMMUNICATIONS EQUIPMENT

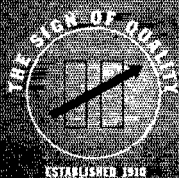

Built like battle craft

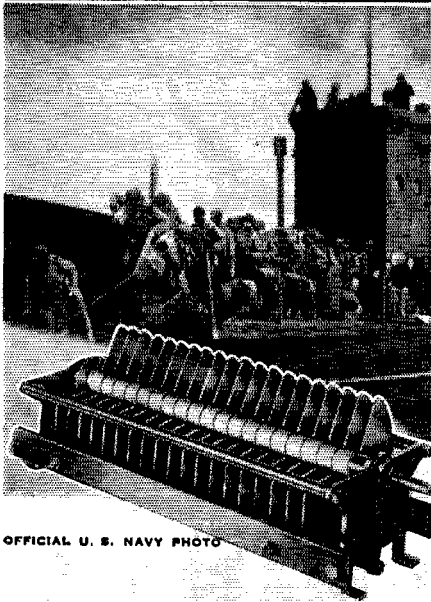

OFFICIAL U. S. NAVY PHOTO

INVASION CRAFT at every beachhead depend upon vital communications to guide them safely through their missions. Vital communications equipment, in turn, depend upon sturdy components for continued operations. Typical of these components is the Cardwell Model TK-300-US Variable Air Transmitting Condenser (illustrated).

Among transmitter manufacturers, Cardwell Condensers have the reputation for being thoroughly acceptable and reliable. Cardwell pioneered the metal frame, grounded rotor variable condenser as it is now used in electronic equipment, and Cardwell products continue to be the STANDARD OF COMPARISON. May they go forward with the Navy to Victory.

CARDWELL CONDENSERS

THE ALLEN D. CARDWELL MANUFACTURING CORPORATION
81 PROSPECT STREET BROOKLYN 1, N. Y.

(Continued from page 68)

France and SPX is a radio operator in Sacramento. UQL from "way up north" writes that he has run across a CO up there who is a W2 and is trying to get transferred into his outfit. SSU is still hopping from Mainland to Island but is hankerin' to join the merchant marine and "put to sea" for added experience, as though radio operator on those flying fortresses wasn't enough. ESX' oldest son, Dick, getting a most thorough and complete education in electronics at Yale, is just about to graduate and get married. The XYL of AEL has just undergone a very serious operation but is coming along. We understand that Jimmy Rollins, a Navy operator at present, met his brother, also in the Navy, upon his arrival on the Island, after not having seen him for a couple of years. RNN of the Inglewood Amateur Radio Club writes that at a recent election all incumbents were retained for another year. This speaks very well for their efficiency and I know the club has done "right well" in holding them over. They are planning on bigger and better things for the coming year. AM writes in for KGWE, to the effect that there are now three of those 6-element beams in their network to date, as described in Sept. QST. Long Beach still is very active in WERS drills. They spend the last half hour of each period in contacting other cities and are still working up to 100 miles very satisfactorily. I hear KGCL once in a while. KGIC is going good, more and better equipment is being worked on, and all drills are well-attended. KGLV, the Los Angeles City net, is functioning quite well. Considerable work is being done with antennas and new rigs. Messages are being handled at each drill period and the whole net is becoming a smooth working unit. Too much credit cannot be given to GZZ for his efforts in being on the job at each drill period to monitor and set rigs on frequencies. Rudy Jepsen in the Valley and Stan Lambert in West Los Angeles are also to be strongly commended for their work and enthusiasm. Most all of the members of the net are doing "swell." Sure would like to hear from MFJ and others so write in, will you, please? Beat of everything to all of you. 73, Ted.

ARIZONA — SCM, Douglas Aitken, W6RWW — A long letter was received from QWG, who has just returned after a year in the Pacific Area with the merchant marine. He has just been commissioned a Lt. (jg) in the merchant service and will continue as communications officer on one of their ships. QEW dropped over here for a visit, says he sold his receiver to the Army, but will be ready to go whenever reactivation comes. REJ dropped in for dinner, and did we rag-chew over old times! He is now a corporal in the Air Transport. NRP dropped a card with his FPO address, so suspect that he is out on the briny deep. RIA, of 10-meter fame, especially wishes to be remembered to the Tucson gang, and says that he is now learning to walk again, and hopes that before too long he'll be able to throw the "props" away and navigate on his own. He has met several of the fellows he used to work. OIF and RIJ dropped in on their way out into the hills on a deer hunt. Eva says she'll be back on the air just as soon as they say "Go." TUW is now a full Lt. in the Navy and has recently taken unto himself a bride. The Salt River Valley WERS reports they are still going strong and have in for 4 more operator licenses. JOF has his radio shack finished, now the gang wants to stage a housewarming. TKL has finished his WERS portable. MAE and NEL keep the tonsils in trim for 10-meter activity by warbling when they get a chance. NGJ also is out in the hills chasing the elusive venison steaks. George Floyd, W6?, is visiting in Tucson. QNC dropped in with a suggestion that is pretty much in line with my notions. Why not a state-wide radio club? It is our notion that such a club would be of benefit to all, as well as being a coordinated organization that might help wield a little pressure when the war is over. We should like to get your opinions — drop a card to me or QNC. Next month we shall try to outline the features of such a club. We're not in any way trying to detract from the local organizations — rather to include them as an integral part of the whole state set-up. 73, Doug.

SAN DIEGO — SCM, Ralph E. Culbertson, W6CHV — Asst. SCM, Gordon W. Brown, W6APG — It looks very much like San Diego is finally going to be heard from in a big way in WERS. A small meeting was held at the home of APG. Those attending were FMJ, LYF, MHL, NDD, OIN, QKI, RGY, CHV, APG and 8VHN. 8VHN gave a very interesting talk on the formation of WERS in Dayton, Ohio. NDD was appointed as tentative radio aide. Some plans were discussed and another meeting scheduled for the last week in October. All those interested and those

THE EFFECTIVE REPRODUCTION OF SPEECH...

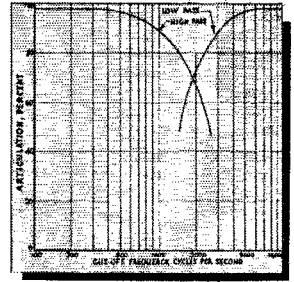
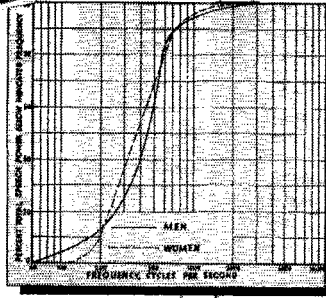
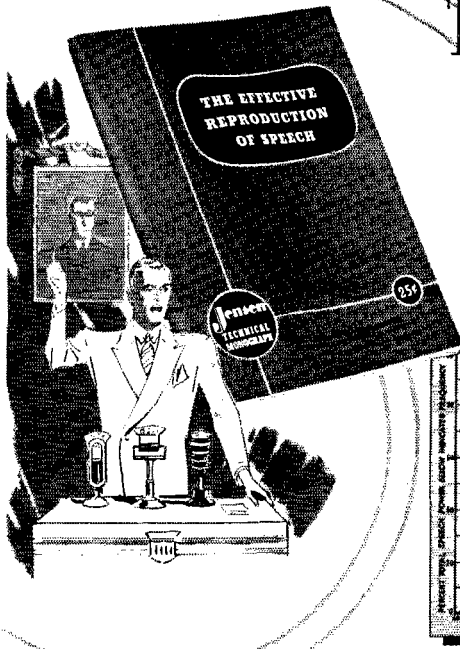

• When casually considered, the reproduction of speech may appear to present less exacting requirements than the reproduction of music. Yet faithful speech reproduction requires a frequency band almost as wide as for music. Amplified speech for strictly communication purposes usually presents a different requirement. Here, such matters as articulation, loudness, masking, power requirements and the ability to deliver the message through noise, become the more important considerations.

"The Effective Reproduction of Speech" — Number 4 in the series of JENSEN Technical Monographs — presents much up-to-date data on this important subject in convenient form, together with useful conclusions and practical information for everyone interested in sound reproduction. Get your copy from your JENSEN jobber or dealer, or fill out the coupon and mail it with 25c for each copy ordered.

The Series So Far Issued

- No. 1. Loud Speaker Frequency-Response Measurements.
- No. 2. Impedance Matching and Power Distribution.
- No. 3. Frequency Range in Music Reproduction.
- No. 4. The Effective Reproduction of Speech.

FREE to men in the Armed Services, and to Technical Schools, Colleges, Libraries.



Jensen

RADIO MANUFACTURING COMPANY

6611 South Laramie Avenue
Chicago 38, Illinois

- Send me The Effective Reproduction of Speech.
 Frequency Range in Music Reproduction.
 Impedance Matching and Power Distribution.
 Loud Speaker Frequency-Response Measurements.

(Check one or more. Send 25c for each book ordered.)

NAME _____

ADDRESS _____

CITY _____ ZONE _____ STATE _____

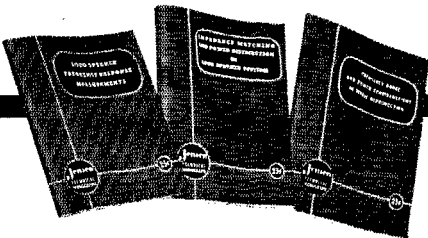

Facts AT YOUR Fingertips

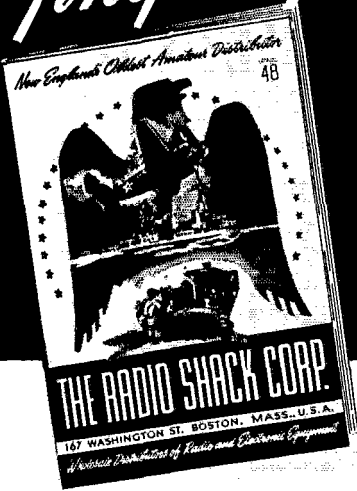

In its convenient, pocket size, the new Radio Shack catalog gives you 108 pages of detailed data on the products of leading parts and equipment manufacturers, and it puts right at your fingertips the facts you need in choosing materials to use in prototype or production models, and in selecting instruments for laboratory testing.

Write today for your free copy of this useful tool.

The RADIO SHACK
 167 WASHINGTON ST.
 BOSTON, MASS., U.S.A. ★

RADIO SHACK CORP.
 167 WASHINGTON ST
 BOSTON 8, MASS.

Please send my copy of your new catalog to

Name

Title

Company

No.

Street

City

State

(Continued from page 68)

having any equipment, please get in touch with APG or myself. A recent visitor was 8QDU of Detroit, who is temporarily stationed in S. D. RME left Convoir to take over the vice-presidency of a large firm in Chicago which manufactures relays, etc. BHF is now a captain in the Calif. State Guard. PFQ is chief boatsman's mate in the Coast Guard and is the proud papa of a new son. RPJ is back in San Diego. 8YIB and 4HGR are temporarily stationed at S. D. Well, gang, how about some news so we can keep this column going. 73, *Ralph*.

WEST GULF DIVISION

NORTHERN TEXAS — SCM, Jack T. Moore, W5ALA — IAU gave up the SCM job to go into the Army. Dale Westbrook (LSPH) has been to sea for six months as 2nd operator with the merchant marine. LJR is co-pilot with Lockheed at Dallas. CJJ is going into the Navy to join three brothers already in the service. GLD is doing radio service work in Dallas. IYC and KJF are working at No. American in Dallas. ILJ sends in a swell report from Kelly Field and advises that he now has 1st-class telephone and 2nd-class telegraph commercial tickets. HTH has the same tickets. HMG is in the Air Corps at Barksdale Field and is a married man now. IWE is "somewhere in Australia" with the Signal Corps. IIN is in the Navy in San Diego. HFN is working for KWFT. JEE is with the USO in Louisiana. MR reports that MA recently made a trip to India and back to this country within a week via a ferrying group. JJE promises news from El Paso. AJG takes time off from WRR to turn in an FB report. EVI should be home from overseas by Christmas. HIP is back on the farm. EQJ is now with WFAA. DXR is in the radio lab. at Braniff. FL is RM1c in the Navy. III is with an ordnance plant in Amarillo. HJX ditto at Waco. EHM is doing civil service work at San Antonio. TW is an instructor at Dallas Aviation School. IT, now is Lt. comdr. in the Navy, stationed in Washington, D. C. HKK is dispatching with DP&L. EDW is supervisor of communications for Braniff. GOB is operator for KVP. ENE is with CAA in Panama Canal Zone. BEH is shipping with a peacetime acquaintance, BD, of Angleton, Tex. Fellows, as this is my first report as SCM, I would like to make a deal with you. Send me some news each month and I promise to report it regularly. How about it? 73, *Jack*.

NEW MEXICO — SCM, J. G. Hancock, W5HJF — ND is still building houses at Orange, Tex. and has his family with him now. 3IRM (ex-Jr.-operator at 5ND) has made three different flying ratings and expects to be flying some kind of "crate" over enemy territory soon. HJF has a heavy schedule of correspondence chess and keeps up with some of the old gang that way, such as ND, ZM and JVV. A very happy holiday season to all you guys and gals and may this one be especially joyful with victories on all our battle fronts. 73, *Jack*.

The Month in Canada

(Continued from page 66)

he dug up a bit of news, which goes as follows: 4KI, Ken Wright, of Strathmore, is wireless officer aboard a Liberty ship, on its way to India at the time of writing. 4AKG, Bob Saunders, of Kirkealdy, at one time Alberta's youngest ham, is now WAG, stationed at Boundary Bay, B. C. 4LA, Bill Harwood, of Strathmore, is in the midst of harvesting. 4LM, Bill March, of Drumheller, is with the RCAF and when last reported was on his way to India.

Our sympathy goes out to 4GE, Stu. Jamieson, of Drumheller, whose father passed away in September. 4JP, of Alliance, has sold his ham shack (from which most of his hamming was done) so Reid will have to find some other place to park his heap by the time we get back on the air. While in BW's joint a few weeks ago I saw 3AOG, Lieut. R. F. Chinnick, of Chatham, Ont., who is with the RCCS here in Edmonton. He is very anxious to contact some of the local boys in Edmonton to do a spot of rag-chewing.

From Albert Potoski, of Lethbridge, we hear of activity in the Lethbridge Club. Albert gave a lecture on saw-tooth oscillators on Sept. 7th, and gave a demonstration with his Burton-Rogers' scope, using a thyatron 884 saw-tooth oscillator (20 to 20,000 cycles). Albert also reports that the "saw teeth" obtained looked so realistic that 4EO, Bill Savage, of Lethbridge, wanted to borrow it for cutting up

AVAILABLE FOR IMMEDIATE DELIVERY . . . AT A



McElroy

WHEATSTONE CODE TAPE
PERFORATOR MODEL PFR-443-A

SUBSTANTIAL PRICE REDUCTION!

Since its introduction, two years ago, the demand for the McElroy Wheatstone Code Tape Perforator has mounted consistently. This has enabled us to effect considerable economies in engineering, tool and die, and other production costs—without affecting the quality or efficiency of the instrument. As a result, the PFR-443-A is now available, for immediate delivery, at \$275.00, which is a substantial reduction over its former price.

The Model PFR-443-A prepares clean and accurate tapes that may be passed through any make of automatic transmitter at any speed (up to 300 words per minute) for which the transmitter was designed. Built for stationary or mobile applications, this perforator consists of two units: The Keying Unit, which is silent in operation . . . and the Electronic Unit, which relieves the keying contacts of high current and voltage, and is designed to protect the delicate electronic components against jolts and jars. Unlike other standard perforators, the McElroy machine permits operators to easily maintain speeds of between 30 and 40 words per minute in all Morse combinations assigned to the Russian, Turkish, Greek, Arabic and Japanese alphabets and languages.



McELROY ENGINEERS
NEVER COPY AND
NEVER IMITATE.
WE CREATE, DESIGN, BUILD.
WE ARE NEVER SATISFIED
WITH MEDIOCRITY.

GIVE FULL SUPPORT TO THE SIXTH WAR LOAN DRIVE

McElroy MANUFACTURING CORP.
82 BROOKLINE AVE. BOSTON, MASS.

WORLD'S LARGEST MANUFACTURER OF AUTOMATIC RADIO TELEGRAPH APPARATUS

PORTABLE POWER PROBLEMS

THIS MONTH—G-E MODEL "B" ELECTROCARDIOGRAPH

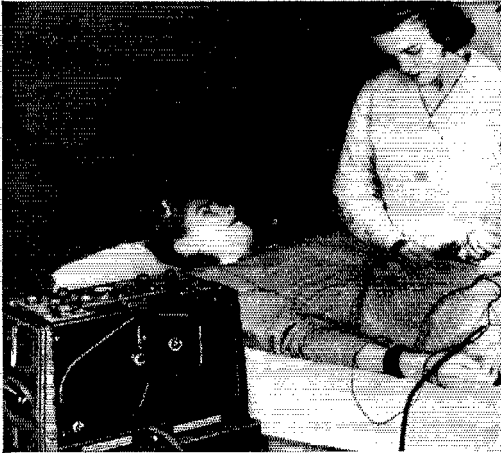

HIGH SENSITIVITY and standardized operation characterize the General Electric Model "B" Electrocardiograph which assists doctors in quickly establishing accurate diagnosis and prognosis of heart conditions. A true photographic record of minute changes in heart potential waves is given by this remarkable lightweight, battery-powered instrument. As a result, it quickly and economically makes available information that would otherwise be very difficult to obtain.

BATTERY COMPARTMENT houses the power heart of the G-E Model "B" Electrocardiograph (Burgess "A" and "B" batteries are standard equipment.) General Electric descriptive literature emphasizes that "batteries provide the most dependable source of power—always smooth." Battery power assures operation anywhere— independent of commercial electric supply. Burgess engineers are constantly adapting special-purpose batteries for special commercial and industrial requirements. Let them solve your portable power problems. Free 80-page Engineering Manual. 25 charts, 36 data tables and 31 descriptive pages on characteristics of dry batteries. Tabbed for ready reference. Write Dept. Q-4 for free copy. Burgess Battery Company, Freeport, Illinois.



BURGESS BATTERIES

(Continued from page 70)

some planks, but as Albert was afraid Bill might dull it, they let the matter drop. It appears that their next lecture will be on rectifiers. 4EO is deep in "math and a.c. vectors." 4ALI, Roy Hopkins, of Lethbridge, is still doing very well collecting QST subscriptions, and he is at present preparing to do a bit of home recording, if the apparatus he has been purchasing is anything to judge by. 4SP, Boyd Clark, of Picture Butte, is returning to civilian life again after spending several years in the RCAF. According to reports he intends to go back to his old line of work including radio servicing. Thanks for the dope, Albert.

A letter from 4AEN, Geo. Marion, of Edmonton, tells us that he has met up with W4ABO down in Charleston, and that when ABO wants any of his gang he hangs out their calls on a buzzer! Geo. has been doing some fishing recently and has had several very pleasant trips. 4ANV, Dave Tait, of Edmonton, forwarded us a short note from 4AQY, Ken McLean, of Edmonton, in which Ken tells us that he has been keeping up with the doings of the Alberta gang through this column. Ken, by the way, is with the RCAF and apparently attached to the R.A.F. Ken was sitting reading QST in one of the Canada Clubs over there when two other hams spotted him. They were 4AIS, Dave Kowall, of Winnipeg, and 4UR, Cliff Greer, of Sovereign, Sask. A real local hamfest took place with ham radio uppermost in the conversation. Thanks for the note, Ken. 4HM, Chas. Harris, of Edmonton, and his YF went down to Vulcan to witness the graduation of their son, Roger, at No. 19 SFTS. While in Vulcan, they visited LQ's folks. 4ADW, Jack Goodridge, of Edmonton, has left the employ of the CPA and has enlisted in the RCN at Saskatoon. Jack was in Edmonton for a few days before reporting for duty with the Navy. Jack told us that 4AGZ, Don Stewart, of Edmonton, now a flight lieutenant in the RCAF is now in Italy. He is in North Africa for some time. 4SL, Johnny Haydamack, of New Brigden, Turner Valley and Vulcan, is in the Army and was stationed at Camp Dundurn in Saskatchewan a month or two ago. ADW saw 4GA, Bill Rogers, of Regina Beach, this summer, and says that Bill is still in fine fettle, and looking ahead anxiously to the day he can get back on the air (who among the hams isn't?). 4ADD, Art Craig, of Edmonton, has the rank of flight lieutenant, and now is in France.

MAILBAG

From David S. Hutchinson, VE3DU:

I HAVE been so disappointed in the news received from Ontario hams that I decided I would write a few lines about the hams from London, also the ones with whom I am working. 3ACO now has turned to farming and has a nice location for skywires when things open up again. 3CM, has been promoted to W/O 1 in the RCOC where he operates the Signal Corps station at London. 3KC now is stationed at Ottawa with the Navy. 3WP-ex-3HB is stationed in B. C. with the RCAF. 3HZ is with the RCOC in Italy and holds the rank of major. 3WX, formerly of Windsor, now is located in London and has recently gone into the accounting business. Best of luck, Bob. 3QC recently took unto himself a wife. Congrats, OM. Ex-3VR has been a prisoner of war in Germany since about 1941. 3WM has completed his course at Kingston and expects he will receive his majority. 3QK, also formerly of Windsor, also is in London where he is a corporal with the RCOC at Central Mech. Depot. The Old Ontario Network is well represented in London with 3QK, 3WX and myself located there although I get down there only one week-end a month. 3AQJ, Rooke, now is stationed in Ceylon where he was moved from India. He is with the RCAF. 3AQK, Clifford, now is CQMS of the First District Signals at London. 3AQF, Jarvis, is CSM of the First District Signals at London. 3AQQ, Kells, now is an instructor at Kingston with the rank of major. 3BBC is with the Navy on inspection work at Spartan Radio. There are many more London and district boys but cannot remember their calls so will have to let this suffice. Have not heard a thing from the St. Thomas gang in a couple of years, so, if any of them see this little report, I hope they send you an account of their doings.

3BAD, Blanchette, of Hamilton; 3LO, Seward, of Niagara Falls; 3YE, Durant; 3RY, Hardcastle, and 3ATI, Sandbrook, all of Toronto, and 3AUW, Smith, of Kirkland Lake, and 3AUQ, Culp, of St. Catharines all are working with me down here. What the nature of the work is cannot be divulged at present but needless to say it is very important.

FOR SAFETY'S SAKE!

Electro-Voice Hand-Held Differential Microphone

Model 205-S

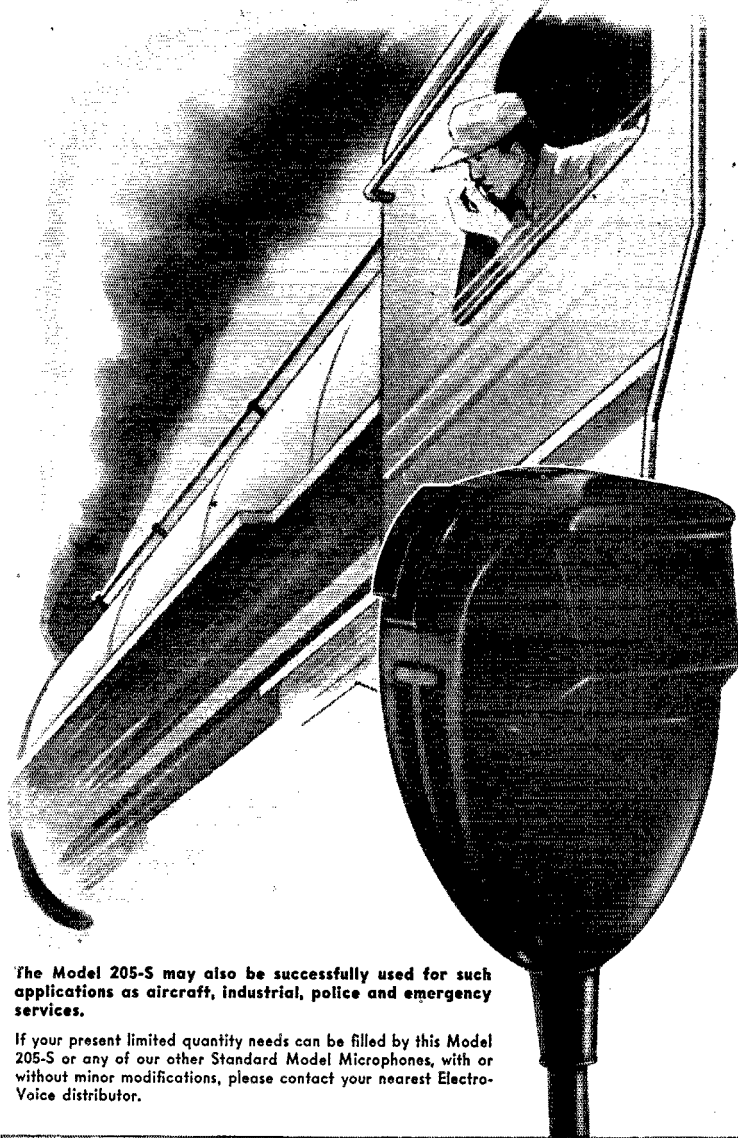

The Model 205-S may also be successfully used for such applications as aircraft, industrial, police and emergency services.

If your present limited quantity needs can be filled by this Model 205-S or any of our other Standard Model Microphones, with or without minor modifications, please contact your nearest Electro-Voice distributor.

The appalling number of railroad accidents in recent months has stimulated the demand for installation of radio communications on railway lines. Eventually, all lines will be thus equipped. Splendidly suited "for safety's sake" is the Electro-Voice Differential Microphone Model 205-S. A noise-cancelling microphone, it enables the transmission of voice clearly and distinctly, unaffected by shrieking whistles or grinding wheels. Ruggedly constructed, it can "take" the punishment of a hard-riding locomotive.

FREQUENCY RESPONSE: substantially flat from 100-4000 c p.s.

LEVEL: -20 DB (0 DB = 1 volt/dyne/cm²)

ARTICULATION PERCENTAGE: 97% under quiet, 88% under 115 DB ambient noise

TEMPERATURE RANGE: -40° to +185°F

WEIGHT: Less than eight ounces

INPUT REQUIREMENT: standard single button input

BUTTON CURRENT: 10-50 milliamperes

MECHANICAL DETAILS: molded, high impact phenolic housing. Minimum wall thickness, 1/8". Vinylite carbon retainer.

SWITCH: press-to-talk, with or without hold-down lock. Double pole double throw contacts provide an optional wide assortment of switch circuits. Standard circuit provides closing of button circuit and relay simultaneously

THERMAL NOISE: Less than 1 millivolt with 50 milliamperes through button

IMPACT RESISTANCE: capable of withstanding more than 10,000 drops

POSITIONAL RESPONSE: plus or minus 5 DB of horizontal

CABLE: 5' three conductor, overall synthetic rubber jacketed

BACKGROUND NOISE REDUCTION: 20 DB and higher, depending on distance from noise source

Electro-Voice MICROPHONES

ELECTRO-VOICE CORPORATION • 1239 SOUTH BEND AVENUE • SOUTH BEND 24, INDIANA

Export Division: 13 East 40th Street, New York 16, N. Y., U. S. A. Cables: Arlab



Are You Letting Others By-Pass You

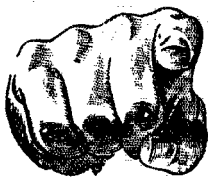

to a Better Job, Greater Pay and a Secure Peace-Time Future in Radio-Electronics?

Learn how a CREI planned program of home study training can prepare you now for post-war security and an important, good paying job in Radio-Electronics engineering.

This means that more radiomen than ever before realize the great opportunities that await technically-trained men. It means that they are investing a small portion of their present-day earnings in CREI study for post-war job security.

Competition Will Be Keen!

JOBS THAT PROVIDE SECURITY — jobs that will mean something long after "tomorrow" has come and gone — must be won and HELD on ability. The men who will RETAIN the important radio engineering positions after the war is over are those men whose positions are essential — whose ABILITIES are specialized.

Today, hundreds of ambitious men are taking our specialized spare-time training to give them the technical skill to supplement their present ability . . . to earn a better living . . . and to create a secure place for themselves in the great post-war world of radio-electronics.

Don't Say YOU Haven't the Time

You can study a few hours a week without interfering with your present work. So, write for all the facts now — this is the time to make sure that your preparation for post-war success shall not be "too little, too late!"

● WRITE FOR FREE BOOKLET

If you have had professional or amateur radio experience and want to make more money—let us prove to you we have something you need to qualify for a better radio job.

TELL US ABOUT YOURSELF, so we can plan a course best suited for your needs. Please state briefly your radio experience, education and present position.



CAPITOL RADIO ENGINEERING INSTITUTE

Home Study Courses in Practical Radio-Electronics Engineering for
Professional Self-Improvement

Dept. G-12, 3224 16th St. N. W., Washington 10, D. C.
Contractors to the U. S. Navy, U. S. Coast Guard and Canadian
Broadcasting Corporation

Producers of Well-Trained Technical Radiomen for Industry

Happenings of the Month

(Continued from page 17)

Amateur Apparatus Is Similarly Available

The total acquisitions and accumulations of apparatus by amateurs are enormous and constitute a reserve of equipment that is invaluable in national emergencies. In the present war, for example, in the early months before quantity deliveries were available under government contracts, thousands of amateur receivers and transmitters and countless thousands of amateur components — particularly meters — were acquired by the military services (with the assistance of our organization) and flown to the fronts where they were desperately needed. Just as the amateurs themselves constitute a pool of available personnel, so do they serve the national interest by possessing specialized equipment which is instantly available for the nation's needs.

Amateur Radio Supports a Manufacturing Industry

The purchases by amateurs of apparatus and equipment for their stations has constituted a business of considerable magnitude. Although of course it has not ranked high in the list of the nation's greatest industries, it was sufficient to support scores of manufacturing establishments catering to the specialized requirements of the amateur, and an extensive distribution mechanism. The expanded business which this industry can expect from the augmented amateur body of the future will be of considerable importance in the days of rehabilitation to come. But much more important to the national welfare has been the ability of this specialized industry to expand and build the complicated electronic apparatus of modern warfare. Much manufactured amateur equipment is highly developed and in many cases it has served in this war with small change. Amateur equipment is the only equipment manufactured in appreciable quantities which holds this possibility of over-night adaptation to military needs. All the plants that have built such amateur equipment are now laboring under unprecedented production requirements, with a constant call for increased output to meet the unending demands of war. The existence of the amateur radio market was responsible for the original formation of many of these companies, and for the establishment of specialized departments in many other plants, causing the building up of organizations competent to deal with specialized applications of electronics. It should be put down as one of the further merits of amateur radio that it supports a manufacturing industry which, in time of war, is capable of ready expansion to fill military needs.

War Emergency Radio Service

Under the head of amateur contributions to the security of the nation I might interpolate at this point a brief mention of the War Emergency Radio Service, particularly the civilian-defense branch thereof. This is a temporary wartime service operating in some of the amateur bands while we are closed down. Its major activity has been the provision of emergency-communication means on behalf of the Citizens' Defense Corps, that is, the civilian defense organization to deal with the threat of enemy raids and sabotage. Several hundred communities perfected communication organizations for this purpose, involving several thousand stations and a good many thousand operators. Operating under its own temporary regulations, WERS has not been an amateur service. But it is a fact that most of its skilled personnel, and particularly the great majority of the radio aides planning and supervising the operations of the system, were drawn from the ranks of amateurs who remained on the home front. And similarly the great bulk of its station apparatus was either lent by amateurs or made up by the amateur members from their spare parts, and it was amateurs who taught the classes where hundreds of additional citizens qualified as WERS operators. Thus although, strictly speaking, this was not an amateur activity at all, the amateur was the major ingredient in its success. Happily it has never had to deal with events brought about by enemy action, but it has been ready.

Welfare

Amateur Radio Is a Vast Training School

It is impossible to over-emphasize the importance of amateur radio as the great training school for the whole radio art. The amateur learns by doing and, because he is driven by the most ardent interest imaginable, he commonly acquires skill and proficiency and knowledge of a high order.

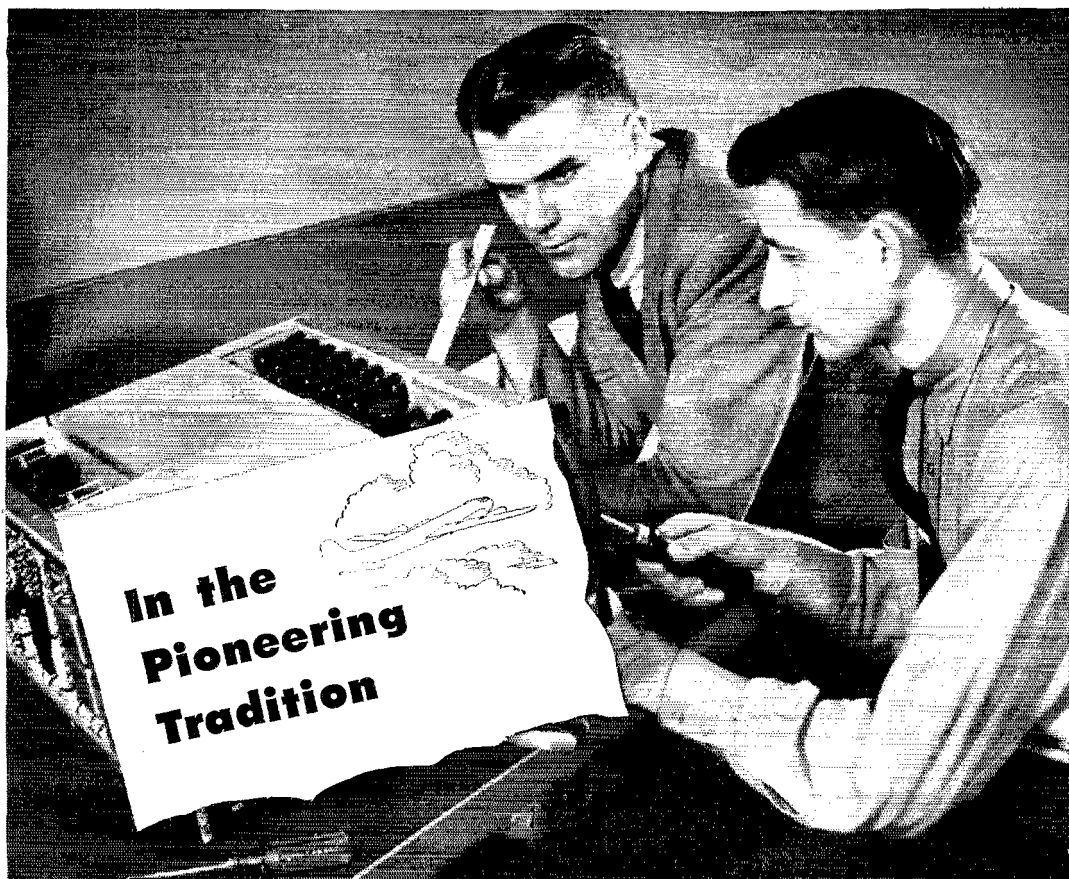

THE COLLINS RADIO organization has always been driven by the urge to pioneer...

To introduce professional standards of design and performance in transmitters and receivers for radio hams in the early thirties.

To engineer a radio outfit that stood up to the rough-and-tumble of Admiral Richard E. Byrd's second expedition to Little America.

To take high quality broadcast equipment out of the laboratory and make it economically practicable for any broadcasting station.

To meet the individual requirements of some of our great airlines with specially engineered communication equipment, including the Collins Autotune.*

To be prepared on December 7, 1941, to



go into production of airborne and ground based radio gear of highly advanced design for the Armed Forces — the result of research and development looking years ahead.

Very soon, we hope, this restless Collins urge to pioneer beyond present horizons will be exerting itself again for the airlines and other commercial and private users of radio communication equipment. *Collins Radio Company, Cedar Rapids, Iowa.*

* The Collins Autotune is a repositioning mechanism which quick-shifts all transmitter or receiver controls simultaneously and with extreme precision to any one of a number of pre-determined frequencies. U. S. Patents issued and pending.



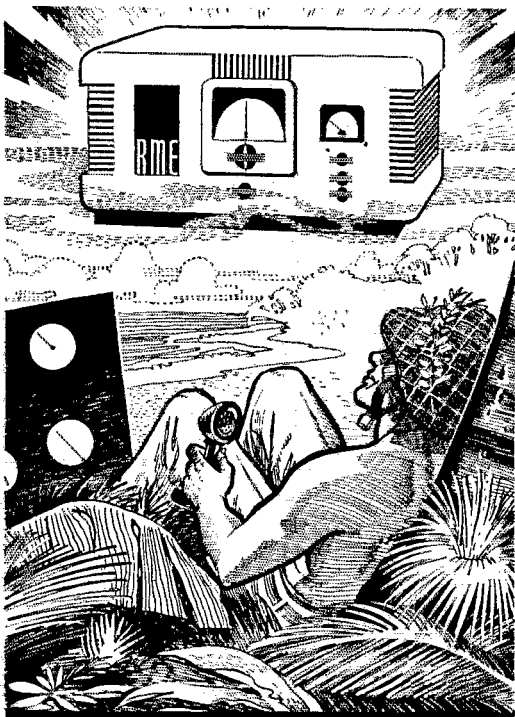

R.M.E. WORKS FOR WAR.. PLANS FOR PEACE

We're thinking about you, too, Mr. Radio Amateur, and we're planning for your return after Victory. R.M.E. engineers have your tomorrow's radio equipment on the drafting table—and you're going to like it! New features—improved design—better performance—gained from war's research. Stand by for your R.M.E. receiver.

"R.M.E. — Since 1933"

R M E



FINE COMMUNICATIONS EQUIPMENT
RADIO MFG. ENGINEERS, INC.

Provia 6, Illinois U. S. A.

(Continued from page 74)

By his practice of amateur radio he trains himself in a complex art at his own expense and thereby builds up a great reservoir of skilled people available for the needs of the nation. Amateur radio is the great source of engineering, operating and even executive personnel for the radio industry. The majority of the familiar figures in the radio world today started as amateurs; a great many of them are still amateurs. Amateur radio operating, because of the interference with which it must contend, develops the most skillful form of operator, and a very large percentage of the licensed stations of this country in categories other than amateur are found to be manned by personnel of amateur background. It is of incalculable value to the nation that this pursuit of an avocation should result in the creation of the personnel necessary to carry forward America's pre-eminence in communications.

A Nationwide Aid to Science

The large number of amateurs and their scattered location all over the nation, and their diversification in interests and operating frequencies, have made the group an invaluable aid to science. Let something arise on which radio physicists need a large number of observations and promptly a considerable group of skilled amateurs can be found who are interested in collaborating. Many amateurs have participated in several projects of this nature under the auspices of the National Bureau of Standards or the Navy Department, bringing to the aid of science observers and facilities that could be commanded through no other medium.

There is, we believe, a general appreciation of the amateur spirit in research, in other lines of endeavor as well as radio. In radio it is particularly significant. It derives, we believe, from the very freeness of spirit with which the amateur meets his problems, flowing from the essential fact that the amateur is truly interested in his art — every detail of it. Great as are the attributes of modern organized laboratory research, it must be admitted that laboratory development by highly-trained technicians following routine research practices are often encumbered with ponderous fetishes, involved mathematics, and the conviction that results can be obtained only by following certain rigorous routines. Amateurs break down these fetishes. By the very fact of their limitations in equipment, and frequently also because of their small formal training in laboratory technique, and their consequent need to secure results by simpler methods, they free the art from many ponderous superstitions and it is simply a matter of history that they have often found the true answer to a problem on which many are working.

The developments of this war have pierced new frontiers in the upper portion of the frequency spectrum. A large number of amateurs have been identified with the development of this new technique, and thousands of men destined to become amateurs after the war have been given training in its operation and maintenance. Despite the magnificent accomplishments of our wartime laboratories, we have only begun to acquire knowledge in this new field. It is a region of great interest to the amateur investigator. Nothing is so likely to advance the art in this portion of the spectrum as for the nation to have a large amateur body, possessed of a lively curiosity in the performance of such frequencies and determined to adapt to amateur communication requirements many of the electronic techniques that come out of the war. We may be confident that postwar amateur radio will make significant contributions to our knowledge and practice in this part of the spectrum.

Invaluable Service in Time of Natural Disaster

But it is in its ability to supply communication in time of emergency, when all other means have failed, that amateur radio probably renders its greatest peacetime public service. There is never a year when some portion of our far-flung country does not encounter disaster through some act of nature that destroys the usual forms of communication and leaves a section of our population in dire distress, cut off from the usual means of aid. In such emergencies, amateurs may be counted upon to supply communication, even under the most difficult circumstances. It is a matter of solemn duty and pride. The vast number of amateurs, their long experience in doing the impossible, their ingenuity in devising artifices, make it certain that with an adequate amateur body, no part of this nation can become isolated and its needs remain untold, even though days elapse before the public services are able to restore communication. We have it as a motto that there is always an amateur listening. The

**77
WATTS
OUTPUT
FROM A PAIR
AT 200
MEGACYCLES**

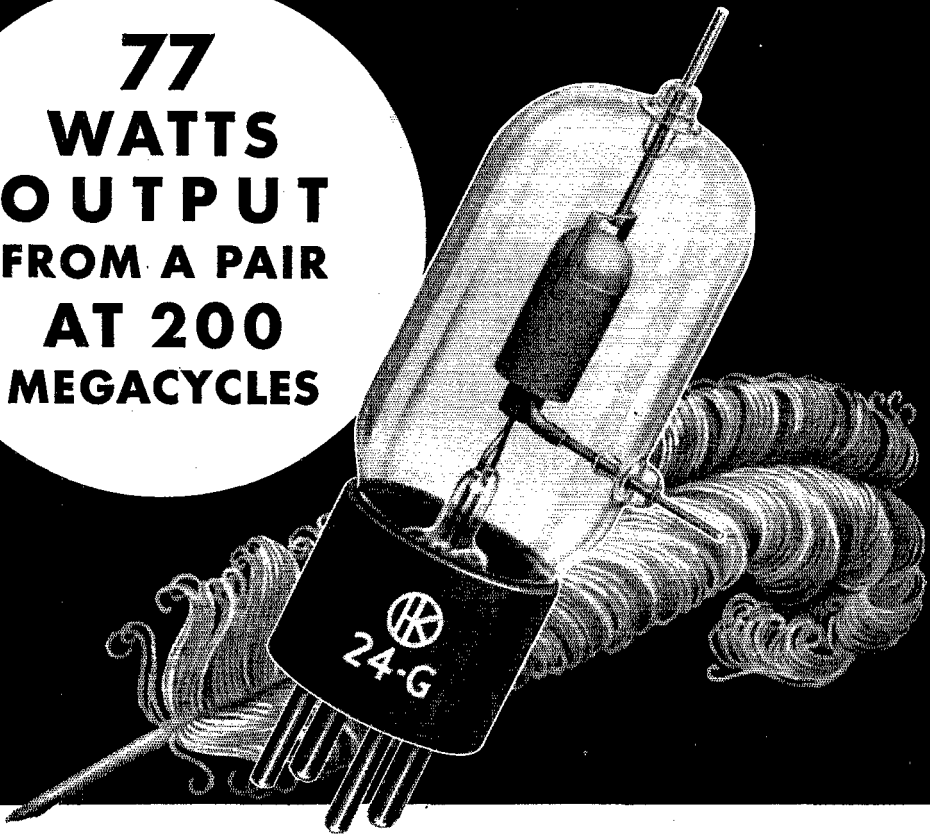

H & K developed this *featherweight* to pack a wallop in the VHF region

The only thing that's small about this 4½-inch, 1½-ounce Gammatron is its size. Heintz and Kaufman engineers originated and perfected this powerful little tube to put out a 77 watt signal from a pair at 200 Mc. as a Class C unmodulated amplifier... 116 watts at 100 Mc. Even at peak frequency, 300 Mc., a pair of HK-24G Gammatrons develop a remarkable 44 watts.

The high efficiency of the HK-24G in the VHF region results from (1) the long, capped tantalum plate, typical of Gammatrons, which confines the entire electron stream for useful output, and (2) the fact that this grid is closely spaced to the filament for short electron time-flight.

The HK-24G triode is easy to neutralize, and parasitic oscillation is avoided, because the inter-electrode capacities are very low, and the grid and plate leads are short. For typical operating ratings of the HK-24G as an r. f. power amplifier, audio amplifier, crystal oscillator, doubler, or tripler, write today for data.

HK-24G MAXIMUM RATINGS

Power Output
Class "C" R. F. . . . 90 Watts
Plate Dissipation . . . 25 Watts
Amplification Factor 25
Plate Voltage 2000 Volts
Plate Current 75 MA
Grid Current 25 MA
Frequency 300 MC

INTER-ELECTRODE CAPACITIES
C Grid-Plate 1.6 UUF
C Grid-Filament 1.8 UUF
C Plate-Filament 0.2 UUF

FILAMENT

Volts, 6.3 Amperes, 3

**LOAN YOUR DOLLARS
DONATE YOUR BLOOD
FOR EARLY VICTORY**

HEINTZ AND KAUFMAN LTD.
SOUTH SAN FRANCISCO • CALIFORNIA



Gammatron Tubes

(Continued from page 76)

Prepare to get your "ticket"!

With the New
1944 Revised Edition of
DREW'S

**HOW TO PASS
RADIO LICENSE
EXAMINATIONS**

By Charles E. Drew, I.R.E., A.I.E.E.



A revised, up-to-date edition of a book which will give you the help and the knowledge you need to pass the government exam and get your "ticket."

So easy to follow, to understand. Questions and answers cover every field of radio communication — transmission or reception — whether in marine, aeronautical, police, or broadcasting.

It explains Basic Radio Laws; Basic Theory and Practice; Radiotelephone; Advanced Radiotelephone; Radiotelegraph; Advanced Radiotelegraphy.

The "Bible" of the radio field — quickest, surest way to acquire the knowledge you must have!

Send for **YOUR** Copy Today!

Second Edition 320 Pages **\$3.00**

ON APPROVAL COUPON

JOHN WILEY & SONS, Inc.
440 Fourth Ave., New York 16, N. Y.

Please send me on ten days' approval a copy of Drew's How to Pass Radio License Examinations. At the end of that time, if I decide to keep the book, I will remit \$3.00 plus postage; otherwise I will return the book postpaid.

Name.....

Address.....

City and State.....

Employed by.....

QST-12-44

amateur body is trained in rendering this service and the Army and Navy, Coast Guard, Red Cross and state and city officials have come to look to us for this assistance. The annals of amateur radio contain a most impressive record of many scores of major emergencies in which radio amateurs, with skill and devotion and frequently at great personal sacrifice, have served their communities and brought relief when no other means was possible. Many thousands of lives, an untold amount of human misery, and millions of dollars in property have been saved by their efforts. The amateur contributions in this respect have received the highest praise from public officials, including members of this Commission. The enterprise and courage and hardihood of the thousands of amateurs who have participated in such relief work have constituted a colorful phase of American life and in their total benefit to the public are one of the strongest justifications for the existence of amateur radio. We have already placed in the Commission's records, on previous occasions, listings of the most important of these accomplishments.

These results do not come about by accident. They are the result of organization. It is part of the philosophy of organized amateur radio that the amateur must be prepared to render emergency service and that he must go into action when disaster strikes. To facilitate this work our League has always maintained liaison with the Red Cross and the military services and with numerous organizations representative of public service and utilities. A deep sense of social responsibility has been built up in the radio amateur. The majority of amateurs possess portable or mobile equipment which they have specially built to accomplish this work without dependence upon the usual sources of power. These amateurs are organized in what we call the ARRL Emergency Corps, their activities in each community centralized under a volunteer worker in our extensive field organization who is called an Emergency Co-ordinator. It is his duty to maintain contact with local authorities, the Red Cross organization and the mayor's committees, to participate in the advance planning that each community undertakes in anticipation of potential disasters, and to co-ordinate into the finished plan the participation of local amateurs so that they may contribute with the maximum effectiveness. But whether the amateur belongs to our Emergency Corps or not, he is always prepared, as a natural part of his thinking and his attitude toward amateur radio, to give his services in time of need to his community or to any community within his range.

After the war we shall have in this country a much larger number of amateurs than before. The performance that amateur radio can give in the relief of natural disasters will be much greater than ever. Our organization considers that one of its most responsible duties when peace returns will be to train and instruct and organize the expanded postwar amateur body for the most effective discharge of this traditional amateur responsibility. It is a task which only the amateur organization itself can hope to encompass. In our long experience in this field we have found it quite unsatisfactory to lay down a rigid organization, with assigned frequencies and nets and places of duty. It is in the very nature of disasters to upset the best pre-laid plans that involve only a limited number of specially-selected personnel. We have seen such plans fail repeatedly through the isolation of key stations and key men. The successful accomplishment of the task involves the preparedness of a relatively vast number of amateurs who have equipped and trained themselves to deal with emergencies and have so studied their local situation and its prospective needs, and have so thoroughly drilled themselves in the maintenance of communication under adverse conditions, that they are ready for any contingency.

We believe that the peculiar nature of the amateur organization lends itself admirably to the organization of this work. Our League is over thirty years old. It maintains contact with its members not only through its own magazine *QST* but through innumerable bulletins specially prepared for the groups interested in particular lines of activity, such as emergency communication. It has hundreds of affiliated local clubs. We are a nonprofit association of the amateurs themselves, and no person may serve as a director or officer who has any business connection with the radio industry. Our Board of Directors is elected by ballot of the membership in each of the fourteen divisions into which we have the United States divided, and this Board controls our policies. Our divisions are further divided into about ninety sections,

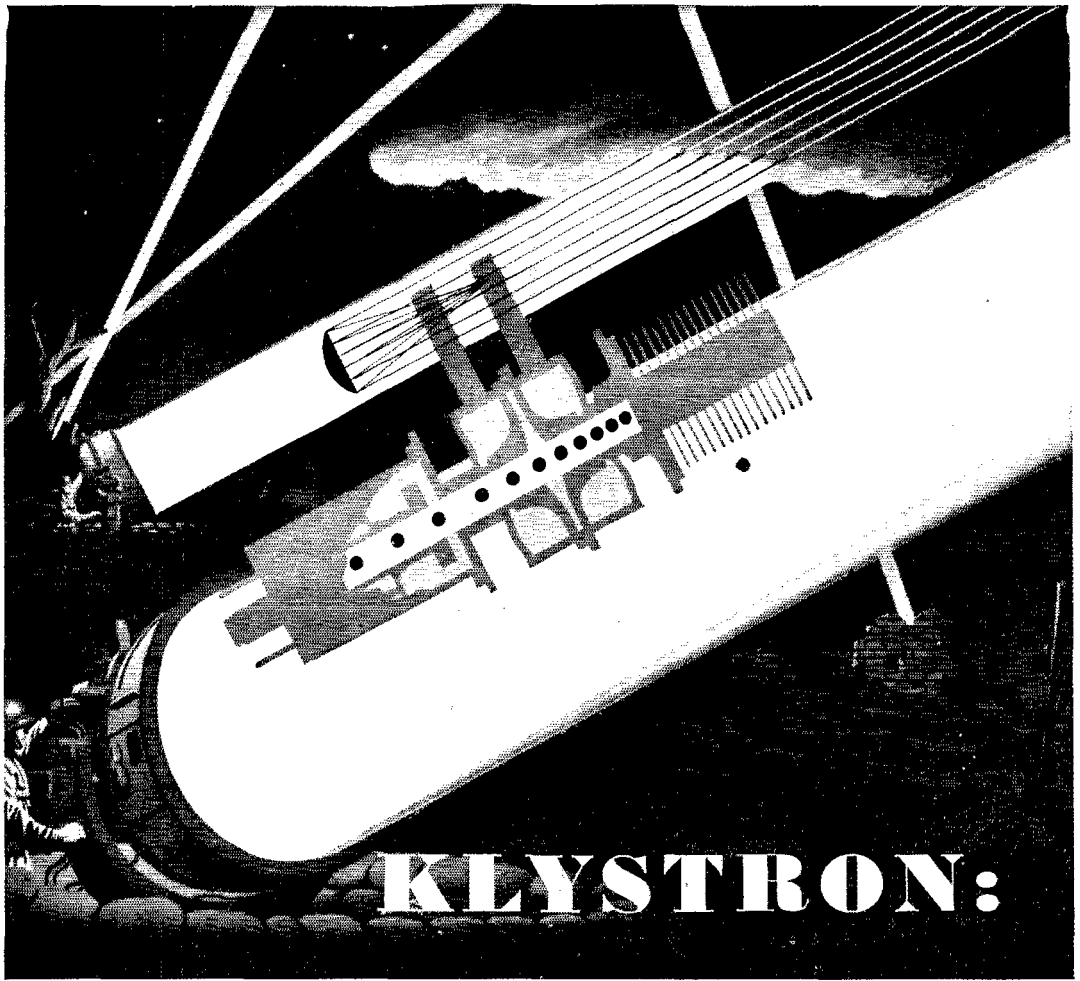

A pencil of energy beamed like light

IF YOU'LL imagine an *invisible* searchlight beam, you'll have a good picture of how Klystron-generated radio waves can be directed into a narrow "pencil" of energy.

► This direction is accomplished by suitable reflectors. The beam of ultra-high-frequency waves travels in a straight line, and it can pierce fog, smoke, and clouds which would stop a light beam.

Sperry-developed Klystron tubes are used in

many equipments now serving our Armed Forces. Later, *Klystronics* will open the door to the development of many ingenious peacetime devices.

► **Klystrons are now being produced in quantities, and certain types are available.**

The name "KLYSTRON" is a registered trademark of the Sperry Gyroscope Company, Inc. Like many other Sperry devices, Klystrons are also being made during the emergency by other companies.

Sperry Gyroscope Company
INC.

GREAT NECK, N. Y. • DIVISION OF THE SPERRY CORPORATION

GYROSCOPICS • ELECTRONICS • AUTOMATIC COMPUTATION • SERVO-MECHANISMS

Time Tested... Time Proven

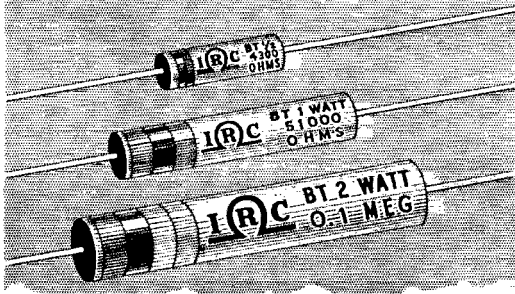

IRC METALIZED TYPE BT RESISTORS

Unexcelled in such essential characteristics as stability, low noise level, low voltage coefficient, mechanical strength, humidity protection, and insulation—IRC type BT resistors have a proven record of performance in millions of applications. Today, after more than a decade of use, these small, sturdy units are recognized as standard around the world. Available in all wanted ratings.



INTERNATIONAL RESISTANCE CO.

401 N. BROAD ST., PHILADELPHIA 3, PA.

IRC makes more types of resistance units, in more shapes, for more applications, than any other manufacturer in the world.



Founded in 1909

RADIO TELEPHONY RADIO TELEGRAPHY PRE-INDUCTION RADIO

Courses ranging in length from 3 to 9 months. Dormitory accommodations on campus for men and women students. Approved by Texas Department of Education with authority to issue a maximum of 80 semester credits for complete training. *If interested, write for details.*

PORT ARTHUR COLLEGE PORT ARTHUR TEXAS

(Continued from page 78)

in each of which the members elect by ballot a section communications manager who co-ordinates the practical operating activity of the League members in his region. He in turn assembles a staff of volunteer workers serving him as route managers and specialized assistants for special purposes. He also appoints an emergency co-ordinator in each community of appreciable size in his section, the latter then acting as the point of contact between the community organization and the local amateur body as concerns organization for the relief of emergencies.

There were several thousand highly-qualified amateurs participating as unpaid volunteer workers in our field organization when war came, all operating under the supervision of a full-time salaried communications manager at our headquarters office who in turn was the contact between his organization and the numerous national agencies whom we served. It is our intention to press this work with the utmost vigor after the return of peace. We believe that the war experience of the country will facilitate the establishment in every community of a continuing planning group with the duty of being prepared should disaster strike. We know that the amateurs of the community can accomplish a service that lies within no one else's power to deliver. The large number of amateurs and their distribution throughout every city and hamlet of the nation and the demonstrated genius of the amateur body for organizing for the effective carrying out of a difficult task—these things combine to offer the assurance that in our complicated postwar life the radio amateurs of the country will be able to maintain all the segments and facilities of our national life in uninterrupted contact.

Sociological Factors

In addition to the more tangible benefits which the nation receives from the existence of the institution of amateur radio, as we have just recounted, we should like to make brief mention of its sociological importance. Every amateur makes countless contacts with fellow amateurs at a distance and thereby facilitates understanding and the interchange of ideas. However, in the social field the most important aspect of amateur radio is probably the self-improvement of the individual. The practice of amateur radio teaches method and industry, encourages the inquiring mind and the reasoning processes, teaches self-reliance and consideration of the rights of others, demonstrates the merit of co-operative enterprise. In such respects it far transcends the usual avocation, for it is a training school in which the tools are those of universal science. Reflecting that our national culture is only as good as the individuals who comprise it, much may be said for the sociological importance of amateur radio.

History

The public services performed by amateur radio are of direct and great value to the national economy. Existing primarily as a giant communication system, these amateurs have developed an organized ability to contribute in many ways to the public security and welfare. I should like to give you a brief description of the origin and growth of amateur radio, whereby it has attained its present importance in the security and welfare of the nation.

Radio amateurs are individuals with a personal and non-pecuniary interest in the technique of radio communication. They are experimenters in the radio science, developers of apparatus and techniques, and communicators interested in two-way communication with their own stations. Fundamental provisions for their operation are set up in world treaties and their activities in this country are controlled by extensive regulations of this Commission. Amateur radio constitutes the only means through which the private citizen has direct and personal access to the communication spectrum which is the fundamental property of the people.

Amateur radio is unique. There has been nothing quite like it even in the technical arts. It is the oldest branch of radio, for of course the early investigators, working before the days of commercial radio service, were themselves amateurs. From the earliest days there has been something about communicating across space that has fascinated those of us who are technically inclined. Rich or poor, old or young, we find an irresistible appeal in the ability, with the product of our own hands and our own brains, to reach out into the ether and make contact with another intelligence. Derived largely from electrical and scientific experimenters, the early amateurs, around the turn of the century, were solitary experimenters, in the main. Occasionally they used

Q.S.O.

Dear OM:

When first you tune in your prewar rig to postwar channels...you'll find them crammed with Q.S.O.'s telling you about the marvelous ham equipment which will be available as a result of war-born transmitter developments.

Much of this equipment—antennae, H.F. switches, coaxial cable and fittings—will be made and marketed by Communication Products, Inc. Then we hope you'll stand by our product, knowing that we'll stand back of them.

73's

J.L. Beaul Sr (W2CQF)

Communication PRODUCTS COMPANY, INC.
744 BROAD ST., NEWARK 2, N. J. • FACTORY: 346 BERGEN AVE., JERSEY CITY, N. J.

Electronics

RADIO ENGINEERING

New Courses for Modern Needs

RADIONICS, the science of electronic applications, is widening its horizon hour by hour. There's a secure future in this field for YOU — provided you put OUR TRAINING ON YOUR *must* list NOW.

Needed at once are specialists in Marine Radio, Police Radio, Aviation Radio, Broadcasting, Television, Frequency Modulation, High Frequency Broadcasting, and Commercial Radio Telegraph. That need will continue.

Our school is co-educational. It offers to women as well as men streamlined elementary and advanced courses for Radio Servicemen, Radio Engineering Assistants, Radio Test and Maintenance men. The work is thorough, practical, void of frills. The courses are approved by State Vocational Departments, Major Airlines, State Police Systems, Radio manufacturers, and hundreds of Broadcasting Stations.

Credit is given for Army radio courses and experience toward any of our courses. High school graduation or its equivalent necessary for advanced courses. Tuition at pre-war levels. Send for catalog *today*.

MAIL THIS COUPON NOW!

VALPARAISO TECHNICAL INSTITUTE

Dept. Q, VALPARAISO, INDIANA

NAME.....

P. O. ADDRESS.....AGE.....

CITY and STATE.....

CATALOG REQUEST — QST

DISTRIBUTORS of QUALITY RADIO AND ELEC- TRONIC MERCHANDISE AND EQUIPMENT

Still Serving the Industrials and War
Agencies with Vitally Necessary Radio
and Electronic Products

AND

Planning Every Way To Give You The
Best Possible Service Throughout The
Years of Peace To Come

**STANDARD RADIO & ELEC-
TRONIC PRODUCTS CO.**
DAYTON—SPRINGFIELD
OHIO

(Continued from page 80)

their apparatus for communication but largely they were not even aware of each other's existence. However, by about the years 1906-1908 a basic change transpired in the character of amateur radio, apparatus and technique having improved sufficiently to enable communication over distances of a few miles. Acquaintances occurred amongst experimenters in metropolitan areas. By 1909 radio clubs were springing up in many of the larger cities. These and other influences produced a gradual metamorphosis in the art, socializing the institution and placing increasing emphasis on communication aspects. Increasing numbers and activity inevitably led to conflict with governmental and commercial services, a situation aggravated by the fact that in the early days many amateurs had superior equipment. By 1910 there were several thousand persons interested in amateur radio, most of them possessing transmitters, and interference between services became a serious problem. The first comprehensive federal radio law was enacted in 1912. It made due provision for private, or amateur, stations, but limited their operation to a frequency of 1500 kilocycles, the belief at that time being that frequencies of this order and higher were essentially worthless for long-distance communication. Growth continued despite the unfavorable restriction and by the end of 1913 about 2,000 amateur station licenses had been issued by this Government. In 1914 the national association of amateurs, The American Radio Relay League, was formed under the leadership of Hiram Percy Maxim, who remained its president until his death. At the end of 1916 the number of licensed stations exceeded 6,000. The declaration of war in 1917 resulted in the closing down of these stations and an appeal from our Army and Navy for their services. In sixty days we inducted over 4,000 of our membership, self-trained radio operators, to give their services to the Army and Navy, forming the nucleus for the most effective radio signal corps possessed by any of the combatant nations. Their record is one of the classics of that war.

Returning to their barren 1500-ke. region following the war, amateurs adapted the fruits of compressed wartime research so successfully that they were at times able to span transcontinental and transoceanic distances with this frequency which had been discarded as worthless. Overcongestion and individual curiosity caused a few amateurs to investigate the almost unexplored frequencies above 1500 kc., and thereupon amateur radio entered its true domain. In 1923 the first two-way amateur communication across the Atlantic Ocean was accomplished, on about 2700 kilocycles. By the end of 1924 the Antipodes had been linked by amateur high-frequency radio, and by about a year later amateurs all over the world were in communication with other amateurs in all continents on frequencies as high as 16 megacycles.

This was short-wave radio developed by the amateurs. They had been given these frequencies in 1912 as the "worthless" end of the spectrum and they turned them into channels useful for the longest terrestrial distances.

Thereafter the growth of amateur radio was more rapid and, with the wise encouragement of this Government, numbers and activities increased until, on December 7, 1941, there were about 60,000 amateur stations licensed by this Commission. It is a testimonial to the efficiency of the organization which the amateur has built up in the meanwhile that when, on that fateful day, the Government advised us that amateur stations were to be closed for the duration, the amateur bands were substantially cleared and silenced in a matter of twenty minutes. In common with all the other people of the United States, the radio amateur again went to war, this time in greater numbers and with higher skill. The American Radio Relay League estimates that over 25,000 of the nation's licensed amateurs are now serving in the armed forces of the United States, many of them in positions of much importance; and additional tens of thousands are serving in civilian capacities in the laboratories and training schools of the nation, in the wartime Government service, in the merchant marine and in the wartime radio manufacturing industry. You have doubtless seen page after page of their names recorded in successive issues of QST. To all their tasks they bring a peculiar skill that can be born only of the genuine love of radio, the hallmark of the amateur.

Future Growth

We believe that the Commission, in its planning for the postwar structure of radio in this country, should be prepared for a very great increase in the number of licensed

The First Completely Informative Catalog of Crystal Unit Designs and Specifications

Here, in one sensibly organized book, is the specific information you need on oscillator crystal units. Here is the first complete assembly of factual data on crystal unit design, construction, and application. It is yours, without obligation and without cost. Keep this new Crystal Products Company manual in your files. Use it as a workable tool in planning circuits and assemblies for precise radio frequency control.

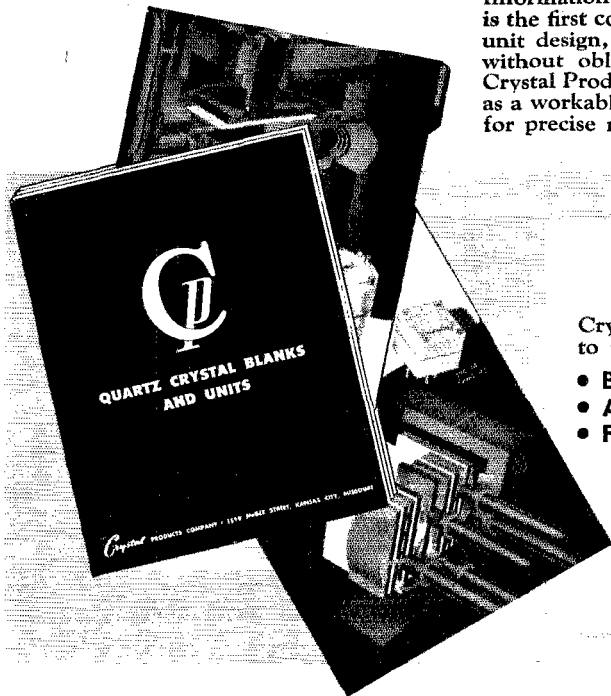

TAB-INDEXED FOR READY REFERENCE

Crystal Units are classified according to their fields of use. These include:

- Broadcasting
- Aircraft
- Amateur
- Test
- Filter
- Police - Marine
- Multiple Units

The latest developments in Crystal Holder design are described, as well as types of Crystal Blanks that can be engineered and finished to your own individual requirements.

A USABLE MANUAL FOR ELECTRONICS ENGINEERS

Profusely illustrated, with concise but complete explanatory descriptions, the pages of this book give:

- HOLDER ILLUSTRATIONS
- CUT-AWAY DRAWINGS
- TECHNICAL SPECIFICATIONS
- FUNCTIONAL DATA

This is not a treatise on the development of the Piezo-Electric properties of Quartz Crystals; it is a series of specific descriptions of approved Crystal Units that are now accepted and used in all types of practical electronic equipment, and that are available for present and future applications.

Crystal PRODUCTS COMPANY
1519 MCGEE STREET KANSAS CITY, MO.

Producers of Approved Precision Crystals
for Radio Frequency Control

WRITE NOW
FOR YOUR FREE COPY

Wanted ENGINEERS

- Radio
- Chemical
- Electrical
- Electronic
- Mechanical
- Metallurgical
- Factory Planning
- Materials Handling
- Manufacturing Planning

Work in connection with the manufacture of a wide variety of new and advanced types of communications equipment and special electronic products.

Apply (or write), giving full qualifications, to:

R. L. D.

EMPLOYMENT DEPARTMENT

Western Electric Co.

100 CENTRAL AV., KEARNY, N. J.

Applicants must comply with WMC regulations

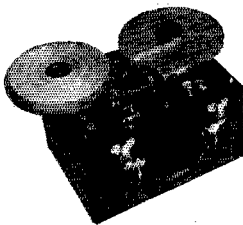

"The Choice of Those Who Know"

**MASTER
THE CODE**
with
Master Teleplex

ALL AC OPERATED. The only all-in-one instrument that will record your own sending and repeat it back to you. Records signals from the air and repeats back at any speed. The perfect instructor for both sending and receiving.

A postcard will bring Booklet N-12 giving full details of ten day **FREE TRIAL**

TELEPLEX CO. 107 Hudson Street
Jersey City 2, N. J.

(Continued from page 88)

amateur stations and operators. The League has made an endeavor to estimate the increase in the amateur population which should be contemplated in such plans and we now wish to disclose it to the Commission.

Before amateur radio was suspended at the outbreak of the first World War there were 6,089 licensed amateur stations. At that time licenses were issued for only a one-year period, and no extensions or renewals were made during the war, so that one year later no licenses were valid and a clean start had to be made after the war. The best information that we can obtain indicates that the total radio personnel in our armed forces during that war numbered approximately 25,000, consisting of about 4,000 amateurs and about 21,000 operators and technicians who were trained by the services. As we look back on it now we realize that the radio art, if not in its infancy then, certainly was in no more than its childhood. Technique and knowledge were elementary by today's standards, the manufacturing industry was small and unorganized, the number of amateurs was small, and our own League had suspended operations during the war. Yet when the restrictions on amateur radio were removed, effective October 1, 1919, amateur radio immediately returned to the air and between that date and June 30, 1920, 5,719 amateurs were licensed.

It seems probable that, in general terms, this figure can be thought of as the return to the air of the prewar amateurs. The annual report of the Department of Commerce for June 30, 1922, shows that on that date there were 15,504 licensed amateurs. That is to say, in the following two years 9,785 additional amateur licenses had been issued, an increase of 160%. In general terms, it seems to us, this very considerable increase in the two years following the first return of amateurs to active operation may be thought of as the growth experienced from the entrance into amateur radio of men who had received a wartime interest in radio at the hands of the military services. If this assumption can be accepted, it is to be noted that of the 21,000 persons receiving wartime radio training, 46.5% had become amateurs in a space of less than three years.

Let us now examine the situation in terms of the present war. All the factors are prodigiously larger. There were about 60,000 amateur licensees at the outbreak of the present war and all these licenses have been continued by the Commission. In addition to this, many thousands of amateur operator licenses have been issued during the war. Thus, contrasting with the last war when no licenses were in force when amateur radio resumed, an estimated 67,000 valid licenses for amateur operation will be in existence when this war concludes. The military services have trained an immense number of people in radio. Our organization has maintained its headquarters and some of its activities, including the publication of our magazine, and amateur spirit and interest remains high, awaiting the time when activity may be resumed. The correspondence of our headquarters office indicates that a very great number of service-trained operators desire to become amateurs after the war. The highly specialized radio industry that catered largely to amateur needs before the war has been greatly expanded and will drive vigorously for new business with fascinating new apparatus. You are all aware that there have been marvelous increases in radio technique, particularly on the higher frequencies, greatly increasing the possibilities for worth-while experimenting and research. There has been a large increase in the interest of the general public in electronic devices of all kinds and there is a growing literature of comprehensive radio textbooks and of practical information on the operation of equipment. It is expected that there will be a huge surplus of government radio equipment that can easily be converted to amateur use, particularly of the type most suitable in organized work for the relief of community emergencies. These factors will surely combine to produce a very great growth in the amateur structure.

It is well known to you all that Government programs have given radio training during this war to a good many hundred thousand persons. The great majority of them have received such training that they would have little difficulty in securing amateur licenses. If we apply to this potential body the rates of growth which amateur radio experienced after the last war, we obtain some rather startling figures. We have rejected the more startling of these figures as fantastic. But in our belief an altogether conservative approach is to conclude that the factors making for increased interest in amateur work will rather surely cause the same percentage growth in the amateur structure as was

(Continued on page 88)

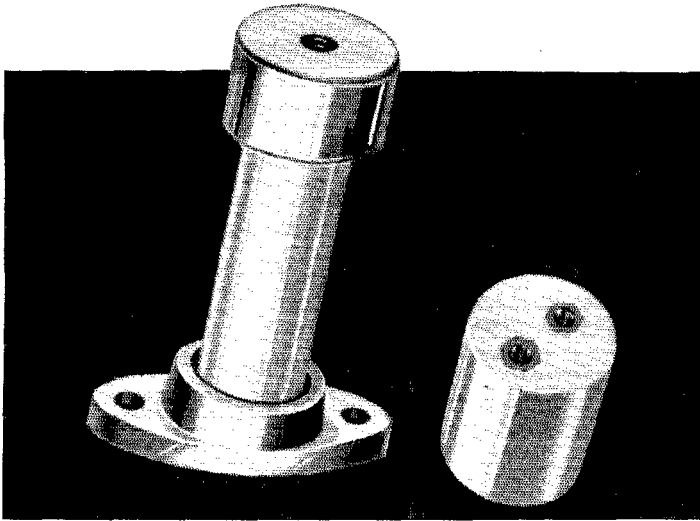

METAL INSERTS FOR STRONGER MECHANICAL ASSEMBLIES

● Where extra strength is required or where insulators or assemblies are subjected to unusual mechanical strains and stresses, greater strength can be had by using General Ceramics metal inserts. These threaded metal inserts are *permanently bonded* into the steatite body, thus assuring an extremely solid construction. The metal inserts are drilled and tapped so that a perfect thread is obtained.

Our engineers will be glad to cooperate with you in designing steatite insulators with metal inserts for your special use.



SERVICE THROUGH THE YEARS!

America's
MOST COMPLETE
Source of Supply
for

RADIO PARTS TUBES
INDUSTRIAL
ELECTRONIC EQUIPMENT
OVER 10,000 ITEMS AT
YOUR FINGERTIPS!

★ Telephone Barclay 7-1840 ★

SUN RADIO & ELECTRONICS CO.

212 Fulton Street, New York 7, N. Y.

1923 1924 1925 1926 1927 1928 1929 1930 1931 1932 1933 1934 1935 1936 1937 1938 1939 1940 1941 1942 1943 1944 1945

**FREE
800-Page
Catalog!**

Authorized purchasing agents and engineers who write on company stationery can obtain our massive buying guide free of charge.

Write Box D

SENDING CODE RECEIVING SPEED

Have Skill, Accuracy

Be a "key" man. Learn how to send and receive messages in code by telegraph and radio. Army, Navy and Commerce need thousands of men. Expansion of air commerce and freight after war should create an even bigger peacetime demand for operators. The famous Candler System, maker of world's champions, teaches you the "knack" of sound sense and sound consciousness that is the secret of speedy sending and receiving. Good pay, adventure. Learn at home quickly.

FREE 52-PAGE BOOK explains extra course of training. Rush name for it today. It's absolutely free.

CANDLER SYSTEM CO.

Dept. 4-O, P. O. Box 928, Denver 1, Colo., U. S. A.
and at 121 Kingsway, London, W. C. 2, Eng.

ELECTRONICS ENGINEERS

TUBE DEVELOPMENT

Television
Ultra High Frequencies

TUBE TECHNICIAN

RADIO

Special Applications

Write Full Details

Box 110

(Continued from page 84)

experienced after the last war. Applying this mode of thinking to the beginning figure of 67,000 persons who will be authorized to operate amateur stations when licensing is resumed, we are led by our charts to expect a total of 184,000 licensed amateurs in something short of three years from the resumption of operation; and we believe we are conservative when we estimate that, assuming satisfactory allocations for amateur work, there will be a minimum number of licensed amateurs of a quarter of a million by the end of five years after our restoration to the air.

Summary

Such a great growth in the institution of amateur radio offers increasing promise of benefits to the nation. It has been demonstrated that the national policy of fostering the amateur has been an exceedingly wise one, particularly for such a country as ours. As we have pointed out, during times of peace, when military needs and activities are small, amateurs occupy the bands of frequencies assigned to them and therein train themselves at their own expense. Thereby they build up a reservoir of expert personnel, they make important contributions to the technique, they accumulate a prodigious quantity of apparatus, they support a manufacturing industry, and they perform many public services including the rendering of emergency communication service in times of distress. By their activities they preserve intact the only bands of frequencies not occupied by commercial or government stations. When war comes to the country, amateur stations are closed for security and the amateur personnel pours into the armed forces and the laboratories and training schools and factories of the country. Amateur apparatus is equally available for urgent initial requirements, while the manufacturers who have supplied amateur needs are able to expand rapidly to produce complex apparatus in unbelievable quantities. And, of major importance, the military services then possess for the duration of the war, a family of frequency bands which they need badly and which they otherwise couldn't possibly get. America's traditional practice of fostering amateur radio must commend itself to everyone as being the wisest kind of national policy.

As president of the amateur organization, I request that you make adequate provision for the amateurs in your postwar plans and, by so doing, make a notable contribution to the security and welfare of our country.

The Ham Shack on the Boulevard

(Continued from page 34)

The large curved show windows are proving a center of attraction for Chicagoans, young and old. The north window contains a scale model of a Pacific island invasion scene complete with landing craft, jeeps, tanks, ducks, and two SCR-299 mobile radio stations. The south window portrays a typical American countryside with a small village in the background. Trucks, cars, tractors, farm wagons and every animate and inanimate object to be expected in such a scene is faithfully reproduced in miniature. Human figures are about an inch and a half in height and are modeled in action, the strenuous work of groups in the invasion scene having its counterpart in the baseball game going on in a meadow in the other window.

The inhabitants of this village are evidently more than ordinarily interested in radio. Besides the vertical radiator of the local broadcast station there are three rotary beams and several assorted Zepps, delta-matched half-wave jobs, etc., obviously a forecast of the great increase in ham activity that is now on its way.

Delco Radio products have worldwide use

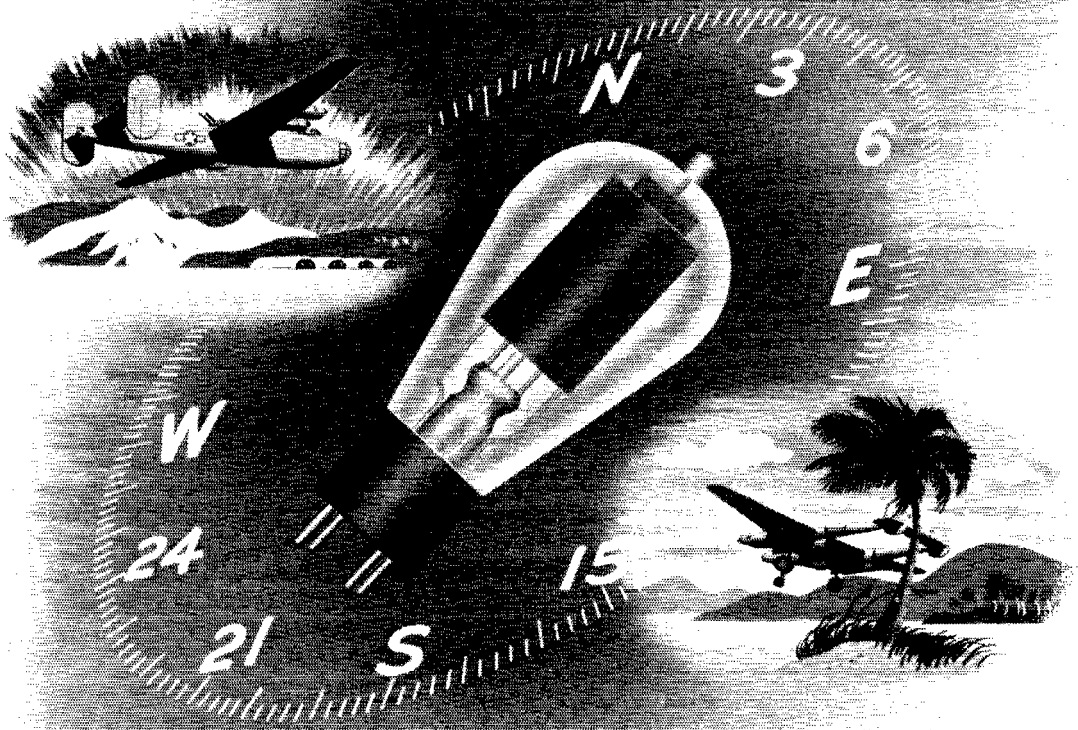

In every theater of war, Delco radio and electronic equipment is helping to coordinate the movement of Allied tanks, aircraft, ships, mobile artillery and field units. Besides these military applications, millions of Delco auto radios are in use both at home and abroad. Whatever the requirement and wherever they serve, Delco Radio products are respected as an effective combination of engineering vision, manufacturing precision. Delco Radio Division, General Motors Corporation, Kokomo, Indiana.

Put Your Dollars in Action—BUY MORE WAR BONDS

Delco Radio
DIVISION OF
GENERAL MOTORS



ORDER ALL RADIO PARTS FROM NEWARK

Filters
Condensers
Rectifiers
Rheostats
Resistors
Transformers
Wire, etc.

Supplied from stock on short notice. Send your order. We ship all available items at once, cancelling balance of order or advising probable shipping date.

Sorry... No Catalogs for the Duration

NEWARK'S SUPER-VALUE FILTER CONDENSERS

NO PRIORITY REQUIRED!

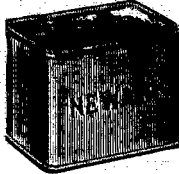

59¢
(1 mfd.)

**Oil-Filled
Oil-Impregnated**
Guaranteed at
rated voltages

Mfd.	DC.	Size	Price
1	1000 v.	5 x 3 3/4 x 1 1/2	\$.59
2	2000 v.	4 7/8 x 3 3/4 x 1 3/4	1.50
4	3000 v.	5 x 3 3/4 x 3 3/4	3.75

ORDER TODAY DIRECT FROM
THIS AD

BUY WAR BONDS

Listen to our Radio Programs every Tuesday
9 to 9:30 A.M., WJJD Chicago

NEWARK ELECTRIC CO. 323 W. Madison St.
Chicago, Illinois

The Troubles of a Wandering Ham

(Continued from page 45)

around an AACs establishment. The boys were pretty tired that night after getting all that equipment in.

Well, all went well for a week. Ships came in and left and we had another small field going. Then came disaster. The wind died down. I have never before seen such a mess. The sand had been so thick in the air that we had built the entire airport 50 feet above the ground and, when that wind died and the sand settled, the whole mess fell 50 feet to the ground. This just shows you some of our smaller problems.

At another station the boys had great trouble in keeping their antenna poles up. The poles would sink into the ground and, upon awakening in the morning, the fellows would find their 300-foot-high antennas only 10 to 20 feet above the ground. After exhaustive tests and investigation, the fellows discovered that it was the dread Himalaya elephant lion (larger cousin of our ant lion). Now we just pour a little of this Indian rum around the base of each tower, being careful not to get any of the rum on the towers because the metal dissolves quickly, and the underground animal leaves the towers alone.

I mentioned the heat over here during May and June. It gradually gets hotter and hotter until about the first you realize the tremendous extent of this heat is when you are walking along and hear a tree pop. You are startled to see the bark curl up, fall off and burst into flames. Then you get to worrying about it. However, you are reassured upon seeing that the thermometer reads only 144 or 149 degrees.

I used to think Texas was the largest continent on earth, but I believe Asia is almost as large. Rather than get into a discussion with some misguided Republicans, or other foreigners, I will close this. If anything else interesting arises in the future I will report same.

A Plan for Tomorrow

(Continued from page 59)

- 7) **SPEED DASHES.** Various events, grouped by wing area, competing against time, over a measured course laid out in a straight line.
- 8) **AEROBATICS.** An award will be made to each individual or group demonstrating aerobatics during scheduled periods. The three most outstanding performers will be awarded special prizes.
- 9) **CLOSED COURSE RACES.** Aircraft will race against time, around a closed triangular course, consisting of pylons set 1/3 mile apart. These events grouped in wing areas.
- 10) **ALTITUDE.** An attempt will be made to establish a world altitude record for model aircraft. Standard aircraft and instruments will be used to measure the altitude.

(Continued on page 90)

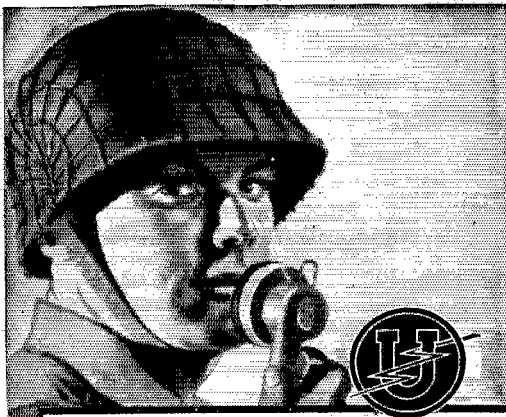

THE NEW YEAR

UNIVERSAL resolves that 1945 would be incomplete without the fervent trust that the organization will continue to merit the appreciations of amateurs, in the service and out, as they use **UNIVERSAL** microphones in their daily work. Postwar microphone models from our factories will "do their job well" and, of course, will carry the usual appeal to the amateur and professional alike.

UNIVERSAL MICROPHONE COMPANY
Inglewood, California

"MUSTS"

FOR EVERY HAM'S BOOKSHELF



*"The All-Purpose Volume
On Radio"*

The Radio Amateur's Handbook

Special Defense Edition

This edition of the HANDBOOK is designed especially for use in radio training courses. It eliminates those portions of the regular edition which are not useful for instruction purposes and has added chapters on mathematics, measuring equipment and code instruction. The first chapter covers the elementary mathematics necessary for the solution of all formula and interpretation of graphs appearing throughout the text. A four-place log table is included in the Appendix.

\$1.00 Postpaid Anywhere

Standard Edition

Text, data book, operating manual—it is all these and more. As a text it is probably more used in radio schools and colleges than any other single volume. As a practical constructional handbook, it stands in a class alone. As an operating manual, it provides information available from no comparable source.

The latest Edition of THE RADIO AMATEUR'S HANDBOOK is the largest ever published. It includes a comprehensive chapter dealing with War Emergency Radio Service plus other new material—all added without sacrificing the essential information in previous editions which made the HANDBOOK the world's most valuable and widely-used radio book. The theory and design sections cover every subject encountered in practical radio communication, sectionalized by topics with abundant cross-referencing and fully indexed.

\$1.00 In Continental U. S. A.

\$1.50 Elsewhere

\$2.00 Buckram Edition

A Course in Radio Fundamentals

By **GEORGE GRAMMER**

special edition for war training purposes or the Standard Edition may be used. References contained in the "Course" are identical in both editions. As a text, this book greatly smooths the way for the student of the technicalities of radio. It contains interesting study assignments, experiments and examination questions for either class or individual instruction. It describes in detail 40 experiments with simple apparatus giving a complete practical knowledge of radio theory and design.

Price 50c

The objective in preparing this course was to accent those principles most frequently applied in actual radio communication. "A Course in Radio Fundamentals" is a study guide, examination book and laboratory manual. Its text is based on the "Radio Amateur's Handbook." Either the

Learning the Radiotelegraph Code

By **JOHN HUNTOON**

erator or access to a code machine. It is similarly helpful home-study material for members of code classes. Adequate practice material is included for classwork as well as for home-study. There are also helpful data on high-speed operation, typewriter copy, general operating information—and an entire chapter on tone sources for code practice, including the description of a complete code instruction table with practice oscillator. Price **25c**

This booklet is designed to train students to handle code skillfully and with precision. Employing a novel system of code-learning based on the accepted method of sound conception, it is particularly excellent for the student who does not have the continuous help of an experienced operator.

The A.R.R.L. Antenna Book

By **GEORGE GRAMMER and BYRON GOODMAN**

Feed systems and their adjustment. Construction of masts, lines and rotating mechanisms. The most comprehensive and reliable information ever published on the subject. Over 100 pages.

Price 50c

A comprehensive manual of antenna design and construction. Sixteen chapters, profusely illustrated. Both the theory and the practice of all types of antennas used by the amateur from simple doublets to multi-element rotaries, including long wires, rhomboids, vees, phased systems, u.h.f. systems, etc.

AMERICAN RADIO RELAY LEAGUE, INC., West Hartford 7, Conn., U.S.A.

20-WATT UNIVERSAL AMPLIFIER

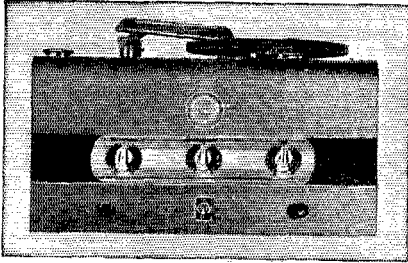

Plug in for A.C. or 6-volt auto battery; no power pack necessary. Uses mike and built-in phono at same time. 78 RPM motor, 9-inch turntable, crystal pick-up, separate on-off switch. Long-playing needle included. Continuously variable tone control on inclined eye-level

control panel. Use one or two 8-ohm speakers without need of extra transformer. Has one 6SJ7GT, one 6SC7, two 6L6Gs in push-pull, two 6X5GTs. Model 6720, with tubes, F.O.B. New York \$56.28 Model 6721, same as 6720, less phono player, \$42.87

TERMINAL RADIO CORP.

85 CORTLANDT ST. NEW YORK 7, N. Y.
PHONE WORth 2-4415

RF Inductors • RF Chokes • IF Transformers
Condensers • Mica Molded Condensers • Trimmer
Condensers • Miscellaneous Apparatus
The F. W. Sickles Co., Chicopee, Mass.



SICKLES Electronic Specialties

Phone, Wire or Write

WHOLESALE

Radio-Electronic Parts,
Tubes and Equipment

R. G. SCALI & CO.

227 Asylum St. Hartford, Conn.

Telephone 2-1144

(Continued from page 88)

- 11) **RELAY RACING.** Each completed round trip from Lakeland Municipal Model Port to Wingfoot Lake Airport, Akron, and return will be given a prize. Special awards will be made to all successful non-stop flights. A main award will be made for the *fastest* round-trip relay flight. During this event, any number of transmitters may be used to control the craft in flight.
- 12) **YOUNG SQUIRT EVENTS.** Contestants under 16 years of age, registering their own planes, will participate in special events limited to young squirts. However, they may also participate in *any* event on the program.
- 13) **YL EVENTS.** Special events sponsored by the Lady-Bird Club of Lakeland, will be planned for YL contestants.
- 14) **HELICOPTERS.** Special contest will be arranged for this type of craft, features such as altitude, elevation per minute, etc.
- 15) **ARRL CUP RACE.** The main event! A race modeled after the world-famous Thompson Trophy Race, this is open to any and all contestants flying any style, any type or size plane, or craft. There will be no handicaps. The race consists of ten completed laps around a closed triangular course marked out by three pylons set $\frac{1}{2}$ mile apart. The start will be made from the ground, race-horse style. The first craft to cross the finish line after completing ten laps of the course will be the winner of the ARRL Cup, awarded by the League members. With this Cup will go the finest prizes of the meet. This race is a challenge to model engineers and should bring out the finest performance in the world. Entrants must qualify by flying their crafts around the course for two laps at an average speed of at least 60 miles per hour prior to a deadline ending two hours before the race is to be called. Those qualifying laps will be measured after the craft is air-borne.

REGISTRATION: See an announcement in a forthcoming issue of *QST* as to the exact date and address where registrations may be made. In the meantime — get started on that gear. The schedule and the requirements are given above. The rest is up to you!

CU at Lakeland Municipal Model Port — with an aircraft!

Splatter

(Continued from page 8)

Texas, for special radio devices. He served for a while with the Amphibious Forces, Atlantic Fleet, and now is on duty at the Naval Air Navigation Radio School, Gainesville, Ga.

The next newcomers on our roster are both in the Signal Corps. **Captain William H. Minor, W9DSN** (p. 18), received his first amateur ticket in 1928, and holds a Class A license. He is a graduate of Ball State Teachers College, Muncie,

(Continued on page 92)

MEN ARE STILL MARCHING . . .

• • • And as long as Astatic's production facilities are required for the manufacturing of sound detection, pickup and reproduction parts and devices, Astatic will continue to serve. When reconversion to peacetime production is permissible, Astatic will be among the first to meet trade demands.

PLEASE NOTE

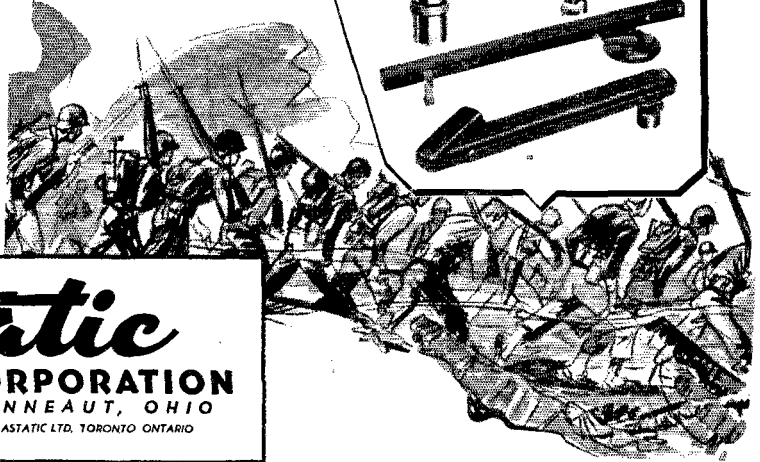

• Having moved its offices and a part of its manufacturing facilities from Youngstown to Conneaut, Ohio, Astatic requests that all mail and other forms of communication henceforth be directed to the new CONNEAUT address.



THE
Astatic
ASTATIC CORPORATION
 CONNEAUT, OHIO
IN CANADA, CANADIAN ASTATIC LTD. TORONTO ONTARIO

What will you need...

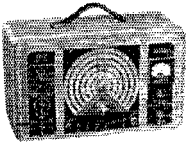
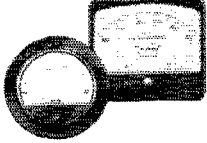
IN THE FIRST SIX POST-WAR MONTHS

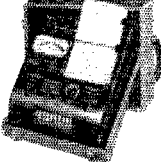
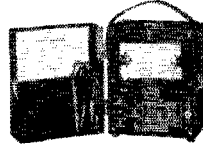
	
SIGNAL GENERATORS	PANEL INSTRUMENTS
	
VOLT-OHM-MILLIAMMETERS	POCKET TESTERS
	
TUBE TESTERS	VOLT-OHM-MILLIAMMETERS

✓ CHECK THE TYPES AND QUANTITY

Estimate your future equipment needs and place a *tentative post-war order* for them with your jobber now. This foresight will enable him to stock the Triplet instruments you will need, and will assure you quicker resumption of civilian business. Give best priority you can obtain to facilitate deliveries as production is available.

Get the complete list of Triplet instruments and radio test equipment.



Triplet

ELECTRICAL INSTRUMENT CO., BLUFFTON, OHIO

The New HARVEY REGULATED POWER SUPPLY 206 PA

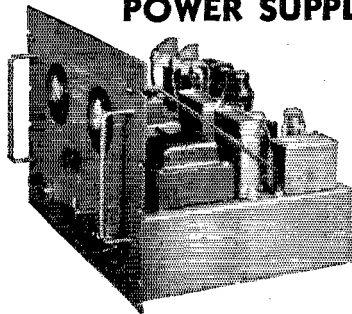

RANGE 500
to
1000 volts

Look It Over! You'll see the quality, sound design and compact construction of this new HARVEY 206 PA. Notice the gray, crackle-finish panel and the copper plated chassis.

The new Harvey 206 PA is equipped with spare fuses, a generous 6 ft. heavy duty Typex cord, two interlocks for safety, overload and time delay relays — everything to make it a thoroughly dependable, easy-to-operate source of laboratory D.C. power.

The picture can't show you how this precision instrument operates in two ranges — 500 to 700 volts at $\frac{1}{2}$ of an ampere; 700 to 1000 volts at .2 of an ampere — with both ranges accurately regulated within one per cent. That's up to the instrument and us. We'd like nothing better than the chance to show you just what this important new development can do.



HARVEY RADIO LABORATORIES, INC.

451 CONCORD AVENUE CAMBRIDGE 38, MASS.

— WANTED — SEVERAL LICENSED RADIO AMATEURS

We have several excellent well-paying positions open in our organization for competent technical men possessing an amateur radio license.

If your background is such that you have spent at least 5 years in the industry and are thoroughly familiar with all types of parts including tubes, meters, "ham" receivers and transmitters we can offer you a splendid salary and an excellent present and postwar position handling our industrial accounts and prospective "ham" customers. This should prove a most pleasant, lucrative opportunity for someone residing in the metropolitan area.

Apply at Once in Person or Writing

New York's Oldest Complete
Radio-Electronic Supply House

SUN RADIO & ELECTRONICS
COMPANY

212 FULTON ST. • NEW YORK 7, N. Y.

(Continued from page 90)

Ind., and holds a degree in mathematics and physics. Inducted into the Army as a private in November, 1941, he was commissioned a 2nd lieutenant in the Signal Corps in May, 1942. After attending Harvard University and M.I.T. there followed three months of special schooling in electronics and u.h.f. communications. At present he is stationed at AOASC, Newark, N. J., as chief of the Radio Repair Branch, Maintenance Division. . . . Major Everett N. Sieder, W2AHN (p. 35), graduated from Rutgers University in 1925 in electrical engineering. A reserve officer, he was called to active duty with the Signal Corps in October, 1942. Stationed successively in Philadelphia, New York, and Warrenton, Va., he now is in Washington where he is in charge of one of the development groups of the OCSigo. An amateur since 1919, with the call 2LW, he was relicensed in 1926 with the call W2AHN, and has been continually active since then on all bands. He has been a member of AARS since 1928 and has served as corp. area NCS, 'phone (2nd C.A.) since 1935.

McMurdo Silver (p. 32), who first appeared in Splatter in March, 1943, p. 10, is probably known to almost every reader of *QST* since he has been hamming since 1911 — and been relatively articulate on radio engineering subjects for some decades past. Though in commercial radio for almost a quarter of a century, Mac is a ham at heart. His hobbies are radio designing, locating antique radio gear for Henry Ford's Edison Memorial Museum at Dearborne, Mich., and hunting up old Colt revolvers.

Also playing return engagements this month are on p. 39, "Helix" (Splatter, September, 1943, p. 84); on p. 43, Major James W. Hunt, W5TG-W5CCU (Splatter, October, 1943, p. 8); and on p. 40, Edward M. Noll, ex-W3FQJ (Splatter, October, 1943, p. 8).

FEEDBACK

AN INADVERTENT ERROR in the listing of new Eimac tubes on page 43 of October *QST* makes the filament rating of the Eimac 527 read "135 amperes at 5.5 watts." This should be 135 amperes at 5.5 volts.

In "A Single-Tube WERS Transceiver," October *QST*, the following sentence should be inserted on page 34, left-hand column, 6th line from the bottom, before the word, "Thereafter:" "Then, leaving those two adjustments alone, switch over to 'R' (receive) and adjust the value of R_3 until a weak signal, such as the hash from a buzzer, comes in strongest."

In the same article, the value of resistor R_2 is 200 ohms. That of R_3 is approximately 2,000 ohms, and its exact value may be found by temporarily substituting a 50,000-ohm potentiometer at R_3 and adjusting same for maximum sensitivity of the receiver. In Fig. 1-A and B, C_3 should be marked "T," since this is a trimmer condenser, and C_2 should be turned around. In Fig. 1-B arrows should be drawn through C_1 and C_3 because both are variable condensers.

"Tailor-made"

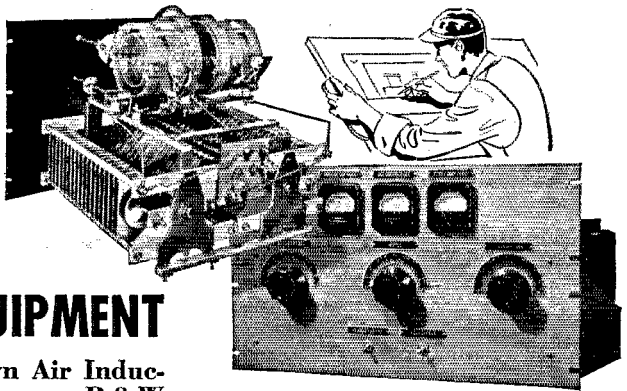

ELECTRONIC EQUIPMENT

In addition to its well-known Air Inductors and Variable Air Condensers, B & W offers a wealth of specialized facilities for the design and production of custom-built electronic equipment. Whatever your need in special transmitters, test equipment, tuning units, high and ultra-high frequency units, high voltage equipment, and similar assemblies, write for details.

B&W

AIR INDUCTORS • VARIABLE CONDENSERS • ELECTRONIC EQUIPMENT ASSEMBLIES

BARKER & WILLIAMSON

DEPT. Q 124, 235 FAIRFIELD AVENUE
UPPER DARBY, PENNSYLVANIA

Export: LINDETEVES, INC., 10 Rockefeller Plaza, New York, N. Y., U. S. A.

The Big Name in the Book

D220

WHEN YOU'RE TALKING MICROPHONES
Wide Range • High Fidelity • Moving-Coil
Three types of response for all purposes

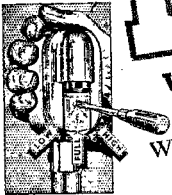

LOW
For pickup systems requiring embellished lows and good intermediate range.
(25 to 5000 cps.)

FULL
For high fidelity requirements where smooth, flat response and broad range are necessary.
(30 to above 10,000 cps.)

HIGH
For all purposes requiring richness in the higher frequencies. Slightly rising characteristic.
(From 150 to 10,000 cps.)

The circuit combines two dynamic generators, each with a specific frequency response. Its ideal quality is produced by coupling the outputs electrically and acoustically. Total band 25 to above 10,000 cps. Broad crossover from 150 to 5,000 cps. Crossover band in the D220 has been designed to eliminate peaks in the middle frequency range.

D220 - Dynamic..... (30 - 50 ohms)
D220T - Dynamic (Available in 200 - 250 ohms, 500 ohms or High Impedance)

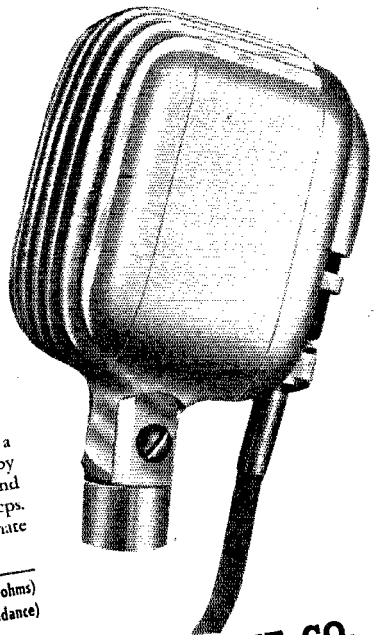

American **MICROPHONE CO.**
1915 So. Western Avenue, Los Angeles 7, California

SEND FOR BULLETINS
ON OTHER MODELS
IN PRODUCTION



Be
Santa Claus
 to
Your Friends

NOT FORGETTING THOSE IN
 THE SERVICE

Each year an increasing number of individuals find *QST* to be the ideal gift. A subscription present is unique, too. It serves as a monthly reminder of your thoughtfulness. A yearly subscription, including League membership, costs only \$2.50, little enough for the ones you have in mind. And... we'll send an appropriate gift-card conveying your Christmas Greetings at the proper time.

A Monthly Reminder
 OF
Your Thoughtfulness
 AND
Good Judgment

QST

38 LA SALLE ROAD
 WEST HARTFORD, CONN.

ELECTRICITY
FOR ANY JOB—ANYWHERE

Onan Electric Plants furnish dependable electricity on projects remote from commercial power. Gasoline driven; single-unit, compact design; sturdy construction, for mobile, stationary or emergency use. Over 60 models, in sizes from 350 to 35,000 watts. A.C. types: 115 to 600 volts, 50, 60, 180 cycles, 1 or 3-phase; 400, 500 and 800 cycles, 1-phase. D.C. types: 6 to 4000 volts. Also, dual voltage types. Write for engineering assistance or detailed literature.

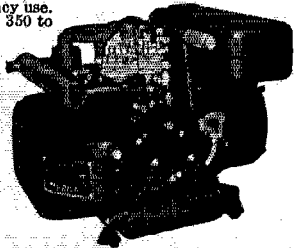

D. W. ONAN & SONS.
 1958 Royalston Ave.
 Minneapolis 5, Minn.
ONAN
 ELECTRIC PLANTS

LEARN RADIO

Pre-Military training for beginners. Catalog on request. We teach all technical branches of radio. Lic. by the Comm. of Mass. Dept. of Education.

MASS. RADIO SCHOOL
 18 Boylston Street Boston, Massachusetts

RADIO TECHNOLOGY



RCA Institute offers an intensive two-year course of high standard embracing all phases of Radio and Television. Practical training with modern equipment. Also shorter specialized courses in Commercial Radio Operating, Radio and Television Servicing, and Aviation Communications.

For Free Catalog write Dept. ST-44
RCA INSTITUTES, INC.

A Radio Corporation of America Service
 75 Varick Street New York 13, N. Y.



RADIO—ELECTRONICS
 Co-educational training in Airline, Merchant Marine, Press Communications, Electronics, Television. FREE booklet. Address Registrar. Ex-Servicemen: Request FREE copy, G.I. bill of rights
 "The Radio School managed by radio men."
 45 West 45th Street, New York 19, N. Y.

MELVILLE RADIO INSTITUTE

COMMERCIAL RADIO INSTITUTE

A RADIO TRAINING CENTER FOR 24 YEARS

Resident Courses Only • Pre-Induction, Broadcast, Service, Aeronautical Television, and Marine telegraphy classes now forming for mid-year term Feb. 5th. Accredited for Veteran training. Literature upon request.

Dept. B., 38 West Biddle Street, Baltimore 1, Maryland

▼ **WOMEN in Radio?**

Certainly. Making good, too—as radio technicians in broadcast stations, with airline companies, police radio networks, radio laboratories and radio manufacturing plants. Our thorough course prepares for all these fascinating fields. Write for details, stating age and education. No salesman will call.

VALPARAISO TECHNICAL INSTITUTE
 Dept. S Valparaiso, Ind.

RADIO-TELEVISION-ELECTRONICS

Prepare now for ever-increasing post-war opportunities. Day and Eve. Sessions. Enroll now for new classes. Consideration given to Veterans eligible for training under the G. I. Bill.

RADIO-TELEVISION INSTITUTE

480 Lexington Avenue, New York 17 (46th Street)
 Plaza 3-4585 Licensed by New York State



In the "Q" code adopted by the International Radio-telegraph Convention, QRV means "I am ready." Today, Harvey-Wells Electronics is signalling QRV . . .

Harvey-Wells is ready with vast and invaluable experience gained in wartime; ready with engineering technique to guarantee precision performance; ready with modern production methods for ruggedly constructed equipment, dependable in every detail; ready with ideas and imagination and know-how to serve you better in peace!

Remember the name HARVEY-WELLS. You can depend upon it for unfailing performance in electronics and communications.

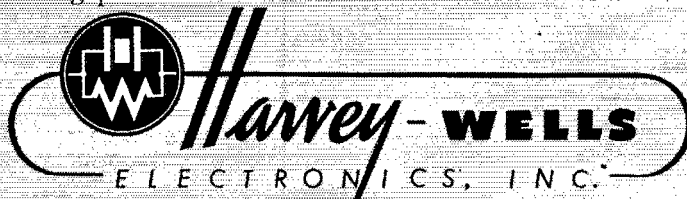

SOUTHBRIDGE MASSACHUSETTS



ENGINEERS

JUNIORS *and* SENIORS

For Research and Development
Work in Electronics

EE DEGREE

3 to 5 years experience desirable

Excellent opportunity with one of America's Foremost
Electronic Laboratories.

HAZELTINE CORPORATION

58-25 LITTLE NECK PARKWAY

Little Neck, Long Island, N. Y.

**QST
YEARLY
BINDERS**

ARE WE RIGHT? You should have at least two of them — one for your complete 1944 file of copies, and one for each 1945 issue as published. **Price \$1.50 postpaid**

AVAILABLE ONLY IN UNITED STATES AND POSSESSIONS

THE AMERICAN RADIO RELAY LEAGUE • West Hartford 7, Connecticut

HAM-ADS

(1) Advertising shall pertain to radio and shall be of nature of interest to radio amateurs or experimenters in their pursuit of the art.

(2) No display of any character will be accepted, nor can any special typographical arrangements, such as all or part capital letters be used which would tend to make one advertisement stand out from the others.

(3) The Ham-Ad rate is 30c per word, except as noted in paragraph (6) below.

(4) Remittance in full must accompany copy. No cash or contract discount or agency commission will be allowed.

(5) Closing date for Ham-Ads is the 25th of the second month preceding publication date.

(6) A special rate of 7c per word will apply to advertising which, in our judgment, is obviously non-commercial in nature and is placed and signed by a member of the American Radio Relay League. Thus, advertising of bona fide surplus equipment owned, used and for sale by an individual or apparatus offered for exchange or advertising inquiring for special equipment, if by a member of the American Radio Relay League takes the 7c rate. An attempt to deal in apparatus in quantity for profit, even if by an individual, is commercial and all advertising by him takes the 30c rate. Provisions of paragraphs (1), (2), (4) and (5), apply to all advertising in this column regardless of which rate may apply.

Having made no investigation of the advertisers in the classified columns, the publishers of *QST* are unable to vouch for their integrity or for the grade or character of the products advertised

QUARTZ — Direct importers from Brazil of best quality pure quartz suitable for making piezo-electric crystals. Diamond Drill Carbon Co., 719 World Bldg., New York City.

COMMERCIAL radio operators examination questions and answers. One dollar per element. G. C. Waller, W5ATV, 6540 Washington Blvd., Tulsa, Okla.

WHY NOT turn your unused equipment into ready cash which may be applied towards new and better equipment after the war? Leo, W9GFQ, offers you the best cash prices for communications receivers and test equipment. Write today for large illustrated catalog. Wholesale Radio Laboratories, 744 W. Broadway, Council Bluffs, Iowa.

CRYSTALS available — all types, including 100 kc., 465 kc. and 100 kc. Broadcast and Aircraft given prompt attention. Scientific Radio Products, Council Bluffs, Iowa.

PROMPT Repair Service on Meters and Electronic Instruments. Braden Engineering Company, 3317 Kenmore Ave., Dayton 10, Ohio.

METERS: Panel instruments 3 1/2" size, microammeters, voltmeters, ammeters, R.F. meters, milliammeters. Large variety. Multi-range small portables. Prompt deliveries. Advise what you want for quotation. Hallcrafters SX-28, 25. Hatry & Young, 203 Ann St., Hartford 3, Conn.

WANTED: Pay top price for one recorder in perfect shape. Floyd Howard, Hodge, Louisiana.

PREPARE NOW for tremendous opportunities in new fields of radio after the war. Training for Federal licenses. Write for particulars. Radio code classes, all speeds. American Radio Institute, 44 East 23rd Street, New York 10, N. Y.

ONE Hallcrafters SX-28 including PM23 speaker, brand new in original carton, \$238. (Present ceiling price.) Immediate shipment. No priority necessary. A. den Breems, 14 Sutton Place South, New York, N. Y.

WILL pay five dollars for instruction booklet Supreme Tube Tester and Diagonometer Model No. 339. Billy Milne, 504 McLain Lane, Kirkwood 22, Mo.

IMMEDIATE shipment on priority: new SX28As, \$223.00; SX25s, \$94.50; PM23s, \$15.00. In stock without priority: Trim #65, Dependable headsets, \$2.28; #100 Featherweight \$6.00; meter rectifiers, \$1.95; coils, transformers, etc. Instructographs for rent. Write for our catalog. Henry Radio Shop, Butler, Mo.

HIGHEST prices paid for used receivers, test equipment, bugs, oscillators. What have you? W9ARA, Butler, Mo.

WANTED: Radio operators for merchant marine. Commercial license. Must join union. Wages \$300 to \$375 monthly. Radio Officers Union, 1440 Broadway, New York.

WANTED to buy: a used Collins 30FXB or 30FXC transmitter. Will be used in conjunction with army tests. Your chance to convert old model into cash for purchase of new post-war design. Capt. Harold B. Churchill, Little Silver, New Jersey.

BUILD a radio, complete kit with tubes, \$9.95. Details. Radio, 9418 Avenue "A", Brooklyn, N. Y.

TWO-SPEED Bruno 12" disc recorder; 20 watt amplifier; microphone; speaker; carrying cases, \$167. Box 2, Woodford Station, Portland, Me.

TRADE National NC101X grey finish, complete, perfect condition, for good camera. Contax, Leica, Welfini or similar preferred. Spangenberg, W2DWG, 115-25 84th Ave., Kew Gardens, L. I., N. Y.

USED 832 transmitting tubes, guaranteed OK, \$5.00 each. Lanam Radio Co., 2320 Shattuck Ave., Berkeley, Calif.

SALE: radiotelephone transmitter, interoffice communications system, transmitting and receiving parts and tubes. Stamp bring details. Ernest Austin, 1445 Ogden Street, Northwest, Washington 10, D. C.

WANTED: Any standard brand 3" oscilloscope with sweep. T/Sgt. L. J. Smith, Det. 103, AACSS Sqdrn, George Field, Lawrenceville, Ill.

WANTED: Echophone EC-1, Lt. E. R. Arms, Det. 103 AACSS Sqdn, George Field, Lawrenceville, Ill.

WANTED: D-104 microphone, 0-200 millimeter, 40 meter xial. James M. Wayman, Moorhead, Minn.

FOR SALE: Transmitter: 5' 8" high, 18" deep, 19" wide. Standard relay rack, 5 sections. All steel panel. Built to operate on 20 meters with v.f.o. Final: 2-155 P.P. to 2-307 P.P. to 1-807 to v.f.o. Audio: 2-RK31 P.P. to 2-2A3 P.P. to speech amp. 3 heavy power supplies, well filtered and choked. Thordarson and U.T.C. 350 watts, \$400. Mrs. L. G. Shawver, 1825 Main St., Kansas City, Mo. Phone Ha. 1890.

WANTED: RME-69 or Hallcrafters SX-28A, A-1 condition. Cash. W. K. Kennedy, 342 No. Oak Crest, Decatur, Ill.

WANTED: Hallcrafters SX-24 receiver and HT-6 transmitter. W5ALA, 5712 Berkshire Lane, Dallas 8, Texas

WANTED: RK20a. State price, condition, etc. WIBB

SELLING amateur station. Transmitter, four bands, 400 watts. C.W. only. Receiver, National NC-200 with spare set, new tubes. Also plenty of large mercury vapor rectifiers, spare parts, etc. Stamp for list. W2BNX, 215-11 111th Ave., Queens Village 9, N. Y.

CRYSTALS: Prompt delivery of dependable Eidson crystals for all classes of service throughout the 100-10,000 KC range. New crystals for transmitters and fixed frequency receivers; also repair and regrinding service. Send for free folder L-5, mentioning needs. "Eidson's", Temple, Texas.

WANTED: Rider's Chalyanist and an oscilloscope. State condition, model, price, etc. Will pay cash. Wm. D. McCas, 1222 W. Union Blvd., Bethlehem, Pa.

TRANSMITTER: factory, used. Box 152, Newport, R. I.

NEW Millen ECO 80-40 meters, never used. First check for \$25 takes same or will trade for camera and pay difference if necessary. G. Goldwasser, 45 Bee St., Charleston, 15, So. Carolina

WANTED: Late model RME69 or RME70 complete. Swap miscellaneous transmitting tubes, meters and transmitting parts. All good condition. Send stamp for list. Wm. Riemann, 2106 Clinton, Berwyn, Ill.

FOR SALE: Meissner Signal calibrator. Good condition. Best offer. Tru-Lite Research Labs, Indianapolis, Ind.

SELL: National NC45; Thordarson 6L8 transmitter; Vibroplex; Bud Audio oscillator; a.c. power supply; 300 v. at 100 ma. 5.3 v. at 4 amps.; H. W. Ryall, WINKW, 72 Bowler St., East Lynn, Mass.

SELL two Collins 4A transmitters, \$35 each. National NSM modulator, \$60. Several tubes, 802, 803, 35Ts. W3QP

TEST instruments, meters, oscilloscope and radio parts wanted for cash. Send list to Walter Jarman, 49 East 96th St., N. Y. C.

WANTED: for cash, used or new communications receiver and Thordarson 300 watt modulation transformer. William Hall, W5ASG, Widener, Ark.

WANTED: National 1-10; Abbott TR-4 and DK-3. Vernon K. Wendt, R.T.3/c U.S.C.G.R. Trg. Sta., Groton, Conn.

FOR SALE: Thordarson 100 watt transmitter in Par-metal cabinet, power supply, r.f. unit, and antenna tuning unit; two 809s in final, 10 to 160 meters, \$150. Coxy keen, \$6. Wanted: SW-3 coils covering 200 to 400 kilocycles. Charles Landsiedel, 220 Elizabeth Ave., Bangor, Me.

SELL: Triplett 1503 tube and set tester; miscellaneous tubes and parts. Want: Echophone EC-4; Precision EV-10P, Hickok 133. LeRoy Green, Tupelo, Miss.

A FEW left: 27, 70; 80, 70; 5Y3, 70; 5Z3, \$1.10; 12SK7GT, \$1.10; 24, 90; 35, \$1; 6U7G, \$1; 6J5, 90; 28, 75; 2A7, \$1.10; 3ASG1, \$2.85; 1T4, \$1.60; 6SK7, \$1; 39, \$1. Kindly add postage. A few new crystal pick-ups, \$5.50, plus postage. Abbott, 2101 Grand Concourse, N. Y. C.

WANTED: Complete Meissner, all-wave tuning unit or all-wave coil assembly for either 410 mmfd. or 230 mmfd. condenser. Gordon O. Taftner, Box 495, Hamilton Field, Calif.

Due to paper restrictions, we are obliged to limit the number of Ham-ads published each month. Insertions are on the basis of priority of receipt. It will help if proper amount accompanies order.

**"...BUT, HOGARTH, THE FOLKS
BACK HOME MUST GIVE UP THINGS—
BE A PAL AND LET ME BORROW
YOUR ECHOPHONE EC-1"**



ECHOPHONE MODEL EC-1

(Illustrated) a compact communications receiver with every necessary feature for good reception. Covers from 550 kc. to 30 mc. on 3 bands. Electrical bandspread on all bands. Six tubes. Self-contained speaker. 115-125 volts AC or DC.



ECHOPHONE RADIO CO., 540 NORTH MICHIGAN AVE., CHICAGO 11, ILLINOIS

Designed for

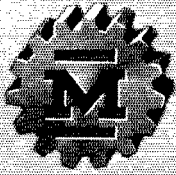

Application

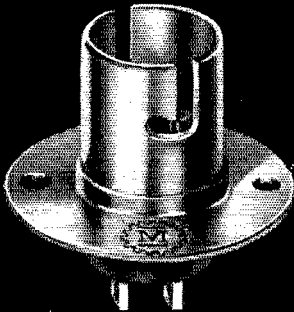

**No. 33991
Voltage Regulator
Tube Socket**

Sturdy, compact with dependable contacts. Another in the series of Millen "Designed for Application" components for modern circuits. For use with miniature neon type dual contact bayonet base voltage regulator tubes such as Radiotron No. 991.

**JAMES MILLEN
MFG. CO., INC.**

MAIN OFFICE AND FACTORY

**MALDEN
MASSACHUSETTS**



Index to Advertisers

	Page
Abbott Instrument, Inc.	**
Aerovox Corporation	**
American Lava Corporation	**
American Microphone Company	93
American Radio Institute	**
Amperex Electronic Products, Inc.	**
Astatic Corporation, The	91
Ayers Automatic Code Machines	91
Barker & Williamson	93
Bliley Electric Company	66
Brach Manufacturing Corp.	**
Browning Laboratories, Inc.	**
Burgess Battery Company	73
Candler System Company	86
Capitol Radio Engineering Institute	74
Cardwell Manufacturing Corp., Allen D.	68
Centralab	**
Claroostat Mfg. Co., Inc.	**
Collins Radio Company	75
Commercial Radio Institute	94
Communications Products Co.	81
Crystal Products Co.	83
Delco Radio, Div. Gen. Motors	87
DX Crystal Company	**
Echophone Radio Co.	97
Eitel-McCullough, Inc.	5
Electro-Voice Mfg. Co.	73
Electronic Laboratories	100
Galvin Mfg. Corp.	**
Gardner & Company	**
General Ceramics & Steatite Co.	85
Hallcrafters Company, The	1, 2
Hammarlund Manufacturing Co., The	65, 67
Harrison Radio Company	**
Harvey Radio Laboratories, Inc.	92
Harvey Wells Communications, Inc.	95
Hazeltine Electric Corp.	95
Heintz & Kaufman, Ltd.	77
Henry Radio Shop	**
Hytron Corporation	**
Instructograph Company	**
International Resistance Co.	80
Jensen Radio Mfg. Co.	69
Ken-Rad Tube & Lamp Corp.	**
Kenyon Transformer Co., Inc.	**
Knights Co., James	**
Madell Publishing House	**
Mallory & Co., P. R.	61
Massachusetts Radio School	94
McElroy Mfg. Corp.	71
McGraw-Hill Book Co., Inc.	**
Meck Industries, John	**
Messner Mfg. Co.	**
Melville Aeronautical Radio School, Inc.	94
Metropolitan Technical School	**
Millen Manufacturing Co., James	98
National Company, Inc.	63, Cov. 111
Newark Electric Co.	89
New York YMCA Schools	**
Nilson Radio School	**
Ohmite Manufacturing Co.	**
Onan Electric Plants, D. W.	94
Oxford-Tartak Radio Corporation	**
Philco Corporation	**
Pioneer Gen-E-Motor	**
Port Arthur College	80
Premax Products	**
RCA Institutes, Inc.	94
RCA Manufacturing Co., Inc.	Cov. 111
Radell Corporation	**
Radio Manufacturing Engineers	76
Radio Shack Corporation	70
Raytheon Manufacturing Co.	99
Rayney Publishing Co.	**
Radio-Television Institute	94
Reel, R. G. & Co.	90
Scientific Radio Products Co.	**
Shure Brothers	**
Sickles Co., F. W.	90
Simpson Electric Co.	**
Sperry Gyroscope Co.	79
Sprague Electric Co.	**
Standard Radio & Electronics Co.	82
Standard Transformer Co.	**
Sun Radio & Electronics Co.	86, 92
Taylor Tubes, Inc.	**
Telegraph Apparatus Co.	**
Telex Company	84
Terminal Radio Corporation	90
Thordarson Elec. Mfg. Co.	**
Triplet Electrical Instrument Co., The	91
Turner Company, The	**
United Transformer Company	Cov. 111
Universal Microphone Company	88
Valparaiso Technical Institute	82, 94
Vibroplex Company, Inc., The	**
Wallace, Don	**
Wallace, William Co.	**
Western Electric Co.	84
Westinghouse Elec. & Mfg. Co.	**
Wholesale Radio Laboratories	**
Wilcox Electric Co.	**
Wiley & Sons, John	78
Waxley (Mallory)	64
Zenith Radio Company	**

All of the above advertisers are cooperating with the A.R.R.L. to permit publication of an editorially adequate QST during this period of war rationing of paper. Using less advertising space at higher rates, they continue their customary support of QST. Some are using smaller space in each issue and some are using space only every second or third issue. Of the latter, those whose advertising does not appear in this particular issue are indicated by the ** above.

JOIN THE **RAYTHEON** FIELD ENGINEERS



... AND SERVE THE NAVY

Because of the reputation established by many hams, now in Raytheon's Field Engineering group, in supervising installation and maintenance of vital radio detection gear, the Navy has asked us to greatly expand our Field Engineering force at once.

If you have had practical experience in building amateur rigs, Raytheon has a place for you in its Field Engineering group, at a United States base or Naval activity abroad.

Not only will you serve the Navy, but you will also be taking a strategic part in this fascinating field of electronic developments, a field in which the art is being advanced at a tremendous pace. This experience will be of inestimable value in any future electronic position.

Send for full details today!



**DEVOTED TO RESEARCH AND THE MANUFACTURE OF TUBES AND EQUIPMENT FOR THE
NEW ERA OF ELECTRONICS**

WRITE TO:

Clark C. Robinson, W1SZ
Raytheon Manufacturing
Company, Field Engineering
Division, Waltham 54,
Massachusetts.



RAYTHEON

Raytheon Manufacturing Company
Waltham 54, Massachusetts

POWER YOUR PORTABLE TRANSCEIVER WITH E-L CHARGEABLE "PORTAPOWER"



You may now have the conveniences and advantages of chargeable, non-spill storage battery power, and high voltage conversion in a single, compact E-L "Portapower." Batteries are easily charged during standby-periods, assuring full plate, grid, and filament voltages for maximum distance coverage. Higher currents and voltages than obtainable from conventional batteries are instantly available.

Electronic Laboratories have proven in wartime applications the extra dependability and efficiency of Vibrator Power Supplies operating from chargeable 2-volt storage cells to give filament and high voltage DC for trouble-free operation.

Pioneering in the field of current conversion, Electronic has developed many exclusive advantages in the heavy and light-duty power supply field. Constant output voltage despite wide fluctuations in input voltage help you to keep that signal steady. If wanted, multiple inputs and

outputs are available in one unit. Power outputs up to 1000 watts are now easily obtainable.

When planning your new layout, consider carefully the advantages that E-L Vibrator Power Supplies can offer. For the marine, aviation, railroad, transit, electrical, and electronic fields, as well as the amateur field, Electronic Laboratories are proving the superior dependability and service of vibrator power supplies through comparable military uses today.

Give your name to your distributor for early supply when civilian production is permitted.

The typical model illustrated is SPC-1602 TRANSCEIVER which utilizes a built-in, high efficiency E-L "Portapower." This transceiver has a combination rechargeable storage battery and E-L Power Supply to furnish the necessary high-voltage DC for this handy, portable receiving and transmitting unit.

Electronic
LABORATORIES INC.
INDIANAPOLIS

VIBRATOR POWER SUPPLIES FOR LIGHTING, COMMUNICATIONS
AND ELECTRIC MOTOR OPERATION - ELECTRIC EXPERIMENT AND OTHER EQUIPMENT

Index to Volume XXVIII—1944

ANTENNAS

Antenna Coupling Circuit (H & K).....	56, Mar.
Directive Antenna for the Low Frequencies, A (Penners).....	40, Feb.
Inexpensive Mounting for a 112-Mc. Array, An (H & K).....	60, Jan.
Installation and Calibration of a Loop Direction Finder, The (H & K).....	59, July
Multiband Antenna Coupling Units (H & K).....	52, Nov.
Multiple Antenna Coupling System, A (Kronenberg).....	9, Aug.
New Antenna Mast Designs (Garretson).....	38, May
"Q"-Matching Transformer for 112-Mc. Antenna (H & K).....	58, Oct.
Six-Element Vertical Array for 113 Mc., A (H & K).....	70, Sept.
So You're On a Liberty Ship (Whittaker).....	22, Nov.
Towers That Never Tire (Donaldson).....	38, Mar.
Universal-Angle V.H.F. Antenna Mounting (H & K).....	56, Mar.
Wright Field's Ham-Built Direction Finder.....	42, Nov.

AUDIO-FREQUENCY EQUIPMENT AND DESIGN

Battery-Powered Camper's Combination, A (French).....	32, May
Correction.....	98, June
Design of Cross-Over Networks for Loudspeaker Units (Sieder).....	35, Dec.
Fundamentals of Magnetic Recording (Pugsley).....	10, May
High-Fidelity Peak-Limiting Amplifier, A (Moorhouse).....	19, May
Practical Applications of Simple Math (Noll)	
Part I — Bias Calculations.....	22, May
Correction.....	98, June
Part II — Plate and Screen Voltages... Correction.....	38, June
Part III — Resistance-Coupled Amplifier Calculations.....	80, Aug.
Part IV — Designing a Two-Stage Audio Amplifier.....	46, July
Part V — Video-Amplifier Design.....	50, Aug.
Part VI — Considerations in Push-Pull Amplifier Design.....	65, Sept.
Part VII — Push-Pull Operating Characteristics.....	47, Oct.
Part VIII — Class-B Amplifier Design.....	39, Nov.
Rotary Audio-Frequency Generator, A. (Palmer).....	40, Dec.
Smoothing the Performance of the Peak-Limiting Amplifier (H & K).....	37, Jan.
	55, Aug.

BOOK REVIEWS

Basic Radio Principles (Suffern).....	51, Mar.
Communication Circuits (Ware and Reed).....	37, Oct.
Electrical Essentials of Radio (Sturzberg and Osterheld).....	37, Oct.
Electron-Optics (Hatschek).....	21, Apr.
Fundamentals of Telephony (Albert).....	51, Mar.
Fundamental Radio Experiments (Higgy).....	44, Feb.
Graphical Construction for Vacuum Tube Circuits (Preisman).....	31, May
Industrial Electronic Control (Coekrell).....	99, Oct.
Maintenance and Servicing of Electrical Instruments (Spencer).....	31, May
Mathematics Essential to Electricity and Radio (Cooke and Orleans).....	44, Feb.
Mathematics of Physics and Chemistry, The (Margenau and Murphy).....	33, June
Primer of Electronics, A. (Caverly).....	51, Mar.
Practical Radio Communication (Nilson and Hornung).....	44, Feb.

Radio Direction Finders (Bond).....	98, Oct.
Radio Waves and the Ionosphere (Bennington).....	37, Oct.
Reference Data for Radio Engineers (Kohlhaas).....	51, Mar.
Successful Soldering (Taylor).....	98, Oct.

CODE PRACTICE

Adapting a Zenith B.C. Receiver for Code Reception and Code Practice (H & K).....	55, Aug.
Electronic Keyer, An (Haskins).....	52, Oct.
Flexible Code Table Circuit, A (Appleton).....	47, Apr.
Press Schedules.....	69, Jan.; 71, July; 55, Dec.
Rotary Audio-Frequency Generator, A (Palmer).....	37, Jan.
Simple Wiring Harness for Class-Room Code Instruction Work (H & K).....	55, Aug.
Simplified Tape Code-Practice Oscillator, A (Bartlett and Burns).....	45, Feb.
Substituting a 1H4G for the 1G4G Tube in the Handbook Code-Practice Set (H & K).....	59, July
Using a Superregen as a Code Practice Oscillator (H & K).....	50, May

COMMUNICATION, NON-RADIO

(See also "Experimenter's Section")

Cameras in Light-Beam Communication (Saunders).....	22, Jan.
Carrier Current.....	53, Feb.; 39, Apr.; 44, May; 42, June; 44, Aug.; 38, Oct.
F. M. for Carrier Current Communication (Guill).....	29, Dec.
Light Beams.....	39, Apr.; 45, Aug.; 38, Oct.
Portable Light-Beam Transmitter-Receiver, A (French).....	22, Apr.
Supersonics.....	40, Apr.

COMMUNICATIONS DEPARTMENT

ARRL Affiliated Club Honor Roll.....	67, Jan; 69, July
Election Notices, SCMs.....	70, Feb.; 62, Apr.; 64, June; 66, Aug.; 66, Oct.; 55 Dec.
Election Results, SCMs.....	70, Feb.; 62, Apr.; 64, June; 66, Aug.; 66, Oct.; 55, Dec.
Meet the SCMs.....	W3CIZ, 71, Feb.; W9VGC, 71, July; W5DKR, 60, Nov.; W4IP, 55, Dec.
Operating News.....	66, Jan.; 68, Feb.; 63, Mar.; 60, Apr.; 58, May; 63, June; 68, July; 63, Aug.; 77, Sept.; 63, Oct.; 57, Nov.; 52, Dec.
Press Schedules.....	69, Jan.; 71, July; 55, Dec.
War Training Program Honor Roll.....	68, Feb.; 63, Mar.; 58, May; 68, July; 63, Aug.

EDITORIALS

After the War.....	7, Aug.
Automatic Relaying.....	7, Sept.
Correspondents Wanted.....	7, Dec.
Cycles & Kilocycles.....	7, Nov.
Keep Up WERS!.....	7, Feb.
Morse and Us.....	7, May
MRI Xmas.....	10, Jan.
NCR Fogies.....	8, Aug.
One Hundred Megacycles & Up.....	7, Dec.
Policy.....	9, Mar.
Pressure.....	9, Mar.
Publicity.....	8, July
Reciprocity.....	7, June
Shining Example, A.....	7, July
Signal Corps, The.....	7, Sept.
Short Waves for Short Distances.....	8, Feb.
Tempus Fidgits.....	7, Oct.
To Our Gang Overseas.....	7, Apr.
Watt Power?.....	9, Jan.
Watt Power — A Report.....	7, May

EMERGENCY AND RELIEF WORK

Extra! Staten Island Shelled; WERS to the Rescue.....	61, May
Oakland WERS Fights a Fire.....	65, Aug.
WERS On the Job During the 1944 Hurricane	57, Nov.
WJH Assists in Cleveland's Gas Explosion Catastrophe.....	53, Dec.

EXPERIMENTER'S SECTION

(See also "Communication, Non-Radio")

Carrier Current.....	53, Feb.; 39, Apr.; 44, May; 42, June; 44, Aug.; 38, Oct.
Light Beams.....	39, Apr.; 45, Aug.; 38, Oct.
Supersonics.....	40, Apr.

FEATURES AND FICTION

Alaska Communication System, The (Fowler) ..	9, Apr
Amateur Broadcasting — A Menace (Bach)....	54, June
Army Airways Communication System, The (DeSoto)	
Part I.....	9, Feb.
Part II.....	18, Mar.
Brain Storm (Wayne).....	49, May
CAP Radio System, A (Capelle).....	29, Aug.
Cuyahoga County Amateurs Accept a Challenge (Kiener).....	26, Apr.
"E" for Excellence.....	50, Jan.
Electricity in Ancient Egypt.....	72, May
Fishin' and Ham Radio (Sourdough).....	50, Oct.
Fleet Service Schools, (Gacek).....	50, Apr.; 46, May
Flying Radiomen of the Ferrying Division (Haines).....	16, June
Hams in Combat	
Atlantic Convoy (Kujampaa).....	18, Jan.
Great Spiderweb, The (Colson and Fleischman).....	44, Oct.
Ham Goes to Sea, A (Jones).....	42, Apr.
Henderson Tower (Roberts and Dunn)....	44, Mar.
In a Jap Internment Camp (Larub).....	47, Mar.
In England with the CTC (Fulton).....	51, Feb.
Italian Invasion.....	15, Jan.
KOs Come Through, The (Ho).....	48, Nov.
Lady of Mercy, A (Wojtkiewicz).....	44, June; 53, July
La Fauconnerie by 1600 (Soehl).....	20, Jan.
One Life to Give.....	50, July
Radioman-Gunner in a B-25 (Tinsley).....	40, Aug.
Radio Station on the Tokyo Road (Beardsley).....	49, Feb.
SOS in the Sahara (Sullivan).....	45, Apr.
Hams in the AACs (DeSoto).....	12, Aug.
Hams in the RID (Read).....	18, Oct.
Ham Shack on the Boulevard, The.....	34, Dec.
In QST 25 Years Ago This Month.....	30, June; 37, July; 25, Aug.; 56, Sept.; 56, Oct.; 44, Nov.; 23, Dec.
Legend of Seldon Hill, The (Read).....	46, Aug.
Leghorn Gang, The (IKW).....	30, Nov.
Lice, Liberty and the Pursuit of Parasites (Burp)	41, May
New Contrapolar Frequency Spectrum, The (Wildenhein).....	52, Mar.
"Patrolling the Ether".....	45, May
Pine Notch Ponderings (Sourdough).....	54, Feb.
Plan for Tomorrow, A ("Helix").....	39, Dec.
Pre-Radio (Sasserath).....	43, June
QST Cruises with the Maritime Service (DeSoto)	9, July
Radio Historical Quiz (Cobaugh).....	57, Feb.; 40, Mar.
Radioteletype in the AACs (Hart).....	12, Nov.
Signal Corps 'Troops in Italy.....	57, Jan.
Them Wuz the Good Old Days (Sourdough)....	38, July
Troubles of a Wandering Ham, The (Hunt)....	43, Dec.
Underwriters' Laboratories 50 Years Old.....	24, June
U. S. Army Signal Corps, The (DeSoto).....	9, Sept.
Vindication.....	25, Nov.
WERS in the Florida State Guard (Hazelton) ..	45, Nov.
When Spring Comes to Pine Notch (Sourdough)	36, May
WKAU Proves Its Worth (Chevillot).....	39, Oct.

HAMDOM

K6TQS, W20CX — ex-K7BAQ, ex-W2BMP..	34, Jan.
W2DWI, W6ATM — ex-WILE, W2BVR — ex-W1KTN	41, June

HAPPENINGS OF THE MONTH

Allocation Work.....	14, Dec.
Amateur Examinations.....	29, Feb.
Amateur Frequencies.....	62, Sept.
"Amateur Radio and Its Contribution to the Security and Welfare of the Nation".....	16, Dec.
Board Meeting Highlights.....	25, June
Board Meeting Minutes.....	21, July
Bootlegging on 112 Mc.....	23, Aug.
Canadian Planning.....	14, Dec.
Changes in Exam Sked.....	27, June
Change in WERS Hours.....	35, Jan.
Chief Engineer.....	18, May
Editorial Assistance Required.....	14, Dec.
Election Notices, Directors.....	36, Jan.; 27, June; 22, July; 63, Sept.; 36, Oct.
Election Results, Directors.....	32, Mar.; 64, Sept.; 14, Dec.
Executive Committee Meetings.....	23, July
FCC Notes.....	19, Apr.
Frequencies.....	17, Nov.
Frequency Requirements of the Amateur Radio Service, The.....	18, Nov.
IRAC Elections.....	26, June
IRAC Proposal, That.....	15, Dec.
Jett as Commissioner.....	32, Mar.
Kilowatt 'Phones Wanted.....	63, Sept.
Navy Needs Officers.....	16, May
Notice to Members Discharged From the Military Services.....	37, Jan.; 33, Mar.; 18, May; 23, July; 64, Sept.; 18, Nov.
Physicists & Engineers.....	19, Apr.; 25, June; 22, July; 23, Aug.; 35, Oct.
Postwar Allocations.....	35, Oct.
Postwar Planning.....	29, Feb.
Proof-of-Use-Again Waived.....	29, Feb.
Radio World Honors K. B. Warner on His Twenty-Fifth Anniversary.....	27, June
Releases to Merchant Marine.....	23, Aug.
RTPB Notes.....	35, Jan.
Segal to Pacific.....	19, Apr.
Ship Operators Wanted.....	25, June
Staff Notes.....	16, May; 24, Aug.
Technical Editor-Writer.....	14, Dec.
This Keating Gal.....	26, June
VWOA's Nineteenth.....	20, Apr.
"Word in Behalf of the Radio Amateur, A".....	20, Apr.

HINTS AND KINKS

January, page 60	
Filament Switch for Prolonging Tube Life	
Pilot Lamp as Ballast Resistor	
Substitutions for 12SA7 Tube	
Shunt Resistor Economizes Use of Paper Condensers	
Soldering Iron Rest to Dissipate Higher Temperatures	
An Inexpensive Mounting for a 112-Mc. Array	
February, page 58	
Handy Calculator for Time Conversions	
Improved 'Phone-Jack Circuit for the Mobile WERS Transceiver	
Extending the Usefulness of a 100-Kc. Oscillator Control Circuits	
March, page 56	
A Universal-Angle V.H.F. Antenna Mounting	
Antenna Coupling Circuit	
Tube-Checker Kinks	
Eliminating Parasitics in a Modulated P.P. 807 Amplifier.	
B.C. Receiver Cut-Off Switches	
April, page 53	
Simple V.H.F. Tank Circuit from Salvaged Material	
Substituting a 14A7/12B7 for a 12SA7	
May, page 50	
Mounting a Crystal Headphone for Microphone Use	
Converting Shim Brass to Spring Brass	
Using the Superregen as a Code Practice Oscillator	
Air Vent Makes Headphones More Comfortable	
Support Flanges for Holding Standard Rack Units	
A Two-Way Intercommunicating System (Correction 98, June)	
Changes in NC101X Receiver for Wartime Use	
Improvised Soldering Torch	
Tension for Building Spaced Feeders	
Test Terminals in H.F. Oscillator Grid Circuit	

June, page 58	
A V.H.F. and U.H.F. Converter Using a Crystal Detector	
Neat Finish for Ham Gear	
A Push-Pull Infinite-Impedance Detector	
Six-Volt Soldering Irons	
July, page 59	
The Installation and Calibration of a Loop Direction Finder	
A WERS Transmitter-Receiver Unit Using 2.5-Volt Tubes	
A Homemade Gas Soldering Torch Constructed from Scrap Copper Tubing	
Substituting a 1H4G for the 1G4G Tube in the <i>Hand-book Code-Practice Set</i>	
August, page 55	
Smoothing the Performance of the Peak-Limiting Amplifier	
The 14Q7 as a 12SA7 Substitute	
A Multirange V-O-M	
Simple Wiring Harness for Class-Room Code Instruction	
Adapting a Zenith B.C. Receiver for Code Reception and Code Practice	
Using a Flit Gun as a Paint Sprayer	
September, page 70	
A 6-Element Vertical Array for 113 Mc.	
Regenerative R.F. Stage using 6L7 Pentagrid Mixer	
Sensitive Battery-Operated Test Rig for WERS	
Simple Magnetic Holder for Ferrous Nuts and Lock Washers	
October, page 58	
"Q"-Matching Transformer for 112-Mc. Antenna	
Check for Ratings of Fixed Condensers	
Calibration for CRL Dial of Impedance Bridge	
Insulated Holder for Small Cartridge-Type Fuses	
Autotransformer for Power Control	
November, page 52	
Filtering Genemotors Used to Supply Receivers	
Multiband Antenna Coupling Units	
Subharmonics	
L/C On Your Slide Rule	
December, page 46	
Variable Voltage Tap for Power Supply	
Self Bias Applied to the TR-4	
Renewing Burnt-Out Tubes	
B.C. Receiver Adapted for Shipboard P.A.	
Improved Autotransformer	
Voice-Controlled Transmitter Switching	
Thinner for Coil Cement	

KEYING

Multivibrator-Type Electronic Key (Page)	17, Mar.
Correction	96, May
Electronic Keyer, An (Haskins)	52, Oct.
Key-Click Elimination (Fiecionado)	41, Apr.
New Electronic-Key Circuits (Gardner)	15, Mar.
Simplified Tape Code-Practice Oscillator, A (Bartlett)	45, Feb.
Simplifying the Electronic Key (Wiley)	40, July

MEASUREMENTS AND TEST EQUIPMENT

Calibration for CRL of Impedance Bridge (H & K)	58, Oct.
Cathode-Ray Tube and Its Application, The (Mix)	24, Oct.
Check for Ratings of Fixed Condensers (H & K)	58, Oct.
Extending the Usefulness of a 100-Kc. Oscillator (H & K)	58, Feb.
Handy Calculator for Time Conversion (H & K)	58, Feb.
Inexpensive Impedance Bridge, An (Cosmas)	32, July
Multirange V-O-M, A (H & K)	55, Aug.
Ohmmeter Circuits (Gadwa)	30, Apr.
Portable Multimeter, A (Long)	18, Aug.
Resistance and Capacitance Measurements with the V.T.V.M. (Mayo)	31, June
Rotary Audio-Frequency Generator, A (Palmer)	37, Jan.
Sensitive Battery-Operated Test Rig for WERS	70, Sept.
Simple Signal Tracer, A (Bradley)	28, Mar.
Correction	98, Apr.
Test Terminals in H.F. Oscillator Grid Circuit (H & K)	50, May
Tube-Checker Kinks (H & K)	56, Mar.

WVW Schedules... 57, Feb.; 74, Apr.; 74, May; 80, June; 80, Nov.

MISCELLANEOUS

Circulation Statement	27, Oct.
Free Radio Training Available to Ex-Service Men	38, Dec.
"Hand-Screening" Process for Amateur Instrument-Panel Lettering, A (Foot)	38, Aug.
Iconoscope, The (Southwell)	26, July
Look Before You Leap (Bradley)	64, July
Meetings and Conventions	
Anglo-American Hamfest	45, Dec.
Cairo Convention	59, Aug.
Chicago "Hamboree"	63, July
Hamfest in North Africa (Longerich, Hansen)	31, Feb.
IRE Winter Meeting	21, Apr.
National Electronics Conference	64, Sept.
Rochester Fall Meeting	34, Oct.
Third United Nations Amateur Radio Convention (Miller)	55, Mar.
New Schematic Symbols	16, Oct.
New Weather Maps for Making DX Predictions	21, Nov.
Radio Aids to Avigation (Oonnigan)	24, Feb.
Correction	10, Mar.
Correction	98, May
Sound-Operated Relay Control, A (Conn)	33, Aug.
Television in K6 Land (Souza)	42, May
Why Low-Level Microphones? (Silver)	32, Dec.
Video Amplifier Design (Merritt)	24, Dec.

OBITUARY

Gold Stars:	
W4EUN, W6SAP	39, Jan.
K7BC-ex-W7BB, W4HJZ-ex-W3BDH	55, Feb.
W9ASB, W9WNQ	33, Mar.
W4EVT, W1PG	25, Apr.
W9FFZ, W9WDR	31, May
W3BSD-ex-W3BRZ, W1LQK	15, June
W9FJH, W5HGE	49, July
W9JJT, W1KCE-ex-W2BTO	32, Aug.
W5HZT, W3IRL	73, Sept.
W9VFS, W2JNS	51, Oct.
W9LVE, W1JQQ	50, Nov.
VE5NV, W. Robinson	31, Dec.
Woodruff, Dr. Eugene C., W8CMP-W8SCK	9, May
Silent Keys	59, Jan.; 42, Feb.; 76, Mar.; 38, Apr.; 37, May; 55, June; 25, July; 54, Aug.; 90, Sept.; 78, Oct.; 78, Nov.; 13, Dec.

POWER SUPPLIES

Autotransformer for Power Control (H & K)	58, Oct.
Beginner's Station, A (Toy)	48, June
Filtering Genemotors Used to Supply Receivers (H & K)	52, Nov.
Improved Autotransformer (H & K)	46, Dec.
Kw. vs. Kva. (Davis)	60, Sept.
Look Before You Leap (Bradley)	64, July
New Apparatus	73, Sept.
Portable Power Supply for WERS, A (Long)	28, May
Power-Supply Design (Hamilton)	26, Aug.
Restoring Dry Cells (Eubank)	11, June
Simple WERS Transceiver with Transformerless Power Supply, A (Roth)	11, Jan.
Variable Voltage Tap for Power Supply (H & K)	46, Dec.

PRISONERS OF WAR AND MISSING IN ACTION

P.O.W.	59, Jan.; 42, Feb.; 76, Mar.; 37, May; 90, Sept.; 78, Oct.
Missing in Action	59, Jan.; 42, Feb.; 76, Mar.; 37, May; 55, June; 25, July; 54, Aug.; 90, Sept.; 78, Oct.

PROPAGATION

F.M. Distortion in Mountainous Terrain (Mayo and Sumner)	34, Mar.
Ignition Noise on the V.H.F. and U.H.F. (Dean)	44, Jan.
New Weather Maps for Making DX Predictions	21, Nov.
On the Very Highs (Tilton)	41, Mar.; 42, July
Topography and V.H.F. Wave Propagation (French)	15, Feb.
Correction	98, Apr.

RECEIVING

Adjustable I.F. Selectivity (Lobel)	49, Mar.
B.C. Receiver Adapted for Shipboard P.A. (H & K)	46, Dec.
B.C. Receiver Cut-Off Switches (H & K)	58, Mar.
Beginner's Station, A (Toy)	48, June
Cathode Follower, The (Minor)	18, Dec.
Changes in NC101X Receiver for Wartime Use (H & K)	50, May
Compact Gear for 224-Mc. WERS (Semel)	9, Nov.
Directive Reception — An Answer to Postwar QRM? (Read)	9, June
Filtering Genemotors Used to Supply Receivers (H & K)	52, Nov.
Ham-Built Communications-Type Receiver, A (Mayo)	13, Apr.
Correction	98, June
Push-Pull Infinite Impedance Detector, A (H & K)	58, June
Regenerative R.F. Stage Using 6L7 Pentagrid Mixer (H & K)	70, Sept.
"Tiny Tim" (Palmer)	57, Sept.
Versatile Two-Tube Regenerative Receiver, A (Bradley)	9, Oct.
WERS Control Station Receiver, A (Heubner)	15, July

RECORDING

Design of Cross-Over Networks for Loudspeaker Units (Sieder)	35, Dec.
Fundamentals of Magnetic Recording (Pugsley)	10, May
High-Fidelity Peak-Limiting Amplifier, A (Moorhouse)	19, May
Smoothing the Performance of the Peak-Limiting Amplifier (H & K)	55, Aug.

TRANSMITTERS — CONSTRUCTIONAL

(see also "Transceivers and Transmitter-Receivers")

Battery-Powered Camper's Combination, A (French)	32, May
Correction	98, June
Beginner's Station, A (Toy)	48, June
Eliminating Parasitics in a Modulated P.P. 807 Amplifier (H & K)	58, Mar.
"QSL"-Type Transmitter with Transformerless Power Supply, A (Palmer)	56, July
Correction	80, Aug.
Correction	96, Oct.

TRANSMITTING — GENERAL

Control Circuits (H & K)	60, Feb.
Radioteletype in the AACS (Hart)	12, Nov.
Voice Controlled Transmitter Switching (H & K)	46, Dec.

TUBES

Cathode-Ray Tube and Its Application, The (Mix)	24, Oct.
New Push-Pull Beam Tetrode V.H.F. Transmitting Tube — 829-B	48, Feb.
New Tube — RCA-6J4	58, July
New Tubes — 68K6, 6AQ6, 6AL5	32, Aug.
New Tubes — G. E. Megatrons; Eimac: 15E, 53A, 127A, 327A, 327B, 527, 25T, 3C24	25T, 3C24
New Tubes — GL-599, GL-446-A, GL-446-B, GL-2C44	44, Nov.
Renewing Burnt-Out Tubes (H & K)	46, Dec.
Substituting a 1H4G for the 1G4G Tube in the Handbook Code Practice Set (H & K)	59, July
Substituting a 14A7/12B7 for a 12SA7 (H & K)	53, Apr.
Substitutions for 12SA7 Tube (H & K)	60, Jan.
Filament Switch for Prolonging Tube Life (H & K)	60, Jan.
Tube Checker Kinks (H & K)	57, Mar.
14Q7 as a 12SA7 Substitute, The (H & K)	55, Aug.

VERY-HIGH FREQUENCIES — APPARATUS

Building WERS Transceivers in the School Shop (Metzger)	17, May
Correction	98, June
Compact Gear for 224-Mc. WERS (Semel)	9, Nov.

Improved 'Phone-Jack Circuit for the Mobile WERS Transceiver (H & K)	58, Feb.
Mobile Gear for WERS (Carter)	9, Dec.
Receiving-Tube 112-Mc. M.O.P.A., A (Espy)	54, Sept.
Self-Bias Applied to TR-4 (H & K)	46, Dec.
Self-Contained Handie-Talkie, A (Haist)	28, June
Simple M.O.P.A. for WERS Service, A (Pattison and Mix)	19, July
Simple V.H.F. Tank Circuit from Salvaged Material (H & K)	65, Apr.
Simple WERS Transceiver with Transformerless Power Supply, A (Roth)	11, Jan.
Single-Tube WERS Transceiver, A (Abell)	32, Oct.
Correction	92, Dec.
Versatile WERS Mobile Station, A (Rand)	33, Nov.
V.H.F. and U.H.F. Converter Using a Crystal Detector, A (H & K)	58, June
Walking WERS Station, A (French)	11, Mar.
WERS Control Station Receiver, A (Heubner)	15, July
WERS Handie-Talkie for \$1538.77, A (Long)	32, Feb.
WERS Transmitter-Receiver Unit Using 25-Volt Tubes, A (H & K)	59, July
WKXM-8 — A Novel WERS Transceiver (Mitchell)	36, Apr.

VERY-HIGH FREQUENCIES — GENERAL

Ignition Noise on the V.H.F. and U.H.F. (Dean)	44, Jan.
On the Very Highs.	56, Jan.; 43, Feb.; 41, Mar.; 40, May; 42, July
Topography and V.H.F. Wave Propagation (French)	15, Feb.
Correction	98, Apr.

WAR EMERGENCY RADIO SERVICE — EQUIPMENT

(See "Very-High Frequencies — Apparatus," "Measurements and Test Equipment," and "Power Supplies.")

WAR EMERGENCY RADIO SERVICE — GENERAL

CAP Radio System, A (Capelle)	29, Aug.
Cuyahoga County Amateurs Accept a Challenge (Kiener)	26, Apr.
Extra! Staten Island Shelled, WERS to the Rescue	61, May
Four WERS Mobile Installations (WJTW)	57, Aug.
Oakland WERS Fights & Fire	65, Aug.
Operating News Leads	
Amateur Training for WERS Permittees ..	60, Apr.
Army Orders	63, Mar.
ARRL Manual	69, Feb.
Changes in Typical Element One Answers ..	58, May
Change Sheets	69, July
C.W. in WERS	60, Apr.
Disaster Strikes Again	63, Aug.
Drills Should Emphasize Problems in Disaster Operation	63, Aug.
FCC Report	60, Apr.
Frequency Tolerances Remain Unchanged ..	63, June
Intermunicipal Agreements	68, July
Mobiles	63, Mar.
New Testing Hours for WERS	66, Jan.
OCB Manual	69, Feb.
Radio Class Questionnaires	59, May
Re: Amendment of Restricted Order No. 2 ..	63, June
Re: Batteries	68, Feb.
Removal of Telephones from DWCS	77, Sept.
State WERS Meetings	77, Sept.
Stay in Your Own Back Yard	63, June
Suspension of Drills	63, Mar.
War Department Attitude	60, Apr.
WERS on the Job During the 1944 Hurricane	57, Nov.
WERS Licensee Total Mounts	63, June
WERS in the Florida State Guard (Hazelton) ..	45, Nov.
WJHH Assists in Cleveland's Gas Explosion Catastrophe	53, Dec.
WJHH Helps Cleveland Set Waste Paper Collection Record	63, Oct.
WKAU Proves Its Worth (Chevillot)	39, Oct.
WNYJ Stages City-Wide Demonstration	66, June

NATIONAL RECEIVERS ARE THE EARS OF THE FLEET



OFFICIAL U. S. NAVY PHOTOGRAPH
BY LIEUTENANT COMMANDER FREDERICK LEWIS

EACH LST
HAS TWO
NATIONAL
RECEIVERS

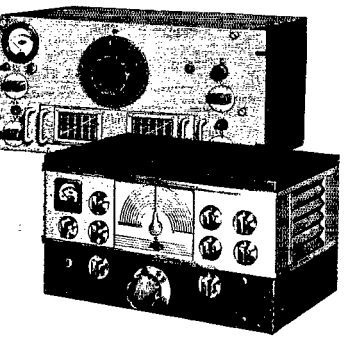

NATIONAL COMPANY

MALDEN  MASS., U. S. A.

NATIONAL RECEIVERS ARE IN SERVICE THROUGHOUT THE WORLD

Announcing

RCA-3B25

New Xenon-Filled Rectifier

Wide Temperature Range; Low

Voltage Drop; Mounts in Any Position

THE RCA-3B25 is a xenon-filled, half-wave rectifier of the coated-filament type. It was designed for war applications and can withstand ambient temperatures as low as -75°C (-103°F) and as high as $+90^{\circ}\text{C}$ ($+194^{\circ}\text{F}$). It can be mounted in any position, and its unusually rugged construction permits operation under conditions of severe vibration.

In single-phase, full-wave operation, a pair of 3B25's will provide 1 ampere d-c output to the filter at 1270 volts. The tube is rated at 4000 volts peak inverse anode voltage and an average anode current of 0.5 ampere.

For more complete data, send for "free data sheet on RCA-3B25." Address: RADIO CORPORATION OF AMERICA, Commercial Engineering Section, Dept. 62-19A, Harrison, New Jersey.

TECHNICAL DATA

GENERAL: Filament volts (a.c.), 2.5; filament current, 5.0 amperes; tube drop (approx.), 10 volts; overall length, 5 7-8" \pm 7-16"; maximum diameter, 2 1-16"; cap, medium; base, medium 4-pin, bayonet; mounts in any position.

MAXIMUM RATINGS (Absolute values): Peak inverse anode volts (at 500 cycles or less), 4000; peak anode current, 2 amperes; average anode current, 0.5 ampere; surge anode current for max. of 0.1 second, 20 amperes; ambient temperature range, -75 to $+90^{\circ}\text{C}$.

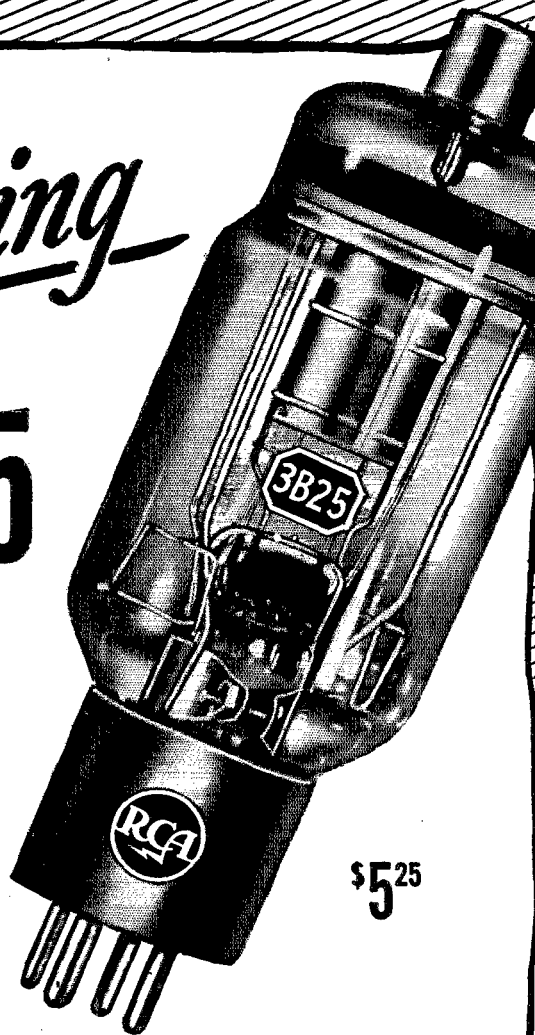

\$5²⁵

The Magic Brain of all electronic equipment is a Tube . . . and the fountain-head of modern Tube development is RCA!

1919
1944



25 Years of
Progress in Radio
and Electronics

62-5431-19

**RADIO CORPORATION
OF AMERICA**

RCA VICTOR DIVISION • CAMDEN, N. J.

BUY MORE WAR BONDS