

QST

may, 1942

25 cents

35c in Canada

devoted entirely to

amateur radio



WOMEN RADIO OPERATORS NEEDED

*AWVS Trains Women
as Radio Operators*

Draft for Women

*WOMEN ON HOME FRONT
More Jobs
Than Men
Women Prepare for War!*

Home Defense

Y.F.R. Starts Radio Training Course

for Victory!

More than 100 types of tubes for use in Commercial Broadcasting, Point to Point Communication, Ultra High Frequency Transmission, Electro Medical Apparatus, High Voltage Rectification and many Industrial Applications.

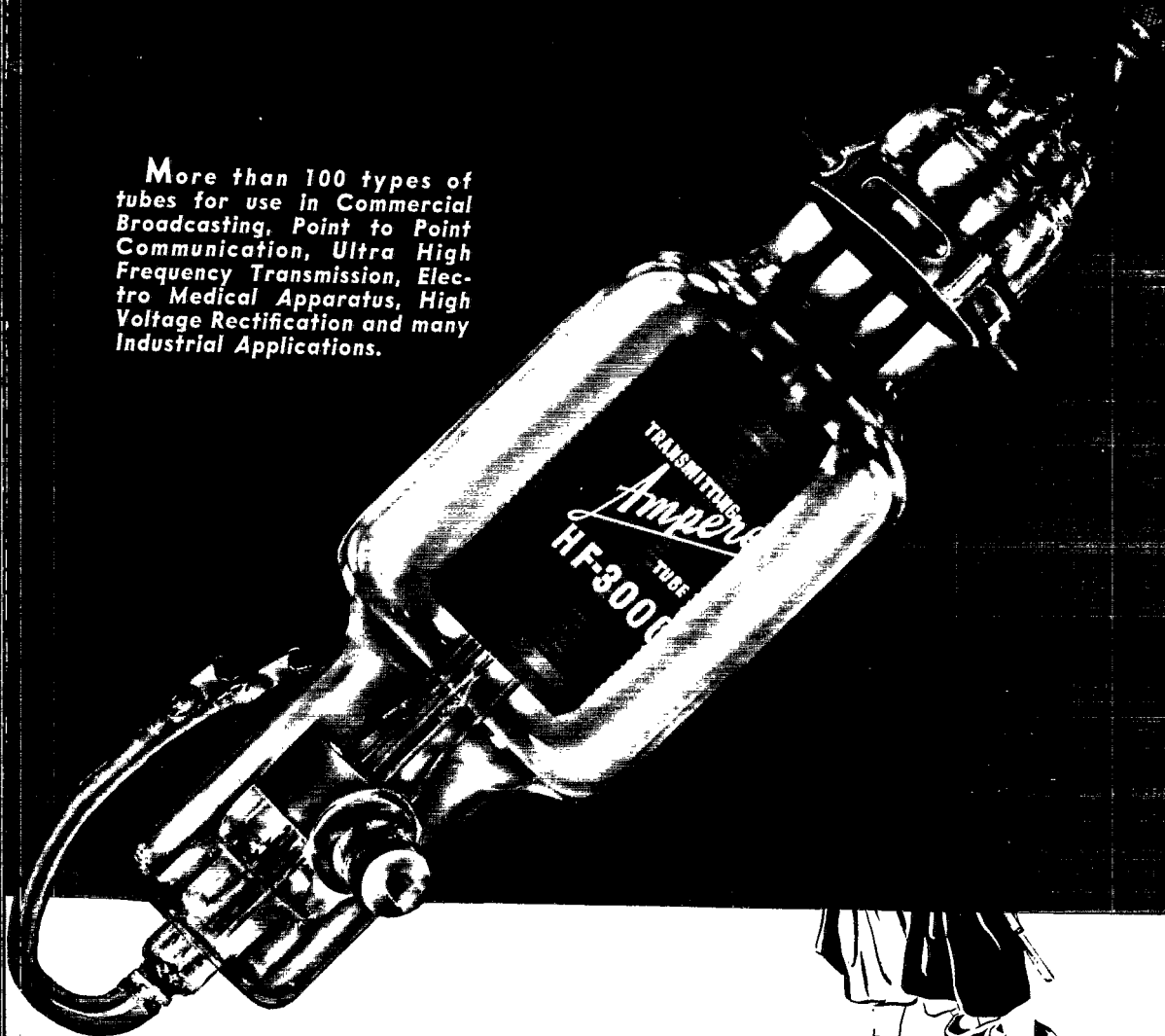

Now, this is a WAR!

"A TOTAL WAR! A war in which the fighting man **DEPENDS** upon radio for his information, his orders and his very life.

"And that odd-shaped bottle is an ultra-high frequency, high-power, air-cooled transmitting tube. Thousands of these, as well as other **AMPEREX** types, are in 'front line' service.

"Folks back home subordinate their civilian requirements to such military needs. It's an 'all-out' war calling for sacrifices from all of the people."

AMPEREX ELECTRONIC PRODUCTS
79 WASHINGTON STREET • BROOKLYN, NEW YORK



Their Aim Must Be Good!

... and it is good! ... because they have the World's finest equipment. American manufacturers are also aiming at a goal and that goal is to produce more and more equipment in record-breaking time ... and they are succeeding far beyond expectations!

With our greatly increased facilities the production of HALLICRAFTERS communications equipment goes forward steadily for both our armed forces and civilian requirements ... we are achieving our aim!

the hallicrafters co.
CHICAGO, U. S. A.

Keep Communications Open

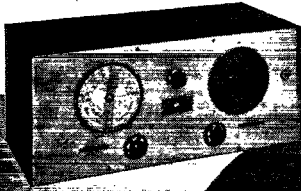

Years Ago!

- S-10
- S-11
- S-12
- S-14
- S-15
- S-16
- S-17
- S-18

S-1... A Good Receiver!

When we first made the S-1 eight years ago it was a good communications receiver and we knew it contained every possible improvement known to our engineers. Eight years is a long time . . . many improvements have been made, our laboratories have been constantly engaged in research for better communications reception. Our work has been rewarded by your confidence in Hallicrafters communications equipment.

S-19R

the hallicrafters co.
CHICAGO, U. S. A.

S-20R

Keep Communications Open

S-21

The SX-28... A Good Receiver NOW...

Incorporating many years of engineering research the SX-28 has had world wide acceptance. The fifteen tubes, six bands with a frequency range of from 550 kc. to 42 mc. give a new high in quality performance.

S-22

SX-23

SX-24

SX-25

S-27

SX-28

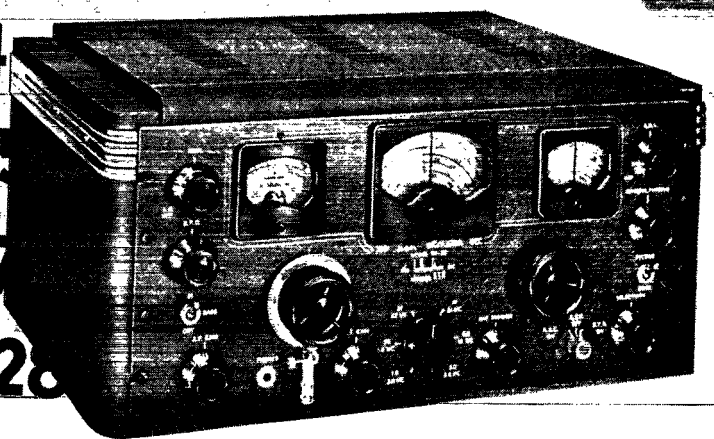

MAY 1942

VOLUME XXVI

NUMBER 5



STAFF

Editorial

KENNETH B. WARNER, W1EH

Editor and Business Manager

CLINTON B. DeSOTO, W1CDB

Assistant Editor

CLARE C. RODIMON, W1SZ*

Managing Editor

GEORGE GRAMMER, W1DF

Technical Editor

DONALD H. MIX, W1TS

BYRON GOODMAN, W1JPE*

Assistant Technical Editors

EDWARD P. TILTON, W1HDQ

Contributing Editor, U.H.F.

VERNON CHAMBERS, W1JEQ*

WALTER E. BRADLEY, W1FWH

Technical Information Service

LOUISA B. DRESSER

Editorial Assistant

JAMES J. LAMB, W1AL*

Research Engineer, A.R.R.L.

Advertising

F. CHEYNEY BEEKLEY, W1GS

Advertising Manager

Circulation

DAVID H. HOUGHTON

Circulation Manager

RALPH T. BEAUDIN, W1BAW

Asst. Circulation Manager

*On leave of absence



OFFICES

38 La Salle Road

West Hartford, Connecticut

Subscription rate in United States and Possessions, \$2.50 per year, postpaid; all other countries, \$3.00 per year, postpaid. Single copies, 25 cents. Foreign remittances should be by international postal or express money order or bank draft negotiable in the U. S. and for an equivalent amount in U. S. funds.

Entered as second-class matter May 29, 1919, at the post office at Hartford, Connecticut, under the Act of March 3, 1879. Acceptance for mailing at special rate of postage provided for in section 1103, Act of October 3, 1917, authorized September 9, 1925. Additional entry at Concord, N. H., authorized February 21, 1929, under the Act of February 28, 1925. Additional second-class entries to cover sectional editions authorized March 20, 1935.

Copyright 1942 by the American Radio Relay League, Inc. Title registered at United States Patent Office.

QST

devoted entirely to

AMATEUR RADIO

PUBLISHED, MONTHLY, AS ITS OFFICIAL ORGAN, BY THE AMERICAN RADIO RELAY LEAGUE, INC., AT WEST HARTFORD, CONN., U. S. A.; OFFICIAL ORGAN OF THE INTERNATIONAL AMATEUR RADIO UNION



CONTENTS

Table with 2 columns: Article Title and Page Number. Includes items like 'It Seems to Us', 'Splatter', 'Our Cover', 'U. S. A. Calls and the YLs Answer', 'Teaching Radio in Summer Camps', 'A Simple Light-Beam Communication System', 'U. S. A. Calling!', 'Interference-Reducing Antenna Systems', 'Happenings of the Month', 'New U.H.F. Transmitting Tube', 'Technical Reviews', 'P.O.W.', 'In the Services', 'Experimenter's Section', 'Army-Amateur Radio System Activities', '25 Years Ago This Month', 'The "Battleship" V. F. O.', 'A Multi-Range Volt-Milliammeter Adapter', 'W6GRL Is China's U. S. Listening Post', 'On the Ultra Highs', 'Notes on 225-Mc. Converter Design', 'Hints and Kinks', 'Feeding the Coaxial Dipole with an Open-Wire Line', 'Correspondence from Members', 'Operating News', 'Honor Roll', 'Meet the SCMs', 'Providence Radio Patrol Members Get Badges', 'Good Morse is Easier', 'WWV Schedules', 'Silent Keys', 'Corrections, Sweepstakes Contest Results', 'Hamfest Schedule', 'The Month in Canada', 'Hamads', 'QST's Index of Advertisers'.

Section Communications Managers of the A.R.R.L. Communications Department

Reports Invited. All amateurs, especially League members, are invited to report communications activities, training plans, code classes, theory-discussion groups, civilian-defense building or planning each mid-month (16th of the month for the last 30 days) direct to the SCM, the administrative official of ARRL elected by members in each Section whose address is given below. Radio Club reports and Emergency Coördinator reports representing community organized work and plans and progress are especially desired by SCMs for inclusion in *QST*. **ARRL Field Organization appointments**, with the exception of the Emergency Coördinator and Emergency Corps posts, are suspended for the present and no new appointments or cancellations, with the exception named, will be made. This is to permit full efforts of all in Emergency Corps plans.

ATLANTIC DIVISION				
Eastern Pennsylvania Maryland-Delaware-District of Columbia Southern New Jersey Western New York Western Pennsylvania	W3BES W3CIZ W3CCO W8PLA W8CKO	Jerry Mathis Hermann E. Hobbs Lester H. Allen Fred Chichester E. A. Krall	6208 Master St. 9701 Monroe St. Silver Spring P. O. 704 Quinlan Ave. 703 Broadway	Philadelphia Linden, Maryland Trenton Sonyea East McKeesport
CENTRAL DIVISION				
Illinois Indiana Kentucky Michigan Ohio Wisconsin	W9ILH W9VMV W9ARU W8DPE W8AQ W9EYH	Mrs. Carrie Jones LeRoy T. Waggoner Darrell A. Downard Harold C. Bird E. H. Gibbs Walter Wallace	2407 Central Ave. 1721 Winton St. 116 N. Longworth Ave. R.F.D. 2 405 Broad St. 9929-A W. Hadley St.	Alton Indianapolis Louisville Pontiac Wadsworth Milwaukee
DAKOTA DIVISION				
North Dakota South Dakota Northern Minnesota Southern Minnesota	W9RPJ W9ADJ W9FUZ W9YNG	Don Beaudine E. C. Mohler Armond D. Brattland Millard L. Bender	620 First N St. Box 149 Birchmont Rd. 608 N. Huron Ave.	Fargo Rapid City Bemidji Spring Valley
DELTA DIVISION				
Arkansas Louisiana Mississippi Tennessee	W5GNV W5DWW W5EGE W4DDJ	John R. Sanders W. J. Wilkinson, Jr. S. Benton Cain M. G. Hooper	P. O. Box 1563 Room 313, Jefferson Hotel 221 E. Monticello 4908 Georgia Ave.	Little Rock Shreveport Brookhaven Nashville
HUDSON DIVISION				
Eastern New York N. Y. C. & Long Island Northern New Jersey	W2LU W2AZV W2LMN	Robert E. Haight E. L. Baunach Edward Gursky, Jr.	356 West 34 St. 102 Central Ave. 367 Van Winkle Ave.	New York City Massapequa, L. I. Hawthorne
MIDWEST DIVISION				
Iowa* Kansas Missouri* Nebraska	W9PJR W9AWP W9AEJ W9WKP	L. B. Vennard A. B. Unruh Wm. G. Skinker Garold Bennett	1113 So. 9th St. 1617 S. Seneca St. 7126 Pershing Ave. 214 East St.	Burlington Wichita University City Hastings
NEW ENGLAND DIVISION				
Connecticut Maine Eastern Massachusetts Western Massachusetts New Hampshire Rhode Island Vermont	W1KQV W1BAV W1ALP W1JAH W1FTJ W1HRC W1KJG	Edmund R. Frazer Ames R. Millett Frank L. Baker, Jr. William J. Barrett Mrs. Dorothy W. Evans Clayton C. Gordon Clifton G. Parker	48 Willow St. 37 Morning St. 91 Atlantic St. 239 Columbia St. P. O. Box 312 70 Columbia Ave., Gaspee Box 537	West Haven Portland North Quincy Adams Concord Plateau, Warwick Morrisville
NORTHWESTERN DIVISION				
Alaska Idaho* Montana Oregon Washington	K7GNN W7AVP W7CPY W7GNJ W7EPB	James G. Sherry Don D. Oberbillig Rex Roberts Carl Austin Carl F. Hofmann	P. O. Box 486 Box 1088 1137 Federal 4413 East E St.	Chichagof Boise Glenview Bend Tacoma
PACIFIC DIVISION				
Hawaii Nevada Santa Clara Valley East Bay San Francisco Sacramento Valley Philippines San Joaquin Valley	K6ETF W6BIC W6IUZ W6FTI W6CIS W6MDI KA1GR W6QDT	Francis T. Blatt Edward W. Heim Earl F. Sanderson Horace R. Greer Kenneth E. Hughes Vincent N. Feldhausen George L. Rickard Antone J. Silva	837 16th Ave. 509 Claremont St. 1213 Claremont Ave. 414 Fairmount Ave. 209 Lincoln Way 113 South Quincy St. Box 849 Route 5	Honolulu Reno San Jose Oakland San Francisco McCloud Manila Modesto
ROANOKE DIVISION				
North Carolina South Carolina Virginia* West Virginia	W4CVB W4BQE/ANG W3BZE W8JRL	W. J. Wortman Orval Ferguson Thomas S. Jones Kenneth M. Zinn	P. O. Box 566 1213 College St. 2918 Montrose Ave. P. O. Box 132	Morganton Columbia Richmond Clarksburg
ROCKY MOUNTAIN DIVISION				
Colorado* Utah-Wyoming	W9KHQ W7GZG	Orval Cunningham Henry L. Schroeder	P. O. Box 731	Towner Laramie, Wyoming
SOUTHEASTERN DIVISION				
Alabama* Eastern Florida Western Florida Georgia West Indies (Cuba) (Puerto Rico-Virgin Islands)	W4GBV W4PEI W4AXP W4AOB CM2OP K4KD	Lawrence J. Smyth Carl G. Schaal Oscar Cederstrom William U. Hanks Mario de la Torre Everett Mayer	808 Winona Ave. Lakeview Hotel Second St. & Bruce Ave. 4 Hunter St., S.E. Escobar 110 (Altos) 24 Lindberg St.	Montgomery Clermont De Funiak Springs Atlanta Habana, Cuba Santurce, P. R.
SOUTHWESTERN DIVISION				
Los Angeles Arizona* San Diego	W6MQM W6MLL W6BKZ	Ralph S. Click Gladden Elliott Louis A. Cartwright	1038 Milwaukee Ave. 218 Loma St. 7214 Fay St.	Los Angeles Nogales La Jolla
WEST GULF DIVISION				
Northern Texas Oklahoma Southern Texas New Mexico	W5HIP W5GFT W5MN W5ENI	George W. Smith Russell W. Battern Horace E. Biddy Dr. Hilton W. Gillett	Route 2 Box 290 1746 Schley Ave.	Celina Enid San Antonio Lovington
MARITIME DIVISION				
Maritime	VE1DQ	A. M. Crowell	69 Dublin St.	Halifax, N. S.
ONTARIO DIVISION				
Ontario	VE3EF	Flying Officer Donald R. Gunn c/o Canadian Bank of Commerce		New Toronto, Ont.
QUEBEC DIVISION				
Quebec	VE2CO	Lindsey G. Morris	Apt. 6, 4510 Girouard Ave., N.D.G.	Montreal, P. Q.
VANALTA DIVISION				
Alberta British Columbia	VE4GE VE5DD	C. S. Jamieson C. O. I. Sawyer	581 W. Riverside Drive 2634 West 31st Ave.	Drumheller, Alta. Vancouver
PRAIRIE DIVISION				
Manitoba Saskatchewan	VE4AAW VE4SY	A. W. Morley Arthur Chesworth	747 McMillan Ave. 1071 4th Ave., N.W.	Winnipeg Moose Jaw

* Officials appointed to act until the membership of the Section choose permanent SCMs by nomination and election.

Ready For Anything

Whether you are interested in Industrial Rectifiers from 1 volt to 250,000 volts and from 1 Ma. to 2500 Amps . . .

Or if you are interested in small transformers in our Ultra-Compact Ouncer or Sub-Ouncer types (our smallest units weigh only one-third ounce) . . .

Or if you require high power transformer equipment for a 500 Kw. transmitter . . .

Or an industrial application or a special Varitran or Voltage Regulator to suit a specific requirement . . .

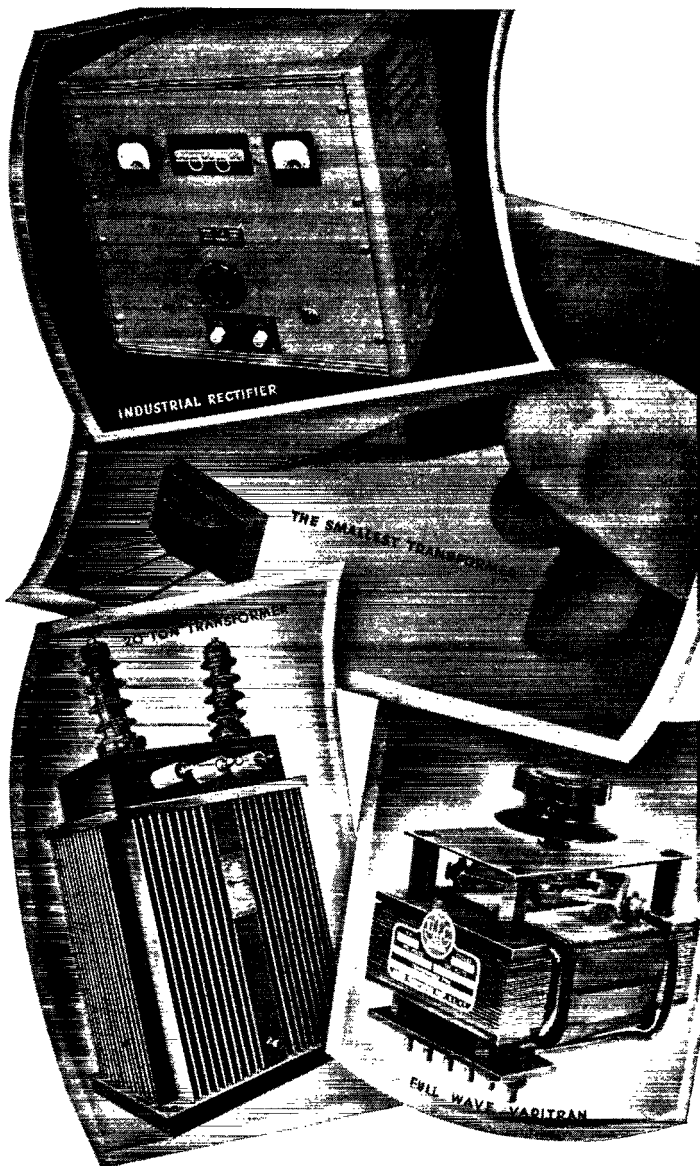

*Is the Choice of
Leaders of Industry*

MAY WE ASSIST YOU IN YOUR PROBLEM?

A note to our Engineering Division will bring a quick response with details on units to your requirements.

UNITED TRANSFORMER CO.

150 VARICK STREET ★ NEW YORK, N. Y.
EXPORT DIVISION: 100 VARICK STREET NEW YORK, N. Y. CABLES: "ARLAB"

THE AMERICAN RADIO RELAY LEAGUE

Directors

<i>President</i>	
GEORGE W. BAILEY	W1KH 74 Webster Road, Weston, Mass.
<i>Vice-President</i>	
CHARLES E. BLALACK	W6GG Box 55, Yuma, Ariz.
<i>Canadian General Manager</i>	
ALEX REID	VE2BE 240 Logan Ave., St. Lambert, P. Q.
<i>Atlantic Division</i>	
WALTER BRADLEY MARTIN	W3QV c/o Naval Air Station, Lakehurst, N. J.
<i>Central Division</i>	
GOODWIN L. DOSLAND	W9TSN 10 No. Clark St., Chicago
<i>Dakota Division</i>	
TOM E. DAVIS	W9VVA 915 W. Becker Ave., Willmar, Minn.
<i>Delta Division</i>	
E. RAY ARLEDGE	W5SI P.O. Box 286, Pine Bluff, Ark.
<i>Hudson Division</i>	
ROBERT AKERIDGE KIRKMAN	W2DSY 250 Albert Place, Elberon, N. J.
<i>Midwest Division</i>	
FLOYD E. NORWINE, JR.	W9EFC 7405 Hiawatha Ave., Richmond Heights, Mo.
<i>New England Division</i>	
PERCY C. NOBLE	W1BVR 37 Broad St., Westfield, Mass.
<i>Northwestern Division</i>	
KARL W. WEINGARTEN	W7BG 3219 N. 24th St., Tacoma, Wash.
<i>Pacific Division</i>	
J. L. McCARGAR	W6EY 66 Hamilton Pl., Oakland, Calif.
<i>Roanoke Division</i>	
H. L. CAVENESS	W4DW 2807 Vanderbilt Ave., Raleigh, N. C.
<i>Rocky Mountain Division</i>	
C. RAYMOND STEDMAN	W9CAA 925 So. Gaylord St., Denver
<i>Southeastern Division</i>	
WILLIAM C. SHELTON	W4ASR Box 652, Daytona Beach, Fla.
<i>Southwestern Division</i>	
JOHN E. BICKEL	W6BKY 801 E. California St., Whittier, Calif.
<i>West Gulf Division (Acting)</i>	
WAYLAND M. GROVES	W5NW Route 1, Overton, Texas

THE AMERICAN RADIO RELAY LEAGUE, INC., is a non-commercial association of radio amateurs, bonded for the promotion of interest in amateur radio communication and experimentation, for the relaying of messages by radio, for the advancement of the radio art and of the public welfare, for the representation of the radio amateur in legislative matters, and for the maintenance of fraternalism and a high standard of conduct.

It is an incorporated association without capital stock, chartered under the laws of Connecticut. Its affairs are governed by a Board of Directors, elected every two years by the general membership. The officers are elected or appointed by the Directors. The League is non-commercial and no one commercially engaged in the manufacture, sale or rental of radio apparatus is eligible to membership on its board.

"Of, by and for the amateur," it numbers within its ranks practically every worth-while amateur in the nation and has a history of glorious achievement as the standard-bearer in amateur affairs.

Inquiries regarding membership are solicited. A bona fide interest in amateur radio is the only essential qualification; ownership of a transmitting station and knowledge of the code are not prerequisite. Correspondence should be addressed to the Secretary.



Past Presidents

HIRAM PERCY MAXIM, W1AW, 1914-1936
EUGENE C. WOODRUFF, W8CMP, 1936-1940

Officers

<i>President</i>	GEORGE W. BAILEY, W1KH Weston, Mass.
<i>Vice-President</i>	CHARLES E. BLALACK, W6GG Yuma, Ariz.
<i>Secretary</i>	KENNETH B. WARNER, W1EH West Hartford, Connecticut
<i>Communications Manager</i>	F. EDWARD HANDY, W1BDI West Hartford, Connecticut
<i>Acting Treasurer</i>	DAVID H. HOUGHTON West Hartford, Connecticut
<i>General Counsel</i>	PAUL M. SEGAL 1026 Woodward Building, Washington, D. C.

Address all general correspondence to the administrative headquarters at West Hartford, Connecticut.

"IT SEEMS TO US—"



THE NEED TO GET TOGETHER

MAN is a social beast. He likes to foregather with his fellows, be it at lodge, church, Saturday evenings at the tavern, twice a month at the radio club — or on the air. We radio folks can't get these contacts on the air now and that state of affairs is leaving a gaping absence in our lives. The result is that the meetings of our radio clubs and the hamfests and conventions for which amateur radio is famous have come into increasing importance, because they are about the only way we can get together.

Occasionally we hear a chap say that the club ought to fold up for the duration, now that we're off the air. Or that we might as well forget the June hamfest, now that the gang isn't pounding brass and tickling mikes. We don't agree for a minute. People are busier than they ever were before and many of the old crowd are away from home, and probably attendance will be below normal, making caution necessary in plans that cost money. But the love of radio that made amateur radio continues to burn in the breasts of hams everywhere, and most of them ardently desire to rally around and chew the fat about circuits and new ideas with their similars. Now, more than ordinarily, because there is no other way of making QSO. We are therefore far from thinking that club meetings and hamfests should be washed out for the rest of the war. We urge the clubs to continue, and to realize that their rôle now is more important than ever. We also hope that hamfests or "conventionettes" can be held in much the same old manner, perhaps with less ambitious plans that reduce the chance of financial miscarriage but that nonetheless answer that yearning to meet with the old gang and chew the sock. Both club meetings and conventions have two valuable functions to-day. They provide a place for the maintenance of the deeply-rooted fraternalism of amateur radio. Their technical talks answer the craving for more radio knowledge and new things to think about. We all want to do these things. Why don't we?

The clubs have an additional reason for carrying on, and a most important one: As continuing organizations there is much that

they can do in their communities to help the war effort — code and theory classes, finding instructors and technicians for wartime jobs, locating needed apparatus amongst their memberships. Some of this will be a chance for patriotic service, but back of the hard work there will also be the simple human pleasure of being in each other's company and of talking with kindred souls of the things that lie warm in our hearts. Another idea for clubs: At Headquarters we get many a hamsheet and bulletin from far-away countries. They reek of the spirit of amateur radio. Most of the gang are away in service but those who are back home are grinding out the mimeographed news of where the fellows are and what they're doing, and sending it to *them*. While *QST* will do its level best in this direction, there's nothing like the old home-town flavor. It will be a breath of spring to your boys in far-off spots to get a bull. from the club sec. with the latest gossip of what the bunch is doing (within censorship rules, of course — hi!). So, if you've got a club paper, by all means keep it going, even if it has to be smaller. And if you haven't, how about starting one?

England's earlier and longer experience in this war has brought many examples useful to America. One thing the G hams have found is that there is more interest in club and group meetings than ever before, and they are flourishing over there. We see much the same thing in other British countries. There's a social side, with picnics and dances and ragchews, and there's the technical side, with shoptalk and discussions of gear and theory. It seems to us that we can do it over here, too, and that it's all very worth while doing! K. B. W.

YOUTH AND THE AIR

THAT America needs amateurs in the air as well as on the air is the theme of a new book by Commander E. F. McDonald, jr., called "Youth Must Fly," recently published by Harper & Brothers. The author is, of course, widely known as the president of the Zenith Radio Corporation, as a yachtsman and explorer and, more recently, through his advocacy of glider training for youth as essential to the creation of an air-minded nation.

It is his contention that, by encouraging flying as a hobby-sport (and by flying he means soaring, not "driving an engine with wings attached") aviation will benefit from its youthful participants as has radio. "Everything we have in radio to-day is due to the youths of the United States," says Commander McDonald. "All that the industry's engineers and extensive laboratories have done is refine the discoveries of amateurs. Moreover, most of our engineers are graduates from amateur ranks; and some of them still come down red-eyed in the morning after nights spent in their ham shacks."

This situation he contrasts with aviation. "There are probably twenty teen-age kids building and flying models for every one that burns his fingers soldering wire to condensers, but there are nearly as many licensed radio amateurs as there are licensed airplane pilots of all types, amateur and professional." The reason, he maintains, is because there are insuperable barriers between the grounding model-builder and a power-pilot's license — barriers of prohibitive cost, lack of facilities, restrictive regulations.

And so he proposes widespread training in gliding and soaring — under suitable controls, of course, just as amateur radio is regulated. But within the financial grasp of the average lad, with a quantity-production sailplane costing about as much as a good transmitter, adequate instruction facilities, and so on.

Naturally, we concur in Commander McDonald's belief. An encouraging aspect of this campaign to encourage amateur soaring is that increasing numbers of qualified people in aviation are coming to share these same views. It's a mighty fine thing to see this growing recognition of the "amateur radio principle" in other

scientific fields. Speaking on behalf of Exhibit No. 1 in Commander McDonald's impressive collection of evidence — the amateurs in radio — we subscribe wholeheartedly to the statement that "What youth has done for radio it can, and will, do for aviation if given half a chance. . . . If we get the masses of youth of the country into gliders they will teach aviation more in five years than aviation will learn in ten years without them."

But there are times when we wonder whether these facts are understood by some others who should understand them. The point that impresses us — and the reason we feel prompted to give editorial space to discussion of a book in a field quite apart from our own — is that in more than one place there can be detected these days a certain lack of appreciation of the very objects Commander McDonald bespeaks, not only in relation to aviation and other pursuits but even in connection with the precedent — the field of radio itself. If he and the numerous other adherents of expanded participation in aviation by youth are having tough sledding in obtaining governmental sympathy for their efforts, this may be due not so much to any special objection to their specific proposal as it is to an inherent tendency to discount the importance of private creative effort. Let us hope that Commander McDonald and his compatriots do not allow themselves to be defeated by those who can not or will not comprehend the inspiration implicit in the amateur spirit. Let us hope, too, that there will remain enough doers and practical men in government to recognize and utilize the vital national asset represented by the amateurs in aviation and other scientific-hobby fields — not forgetting amateur radio.

C. B. D.

★ SPLATTER ★

For the benefit of those who are building the all-wave converter described beginning on page 9 of the April issue, Don Mix has prepared the following table of oscillator-circuit values:

APPROXIMATE OSCILLATOR-CIRCUIT VALUES

Coils	Signal Range (kc.)	Parallel Cap. $\mu\text{fd.}$	Series Cap. $\mu\text{fd.}$	Inductance $\mu\text{hy.}$
A	10,000-17,000	50	228	1.4
B	4000-12,000	50	555	2.6
C	1500-4500	50	190	12
D	1560-520	170	300	12
E	550-185	315	190	12
F	200-67	440	72	12

Several of the gang have inquired about the new kind of "close-spaced" array shown as Fig. 5 on page 16 of the February, 1942, issue. Actually, of course, the dimensions R-A, A-D and D-D of the "knock-down beam" are in feet rather than inches.

OUR COVER

This month's cover shot combines business with pleasure. Not only are YL operators needed, but it's a darn good idea!

Unable to locate a southpaw harness to fit QST's left-handed cover, we were forced to use a professional model — so there's no need to go thumbing through the Call Book, OMs. Anyway, the wedding ring is quite authentic, and it wouldn't do a bit of good!

U.S.A. Calls and the YLs Answer

Women to Play Important Radio Role in War; Training Classes Being Established Throughout Nation

BY CLINTON B. DE SOTO,* WICBD

THE April issue of *QST* emphasized editorially the importance of women's auxiliaries in future war work. "We're probably ahead of our time in proposing this, but it seems to us the gals may profitably begin to think about it and start boning up," we said. That prophecy is already well along on the road to becoming fact. From a number of official sources — including the Congress — has come the opinion that many of the tasks carried on behind the line of battle can be done as effectively by women, making more men available for active combat.

There's nothing surprising in that, of course. Traditionally, when men go to war the womenfolk seize the plowhandles and the scythe and carry on the work at home. In this war, however, woman's role in the battle behind the battlelines is even more comprehensive than ever before. Along the production lines which supply the front lines, in the clerical and operating and supervisory jobs, in non-combatant military service — women are needed to fill many important posts.

As the armed forces expand and the United Nations become pressed for additional manpower, this need will expand. Should the winning of the war require the building of an American fighting force of upwards of ten million men, as there is good reason to believe it will, there is no question but that the assumption by women of many additional tasks, both civilian and military, now carried out by men will be necessary. And that is why, in the vast training programs in all branches of vital military endeavor, the need for equipping women with specialized skills is being emphasized now as never before.

In the radio field the opportunities for service by women are exceptionally great. So much radio work, from production to operating, is the kind that can be done skillfully by girl workers. Thousands are to be found even now right in the heart of the production front — assembling, soldering, inspecting, adjusting — and thousands more are needed. These girls wind the coils, rivet the subassemblies, assemble the frail filaments and fragile grids, lay out the wiring harnesses and solder the connections in the radio equipment used by the fighting men. Their work falls into more than a score of classifications. One out of every five production workers in the radio indus-

try is now a woman, and the ratio is steadily growing.

Production work is, of course, highly specialized and the training for it usually is obtained right in the factory, which takes a green employee, gives her aptitude tests to determine where her abilities lie, and then trains her to do a specific production job.

Operators and Technicians Needed

This specialized work by skilled laborers, while an important need in itself, is not new. What is new is the requirement for competent radio operators and technicians — women equipped with a broad training to do the jobs now handled almost exclusively by men, thoroughly-trained technicians with a comprehensive knowledge of radio theory and technique, qualified operators who can hold down a c.w. circuit along with the veterans, specialized clerical workers with an understanding of radio and electricity to perform the unique tasks arising from the amazing developments of modern warfare.

There's no doubt that women can do these jobs efficiently. We've evidence enough of that now — our own YL amateurs teaching radio to men, holding down important posts in the War Department, doing dozens of other specialized jobs. Over in England the WAAF's and WREN's work with radiolocators just as they serve as aircraft mechanics and armorers. Yes, they can do it — provided they have the training and experience.

And that's the job ahead — that of providing



Girls' radio class at Smith College. Dr. Yardley Beers, W3AWH, instructor, at right. Lab periods cover soldering, drilling holes in metal, construction of simple receivers.

*Assistant Editor, *QST*.



Guest speakers at "graduation" of 17 new YLs from AWVS radio classes in New York. Left to Right: Major W. H. Moody, Second Corps Area, representing the Signal Corps; Lieut.-Comdr. Walter Freeman, Third Naval District; Mrs. Sara Sparks of Western Union; Dr. Edna Farrel Haskins of England; and Lenore Kingston Conn, W2NAZ, chairman of AWVS radio code classes.

this training. Fortunately it's a job that has already been begun, with enough experience accumulated to make the bigger job ahead an easier one. There are some radio training courses for women now; in fact, there are a variety of them, corresponding to the wide range of tasks the vast potential army of girl war workers can perform. What is needed now is to establish a dozen such courses where one existed before — and even ahead of that to train the instructors for these courses.

It's a job for our corps of YL amateurs if ever there was one. You two-thousand-odd licensed girl operators constitute the bulk of America's radiowise feminine population. Here is a magnificent opportunity for you to do your part of the biggest job America has ever faced — to take your places in the technical classrooms and the laboratories, on the firing line of science, where this war ultimately may be lost or won.

The First Step

The purpose of this article is to take the first step — to tell of the work that has been done so far. To see what's being done, let's take a look around at a representative selection from the groups and classes now functioning.

Undoubtedly the biggest current activity in this field is that of the American Women's Volunteer Service. AWVS classes have been organized in a number of major cities, and the extent of their activities is growing constantly.

Probably the best and certainly the largest example of AWVS work is to be found in the greater New York Area. Over 27 classes have been formed in that region since the work was begun in April, 1941. Nearly a thousand students are now enrolled, with as many again waiting for new classes to start. Lenore Kingston Conn, W2NAZ, is chairman of code instruction, while Virgiline

Heffernan, W2OJT, takes care of theory. Other YLs engaged in instruction in these classes include W2NSL, W2NRC, W2NFR and W2MYV.

The standard of graduation in these classes is passing of the Class-B amateur license exam. Most classes meet three times weekly, and all work is voluntary.

The first New York AWVS class was officially "graduated" the evening of February 27th, when seventeen women were formally presented with their Class-B amateur tickets. This was the first group to complete their training to the point of actually going down to the Federal Building to take their examination, and the occasion was celebrated with impressive exercises at the New York Times Hall, where Kathleen McLaughlin, women's editor of the *Times*, acted as hostess. W2NAZ was the presiding chairman and introduced the guest speakers, including Major W. H. Moody of the Second Corps Area Signal Office, Lieut.-Commander Walter C. Freeman of the Communications Division of the Third Naval District, Sara Sparks, personal service director of Western Union, Dr. Edna Farrel Haskins of the English Administrative Office, and Ed Baunach, W2AZV, SCM for New York and Long Island, representing ARRL.

AWVS Ceremonies Broadcast

During the ceremonies, which were broadcast over WMCA, Commander Freeman told the audience of several hundred persons that he did not know "why women shouldn't be as well fitted as men to be radio operators." In fact, he added, "their reflexes are probably more sensitive than men's, and they should be better."

Major Moody told of the importance of amateur contributions in the field of radio. In the Second Corps Area, he said, 400 women had already replaced men, and there were still more opportunities for women to share in the work of the Signal Corps. He told also of the work of Viola Grossman, W2JZX, both in the civilian sphere and in training soldiers at Fort Dix to be radio operators.

Both Commander Freeman and Major Moody stressed the value of teleprinting ability and suggested that instruction in this field be included in all women's radio training courses.

Mrs. Sparks, who was in charge of the Western Union Telegraph School which trained wire operators for the Signal Corps during the last war, congratulated the YL graduates on their accomplishments and said she hoped it would not be long before they were called into service by their country. Dr. Haskins spoke of her experiences in England and told of the fine communications work being done there by women. She declared that over a million English women were in the service of their country in an active capacity, and that quite a few of them were aiding in radio and telegraph work.

The whole occasion was one to inspire not only the "graduates" but also the instructors. "The events of the evening gave one the impression that there is hope, after all, that women will have an opportunity to help out as radio operators," said Mrs. Conn. "I tried to get over the point that the discipline of their radio training has made them efficient and accurate workers — and surely that should qualify them for communications work."

Many of those who qualify in the AWVS classes, as well as an increasing number of previously-licensed YLs, are going on to take additional training in order to qualify as instructors. Thus not only is their training put to immediate service, but the circle of trained operators and technicians grows constantly larger.

Problem of Recognition

The question of getting recognition for their work and finding posts for their graduates has been of grave concern to the sponsors of these classes — as indeed it has been also to those in many other types of civilian activity and training in this war. The urgent need they so grimly foresee is not yet apparent to many of those in authority. Yet they persevere, knowing that sooner or later their country will call.

When the going gets especially tough they contemplate the example of one of their sisterhood who has made the grade — Mildred ("Mickey") Marglin, ex-W9ZTU, who became the Army's first woman radio operator January 26, 1941. She won recognition handling traffic over ham nets for the cavalry at Fort Knox during maneuvers, was offered a job at the Army's WTY, and thus became the first girl ever allowed to sign herself "Radio Operator, U. S. Army." Now in her second year in the service, she has received offers from various other branches with enticing promises of promotion, but prefers to remain at her present post as senior Civil Service operator at the Post Signal Office, Fort Knox.

And it is from there, from the depths of her own experience, that she sends the following words to her aspiring sisters: "From experience, I know it will be a very tough grind for the weaker(?) sex. It is no bed of roses. No favors are asked and you are not treated as anything but one of the fellows. Success and luck to you."

It is truly no bed of roses for women in radio — and least of all for teachers and students in the women's radio training courses. Not only is there a lot of hard work and study and a total absence of glamor in the business of learning radio code and theory, but there is the added problem of stimulating continued interest in these training activities in the face both of official dilatoriness in setting up civilian defense communications systems.

Yet they carry on. The radio classes of the Massachusetts Women's Defense Corps, sponsored by the Massachusetts Committee on Public Safety, are a case in point. This Corps has conducted two night classes and one day class for some months past, and recently has started one more day class. In addition, it is planned to recall all of the active personnel for refresher courses.

The training course, which is in charge of Emily Saltonstall, daughter of Massachusetts' governor, includes instruction in chemical warfare, ARP, first aid, code and theory. Students in the first graduating class of about twenty girls assembled a transmitter for the 40-meter band which proved "most successful."

"Our original purpose was to send the students out with our mobile units so that we could keep in contact with their progress," says Miss Saltonstall. "But," she continues, "we have not been able to do this, of late, because of the Defense Communications Board. Our activities have been considerably curtailed due to this order so that many of the girls have been teaching other subjects, such as first aid or chemical warfare, while waiting for a decision from the DCB as to our future set-up."

YLRL Active

As would be expected, the YLRL is highly active in the field of training women by radio. A number of members of this organization have either started local classes, enrolled as AWVS instructors or are teaching in the Army. Nothing like a complete list of the YL participants in this work is available, but the following are typical instances from the March issue of *YL Harmonics*:

Ruth Mask, W9WCW, is teaching code to coeds as part of an Army-sponsored program at the University of Wisconsin. Bea Austin, W7HHH, has a class of twenty civilian students. Helen Davy, W4GFO, teaches two classes of potential selectees. Elizabeth Zandoninni, W3CDQ — who was a uniformed radio instructor in World War I



First graduates of AWVS radio classes receiving certificates and being congratulated on passing Class-B amateur exam., Feb. 27th, New York Times Hall, New York City.

and a second lieutenant in the Signal Corps — is back in harness teaching code classes in Washington. Frances McGivney, W1MDW, has three young boys of her own but finds time for code classes for local boys and girls in connection with her defense work.

And so it goes — dozens of our YL amateurs teaching, hundreds of others acquiring further training, taking commercial exams, preparing themselves for future need.

Apart from the special training courses being organized by and on behalf of women, many are found attending the general courses being organized in the radio field. A check of typical ESMDT training classes shows a feminine enrollment averaging between 10 and 20%, for example. The commercial training schools, too, now find the number of women in their classes to be rising. In fact, not a few of the graduates of the "primer" classes go on to the technical schools and colleges for advanced training. A great many AWWV students in the greater New York area have done just that, according to W2NAZ.

There is another phase of this training program that deserves comment, as well. It is that provided by the girls' schools and colleges of the country, as a part of their regular curricular activity. Illustrative of these courses is that conducted by the Department of Physics at Smith College, Northampton, Mass., headed by Dr. Yardley Beers, W3AWH.

Smith is, of course, one of the leading girls' schools of the country, and it was in the forefront in establishing radio training.

Courses of two different types are being conducted at Smith at present. One course does not count for college credit and is designed not to qualify the student for anything in particular but rather to stimulate interest in the general subject of radio. "This course was conceived last fall when we did not have a very clear idea of what the government needed, but we thought that we could make a contribution to defense by stimulating interest in radio," says Dr. Beers. The course was designed so that those who completed it could pass the amateur license examinations without much extra study.

The non-credit course meets for two and one half hours one evening a week. The first fifteen or

(Continued on page 88)

In line with the call for augmented radio training programs, Jean Hudson, W3BAK, makes a plea in the adjoining column for adoption of radio training at an even earlier stage — in boys' and girls' summer camps. Particularly timely now with the opening of such camps but a few weeks off, her advice is worth heeding by those in a position to do something about it.

Teaching Radio In Summer Camps

BY JEAN HUDSON,* W3BAK

ABOUT forty years ago Marconi made some experiments which developed into what we know to-day as radio and, more particularly, ham radio. From the time of spark-gaps and the sprawling transmitters of the earliest hams to the very latest of all-but-commercial rigs, this entrancing hobby has captured the minds and imaginations of countless enthusiasts.

While radio was in the very early stages of its development a new idea in the way of entertainment and amusement was introduced and gradually gained popularity among the youth of the country. To-day summer camps are numbered by the hundreds and campers aggregate thousands of



Jean Hudson, W3BAK, has been a licensed amateur since she was 8. At the age of 9 she won the world's code speed championship (Class E) at the ARRL convention at A Century of Progress in Chicago in 1933.

boys and girls from Maine to California. It was inevitable that two such great hobbies should be combined, though strangely enough the collaboration was not brought about, at least officially, until a very few years ago.

In girls' camps, understandably enough, radio was slower to make its appearance. This is due to the fact that, though not essentially so, ham radio has always seemed more of a man's hobby. In fact (though I make this statement with some trepidation) I believe that our station at a girls' camp in New Hampshire was probably the first, and no doubt still is the only, official camp installation in the country. If I am correct in this statement, I feel that it is unfortunate because, whether for boys or girls, it's hard to conceive a better hobby to combine with the outdoor activities of camp life.

There was some doubt at first in the mind of the directress concerning the possible advantages of a station, especially as ours was a girls' camp. The expense of the equipment was one consideration

(Continued on page 88)

*660 Riverside Drive, New York City.

A Simple Light-Beam Communication System

Transmitting Voice with a Flashlight

BY JAMES B. STEVENS,* W6PCB, AND
ELEANOR C. STEVENS,* W6TOY

If you have a speech amplifier and can buy, borrow or beg a phototube, light-beam communication is well within your grasp. Here's a simple and practical system that any ham can put into operation with a minimum of expense and trouble.

THE following method of light-beam communication has been found to be entirely satisfactory for short range work. With the simple equipment described here, consisting of a modulated flashlight-lamp transmitter, phototube pickup and an audio amplifier, a distance of well over $\frac{1}{4}$ mile has been bridged. At this distance the spot of light, in spite of the so-called focusing flashlight used, was over 20 feet in diameter. If a parabolic reflector of sufficient size were used to reduce the size of this spot to a few feet, distances of several miles would be entirely possible.

As shown in the drawing, Fig. 1, the audio amplifier is identical to most speech amplifiers used in amateur or public address work except that there are two input channels, one excited by a gas phototube and the other by a crystal microphone. A transformerless carbon microphone input circuit is shown in Fig. 2. The output with this latter method is slightly greater than with

* Formerly Tucson, Ariz.; present address 1551 Pennock Road, Pittsburgh, Pa.

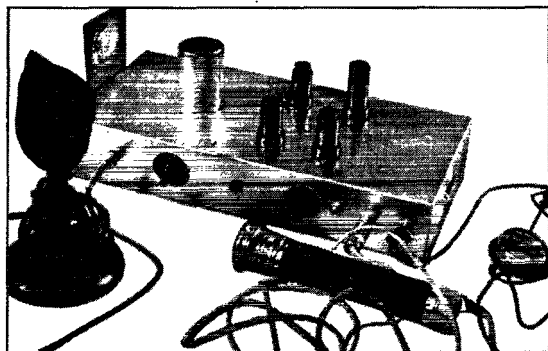

The complete communication system. The audio amplifier is arranged for either microphone or phototube input. The reading glass at the left end of the chassis is mounted so that the incoming modulated beam is focused on the sensitive surface of the phototube through a half-inch hole in the shield can. The flashlight provides the light-beam, which is modulated by the output of the amplifier.

the crystal microphone but is not as great as with the conventional transformer-coupled circuit.

The "beam head" is an ordinary three-cell focusing flashlight. A fiber disc of the same diameter as the flashlight cell is used to insulate the spring contact in the screw cap from the battery. A small hole is punched in the center of this disc and a wire is pulled through. A drop of solder is sweated to it for a contact. A hole is also drilled in the screw cap to bring this connection to the outside. The other side of the circuit is soldered directly to the screw cap. A close-up view of the cap and insulating disc is given in one of the photographs.

In this method of light-beam transmission the beam head is connected to the voice-coil winding of the output transformer of an audio amplifier having a few watts output. The audio current from the transformer is impressed upon the direct current used to light the flashlight bulb, in the same way that the d.c. input to a Class-C r.f. stage is modulated. Care should be taken not to turn the audio gain up too high or the light will be burned out.

We are not sure just exactly what takes place when the light beam is modulated. At first we thought the increase and decrease in brilliance of the light caused audio voltage in the phototube circuit, but we can't see how the temperature of the filament can change thousands of times a second. (The frequency range is approximately 50 to 5000 or 6000 c.p.s.) We have come to the conclusion that the a.c. passing through the hot filament causes it to vibrate at audio frequency and in turn modulate the light beam. An ordinary flashlight pointed at the photo-tube and tapped with a pencil or other solid object will give a bell-like tone at the receiving end, proving that mechanical vibration will produce sound.¹

Most any auto-radio set having a separate speaker can be used for transmitting, when portable work is to be done. The speaker cable usually will consist of a common

¹ This effect is a difficult one to explain, considering the fact that the intensity of the light at the phototube must vary if an alternating current is to be set up in the tube's output circuit. If filament vibration is the cause, it should be possible to modulate the beam by placing the lamp in a varying magnetic field. This experiment was tried at W1ANA and gave entirely negative results. — Editor.

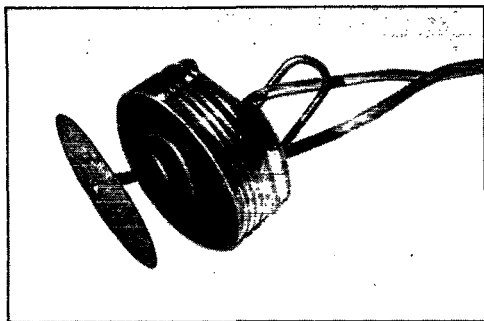

A close-up of the insulating disc inserted in the end of the flashlight so that audio power can be introduced in series with the d.c. for modulation.

ground lead, a 6-volt d.c. hot lead and the voice-coil lead. If a small 6-volt bulb is connected between the 6-volt lead and the voice-coil lead, the filament can be modulated and used to test the beam receiver at a distance. The beam head can also be connected from the voice-coil lead to ground.

The light-beam receiver (which also has several other uses, as will be described later) is shown in the photographs. Circuits and design need not be discussed, since most amateurs have their own ideas on tube line-up and placement of parts. Care should be taken to shield the phototube and microphone circuit completely; an interstage shield and chassis bottom plate are highly recommended. We have also found that it is advisable to have the power supply on a separate chassis. The inside of the phototube shield should be painted flat black and the opening through which the light is introduced should be covered when not in use, to keep strong light out. For use over

distances of several hundred feet or less one 6C5 stage in the amplifier may be omitted. We used an RCA 923 tube, but any gas phototube can be substituted if the manufacturer's specifications are followed. Your local movie house can be a source of supply of used tubes.

When the audio unit is completed and working, turning on a 110-volt a.c. lamp and allowing some of the light to strike the phototube should give a 60-cycle note in the speaker or 'phones, when S_1 is in position "R." With a microphone in J_1 and with S_1 in position "S," the unit can be used as a p.a. system. A speaker (p.m.) with a 6-ohm voice coil is plugged in J_2 . Monitoring phones are used in J_4 . The beam head is connected in through J_3 when the unit is being used to transmit or relay. The speaker is disconnected when the beam head is in J_3 . One section of S_1 removes the voltage from the phototube and discharges C_1 when in position "S."

To receive a modulated beam, S_1 is in position "R," with a speaker in J_2 or headphones in J_4 . To transmit over a beam of light S_1 is in position "S" and the beam head is in J_3 . This disconnects the speaker from the output circuit, but 'phones can be used for monitoring. With S_1 in position "S" and the beam head in J_3 the unit can be used to relay a signal being received, again with the 'phones used for monitoring. For public address work, S_1 is in the "S" position, the microphone in J_1 , the speaker in J_2 and the beam head removed from J_3 . As a listening device, the speaker and beam head are removed and the 'phones used (a speaker can be used if the microphone is far enough away to prevent feedback). Airplanes can be heard several minutes before the ear can detect them. In our experiments using

(Continued on page 98)

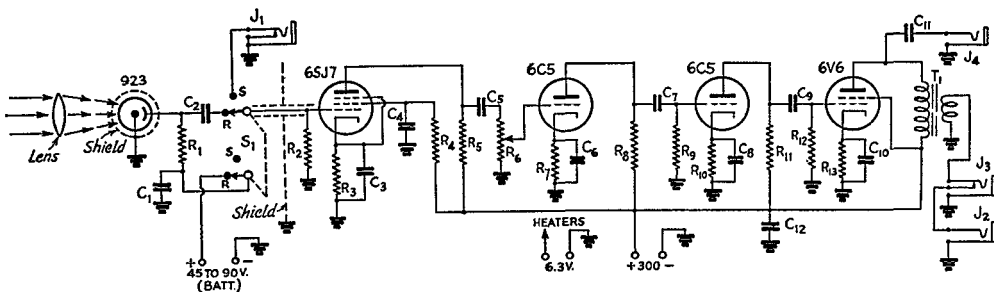

Fig. 1 — Modulator-amplifier circuit for light-beam communication.

- C_1 — 2- μ fd. paper.
- C_2, C_9 — 0.01- μ fd. paper.
- C_3, C_6, C_8 — 5- μ fd. electrolytic, 25 volts.
- C_4 — 0.1- μ fd. paper.
- C_5 — 0.002 μ fd.
- C_7 — 0.008 μ fd.
- C_{10} — 50- μ fd. electrolytic, 50 volts.
- C_{11} — 0.005- μ fd. mica.
- C_{12} — 8- μ fd. electrolytic, 450 volts.
- R_1 — 3 megohms, $\frac{1}{2}$ watt.
- R_2 — 2 megohms, $\frac{1}{2}$ watt.
- R_3, R_7, R_{10} — 2000 ohms, $\frac{1}{2}$ watt.

- R_4 — 2.5 megohms, $\frac{1}{2}$ watt.
- R_5, R_6, R_{12} — 0.5 megohm, $\frac{1}{2}$ watt.
- R_8 — 0.25 megohm, $\frac{1}{2}$ watt.
- R_9, R_{11} — 0.1 megohm, $\frac{1}{2}$ watt.
- R_{13} — 600 ohms, 1 watt.
- S_1 — D.p.d.t. rotary switch.
- J_1, J_3 — Closed-circuit jack.
- J_2, J_4 — Open-circuit jack.
- T_1 — Output transformer, 6V6 to 6-ohm voice coil.

Lens — 3- to 4-inch reading glass.
Shield on 923 is a National type J30 with $\frac{1}{2}$ -inch hole for admitting light to phototube.

Yhpargotpyrc Ni Detseretni?

Solution of an Elementary Type of Cipher

BY JOHN HUNTOON,* WILVQ

Amateur interest in the science of cryptanalysis has formerly been limited principally to correspondence training courses of the AARS and NCR. Now that our ragchewing and DXing and traffic-handling activities have been shelved for the duration and we are devoting more time to non-operating aspects, there may be more widespread interest in the fascinating science of secret communication. The purpose of this article is to describe briefly a simple application of elementary cryptanalysis, and to solicit your expression as to whether or not you would be interested in a series of articles dealing with the subject in detail. If you would, drop the Editor a note.

IN THE field of secret communication there are many schemes such as secret inks and masked letters, but in the case of material to be transmitted by radio there are but two general systems: code and cipher. A code system, wherein a phrase or entire sentence of plain English text is represented by a single word, is far too complex of analysis for amateurs to consider as a field of study. The second system, cipher, consists of a mechanical substitution for, or rearrangement of, letters of the plain English text. Because the cipher systems follow orderly, mechanical rules for the most part, a person with some knowledge of the makeup of the English language and alphabet is capable of analysis and solution of the simpler cryptograms in this class.

There are two basic kinds of cipher. The first is transposition, wherein the letters of a plain text message are rearranged by some orderly method to make a new text, apparently unintelligible. For a simple example, the word "the" might be written as "eht," or "hte." (The title of this article is a simple transposition cryptogram of this type.) The second kind is substitution, wherein the letters of a plain English alphabet are replaced with substitute symbols which may be letters, numbers or other signs. If we decided to make the first three letters of our cipher alphabet **GQN**, for example, replacing the usual **abc**, we would then write the word "cab" as "NGQ." In complex substitution ciphers, a plain text letter may be represented by a great number of different cipher letters according to a prearranged key.

Here's an example of a simple cryptogram, with the text divided into letter groups of five for convenience in transmission just as we might receive it over the air:

**GSVZN VIRXX MIZWR LIVOZ BOVZT
FVRHG SVMZG RLMZO ZHHLX RZGRL**

* Assistant Secretary, ARRL.

**MLUZN ZGVFI IZWRL LKVIZ GLIHR
MGSVF MRGVW HGZGV HLUZN VIRXX**

We want to find out what its plain text says — and that's not very hard to do, in this case. Here's how:

We know that the English language is so constructed that in any large amount of text each letter will appear, on the average, a certain number of times. E, for example, is the most frequent, appearing an average of 13 times in every 100 letters. The order of frequency of appearance is approximately **e t a o n i r s l h d u c m p f w y b g v k q j x z**. The occurrences of vowels **aeiou** constitute about 40% of the total, the consonants **lnrst** about 30%, a total of approximately 70%, while the low-frequency group **jkqzz** accounts for about 2%. By counting the letters in our cryptogram and comparing that count with the standard frequency tables, we can learn a good deal about our message; so we make a tabulation as shown below. There happens to be a total of 100 letters, which will make our later calculations simple.

A		J		S	III
B	I	K	I	T	I
C		L	### IIII	U	II
D		M	### I	V	### ### II
E		N	III	W	III
F	III	O	III	X	III
G	### ###	P		Y	
H	### I	Q		Z	### ### ### I
I	### III	R	### ###		

Now, if our message is a transposition consisting simply of a rearrangement of letters, all the letters will retain their normal frequency and group counts will be normal. Totalling the **aeiou** group, however, we find it constitutes only 13% of the text; **lnrst**, 26%; **jkqzz**, 20%. With such wide



divergences from the normal, evidently other letters have been substituted for the plain text letters. If this is true, whichever letters were chosen to represent **aeiou**, **lnrst** and **jkqzx** should total about the same as the standard counts. So we total the ten highest and five lowest frequency letters in our cryptogram, as approximate equivalents of these test groups, and find as follows:

ZVRGL, 57%; **IHMFN**, 26%; **ACDEJ**, 0%

(We might have used **O**, **S**, **W** or **X** in place of **F**, **N**, since each has the same appearance frequency; similarly in the low-frequency group, which includes letters not appearing at all, we might have used **P**, **Q** or **Y**.)

While the first group is quite high, in a short text we may expect to find such variations in count. A better check is to compare the appearances of the first *ten* frequent letters of cipher text to the normal (70%) for plain text, since we cannot always be certain that each group of five divides up correctly when we make our assumptions; even this is fairly high, but permissible in a text of this length. In this particular test, high-frequency groups may be higher than normal, low-frequency groups lower than normal — but not vice versa. The low-frequency group here shows nil, which is excellent particularly in a text as short as this. (If the tabulation of these groups had shown a more even distribution, or less difference between high- and low-frequency groups, we would have been confronted by a multialphabet cipher and would start looking for a “period” — which is quite another story.) We decide, then, that our cryptogram was prepared by “simple substitution,” and our task now is to determine which cipher letter represents which plain text letter. In the analysis below, to avoid confusion, we shall follow custom and use capitals for letters of the cipher text, lower case for letters of the plain English text.

We cannot always assume that the highest frequency letter of our cryptogram represents **e**, the next highest **t**, and so on, because variance is inevitable in different texts and particularly so in one this short. But we can apply some rules to determine pretty closely which represents which, and then finish solution by trial and experimentation. Of our cipher high-frequency group **ZVRGLIMH**, we wish to determine probable

letters. We know that in English text, letters appearing next to low- and medium-frequency letters are usually vowels. So we take the lower-frequency cipher letters **BKTUXFNOSW** and list them as they appear in the message together with the preceding and following letters in each case, thus:

ZBO	RXZ	VFI	BOV
LKV	LXR	ZNV	GSV
ZTF	TFV	VOZ	VWH
LUZ	VFH	ZOZ	ZWR

Counting the number of appearances of our high-frequency letters **ZVRGLIMH** as “contacts” of these low-frequency letters, we find:

Z-9 V-9 R-3 G-1 L-3 I-1 M-1 H-1

Z and **V** are shouting “vowel” to us, and probably **R** and **L** are likewise, while the letters **GMIH** behave like consonants. **ZVRL** probably represent our English high-frequency vowels **eoai**; **GMIH** probably represents the **tnrs** consonant group. But which? Our approach to solution can now make use of the fact that, just as some letters have much higher frequencies in English than others, so do two- and three-letter combinations called “digraphs” and “trigraphs.” Some of the most frequent are:

th on er re an he ar en at ti te in ha ou it es st or nt hi ea ve co de ra ro li ri io le nd ma the ing and tha ion ent for tio ere her ate ver ter ati

Because of its frequency in our cipher text, probably **Z** represents **e**. Then **ZN** and **ZG**, which we find repeated several times, would make excellent digraphs such as **er**, **et**, **es**, in English words. But wait: notice the digraph **VZ**, two letters we have determined are vowels. When two vowels in English come together, the combination is nearly always **ea**, **io**, or **ou**. The latter two are improbable since the appearances of **V** and **Z** are too frequent for **i**, **o**, or **u**, but the count reasonably jibes for **e** and **a**. Checking the digraph tables, we find good prospects for the **e** and **a** combinations on this basis, so we assume that **V** is **e**, and **Z** is **a**. Checking mutual contacts of other cipher letters we have assumed to be vowels, we find **RL**; it offers no encouragement as **ou**, since the occurrence of **L** is too high, but its

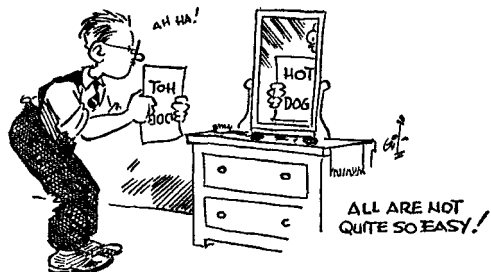

appearances are excellent to represent plain text *io*.

Now, making further use of our digraph and trigraph tables, let us attempt to assign English equivalents to as many other letters as we can. Some of them may be wrong, of course; by making definite assumptions only when reasonably logical our percentage error will be small, however. The word "the" does not often appear in telegraphic texts, but that frequent trigraph may be present in such combinations as "then," "there," "other." We have decided that plain text *t* is represented by one of the high-frequency consonants **GIMH**. Let us now try to locate a repeated cipher trigraph beginning with one of those letters, ending in cipher **V** (for *e*), and with a second letter of medium frequency (for *h*). We find **GSV** appearing three times; since the individual letter-frequency counts check, since we note appearances of cipher digraphs **ZG** for *at*, **RQ** for *it*, **GR** for *ti*, **GV** for *te*, and since we find **S** (*h*) often preceding **V** (*e*) but never following it, we may decide our assumption is correct.

It is well now to write the cipher text on a sheet of paper, leaving a space or two between each letter and triple spacing lines. As we go along we insert under each letter the assumed plain text equivalent, thus:

G S V Z N V I R X Z M I Z W R
t h e a e i a a i etc.

With this in view, we can often determine additional letters by logical guessing at probable words, confirming assumptions only when the frequency count reasonably bears them out, and thereby finish solution. As a matter of fact, our cryptogram is at that stage now. More difficult ones than it will require somewhat more analysis, a few suggestions for which follow:

Let us refer again to our digraph tables. We find repeated cipher digraphs **VI**, **VF**, which, since we have **V** = *e*, probably represent frequent plain text digraphs *en*, *er*, or *es*. We can be doubtful of *es* and *en* as possibilities since we find both cipher digraphs reversed as **IV** and **FV**, whereas plain text *ne* and *se* are not frequent occurrences. Since cipher **F** is quite low in frequency it cannot be plain text *r*, so **I** must represent *r*. To determine what letter represents *n*, we look for a possible cipher **V-T** for *ent* — without success. But we have **RL** representing *io*, and find the repeated cipher trigraph **RLM**; since the frequency count of cipher **M** approximates that of plain *n*, we can logically assume **M** is *n*, so **RLM** is *ion*. By filling in under the cipher text each plain text letter we have so far evaluated (nine in all), we can now easily guess words and complete the solution.

Constructing an alphabetic table of equivalents, we find that our cryptogram was prepared with an alphabet as follows:



A B C D E F G H I J K L M N O P Q R S T
y u t s r p o n m l i h g
U V W X Y Z
f e d c a

and we immediately notice the second (plain) line appears to be simply a reversed (reciprocal) alphabet, so we can complete the gaps. (Actually there is a quicker method of solution of this particular cipher, but we chose the one which more completely could demonstrate the simpler analytical procedures.)

This was, of course, an extremely simple cipher, as cryptograms go. With a little study of the mechanics of the English language and its peculiarities, however, we can become reasonably expert in solving more difficult ones. Of great importance is the following of a definite routine in analysis, preparing detailed charts and tables of the cryptogram's letters, making assumptions only when confirmed by reason — and most of all, having great patience. It's a satisfying pastime, and one that offers plenty of mental challenges.

Meanwhile, here are a few to try on your own hook. Remember first to determine the *type* of cipher — whether simply a rearrangement of the letters as in transposition, or a substitution for the letters, in which case letter frequency counts will not be the same as in English.

- (1) **ESNEC ILSRO TAREP OSSAL CDNOC**
ESENO HPELE TOIDA RROFN OITAN
IMAXE
- (2) **YUOTI DHRSA SMLAT IOEOW NFNTE**
ETSIP ESHSN
- (3) **QNPIQ NPLPV PHDHU DMBQI HQNPO**
LIHQJ ILANI VPLEI ICDHU BRPBT
QDOTF MAPHP DHQNP VBFFP YBGDF
PRHP BQNGY JFBAP IOLPM DSPHA
PMQIJ

Amateurs wishing a detailed elementary textbook on the solution of ciphers can secure "Elementary Cryptanalysis," by Helen Fouche Gaines, from the American Photographic Publishing Co., Boston, price \$3.50, postpaid. *The Cryptogram* (\$1.00 per year), official organ of the American Cryptogram Association, Burton, Ohio, is excellent material for the intermediate or advanced analyst.

A 112-Mc. Transmitter-Receiver Combination

Simple Gear Which is Readily Adaptable to Civilian Defense Communication

BY JAMES W. BRANNIN,* W6OVK

IN PLANNING and building the 112-Mc. transmitter and receiver to be described, three objectives were kept constantly in mind. The first — and most important — was to make a non-radiating receiver and at the same time one that was simple to build and adjust. The second was to use old parts and easily-obtainable standard tubes — components to be found in the junk box or in discarded rigs. The third was to build the unit so it would work with emergency power from vibrapacks or dynamotors and also with power supplies already built for lower-frequency rigs.

Transmitter and receiver are both built on the same chassis, as shown in the photographs. A modulator for the transmitting oscillator also is included. The chassis is $6\frac{1}{2}$ by $12\frac{1}{2}$ by 3 inches and the panel is $13\frac{1}{2}$ by 7 inches, both being made of No. 20 gauge galvanized iron. The baffle shields above and below the chassis are of No. 24 gauge galvanized iron, cut to fit and soldered in place; the necessary holes for wiring through the shields were cut before they were soldered to the chassis.

Receiver Circuit

The receiver is of the type described recently in *QST*.¹ It is a simple superhet using only four tubes: 1232 mixer, 6C5 high-frequency oscillator

* Southern Pacific Telegraph Office, Tucson, Ariz.

¹ Brannin, "An Experimental 112-Mc. Receiver," *QST* December, 1941.

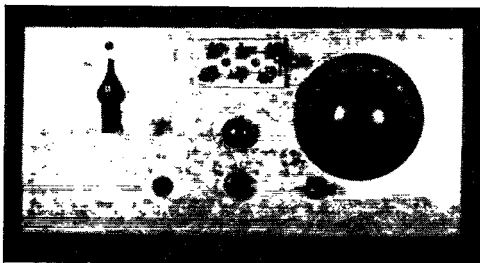

A panel view of the combination transmitter and receiver for 112 Mc. The large dial on the right is the receiver-oscillator tuning control. The send-receive switch is below this dial. The d.p.d.t. knife switch is for antenna changeover; just below it is the mixer tuning control and below the latter is the second detector regeneration control. The large pointer knob at the left is the transmitting oscillator tuning control. The jack is for the carbon microphone.

6J5 superregenerative second detector operating on 20 Mc., and a 6C5G audio amplifier. The sensitivity and selectivity with this type of receiver are better than can be secured with the average 112-Mc. superregen receiver, and radiation is eliminated. No great amount of experience is necessary for aligning it properly, and no special test equipment is required.

The circuit diagram of the receiver is shown in the upper part of Fig. 1. The mixer input circuit is inductance-tuned by means of a "gadget" consisting of a copper plug cemented to a thin piece of celluloid 3 inches long and $\frac{1}{2}$ inch wide. The celluloid strip is fastened to a small angle bracket to the right of the 1232 mixer coil, and is brought up at an angle so that the copper plug will go into the grounded end of the mixer coil without touching it. The plug is a $\frac{3}{8}$ -inch piece of $\frac{3}{16}$ -inch copper tubing. A piece of small fishline is brought from the upper end of the celluloid strip to the panel and then through an "eye" and over to the tuning control. The eye is a piece of No. 18 copper wire soldered to the panel and then bent into a small ring so that the string will slide through it freely. The control for this gadget is made as shown in Fig. 2.

In lining up the mixer circuit, care should be used to see that the copper lug is not too far inside the mixer tank coil. The padder, C_1 , should be adjusted so that the circuit is resonant at 116 Mc. with the copper lug just barely inside the end of the coil. The circuit will resonate at 112 Mc. with the lug about $\frac{1}{4}$ inch away from the coil if this procedure is followed. If the lug is used too far inside the coil the losses in the circuit will increase. This method of tuning was used in preference to a variable condenser as a means of securing a better L/C ratio; in this case it was possible to put $1\frac{1}{2}$ more turns on the coil than could be used with condenser tuning.

Injection of the 6C5 oscillator voltage into the 1232 mixer circuit is secured by bringing one piece of No. 22 insulated hookup wire from the grid end of the mixer coil and another piece from the center of the oscillator tank coil, then twisting the two together for a distance of 1 inch to form a small capacity. The oscillator coil, L_2 , should be pruned, if necessary, so that it operates at the proper frequency with the padder, C_8 , at half or a little more than half capacity, to give fairly high C in this circuit and thus stabilize the oscillator.

Grounds in the mixer and oscillator circuits

should be made to one point on the chassis in each stage. If it is necessary to separate these ground connections more than a half inch or so it would be advisable to run a heavy copper wire between the two ground points.

Two wires were used for the filament circuit throughout the receiver, even though one side of the filament circuit is grounded in the transmitter section. This was done to keep the filament circuit balanced and to minimize ripple in the h.f. oscillator circuit.

The i.f. transformer is of the "open air" type, the coils being wound on $\frac{3}{4}$ -inch bakelite forms $\frac{3}{4}$ inch long and mounted on small angle brackets so that the coupling between them can be adjusted for maximum input to the second detector. The windings should be connected so that the plate end of the detector coil is nearest the "cold" or "B" supply end of the mixer plate coil. The superregen detector and audio circuits are both conventional and may be altered to suit other types of tubes. Some experimenting with different grid leak values in the detector circuit and with different values of by-pass condenser C_{18} may be advantageous in securing good superregen action in this circuit.

The antenna coil is air wound with two turns of No. 16 enameled wire. Its diameter is slightly larger than that of L_1 so that it will fit over the grounded end of L_1 with about $\frac{1}{8}$ -inch clearance. The No. 12 wire from the antenna change-over switch on the front panel is supported by a thin piece of celluloid at a point just above L_1 where the antenna coil is soldered on.

The send-receive power switch, S_1 , can be any type of double-pole double-throw switch that will handle 300 volts. The one used in this rig was taken from an old h.c.l. receiver. The voltage divider, R_{10} , is used to drop the supply voltage to 150 for the receiver section. Other resistances might be used, so long as they have sufficient power rating and are not over 30,000 or 40,000

This outfit, built last fall, had a good tryout before the close-down, gave excellent performance. Low cost and simplicity of construction were primary objectives in building it. The construction arrangement readily can be varied to suit special needs for portable operation in 112-Mc. civilian defense nets.

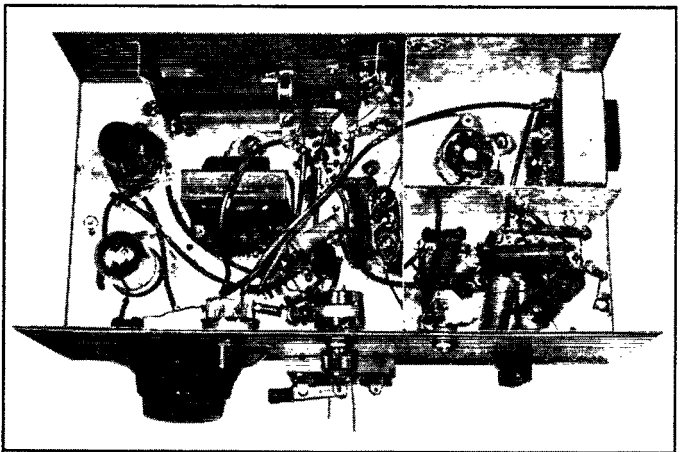

The various sections of the unit are boxed off by baffle shields as shown in this bottom view. The modulation choke is in the upper right-hand compartment. Other components are readily identifiable.

ohms. Lower-resistance dividers give better regulation for the receiver voltage. The full 150 volts is applied directly to the plate of the high-frequency oscillator. This minimizes pulling by the mixer circuit, since this comparatively high voltage gives plenty of output so that loose coupling can be used between the oscillator and mixer.

Receiver Alignment

After the rig has been wired and checked, the voltage should be measured to see that tap on R_{10} is at a point where 150 or 160 volts is applied to the receiver section. Next remove the mixer and the oscillator tubes from their sockets and check the frequency of the superregenerative detector. Very loose coupling should be used between L_3 and L_4 at the start. The detector will generate a loud hiss over a broad section of the dial on a standard superhet receiver, so that it is easy to set the frequency at approximately 20 Mc. by adjusting the padder, C_{13} . After the superregen detector is tuned up and found to be regenerating properly, C_5 should be tuned to resonance, which will be indicated by a tendency to pull the detector out of regeneration. The coupling between L_3 and L_4 should be as tight as possible while still permitting smooth regeneration. After this adjustment is completed the 6C5 and 1232 tubes should be replaced; a slight readjustment of the i.f. circuit will be required when this is done.

The front end of the receiver may be adjusted by using a locally-generated $2\frac{1}{2}$ -meter signal, preferably from an oscillator several feet away operating at as low plate voltage as possible. With C_1 and C_7 set at about half capacity, carefully tune C_3 with an insulated adjusting tool until the signal is heard. Then tune C_1 to resonance. To get

the correct setting for C_1 , the band extremities must be known. The local signal-generating oscillator can be calibrated for this purpose by means of Lecher wires.² The copper lug should be about $\frac{1}{4}$ inch from the end of L_1 when lining up at 112 Mc. With the receiver set at this frequency and with the superregen detector just barely on the edge of superregeneration a faint swish will be heard when C_1 is tuned through resonance. When this adjustment is completed it will be found that, as the copper lug is pulled toward the coil by the tuning control (tuning gadget and control string),

² "A Lecher Wire System for U.H.F. Measurement," *QST*, October, 1941.

the mixer will resonate at higher frequencies. Resonance at 116 Mc. will be reached with the lug just a fraction of an inch inside the cold end of L_1 .

If the oscillator shows a tendency to stop oscillating at one end of the band (usually the high-frequency end), the trouble may be in the position of the cathode tap. The farther the tap is from ground the greater the feedback and the stronger the oscillation. However, if this tap is moved too far up on L_2 it may cause squegging. Too close coupling to the mixer circuit may also cause the oscillator to stop, so some pruning of the twisted hookup-wire "condenser" may be necessary.

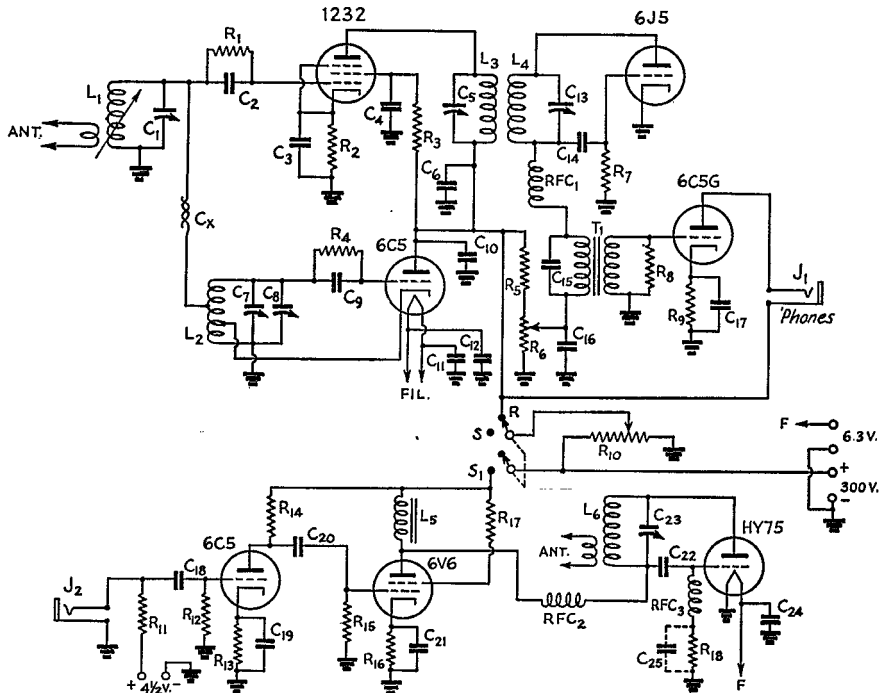

Fig. 1 — Circuit diagram of the 112-Mc. transmitter-receiver. Both shields of the 1232 should be grounded.

- C_x — Oscillator-mixer coupling condenser; see text.
- C_1, C_5, C_8, C_{13} — 5-35- μ fd. midget padder.
- C_2, C_9, C_{14} — 100- μ fd. mica.
- C_3, C_4 — 500- μ fd. mica.
- $C_6, C_{11}, C_{12}, C_{15}, C_{24}$ — 0.01- μ fd. paper, 400 volts.
- C_7 — 2-10- μ fd. midget variable.
- C_{10} — 0.002- μ fd. mica.
- C_{16} — 0.006- μ fd. mica.
- C_{17}, C_{19}, C_{21} — 10- μ fd. electrolytic, 50 volts
- C_{18} — 0.1- μ fd. paper, 400 volts.
- C_{20} — 0.05- μ fd. paper, 400 volts.
- C_{22} — 100- μ fd. mica, 1000 volts.
- C_{23} — 10- μ fd. variable.
- C_{25} — See text.
- R_1 — 4 megohms, $\frac{1}{2}$ watt.
- R_2 — 500 ohms, $\frac{1}{2}$ watt.
- R_3, R_4 — 50,000 ohms, $\frac{1}{2}$ watt.
- R_5, R_{17} — 10,000 ohms, 1 watt.

- R_6 — 50,000-ohm volume control.
- R_7, R_{12}, R_{15} — 1 megohm, $\frac{1}{2}$ watt.
- R_8 — 0.5 megohm, $\frac{1}{2}$ watt (lower resistance may be used for eliminating squeal, if present).
- R_9, R_{13}, R_{16} — 1000 ohms, 1 watt.
- R_{10} — 10,000 ohms, 75 watts, tapped.
- R_{11} — 400 ohms, $\frac{1}{2}$ watt.
- R_{14} — 75,000 ohms, 1 watt.
- R_{18} — 5000 ohms, 2 watt.
- L_1, L_2 — 4 turns, diameter $\frac{5}{8}$ inch, length $\frac{1}{2}$ inch.
- L_3, L_4 — 7 turns No. 22 close-wound (see text).
- L_5 — "30-henry" filter choke, 100 ma.
- L_6 — 3 turns No. 12, diameter 1 inch, length 1 inch; antenna coupling coil, 3 turns No. 16, diameter $\frac{3}{4}$ inch, length $\frac{1}{2}$ inch.
- RFC₁ — 40 turns No. 26 d.c.c. $\frac{3}{16}$ -inch dia.
- RFC₂ — Same as RFC₁
- RFC₃ — Same as RFC₁
- J_1, J_2 — Open-circuit jack.
- T₁ — Interstage audio transformer.
- S₁ — D.p.d.t. switch (for 300 volts).

The Transmitter

The transmitting oscillator and modulator are shown in the lower part of Fig. 1. The oscillator circuit will be recognized as the ultraaudion customarily used at this frequency, the tube being an HY-75. For best output it may be found necessary to by-pass RFC_3 to ground with a 100- or 500- μ fd. condenser at the point where the choke connects to the grid-leak resistor. Checking the oscillator output with a loop and 10-watt lamp will determine whether this by-pass is necessary or not. In this particular oscillator the output increased 25 per cent after the by-pass was put in the circuit.

Some care in adjusting antenna loading is essential for maximum output and best modulation. A small flashlight lamp in series with one feeder will indicate maximum output. A better method, however, is to place a flashlight lamp across about 8 to 12 inches of the center of the antenna (half wave) and adjust the antenna coupling for maximum lamp brilliancy. The lamp can be removed in either case after the proper coupling is found. If the light is used in series with one feeder it may be necessary to shunt it with a 6- to 12-inch piece of magnet wire to prevent burnout. It may be necessary to try two or three places along the feeder before finding a point where the light will glow. Lecher wires² or an absorption wave meter may be used to check the frequency of the oscillator. In the latter case the absorption type wave meter should be checked against a 112-mc. oscillator that is known to be in the band.

The modulator and speech amplifier consists of

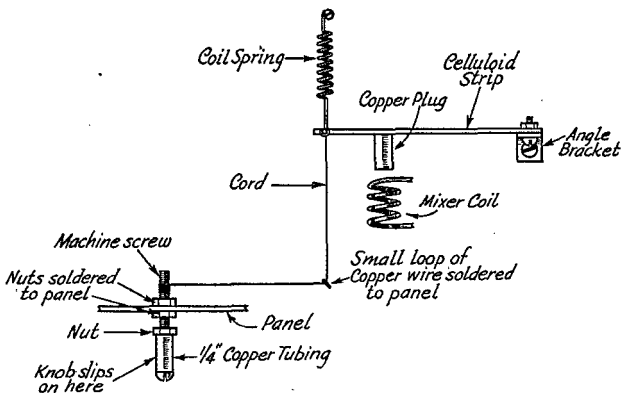
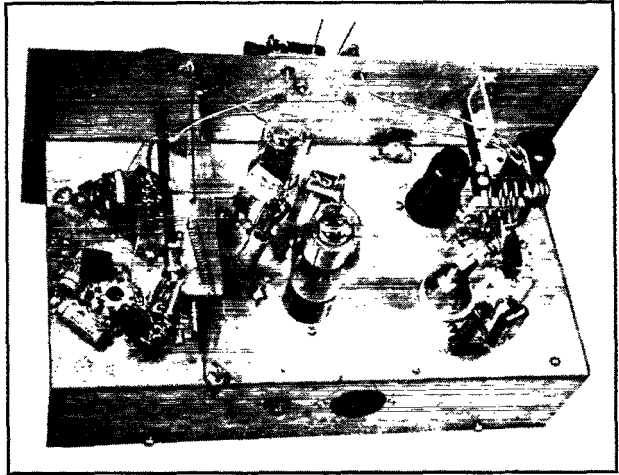

Fig. 2 — Mechanical system for varying the inductance of the mixer grid coil. The cord (thin fishline) winds up on the machine screw when the control knob is turned. The coil spring keeps the cord tight and pulls the copper plug away from the coil when the cord unwinds.



In this top-of-chassis view the transmitting section is at the right, with the speech tubes near the panel. The receiver mixer and oscillator (the former is nearest the panel) occupy the section to the left of the baffle shield; the tubes are mounted upside down under the chassis to shorten the leads to the tuned circuits. The superregenerative second detector and audio amplifier are to the right of the baffle shield.

a 6C5 resistance-coupled to a 6V6. The modulator is choke-coupled to the oscillator, using an ordinary 50-henry filter choke. The microphone input circuit to the 6C5 is simple and easy to handle, and a fair amount of gain is obtained in this stage. More gain can be secured if necessary by using a microphone transformer for coupling between the carbon microphone and the grid of the tube. The circuit shown in the diagram worked very satisfactorily with a high-gain single button carbon microphone.

The transmitter output with the HY-75 is in the neighborhood of 6 watts. If an HY-75 is not available, or if the builder wishes to economize a bit on the transmitter section, a 7A4 will make a good substitute. The power output should be a watt or so at a safe plate current of 15 to 20 ma. Some change in the value of grid leak may be necessary if the 7A4 is used, but no other changes should be required.

This outfit was completed not long before the close-down, and during the short time it was in use gave a good account of itself on transmitting, especially when used with a good antenna. The receiver compared very favorably with the 7-tube superhet¹ having r.f. and i.f. amplifier stages, and it seemed that just about any signal that came through on the 7-tube set could be heard on this 4-tube job also, although the gain was not as great. The quality on both transmission and reception was entirely satisfactory.



U.S.A. CALLING!



F.B.I. NEEDS OPERATORS

THE Federal Bureau of Investigation desires applications from persons qualified as radio operators or engineers. These are civilian positions, in what FBI calls Grade CAF-5, beginning salary \$2000. Applicants must have at least high school education, must be able to receive and transmit at 25 w.p.m. and to copy at that speed on typewriter; be able to operate a teletypewriter; be capable of doing ordinary repair and maintenance work under direction of a radio engineer. Preferential consideration is given applicants having a college degree in science or engineering or commercial qualifications in electrical design, construction, operation or repair, or communications engineering.

Applicants must be U. S. citizens, in good health, willing to accept assignment anywhere in the U. S. or its Possessions, and willing from time to time to accept special duty as the FBI service may require. For further particulars you may call at or write to the nearest office of FBI or direct to the Director, FBI, Department of Justice, Washington.

RADIOLOCATOR EXPERTS

THE search continues for candidates for second lieutenantcies in the Electronics Training Group of the Signal Corps. This is the very hush-hush microwave stuff which is so immensely intriguing and which has been frequently mentioned in *QST*. College graduates in E.E. or physics, particularly those with ham licenses or commercial engineering experience, are wanted. Hundreds of your fellows are in this service. Full particulars and application forms from George W. Bailey, National Research Council, 2101 Constitution Avenue, N. W., Washington.

MORE SIGNAL CORPS COMMISSIONS

VACANCIES exist for the immediate appointment of a limited number of second lieutenants in the Signal Corps, for general SC duty. Applicants may be either civilians or officers or enlisted personnel in any component of the Army, either active or inactive!

Applicants must have a college degree or its practical equivalent in electrical engineering or electronic physics, must be between 18 and 46 years of age, must meet the prescribed physical standards. Already-commissioned lieutenants who wish to transfer to the Signal Corps in grade may make application therefor through channels,

under authority of AGO letter AF 210.1 Sig. Corps, dated Feb. 17th. Enlisted men of proper qualifications, in any component of the Army, are similarly invited to apply, as are qualified civilians. Personnel commissioned under this authority will be given brief instruction at Fort Monmouth and their training then continued at other locations. All applications should be submitted by letter to the Chief Signal Officer, Washington, giving name, address, age, military status if any, and an outline of technical qualifications and experience.

F.C.C. OPERATORS, MONITORS, INSPECTORS

THE Federal Communications Commission has openings for additional personnel in connection with its national defense monitoring operations. You know the duties — patrolling the radio spectrum, detecting and locating illegal and subversive stations, participating in the AWS in cooperation with the Interceptor Commands. These are Civil Service jobs. They require operators skilled in the identification of radiotelegraphic traffic. Amateur or commercial operators with a speed of 25 w.p.m. are wanted; those who have served in the Army and Navy amateur nets are especially desired. All appointments are made from Civil Service registers. See the nearest representative of the Civil Service Commission and request Announcements 166 and 203. Operators are appointed initially at \$1800, with good possibility of promotion. Those who have radio engineering background as well are eligible for appointment as Assistant Monitoring Officer at a beginning salary of \$2600. These are jobs in which many amateurs have already given splendid account of themselves, many beginning as operators having been promoted to A.M.O., and the Commission is eager to have more of us.

FCC also has vacancies as Radio Inspector — whose duties involve inspecting radio equipment on ships and aircraft and at various land stations. There is an assistant position at \$2000, a full inspectorship at a beginning figure of \$2600. Maximum age, 45. Candidates for assistants must have completed a four-year college course in electrical or communication engineering or physics, or may substitute radio engineering experience therefor. In addition, the full inspectorships require a year of engineering, teaching or graduate study in communications; and code knowledge is essential. Applications will be accepted from senior or graduate students in communication

engineering if their courses will be completed by October 1st. See announcements and obtain forms at any first- or second-class post office or from the U. S. Civil Service Commission at Washington.

U.H.F. IN THE NAVY

The letters UHF for years have meant new horizons for the amateur. In the commercial and experimental world they have meant television and f.m. To-day, in a world at war, u.h.f. is playing another part, a highly-secret one that may decide the fate of battles.

What does this have to do with u.h.f. hams? Just this: In Chicago to-day, and shortly throughout the nation, the Navy is training men, most of them with amateur or repairman background, in the basic principles of ultrahigh work. After that course they get into secret operation and maintenance. The details are military secrets but the Navy is looking for hams who want to learn about the u.h.f., really learn about them. The Navy is giving ratings and in some cases commissions to men who qualify. And the course of study is the peacetime equivalent of years of schooling.

The Chicago school is an unusual one. Directed by Lieutenant William C. Eddy, USN retired submarine commander and now television director for Balaban & Katz, the school has the television engineers of W9XBK for its instructors. W9XBK has turned over its facilities and equipped the top floor of a downtown office building with laboratories and lecture halls, as part of its wartime contribution. Half a million dollars' worth of equipment is used in everyday classroom work: u.h.f. transmitters, antennas, c.r.o.'s, a complete set of u.h.f. tubes donated by RCA, etc. There's a 1-kw. television transmitter, a 1-kw. f.m. rig, one of the three 20-inch cathode-ray oscilloscopes in the country, a television camera which is the subject of 35 of Lieutenant Eddy's patents. The course of instruction includes mathematics, electricity, shop practice, slide rule and radio. There's a laboratory where each man will build a u.h.f. superhet, where a.c. and d.c. machinery is studied and where resonant circuits are "cussed and discussed." In addition to Lieutenant Eddy, the instruction staff includes "Dean" Arch Brolly, W6RG; William Kusack, W9QEE; Stanley Osterlund, W9TJL; and William Kunz, W8SNS. After the present course of 12 intensive weeks, the graduates go into work on the secret apparatus, some of it involving aircraft detection, some of it leading to the other confidential uses of u.h.f. Why mathematics and electricity? They are necessary to maintain and operate the u.h.f. gear that's going to help win this war. The strides made in the band around 1 meter have been so rapid that you have to have sound knowledge of theory and math to get along. When you pour a kilowatt into one of those sets, as Navy students

are doing to-day, you have to know the answers if you want results. This training has great value beyond its wartime purposes. After this war is over the u.h.f. are going to have a very practical application to peacetime life, so the men who enter this work are preparing themselves doubly.

To get the proper men, those who have held ham licenses or done repair work, the Navy is offering ratings that mean the equivalent of \$200 a month in civilian life. The training is free and the Navy offers the opportunity if you'll give your work and interest in return. Interested applicants may obtain full particulars by applying in person or writing, either to the District Procurement Officer of their Naval District (list on page 24, April QST) or to any Naval Recruiting Station, and asking for the dope on radiolocator maintenance men, initial appointment as radioman second class.

NAVY AVIATION SPECIALISTS

The training division of the Bureau of Aeronautics of the Navy has openings for men with some college training (physics and electrical engineering preferred) plus a commercial or amateur radio license. Radio training and experience are absolutely necessary. They will be commissioned in ranks from ensign to lieutenant-commander, depending on age and experience. They will first receive special schooling and will then deal with the installation and maintenance of air-borne radio equipment. The men will not fly, but a knowledge of airplanes is in their favor; and, although a pilot's license or flying experience

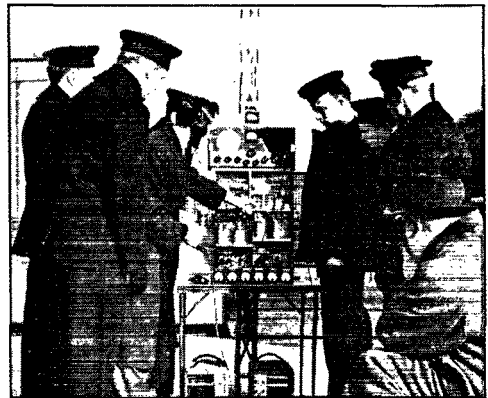

Students at the Navy's u.h.f. school in Chicago here are working with a 210-Mc. television relay transmitter which is crystal-controlled, employing both tripling and doubling. In the background is a unique collapsible 40-foot tower supporting a combination broadside and colinear array developed by W9QEE, one of the instructors, fed by a 300-ohm open-wire line. The transmitter has an output of 100 watts, "peak to peak," the final consisting of a pair of 1628's push-pull, grid-modulated by 807's. The truck in the background contains a gas generator and control equipment for operation independent of commercial power.

is not necessary, it will help. These officers will be classified as Aviation Volunteer Specialists.

For particulars, apply to George W. Bailey, National Research Council, 2101 Constitution Avenue, N. W., Washington.

NAVY COMMUNICATIONS ENGINEERS

THE Navy has recently announced that persons who have had two years of college training in electrical engineering or physics, plus an amateur license, may apply for reserve commissions as communications or radio engineers. There are three classifications: Aviation Volunteer Specialists, Ordnance V.S. and Engineer V.S. For details, write to G. W. Bailey, National Research Council, 2101 Constitution Ave., N. W., Wash.

CIVILIANS, RESEARCH & DEVELOPMENT

ARRL President G. W. Bailey is deeply immersed in the procurement of specialized personnel for the radio needs of the fighting forces, being in charge of that branch of the work at National Research Council, 2101 Constitution Avenue, N. W., Washington. He advises us there are quite a few good jobs open in civilian capacities, Civil Service status.

Some of these are on behalf of the Signal Corps, which needs civilians for research and development work in its laboratories.

In the Bureau of Ships of the Navy Department there are some administrative positions, involving some design work and technical details in connection with the radiolocator.

In general these positions require a background of electrical engineering or physics. While college-trained men are preferred, engineering degrees are not necessary, but some experience in radio absolutely is and an amateur license is particularly desirable. Salaries depend upon the age and experience of these applicants. You may get more information by writing, giving particulars on your qualifications, to Mr. Bailey at above address.

AND WOMEN, TOO:

TECHNICALLY-TRAINED women, available for employment, are requested to communicate with G. W. Bailey, National Research Council, 2101 Constitution Avenue, N. W., Washington. Mr. Bailey, who is chairman of the radio section of the Office of Scientific Research & Development, in a recent address stated that a civilian army of at least 25,000 women will be employed by the armed forces to operate radiolocators and to do other vital work in the field of radio. "This is a radio war," he declared. "This war is not exclusively a soldier's war: it is a civilian's war, it is a scientist's war, it is a woman's war."

Right now the Navy is looking for skilled women, some of them for service in the Bureau of Ships at Washington, some at the Naval Research Laboratory. Women with college degrees, preferably in physics, and also holding ama-

teur licenses, are particularly desired. For them, civilian appointments at \$2000 a year are immediately available: radiolocator work, in research laboratories, or in the development and installation of communication facilities. Note that the college degree does not have to be in a technical subject, may be in the liberal arts. Women with degrees in physics or E.E., but with no radio experience, will also be taken on as junior physicists and junior engineers at \$2000. Those who have amateur licenses but no degree will be started at once on radio communication facilities at \$1620. In other words, any licensed YL can get a job at \$1620, and if she has any kind of a degree from a recognized college she can get \$2000. The Army Signal Corps will also soon offer jobs to college women of similar qualifications.

For further information, communicate your qualifications to Mr. Bailey at the above address.

ENGINEERING STUDENTS AS OFFICERS

THE Signal Corps offers commissions as second lieutenants to junior and senior students of electrical engineering or electronic physics, upon graduation, with deferment from active duty until graduation. Engineering students should not let the draft interrupt schooling. Get deferment, finish up, serve as an officer. Here's the dope:

You will be temporarily enlisted in the Enlisted Section, Electronics Training Group, Signal Corps. Application for such enlistment should be made direct to the Chief Signal Officer of the Army, Washington. It must be accompanied by a statement by your Dean of Engineering that you may reasonably be expected to graduate. If your college has an ROTC unit, you should have a statement from its Provost Marshal to the effect that you are officer-candidate material. (If no ROTC, a Signal Officer will interview prospects.) When accepted, you are allowed to complete your schooling and, upon graduation, are appointed a second lieutenant. Your Dean of Engineering has further particulars.

Strays

A recent British publication states that seven out of every eight radio servicemen in England are in the armed forces.

For the purpose of determining the merits of the use of f.m. by state-police radio systems on a frequency below the present allocated range, the FCC has granted construction permits to the New Jersey State Police for 27 experimental stations, all to operate on a frequency of 27,925 kc. with a power of 60 watts. For those who are interested in propagation effects, these signals should provide a good check on what f.m. in the ten-meter ham band might sound like if—

Interference-Reducing Antenna Systems

Overcoming Electrical Noise Problems in Reception

BY ALFRED CROSSLEY*

IN THIS brief article it is the intention of the author to present the subject of interference-reducing antenna systems from the practical standpoint, based on experience covering a period of many years.

The following phases of this problem have to be considered:

1. The source and frequency of the radio interference.
2. The type of receiving equipment employed.
3. How the interference is picked up.
4. Means for eliminating the interference.

With reference to sources of interference, we may say that the chief offender is an electrical device which includes sparking contacts. This sparking causes the associated circuits and wires leading therefrom to radiate a broad radio wave, the frequency range of which depends on the inductance, resistance, capacitance and distributed capacitance of the circuits excited by the spark discharge.

This sparking may be in air or in a gas, or it may be through chemical combinations such as oxides or sulfates. In this latter class we can cite dry disc rectifiers, which produce a hissing sound in a radio receiver.

The following devices represent a small part of the total number of sources of interference:

1. Universal-type motors.
2. D.c. motors in fans and refrigerators.
3. Street cars or busses.
4. Signs of all kinds, including traffic lights.
5. Neon and fluorescent lights and x-rays.
6. Electromedical machines.

* Consulting Engineer, 549 W. Randolph St., Chicago, Ill.

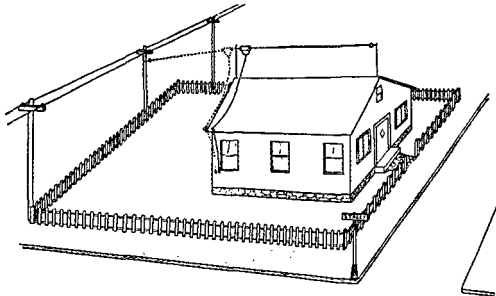

Fig. 1 — Illustrating correct placement of the receiving antenna for minimum noise pick-up. With power lines in the rear, antenna runs to the front of the house. If power lines were in front antenna would be installed as shown by dotted lines.

This article is based on a paper presented by the author at a Radio Interference Conference held on the University of Illinois campus in 1941. It represents an excellent summary of accepted practice in reducing electrical-noise interference with reception.

7. Leaky electric-power lines, defective transformers and equipment.

8. Vibratory machines such as electric shavers, haircutters, etc.

The tuning or frequency range of the interference from these different sources is quite different for the respective sources, and can be determined only by practical measurements with a radio receiver or special radio field strength measuring devices. In general, interference will be experienced over a range from 15 kc. to at least 100 Mc., with a maximum intensity in the band from 1500 to 2000 kc. In certain locations where d.c. elevators are present the maximum intensity will usually be in the range from 200 to 500 kc. Practically all interference covers a broad tuning range and seldom can be found on a single frequency or narrow band of frequencies.

Radio receivers are sometimes poorly designed to cope with this problem. A.c.-d.c. type receivers which obtain their power supply directly from the electric power source are inherently the worst type of receiver for use in areas where interference is met with. Such receivers are so designed that the rectifier tube links the radio circuits directly to the power line. This direct connection permits interference in, or picked up by, the power line to be fed into the radio receiver.

It does not matter whether the a.c.-d.c. receiver employs a loop or a regular antenna, because the interference pickup through the antenna generally is small compared to the line pickup. It may be possible in a few cases to orient the position of the loop with respect to the interference when receiving some stations and obtain a reduction in interference, but as soon as the loop is rotated to pick up other stations the interference is again heard.

The ideal type of radio receiver is the regular a.c. receiver which employs the isolating transformer with its static shield to separate the receiver radio- and audio-frequency circuits from the power line. Such a receiver can be further

improved upon from an interference-rejection standpoint by adequately shielding the r.f. circuits and exposed grid leads with metal enclosures. Experience has indicated that exposed grid, antenna or r.f. leads can pick up an annoying amount of interference from local sources.

Having presented the problem and the receiver characteristics, we may now consider how this interference is picked up and means for reducing it to a negligible amount.

Interference is picked up by a radio receiver in three ways, namely, through the antenna, the power line, or directly by means of exposed grid leads and r.f. circuit wiring. By shorting the antenna and ground terminals at the receiver input, it can be determined if the interference is being picked up by the antenna. In this operation be sure that the antenna and ground wires are disconnected from the receiver and the shorting connection and antenna-ground leads are not in excess of a few inches in length.

If interference is still noted with the antenna circuit short-circuited, we may assume that the interference is being received from the power lines or by direct pickup. Connecting a good power line filter between the power line socket and the receiver will reduce power line pickup, if any, and prove whether or not it exists.

If interference is still obtained with the proper antenna system and power line filter, it is recommended that the receiver chassis and the r.f. circuits be adequately shielded. This shielding may consist of a metal plate directly under the receiver chassis or the addition of a metal cover over exposed r.f. parts such as the variable condenser.

Antenna interference pickup can be greatly re-

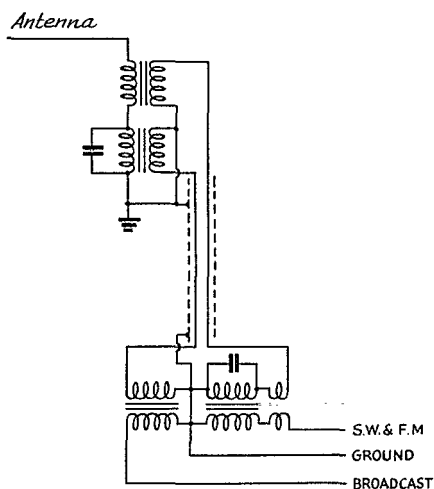

Fig. 2 — Modern all-wave antenna system covering range from 400 to 22,000 kc., with shielded transmission line and two-channel double-transformer couplers at antenna and receiver.

duced by employment of a good antenna system which includes the proper size antenna, an antenna coupler, a transmission line and a receiver

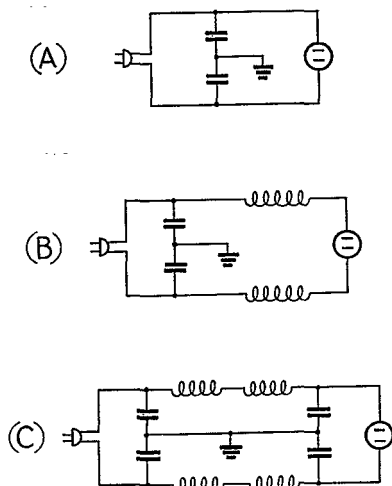

Fig. 3 — Representative types of power-line filters.

coupler. Such an antenna system permits the placement of an antenna at a distance from any interference-producing source by the use of the transmission line with its impedance matching couplers or transformers. Fig. 1 shows a typical installation of such an antenna system on a private home.

Where the power line or other interference source is in the rear of the home, the antenna location indicated by the solid lines should be used. In those locations where the source of interference is in front of the home, resort should be made to the location of the antenna shown by the dotted lines. Sometimes excellent results are obtained by rigging the antenna at a desired angle to the known source of interference.

In congested cities where interference is bad near the receiving center, it is recommended that the antenna be erected at a distant position where there is minimum interference. For such installations, the loss in a good transmission line is negligible compared with the decrease in interference observed. Distances as great as 1000 feet between antenna and receiver have been employed without appreciable reduction in signal strength even at short wave lengths (6 to 22 Mc.).

A modern all-wave antenna system¹ is shown in Fig. 2. In this system the flat-top antenna is connected to a double-transformer antenna coupler, the output of which is delivered to a shielded transmission line. This transmission line is terminated at a receiver coupler having three transformer windings.

(Continued on page 100)

¹ U. S. Patent 2,222,406, 11-19-40.

HAPPENINGS OF THE MONTH



CIVILIAN DEFENSE PLANS

WE HAD certainly expected by this issue to be able to report to you the announcement of the DCB order putting into effect the OCD plan for employing amateurs and their gear in civilian defense. But another month has rolled by and there is still no announcement. Nonetheless, distinct progress has been made and, despite the discouraging delay, there seems every reason to expect favorable news in the near future. You fellows will understand that it is one thing to propose an idea and quite a different thing to reduce that idea to legal and administrative terms. It takes time to progress from one to the other.

The need for this service remains as great as ever. Washington seems to realize that, and it is now believed that the matter will roll along rapidly. Keep your chins up, fellows, and we'll get there yet!

APPARATUS FOR TRAINING SCHOOLS

THE numerous universities, colleges and schools engaged in the training of radio personnel are on a spot for apparatus. They have government funds available, but the priorities they enjoy do not permit them, in many cases, to get apparatus ahead of the needs of the military services themselves. Some of these schools are teaching civilian operators and maintenance men, but many are on contract to the armed forces and are giving instruction to men in uniform, either enlisted or commissioned, and either Army or Navy. Sometimes they need only a little equipment for classroom demonstration, where almost anything will do, but often their need is for laboratory equipment for engineering instruction; and occasionally they need parts in prodigious quantity for the wholesale instruction of technicians and mechanics.

While the dealers' shelves of the country are groaning with the dead weight of many radio components, we are informed that there is a great deal of gear needed in these institutions which is not available from dealers or manufacturers. An appeal is, therefore, being made to amateurs in every community to get in touch with these schools and colleges to see if they cannot be given a lift in their pressing needs. Amateur clubs are particularly invited to undertake the patriotic job of establishing contact, finding out what is needed, and locating it amongst their memberships. Many amateurs will be glad to assist this work by lending oscillators, oscilloscopes and similar pieces of equipment to an eminently worthy cause, to be returned at the conclusion of

the war. But these institutions also have funds available and are perfectly willing to buy outright. In any event they need the equipment, we have it standing idle and we need to get together with them. It is a way in which the civilian amateur, or the amateur away from home in the services, may do something more to contribute to the winning of the war.

BOARD MEETING

THE Board of Directors of ARRL will hold its regular annual meeting in Hartford on May 8th. The Board has issued standing instructions to inform members in the May issue of *QST* of pending matters of business, so that members may write their directors their opinions thereon. Generally the Board's agenda include topics of wide popular interest, such as proposed changes in the 'phone bands, requests to be made of FCC, etc. They naturally are missing this year and so far there is nothing very exciting on the list.

The Board of course will make a careful examination into the status of the amateur and his future, and of the opportunities to assist the present national effort. A new president and vice-president are to be elected this year. Other known items of business include recommendations: to continue the SCM allowance for travel to conventions; to relax the ARRL-membership requirement on affiliated clubs if noncompliance is attributable to the effects of the war; to alter Board eligibility specifications to make it clear that radio servicemen and radio advertising agents are not eligible; to postpone until the war's end consideration of a proposal to change the status of the Philippine Islands in the League organization.

If you have any suggestions for the meeting, write your director. His address appears on page 6.

KNOW YOUR PURCHASERS

IN ALBUQUERQUE, last month, FBI agents and police raided an enemy alien hangout and seized guns, ammunition and cameras — and a perfectly good ham panel transmitter and communications receiver. The rig was being used by a German agent for subversive purposes. It had belonged to an Albuquerque amateur. When the war stopped amateur activity, this ham offered his apparatus for sale. The purchaser who showed up turned out to be the alien agent, according to information received at headquarters.

Think about the moral in this, fellows. Maybe

you've been approached by unknown people, too. Here's our warning: Never sell a transmitter or short-wave receiver to anyone whom you do not know to be an American citizen; be sure that you know that their intentions are lawful and proper, and ascertain where the apparatus is going to be. You don't want to help an enemy, and there is also the thought that it may be embarrassing if the FBI comes around and asks you where your transmitter is and you don't know. Our own government and its allies, yes, and our universities and training programs — but beware of unknown purchasers.

COMMERCIAL LICENSES

FROM our daily correspondence it would seem that there is more than normal interest in obtaining commercial licenses. Naturally enough, for in marine, airline, and broadcast operating there are many openings — and more every day as men are called into military service. We particularly recommend that women, and men with slight physical defects, prepare themselves for commercial tickets to help allay this shortage — and, not incidentally, obtain a good position. Here are some general data:

Commercial radio operator licenses are issued in three classes each, under "radiotelephone" and "radiotelegraph" divisions. In each case, the first-class license carries the greatest privileges and naturally has the most inclusive requirements. FCC commercial written examinations are divided into elements, thus:

- Element 1 — Rules and regulations
- Element 2 — Fundamentals of radio
- Element 3 — Radiotelephone
- Element 4 — Advanced radiotelephone
- Element 5 — Radiotelegraph
- Element 6 — Advanced radiotelegraph

Each license requires the passing of certain combinations of these elements, as follows:

Radiotelephone:

- Third Class — Element 1
- Second Class — Elements 1, 2, 3
- First Class — Elements 1, 2, 3, 4

Radiotelegraph:

- Third Class — Elements 1, 2, 5; 16 w.p.m. code test, usually coded groups
- Second Class — Elements 1, 2, 5, 6; 16 w.p.m. code test
- First Class — Elements 1, 2, 5, 6; 25 w.p.m. code test; service endorsement on second-class license

Speaking broadly, in the radiotelephone division a third-class license (actually a "permit") is useful principally for police radio dispatchers and

operators, and for owners of private radio-equipped aircraft and boats; a second-class license is usable for nearly all stations employing A-3 emission except broadcast and television transmitters, which normally must be operated by first-class licensees — but because of the present shortage of men a second-class licensee may operate such equipment if a first-class licensee is in general charge. In the radiotelegraph division, a third-class license is useful for airline and police point-to-point operating; a second-class license is good for any kind of telegraph operation except the position of chief operator aboard certain ships which must be manned by first-class licensees (although temporarily a second-class licensee may now hold such a position). Holding a second-class license of both radiotelephone and radiotelegraph grade, then, a person is legally equipped to handle almost any operating job.

Commercial operator examinations are given at the FCC offices listed in February *QST*, the *Handbook* and the *License Manual*; write the one nearest you for data on exact time and day, and to make an appointment. Simultaneously request the necessary application blanks so you can arrange for notarization in advance; if you already hold an amateur license, duplicate proof of citizenship is not necessary. Each examination element requires between 1 and 1½ hours for completion, so allow yourself time accordingly. If you fail certain elements but pass others, you will automatically be issued a license of proper grade if the passed elements entitled you to it. For example, if in trying for a second-class telegraph license you fail Element 6 but pass in all other respects, you will receive a license carrying third-class telegraph and telephone privileges.

The commercial equivalent of the amateur *License Manual* is *Radio Operating Questions & Answers*, by Nilson and Hornung. If you are a reasonably good technical man and familiar with the theoretical dope in the ARRL *Handbook*, you'll have no trouble other than learning commercial regulations; if not, you'll need some study. Go to it!

IF YOU'RE NOT YET AN AMATEUR . . .

WHEN a licensed amateur volunteers in the Army or Navy, he gets a radio assignment. If a draftee possesses a ham ticket, he also gets special consideration. (If he is a competent amateur and doesn't get a radio berth, he should let ARRL know.) There is great need for radio people. Countless thousands of young Americans who expect to see service are training themselves at home, and in defense training classes, for radio work. It is a wise idea, for it helps to fill a national need and it qualifies the selectee for something more interesting and more important.

The standard for such radio assignments is the possession of an amateur Class B license. Thus it

ARE YOU LICENSED?

When joining the League or renewing your membership, it is important that you show whether you have an amateur license, either station or operator. Please state your call and/or the class of operator license held, that we may verify your classification.

happens that the literature published by ARRL as an aid to its members is directly applicable to the needs of the young man and woman training for war service. We mentioned last month the availability of a radio class outline based upon the new special defense edition of *The Radio Amateur's Handbook*. That book will also serve as an excellent manual of radio theory for the home student. *The ARRL Antenna Book* offers an interesting expansion of the *Handbook's* antenna chapter. *The Radio Amateur's License Manual* remains a reliable guide to preparation for the actual examination for the ticket which attests proficiency. Free data for clubs and groups teaching code classes are available from the Communications Manager. Most League books can be found at any radio dealer's.

ATTENTION, REGISTRANTS!

THOSE who have registered with ARRL their availability for radio employment, or their willingness to sell certain radio apparatus for defense purposes, are requested to advise headquarters if they or their apparatus become unavailable, so that we may cancel the listing. A post card will do; thanks.

Amateurs who have reported their presence in the military services, for our service roster, are requested to advise us of promotions or other changes that should be on the record.

For information on the Apparatus Bureau, see page 16, April *QST*; service records, page 18, April; personal availability, page 19, April, page 27, December.

PROVIDENCE FOOTNOTE

FCC GIVES police experimental licenses in the 116-117-Mc. vicinity only for police-department purposes. These frequencies are not specially available for civilian-defense purposes as such. It happens that in Providence the P.D. has the sole responsibility for ARP communications and hence the scheme worked very nicely there. That may be the case in many other communities. But the method is no cure-all substitute for an OCD plan and is not available in communities where the police functions are separate from the organization of the secondary system of civilian-protection communication.

Strays

Andreas Bertnes, LA6R, was arrested early in the spring of last year by the Germans and accused of espionage and of illegally using a radio transmitter. The German Field *Kriegsgericht* recently sentenced him to death, and he was shot a few weeks ago. Andreas was 25 years of age and a medical student who lived in Sendefjord with his father, who was a doctor.

— *The T. & R. Bulletin*

New U.H.F. Transmitting Tube

GENERAL ELECTRIC has recently announced the type 8010-R, a triode with a 50-watt plate-dissipation rating designed to operate at full rating at frequencies up to 350 Mc. For a tube of such high power rating, its physical dimensions are particularly interesting. The glass envelope enclosing the elements is only 1 inch in diameter and 1¾ inch long. Cooling vanes at each end of the glass section extend its overall length to only 4¾ inches — not much larger than a 6L6. The tube is designed to operate with forced-air cooling from a small blower. Important ratings are as follows:

Filament.....	6.3 volts, 2.4 amperes
Amplification factor.....	30
Maximum plate voltage.....	1350
Maximum plate current (ma.).....	150
Maximum plate input (watts).....	100
Maximum plate dissipation (watts).....	50
Maximum grid voltage.....	—1000
Maximum grid current (ma.).....	20

The interelectrode capacities are as follows:

Grid-Plate (μfd.).....	1.5
Grid-Cathode (μfd.).....	2.3
Plate-Cathode (μfd.).....	0.07

— . . . —

The largest standard tube produced by RCA stands 5 feet high and is capable of delivering 100,000 watts output, while the smallest is the size of an acorn, handling an input of ¼ to 1½ watts.

— . . . —

The plate-current meter for the final amplifier of W8XO, the experimental station of WLW, has a scale of 100 amperes. Normal plate current is 61 amperes! — *W8PPK*.

— . . . —

W5ELC warns amateurs to be on their guard against a bogus salesman of decorative call letters operating under the name of A. M. Filmore. W5ELC states that an order placed by a friend of his, with payment in advance, was never filled.

— . . . —

The July, 1941, issue of *QST* carried a warning to amateurs in the southeastern part of the country to be on guard against one John B. Kenney, who had the habit of representing himself as W4SP in negotiating one-way "loans." These amateurs will be glad to know that this warning directly resulted in the deposit of Mr. Kenney behind bars (minus the brass rails with which he was also well acquainted!). His doom was sealed when he approached W4EBZ of Birmingham, who had read the *QST* warning.

Credit for the original warning goes to Doc Cheatham, W4DU, the play being W4DU to W4ASR to *QST* to W4EBZ.

● *Technical Reviews*

"An Analysis of the Signal-to-Noise Ratio of Ultrahigh-Frequency Receivers"

THIS paper, which was delivered by E. W. Herold at the Winter Convention of the Institute of Radio Engineers held in New York in January, and subsequently published in the January, 1942, issue of *RCA Review*, holds much of interest to amateurs, particularly those specializing in u.h.f. work. Most of us differentiate instinctively between "sensitivity" and "amplification," realizing that there is something more to obtaining good reception of weak signals than simply providing lots of gain. If there were not, receiver design essentially would be a matter of providing the utmost gain possible, since the higher the amplification the weaker the signal it would be possible to receive with readability. The limiting factor which prevents our hearing the signals which cannot now be picked up is, of course, noise.

The noise which limits the sensitivity of a receiver may arise from several causes. An obvious source of noise is atmospheric electricity and radiations of a similar nature from electrical circuits and apparatus. It is possible to choose a location where the man-made or artificial variety of static is completely absent and not impossible that, at least at times, there may be no natural static to affect the receiver. But with no static at all there would still be noise in the receiver, noise which a signal has to be strong enough to overcome if it is to be readable. This remaining noise constitutes an absolute limit to the sensitivity of a receiving system, since it is inherent in the system itself.

At frequencies up to about 20 Mc. there are three important components to this residual noise. Two of these arise as the result of thermal agitation in conductors. The random movement of

electrons in the conductors causes small but finite currents which, in flowing through the conductor resistance, develop voltages of irregular nature which cause a smooth "hiss" type of noise. In a parallel-tuned circuit the noise voltage which appears across the circuit terminals and is applied to the grid of the tube with which the circuit is associated is, like any signal introduced into the circuit, amplified in proportion to the resonant rise in voltage in the circuit. That is, the higher the Q of the parallel-tuned circuit the higher the noise voltage which appears across its terminals; the noise is, in fact, proportional to the resistive component of the parallel impedance. Thus the tuned circuit itself is a source of noise, and the better the tuned circuit the more noise it will create. This type of noise also depends upon the absolute temperature of the circuit, being greater the higher the temperature, hence the name "thermal." Short of keeping the circuits in a box cooled by liquid air or something of the sort which will reduce the temperature to a point well down on the absolute scale there is not much that can be done about it.

Antenna Noise

Now even if we could eliminate entirely the thermal noise in the first tuned circuit we should not have rid ourselves of the thermal limitation. To pick up signals we need an antenna, and an antenna is a conductor subject to thermal agitation effects just as is any other conductor. Since the effective resistance of an antenna is its radiation resistance, the thermal noise developed in the antenna is proportional to the radiation resistance. While the radiation resistance is low compared to the resistance offered by a good tuned circuit at resonance (less than a hundred ohms as compared to thousands of ohms in many cases), the noise developed by the antenna is amplified in the resonant circuit to which it is coupled just as an incoming signal is amplified. Hence, looking at the circuit from the grid of the first tube, it is the *reflected* antenna resistance which is the noise maker. This reflected resistance is proportional to the square of the step-up in voltage from the antenna coil to the tuned circuit terminals—the familiar relation that the impedance ratio varies as the square of the voltage ratio.

The sensitivity of a receiver is limited by the ultimate noise which the signal must overcome before it can be usable. Here is a discussion of the factors contributing to the inherent receiver noise and their relationship to signal-to-noise ratio. Although the paper deals primarily with u.h.f. receivers, the conclusions can be applied to low-frequency sets as well.

Thus a completely noise-free receiver, if such a thing were possible, would still encounter an irreducible noise level as soon as it was connected to an antenna, even though no static were present. Antenna thermal noise therefore sets the ultimate limit of receiver sensitivity. Consequently it can be used as the basis for comparison of different receivers, by comparing the signal input necessary to equal the actual noise to the antenna noise alone, the latter being calculated. This gives a "figure of merit" which for the ideal receiver would be 1, but which for practical receivers necessarily will be higher than 1. The lower the figure of merit the better the receiver.¹

Ultrahigh-Frequencies

The third factor is noise originating in the tubes, and particularly in the first tube. Below 20 Mc. this is almost wholly "shot effect," or irregularities in the electron stream to the plate. The magnitude of tube noise will vary with the type of tube and it cannot be reduced by any means which might be employed to reduce the circuit noise.

Conditions become worse as the frequency is raised. The irregularities in the electron stream also cause noise currents to be induced in the grid circuit, and since this "fluctuation" noise is proportional to frequency it becomes more important at ultrahigh frequencies. It is inappreciable below 20 Mc. Transit-time effects and cathode-lead degeneration both operate to load the input circuit, thereby lowering its Q and resonant impedance to values which may be only a small fraction of those attainable on the lower frequencies.² This loading limits the gain of the tuned circuit so that only a relatively small signal voltage can be developed at the grid of the tube. There is a corresponding decrease in the thermal noise from the tuned circuit (including the noise from the antenna) but the tube noise remains the same. Hence the higher the frequency the greater the contribution of the tube to the total noise, and since this part of the noise is independent of the signal (whereas the tuned circuit gain affects both noise and signal) the signal-to-noise ratio becomes poorer as the frequency is raised. Thus to a considerable extent an improvement in signal-to-noise ratio can be brought about only by using improved tubes, tubes in which transit-time effects and lead inductance have been reduced to the greatest possible extent.

In evaluating the relative importance of the various factors in their effect on the signal-to-noise ratio, use is made of an equivalent circuit in which noise sources are combined wherever possible. Such an equivalent circuit is shown in Fig. 1. The antenna resistance is referred to the

grid tuned circuit and is therefore combined with the resonant impedance of the circuit alone in the equivalent resistance R_1 across the circuit. Also contained in R_1 is the electronic or transit time input resistance mentioned above. Noise current, considered as being supplied by a constant-current generator, G_1 , flowing in this resistance causes a noise voltage drop which appears between grid and cathode of the tube. The plate-circuit tube noise is for convenience referred to the grid side so that it can be included on the same basis as grid-circuit noise, and appears as a constant voltage in an assumed equivalent resistance R_{eq} . R_{eq} is assigned a value such that its thermal noise would, when applied to the grid and amplified through the tube, give the same noise power as actually is developed in the plate circuit. In this way the two distinct types of noise source can be kept separate.

Signal-to-Noise Ratio

The various types of noise considered all have the characteristic of being uniformly distributed over the spectrum, at least in the slices of the spectrum likely to be utilized in a complete receiver. Hence the noise power output of the receiver will be a function of the width of the overall receiver pass-band. The smaller the pass-band — that is, the higher the selectivity — the lower the noise output. For a given signal, antenna noise and receiver bandwidth, the analysis of the equivalent circuit shows that when the antenna coupling is adjusted for maximum gain, the signal-to-noise ratio depends upon the ratio of R_1 to R_{eq} and also upon the fraction of the total input resistance, R_1 , which is electronic. Maximum gain, of course, results when the antenna and grid-circuit impedances are matched.

An interesting result of the analysis is that the best signal-to-noise ratio does not necessarily result when the matched-impedance condition obtains. This is shown by the curves of Fig. 2, where a quantity called the "minimum signal factor" is plotted against the ratio of R_1 to R_{eq} — that is, speaking loosely, the ratio of circuit noise to tube noise (it should be remembered that induced grid noise is grouped with circuit noise in R_1 , but it is found that this noise is not a major part of the total noise). Minimum signal factor is defined as the factor which must be applied to the open-circuit antenna thermal noise voltage to give an open-circuit antenna signal voltage which

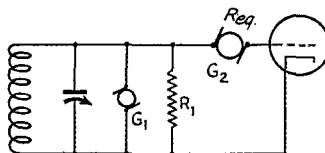

Fig. 1 — Simplified equivalent circuit for analyzing effect of various contributions to total noise.

¹ D. O. North, "The Absolute Sensitivity of Radio Receivers," *ECA Review*, January, 1942.

² "Input Resistance of R.F. Receiving Tubes," *QST*, May, 1939.

just equals the *total* noise when both signal and noise are referred to the grid circuit. Open-circuit conditions — that is, antenna delivering no power to the receiver — are specified so that different degrees of coupling can be compared directly in terms of the two significant independent quantities, the inherent antenna noise and the signal voltage induced in the antenna by a passing wave. The lower the minimum signal factor the better the signal-to-noise ratio, obviously, since a smaller signal will equal or overcome the noise.

Two limiting sets of conditions are shown, one for the case where the loading on the tuned circuit is entirely electronic, and one for the case where there is no electronic loading. These limiting conditions therefore show the effect of induced grid noise on the signal-to-noise ratio, since this type of noise is maximum when the loading is all electronic and is zero when there is no electronic loading. The curve for no electronic loading is applicable at low frequencies, where transit-time effects are negligible. At ultrahigh frequencies the extreme of all-electronic loading may be approached.

Inspection of these curves shows that, in the case where the antenna coupling has been adjusted for best signal-to-noise ratio, induced grid noise has a relatively minor effect on the signal-to-noise ratio. Its maximum effect is indicated by the spread between the two solid-line curves and is slightly more than 1 decibel in the region between $R_1/R_{eq} = 2$ and $R_1/R_{eq} = 20$. It is more important in the case where the coupling has been adjusted for maximum gain, and may reduce the signal-to-noise ratio by as much as 5 db. in the same region of R_1/R_{eq} . It is also quite obvious, and of course to be expected, that the lower the tube noise (R_{eq}) the better the signal-to-noise ratio, since the minimum signal factor becomes smaller as the denominator of the frac-

tion R_1/R_{eq} is made smaller. In the practical case R_1/R_{eq} is usually less than 10, and when the electronic loading is heavy, as is likely to be the case at 56 Mc. and above, a signal-to-noise ratio improvement of 3 or more decibels may be possible by adjusting the antenna coupling for maximum signal-to-noise ratio rather than maximum gain. The best signal-to-noise ratio is obtained when the coupling between the antenna coil and the tuned grid circuit is greater than that necessary to match impedances. Incidentally, the curves also show that very little improvement in signal-to-noise ratio is secured by over-coupling when the electronic loading is negligible, as would be the case at the lower frequencies. At ordinary communication frequencies, therefore, the coupling which gives maximum gain also gives maximum signal-to-noise ratio, practically speaking.

The effect of antenna coupling on signal-to-noise ratio is perhaps shown more clearly in the curves of Fig. 3. In the region below $R_1/R_{eq} = 10$ it is evident that the signal-to-noise ratio is improved to practically the same extent that the gain is reduced. For example, for $R_1/R_{eq} = 3$ the improvement will be 2 db. when the coupling is adjusted for maximum signal-to-noise ratio as compared to the adjustment which gives maximum gain, and the gain for this optimum adjustment also will be 2 db. less than the maximum possible. At low values of R_1/R_{eq} no appreciable improvement is possible.

Although not shown by the curves, the effect of any coupling less than that which gives maximum gain is to reduce the signal-to-noise ratio. As the coupling is decreased the signal voltage coupled in also decreases, and simultaneously R_1 rises because the circuit Q increases with looser coupling. Hence the thermal noise increases, with the net result that the signal-to-noise ratio is adversely affected.

Effect of Tubes

It is apparent from the curves that the signal-to-noise ratio is not only primarily dependent upon the ratio R_1/R_{eq} but also that the improvement possible by choice of optimum coupling increases with an increase in this ratio. At ultrahigh frequencies the tube input conductance is the factor which principally determines R_1 — the higher the conductance, i.e., the lower the tube input resistance, the smaller R_1 becomes. Even though the induced grid noise which accompanies transit-time conductance may not contribute greatly to the total noise, the tube loading (including the loading resulting from cathode-lead inductance) so drastically reduces R_1 below the values which it is possible to obtain with the tuned circuit alone that R_1 may be-

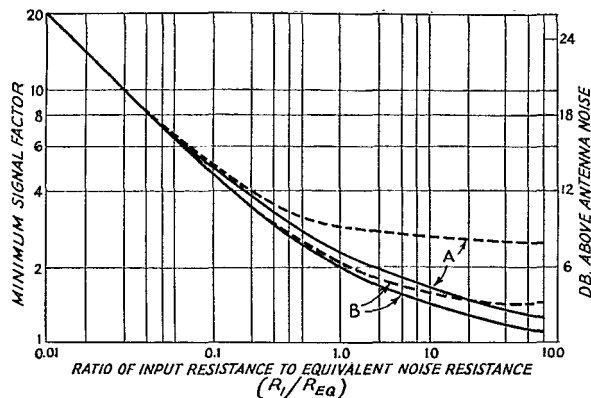

Fig. 2 — Minimum signal factor vs. R_1/R_{eq} . Dashed lines, antenna coupling adjusted for maximum gain; solid lines, adjusted for maximum signal-to-noise ratio. A, all electronic loading; B, no electronic loading.

come quite small in comparison to R_{eq} . On lower frequencies where tube loading is negligible a tuned circuit of the same inherent Q but free from tube loading would give a figure for R_1 ten or more times as high as R_{eq} . In the end, therefore, the tube, not the tuned circuit, determines the signal-to-noise ratio at ultrahigh frequencies. This is simply another way of saying that it is more or less a waste of time to build a high- Q receiver tuned circuit unless the tube with which it is used is good enough to give it a chance to work. The higher the frequency the more directly does this statement apply. Improvements in u.h.f. receivers will have to come about as the result of the development of better tubes, either tubes having a low R_{eq} — that is, low inherent plate noise — or low input conductance so that R_1 will be larger.

Using figures given in the paper, 0.003 micromhos per megacycle squared for electronic input conductance and 0.2 micromhos per megacycle for non-electronic input conductance for a 955 or 954 mixer, and corresponding values of 0.005 and 0.2 for a 954 amplifier, together with some older (and possibly somewhat too favorable) figures² for the 6AC7/1852, a few calculations give the following input resistance figures in ohms:

	56 Mc.	112 Mc.	224 Mc.
955 or 954 mixer	49,000	17,000	5100
954 amplifier	37,000	12,000	3400
6AC7/1852 amplifier	2,400	600	150

These represent the maximum possible values of R_1 when losses in the tuned circuit are negligible, including coupled-in resistance from the antenna. On the assumption that the circuit could be tuned wholly by the rated tube input capacity to give the highest possible R_1 , the maximum possible Q (in the case of the 955 mixer at 56 Mc.) would be 42 without antenna coupling. With the coupling adjusted for maximum gain the effective Q would be reduced to 21, or one-half the uncoupled value. To maintain this maximum condition the tuned circuit alone should have an inherent Q about ten times as high, or in the neighborhood of 200. Since an ordinary coil probably would have a Q in the vicinity of 100, some improvement should result from the use of a circuit of the linear type. This would be true also of the 954 amplifier at 56 Mc. In the case of the 6AC7/1852 the effective Q would be less than 5, so that even a fairly poor coil would give just as good performance as the best linear circuit that could be devised. At 112 Mc. an effective Q of 12 to 15 would obtain with the acorns, so that a coil Q of 100 would be ample. High- C linear circuits could help in providing better selectivity, but there would be no improvement in R_1 and hence none in the signal-to-noise ratio. However, should the coil Q be only 50 the

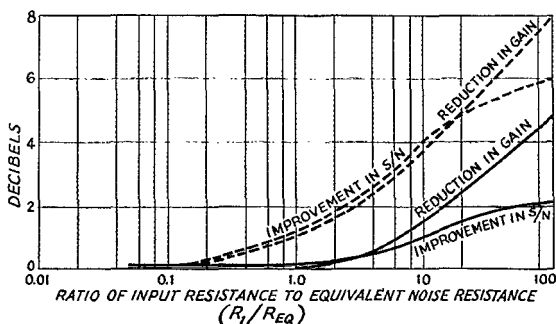

Fig. 3 — Comparison of coupling for best signal-to-noise ratio to coupling for maximum gain. Dashed lines, all electronic loading; solid lines, no electronic loading.

linear circuit should help. Practically nothing could be done about the 6AC7/1852, since the effective Q in this case would be of the order of 2 or 3.

The tabular data given in the paper show that the 955 mixer has a lower equivalent noise resistance (when the associated oscillator works at its fundamental frequency) than does a 954 r.f. amplifier. Hence a 955 mixer used as the first tube in the receiver will give a better signal-to-noise ratio than a 954 r.f. amplifier, since R_1 also is higher for the 955. R_{eq} for the 954 as a mixer is approximately six times as high as R_{eq} for either the 955 mixer or 954 amplifier, while R_1 with the 954 mixer is the same as for the 954 amplifier. The 954 is therefore decidedly not the tube to choose for the mixer in a u.h.f. superhet.

The part of the total noise output of the receiver which is contributed by the second stage is generally negligible at low frequencies, but becomes more important as the frequency is raised. The same considerations apply in determining its amplitude as in the case of the first stage, and the contribution of the second stage may be referred back to the grid of the first tube where it can be considered to be a part of a new and larger R_{eq} . The lower the gain of the first stage the more important the second-stage noise becomes, and since the gain decreases when the frequency is raised we find R_{eq} increasing while R_1 is decreasing. All of which adds up to the fact that, until tubes are developed which are capable of performance equivalent to that of the standard varieties on ordinary communication frequencies, we cannot hope to build u.h.f. superhets which are capable of the results that we now get from our communication-frequency receivers.

— G. G.

P.O.W.

It is reported that Sgm. J. B. Kay, G3CO, of Blackpool, England, is being held as a prisoner of war.



RADIOLOCATOR TRAINING

THIRTY-FIVE amateurs are receiving an intensive course in mathematics and physics, preliminary to advanced radiolocator training, at Grove City College, Penn., one of four schools selected for this purpose. They are second-class radiomen: Snow, INGG; Weiner, 1JXM; 1JMU; Prevett, 1NAL; Blaisdell, 1NOI; Grenier, 1MDL; Sudia, 2NGJ; Donnelly, 2LHK; Murnighan, 1QT; Altman, 2HXX; Mulligan, 2ILZ; Goldenberg, 2INZ; Garnier, 2AUD; Hurford, 2GYT; Weiss, 2LSW; Grant, 2LWI; 2OZL; Hall, 3HMX; Bullington, 3GKL; McMillan, 3BMA; Michael, 3JPI; Scoles, 3GFP; Pope, 3IJW; Starkey, 8MXC; Phillips, 8WRF; Tesche, 8FPH; Oncken, 8ASV; Goodwin, 8NOU; Colesar, 8VYY; Seitz, 8QFB; Shemmer, jr., 8OMZ; Fennell, 8TIG; Vergona, 8RVX; McFarland, 8JCV; KF6SJJ. In sending us the list, Hall, 3HMX, comments: "Not only the student body but the townspeople as a whole have been very cordial and friendly — seemingly almost envious of the Navy men. The course of instruction here has proven to be wide in scope and somewhat difficult, as we are receiving a college course in mathematics and physics in only three months. Those of us who are hams find we have a distinct advantage over those who have never applied theory to practical radio."

Radiolocator trainees in the Chicago area include Baker, 9FOR, and West, 9NHF, at Great Lakes; Goyette, 9PBU, at the Naval Armory; Butler, 9ZRP, and Smith, 9QHO, in the



We're a bit late with this one — Class No. 13 from the San Diego Naval Training Station. Front row: Hopp, 8ENP; Mattson, Director of School; Clark; Bray, 9YNW. Second row: Anderson, 9LRJ; Devore, 9RXS; Walgren, 9KWG; Brazda, 9TAS; Heinritz, 9ZCU; Snider, 9IRE. Back row: Parker, 8KA; Darby, 9BQM; View; Monti, 9VBW; Hoffman, 9CCU.

W9XBK school. At Treasure Island there are Wastradowski, 7JAS, Kruse, 7IZV, and Schmidt, 8SLH, besides a few hundred others we wish would register with us! Gribetz, 2OCE, and Jackowski, 2GOJ, are awaiting assignments from the Naval Receiving Barracks in Brooklyn, N. Y.

SIGNAL CORPS

ATTENDING Chicago's Crane Technical High School for six months' radio technician training for the Signal Corps are Morterud, 9FPB; Hanson, 9WRE; Foral, 9NGE; Slapansky, jr., 9RTD; Podach, 9NRQ; Puotinen, 9SVB; Bresette, 9YYL; 9ZKP; 9MHY; Schuessler, 9UUL; Erickson, 9MEE; Watt, 9HYQ; Beer, 9UTU; Malia, 9JAI; Ostergaard, 9ILR; Horwitz, 9TNV; Ricks, 9QMJ; Kloer, 9SZB; Warren, 8JYL; Draper, 8TOY; Stroh, 8PAD. Instructors are Liska, Whiteman, MacIntosh, Sterenberg and Andrus.

Ft. Monmouth almost deserves a subtitle of its own, this month. In civilian status in the Laboratories we find Torreti, 3BAQ; Waite, 3HKO; and Marshburn, 4AEL. In the various training battalions for operators and maintenance men are Pvts. Woosley, 5EIJ; Held, 2KLD; Moss, 4HYW; VanDeraa, 9GJV; Agaloff, 6PSW; Greenberg, 2LTP; Wilkinson, 9GSD; Corbett, 1JLL; Britner, 1JZV; Page, 4DVJ; and Petty, 3HAZ. Instructors in the Officer Candidate Department are Captain Kenworthy, 3IBJ; Lt. McGalliard, 5JRU-2ONM; Davis, 5FJM-2OOX; Goodwin, 6FPP; Schissler, K5AF.

At the new Signal Corps school at Camp Crowder, Mo., we find Pvt. Herman, 6URB; Davison, 9FSX; and Tomblin, 9ULO. Tomblin, incidentally, had the misfortune to be on the troop train struck by the "Will Rogers" — in case you remember reading about it in the papers — but was uninjured. Pvt. Erdmann, 2MZN, is in signal work at Fort Dix, N. J.; Davis, K7DIS, at Nome, Alaska; Robb, 9BHA at the Portland, Oregon, Air Base; Dickinson, 9TFW, and Maruszar, 9TXV, at Ft. Jay, N. Y.

Major Mead, jr., 2OP, is assistant signal officer of the First Air Force, Mitchell Field, N. Y. Lt. Brown, 4HRZ, serves with the 3rd Sig. Svc. Co. at Fort Devens, Mass. Congratulations to Nye Elward, 3JJO, recently promoted from Major to Lt. Col. as Commanding Officer of the 64th Sig. Bn., Fort Meade, Md. Lt. Coleman, 8OP, instructs in electronics for the Signal Corps at Harvard University.

With the 40th Sig. Co., San Diego, Cal., area,

are Sgt. West, 6QLO, Corp. Johnston, 6MZQ; and Pvt. Paup, 6TRD; Taylor, 6UOF; and Dewig, 6KPD. Pvt. Wilson, 9DXT has signal duties at Barksdale Field, La.; Schroder, 2MVU, at Camp Gordon, Georgia; Husting, 9RSR, at Camp Grant, Illinois; and Sivo, 3HWT, in the Panama Canal Zone.

NAVY

Lt. (jg) LELAND, W9MRW, and former SCM Oliver, 6KOL, are receiving electronics training at Harvard University. At Bowdoin College, Maine, for the same purpose are Ens. Matthews, 9AAH; Lt. Mumford, 7AZX — who, as 7ZJ, was a Navy electrician first-class in 1917. Ens. Milius, 2NJF, is in the office of Chief of Naval Operations, Washington. After serving a period as code instructor in Los Angeles, Rm3c Falls, 6FTV, was commissioned as Ensign and sent to London, England. Ens. West, 4APA, has been ordered to active duty, awaiting assignment. Lt. Dean, 4HNZ, is with the Coast Guard patrol in Boston. Lt. (jg) Gaynor, 2AZM, Communications Officer of the Navy Port Director's Office in New York, keeps a bug and oscillator on his desk to keep from getting rusty with the code. Lt. (jg) Plage, 4DQT, is stationed at the Naval Air Station at Corpus Christi, Texas, as a ground school instructor. Also at that station are Rm2c Hicks, Jr., 4BUD; Pagett, 4FYC; Sims, 5GKG; Miller, 5DED; Pfrehm, 5DUT; Mullins, 5IYT. Lt. Jack, 6FPW and Lt. Miller, 6DXG attend the Naval Academy at Annapolis, Maryland.

The government censor's office requests us not to link the names of men with their ships, so we can only tell you that the following amateurs are operating aboard naval craft: Rm2c Smith, 7GYT; Axelrod, 2MRV; Christian, 1DNM; Judkins, 7FHW; Rm3c Miller, 5CMQ; CRM Feeley, 1ADW; Rm2c Briggs, 2NUC; Rm1c Gose, 7WC; Yoka, 8SKK; Glasel, 9FCZ; Flanders, 1KTQ; Corby, 1LGT.

Assigned to land duties are Rm3c Rogers at the Naval Base in Newport, R. I.; Rm1c Guile, 1EBO, Winter Harbor, Maine; Rm1c Quarles, 2NVP, New York City; CRM Littlefield, Jr., 1DUK, Portland Section Base, Maine; Rm3c Archibald, 1NBP, Boston, Mass.; and Rm1c Whittaker, 7TK, instructing at the NTS at Los Angeles, Calif. Others "in the Navy" are Mortan, 6LSF; Cobb, 6HIB; Hodge, 6RFO; Wright, 6QYP; and Scranton, 6UGV. Ens. Scully, 6SSV, is a Naval pilot. Kerr, 3CCC, is now at the monitoring station at Amagansette, L. I. In the Ma-

From information received from a reliable government source in Washington, the number of amateurs in service in the Army and Navy on March 15th, by actual count of the records of the armed forces, was 14,813.

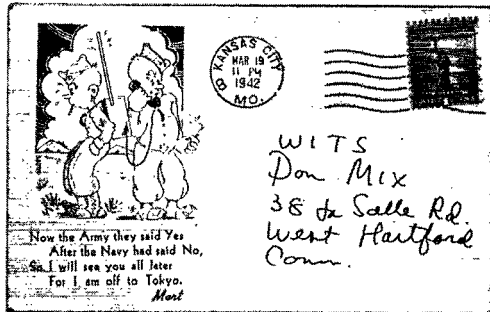

Merton Meade, 9KXL, used this novel way of announcing his departure for active duty.

rines are Pfc. Smith, 9NDO, and LaSaine, 6TYD.

We regret to record the death of Radiomen Joseph Ivantic, 9DWT, and brother Paul Ivantic, killed in action.

ARMY, GENERAL

At Fort Lewis, Wash., Lt. Morse, 6VD; Tech. Sgt. McGill, 3JQF; Goldstone, 8MGQ; and Pfc. McMurray, 7GXN, are assigned communications duties. Fort Knox, Ky., boasts Staff Sgt. McKenzie, 9YUW, and Pvt. Corbett, 8HKV, and Rules, 9FJH. Selectee Pollock, 8POZ, is assigned to chemical warfare service at Edgewood Arsenal, Md. Selectee Knight, 3GAH, is at Camp Wheeler, Ga., awaiting assignment. At Fort Bragg, N. C., are Staff Sgt. Swisher, 5JTQ, instructing, and Pvt. Hayden, 3IWS. Kuble, 9TEQ, attends radio school at Clinton, Ontario. Chief operator on a "GI" transport is Richards, 9GDK.

Amateurs assigned to American units moving to Great Britain will appreciate the warm welcome extended by the R.S.G.B. The headquarters address is 16 Ashridge Gardens, London, N. 13. Says Secretary Clarricoats, "I feel sure your boys over here will be glad to drop us a line on reaching G even if they cannot get to London." Data are available from the headquarters office on times and places of local club meetings.

Classes in the Field Artillery School of Communications at Ft. Sill, Okla., include a number of amateurs, many of whom will be retained as instructors upon graduation. In Class 17 are Pvts. Bartz, 9YXJ; Panosh, 9VMZ; Porch, 3JKP; Alterman, 2MVF; Clinton, 8STP; McGee, 9RAL; Maleski, 2IJE; Tech. Sgt. McNeil, 4HYU; Mstr. Sgt. Allen, 4EEP; Sgt. Kahmer, 3FJD. At the Coast Artillery School of Ft. Monroe, Va., are warrant officer Brashear, 3JKE-K5AA, and Lt. Kirkwood, 4FFO. "Out again, in again" is the story of Tech. Sgt. Sweeny, 9CZB, temporarily released on the "over 28" rule, now back as an instructor at Camp Forrest, Tenn. Irving, 9GQO, instructs in radio at Lexington Field, Ky. Master Sgt. Bartges, 3HOA, is assigned to the 65th Med. Regt., Ft. Oglethorpe, Ga.



EXPERIMENTER'S SECTION

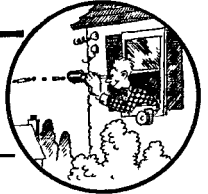

Address correspondence and reports to ARRL, West Hartford, Conn.

WELL, gang, the Experimenter's Section got off to a fine start this month, with responses to the various projects streaming in from all parts of the country. All it required was a little push to get things started in a big way. It now seems very probable that we'll soon hit upon some method of communication which we can use as a substitute for radio (in case we have to) in our emergency set-ups — and in the meantime have the satisfaction of developing it.

At this date, the largest group registering is for work on Project A — communication by means of carrier current. This undoubtedly is the result of By Goodman's article in the March issue. However, plenty of interest is evident in every one of the experimental projects listed. Especially enthusiastic is the group working with light-beam communication. Preliminary reports seem to indicate that their enthusiasm is well founded. Group Leader Bourne is devoting his space in this section this month to a brief outline of the principles involved in light-beam communication. He also turns in the article by W6PCB to be found elsewhere in this issue.

We have some notes and discussions on other projects which are getting under way, too, so let's call the meeting to order.

PROJECT A

Carrier Current

REGISTRATIONS for work with carrier current have come in from all of the nine U. S. call areas as well as VE4. Robert Meagher, 157 Boston St., and Thomas Reid, 8 Ober St., both of Salem, Mass., have worked two-way over a half mile with as little as 4 watts input and have worked one-way for two miles with 20 watts input. Both have 6L6 transmitters and are now building modulators for them. They mention some trouble with fluctuation in house lights when power above 15 watts is used. Capacities of 0.1 μ fd. connected across the affected lamps may reduce this trouble. They report that several other fellows in Lynn are busy building gear and that they hope to have a net going there soon. W8RLI has succeeded in picking up W8WIF's signals at a distance of $\frac{3}{4}$ mile. W6ULE is building a rig for that 809 that he walked all over L.A. to find on December 6th!

W6NRM suggests that f.m. may be used to overcome noise, although the number of channels available seem to be too limited for any extended use of f.m. VE4ADU reports that five club members in Calgary are building *QST* transmitters. W8VXN is setting up a carrier-current emergency system for the Buffalo Technical High School. The transmitter consists of a 117L7GT oscillator modulated by a 6G6G, while a simple regenerative receiver is used. W8ESN reports that 60 members of the CARSMARS are forming a carrier-current net for emergency work.

W7FRA warns that any carrier-current system should not be regarded as a "private" line, because harmonics may readily be picked up on near-by broadcast receivers. So be careful what you talk about! W7FRA, who has worked with carrier equipment, says that under favorable conditions it has been possible to cover distances up to 70 miles with 3 watts input to a 59!

Many others have registered and are engaged in building gear for the project.

In response to several inquiries, a license is not required for carrier-current work. Radiation is not permitted, of course. If the field strength of the signal does not exceed 15 μ v. per meter at a receiving antenna removed about 900 feet (for a frequency of 170 kc.) from power wiring which



W2ACB of G. E.'s Research Laboratory in Schenectady adjusting a three-ampere arc-light beam. This apparatus was used several years ago to carry President Roosevelt's voice from the top of Whiteface Mountain to Lake Placid, a distance of about eight miles; similar apparatus, using a seventy-five-ampere arc, has covered a distance of thirty-two miles, limited only by the curvature of the earth.

may be carrying the r.f., it is probably safe to assume that radiation is not taking place. — D. H. M.

PROJECT B

Light Beams

PRACTICALLY every sea-going boat is equipped with the well-known "blinker" system of communication. It is an obvious method of communication using a ray of light. In its simplest form it is non-directive and very wasteful of light energy. Nevertheless it is used over distances of several miles at night.

During the last war, Professor Wood of Johns Hopkins developed a highly-directive light-beam communication system using a telescope, an automobile lamp and an eyepiece. His lens was a magic lantern projection lens, probably of relatively short-focal length. Fig. 1 shows a schematic of this system.

The fundamental principles involved are as follows: The lens has a definite focal length, which may be measured as the distance from the center of the lens to the image of the sun when, for instance, the lens is used like a burning glass. The light from the sun comprises substantially-parallel rays, and if a small source of light is placed where the sharpest image of the sun is formed, that is, at a distance away from the lens equal to the focal length of the lens, the light from the small source will leave the lens in substantially-parallel rays and can be directed at a receiving location with remarkably-small spread. The eyepiece, which is a small magnifying lens, is placed as shown and adjusted so that the filament of the lamp is in sharp focus. The eyepiece and lamp are then simultaneously moved with respect to the objective lens (or front lens) until the receiving location is in sharp focus, as seen through the glass bulb of the lamp. The distant scene will be upside down as viewed in the eyepiece, and the filament will show against the distant target. If we had a perfect optical system, the only place where the light could be seen at a distance is where the filament appears to be projected against the target. As a matter of fact, in Hartford we have set up a two-way system over a distance of one mile and attained spreads of about three feet. It is a weird sensation to see

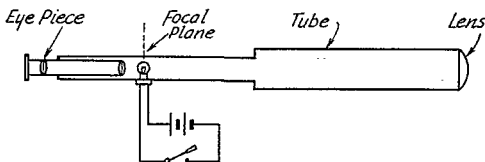

Fig. 1 — Light source in place in telescope used in simple light-beam communication experiments.

the powerful blinker system, in daylight, then move a couple of feet to one side into a region where it is invisible. We use 2.5-volt flashlight bulbs on two dry cells and key the filament. Ten words a minute at first is good going. The brighter the light, the faster one can receive. We do the receiving with or without the telescope. It is a little easier on the eyes without the 'scope, if the light is bright enough. Fig. 2 shows what is seen looking through the eyepiece. Don't light the

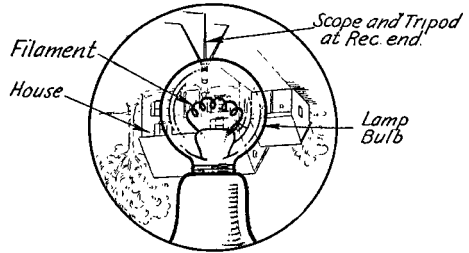

Fig. 2 — Light source and receiving point as seen in the eyepiece of the telescope.

filament while looking through the eyepiece, as you may damage your eye. The sharpness of the scene is somewhat wrecked by the necessity of looking through the small bulb, but is ample for adjusting. The telescope must be held rigidly.

For a given focal length and given lamp, the received brightness will vary as the square of the aperture of the lens. A three-inch diameter lens will yield nine times as much light as a one-inch lens. Small but bright lamps should be used. The spread is directly proportional to the size of the light source and inversely proportional to the focal length. Large filaments result in useless spread. Some gain in selectivity is obtained by orientating the filament so that the plane of the filament lies in the axis of the 'scope. A single straight short filament would be best of all.

We used actual telescopes in the tests, but there is no need to have expensive instruments to do a good job. Excellent results can be obtained from the simplest of equipment. Your local optician will have unfinished spectacle lenses in stock, probably costing less than a dollar (ours was 75¢). Ask for a "2-diopter" plano-convex lens (one side flat, the other 2 diopters convex). If he does not have one like that, a double-convex lens (both sides convex, each one diopter) can be used as a second choice. The term *diopter* is simply a measure of the focal length. A 1-diopter lens focuses at about 40 inches, a 2-diopter lens at about 20 inches. If you can find an old spectacle lens with a *positive* cut (generally used for far-sighted persons), it will serve just as well. You can determine its focal length by using it as a burning-glass and measuring the distance from the ground at which it focuses the smallest circle of brilliant light (actually, an image of the sun) on the ground. If the lens will not so focus a sun

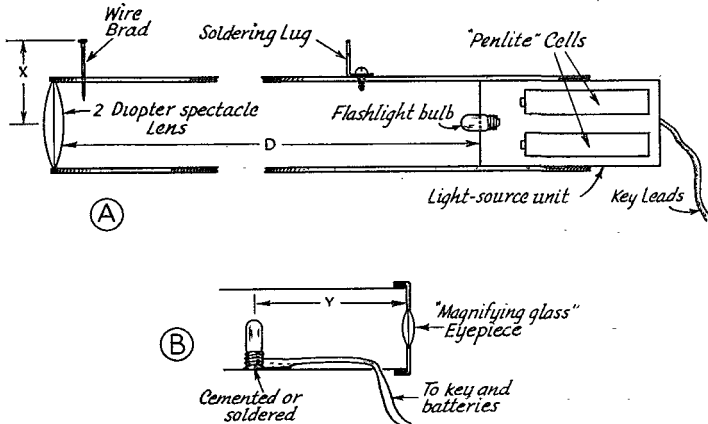

Fig. 3 — A—"Schematic" of the light-beam transmitter. The simplest light source is shown in position in the tube. At B is illustrated the preferable unit giving more accurate control of the beam's direction. Distance D is the focal length of the spectacle lens — about 20 inches for the lens shown. Distance Y is the focal length of the magnifying glass or "linen-tester."

image, it is doubtless a *negative* cut (for near-sighted persons) and is not suitable for the purpose.

Get a mailing tube of the approximate diameter of the spectacle lens and as long as its focal length (20 inches in the case of the 2-diopter lens). With a rag or milk-bottle brush, coat the inside with a dull-black paint (lampblack is excellent), or form a cylinder of dull-black paper and insert it in the tube. Fasten the lens to one end of the tube with Duco cement, or preferably by some mechanical support such as the threaded flange of an old flashlight since this will facilitate removal and cleaning of the lens.

For the light-source unit (see Fig. 3A), get a small tube shield, split it lengthwise and spring it to a larger diameter so friction will hold it to the inside of the mailing tube. Then mount a couple of "penlite" cells and a small flashlight bulb of the proper voltage as shown in the sketch. This little unit will slide inside the mailing tube, allowing you to get the bulb's filament at the exact focus — distance D.

A mechanical sighting system can be rigged up by the use of a small wire brad (the head for the rifle-sight bead) and a soldering lug (the smaller hole for the sighting field). Tack the brad into the mailing tube at the lens end, allowing about one-half inch to remain visible. Fourteen or so inches to the rear drill a small hole and use a self-threading screw to attach the soldering lug, bent into an "L" bracket. To calibrate the sight, turn on your light-beam system in a dimly-lighted room and point the spot at a far wall. Then adjust the height of the brad head so that, by sighting it through the tiny wire hole of the lug, it is aimed at a point above the spot by a distance equal to the distance between the head of the brad and the axis of the mailing tube (distance X, Fig. 3A — probably two inches in the average case). If you were to adjust the sights directly at the spot in such a short distance, it would be quite inaccurate at longer distances.

Correct adjustment, as described above, will give a theoretical maximum error of two inches at any distance.

A much more convenient light-source unit is shown in Fig. 3B. Utilizing a magnifying eyepiece, it helps immeasurably in pointing the beam exactly where you want it and makes the mechanical sighting system unnecessary. It may be substituted for the light-source unit shown in place in Fig. 3A. Any small magnifying lens of good quality (no flashlight lenses, please!) will suffice. The "linen-tester" type is excellent and the cost at an optician's is less than a dollar. Get a coil form or tube shield or some cylindrical piece which will fit snugly inside the mailing tube; you may have to wrap a layer or two of adhesive tape around whatever you choose to make it fit. Using glue, solder or some alternative mechanical scheme, mount the eyepiece at one end of the cylinder and the flashlight bulb inside it at the focal point of the *eyepiece* (distance Y) which you can easily determine by moving the bulb back and forth until the filament is in exact focus as seen through the glass by your eye. Now the entire cylinder assembly may slide back and forth inside the tube, and actually you have a crude telescope.

When focussing on a distant objective, viewed through the lenses, the center of your projected beam may be accurately known from the position of the bulb filament superimposed on the distant scene. Don't be surprised when you find the image upside down; remember your study of lens systems in physics. In communicating, the transmitter must be supported firmly to prevent *shimmying*; this is important since the field is so narrow. Scout up an old camera tripod if you can. With such an arrangement, signals can be seen easily at night at a distance of five miles. For receiving code signals the naked eye or a pair of field glasses can be used.

We have carried out some experiments with i.c.w. over a short distance, using an interrupter

disc in front of the lamp and a photocell at the receiving end, feeding an audio amplifier and 'phones. Results indicate that it should be a cinch to use this system over distances of a mile or more, using fairly good telescopes. We hope to have a complete report on this in the next issue.

Elsewhere in this issue is an account of experiments using voice modulation on an ordinary hand flashlight. We have tried this scheme on a small scale indoors and can verify that it works! The speech quality was unexplainably good.

We have in the works an experimental set-up involving modulating the light by means of a voice-coil-driven variable slit. This requires some mechanical ingenuity and we have no simple dope to offer at the present writing.

It is suggested that those seriously interested in optical systems and simple telescope making, purchase *Amateur Telescope Making*, published by the Scientific American Publishing Company, New York, price \$2.50.

Everyone who has witnessed our blinker system in operation has been greatly impressed with the small field, brightness of the flash and low power (less than one watt).

— R. B. Bourne, W1ANA, and John Huntoon, W1LVQ.

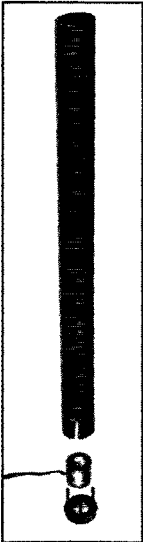

The parts for a light-beam transmitter are easily obtained and assembled. Components are here shown in "exploded" view. The flashlight bulb may be plainly seen in the aluminum shield can which, when assembled with the eyepiece, slides inside the mailing tube for focusing purposes. Slots were cut in the tube to permit use of the "linen-tester" magnifying glass as an eyepiece without removing its tripod legs. The mailing tube houses a spectacle lens, at the top in this view.

At right is shown a less-desirable but simpler light source with self-contained power supply, use of which necessitates mechanical sights as described in the text.

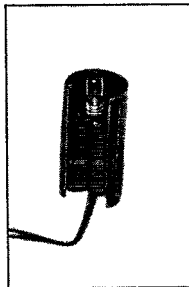

PROJECT C

A.F. Induction Fields

THE only report we have so far on the practical aspects of communication by audio induction is a letter from WSATF, who is doing some work with it. Thus far he has been able to cover several yards, using only miscellaneous coils which happened to be available. With more specialized equipment he hopes to cover a considerably greater range.

PROJECT D

R.F. Induction Fields

TO DATE we have six experimenters enrolled for work with r.f. induction fields. Since the publication of the basic information in the April issue, several pieces of equipment (20-kc. converter, etc.) are under construction.

The question has arisen as to the project classification under which college and (in future, presumably) community "radio" networks come. Initially it was considered that these constituted "carrier-current" or Project-A work. However, Alvin Eurich, W7HFZ (ex-WCFT-W1OXDA), argues that this is also induction, in that the "final jump" is by means of the inductive field. Citing his work with such a system at Williams College, W7HFZ says:

"I had hopes of working out a wired system of carrier-current communication over the a.c. lines to pick up remote programs for the college. After we laid over seven miles of wire to cover just three points we soon gave it up, however. . . .

"The system finally installed at Williams was an interesting affair. The problem was an unusual one in the first place in that the campus was spread out over an area of several miles. The first approach to get coverage in all parts was to use glorified phono oscillators with the output coupled into the steam-heat pipes near the tops of the buildings. The disadvantage of this system was that there was enough leakage from one unit to another to cause interference of a heterodyne nature on sensitive receivers. This system was changed to one where a complete r.f. unit located at the studio was modulated and the r.f. then wired over our own system to the various buildings, and there fed into a Class-A r.f. amplifier which was coupled into the heating pipes. This resulted in a good program, with no heterodyne from one unit to another. In fact, various units would add to each other."

We hope to have a detailed story on this type of operation in a future issue of *QST*. In the mean-

time, W7HFZ emphasizes two points of caution: The first is to make sure the radiated field falls within the specified limits (April, 1941, *QST*, p. 28); the second, to go easy on the broadcast band. "B.c.l.'s are very touchy!" he warns. — C. B. D.

PROJECT E

Acoustic Aircraft Detection

IN REFERENCE to the article describing the aircraft detector in March *QST*, several readers have referred to a statement in a recent issue of *Reader's Digest* that acoustic systems for aircraft detection are useless because of the relatively small difference between the speeds of sound and aircraft flight. This difference, however, has no bearing upon the purpose for which the unit described in *QST* was designed. Observers in the Aircraft Warning Service are interested primarily in knowing when enemy aircraft is in the immediate vicinity of one of the observation points. They customarily make these observations by ear, unless it is possible to locate the plane by sight. The amplifier is intended merely to provide means of detecting the presence of aircraft in the vicinity of the observer's post without the necessity for remaining out-of-doors continuously.

Acoustic systems also have another use in which the time-lag factor plays no important part. This is in determining the course of approach with a directive system. With such a directive system, the observer notes the change in bearing of the sound over a period of time. If the horizontal bearing changes this indicates that the approaching aircraft probably will not pass directly overhead. On the other hand, if the horizontal bearing remains unchanged, while the vertical bearing increases, this is an indication that the observer is on the course and bombing may be expected. In this way, factories in England equipped with acoustic systems have been able to work with far less interruption than those which depend solely upon government regional warnings.

We have been advised that mail to Mr. A. E. Hayes, Jr., Group Leader for this section, should be addressed to him at 1315 Commonwealth Ave., Boston, Mass., instead of the address given in the April issue.

PROJECT F

Supersonics

REGARDING the re-born "Experimenter's Section" project on supersonic communication, I thought it might not be amiss to offer a few com-

ments on some work I started just recently in this field — with the same object in mind as the ARRL Hq. gang — and perhaps I might even be rash enough to offer a few prophecies based on very incomplete evidence.

So far, the work at W2AER has consisted of building the most sensitive detector for sound waves just above the audible range that I could make with standard parts. After a few Sundays of playing around, the present stage of things is as follows: An Astatic N-30 crystal mike is coupled in usual fashion to a 6AC7 amplifier with a plate load consisting of an 85-mh. coil tuned by a 0.0007- μ d. condenser. This output voltage is fed to the signal grid of a converter tube, which just happens to be a 6A8. The oscillator section works at 400 kc. and the converter-tube output is loosely coupled to an HRO receiver tuned to 380 kc. If coupling is too loose, the receiver noise level will predominate, but if tightly coupled the 400-kc. carrier will be so strong as to cause overloading. To minimize this, the oscillator portion of the 6A8 is run at lower than usual plate voltage, and a crude balancing system was used to balance out most of the 400-kc. signal. A balanced modulator would be more elegant, but was not installed because the present set-up has a noise level almost entirely created in the first amplifier tube, and no improvement is needed.

In regard to signal-to-noise ratio, the noise due to thermal agitation in the microphone load resistor is inversely proportional to the square root of the resistance, and about equals the 6AC7 noise if the resistor is $\frac{1}{4}$ megohm and frequency is 20,000 c.p.s. By making the resistor several megohms, the tube contributes most of the noise. On paper, the situation can be improved by connecting the microphone to a step-up transformer, but none made is good enough. Several tubes might be used in parallel for the input stage, or the microphone capacitance might be tuned with a parallel inductance on the order of 80 mh. of very high Q . But average coils are not good enough and they also pick up long-wave commercial stations unless very well shielded. Theoretically there is no limit to the improvement obtainable, but practically only a few-fold improvement might be possible by taking great pains.

The best type of microphone available seems so far to be the crystal-diaphragm type. Theoretically, one might think some sort of microphone relay action, such as a condenser mike unbalancing a bridge circuit, or varying an oscillator frequency and using an fm. detector, would be of use, but the variation obtained will be so small that it becomes thoroughly impractical. If one can go into the microphone-building business, I suspect that a big improvement would result from use of resonance; e.g., the sound source described by St. Clair in the May '41 *Review of Scientific Instruments* used as a mike, or a reso-

nant bar with crystal pick-up attached. The ultimate limit will be when thermal agitation of the air molecules becomes the chief noise source. I do not know how far this noise level lies below the noise level of my present equipment.

The present set-up is roughly as sensitive as the ear at the upper audible frequencies. At 20 kc. we can pick up the sound of coins jingling or dog whistles anywhere in the house, birds twittering at 20 kc. (about their top frequency) at over a hundred feet. Many unsuspected noise sources are disclosed, the most impressive being metal objects, frictional noises, sibilancy of speech, crinkling cellophane, tinfoil, etc.

My future program for spare Sundays includes rigging up a 20-kc. oscillator, amplifier, and usual speaker to see what can be done with simple equipment. Then I hope to build a more powerful sound source of the type described by St. Clair, for which he claims 50 watts of *sound* output, and also a pair of carefully-figured parabolic reflectors, which would seem to be better than horns for this purpose, and, thirdly, some microphones using low-loss resonant bars. John Dyer, also of the CBS television department, is quite interested and has a lathe which will be useful.

As to predictions, this type of propagation is characterized by attenuation of so many db. per unit of distance (you can find the figure in handbooks) so that every ten-fold increase in power, sensitivity, directivity, and selectivity will result in an extension of the range by a disappointingly small amount. Contrast this with radio or light propagation in a line-of-sight path where a four-fold power increase doubles the range. The range will always be quite limited, therefore, although some interest will be added by the expectation that freak weather or topography may give quite large undeserved increases in effective power. As to what the limiting range is, I am entirely unprepared to guess, but I will guess anyway that since a locomotive whistle can be heard several miles with the whistle as a source, the ear as detector, no directivity or selectivity to speak of, and attenuation not so very much less than at 20,000 cycles, we might get a range on the order of a mile with good equipment, and probably a quarter of a mile with simple equipment. Even simple mikes and speakers have a quite directive pattern at this frequency.

The investigation will be very entertaining even if nothing ever comes of it!

—John Hollywood, W2AER.

PROJECT G

Earth-Current Communication

A PROMINENT amateur on the West Coast writes as follows:

"I notice by March *QST* that the gang is embarked on a program of communication by gas pipes, sewers, light lines, barbed wire and blinkers. This is swell. But I've got still another suggestion.

"A few years ago, in the process of some geophysical research, I put a couple of electrodes in the ground about 1000 feet apart and connected output of a 300-watt modulator across them. It required rematching the impedances, of course, because the resistance between the stakes was only a few hundred ohms.

"The receiving point was about two miles away, and the equipment consisted of a good audio amplifier, level measuring equipment and provision for inserting various filters into the lay-out. The pick-up was also a couple of electrodes, with provision for varying the spacing and trying several configurations for directional effects. The impedances between the network of electrodes and the grid of the first amplifier tube was matched and phased by ordinary audio transformers of the line-to-tube type.

"The low frequency a.c. impedances between electrodes is approximately the same as for d.c. so long as one keeps the d.c. current low. With high d.c. currents, one may get into polarizing difficulties. For all practical purposes, however, the resistance as read on an ordinary serviceman's d. c. ohmmeter is the equivalent of the low-frequency a.c. impedance. At high audio fre-

(Continued on page 96)

Strays

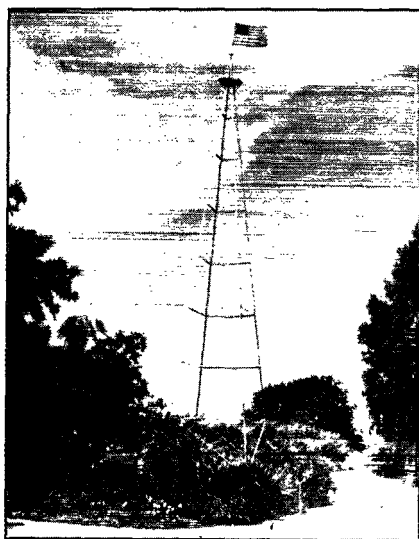

Old Glory replaces the beam on W6AK's tower. This is the second time that he has lowered his antenna because of war!



ARMY-AMATEUR RADIO SYSTEM ACTIVITIES



War Department, Office of the Chief Signal Officer, Washington, D. C.

There have been numerous attempts to present a case in favor of operating privileges for selected amateurs since the issuance of FCC's closing Order No. 87 on Dec. 8th. Active enthusiasm for most of the proposed plans could not be initiated because they were not coordinated with the civil defense plan, which would cause continuous confusion by the injection of new ideas, policies and programs as the national effort gained momentum. Therefore they were of little more practical benefit than an echo.

The DCB has indicated to the Office of Civilian Defense that it will be receptive to a well coordinated plan for the use of amateurs in civilian defense. An outline of such a plan has been submitted to the Coordinating Committee. The Chief Signal Officer has received hundreds of inquiries from amateurs requesting information as to how they could be most useful during the emergency. Some of them indicated they would like to sell their equipment, some submitted plans of utilization, while others attempted to issue "friendly advice." This column will have served its purpose if answers to the above questions are given.

The communications effort has now reached a stage where its details are so varied and so numerous that it is difficult to determine which phase is most important. Space and time do not permit a discussion of each, so for sake of brevity, let's be satisfied with statements of fact.

CAPABILITIES

The Chief Signal Officer is aware of the potential capabilities of the amateur radio operator and his equipment. However, communication security requirements necessarily come first. Strict enforcement of security regulations may prevent eventual legislation to conscript, seal or pool all the physical facilities of amateur stations which might prove useful to the enemy for aircraft position-finding.

SALE OF EQUIPMENT

A number of amateurs have offered their equipment to the government for the duration of the emergency, while others have offered to sell their equipment to the armed forces or anyone else that could pay their price. Answers to the above questions respectfully are: while your government greatly appreciates your genuine patriotism in offering your equipment, it is not considered economically sound to accept a variety of transmitters and receivers that would require a store-house of varied replacement parts, ultimate objective being a minimum of types.

If you must sell your equipment, be sure of the purchaser, be sure that your amateur facilities will not be subverted to the use of "fifth columnists." It is hard to imagine anyone buying amateur equipment at this time for strictly defense purposes.

HOW TO AID YOUR COUNTRY MOST

In the affairs of men and nations there must be "firsts." Preparing ourselves for duty in a position of need is the amateur's "first" to-day. Important in Signal Corps activities is the need for an abundant supply of radio operators and technicians, and this end can be accomplished only if each of us finds his most useful spot and does his utmost to assist the national effort. Because our "rigs" have been put aside to permit government facilities to function, we are not going to sit back and "brood." Those of us who prefer to operate will enlist in the service as operators, while those who are technically inclined will enlist as technicians. Recently the Chief Signal Officer received a letter from a Blairstown, Iowa, high-school youth, who stated that he and his class "would like to do their part in the war." In his answer to the youth, Major General Dawson Olmstead said, "Actually the way you can help most is by making radio technicians for the Signal Corps out of yourselves." During World War I there were approximately 5000 amateurs in the military service. Records of this office indicate that at present there are in excess of 12,000 already in the service in this war and, *if we don't have your name yet*, better see your recruiting officer, join your pals for a personal QSO, and get on the Honor Roll.

HOW YOU CAN PLACE YOURSELF TO BE OF MOST BENEFIT

If you are of military age, physically fit, and not bound by marital ties, you can enlist in the Signal Corps as radio operator or technician by presentation of your operator license to the recruiting officer. Or if you have the educational qualifications (either a degree in EE or its equivalent in technical knowledge and practical experience) you may apply direct to the personnel section, Chief Signal Office, stating your qualifications. You will then be in a position to be interviewed for possible future assignment to the Electronics Training Group and a commission in the Signal Corps.

If you are not in position to accept military service by reason of physical defects, marital ties, sex, age, or for any unmentioned reason, you

can either apply to your local civil defense board and state your case, or contact your C. A. Signal Office (page 31, February *QST*) for possible assignment as radio operator in Civil Service. If for any reason you prefer the Navy, the Marine Corps or the Coast Guard, then by all means go to their aid. Just remember that the services need you, and if I know my hams — and I think I do — *you'll be there.*

THE COÖRDINATION BRANCH

AMERICAN inventive genius has brought forth so many new types of radio signaling equipment that the Signal Corps has set up a special branch for the purpose of reducing its communication system to a limited number of standardized models.

The new Communication Coördination Branch is headed by Colonel David N. Crawford, one of the Army's leading radio specialists. Colonel Crawford comes to the assignment from a tour of duty with the air defense activities of the Air Force Combat Command. His instructions from Major General Dawson Olmstead, Chief Signal Officer, are to reduce the number of types of equipment to a minimum consistent with the requirements of all the Army's arms and services.

In order to reconcile the communication requirements of all the fighting arms, these arms are represented by specially qualified officers on the Army Communications & Equipment Co-ordination Board. This board includes representatives of the Infantry, Field Artillery, Cavalry, Coast Artillery, Air Corps and Armored Force, as well as the Signal Corps. Also on the board are liaison officers from the Navy, the Marine Corps and the armed forces of the other United Nations. Considerable progress has already been made in coördinating the equipment of Great Britain and the United States, utilizing the best features of inventions developed in the laboratories of both nations.

A major task of the new branch is to recommend the frequency bands to be allotted to the various arms and services. This task is similar to some of the controls exercised by the Federal Communications Commission in respect to the activities of commercial companies. In the case of the Army the problem is complicated by the fact that the transmitters are for the most part not fixed geographically like those for a civilian broadcasting station. Instead, thousands of them are in rapidly moving airplanes, tanks and other vehicles. It is the problem of the Signal Corps to keep those transmitters functioning without interference that would disrupt the Army's lifeline of communications. A third function of the branch is to insure uniformity of procedures for using the equipment in the field, to the end that all elements of the Army may work together as combat teams and enjoy speedy and thoroughly co-ordinated communications.



THE lightning has struck and we are at war with Germany as the May, 1917, *QST* appears: "War has come to our good old Star Spangled Banner, and all the sacrifices we have dimly dreamed in the past are now up to us to make." By presidential authority, the Navy's District Communication Superintendents have ordered the immediate closing of all stations, both transmitting and receiving; antennas lowered, apparatus disconnected from aerial and ground and otherwise rendered inoperative. The League has placed its services and resources at the disposition of the government. All amateur traffic is halted where it happened to be. The League's president and general manager have been called into consultation to help secure both operators and apparatus, and members are asked to "Step up promptly and get into the game with the spirit and snap for which the ARRL is famous. If we cannot work our own stations, we can easily enough work one of Uncle Sam's." Meanwhile the Editor tentatively drops *QST* to 48 pages to offset the temporary decrease in revenue, because many advertisers cannot continue.

The League is three years old, had grown lustily, and on the very eve of war has perfected its national organization with the help of many of the best-known amateurs of the country. The first formal constitution has been adopted on February 28th. H. P. Maxim, 1ZM, and C. D. Tuska, 1ZT, continue as president and secretary, respectively. A. A. Hebert, 2ZH, has been elected vice-president and general manager, and C. R. Runyon, Jr., 2ZS, is the treasurer. Directors already elected consist, in addition, of J. O. Smith, 2ZL; R. H. G. Mathews, 9ZN; J. C. Cooper, Jr.; F. M. Corlett, 5ZC; W. H. Smith, 9ZF; H. C. Seefred, 6EA; V. F. Camp, 2RL; H. L. Stanley, 2FS; W. T. Fraser, 8VX; W. T. Gravely, 3RO; Theodore E. Gaty and Miller Reese Hutchinson — with others yet to be elected from large centers. League divisions appear for the first time, six of them, with division managers to supersede the old trunkline managers: Atlantic Division, J. O. Smith, division manager; East Gulf, J. C. Cooper, jr.; Central, Ralph Mathews; West Gulf, Frank Corlett; Rocky Mountain, W. H. Smith; Pacific, H. C. Seefred. The division managers appoint district superintendents and the latter appoint assistants, the whole constituting an operating department covering the country. The management of such operations is in the hands of General Manager Hebert, with offices in New York, while *QST* continues to be published at Hartford. The dues have been set at \$2 and now include *QST*.

The "Battleship" V.F.O.

The Mechanics of Oscillator Construction

BY P. H. BLOOM,* W8DV

HAVING been a "one crystal" man since going on 20-meter 'phone over a year ago, I have had plenty of sad experiences in being covered up by interference, with a good many contacts lost. The number of incomplete contacts in 90% of the cases was due entirely to an immovable frequency. Then there were many possible contacts that could have been made with stations on the other end of the band, calls that were not even attempted because of the curious and oft-lamented fact that so many hams wouldn't cover the complete band after a CQ. The obvious answer was a variable-frequency oscillator.

Which of the dozens of circuits available should be used was quite a problem. Those that I had seen or heard on the air did not have the points I believed should be available in so important a part of a transmitter as its frequency control. Then came the March, 1941, issue of *QST* containing By Goodman's idea of a v.f.o.,¹ which looked so good in the reading that I had just about decided to duplicate it. At about that time Merle Masiker, W8SYZ, happened to drop in for a visit, and we discussed that article. He also decided that it looked good. In fact, before the week was out he had it finished and working. The layout, parts list and circuit of Goodman's article was followed exactly, and the performance was all that By claimed for it.

Before Merle put the oscillator in service in his transmitter, I had a chance to work with it, give

* 2103 Evansdale, Toledo, Ohio.

¹ Goodman, "A Gang-Tuned V.F.O.," *QST*, March, 1941.

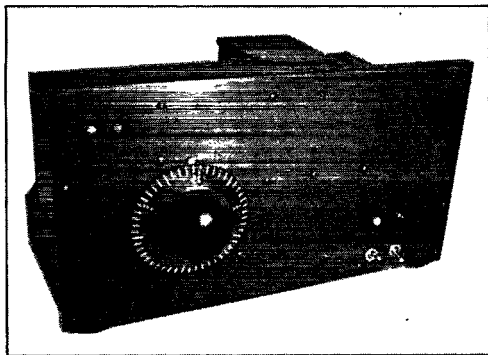

The "battleship" v.f.o. is a business-like unit, with only control switches and the tuning dial on the front panel. Padder and other adjustments are screwdriver controlled.

it some frequency runs, test its stability, and in general marvel at its performance. However, in the testing several improvements came to mind which were later incorporated in my own version of the oscillator. In the first place, Goodman did stress that his model was designed to be as simple and straight forward as possible. Therefore, in spite of the additional bracing, the v.f.o. could not be handled without a noticeable change in frequency. Not that a person will attempt to pick up the v.f.o. while in actual operation on the air, but it is a perfect test of mechanical stability to be able to do so without affecting the frequency. To my mind, mechanical stability in a variable frequency oscillator is fully as important as its electrical stability.

Also, more bandsread was considered desirable on the higher frequencies. Because of the ganging of three condensers, each of which is designed to hold its setting in any position (necessitating rather tight bearings) so much force is required in turning the gang that none of the friction-type vernier dials will drive the assembly without slipping. On the other hand, on a straight dial the 20-meter 'phone band occupies only a few degrees, making small adjustments of frequency, or resetting to a predetermined frequency, quite difficult. Also, because of the aforementioned tight bearings in the condenser assembly, the shaft of the last condenser will store some torsional energy which will gradually — and sometimes suddenly — let go and swing the other condensers if the v.f.o. is jarred or bumped or the dial touched, resulting in a frequency shift.

Another thought was to incorporate more thorough shielding, designing the chassis to take advantage of that shielding to produce a very rigid assembly. I decided then to take up where Goodman left off, to see how far I could go to reach the utmost in both electrical and mechanical stability with tools and services available to the average ham. The last of the changes was to incorporate a power supply to make a self-contained unit.

The problem of a rigid chassis was solved with the help of my good friend "Doc" Jarvis, W8RRZ, who in his capacity as Superintendent of the Superior Metal Casket Company knows all the tricks of the bending machines. He worked out the details of the interstage shields and the pan, and the finished assembly, though made of No. 20 gauge metal, is as strong as the Rock of Gibraltar has so far turned out to be.

The dial question, for bandspread, was neatly solved by the National PW-O dial and gear unit. The extra cost was more than justified by its performance in the finished model. A bit of pencil work showed a reset accuracy of 0.02% (for 180 degrees) which is nearly as good or better than all but the most expensive laboratory precision oscillators. That accuracy applies only to the unloaded dial, and would have applied to the output frequency but for the condenser drag mentioned earlier in this article. With an extra mark between each present dial division, and ball bearings on the condensers, the reset accuracy on the output frequency in the 80-meter band would be 0.01%.

The extra dial marking is a future improvement to be made here. And I will be the first customer for a small ball-bearing condenser similar in size to the condensers used in this v.f.o., and especially designed for gang use. To get back to the present, this dial gives me a bandspread of 12 feet on the output frequency, 3500 to 4000 kc., and nearly 5½ inches of bandspread on the 20-meter 'phone band alone. The bandspread on 20 'phone would have been even greater had I been able to buy condensers with semi-circular plates instead of the midline type.

Plate and filament power supply transformers are mounted on rubber. The tedious work, and the part that took most of my time in building, was fitting the shield walls. The rigidity of the finished unit depends entirely on doing this part of the job properly. The chassis and shields were assembled and taken apart many times in the process until each piece fitted right, producing the sought-for rigidity.

Description

The photo of the front of the model shows the simplicity of the front panel, which has only the dial and control switches on it. This obviates any temptation to fiddle with vital controls, both by the operator himself and by curious

What better time than now to get those needed improvements to the v.f.o. under way — or, for that matter, to build a good one if you haven't used one before? Here are some good pointers on the mechanical layout and construction of such a unit, aimed particularly at eliminating those constructional faults which may be as important as circuit details in determining stability.

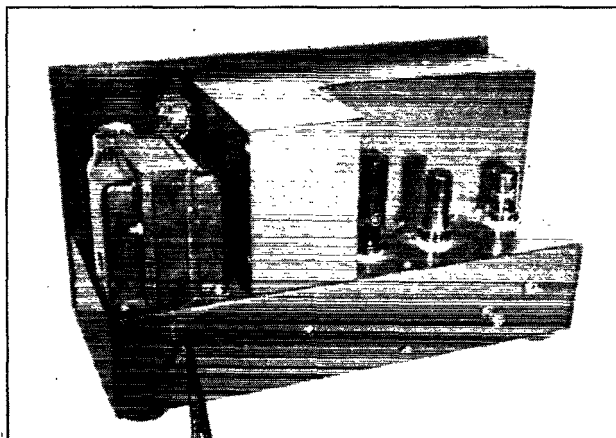

A rear view. Tubes are accessible, but all other working parts are enclosed in shielded compartments.

visitors. The oscillator bandset, doubler and final padders are screw-driver adjusted through openings in the chassis and shield covers. Looking at the rear view, the hole through which the 6L6 final padder is adjusted can be seen in the left center of the back drop of the pan. At the bottom center is the hole through which the neutralizing condenser is adjusted. To the right of that is the ground post, and farther to the right is the key jack. The 5Z3 is behind the plate transformer. To the right of the rectifier, but hidden from view, is the VR150-30, and just above that tube is the midget remote relay. The first choke is mostly hidden by the rectifier tube. R.f. output is taken from the two feed-through insulators. In the front view, the left-hand toggle controls filaments, with the white pilot light operating, and the right toggle controls the plate supply with the red pilot light indicating. This switch turns on the v.f.o. without energizing the rest of transmitter, for setting or listening to the oscillator.

The bottom view shows the placement of most of the parts. The three 8-μfd. filter condensers are at the left, with the bleeder just below. To the right is the 5000-ohm dropping resistor to the VR150-30, the socket for which is under the right-hand end of the resistor. The second filter choke is fastened to the wall that shields the 140-140 6L6 padder condenser. Inside that shield and just to the left of the condenser are the three feed-through insulators which carry the r.f. and plate current to 6L6 tank coil. The 6L6 socket, neutralizing condenser, and associated resistors, by-pass condensers, r.f. choke, etc., are in the compartment to the right. The filament transformer is just below.

Next in line is the compartment containing the 6V6 doubler components, most of them readily identifiable. Fastened to the right-hand

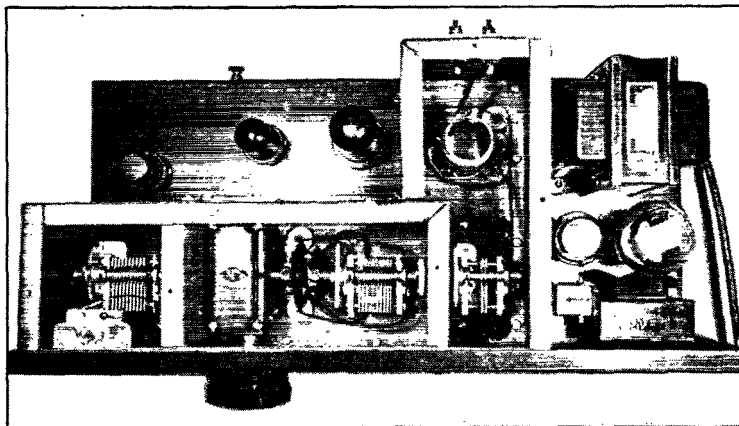

Top-of-chassis view with the shield covers removed. The parts layout is described in the text.

wall is the doubler padder, which is adjusted through a hole in the bottom dust cover. The doubler coil can be seen just above and to the left of the padder condenser. The two feed-through insulators carry the doubler r.f. to the appropriate condenser in the tuning gang. In the right top compartment are the 6J5 oscillator parts with the exception of the plate coil, zero-coefficient tank condensers, and the tickler coupling condenser. The last-mentioned components are located in the shielded compartment at the lower right. The wall of this compartment is $\frac{1}{2}$ inch lower than the others, allowing a separate cover for this compartment. This cover, in addition to providing further shielding for the oscillator coil, prevents some frequency change caused by pressure on the bottom dust cover when the unit is resting on the table. Note the gussets in each corner and the in-turned lip all around. These are big factors in increasing the strength of the chassis.

The top view, with the top shield dust cover removed, shows the arrangement of the condenser gang, tube and power supply layout. The 6J5 oscillator plate tuning condenser is in the compartment at the left together with the bandset condenser, which is fastened to the front panel and is adjusted through a hole in the top cover. The 6J5 is directly above. In the next shield compartment is the dial gear box, insulated coupler, doubler plate gang-tuning condenser, and smaller insulated coupler. The 6V6 and 6L6 are directly above this compartment. The next compartment contains the 35- μ fd. 6L6 plate gang condenser and the final coil. Outside the last compartment to the right is the power supply.

Layout and Construction

Before actually starting any work on a

new job it has been my custom to make a full-size paper layout, showing all the parts in their actual size. After deciding on a tentative layout, the complete wiring is drawn in, pictorial fashion. After the first paper layout is finished, a number of interesting things show up. One can immediately see if the orientation and placement of sockets are right for best wiring, and which sockets and parts should be pre-wired because they will be located in difficult-to-get-at spots. The location of the shield wall

can be more easily determined, as well as the location of holes for feed-through insulators and inter-shield wiring. It can be seen how and where to run wiring to facilitate cabling, and one can even determine the length of leads. After all changes that seem necessary have been made to the first layout, a new one is drawn up with all the corrections incorporated. Hours of time, temper and sometimes money can be saved by this procedure, with the knowledge that a well-planned, neat-looking job will result. At one time or another nearly every ham has wished it would be possible to move a socket hole just a bit, or to turn a transformer, socket, or other apparatus around, or change its location, after it has been wired in place. Well, it can be done easily with an eraser and pencil before a single hole is drilled in a new chassis! Then, during the wiring, this same pictorial will save 75% of the time. No time is lost wondering how and where to put a lead, because one already knows. It's not a new system, but certainly a valuable one when properly used.

Several tools that are a practical necessity when working with metal are a small square, a

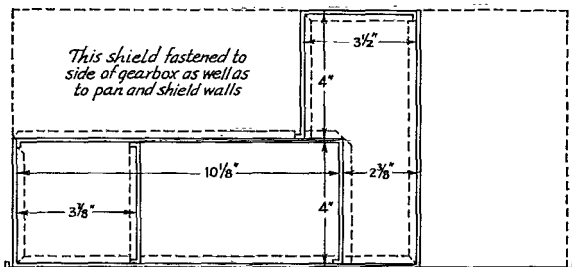

Shield compartment depth $5\frac{1}{2}$ "

Fig. 1 — Top view of shielding above the chassis.

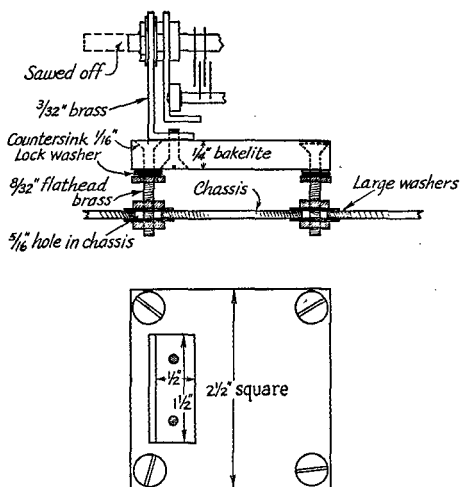

Fig. 2 — Adjustable condenser mounting for oscillator section of condenser gang. Only this mounting has four legs; the other two mountings have three legs each.

flexible steel tape, several small "C" clamps, and a "split-shank" screwdriver that will hold a screw by its slot, a set of small socket wrenches, and a set of small, thin "S" wrenches. In my case these all came from the five and dime, and worked fine.

The overall dimensions of this model are 9 inches high, 17 inches long and 8 inches deep. The chassis pan is 8 by 17 by 3 1/2 inches, with a half-inch turned-in lip all around, and with gussets soldered in each corner as shown in the drawing, Fig. 3, and the bottom-view photograph. As mentioned before, this is a custom built job, and dimensions apply only to this particular model and layout. The whole idea behind this article is not so much to give a complete, detailed description with the expectation that it will be followed to the letter, but rather to show how it was done in this particular model. Changes can of course be made to fit the needs of your own particular circuit. Start with the chassis pan available. The pictorial diagram that should be drawn up to fit your circuit will soon show whether that pan is suitable. Determine placement and dimensions of shield walls, draw up specifications

for them and then have your local sheet metal shop bend them up for you. By having all dimensions ready you will save money, as the fee is based on labor charge.

Don't expect the shields to fit well when the bender gets through with them. It takes filing, fitting, more filing, cutouts to clear screws and apparatus coming from above, and some bending of lips, until shields fit snugly. After that stage has been reached, holes should be drilled in the lips of shields to clear No. 6 by 3/8 sheet metal self-tapping screws for fastening shields to the pan and to each other. Have ample clearance so that shields can be shifted around slightly to take up any possible misalignment. With a scratch awl or ice pick spot holes in the pan to take the self-tapping screws, using the lips of the respective shield walls as templates. A No. 35 drill is just right for a No. 6 screw. Screws should be spaced at least every 2 inches. One shield at a time should be drilled and fastened lightly to the chassis, until all are in place. With the under-chassis shielding fastened lightly in place, the same procedure is gone through with the top-of-chassis shielding — first, however, mounting the National dial gear unit and condenser gang. This part of the work is one of the most important operations, since continued reset accuracy of any v.f.o. is a function of a well-aligned smooth-working condenser gang free from binding or sticking.

Special Condenser Mountings

After spending several hours trying to get a smooth-turning condenser lineup in the manner described by Goodman in his original article, it was found that no matter how they were adjusted, there would always be some point in the arc where one or the other condenser would bind. The reason was soon found to be that the angles on the condensers were not square! So a different

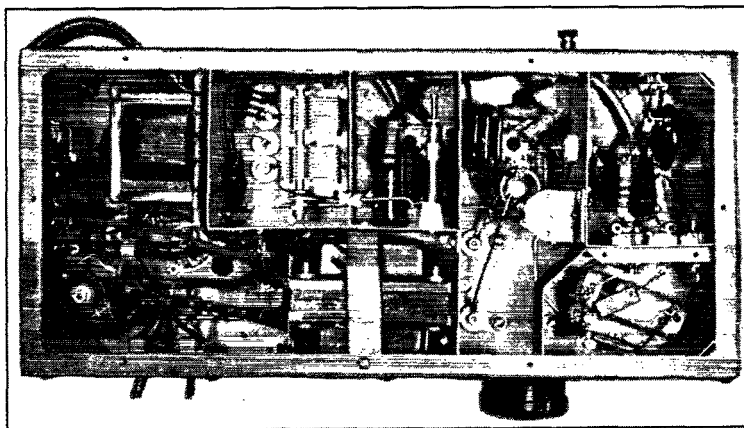

Bottom view with dust cover off. The oscillator coil compartment, in the lower right-hand corner, has a separate cover so that bending of the chassis cover cannot cause a frequency change.

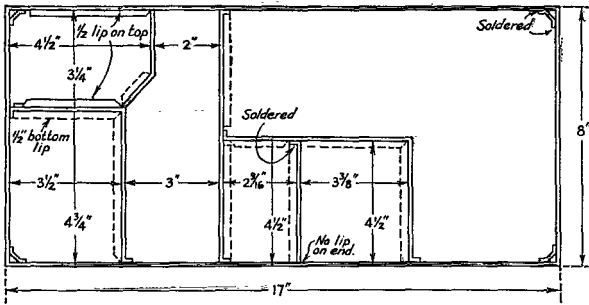

Fig. 3 — Below-chassis shielding layout. Thickness of shield walls is exaggerated to show lip turns. Lips drawn with solid lines on oscillator coil compartment (upper left) are for separate cover. Lips shown dotted fasten to bottom of chassis. The turned-in half-inch lip all around the bottom of the chassis is not shown, to make clear the bending and placement of shield walls. Chassis depth is $3\frac{1}{2}$ inches.

type of mounting was evolved, one that permitted the adjustment of each condenser in any plane. With this mounting a true, bind-free alignment can be quickly reached. Complete details are shown in the drawing, Fig. 2. It may seem like a lot of work, but it has proved its worth here, in that in the six months this v.f.o. was in constant use not the slightest realignment was found necessary during a test while getting together the material for this article.

Before using the couplers, true them up by loosening the four bolts, then re-tightening them, and when the assembly is found to be running true, lock each nut with another nut. During the adjustment for lining up the condensers do not use the dial to turn them, since the gear box develops so much power that it is hard to tell when the condensers are binding. Loosen the coupler on each side of the gear box and turn the gang by hand; then, when the condensers are felt to be running free, the couplers can be tightened to the gear-box drive shaft. Top-of-chassis shield compartments can now be assembled, drilled, and fitted to the pan. The hole for the dial shaft was made with a socket punch to give plenty of clearance and to allow for any misjudgment in spotting the shaft. Now inspect and check the chassis to see if all necessary holes have been drilled. The front panel can now be drilled and attached to the chassis, using the chassis as a template, transferring location and size of holes with a bent scratch awl or ice pick.

The model is now ready for painting. All apparatus should be taken off, all shields fastened lightly in place, all front panel screws in place. One ground coat is sprayed on, inside and out, and when that has dried thoroughly, the finish coat is sprayed on, covering the outside only. The reason for not spraying pieces separately is that a lot of time is saved in not having to scrape paint off where the metal parts fasten to the chassis and to each other, for electrical conductivity.

Wiring and Adjustment

The tough and tedious part of the work is now over, and things progress much faster. After the second coat of paint or lacquer is thoroughly dry, take the chassis apart, using care to prevent chipping the paint. Check with the pictorial diagram to see which parts need prewiring, and do that part of it first. The first parts to be mounted are the gear box and condenser gang. This is quickly done, since one has already had the experience of the preliminary lineup. It may be necessary in some layouts to mount the feed-through insulators in the condenser compartments first. Other parts are then mounted, shield walls put in place and fastened, and wiring started. Our policy has always been to wire filaments first. I should have mentioned the mounting of the plate transformer, before going any further. The drawing shows clearly how this was done on this particular model, and it worked out very nicely.

Thanks to the full-size pictorial wiring diagram, wiring is really fast, since the relative position of every wire has already been determined. All leads carrying r.f. are made with No. 14 soft drawn copper wire. Not shown in the photographs but noted in the wiring diagram of the power supply is an additional 20 μ fd. of input filter added to the 8 μ fd. originally installed; this took out the last trace of a.c. ripple from the d.c. supply. Also not shown in the photographs is a sheet of $\frac{1}{8}$ -inch asbestos fastened with Duco cement to the side of the plate transformer next to the 5Z3. This prevents heating of the transformer by radiation from the rectifier tube, which was considerable.

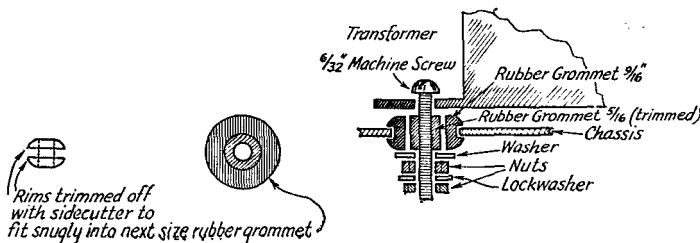

Fig. 4 — Details of floating mounting for plate transformer. The first nut should be tightened only enough to hold firmly, then locked with second nut.

One of the two 6-foot rubber cords that end in male a.c. plugs comes from the primary of the power transformer and is plugged into an outlet controlled by the main station switch, which, when operated, turns on all filaments in the transmitter and modulator. The other plug and cord terminates in the relay coil, and plugs into an outlet controlled by the station send-receive switch, energizing the v.f.o. in the "transmit" position. The plate toggle switch on the panel is connected across the relay contacts. The relay is mounted in rubber simply by using a small rubber grommet inserted in the hole in the shield wall, tightening up on the single mounting screw only enough to hold the relay, and locking with another nut.

The rubber feet used for mounting supports also come from the helpful five and dime, and are ordinary rubber furniture casters. The most flexible type is the "Daisy," which sells two for 5 cents. The flat side is fastened to the bottom dust cover with 6-32 screws and at least a half-inch washer under each nut. The hole in the rubber is easily made with a hot nail. Tighten nuts only enough to hold snugly, then trim off all of the screw that protrudes and solder the nut to the screw to prevent its working loose. The cuplike part of the caster acts as a suction cup and prevents slipping and sliding.

Operation

This unit was in operation at W8DV for nearly six months, during which time its use was a real pleasure. The number of contacts made increased by 150%, but what is more important, practically all were completed! Operation was on the 20-meter 'phone band, and all checks and tests were made by listening to the 20-meter harmonic of the v.f.o. The reset accuracy was checked by measuring the frequency of a random but even setting of the dial, as for instance 460, which in this case corresponded to a frequency of 14206.5. Out of 25 trials in returning to that setting, the greatest deviation measured was 800 cycles, with 15 of them varying from 250 to 500 cycles — and one bull's-eye. This was more than satisfactory, as most of the calibrated bandspread receivers have only 5-kc. markers. I might also mention that during the tests the frequency meter was turned off frequency after each measurement, the audio gain control turned off, and of course the "S" meter was not watched. It was soon found that the drag of the condenser gang,

made it necessary always to approach a given setting from one direction for greatest accuracy. With ball-bearing condensers the accuracy would have been as great as that of the dial itself.

The maximum drift noted in several continuous 3-hour test runs was between 800 and 1000 cycles on 20 meters, from a cold start, depending on the temperature of the shack. Most of this was in the first five minutes.

The adjustment was fully described by Goodman in his original article, with the exception that when the v.f.o. is lined up with a bulb on the output frequency, it will not necessarily be right for feeding the transmitter because of the difference in impedance. If trimming of the final coil is found necessary, as it was in my case, do the trimming while actually feeding the transmitter. The neutralizing condenser was wired in but later disconnected as the shielding of the final stage is so complete that the 6L6 is stable in the complete range. Wires carrying d.c. to the various compartments are shielded. All by-pass condensers for r.f. are 2500- or 5000-volt micas.

In summing up, I would again like to stress the great importance of mechanical stability, or more simply, rigidity of chassis. This can be easily achieved in even the most flimsy of chassis pans by soldering gussets (corner braces) in each corner, and fitting in shield compartments on both top and bottom, even though they may not be necessary to the electrical circuit.

My favorite stunt with visitors, when demonstrating this model, was to turn on my receiver for c.w. reception on the 20-meter band, turn the v.f.o. on and beat it with the b.f.o. in the receiver, then pick up the v.f.o., turning it around and about and shaking it, without any noticeable change in beat note. On the 10-meter harmonic, in zero beat with the receiver, about a 30-cycle change is noticed. When adjusted to a 1000-cycle beat, no change can be detected.

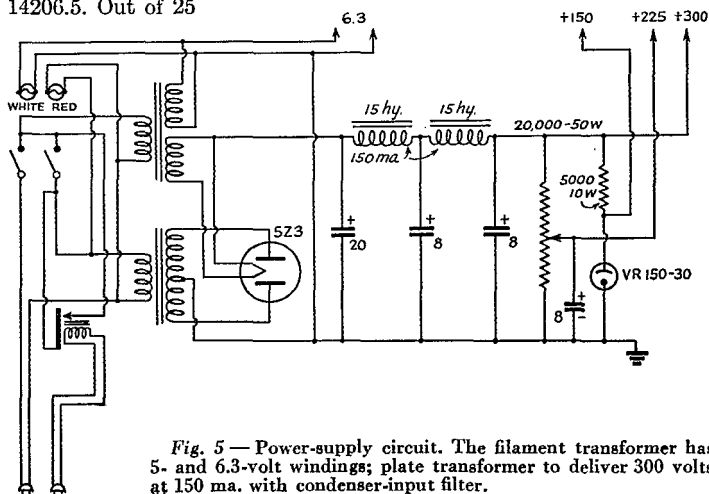

Fig. 5 — Power-supply circuit. The filament transformer has 5- and 6.3-volt windings; plate transformer to deliver 300 volts at 150 ma. with condenser-input filter.

A Multi-Range Volt-Milliammeter Adapter

The Construction of an Inexpensive Test Instrument

BY VERNON CHAMBERS,* WIJEQ

EVERY amateur has occasion to make voltage and current measurements during the construction, operation and maintenance of his amateur equipment. The more advanced amateur may make such measurements for any number of reasons. Perhaps *E* and *I* readings are essential details in the shifting of his transmitter frequency, or FCC regulations demand that he have various meters available because the power input to the final stage is more than 900 watts. He may be an experimenter having continual need for meters — or he may be just plain curious about what's going on inside the rig.

The beginner's meter requirements may not be quite as varied as those of the advanced ham, but they are probably more imperative. The chances are fairly certain that the novice will pattern his equipment after models described in constructional articles and, as a result, he will depend upon the author's findings. He won't know that his transmitter or receiver is working correctly unless it draws so many milliamperes plate current with so much plate voltage applied and, of course, the problem isn't going to be solved with complete success unless meters are on hand. Yes, we feel that the beginner is really the fellow who gets the most out of his meters — and he very likely is the one who worries the most about buying them.

Fortunately, the cost of metering equipment can be greatly reduced by using a single instrument in a multi-range volt-milliammeter circuit. This lowers the cost to the price of one meter, a few resistors, and a switch. Total? \$7.50 at the most. And then we have a piece of test gear with five current-reading ranges and six voltage ranges. Furthermore, you may even be able to get out of buying the meter (if you can borrow one!) so long as the proper shunt and series resistor network is constructed. Perhaps you can make a deal. You know — "I'll use your meter — and you use my switcher."

The unit to be described makes use of a 0-1 milliammeter connected externally to the switching box. A low-range meter of this type is best suited for the purpose because it allows small values of current flow

* Technical Information Service, ARRL.

to be measured with good accuracy. The current ranges available are 1, 10, 100, 250 and 500 milliamperes. The voltage ranges are 3, 10, 50, 100, 500 and 1,000 volts. Home-made parallel shunts are used to increase the current range of the meter, and commercial resistors are used as multipliers when the meter is employed as a voltmeter. It will be beneficial for the reader to understand the design of these shunts and multipliers and we shall therefore cover this subject in detail before going into the actual construction of the unit described.

Shunts and Multipliers

It must first be realized that voltmeters and ammeters are basically identical instruments, the difference being in the method of connection. A voltmeter is an ammeter which measures the current through a high resistance connected across the source to be measured; its calibration is in terms of the voltage drop in the resistance, or multiplier. An ammeter is connected in series with the circuit and measures the current flow. The ranges of both voltmeters and ammeters can be extended by the use of external resistors, connected in series with the instrument in the case of a voltmeter or in parallel in the case of an ammeter.

Highly accurate precision resistors are used as shunt and series multipliers for meters, so they will not contribute errors to the meter reading.



A photograph of the multi-range volt-milliammeter. The leads of an internal 0-1 ma. meter are plugged into the jacks at the top of the box. Test leads plug into the jacks at the bottom.

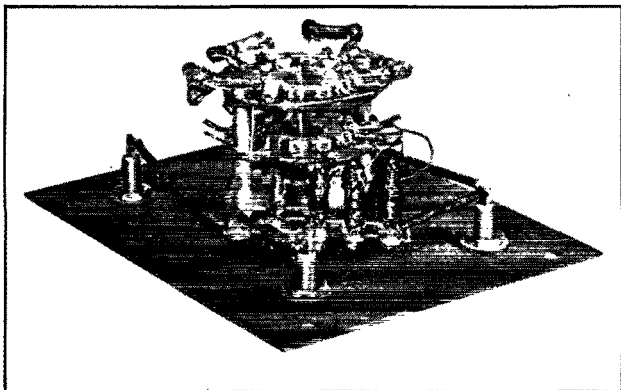

This view shows the series resistors mounted on the switch and the parallel shunts supported by a lug strip.

Handmade shunts may be made as accurate as the constructor wishes because the resistance can easily be varied. Ordinary carbon resistors, selected for accuracy, may be used as multipliers when economy is the prime consideration.

To calculate the value of a multiplier or shunt it is necessary to know the resistance of the meter; this information can be obtained from the manufacturer's catalog. We shall give a few examples to show how shunts and multipliers were calculated for the meter described.

First, we have a 0-1 milliammeter having a resistance of 33 ohms. The resistance of a shunt for the 10-ma. range can be found from the formula:

$$R = \frac{R_m}{n - 1}$$

where R is the shunt resistance, R_m the resistance of the meter, and n the scale multiplication factor. In this case R_m will equal 33 ohms and n will be 10 minus 1 (since the scale is being increased from 1 ma. to 10 ma.). Therefore

$$10 - 1 = 9; \quad 33 \div 9 = 3.66 \text{ ohms.}$$

In going to the 100-ma. scale, n would equal 99 (100 - 1) and the answer is 0.333 ohms. The 250- and 500-ma. ranges call for shunt resistances of 0.132 and 0.066 ohms respectively.

We must now consider the size of the wire that is to be used. We know that the wire must handle a current flow equivalent to the current rating of the shunt and that the resistance of wire increases with decreased diameter. A glance at the *Radio Amateur's Handbook* wire table shows that No. 38 wire will carry 15.72 ma. (consult the circular mil area column) and this size will therefore be ideal for the 10-ma. shunt.¹ The ohms-per-1000-ft.

¹ With adequate ventilation, the current density in open windings can safely be increased to 250 circular mils per ampere. At this rating No. 38 wire could be used for currents up to 60 ma.

column tells us that No. 38 wire has a resistance of 0.672 ohms per foot (0.672 ÷ 1000). Therefore, 2.459 feet will be required for a resistance of 3.66 ohms (0.672 × 3.66). Wire sizes No. 28, 24 and 22, respectively, are chosen for the 100-, 200-, and 500-ma. shunts in order that the current carrying capacity of the shunts will increase as the scale range is increased.

The wire lengths arrived at by means of the aforementioned procedure should be considered as approximate only because they do not allow for discrepancies caused by meter connections and test leads or the variations found in the diameter of a wire of a supposedly given size. A sure-fire method of determining the exact wire length will be described along with the multirange milliammeter construction details.

If a milliammeter is to be used as a voltmeter, the value of the series resistance can be found by Ohm's law, or

$$R = \frac{1000 E}{I}$$

where R is the resistance of the multiplier, E is the desired full-scale voltage, and I the full-scale reading of the instrument in milliamperes. Therefore, in this case, the resistance of the multiplier for the 3-volt range can be found as follows:

$$1000 \times 3 = 3000; \quad 3000 \div 1 = 3000.$$

A 3000-ohm multiplier is required. It is evident that 10,000, 50,000, 0.1 meg., 0.4 meg., and 0.5 meg. are the resistance values required for the 10, 50, 100, 500 and 1000-volt ranges. It also becomes apparent that it is entirely impractical to attempt to wind these resistors by hand because of the quantity of wire needed. We therefore turn to the commercial resistors which are wound with special resistance wire.

Construction

The multi-range volt-milliammeter switch assembly is housed in a metal utility box measuring 3 by 4 by 5 inches. All of the parts are mounted on one of the removable covers as shown in the photographs. The lug strip on which the shunts are mounted is held in place by one of the machine screws which helps to hold the switch sections together. The shunts are connected to the switch section nearest to the panel and the multipliers are connected across the terminals of the rear section. The switch is located at the center of the panel and need not be insulated from the panel.

The shunts are wound over the insulation of

short lengths of solid push-back wire. One end of each shunt is soldered to its push-back wire form and the stiff wire is in turn soldered to one of the lug-strip terminals. The lug-strip terminals are all connected together and connected to the negative test-lead socket. The top ends of the shunts connect to the switch.

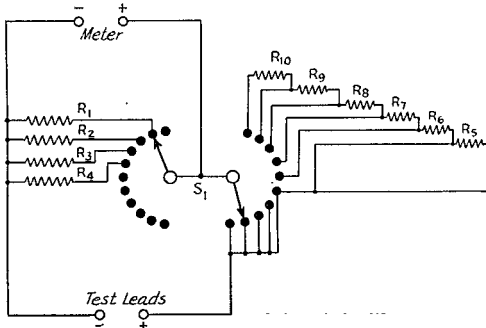

Fig. 1 — Wiring diagram of the multi-range volt-milliammeter-adapter.

- R₁ — 10-ma. shunt, 3.66 ohms.
- R₂ — 100-ma. shunt, 0.333 ohms.
- R₃ — 250-ma. shunt, 0.132 ohms.
- R₄ — 500-ma. shunt, 0.066 ohms.
- R₅ — 3000 ohms.
- R₆ — 7000 ohms.
- R₇ — 40,000 ohms.
- R₈ — 50,000 ohms.
- R₉ — 0.4 megohms.
- R₁₀ — 0.5 megohms.

See text for constructional details of shunts. Multipliers R₅ through R₁₀ are 1/2-watt carbon resistors.
S — 2-pole 11-position shorting type switch (Centralab Assembly No. K-122 with two type B bakelite sections).

Meter — 0-1 ma. (Triplett 227-A).

As we have said before, it is not possible to predetermine the size of the shunts with great accuracy. We therefore suggest that each shunt be carefully cut to size by the following method. The shunt of approximate size is mounted in place and the external meter and the test leads are plugged into the jacks. A variable resistor of 1500 ohms or more is placed in series with the test leads and a 1.5-volt dry cell. The switch is rotated to the 1-ma. position and the resistor adjusted until the meter registers a current flow of 1 ma. With the 10-ma. shunt in place, the switch should now be rotated to the 10-ma. position. If the shunt resistance happens to be correct the meter will read exactly 0.1 ma. More wire is required if the reading is too low and less wire is needed if the reading is too high. After the current adjustment resistor has been set for any one particular shunt, it is not touched again until work on the next higher resistance shunt is begun.

The 100-ma. shunt should be treated next. The switch is rotated to the 10-ma. position and the

adjustment resistor set to pass 10-ma. When the 100-ma. shunt is switched in place the meter should again read 0.1 ma. if the resistance is correct. Follow the procedure outlined above if the reading is not correct.

The two high-current shunts should now be lined up in proper order. The 100-ma. scale is used as the standard during these tests. In other words, the meter is made to register 100-ma. by means of the 100-ma. shunt and the current adjusting resistor. The reading should be 0.4 ma. for the 250-ma. shunt and 0.5 ma. for the largest shunt. When the shunt trimming has been completed, it is suggested that each winding be covered with a coating of Duco cement.

The multipliers are wired to the switch as shown in Fig. 1. This arrangement is most convenient because it allows each resistor, or set of resistors, to become a part of the next higher resistance value. For instance, R₁ provides the necessary 3000 ohms for the 3-volt multiplier; it also adds to the 7000-ohm resistor, R₂; to form the 10-volt shunt. R₁, R₂ and R₃ then combine to form the 50-volt multiplier, and so on up the scale.

The front-view photograph shows the scale that was made for the switch. It is made from a piece of stiff cardboard and is covered with a piece of celluloid. The scale points are marked in place after the disk has been placed beneath the switch control knob; the points are marked off as the switch knob is rotated in a clock-wise direction.

It is evident that the divisions of the meter scale can be used to obtain a direct reading only when the meter is used with the selector switch at the 1-ma. position. For voltage, or extended current ranges, the scale may be calibrated as follows:

Extended Ranges		Volts or Ma. per Each 0.1 Division on 1-ma. Scale
Ma.	10	1
	100	10
	250	25
	500	50
Volts	3	0.3
	10	1
	50	5
	100	10
	500	50
	1000	100

Strays

The smallest current that the average person can detect is about 1 milliamper, while currents above 15 ma. produce such muscular contraction that one cannot release his grip from contact! — *Ohmite News.*

W6GRL Is China's U. S. Listening Post

WE HEAR stories of radio hams in many a fascinating job these days — most of which we can't talk about now, of course. But one that we can talk about was called to our attention recently by United China Relief. It concerns one of the most interesting war-time radio assignments anywhere in the world — that of official American listening post to short-wave broadcasts from China, a job held by Century Clubber Dr. Charles E. Stuart, W6GRL.

W6GRL's work — to which he was assigned by the Central Chinese government in Chungking — is to receive and transcribe the daily English voice-broadcasts emanating from XGOY and XGOX, Chinese international broadcasting stations in Chungking. These broadcasts consist of military and general news and talks by distinguished Chinese and foreigners, and are made primarily for use by the Chinese News Agency in New York City and by United China Relief.

Dr. Stuart is responsible for the most complete coverage of official Chinese government events, speeches, etc., received in this country. The Associated Press, United Press, etc., have correspondents in Chungking, but due to expense of cables they do not always give full details. The Chinese News Agency in New York is able to supply these, thanks to W6GRL.

An outstanding recent service was performed by Dr. Stuart in the week following our declaration of war and occupation of Manila. Newspaper correspondents had much difficulty getting cables through, and the transcribed XGOY broadcasts, giving military news of China, were in great demand by the newspapers. Dr. Stuart supplied the first complete text of China's declaration of war on the Axis, for instance.

The frequencies used by XGOY and XGOX for their American broadcasts and the time of day set for the transmissions are determined by Dr. Stuart, and vary with the seasons. At the present time, the frequencies are 11.9 and 15.2 Mc. respectively, at 6:30 A.M. and 7:00 A.M. PWT. The programs are recorded on acetate instantaneous discs (Doc usually shaves while this is going on!), and then are transcribed. Dr. Stuart is aided in his unique radio job by Mrs. Alicia Held, probably the only secretary in the world who takes dictation from a source 7000 miles distant, through static and heterodynes, fading and hash.

Dr. Stuart uses unidirectional terminated rhombic antennas which are also reversible. When Dr. Stuart misses the direct Chungking-Ventura broadcast (7000 miles), he can reverse the antenna and pick the broadcast up a little later from the other direction. One of the antennas is a highly-directive diamond with a full mile of wire in the system. This gives great signal

strength from Chungking, plus reliable reception when general conditions are poor. W6GRL's location at Ventura, Calif., is ideal for the purpose, being on a flat stretch of beach land underlaid with salt water, which gives maximum reflection and ground conductivity.

The Chungking broadcasting studio, located in the heart of Free China's much-bombed capital, is constructed of huge blocks of granite four feet thick, and is bomb-proof. The transmitter is set up outside the town in a dugout blasted from the side of the hill on which Chungking sits. Broadcasts from Chungking are piped through to the transmission station by wire line.

Dr. Stuart and an elder brother built their first station in 1912. Then only 11, Doc learned the code and built a spark-coil transmitter and a receiver capable of hearing signals several hundred miles. In 1914 he received his first amateur license from the Department of Commerce. World War I caused a temporary cessation of his amateur activities, and he did not have another station until 1922-23, when he was attending the University of Southern California in preparation for his D.D.S. degree. In the interim, however, he had built several receiving sets. In 1926 he obtained another license, but was too busy developing a dental practice to do much with it. In 1932 he was licensed as W6GRL, the call he has kept in force since that time, winning fame in several international DX contests as well as Century Club honors.

When international DX was suspended he looked around for a worth-while war-time job to do. That he has found it there can be no doubt.

— C. B. D.

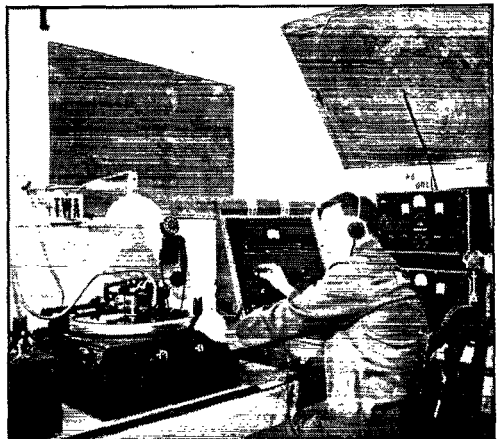

When China talks, W6GRL listens. Dr. Charles E. Stuart, well-known DXer, transcribes Chungking broadcasts on acetate discs for the Chinese government.



ON THE ULTRA HIGHS



CONDUCTED BY E. P. TILTON,* W1HDQ

SOME of us who were fortunate enough to have been in on the rampages of the 112-Mc. band last summer have since spent some time wondering what 2½ would have been like had we been using better equipment. In practically every case the transmitter was something which would make a more or less intelligible noise with the smallest outlay of time and money, and receivers in general use were equally crude. If stations up to 150 miles or more could be worked with such contraptions, what could we have done with something having a semblance of efficiency? Obviously our style in the transmitter department is going to be rather cramped for some time now, so let's have a look at the receiver situation and see what can be done.

Though the superregenerative receiver occupies a prominent place in the u.h.f. picture, especially for portable and mobile work, we will assume that nearly everyone is familiar with the problems encountered in working with this type of receiver, and concern ourselves with the superhet in various forms.

Anyone who has built receivers for 56 Mc. knows that one of the prominent headaches is oscillator instability. It is many times more troublesome when we try to go on to 112 Mc. Of course, if we use an intermediate frequency of 20 Mc. or so and operate the oscillator on the low side of the signal, the oscillator frequency is low enough so that good reception of stable voice signals is feasible, but even with all precautions there is bound to be enough "pulling" and hum modulation to make it difficult to get a steady p.d.c. note when the b.f.o. is used.

At W1HDQ we had, in common with several other 56-Mc. DX-hounds, the yen to see what could be done with 112-Mc. c.w. and a sharp superhet. How we managed (long after Dec. 7th, unfortunately) to get c.w. reception with our National NHU may be of interest.

First George Grammer's converter (September, 1941, *QST*) was tried, working into the NHU on 13.5 Mc. This was quite good; fine, in fact, for the crystal-controlled 'phone stations; but it was just a bit hard to handle on c.w., and besides, it didn't belong to me! Well, that NHU had three acorns in the r.f. section; why not try to get it down to 2½? There was a tuning range from 34 to 47 Mc., now of little value due to the encroachment of f.m. in this region; so out came the coils and in their places were substituted a set for 112 Mc. The result was pretty awful. With such a low intermediate frequency (1600 kc.) the oscil-

lator pulling was terrific, and the "note" sounded like some of the c.w. we used to hear on 28 Mc. back in 1935!

At about this stage, along came Tom Chapman, W1KK, with a bright idea — why not try the double-conversion system used in some commercial f.m. receivers? To give the idea a try a 112-Mc. coil was put into the grid circuit of the 956 r.f. stage in place of the one in the 56-Mc. range. Some oscillator output was brought over to this circuit with a haywire external coupling arrangement, and — presto, it worked! Duplicates of the 56-Mc. oscillator and mixer coils were then put into the former 34–47 Mc. range, and a 112-Mc. grid coil which would track (not as simple as it sounds) was installed in the 956 input circuit. Oscillator injection (shown dotted in schematic) was made a part of this range so that the functioning of the receiver on the normal ranges was not affected. Tracking was something of a problem in this particular receiver, but it was finally solved by tapping the tuning condenser down on the coil. The correct point, after much cutting and trying, was found to be one turn up from the ground end.

Sensitivity is not up to that of the NHU on the normal ranges, of course, but something less than 10 microvolts produces a readable signal, and the stability is comparable to that of the 56-Mc. range. By the addition of an external preselector stage we have more gain than with the converter, and improved stability since the oscillator is working at a lower frequency.

Probably not many owners of commercial superhets will care to go probing around in the r.f. sections in an attempt to duplicate this feat, but for home-built receivers having plug-in coils it should be a simple matter to give the idea a try. The regular 56-Mc. coils can be used in the mixer and oscillator stages, it being necessary to make only a new coil for the r.f. stage (which now becomes the first mixer) and provide a clip-on device for oscillator injection. An external r.f. stage is advisable, in order to increase the sensitivity and prevent radiation on 56 Mc. (the oscillator is coupled into the antenna circuit otherwise) but even this leaves the whole job considerably simpler and less expensive than the construction of a 112-Mc. converter.

Some months ago we mentioned the interesting possibilities of this type of circuit for 112-Mc. work. Since then we have received numerous letters asking for information on the design and operation of the double-conversion system. Probably the simplest explanation lies in the

*329 Central St., Springfield, Mass.

formulas for determining the frequencies at which the mixers and oscillator operate:

$$F_o = \frac{F_s \times \text{I.F.}}{2} = \frac{112 \times 1.6}{2} = 55.2 \text{ (Mc.)}$$

$$F_m = \frac{F_s \times \text{I.F.}}{2} = \frac{112 \times 1.6}{2} = 56.8 \text{ (Mc.)}$$

Where F_o = Oscillator Frequency
 F_m = Second Mixer Frequency
 F_s = Signal (First Mixer) Frequency
 I.F. = Intermediate Frequency (1.6 Mc. in the NHU)

Thus, in the revised NHU, to receive a signal on 112 Mc. the first stage is tuned to this frequency, the second mixer to 56.8 Mc. and the oscillator to 55.2 Mc. Oscillator-mixer action in the first stage produces a resultant of 56.8 Mc. This is passed on to the second mixer where, in the same manner, a difference frequency of 1.6 Mc. (the i.f.) results.

A word or two about r.f. stages in general. Anyone who contemplates doing any work from a home station on 112 Mc. should have a tuned r.f. stage ahead of his super-regen. It is only common courtesy to the others on the band, in the reduction of radiation, and it pays other dividends as well. Just getting rid of that annoying antenna resonance effect is worth the price of a 9001 or 9003; and if you want some real added gain, the 954 or 956 reigns supreme.

Once upon a time, in the early days of the acorn tube, it was thought that this little button was a bit of magic — that the mere presence of it in a receiver, whether it served as an r.f. amplifier, mixer, superregenerative detector, or oscilla-

tor, was a guarantee of superlative performance. But, alas, many workers spent their hard-earned dollars (and they were especially "hard-earned" about that time) only to find that somehow the acorn didn't seem to do half what was expected of it. Then along came the 1851, and it was soon discovered that this tube and its later relatives in the "high G_m " field actually outperformed the acorn in some high-frequency receivers. A glance at the characteristics and the inter-element capacitances will show why this was so. The so-called "television pentodes," the 1851, 1852, 1853, 1231, 1232, 7V7, and 7W7, all have much higher mutual conductance than the acorns, and some have equally low grid-plate capacity. Their disadvantage is high input conductance. However, unless we take advantage of the acorn's possibilities by employing short leads, small values of circuit and tuning capacitance, and the best possible tank circuits, we might just as well save our money and use the lower-cost tubes. But with concentric-line or other high-Q tuned circuits the acorn is more than worth its extra cost.

How about the 9000-series substitutes? Decidedly worth-while, especially when working on 112 Mc. or higher, but not quite in a class with the acorns as r.f. amplifiers. The difference in grid-plate capacity is the answer. With really efficient tuned circuits in both grid and plate (necessary for a high gain r.f. stage) excellent shielding is required to prevent oscillation. Isolation of grid and plate circuits, difficult with the single-ended construction of the 9000 series, is a simple matter with the acorns. And even with good shielding the higher grid-plate capacity of

(Continued on page 96)

Basic circuit of the NHU r.f. section, showing changes made in 956 stage for 112-Mc. reception.

- C_1 — 50 μfd .
- C_2 — Insulated leads — twist together to give most effective injection.
- C_3 — 50 μfd .
- L_1 — 3 turns No. 16, $\frac{1}{2}$ -inch diameter, tap at 1 turn.
- L_2 — 1 turn No. 18 rubber covered.

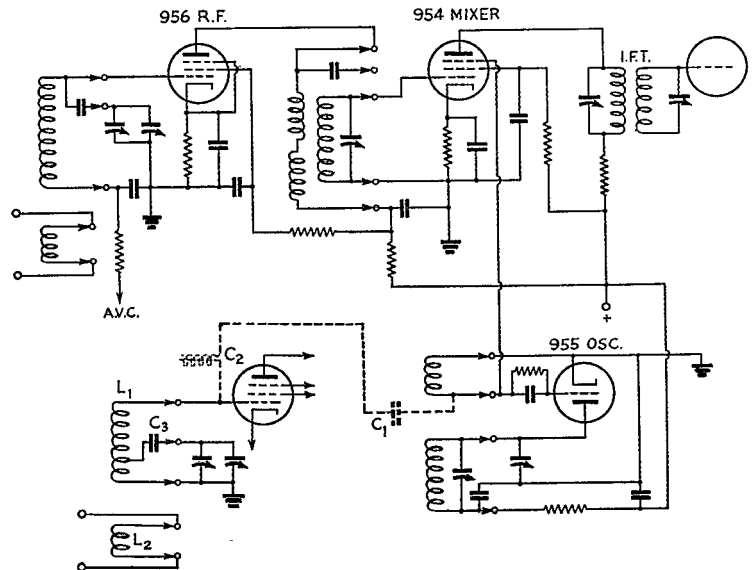

Notes on 225-Mc. Converter Design

Simple 1¼-Meter Converter for Experimental Work

BY ARTHUR BENT,* W1C00

Most of the transmitters used on 225 Mc. by amateurs are not stable enough to allow the use of superheterodyne technique, but it may not be too early to look in that direction, particularly when one looks at the rapid development in technique on the other u.h.f. bands. During some tests on 1¼ meters at the Mount Washington Observatory,¹ a simple converter was developed which gave results equal to those obtained with the superregenerative receiver usually used.

This converter was built with the idea of finding out what could be done with the ordinary parts available to amateurs. It is probably true that the converter of the future will employ specially designed parts and high-*Q* resonant circuits but, on the other hand, it is interesting to know that good results can be had almost at once with familiar circuits and parts. Some preliminary work with conventional designs may be a good introduction to experimenting with more advanced ideas.

The wiring diagram in Fig. 1 shows how the converter uses an acorn pentode mixer with an

* Research Associate, Harvard University, Box 295, Exeter, N. H.

¹ Bent, "Progress on 225 Mc. at Mount Washington," *QST*, Sept., 1939.

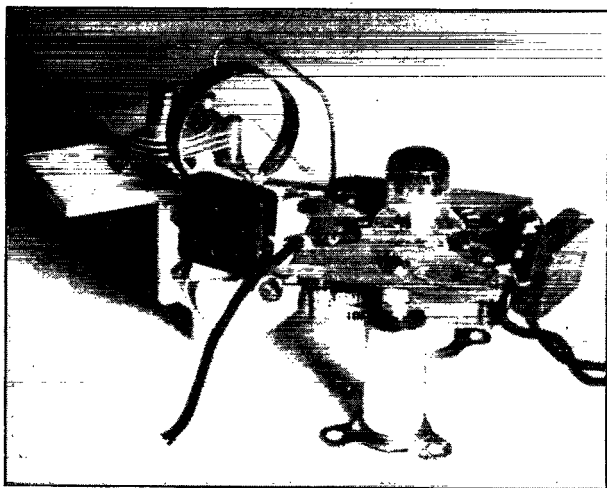

A close-up of the oscillator showing the copper-strap inductance and the condensers arranged to give short leads.

This story is aimed at the many u.h.f. experimenters who might think the use of a converter at 225 Mc. is out of the question and consequently would never consider one for the band. There is nothing particularly new about the design but it does show what can be done with standard parts.

acorn triode oscillator. Suppressor-grid injection of the oscillator voltage is used. No radio frequency amplification was attempted. The intermediate frequency employed was about 27 Mc., and the receiver used for this purpose was a Hallicrafter 5-10. Results in receiving the 225-Mc. signal over the ninety-mile path were about the same as with the superregenerative National 1-10 receiver. The most notable limitation appeared to be the stability of the transmitter. The transmitter used a W.E. 316A tube in a Peterson high-*Q* oscillator and, since it was directly modulated, some frequency modulation resulted. Reception of speech was only possible with the band width of the Hallicrafter receiver adjusted to the wide position. Attempts to pick up the signal using a National HRO receiver as the intermedi-

ate amplifier resulted in only a faint scratching sound. On the other hand, the stability of the transmitter was evidently much greater than is usually found on 225 Mc. or superheterodyne reception would not have been possible at all.

The first consideration in converter design is the stability of the oscillator. If even the relatively high intermediate frequency of 25 Mc. is chosen, the oscillator must operate at 200 Mc. To secure stability at this frequency great attention must be paid to the design and placing of circuit components. The ultimate in a stable converter oscillator for this frequency may be in the design of a special low-loss tank circuit, but if we are to employ parts of standard construction our approach will be in the direction of the familiar high-*C* tank, at the same time keeping losses as low as possible. The writer's impression is

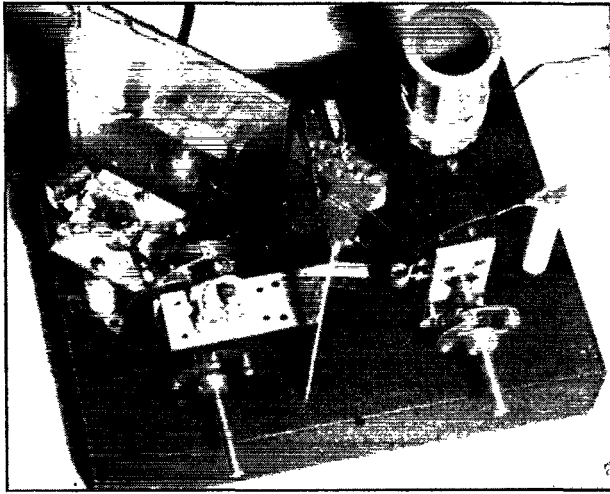

A top view of the 225-Mc. converter with the panel removed. The oscillator portion is at the left and the mixer section is at the right. The coil form at the upper right is the i.f. output transformer.

that the possibilities of really high C have not been fully explored in high-frequency converters, even at frequencies as low as 60 Mc. It may be that ideas as to what actually constitutes high C for a given frequency should be revised somewhat. With the oscillator shown, about 12 $\mu\text{fd.}$ of fixed capacity is used in the padding condenser at 200 Mc. The oscillator inductance is cut from thin copper sheet and the strip is about $\frac{1}{4}$ -inch wide. A small amount of copper sheet in two weights will be convenient in experimenting on these frequencies: light weight for making special by-pass condensers and heavier stock for inductances and leads.

The unit is mounted on a 9-by 7-by 2-inch chassis with an aluminum baffle shield between oscillator and mixer. The oscillator is placed at the left so that the grid terminal of the tube is conveniently placed for a short lead to the mixer. The mixer plate-circuit inductance is shielded to avoid direct pick-up at the intermediate frequency. This inductance is wound on a plug-in form for convenience in experimenting and is tuned, in this case, with a fixed mica condenser. The inductance is proportioned to resonate at the desired frequency and consists of ten turns of No. 20 wire. A coupling link of three turns is wound about a quarter of an inch from the low potential end of the coil. The coupling link is not critical but may require adjust-

ment depending upon the input characteristics of the receiver being used as the i.f. amplifier. The lead to the receiver may be a shielded twisted pair. Resonance between receiver and converter output circuit is indicated by a rise in background noise. Because of the application of the oscillator voltage to the mixer through the suppressor a metal socket cannot be used. In an effort to secure some by-passing for the mixer filament circuit a metal socket was cut in half, the portion having the filament and cathode terminals being used, and a new half of insulating material being made to support the screen and suppressor terminals.

The operation of the converter is quite conventional, the use of acorn tubes resulting in operation being much the same as on lower frequencies. A test oscillator is a great convenience in lining up such a converter, specially if it has some tone modulation for identification. A super-regenerative receiver is also a convenience in

(Continued on page 78)

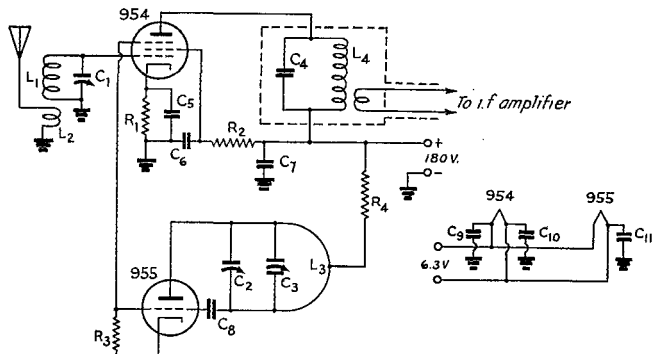
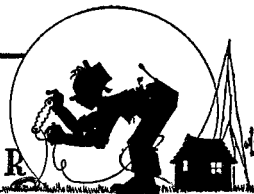

Fig. 1 — Wiring diagram of the 225-Mc. converter.

- C_1, C_2 — 15- $\mu\text{fd.}$ variable (National UM-15).
- C_3 — 5- $\mu\text{fd.}$ variable (Cardwell ZV-5-TS).
- C_4 — 50- $\mu\text{fd.}$ fixed mica.
- C_5, C_6 — 0.005- $\mu\text{fd.}$ fixed mica.
- C_7 — 0.002- $\mu\text{fd.}$ fixed mica.
- C_8, C_{11} — 100- $\mu\text{fd.}$ fixed mica.
- C_9, C_{10} — By-passing in National socket (filament half only). Type XMA.
- R_1 — 2000 ohms, $\frac{1}{2}$ -watt.
- R_2, R_4 — 0.1 megohms, 1-watt.
- R_3 — 10,000 ohms, $\frac{1}{2}$ -watt.
- L_1 — 2 turns, No. 14 tinned wire, $\frac{1}{2}$ -inch diam., spaced diameter of wire.
- L_2 — Two-turn coupling coil, No. 24 d.s.c., self-supporting at low potential end of L_1 .
- L_3 — Copper strip inductance (see text), 1-inch diam.
- L_4 — 10 turns No. 16 d.c.c., close-wound on $1\frac{1}{2}$ -inch diam. form. Three-turn coupling link wound $\frac{1}{4}$ -inch from cold end of L_4 .



HINTS AND KINKS FOR THE EXPERIMENTER



FEEDING THE COAXIAL DIPOLE WITH AN OPEN-WIRE LINE

THE merits of the coaxial-type antenna have been pointed out before.¹ The chief object accomplished with this system is the feeding of a half-wave dipole at the center without bringing the line into the field of the antenna, thereby reducing the possibility of distorting the radiation pattern of the antenna.

However, it is customary to feed such an antenna with coaxial cable, which is more expensive in long lengths than many hams can afford. Fig. 1 shows a system I have been using in which an open-wire line may be employed to feed an antenna of this type. The transmission line is designed for a characteristic impedance of very close to 400 ohms. It consists of a pair of No. 12 wires spaced $1\frac{1}{4}$ inch, separated by 2-inch spreaders in which holes with the correct spacing have been drilled.

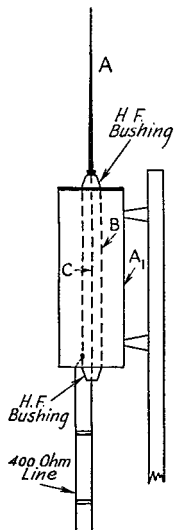

Fig. 1—W8SR's scheme for feeding a coaxial antenna with an open-wire line. A and A₁ are halves of the half-wave dipole, while B and C form a quarter-wave matching section.

Referring to the sketch, the rod A and the 3-inch diameter cylinder A₁ are the two halves of the half-wave dipole. They must be insulated from each other. The 1-inch-diameter metal tube B and the No. 12 wire C, mounted inside A₁ make up a concentric quarter-wave section of about 160 ohms for matching the 400-ohm line

¹Long, "The Coaxial Vertical Radiator." *QST*, Jan., 1939.

to the center of the dipole. The top end of B is, therefore, connected electrically to the top end of A₁, while top end of the center conductor of the matching section is connected to the bottom end of A. The 400-ohm line is connected to the lower ends of B and C.

A₁ is a 2-foot section of 3-inch round rain spouting, while B is a 2-foot section of 1-inch thin-wall electric conduit. A single National type XS-1 h.f. bushing is divided to form an insulating support at each end of B for the No. 12 wire C. The threaded rod is cut in half and each piece soldered to one end of the wire. The nuts may then be used to draw the wire up tight. The upper half of the bushing is also used to support the upper half of the antenna A. A 3-inch ring of metal with a 1-inch hole at the center may be used to fasten the top ends of A₁ and B together. The bottom ends may be held together by a similar ring cut from polystyrene sheet, or 1-inch stand-off insulators may be used between the lower ends of A₁ and B. The whole assembly is mounted on the pole with heavy stand-off insulators. The line should be anchored to the pole to take the strain off the assembly. With the line coupled to the transmitter with a hairpin loop, this system has given very excellent results.

— H. R. Gebhardt, W8SR.

—

IMPROVING VOLTAGE-FREQUENCY STABILITY OF THE HRO RECEIVER

I RECENTLY made a couple of changes in my HRO which greatly improved the stability of the high-frequency oscillator, the instability of which has been annoying me when using maximum selectivity on c.w. signals. Slight changes in line voltage, such as those produced by taking more or less power off the line, had a perceptible effect on the oscillator, but more annoying was the fact that adjustment of the r.f. gain control had a marked detuning effect. Also, a strong incoming signal had quite an effect on the h.f. oscillator frequency.

The h.f. oscillator is affected by the position of the r.f. gain control, and by strong signals, because the oscillator-screen and mixer-screen voltages are taken off the same high-resistance voltage divider. When the r.f. gain is turned up, or when a strong signal comes in, the mixer draws more screen current, the voltage drop through R₁ increases, the voltage on the oscillator screen

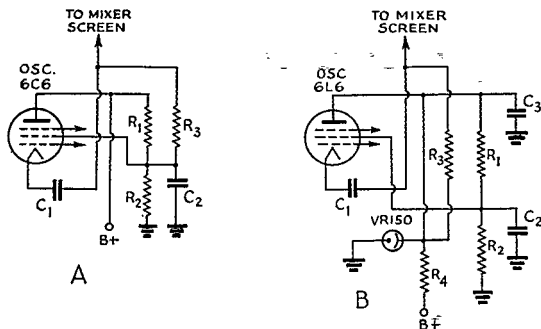

Fig. 2—HRO receiver circuit changes suggested by W3JVJ for improving voltage-frequency stability. A—Original circuit. B—The modified circuit. C_1, C_2, C_3 —0.1 μfd . R_1 —50,000 ohms. R_2, R_3 —100,000 ohms. R_4 —3000 ohms, 5-watt.

goes down, and the oscillator frequency is thereby changed. Also, of course, turning up the r.f. gain or tuning in a strong signal causes the r.f. and i.f. tubes to draw more plate and screen current. The total load on the power supply increases and the voltage on the plates of all tubes, including the h.f.o., drops. The suggested changes, shown in Fig. 2, take care of this, too.

Regulation of plate voltage to the oscillator was effected by putting a VR-150 into service with a 3,000-ohm resistor in its supply lead. The plate of the oscillator must then be by-passed to ground. The effect of the common screen resistor was eliminated by connecting the detector screen to the oscillator plate through the 100,000-ohm resistor already in the set.

The original circuit is shown at A, while the revised circuit is shown at B. The improvement effected has been very gratifying.

—John D. Edgerton, W3JVJ.

FIVE BANDS WITH TWO COILS

I HAVE a commercial transmitter which was not originally intended for maximum performance on the higher-frequency bands since the tank condenser in the final was a 220- μfd . single-section job with the rotor grounded and one end of the tank coil grounded. For high-frequency operation, I was confronted with the problem of getting the right L/C ratio and still being able to work 160 meters with the same coil and condenser. There was not sufficient room to install a "J" unit or fixed air condenser in parallel with the final if I installed a split-stator condenser. So I replaced the 220- μfd . tank condenser with a split-stator condenser of 100 μfd . per section and used the circuit shown in Fig. 3, using an Isolantite two-circuit band switch. With this arrangement 160-, 80- and 40-meter operation is

accomplished with one coil and 20- and 10-meter operation with a second coil.

This arrangement could be used in exciter stages using an ordinary receiving-type band switch. With this circuit, the two sections of the condenser are paralleled for 160-meter operation and the bottom end of the tank coil is grounded, completing the tank circuit. For 80-meter operation, the same coil is used only in a split-stator circuit which reduces the total capacity across the coil from 200 μfd . to 50 μfd . For 40 meters, the bottom end of the coil is shorted. The coil used was wound on an Isolantite form 3 inches in diameter, 6 inches long, with 32 turns of No. 12 wire. On 40 meters, 18 turns are shorted out with the band switch. The normal coil calculations for 20 and 10 meters, using a capacity of 50 μfd ., will apply. This circuit is especially applicable to screen-grid tubes.

The antenna tank circuit is coupled to the out-

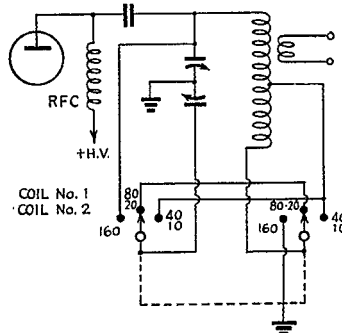

Fig. 3—W9IXE's arrangement for covering five bands with two coils.

put tank circuit by means of a link wound around the tank coil near the short-circuiting point.

—Harold Bourell, W9IXE.

SIMPLIFIED FREQUENCY STANDARD

IN CASES where a strong local signal at the higher-frequency harmonics is not required for calibration purposes, the frequency standard described by Grammer in *QST* for June, 1938, and modified in recent editions of *The Radio Amateur's Handbook* may be simplified.

The abbreviated circuit is shown in Fig. 4. It will be noticed that the harmonic-modulated amplifier has been eliminated. The output of the 10-ke. multivibrator is used to modulate the 100-ke. oscillator directly.

The multivibrator (6N7) is locked at 10 kilocycles when R_5 plus R_6 is about 20,000 ohms using the constants shown in the figure. C_7 introduces the control voltage at the cathode and C_{10} connected to the suppressor of the 6SK7 results in

(Continued on page 70)



CORRESPONDENCE FROM MEMBERS

The Publishers of *QST* assume no responsibility for statements made herein by correspondents.

WAR IN K6

EDITOR'S NOTE — Vigilant censorship has controlled the forwarding of information of possible military significance from Hawaii to such an extent that only now are we able to publish the following correspondence concerning amateur activity in the Territory following Pearl Harbor. K6CIB, for many years our SCM there and a competent and respected amateur, gives us a graphic picture of what war means. K6OTH, now the Hawaiian SCM, had his official report returned by the censor, was forced to content himself with the interim report reproduced herewith.

Honolulu, T. H.

Editor, *QST*:

. . . Hawaiian radio amateurs had their equipment confiscated during the first two days of the war. The Army requested the local police to "bring in" all amateur transmitting gear. My station was confiscated, too. The police did not bother to tell me they were coming, but broke in the door to my station and took my transmitter, 15-tube Patterson receiver, electric clock, 20 pole steps, a Boy Scout axe, over \$100 worth of spare tubes and meters, a quantity of electrical supplies for house wiring and many other items not related to radio transmission. . . . They were utterly ruthless in their methods and severely damaged much of the equipment they took. . . . Officials I have talked with said that the police damaged amateur transmitting equipment on all the Hawaiian Islands, and were fearful lest the police on the mainland do likewise in many localities. They were about the most jittery outfit in Hawaii in this emergency. The most inexperienced amateur could have handled the situation better, in my opinion. Thousands of dollars in useful radio transmitting equipment would thus have been saved for Army use (and they used a good many amateur sets, too). I could have superintended the moving of my equipment so that it could have been operating in half an hour in a new location, but the damage done by confiscation was such that it took me six days working nearly 17 hours out of each 24 to get it on the air. By the way, they cut down my antenna and took it, too. It was made of No. 8 gauge copper wire 119 feet long, folded into an 80° V doublet. The lead-in was EO-1 cable ripped apart, each wire taped with two thicknesses of friction tape and two more layers of tape over all. . . .

The Army has agreed to pay for my transmitter

and receiver but the \$100 worth of spare transmitting tubes and meters has not been located, and the Army refuses to pay for them since they claim they did not receive them from the police. The police assert they did not take this particular equipment, although I had the privilege of identifying all of my confiscated equipment except this one box full of tubes. I am still conducting correspondence with the chief of police about this last missing item. Many other amateurs suffered great damage to their equipment. I have heard that the Army is buying several of the best amateur transmitters among those confiscated.

Army-Amateur nets functioned almost day and night for a few days after the December 7th attack, and some civil officials feel that it would have been wise to have had them continue, but the military officials seemed to fear that opportunity would thus be given for espionage transmissions, either to go undetected or be much more difficult to detect. Hugh C. Rea, K6OTH, was head of the Army-Amateur net on this Island and Jack Wada, K6FKN, on Kauai. I did not hear any other units on the air after December seventh. . . .

My last transmission over K6CIB was the night before the attack. I was on 75-meter 'phone from 9:05 P.M. until 12:10 A.M., just seven hours and forty-five minutes before the attack began. During that evening I contacted the following stations: K6ETF, W6DYJ, W6PWR, W4HMT, W6MDD, W6AA, W6OQB, W6AAN, W6JTS, W9ZVT, W6FMK, W8GHP, and W5BCO. It was a most enjoyable series of contacts. Little did any of us dream then what would happen a few hours later.

My log book has a diary of events happening since the attack, and of the things I did for the defense of these Islands. I was given two citations for my work in rebuilding my equipment for Army use, one by Colonel Weddington, commanding officer of Bellows Air Field, and the other by Lieut. W. A. Cummings, communications officer at Bellows Field. The services using my transmitter and antenna are delighted with its performance. I simply lengthened the antenna from 119 to 141 feet, and it is functioning perfectly day and night with full signal ratings as far as needed.

Owing to the large number of Japanese amateurs, some of whom no doubt are under suspicion, the Army has said there will be no OCD activities. Amateurs were begged to enlist and

function as part of the regular Army on Army frequencies with Army equipment.

Many rumors were circulating the first week of the war that alien Japs were using transmitters to communicate with Japan and its armed forces. I did a lot of work for the services and know what circulated in the gossip of military officials, but I cannot tell you about it now as I feel we should not spread rumors. After the war is over all this information will be released. Of course, these aliens were unlicensed and operated illegally.

K6OJI did a very unsportsmanlike thing, in my opinion. After rushing to a point with a good view of Pearl Harbor, he came home and contacted an amateur in Kansas City on 20-meter 'phone and broadcast his version of the attack. No doubt there were thousands of short-wave fans and amateurs who heard him and that is probably the source of the rumors that arrived at West Hartford.

Long before the December 7th attack, the FCC monitoring force was increased several hundred per cent, and they have been right on the job. Of course, there are other monitoring services in connection with the military branches, as you well know, and they are also on the job watching the local situation.

Concerning the loyalty of Hawaiian amateurs of Japanese racial descent . . . all races have their good and bad folk. . . . There are many of the better class of Japanese families who were mortified over the cowardly attack of December 7th. These folks are thoroughly American, and some of them freely state that one visit to Japan will convince anyone that the good old U.S.A. has by far the better government and living conditions, and they are proud to be Americans. I believe thoroughly in their honesty and integrity. My personal opinion is that about 10 to 15% of our total Japanese population falls in this highly loyal group. . . . Our one big problem is the Japanese of American birth who have grown up in slum areas and do not know how to be good American citizens. Their background is most unfortunate and they are insolent in school, disrespectful to teachers, cocky on the streets, rude on the highways. . . .

Last month the entire 250,000 people on this island were fingerprinted on three sets of cards, one for official records at Washington, D. C., one for the local police department and a small card for individual identification. I was a chief at one of the fingerprinting stations where fourteen fingerprinters worked almost a month doing some 6000 persons, and we found an occasional alien who deliberately and purposely ruined the prints by jerking their hands and smudging the prints. We simply called the police and let men in uniform do this work. The effect was most gratifying.

I just to-day got to see the issue of *Life* which had pictures of the Pearl Harbor affair. I have seen the real thing and those pictures are gen-

uine. . . . The local radio stations did not go off the air for some time after the attack. They broadcast to the public, telling everyone that military orders were to stay at home, keep off the streets and keep cars off the streets and highways. In spite of this, many people got in their cars and went out toward Pearl Harbor, congesting the highways so that military traffic had difficulty in moving. Some people drove up onto the hillsides where a full view of Pearl Harbor could be had, and watched from there.

We live in Manoa Valley, some ten miles from Pearl Harbor and behind a high hill, yet when the attack occurred it was quite audible here. If you ever heard a bunch of firecrackers with all the fuses braided together lighted and exploding very rapidly, then change this into the sharp concussions of air bombardment and large heavy rumbling of aerial torpedoes, you have the picture. It was simply awful to sit at home, helpless, listening to that awful din and not able to do anything about it. I had only a .22 calibre rifle in the house at the time. . . . No planes were visible from our home during the period of explosions, but two shells hit near our home and sure made the dirt fly. These shells or bombs came whistling down and then exploded with a deafening high-pitched report. Clouds were about 2000 feet high so we do not know whether it was a Jap bomb or an anti-aircraft shell that did not have the proper set on its timer and exploded on ground contact. . . .

I worked at Pearl Harbor as a journeyman electrician after the attack and saw much of the damage done. The devastation at Pearl Harbor and adjoining Hickam Field was thoroughly sickening to me. No doubt you have seen the articles released to the national news agencies and have a good idea of the happenings. Sherman sized it up correctly about 1864.

It was my good fortune to see one of the two-man subs the Japs used in the attack. I saw it just after it was beached. The local papers described it as 5 feet in diameter and 41 feet long. I also saw a big Jap sub come up near shore two weeks later, running awash about two miles off with several men on deck. It got away temporarily, but was probably the one announced a few days later as accounted for. Whatever has appeared in print the censors are expected to pass, and that is my reason for mentioning this. Of course, the sergeant with me reported the sub as promptly as possible, and military action was immediate. . . .

The one thing that makes me furious is that, after being a big-game hunter for a museum and bagging deer, elk, moose, antelope, lynx and hundreds of smaller birds and animals, here I am with nothing but a .22 rifle to my name. I am joining the OCD now, and we will all have *real* shootin' irons shortly. I do not want to evacuate as many other folks are doing. I want to help

as many other folks are doing. I want to help whip the ——— (write in your own words!) . . .

Aloha, best greetings and . . . —
— L. A. Walworth, K6CIB

Honolulu, T. H.

Editor, *QST*:

. . . I would like very much to be able to tell you what you want to know, but at the present time under our censorship rules this cannot be done. I can only say that when this war is ended I shall send you a full account of what the Hawaiian radio amateurs have done towards national defense, and I am sure that American hamdom will agree with me that they have done their part.

I am sorry I cannot give you any more details at the present time, but assure you that over here we are facing things with a smile, and look forward to the day when the world returns to normalcy and we can again contact our friends on the mainland through the medium of amateur radio.

Aloha and best wishes!
— Hugh C. Rea, K6OTH

DYNAMO DAN OUTDONE

221 Greeley St., Clinton, Mass.

Editor, *QST*:

In March *QST* there is a letter from one B. L. Toy. Now from the tone of his letter I take it that he is a little skeptical of the truth of "Dynamo Dan and his crystal sending set." (I think I heard that one myself.) But I actually saw a case similar to the one he describes. It was a marvelous exhibition of technical skill and shows how versatile the reporters on our newspapers really are.

The gangster and his hoodlums had captured the intrepid reporter and two of his YL friends (very nice ones, too), and had left one of the stooges to guard them while they went about their nefarious business. In the meantime they had given some poisonous headache powders to a perfectly lovely old gentleman who was going somewhere on an airliner.

Stymied for a means to stop this cold-blooded murder, the reporter and his friends paced the floor of a beautifully-furnished apartment. One of the YLs spotted the radio and turned it on, tuned to the local b.c. station. Our hero had an inspiration. Quickly he snatched the set from its place against the wall and took it to a table in the center of the room. Opening the top of the b.c. set he removed two wires from the speaker and, by reversing the connections, he was able to converse with the local b.c. station using the speaker as a mike. Switching the wires back, he had a receiver.

When the stooge came back (he had been sent for a drink while this was going on) he (the stooge) was persuaded that if he would talk into the speaker the reporter would be able to determine

if he (the stooge) should have a regular audition. Of course, the stooge was led on to confess the whole lay-out. The conversation was picked up by the plane and the old gentleman didn't take the poisonous headache powder, and the state police (who also were listening on that frequency — hi!) sent over the whole force to capture the hoodlums. The idea was that the reporter was broadcasting to the local b.c. station and they were sending it out in place of their regular program. I dunno what the FCC thought about that.

I wish you boys down there would look into that matter, as I tried it here on a b.c. receiver without any success. So let's see what you can do with that in your experimenter's department. Of course, this took place in a movie, but I believe it all right. I saw him do it.

— Jim Liard, W1JLM

P.S.: Another time the traitor was trying to contact a U-boat that was following the ship, and he went to the shack but there was only a c.w. outfit aboard. So he scouted around until he found a copy of the ARRL *Handbook*, which of course contained the c.w. code, and, sitting at the sending table with the book in front of him, he sent the best fist that you have ever heard at about 50 w.p.m. on a Mackey!

NOW IS THE TIME

901 Walwood Pl., Kalamazoo, Mich.

Editor, *QST*:

By all means — NO. No membership in ARRL must be allowed to lapse at this time. Of all times, now we must hold together. I wish there was some way to get the message across to the gang that, if they ever loved their ham radio, now is the time to express it with support even stronger than ever. Now!

— Ralph O. Williams, W3AJC

KEEP 'EM OSCILLATING

83 Macdougall St., New York

Editor, *QST*:

Congratulations on your determination to keep *QST* coming off the presses. Let our motto be, "Keep 'em oscillating," whether it be a code-practice oscillator, b.f.o., wired wireless, test oscillator, or what have you.

— John L. Belfi

HELP NEEDED

940 Bay St. N., St. Petersburg, Fla.

Editor, *QST*:

Enclosed is a clipping from the March 1st issue of the St. Petersburg *Times*, showing the activity of local hams in defense work.

The classes being held here in both radio code and theory are becoming so large it has been necessary for the instructor to appoint assistants.

(Continued on page 74)



F. E. HANDY, WIBDI, Communications Manager

J. A. MOSKEY, WIJMY, Asst. to the Coms. Mgr.

ARRL Radio-Training Programs. Requests have come from far and near for the ARRL Code Lessons announced on this page last month for instructors engaged in code instruction. The Radio Course Outline and the Code Lessons have been in steady demand from clubs and individuals arranging to extend radio knowledge to groups. These helps continue to be available on request, sent free of charge by ARRL for inspection and return, or to keep for use in any serious training effort undertaken.

It is a service to the individual as well as the nation to help qualify radio specialists. With about one in twenty of the men in the armed forces required to know something of radio technique it is imperative that this work continue. Some clubs write that plans are being made whenever the courses now under way are completed to continue by announcing through local papers that a new enrollment is possible with new classes starting over for those not given previous radio training in such a course.

Time is of the essence. It is just as important to speed up and extend the means for training of specialists as it is to speed up production. The necessity to replace civilian radio workers who have volunteered for military service is greater every day, too. Of course few training courses can turn out graduates competent to take over responsible positions in high-power transmitting stations or research or design. Experience, as well as a thorough grounding in knowledge of fundamentals, is required to make practical radio men. No school can or should boast its ability to give one a "completed" education. One's radio education is ever incomplete. The radio art progresses continuously. We live to learn more about our chosen specialty! After sound basic training it is customary for individuals to specialize. There is need for experts in u.h.f. technique, also for the low frequency applications in the extensive and ever-growing radio field. The best our radio training can do is to establish a foundation on which can be erected a sure understanding of and preparation for later training in practical adjustment and operation of the devices built around vacuum tubes and electric circuits. There are more opportunities for skilled radio people for the war (and after the war) than ever before!

No student should hesitate in starting to study radio technique for fear that he may be called into service before he can complete a given course.

The pre-military instruction helps the individual to get classified for specialist ratings. Those with such courses fresh behind them required shorter courses to fit them for particular skilled jobs. The radio training time in government schools is often cut down by classification of the more skilled students into advanced classes. Any radio club and any individual instructor imparting knowledge to those voluntarily enrolling can feel that he is doing a vital and important part in assisting the all-out war effort.

Is your local radio club among those on our Honor Roll? All clubs or associations maintaining either code or theory courses in radio technique are invited to report the nature of the courses and the number attending class, and the progress made monthly via the Section Communications Managers (see address, page 4 *QST*) for *QST*'s Honor Roll listing. If nothing is in progress locally and you can see the right people and get something started, by all means do so! ARRL will be pleased to assist by sending its information on either Code Instruction or Radio Theory if you will but ask.

This war is one fought on a thousand fronts. The RADIO TRAINING front is a mighty important one. Any skilled amateur who can instruct ought to do so . . . any amateur not so using his time is well advised to identify himself with a student group to extend and perfect his radio knowledge. The knowledge each of us has must be kept ready, and must be used wherever opportunity permits for the good of the nation . . . and the ultimate credit of Amateur Radio and that individual.

Club Course Objectives. Ten clubs of every eleven responding to questions in the recent ARRL survey of club attendance, interest in experimenter's section projects, training program information etc. informed us that the Amateur Operator License was one of the main objectives of students in their Training Program. This points to the wisdom of Uncle Sam in continuing the issuance of amateur operator licenses for the duration. See page 24, February *QST* for the FCC Examination Schedule.

The ARRL Club-Award Code Proficiency Certificates are used regularly in groups winding up code classes, which are of 14-weeks duration in the case of the average club. The shortest code course we have heard of runs for 10 weeks, the longest for 24 weeks. Two-thirds of all the affli-

Honor Roll

The American Radio Relay League War Training Program

The maintenance of listings in this column depends on submission of reports from month to month stating the continuance of code and/or theory classes. Only radio clubs and institutions of learning engaged in a program of defense radio training are eligible for the Honor Roll. Those groups listed with an asterisk teach both code and theory; those listed with two asterisks teach theory only. Others conduct only code classes.

- Advance Radio Club, Jonesboro, La.
- Aerial Radio Club, Akron, Ohio.
- *Albany Amateur Radio Association, Albany, N. Y.
- **American Women's Voluntary Services, Inc.: New York, N. Y.; Santa Fe, N. M.; St. Louis, Mo.
- *Arbor Vitae-Woodruff Schools, Woodruff, Wis.
- Binghamton Amateur Radio Association, Binghamton, N. Y.
- Boy's Club of St. Marys Amateur Radio Society, St. Marys, Pa.
- **Boys Vocational School, Baltimore, Md.
- Butte-Anaconda Radio Club, Butte, Mont.
- Canton Amateur Radio Club, Canton, Ohio.
- Central Oregon Radio Club, Bend, Ore.
- Charlotte Amateur Radio Club, Charlotte, N. C.
- Chicago Radio Traffic Association, Chicago, Ill.
- Civilian Air Reserve Monitor and Relay System, Toledo, Ohio.
- Columbus Amateur Radio Association, Columbus, Ohio.
- *Cranston High School, Cranston, R. I.
- *Culver Military Academy, Culver, Ind.
- Dallas Amateur Radio Club, Dallas, Texas.
- Delta Radio Club, New Orleans, La.
- Downers Grove High School Radio Club, Downers Grove, Ill.
- East High School Radio Class, Erie, Pa.
- Electric City Radio Club, Great Falls, Mont.
- Elkins Kiwanis Club, Elkins, W. Va.
- *Enid Amateur Radio Club, Enid, Okla.
- Five Towns Defense Council, Cedarhurst, L. I., N. Y.
- Fort Wayne Radio Club, Fort Wayne, Ind.
- Freehold Amateur Radio Club, Freehold, N. J.
- Galveston Amateur Radio Club, Galveston, Texas.
- Grant County Amateur Defense Organization, Marion, Ind.
- Hannibal Amateur Radio Club, Hannibal, Mo.
- Heart of America Radio Club, Kansas City, Mo.
- Indianapolis Radio Club, Inc., Indianapolis, Ind.
- Irvington High School Radio Club, Irvington, N. J.
- Jackson County Amateur Radio Club, Jackson, Minn.
- Jersey Shore Amateur Radio Association, Long Branch, N. J.
- Joliet Amateur Radio Society, Lockport, Ill.
- Knoxville Radio Communication Club, Knoxville, Tenn.
- Lane Technical High School Radio Club, Chicago, Ill.
- Lorain Amateur Radio Operator's Club, Lorain, Ohio.
- Lowell Radio Operators Club, Lowell, Mass.
- *Manchester Radio Club, Manchester, Conn.
- Mike and Key Club, Green Bay, Wis.
- Milwaukee Radio Amateurs Club, Milwaukee, Wis.
- *Montclair High School Radio Club, Montclair, N. J.
- Mountaineer Amateur Radio Association, Fairmont, W. Va.
- Muskegon Area Amateur Radio Council, Muskegon, Mich.
- Nashville Society of Licensed Radio Amateurs, Nashville, Tenn.
- New Haven Amateur Radio Association, New Haven, Conn.
- Northern Minnesota Amateur Radio Association, Unit One, Bemidji, Minn.
- *Oklahoma City Amateur Radio Club, Oklahoma City, Okla.
- *Olympia Radio Club, Olympia, Wash.
- Pasadena Short Wave Club, Pasadena, Calif.
- Peninsula Amateur Radio Club, Newport News, Va.
- *Pilot Mound High School, Pilot Mound, Iowa.
- Piqua Radio Club, Piqua, Ohio.
- Plainville Radio Club, Plainville, Conn.
- Portland High School, Portland, Mich.
- *Radio Club of Arizona, Phoenix, Ariz.
- Radio Club of Brooklyn, Elmhurst, N. Y.
- Radio Clubs of the Denver Area, Denver, Colo.
- Richmond Amateur Radio Association, Richmond, Ind.
- Sioux Falls Radio Club, Sioux Falls, S. Dak.
- Starved Rock Radio Club, Utica, Ill.
- *South Central Nebraska Radio Club, Hastings, Nebr.
- Tennessee Valley Radio Amateurs, Knoxville, Tenn.
- The T-9 Society, Ocean Grove, N. J.
- University of North Carolina Radio Club, Chapel Hill, N. C.
- Vermont Academy, Saxtons River, Vt.
- *Victory Radio Club, Rupert, Idaho.
- Walnut Hills High School Radio Club, Cincinnati, Ohio.
- Westerly Radio Association, Westerly, R. I.
- Western Maryland Amateur Radio Club, Cumberland, Md.
- Whittier Experimental Association, Whittier, Calif.
- *Young Ladies Radio League, St. Louis, Mo.

ated clubs report interest in the new radio-training effort.

CD Staff Changes. Communications Department must add more names to those leaving ARRL Hq. for new wartime fields of service. Bob Morwood, W9QMD, is radio-operating on foreign soil. (He met Buckler, W9NFL, en route to his post.) Joseph Moskey, W1JMY, is on leave, engaged in special work in connection with de-

velopment of secret devices. We're not at liberty to give any of their locations at this time. Best of luck, Joe and Bob. George Hart, W1NJM, succeeds to Joe's post, holding down the desk vacated by Ev Battey, W1UE, who took leave to permit active duty with the Navy. George needs no introduction to hams who have met him through QSO with W1AW.

Report to SCMs Monthly. All amateurs are

requested to report each mid-month to SCMs (address on page 4) the training-in-radio, experimental communication projects, civilian defense building and planning that is going forward. Emergency Coördinators and Clubs have been sent forms to facilitate reporting monthly. Through *QST* these SCM reports will keep us amateurs together. The ground current, wired wireless, and light beam substitutes for radio each have a following, and the monthly amateur activities section can help us find fellow experimenters who have a bent after our own heart without undue trouble. Drop your SCM a line before May 18th to use for his report in *QST*.

— F. E. H.



Meet the SCM's

W9ILH

Here is an SCM who needs little introduction to hams who have done a lot of listening on the 3.5- and 7-Mc. bands. Carrie Jones, W9ILH, first became interested in amateur radio in 1930, was licensed under her present call in 1931, and has since hung up an impressive record of amateur activity. With her 400-watt 852-final rig and her NC10LXA receiver, located in the Jones dining room, Carrie has for many years pounded brass on the League's traffic lanes as well as chewed the rag with hams in all parts of the country. Before the war started she took part in ORS parties, RM-Nites, Sweepstakes Contests, and Field Day, along with extensive traffic-handling activity that frequently placed her in the BPL. She was a member of Trunk Line G and the National Trunk Line, and NCS of the YLRL 3.5-Mc. Net. In 1937 Carrie received a Public Service Certificate for her work during the Ohio flood disaster. She is a member of YLRL, YL Radio Club, and an honorary member of the Central Illinois Amateur Radio Club. After her election as SCM she published a popular section bulletin called *Illi-Noise*. Her other hobbies include duck hunting, game fishing and trap shooting. A real SCM!

ARTICLE CONTEST

The article by Mr. George C. Wetmore, W4HVH, wins the CD article contest prize this month. We invite entries for this monthly contest. Regarding subject matter, we suggest that you tell about what activity you find most interesting in amateur radio. Here you will find an almost limitless variety of subjects. Perhaps you would like to write on working for code proficiency, Emergency Corps planning, traffic work, working in Section Nets, 'Phone and Telegraph operating procedures, holding a League appointment, working on radio club committees, organizing or running a radio club, the most interesting band or type of ham activity, or some other subject near to your heart.

Each month we will print the most interesting and valuable article received. Please mark your contribution "for the CD contest." Prize winners may select a bound *Handbook*, *QST* Binder and League Emblem, six logs, eight pads radiogram blanks, DX Map and three pads, or any other combination of ARRL supplies of equivalent value. Try your luck!

Radio Clubs in the War Effort

BY GEORGE C. WETMORE,
W4HVH*

Now that amateur radio activity has ceased on the air, many of us are wondering about the place of the radio clubs established throughout the country. Along with the fact that the usual air activity — which was the main interest of many a club-goer — is now out for the duration, we are also faced with the fact that many people at home are working longer hours, which cuts down their spare time; then, too, a good many hams have been inducted into military service.

Despite these considerations, however, the outlook is not unfavorable for the radio clubs. Many clubs might consider it easier to close up for the duration. Easier it may be, though hardly wiser, when there are programs in the national interest to carry forward. Unquestionably there is going to be a defense job — an active job — for the amateur, just as soon as a sure-fire plan can be drawn up and approved. And, as always, the successful promulgation of that program is going to rest on a central organization of hams in each community.

Clubs were originally organized because it was obvious that cooperation and coordination and service to club members can best be realized by proper organization. At the time it was for fun — a hobby. Yet mutual benefits to members, the advantages of unity, even for fun, were aptly proven. Now, in this time of national distress, the need for unity is ever more present. Amateur radio is no longer primarily a hobby; now, it's first a service, and service is duty.

Many of us are doing our bit by serving in the armed forces. But many of you will find your job at home. Just as it's our duty to be of service in the armed forces, it's your duty — you at home — to carry on the work of the radio club, among other things. It's your job to keep in touch with the radio gang, to keep in touch with the ARRL Headquarters. You must decide and plan the means whereby the radio amateur at home may best serve, and you must successfully execute your plan.

One of the most crying needs of the armed services is for trained radiomen. Radio clubs here have a very important opening through which they can stimulate club activity at the same time they do a service for their country. Organization of code and theory training classes is of primary importance to any radio club at this time. Start things going, get some of the members to volunteer their services as instructors in such courses, and then let it be known locally

* APO 43, Camp Shelby, Miss.

that such courses are being organized. You will find your courses over subscribed. Hundreds of young men about to enter the services right in your community would be glad of the opportunity to qualify for this branch of Army or Navy.

Many of the hams left at home are the older and more experienced ones. Their knowledge and experience can be employed in experimental development in some of the many fields suggested by the League. Turn to your League for guidance and aid if you find it difficult to promote activity. ARRL has numerous circulars and pamphlets especially designed for such use.

Just because some of us aren't around any longer and you can't put the rig on the air, or you're too busy working nites and week ends — don't close up the club because it's the easy way. Just because we aren't around for the 'fests and the meetings doesn't mean we aren't in the club anymore. We're there, and we're counting on you fellows to do your job, as you're counting on us to do ours.

And by the way, life in the service can be kinda lonesome sometimes. A letter or a bulletin from the radio club makes mighty interesting reading.

Providence Radio Patrol Members Get Badges

MEMBERS of the Providence Police Mobile Radio Patrol have each received lapel buttons which are exact miniatures of the regular police badge. Each badge is numbered and each has been assigned to one of the 70 members of the patrol, as well as to members of the Bureau of Police and Fire.

The seventy members of the patrol are all amateurs and are full-fledged but non-paid members of the police department. They are assisting in the emergency communications of the civilian defense set-up. Members of the patrol are thus identified in addition to the regular police badge.

BRIEFS

The Washington State Patrol desires the assistance of amateurs in the state of Washington in connection with the communications system of the Patrol. Arrangements are under way to use amateurs as relief operators in State Patrol radio stations in the event of an emergency, and some amateur stations at points where the State Patrol does not have coverage. There will be a place for 100 or more amateurs if the proposed program goes through.

Questionnaires will be sent on request, to be filled out preliminary to organization. Amateurs in the state who are interested are requested to contact W7IOQ, W7ZL, W7FWD, or W7BG.

The Amateur Radio Association of Bremerton, Wash., reports that it is having more activity than ever before. Membership is actually increasing because of the influx of defense workers, and meetings are well attended and discussions lively. Interest in wired wireless is the main attraction at present. In January the club purchased \$275 worth of defense savings bonds. They also raffie off some defense stamps at each meeting.

The British Broadcasting Corporation is planning a series of test programs on the North American transmission starting Friday, April 24th and continuing every Friday for six weeks. The program will be on the air from 8:45 to 9:00 P.M. EWT and will consist of voices of different pitch, instrumental and other music, and various sound effects. It will be entitled, "Lend Us Your Ears." Frequencies normally used are 9.58 and 11.75 Mc.

Reports on reception of this program will help give BBC engineers a better picture of reception conditions in this country. Reports should be sent to the BBC North American Office, 630 Fifth Ave., New York City.

Good Morse is Easier

BY T. R. McELROY*

WITH all the emphasis that can be conveyed through type I'd like to say that any person of reasonable intelligence can become a very fine operator. There aren't any exceptions. When I say a fine operator I mean a person who can transmit clear, smooth and easily readable Morse at about 25 words per minute with the hand key or 35 words per minute with a "speed key." These figures are conservative. They are right. Swinging to the extreme I say for the purpose of showing what the real enthusiast may expect to achieve, that the extreme limit for good hand sending is possibly 40 with a bare possibility of 45 words per minute; with "speed key" sending about a couple words per minute faster. And incidentally at this point I might say that these "bug" keys should be termed "ease" keys, rather than "speed" keys. Their most valuable asset is in making good sending so much easier — not faster.

Getting to the receiving end of this code business, I will say that approximately the same speeds hold true, with the exception that in some instances because of skill as a typist and because of the excellence of mechanical transmission it is possible for an operator to attain copying speeds up to 50 and sometimes 60 words per minute. In my nearly 25 years of experience as a commercial operator I have known of but a mere handful who can copy anything like 60 words per minute. But we're dealing now with the average person who desires to become a good operator. And the man who can copy 25 words per minute with pencil is a very good operator. The man who can copy 45 words per minute on the typewriter is likewise very good indeed.

Now to get on the road to attaining this degree of skill that I again emphasize as so easy to achieve. I'm going to talk about the real easy method and I know that my plan works, having tried it out on a class of about 16 average individuals. Through friendship for an old-time operator friend of mine, who opened a school for training radio telegraphists in Boston, I voluntarily, and for no remuneration whatever, took on the job of teaching the code. I took a group of about 16 chaps averaging 18 years of age, although actually two were only 15 years old and four 40 years of age. Not one of them new a dot from a dash!

The first night! Get this, my friend. The first night, I had them copying simple words at 20 words per minute. Now I realize that that sounds like a pretty tall story. But it is true. How? That's what we're getting to. On the ordinary paper slip, in a Mac Recorder, made with an ordinary hand key, I made about a half dozen dots, spaced very widely apart. Then after a half minute or so, I made a half dozen series of two dots, the two dots being right together as they should be, but much space between each group of two dots. Then after an interval, three dots, the same way. Then four dots. And then five dots. Then two dots again as originally. On the first night, I ran that slip through my Mac Auto at 20 words per minute. A dot ran through, and I announced loudly, "That is a dot. One dot, or 'dit,' is the letter 'E.' Now here it is again; write it down with your pencil. Forget that it is 'dit' — it is 'E.'" And the slip meanwhile, running through at 20 words per minute, had come to the second dot. Each of the 16 persons in the group almost automatically wrote "E" when they heard it. And here may I say that in all my experimenting I have found no speed of transmission that is as easy to read as about 20 words per minute.

Then we came to the two-dot group. I said, "Now we'll hear two 'dits.' Listen." And along came "dit dit," at 20 words per minute. I said, "That is 'I.' Now here it is again. Write it down with your pencils when you hear it." And the slip running all the while, came to the two dots, and again automatically the group wrote "I." After doing that a half a dozen times, they would recognize "I" when they heard it. Mind you, they'd never heard a dot or a dash before. But at 20 words per minute they automatically slapped down "I."

(Continued on page 88)

* World's Champion Radio Telegrapher, 100-102 Brookline Avenue, Boston, Mass.



UNTIL RECENTLY, amateurs and other users of electronic equipment have been able to buy nearly all items they needed from dealers, even though the most skillful manufacturers were working almost wholly for defense. This happy state of affairs has been due to the well stocked shelves with which the dealers entered the war period.

That is about over now, so we would like to tell our customers what they may expect in the way of deliveries. Perhaps we can save a few telephone calls by so doing. As matters now stand, those of us who keep track of deliveries have to spend most of the day listening to exhortations over the telephone, and do not get much constructive work done until our customers go to bed at night. We enjoy hearing from our customers, but the present situation is becoming burdensome to everybody.

We can definitely state that production is really getting rolling and deliveries are becoming impressive in quantity, in quality and in promptness. This is partly because the men and women who build National products are doing a magnificent job. It is partly because the new priorities system will eliminate most of the obstacles to production resulting from the old system. Before Pearl Harbor, there were two to six weeks of paper work between the time an order was received and the time we were able to order material to fill it.

We do not have much choice when it comes to deciding where the finished products go. High priorities get first call; after that it is first come first served. So far this year, our records do not show a single delivery known to be for non-defense purposes. For many items, an A-2 priority is not good enough for even a delivery promise.

Obviously, we cannot be very specific here, but the above does give a general idea of how matters stand. We are sorry that we have to disappoint old customers sometimes, but the job to be done comes first.

GENE SIMMS





More than Quality

Every Mallory product has an unseen asset that goes beyond the product itself. This unseen value exists because a radio product is bought for the service it is expected to deliver. Satisfactory service means:

1. Selection of the correct product.
2. Proper installation.
3. The merit of the product selected.

You can see and measure the quality of a Mallory product, but you cannot see or measure the service that goes with it. Whether it be a tiny rubber grommet or a 6,000-ampere Rectoplater, Mallory will help you select the best, most economical product for your application . . . and advise you how to use it.

It is this friendly service, available for the asking, that has made Mallory outstanding as a source of supply for radio and electrical products. We're here to help you.

P. R. MALLORY & CO., Inc.
INDIANAPOLIS INDIANA
Cable Address — PELMALLO



Standard Frequency Transmissions From WWV

The standard frequency service of the National Bureau of Standards station WWV has been extended to include another carrier frequency (15 megacycles). Temporary equipment is still in use while a new transmitting station is being built.

The broadcast is continuous at all times day and night from 1-kilowatt transmitters, and carries the standard musical pitch and other features. The radio frequencies are:

- 5 megacycles (= 5000 kilocycles = 5,000,000 cycles) per second
- 15 megacycles (= 15,000 kilocycles = 15,000,000 cycles) per second.

The standard musical pitch carried by the broadcasts is the frequency 440 cycles per second, corresponding to A above middle C. In addition there is a pulse every second, heard as a faint tick each second when listening to the 440 cycles. The pulse lasts 0.005 second, and provides an accurate time interval for purposes of physical measurements.

The 440-cycle tone is interrupted every five minutes for one minute in order to give the station announcement and to provide an interval for the checking of radio measurements based on the standard radio frequency. The announcement is the station call letters (WWV) in telegraphic code (dots and dashes).

The accuracy on the 5- and 15-megacycle frequencies, and of the 440-cycle standard pitch as transmitted, is better than a part in 10,000,000. Transmission effects in the medium (Doppler effect, etc.) may result in slight fluctuations in the 440-cycle frequency as received at a particular place; the average frequency received is, however, as accurate as that transmitted. The time interval marked by the pulse every second is accurate to 0.000 01 second. The 1-minute, 4-minute, and 5-minute intervals, synchronized with the seconds pulses and marked by the beginning and ending of the announcement periods, are accurate to a part in 10,000,000. The beginnings of the announcement periods are so synchronized with the basic time service of the U. S. Naval Observatory that they mark accurately the hour and the successive 5-minute periods; this adjustment does not have the extreme accuracy of the time intervals, but is within a small fraction of a second.

The service from the temporary transmitters will continue for some months. It will be continuous except for such breakdowns as may possibly occur because of the use of temporary apparatus. As rapidly as possible the Bureau is establishing a new station to provide more fully than in the past standard frequencies reliably receivable at all times throughout the country and adjacent areas.

SUPER PRO

"SERIES · 200"

Built to last a life-time!

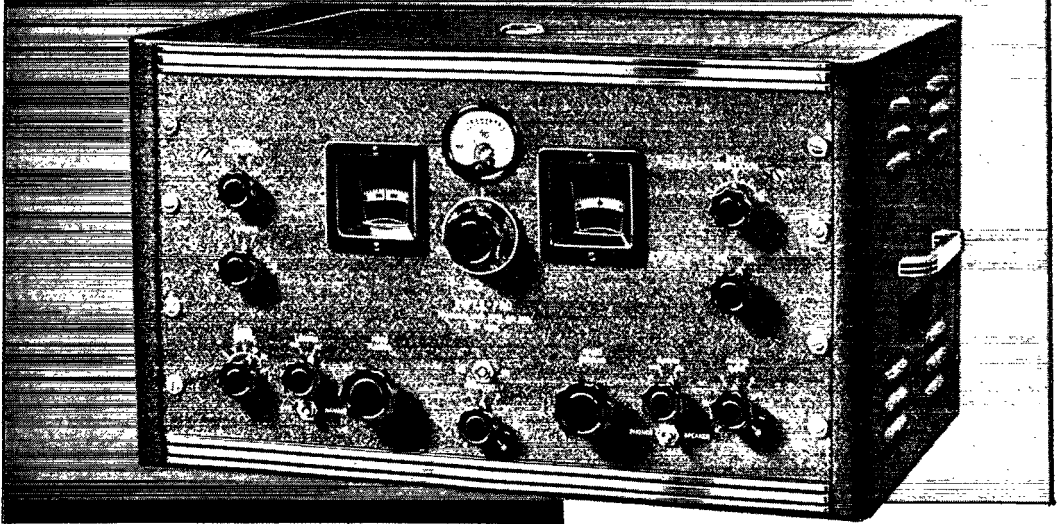

THE "Super-Pro" Series 200 is designed and built to give years of service. It is a *plus* receiver all the way. When you buy a "Super-Pro," you are not only assured of getting a modern receiver, but you are getting one that will still be in a class by itself even after years of use. One happy "Super-Pro" owner puts it this way: "I have owned a half dozen or more receivers of the communications type, but I have bought my last receiver — it is a 'Super-Pro.'"

The "Super-Pro," being a professional receiver, naturally has many features especially appealing to the amateur. Two stages of TRF

provide high image ratio and low noise level. Variable I.F. band width and variable crystal selectivity cover practically every requirement in crowded bands. The "S-Meter" problem is nicely solved with an adjustment that can be made to provide the exact "S-Meter" readings desired.

SEND FOR BOOKLET!

HAMMARLUND MFG. CO., INC.
424-438 W. 33rd St., New York City

Please send "Super-Pro" Booklet

Q-5-42

Name

Address

City State



HAMMARLUND MFG. CO., INC.

424-438 WEST 33rd ST., NEW YORK



CANADIAN OFFICE: 41 WEST AVE. NO., HAMILTON, ONTARIO

EXPORT DEPARTMENT: 100 VARICK STREET, NEW YORK CITY

Hints and Kinks

(Continued from page 59)

suppressor modulation of the 100-kilocycle signal. The 10-kilocycle beat notes are slightly weaker than those at 100-kilocycle intervals and on 80 meters and higher every alternate beat note has

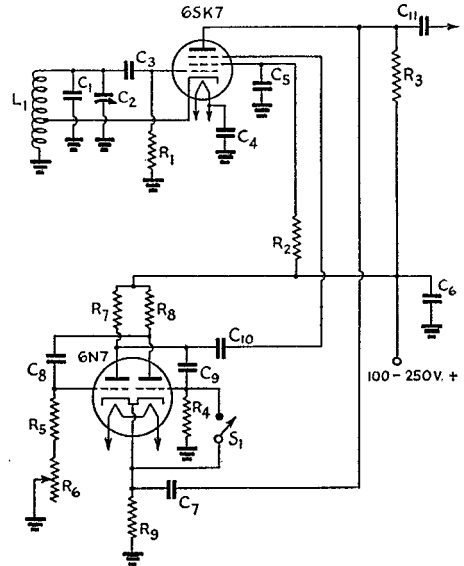

Fig. 4 — Circuit of simplified frequency standard.

- C₁ — 0.0015- μ fd. mica (Low-drift silver, if possible).
- C₂ — 100- μ fd. tuning condenser.
- C₃ — 250- μ fd. mica.
- C₄, C₅, C₈ — 0.1- μ fd. paper.
- C₇ — 50- μ fd. mica.
- C₈ — 0.003- μ fd. mica.
- C₉ — 0.002- μ fd. mica.
- C₁₀, C₁₁ — 250- μ fd. mica.
- L₁ — Coil from i.f. transformer, tapped.
- R₁ — 250,000 ohms, 1-watt.
- R₂, R₃ — 50,000 ohms, 1-watt.
- R₄ — 40,000 ohms, $\frac{1}{2}$ -watt.
- R₅ — 15,000 ohms, $\frac{1}{2}$ -watt.
- R₆ — 30,000-ohm potentiometer.
- R₇, R₈ — 3000 ohms, 1-watt.
- R₉ — 300 ohms, 1-watt.
- S₁ — S.p.s.t. toggle.

quite a bit of hum, but this does not interfere with the ease of calibration. Output on the higher order of harmonics is naturally down, but the 14- and 28-Mc. bands can be calibrated using direct connection between the output condenser and antenna binding post of the receiver.

— W. B. Thompson, W80KC.

LIGHT METAL TURNING ON A DRILL PRESS

OUR neighborhood dealers do their best to carry a complete line of radio hardware, but every so often we find need for something which is not a stock item. Then too, hams are an impatient lot when it comes to needing "just one little gadget to get the thing running"!

Small shaft reducers, couplings, bushing, etc.,

(Continued on page 72)

ONLY THE Voice OF AMATEUR RADIO

IS SILENT

In spite of uncanny silence in the amateur bands, forces already are working to create a greater amateur radio. Thousands of Americans are engaged in the operation and maintenance of military and defense radio. When peace returns, many of these experienced men will join the existing "ham fraternity." Component manufacturers — such as Bliley — likewise are contributing to this great, future rebirth. Expanded equipment, intensified research and experiences gained in high production for rigid government requirements will result in superior components. Yes, its voice may be silent, but amateur radio still carries on!

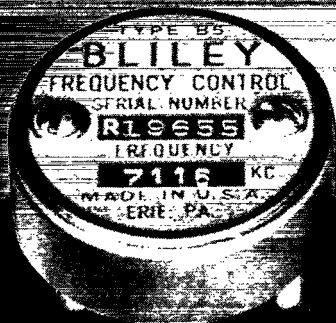

BLILEY ELECTRIC CO.
UNION STATION BUILDING ERIE, PA.

Ask an "HQ-120-X"
Owner!...

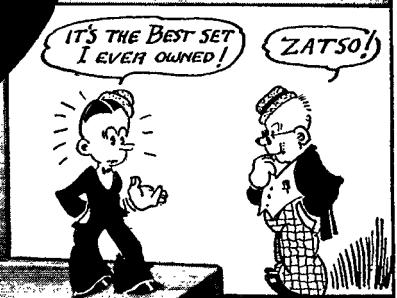
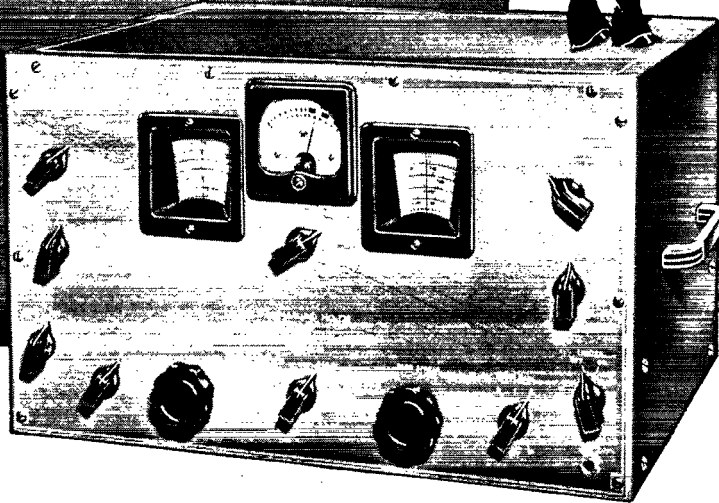

"HQ-120-X" owners are continually expressing their enthusiastic approval of this fine receiver. That is why we say, "Ask an 'HQ-120-X' owner." The variable selectivity crystal filter and the calibrated band spread dial have hit a vital spot with the amateur. Many say they would never be without these features again. This new crystal filter has everything for CW that crystal filters have ever had, and in addition, there are four wide band ranges, one for medium CW selectivity and three for phone reception without spurious responses. It is absolutely smooth and stable. The calibrated band spread dial can be set for exceptional accuracy. Four amateur bands, 80, 40, 20, and 10 have scales of over 310 degrees. These are, by no means, the only features — talk to someone who owns an "HQ-120-X" and get the real low-down. You will be amazed.

We have prepared a 16-page booklet containing complete technical information — curves and diagrams included. If you do not have a copy of this booklet, ask your jobber for one or write direct to the factory. It contains a lot of useful information.

HAMMARLUND MFG. CO., INC.
424-438 W. 33rd St., New York City

Please send "HQ" Booklet. Q-5-42

Name.....

Address.....

City.....State.....

Canadian Office: 41 West Ave.
No., Hamilton, Ontario



HAMMARLUND



E. H. Rietzke
Pres. CREI

There's NO PRIORITY

ON YOUR FUTURE SUCCESS



**Add Technical Training to Your
Practical Experience—THEN Get
That BETTER Radio Job You Want!**

CREI home-study training in practical radio engineering enables you to go after — and get the *better* job that means something in radio. There's no priority on success — but the better jobs are "rationed" to those men who have the necessary technical ability.

Jobs that provide security — jobs that will mean something long after "tomorrow" has come and gone — must be won and held on ability. The men who will *retain* the important radio engineering positions after the war is over are those men whose positions are essential — whose abilities are specialized.

If the lack of technical training is *your* stumbling block . . . you can do something about it now — *if you will*. Your present radio experience backed up by CREI spare-time training will equip you to fulfill the exacting requirements necessary to obtain the position and security you desire.

WRITE FOR FACTS TODAY
about CREI Home Study Courses

Our free booklet and personal recommendations may hold the answer to your future success. In your inquiry please state briefly your background of experience, education and present position.



Capitol Radio Engineering Institute
Dept. Q-5, 3224 16th St. N.W., Washington, D. C.

Contractors to the U. S. Signal Corps and U. S. Coast Guard
Producers of Well-trained Technical Radiomen for Industry

(Continued from page 70)

can be made quite accurately on an ordinary drill press when a bench lathe is not to be had. That is precisely the state of affairs here at W9YZH! For example, a small steel shaft with hub was needed recently to couple from a motor shaft of 5/32-inch diameter to a spur gear having a 1/4-inch diameter hole. The operation was enough to cause any self-respecting machinist to gnash his hair and pull his teeth, but anyhow here are the steps:

1. Cut off the desired length of 3/8-inch round stock with a hacksaw from a bolt, lag bolt, or piece of scrap rod.

2. Clamp a piece of scrap iron (at least 1 inch thick) to the drill-press table. Drill a 5/32-inch hole 3/4-inch deep. Remove the drill from the chuck and stand the shank in the hole. Clamp the work in the chuck (with exposed end center-punched by eye) and come down on the drill far enough to allow for a good hold on the motor shaft, about 1/2 inch.

3. Grind the end of a worn-out 8-inch flat file into a cutting tool and clamp the file flat along the top of the drill-press table with the cutting edge extending into the center hole of the table. Use two "C" clamps, one near the table edge and the other through one of the bolt slots.

4. Slip the work up in the chuck (or turn it end for end if too long) until the ends of the three chuck jaws can serve as markers for prick-punching for the setscrew holes. The punch must be tapped lightly to prevent injury to the chuck or the spindle; the points may be punched deeper when the work is held in a vise for drilling and tapping for the setscrews.

5. Start the screws, break off the shank of the 5/32-inch drill and insert it as a temporary shaft. Tighten the screws and clamp the shaft in the chuck (up close). Set the feed stop so the tool will stop at the hub line each time the work is fed along the cutting edge. Tighten the clamp handle on the table bracket moderately snug and then tap the table lightly with a hammer until the tool starts to take a light cut. Then proceed to turn down the 1/4-inch shaft section. Run the press at slow speed (not over 600 r.p.m.) and take light cuts to prevent chattering and possible injury to the spindle or bearings. Draw the work down across the cutting tool very slowly, then let the feed lever up fast. Tap the table for a new cut and repeat the process until the job is done!

6. Turn the work end for end in the chuck, remove the drill shank and setscrews, increase the speed to about 1200 r.p.m., take one or two very light cuts until the hub is true, and then finish it with a flat file.

7. Press the gear onto the shaft end and crimp it in place.

The important thing to keep in mind when attempting anything of this nature with a drill press is that the cutting tool must be ground and clamped against the work properly so it can actually make a clean cut. A handbook titled "How to Run a Lathe" is (or was) obtainable from the South Bend Lathe Works, 435 E. Madison Street, South Bend, Indiana. The price is



EXCELLENT OPPORTUNITY FOR OUTSTANDING MEN

THE Farnsworth Television & Radio Corporation is adding to its staff of research and development specialists—the closely knit group which has won recognition throughout the world for its developments in the field of electronics. These men know how to work harmoniously toward a common goal, for each realizes that his opportunity to succeed is controlled only by his ability and ambition.

The urgency for additional research and development of highly specialized electronic apparatus at this time enables us to solicit applications from

qualified American citizens including junior and senior engineers and physicists having suitable qualifications.

Excellent opportunity to participate now in most important engineering developments as well as to qualify for responsible positions in post-war activities.

Replies, including complete statements of experience and training, references and photographs, should be addressed to this company, attention of Personnel Manager, at its main office at Fort Wayne, Indiana.

Personal interviews will be by appointment only.

FARNSWORTH TELEVISION & RADIO CORPORATION

Fort Wayne, Indiana

Marion, Indiana

*Makers of RADIO AND TELEVISION TRANSMITTERS AND RECEIVERS, THE CAPEHART,
THE CAPEHART-PANAMUSE AND FARNSWORTH PHONOGRAPH-RADIO COMBINATIONS*

NOW—a really high-powered RADIO ENGINEERING LIBRARY

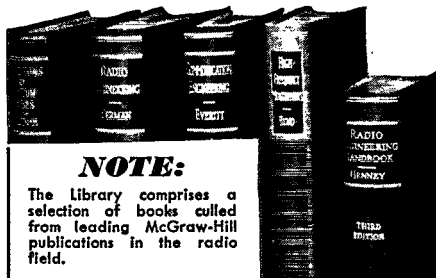

NOTE:

The library comprises a selection of books culled from leading McGraw-Hill publications in the radio field.

- ➔ especially selected by radio specialists of McGraw-Hill publications
- ➔ to give most complete, dependable coverage of facts needed by all whose fields are grounded on radio fundamentals
- ➔ available at a special price and terms

THESE books cover circuit phenomena, tube theory, networks, measurements, and other subjects—give specialized treatments of all fields of practical design and application. They are books of recognized position in the literature—books you will refer to and be referred to often. If you are a practical designer, researcher or engineer in any field based on radio, you want these books for the help they give in hundreds of problems throughout the whole field of radio engineering.

5 volumes, 3559 pages, 2558 illustrations

- Eastman's **FUNDAMENTALS OF VACUUM TUBES**, 2nd edition
- Terman's **RADIO ENGINEERING**, 2nd edition
- Everitt's **COMMUNICATION ENGINEERING**, 2nd edition
- Hund's **HIGH FREQUENCY MEASUREMENTS**
- Henney's **RADIO ENGINEERING HANDBOOK**, 3rd edition

10 DAYS' FREE EXAMINATION

SPECIAL LOW PRICE

EASY TERMS

Special price under this offer less than books bought separately. Add these standard works to your library now; pay small monthly installments, while you use the books.

SEND THIS EXAMINATION COUPON

McGraw-Hill Book Co., 330 W. 42 St., N. Y.

Send me Radio Engineering Library for 10 days' examination on approval. In 10 days I will send \$3.00 plus few cents postage, and \$3.00 monthly till \$24.00 is paid, or return books postpaid. (We pay postage on orders accompanied by remittance of first installment.)

Name

Address

City and State

Position

Company.....QST 5-42

(Continued from page 72)

25 cents, postpaid, and an amateur who is interested in shop work will surely be able to find much useful information therein.

— Henry E. Rice, Jr., W9YZH

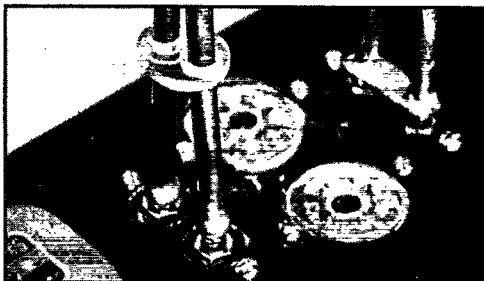

National type FWB polystyrene terminal strips are inexpensive items which may be used in a number of different ways in places where good insulation is required. In pairs, or cut in half, they may be used as feed-through insulators for compact jobs. Since their center-hole spacing is 3/4-inch, the same as that of the mounting holes for the type ST condensers, they make good insulating mounts for these condensers. Cut in half, with adjacent holes drilled out, they make excellent spacers for 1/4-inch tubing in line oscillators. They will be found handy frequently in a number of other similar applications.

TESTING FOR SHORT-CIRCUTED BY-PASS CONDENSERS

As a new member of the ARRL and an old-time reader of *QST* permit me to donate the following hint for your Hints and Kinks section.

Most instruction books state that to test for shorted condensers that are shunted by resistances, it is necessary to unsolder one terminal of the condenser before applying the ohmmeter test. In order to save time and work unsoldering condensers, the shorted condenser often can be determined by using an ohmmeter range that is less than the resistance of the shunt. A 0- to 10-ohm range will usually show infinite resistance for good condensers and zero resistance for shorted ones because resistances have a resistance of more than 10 ohms d.c.

— E. Esbrook, Barranquilla, Colombia.

Correspondence

(Continued from page 68)

The training the radio hams have had especially fits them for this job, and their help has been warmly welcomed.

It seems to me that this is a splendid way for other amateurs to help out in the present emergency, especially those who are too old to enlist or who are deferred for other reasons. If all hams would contact their local EC or OCD office, I am

(Continued on page 76)

VACUUM

*The Invisible Protection
for Filament Emission*



EIMAC 200T

Filament Voltage . . . 10 volts
Plate Voltage . . . up to 6000 volts
Plate Dissipation . . . 2000 watts
Power Output (75% eff.) 6000 watts



Like a solid coat of armor-plate, hard, high vacuum protects filament emission in every Eimac tube. Extremely efficient evacuating pumps developed and built in the Eimac laboratories for the precise purpose of producing the highest possible degree of vacuum are shown in action above. It is this excellent vacuum that proved the idea fallacious that plate temperature destroyed emission...caused premature failures. Chiefly because of this processing, Eimac tubes today, and for the past number of years, have provided longer life, greater stamina and vastly superior performance.

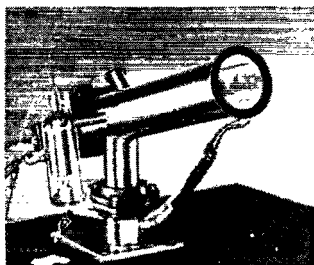

ELECTRON MICROSCOPE virtually gives a moving picture projection of the action of electrons being emitted from a heated filament. Such observations enable Eimac engineers to constantly produce better filaments.

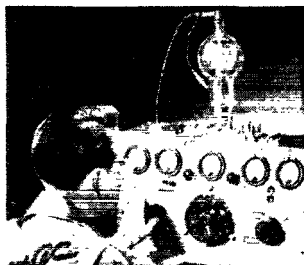

PEAK EMISSION TESTER measures the flow of electrons from the filaments of completed Eimac tubes. Of the long series of gruelling tests made to insure more efficient filament emission in every Eimac tube, this is the final test.



FLASH FILAMENT TESTER checks filaments before tubes are assembled and pumped. Here tubes are placed under a temporary vacuum, heated to much higher temperatures than will ever be required in normal use. Only perfect filaments reach the final stages of manufacture.

*In Peacetime or Wartime
...wherever you look...in
the air, on land and at sea
...you'll find Eimac tubes
doing their bit. Right now
the Armed Forces get first
call on our facilities and
Eimac tubes are receiving
enthusiastic acceptance
from all quarters.*

Follow the Leaders to

Eimac TUBES

Eitel-McCullough, Inc.
San Bruno, California, U.S.A.

EIMAC REPRESENTATIVES

California, Nevada
HERB BECKLER, 1496 South
Grand Ave., Los Angeles, Calif.
N. Y., N. J., Penn., Md., Del.,
Dist. of Col., Maine, N. H.,
R. I., Conn., Mass.
ADOLPH SCHWARTZ, 262
Cravson Place, Teaneck, New
Jersey.

Wash., Ore., Idaho, Mont.
GENERAL SALES CO.,
Verner O. Jensen, 2605 07
Second Ave., Seattle, Wash.
Colo., Wyo., New Mexico,
Arizona, Utah
RICHARD A. HYDE, 4253
Quitman St., Denver, Colo.
Export Agents: Fraxor & Co., Ltd., 301 Clay Street, San Francisco

Chicago, Illinois, Wisconsin
G. G. RYAN, 549 W.
Washington Blvd., Chicago,
Ill.
N. Caro., S. Caro., Georgia,
Tenn., Flor., Ala., Miss.
JAMES MILLAR, 316 Ninth
St. N. E., Atlanta, Georgia.

Texas, La., Okla., Ark.
J. EARL SMITH, 2821 Live
Oak St., Dallas, Texas.
Ohio, Mich., Ky., Ind., Minn.,
Mo., Kan., Neb., Iowa
PEEL SALES ENGINEER-
ING CO., E. R. Peel, 154
E. Erie St., Chicago, Ill.

Kits for DEFENSE RADIO TRAINING

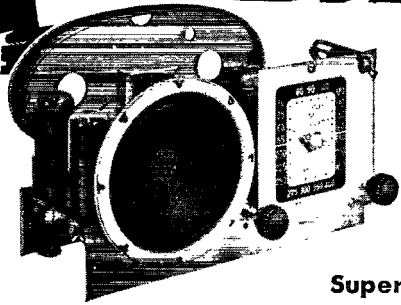

**5-Tube
AC-DC
Super-het Kit**

Using a small number of tubes, this Meissner engineered 5-tube AC-DC Super-het is compact in size and contains a factory wound loop antenna. Only two controls are used, making the set very simple to operate. It's simple to build... you can easily follow the schematic and pictorial wiring diagram. The Kit is complete — there is nothing else to buy. Kit with tubes — \$31.25 list.

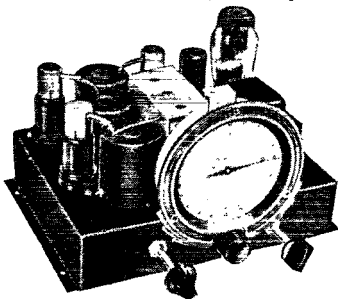

**5-Tube
AC T.R.F.
Kit**

Here's a Kit that is low in cost and high in quality. Operates from 110 volt 50-60 AC with a frequency range of 530 to 1600 kc. (187 to 565 meters). Complete kit includes all parts necessary for construction of the receiver with exception

of tubes and speaker. Meissner pictorial diagrams make this set extremely easy to build. Kit — \$27.00 list.

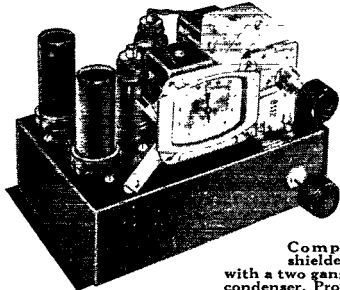

**4-Tube
AC-DC
T.R.F. Kit**

Here is a very small compact receiver with exceptional sensitivity and tone quality. Frequency coverage of 530 to 1600 kc.

Compact, high gain shielded coils are tuned with a two gang precision tuning condenser. Provision for mounting 5" dynamic speaker. Kit contains all parts except tubes and speaker. Pictorial diagrams aid you to construct this receiver easily and quickly. Kit — \$19.50 list. See your nearest Meissner jobber.

Write for complete new catalog. Address Dept. QS-5

Meissner

MT. CARMEL, ILLINOIS

"PRECISION-BUILT PRODUCTS"

(Continued from page 74)

sure their help would be very much appreciated in training operators for active duty, or to replace those called to service. — *W. C. Spence, W4EYI*

FAITH

3316 N. Arsenal Ave., Indianapolis, Ind.
Editor, *QST*:

For the amateur who is down in the dumps and would just as soon let his hard-earned ticket lapse, I recommend that he read the radio address of the Hon. Frank R. McNich, chairman of the FCC, in *QST* for September, 1938, pages 43 and 44. . . .

Remember, please, this is a temporary condition, this war. After the last war, amateurs had a large job on their hands to get their tickets back. Will that happen after this war? I don't think so. We are still licensed amateurs and, as yet, we still have our rigs ready to go. And maybe before long some of us will be on the emergency band-wagons.

The government has faith in us, and if we are to get those rights back like we had them in the good old days with DX and all, we must be patriotic and do our best to see this thing completely through. — *Wade C. Kingery, W9JGZ*

SUGGESTIONS?

53 Newcomb St., Quincy, Mass.

Editor, *QST*:

A "Ham," in amateur radio lingo, has a "YL" if he *isn't* married, and an "XYL" or an "OW" if he *is* married (and she should make him pay for that one!).

Supposing he has none of these, but does have an interested mother. How about a tag for her?

— *Mrs. Francis J. Saltus*
(Mother of W1KCP)

Strays

For those who have encountered trouble from continuous oscillation of the keying monitor at low frequencies with the key open, I suggest that the circuit shown by W9QJR in September *QST* be modified to include a 500-ohm, 10-watt resistor in series with the heater. Not only does this cure the trouble, but it will prolong the life of the tube without limiting the output to any appreciable extent. — *W4HMS*.

One of the important uses for television in national defense is in the training of some 54,000 air-raid wardens in the New York, Philadelphia and Albany areas. NBC is putting on six sessions each day, six days per week, in which the lectures are accompanied by demonstrations by a group of actors with actual equipment.

The SURVIVAL of The INFORMED

The pace of development in the electronic industries — always fast — was stepped up to lightning speed when war was declared.

Important developments began breaking thick and fast — and engineers had to have FACTS. Today, more than ever, it's a matter of the survival of the informed. Almost every new electrical development brings a new insulation problem.

American Lava Corporation gives you needed information and help in selecting the proper ALSiMag steatite ceramic insulation in three ways:

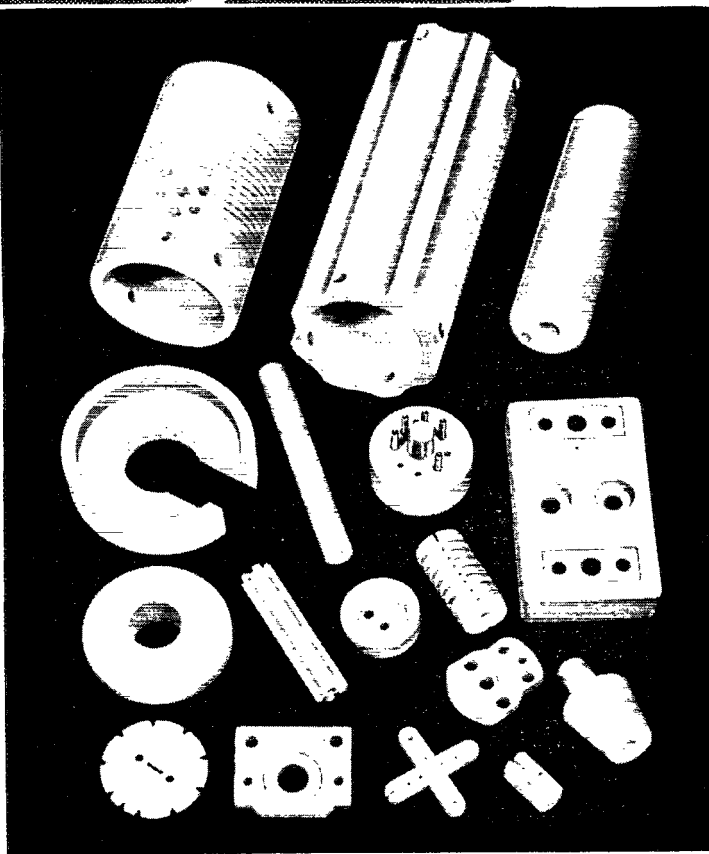

ALSiMAG PROPERTY CHART

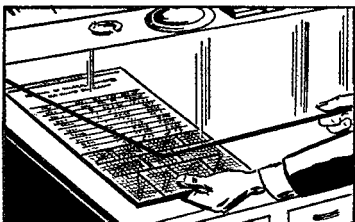

1. A chart of Physical Properties of the more frequently used ALSiMag compositions, sent free on request. We know of no other data available with comparable detail or accuracy.

ALSiMAG SPECIAL COMPOSITIONS

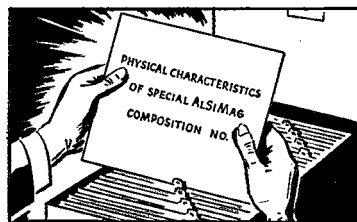

2. In its research department there are records of the physical characteristics of a great number of special ALSiMag steatite ceramic compositions which have been evolved for specific applications.

ALSiMAG RESEARCH DIVISION



3. An Engineering Staff and Research Laboratories that are unrivalled in the industry stand ready to advise or assist in any problem involving technical ceramics.

● When you have a problem, old or new, involving technical ceramics you can probably find the answer here.

ALSiMAG

FROM CERAMIC HEADQUARTERS

AMERICAN LAVA CORPORATION • CHATTANOOGA • TENNESSEE
CHICAGO • CLEVELAND • NEW YORK • ST. LOUIS • LOS ANGELES • SAN FRANCISCO • BOSTON • PHILADELPHIA • WASHINGTON, D. C.

2

Handy Aids for Resistance Problems Today!

**New OHMITE
Quick Reference
Catalog 18 FREE**



Gives up-to-date information on the wide range of Ohmite stock resistors, rheostats, chokes and switches used in all types of applications. Helps you select the right units for each job easily, quickly. Write for Catalog 18 now — it's Free.

**Handy OHMITE
Ohm's Law
CALCULATOR**

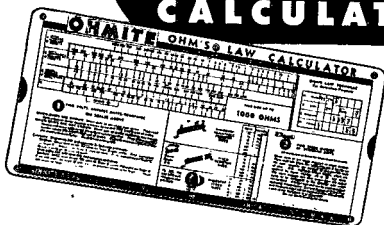

Figures ohms, watts, volts, amperes — quickly, easily. Solves any Ohm's Law problem with one setting of the slide. All values are direct reading. No slide rule knowledge necessary. Size $4\frac{1}{8}'' \times 9''$. Yours for only 10¢ to cover handling cost. Send for it today.

OHMITE MANUFACTURING CO.
4864 Flounoy Street, Chicago, U.S.A.

Be Right with **OHMITE**
RHEOSTATS · RESISTORS · TAP SWITCHES

Silent Keys

It is with deep regret that we record the passing of these amateurs:

- Andreas Bertnes, LA6R, Sandefjord, Norway
- Dr. Juan E. Cagnet, CO8EC, Santiago de Cuba
- Donald O. Carruth, W7FQV, Portland, Oregon
- Thomas H. Clayton, W6KOC, Lewiston, Calif.
- W. R. Emery, G6LW, Twickenham, England
- Lt. Cmdr. D. Grove-White, G W, Jersey, C. I.
- Carl O. Hansen, W2OGB, Scotia, N. Y.
- Joseph J. Ivantie, W9DWT, No. Chicago, Ill.
- Paul Ivantie, W9DWT, No. Chicago, Ill.
- Harold S. Jones, W5GOV, Fort Worth, Texas
- Virgil M. Krell, W6TIU, Tucson, Arizona
- J. L. C. Stone, G2ZL, London, England

225-Mc. Converter Design

(Continued from page 57)

adjusting the oscillator frequency. This converter, while satisfactory enough in operation, should be regarded as simply something to begin exploring superheterodyne technique with on these frequencies. Coils and condensers should be abandoned as soon as possible in favor of circuit elements more suitable.

Looking ahead towards better design a few ideas have been brought out by working with this equipment. Several comments might be made on acorn tubes themselves. In the first place, it is difficult to tell the condition of an acorn tube, and about the only reliable test is by comparison in some piece of high-frequency gear. Often tubes that give satisfactory results at 60 Mc. do not work well at 225 Mc. Tests should be made on weak signals, since poor tubes do not attract attention when working at high signal levels. Care should be taken in inserting acorn tubes in the delicate sockets used with them as damage may result in a poor contact. Both the sockets and tube terminals should be examined from time to time for corrosion, particularly the grid and plate terminals and connections of the pentodes. If any amount of power is used in transmitting, the acorn tubes should be protected from damage by radio-frequency pickup. At the higher frequencies only a few feet of transmission line at the receiver may resonate and bring a point of relatively high r.f. voltage to the grid of the first tube. This is particularly true in cases where relays or switches are used to change over from send to receive. The only safe protection is a

(Continued on page 56)



**WHEREVER THERE IS RADIO
THERE ARE SPRAGUE CONDENSERS**

Sprague Condensers are made to the highest quality standards in a complete line meeting practically every electronic, electrical and industrial need. It is natural then, that today's production is largely devoted to a complete, fully approved assortment for Army and Navy uses. Our engineers will gladly cooperate in solving your capacitor problems.

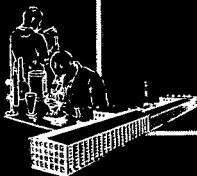
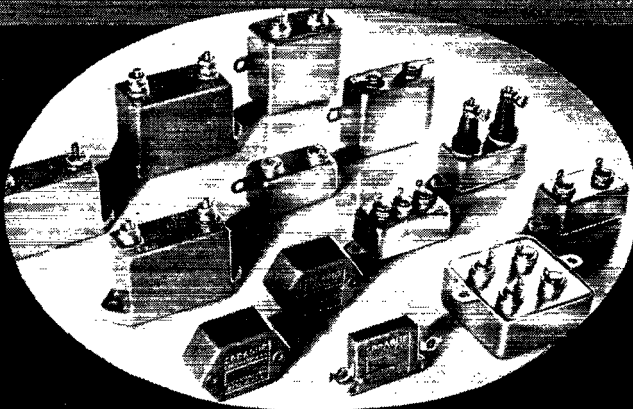

SPRAGUE

CONDENSERS—KOOLOHM RESISTORS

Quality Components • Expertly Engineered • Competently Produced

SPRAGUE SPECIALTIES COMPANY, NORTH ADAMS, MASS.

Recognizing the fact that radio amateur activities are being seriously curtailed for the duration of the war, so far as ham communications are concerned, Aerovox engineers are compiling and already releasing practical data on electronic gadgeteering as a promising outlet for the equipment, skill and ambition of the radio hobbyist. Articles on radio-control circuits and the industrial applications of electronic devices are currently appearing in the monthly *Aerovox Research Worker*. Copies will be sent to anyone writing Aerovox Corp., New Bedford, Mass. Also, a free subscription may be obtained by getting the endorsement of any Aerovox jobber.

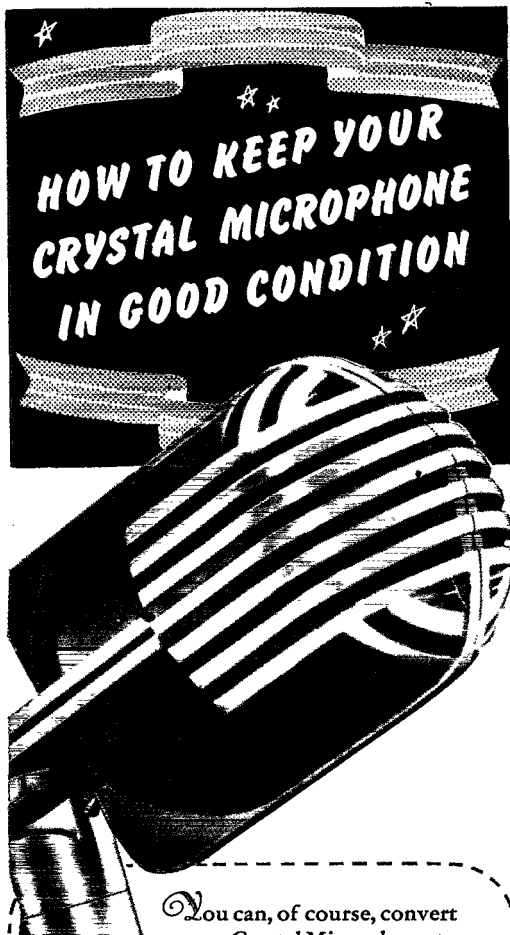

You can, of course, convert your Crystal Microphone to other uses, such as home recording, and get a lot of enjoyment out of it. *But*, if you are putting it away for the "duration"—follow these two simple precautions: 1. *Wrap it in a moisture-proof, dust-tight package.* 2. *Do not expose it to high temperatures.* In this way, your Microphone will be ready for any special civilian defense use now, or for regular service after the war is won. ★

Shure Engineers today are devoting their energy and skill to the production of Microphones for war purposes.

SHURE BROTHERS
225 West Huron Street, Chicago, U. S. A.

Designers & Manufacturers
of Microphones and
Acoustic Devices

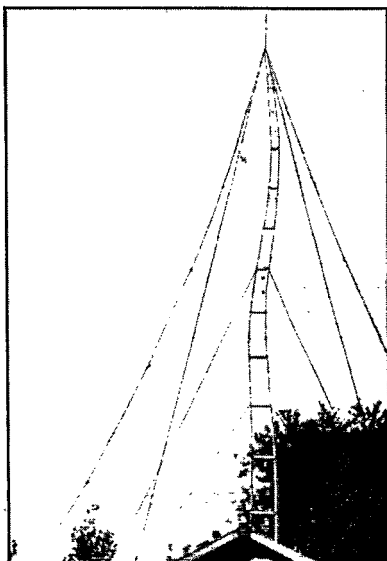

The Mae West type mast tried out by W9SVH has recently been replaced by a more modern streamline version minus the hips.

In looking over my log the other day, I discovered that my first contact on the air was with W7WR on April 24, 1933, while my last contact, on December 7, 1941, was also with W7WR! But volumes could be written on what transpired between those two contacts! — W7DDZ.

A newly-developed machine, the *rheotron* or electron accelerator, increases the speed of electrons to within one-tenth of one per cent of the speed of light. The X-ray power produced is equivalent to the radioactivity of 1000 grams of radium — more than the entire available world's supply! — *Ohmite News*.

The street in Columbus, Ohio, where license exams are held is Marconi Boulevard! — W8HMH.

A GIANT NEW FLYING BOAT TAKES TO THE SKIES ...AND ISOLANTITE INSULATION HELPS MAINTAIN VITAL COMMUNICATIONS LINKS

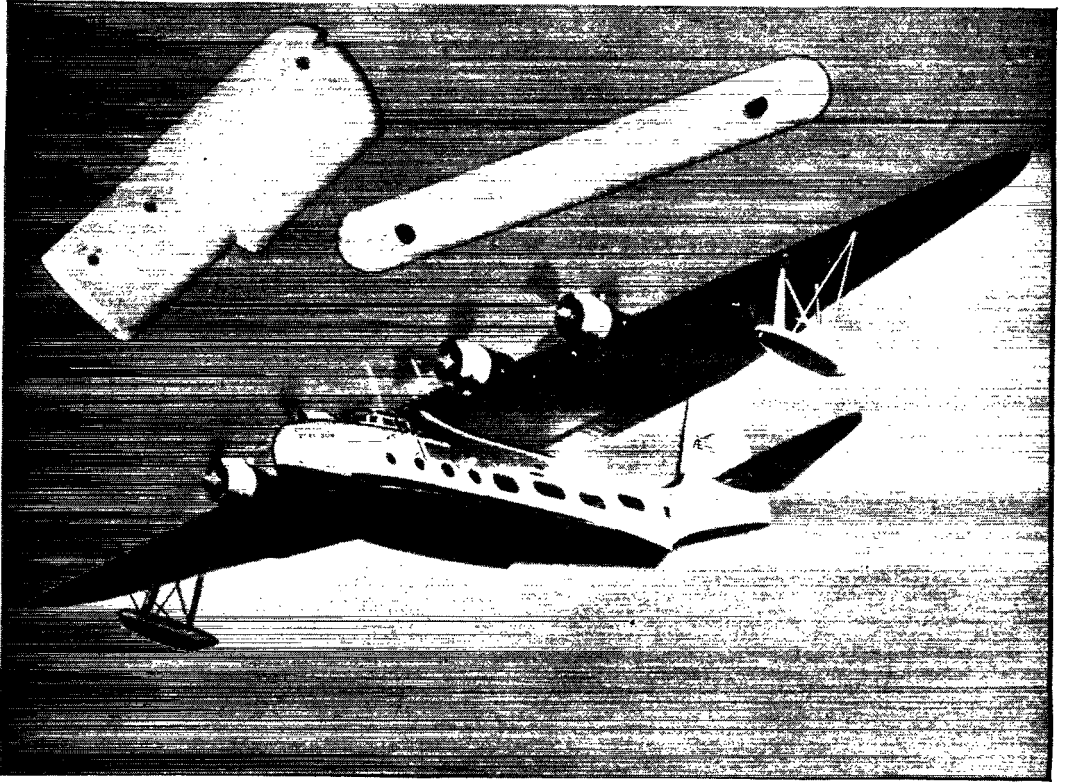

A NEW chapter in aviation history was written with the launching of the EXCALIBUR, first of the Flying Aces built for American Export Airlines, Inc., by the Vought-Sikorsky Aircraft Division of United Aircraft Corporation.

Longest-range commercial aircraft ever built, the EXCALIBUR and its sister ships will soon be spanning the ocean in a new service, linking New York and Eire in non-stop flight.

Since highest efficiency and complete dependability of communications equipment are vitally important in the operation of these giant flying boats, Isolantite* insulation was selected for a number of essential applications. Isolantite's unique combination of properties—high strength, dimensional accuracy, electrical efficiency, non-absorption of moisture—has established this unusual ceramic as the choice of leading manufacturers of sets and component parts,

for aircraft applications and for every other branch of the communications industry.

The radio amateur, too, has long recognized the advantages of Isolantite in condensers, coil forms, antenna insulators, stand-offs, lead-ins—and though amateur sets may be temporarily silent, Isolantite continues to look toward the future, when it will serve the amateur again as it has in the past.

ISOLANTITE

CERAMIC INSULATORS
ISOLANTITE INC., 233 BROADWAY, NEW YORK, N. Y.

*Registered trade-name for the products of Isolantite Inc.

RADIO SERVICE MEN WANTED

ZENITH RADIO CORPORATION — 6001 DICKENS AVENUE — CHICAGO

OFFICE OF
E. F. McDONALD, JR.
PRESIDENT

To Radio Amateurs:

The government has said "No more civilian radio after April 22nd." Defense comes first - and we are glad and eager to do our share.

But if free America is to keep an ear on the air, thousands of radio sets now in use must be kept in tip-top shape and men must be found to do it.

For the Army and Navy are taking experienced radio service experts away from the radio industry faster than new ones can be found.

This condition makes a wonderful opportunity for amateurs ambitious to land a service position.

Good pay, a good job, await you if you can qualify to replace one of these men.

Then, if you remain a civilian, you have an assured profession. If you go into military service, your specialized training and higher rating should get you more money.

The history of you "hams" shows it was you who discovered the great radio inventions. Manufacturers came along later and merely refined them.

I feel the radio business at this time has a real use for the ambition, initiative and inventive genius of the American "ham". He can serve in an important way, as he has in other great emergencies.

On the opposite page is a list of Zenith distributors by cities.

Why not drop the nearest one a line today, telling him you're interested in becoming a ZENITH SERVICE MAN.

Your letter will be expected. If you have ability, and know the "insides" of a radio, you may be the man for one of these jobs.

Sincerely,

E. F. McDonald, Jr.
E. F. McDonald, Jr.

EFM/p

Write THE ZENITH DISTRIBUTOR NEAREST YOU

Aberdeen, S. D.
REINHARD BROTHERS CO., INC.
Albany, N. Y.
E S & E CO., INC.
294 Broadway
Amarillo, Texas
NUNN ELECTRIC CO.
425 Folk St.
Atlanta, Ga.
GRAYBAR ELECTRIC CO.
167 Walton St. N. W.
Baltimore, Md.
BALTIMORE GAS LIGHT CO.
111-113 E. Lombard St.
Billings, Mont.
MIDLAND IMPLEMENT CO., INC.
Opposite Union Depot
Birmingham, Ala.
MOORE-HANDLEY HDW. CO.
27 South Twentieth St.
Boston, Mass.
NORTHEASTERN RADIO, INC.
588 Commonwealth Ave.
Buffalo, N. Y.
JOSEPH STRAUSS CO., INC.
25 High St.
Charleston, S. C.
THE GAS ENGINE & ELECTRIC CO.
280-282 Meeting St.
Charleston, S. C.
ESKEW, SMITH & CANNON
Brooks & Wilson St.
Charlotte, N. C.
GLASGOW-ALLISON CO.
209 E. Fifth St.
Chattanooga, Tenn.
SOUTHERN FURN. SALES CO.
633-35 Broad St.
Chicago, Ill.
ZENITH RADIO DIST. CORP.
5801 W. Dickens Ave.
Cincinnati, Ohio
GRIFFITH DISTRIBUTING CO.
2410 Gilbert Ave.
Cleveland, Ohio
THE ARNOLD WHOLESALE CORP.
6209 Detroit Ave.
Columbus, Ohio
APPLIANCE DISTRIBUTING CO.
163 N. Ludlow St.
Dallas, Texas
RADIO CITY DISTRIBUTING CO.
800 Jackson Blvd.
Davenport, Iowa
A. A. SCHNEIDERHAHN CO.
218 Brady St.
Denver, Colorado
INTERMOUNTAIN APPLIANCE CO.
1541-49 Wynkoop St.
Des Moines, Iowa
A. A. SCHNEIDERHAHN CO.
11th & Walnut Sts.
Detroit, Mich.
RADIO DISTRIBUTING CO.
100 Selden Ave.
El Paso, Texas
ALBERT MATHIAS & CO.
Fargo, N. D.
REINHARD BROTHERS CO., INC.
Fort Smith, Ark.
WILLIAMS HARDWARE CO.
4th St. & Rogers Ave.
Fort Wayne, Ind.
WAYNE HARDWARE CO.
Grand Rapids, Mich.
J. A. WHITE DISTRIBUTING CO.
219 Ottawa Ave. N. W.
Green Bay, Wis.
MORLEY-MURPHY CO.
Harrisburg, Pa.
KNERR, INC.
317 S. Cameron St.

Hartford, Conn.
STERN & COMPANY, INC.
210 Chapel St.
Houston, Texas
AUTOMAT-IC SALES CORPORATION
325 M & M Building
Indianapolis, Indiana
ROSEFELD CO.
128 Kentucky Ave.
Jacksonville, Fla.
CAIN & BULTMAN, INC.
505 W. Adams St.
Johnstown, Pa.
CAMBRIA EQUIPMENT CO.
12 Iron Street
Kansas City, Mo.
FEDERAL DISTRIBUTING CO.
1717 Walnut St.
Knoxville, Tenn.
GRAYBAR ELECTRIC CO.
Henley St. & Union Ave.
Little Rock, Ark.
555, INC.
2nd to 3rd on Broadway
Los Angeles, Calif.
RAY THOMAS COMPANY
1601 S. Hope St.
Louisville, Ky.
THE OTIS HIDDEN CO., INC.
529 W. Main St.
Lubbock, Texas
NUNN ELECTRIC CO.
611 Broadway
Manchester, N. H.
JOHN B. VARICK CO.
509 Elm Street
Memphis, Tenn.
STRATTON-WARREN HDW. CO.
37 E. Carolina Ave.
Milwaukee, Wis.
MORLEY-MURPHY CO.
434 N. Flankinton Ave.
Minneapolis, Minn.
REINHARD BROTHERS CO., INC.
11-17 South Ninth St.
Nashville, Tenn.
BRAD ELECTRIC CO.
109-115 Eleventh Ave. So.
Newark, N. J.
E. B. LATHAM & COMPANY
1010 Broad St.
New Haven, Conn.
THE PLYMOUTH ELECTRIC CO.
393 Chapel St.
New Orleans, La.
RADIO SPECIALTY CORP.
841 Carondelet St.
New York, N. Y.
COLEN-GRUHN CO., INC.
337 Fourth Ave.
Norfolk, Va.
R. F. TRANT, INC.
Monticello Ave. & Princess Anne Rd.
Oklahoma City, Okla.
MILLER JACKSON CO.
11 E. California Ave.
Omaha, Nebraska
MAJOR APPLIANCE CO.
2558 Farnam St.

Philadelphia, Pa.
MOTOR PARTS CO.
17th St. & Indiana Ave.
Pittsburgh, Pa.
J. A. WILLIAMS CO.
401-433 Amperson Ave.
Plattsburgh, N. Y.
A. H. MARSHALL CO., INC.
84 Margaret Street
Portland, Maine
FRANK M. BROWN CO.
8-16 Free St.
Portland, Oregon
ELECTRICAL DISTRIBUTING, INC.
525 N. W. Tenth Ave.
Providence, R. I.
BALLOU-JOHNSON & NICHOLS CO.
128 Dorrance St.
Richmond, Indiana
ROSEFELD CO.
95 West Main St.
Roanoke, Va.
THURMAN & BOONE CO., INC.
405 S. Jefferson St.
Rochester, N. Y.
CHAPIN-OWEN CO.
205-213 St. Paul St.
Sacramento, Calif.
JAS. S. REMICK CO., INC.
5th & R Sts.
St. Louis, Mo.
ELECTRIC LAMP & SUPPLY CO., INC.
Vandeventer & W. Pine
Salt Lake City, Utah
FLINT DISTRIBUTING CO.
316 W. 2nd South St.
San Antonio, Texas
SOUTHERN EQUIPMENT CO.
Div. of A. B. Frank Co.
419 S. St. Mary's Street
San Francisco, Calif.
H. R. BASFORD CO.
425 Second St.
Scranton, Pa.
SCRANTON ELECTRIC CONST. CO.
625 Connell Bldg.
Seattle, Wash.
SEATTLE HARDWARE CO.
501 First Ave. S.
Shreveport, La.
McWILLIAMS HDW. & FURN. CO.
1321 Texas Ave.
Spokane, Wash.
COLUMBIA ELEC. & MFG. CO.
S. 123 Wall St.
Syracuse, N. Y.
ONONDAGA AUTO SUPPLY CO.
351-57 E. Onondaga St.
Terre Haute, Ind.
WALKER ELEC. SUPPLY CO., INC.
126-130 So. 3rd St.
Toledo, Ohio
V. J. McGRANAHAN DIST. CO.
1702-04 Madison Ave.
Washington, D. C.
EDGAR MORRIS SALES CO.
712 Thirteenth St. N. W.
Wichita, Kansas
THE S. A. LONG CO., INC.
146 N. Market St.
Williamson, W. Va.
PERSINGER SUPPLY CO., INC.
Third Avenue

●
**AMERICA'S
OLDEST
MAKER OF FINE
RADIOS FOR
THE HOME**



Station Activities



NEW ENGLAND DIVISION

CONNECTICUT — SCM, Edmund R. Fraser, W1KQY — Newly appointed ECs are W1ED, Danielson, and W1HXL, Noank. The latter is teaching a code and theory class in Noank School. 3AOH is teaching radio school in Bridgeport, Tuesdays and Thursdays. 1B1H, EC Torrington, reports Asst. EC KXB doing fine job with code and theory class. Several are ready for exams, one already having received his operator's license. The report center installation in City Hall is complete right up to the 112-Mc. double zepp on the roof. ATH, Secy. of the NHARA, reports theory class conducted by FJE has been successfully completed. A code class will start in two weeks. Asst. SCM CTJ reports the Conn. Brasspounders Assn. has completed plans for a code and theory class to be held shortly. On Feb. 28th a Hamfest was held at the American Legion Hall, in Groton, by the gang in New London and vicinity. Attendance around 100 included: PAM LTZ, ECs NEK, IED, KYW, ALW, IWY, JQK, JFN and JXP, along with hams from USN Submarine Base, US Coast Guard, and Pres. Brennan and EC Hustwit of the Westerly, R. I., Radio Club. Speakers included JFN, asst. secy. ARRL; Mr. Warner of Communications Dept., State Police; defense officials, and your SCM. QV's round-the-house rhombic was again in the lime-light only to be topped by DET's version of amateur radio activities. BRA is constructing airplane detectors for plane-spotters in Wilton. Seventy amateurs gathered at Darien Police Barracks, March 18th, at a special meeting of the Southern Fairfield County Amateurs called by Chairman KTF. Among those present were BDI, UE, Selectman Barret of Stamford, Police Chief Tinker of Darien, Police Sgt. Brophy and defense council officials. KTF just returned from Washington, D. C., and spoke of visiting ARRL Pres. Bailey, OCD, FCC and DCB officials. BDI brought the gang up to date on amateur activities. FMV, Veteran Wireless Assn.'s representative for Conn., has signed up VB, FJE and KQY. All qualified hams interested can secure full particulars by dropping FMV a line. TD and FWB have recently obtained new employment. ECs and club secretaries, please send in monthly reports.

MAINE — SCM, Ames R. Millett, W1BAV — W1LNI and some of the gang around town are experimenting with wired wireless. NR is working at the Bath shipyard. LOA expects to be in the Army soon. All through the state there are excellent and well-trained potential emergency nets that are only waiting for a chance to prove their ability to function. The opportunity afforded to young and old alike in this radio game is something that has never before been presented to hams. The excellent program outlines available from headquarters for code and theory instruction should be very interesting to the clubs here in the state and some very educational classes could very easily be put on.

EASTERN MASSACHUSETTS — SCM, Frank L. Baker, Jr., W1ALP. New ECs: LK, Lakeville; GDY, Suffolk County; NQA, Back Bay Section of Boston; ILR, Allston and Brighton; NPE, Jamaica Plain; MZD, East Boston. Let's have some more members in the Emergency Corps, gang. NAV is moving to Needham. HRF and xyl have a new baby y! Congrats! If any of you have any spare parts that you do not want and that can be used by the radio classes in the three boys' clubs of Boston, in Roxbury, South Boston or Charlestown, please get in touch with your SCM or DWG. BNJ has his first-class tel. ticket. NAH and NEZ have built a wired wireless rig and have covered about two miles. LAG and KLG are now in the Navy. DBD has a medical discharge from the Army. NDE is at Treasure Island, Calif. LTS entered the Signal Corps. NLQ is in Naval Reserve. LNO is doing defense work in Cambridge. EVJ says that they were cut off from communication with the mainland during a storm in February, but could not help out as in past years. FEC gets the hams in Middleboro together once in awhile. JMJ is working in Waterbury, Conn. The officers of the new club on the North Shore known as "The Yankee Radio Club" are: Pres., 1BF; vice pres., NVB; treas., AMT; secy., MVQ. AAT, AMT, JNK, MYO and Sparky are going to try wired wireless. NF has gone to White River Junction Hospital for an operation. Wish you luck,

OM. MIF has gone to Panama with the Signal Corps. LQQ got married. HKK is in the Navy. DBH is working in New Jersey. ZN is working at the Navy Yard. The following are working in the Communications Section of the Mass. State Staff: ZK, AGR, IYU, BNJ, HSB, LWI, ZN, MGH, MON, LHR and RP. HY and JXH are working on defense communications in Holbrook. MON has a rig on wired wireless and hopes to have a net soon. Don't forget the Framingham Hamfest in the latter part of May, for one of their famous turkey suppers and get-togethers. See announcement in another part of this issue. HWC and LBL are helping out on a radio course in Lexington. NIT reports that the Gloucester Amateur Radio Corps is giving code practice. FB, gang. NEZ received his Class A ticket. JLK reports that the hams in his town are ready to help out when they get the word.

NEW HAMPSHIRE — Mrs. Dorothy W. Evans, W1FTJ — W1NEI has sent in his application for ARRL Emergency Corps Civilian Defense. LIN has a new second harmonic at his house. It's a boy, and congratulations are in order for Cal. The Nashua Mike and Key Club has started a code class. They are completing vibrapacks for use on 112 Mc. FTJ and BFT want to thank their many friends for all the good wishes extended them on the birth of their son. MCB is now an operator at WMUR. JDP and YF MWI are moving back into our Section. We'll sure be glad to welcome them once more. LVG is now located at Morrison Field at West Palm Beach, Fla. IVU is working in Cambridge, Mass. DUK has left New Hampshire to once more enter the U. S. Navy. Best of luck to you, Perley! JSL has also enlisted in the armed forces. EDN is working in Connecticut and gets home only occasionally. CME's QTH is now Fort Lauderdale, Florida. AOQ is still building radio equipment. AVJ is waiting for the "go" signal to put his emergency network in operating condition. CCM and YF IQT recently visited FTJ at Concord. BII is taking a course in u.h.f. radio at Boston. HJI is now under Civil Service and is located in Washington. FTJ wishes that the boys from our Section who are in the service would write, letting her know how they are getting along, etc. It's plenty hard to get news these days, and your writing to the SCM would help a lot as, of course, your many friends are interested in your doings.

RHODE ISLAND — SCM, Clayton C. Gordon, W1HRC — The Providence Radio Association is getting an attendance of 25 at its radio school. Two of the club gang have strung up a back yard telegraph line. Most of the members living in Providence are members of the Providence Police Radio Patrol. W1HEH was number one in the March 7th draft for his district. CAB brought his family back to Providence and has been transferred to shore duty with the Navy after a year at sea. He recently visited the PRA and told us something about the South Sea Islands that took a lot of glamour out of them for those of us who thought they were paradise. The Holmquist twins have written home from the Navy that the equipment they are using is tops and that they think the place is swell. They expect to be radio locator boys after a spell. Joe Sock drops the PRA gang a line now and then, and has had at least one promotion since being taken into the Army. On the home front it's rather quiet. Some of the gang have found things to do in civilian defense. Most of them are working pretty hard at their jobs, and there is no grumbling for things for idle hands to do. Club secretaries, please report club activities.

VERMONT — SCM, Clifton G. Parker, W1KJG — W1JRU is now located at Windsor where he is employed in defense work. CBW has also secured employment in radio work and left our Section. The Burlington Amateur Radio Club persists in its good work and has gone ahead in great shape with emergency work. The area has borrowed a page from the Providence gang, and the present arrangement provides for police and fire service radio communication on ultra-high frequencies, all working under X calls. The Burlington gang is also participating actively in the Naval Volunteers organization. HLIH is ensign and IQR is 3rd class petty officer. Reports indicate "P.L." will soon rate chief petty officer. LWN has been doing good work for the gang with his lecher wire experiments. The month provided nice visits from IDM and JVS and your SCM located several of the gang while about the state. Considerable interest in local problems in induction and wired wireless systems is indicated with several units being put through tests, the results as yet unreported. As the gang travel in the vicinity of Waterbury, it will certainly prove interesting and instructive to go through the NYA School at Little River Dam-CGV and EKV are on hand as instructors, and they are doing a fine job there. An all-band rig was completed just prior

to the ban, and the boys have built a vertical radiator which is worth looking over carefully. KUY has returned from his trip at sea and is now engaged in radio work ashore. Your SCM, for want of traffic, is doing some exploring in the use of the induction type transmitter and a portable receiver by fire-fighting crews. Let's try to keep up on our code. A few turns with the commercial operators each day certainly will do none of us any harm and when it is necessary to operate under circumstances we cannot foresee it is too late to brush up on the c.w. Don't let your tickets lapse! Apply for renewals the same as ever.

ATLANTIC DIVISION

SOUTHERN NEW JERSEY — SCM, Lester H. Allen, W3CCO. Ass't SCM, W3ZI. Regional Coördinator in charge of Emergency Coördination, W3BAQ. Emergency Coördinators: Atlantic City, W3EFM; Camden, W3KW; North Plainfield, W3GQU; Vineland, W3GMY; Somerville, W3EBC. This month finds some new members in the AEC group: 3JRG, JL, FSR, DHJ, CKN, JWX and JNO. HAZ is now stationed at Fort Monmouth and would be glad to hear from the gang. JSF reports for the first time and mentions that he has his u.h.f. equipment all ready to go. Joe also mentions that FMQ, JPC, JKI and JKH also have their u.h.f. equipment in order just awaiting official word. JRG of Wenoh reports his dad is also now an operator and both are willing to help in any defense measure. JBU is taking the radio technician course supervised by Rutgers University. FFE met some of the CO and CM hams down Cuba way during his vacation. ABS is soon to lead a school in radio for the Hillsborough Defense Council. The South Jersey Radio Association held its regular monthly meeting in the studios of W33PH and enjoyed a first hand visit at the new f.m. station. HVO is still receiving QSL cards and has a return of about 90% of what she sent out. AID is spending his spare time listening on the 600 meter band with his good ole SE-1420. BOI is located in Brooklyn, N. Y. GNU is doing engineering work for Federal Telegraph. JLI is stationed at the Naval Training Station on Long Island. BMM is in the Naval Reserve stationed down Cape May way. CYW is located in New Hope, Pa. GRW is chief op on an oil tanker. CFT is stationed at Pine Camp and sends his regards to the gang. CCC is back again at Amagansette. SW is on active duty with the Navy. HTL is doing signal work in the British West Indies. IDY is a papa for the second time. Congratulations, George! HWT recently graduated from the Naval School and is on active duty with the Navy. GMN is doing a nice job as Staff Sergeant. AFA has a swell dust cover for the rig. ZI was recently appointed Associate Editor of DVRA News. GPS moved his transmitter to the attic for the duration. FBT is teaching code at one of the local defense schools. ASQ is doing a good job as leader for the Hamilton Township Defense School. The DVRA held its annual election and the following officers were elected for the year: Pres., CCO; vice-pres., ARN; sec'y, ZI; treas., EED. The DVRA announces that visitors are always welcome at their meetings, held the 2nd Wednesday of each month and every meeting will bring forth a short technical lecture on new equipment. Until next month 73.

WESTERN NEW YORK — SCM, Fred Chichester, W8PLA — W8MCX, NOU and YLG have joined the Navy and are now radiomen 2nd class. RTW is installing the f.m. apparatus in the main control room and the prow cars of the Elmira Police Department. In a recent test John, operating from one of the prow cars, worked another car some 60 miles away. At the mike in the other car was another ham, a W9. This was a very good haul because it was over hilly country. A new call in the Elmira territory is WOW. The owner of the call is Mrs. Albert Keltz, XYL of TXB, and she is the first woman amateur in Elmira. Members of the Central New York Radio Club are planning a code class and expect to get started in the near future. Some of the members have started construction of wired wireless apparatus. NQX is now an operator at WPEA, the Syracuse Police transmitter. WIF, Rochester, has a wired wireless rig in operation and asks that hams in his section of the city listen for him on from 150 to 200 kc. at 8 p.m. Monday through Friday. In a letter just received from ROU, who is summering in Iceland, Bob states that RYF is his next door neighbor. VFG has enlisted in the Signal Corps and is stationed at Ft. Monmouth. 2NZH has moved into the eighth district and is located at Buffalo. SMH has received a commission and is now on active duty. FCG is a sergeant in the Home Guard. BDO reports plenty of activity in the Lockport Club in spite of the shut-down.

WESTERN PENNSYLVANIA — SCM, E. A. Krall,

W8CKO — Assistant SCM in charge of Emergency Coördination, 8AVY. W8TTD has had requests for cryptanalysis work and as the Army has discontinued its course for the duration, Dave has volunteered for instruction service. He expects to take an advanced course himself. VYU has asked TTD to cooperate in emergency work in his district. Theresa, Mac's XYL, is doing excellent work herself. HIKU and the gang meet once each week to study the questions on radio laws, to prepare themselves for third class radiotelephone licenses, in order to be of real assistance to the local police in emergencies. RM NCJ has moved to a new location. Beth, the XYL there, has made her fourth solid copy of the Navy Day Message. Ray says that due to the smallness of Knox there is no opportunity to offer services for emergency communication, but he is keeping on the job in case anything develops. PER has things well organized at New Kensington and is only waiting verification to produce some good work. MHE has been asked to attend defense committee meetings so as to keep in close touch with all plans. RAT has finished an aircraft detector and has had plenty of fun experimenting with it. OW has accepted a position at the National Bureau of Standards at Washington, D. C. EHB is at the Norfolk Naval Air Station as a radio mechanic. He offers the use of his home radio equipment in case of need for it. His present address is, P. C. Lustig, Third St., c/o E. F. Weeks, East Ocean View, Norfolk, Va. All W. Pa. amateurs are reminded of the joint meetings of all radio clubs at the Fort Pitt Hotel, Pittsburgh, Pa. the fourth Sunday of each month. Very interesting programs are arranged and it is a good place to meet fellow hams.

DELTA DIVISION

LOUISIANA — SCM, W. J. Wilkinson, Jr., W5DWW — The Advance Radio Club has begun radio classes and is abandoning regular club meetings and activities in order to devote full time to this project. Theory and code classes are combined and an enrollment of 40 students has been attained. After the class has advanced to the transmitter and receiver building stage, 112-Mc. units will be built under supervision of the club. W5KOS has been quite active as EC for Shreveport and vicinity, and quite a number of new applications have been received for enrollment in the AEC. ZS has been appointed Communications Chief by the Shreveport office of Civilian Defense. Again we ask that you take it upon yourself to advise your SCM of any of the gang joining the armed forces. Please give the branch of service which they enter.

TENNESSEE — SCM, M. G. Hooper, W4DDJ — The Nashville Amateur Radio Club is planning a defense course both in c.w. and theory. W4DFB is studying code seriously and has re-rigged the HRO to an oversize speaker. He has rebuilt his workshop and has converted his upper half-story into a full-sized room hamshack, containing his own and J. A. Rogers, Jr.'s rigs. Jim has everything now but the ticket, and can copy 13 off the air, so he should be coming thru with the pastebard following the May FCC examination. The Univ. of Tenn. and the Univ. of Chattanooga, in co-operation, have started a 16-week defense course in radio theory and practice at the Univ. of Chattanooga. Local hams enrolled are: W4EHO, HZI, FHO, DVK, CBU, PL and BOZ, who is one of the teachers of the above course. DUS has secured an appointment to the Signal Corps School at Ft. Monmouth, N. J. He will find there Henry Buhrman, SWL, a member of the Chattanooga Club who was transferred there from Tampa, Fla. BOU, one of the old-time traffic hams, paid a brief visit to PL. He is a captain in U. S. Engineers. Your SCM has just completed his Civilian Defense training as fire warden and in first aid.

ROANOKE DIVISION

WEST VIRGINIA — SCM, Kenneth M. Zinn, W8JRL — W8DYB left for Maxwell Field, Alabama, where he will work as a teletype operator. DFA, Captain of Wheeling Fire Department, is training CD classes in fire-fighting. ZW and BOH, both of WVVA, are instructing radio technician courses at Linsley Institute evening school. The Huntington Radio Club is using the ARRL code lessons, as outlined, and say they are very efficient. SDU is a radio engineering student attending night classes at Marshall College. MZT is instructor at WVS classes. The following EC's have been appointed: QFN, Huntington; TDJ, Morgantown; TZT, Logan; JM, Fairmont; UFQ, Oak Hill; and HD, Wheeling. KWL, with the help of Rhodes and Wardles, is teaching a code class in Morgantown. TDJ-SPY is teaching the fun-

(Continued on page 88)

RADIO TRAINING



FOUNDED IN 1909

PORT ARTHUR COLLEGE, a non-profit-making educational institution, offers a practical radio operator's course at the lowest tuition price in its history. Each radio graduate receives two months' actual operating experience at the college's commercial broadcasting station KPAC. This station is equipped with the latest type 1000 watt high fidelity RCA transmitter — 1250 kc. — directional antenna system. KPAC operates in new modern studios located on the campus.

The college has never advertised jobs or positions in lieu of education. Today it is well known there is a shortage of radio operators in every branch of radio; particularly flight and ground operators for airlines in America and South America — marine operators for ships traveling coastwise and foreign — geodetic-geographic research — broadcast stations — the Army and Navy — other positions in many departments of the United States Government. Therefore, we believe it is good common sense to mention that Port Arthur College is the sole radio school in America which owns a commercial broadcasting station with commercial advertising representatives in New York, Chicago, San Francisco, and many of America's leading cities, with active membership in the National Association of Broadcasters, and Broadcast Music Incorporated. Through these contacts the college receives from the broadcast industry alone more calls for radio operators than it is possible to supply.

AUTHORIZED TO TEACH RCA TEXTS
If interested, write for Bulletin R

PORT ARTHUR COLLEGE
PORT ARTHUR (World-Known Port)
TEXAS

AMATEUR
CRYSTALS
EXCLUSIVELY



COMMERCIAL
SINCE
1934

PETERSEN RADIO CO., Council Bluffs, Iowa

• **"Three-Way" Transmitter-Receivers for CD and Military Use**

Write for Circular CD

• **Radio Remote Control Equipment for Models and Industry**

1942 Edition of The Radio Control Instruction Manual, 25c postpaid

RADIO CONTROL HEADQUARTERS, INC.

P. O. Box 214

Deol, New Jersey

New... Handy

UNIVERSAL REPLACEMENT CAPACITORS

Write for catalog

SOLAR MFG. CORP., Bayonne, N. J.

(Continued from page 73)

relay directly at the receiver to cut off and ground the remaining transmission line during periods of transmission.

The oscillator circuit shown is a particularly good one for high frequencies, where combinations of low plate voltage and high relative capacities make for unfavorable conditions for oscillation. Later experiments appear to indicate that at these high frequencies better results are secured by application of the oscillator voltage to the control grid of the mixer through a small capacity. This would have the added advantage of making the use of a metal socket possible. There are a great number of ways of coupling the oscillator voltage to the mixer, of course, and it is not easy to choose the "best," a matter which often depends upon the particular circuit conditions and layout involved. Several interesting circuits are suggested in an article by W. A. Harris.²

The usual wire lead mica condenser is likely to have appreciable inductance at high frequencies. As a matter of fact, it is not always easy to tell an inductance from a capacity at 225 Mc. If commercial condensers are used, the type having a flat lug has less inductance than the usual wire lead variety. This remark also applies to all leads carrying r.f., a flat ribbon of copper having much less inductance than a wire the same length. This is one reason for the use of ribbon in the inductance of the oscillator. For by-passing, small condensers can be made with copper foil placed between small mica sheets and clamped to the metal base by a small square of brass, having dimensions of the order of $\frac{5}{8}$ by $1\frac{1}{4}$ inches. Filament circuits giving much trouble can often be brought down to ground by means of quarter wave sections, as is done in transmitters.

The application of superhet technique on the $1\frac{1}{4}$ -meter band should ultimately be as successful as it has proved on five meters, but it should be kept in mind that only very stable transmitters can be employed.

U. S. A. Calls VLS

(Continued from page 12)

twenty minutes are given over to code practice. This is followed by a technical lecture of about an hour — a lecture which usually includes numerous demonstrations. The remaining time is given over to practical work in the laboratory. A code practice machine is available for use by the students at their convenience, and a number come in at odd moments for practice.

The first section of this course started last fall and was open to all undergraduates. So many applied, however — about ten times the number

(Continued on page 90)

²Harris, "The Application of Superheterodyne Frequency Conversion Systems to Multirange Receivers," *Proc. I.R.E.*, April, 1935.

ORV

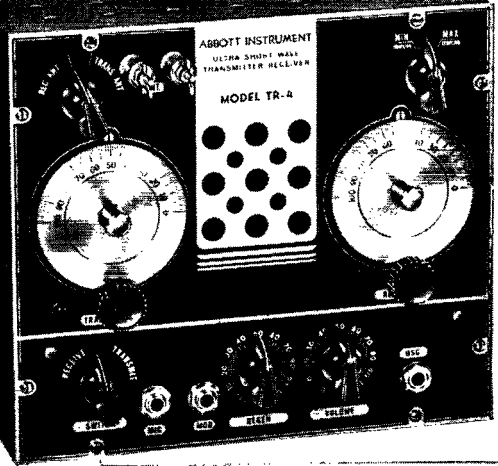

THE **YANKEE**
NETWORK

STATION WEAN
CROWN HOTEL
PROVIDENCE, R. I.

November 27, 1941

Abbott Instrument Co. Inc.,
5 West 18th Street,
New York, N.Y.

Gentlemen:

In co-operation with the National and Civilian Defense Programs WEAN has purchased 2 Abbott TR-4, 2 $\frac{1}{2}$ meter, Transmitter-Receiver units. One is being used as a portable and the other as a portable-mobile unit. They are being operated by men holding amateur licenses and will form a link of the Emergency Communications System in Rhode Island.

These units perform excellently - are compact - and the separate Transmitter-Receiver feature makes them most satisfactory.

Sincerely yours,
Harry H. Tilley
Harry H. Tilley,
Chief Engineer WEAN.

HHT/af

ABBOTT TR-4 TRANSMITTER - RECEIVER for 2 $\frac{1}{2}$ METERS

A compact, efficient unit, designed for either fixed station or mobile operation. Transmitter and receiver sections are completely separated. The 5 inch PM speaker is self-contained. Single inter-connected switch permits use of a common antenna for both transmitter and receiver. The TR-4 requires a 6 volt battery or 110 volt, 60 cycle AC power supply. Receiver radiation is necessarily reduced to a minimum.

TR-4 Overall size 9" x 8" x 4 $\frac{1}{2}$ ", less tubes and power supply, list price **\$65.00**

● **FREQUENCY:** 112 to 116 MC. ● **RANGE:** Varying from 5 to 75 miles, depending upon terrain. Contacts up to 150 miles have been completed in field tests. ● **TUBES USED:** One each of Hytron HY-615, Hytron HY-75, 7F7, 6V6 or 6L6. ● **MICROPHONE:** Any good single button microphone.

ABBOTT INSTRUMENT, INC.

8 WEST 18 STREET • NEW YORK, N. Y.

(Continued from page 85)

damentals of radio to a class of 25 in Morgantown. This is a part of the West Virginia University's defense training program. Charlie has his hands full, as he also has charge of 12 other classes throughout the state, some 350 students in all. GBF is teaching the technical course in Fairmont. KWI, after joining the Navy, was in the hospital three weeks with mumps. PNE's log cabin burned to the ground, with the loss of several thousand dollars' worth of radio equipment, including two kilowatt transmitters. Code classes in Elkins and Clarksburg, sponsored by the MARA, are coming along fine. Your SCM at this time wants to thank each and every ham who is helping in code and technical classes in our state, and certainly hope you keep up the good work. 73's — Ken.

SOUTHEASTERN DIVISION

ALABAMA — Acting SCM, Larry Smyth, W4GBV — A W4DVJ is with the Signal Service Company at Ft. Monmouth, N. J. DGS reports from Washington that he is seeing some plain and fancy radio. He is more impressed than ever with the vital part radio plays in the defense of our country. BUM visited DGS in Washington. DHG and CPC are taking civilian courses at Ft. Monmouth. They are studying to be civilian instructors of the armed forces. EOX goes from police radio in Birmingham to join the Navy. The Montgomery hams are still pegging away in that course on radio theory. Many of them are finding out how it works and why. Maybe there will be fewer green tickets when we get on the air again. Yours truly has certainly found out plenty that will help in building all future rigs. HEM is ready for a civilian defense station in Pell City. Let's hear from you. 73 — Larry.

WEST FLORIDA — SCM, Oscar Cederstrom, W4AXP — To the members of the Section who are interested in learning more about what makes the wheels go around in radio, there are courses available. The Pensacola Trade School will give you desired information on request about these courses. While the opportunity is open, jump in and make the most of it and make yourself more useful to Uncle Sam. He needs radio men. You amateurs who want to do something, organize code classes or code and theory classes in your community. Let's hear from those interested either in teaching or those who want to learn. W4PE has moved from Pensacola to Daytona Beach where he will be an instructor. We wish Tompkins luck in his new work.

Corrections, Sweepstakes Contest Results

IN THE April QST write-up of the Sweepstakes results, we forgot to mention that W6GQZ, third-highest 'phone scorer and winner for 'phone in the Los Angeles Section, was operated by Dawkins Espy, W6UBT, ex-W5CXHL.

Also W5FWD, 'phone winner in Arkansas, was incorrectly listed as W5EWD. Our apologies for these two slips-ups.

W1LWA's call was inadvertently omitted from the list of Navy Day winners in March QST.

W. P. R.

BY MAYOR, K4KD, assistant SCM of the West Indies Section, sends us the list of WPR (Worked Puerto Rico) certificates issued to date by the Puerto Rico Amateur Radio Club:

- | | |
|--------------------|-----------|
| Cert. No. 1. K4FKC | 8. K4EIL |
| 2. K4FAB | 9. W3EDP |
| 3. K4KD | 10. K4FOW |
| 4. K4EZR | 11. W9FFB |
| 5. K4FCV | 12. W4FIJ |
| 6. K4ESH | 13. K4DSE |
| 7. W8JIW | 14. K4HEB |
| | 15. K4HLR |

W9FFB made his WPR exclusively on 'phone; the rest were awarded for a combination of 'phone and c.w. work.

Hamfest Schedule

April 26th, at Ypsilanti, Mich.: The Fourteenth Annual Hamfest sponsored by the Detroit Amateur Radio Association will be held at the National Guard Armory, Ypsilanti, Mich., Sunday, April 26th. Dr. Eugene C. Woodruff, W8CMP, will be there with his bag of tricks. An OCD official is expected to speak. Other features will be recordings of fists and voices, prizes, ladies bazaar, and card party. Activities begin at 10:00 A.M. and last until you go home. Admission: ladies, 25¢; OM's, 75¢, at the door, or send your money to F. J. Beechler, W8MV, 8667 Waltham, Detroit.

May 23rd, at Framingham, Mass.: The Framingham Radio Club is holding its Annual Hamfest at the Hotel Kendall, in Framingham, on May 23rd. Instead of the usual prizes, defense bonds and stamps will be given. Further details from Herb Wells, W1WS, secretary, Natick, Mass.

The American Radio Institute Radio Club has issued approximately 35 ARRL Club Code Proficiency Certificates. Twice monthly tests are sent using automatic equipment, and non-members are cordially invited to participate. Tests will be run from 1:00 to 8:00 P.M. of the following dates: May 14th and 28th; June 11th and 25th; July 16th and 30th.

W2LMN's score in the Code Proficiency Frolic was mistakenly credited to W2MLW in March QST. Ed's score was 8400, working 235 stations in 36 sections. Nice going, and sorry for the error.

Good Morse Is Easier

(Continued from page 66)

Then the letter "S" the same way. Then we came through the letter "H" and the figure "5" the same way. And then back over it again, excepting that this time I said: "Now remember this is 'E,' and a single dot ran through. This is 'I,' and two dots ran through. This is 'S,' etc. Now then, friends, here is a word. Write it down just as you did the letters. Don't let it fool you." And then letter "S" ran through. All of this at 20 words per minute, you understand, but with a lot of space between the letters. Then the letter "I" and then the letter "S" again. "And now, friends, you've copied the word 'SIS' at 20 words per minute. Isn't it easy?" And by showing them how simple the code is, and how easy to copy at 20 words per minute, they had the job licked before they hardly had started. Then came the word "HIS" and the word "SHE," etc., all along the line. By the end of that first hour, from a group that didn't know what a dot or dash was, they were copying perfectly, easily, automatically, at the rate of 20 words per minute.

The second lesson, two nights later, I took them to the dash characters and the third lesson, two nights later, to the combinations. Very easy ones, of course, but words just the same. The entire group, after the first week, of three nights, one hour each night, were copying, automatically and happily, easy words at 20 words per minute and copying them correctly, too. She, He, Her, Ship, This, Is, Him, These, Those, Them, Mess, Miss, Mass, etc., all along the line.

We started on sending the second week, spending about 45 minutes on receiving, 15 minutes on sending. You place the key on your desk in front of you with the key arm running on a line with your arm. Your arm should have the elbow off the table, and resting on the muscles of the forearm. Keep the wrist and fingers loose. Rest no part of the hand or wrist on the table. The only part of your arm touching the table is the muscles of the forearm. Then slap the key as though you did not know what it was for. Just rattle it easily up and down as though you were playing with a fork while waiting for lunch to be served. That same easy, smooth playing manner. Now interrupt that by holding it down occasionally and before you realize it you are making dots and dashes. Now make a letter "E" the same as you heard it when you wrote it. "E" and the letter "I," etc. I've given a brief outline of my scheme and, if you fellows really want to become good operators within a very few months, follow through along the general lines suggested. I'll be surprised if you don't make real progress, rapidly. Let me know how you get along.

The Month in Canada

I had the pleasure of calling on the Headquarters gang a few days ago. No one entering the offices would ever imagine that amateur radio is on the suspension list for the duration. What a job these boys are doing for democracy. Let's help them by supplying all the news we can, so they can pass it along to the boys on the firing line.

— Alex Reid, VE2BE

QUEBEC—VE2

From Lin Morris, 2CO:

2OP writes that he has been operating portable on manoeuvres overseas and has a longing to own a bug. **2DM** is a signalling instructor in the reserve army. **2EQ** is on active naval service. **2IO** suffered a broken leg in a plane crash. **2IP** is a code examiner in the RCAF with rank of WO1. **Bill**, at **W2BNX**, writes that he will be back at Belmont Park in May for his 11th summer, and will be looking for the gang; he also reports having a visit from **2EE**. **F/O 2FG** has returned from the other side. **2HM** and **2KS** are teaching code to air cadets. **2DU** had an oldtime ragchew with **2DR** in Ottawa. **3VQ** has been transferred to the Montreal end of the CBC. **2BE** had an interesting letter from **2JT** dated at Singapore, December 5th! Seen but not heard: **2IE**, **2HT**, **2BF**, **2HH**, **2BT**, **2EM**, **2GA**, **2FI**, **2HT**.

Montreal hams who would like to do volunteer code teaching one night weekly, please get in touch with **2CO**.

ONTARIO—VE3

From Len Mitchell, 3AZ:

3AGG, who has been Electrical Superintendent at Wright-Hargreaves Mine, Kirkland Lake, has been granted leave of absence to take a position with the Dominion Magnesia Co. at Haley, Ont., where he will supervise the installation of electrical equipment for their new plant. Besides being an active amateur and member of the newly-formed Kirkland Amateur Radio League, Bert was an ardent golfer, and at a farewell banquet the Kirkland District Mining Electrical Association presented him with a silver ashtray on the edge of which was poised a golfer at the peak of his drive. The tray was inscribed, "Keep Out of the Rough."

3QB is still producing cheese for Britain but complains that other wise things are dead and he seldom sees a ham.

ALBERTA—VE4

From W. W. Butchart, 4LQ:

Have you ever listened to CFRN on Saturday evenings when they carry the broadcast from Edmonton's "Palace Gardens"? If you have, did you recognize the announcer's voice? It belongs to the now-famous **4AKK**! He does a spot of announcing once in a while in addition to station-engineer duties.

While visiting **4AEN** the other day he played over some attempts at home recording in which the "stars" are **4HF** (he of the erstwhile 3-watt peanut roaster), **4ALO** of 160-meter fame, and **AEN** himself. The lingo and sound effects are "tops," and they imitate anything from the 75-meter 'phone band on a good night to an aerial battle between a Spitfire and a Messerschmidt!

Hilda, **4WH**, has a brother who was in Singapore with the RAF as wireless op. at the time of the siege. We sincerely hope that he was able to get clear before the "little yellow devils" walked in. **Archie McMullen**, **4AHQ**, had a nice little write-up in the Edmonton Journal a day or two ago. The article played up Archie's huge proportions, and stated that he more than fills the cockpit of any plane made! The NARC held a Social Evening on the 18th of March. An amateur movie production, "Winter Escapade," was shown. **4HM** is diverting his surplus energies to "hi-fi" amplifiers, and says that he has a pretty fair outfit rigged up now. He is playing around with a combination "bass-treble" control which appears to have possibilities. **4XE** (RCCS,

Edmonton) is in charge of a signalling school in Edmonton:

That old bus of **4ATH**'s sure gets around, and its propensity for picking up swell-looking dames makes us sit up and take notice. **Don Langbell**, **4ANQ**, formerly of Camrose, now with CFRN in Edmonton, pulls some real spicy jokes on "The Camrose Mail-bag" program, of which he is MC. **Don** has been lying in wait for **4AEV** ever since he heard that that worthy one is stationed out at the RCAF Manning Pool in Edmonton. The two boys have insulted each other plenty over 160 'phone, but haven't had the misfortune of meeting personally! **4AHY** (RCCS Ottawa) has been transferred but we have not been advised of his new QTH. **4EA** has been working very hard helping an Edmonton Ciné Club group produce a "whodunnit" mystery, and as this goes to press the grand "première" is scheduled for March 19th or thereabouts.

How about sending in some news, fellas? It seems to get harder each month to round out our column. How about a bit of help?

GENERAL

From the month's mail:

FROM **G4FN** comes an interesting letter in the course of which he discloses that **VE4EU** is now a W/T Sergeant on duty in England, and that he is well and sends 73 to all old friends. "I can tell you that he sure enjoyed a local dance here last Friday night! Hi! Hope to have the pleasure of running across one or two of your lads now . . . for I am sure that the amateur ranks are well represented in your forces as they are in ours."

A. L. Chown, **VE3IW**, sends us a clipping from the Toronto *Evening Telegram*, headed, "Cleric Fit to Fight Rejects Chaplaincy." The account tells how Rev. Victor J. Monk rejected a chance to become a commissioned chaplain in the armed forces in favor of a job as radio technician in the RCAF, with the initial rank of aircraftsman. Before the war he was an "amateur radio broadcaster," according to the *Telegram*. That's ham spirit for you, isn't it?

A. W. Morley, ex-**VE4AAW**, SCM of Manitoba, writes from Winnipeg that he's been travelling hither and yon on war work. Something to do with the Air Training scheme, it seems. "I've purchased **QST** wherever I could get my hands on it, and fortunately I haven't missed an issue and know pretty well what goes on and gives out."

Last month **1FQ** mentioned the experiences of **Doug Smith**, **1FO**, in Africa. We didn't have room for the complete story then, which was probably just as well, because now we have a happy ending to add. Probably the story is best told by quoting the following CP Cable from Malta:

"A young flying officer from Halifax, N. S., is not fighting the Battle of Libya single-handed, but it looks as if he was trying to win it with the aid of his observer. . . ."

"The Haligonian opened his 'offensive' Dec. 1 on the Tripoli-Bengasi road, along which he made six diving attacks on enemy trucks, and then shot up four gasoline tankers, two of which caught fire. During the operation he was attacked by two Italian fighter planes, but evaded them."

"On the following day he returned to the fray and had a set-to with an Italian plane near Sirte. After half a dozen bursts the enemy aircraft landed on a beach. The hustling Canadian calmly photographed the machine, then shot it up until it caught fire, after which he photographed it again!"

"Later he attacked some 20 motor trucks. Most of them had machine guns, 'but they were unmanned as the gunners seemed to go along with the drivers who hopped out and ran about 50 yards, throwing themselves in the sand.'"

"Next the Canadian pilot swooped down on five gasoline tankers and trailers, setting them all on fire. He also took photographs of two of these trailers in flames. 'Machine guns were getting too accurate for further photographs,' he reported apologetically to his commanding officer. . . ."

That story was about Flying Officer **D. A. Smith**, **VE1FO**. Hardly had the story of **1FO**'s heroism in the battle of Libya reached these shores when word came that he was "missing" on active service. For some time he was given up for lost, and not only the ham fraternity but a host of friends throughout Nova Scotia paid tribute to his gallantry, initiative and courage.

Then came the happy ending mentioned in the beginning — happy, that is, in comparison with the fate originally feared. Early this year another report came through, saying that Flying Officer **Smith** had been located. He is now a prisoner of war "somewhere in Italy."

— C. B. D.

DAVEN POPULAR PRICED ATTENUATORS

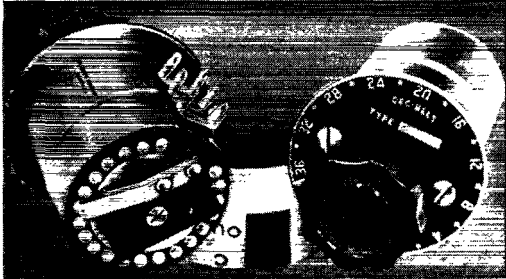

Compact low impedance mixing and gain controls for use in portable amplifiers, broadcast equipment and public address systems . . . similar in construction to our larger and costlier units . . . are specifically designed for popular priced systems.

Literature upon request

THE DAVEN COMPANY
158 SUMMIT STREET • NEWARK, N. J.

NOW . . . THE MATH YOU NEED
to solve everyday radio
and electrical problems
IN THIS NEW BOOK

Out of the U. S. Navy Radio Materiel School at Anacostia Station comes a complete home-study text that teaches you mathematics from elementary algebra through quadratic equations, logarithms, trigonometry, plane vectors and elementary vector algebra with direct applications to electrical and radio problems.



Just Out! MATHEMATICS for ELECTRICIANS and RADIOMEN

Based on more than 8 years' experience teaching mathematics to U. S. Navy electricians and radio operators. By N. M. Cooke, Chief Radio Electrician, U. S. Navy. 604 pp., 6 x 9, \$4.00.

10 DAYS' FREE EXAMINATION

McGraw-Hill Book Co., Inc., 330 W. 42nd St., New York

Send me Cooke's Mathematics for Electricians and Radiomen for 10 days' examination on approval. In 10 days I will send you \$4.00 plus few cents postage or return book postpaid. (We pay postage if you remit with order.)

Name

Address

City and State

Position

Company QST 5-42

90

(Continued from page 88)

expected — that it was necessary to make an arbitrary selection. Many were attracted because of a desire to contribute to defense rather than because of any interest in radio. Nevertheless, attendance held up remarkably well and those remaining show keen interest.

A second section of this course was started at mid-years. This again was over-subscribed but not so much as the first one, being limited to those who had taken a course in physics.

This type of course has been of considerable value both as a feeder to the regular courses and in giving some of the regular physics students valuable supplementary knowledge, both practical and theoretical, as well as in carrying out its original purpose of stimulating interest. However, since the school now has a clearer idea of what is wanted by the government and since the course has completed its original purpose of stimulating interest, it is doubtful that the non-credit course will be given next year.

Smith Gives College Credits in Radio

The other type of radio course given at Smith is one for college credit. This is open to all who have had one previous college course in physics. The class meets for one three-hour laboratory period and two one-hour recitation periods a week and runs for the semester.

Next year it is planned to give this course both terms, with necessary changes based on present experience or to meet the requirements for students qualifying for the various Civil Service positions which are being announced.

"Our employment office is besieged by requests for people trained in all branches of physics, although by far the largest demand is for people trained in electronics," says Dr. Beers. "We have also had urgent demands from the Navy for women trained in general physics to work on the anti-mine program and for women trained as photographers. There are all sorts of industrial and teaching jobs clamoring to be filled — just to mention a few. The number of physics majors at present is small (though in proportion about the same as in men's colleges), so most of these jobs will have to go begging for the present. However, we are hoping to have an increase in registration for the physics major next year as well as in our specialized courses in radio and in photography. There are indications we are going to get it, but we do not know how large it will be. At any rate, we are equipped to turn out a good number of technicians. Our main problem is in convincing the group that is technically-minded that in this way they can make their greatest contribution to defense. Unfortunately, there are so many less important activities which tend to becloud the issue locally. Editorials such as that in April QST are just the type of thing we need to help us solve this problem."

The courses of study offered in these various training classes vary widely, as widely as the range of tasks our vast army of girl war workers can perform — civilian defense, professional oper-

Centralab

The Quality Line

Special orders, recommendations and handling procedures for the use of Centralab products. These instructions are a part of the product literature and should be read carefully before use.

SEND FOR CATALOG NO. 23

Centralab

For Every Need in EVERY Emergency

Centralab AXIAL LEAD RESISTORS

Under water, in hot air, under shock, under "blast" these famous resistors will hold their own in the most trying conditions. They are made of a special mixture of ceramic and metal, and are completely impervious to moisture, heat, and vibration.

CENTRALAB DIV. OF GLOBE-UNION INC. MILWAUKEE, WIS.

Complete NET only \$4.98

Always THE RIGHT REPLACEMENT CONTROL WITH THIS CENTRALAB PORTABLE

Answering the Call

Centralab controls are always in step with progress in civilian or defensive use. In personal projects or in purchasing, specifying numerous Centralab controls can save you money and increase efficiency. And when you are called upon to remember that Centralab controls are the ideal replacement for every job.

CENTRALAB Division of Globe-Union Inc., Milwaukee, Wis.

Centralab RADIOHMS

A—STANDARD
Long life, low resistance, low temperature coefficient, low noise, low inductance, low capacitance, low resistance to shock, low resistance to vibration, low resistance to moisture, low resistance to heat, low resistance to cold, low resistance to light, low resistance to radiation, low resistance to magnetic fields, low resistance to electric fields, low resistance to mechanical stress, low resistance to chemical attack, low resistance to aging, low resistance to handling, low resistance to storage, low resistance to transport, low resistance to use.

B—MIDGET
Small in size, but big in performance. Low resistance, low temperature coefficient, low noise, low inductance, low capacitance, low resistance to shock, low resistance to vibration, low resistance to moisture, low resistance to heat, low resistance to cold, low resistance to light, low resistance to radiation, low resistance to magnetic fields, low resistance to electric fields, low resistance to mechanical stress, low resistance to chemical attack, low resistance to aging, low resistance to handling, low resistance to storage, low resistance to transport, low resistance to use.

C—MILITARY
Designed for use in the most severe environments. Low resistance, low temperature coefficient, low noise, low inductance, low capacitance, low resistance to shock, low resistance to vibration, low resistance to moisture, low resistance to heat, low resistance to cold, low resistance to light, low resistance to radiation, low resistance to magnetic fields, low resistance to electric fields, low resistance to mechanical stress, low resistance to chemical attack, low resistance to aging, low resistance to handling, low resistance to storage, low resistance to transport, low resistance to use.

Plotting the Course of Progress

For those Centralab controls are the only ones that can be used in the most severe environments. Low resistance, low temperature coefficient, low noise, low inductance, low capacitance, low resistance to shock, low resistance to vibration, low resistance to moisture, low resistance to heat, low resistance to cold, low resistance to light, low resistance to radiation, low resistance to magnetic fields, low resistance to electric fields, low resistance to mechanical stress, low resistance to chemical attack, low resistance to aging, low resistance to handling, low resistance to storage, low resistance to transport, low resistance to use.

Centralab RADIOHMS

CENTRALAB Division of Globe-Union Inc. Milwaukee, Wis.

We view with pride — Old Man Centralab

In his humorous way, Old Man Centralab has been telling you about Centralab products for so many years that he seems an actual person. We are proud of that fact . . . proud too, to say that while Old Man Centralab's products are needed now on many fronts, we are still pledged to serve you.

At your jobber's — you may still "SPECIFY CENTRALAB" with assurance that the Old Man is there to serve you.

QUALITY
PERFORMANCE
DEPENDABILITY

There's a

Centralab

Div. of Globe-Union Inc., Milwaukee, Wis.

CONTROLS • SWITCHES

RESISTORS

CAPACITORS

More than 20 years of experience in the design and manufacture of electronic controls, switches, resistors, capacitors, and other electronic components. Our products are used in a wide variety of applications, from consumer electronics to industrial and military equipment.

CENTRALAB DIVISION OF GLOBE-UNION INC. MILWAUKEE, WIS.

Centralab

Div. of Globe-Union Inc., Milwaukee, Wis.

CONTROLS • SWITCHES

RESISTORS

CAPACITORS

More than 20 years of experience in the design and manufacture of electronic controls, switches, resistors, capacitors, and other electronic components. Our products are used in a wide variety of applications, from consumer electronics to industrial and military equipment.

CENTRALAB DIVISION OF GLOBE-UNION INC. MILWAUKEE, WIS.



Many manufacturers have found, to their advantage, that the vital part which may be delaying completion of an order may be purchased at HARVEY'S.

Stocking, as we have been in the past, duplicate replacement components and equipment from more than 80 of the country's leading radio equipment and parts manufacturers, we find that our shelves still contain an assorted (if not complete) supply of vital materials.

These will be sold to manufacturers who NEED THEM TO FILL WAR ORDERS. Customary, normal prices prevail.

We are also encouraging radio amateurs to sell us their standard equipment (testers, amplifiers, communications receivers, etc. . .) so that these may become available in our WAR EFFORT.

★ AMATEURS: If you have idle equipment, contact us immediately. The country's war services and manufacturers need it.

★ MANUFACTURERS: We may have the equipment you want, ready for IMMEDIATE delivery.

For the duration, HARVEY'S can be your emergency "clearing house."

W2JL ● W2LJA ● W2PL ● W2KWY

OUR *Best* VALUE IS OUR RECORD OF LOYAL SERVICE

HARVEY

Radio Company of New York

103 WEST 43rd STREET • NEW YORK, N. Y.

CABLE ADDRESS "HARADIO"

(Continued from page 90)

ating or technical work, noncombatant military duty, research.

The starting goal, however, as already stated, is almost invariably the passing of the Class-B amateur license exam. As has already been recognized by the Army and Navy and much of private industry in the enlisting of the nation's manpower for specialized radio assignments, possession of an amateur license is equivalent to a diploma in basic radio.

The first objective, therefore, is to train students in radio code and theory to the point where they can pass the amateur exam. Other courses, giving advanced training, may follow — but this comes first. On this those who are organizing and teaching such courses are urged to concentrate.

It is not practicable to give detailed suggestions for the conduct of such courses within the scope of this article. For the benefit of those sponsoring or teaching such courses, however, as reported in April *QST*, p. 18, ARRL has prepared a detailed study outline which can be adapted to almost any need; it is available upon request, free of charge. This outline is already in use, with marked success. Additional helps in the form of practical teaching aids and simple experiments — useful, of course, in both men's and women's classes — are in process of preparation and will be presented in future issues of *QST*.

Radio in Summer Camps

(Continued from page 18)

while the lack of a suitable room presented another stumbling block, and the most important of all (so I have since been told) was the difficulty in finding a girl operator. To this last circumstance I owe my happy years at camp. Most women operators are *XYL*'s and therefore are not able to spend their summers in a camp. But, thanks to my Daddy, I was available for the job despite the fact that I was only twelve. As a matter of fact, I had already been an operator for four years, but even so was hardly the one to take charge of a radio class at such a tender age. Nevertheless, we had a good time.

It's true enough that the advent of a radio station in our camp seemed to cause no great excitement or interest on the part of the campers or the staff. But this was not for long. After stringing up the antenna and getting the station in operation, the mysteries of radio attracted all. Our first QSO caused quite a stir among the girls. I don't honestly believe that they expected a voice to answer our call so clearly and definitely as one did. There was but a handful of pioneers that first day, but soon the shack became the most popular place in camp. It was rare that a girl missed a schedule. At first curiosity was the principal attraction but, as time went on, certain of the girls began to show interest in the code, others in the technical features, and almost all liked to say an occasional word over the air. A few showed an ambition to obtain tickets and occupied most of their leisure

TRUTH *Stands* *the Test of Time!*

In March 1938, the introduction of Taylor Wonder Tubes, T-40 and TZ-40 set an entirely new standard of quality, dependability, performance and value.

Now, four years later, with the enthusiastic endorsement of thousands of loyal users, the T-40 and TZ-40 have proved to be the outstanding tube values not only for amateur but for commercial applications as well.

After this war is won, there will be many reports of how Taylor Tubes did their important part in helping to successfully carry the fight to our enemies. As always, Taylor will carry on — continuing to build the finest tubes possible to produce.

Taylor Tubes, Inc.

MORE WATTS Manufacturers of Vacuum Tubes **PER DOLLAR**
2341-43 WABANSIA AVE., CHICAGO, ILL.
TELEPHONE ARMITAGE 1730-4

To the Amateur:

I honestly believe that the T-40 and the TZ-40 represent the best values ever offered to an amateur.

When you use these tubes you will get a new conception of quality, stamina, dependability and performance.

We are proud to be able to offer you these wonder tubes.

Yours for **MORE WATTS PER DOLLAR**.

Frank J. Hajek

FRANK J. HAJEK - WOECA.
SECRETARY & TREASURER

Reproduction of Open Letter Carried in March 1938
T-40 and TZ-40 Announcement Advertisement.

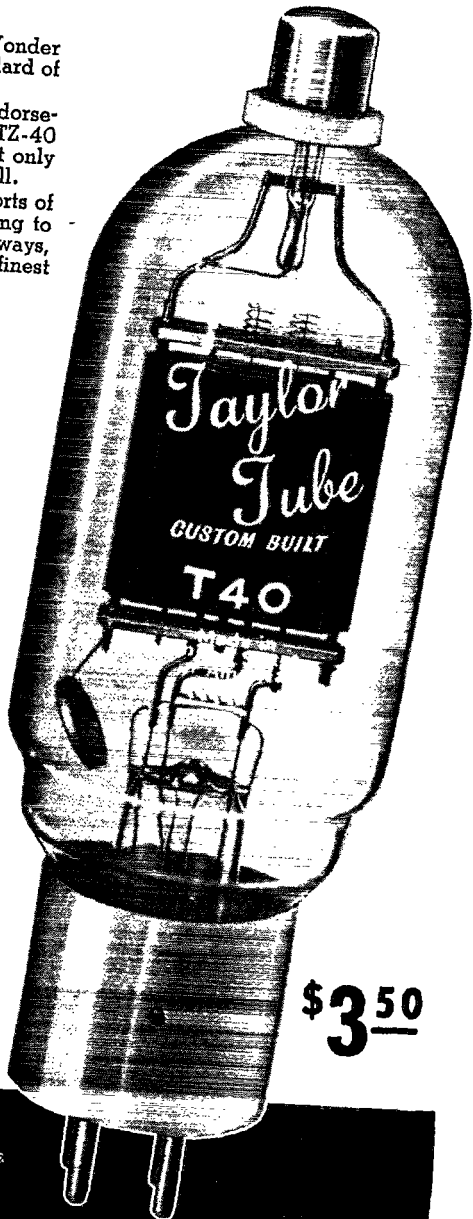

\$3⁵⁰

Taylor HEAVY CUSTOM BUILT DUTY **Tubes**

TAYLOR TUBES, INC., 2341 WABANSIA AVE., CHICAGO, ILL.

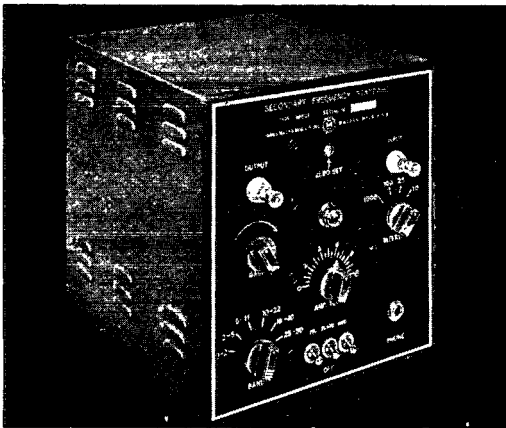

A Precision Crystal — Secondary
FREQUENCY STANDARD

That Has Been "Designed for Application"

A precision frequency standard capable of being adjusted to WWV or some other primary standard and putting out uniformly accurate calibrating signals with 10, 25, 100, 1000 KC intervals. Uses the new GENERAL ELECTRIC No. 18A 1000 KC crystal having a frequency temperature coefficient of less than one cycle / Mc/C*. The crystal is sealed in Helium in a standard metal tube envelope.

The self-contained AC power supply has VR150-30 voltage regulator tube.

In addition to oscillator, multivibrators, and harmonic amplifier, a built-in mixer with phone jack and gain control on panel is incorporated.

JAMES MILLEN MFG. CO. INC.
 150 EXCHANGE ST. MALDEN, MASS.



(Continued from page 98)

time in practising code and studying the *License Manual*. They derived a great deal of pleasure, passed many happy hours, gained much useful information, and it is still not beyond the realm of possibility that a few of the more interested may eventually have their own calls. In any event, I am sure that they will look back on their radio hours as among the most pleasant and memorable spent in camp.

In spite of the disadvantages of so young an operator, the station proved successful and has been in operation for several years. Rainy days (the bane of every camp director) lost their dullness, and the usual dragging hours passed quickly in the shack. When not actually making contacts, the girls delighted in decorating the walls, re-arranging QSL cards, and printing signs to help them remember the "ham lingo" — such terms as QRM, QRT, etc.

Code classes were popular with quite a large group. Theory sessions claimed fewer, but no less enthusiastic, would-be-hams. Even rest-period found private keys by the beds with girls sending to each other across the room. At night they tried the councilors' patience with a door-bell buzzer which they seemed to prefer to oscillators and buzzers of the usual high frequency type, possibly because it made so much noise and could be heard at such a great distance. I must confess that they tried even *my* patience sometimes in their enthusiasm, though of course "Dit," as they called me, had to smile and cooperate at all times. They *did* enjoy it, so I hadn't the heart to refuse to help such earnest and sincere potential YL's. Nor did their interest lag or abate from one season to another. In fact, some girls requested and received keys, buzzers, and oscillators from Santa Claus — much to the delight of most of the parents, who were only too glad to further a hobby so educational, wholesome and worthwhile.

Uncle Sam has asked our secondary schools all over the country to further the interest of national defense by adding radio, both code and theory, to their regular programs, and it seems to me that summer camps may be of great assistance by offering training of this nature in a way which should prove most effective. Whereas a course in school may come under the head of "work" to a student, the same classes may be considered "fun" at camp. With the government's call for more and more "wireless men" to urge them on, there is no reason why children of both sexes should not win licenses by the hundreds as a result of the summer's work.

I have had so much fun operating the station at camp, the girls have enjoyed so greatly helping with the QSO's and learning the code and theory, and the directress has been so delighted in the results of her at first somewhat doubtful experiment, that I thought perhaps some of you YL's and hams of camp age might be interested enough to recommend the establishment of a station at your own camps, if you haven't one already. And if any of you who control the destinies of boys' or girls' camps chance to read this, I would strongly

This is YOUR
CHANCE!

No matter what the job is you always see the trained fellow in the best position. This is YOUR CHANCE RIGHT NOW! Radio code operators are wanted by the Army, Navy and in the Commercial Communications fields. Our Merchant Marine wants 40,000 trained radio operators now! You can learn this interesting way to a better future without leaving your own home!

The Candler System has, for over a quarter of a century, shown the way to learn code and develop code proficiency at home by their simplified method. You owe it to yourself to take advantage of this opportunity. Why not write today — there is no obligation, no salesman will call — find out how you too can have a better future.

Get the Free Book

Drop a post card today for this interesting BOOK OF FACTS which tells you all about the fascinating way to quickly learn code and acquire speed and skill. A copy of this 52 page book is yours — write for it!

**CANDLER
 SYSTEM CO.**

BOX 928, DEPT. Q-5,
 DENVER, COLORADO



J E N S E N

JENSEN has taken on the job of producing large quantities of highly specialized sound reproducers for the armed forces . . . reproducers which will speed vital communications . . . facilitate military operations in many ways.

EXPERIENCE in designing for severe service requirements on land and sea . . . in meeting highly technical specifications . . . in solving new problems and delivering the answer in production quantities—these are our qualifications for this big assignment.

NECESSITY dictates that war production be given a clear track over everything else, with first call on all materials, machines and manpower.

SOME civilian orders for Jensen speakers and reproducers must therefore go unfilled until the war is successfully ended. We appreciate the spirit of cooperation and understanding displayed by our many customers and friends under these trying conditions.

EVERY effort should be made to repair and continue in service existing speakers. Our Service Department will help keep Jensen speakers in operation.

BETTER and brighter days are not too far away. New technical horizons lie ahead. And when the Big Job is done, Jensen will be ready with even greater achievements in the field of fine sound reproduction.

These standard Jensen designs have found extensive applications with the armed forces. Priority inquiries for these and other types of sound reproducers are solicited.

Jensen
6601 SOUTH LARAMIE AVE. • CHICAGO
CABLE ADDRESS • "JERAD" CHICAGO

HEAVY Duty Speakers
for service receivers
and intercom equipment.
Marine approved types.

PM3-F PM6-C

**SPEECH
MASTER**
for high efficiency
transmission and sound.

**HYPEX
PROJECTOR**
For industrial plant,
air field and
alarm systems.

**TYPE "E"
SYSTEM**
Wide range two way system
for sound-on-film recording
and entertainment.

3 BIG REASONS

WHY TERMINAL IS
YOUR MOST RELIABLE
SOURCE OF SUPPLY

1. Largest Stock of Radio Parts and Electronic Equipment in our History! This tremendous increase in inventory is due to the consolidation of our two stores, concentrating all stock at one source.

2. Every Terminal salesman is an experienced radio man — not a mere order taker. If a particular brand you want is on priority, he is qualified to recommend an equal or similar make to your satisfaction.

3. Priority orders receive first consideration at Terminal. We're all out to assure quickest delivery of equipment for the National Victory program — and we have geared ourselves to handle priority orders without delay.

TERMINAL RADIO CORP.

85 CORTLANDT STREET

New York City • WOrth 2-4416

(Continued from page 84)

urge that you give ham radio a chance to prove itself a useful hobby, a new activity with a moderate initial cost and practically no upkeep, a rainy day blessing, and an educational selling feature for your camp.

Experimenter's Section

(Continued from page 41)

quencies, of course, one must consider the inductance and capacity effects, and the a.c. impedance may be two or three times the d.c. resistance.

"The receiving electrodes can be stakes driven into moist ground. For transmitting at low power the same thing is all right, but better results may be obtained by using iron pipes surrounded with iron chloride, copper pipes with copper chloride, etc. I was afraid of chemical action at the time, but upon looking back, I don't think it was so important. The main thing is to get down into good wet soil. If holes are drilled near the bottom end of the pipe, water can be poured in the top.

"I never did find out the maximum range, but the signal was S9 at several miles.

"The most interesting thing, to me, was the frequency response of the system. It was flat, within the limits of measurement, from about 10 to 25,000 cycles. We were unable to get outside this range with the equipment at hand. This opened the possibility of using modulated carrier, although we didn't actually try it. The communication band on the low end was limited by power-line noise and its harmonics. With a high-gain amplifier we found the latter were troublesome up to several thousand cycles. On the high-frequency end we ran into interference from long-wave radio stations. At 25 kc. it was pretty bad. I don't know how badly we were radiating, either. Nevertheless, there is a good band of about 20 kilocycles ready for somebody, and it opens up a new line of attack using existing equipment."

On the Ultra Highs

(Continued from page 55)

the 9001 and 9003 becomes a limiting factor. The lower price and greater convenience make them attractive, however, and they are especially useful in superregenerative receivers where reduction of radiation and elimination of antenna-resonance effects are primary considerations.

About this time we think we hear a question — "What about f.m.?" "Why fool around with c.w. and crystal filter superhets on 2½ when everyone knows that f.m. is the technique for u.h.f. communication?" To which we hasten to agree. F.m. is undoubtedly going to supplant amplitude modulation to a large extent when we get back to random u.h.f. operation. There exists some doubt as to the usefulness of the crystal c.w. - b.f.o.

SOUND ADVICE

With manufacturing facilities rapidly being converted to defense production, replacement parts for public address systems may eventually be difficult to procure. At the present time, however, it is still possible to obtain Astatic Crystal Microphones, Pickups and Cartridges at your Radio Jobber's. Keep the operating efficiency of your sound equipment up to par. Make all necessary parts replacements now. Neglect may be costly.

ASTATIC

THE ASTATIC CORPORATION

YOUNGSTOWN, OHIO

Licensed Under Bush Development Co. Patents

In Canada
Canadian Astatic Ltd.
Toronto, Ontario

SEE PAGE 108 FOR DOPE ON
ARRL'S

REGULAR AND DEFENSE EDITIONS

of the

RADIO AMATEUR'S HANDBOOK!

RADIO OPERATING QUESTIONS AND ANSWERS

Nilson & Hornung's new edition covers all FCC commercial license exam elements. Standard handbook 20 years. \$2.50, postpaid. Money back if not satisfied and book returned in 10 days. Send check or money order . . . not cash. *Free circular on request.*

NILSON RADIO SCHOOL, 51 East 42nd St., New York

LEARN CODE THE WAY YOU'LL USE IT—BY HEARING IT

Type S = \$17.50

Sends from 4 to 40 words per minute. Higher speeds if desired. Complete with 10 rolls of double-perforated lesson tape of carefully selected and arranged matter for speediest results in learning code. Most compact and practical code teacher on market.

Type J = \$12.50

Sends 6 to 65 words per minute. Built-in tape perforator. Cut your own practice and message tapes. Complete with one roll of practice tape covering Alphabet, Numerals, Words to five letters; and 5 rolls of blank tape.

If your dealer can't supply you, write us

GARDINER-LEVERING CO. Haddon Heights
New Jersey, U. S. A.

*Good
Capacitance
at a
BARGAIN*



● Aerovox PBS cardboard-case dry electrolytics are mighty easy on your pocketbook. That's why you can afford to be extra-generous with capacitance for ideal filtering efficiency, when you use PBS's.

Adjustable metal mounting flanges; polarity-indicating colored leads; generous voltage ratings; full rated capacities; minimum bulk—these and other features brand PBS electrolytics as "tops" with critical radio men.

Ask the Aerovox jobber for PBS electrolytics. Ask for latest catalog — or write us.

AEROVOX CORPORATION
NEW BEDFORD, MASS., U. S. A.
In Canada: AEROVOX CANADA LTD., Hamilton, Ont.
EXPORT: 100 Varick St., N. Y., Cable 'ARLAB'

ORDER THESE BARGAINS DIRECT FROM THIS AD!

OIL FILLED — OIL IMPREGNATED FILTER CONDENSERS

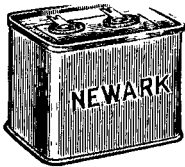

As Low as **59¢**

Mfd.	Volts DC.	Size	Price
1	1000	5 x 3 1/2 x 1 1/2	\$.59
2	2000	4 1/2 x 3 1/2 x 1 1/2	1.50
3	2000	5 x 3 1/2 x 3 1/2	2.75
4	3000	5 x 3 1/2 x 3 1/2	3.75

Quality-built by reliable maker. Guaranteed at rated voltage.

FREE CATALOG

Thousands of bargains, sets, parts, accessories, supplies, of best known makes. Hundreds of illustrations. This book belongs in every "ham" shack, ready for instant reference. Helps you plan your new rigs, figure costs.

Full line **HALLICRAFTERS RECEIVERS** Now in Stock for Immediate Delivery. **ORDER YOUR NEEDS TODAY** from Newark's big stock of **RADIO PARTS**. We have everything you need at the prices you want to pay.

NEWARK ELECTRIC COMPANY

323 W. Madison Street Dept. Q. Chicago, Illinois

Hams, Defense School Students and Gov't Men

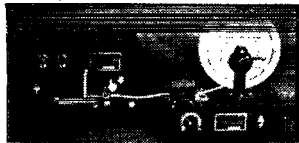

Ayers Automatic Code Machines Dept. Q-5, 711 Boylston Street, Boston, Mass.

are learning the code the right way, quickly and easily with the all electric Ayers machine. Built by Code Champion McElroy for our future champions. Largest selection of tapes in World available with each machine. Low monthly rental. Tapes for MacAutos, recording slip and special inks for sale.

LEARN CODE

the way you'll be using it by SOUND

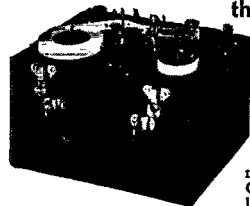

The best way to learn to read code is by listening to code. The best way to learn to send code is by hearing your own sending repeated back to you. With the new All-Electric Master Teleplex Code Teaching Machine, you learn code the natural, easy, fascinating way. Only instrument ever produced which records your sending in visible dots and dashes — then SENDS BACK your own keywork at any speed you desire. There are NO PERFORATIONS — NO INK. A marvel of simplicity. That's why practically every school teaching code uses TELEPLEX. We furnish complete course, lend you All-Electric Master Teleplex, give you personal instruction with a MONEY BACK GUARANTEE — all at a surprisingly low cost per month. Write today for FREE catalog Q. 5. No obligation.

Standard Teleplex — a highly efficient code teacher using heavy specially prepared waxed paper tape, having two rows of perforations: Write for Free folder "Q.T.S."

TELEPLEX CO. 107 Hudson St. Jersey City, N. J.

High Voltage Power TRANSFORMERS

Made by one of the largest transformer manufacturers.

Guaranteed. As illustrated.



QUANTITIES LIMITED

No. 1549 — 300-0-300...100 Ma. 6.3 V.-3 amp; 5.0 V.-3 amp.\$1.95
No. 4140 — 600-0-600 V. — 200 Ma. Filaments: 7.5 V.C.T.-3 A. — 5.0 V.C.T.-3 A. — 2.5 V.C.T.-10 A. Wt. 8 1/2 lbs. \$3.45
No. 4240 — 600-0-600 V. — 200 M.A. Filaments: 6.3 V.-4 A. — 6.3 V.-3 A. — 5.0 V.-3 A. Wt. 8 1/2 lbs.\$3.45

LOOK! YOUR CALL LETTERS in Gold, 10¢

Big shadowed decals, nearly 2" high. For ham shack door, windshield, etc. Be sure to give your call letters.

technique on frequencies above 60 Mc., and the effectiveness of f.m. has brought many of us to the point where we doubt that there is much justification for taking up with a.m. again on 2 1/2.

But some of us are DX hounds at heart. New developments are good, to us, only if they mean a chance to reach out a little farther. Because the use of c.w. has proved to be a great aid in pushing the maximum operating range farther and farther out on 56 Mc., we are curious to find out whether it will not accomplish the same end on 2 1/2 — and we're not forgetting the possibilities of aurora DX on 2 1/2, too. We'll be set when the time comes, anyway.

A Simple Light-Beam System

(Continued from page 14)

the unit as a listening device a noise was heard that could not be identified; it was later found to be a well driller over two miles away. The softest whisper can be heard 20 to 30 feet from the microphone. This is along the same lines as the article in March *QST*,² and with slight modification the *QST* unit can be used as a light-beam transmitter or receiver.

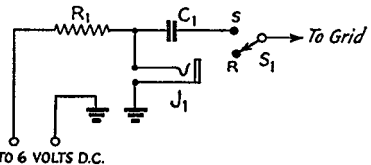

Fig. 2 — Input circuit for single-button carbon microphone.

R_1 — 50 to 200 ohms (adjusted to give microphone current of approximately 10 ma.).

C_1 — 0.01- μ fd. paper.

J_1 — Open-circuit jack.

For long range work it may be desirable to put the phototube in a housing of its own and place it on a mast or the top of the house. In this case a length of crystal microphone cable should be used to connect it to the socket ordinarily used for the phototube.³ Be sure that the center conductor goes to pin No. 2 and the shield to pin No. 4.

There are two other methods of light-beam transmission with which we are acquainted. In one method a constant source of light is passed through a "light gate," the width of which is varied at audio frequency. This method is also used to record sound on film. In the other method a constant source of light is directed at a small mirror vibrating at audio frequency and the

² Mix, "An Acoustic System for Aircraft Detection," *QST*, March, 1942.

³ If the line has appreciable length, such a cable will represent a considerable capacity shunt across the high-resistance load for the phototube, and consequently will reduce the high-frequency response. It would be advisable in such cases to incorporate a pre-amplifier in the phototube assembly, using a tube-to-line transformer to bring the audio signal into the house. — Edron.

"...GIVE ME LIBERTY OR GIVE ME DEATH"

— PATRICK HENRY

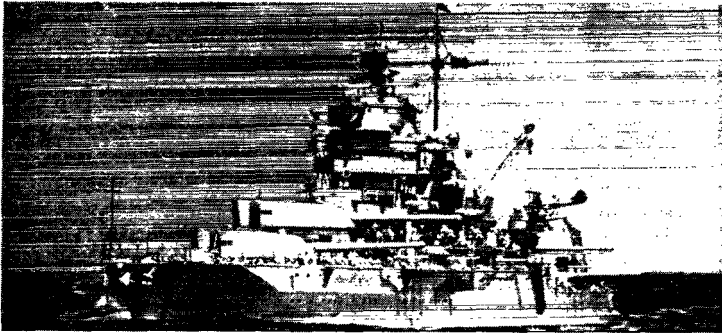

A AMERICANS are again repeating, "Is life so dear, or peace so sweet as to be purchased at the price of chains and slavery?" Today, the roaring activity of our defense industries is America's triumphant hymn of determination . . . and we are proud to add our part . . . for LIBERTY.

KENYON TRANSFORMER COMPANY, Inc.

840 BARRY STREET

NEW YORK, N. Y.

WANTED TO BUY

BROADCAST STATION EQUIPMENT

Used or New in its entirety or singly one 250-watt transmitter with associated monitors and speech input equipment; one 150- to 500-foot self supported vertical radiator. Box G, QST, West Hartford, Conn.

CRYSTALS by HIPOWER

The Hipower Crystal Company, one of America's oldest and largest manufacturers of precision crystal units, is able to offer the amateur and manufacturer attractive prices because of their large production and the exclusive Hipower grinding process. Whatever your crystal need may be, Hipower can supply it. Write today for full information.

HIPOWER CRYSTAL CO.

Sales Division—205 W. Wacker Drive, Chicago
Factory—2035 Charleston Street, Chicago, Ill.

EASY TO LEARN CODE

It is easy and pleasant to learn or increase speed the modern way — with an **Instructograph Code Teacher**. Excellent for the beginner or advanced student. A quick and practical method. Available tapes from beginner's alphabet to typical messages on all subjects. Speed range 5 to 40 WPM. Always ready, no QRM, beats having someone send to you.

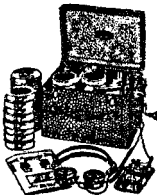

MACHINES FOR RENT OR SALE

The **Instructograph Code Teacher** literally takes the place of an operator-instructor and enables anyone to learn and master code without further assistance. Thousands have used and endorse the **Instructograph System**. Write today for full particulars and convenient payment and rental plans.

INSTRUCTOGRAPH COMPANY

4709 Sheridan Road, Chicago, Illinois

Representative for Canada:

Radio College of Canada, 54 Bloor St. West, Toronto

We have a large stock of

HALLICRAFTERS NATIONAL HAMMARLUND RME HOWARD

RECEIVERS, transmitters and all radio supplies of all sorts at lowest wholesale prices. Order from us for immediate delivery. We will help you get the best equipment for your use and cooperate with you to see that you are 100% satisfied.

- YOU get 10-day trial
- YOU get best trade-in

We also have a store at 2335 Westwood Blvd., West Los Angeles, Calif. Write, fone, telegraph us anytime about any radio supplies. It will pay you to deal with us. Your inquiries invited.

HENRY RADIO SHOP

Butler, Missouri

"World's Largest Distributors of Communications Receivers"

SUN RADIO

IS GEARED
for
**PROMPT
SERVICE!**

Surprising as it may seem in these times, in view of material restrictions and allotments, our present stock of radio parts and electronic equipment is amongst the largest ever in our long history. This facility, combined with a greatly enlarged staff of trained personnel, has made SUN RADIO a prime source of supply for hundreds of firms and agencies actively engaged in government work. We are prepared to offer immediate attention to the following:

- ★ INDUSTRIAL MANUFACTURERS
- ★ SIGNAL CORPS
- ★ ARMY—NAVY—MARINES
- ★ COAST GUARD
- ★ SCHOOLS—COLLEGES
- ★ AIRCRAFT INDUSTRY
- ★ SHIPYARDS
- ★ BROADCAST STATIONS
- ★ SCIENTIFIC LABORATORIES
- ★ CIVILIAN DEFENSE LEAGUES
- ★ POLICE DEPARTMENTS
- ★ PUBLIC UTILITIES

AMATEURS! ENGINEERS! You are not forgotten! We have thousands and thousands of parts for commercial and experimental purposes. All the leading lines — I.R.C., Ohmite, RCA, Thordarson, Stancor, Cornell-Dubilier, Triplett, Weston, Hallicrafters, Hammarlund, National, etc. Write or phone us for complete information on any standard nationally-advertised product.

ATTENTION! CODE PRACTICE CLASSES

We Carry a Complete Stock of
HEADPHONES
TELEGRAPH KEYS
CODE PRACTICE OSCILLATORS
BATTERIES
TUBES • WIRE
COMMUNICATIONS RECEIVERS
also BOOKS

Radio Operating Questions and Answers — Nilson and Hornung — 427 Pages..	\$2.50
Practical Radio Communication — Nilson and Hornung — 754 Pages.....	\$5.00
Understanding Radio — Watson, Welch and Eby.....	\$2.80
Radio Engineering Handbook — K. Henney — 850 Pages.....	\$5.00
Radio Physics Course — Ghirardi — 972 Pages.....	\$5.00
Radotron Designer's Handbook — F. L. Smith (RCA).....	\$1.00

Radio's MOST COMPLETE Source
TELEPHONE Barclay 7-1840



RADIO CO.

212 Fulton Street, Dept. QM New York
Cable Address SUNRADIO NEW YORK

reflected light directed at the phototube. This is the least efficient method of the three. There may be other good methods, and if so we would be interested in hearing of them.

A lot of fun and pleasure can be had from experimenting with a unit like this. It also shows possibilities as a trick gadget to set up in a radio store for the amazement of the customers.

Here at W6PCB/W6TOY we use our Howard home recorder as a transmitting unit, being able to transmit broadcast programs, speech or records. With this arrangement a demonstration was put on at the local radio club (Tucson Shortwave Association) on February 6, 1942. For "DX" we use the auto receiver, driving the car across the desert and pointing the beam head at the beam receiver. A demonstration of the unit as a listening device also was put on for the u.h.f. group of the club on February 15, 1942, at the judging of the U.H.F. Defense Equipment Contest sponsored by our club.

Interference-Reducing Antenna Systems

(Continued from page 28)

The two transformers in the antenna coupler include special iron cores which provide tight coupling combinations and remarkable power transfer, even at high frequencies. The tight coupling eliminates dead spots met with in air-core couplers, thus producing a substantially flat gain over a band from 400 to 22,000 kc.

Efficient transfer of power through the transmission line is possible by the use of two channels. One channel comprises one conductor and the shield return path, passing frequencies from 400 to 4000 kc., whereas the other conductor and the shield return permits transmission of frequencies from 4000 to 22,000 kc. and a fair signal in the 40 Mc. f.m. range.

The receiver coupler includes iron-core transformers with the addition of an air-core f.m. coupler. A two-conductor shielded cable on the receiver coupler permits connection to the input terminals of the radio receiver. This shielded cable is of importance where the receiver is in location where the local interference is bad. An unshielded antenna lead six inches long will pick up a surprising amount of interference.

When experiencing extreme interference conditions, it is advisable to ground the shielded cable at the antenna coupler as shown in Fig. 2.

Multiple receiver couplers are of value for apartments and radio stores, but for best interference reduction the transmission-line connection between couplers should be shielded. This same condition holds for the aerial transmission line because an unshielded transmission line will pick up interference. The latter statement is based on the fact that the transmission line is not balanced and also is approximately matched to 38 ohms at the antenna and receiver couplers for the enormous frequency range 400 to 22,000 kc.

As many as ten receiver couplers have been

Get that ticket!

IT'LL GET YOU IN TO THE SIGNAL CORPS IN THE ARMY . . .

(and don't bother trying to enlist there without it)

OR IF YOU PREFER THE NAVY, YOU CAN START OUT AS RM2C . . .

(at nearly four times the pay of an apprentice seaman)

Sure!—THE F.C.C. STILL ISSUES THEM!

And the League shows you how to get them

THE A.R.R.L. LICENSE MANUAL

Complete with representative exam questions and their correct answers

25¢ postpaid from The American Radio Relay League,
West Hartford, Connecticut

NO STAMPS PLEASE!

LEARN WIRELESS and TELEGRAPHY!

A BOOK EVERY AMATEUR
SHOULD HAVE—

Send Now

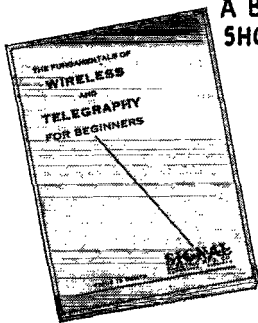

Hundreds of amateurs have
earned from this book,
so can you.

15¢

POSTPAID
COIN, OR
STAMPS

This book gives you the fundamentals of wireless and telegraphy. It contains the codes and how to learn them. Mail your order now to:

SIGNAL ELECTRIC MFG. CO., Menominee, Mich.

ESTABLISHED
1892

SIGNAL

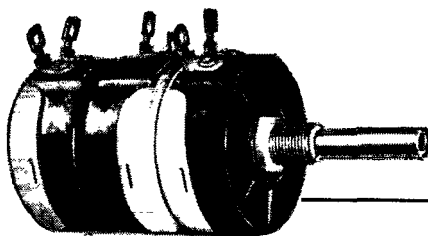

WIRE-WOUND

Controls

- ★ For applications requiring dependable, precise rheostats or potentiometers, simply insist on Clarostat Wire-Wound Controls. Such controls are found in the finest instruments, in broadcast control rooms, in commercial and top-flight "ham" equipment. ★ Single units, linear, from 1 to 100,000 ohms; tapered, 10 to 50,000 ohms. Wattage ratings 1.5 watts to 25 watts. ★ Also available in dual and triple units as L-pads, mixers, T-pads and other precise controls.
- ★ Ask your local jobber for these Clarostat Wire-Wound Controls. Ask for latest data. Or write Clarostat Mfg. Co., Inc., 285-7 N. 6th St., Brooklyn, N. Y.



HARVEY RADIO LAB'S, Inc.
Manufacturers of
Radio Transmitters
ELECTRONIC APPARATUS
 447 CONCORD AVENUE, CAMBRIDGE, MASS.

SICKLES COILS
 ALL TYPES OF RF AND IF WINDINGS

Manufactured by
F. W. SICKLES COMPANY
 P. O. Box 920 Springfield, Mass.

PREPARE YOURSELF FOR A COMMERCIAL RADIO POSITION

through a Home Study Course, written for the man who has forgotten higher mathematics and who has had a non-technical education. This course qualifies you to pass the Federal Radio Telegraph and Telephone Examinations. An easily read, easily understood course. Moderate tuition fee. Write for particulars.

American Radio Institute, 1123 Broadway, N. Y.

COMMERCIAL RADIO INSTITUTE

A radio training center for over twenty years. Well equipped. Excellent faculty. Practical resident courses in Radiotelegraphy, Broadcast, Servicing, Television, Aeronautical Drafting, Mathematics, Industrial and Studio Technique. Placement bureau. Day and evening classes now forming. Send for catalog. Dept. B.
38 WEST BIDDLE STREET, BALTIMORE, MARYLAND

GOOD JOBS in RADIO
 for young men age 17 to 20

As older men leave for the army, Radio calls for high school graduates. So don't snap up just any temporary job! Train for \$150 to \$250 per month positions at school where the army has sent many men the past year. Next class starts June 22. Write for free catalog now!

THE DODGE TELEGRAPH & RADIO INSTITUTE
 408 Monroe St., Valparaiso, Indiana

LEARN RADIO • TELEVISION

60-page catalog on request. Oldest, largest and best equipped in New England. New classes now forming. Write for new catalog.

MASS. RADIO SCHOOL
 18 Boylston Street Boston, Massachusetts

Nilson's MASTER COURSE
IN RADIO COMMUNICATION



Fits you for a job, advancement or license examination. Course by A. R. Nilson for home study covers same scope as resident school course. Every Nilson graduate to date has commercial license, or a good radio job.

FREE circular 3-Q gives full information. Write today.

NILSON RADIO SCHOOL, 51 East 42nd St., New York

RADIO TECHNOLOGY



RCA Institutes offer an intensive course of high standard embracing all phases of Radio and Television. Practical training with modern equipment at New York and Chicago Schools. Also specialized courses in Aviation Communications, Radio Servicing and Commercial Operating. Illustrated Catalog on request.

RCA INSTITUTES, INC. Dept. ST-42

A Radio Corporation of America Service

75 Varick St., New York 1154 Merchandise Mart, Chicago

(Continued from page 100)

connected in parallel with the transmission line from a single antenna system without too great a reduction in signal strength.

Having provided the proper antenna system, we can now consider the problem of eliminating interference which is developed in, or picked up by, the power line and then delivered to the radio receiver through the power supply circuit of the receiver.

Most radio receivers have little or no means for filtering out or eliminating interference delivered to them by the power line. It is true that the better receivers employ transformers with static shielding between primary and secondary and some of the more expensive receivers have one or two condensers shunted across the power line, but these precautions do not solve most problems.

In Fig. 3 is shown three types of power line filters. Fig. 3-A is the simple type having two condensers with the mid-connection grounded. Such a combination can be made satisfactory if the condensers are 0.5 μ fd., having heavy leads and low internal inductance. The Underwriters Laboratories specify the use of a three-wire power cable for this high-capacity filter, one wire of which is the grounding wire. This wire terminates at a screw plug which screws into the face plate of the power socket outlet.

Fig. 3-B is a combination inductor and condenser type which is quite common. It generally employs condensers having about 0.05- μ fd. capacitance. This type of filter is not as effective as the high-capacity type, particularly in the short-wave band where the distributed capacity of the inductors permits passage of short-wave interference.

A deluxe type of filter is shown in Fig. 3-C which employs the three-wire grounding cable and two high-capacity condenser traps with a high-Q inductor in each line. The inductors are universal-wound and with their double coil connection provide low distributed capacity. Care is taken in this filter construction to reduce to a minimum any common couplings which are detrimental at high frequencies (2 to 22 Mc.).

In conclusion, the solution of the interference-reducing problem resides in the use of a properly-designed antenna having antenna-receiver couplers, a shielded transmission line and the placement of the antenna as far from the interference source as possible. For best results this antenna system should be connected to a good a.c. receiver to which is attached a well-designed power-line filter.

Strays

Among the remaining population of six rescued from Howland and Baker Islands on January 31st was Thomas W. Bederman, K6OWR/KF6. It was also revealed that KF6OQS was killed during a Japanese air raid.

Where to buy it

A directory of suppliers who carry in stock the products of these dependable manufacturers.

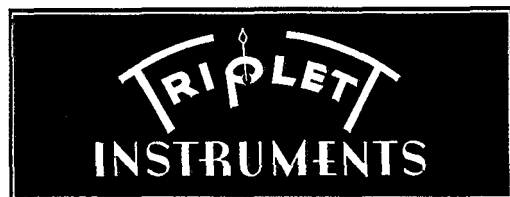

ALBANY, N. Y. Uncle Dave's Radio Shack 356 Broadway
BOMBAY, INDIA Eastern Electric & Engineering Company
BOSTON, MASS. Radio Shack 167 Washington Street
BRIDGEPORT, CONN. Hatry & Young, Inc. 177 Cannon Street
BUFFALO, N. Y. Dymac, Inc. 1531 Main Street
BUTLER, MISSOURI Henry Radio Shop 211-215 N. Main Street
CHICAGO, ILL. Allied Radio Corp. 833 W. Jackson Blvd.
CINCINNATI, OHIO United Radio, Inc. 1103 Vine Street
DETROIT, MICH. Radio Specialties Co. 325 E. Jefferson Ave.
DETROIT, MICHIGAN Radio Specialties Co. 11800 Woodward Ave.
HARTFORD, CONN. Radio Inspection Service Company 227 Asylum Street
INDIANAPOLIS, INDIANA Van Sickle Radio Supply Co. 34 West Ohio Street
KANSAS CITY, MO. Burstein-Applebee Company 1012 McGee Street
NEW HAVEN, CONN. Hatry & Young, Inc. 1172 Chapel Street
NEW YORK, N. Y. Harrison Radio Co. 112 West Broadway
READING, PENN. George D. Barbey Company 404 Walnut Street
SCRANTON, PENN. Scranton Radio & Television Supply Co. 519-21 Mulberry Street
WASHINGTON, D. C. Sun Radio & Service Supply Co. 938 F Street, N. W.
WATERBURY, CONN. Hatry & Young, Inc. 199 South Main Street

ALBANY, N. Y. Uncle Dave's Radio Shack 356 Broadway
BOSTON, MASS. Radio Shack 167 Washington Street
BRIDGEPORT, CONN. Hatry & Young, Inc. 177 Cannon Street
BUFFALO, N. Y. Dymac, Inc. 1531 Main Street
BUTLER, MISSOURI Henry Radio Shop 211-215 N. Main Street
CHICAGO, ILLINOIS Allied Radio Corp. 833 W. Jackson Blvd.
CINCINNATI, OHIO United Radio, Inc. 1103 Vine Street
HARTFORD, CONN. Hatry & Young, Inc. 203 Ann Street
MINNEAPOLIS, MINNESOTA Lew Bonn Company 1211 LaSalle Avenue
NEW HAVEN, CONN. Hatry & Young, Inc. 1172 Chapel Street
READING, PENN. George D. Barbey Company 404 Walnut Street
WASHINGTON, D. C. Sun Radio & Service Supply Co. 938 F Street, N. W.

Listings on this page do not necessarily imply endorsement by QST of the dealers or of other equipment sold by them.

NEED PARTS IN A HURRY?

Manufacturers—
Gov't Agencies—
Laboratories—
Commercials—
Schools, etc.—

call **HARRISON** first

for your emergency pick-ups and limited production requirements. Our enormous stock and "all-out" service will help you to "Beat the Promise!"

**HARRISON
RADIO CO.**

Factory Distributor for All
Leading Radio Manufacturers

12 West Broadway · New York City
Phone WOrth 2-6276

Strays

Those who like their light reading flavored with crime will be interested in the novel "For Murder Will Speak," by J. J. Connington (published by Hodder & Stoughton). It is unusual to find a reference to amateur radio in fiction, and here it not only plays quite a prominent part but, also, happily, is described very accurately. In the book, Jim Telford, GM3EB, is Suspect No. 1 and his alibi is a QSO with another amateur. It would spoil another's reading to say whether we have a murderer in our ranks!

Those who like mystery novels will find this a very well thought-out novel with the added attractions of amateur radio included. The way in which our hobby is described is so well done that the writer wonders whether the author is himself an amateur.

— *The T. & R. Bulletin*

Ham: "Statistics show that radio amateurs seldom commit suicide."

Sam: "How about their neighbors?" — *The (N. C.) Arc*.

Just to prove that the ham bands are not entirely dead, W3JAK sends in the following list of Cubans heard on 7 Mc.: 2AS, 2BN, 2BP, 2BU, 2CE, 2DB, 2DO, 2DR, 2FC, 2HL, 2JP, 2PP, 2SF, 5AJ, 5FL, 6BA, 6DP, 7AU, 7CX, 8AD, 8AZ, 8BB, 8BN, 8MP, 8NS. HH3DNC is also reported.

Crown Point, Ind., a town of about 5000, should be known for something besides its marrying JP's and the John Dillinger escape. It has also supplied more than its share of operators for the commercial services. W9BYL, W9CNY, W9DHJ, W9OZR, W9TCD, W9WDS and myself are all commercial ops. — *W9NZZ*.

\$

IMMEDIATE CASH

for your—

RECEIVER · TRANSMITTER
TEST EQUIPMENT
METERS · TUBES
PARTS
ETC.

Send us a complete description of your equipment. Mention make, model, age, condition, "improvements," etc. If you have an approximate price in mind, state it. We will make a fair cash offer by return mail.

Hit 'em **TWO** ways—

- 1—Put your idle apparatus to work, for Victory!
- 2—Buy Victory Bonds with the cash we give you!

Send in your list today!

**HARRISON
RADIO CO.**

12 West Broadway · New York City

\$



How true! Shot by W4GQM.

Last Month

we advised through *QST* thousands of amateurs now employed in national defense projects, in industry, in laboratories, and by the government, that, as ever before, we were solidly behind them in their new capacity —

THAT WE WOULD DELIVER THE GOODS

As a result of this notice, seventy orders from manufacturers, schools, laboratories, and government agencies were received and prompt shipment was made. We, of course, are extremely happy in being able to supply much needed equipment, possibly breaking a small bottleneck somewhere along the path to ultimate Victory. As ever, the amateur proves his alertness and capacity in an emergency.



*A huge stock still exists here and we
again invite inquiries and orders from
all in the national defense program*

The **RADIO SHACK CORPORATION**

167 Washington Street, Boston, Massachusetts

**YOU AIN'T DONE NOTHIN', PAL- THE
OLD MAN JUST WANTS TO BORROW
YOUR ECHOPHONE EC-1!**

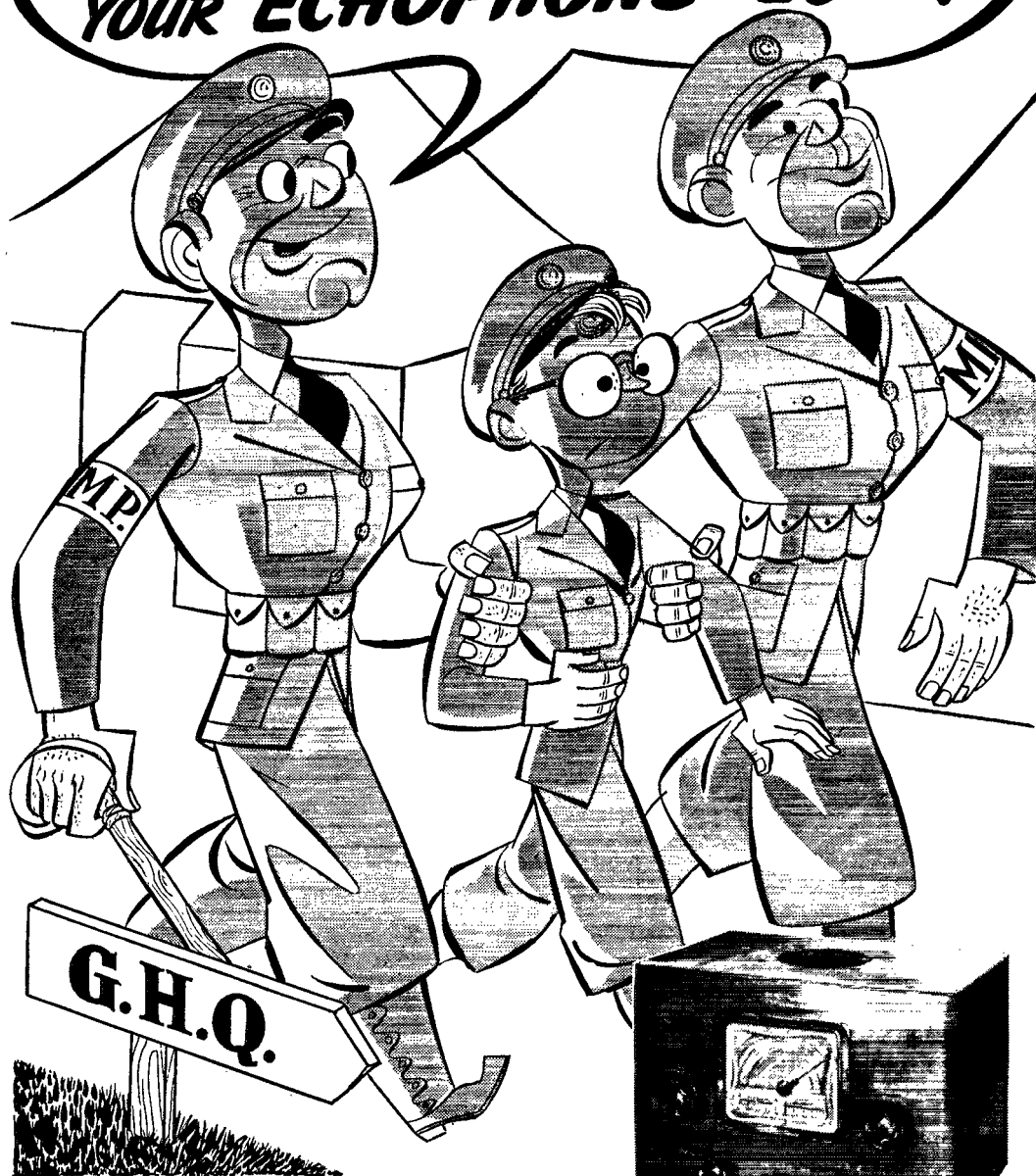

Echophone Model EC-1

6 tubes, 3 bands. Tunes from 550 kc. to 30 mc. Beat frequency oscillator. Bandsread logging scale. Self-contained speaker. Electrical bandsread on all bands. AC/DC. 115-125 volts.
ECHOPHONE RADIO CO., 201 EAST 26TH ST., CHICAGO, ILLINOIS

\$2450

HAM-ADS

(1) Advertising shall pertain to radio and shall be of nature of interest to radio amateurs or experimenters in their pursuit of the art.

(2) No display of any character will be accepted, nor can any special typographical arrangement, such as all or part capital letters be used which would tend to make one advertisement stand out from the others.

(3) The Ham-Ad rate is 15¢ per word, except as noted in paragraph (6) below.

(4) Remittance in full must accompany copy. No cash or contract discount or agency commission will be allowed.

(5) Closing date for Ham-Ads is the 25th of the second month preceding publication date.

(6) A special rate of 7¢ per word will apply to advertising which, in our judgment, is obviously non-commercial in nature and is placed and signed by a member of the American Radio Relay League. Thus, advertising of bona fide surplus equipment owned, used and for sale by an individual or apparatus offered for exchange or advertising inquiring for special equipment, if by a member of the American Radio Relay League takes the 7¢ rate. An attempt to deal in apparatus in quantity for profit, even if by an individual, is commercial and all advertising by him takes the 15¢ rate. Provisions of paragraphs (1), (2), (4) and (5) apply to all advertising in this column regardless of which rate may apply.

Having made no investigation of the advertisers in the classified columns, the publishers of *QST* are unable to vouch for their integrity or for the grade or character of the products advertised

* * * * *

Gear is short. You can sell your old and extra gear through Ham-Ads.

* * * * *

QUARTZ — direct importers from Brazil of best quality pure quartz suitable for making piezo-electric crystals.

Diamond Drill Carbon Co., 719 World Bldg., New York City.

COMMERCIAL radio operators examination questions and answers. One dollar per element. G. C. Waller, W5ATV, 6540 Washington Blvd., Tulsa, Okla.

TELEPLEXES, Instructographs bought, sold. Ryan's, Hannibal, Mo.

AVAILABLE communications receivers wanted. Sell your receiver for cash. In writing specify date of purchase, if with crystal, model number, serial number, if speaker is in cabinet or not, if speaker is factory unit, color, your opinion of condition. Oscillographs wanted. Volt-ohmmeters wanted. Be complete. If you have a price in mind, please state it. Prompt reply. Hatry and Young, Hartford, Conn.

RADIO headquarters — tremendously large stock of receivers (over 200 on hand), transmitters — all sizes, transceivers — over five different models, radio parts of all kinds. Write to Leo, W9GFQ, for that big bargain catalog and reconditioned receiver list today. Wholesale Radio Laboratories, Council Bluffs, Iowa.

OLD QSTs. Buy 1915/25. Sell — trade 1920/41. W6SN.

WANTED: radio operators for Merchant, Marine, must have commercial license, wages \$200 to \$325 monthly. Radio Officers' Union, 265 West 14th St., New York, N. Y.

QSL'S. SWL's. Theodore Porcher, 7708 Navajo, Philadelphia.

TRADE Supreme model 535 2 inch oscilloscope and N.R.I model 1175A combination multimeter, plug-cable analyzer, and signal generator for factory made transmitter. Edward Koch, Signal Office, Camp Grant, Ill.

WANTED — Radio test gear. Communications receiver. Power tools. Late models. Jensen, 1220 Forest, Oak Park, Ill.

DB-20 wanted in trade for Abbott MRT-3 with tubes, a.c. and 6 volt supplies. W1NSS, B-11 Kirkland, Cambridge, Mass.

SELL Hallcrafters SX23 receiver. Prepaid \$60. Works, looks excellent. W6DTX, 6537 Brynburst, Los Angeles, Calif.

EARLY QST file for sale. Fairly complete from first issue to 1935. Robert Kruse, East River, Conn.

WANTED: June 1925 Radio News. P. Delaup, Lafayette, La.

WANTED: Eastman EE projector and good candid camera for good xmtr, recvr parts. Stamp for list. W9OFZ, 1242 E. 46 St., Chicago.

WANTED: a used Candler Code Course. Quote price for entire course only. William Muir, Stonington, Me.

SELL, in interest of national defense effort, commercial H.D. type components for high power xmtr's or complete units. UTC, Thordarson, Eimac, Dunco, Weston, Triplett, etc. Perfect condition, little used. No junk. Box 703, Enid, Okla.

FOR sale from estate of W2BLV — Hammarlund HQ-120 receiver and Utah 450-watt phone and c.w. transmitter, all in perfect condition. Write Morris N. Scharf, Attorney, Ramsey, N. J., or phone Ramsey 600.

WILL pay cash for factory built phone 50 watts or less transmitter. Want good communications receiver. Curtis, Longview, Texas.

FOR sale — trade — new 861, other tubes, transformers and radio parts; wanted — bench type milling machine and machinist tools. Ralph Gibbons, W7KV, Troutdale, Ore.

SWL'S — **QSL's** — Stationery. Samples? W8DED, Holland, Mich.

TRADE late model Motorola golden voice car radio for ECO. Ed Gillespie, 405 Church, Jefferson City, Mo.

WANTED: Good HRO, pay cash or trade. Eidson's, Temple, Texas.

SELL Skyrider Marine, S22, T-1. 3 months in use. Fishl, 244 W. 106 St., N. Y. C.

RADIO headquarters. Large stock of receivers, transmitters, transceivers, code teaching equipment, Vibroplexes, radio supplies of all sorts. Code machines rented. Your inquiries and orders invited. Henry Radio Shop, Butler, Mo., or 2335 Westwood Blvd., W. Los Angeles, Calif.

RECONDITIONED guaranteed communications receivers and transmitters and equipment. All makes and models cheap. Free trial. List free. Henry Radio Shop, Butler, Mo.

WANTED: Used SX28s and other used receivers. Send information and cash price wanted. Also want Biley 80C-100 crystal units and audio oscillators. Bob Henry, Butler, Mo.

CRYSTALS: police, aircraft, defense, marine, etc. Eidson low drift commercial crystal units meet FCC requirements and satisfaction is guaranteed. Good advice: Anticipate your needs and order early, regardless of your supplier. Eidson's, Temple, Texas (Phone 3901).

FOR sale bst ofr. Hallcrafters HT9 10, 20, 80, coils, tubes, 5 Biley xtals, relay, D104 & stand. SX-28 and SX 8" spkr. RCA auto. record changer in cabinet. W6SPQ, 5537 La Mirada, Hollywood, Calif.

TRANSMITTER 6L6 xtal RK20A, Samson Pam 19 speech, power packs, all on chassis, less xtal and xtal mike \$50, PP852s in cabinet 2 meters complete \$30, W.E. 212D and socket \$5, new Rectobulb \$2, 500-ohm to grid Kenyon transformers type KLG4, pole transformer 1100, 2200, 3300, 4400 v. \$12, Thordarson fil. bridging transformer, other equipment. Write me. W8UN, 623 South St., Findlay, Ohio.

WANT new or used 828 804 and RK20A tubes, broadcast mica capacitors, also contact lens. Mims Radio Co., Box 504, Texarkana, Texas.

WANTED: Par-Metal rack No. RR195. W1JVE.

ABBOTT DK-3 new transceiver antenna tubes twelve bucks. W8CVU.

WANTED, old wireless equipment such as loose-couplers, spark gaps, transformers, detectors, etc. Must be in good condition. Gallery, 4424 Montgomery Ave., Bethesda, Md.

"The American Radio Relay League — and What It Means to You"

is the title of a new little booklet which we will be glad to mail free on request. Designed to tell prospective members what they should know about the League, it will be likewise interesting and informative to members.

The American Radio Relay League
West Hartford, Connecticut

THE 1942 RADIO AMATEUR'S HANDBOOK

"the all-purpose volume on radio"

Text, data book, operating manual—it is all these and more. As a text it is probably more used in radio schools and colleges than any other single volume. As a practical constructional handbook, it stands in a class alone. As an operating manual, it provides information available from no comparable source.

REGULAR EDITION

IN BUILDING THE 1942 EDITION the ARRL Headquarters staff designed a new, non-mathematical, simple yet thorough treatment of fundamentals to make the **HANDBOOK** even more useful. Stripped to essentials, the new theory and design sections cover every subject encountered in practical radio communication, sectionalized by topics with abundant cross-referencing and fully in-

dexed. The new **HANDBOOK** is an ideal reference work. All this was achieved without sacrificing any of the constructional information on tested and proved gear which has always been the outstanding feature of the **HANDBOOK**. In fact, the constructional chapters are given more space and contain more new designs in this edition than ever before.

\$1 postpaid in Continental U. S. A.

\$1.50 postpaid elsewhere

Buckram Bound, \$2.50

SPECIAL DEFENSE EDITION

Announced last month, this new edition of the Handbook is designed especially for use in radio training courses. It eliminates those portions of the regular edition which are not useful for instruction purposes and has added chapters on mathematics, measuring equipment and code instruction. Brand new is the first chapter covering the elementary mathematics necessary for the solution of all formulas and interpretation of graphs appearing throughout the text. This includes a review of decimals, method of extracting square root, algebraic notation and manipulation of formulas, laws of exponents, logarithms, a discussion of linear, power and exponential functions and their application to graphs, and the use of polar coordinates. Supplementing this chapter, a four-place log table is included in the Appendix.

The constructional chapters of the regular edition have been condensed into one new chapter in which representative types of radio equipment are featured. Data on and photographs of the more generally used commercial receivers and transmitters are included, along with selected equipment described in the regular edition. Similar treatment has been given the chapter on measurements. There is a new chapter on learning the radio telegraphic code. Its treatment is based on up-to-date methods of learning by hearing, and is believed unique in its handling of the subject. It can be used either for self-instruction or for the guidance of those interested in giving code classes, for whom suggestions for the construction of special code-instruction tables for large groups are included.

\$1 postpaid anywhere

AMERICAN RADIO RELAY LEAGUE, INC.

West Hartford, Connecticut, U. S. A.

Your Nearby Dealer Is Your Best Friend

Your nearby dealer is entitled to your patronage. He is equipped with a knowledge and understanding of amateur radio. He is your logical source of advice and counsel on what equipment you should buy. His stock is complete. He can supply your needs without delay. His prices are fair and consistent with the high quality of the goods he carries. He is responsible to you and interested in you.

One of these dealers is probably in your city — Patronize him!

BALTIMORE, MARYLAND

Radio Electric Service Co.
3 N. Howard St.
Everything for the Amateur

NEW YORK, N. Y.

Harrison Radio Company
12 West Broadway
Harrison Has It! Phone WO 2-6276 for information or rush service

BUFFALO, NEW YORK

Radio Equipment Corp.
326 Elm Street
W8PMC and W8NEL — Ham service and sound equipment

PHILADELPHIA, PENNSYLVANIA

Eugene G. Wile
10 S. Tenth Street
Complete Stock of Quality Merchandise

BUFFALO, NEW YORK

Dymac, Inc.
1531 Main Street — Cor. Ferry — GA. 0252
One of the Largest Ham Supply Houses in Western New York

PROVIDENCE, RHODE ISLAND

W. H. Edwards Company
85 Broadway
National, Hammarlund, Hallicrafter, Thordarson, Taylor, RCA

HARTFORD, CONNECTICUT

Radio Inspection Service Company
227 Asylum Street
What do you want? We have it. Radio exclusively

SCRANTON, PENNSYLVANIA

Scranton Radio & Television Supply Co.
519-521 Mulberry Street
Complete Stock of Quality Amateur Supplies

HARTFORD, CONNECTICUT

Hatry & Young, Inc.
203 Ann Street
Stores also in Bridgeport and New Haven

WATERBURY, CONNECTICUT

Hatry & Young, Inc.
199 South Main Street
Time Payments for Connecticut Hams

YOU CAN BE SURE
WHEN YOU BUY FROM

QST

ADVERTISERS

“Advertising for *QST* is accepted only from firms who, in the publisher’s opinion, are of established integrity and whose products secure the approval of the technical staff of the American Radio Relay League.”

Quoted from QST’s advertising rate card.

Every conceivable need of a radio amateur can be supplied by the advertisers in QST. And you will know the product has the approval of the League’s technical staff

Index to Advertisers

	PAGE
Abbott Instrument, Inc.	87
Aerovox Corporation	97
American Lava Corporation	77
American Radio Institute	102
Amperex Electronic Products, Inc.	Cov. II
Astatic Corporation, The	97
Ayers, N. C.	98
Biley Electric Company	70
Candler System Company	94
Capitol Radio Engineering Institute	72
Centralab	91
Clarostat Mfg. Company	101
Commercial Radio Institute	102
Daven Company, The	90
Dodge Tele. & Radio Institute, The	102
Echophone Radio Company	106
Eitel-McCullough, Inc.	75
Farnsworth Television & Radio Corp.	73
Gardiner-Levering Company	97
Hallicrafters Company, The	1, 2
Hammarlund Mfg. Company, Inc.	69, 71
Harrison Radio Company	104
Harvey Radio Company	92
Harvey Radio Laboratories, Inc.	102
Henry Radio Shop	99
Hipower Crystal Company	99
Instructograph Company	99
Isolantite, Inc.	81
Jensen Radio Mfg. Company	95
Kenyon Transformer Company, Inc.	99
Mallory & Company, Inc., P. R.	68
Massachusetts Radio School	102
McGraw-Hill Book Company, Inc.	74, 90
Meissner Mfg. Company	76
Millen Mfg. Company, Inc., James	94
National Company, Inc.	Cov. III, 67
Newark Electric Company	98
Nilson Radio School	97, 102
Ohmite Mfg. Company	78
Petersen Radio Company	86
Port Arthur College	86
RCA Institutes, Inc.	102
RCA Manufacturing Company, Inc.	Cov. IV
Radio Control Headquarters, Inc.	86
Radio Shack, The	105
Shure Brothers	80
Sickles Company, F. W.	102
Signal Electric Mfg. Company	101
Solar Mfg. Corporation	86
Sprague Specialties Company	79
Standard Radio Parts Company	100
Sun Radio Company	100
Taylor Tubes, Inc.	93
Teleplex Company	98
Terminal Radio Corp.	96
Thordarson Electric Mfg. Company	112
Triplett Elec. Instr. Company, The	111
United Transformer Company	5
Wholesale Radio Laboratories	104
Waxley	68
Zenith Radio Corporation	82, 83

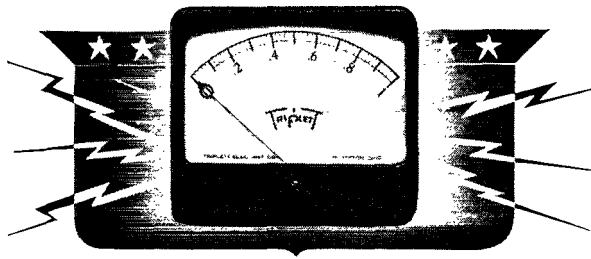

"THERE IS A BRIGHT SIDE"

An Open Letter to Users of Electrical Measuring Instruments

Much more than instruments is needed to fill the vast requirements of America's gigantic production program. Experience gained by many years of actual instrument manufacturing is vital. Triplett's broad experience in filling peace-time needs is answering the call to arms — is doing its part in re-establishing in the world the Democratic ideals of freedom.

Private business must undergo restrictions for the sake of National security. As good Americans we will bear these willingly.

And there is a bright side. Rapid expansion, new fields and improved processes mark today's instrument program. New developments unbelievably revolutionary in their scope are growing out of the vast proving ground of war-time production. When war ends, these advantages will be passed on to all of you. From the experience of today will come many new and greatly improved instruments to better serve the peaceful world of tomorrow.

N. A. Triplett
Sales Manager

THE TRIPLETT ELECTRICAL INSTRUMENT CO.

FOR DEFENSE



**BUY
UNITED
STATES
SAVINGS
BONDS
AND STAMPS**

We Can All Help . . .

Buy Defense Stamps and Bonds. Buying them regularly is the best way you can help General MacArthur and our fighting men. We must all pull together now, and your dollars can best serve in stamps and bonds.

THE TRIPLETT ELECTRICAL INSTRUMENT CO.

BLUFFTON, OHIO

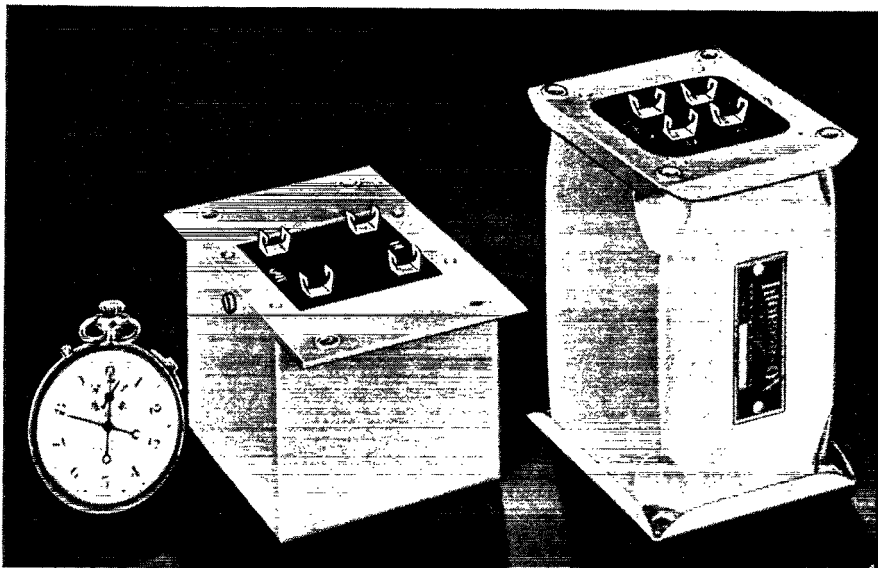

Wave FILTERS

THORDARSON laboratories have been active in the design and manufacture of wave filters since engineering practice first prescribed their use. These laboratories have developed filters with unusually sharp cutoff characteristics. THORDARSON wave filters are outstanding in the following characteristics:

1. Low insertion loss in the pass band.
2. Stable performance.
3. Minimum cubic size.
4. Sharp cutoff.

A typical example of unusual performance is illustrated by the curve of stock type T-4E05 shown below. Sharp cutoff at 7500 c.p.s. +10 db maximum level.

For use on 500-600 ohm line.

Dimensions: 3" x 4 1/2" x 2 3/4".

Weight 2 3/4 lbs.

Confer with us on all of your filter problems.

THORDARSON

ELECTRIC MFG. CO.

500 WEST HURON STREET, CHICAGO

TRANSFORMER SPECIALISTS
SINCE 1895

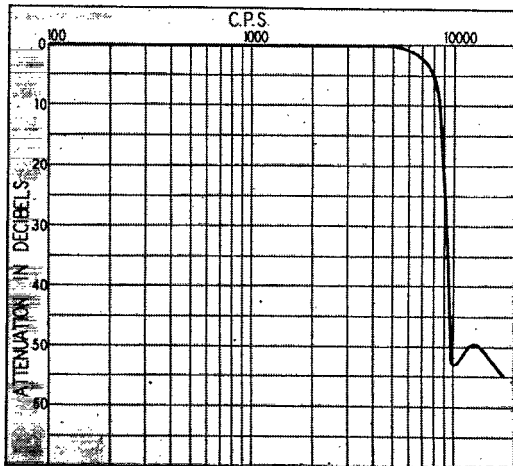



The HRO gives superb unfaltering service, 24 hours a day, week in and week out, year after year. It's a receiver to depend on.

NATIONAL COMPANY, INC., MALDEN, MASS.

DOUBLE THE LIFE OF HARD-TO-GET TUNGSTEN-FILAMENT TUBES

**5% LESS VOLTAGE..
100% LONGER LIFE!**

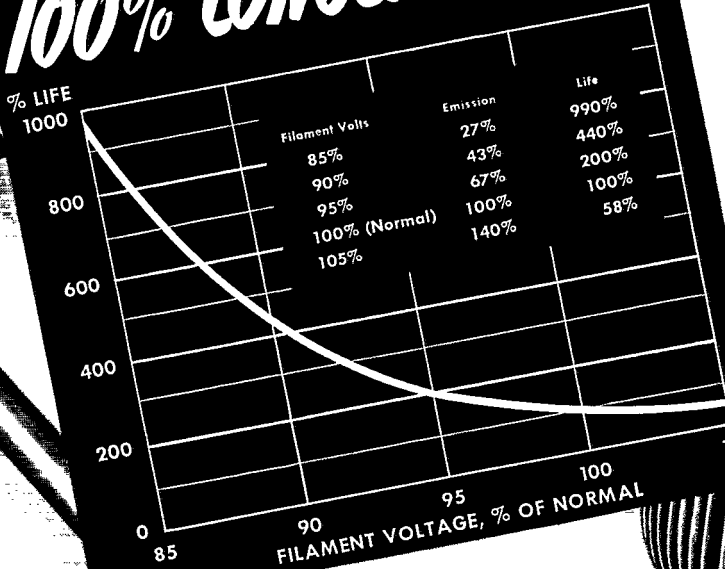

The Radiotron Designer's Handbook

Edited by F. Langford Smith especially for the radio set designer, this book (now in its Third Edition) is equally valuable to others interested in the fundamental principles of practical radio circuit design. Chapters cover Audio Frequencies; Tests and Measurements; Valve Characteristics; General Theory, etc. Contains 356 pages, with many illustrations, numerous reference charts, tables, and other data. Send your remittance to RCA Manufacturing Company, Harrison, N.J. Price \$1.00 postpaid.

The accompanying chart showing how the life expectancy of pure-tungsten-filament tubes increases by leaps and bounds as filament voltage is reduced, serves as a convincing illustration of how simple precautionary measures can often add thousands of hours of life to tubes already in use. In tungsten-filament tubes, reduction of only 5% in the filament voltage doubles tube life. A reduction of 15% increases it almost tenfold!

Obviously, a 15% filament-voltage reduction with its resultant decrease of 73% in tube emission would hardly be feasible in most applications. On the other hand, a less drastic reduction might. Admitting that maximum signal quality is important to a broadcast station, it is well to recognize that these are days when circumstances might well alter cases. In many instances, it may prove highly advisable to adjust station operation conditions closer to

the maximum permissible distortion in order to operate tungsten-filament tubes at the lowest possible filament voltage and thus add materially to the life of units which may be difficult to replace.

It is an old story that RCA Transmitting Tubes are built to withstand plenty of abuse—so much so, that abnormal operating conditions are frequently accepted as "normal." Even though tube life has been entirely satisfactory under such conditions, it is by no means as long as might be obtained, simply by operating the tubes as conservatively as possible, and in accordance with the information given in the Instruction Booklet packed with each one. Not only does conservatism in the use of tubes mean the saving of essential war materials, but it may well be a station's assurance of staying "on the air" at a time when the civilian supply of new tubes has been drastically reduced.



Transmitting Tubes

PROVED IN COMMUNICATION'S MOST EXACTING SERVICES

RCA MANUFACTURING CO., INC., CAMDEN, N. J. • A Service of The Radio Corporation of America

In Canada: RCA VICTOR COMPANY LIMITED, MONTREAL

