

QST

September, 1941

25 cents

35c in Canada

devoted entirely to

amateur radio



In This Issue—Getting Set for the New Regulations

At 60 megacycles 500 watts plate power output can be obtained from the Amperex HF-300. This tube, together with the HF-200 and HF-100, were developed by Amperex a number of years ago primarily for physiotherapy apparatus in which tubes capable of handling abnormally high currents at ultra high frequencies and at reasonably low voltage were required and none at the time available.

So universal was the recognition of the merits and efficiency of these tubes that now more than 70% of all diathermy ultra short wave generators are equipped with Amperex tubes and thousands more are in operation in almost every country in the world in broadcast, communication, amateur and industrial apparatus where they have replaced more costly or less efficient tubes.

Some of the design features which are responsible for the remarkable efficiency of these tubes at ultra high frequencies are as follows:
 A high mu in combination with a high transconductance reducing requirements for grid excitation and grid power loss to a minimum.
 Long insulation paths between electrodes, permitting the safe application of high voltages and reducing dielectric losses.
 Extremely low interelectrode capacitances reduce the magnitude of circulating R.F. currents and permit more efficient circuit design.

- Large heat radiating area at plate terminal
 - One insulating spacer between grid and filament only
 - Large area plate leads
 - Anode of graphite. The perfect heat radiating material
 - Standard 50 watt base
 - Long insulation path, grid to plate
 - Large heat radiating area at grid terminal
 - Long insulation path, grid to filament
- Transit time power losses are reduced to a minimum in the AMPEREX high Gm planar filament structure without sacrificing the decided advantage of extremely low interelectrode capacitance.

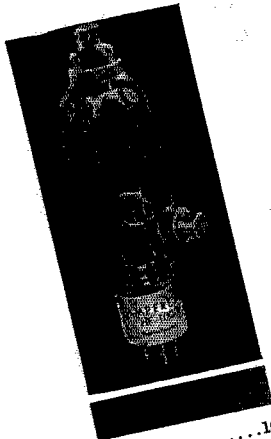
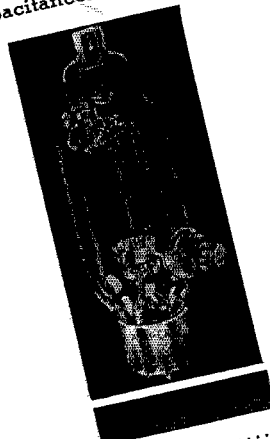
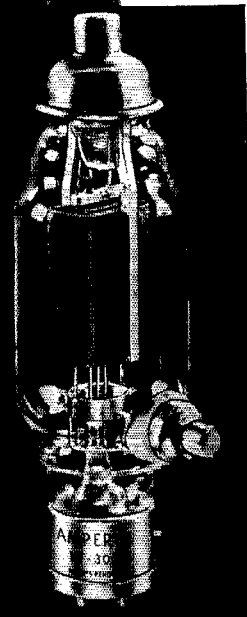
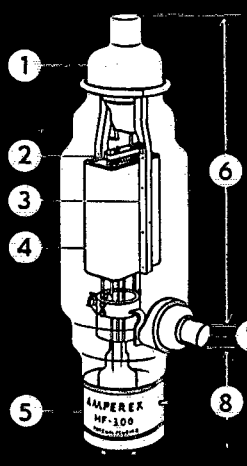

Filament voltage	10-11 volts
Filament current	3.4 amperes
Grid to plate	5.8 mmf.
Grid to filament	5.2 mmf.
Plate to filament	1.2 mmf.
Amplification constant	5000 micromhos
Plate dissipation	180 watts
Plate power output	350 watts

Filament voltage	10-10.5 volts
Filament current	2 amperes
Grid to plate	4.5 mmf.
Grid to filament	3.8 mmf.
Plate to filament	1.4 mmf.
Mutual conductance at 150 ma.	4200 micromhos
Amplification constant	75
Plate dissipation	170 w
Plate power output	

\$24.50

\$12.

**the 1941
SUPER**

Skyrider

GIVES YOU ALL THESE FEATURES

15 tubes. Two stages preselection. Calibrated bandspread inertia controlled. Micrometer scale tuning inertia controlled. Tone and AC on off. Beat frequency oscillator. AF gain. RF gain. Crystal phasing. Adjustable noise limiter. Send-receive switch. AVC-BFO switch. Bass boost switch. Phono. jack. 80/40/-20/10 meter amateur bands calibrated. Wide angle "S" meter. Band pass audio filter. Improved signal to image and noise ratio. Push-pull high fidelity audio output. Six-step wide range variable selectivity. Improved headphone output.

★ ★ ★

*The 1941
SUPER SKYRIDER
Model SX-2B \$179.50*

★ ★ ★



the hallicrafters co.
CHICAGO, U. S. A.

**USED BY 33 GOVERNMENTS
SOLD IN 89 COUNTRIES**

the 1942

Skyrider 32

IS SETTING A NEW HIGH IN COMMUNICATIONS VALUE!

Hallicrafters new Skeyrider 32 offers excellent value and quality performance. 13 tubes. 6 bands. Tunes from 500 kc. to 40 mc. 2 RF stages on bands 3, 4, 5 and 6. Push-pull high fidelity audio output. 6 step wide range variable selectivity. 80/40/20/10 meter amateur bands calibrated. Wide Angle "S" meter. Temperature compensated high frequency oscillator. Calibrated bandspread inertia controlled.

The 1941 Sky Champion

One of the best values ever offered in the communications field! 9 tubes. 4 bands. Tunes from 545 kc. to 44 mc. Automatic noise limiter. AVC switch. Standby switch. Inertia bandspread tuning. Separate electrical bandspread. Beat frequency oscillator. Battery-Vibrapack. DC operation socket.

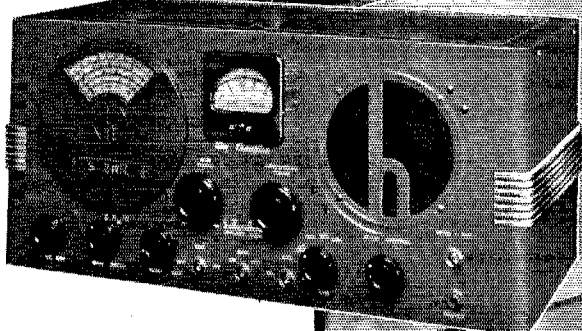
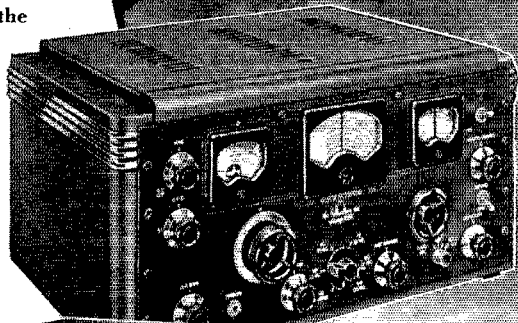

* * *

***The SKYRIDER 32 with
Crystal and Tubes \$149.50***

* * *

***The SKY CHAMPION with
Tubes \$54.50***

* * *

the hallicrafters co.
CHICAGO, U. S. A.

USED BY 33 GOVERNMENTS • SOLD IN 89 COUNTRIES

SEPTEMBER 1941

VOLUME XXV

NUMBER 9



STAFF

Editorial

KENNETH B. WARNER, W1HQ
Editor and Business Manager

CLARK C. RODIMON, W1BZ
Managing Editor

GEORGE GRAMMER, W1DF
Technical Editor

DONALD H. MIX, W1TS
BYRON GOODMAN, W1JPE
Assistant Technical Editors

EDWARD P. TILTON, W1HDQ
Contributing Editor, U.H.F.

VERNON CHAMBERS, W1JEQ
Technical Information Service

JAMES J. LAMB, W1AL
Research Engineer, A.R.R.L.

Advertising

F. CHEYNEY BEEKLEY, W1GN
Advertising Manager

Circulation

DAVID H. HOUGHTON
Circulation Manager

RALPH T. BEAUDIN, W1BAW
Asst. Circulation Manager



OFFICES

38 La Salle Road
West Hartford, Connecticut

Subscription rate in United States and Possessions, \$2.50 per year, postpaid; all other countries, \$3.00 per year, postpaid. Single copies, 25 cents. Foreign remittances should be by international postal or express money order or bank draft negotiable in the U. S. and for an equivalent amount in U. S. funds.

Entered as second-class matter May 29, 1919, at the post office at Hartford, Connecticut, under the Act of March 3, 1879. Acceptance for mailing at special rate of postage provided for in section 1103, Act of October 3, 1917, authorized September 9, 1922. Additional entry at Concord, N. H., authorized February 21, 1929, under the Act of February 28, 1925. Additional second-class entries to cover sectional editions authorized March 20, 1935.

Copyright 1941 by the American Radio Relay League, Inc. Title registered at United States Patent Office.

QST

devoted entirely to

AMATEUR RADIO

PUBLISHED, MONTHLY, AS ITS OFFICIAL ORGAN, BY THE AMERICAN RADIO RELAY LEAGUE, INC., AT WEST HARTFORD, CONN., U. S. A.; OFFICIAL ORGAN OF THE INTERNATIONAL AMATEUR RADIO UNION



CONTENTS

Editorials	7
Handle Your Traffic on 160! George Grammer, W1DF	11
Radio at the National Model Airplane Meet Clinton B. DeSoto, W1CDB	15
The New Miniature U.H.F. Receiving Tubes in a 56- and 112-Mc. Converter George Grammer, W1DF	18
Five-Meter Wave Paths. Part II Melvin S. Wilson, W1DEI	23
Ham Haven Dot Beardsley, W4DEN	28
Connecticut State Convention	29
Maj. General J. O. Mauborgne Says	29
What the League Is Doing	30
Vermont State Convention	31
Southwestern Division Convention	31
For the Junior Constructor A 50-, 100- and 1000-kc. Oscillator for Band-Edge Spotting	32
The Secrets of Good Sending. Part I E. L. Battey, W1UE	35
Antennas for Domestic Work Don Mix, W1TS	38
U. S. A. Calling	43
P. O. W.	43
In the Services	44
"Frequency-Halving" Oscillators Byron Goodman, W1JPE and Hal Bubb, W1JTD	46
Code Proficiency Frolic	48
Got Your Proficiency Award?	49
WIAW Practice Subjects and Qualifying Runs	49
On the Ultra Highs E. P. Tilton, W1HDQ	50
In QST 25 Years Ago	53
Silent Keys	53
Results, 1.75/28-Mc. W.A.S. Parties J. A. Moskey, W1JMY	54
A.A.R.S. Activities	56
WWV Schedules	57
Would You Believe It?	57
Hints and Kinks Adapting the 6L6 "Grid-Plate" Oscillator — Repunching Socket Holes — Audio Attenuator for NC100 and 101 Re- ceivers — Treatment for B.C.I. — Higher Voltage from Pole Transformers — Kink for Superhet Receivers — Another Single-Switch Control System — Code-Practice Oscillator and Keying Monitor	58
Correspondence from Members	61
Operating News	62
The Month in Canada	66
Station Activities	88
New Transmitting Tubes	90
New Receiving Tubes	100
West Gulf Division Convention	102
Hamads	107
QST's Index of Advertisers	110

Section Communications Managers of the A.R.R.L. Communications Department

All appointments in the League's field organization are made by the proper S.C.M., elected by members in each Section listed. Mail your S.C.M. (on the 16th of each month) a postal covering your radio activities for the previous 30 days. Tell him your DX, plans for experimenting, results in 'phone and traffic. He is interested, whether you are an A.R.R.L. member or get your QST at the newsstands; he wants a report from every active ham. If interested and qualified for O.R.S., O.P.S. or other appointments he can tell you about them, too.

ATLANTIC DIVISION				
Eastern Pennsylvania Maryland-Delaware-District of Columbia Southern New Jersey Western New York Western Pennsylvania	W3BES W3CIZ W3CCO W8PLA W8CKO	Jerry Mathia Hermann E. Hobbs Lester H. Allen Fred Chichester E. A. Krall	6042 Master St. 9701 Monroe St. Silver Spring P. O. 704 Quinton Ave. 703 Broadway	Philadelphia Linden, Maryland Trenton Sonyea East McKeesport
CENTRAL DIVISION				
Illinois Indiana Kentucky Michigan Ohio Wisconsin	W011H W9AB W9ARU W8DPE W8AQ W9UIT	Mrs. Carrie Jones Harry B. Miller Darrell A. Downard Harold C. Bird E. H. Gibbs Aldrich C. Krones	2407 Central Ave. 729 E. Lowell Ave. 116 N. Longworth Ave. R.F.D. 2 405 Broad St. 2702 So. 46th St.	Alton Milawaka Louisville Pontiac Wadsworth Milwaukee
DAKOTA DIVISION				
North Dakota South Dakota Northern Minnesota Southern Minnesota	W9RPI W9ADI W9FUZ W9YNG	Don Beaudine E. C. Mohler Armond D. Brattland Millard L. Bender	512 14th St., S. Box 149 Birchmont Rd. 608 N. Huron Ave.	Fargo Rapid City Bemidji Spring Valley
DELTA DIVISION				
Arkansas Louisiana Mississippi Tennessee	W5GNY W5DWW W5EGE W4DDJ	John R. Sanders W. J. Wilkinson, Jr. S. Benton Cain M. G. Hooper	P. O. Box 1563 Room 313, Jefferson Hotel 221 E. Monticello 4908 Georgia Ave.	Little Rock Shreveport Brookhaven Nashville
HUDSON DIVISION				
Eastern New York N. Y. C. & Long Island Northern New Jersey	W2LIJ W2AZV W2LMN	Robert E. Haight E. L. Bainach Edward Gursky, Jr.	511 South Holmes St. 102 Central Ave. 367 Van Winkle Ave.	Scotia Massapequa, L. I. Hasthorne
MIDWEST DIVISION				
Iowa Kansas Missouri Nebraska	W9CTO W9AWP W9OUD W9WKP	Ray L. Martin A. B. Unruh Miss Letha Allendorf Garold Bennett	209 Leffler St. 1617 S. Seneca St. 1015 West 3rd St. 914 West 7th St.	West Burlington Whitita Joplin Hastings
NEW ENGLAND DIVISION				
Connecticut Maine Eastern Massachusetts Western Massachusetts New Hampshire Rhode Island Vermont	W1CTI W1BAV W1ALP W1JAH W1FTI W1HRC W1KIG	Frederick Ellis, Jr. Ames K. Millett, Frank L. Baker, Jr. William J. Barrett Mrs. Dorothy W. Evans Clayton C. Gordon Clifton G. Parker	19 Merrill Rd. 37 Morning St. 91 Atlantic St. 239 Columbia St. 163 South Main St. 70 Columbia Ave., Gaspee Box 537	Norwalk Portland North Quincy Adams Concord Plateau, Warwick Morrisville
NORTHWESTERN DIVISION				
Alaska Idaho Montana Oregon Washington	K7GNN W7CRL W7CPI W7GNJ W7EPB	James G. Sherry Clifford A. Jessup Rex Roberts Carl Austin Carl F. Hofmann	Post Office Dept. Box 1088 1137 Federal 4413 East E St.	Chichagof Moscow Glendive Bend Tacoma
PACIFIC DIVISION				
Hawaii Nevada Santa Clara Valley East Bay San Francisco Sacramento Valley Philippines San Joaquin Valley *	K6ETF W6BHC W6IUC W6TTI W6CTS W6MDI KAIGR W6PFO	Francis T. Blatt Edward W. Helm Earl F. Sanderson Horace R. Greer Kenneth E. Hughes Vincent N. Feldhausen George L. Rickard H. S. Walling	837 16th Ave. 509 Claremont St. 101 Claremont Ave. 414 Fairmount Ave. 209 Lincoln Way 113 South Quincy St. Box 549 Box 929	Honolulu Reno San Jose Oakland San Francisco McCloud Manila Fresno
ROANOKE DIVISION				
North Carolina South Carolina Virginia West Virginia	W4CVB W4BOE/ANG W3GWO W8OXO	W. J. Wortman Ted Ferguson Frank S. Anderson, Jr. W. D. Tabler	P. O. Box 566 1213 College St. 4703 New Kent Ave. 1004 So. Davis Ave.	Morganton Columbia Richmond Elkins
ROCKY MOUNTAIN DIVISION				
Colorado Utah-Wyoming	W9EHC W7ZGZ	Carl C. Drumeller Henry L. Schroeder	224 Colorado Ave., Apt. 3 P. O. Box 731	Pueblo Laramie, Wyoming
SOUTHEASTERN DIVISION				
Alabama Eastern Florida Western Florida Georgia West Indies (Cuba-Puerto Rico- Virgin Islands)	W4DGS W4PEI W4AXP W4AOB CM2OP	James F. Thompson Carl G. Schaal Oscar Cederstrom William U. Hanks Mario de la Torre	12 Clanton Ave. Waucoma Apts. Lakeview Hotel Second St. & Bruce Ave. 4 Hunter St., S.E. Escobar 110 (Altos)	Montgomery Clermont De Funiak Springs Atlanta Habana, Cuba
SOUTHWESTERN DIVISION				
Los Angeles Arizona San Diego	W6MQM W6KOL W6BKZ	Ralph S. Click John K. Oliver Louis A. Cartwright	1038 Milwaukee Ave. Box 642 7214 Fay St.	Los Angeles Nogales La Jolla
WEST GULF DIVISION				
Northern Texas * Oklahoma Southern Texas New Mexico	W5EAV W5GFT W5MNI W5ENI	R. E. Hughes Russell W. Battern Horace E. Biddy Dr. Hilton W. Gillett	1410 Ave. E, N.W. Box 290 1746 Schley Ave.	Childress Enid San Antonio Lovington
MARITIME DIVISION				
Maritime	VE1DQ	A. M. Crowell	69 Dublin St.	Halifax, N. S.
ONTARIO DIVISION				
Ontario	VE3EF	Flying Officer Donald R. Gunn	7/10 Canadian Bank of Commerce	New Toronto, Ont.
QUEBEC DIVISION				
Quebec	VE2CO	Lindsay G. Morris	Apt. 6, 4510 Girouard Ave., N.D.G.	Montreal, P. Q.
VANALTA DIVISION				
Alberta British Columbia	VE4GE VE5DD	C. S. Jamieson C. O. I. Sawyer	581 W. Riverside Drive 2634 West 31st Ave.	Drumheller, Alta. Vancouver
PRAIRIE DIVISION				
Manitoba Saskatchewan	VE4AAW VE4SY	A. W. Morley Arthur Chesworth	747 McMillan Ave. 1071 4th Ave., N.W.	Winnipeg Moose Jaw

* Officials appointed to act until the membership of the Section choose permanent S.C.M.s by nomination and election.



Centralab controls are always in step with progress in civilian or defensive use. In peaceful pursuits or in punishing, gruelling manoeuvres Centralab controls continue to perform smoothly and efficiently. And when you are called . . . remember that Centralab controls are the ideal replacements on every job.

CENTRALAB: Division of Globe-Union Inc., Milwaukee, Wis.

Centralab RADIOHMS

A—STANDARD

Long famous for the reliability of Centralab's non-rubbing contact and long wall type resistor. Available plain, or with one, two, or three taps, and with SPST, DPST, or SPDT Underwriters Approved Switches.

B—MIDGET

Small in size, but large control efficiency. Available single, dual, or triple, plain, or tapped, with SPST, SPDT, DPST.

C—ELF

Small . . . but it too, features the long, straight, resistor strip, with SPST Switch . . . with, or without dummy lug. Switch rated . . . 2 Amps. 125 V. Underwriters approved.

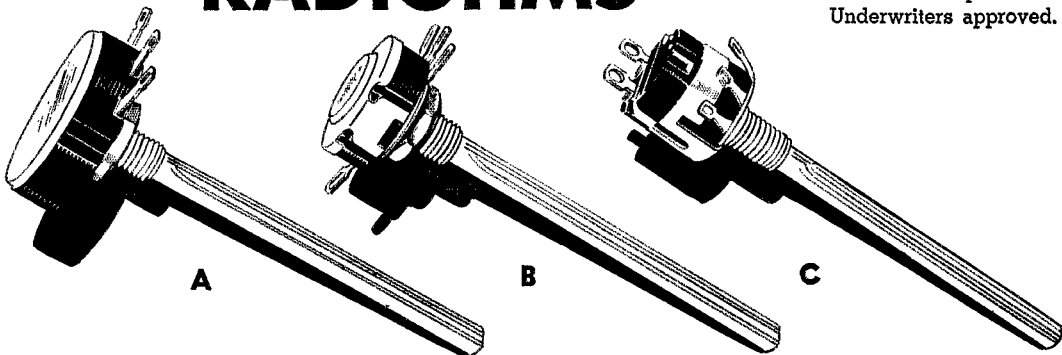

THE AMERICAN RADIO RELAY LEAGUE

Directors

President
GEORGE W. BAILEY W1KX
74 Webster Road, Weston, Mass.

Vice-President
CHARLES E. BLALACK W6GG
Box 55, Yuma, Ariz.

Canadian General Manager
ALEX REID VE2BE
169 Logan Ave., St. Lambert, P. Q.

Atlantic Division
WALTER BRADLEY MARTIN W3QV
Box 612, Roslyn, Pa.

Central Division
GOODWIN L. DOSLAND W9TSN
10 No. Clark St., Chicago

Dakota Division (Acting)
ADOLPHUS A. EMERSON W9ITQ
5336 S. Elliott Ave., Minneapolis

Delta Division
E. RAY ARLEDGE W5SI
P.O. Box 286, Pine Bluff, Ark.

Hudson Division
ROBERT AKERIDGE KIRKMAN W2DSY
920 Eighth Ave., Brooklyn

Midwest Division
FLOYD E. NORWINE, JR. W9EFC
7405 Hiawatha Ave., Richmond Heights, Mo.

New England Division
PERCY C. NOBLE W1BVR
37 Broad St., Westfield, Mass.

Northwestern Division
KARL W. WEINGARTEN W7BG
3219 N. 24th St., Tacoma, Wash.

Pacific Division
J. L. MCCARGAR W6EY
66 Hamilton Pl., Oakland, Calif.

Raleigh Division
H. L. CAVENESS W4DW
2607 Vanderbilt Ave., Raleigh, N. C.

Rocky Mountain Division
C. RAYMOND STEDMAN W9CAA
925 So. Gaylord St., Denver

Southeastern Division
WILLIAM C. SHELTON W4ASR
Box 652, Daytona Beach, Fla.

Southwestern Division
JOHN E. BICKEL W6BKY
801 E. California St., Whittier, Calif.

West Gulf Division (Acting)
W. T. CASWELL, JR. W5BB
1302 West Ave., Austin, Texas

THE AMERICAN RADIO RELAY LEAGUE, INC., is a non-commercial association of radio amateurs, bonded for the promotion of interest in amateur radio communication and experimentation, for the relaying of messages by radio, for the advancement of the radio art and of the public welfare, for the representation of the radio amateur in legislative matters, and for the maintenance of fraternalism and a high standard of conduct.

It is an incorporated association without capital stock, chartered under the laws of Connecticut. Its affairs are governed by a Board of Directors, elected every two years by the general membership. The officers are elected or appointed by the Directors. The League is non-commercial and no one commercially engaged in the manufacture, sale or rental of radio apparatus is eligible to membership on its board.

"Of, by and for the amateur," it numbers within its ranks practically every worth-while amateur in the nation and has a history of glorious achievement as the standard-bearer in amateur affairs.

Inquiries regarding membership are solicited. A bona fide interest in amateur radio is the only essential qualification; ownership of a transmitting station and knowledge of the code are not prerequisite. Correspondence should be addressed to the Secretary.



Past Presidents

HIRAM PERCY MAXIM, W1AW, 1914-1936
EUGENE C. WOODRUFF, W8CMP, 1936-1940

Officers

President GEORGE W. BAILEY, W1KX
Weston, Mass.

Vice-President CHARLES E. BLALACK, W6GG
Yuma, Ariz.

Secretary KENNETH B. WARNER, W1EH
West Hartford, Connecticut

Communications Manager . . . F. EDWARD HANDY, W1BDI
West Hartford, Connecticut

Acting Treasurer DAVID H. HOUGHTON
West Hartford, Connecticut

General Counsel PAUL M. SEGAL
1026 Woodward Building, Washington, D. C.

Address all general correspondence to the administrative headquarters at West Hartford, Connecticut.

"IT SEEMS TO US—"

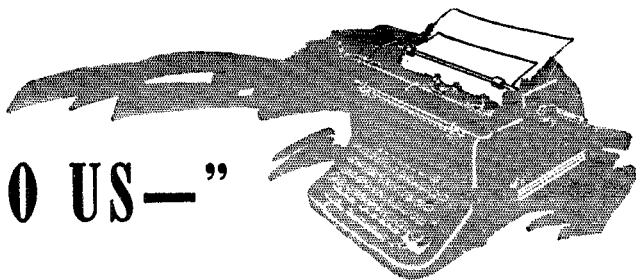

OUR CONTRIBUTION TO NATIONAL DEFENSE

ELSEWHERE in this issue we reproduce the text of a public notice to amateur licensees issued on July 22d by the Federal Communications Commission. It advises us that the needs of national defense are going to result in temporarily depriving us of the use of 300 kc. in our 80-meter band, within the continental limits of the United States. The frequencies are to be taken by instalments over the next eight months or so, for the duration of the emergency only, thereafter to be returned to us.

If it was inevitable that we temporarily give up the use of some of our frequencies during the emergency, to permit their employment in the national effort, we can be proud that they were required for the magnificent Air Corps pilot-training program, the heart of the defense activity. This is no picayune project of small importance, whose conquest of our frequencies would properly leave us grumbling, but something of inspiring dimensions and a thing of transcendent importance to every American. Our loan of some of our frequencies to this program constitutes another contribution by the United States amateur to the defense of his country.

EVERYONE is aware of the immense national effort in the building of military airplanes, but not everyone seems aware that there is in effect a similarly prodigious plan for the training of military pilots. In addition to all the present Army flying schools, and the large number of civilian schools that are giving elementary flying training on a contract basis, some forty-odd new basic and advanced schools are under construction and are being commissioned rapidly. Depending upon the type of airplane, each school will have from three to ten squadrons, each maintaining twenty-five to fifty airplanes. These schools are planned to realize an annual output of 30,000 American and 7000 British pilots. Nearly 20,000 fliers will be under instruction at one time, when the plan reaches full production. The instruction of pilots at this rate has required the evolution of a new training technique, based on radio communication. After a student pilot is soloed in a basic trainer, his instruction is carried on largely by radiotelephony. Saturated traffic

conditions also require strict and immediate radio control and supervision. The instructor directs a number of student pilots from the flying line, from his own plane in flight, or from a nearby auxiliary field. He adjusts landing and take-off traffic and, in case of dangerous emergencies, may avert crashes by warning students when to cut the throttle and drop the flaps and how to adjust them, or when to gun and go around again. When the student advances to formation flying and cross-country, he is similarly watched and directed by an instructor in an accompanying plane. Every student pilot also has a transmitter in his plane, which he may use to report trouble and to request emergency instructions. The curriculum of course includes night flying, and the operating hours at every field using radio control are from 7 A.M. until 2 A.M. The lives of these pilots and the efficiency of their training depend upon a well-organized radio communication system, keeping them in instant and reassuring contact with their instructor. In addition, instruction and practice in radio procedure and operation are vital to the combat pilot engaged in modern radio-directed aerial warfare. Training considerations demand that combat-type radio equipment be used. The plane sets have an output of only 4 or 5 watts and the ground stations 50 watts; in their training work, they must provide reliable communication over distances something over 25 miles and with freedom from interference.

The frequency needs for this many squadrons at this many fields are quite large, even with the best possible duplication of use. Pressure for frequencies in this part of the spectrum has long been acute, and defense needs have made the situation worse. During the past year, various government departments have taken nonexclusive rights to many hundreds of commercial frequencies. Domestic point-to-point, as another example, has been stripped of most of its frequencies, retaining only three channels below 4 Mc. and not even shared rights on any other such frequencies. When the pilot-training program came along, it created a new frequency problem of much greater magnitude than anything before. Every possibility of further use of available frequencies had been exhausted. No other service enjoyed an allocation in this range of sufficient size to fill the need — a need which was impera-

tive in the national interest. The employment of a part of our band was therefore deemed the only solution.

The majority of amateurs consider our 160-meter band much less valuable than 80 and will ask why it wasn't used instead. There are several reasons. Planes come through production now equipped with standard combat radio sets that won't cover that band. If the Army tried to change the specifications, there would be long delay — too long, as careful examination of this possibility showed. Moreover, it was felt that the pilots must be familiar with the sets and the performance of the frequencies they would use in combat. Still another reason is that it is difficult to get satisfactory radiation at 1750 kc. from the short antenna on a fighter. But, at that, they would have used 160 if they could — would have preferred its performance to 80. The trouble was they couldn't, for the reasons stated. It is also, of course, a great pity that the Air Corps is not prepared to do this job on u.h.f., which would be ideal for the purpose.

WHEN this matter came to issue at Washington, there were several ways it could have been handled. Under the President's emergency proclamation, the government could simply have preempted our entire band by executive order, without warning. Instead, it was handled as a civil matter through FCC, in a fashion that made possible the collaboration of ARRL officials in working out many of the details. As a result, the changes are going to come about gradually, only as the War Department needs the frequencies, with opportunity for us to rearrange ourselves. To facilitate our readjustment, some other changes in our assignments and temporary modifications of amateur rules will simultaneously be made — some of which will introduce important new operating rights for many amateurs.

It is contemplated that our giving up of the frequencies 3650-3950 will be accomplished in three separate steps. We must bear in mind that we can't tell exactly what "the exigencies of national defense" will require and that the timetable is therefore a little uncertain. The War Department is genuinely desirous of inconveniencing us as little as possible, of taking over only when they actually require frequencies. If plans slow down, we'll have more time; if they speed up, less. Remembering these limitations, let us see what we have:

Step No. 1. Some time in August we may expect an FCC order that will direct us, effective September first, to vacate the frequencies 3800-3900. At the same time, 1800-1900 will be denied to 'phone and assigned exclusively to c.w. The trunk lines and c.w. nets will commence readjusting themselves. The 75-meter 'phone band will not be affected. A brand-new 'phone band will be opened from 7250 to 7300 kc. The distinc-

tion between Class A and Class B/C will be temporarily abandoned, all 'phone frequencies opened to all amateurs.

We spoke above of vacating 3800-3900. Not quite. While nighttime ranges make sharing at night impossible, a plan has been worked out to permit continued daylight c.w. work even after the frequencies have been taken over, in regions not likely to interfere with the flying schools. Most of the schools are in southern states and in California, because they afford more hours of good flying weather. It is expected that amateurs in specified northern states* will be granted the right to operate c.w. from two hours after sunrise until two hours before sunset, on the condition that no interference occurs and with the understanding that FCC will promptly pipe down anyone who does interfere. We estimate that this daylight right will be retained by seventy per cent of the country's amateurs; it will be particularly helpful on week ends. The Army will have to be given very prompt relief if interference develops, since pilots' lives will be at stake. We therefore suggest to amateurs in the exempted daylight regions that, to avoid the loss of the permission, they religiously reduce power to the minimum necessary. (An input of 100 watts shouldn't interfere.)

Step No. 2. Late this year we are to expect another order directing us, about the first of the year, to give up 3750-3800 and 3900-3950. This will automatically halve the 75-meter 'phone band, but by that time the redistribution amongst the other 'phone bands should be well along. The continuation of daylight work in exempted areas is to be expected on 3750-3800 but is questionable on the 'phone frequencies.

Step No. 3. Late in the winter the third order is expected, calling for the vacating of 3650-3750 very early in the spring — if the frequencies are still needed then.

Some further points worth noting:

We haven't lost these frequencies. We're just lending them. Their return when the emergency is over has been pledged to the League.

None of the emergency bands (2025-2050, 3500-3525 and 3975-4000) is affected by these changes. Thus there is no disturbance of plans for emergency communication work.

The changes affect only continental United States, have no effect on K4, K6 and K7 amateurs.

Although the Class A ticket will temporarily be unnecessary for working 4- and 14-Mc. 'phone, the examination will still be available for those

(Continued on page 10)

* Probably the states of Maine, New Hampshire, Vermont, Massachusetts, Rhode Island, Connecticut, New York, New Jersey, Pennsylvania, Delaware, Maryland, District of Columbia, Ohio, Michigan, Indiana, Illinois, Wisconsin, Minnesota, Iowa, North Dakota, South Dakota, Wyoming, Montana, Idaho, Oregon and Washington. Listen to Official Broadcasts at the time, for verification.

Public Notice

July 22, 1941

The Federal Communications Commission hereby gives notice to the licensees of amateur radio stations of its intention to take action over the next few months that will temporarily restrict amateur operation within the continental United States on the frequencies from 3650 to 3950 kilocycles, normally assigned exclusively to amateurs, to make them available for a large-scale national defense project of great importance, for the duration of the present national emergency. This advance notice is given amateurs so that they may have ample time to procure any necessary equipment and adjust their stations to the change.

There is under way in this country a vast plan for the training of many thousands of additional military aircraft pilots at a large number of new air fields located throughout the United States. An essential part of their training involves a large-scale use of radio communication. Amateurs are well aware of the congestion existing throughout the frequency spectrum and those who are students of the problems of frequency allocation know that in the medium-high frequencies the congestion has been acute for years. It is the desire of the Federal Communications Commission to cause the least inconvenience to existing services and to divert for any defense requirements the minimum number of channels possible. The Commission is also aware that the amateurs maintain some of their most important services in the band 3500-4000 kilocycles, but the new pilot training program is a vital component of the defense plans of the country; and from the considerations of the equipment available for it and the number of frequencies required, no other portion of the spectrum is capable of accommodating this need.

The Commission will, within the next few days, issue an order specifying the procedure for effectuating this plan. It is expected that the first release of a part of the amateur frequencies in question to defense uses (probably 3800 to 3900 kilocycles) will become effective about September 1st, followed by additional transfers as the exigencies of the service demand. So far as can be seen at the present time, the ultimate demand for the entire 300 kilocycles will not be reached until March, 1942.

When these changes are made, it is the Commission's intention to rearrange certain other amateur allocations to provide maximum facilities for the various types of amateur work, specifically:

(1) *C.w. operation, Type A-1 emission.* The frequencies 1800-1900 kilocycles, heretofore available for radiotelephony, will be assigned exclusively for Type A-1 emission. Thus there will be available for the radiotelegraph networks and organized amateur c.w. activities

heretofore existing below 3900 kilocycles the bands 1750-1900 kilocycles and 3500-3650 kilocycles. Amateurs now operating in the frequencies 3650-3900 kilocycles are urged to make preparations to readjust themselves in the new assignments so as to be able to carry on their work.

(2) *Radiotelephone operation, Type A-3 emission.* There will remain available for radiotelephony the frequencies 1900-2050 kilocycles and 3950-4000 kilocycles. To compensate for the loss of the use of the frequencies 1800-1900 kilocycles and 3900-3950 kilocycles for radiotelephony, a new radiotelephone assignment will be made from 7250 to 7300 kilocycles. In view of the unavoidable dislocation of some 'phone stations, and because the distinction between Class A and Class B privileges has been becoming of less importance over recent years, the special frequency privileges adhering to the Class A operator license will be temporarily abandoned and all amateur radiotelephone frequencies will be available to all amateur licensees.

After these changes are accomplished, the amateur allocations, available to all classes of amateur licensees, will read as follows:

1,750 to	1,900 kc.	A-1	---	---	A-4	---
1,900 to	2,050 kc.	A-1	---	A-3	---	---
3,500 to	3,650 kc.	A-1	---	---	---	---
3,950 to	4,000 kc.	A-1	---	A-3	---	---
7,000 to	7,250 kc.	A-1	---	---	---	---
7,250 to	7,300 kc.	A-1	---	A-3	---	---
14,000 to	14,150 kc.	A-1	---	---	---	---
14,150 to	14,250 kc.	A-1	---	A-3	---	---
14,250 to	14,400 kc.	A-1	---	---	---	---
28,000 to	28,100 kc.	A-1	---	---	---	---
28,100 to	30,000 kc.	A-1	---	A-3	---	---
56,000 to	60,000 kc.	A-1	A-2	A-3	A-4	---
112,000 to	116,000 kc.	A-1	A-2	A-3	A-4	A-5
224,000 to	230,000 kc.	A-1	A-2	A-3	A-4	A-5
400,000 to	401,000 kc.	A-1	A-2	A-3	A-4	A-5

Note should be taken that this reallocation of 300 kilocycles is made necessary purely by a situation arising out of the national emergency and does not necessarily represent a continuing or permanent situation. Amateurs are urged to take advantage of the advance notice given herein to make all necessary preparations so that this plan may be placed in effect by future Commission orders that may provide but short additional notice. They are also requested to cooperate by not engaging in correspondence with Washington intended to effect changes in the plan, the details of which have been carefully worked out.

The Commission believes that the enterprise and skill for which the American amateurs are noted will enable them to readjust themselves in the new emergency allocations in a manner that will maintain their ability to render emergency communication service to their communities and to carry on their work of self-training. It counts on their patriotic understanding of the needs of the situation.

Our Contribution

(Continued from page 8)

who want it as a mark of skill or prestige, or against the future.

Whenever FCC names an effective date, the order takes effect at 3:00 A.M. Eastern Standard Time on that date.

ARRL Official Broadcasts will keep you informed on the orders. Watch particularly for news on the first one in the last part of August.

From time to time you may hear some of this pilot-training on frequencies not yet abandoned by us. That will be proper, as the government has such a nonexclusive right and some use of our frequencies is already being made. Moreover, if they find they can work through us, it might just possibly result in postponement of some of the orders.

OUR Communications Department now has a large job ahead of it. C.w. traffic nets and trunk lines are the backbone of amateur radio. They must be redistributed now in an orderly and sensible way. The first loss of 3800-3900 affects only twenty-two nets known to ARRL hq., but we must look ahead to the completed picture when we have available for traffic purposes the bands 3500-3650 and 1750-1900, plus of course the 7-Mc. band. We must plan now the moves necessary for the winter season.

We have never made adequate use of the c.w. portion of the 1.75-Mc. band; in fact, we've almost lost it through nonoccupancy. Yet, as our 160-meter parties of recent years have shown, it is a splendid band, and the antenna problem is not nearly so difficult as most h.f. amateurs imagine. Interestingly enough, we are arriving at that part of the solar cycle where the probabilities are that the 80-meter band will skip out on short hauls this coming winter, so that some of our nets would have to go to 160 anyhow, to maintain their contacts. Unquestionably, many short-hop nets can perform better in this band this winter, so the change may have some of the qualities of a blessing in disguise. On the other hand, some of our long-jump trunk lines will actually perform better on 40 than on 80, particularly in the earlier hours of the evening.

The enforced shifts therefore give us an excellent opportunity for a better "planned use" of our bands, under the leadership of our Communications Department. The ARRL Trunk Lines and the numerous state nets organized by RM's may be said to "belong" to the League, and them we can shift according to our own plans. There are innumerable independent nets not organized under CD auspices to whom we can't dictate but with whom we can work coöperatively. Somehow, we must all succeed in working together and accomplishing the changes in an orderly, en-

gineering manner. Not every net now located in 3500-3650 can feel itself morally entitled to remain there. We must employ 3500-3650 for the important nets whose working distances require those frequencies, while short-jump state nets move down to 1.75 Mc. and some of the long-haul boys go up to 7 Mc. Inescapably it represents some hard work, but we can do it. The CD invites correspondence from all nets, with a view to coördinating the readjustments.

For voice men, the opening of 7-Mc. 'phone represents something that long has been agitated by many and that will be of interest to almost all. (That first night on 40 'phone is going to be sumpin'!) And the opening of all bands to Class B/C represents new opportunity for two-thirds of the hams of the land. The reductions of 160 'phone soon, and of 75 'phone early next year, of course inevitably involve some moving. The choice will be dictated by personal preferences: those who attach greatest importance to nearby reliable contacts with old friends will seek a low frequency, while those to whom greater DX is attractive will prefer the new 40 allocation. The very inability to foresee in which direction preferences would run made it impossible to envisage a just and lasting subdivision between Classes A and B and impelled the Commission in the temporary abandonment of the distinction — that, plus their feeling that, with approximately 20,000 Class A licenses in existence, the distinction had long been losing validity. The changes are going to give us greater diversification, more democracy and an increased ability to choose the right band for the distance.

LET us now examine our future under these changes.

Some of us have realized that defense needs for frequencies would be likely to put greater pressure on our bands than any fears about the wisdom of letting amateurs continue. But there is now neither talk about closing us down from security considerations nor of needing more of our frequencies. We won't minimize the fact that it is disconcerting to have our best traffic band shaken up, but we'll get by. The Commission says that our notable enterprise and skill will enable us to readjust ourselves, and we believe that. It is simply that, like every other group of patriotic citizens, we have been asked to give up something "for the duration." But we can get along without these frequencies for a while, when we know we're going to get them back, and particularly when we realize that in the meantime their loan constitutes a big contribution by us to the defense of the nation. Although these changes will be work for us, they will also be fun. That's what all amateur radio is: hard work for the sake of the enjoyment of doing it. Let us, then, be up and doing, putting our skill and coöperation to work for us.

K. B. W.

Handle Your Traffic on 160!

Practical Suggestions for Shifting Frequency

BY GEORGE GRAMMER,* W1DF

THE major problem arising from the temporary FCC orders taking part of the 80-meter band during the present emergency is no doubt that of relocating existing 80-meter traffic nets. The logical place to go for the short-haul work is into the 160-meter band, and to meet this condition the c.w.-phone allocations in that band have been changed as described elsewhere in this issue.

In one way this reallocation is a fitting item for the "Blessings in Disguise" department, because this winter undoubtedly would have seen many

The question seems to divide itself into three parts — generating the right frequency, getting the tuned stages fixed up, and rigging a suitable antenna.

Frequency Control

To some folks the problem of frequency control will be no problem at all — these are the ones already using 160-meter crystals. And of course a simple solution for the others is to acquire such crystals to replace their 80-meter frequencies. Changing the oscillator tank circuit to work on the lower-frequency band is simply a matter of winding a new coil. For the same tuning capacity, four times the 80-meter inductance will be needed; for purposes of comparison with your old coil, the new one can have the same length and diameter but twice as many turns. Possibly it won't need to be that big, if your oscillator tuning condenser was normally set near minimum capacity; in that case figure on using nearly maximum capacity and cut the coil accordingly. More specific information is given in Fig. 1, which shows how many turns of different practicable sizes of enameled wire you will need with any capacity from 50 to 250 $\mu\text{mfd.}$, for coils wound on the popular 1½-inch diameter plug-in forms. Since these curves do not take into account stray capacities in the tubes, circuit and coils, you can probably get away with fewer turns (or a bit less capacity) than indicated, especially since the data are based on a frequency of 1700 kc. to be on the safe side.

Whether or not any further doctoring of the oscillator will be needed depends upon the circuit. The Tri-tet will need a new cathode circuit; 20 turns of No. 22 enameled on a 1½-inch form, shunted by a fixed 100- $\mu\text{mfd.}$ mica condenser, will

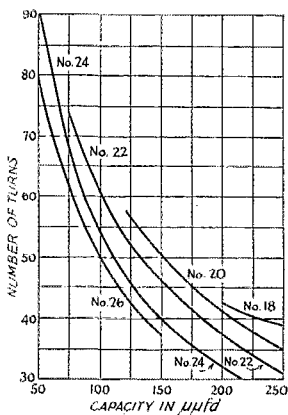

Fig. 1 — Turns required for various tuning capacities to resonate at 1700 kc. Sizes of enameled wire are indicated on the curves. Coils close-wound on 1½-inch forms.

80-meter circuits struggling with poor conditions, in the form of weak signals over short distances and QRM from stations considerable distances away. This is one of the inevitable things that (so far as we know) has nothing to do with wars or emergencies but is wholly a matter of the Sun and his cycles. And until the Sun gets through his present state and back to "normal" — it's going to take a few years — the wise traffic handler will betake himself to fields where he can get the kind of communication he wants. That place is the 160-meter band.

For those who haven't taken part in WAS parties (there may be a few) the question is, how? Considering what plenty of amateurs have been able to do with equipment — and especially antennas — that would be flattered by the word "makeshift," the thing doesn't look too tough.

* Technical Editor, QST.

Traffic handlers lend 250 kc. on the 80-meter band to the Army under the temporary FCC orders. It doesn't take much imagination to see what will happen if all the stations displaced move into the remaining 150 kc. But with an exclusive assignment of 150 kc. for c.w. in the 160-meter band a part of the reallocation plan, operating congestion will be relieved — if fellows move in. It isn't hard to do, technically, and there are important subsidiary advantages to be realized. Here are some thoughts on changing the rig over.

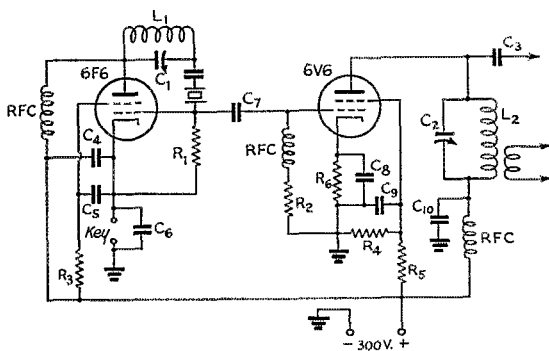

Fig. 2 — Circuit diagram of the 160-meter exciter using an 80-meter crystal.

- C₁, C₂ — 100- μ fd. variable.
- C₃, C₇ — 100- μ fd. mica.
- C₄, C₅, C₆, C₈, C₉, C₁₀ — 0.01- μ fd. paper.
- R₁ — 0.1 megohm, 1-watt.
- R₂ — 50,000 ohms, 1-watt.
- R₃, R₅ — 15,000 ohms, 2-watt.
- R₄ — 500 ohms, 1-watt.
- RFC — 2.5-mh. r.f. choke.
- L₁, L₂ — 40 turns No. 26 d.c.e. close-wound on 1½-inch diam. form.

do the trick. The grid-plate oscillator, using a pie-wound choke in the cathode circuit, will need no further changes. Straight tetrode and pentode oscillators may need some additional feedback capacity between plate and grid to make 160-meter crystals oscillate reliably. This capacity can be provided at no expense and little trouble by soldering a wire to the plate prong on the socket and bringing it close to — but not touching! — the grid prong. Triode oscillators should not need this additional capacity.

On the other hand, replacing a whole set of crystals may represent too great a cash outlay; besides, there's no telling what the situation will be with respect to availability of crystals this coming winter. Which makes one think longingly of using the old 80-meter slab to control a 160-meter transmitter. Well, it can be done. One circuit that will do it was described by W. D. MacGeorge, W3GHR, over a year ago in *QST*.¹ Although no mention was made of it at the time, W3GHR has used it that way and we've tried it out in the lab with good success. The diagram is repeated here as Fig. 2, and it will be observed that it is a two-tube arrangement with the second tube acting as an amplifier. The oscillator part is an ultraudion with the crystal between the tube and tank. It is therefore a self-controlled job with the crystal as a locking element. Because of this it is more tricky than the ordinary crystal circuits and should be checked frequently to make sure the frequency stays locked, but that seems a fairly reasonable price to pay for using the 80-meter crystals on hand. The way to adjust it is to set the receiver to half the crystal frequency and

¹ MacGeorge, "A Simplified Exciter Circuit," *QST*, April, 1940.

tune C₁ until the crystal is heard to lock in; it will stay locked over a small portion of the condenser range and then lose control as the tuning gets too far away from the "sub-harmonic." If the oscillator is keyed it is easy to tell when the circuit is locked, since "crystal" keying will be obtained under those conditions while the keying will be chirpy when the oscillator is out of control. Also, the oscillator frequency will be affected by hand capacity at the tuning control and will be subject to "pulling" as the amplifier plate circuit is tuned through resonance, when the frequency is out of control. Neither of these effects occur when the circuit is locked. The output of the amplifier will drop slightly when the oscillator locks, so the unit should not be tuned for maximum drive to the following stage but by listening on the proper frequency. There may be some other possibilities along similar circuit lines, and it is evident that here is an interesting and possibly fertile field for experiment.

As an alternative to crystal control, one can take the step that many already have taken and go e.c.o. So many varieties of these frequency-control units have been described in past *QST*'s that we won't attempt to cover the subject to any extent, but simply refer to the following as giving suitable oscillator constants for 160-meter operation:

- Stiles and Blair, "Let's Talk E.C.O.," *QST*, August, 1941.
- Shuart, "Transmitter Frequency Control Unit," *QST*, June, 1941.
- Metcalf, "An Improved E.C. Oscillator," *QST*, May, 1941.

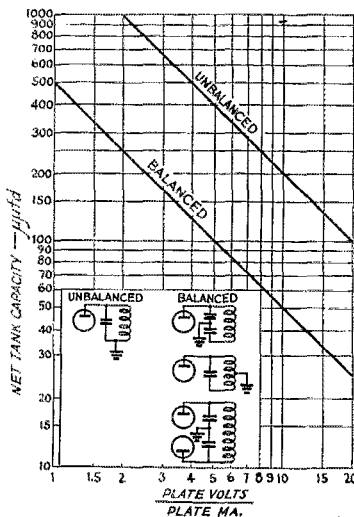

Fig. 3 — Tank capacity required for a Q of 12 for various plate-voltage/plate-current ratios.

Roberts, "Portable Emergency Transmitter," *QST*, April, 1941.

Goodman, "Gang-Tuned V.F.O.," *QST*, March, 1941.

Mix, "E.C.O. Exciter," *QST*, October, 1940.

Brown, "Stabilized Variable-Frequency Oscillator," *QST*, July, 1940.

Most of these circuits have 1.75-Mc. oscillators with untuned coupling to the following buffer, in which case simple substitution of a 160-meter coil in the buffer — Fig. 1 can be used as a guide — will give you 160-meter output. In reading over the articles, you will find general unanimity on the desirability of doubling in the buffer stage, but this practice becomes more important on the higher frequency bands and can be dispensed with on 160 if reasonable care is used in construction and tuning. Going over all the articles listed will be an education in the fundamentals of good e.c.o. practice — a background which everyone should have before attempting to put one on the air.

Tank Circuits

The larger tank circuits may cause some head-scratching, because it isn't always possible to get coils to fit a given condenser nor (with the aluminum situation in its present state) condensers to fit a given coil. Low power stages, where coils wound on plug-in forms are practicable (up to perhaps 50 watts for the 1½ inch forms), are relatively easy to handle since the same tuning condenser with a new coil — Fig. 1 again — will work out satisfactorily. It will pay to use the largest practicable wire size which, for a 100- μ fd. tank condenser, will be about No. 20. The curve for this wire size stops at about 120 μ fd. (no more turns can be accommodated on the form), but the circuit capacity usually will add 20 μ fd. at least to the total; besides, as previously pointed out, these curves are based on 1700 kc.

For powers up to about 150 watts the "jumbo" forms — 2¼-inch diameter — can be used, provided a reasonable amount of tuning capacity is available. If the form is wound full of No. 14 wire (about 45 turns) a capacity of around 140 μ fd. will be required for tuning to the low-frequency end of the band. Adding stray capacities, a 125- μ fd. condenser ought to do it, so that a 250-per-section condenser would be necessary with a balanced circuit. Such a condenser (or even a 200 per-section) will also work with the self-supporting manufactured coils. But with the jumbo form the 200-per-section condenser will be likely to miss the lower half of the band unless No. 16 wire is used, winding the form practically full.

Thus the chap having a final tank condenser with a net capacity of 100 μ fd. isn't too badly off. Manufactured coils in suitable power ratings are available, and for moderate power a coil can be wound on a standard form. For several hundred watts the jumbo form probably would not

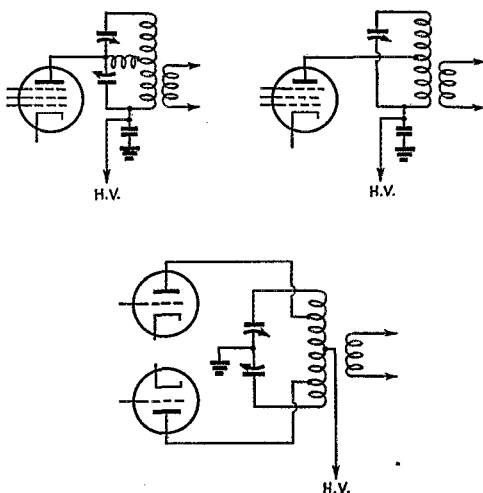

Fig. 4 — Tapping down on the plate tank to increase Q . The neutralizing condensers in the push-pull circuit should connect directly to the plates of the tubes rather than to the stator plates of the tank condenser sections.

do, since the wire would have to be comparatively small to provide enough inductance. Lacking big-enough forms, homemade high-power coils can be wound on celluloid strips on a temporary form, the turns cemented to the strips, and the form knocked out to make the coil practically air wound. No. 12 wire will do for a half kilowatt, especially if the wire is spaced slightly to reduce losses and to help in the radiation of heat. As an example of the size of coil necessary, 46 turns of No. 12, wound 8 turns to the inch with an inside diameter of 3½ inches, will tune to 1750 kc. with a 100- μ fd. condenser. Of course there's nothing to prevent winding the coil on a form, if one of reasonably low losses is available. Bakelite tubing sometimes can be found in the junk box, and even a good dry rolling pin will not be too bad.

At this point the Q of the circuit needs some consideration, since preventing harmonic radiation will be important. We'll do the Army no good if we move from 80 to 160 and then proceed to fill the vacated band with harmonics. Part of the harmonic suppression story is maintaining reasonably high Q in the final tank circuit. For a Q of 12, a generally satisfactory value, fairly high capacities are needed when the plate voltage/plate current ratio becomes low. The 200-per-section condenser, worked at maximum capacity at the low end of the band, is good for a Q of 12 when this ratio is 5 or more (see Fig. 3) — for instance, 500 volts and 100 ma., 1000 volts and 200 ma., 1500 volts and 300 ma., and so on. Lower ratios should have a higher capacity; 1000 volts and 300 ma., giving a ratio of 3.33, requires a tuning capacity (actually used) of 150 μ fd. for a balanced circuit, or 300 per section. These rather large capacities are usually not available in single

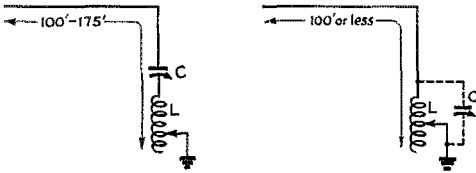

Fig. 5 — Simple grounded antennas. For values of L and C , see text.

condenser units, therefore the best thing to do is to add another condenser in parallel to bring the total capacity up to the optimum value. For low voltages a suitable condenser often can be unearthed in the spare parts supply, but higher voltages may not be so easily handled. A fixed air condenser to make up the deficient capacity is good, but there are probably few of them in stores and none available now from manufacturers. If you have any sheet metal of good conductivity (aluminum, brass, copper, etc.) it is not difficult to make up such a fixed condenser, using threaded rods for supports and nuts or short pieces of tubing for spacers; old condenser parts will come in handy for this purpose. But it probably won't be possible to buy such sheet metals by the time this is in print. However, if you *can* make such a condenser the capacity can be calculated closely enough by the formula

$$C (\mu\text{fd.}) = \frac{0.22 A}{d} (n-1)$$

where A is the area of the facing surfaces of the plates in square inches, d is the spacing between plates in inches, and n is the total number of plates. Two 3-inch square plates (area 9 square inches) separated by $\frac{1}{8}$ inch have a capacity of approximately 16 $\mu\text{fd.}$, as an illustration, so 7 of them would give a capacity of nearly 100 $\mu\text{fd.}$ With twice the spacing ($\frac{1}{4}$ inch) the capacity would be half, or about 50 $\mu\text{fd.}$

For a net capacity of 50 $\mu\text{fd.}$ in a balanced circuit (100- $\mu\text{fd.}$ per section condenser) a ratio of 10 is necessary to attain a Q of 12. This is a 1000-volt, 100-ma. amplifier, or one taking 2000 volts and 200 ma., and so on. If these are the actual conditions, the coil turns out to be a monster, at least in a small way. Taking the same No. 12 wire, 8 turns to the inch, and $3\frac{1}{2}$ -inch inside diameter of the previous illustration, such a coil

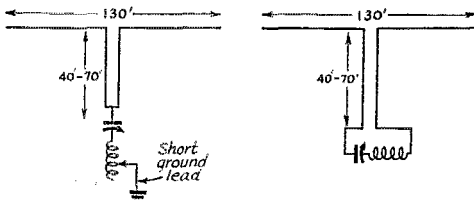

Fig. 6 — Modifications of the center-fed 80-meter antenna for 160-meter operation.

would have to have some 75 turns and would be nearly ten inches long. It would be better to increase the diameter to 5 inches, when a 46 turn coil would do. Even so, 60 feet of wire will be needed. The chances are that an E_p/I_p ratio of 10 is higher than is normally met with in practice, so if the 80-meter tank condenser is only 100 per section, a decent L/C ratio at 160 meters can be secured only by adding a second condenser, either fixed or variable, in parallel.

Single-ended amplifiers with unbalanced tank circuits run to large tank capacities on the 160-meter band. Possibly they only *look* high, since the same tank condenser will handle the same power in either balanced or unbalanced circuits, provided the Q is the same. Our 200-per-section condenser with the sections in parallel, for instance, will have a capacity of 400 $\mu\text{fd.}$ at half the voltage rating of the split circuit, and can be used with a single-ended pentode amplifier having a plate-voltage/plate current ration of 5. Since in the balanced circuit the same plate voltage will give twice the tank voltage for the same power input, the condenser will stand just as much either way.

The Q of the circuit can be increased in two ways without changing the tank constants. The first is to adjust the E_p/I_p ratio to give the desired Q with the capacity available; if the condenser is too small in the first place this means that the input must be reduced. If it turns out to be necessary to reduce input to control harmonic output there is at least one consolation — the tubes will last longer. This may not be a joking matter if tubes become hard to get in the near future. However, reducing the plate current probably won't do as much good as expected unless something also is done about reducing the excitation at the same time, since unnecessarily high excitation will generate an unnecessarily high harmonic content in the output. The more harmonic you put in the tank the more you get out, regardless of the tank Q , so it would be just as well to give some attention to the excitation question even if your tank Q is satisfactory. Excitation is likely to be large on 160 meters, and it would be wise to cut it down to the minimum required for reasonably efficient operation. Over-biasing of the amplifier is likewise to be avoided.

The second way to increase the Q is to tap the amplifier plate (or plates) on the tank as indicated in Fig. 4. An increase of about 4 times at the same plate input can be secured by tapping half way down, but in many cases this system will not be practicable. For one thing, the tank voltage will be twice as great, so that unless the tank condenser was operating well below its voltage rating in the first place, tapping down will simply result in condenser breakdown. The second bad feature is that tapping the plate of a neutralized amplifier on a coil is a good way to open up the circuit

(Continued on page 70)



Radio at the National Model Airplane Meet

Radio-Controlled Models and Two-Way Communication Feature Event

BY CLINTON B. DESOTO, WICBD*

IF A builder of radio-controlled model aircraft were to dream of an ideal model meet in which r.c. jobs did all the stupendous feats that could be visualized, his dream would probably resemble the actual 1941 National Model Airplane Championship Meet. Loops . . . smoke-writing . . . radio-controlled take-offs and spot landings . . . figure-eights . . . cross-country flights to an objective and return . . . even spins and power dives ending in crashes, all of these spectacular sights and more, thrilled the crowds assembled to witness the greatest radio-control exhibition ever staged.

More than forty radio-controlled flights were made by the eight r.c. models participating in the radio control event at the 1941 Nationals in Chicago on July 3rd, 4th, and 5th. These eight were the flight-tested survivors of twenty-six original entries — of which thirteen reached the field, five failing to make official flights for one reason or another.

But the eight ships that did make official flights delivered history-making performances. When the final scores were tabulated the Roberts National Radio Control Championship trophy was awarded to N. E. ("Jim") Walker of Portland, Oregon. Second place was won by Earle Arthur, W9FP, of Chicago, while Charles H. Siegfried, W9JLR, of Wichita, Kansas, was third. Three other places were awarded, as follows: Marvin S. Hemp, W9BCS, Neillsville, Wis., fourth; John Wm. Ault, Alliance, Ohio, fifth; and George Karpovich, Springfield, Mass., sixth.

A strong 15- to 20-mile wind handicapped flying the first two days. On Thursday, the first day, only five flights were made in all. Friday brought more wind, and up to 4 P.M. only one official flight had been attempted. In the late afternoon things began to quiet down a bit, however, and the next three hours saw some real radio control. No less than fourteen flights were made. As soon as one ship came down the red flag meaning "Clear the air!" would go up and another would take off.

But if there were thrills on Friday afternoon, they were nothing to those that came on Saturday. On his second flight of the day Earle Arthur made a beautiful spot landing that looked as though it would just reach the flag, but tall grass caught the wheels and they touched 54 feet from the pin.

* Assistant Secretary, ARRL.

After lunch Siegfried completed a successful cross-country to objective and return. Arthur made a well-controlled flight for the benefit of the newsreel cameramen. Jim Walker followed with a radio-controlled take-off, the ship standing on the runway, engine idling, no one within yards of it, then leaping forward under control and taking the air. On this flight Walker also accomplished a cross-country to objective and a spot landing, the latter achieved only after an exciting effort to drop the land-shy little ship sharply over the heads of the crowd. A dozen more flights followed in quick succession, each contestant striving to outdo the other with increasingly spectacular stunts.

It was on his last official flight of the day that Charles Siegfried accomplished the *ne plus ultra* — the radio-controlled loop. After sending his ship up in a steady climb to a height of several hundred feet, he headed it earthward in an almost vertical power dive. Only a few feet off the ground the big ship lifted its nose and climbed steeply, arching gracefully over on its back perhaps 300 feet above the ground. As it dove earthward again "Sig" levelled off and came in for a landing. The crowd went mad!

After this it seemed the day could hold no more thrills — but it did. Barely getting under the 5 P.M. closing wire, Jim Walker sent his entry cavorting about the skies in a "smoke-writing" demonstration, leaving a tenuous trail of white smoke in its wake. When he brought the proud little model down again to enthusiastic applause the meet was over.

With one or two notable exceptions, it was the flying at this meet that was unique — not the apparatus. Practically all the successful flights were made with tried and proved systems of control installed in orthodox ships — equipment which was successful because all the bugs had been ironed out and the operators thoroughly familiarized with the flying technique.

The models ranged in size from Champion Walker's beautiful little 6-ft. wingspan job to Charles Siegfried's massive 15-footer. Controls ranged from rudder alone or rudder and motor cut-off to elaborate rudder, elevator and throttle combinations. Here are some of the highlights:

Jim Walker's brilliant performer weighed only 5 lbs. complete with rudder and motor control. It contained two standard manufactured receiv-

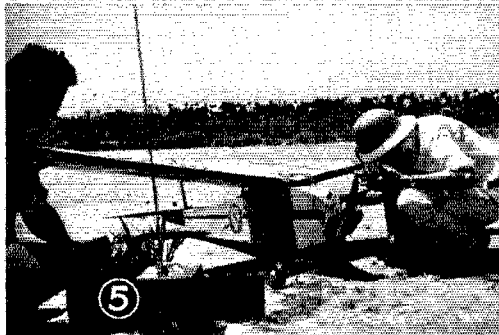
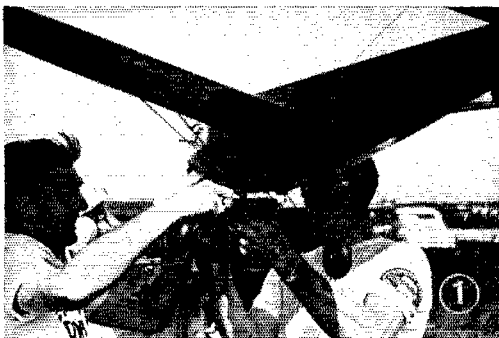

(1) Jim Walker (r.) and a thrilled assistant holding the winning radio-controlled ship aloft. (2) The small size (6-ft. span) and light weight (5 lbs.) of Champion Jim Walker's plane are emphasized in this shot. (3) Earle Arthur, W9FP, lifts the tail of his big, red second-place winner for inspection. (4) Third-place winner Charles H. Siegfried, W9JLR, at the controls, "joystick" in hand. (5) John Ault tuning up, a miniature test oscillator in his hand, the regular transmitter in front. (6) George Karpovich having a serious get-together with the Forster-powered end of his Custom Cavalier. (7) "Sig" brings his big ship, framed now by W9FP's two V-matched-doublets, around over the heads of the spectators massed on the left. (8) Walter and Bill Good, W8IFD, perennial former national r-c champions. Because of honeymoons, national defense, etc., they were only interested spectators this year — but how interested!

ers with RK-62's, one manipulating the rudder under continuously reversible control and the other regulating motor speed. The highly ingenious rudder control drive involved a variable-speed d.c. motor linked to the rudder through a fluid-drive clutch. The ground control unit incorporated another variable-speed motor with a series rheostat, the handle of which constituted the rudder stick. This motor operated a contactor which keyed the transmitter at varying speeds, thereby setting the rudder in the ship at full left (normal off), center (half speed), full right (full speed) or intermediate points. The Brown Jr. engine was equipped with two ignition timers, one set for full speed and one for slow. The motor control receiver relay normally connected up the full-speed timer, but with signal it switched to the slow timer. The whole arrangement represented a notable achievement in design and hard work in ironing out bugs and acquiring flying skill, and Walker merits the heartiest congratulations.

The large, red, 9-ft. 7-in. span ship flown by Earle Arthur, W9FP, was his own design — the first model airplane he had ever built. Powered by an Ohlsson 60, it flew strikingly well. Rudder, elevator and motor cut-off controls were provided, with three conventional RK-62 receivers. Tail escapements were mounted in fin and stabilizer à la the Good brothers, three-year national champions.¹ Door-bell push-buttons mounted on the ground control panel keyed the transmitter. Synchronized rows of dial-light bulbs which lit in sequence indicated the position of each control. Arthur handled his equipment with great skill and flew his ship to maximum advantage at all times.

Charles Siegfried, W9JLR, had the largest plane at the meet — 14-ft. 10-in. span. Its control system has previously been described in *QST*.² A crystal-controlled transmitter with push-pull 807's feeding a vertical "J" antenna and an elaborate "joystick"-style control box, incorporating a miniature telephone exchange with pulsing relays, selector, slow-release relay, etc., completed the intricate set-up. "Sig's" flying was spectacular and his performance at all times a crowd-pleaser.

Marvin Hemp, W9BCS, did a splendid job with his Barker-powered Miss America until he had the misfortune to crash it into a spectator's car. The radio control set-up closely duplicated the Good design,¹ with Type 30's in the receivers and tail escapements for rudder and elevator.

John Ault made seven good flights with his 8½-ft. original job, which also used a Type 30 receiver, a rudder escapement of his own design and an optional motor cut-off switch. A telephone anti-capacity switch was his control lever.

George Karpovich had an elaborate installa-



W9YDV, central control station for the meet, located in the press tent.

W9SXZ at the mike, a contestant reporting a local model in the center, and W9YDV, meet radio director, on the right.

tion in his Forster-powered 9-ft. Custom Cavalier, with two r.f. channels following the Good design, tail escapements in fin and stabilizer (the latter not used during the meet) and throttle control.

Harold Edwards also had a Forster-powered Cavalier, with optional rudder and throttle control using the reversible d.c. motor system. Robert Reder's 8-ft. Sailplane had one-channel escapement control of the rudder.

The "mystery ship" of the meet was a massive job sponsored by a crew from Purdue University, led by Kenneth Harker. Powered by a ¾-hp. Mercury Avion, the unorthodox-appearing ship carried a 14-tube receiver, apparently utilizing audio selection. To everyone's disappointment, the ship was not flown. Another interesting-looking job which did not make an official flight was that of George Blauvelt of Maywood, Ill. The radio installation was by Karl W. Miles, well-known designer of communications receivers, and was based on 100-kc. modulation of the 56-Mc. carrier. A super-regenerative detector feeding a 100-kc. amplifier employed "button" tubes.

All entrants used 56 Mc., with transmitter powers ranging from 5 to 60 watts from familiar u.h.f. circuits with 6N7's, 6V6's, 6L6's, and 807's. Horizontal receiving antennas were universal, but several fliers disregarded polarization effects and had vertical transmitting antennas for convenience sake.

The meet as a whole was run off in smooth and, considering the circumstances, efficient fashion. Credit for this smooth administrative performance goes to the judging staff and to Ed. Roberts, president of the Academy of Model Aeronautics, sponsor of the event. The competent chief judge was R. J. Thomas of Pittsburgh, with Harry Copeland, New York State AMA contest director, and Frank Zaic, noted model aviation authority, as point judges and timers.

(Continued on page 76)

¹ Good, "Winning the National Radio Control Meet," *QST*, March, 1941, p. 24.

² Bohnenblust, "New Radio Control Gear for Model Airplanes," *QST*, August, 1940, p. 9.

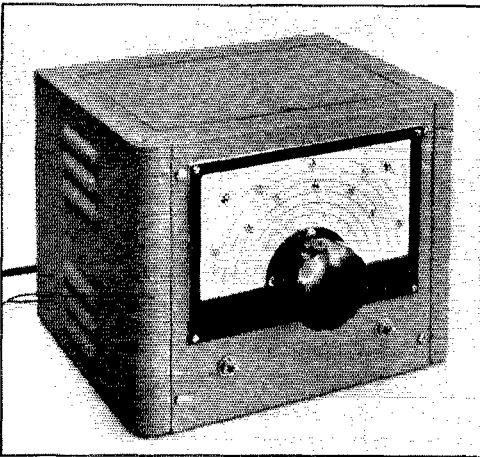

Answering many inquiries about how the new single ended u.h.f. tubes — 9001-2-3 — compare with the acorns, this article describes the construction of a converter unit for the two most popular u.h.f. bands. In a nutshell, the new tubes handle a bit differently but work just as well — and practically any amateur can afford to use them.

A Two-Band "Front End" for the U.H.F. Superhet

◆
The 2½- and 5-meter converter, complete with power supply, is mounted in an 8-by-8-by-10 cabinet. Plug-in coils give broadcast coverage of the 56- and 112-Mc. bands.

The New Miniature U.H.F. Receiving Tubes in a 56- and 112-Mc. Converter

BY GEORGE GRAMMER,* W1DF

INTEREST in the new 9001-2-3 tubes appears to be high among the u.h.f. gang, and justifiably so, on a cost basis if nothing else. Also, the new tubes have obvious mechanical advantages, since the more or less conventional base means that they can be put into and taken out of sockets much more easily, to put it mildly, than the regular acorns. The new types utilize the same electrode structures as the 944, 955, 956, respectively; the electrical differences lie in the way in which leads are brought out.

One innovation in the new types is the double cathode lead, to allow separation of the grid and plate return circuits and thus eliminate the degenerative effect of common cathode-lead inductance. The older acorns do not have this feature, so the circuit loading with the new tubes should be even less than with the acorns, since there does not appear to be much difference in overall lead length. In the triode 9002, the plate is connected to two of the base pins for convenience in circuit layout. Except for necessary additional length of leads in the socket prongs, the new base adapts itself nicely to compact circuit arrangements.

In view of the single-ended base, it is of interest to compare interelectrode capacities of the new tubes with those of the acorns. So far as input and output capacities are concerned, the

* Technical Editor, QST.

differences are quite small and can be considered negligible at least for frequencies below 300 megacycles. In the pentode types, the grid-plate capacity is rated at 0.01 $\mu\text{fd.}$ against 0.007 for the 954 and 956, an increase of some 40 per cent. This figure of 0.01 is, in fact, higher than that attained with conventional tubes which, in the glass types, runs 0.007 and in the metal types, either single or double ended, 0.005. The higher grid-plate capacity, combined with lighter loading on the tuned circuits and somewhat greater difficulty in securing good interstage shielding because of the single-ended construction, means that more care is necessary to prevent oscillation in r.f. stages than is called for with acorns. In practice this seems to be the case, although with reasonably good shielding and proper circuit constants completely stable operation can be obtained. In point of fact, oscillation troubles are likely to be encountered only when the circuit losses are low; even with only sketchy shielding it has been our experience that a "hot" r.f. stage cools off immediately as soon as an antenna is connected.

So long as good u.h.f. tubes are available, it seems only reasonable to attempt to cover more than one band with a single receiving combination. This does not seem to be general amateur practice, at least insofar as the 56- and 112-Mc. bands are concerned. One reason is the fact that

different transmitter stability requirements exist in the two bands, so that a selective receiver for 56 Mc. is practically unusable on 112-Mc. modulated oscillators. On the other hand, there are a good many stable transmitters on 112 Mc. these days, and selective receivers can be used on those signals; besides, widespread use of better receiving equipment is likely to speed up the trend toward more stable 112-Mc transmitters. A second reason for the slowness with which combination $2\frac{1}{2}$ - and 5-meter supers are coming into use probably has been the lack of suitable low-loss components for plug-in coil circuits, but this no longer is the case, since there are now available miniature plug-in forms and bases with polystyrene insulation. All of which, it seems to us, spells the desirability of a superhet which will cover both bands, with selectivity such as to take advantage of the most stable signals on the air.

The first step in building such a receiver is the development of a suitable front end, which can of course be used as a converter to work into a regular communications receiver if desired. It was partly with this in mind and partly to try out the new tubes that the unit pictured here was constructed. Although intended for later incorporation in a complete receiver, it was more convenient to consider it simply as a converter at first, hence it was built up in that form.

Circuit Notes

The circuit, Fig. 1, is quite in line with practice on the lower frequencies. The r.f. amplifier may be either a 9001 or 9003; the latter would be preferred if a v.c. is to be applied to the r.f. grid. The 9001 should give a slightly better signal to noise ratio, however, and since we did not want the a.v.c. feature the sharp cut-off type was chosen. It should be mentioned that the 9003 will give somewhat more gain, but the difference is not marked enough to warrant giving this factor too serious attention.

Coupling between the amplifier plate and mixer grid is through an ordinary transformer with an "untuned" primary. This system was used in preference to the more common (in amateur receivers, at any rate) parallel-fed plate or grid with a single tuned circuit for two reasons. First, the band is relatively narrow so that resonance in the primary is not likely to make the gain vary between wide limits, with frequency, as it might in wide-band receivers, and adjustment of the size of the primary affords a convenient method of adjusting the coupling to optimum.

Second, we were not inclined to put much dependence on the efficiency of either chokes or resistors as coupling elements at 56 and 112 Mc. With transformer coupling, series feed can be used in both the amplifier plate and mixer grid circuits, thereby reducing the tendency of unwanted r.f. to get into the supply leads.

As indicated in the diagram, the screen and plate by-pass condensers are returned to one cathode lead (the one to which the suppressor is connected) while the other lead is grounded through a condenser to serve as the grid return. In the mixer plate circuit a low-drift mica condenser, C_{14} , is connected directly from plate to cathode to short-circuit the signal-frequency component in the plate circuit. This condenser is of course part of the i.f. tuned circuit and its capacity must be taken into account in calculating the inductance required at L_7 .

The mixer and r.f. tuned circuits are made as low-C as is possible under the circumstances; the use of plug-in coils unavoidably introduces some stray capacity that would not be present if the circuits were made to operate on one frequency only. The tuning condensers are cut down to two plates each, and have just about enough capacity range to cover the 56-Mc. band with a little to spare. The trimmers are mica units operated at nearly minimum capacity so that the mica is a negligible factor in the operation of the condenser; for all practical purposes the dielectric is purely air. The L/C ratio compares favorably with those commonly attained with acorn re-

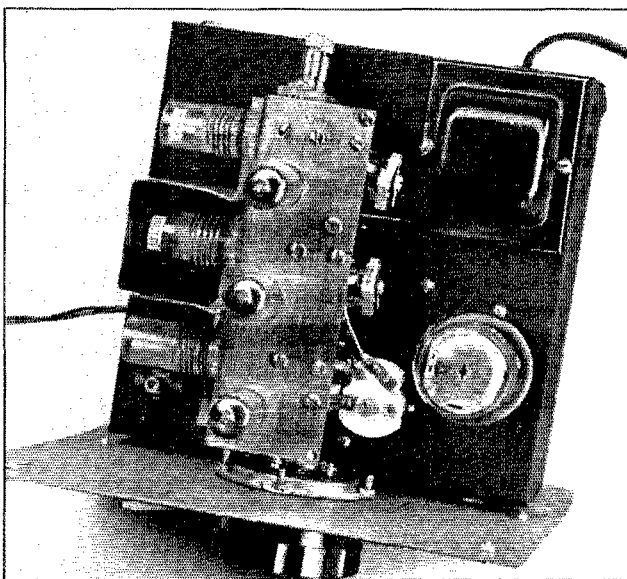

A top view, showing arrangement of tubes and coils. The shaft projecting through the main chassis at the lower left is the i.f. transformer tuning control. The power transformer is sub-mounted so it does not interfere with adjustment of the r.f. trimmer.

ceivers, even though the coils may look small; actually one of these coils, wound on a $\frac{3}{4}$ -inch diameter form with a rather high number of turns per inch, is equivalent to about a 10-turn coil of No. 12 wire double spaced and wound on a half-inch diameter form.

The oscillator circuit is of the grid tickler type, with the tuned tank in the plate circuit. The tuned circuit is made higher- C than the signal-frequency circuits to improve the stability, and as a consequence somewhat more tuning capacity is needed to cover the requisite frequency range. The tuning condenser is a 15- μ fd. unit cut down to three plates, and the trimmer is a 25- μ fd. air-dielectric job. Oscillator and mixer are coupled through a small condenser, homemade, tailored to give suitable injection of oscillator voltage into the mixer grid circuit.

The intermediate frequency is 10.2 megacycles. There seems to be no frequency below 10 Mc. which is free from all objectionable features. With i.f.'s between about 3 and 9 Mc., images from f.m. broadcasters will fall inside the band

when the oscillator is on the low-frequency side of the signal—the desirable side from the standpoint of stability. Between 9 and 10.1 Mc., harmonics of the high-frequency oscillator in the communications receiver (assuming a 456-kc. i.f.) will fall in either the 5 or $2\frac{1}{2}$ meter bands. A small region centering around 10.2 Mc. is free from both these effects. Frequencies lower than 3 Mc. are not especially desirable with this type of oscillator-mixer circuit, since pulling is considerably more in evidence than with higher-frequency i.f.'s, and of course the image ratio is poorer. This latter might not be so objectionable with an i.f. between 2 and 3 Mc. were it not for the fact that there is a television channel just outside the low-frequency end of the band.

The power supply part of the circuit needs no comment except to explain that the separate filament transformer was used simply because the smallest plate transformer we could get at the time had only a 2.5-volt filament winding. Its use was dictated by the fact that the compact chassis lay-out did not permit using anything

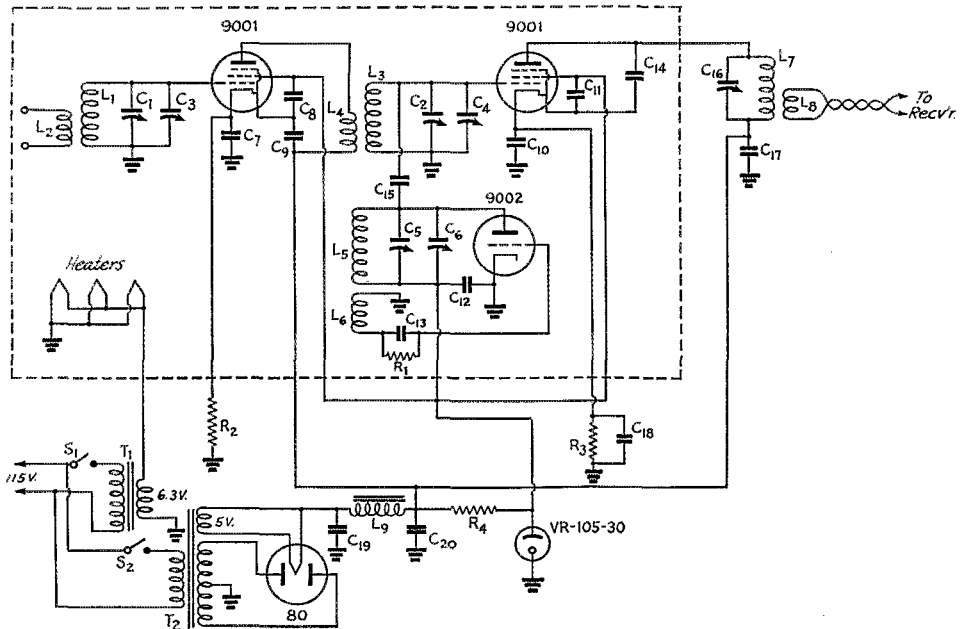

Fig. 1 — Circuit diagram of the 56-112-Mc. converter.

- C₁, C₂ — Approx. 5- μ fd. variable (National UM-15 cut down to 2 plates).
- C₃, C₄ — 3-30- μ fd. trimmer (National M-30).
- C₅ — Approx. 8- μ fd. variable (National UM-15 cut down to 3 plates).
- C₆ — 25- μ fd. air trimmer (Hammarlund APC-25).
- C₇-C₁₂, inc. — 50- μ fd. midget mica.
- C₁₃ — 100- μ fd. mica.

- C₁₄ — 50- μ fd. silvered mica.
- C₁₅ — Osc.-mixer coupling condenser (see text).
- C₁₆ — 25- μ fd. air trimmer (Hammarlund APC-25).
- C₁₇ — 0.002- μ fd. mica.
- C₁₈ — 0.01- μ fd. paper.
- C₁₉, C₂₀ — 8- μ fd. tubular electrolytic.
- R₁ — 50,000 ohms, $\frac{1}{2}$ -watt.
- R₂ — 1200 ohms, $\frac{1}{2}$ -watt.
- R₃ — 10,000 ohms, $\frac{1}{2}$ -watt.
- R₄ — 6000 ohms, 10-watt.

- L₁-L₆, inc. — See coil table.
- L₇ — 18 turns No. 22 enam., close-wound on $\frac{5}{8}$ " diam. form.
- L₈ — 8 turns similar to L₇, at ground end of L₇.
- L₉ — Filter choke, 8 henrys, 55 ma. (Thordarson T-14C62).
- T₁ — Filament transformer, 6.3 v., 1.2 amp. (Stancor P-6134).
- T₂ — Power transformer, 560 v. c.t., 30 ma. (Thordarson T-60R49).
- S₁, S₂ — S.p.s.t. toggle.

larger, plus the necessity for below-chassis mounting so that the trimmer adjusting screws would be accessible. The filament power could just as readily be taken from a 6.3 volt winding on the plate transformer as from a separate 6.3-volt unit.

Layout Details

The physical layout of the converter was dictated by the desirability of getting leads down to minimum length while maintaining reasonable stage separation. To a considerable extent it was also determined by the tuning condensers used, these being selected because they could be ganged and plates readily could be removed to give adequate bandspread. The "chassis" on which the converter is assembled is a piece of sheet copper, somewhat less than $\frac{1}{16}$ inch thick, $5\frac{1}{2}$ inches long, and bent as shown in the photographs. The width on top is $1\frac{3}{4}$ inches, the height $2\frac{1}{4}$ inches, and the bottom lip, for fastening to the main chassis, is $\frac{3}{4}$ inch wide. The tubes are mounted on top near the bent edge, allowing just enough room to insert the socket mounting ring, and are $1\frac{1}{4}$ inches apart, center to center, with the r.f. tube $1\frac{3}{8}$ inch in from the rear edge. The coil sockets are mounted on the side, $\frac{3}{4}$ inch down from the top, so that the connections between socket prongs and the tuning condenser terminals can be made directly, without additional wires. The spacing is such that the lead from the stator connection to the grid prong on the tube socket is only about $\frac{1}{4}$ inch long.

In building an assembly of this type, it is a practical necessity to do all the wiring before the tuning condensers are mounted. The inside view gives some idea of the arrangement of by-pass condensers; the chief consideration in placing them was to eliminate leads, insofar as possible. Each stage has its own ground point, which in the case of the r.f. and mixer stages is on the side of the chassis directly below the tube socket and the length of the cathode by-pass condenser away from it. The screws which hold the ground lugs in place are threaded into the copper, and on the outside also help support the vertical inter-stage shields. The oscillator ground is also on the side, but close to the cathode pin, which is grounded directly; the plate by-pass condenser, C_{13} , is brought to the same point. In the other two stages the ground leads from the tuned circuits are $\frac{3}{8}$ -inch wide strips of thin copper, this being used in preference to wire to reduce the inductance.

For electrostatic shielding between the r.f.



Inside the converter unit, showing the arrangement of tuning condensers. The layout is quite compact, every effort having been made to keep leads as short as possible.

and mixer stages two baffle plates are used. One small plate, not visible in the photograph, is fastened to the side of the chassis directly opposite the tube socket and is soldered to the shield cylinder in the center of the socket. It effectively shields off the grid wiring from the plate circuit and is about an inch square. Since it crosses the tube socket and should get as close to it as possible, care must be taken to see that the socket prongs are bent away so they cannot touch it. The other shield is almost all on the outside, and is used chiefly to prevent electrostatic coupling between the r.f. and mixer trimmer condensers, which are mounted on the sides of the tuning condensers. A transverse shield plate completely boxing off the two stages would be better, but is an awkward job mechanically in view of the necessity for assembling the condenser gang. We started out first with no shielding of this type to see what the minimum requirements would turn out to be in practice, and there is some question even now as to whether the inside shield plate actually is necessary. There is no doubt about the need for the one between the two trimmer condensers, however.

No shielding is required between the mixer and oscillator; in fact, the stray coupling is too small to give good frequency conversion. The trimmer condenser is supported from the top of the chassis by a small bracket made from brass strip, bent to such size that the rotor connection of the trimmer comes right at the rotor spring on the tuning condenser, where the two are soldered together. A small strip of copper is soldered between the two sets of stator plates, using the soldered mounting on top of the trimmer for its connection. The coupling condenser is a small piece of copper bolted to the trimmer end plate and bent to face the other soldered mounting. The separation is about a sixteenth inch.

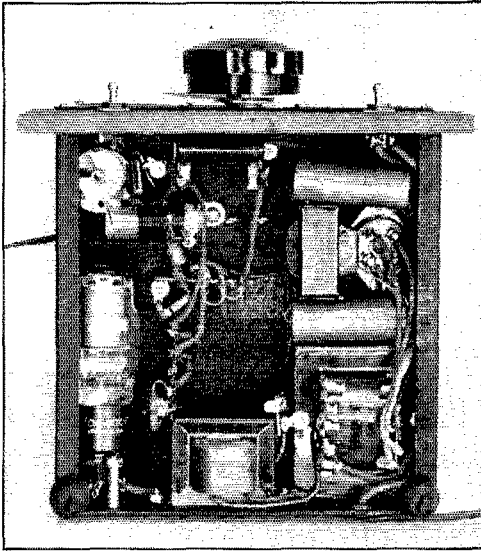

The plate power supply occupies the right-hand section of the chassis in this bottom view. The i.f. output section is in the upper left corner.

The vertical shield plates between the coils are $2\frac{3}{8}$ by $1\frac{3}{8}$, with bent-over edges to fasten to the side of the chassis. To complete the magnetic shielding the end of the mixer coil must be boxed in, which is done by a piece of copper in the shape of a shallow U, held in place simply by making it fit tightly between the vertical shields. This piece must be removable for changing the mixer coil.

Care must be used in making soldered connections on the polystyrene sockets and forms, since the material will soften with the application of heat. Have the connections well cleaned before attempting to solder, and hold the iron on the lugs just long enough to get a good joint and no longer.

The bottom view shows the arrangement of the power supply and the i.f. output circuit. The transformer for the latter is wound on a polystyrene form, not particularly to keep losses down but because forms made of this material are readily available in a variety of small sizes. It is mounted on a bracket to keep it about equally spaced from the top of the chassis and the bottom of the cabinet in which the chassis fits. The various a.c. and d.c. supply connections from the converter are brought to lug strips as shown; the cathode resistors for the r.f. and mixer stages are mounted here where they are readily accessible for trying different values. The power supply parts are simply arranged to fit in the remaining space, although the power transformer is probably in about the only spot where it could be placed without interfering with anything on top. The rubber

feet at the rear of the chassis are used to give a little space for circulation of air, since a fair amount of heat is developed by the transformers and regulator tube.

Alignment, Mechanical and Electrical

A few mechanical points should be given consideration in assembling the tuning condensers. The screw-on shafts are likely to come loose with use unless they can be anchored in some way. Soldering is about the simplest scheme — and probably about the only usable method without special tools. The heat tends to cause the lubricant to run out of the shaft bearing, however. Another important point is to get the shafts of the three condensers lined up accurately so that the rotors turn freely. While a vernier dial will give enough mechanical advantage to make the assembly turn readily, unnecessary friction is no asset. But the chief thing is that any twist, particularly at the oscillator condenser shaft, will tend to bend the rotor out of line slightly with respect to the stator, and since the twisting depends upon the direction of rotation, this means that the assembly will have bad backlash. For the same reason the dial must be lined up accurately with the condenser shafts. It is hard to give any but general directions; line up the shafts as accurately as possible, and fix the stators where they want to come on the chassis, using shims if necessary. What is really needed is a three-gang condenser having an insulated shaft, individual rotor connections, and constructed so that plates are readily removable. If the plates are small and lead inductance kept to a minimum, we'd really have something to use as a basis for a u.h.f. front end!

Alignment of the converter will involve some cut and try, using the coil specifications given in the table as a guide. It is best to line up the 5-meter coils first, before tackling the $2\frac{1}{2}$ -meter band. The first step is to make the oscillator cover the proper range, the object being to spread the band over about 75% of the dial scale. With the

(Continued on page 80)

COIL DATA					
Band	Coil	No. of Turns	Wire Size	Length Inches	Remarks
112 Mc.	L ₁	11 $\frac{1}{2}$	18	$\frac{5}{32}$	1/8" from L ₁
	L ₂	11 $\frac{1}{8}$	24	1/8	
	L ₃	11 $\frac{1}{4}$	18		1/8" from L ₃
	L ₄	17 $\frac{1}{2}$	24		
	L ₅	3/4	18		1/8" from L ₅
	L ₆	1 $\frac{1}{8}$	24		
56 Mc.	L ₁	45 $\frac{1}{2}$	18	$\frac{3}{8}$	1/8" from L ₁
	L ₂	27 $\frac{1}{2}$	24	$\frac{1}{8}$	
	L ₃	41/2	18	$\frac{1}{8}$	1/8" from L ₃
	L ₄	27 $\frac{1}{2}$	24	$\frac{1}{8}$	
	L ₅	3 $\frac{3}{8}$	18	$\frac{3}{8}$	1/8" from L ₅
	L ₆	27 $\frac{1}{2}$	24	$\frac{5}{32}$	

All coils wound on $\frac{3}{4}$ -inch diameter forms (Amphenol type 24-5H, 5 prong).

Five-Meter Wave Paths

The How and Why of 56-Mc. DX

BY MELVIN S. WILSON,* W1DEI

In Two Parts—Part II**

Tropospheric Influences

THE troposphere — the lowest part of our atmosphere, extending from the earth's surface to a height of about nine miles — is of extreme interest because, as already indicated, ultra-high-frequency waves can be bent within this space. Tropospheric refraction may take place at either or both ends of a skip contact, and thus can alter the simple skip described above. In general, useful lower atmospheric bending takes place not within a small space, but over a distance of 100–500 miles, and is consequently a continuously refractive nature. It might seem that since the troposphere is relatively thin the path of a skip wave arriving from the ionosphere could be only a few miles long before the ground is reached, but when considering the low angles of radiation necessary for the longer skip, it can be shown that the wave path must pass at least 150–200 miles through the troposphere. As the skip distance decreases, the effect of lower atmospheric bending also decreases, slowly at the low radiation angles then rapidly becoming unimportant as the angle becomes greater.

Although this bending may be slight, it obviously has a profound influence at low angles. Because of air mass movement and subsidence, temperature inversions often are present and ultra-high-frequency waves are bent towards the earth's surface. The relative position of a temperature inversion area to the wave path determines whether the maximum skip will be longer or shorter than it would be without lower tropospheric bending. If the inversion area cuts the wave plane at or just beyond the maximum one-hop distance, it will refract the wave path so as to increase the distance. Theoretically a suitable inversion in exactly the proper position would

extend the distance some 300 miles, and if such inversions occurred at both ends of the skip the distance would be increased to an overall 1850 miles. However, such a case would be extremely rare; lower atmospheric bending seldom adds more than about 200 miles to the maximum distance. On the other hand, if the inversion area cuts the wave-path plane inside the maximum distance, the skip is shortened, although the effect is less than in the case above. The various conditions are depicted in Fig. 7.

Tropospheric bending frequently appears at one end of skip, and it is likely that this is not a matter of chance. The location of a sporadic mass seems to be determined by physical means. From analysis of all reported skip the mass has with few exceptions been at a place of downward direction of general atmospheric motion, and this physical placement possibly corresponds to a warp or dent within the ionosphere. If this is true, the virtual height of the mass is less than the normal height of the *E* layer, and this fact could easily help explain the shorter than theoretical great-circle distance of five-meter skip. On the surface of the earth this physical relationship is usually manifested by precipitation directly under the mass. In general, the pressure of the troposphere is lower, and a mass rarely ever appears over a high pressure area — never, when it is well developed. These surface indications are of extreme importance when considering multiple-hop skip, since more than one mass must be present; thus general precipitation and no well-developed high pressure areas can be present over the wave path. It must be emphasized, however, that this relationship of the troposphere and the ionosphere is physical and not electrical. The appearance of a sporadic-*E* mass is in no way determined by any tropospheric condition. The important result of this physical placement of a mass is that a temperature inversion is present

* 131 Bacon St., Natick, Mass.

** Part I appeared in *QST* for August, 1941.

In this concluding part of the article more complex skip paths are examined and some practical aspects of 5-meter DX work discussed. Some of the material is necessarily speculative, since very little experimental evidence is available; the intention is to offer a reasonable explanation for observed phenomena. Aside from the valuable suggestions for bettering 56-Mc. communication, it is hoped that the theoretical concepts outlined will stimulate further constructive thinking. The subject is complicated — but it is the amateur's own field, one in which he can make valuable contributions.

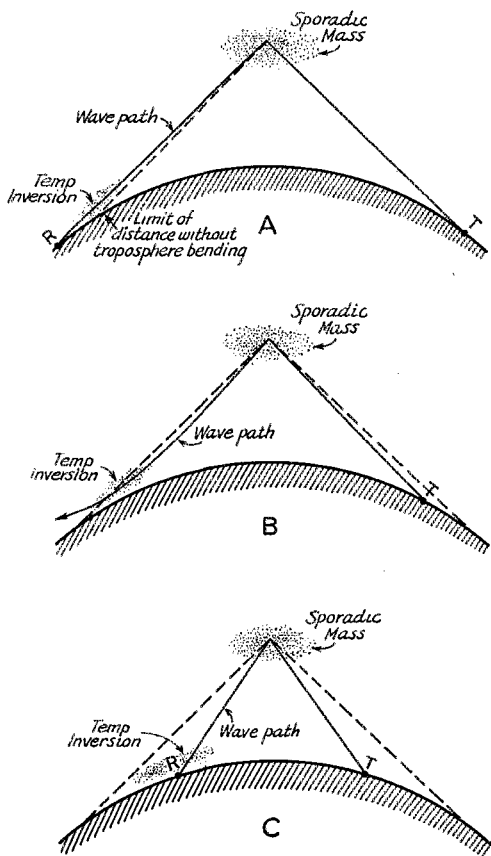

Fig. 7 — Effect of troposphere bending at the end of a skip path. At *A* the downcoming wave penetrates the region of the temperature inversion at practically horizontal incidence and is bent downward just as in the case of a wave originating on the earth's surface. In *B*, the wave arrives "on top" of the inversion, which from this viewpoint looks the same as it does from earth (i.e., the wave is travelling from a region of cooler air into warmer air), hence the wave bends away from the warmer air and away from the earth. In *C* the angle of incidence is still greater and the wave travels through the temperature inversion region because the bending is negligible.

In each case the dashed line indicates the wave path for maximum distance without the temperature inversion effects. The drawings are, of course, greatly exaggerated in scale.

at one or both ends of skip. Usually this bending area appears on the eastern end during summer and the western end during winter. North-south skip is affected at the northern end, but the magnitude of the effect is small and, except for local subsidence, can be ignored.

The influence of the troposphere can also cause another interesting phenomenon. Should there be a discontinuity in the proper position relative to the wave path, signals may travel in one direction

but not the other.⁵ This condition does not always occur, but is noticed frequently during skip. The complete phase, should the discontinuity appear at the eastern end of skip, is first for west to east travel only, then two-way transmission, finally east to west only. The complete cycle appears only once for any given location, and may last for a period as long as an hour. The distribution of time is not evenly divided into the three parts. Usually the opposite one-way transmission periods are the same in length of time and equal to about half the duration of the two-direction period. If the skip signals are still present after this cycle, normal reciprocal wave paths again appear until the skip is over.

Polarization

The polarization of a received signal refracted from a sporadic mass has little relation to that of the transmitting antenna, but is determined by the mechanics of bending within the mass and the relative position of the mass to the transmitting and receiving areas. Probably because of the magnetic influence of the earth, a five-meter wave path seems subject to a separation into several paths upon its penetration of the mass, and each path thus assumes a different phase velocity.⁶ The resultant signal contains all degrees of polarization, and for a restricted receiving area is circularly polarized, but because of the unstable character of the mass the useful area of the circularly polarized waves is small. Outside of this area the polarization seems to tend toward either horizontal or vertical depending upon the great-circle distance and the tilt of wave-path plane. From observation it appears that the component of polarization lying within the wave-path plane is bent more than other polarization at an angle to the plane. Thus for both transmitting and receiving when the wave-path plane is perpendicular to the earth's surface, horizontal polarization is the better for greater than normal distances (i.e., the bending is less) and vertical polarization for less than normal distance. As the wave-path plane becomes tilted, however, polarization considerations change, and only that polarization giving greatest bending is useful. Although the critical polarization never actually reaches the horizontal, in this tilted case a horizontally polarized system is very effective. The vertical component is usually at angles less than the angle required for returning to earth and is thus lost.

Vertical Angles

Since all skip signals must arrive at the receiving location via the highly ionized mass, the

⁵ This effect probably is similar to a comparable phenomenon occurring in the transmission of sound waves. See Tyndall, "Sound," D. Appleton Century Co., New York.

⁶ Phase velocity is the rate of change of phase along the wave path, and may differ considerably from the signal velocity.

direction and vertical angle of the received wave are naturally dependent upon the position of the mass relative to the receiver. When the wave-path plane is normal to the earth the true direction and the observed direction of the received signal coincide, but as the plane becomes tilted the observed direction will shift to one side. The maximum possible deviation from the true bearing is theoretically 90 degrees, but this would require pure reflection. The maximum shift observed has been about 40 degrees. The usual amount is small, and only with special equipment and full knowledge of polarization and wave-angle considerations can signals be heard beyond about 25 degrees from true bearing.

If the mass is within the tangent plane low vertical angles must be used for all signals. As the distance to the mass decreases the angle will slowly increase, but it cannot become greater than 10 degrees less than the total amount of bending within the mass. Since the maximum bending reported to date has been about 38 degrees, the maximum angle probably has never been above 28 degrees. Such a high angle would permit communication via a mass only about 100 miles from the receiving location, and this condition is rarely possible. The more usual distance of about 400 miles requires about five degrees, assuming "normal" tropospheric conditions, and seldom will the angle become greater than a maximum of 10 degrees for single refraction skip. In general the lowest angle possible will be best for the majority of skip. Although in the above the receiving location was used for illustration, it should be understood that the same requirements are necessary for the transmitting angle of radiation.

Interpreting Conditions

To present a picture of five-meter skip phenomena it was necessary to center attention at the ionized mass, then visualize in three dimensions the various possible wave paths and the resulting change in the locus of the transmitting and receiving areas. It was assumed that a mass was present and its location more or less fixed, and the transmitting and receiving areas shifted with time and density of the mass. This is about what actually takes place, but the operator is at a fixed point on the earth and can observe only the end view of the skip. From his point of view, he must endeavor to visualize the complete picture from the indications he can gather. He must determine first whether a mass is within useful distance, then find the actual direction and distance of the mass relative to his location. With these two facts, he can then use the proper polarization, direction and wave angle for any unusual contacts he might wish to make.

If a sporadic mass is within useful range, its presence is obvious if there is any activity at the proper distance and direction. If no signals

are heard, it is difficult to know of the existence of a mass. Some operators, however, can guess quite accurately by observing an increase in the background noise in the receiver. Another indication is the decrease in signal strength of stations 25-50 miles distant. A means of measuring this change is usually necessary, but the added equipment is well worth while in any case. Until the signal strength of such stations returns to normal value, conditions are suitable for skip. Especially useful is this indication at the end of a skip period, for many times unusual skip can be heard after most skip signals have faded out and before the signal strength of local stations returns. If the mass appears below the tangent plane, and no lower tropospheric bending is present, there is no indication of its existence by listening on the band. Of course a mass in this position is not useful, but the DX man, if he knew it were present, would stand by hoping to work the "fringes." A most helpful indication can be obtained by listening at lower frequencies, and with many commercial and police radio stations between the five- and ten-meter bands, it is frequently possible to find the highest refracted frequency and to determine whether this frequency is increasing or decreasing. By listening in the ten-meter band, observing the locations of the stations heard and the locations of the stations they are working or calling, an approximation to existing conditions can be made if care is used.

Short skip on the ten-meter band is caused by the same conditions which give five-meter skip, and the actual relation between the two is a simple one. The lower frequency, of course, is refracted the greater amount, and from a side view it is easy to see what takes place. From an operating point, however, only the end view of skip is observed, and this simple relation becomes very complicated. A general rule used by many operators is that when ten-meter skip creeps close, five-meter signals become refracted in the same direction. This rule is often true, but by no means can it always be true. A sporadic mass suitable for five-meter skip is usually surrounded by ionization high enough to refract ten-meter signals. If the mass is located some 400 miles away, it becomes possible for five-meter skip to be *shorter* than ten-meter skip. That is, the ten-meter signal can be refracted in the less dense ionization in the outer part of the mass and never penetrate to the more highly ionized core, hence the bending is comparatively small and the signal travels a longer distance. The five-meter signal, on the other hand, will penetrate the outer ionization, only to be refracted at a sharper angle in the high ionic density of the core. A similar possibility exists in the case of a ten-meter signal refracted from the side of a mass (tilted wave-path plane) when the five-meter signal is refracted without tilt. In this case the ten-meter

skip will be longer and in a different direction than the five-meter skip. It can also be shown that short skip on ten meters is possible in all directions, yet five-meter skip is not possible. These possibilities are obvious if conditions are diagrammed. Generally a vague relation exists but it cannot be relied upon except in very rare cases. However, listening to ten-meter signals can be very useful if judgment is used in drawing conclusions, and often a suspected mass can be located quickly by observing ten-meter conditions. If a ten-meter station some 500-600 miles distant is in contact with another, and the separation of the two is not very great, the five-meter operator could assume a mass somewhere between them.

After the existence of a useful mass is known, the direction and distance must be determined. With a horizontally sharp beam and necessary care in its use the direction can easily be found. The wave angle is about the only way of actually determining the distance, and the measurement of this angle is extremely difficult without the use of proper equipment. The ground characteristics at the time must be known, unless a double antenna system is used, and thus other than average equipment is necessary. Simply tilting the antenna will not give the actual angle. A practical solution can be found, however, by carefully considering the locations and great-circle distances of the skip heard in relation to the observed direction. If a station is heard whose location is close to maximum distance, the direction of the signal received and the true direction must be very close, and the mass must be close to the middle of the skip. Lower tropospheric bending may alter this somewhat, but the operator should know whether bending is present at his own end, and by following weather disturbances should be able to approximate conditions at the other end of the skip. As the great-circle distance of skip becomes less, it becomes increasingly difficult to find the distance to the mass. If the mass is small and the stations heard are at least a hundred miles apart, the approximate distance can be found by observing the direction and polarization of the signals. Should only one station be heard, there can be no solution unless the wave angle is known. As the mass increases in size, the need for knowing the distance becomes of less importance, but it should be roughly known nevertheless. In any case stations as far apart from each other as possible should be used when finding this distance to the mass.

Double Skip

Although single-refraction skip is the usual type taking place during a sporadic *E*-layer condition, double refraction occasionally occurs. This is of extreme importance to the WAD and WAS DX men since it allows contacts which never could take place by a single refraction.

Double skip becomes rather complicated, however, and it must be emphasized that an operator must understand the single-refraction skip before attempting a study of this type. The following discussion will be mainly theoretical since few data are available. Since there is an infinite number of possible wave paths when considering double skip the discussion will be limited to certain types, and it is assumed that the reader will realize that the following is very elementary.

Much confusion arises when considering double skip because no good definition has been offered. For this reason the following is suggested: *A double skip is a wave path which is reflected or refracted twice within the ionosphere.* Considering this limitation it is easily seen that there are three possible types of wave paths: (1) those which require reflection from the earth at the mid-point, (2) those which are refracted within the troposphere and thus do not reach the earth at mid-point, and (3) those which are bent only twice and thus jump between masses. These three types are shown in Fig. 8. The maximum great-circle distance covered by the skip occurs when the three types are coincident, and the path lies close to the tangent plane at the mid-point. A wave path of double skip rarely if ever lies below this tangent plane, as it can for single skip, since lower tropospheric bending does not take place in the proper relation. Thus the maximum distance is simply the addition of one maximum single skip to another. This assumes that two separate masses are present and that they are spaced just the proper distance from each other and from the transmitting and receiving areas. Such a critical condition is rare and has been reported only a few times during the past six years. Shorter double skip, however, is much more frequent, and the reason is obvious. The minimum distance covered by double skip is theoretically zero for pure reflection, but as in the case of single skip this will probably never occur. The shortest distance ever reported was about 1000 miles, but even this is unusual and the average is well beyond this distance.

The first type, or *A* in Fig. 8, is no doubt familiar to all since it represents the usual explanation of double skip on the short waves. The wave path starting from the transmitting antenna at *T* travels to the first ionized mass, is bent to earth where it is reflected to the second mass, and is returned to earth at receiving area *R*. Reflection takes place at *O* due to the discontinuity at the mid-point. Since the earth is not a good five-meter conductor, energy is lost at this point. Waves on the surface of water and irregularities on the surface of the earth also cause a loss of energy with respect to the useful wave angle. At maximum skip no reflection takes place.

The second type of wave path, *B*, is similar to type *A*, but is different in that the wave path strikes the earth at only two areas. The advantage

of this type lies in the fact that there is less absorption and diffusion. This type is only possible with the longer double skip since it is limited by the amount of refraction within the troposphere. This refraction is usually higher than average when double skip is present and for this reason the maximum skip is usually less than expected for any given conditions. The refraction, of course, is just the reverse of the positive temperature lapse rate bending necessary for extended lower atmosphere work.⁷

Type *C* has only two areas of bending and is thus the least affected by factors introducing loss of energy. The wave path from the transmitter is refracted in the first mass only enough to allow it to reach the second mass from which it is returned to earth. This type can exist from theoretical limits of maximum double skip to minimum single skip, and thus is the best of the double skip types if properly used. Although many times this type requires the use of a high angle of radiation and reception this must not be considered necessary, since as in the case of single skip the distance of the mass from the transmitting or receiving area determines the angle. Another advantage of this type of skip is that less bending is required at either mass, and it is thus possible to work double skip when single skip is impossible.

Except in the case of type *C* double skip, the wave paths form two approximate wave planes which are usually not coplanar. It is impossible to enumerate the resulting limitations within this discussion, but these can be found by applying the principles of simple skip. It must be remembered, however, that some deviation from the theoretical considerations takes place in double skip because of diffusion and imperfect reflection. Other factors which have but slight influence upon single skip become noticeable when considering

⁷ It corresponds to the type shown at *B* in Fig. 7.

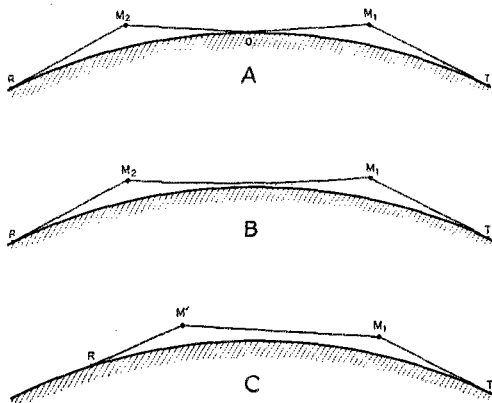

Fig. 8 — Three possible types of double skip. Type *A* involves direct reflection from the earth; type *B* upward refraction in the troposphere; type *C* a direct upper-atmosphere path between two sporadic masses.

double skip. Type *C* double skip, of course, has no wave plane and thus is not subject to wave plane limitations.

The polarization of double skip is extremely complicated and cannot be determined unless conditions become stable for a suitable time. In general, if the type of skip is known the more useful polarization can be guessed. As in the case of single skip the choice of polarization is determined by the difference between the average amount of bending present and the desired amount of bending. If the difference is positive (i.e., less bending desired) other factors being equal, horizontal polarization seems better, and if negative (more bending desired) vertical seems better. This difference for double skip is difficult to determine, since it must represent the summation over the entire wave path. Usually the controlling factor seems to be what the conditions are at the mid-point. For the longer skip it is desirable to have the major wave path refracted rather than reflected within this area since the energy loss will be less. If the troposphere is homogeneous at the mid-point, vertical polarization is usually necessary because of its greater bending, unless the nearer mass is very highly ionized. If conditions such as shown in Fig. 7-B exist, the choice of polarization depends almost entirely upon the distance from the mid-point to the second mass, since the wave path is refracted away from the earth's surface. For type *C* skip the polarization is determined by the relative positions of the masses and the amount of bending in each, and thus is similar to single skip considerations except when attempting a zig-zag wave path. Horizontal polarization almost without exception is required for this latter case.

Wave angle (radiation angle) considerations for double skip are the same as for single skip except for type *C*, which allows much higher values. Even in this type, however, the angle depends upon the distance from the antenna to the nearer mass. The higher values for this type become possible only because the mass may be much closer to the antenna and still be useful since less bending is required. When considering the limited wave angles and directions of skip wave paths, the advantage of concentrating energy at a definite area is very apparent. The use of antennas giving beam directivity both vertically and horizontally results in much higher efficiency. When more than one type of wave path is possible the proper choice of polarization and wave angle usually results in a reduction of fading.

Multiple Refractions

Multiple ionospheric refractions, or more than two refraction areas within the ionosphere, are quite possible, and although practically all five-meter skip analyzed over the past six years can

(Continued on page 84)

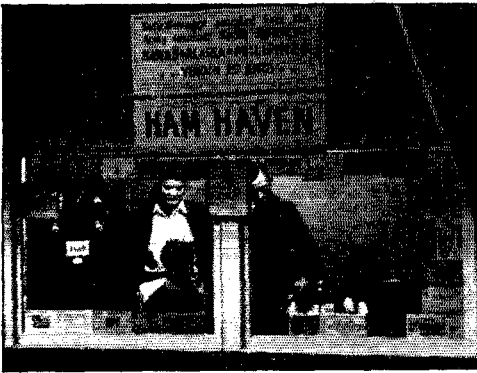

Ham Haven

A New Idea for Amateur Groups

BY DOT BEARDSLEY,* W4DEN

Ham Haven sponsored a booth at the Lake County (Fla.) fair. Left to right, standing: Bud Beardsley, W4DEN; Tracy Cramer, W4DXH; sitting, Ken Glass, W4AHK.

IN FLORIDA, on a wooded hillside sloping gently to the white sandy shores of a vivid blue lake, is a haven for hams.

Recently incorporated, and with a rapidly growing membership, Ham Haven, Inc., is an organization of, by and for amateur radio operators and their families. "The general purpose of this corporation," quoting from Section Two of the charter of Ham Haven, "shall be to foster, establish and maintain fellowship and personal contact among the amateur radio operators of the U.S.A.; to promote the high standards of ethics inculcated in the Amateur Radio Operator's Code of Ethics; and to cooperate in the training program of the various branches of the armed forces of the U.S.A. as related to amateur radio operators."

The idea of Ham Haven originated among members of the Knights of the Kilocycles, a group of hams in Florida and Georgia who QSO Sundays on 3910 and who frequently gather at hamfests. Heretofore, one problem puzzling the Knights has always been "where to have the next hamfest." In a conversation between W4DU, W4AKI, and W4ACZ, one inspired Knight asked, "Why don't we get a place of our own?" 3910 squealed with heterodynes of delighted assent. And at the next meeting, W4AKI read the following proposal:

"We do hereby propose that Ham Haven, Inc., be established by the hams of Florida, with the building of a camp—location to be

* Mt. Dora, Fla.

decided upon by a committee—somewhere in the central part of Florida, preferably on a lake or river. The idea being that the acreage have enough timber to build—this summer, or at the first opportunity—a log cabin for an administration or central building, with small cabins to be built with donations received from individuals or manufacturers. These small cabins shall be named for the person or concern so sponsoring them. The start of this project shall be handled by the Knights of the Kilocycles, and at such time as is deemed proper, other organizations are to have a part. The use of buildings, property, etc., shall then be administered by a committee chosen from these groups. It is suggested that W4CLW, W4DEN,

W4AHK, W4CNZ, and W4CPG be chosen to act as a location committee. After establishment, members will have the privilege of camping, with only the actual expense of such camping. However, other hams may use the camp by paying a small fee to be fixed by the administrative committee."

This proposal was met with enthusiastic approval by all members and work began immediately. It was decided to incorporate and proceed in a businesslike manner. W4AHK, at Eustis, contacted an attorney, Mr. Harry Gaylord, who is on the way to becoming a licensed operator, and who enthusiastically agreed to act gratis as attorney for Ham Haven. A scenic spot, ideal from every angle, was soon secured. The gang was informed at the next Sunday meeting and they



This shot was not taken for the Liars' Contest, but is an actual "in action" of the famous jumping bass at West Crooked Lake.

promptly decided to have a hamfest at this chosen site in order to have a business meeting, adopt a charter, and find out for themselves whether or not the location committee had exaggerated the charms of this property. Evidently the committee had not, for the gang chorused their delight and approval of the site.

What the committee had found was ten acres of woodland fronting on West Crooked Lake, just outside the city of Eustis, in Lake County, central Florida. Ten acres of large oak trees and majestic pines on a hillside gently descending to the white sandy beach of West Crooked Lake; ten acres of semi-tropical beauty. And in the center of the property the gang discovered a natural amphitheater, ideal for hamfests. West Crooked Lake is a mile long and almost a mile wide and affords excellent sailing, boating, fishing and swimming. It is the lake mentioned in an article appearing recently in *Field & Stream*, telling of the jumping fish.

Across the lake from Ham Haven lives Mr. Stanley Nelson, who regularly feeds a ten-pound bass which jumps clear of the water to snatch food from the hand of its benefactor. We have had the pleasure of taking a picture of this thrilling performance of the big black bass.

A short canal connects our lake with a slightly larger lake, thus permitting interesting boat trips. And the gradual slope of the white sandy bottom is a swimmer's delight, safe for children and waders and inviting to those more daring and adept who like to swim out a bit. High on a hill overlooking both lakes is the Lake County Country Club where those who would golf may pursue the little white ball.

At the organization meeting, after the tall pines had been eyed, inspected, and favorably compared to antenna poles, the following officers were elected: president, Captain G. C. Cole, W4CLW; first vice-president, J. M. Smith, W4CNZ; second vice-president, M. L. Patterson, W4WS; business manager, Orville Cheatham, W4DU; secretary-treasurer, H. K. Glass, W4AHK. The board of directors consists of the above-named and in addition: A. Litschauer, W4ACZ; F. E. Bassett, W4AKI; Captain D. W. Phillips, W4CRA; George P. Aldrich, W4FGX; William C. Shelton, W4ASR¹; and F. C. Beardsley, W4DEN.

One certificate of stock or membership entitles the holder to all the privileges of membership and an equal part in the ownership of Ham Haven, Inc. At present these memberships cost five dollars each and are issued only to licensed hams and

¹ At the annual meeting of the ARRL Board, Mr. Shelton, director of our Southeastern Division, proposed that the League sponsor "Ham Haven" as part of amateur radio, to advance the recreation side of the amateur and to put an official OK on it as a purely ham project. The Board appointed him chairman of a committee which is now studying the desirability of approval or sponsorship by the League. — Ed.

are not transferable. The money is used entirely for the development and improvement of Ham Haven, as time and efforts have all been donated. When the property becomes more valuable, the certificate of membership becomes more valuable, and an increase in price of memberships was foreseen at the last meeting of the board of directors.

In the near future we shall be in a position to offer an ideal vacation spot for the hams in Florida and the rest of the country — a haven for hams, where ham radio facilities are excellent, where the climate is comparable to Eden, where the natural beauties of a semi-tropical land are breath-taking, and where you can swim, fish, sail, "ham it," or just bask in the sunshine.

Connecticut State Convention

(New England Division)

**Bridgeport, Conn., September
27th-28th**

THE Bridgeport Amateur Radio Association invites first district amateurs to a Connecticut State Convention to be held in their city, September 27 and 28, 1941, at the Hotel Stratfield. Saturday afternoon will be devoted to technical discussions and demonstrations, followed by free refreshments. After a Dutch treat supper, there will be a party, including dancing and entertainment. Sunday morning's program will include meetings for various traffic, operating and military groups, and an open forum session; the banquet is scheduled for 2:00 P.M. to allow distant visitors to return home by day travel. Registration fee, \$3.50, and a special ticket at \$5.50 for hams with XYLs. For reservations or further data, write Co-chairman Gilbert F. Williams, W1APA, Route 1, Bridgeport.

The Chief Signal Officer of the Army, Maj. General J. O. Mauorgne, says . . .

Ultra-high-frequency portable or movable *self-powered* apparatus will be of extreme value in the future, and every amateur possessing such apparatus in working order will be mighty glad he has it.

There is a tip for you fellows from high up. We'll add a couple of our own. Spot-frequency nets connecting nearby towns are going to be of maximum importance. If you can get a buzzer in front of the mike, for A-2 also, so much the better. And don't count on B-batteries; they may not be available in smaller sizes. Plan your gear to be independent of both commercial juice and B-bats.

★ WHAT THE LEAGUE IS DOING ★

ELECTION NOTICE

To all members of the American Radio Relay League residing in the Atlantic, Dakota, Delta, Midwest, Pacific and Southeastern Divisions:

YOU are hereby notified that, in accordance with the constitution, an election is about to be held in each of the above-mentioned divisions to elect both a member of the ARRL Board of Directors and an alternate thereto for the 1942-1943 term. Your attention is invited to Sec. 1 of Article IV of the constitution, providing for the government of ARRL by a board of directors; Sec. 2 of Article IV, and By-Law 12, defining their eligibility; and By-Laws 13 to 24, providing for the nomination and election of division directors and their alternates. Copy of the Constitution and By-Laws will be mailed any member upon request.

Voting will take place between November 1st and December 20, 1941, on ballots that will be mailed from the headquarters office in the first week of November. The ballots for each election will list, in one column, the names of all eligible candidates nominated for the office of director by ARRL members residing in that division; and, in another column, all those similarly named for the office of alternate. Each member will indicate his choice for each office.

Nomination is by petition. Nominating petitions are hereby solicited. Ten or more ARRL members residing in any one of the above-named divisions may join in nominating any eligible member of the League residing in that division as a candidate for director therefrom, or as a candidate for alternate director therefrom. No person may simultaneously be a candidate for the offices of both director and alternate. Inasmuch as the by-laws were recently amended to transfer all the powers of the director to the alternate in the event of the director's death or inability to perform his duties, it is of as great importance to name a candidate for alternate as it is for director. The following form for nomination is suggested:

Executive Committee

*The American Radio Relay League
West Hartford, Conn.*

We, the undersigned members of the ARRL residing in the Division, hereby nominate, of, as a candidate for DIRECTOR; and we also nominate, of, as a candidate for ALTERNATE DIRECTOR; from this division for the 1942-1943 term.

(Signatures and addresses)

The signers must be League members in good standing. The nominee must have been both a member of the League and a licensed radio amateur operator for a continuous term of at least four years immediately preceding receipt by the Secretary of his petition of nomination, except that a lapse of not to exceed ninety days in the renewal of the operator's license and a lapse of not to exceed thirty days in the renewal of membership in the League, at any expiration of either during the four-year period, will not disqualify the candidate. He must be without commercial radio connections: he may not be commercially engaged in the manufacture, selling or renting of radio apparatus normally capable of being used in radio communication or experimentation, nor commercially engaged in the publication of radio literature intended, in whole or part, for consumption by licensed radio amateurs. Further details concerning eligibility are given in By-Law 12. His complete name and address should be stated. The same requirements obtain for alternate as for director. All such petitions must be filed at the headquarters office of the League in West Hartford, Conn., by noon EST of the 20th day of October, 1941. There is no limit to the number of petitions that may be filed on behalf of a given candidate but no member shall append his signature to more than one petition for the office of director and one petition for the office of alternate. To be valid, a petition must have the signatures of at least ten members in good standing; that is to say, ten or more members must join in executing a single document; a candidate is not nominated by one petition bearing six signatures and another bearing four. Petitioners are urged to have an ample number of signatures, since nominators are frequently found not to be members in good standing. It is not necessary that a petition name candidates both for director and for alternate but members are urged to interest themselves equally in the two offices.

Classification of members into Full Members and Associates is still in process, occurring at time of renewal throughout the coming year.

ARE YOU LICENSED?

When joining the League or renewing your membership, it is important that you show whether you have an amateur license, either station or operator. Please state your call and/or the class of operator license held, that we may verify your classification.

Members possessing certificates of Full Membership, and members not yet classified and holding valid old-style membership certificates, may nominate candidates, or may stand as candidates if otherwise eligible. But members holding certificates of Associate Membership are not eligible to either function.

Present directors and alternates for these divisions are as follows: Atlantic Division: director, Walter Bradley Martin, W3QV; alternate, Herbert M. Walleze, W8BQ. Dakota Division: director (removed from division), Fred W. Young, W9MZN; alternate (acting director), Adolphus A. Emerson, W9ITQ. Delta Division: director, E. Ray Arledge, W5SI; alternate, E. H. Treadway, W5DKR. Midwest Division: director, Floyd E. Norwine, Jr., W9EFC; alternate, Samuel C. Wallace, W9FAM. Pacific Division: director, J. L. McCargar, W6EY; alternate, Elbert Amarantes, W6FBW. Southeastern Division: director, William C. Shelton, W4ASR; alternate (now removed from division), Bennett R. Adams, jr., W4EV.

These elections constitute an important part of the machinery of self-government in ARRL. They provide the constitutional opportunity for members to put the direction of their association in the hands of representatives of their own choosing. Members are urged to take the initiative and to file nominating petitions immediately.

For the Board of Directors:

K. B. WARNER,
Secretary

RENEWING LICENSES

REMEMBER Order 76-A, which extended licenses until September 30th if proper application for renewal had been filed, etc.? Well, it's not being renewed. FCC has caught up in its work and is able to do its part now. But amateurs who are late in filing applications for renewal, or who make incomplete applications and showings of citizenship, will almost certainly have to go off the air while awaiting their new tickets — and through no fault of FCC. Regulations require you to file renewal applications sixty days before expiration. The Licensing Section is entitled to that much time. Give yourself leeway for correspondence in case there is anything the matter with your papers. If you don't want your operating interrupted, file those applications sixty days before expiration!

EXAMINATION POINTS

COMMENCING in October, the examinations at Pittsburgh will be held during the months of October, January, April and July — which is one month later than previous practice.

Examinations at Cleveland (541 Old Post Office Building) are now held on the first and third Fridays and Saturdays of each month — and at other times by appointment.

FCC on July 1st established a suboffice at Beaumont, Texas, as a branch of the Galveston office. Amateur examinations are given in Room 329, Post Office Building, Beaumont, on the first and third Thursdays of each month and at other times by appointment. Establishment of Beaumont as a regular examining point means no more Class C licenses to amateurs within 125 miles thereof.

It also means that all Class C amateurs living within 125 miles airline from Beaumont must qualify for Class B before November 1st or forfeit their licenses. See Sec. 12.45 of our regs and the discussion thereof on page 29 of August *QST*. To insure remaining on the air, all such amateurs should go up for the Class B examination as quickly as possible. It may be taken at any examining point.

Alaska has become FCC District 23, with headquarters at Juneau. All amateur matters there should now be handled with Juneau and no longer with Seattle. However, Alaskan amateurs are not obliged to go to Juneau for examination, but may get envelopes for either Class C or Class A through any Signal Corps officer.

Vermont State Convention

(New England Division)

Burlington, Vt., October 4th

THE fourth annual Vermont State Convention, sponsored by the Burlington Amateur Radio Club, will be held at the Hotel Vermont, Burlington, on Saturday, October 4, 1941. Speakers, exhibits, code and liar's contest; skit by club members; dancing; Vermont turkey dinner with all the fixings, held on the Roof Garden. Advance registration, \$1.50. For further information write to Burtis W. Dean, W1NLO, P. O. Box 81, Burlington, Vt.

Southwestern Division Convention

**Hotel Huntington, Pasadena, Calif.
August 30th-31st, September 1st**

SOUTHWESTERN DIVISION members are requested to note the change in location, made necessary by the unavailability of meeting facilities in San Diego on the convention dates. Registration fee, \$3.30. For reservations or further information write Director John E. Bickel, W6BKY, 801 East California St., Whittier, Calif.

• For the Junior Constructor —

A 50-, 100- and 1000-Kc. Oscillator for Band-Edge Spotting

THE FCC regulations require that every amateur have means for measuring his frequency but they purposely set no tolerances. This puts it up to the amateur to work no closer to the edges of the bands than his frequency-measuring equipment is good for, and if he wants to use his receiver for a frequency-checking device he is at liberty to do so. The oscillator to be described is a handy little gadget that allows the receiver to be recalibrated at any time to within a kilocycle at 14 Mc. and proportionately less at the lower frequencies. No great claims are made for the inherent long-time stability of the oscillator but, by checking it against WWV or a local b.c. station at the time the measurements are made, excellent results can be obtained over the period of measurement. Three fundamental oscillator frequencies are available in this unit — 1000, 100 and 50 kc. — and the harmonics of these frequencies are listened to and used as check points. The 1000-kc. harmonics are useful for spotting the edges of amateur bands that are exact mul-

tiples of 1000 kc. and also for finding intermediate spots between the bands when listening for one of the other services. The 100- and 50-kc. harmonics are used to spot the other edges of the bands, and they are properly identified by the 1000-kc. harmonics. For example, switching the oscillator to the 1000-kc. position will give signals in the receiver at 1000, 2000, 3000, 4000, 5000, 6000, 7000, etc., kc. down through the spectrum. Having spotted, let us say, the harmonic at 7000 kc., switching to the 100-kc. position will still give a signal at 7000 kc. and also others at 7100, 7200 and 7300 kc. Having thus spotted these points on the receiver, the 50-kc. range can be switched in to give signals at 7000, 7050, 7100, 7150, 7200, 7250 and 7300 kc.

The Circuit

The oscillator is an electron-coupled affair using a 117L7GT, as can be seen from Fig. 1. The 117L7GT, which is a rectifier and beam tube combined in the same envelope, allows the oscillator to be built with its own transformerless power supply, thus adding to the economy and convenience of the unit. A switch is used to select the proper frequency range, and a variable condenser controlled from the panel allows the frequency to be set exactly during operation. A power switch is provided for cutting the plate supply, to help in identifying the signal. The power supply filter is a resistance-capacity affair which has the merit of being inexpensive and compact. The signal is not a pure d.c. T9 note (particularly in the 30- and 60-Mc. ranges), but it is not too broad to prevent zero-beating with it, and the slight modulation helps in identifying it. The output of the oscillator is taken off from the plate through a small coupling condenser.

Since the unit is not isolated from the 115-volt line by a power transformer, there would be danger from shock from the chassis if the single-wire connection to the power line weren't used. However, this oscillator is always safe because if the plug is put into the line socket wrong the tube heater won't light. When it is plugged in correctly, the return path is through the ground wire which can be any convenient connection to a water pipe or other external ground.

Construction

The oscillator is built in a 3- by 4- by 5-inch steel case, using one of the 3- by 5-inch faces for the panel. This allows both sides to be removed during wiring, a necessity because of the small

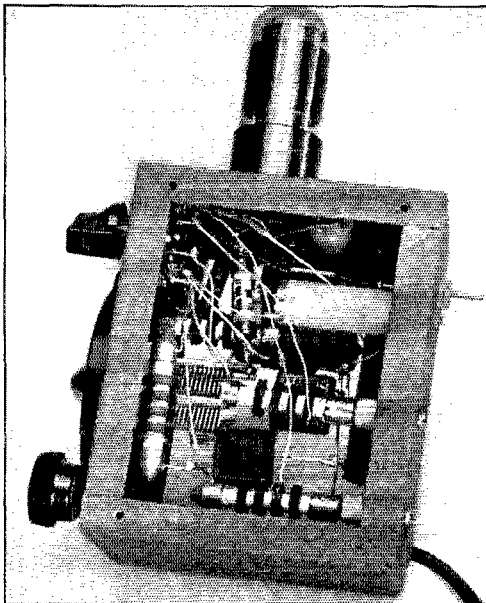

A shot of one side shows the arrangement of the inductances for the three tuning ranges. The long cathode leads running from the inductances are tied down at convenient points by drops of Duco cement. The 1000-kc. coil is at the top and the 100-kc. coil is in the center. Note that the 50-kc. inductance consists of two r.f. chokes at right angles.

An oscillator capable of delivering harmonics of 50, 100 and 1000 kc. throughout the communications spectrum is a handy adjunct to any amateur station, since it can be used for spotting band edges and for more accurately calibrating one's receiver over the entire range. The oscillator described here is inexpensive, self-contained and easy to build and adjust.

space available. Reference to the photographs will give a general idea of the placement of the parts. The dial is mounted on the panel low enough to make room for the two switches above it, and the tuning condenser is supported on the front panel by small mounting pillars that are furnished with the condenser. A National TPB threaded polystyrene bushing runs through a hole at the back of the box and is used as the output terminal, and the line cord is brought out through a rubber grommet at the bottom rear of the box. The line cord is split, and one wire goes to the plug and the other to ground.

When wiring the unit, it is suggested that the heater leads, power supply filter and by-pass condensers be wired in first, followed by the other leads to the socket and the tuning condenser. The wiring takes a bit of planning, with the thought in mind of leaving a maximum of room for the inductances and their padding condensers.

As can be seen from the parts list in Fig. 1, the inductances for the 50- and 100-kc. ranges are small r.f. chokes with suitable cathode taps brought out. The taps are made by loosening a turn of wire between the correct two pies, cutting and unwinding one turn and then soldering a short length of fine wire (the No. 34 d.c.c. used on L_1 will do nicely) to the cut ends. A drop or two of coil dope or Duco household cement will fasten the tap back to the pie and prevent the coil from unwinding. The 1000-kc. inductance is wound on a National PRE-3 form, with the ends fastened to the form by spots of coil dope or Duco cement. The cathode tap is made by twisting a loop of the wire together at the proper turn and then continuing the winding.

Adjustment

Since the fixed mica condensers used as padding capacities in the tank circuits are manufactured with some 10% or more tolerance, there is an excellent chance that the first condenser one tries will not bring the circuit into the proper range. However, it is not a difficult matter to try several condensers of the proper rated capacity until one is found that brings the circuit within the range. The condensers do not have to be soldered into the circuit to try them, and if you know your radio dealer well enough he might let you try a few until you hit the right value.

It is suggested that the 100-kc. range be adjusted first. The calibration of a broadcast or communications receiver should be checked in the broadcast range by comparison with the local b.c. stations, and it can then be used for a rough check on the 100-kc. oscillator. Connect a wire to the output terminal of the oscillator and lay it near the antenna terminal of the receiver and then plug in the oscillator cord to the 115-volt line. While the heater is warming up, and with Sw_2 turned to the "off" position, temporarily connect in C_3 across the tuning condenser C_1 . Turn Sw_2 to "on" and tune the b.c. receiver to 600 or 700 kc. If you are lucky you will be able to tune C_1 and bring in the oscillator signal on the b.c. receiver and, upon tuning the b.c. receiver across its range, find the oscillator signal at each 100-kc. point across the dial. If by tuning C_1 you can't bring in the signal at 600 or 700 kc., tune around with the broadcast receiver until you find the signal and you will be able to tell the frequency of the oscillator by the frequency separation between the points where it can be found in the b.c. range. If the signal can't be found it indicates that the oscillator isn't working and the wiring should be checked. It may be necessary to try several condensers at C_3 before one is found that brings the circuit to the proper frequency, but it is not a difficult or laborious task and doesn't take much longer than it does to describe it. When a condenser is found that allows

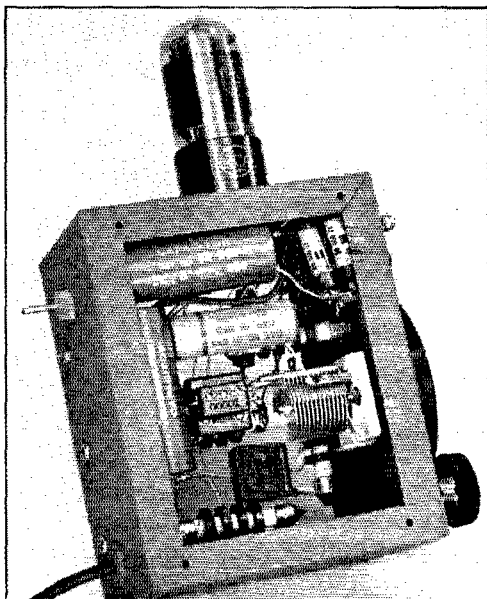

Another view of the inside of the oscillator shows the two filter condensers and the plate by-pass condenser C_4 . The screen by-pass condenser, C_3 , is mounted under the top alongside the tube socket. The r.f. choke that can be seen above the tuning condenser is the plate coupling choke RFC.

the circuit to be tuned to 100 kc. it can be soldered permanently across L_2 .

The 50-kc. range can next be checked. It is done in a similar manner except that the signal should appear every 50 kc. across the b.c. band rather than every 100 kc. It may be a little harder to find the right capacity for this range because the tuning condenser C_1 has less effect on the frequency than in the case of the 100-kc. range. When the proper value is found it can be soldered in place across the coil.

The 1000-kc. range is checked similarly except that it will be heard at only one spot in the b.c. band, at 1000 kc. Although the 50- and 100-kc. ranges will oscillate with no wire attached to the output terminal, the 1000-kc. range probably won't work without a wire attached, because of a resonance effect in the plate choke RFC. This is no disadvantage, of course — it is mentioned because it had us puzzled for a while.

When the three ranges have been adjusted, the sides can be fastened back on the cabinet and the tuning dial properly marked for ready reference.

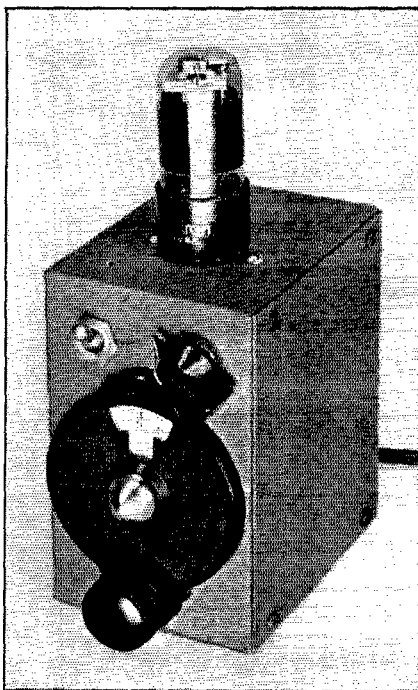

The oscillator is housed in a 3- by 4- by 5-inch metal box. The dial sets the tuning condenser, the toggle switch turns the plate supply on, and the knob selects the frequency range.

It is suggested that WWV be used as the standard when marking the dial because of the greater accuracy.

When using the oscillator in any of its ranges, it should be adjusted to zero beat with WWV (5000 kc.) and not just set to what is considered to be the proper dial setting. Setting the dial from memory is satisfactory for a rough check but not for any reliable long-time accuracy. The 50-kc. oscillator will give harmonics that can be heard every 50 kc. up to about 15 Mc., the 100-kc. harmonics can be heard every 100 kc. up to about 30 Mc. with a little close listening, and the 1000-kc. harmonics are good every 1000 kc. up to 60 Mc. It is necessary, however, to run a wire directly from the output terminal of the oscillator to the antenna post of the receiver to hear the higher harmonics and not to depend upon stray radiation

as can be done on the lower frequencies. If the output of the oscillator is not adequate to suit one's needs, the voltage can be raised by decreasing the value of R_1 to 25,000 ohms or less, but

(Continued on page 84)

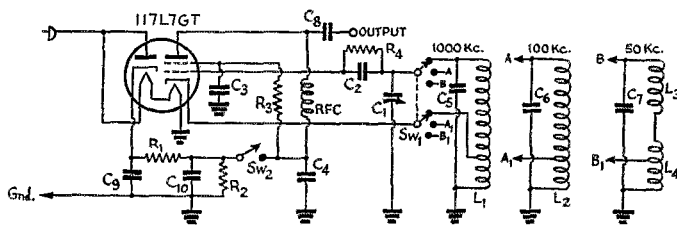

Fig. 1 — Wiring diagram of the 50-, 100- and 1000-kc. oscillator.

- C_1 — 100- μ fd. midget variable (Hammarlund HF-100).
- C_2 — 250- μ fd. mica.
- C_3, C_4 — 0.02- μ fd., 400-volt paper.
- C_5 — 500- μ fd. mica.
- C_6 — 0.001- μ fd. mica.
- C_7 — 0.002- μ fd. mica.
- C_8 — 50- μ fd. mica.
- C_9, C_{10} — 8- μ fd., 450-volt electrolytic.
- R_1, R_2 — 50,000 ohms, 1-watt.
- R_3, R_4 — 0.1 megohm, 1-watt.
- RFC — 2.5-mh. r.f. choke (National R-100).
- SW_1 — 3-position, 2-circuit selector switch (Mallory 3223J).

- SW_2 — S.p.s.t. toggle switch.
 - L_1 — 100 turns No. 34 d.c.c., close-wound on 9/16-inch diam. (National PRE-3) form. Cathode tap at 30th turn from ground end.
 - L_2 — 2.5-mh. r.f. choke (National R-100U). Cathode tap between first and second pie from ground end.
 - L_3 — 2.5-mh. r.f. choke (National R-100) at right angles to L_4 .
 - L_4 — 2.5-mh. r.f. choke (National R-100U). Cathode tap between second and third pie.
- The cabinet is a Parmetal MC-453.

The Secrets of Good Sending

In Two Parts—Part I*

BY E. L. BATTEY,** WIUE

IN TACKLING the problem of learning to send correctly, it must be remembered that it will take time and application. Good sending is an art in itself. It requires skill, and skill is normally attained only through practice and more practice. As in the case of an accomplished pianist or a skillful typist, hours and hours of effort must be applied. Most of us are born with no particular talent, but most of us can develop a talent if we apply ourselves. It is true that we hear occasionally of an unusual individual who is referred to as a "born telegrapher." There are such people, but they are few and far between. Most good operators learned the hard way—through practice. "Practice Makes Perfect" is no mere song title when it comes to learning to send properly! You cannot learn to send perfect code over-night. It may take you weeks, even months, to develop a really good "fist," but *you* can do it just as surely as the next man. Remember that! All you need is the "will to learn" and the "will to practice."

This article is directed to those who already know the code; that is, those who can copy at least 5 words per minute. It is a mistake to attempt to manipulate a telegraph key before you have reached at least this receiving speed. The basic requirement in learning to send correctly is to *know how good code sounds*. You cannot send it right if you don't know how it should sound. The best way to get accustomed to the sound of good code is to listen to automatic transmissions. You must know how you want your sending to sound or you will be handicapped at the start. We are not machines, although we can aim at machine precision.

*Part II will appear in a forthcoming issue.

** Assistant Communications Manager, A.R.R.L., on leave of absence; Ensign, USNR; instructor, Naval Reserve Radio School, Noroton Heights, Conn.

The ideal condition would be to learn under the personal instruction of a qualified proficient operator, but barring this there are certain basic precepts which may be followed. A good "fist" *can be developed* by an individual working alone and it is the intention of this article to aid the individual, within the confines of his own home, radio shack or wherever he may be, to develop his fist along correct lines.

At this point all operators are urged to master the hand key before attempting any sort of automatic sending devices. The real art of telegraphy is based on the hand key. "Bugs," or other semi-automatic keys, should be used only after mastering the hand key. And you will find yourself better able to operate a bug if you first have mastered the hand or straight key.

Key Adjustment

Correct key adjustment is that adjustment which fits your particular touch, and it is important that you arrive at the correct adjustment before attempting to use the key. A reliable rule is that there should be a vertical movement of about one-sixteenth inch at the key knob. This is measured from the *top surface of the knob*. It is set by the rear screw adjustment. When the knob's top surface goes down about one-sixteenth inch upon pressing the key, you have the approximate "average" spacing between the key contacts. In making any key adjustment, be sure to loosen the lock nuts first, so that you do not strip the threads. Tighten all lock nuts when you complete the adjustments. The contact points should be perfectly aligned by means of the side screws. There should be a *very slight degree* of side play, between the two side screws. These screws should be tightened, then loosened just a bit so that the key moves freely and does not bind. Recheck the contacts after this adjustment to be sure they are true, making any slight readjustment necessary.

Although the "one-sixteenth inch rule" is a good one to follow for first adjustment, the amount of vertical movement can later be changed to suit your particular fist. The spring tension, likewise, must be set for the individual operator. Some prefer a heavier spring than others. The primary consideration is to send *good code*; how you have your key adjusted to do this depends on what you find best for you. However, it should be remembered that *too heavy* a spring tends to make your sending "choppy," causing you to "clip" your dashes and dots, as well as

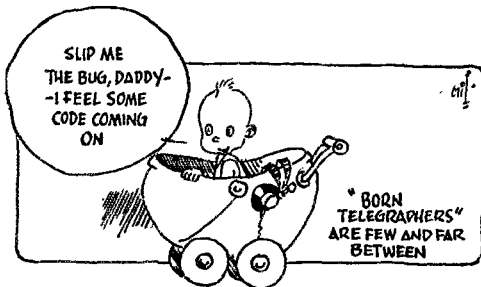

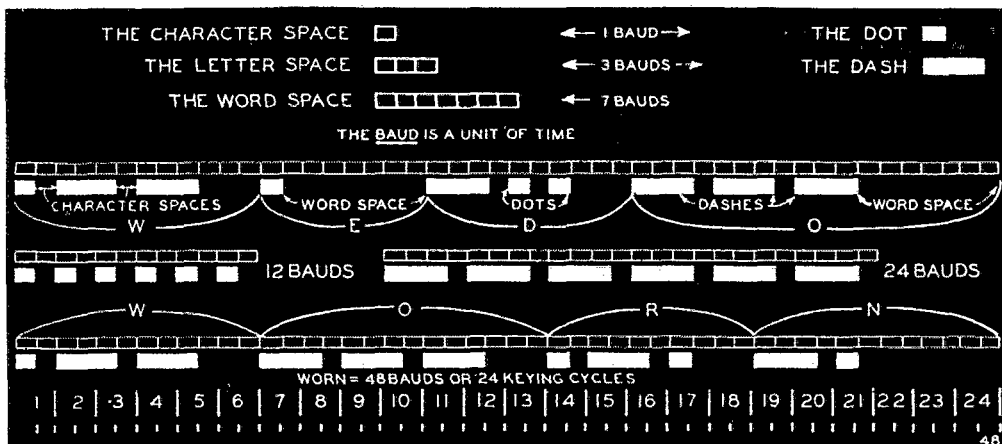

In International Morse (Radio) Code, all signalling is accomplished by various successions of five Basic Signalling Lengths. First, the Dot, of one unit length. Second, the Dash, of three. Third, the Character Space, of one unit; no dot nor dash is a signal unless it is followed by one. Fourth, the Letter Space, of three unit lengths, to which each code letter owes its existence. Fifth, the seven-unit word-space, which, when following a group of letters, carries the significance that a word has been completed.

A typical grouping of these Five Basic Signalling Lengths is shown on the diagram, representing in code the words "WE DO." Notice the part the three "space" lengths play in the combination. Of the 48 time units, 26 are "space," 22 are "mark."

The word "Baud" is a terminological blessing which honors M. Baudot, inventor of the five-unit printer code. It replaces the clumsy near-equivalents "half cycle" and "time unit." The Baud is the primary structural interval in telegraphic mechanics, and has a duration — at any speed — of one-half a keying cycle. It is basic because it is the shortest possible time in which either keying condition can be represented.

The Five Basic Signalling Lengths, being built of these primary units, bear relation to them. On the diagram, this is expressed in Bauds; a Dot or a Character-Space is one Baud long; a Dash or a Letter-Space, three; and a Word-Space seven. . . .

A "Word" in radio code is the amount of intelligence that can be expressed in 24 keying cycles. The word "WORN" happens to require exactly that amount. Words of various code- and letter-lengths are, of course, mixed in transmission without regard to the *actual* word length, but their average code length has been determined at 24 cycles of keying, or 48 time units. The computation involves an elaborate consideration of word lengths compared with the frequency with which they appear and of the code length of letters, compared with the number of times they are used.

If the word "WORN" is sent in three seconds, the rate will be 20 words per minute (w.p.m.). The ratio between keying speed (in cycles per second) and w.p.m. is two to five. The rate in c.p.s., then, would be eight. At this keying speed, each dot *cycle* would last an eighth of a second; each two-cycle dash a quarter second. At ten w.p.m., at a keying speed of four cycles, the dot-cycles would be a quarter second long, and the two dash-cycles, a half second. "WORN," at this speed, would be sent in exactly six seconds.

The Five Basic Signalling Length Proportions on the diagram hold good, of course, at any keying speed. Estimating your speed by means of Basic Signalling Lengths will give you more accurate results than by the usual "counting of letters per minute and dividing by five." The "BSL" method is based upon the code lengths being sent, while the other considers all letters of equal length. — From "Conquer the Code with Rhythm," an article by Ray Hutchens, R.C.A. Communications, Inc.

being tiring for long periods of sending. Similarly, *too light* a spring tends to cause you to "run" characters together, there being insufficient "control" of the key. Remember, *you* are making the characters, the key isn't! The key is the implement by which you make them, true enough. But the key cannot make them for you. Therefore, you must have complete control of the key. It is the writer's opinion that a somewhat heavy spring allows better control, particularly of dots. With a spring of "feather-weight" tension, the dots are likely to run away from you and you will find yourself slurring them. No treatise on key adjustment ever can solve the individual's problems in this line. Only by personal use can you find the correct adjustment for yourself. But you must find it before expecting to send really good code.

How to Grasp the Key

The question of the correct manner in which to grasp the key — the manner in which the fingers should hold the key knob — is one which is open to debate. The most generally accepted method is as follows: Place the thumb against the left edge of the key knob; the first finger on top of the knob at the rear and lapping over the rear edge just a bit; and the second finger against the right edge of the knob, about in the center or slightly to the rear of center. Another accepted method is for the thumb to rest against the left edge as in the preceding example, but for the first and second fingers to both rest directly on top of the knob. In both cases the thumb should press gently against the side, enough to hold the key and partly aid its upward motion after depression, but

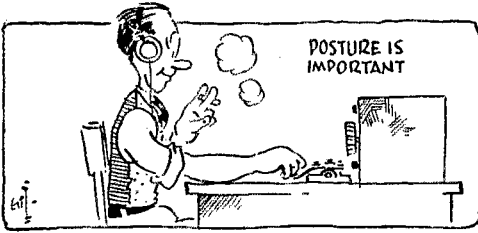

in no event should the grip be tense. The first and second fingers should be slightly arched, not held out straight. The third and fourth fingers should be permitted to curl naturally toward the palm of the hand, but they should not be tightly clenched. Keep the fingers, hand and wrist relaxed at all times.

From observation and study of the methods used by many experienced operators, it is the writer's opinion that the method of holding the key, insofar as the position of the fingers and thumb are concerned, is not a decisive factor in good sending. It has been observed that only about one operator in ten actually keeps his thumb on the key at all times. It is held as a personal theory of the writer that to hold the thumb on the key tends to cause the hand to tighten up and defeat the desired condition of relaxation. It is believed, however, that the thumb should take its position alongside the left edge of the knob, if not actually touching the knob. It is suggested that each operator will do best to adjust his grip to his own particular tastes — using the grip with which he can send the best code! That is our first and primary aim — to send good code. But it is good to start out with the generally-accepted grips, outlined in the preceding paragraph, and develop your own (possibly unorthodox) grip from there, if necessary. Find the grip that enables you to best keep your fingers, hand and wrist relaxed, and that will be the grip for you.

Correct Sending Posture

Regardless of how you hold the key, there is a definite sending posture which should be followed. Sit upright in your chair, square with the operating table, with your arm on a line with the key. The arm should rest lightly on the table, with the muscle of the forearm supporting the weight, and with the wrist off the table.

Once we have adjusted the key and learned the correct way to grasp it, we can proceed with the actual sending practice. For some of the more seasoned operators this may mean almost learning to send all over again. However, there is a right way to do everything and, if you get the knack of accepted proper key manipulation, you will find yourself sending better code, with greater ease, than ever before. You will find yourself among those operators who are pointed out as having a "swell fist." And on the air that is your

only claim to fame as an operator! If you are satisfied to be a mediocre operator, you will be labeled just that on the air. You are known by your fist, as well as your call letters.

Proper Wrist Action

The first step in actually manipulating the key is to develop the proper wrist action. Keep the wrist flexible. Avoid becoming tense. Correct wrist motion may be developed by exercising the wrist up-and-down, like a hinge, and by rotating the wrist in circles, clockwise. These wrist exercises are helpful regardless of what your state of proficiency may be. They help to keep the wrist limber.

In sending, remember that the wrist should do the work. To close the key: The hand moves forward and downward, while the wrist moves upward. To open the key: The hand moves backward and upward, while the wrist moves downward. In effect, you should find your hand engaged in a rocking movement, forward-downward, backward-upward, forward-downward, backward-upward, etc. And the wrist causes the action. Keep the wrist loose. The fingers have been likened to a hammer-head when you drive a nail. The hammer-head merely transmits the action to the nail. The fingers merely transmit the action to the key knob. The actual moving force is the wrist. Check your sending: If your wrist moves downward when you close the key, you do not have what is accepted as correct wrist action. The wrist should move upward when you close the key. If your hand or arm tires easily, recheck your wrist action. Proper wrist action is one of the secrets of good sending.

Spacing

The too-often-forgotten element in good sending is "correct spacing." This is the element which holds the balance between good sending and poor sending. Attention is called to the "spacing chart" reproduced from an article in the March, 1941, issue of *Relay*, family magazine of R.C.A. Communications, Inc. Code does not exist without spacing. Spacing is just as much a part of a character, or a word, or a sentence, as the units we hear as sounds. Basically, a dash is equal in length to three dots; the space between parts of any character is equal to one dot; the space between any two letters or characters is equal to one dash; the space between any two words or groups is equal to seven dots. By aiming at all times to keep these relative lengths throughout our sending, we will develop machine-like precision insofar as the human element permits. It is this correct spacing that makes the fists of some operators stand out so glaringly as good or bad. By keeping the relative lengths of dots, dashes and spaces constantly in mind, we

(Continued on page 108)

Antennas for Domestic Work

Well-Known but Often-Ignored Points About Simple Skywires

BY DON MIX,* WITS

MANY of those who operate at the lower frequencies more or less exclusively are accustomed to think of antenna directivity in terms of three-element rotaries, rhombics, Vee's or the other various forms of highly-directive antennas

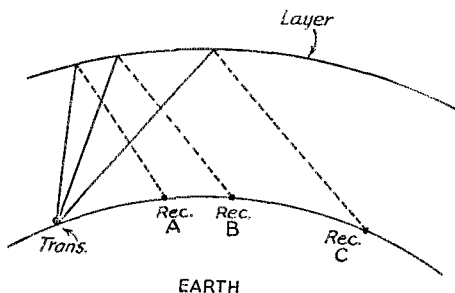

Fig. 1 — Signal paths from transmitter to various receiving points via ionospheric reflections. Signals received at A must be radiated at high angles, while radiations at lower angles are required for the more-distant points B and C.

used for DX work at 14 and 28 Mc. It is less often that the ham engaged in domestic work with simple antennas gives a second thought to directivity. You may hear him complain that although he gets out well on 80 he has never been able to do much on 40. He's been living that way for years, while the chances are that nothing drastic in the way of antenna alteration would be required to remedy the trouble.

Paths of H. F. Waves

Before we get down to a discussion of antenna directive patterns, it might be well to consider briefly the general idea of what takes place in radio transmission at high frequencies between the time the signal leaves the transmitting antenna until the time it arrives at the receiving antenna — if it ever does arrive! The energy in high-frequency waves which travel along the earth's surface (ground wave) is rapidly dissipated and these waves are, therefore, effective for communication over only very short distances. The only thing which makes long-distance communication at high frequencies possible is the presence of the *ionosphere*. This consists of a layer (or several layers) of ionized atmosphere surrounding the globe at distances of 30 to 250 miles from the earth's surface. Waves which leave the antenna in an upward direction eventually strike

one of these layers and (under certain conditions) are reflected back to earth at some distant point with comparatively little loss. Since the waves are returned at an angle equal to that at which they strike the reflecting layer, it can be seen from Fig. 1 that shorter distances are covered by waves radiated from the antenna at high angles, while those radiated at low angles are returned to the earth at greater distances.

"Skip Area"

There are several factors, however, which complicate the picture and make it difficult to predict the behavior of the sky wave. The ionosphere is not a perfect reflector. In fact, under certain circumstances it will not reflect high-frequency waves at all. Fig. 2 will serve to illustrate this point. A, B, C and D represent waves which may be radiated simultaneously from the transmitting antenna. Wave A is transmitted perpendicularly to the ionosphere but is not reflected and passes on through into space. Wave B, at a

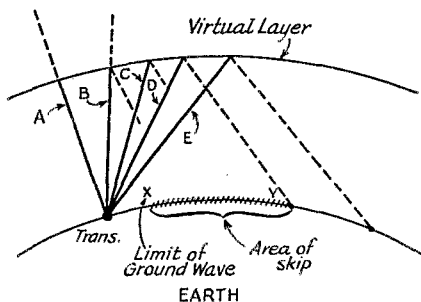

Fig. 2 — Illustration of how "skip" occurs. Signals B and C which would otherwise be returned to earth at points between X and Y pass through the layer into space without being reflected. This results in no signals with the X-Y area.

slightly smaller angle also passes through or is only weakly reflected. As the angle at which the wave strikes the ionosphere becomes smaller a certain critical value is reached at which the ionosphere will start to reflect the waves back to earth. All waves at lower angles will be reflected back to earth at progressively greater distances.

The region between the short-distance limit of the ground wave and the point where the wave at the highest angle is returned to earth is the "skip" area throughout which satisfactory communication will not be possible under that par-

* Asst. Technical Editor, QST.

In addition to a review of the theory of how signals travel from the transmitter to a distant receiver, this article discusses the orientation of simple antennas which will give best domestic coverage on various bands. Written primarily for those who are wondering what it is all about, it also contains pointers which are often overlooked by those who should know better.

ticular set of conditions. The higher the frequency, the more readily will the waves pass through the ionosphere into space. Therefore, as the frequency is increased, high-angle radiation from the antenna becomes less and less useful and communication is carried on by the lower-angle waves only. In this case, energy radiated from the antenna at high angles is wasted. Since we have seen that waves transmitted at low angles return to earth only at relatively-great distances, it is evident that the area of "skip" and the distances over which communication is possible both increase with an increase in frequency. This explains the great differences in the performances of transmitters working at 3.5 Mc. and at 14 Mc.

Other Considerations

Another thing which complicates the picture is that there is more than one reflecting layer, each at different distances above the earth's surface. A wave passing through one may be reflected from another. The height of any one of these layers, and its ability to reflect waves of any particular frequency, varies between day and night and, more slowly, between summer and winter. For these reasons, it is impossible to predict the performance of an antenna under a given set of conditions except in more or less general terms.

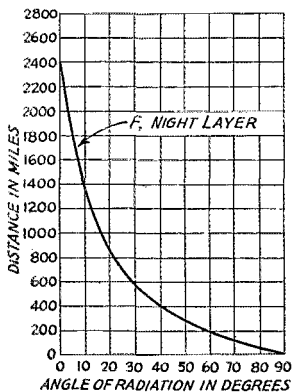

Fig. 3—A chart showing the distances from the transmitter at which waves at various vertical angles will be returned to earth from the night F layer under average conditions.

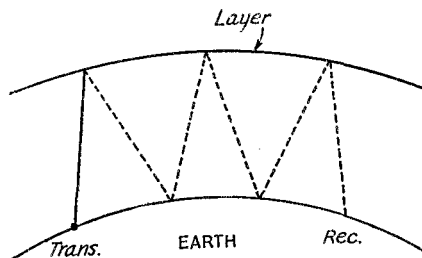

Fig. 4—Illustrating how it is possible to cover long distances with high-angle radiations by means of multiple reflections.

Of the several layers in the ionosphere, only one (called the F layer) is normally involved in the night-time transmissions by which the great bulk of amateur domestic communication is carried on. Most of the antenna discussion which follows will be based upon reflections from this layer under average conditions.¹

Multiple Reflections

Fig. 3 shows a curve for the average night F layer in terms of the angle of radiation versus the distance at which the signal will be returned to earth.² It shows, for instance, that waves radiated at a vertical angle of 30 degrees will be returned to the earth at a point approximately 550 miles from the transmitter. Of course, it is well known that it is possible to communicate over distances greater than this with an antenna which does not radiate at angles lower than 30 degrees. This is accounted for by the fact that multiple reflection may take place between the ionosphere and the earth. The waves reflected back from the ionosphere strike the earth and may again be reflected back to the ionosphere as pictured in Fig. 4. These multiple reflections may continue indefinitely to cover very long distances under favorable conditions. The longer path which the wave must follow added to the fact that each reflection involves losses, results in much-less efficient transmission than in the case where the distance may be covered by a single reflection from the ionosphere.

Antenna Directivity

Different types of antennas have different directive characteristics. Some transmit in some directions and at certain vertical angles more readily than others. The directivity of an antenna may be visualized by a study of the theoretical radiation pattern. Typical examples are shown in Fig. 5. The heavy line of the pattern may be looked upon as the path which an observer would

¹ For those who wish a more-detailed discussion of sky-wave transmission phenomena, reference is made to the article, "The Ionosphere and Radio Transmission," *QST*, March, 1940.

² Rocky, "Distance vs. Angle of Radiation," *QST*, October, 1940.

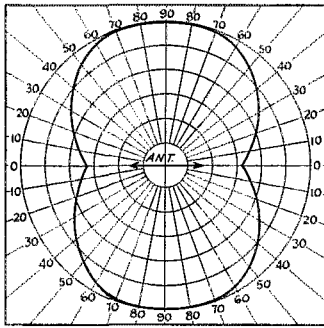

A

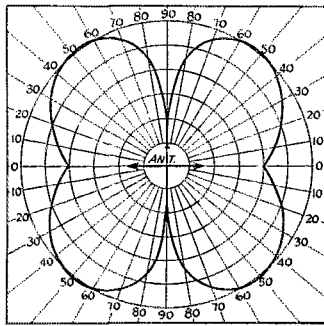

B

Fig. 5—Typical horizontal radiation patterns help to visualize antenna directivity.

have to follow about the antenna with a field-strength meter to maintain a constant reading on the meter. In *A* he would have to come much closer to the ends of the antenna to obtain the same reading of field strength that he obtained at a greater distance in a line at right angles to the antenna. This indicates that less energy is radiated from the ends than at right angles to the antenna. In *B*, the path he would have to follow to maintain a constant reading would be more complex and at a point directly at right angles to *this* antenna, he would obtain essentially no reading at all, indicating that no energy was being radiated in this particular direction.

Now, if it were possible for the observer to fly about the antenna at various heights, he would find that the pattern thus obtained would be different for the various altitudes. The reason is that the geometric figure formed by the radiation from the antenna is a solid, and a cross-section of this solid changes with the vertical angle at which it is taken. Therefore, when a plane horizontal pattern of directivity is discussed, the vertical angle at which it is taken must be considered. The radiation from certain antennas in the horizontal plane is sometimes zero in certain directions, while the radiation in the same directions may be appreciable at higher vertical angles.

Antenna Height

One more factor comes into play in determining the directive pattern. This is the height of the antenna above ground. Waves which are radiated downward at angles below the horizontal strike the earth and are reflected. These reflected waves combine to reinforce, cancel, or partially cancel the effect of the waves radiated at angles above the horizontal and thereby alter the pattern which would be obtained in free space. Horizontal antennas at a height above ground of one-quarter wavelength or less radiate chiefly at high angles, while appreciable low-angle radiation from simple horizontal antennas is obtained only when the antenna is elevated to a height of one-half wavelength or more.

When an antenna is erected vertically, the pattern is rotated through ninety degrees so that a horizontal antenna which radiates chiefly at high angles becomes a good low-angle radiator when vertical, while a horizontal antenna with good low-angle radiation becomes a high-angle radiator in the vertical position. With these points in mind we can now consider some practical examples.

The Half-Wave Antenna

Let us consider the directive characteristics of the simple single-wire antenna, starting with a half-wave horizontal job, a 130-foot wire at 3.5 Mc. Its height above ground will be one-quarter wavelength (65 ft.) or less in all but the most

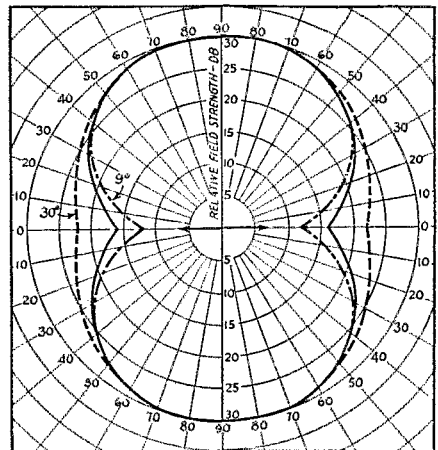

Fig. 6—Directive patterns of a horizontal half-wave antenna at three vertical angles, 9, 15 (solid line) and 30 degrees. The direction of the antenna is indicated by the arrow. These patterns are plotted to a 30-db. scale, which is about proportional to signal strength as determined by ear. If 30 db. represents an S9 signal, 0 on the scale will be about S1. All three patterns are plotted to the same maximum, but actual amplitudes at the various angles will depend upon the antenna height. The patterns show only the *shape* of the directive pattern as the angle is varied.

unusual cases. From Fig. 6 which shows the directive pattern for three different vertical angles, it is evident that such an antenna is not particularly directional at the higher vertical angles of radiation (notice the 30-degree line) which are useful in work over short and moderate distances. At the lower angles which come into play at distances of 1000 miles or more, however, the difference between the radiation at right angles to the wire and that off the ends of the wire is sufficient to make it worthwhile to run the antenna at right angles to the course over which the longer-distance work is required, whenever a choice is possible in putting up the antenna. Since the greater distances to be covered in domestic work run east and west in most parts of the country, the antenna should be run north and south whenever possible.

Harmonic Operation

The same antenna operated at 7 Mc. will be a full-wave antenna. If the antenna is end-fed, the more or less oval pattern we obtained at 80 is now changed to one resembling a four-leaf clover as shown in Fig. 7. The worst part of this is that a null occurs at right angles to the wire in place of the maximum radiation we had on 80. While this null is rather sharp, it does not have to be very broad to cut down signals, for instance, received anywhere on one coast from a station on the opposite coast, since each coast is embraced in an angle of about 25 degrees when viewed from the opposite coast. A station located in the central part of the country will lose out on a smaller portion of each coast, but the two poor areas will combine to form an equivalent area of poor performance. Stations in the central part of the country near the borders would lose less, but nevertheless might find it difficult to work the small portions of the country due east and west of them.

Stations in the extreme four corners of the country could minimize the effect of the null at 40 by running the antenna approximately northeast and southwest, in Southern California and New England, and northwest and southeast in Florida and Washington, but this orientation would place the antenna in the most unfavorable position for long-distance work on 80. There remain two alternatives, however. A separate antenna might be put up for 7 Mc. A more satisfactory solution for most of us would be to leave the antenna in the north-south direction and use center feed instead of end feed. While this change does not affect the radiation characteristics of the antenna at the fundamental, it not only restores the broadside radiation at 40, but provides appreciable gain over a separate half-wave antenna for 40 running in the most-favorable direction, since the two sections operate in phase. The pattern is quite similar to that shown for the fundamental in Fig. 6. There are no nulls at useful vertical angles. The difference between the performance of the end-fed antenna and the center-

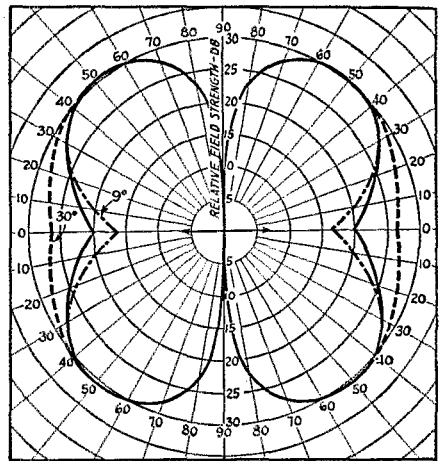

Fig. 7 — Horizontal pattern for a full-wave antenna, for vertical angles of 9, 15 and 30 degrees. Qualifications which are given under Fig. 6 apply to this pattern also.

fed antenna in a direction at right angles to the antenna will be outstanding, because the null of the former is replaced by the reinforced lobe of the latter. In this case, the change to center feed is definitely of great advantage even though it may be necessary to bring the feeders back underneath one half of the antenna. It is, of course, preferable to make the angle between the antenna and the feeders no smaller than is necessary.

More Gain at 40

If space is available, the gain of the antenna at 40 can be increased by lengthening each half of the antenna to form an extended double Zepp. The length of each half should be 87 feet instead of the usual 66 feet. This increase in length will have no appreciable effect upon the performance of the antenna at 80.

Further Advantages of Center Feed

Center feed also has the advantage that it provides a constantly-balanced system which permits the feeders to perform with minimum radiation at all times. With end feed, the currents and voltages along the feeders are most nearly balanced only when the antenna itself is cut accurately to the correct length for the particular frequency in use. At higher frequencies, the effective length of the feeder connected to the antenna will be greater than that of the open feeder, while at lower frequencies, the connected feeder will be shorter than the other. This results in unbalanced currents and voltages in the feeders, as illustrated in Fig. 8, with consequent loss of power from feeder radiation. With center feed, such an unbalance cannot occur, since any discrepancy between the actual antenna length and the correct length for the frequency is distributed equally between

each half of the system. This means that the flat-top length of the center-fed antenna is not at all critical. In fact, such a system may be operated with balanced feeders at any frequency at which it is found possible to tune the system, or its harmonics, which takes in a lot of territory.

160 Meters

We frequently find cases where restriction of

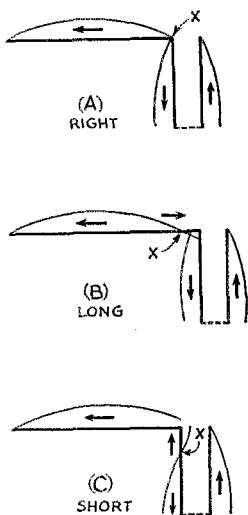

Fig. 8 — Most accurate balance with end feeders can be obtained only when the antenna is cut accurately to the correct length. At *A* the antenna is of the correct length and the feeders are balanced. At *B* and *C*, the antenna proper ends at the points marked "X", causing the effective length of the feeder connected to the antenna to be longer than the open feeder at *B* and shorter at *C*.

space makes it necessary to operate an antenna at half the frequency for which the flat top is cut; for instance, a 40-meter half-wave antenna operated at 80. In such cases, the center-fed system will deliver more power to the antenna than the end-fed system, since negligible radiation takes place from the feeders with center feed, while the end feeders are hopelessly unbalanced and power is lost by radiation from them. The 80-meter center-fed antenna we have been discussing will do a pretty fair job on 160 over medium distances although radiation at the low angles most useful for longer distances without multiple reflections is lacking.

14 Mc.

When we operate the 80-meter center-fed antenna at 20 meters, we again obtain the cloverleaf pattern with the null at right angles to the wire. About the only simple remedy for this is the erection of a separate half-wave antenna for this band. This will not often be a serious problem because dimensions are small. A 20-meter horizontal antenna requires a height of only 30 to 35

feet to be a half-wavelength above ground where good low-angle radiation will take place. For general coverage, the vertical antenna is probably somewhat better, and it may be placed at right angles to the other antenna, while good low-angle radiation will be obtained with the center of the antenna only 20 or 25 feet off the ground. Either the horizontal antenna or the vertical will also make an excellent antenna for 28 Mc., as well as for 14 Mc., if center fed. The antenna should, of course, be erected as free as possible from surrounding objects which might shield it.

A Better Antenna for 1.7 Mc.

For most hams, an effective antenna for 160 presents a real problem. Many of the 160-meter boys who have the space simply string out a wire as long as possible and let it go at that. The trouble with the use of a horizontal antenna at 160, however, is not so much that of obtaining sufficient length as that of obtaining enough height to make it effective for the longer distances. Even heights of 60 or 70 feet are so small in comparison with the length of a half wave that radiation from a horizontal antenna is for all practical purposes entirely at high angles. This means that all but relatively short distances must be covered by multiple reflections between the earth and the ionosphere. For this reason, the vertical antenna offers the only practical means of obtaining the low-angle radiation which will permit the longer distances to be covered without the losses involved in multiple reflections.

Of course, a vertical section of a half wavelength, or even a quarter wavelength, is out of the question for most of us. However, much

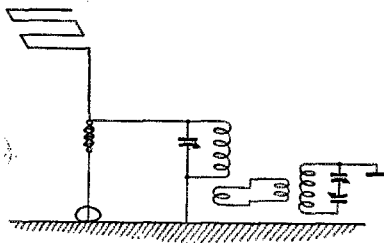

Fig. 9 — Sketch of the short vertical for 1.75 Mc. The total length of the wire is one-half wavelength. The folded portion at the top of the vertical section has a total length of one-quarter wavelength. The vertical portion is made as long as possible, while the remainder of the half wave is used as the lead to the transmitter.

shorter vertical sections will do a satisfactory job if the system is arranged to bring, by fair means or foul, a point of high current at the top of the vertical section. Various schemes have been suggested from time to time to obtain top loading with this object in view. Most of these, however, require more or less fussy construction and adjustment. One of the simplest schemes which works

(Continued on page 84)



U. S. A. CALLING



COMMISSIONS FOR ELECTRONIC SPECIALISTS

OPPORTUNITIES for commission in either Signal Corps or Navy are still open to qualified engineers and electronic specialists in the special new field of work reported at the top of this column in the last two issues of *QST*. While hundreds of candidates have stepped forward, there is lots of room for more. The office handling this specialized personnel advises us that the response from amateurs has been "marvelous," and that many hams at the moment are being considered for commission. *QST* is bringing them, from the ARRL ranks, more candidates than any other source, so it is apparent that an interested amateur will find plenty of skilled ham company in these specialized services. We assume that by this time everyone knows the nature of this very interesting special field of work. For details see July and August *QST*. Single men from 21 to 36 are wanted for the Signal Corps' Electronic Battalion, which seems to offer the only existing chance for stepping into a Signal Corps commission. Married men, from 21 to 44, are eligible for the Navy's branch of this work. For further information, write George W. Bailey, National Research Council, 2101 Constitution Avenue, N. W., Washington.

Applicants who have been rejected for insufficient college education should QRX and not be too discouraged. The time will come when those who are otherwise good radio men will be accepted for a vital place in this work.

LABORATORY ASSISTANTS

THE Signal Corps Laboratories at Fort Monmouth, engaged in research and development for communication equipment for the various branches of the Army, are in need of Engineering Aides, civilian positions which pay from \$1260 to \$2600 per annum.

Applicants must be citizens of the United States, not over 55 years of age, in good physical condition. They must be high school graduates, or have completed 14 units of high-school study, and preference is given those who have had special schooling in radio communication. They must have had at least one year of paid progressive experience in radio servicing, testing, design or construction or other allied activities. Credit for experience will be given holders of FCC licenses.

Interested amateurs should outline their qualifications by letter to Captain F. B. Valentine, Personnel Officer, Signal Corps Laboratories, Red Bank, N. J.

CIVILIAN TECHNICAL CORPS

WE CALL attention to our article in this department last month reporting the call of the British, with the approval of our government, for civilian radio men to work in the maintenance of radio-locator gear. Full information is to be had by writing the Civilian Technical Corps, c/o the British Consulate General, 25 Broadway, New York. Local draft boards have been authorized to release U. S. technicians who enroll in the CTC, putting them in Class II-B upon proof that they have been enrolled.

MESSAGE-CENTER PERSONNEL

THE War Department Message Center at Washington has put out a call for student communication personnel. Here is a chance to learn to be a crack professional operator in the field of automatic equipment.

Amateur operators who know touch typewriting at at least 50 w.p.m., and have a code speed of 25 w.p.m., are eligible for this work if in sound physical condition and between the ages of 18 and 30. The beginning salary is \$1440 a year. The men accepted will also be given instruction in reading siphon-recorder tape, and those who qualify will be advanced to the grade of Junior Communication Operator at a salary of \$1620. Selected applicants must be able to report at Washington at their own expense. For further particulars and application forms, write the War Department Message Center, Munitions Building, Washington, D. C.

FURTHER ENSIGN COMMISSIONS

The Navy Department announces that it requires approximately fifty "radio physicists" who may be commissioned as Ensigns C-V(S) USNR, provided they establish the necessary professional qualifications which consist of a minimum of two years college in an accredited institution and practical experience in amateur or commercial radio. Pay rates and other details are generally

(Continued on page 88)

P.O.W.

It is reported that the following amateurs are being held as prisoners of war:

Lt. J. Hill, ZL3CS, Gefangenennummer 304, Oflag V B, Germany
Arthur Webb, G6WQ



▲ OUR file of military service records grows, it presents an impressive record of the extent to which radio amateurs to-day permeate the whole of Uncle Sam's communications systems. We find some of our number teaching radio to recruits and fellows who need brushing up; we find others attending those very schools for the additional specialized training that military work requires. There are those who have won their spurs; these form the backbone of communications as radio operators. There are those of junior officer class who supervise and coordinate individual radio facilities; those in executive positions, commanding entire units; and, a part of it all although not actually in military service, those engaged in research and the development of new and better gear.

It is a reassuring picture . . . self-trained amateur specialists in radio operating and technique, able to step into any part of the communications set-up. Let's sample a small cross-section of each field, starting with amateurs doing instruction work — the men whose responsibility is the communications training of recruits to turn them into skilled radiomen. We've reported many in previous pages of this column; here are some more:

Lt. Brennan, 2DJU, is in charge of the radio school at Jacksonville, Florida's Naval Air Base. As instructors at Scott Field, Ill., there are Jones, 4GYG, Pearson, 9OTS, Williams, 5HUW, Knowles, 9PYN, and Yund, 9VMB. Ensign Nadeau, 7GEV, is officer in charge of the Navy's Bainbridge Island (Wash.) radio school, and instructors are CRM Cornelius, 7GXU, and RM3c Sittaro, 7GTG. Lt. Moor, 3SB, and CRM Robertson, 1BPN, are new Navy instructors at Noroton. Lt. Whittaker, 6SG, teaches military science and tactics at the U. of San Francisco. Men at Grosse Ile (Mich.) Navy Air Base learn radio and navigation from RM3c Bernhard, 8QYK and RM1c Barnes, 8FQK. Staff Sgt. Shaw, 5ARV, instructs in radio at Camp Bowie, Texas, and Billings, ex-W2NBP, in elementary theory at Ft. Buchanan, P. R. Pvt. Ribling, 9FTL, is a Link Trainer instructor at Ellington Field, Texas, and Luedtke, of the K5AI gang, teaches communications to members of the 19th Bomb. Wing, Albrook Field, C. Z. Training school classes at Chicago's Naval Armory learn blinker signalling from RM3c Hughes, 8UIL. Lt. (jg) Hoffman, 8FRY, runs the Navy's Norfolk radio school. Pvt. Gordon, 9ADB, instructs in radio at Ft. Custer, Mich. CRM Ramalho,

6AWY, teaches radio at San Pedro's Naval Base. RM2c Woolsey, 6SBA, instructs for the Navy's Patrol Wings Radio School, Norfolk. Pvt. Jacobs, 2JGC, did such an efficient job of instruction among men of the 105th F. A. at Ft. McClellan, Ala., that a letter of commendation was written his commanding officer by the brigadier-general — the first such commendation in the 27th Division since it was mobilized! The 46th Signal Co. at Camp Beauregard, La., is in charge of Capt. Adams, 4EV, who has placed the radio school under the supervision of Lt. Wilson, 4EUQ; the bulk of instruction work is handled by Mstr. Sgts. Shannon, 4BBE, Palmer, 4GSW, and Staff Sgt. Zern, 2LOI.

Many amateurs are going to these schools, too, to put finishing touches on general operating ability and to absorb data on military communications work. Witness the gang in the accompanying picture, and as further examples the few named below in supplement to previous listings:

At the Bainbridge Island school are Butz, 7HIN; Mays, 7GWE; Klammer, 7DMN; Puciloski, 7HGY; Powell, 7IAG; Rodgers, 7IHF, and Eberly, 7HGH. Cadet Vroom, 2HMT, studies at the Navy's Jacksonville School. Learning Army radio at Ft. Knox, Ky., to become operators in tanks, we find conscripts Peters, 7FEP; Puel, STTZ; Cheney, 1GLA; Tippet, 8RTN; Rules, 9FJH; Leigh, 9KBJ; Owings, 9FHR; Webb, 9MDZ; Jones, 9TCI; Bieschke, 9YFX; Bales, 9ADH; Hergesheimer, 2NOU; Johnson, 8VLE, and Brown, 2KOC. Ensign Wambsganss, 2LRO, is taking a postgrad course at Annapolis. King, 4GMO, and Hart, 4GWH, are qualifying for RM3c at Charleston Navy Yard. Still, 6LDX, and Watt, 6OWN, are studying in the fleet radio school at Pt. Loma, Cal., Cranston, 6QQH, at San Diego, and Anderson, 6LCR, at the Goat Island school. The hams schooling in Co. B, 3rd Signal Training Bn., Ft. Monmouth, include 2FYP, 8KNK, 6MIJ, 9ZOQ, 6KJD, 6IWI, 8MCO, 3IBK, and K7ABQ. Pvt. Geenen, 8SWA, trains at Camp Livingston, La., Cpl. Yamazaki, 9QDE, at Camp Claiborne, La., Pvt. Thurlow, 8ENL, at Pine Camp, N. Y., and Pvt. Gardner, 8QBC, at Ft. Eustis, Va. Enrolled in Scott Field's Air Corps communication classes are Howard, 1JBV; Ostrow, 8VCN; Fry, 8RZO; Read, SRZK; Camp, 8UFN, and Medlock, 9NWQ. Plc Leonard, 5HDR, and Kovacevich, 8TXE, are schooling at Ft. Sill and Tulsa, Okla., respectively.

Those amateurs who are taking advanced

training for special communications work are typified by members of the officers' communication class in session during May at the Naval Reserve Radio School at Noroton, Conn.: Ensigns Fox, 9GVM; Farkas, 8FQL; Bates, 9FO (formerly of the Call Book); Chipp, 2INB; Harrington, 9WDR; Clark, 9BG; Flynn, 3ECE; Warren, 1FKQ; j.g. Lieutenants Freedman, 1FJS, Lee, 2KTQ, Champion, 8DSD, and Lt. Nichols, 2LXT. Lt. Monsees, ex-6HJP, is at Moffett Field, Cal., for advanced training. Some are entrusted with confidential military research and development in the field of communications, such as Ensign Medrow, 9AKT, at Bowdoin College, Me., RM2c Chinnock, 2FZY, at the Naval Radio Station in San Juan, P. R., and CRM Peterson, 6JWL, at the magnetic range, San Pedro, Cal. Add to the list of men doing design work in the Navy's Bureau of Ships, Washington, the names of Ensign Rea, 2MZK, and Wilson, 2GUR. Also in duty in Washington are j.g. Lieutenants Anderson 9NL, Tiffany, 9DEB, Leglar, 9PB, Ensigns Allensworth, 9LQW, and Thompson, 3CQS.

The "non-com" and petty officer group provides important liaison between commanding officers and the bulk of enlisted men. For example, RM1c Radloff, 9AIR, is in charge of the radio room aboard the *McCawley*. Tech. Sgt. Vanderhoof, 6SLU, has similar duties with the Marine Corps in San Diego. Chief op of the 6th Sig. Co., Ft. Wood, Mo., is Staff Sgt. Ernst, 9OVV, and men of similar rank and duties are Deane, 8RPJ, 145th Inf., Camp Shelby, Grechen, 8RUF, 107th F. A., Indiantown Gap, Pa., and Kernagis, 3IDH, 166th F. A., Camp Shelby. There are Mstr. Sgt. Carmichael, 9SGC, Tech.

Sgts. Brown, 9UII, and Wright, 9CVJ, serving with the 33rd Sign. Co. at Camp Forrest, Tenn. Tech. Sgt. Marley, 4EW, is assigned to the 31st Div. Hq. Co., Camp Blanding, Fla. RM1c Musgrave, 9ZGB, is aboard the *Salt Lake City*; and RM1c Antrim, 9TAP, on the *Ranger*.

The pursuit of amateur radio is admirable basic training, and many amateurs who have been active and received commissions in reserve groups now find themselves in key positions and in command of communications units. Out of eleven officers in the communications office of the First Naval District in Boston, eight are hams. Lt. Smith, 1LBD, is issuing officer; Lt.-Comdr. Meader, 1KG, Acting DCO; Lt. Chisholm, 1FI, Lt. (jg) Evans, 1BFT-DMD, and Ensign Livingston, 1KBG, are watch officers; and Lt. Sharp, 1ACH, Ens. Mower, 1CFG, and Ens. Williams, 1CJX, are coding officers. We also find Lt. (jg) Linell, 1AJK, and Ens. Hersey, 1BE, watch and coding officers at Radio Boston (NAD). Lt. (jg) Hart, 1RH, is communications officer with the inshore patrol at Boston; Ensigns Jackson, 2BZ, and Peterson, 9WRW, have been added to his staff.

Reservists on active duty at the Norfolk Navy Yard include Lt. (jg) Daniels, 9LGR, and Ensigns Collins, 9NXN, and Furrow, 8IX-BNY. Ensign Tatro, 7EKW, becomes coding officer for the Navy in Seattle, and Ensign Bedwell, 7BAN, watch officer. Ensign Fischer, 2LA, is on active duty at Naval Hq. in New York. Lt. (jg) Muncey, 3ADI, has been assigned to the New London, Conn., submarine base. Ensign Woolverton, 6PQ, is in the Navy's issuing office at Pearl Harbor, T. H., and Ensign Fisher, 6AFQ,

(Continued on page 94)



These 91 amateurs were shipmates at the Naval Reserve Radio School, Noroton Heights, Connecticut, during the four months ending June 30, 1941. The majority received Radioman 3C ratings upon completion of the course, the remainder having been at the school for a "refresher course" in the ratings they already held when reporting to Noroton.

In the group are 2HOS, 6SHN, 3IKU, 2MRV, 2JNO, 1MGL, 2MGL, 3HWT, 3HTO, 2LBD, 2KAU, 2JZT, 2DZP, 3BMM, 1LMJ, 8TIS, 1ERS, 2IIS, 2JWK, 2LSQ, 8ORK, 2MRP, 2JZO, 2MVM, 2KZT, 8QMW, 8NEB, 1LOK, 8DDH, 9YDW, 1NCY, 3IGR, 1MSY, 2LAB, 1HWW, 1LIV, 2LXN, 2EPC, 2FCE, 1MQW, 1KOI, 2MLO, 1LER, 2ISW, 2IMX, 8UJA, 1LYB, 1MBV, 8RCL, 1KUT, 1MCF, 1KLI, 1HZE, 1KCF, 8RQT, 8RKX, 1MXA, 1PPT, 1JXN, 8JOE, 1KMT, 1LKL, 1LWK, 8KXG, 3IAW, 3FVO, 2NKZ, 2KLC, 3IGW, 2LUD, 2HIG, 8RXB, 1KKB, 1MSF, 2MJM, 8RLL, 2NWK, 2KAT, 3EIE, 1MBI, 2JTT, 3JFY, 2GIJ, 1JWY, 2IHN, 8OQC, 1KWY, 8JFK, 3HYM, 8FZG and 8TRI.

Looks like the Navy is taking over the hams . . . or perhaps vice-versa!

"Frequency-Halving" Oscillators

160-Meter Operation With 80-Meter Crystals

BY BYRON GOODMAN,* WIJE AND HAL BUBB,** WIJTD

ALTHOUGH it has always seemed that it would be a good idea to be able to work a crystal on half or one-fourth its frequency instead of always working on the harmonics, no real need for such a device was present until the present emergency made necessary the borrowing of some of our 80-meter net frequencies, leaving the 160-meter band the logical place for the continuance

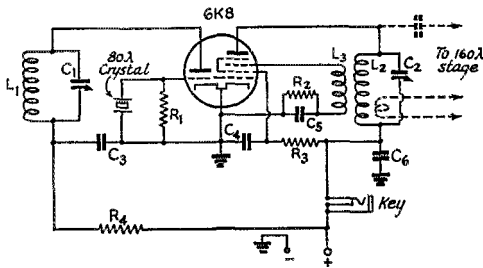

Fig. 1 — A "frequency halver," using a 6K8. Using an 80-meter crystal, 160-meter output is obtained from L₂-C₂.

- C₁ — 150- μ fd. variable.
- C₂ — 250- μ fd. variable.
- C₃, C₄, C₅ — 0.002- μ d. mica.
- C₆ — 500- μ fd. mica.
- R₁ — 50,000 ohms, $\frac{1}{2}$ -watt.
- R₂ — 25,000 ohms, 1-watt.
- R₃, R₄ — 15,000 ohms, 1-watt.
- L₁ — Tunable to 80 meters.
- L₂ — 38 turns No. 20 d.c.c., close-wound on $1\frac{1}{2}$ -inch diam. form.
- L₃ — 24 turns No. 26 d.s.c., close-wound next to L₂ on same form.

of the nets. Since it is expected that most of the nets will move into the 160-meter band and operate on just half the frequency of the present 80-meter spot, it seemed expedient to find means for operators with crystals for 80-meter net operation to use those same crystals on 160 meters. As mentioned elsewhere in this issue, a circuit developed by W3GHR can be used for this purpose, and our investigation started from there.

The Circuits

The circuit of W3GHR uses an ultra-audion type oscillator with the crystal in series with the tuned circuit. The oscillator operates at a frequency determined by the tuned circuit, but when this frequency is very close to a sub-multiple of the crystal frequency, the oscillator will

* Assistant Technical Editor, QST.

** Chief Operator and Station Engineer, W1AW.

"lock in" on that frequency and practical crystal control is obtained. This article deals with another type of circuit in which the crystal is made to oscillate continuously while the 160-meter output is keyed.

The first circuit to be tried is that shown in Fig. 1. The triode portion of a 6K8 is used as a conventional 80-meter crystal oscillator, and the hexode portion is used as a 160-meter oscillator using the tuned-plate grid-tickler type of circuit. The thing worked right off, and all that is necessary to tune it is to tune C₁ until the crystal is oscillating and then adjust C₂ until the hexode is oscillating near half the frequency of the crystal, at which point the hexode will lock in and the output will be crystal-controlled. Keying the hexode gives a crystal-controlled signal with no chirps or back-wave on 160 meters. The output is low, as might be expected, but it is adequate to drive a 6F6 or 6L6 to the output the 6F6 or 6L6 would normally give as a crystal oscillator.

The circuit of Fig. 1 uses electronic injection of

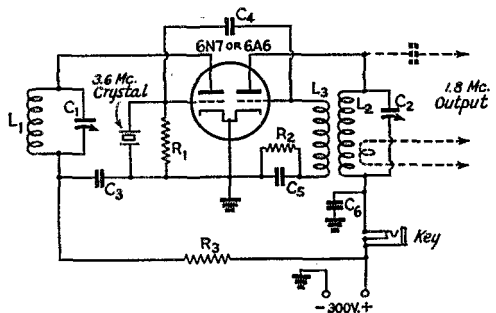

Fig. 2 — Another version of the "frequency halver," using a twin triode.

Circuit constants the same as Fig. 1, except that C₄ is a 3-30- μ fd. adjustable mica trimmer.

the control frequency, so the next step was to see whether or not such injection was necessary. The circuit of Fig. 2 was tried, using a twin triode tube with one triode for the crystal oscillator on 80 meters capacity-coupled to the other triode operating self-excited on 160 meters. This circuit also worked, and it gave more output than did that of Fig. 1, undoubtedly because the 160-meter section of the twin triode (a 6N7) can handle more current. The excitation to the oscillator could be controlled by the setting of C₁ but it wasn't found to be too critical. The self-excited

oscillator locked in over about the same range that it did with the 6K8.

Looking for greater simplification, the crystal oscillator portion was changed to use the Pierce circuit, which requires no tuning for different crystals, and the circuit of Fig. 3 resulted. It was found to be satisfactory in every respect, locking in over the same range and it seems to represent the simplest form of this type of circuit, since it is only necessary to plug in the proper crystal and set C_1 to the proper position. Although the key is shown in the positive lead to the oscillator, a double triode with separate cathode leads (like the 7N7 or 6SN7) would permit cathode or negative-lead keying of the oscillator without keying the continuously-running crystal oscillator. This makes for an ideal type of break-in arrangement, since the chances for chirps are greatly reduced by keying a stage other than the crystal oscillator.

With 300 volts on the plate of a 6N7, the 160-meter output from the arrangement in Fig. 3 is about 2 or 3 watts. This is quite enough to drive any of the ordinary tubes used as crystal oscillators (6V6, 6L6, 6F6, 807), and the excitation can be coupled in through capacity coupling or link coupling. The capacity coupling is easier, of course, since it does away with another tuned circuit. The tubes mentioned above will very probably not have to be neutralized on 160 meters, unless there is some inductive coupling between grid and plate circuits, so the oscillator of Fig. 3 can be coupled to the old crystal oscillator by running a wire from L_1 (shown dotted) through a 250- μ fd. mica coupling condenser to the grid of the old crystal oscillator.

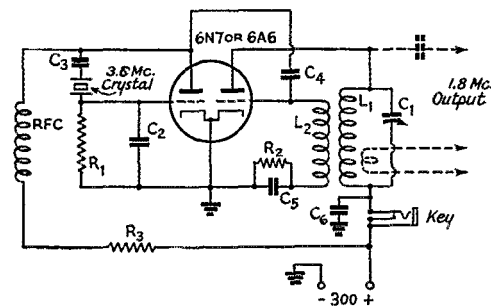

Fig. 3 — The simplified version of Fig. 2, using a Pierce crystal oscillator circuit, and the most practical of the "frequency halvers."

C_1 — 250- μ fd. variable.

C_2 — 100- μ fd. mica.

C_3 — 0.001- μ fd. mica.

C_4 — 3-30- μ fd. adjustable mica trimmer. A 10- μ fd. fixed can be used.

C_5 — 500- μ fd. mica.

C_6 — 0.002- μ fd. mica.

R_1 — 50,000 ohms, 1-watt.

R_2 — 25,000 ohms, 1-watt.

R_3 — 5000 ohms, 2-watt. Used only if crystal shows signs of heating.

L_1, L_2 — Same as in Fig. 1.

RFC — 2.5-mh. r.f. choke.

The temporary order borrowing part of the 80-meter band will cause a general exodus of many traffic nets to the 160-meter band. Since the most logical rearrangement of net frequencies would be a simple division by 2 of the 80-meter frequency, this article should be of considerable interest to the traffic man who doesn't want to junk his present 80-meter crystal or crystals. The gadget is simple to build and adjust, and will give little more trouble than the ordinary crystal oscillator. It has the further advantage that good keying is easier to get with this system than with an ordinary keyed crystal oscillator.

It wouldn't be fair to describe the oscillator without pointing out the disadvantage it has over conventional crystal control. With an ordinary crystal oscillator, one can only get output on the frequency of the crystal, i.e., the crystal either oscillates or it doesn't, and when it doesn't there is no signal. The oscillators described here are capable of putting out a self-excited signal on 160 meters if they are not tuned properly and, while they will lock in satisfactorily over a decent range, they are not to be considered as foolproof as crystal. This, however, works a hardship on no one but the careless operator who can't find time to check his rig before he goes on the air.

Circuit Constants

The circuit constants do not seem to be too critical, and those given in Figs. 1, 2 and 3 can be departed from considerably without harmful results. The coupling between the crystal oscillator and the self-excited one has some effect on the ease with which the s.e. oscillator will pull in, and it is recommended that this be experimented with a bit. If it is too loose it is possible to make the s.e. oscillator oscillate within audio range of the crystal without locking in, resulting in a beautifully-modulated signal that no amateur would want (with the regulations as they are). On the other hand, if the coupling is too great the crystal can be tuned slightly by the s.e. oscillator. A variable coupling condenser and a little experimenting is the best recommendation.

In an effort to make the s.e. oscillator lock in over a wide range and thus do away with any tuning for different crystals, the tank circuit of the s.e. oscillator was made very low- C , but this showed little or no improvement, and it seems best to have at least 150 μ fd. in the 160-meter tank. If the s.e. oscillator is made a weak oscillator by reducing the tickler turns, it will lock in over a slightly greater range, but the output will be greatly reduced.

Numerous modifications and variations of these circuits will suggest themselves to the gang and,

(Continued on page 98)

Code Proficiency Frolic

September 12th-14th and 19th-21st—All Holders of ARRL Code Proficiency Certificate Awards Invited

THIS is an on-the-air activity to promote contact, fraternalism and operating ability between all amateurs who hold Code Proficiency Awards. The possession of such an ARRL Award is the ticket of admission to this activity. The call CQ CP will invite answers from all other CP certificate holders. Besides a fine test of stations and operating fun the CP gang will push along any routine message proffered, and may relay a message or two to the boys in the services, not to pass up any bets.

Frolic Time

The two week-ends are identified by dates above. Actual operating time is limited to not more than 50 hours total in the two week-ends. This may be taken in one week-end or divided between each Fri.-Sat.-Sun. period. Any hours desired can be selected between the following starting and ending times as long as not more than 50 hours of the 108 hours of the two week-ends is utilized.

Start: Friday, 3:00 P.M. P.S.T., 4:00 P.M. M.S.T.,
5:00 P.M. C.S.T., 6:00 P.M. E.S.T.
End: Sunday, 8:59 P.M. P.S.T., 9:59 P.M. M.S.T.,
10:59 P.M. C.S.T., 11:59 P.M. E.S.T.

The participant with one hour to spend is as welcome as the man with more time. It is hoped that making *some* of *several* evenings available for operating will enable *every* CPA holder to get on the air at least a short while and send a report. If one operates more than 30 of the possible 50 operating hours, he will be expected to list on-off times from his FCC log in sending in results.

Scoring Record

To make interesting comparisons of station work possible, we suggest that all hands keep a list of the stations as worked. Exchange the name of your ARRL Section ¹ and the *month and date* of the WIAW run on which you got your initial CP Award with each station worked. This information can be taken right from your ARRL CP certificate, and the year (not required) may be omitted in the exchanges. In your list reported to ARRL note (1) the call of each different station worked, (2) its Section ¹ location and (3) the month and date given you. Note in the list only information *received*. With your signature and call at the end of your report, give your own Sec-

¹ See page 4 of this issue of *QST* for a complete list of ARRL Sections.

tion and the month and date of your CP Award which will check with our card file.

Count one point for each different station so listed. (Second QSOs with the same station do not add to the contact score.) Add all points made in the contest period(s) and also points for each time a message was handled by radio (to be explained). Multiply this sum by the number of different ARRL Sections represented in your worked list to give yourself a score.

Message Credits

To make traffic go along nicely in the frolic a part of the score-before-multiplier may derive from credit for *each radio handling* of an amateur radiogram in proper form. Not over three *originated* messages (proper check required) nor over ten completed radio handlings of messages in all may be counted for credits, placing a ceiling on this part of the score. However, for each message handling by radio credit 10 points before multiplier. Contact and section credits are obtained *only* by work with CP certified operators, but the traffic credit is granted for exchanges with CP amateurs or others. Most traffic of course will be with CP actives.

For message credits submit a separate brief tabulation to substantiate each 10-point claim. On each line give the call of the station to which you sent or from which you received a message by radio. Show "S" or "R", the date of handling and TOR ² for the message, then copy the complete *preamble* of that message in proper order, ³ including the check. A possible 100 points may be claimed based on traffic work in the contest period.

No one is *required* to start a message. It is quite in the spirit of the times to get one or two off to trainees, reservists, or service regulars for yourself or others, however. An item of local news or greeting may raise their spirits. A step beyond the CP certificate is to become familiar with all traffic and operating procedures. If you haven't trainee traffic on the hook, remember your more distant ham and CP friends, or refer to our *In the Services* pages and send some messages anyway. There is no restriction as to use of any particular band,

² S for sent, R for received-by-radio. TOR refers to the Time of Receipt or radio acknowledgment of the radiogram.

³ President Bailey has a memorizing hint for amateurs in connection with getting the sequence of a message preamble correct. He uses the sentence:

NUMEROUS SHORTS CAUSE POWER TRANSFORMER DAMAGE
for
NUMBER STATION CHECK PLACE TIME DATE

CODE PROFICIENCY FROLIC

Dates: Sept. 12th-13th-14th, Sept. 19th-20th-21st.

Starts: Friday 5 P.M. C.S.T.

Ends: Sunday 10:59 P.M. C.S.T.

Operating Time: Any 50 hours selected of the two week-ends. Not more than 50 hours. Exchange name of your Section, and month and date you got your CP Certificate. General Call, CQ CP.

Scoring: 1 point for each different station worked. 10 points for each message handled by radio. (Not over ten messages may be reported for credit; only three of these may be originated.)

Score is sum of all such credits multiplied by the number of different ARRL Sections represented in the CP station-worked list.

Prizes: The five leaders in score will receive copies of "Calling CQ" by Clinton B. DeSoto.

or to 'phone or c.w. for this activity. 'Phone is best for command channels and c.w. for record traffic of this type, of course. All who have crystals or eco's in the 1750-1900 kc. sector may well give this part of our territory a Band Warming in connection with our little party. Since thousands of CP Awards have been issued by ARRL, there should be little difficulty in moving traffic to almost any section of the country.

Prizes

The five amateurs taking part who have the five best over-all scores will each receive a copy of the new DeSoto book *Calling CQ*, 291 pages of the adventures of short wave radio operators. The book is published by Doubleday Doran and Co., and is full of thrilling stories about our Amateur Radio. All prizes will be autographed by the author. Those with high scores having the book may, if they win, elect to receive ARRL publications of equivalent value.

Report results for the credit of other CP operators worked and so full results appear in *QST*. Any stations that ask how to get CPA status can be told that the next official code proficiency qualifying run from W1AW will be held Saturday, September 20th, and if they get their award then they will be eligible for the next CP Frolic! Have you your CP Award? Then don't miss this September Party.

— F. E. H.

Got Your Proficiency Award?

CODE PRACTICE is sent nightly except Friday from W1AW, starting 9:45 P.M. E.S.T. (8:45 P.M. C.S.T., 7:45 P.M. M.S.T., 6:45 P.M. P.S.T.) using 1762, 3575, 7150, 14,253, 28,510 and 58,970 kcs. (simultaneous transmission). Approximately 10 minutes' practice is sent at progressive speeds of 15-20-25-30-35 words per

(Continued on page 98)

W1AW SENDING-PRACTICE SUBJECTS AND QUALIFYING RUNS

August 18th to October 1st, Sunday, Tuesday, Thursday

Daily-except-Friday practice starts at 9:45 P.M. EST.

Date Subject of Practice Text from August QST.

Aug. 18. Evening qualifying run at 9:45 P.M. EST with unannounced copy.

*Aug. 19. *In the Services*, pp. 27 and 68.

*Aug. 21. *U. S. A. Calling*, p. 32.

*Aug. 24. *Optimum Q and Impedance of R.F. Inductors*, p. 28.

*Aug. 26. *W9BSP Paley Award Winner*, p. 26; *Ionosphere Predictions*, p. 24.

*Aug. 28. *Hints and Kinks*, pp. 40 and 86.

*Aug. 31. *Notes on UHF Antenna Heights, WWV Schedules*, pp. 38-39.

Sept. 2. *An Inexpensive 112-Mc. M.O.P.A.*, p. 12.

Sept. 4. *Let's Talk E.C.O.*, p. 14.

Sept. 7. 1:30 P.M. EST, W1AW daylight qualifying run. Unannounced copy.

Sept. 9. *A Modulator and Power Supply for the Inexpensive 56-Mc. Transmitter*, p. 18.

Sept. 11. *Five-Meter Wave Paths*, p. 23.

Sept. 14. *What the League Is Doing*, p. 28.

Sept. 16. *Further Developments in the Foolproof Rig*, p. 30.

Sept. 18. *Trainee Traffic Grows, Hams Get in This*, p. 33.

Sept. 20. Saturday evening qualifying run at 9:45 P.M. EST. Unannounced copy.

Sept. 21. *U. S. A. Calling, Navy Commissions for Electronics Specialists*, p. 36.

Sept. 23. *A Simple Filter for Elimination of B.C.I.*, p. 47.

Sept. 25. *Signal Corps Radio School*, p. 9.

Sept. 28. *Here and There*, p. 43.

Sept. 30. *The Radiolocator*, p. 7.

* July '41 QST.



ON THE ULTRA HIGHS



CONDUCTED BY E. P. TILTON,* W1HDQ

Is your pet band not what it used to be as a result of the new emergency regulations? If you are one of the many who are thinking of the Ultra-Highs for the first time, here is a rough idea of what you will find awaiting you, should you decide to move up for the duration.

On Five, you'll find the most interested and devoted body of amateurs to be found in any amateur band. You'll find a new field for your DX talents here, too, and you'll find that DX does not necessarily mean rare prefixes and un-pronounceable names. Are you a "rag-chewer"? Then there's not another band where the percentage of "100 per cent QSOs" runs as high as it does on the Ultra-Highs. Like to put up fancy antennas? High-gain beams are easy here! Are you fond of experimental work, but rather scared by the complex gear now generally used by leading stations on the lower frequencies? Then 112, 224, 400 Mc. and higher are your dish. Development of these frequencies is just getting under way — the old thrill of pioneering in a new field is yours all over again.

Maybe you're just a little tired of the struggle with the QRM anyway, so come on boys — there's plenty of room for everyone on the Ultra-Highs. You may be surprised to find that you've been missing something all these years!

It is fortunate that the two-part article on "Five-Meter Wave Paths" by Mel Wilson,

*329 Central St., Springfield, Mass.

W1DEI, is appearing at this time. We heartily recommend this material to all who have the slightest interest in u.h.f. work. It's so much more fun when you have at least a fair idea of what it's all about. Mel tells us — in language we can all understand.

Five lived up to its reputation for pulling the unexpected during July. We have come to think of February, March, April, September, October, and November as the months in which to look for aurora DX. And now it comes along in July! A magnetic storm, severe enough to put wire services and low-frequency amateur and commercial frequencies out of business, sent Five on a rampage on July 5th. A c.w. session for W1, 2, 3, 8, and 9, equal to the best colder weather ever produced, was the result.

At least two instances of double-hop sporadic E DX were noted during July, on the 8th and 22nd, resulting in numerous contacts between W6's and W8's and 3's.

The hot summer weather was productive of almost nightly temperature inversions, with several contacts up to 350 miles being made on Five without the aid of the E-Layer. Along the North Atlantic Coast and in Southern California, these inversions were the cause of some excellent DX work on 112 Mc.

It isn't often that we have international news now, but here's an interesting bit from France, telling of inter-continental work on Five just before the outbreak of the current unpleasantness:

"During the very last days of peace in Europe, F8IHH (Algeria) ran a 56-Mc. sked with F8GQ (Paris), seconded by F8RJ. On August 16th, at 1305 G.M.T., a two-way contact was established for two minutes, each end being QSA 3 R 5, bad QSB.

"A few hours later, war crashed over Europe; so no written evidence was possible to set up. Then came armistice and broken mail between Paris and Algiers. It was only in June, 1941, that F8RJ had an opportunity to cross in Africa, rush in F8IHH and get 100% evidence of this record-breaking QSO on Five.

"F8IHH used 50 watts on RK-20, homemade receiver, à la HRO, and 14-Mc. regular antenna. F8GQ used 50 watts on T-20's, 3 tubes homemade receiver and regular traffic antenna.

"And now F8IHH and F8GQ wait return of peace for round Nr. 3 towards first 56-Mc. WAC Certificate."

The signature and QTH are marked by the censor "Not to print"! Our thanks to this unnamed gentleman for letting this story through!

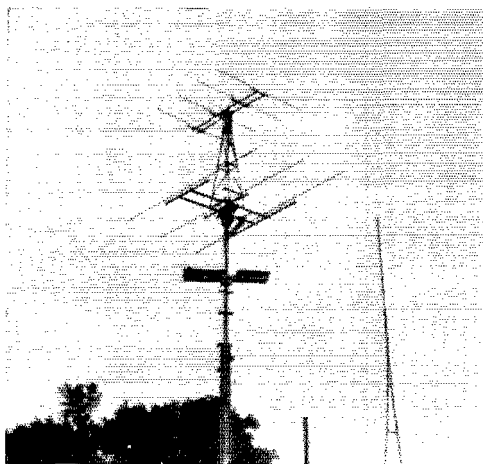

The 28- and 56-Mc. rotary arrays at W5DNN, Austin, Texas. The top section, recently added, is a 4-element array of the W6QLZ variety.

HERE AND THERE:

At this writing W2BYM remains the only station in the East to have worked the elusive W7. There has been plenty of waiting on the part of W1's EKT, AEP, HDQ, W2GHV, and W3's OR, HDJ, IIS, and others who need only W7 to complete WACA. And W2BYM needs W6 — but we're betting on Mel to be the first to make the grand slam.

W1MEP/1 has been handing out quite a few of those coveted Vermont QSL's this summer. W9BDL, Marshall, Ill., was worked on the Fourth, and on the 16th Chet connected with W5HTZ, Cromwell, Okla., for a new record for low-power DX on Five—1350 miles on 2½ watts input! On several occasions W1MEP/1 has been getting into Eastern Massachusetts, working W1's JNX, DA, HXP, KSA, NF, and CGY/1, the last mentioned being on Cape Cod, 150 miles distant. W2AMJ and W2BQK have made the grade from W2. Chet has no monopoly on the low-power field, however. W3FFP, Merchantville, N. J., has been putting a fine signal up to W1KJL, 150 miles, and W1HDQ, 190 miles, with nothing more than five watts input to a 6L6 doubler and a vertical folded doublet.

W1LLL reports a new source of "neighbor trouble." Next door to Brownie is a lad who plays an electric guitar — with the voice of W1LLL "calling CQ—Five DX" as accompaniment. Having been received on cigar-box radios and crystal pickups, Brownie says he would not be surprised to have some one pick him up on a bass drum or a typewriter!

W5AJG has been transmitting on two different frequencies simultaneously: on 56.6 with 30 watts and a low antenna, and on 57.6 with 300 watts and a high antenna. At certain critical skip distances the low-power low-antenna combination works out better. A comparison between the results of the two combinations aids Leroy in judging the condition of the band.

W5HTZ, Cromwell, Okla., is doing all right for a beginner! Since May 10th, Merlin has worked 28 states and all call areas on Five! W5AFX in Oklahoma City is now using horizontal polarization and these two are hoping for many new converts within the local range to keep things going on Five during the months when there will be very little skip DX. With the growth of activity in Texarkana, Shreveport, Dallas, Denton, and other points within a 200-mile radius there may yet be such a thing as year-round activity on 56 Mc. in W5. W5DXW in Texarkana is off temporarily, but will be back on from a new QTH by the time this appears in print.

W5JGV, Hurley, N. Mex., notes that when Ten shows both short and long skip Five is open in the same direction. Wayne is running up an impressive DX record in his first season on Five, with 21 states worked up to July 16th, and all call areas except W4. Band openings were an almost daily occurrence in June and July.

Some very short skip is reported by W6QG, Santa Ana, Cal. Ray has been working the Arizona gang, a distance of only 350 miles. These contacts are usually made when the band is open to other sections of the country, indicating that these extremely short-skip contacts are, in some way, a by-product of the more normal 800-1200-mile condition. Other California W6's worked by the Arizona stations include LFN, Los Angeles; OFU, Colton; SJB, San Bernardino; ANN, San Pedro; AVR, Altadena; NHO, San José; and BPT, Santa Clara. All of these represent shorter skip than is reported from any other section of the country.

W6's OVK, QAP, and SLO of Tucson, Ariz., really watch the band. Between these three, DX was worked from Tucson almost every day in June and July. W6QAP reports hearing W1's SI, AEP, and KJL, and W2's BYM, AMJ, and CUZ, on June 28th. What those fellows wouldn't give for a W6, too! July 8th was another good night for double hop. W6OVK worked W8CIR, W8QUO, W3CGV, and W3OR and a whole string of W5's and 9's, and heard W8RKE, W8QQS, and W8BKB. W6QAP's list for the evening includes W8's CIR, KKD, and QQS, worked; and W3's AXU, OR, CGV, BKB, W8's QUO, RKE, RFW, and VIB heard; as well as numerous W5's and 9's within the normal skip range. Openings to W7, W5, and W9, were an

U.H.F. MARATHON

Call	Contacts Through July 15th				Score	States in 1941
	56	112	224	400		
W1AEP	102				967	22
W1AVV	112	34			847	18
W1BCT		33			153	2
W1CGY	52				396	13
W1DJ	108	75			762	9
W1DLY	63				471	13
W1EHT	54				395	5
W1EKT	106				707	16
W1ELP	67				296	4
W1HDQ	214	46	4		1970	29
W1IJ	58	36			524	7
W1KJL	178	39			1444	26
W1LCC	9	7			40	2
W1LFI	7	133			585	5
W1LLL	139	51			1449	23
W1LMU		50			162	2
W1LSN	79				670	14
W1MBS		206			770	3
W1MEP/1	32				269	8
W1NCQ	56				239	14
W2ADW	1	86			566	5
W2AMJ	161				1367	21
W2BYM	166	4			1302	27
W2COT	97	18			488	6
W2DZA		249	3		912	5
W2FJQ	56	45			432	12
W2LAL	89	6			470	6
W2LXO		168			595	4
W2MBS		45			124	3
W2MEU	52				251	5
W2MGU		131			537	3
W2MIV	21	57			217	6
W2MQF		76			307	2
W2NSD		4			16	1
W9A0B/2		43			176	2
W3ABS	50				195	5
W3ACC	86	3			525	12
W3AXU	107	19			712	17
W3BZJ		179			342	3
W3CGV	84	6			610	14
W3FJ/3	38				325	14
W3GJU	53				232	9
W3HDJ	60				471	18
W3HOH	95	210			1250	12
W3IIS	68				736	16
W3RL	23				288	9
W4FBH	58				610	16
W4FKN	25	2			206	6
W5AJG	148				1650	25
W5DNN	38				436	13
W5FSC	39				405	15
W5JGV	48				854	19
W6ANN	49	125			1057	11
W6BPT	8				77	4
W6OVK	66	6			1337	22
W6QG	49				878	10
W6QKM	4	73	1		286	1
W6QLZ	53	5			818	15
W6SLO	53				1182	17
W7CIL	13				205	4
W7ERA	15				90	6
W8CIR	81	10			1371	16
W8KKD	89	35			1040	14
W8KWL	11				96	8
W8MHM	2	12			81	1
W8QQS	50				562	15
W8RUE	49	10			491	11
W8TDJ	26				318	10
W8UUY		9			127	1
W9AB	16				149	7
W9ANH	39				550	11
W9ARN	76				932	19
W9BDL	76				1057	19
W9FHS		24			87	2
W9LLM	64	27			628	13
W9PK	90				789	22
W9PNV		33			488	2
W9RLA		42			216	2
W9YKX	81				1040	24
W9ZHL	60				727	15

Fifth Period Winner: W6SLO, 616 points.
Sixth Period: W2BYM leads with 676 points.

almost daily affair. W6OVK reports that the signals from the 800-1200-mile range take on a rapid fluttery fade just before the double hop appears. Jim has been checking with a low vertical extended double Zepp in comparison with his 4-element horizontal, and finds some occasions when this low vertical is better, though the horizontal is superior most of the time. W6QG has a high vertical and a low horizontal. Ray finds the high vertical best on the longer hops (W9's at 1200 miles or so) probably due to its lower radiation angle. During the short skip periods, he has heard harmonics from 28-Mc. stations in Tucson, only 350 miles distant!

W1MHM, Glastonbury, Conn., never had much luck in working DX on Five. He had a poor location, low power, and plenty of high-powered W1 competition. But things are different now! As W71FL, Cheyenne, Wyoming, Johnny is a rare prize, and he is having the time of his life. With 35 watts to an 807 (on 57,152 kc.) Johnny has 16 states in 5 call areas, and lacks only a contact with the East Coast to make the 1941 season a complete success.

During the evening of July 16th, W8's KKD, VIB, and QDU were in a three-way confab when W71FL broke through. Three beams were quickly headed west. W8QDU hooked him and passed him around "like a bowl of rice among starving Chinese" until all three had the coveted W7.

Activity in Oregon and Washington reached a new high during this summer season. Except for local work, these fellows have had little encouragement in past years. Now, with plenty of stations to work in W6, and western W9, and occasional skip to W5, W8 and eastern W9, and other parts of W7, Five has taken on a real interest for the boys in the Northwest. W7ERA, Milwaukie, Oregon, reports skip contacts on June 19th, 23rd, 25th, 27th, 28th, 29th, July 6th, 8th, 9th, 10th, 11th, 18th, and 20th. W8RKE, Grand Rapids, Mich., was heard on June 23rd. Walt reports that W7FFE and W7FDJ heard W8TDJ in Morgantown, W. Va., on June 28th, a distance of more than 2200 miles!

W8QXV, Barberton, Ohio, reports that the use of double polarization, mentioned last month, is not always effective in working skip DX. A drop of 20 db has been noted on W5's and W6's on two occasions when both polarizations are

used simultaneously, though most of the time there seems to be no ill effect. In working extended-local contacts, the use of double polarization has always worked out satisfactorily, to date. Doc heard plenty of stuff during the surprise aurora session July 5th. W1LLL and W1K1J were worked, and W1's DJ, HXP, QB, W2's CUZ, AMJ, TP, BYM, W8's RUE, KDR, QDU, CIR, and W9IOD were heard.

W8QDU, Detroit, a recent convert to horizontal polarization, has found a way to get real performance out of a horizontal array. Fred has been working with a 4-element array and has now added another array eight feet below it. The two are fed in phase with a transposed Y match, with the feed line attached to the lower section. Lowered radiation angle is evidenced by reduction in airplane interference. Fading is reduced in comparison to the single 4-element. Ignition interference is stronger along the line of the array, but weaker from other directions. Though the new array is lower than any previous antennas used at W8QDU, signals from all points within a 250-mile radius are up above anything in previous experience.

Many fellows are still shy of the multi-element parasitic array because of the complexity of tuning up such a system for maximum performance. The 4-element array shown in the accompanying sketch can be tuned up with hardly more trouble than is entailed in tuning the rig itself. The information was supplied by W9WAL who reports that this system has been used very successfully by the Ozark Net. To tune the array it is merely necessary to put a field-strength indicator in front of the antenna and tune the director condensers for maximum indication, then turn the array around and adjust the reflector condenser for minimum. The folded doublet used for the radiator, and the method of matching to the open line used, are less critical as to frequency response than the delta match or "Q"-bar arrangements, and can be made to perform over a fairly wide range of frequencies by merely cutting the radiator to length by the customary formula. Insulation of the condensers used in the parasitic is unimportant, as the r.f. voltage is practically zero at the center of the elements.

The use of flexible matching sections is an advantage when the feedline must be run up to the array through a hollow drive shaft. W9EGQ, Gary, Ind., puts a coil (10 turns, 1 1/4-inch dia. 2 inches long) across his slip rings and runs a 1/2-wave section of EO-1 cable up to his array. The cable is tapped across four turns at the center of the coil.

W9LLM, Downers Grove, Ill., has his "W6QLZ Array" up to 65 feet and is working W9AQQ, Indianapolis, at 175 miles, with good sigs. W8VIB, Three Rivers, Mich., and other stations around Detroit are now being heard. Frank reports W9FXB, W9AEH, and W9ZWF, as new stations on Five in that area.

W9YKX lost that beautiful 12-element horizontal array in a "twister," July 17th. But that won't keep Bill down, and W9YKX will be back in full swing before this appears in print.

Dud Little Memorial Award

In memory of DeMotte H. "Dud" Little, W9VEG, deceased member of the Ultra-High Frequency Club of Chicago, the club will present an award to the amateur in Illinois and bordering states, including Michigan, who shows the greatest achievements in Five-Meter work in the period of Jan. 1st to Dec. 31st, each year for the next five years.

Any amateur may nominate one or more stations from this area for the award. No amateur will be eligible for the award more than once. Nominations should be addressed to Edward C. Hamel, W9EWE, Secretary of the U.H.F. Club of Chicago. Members of the club will act as judges and therefore are not eligible for the award. The first award will be for the year 1942.

112 MC. AND UP:

THE favorable conditions of July and August used to provide "DX" for the boys on Five back in the early days of activity on that band. These early thrills are now being experienced by the operators on 2 1/2, with many contacts beyond 100 miles being made with low power and

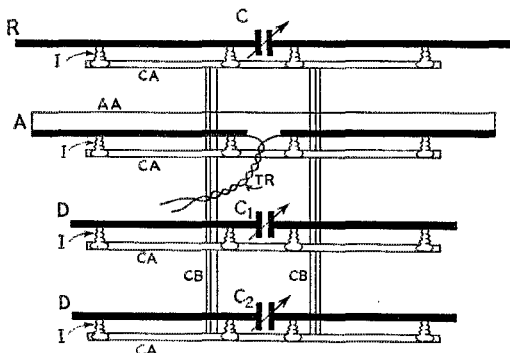

The multi-element array at W9WAL

- CB — 2" x 3" cypress, 6' 6" long.
- CA — 1' x 1 1/2" cypress, 4' long.
- I — 3" stand-off insulators.
- R — 1/2" O.D. thin wall conduct, 8' 6 1/8" long.
- A — 1/2" O.D. thin wall conduct, 8' 2 1/8" long.
- AA — No. 12 wire 6" from A and connected on at both ends of A.
- D — 1/2" O.D. thin wall conduct, 7' 11 1/4" long.
- C — 150- μ fd. variable.
- C₁ — 50- μ fd. variable.
- C₂ — 100 μ fd. variable.
- TR — Two No. 10 solid insulated house wire, 2' 5 1/2" long, twisted 3 turns to the foot, feeding into a 2" open wire No. 12 line.

simple equipment. During the evenings of July 5th and 6th, W1JFF, Newport, and W1LPO, Tiverton, R. I., worked an imposing list of stations, including W3BZJ/1, Mt. Greylock, Mass., 135 miles, W2LAU, Summit, N. J., 160 miles, W2MCG, New York City, 150 miles, and W2GPO, Huntington, L. I. and W2ADW, E. Quogue, L. I. LPO uses and HY-75 transceiver, and JFF a 6E6 oscillator.

W2GPO recently put a 12-element array up 55 feet above ground and is now S9 at W1HDQ, 105 miles, under any conditions. When 2½ is hot, Puss actually pushes some of the locals around! He has worked three stations in Rhode Island, and on July 14th connected with W1LZB at Boston, a distance of 160 miles. Just prior to this contact, W1LZB was heard working W1LOP in Hartford, Conn.

W2LAU reports that he was using horizontal polarization for transmitting during the contacts with W1JFF and W1LPO on July 6th. Warren will be testing with vertical and horizontal antennas alternately through the balance of the summer and would appreciate comparative reports from stations beyond the normal range. The rig at W2LAU is a pair of HK-24's at about 100 watts.

George Baptiste of Howard, R. L., reports reception of W2's ADW, LAU, NKO, LXO, and W1MNK and W1MIF in Beverly, Mass., and W1LZB in Boston, during the strong inversion bending of July 5th and 6th.

But for ideal temperature inversion conditions the California coast still holds the record. W6QKM has heard W6OIN in San Diego, a distance of around 110 miles, while driving through the streets of Los Angeles! On June 29th, Don worked W6QDW/6 when the latter was only five miles north of the Mexican border and W6QKM/6 was in Beverly Hills, a distance of 140 miles.

W4EDD, visiting W2AMJ, tells of big doings around Miami on 2½. Robbie insists that his 500 watts is going to get through to W1 and W2 on 2½. Anyone tempted to laugh at this suggestion should remember that it was not too many years ago that Robbie surprised the whole 5-meter fraternity by making a sked with W2AMJ — and getting through! A 2½-meter Army net has been organized in the Miami area, with six mobile stations included. A 25-watt aircraft installation is now undergoing tests. Several stations are active in West Palm Beach and contacts with the Miami stations are expected shortly.

W9INI, Pleasant Hill, Mo., reports W9CXB and W9VRF Belton, Mo., and W9QYA, South Park, Kansas, as new stations on 2½. Harry reports that W9DDX has replaced his coil and condenser circuit with a concentric line with improved results.

To those who may be looking for something really "hot" in the way of receivers for 2½, we suggest that they look into the simplified "double superhet" circuit now being used in commercial f.m. receivers. Ask your service-man friends for information of the GE Model JFM-90. With only one tuned circuit required for the signal frequency, this arrangement should solve the problem of efficient r.f. sections for 112 Mc. A converter of this type, working into an f.m.-a.m. i.f. channel should provide about the ultimate in reception of weak signals on 112 Mc.

A message via the New England Army Phone Net, tells of a pair of 800-Mc. oscillators now working at W6IOJ. It appears that John is not satisfied with holding the 224 and 400-Mc. records! Going up?



OST for September, 1916, was an invaluable number because it contained the second part of Paul Godley's classic on applications of the audion, but the editor gave first place to a confection of his own on "The Propagation of Wireless Waves," mostly cribbed from Zenneck. . . . TOM's articles have aroused three con-

tributors to writing "rotten" articles, mostly in honest indignation about something. For example, the Redlands (Calif.) Electric Company is refusing to supply juice to houses where there are amateurs, on the grounds that the transformers injure their power lines. The editor says, "Light companies are human like the rest of us. Try rubbing their fur the right way and see if they won't purr." . . . Nelson Dunham describes a 50-foot lattice mast which can be easily carried and erected by two men. . . . Small-boy spark coil interference is becoming terrible; Charles S. Wolfe complains:

"When old man Hertz got busy and coerced a spark coil, condenser and two chunks of zinc into uniting for the purpose of tormenting a broken hoop which was resting peacefully across the room, he started something, believe me. He produced the Hertzian wave and, as near as I can make out, Hertzian waves don't care who produces 'em. A learned college professor sits down, brushes his alfalfa field out of the way, covers a sheet of paper with X's and Y's and a table with junk, and fires off a couple of Hertzian waves in an endeavor to ascertain whether figures ever lie. The kid across the street litters a table with similar junk, omits the X's and Y's, and turns loose a whole darned air full of Hertzian waves. In order to ascertain whether or not he can disturb someone. He can! He's a success as a disturber."

He knows what to do about it:

"A hint, brothers. Go to the station of such fiends as I have described, look wise, praise the murderous outfit in general, but remark casually that you know of a much more efficient hook-up. Proceed then with diligence to make connections anew, leading all important wires to the post

(Continued on page 90)

Silent Keys

It is with deep regret that we record the passing of these amateurs:

Floyd V. Barnes, W5EVV, Houston, Texas
 Alphy L. Blais, VE2AC, Thetford Mines, P. Q.
 Bruce Carruthers, VE3AFD, Islington, Ont.
 J. W. Clennett, G3KR, Darlington, England
 John W. Glen, Jr., W5AJF, Tyler, Texas
 Kenneth S. Ives, W3EPG, Catonsville, Md.
 Eugene E. Lovejoy, W7AJV, Portland, Ore.
 Harvey L. Perhatz, W9EBM, Oshkosh, Wis.
 David T. Reisland, W8OYX, Lakewood, Ohio
 R. O. G. W. Sands, G3DC, Salford, Lancs.
 S. F. Sapp, W4BPF, Waycross, Ga.
 Phil Sherriff, G5CJ, Kendal, Westmorland
 George A. Turcott, W8NFG, Watertown, N. Y.
 Rev. Arthur Wake, W3JEQ, Strasburg, Va.

Results, 1.75/28-Mc. W.A.S. Parties

BY J. A. MOSKEY,* WJMY

LITERALLY every kilocycle between 1750 and 2050 abounded with signals during the third ARRL 1.75-Mc. WAS Party held February 14th-15th-16th. It was a week-end of intense activity during which there were probably more stations on the band than at any one time in the history of amateur radio. Records set last year were topped by immensely large margins, and it is interesting to note the vastly increased use of c.w. this year by most of the high-scoring stations. Conditions were ideal for the shindig and coast-to-coast contacts were reported in numerous instances. There's no doubt in our minds that everybody had a good time!

Among the top-flight performances, that of W9JID is most noteworthy. This lad really did a nifty chunk of operating! Running 200 watts on both 'phone and c.w., he managed to contact *all states* — a record for 160 meters in any man's language! W9ZVT worked 'em all except Arizona. W9WGL worked 45 states; those missed were New Mexico, Utah and Vermont. W9DJA, W4FLS and W9ROQ each got 44 states. W9DJA missed Idaho, Nevada, Utah and New Mexico. W4FLS got all but Arizona, Colorado, R. I. and Utah. Maine, Nevada, R. I. and Utah were missed by W9ROQ. W4GWV snagged 42 states and 41 were worked by W8UMD, W8KWI and W9KLC.

Leader in number of contacts was W9JID with 352. Other highs in contacts were W6AM 340,

* Assistant to the Communications Manager.



W9JID, Berwyn, Ill.

Bill Guimont, W9JID, was the outstanding operator in the party. He led the country in scoring, number of contacts and *worked all states!* The rig at left is used for 'phone, the one at right for c.w. Both units have identical r.f. lineups — 6F6 a.c.o.-6F6 bfr-dblr, 807 driver, TZ40's final. Input run was 200 watts. Antenna was a half-wave Zepp, 80 feet high. The station receiver is an HQ120X.

W6SPX 315, W9YYZ 308, W1TS 305 (non-competing), W9WGL 295, W9RQM 281, W3GKR 281, W6YX 280, W9DJA 278, W9ZBG 269 and W1JHV 256.

The following were leaders in their respective call areas: W1JHV 38,400, W2LNQ 31,450, W3GKR 53,835, W4FLS 53,020, W5KC 25,500, W6AM 64,750, W7HBC 23,100, W8UMD 45,305, W9JID 86,880.

The nine highest scorers used both 'phone and c.w. in running up their FB totals. The national high score, 86,880 points (352 stations, 48 states), was made by W9JID, Illinois. For second place, W9WGL worked 295 stations in 45 states to total 68,625 points. W6AM placed third with 64,750 points, 340 stations, 37 states. Also using both 'phone and c.w., the following stations merit mention: W9DJA 63,360, W9YYZ 61,600, W9RQM 56,745, W6SPX 56,700, W1TS 55,125 (non-competing), W3GKR 53,835, W6YX 53,650, W9ZBG 52,455.

Of those operators operating exclusively on 'phone, W4FLS placed highest by contacting 241 stations in 44 states for a final score of 53,020. Next in line was W8UMD, 45,305 points, 221 stations, 41 states. Other all-'phone highs were W9ZGX 43,875, W9ROQ 43,780, W8VDJ 40,800 and W4GWV 40,530.

In the c.w.-only class W8WQ's score, 26,400, 155 stations, 32 states, was outstanding. W5KC was a close second with 25,500 points, 140 stations, 34 states. Other high c.w.-only participants were W9BRD 20,100, W3IWM 18,620, W9MUX 18,000, W8AQ 16,500, W1EJK 15,985 and W2ASH 15,820.

Comments

"I got quite a kick out of the 160-c.w. band. The boys really turned out in fine style." — W9AEJ. "Was very much surprised to find out how well my rig worked on the 160-meter band. Heard several W's. Enjoyed the party." — W8JM. "I worked three new states I needed for WAS." — W9WWL. "Out of 111 stations heard, 101 were worked. Out of 28 states heard, 25 were worked." — W3BXE. "My first WAS party and enjoyed it very much. I was surprised to hear so many SS'ers and ORS'ers in it." — W2LXI. "Worked 165 stations and 28 states with 150 watts input to a pair of HY40Z's." — W7HBC. "I had a swell time. Used 80 watts and worked a few more new states. Will be looking forward to the next contest." — W2MIG. "I had a great time and hope to be able to participate in the next one. Words cannot begin to describe the real pleasure that I derived from the competition." — W9GWL. "All hail to the 160-meter contest and long may it reign! We wouldn't miss that feverish work, those late hours and the lost sleep for anything." — W1DMV (operating W6YX). "Had a swell time in 160-meter WAS Party. Worked everything I heard on c.w. Will use 'phone and c.w. next year." — W5KC. "Got the biggest thrill during the last few hours of the contest trying to snag an extra state. This was my first attempt at the WAS Party. One certainly shouldn't underestimate the possibilities of 160 meters." — W9WGL. "The contest

seemed more lively than last year." — W3AJS. "Great fun. Will be in next year." — W2CEJ. "Had a swell time. It was the first time I had ever tried 160 and I've been on the air since March, 1928. Used 40 watts input. All operation here was on c.w." — W1CRP. "It was a whale of a lot of fun and I would not have missed it for anything." — W9FDQ. "The contest confirmed my faith in low power as my little fifty water seemed to hold its own in the QRM with its bigger brothers." — W8MON. "In my sixteen years on the air I have never heard so many stations on the 1.75-Mc. band." — W9BBS.

Scores, 1.75-Mc. W.A.S. Party

(Stations are listed in order of scores. . . . Score, number of states and number of contacts indicated. . . . Stations whose calls appear in boldface type submitted the highest score from their states).

W9JID**	86380-45-352	W8FGX	13680-24-104
W9WGL**	68625-45-295	W7HAZ	13500-20-125
W6AM**	64750-37-840	W1KLV**	12870-22-107
W9DJA**1	63360-44-378	W8OKC*	12750-25-92
W9YYZ**	61600-40-308	W8MON**	12480-26-96
W9RQM**	56745-39-281	W7GNJ	12285-21-107
W6SPX**	56700-36-385	W5CJJ	12180-29-84
W3GKR**	53835-37-281	W8ROX**	11845-23-93
W6YX**2	53650-37-280	W1KYT**	11700-20-107
W4FLS	53020-44-241	W9WWL*	11560-34-68
W9ZBG**	52455-39-269	W4GNQ*	11550-30-77
W8UMD	45305-41-221	W9GLU*	11520-24-86
W9ZGX	43875-39-225	W2KLG*	11500-20-105
W9ROQ	43780-44-199	W4AFQ**	11440-26-78
W8VDJ	40800-40-204	W8JMQ*	11400-24-85
W4GWV	40530-42-193	W9PNE*	11250-25-80
W8KWI**	39770-41-184	W1MEM**	11685-19-123
W1JHV	38400-30-256	W9ZVT	11220-33-68
W3IMY	37260-36-207	W2JWK	11000-22-100
W9KOH**	37100-35-212	W8NNV	11000-25-88
W9BBS**	37000-40-175	W2HAE*	10875-25-77
W1LOP**	34365-29-227	W8TUD**	10800-24-90
W3AQ³	33015-31-213	W3OWK**	10530-26-71
W8BOR**	32130-34-189	W8NKU*	10500-25-74
W9KLC	31570-41-154	W9GDB	10121-29-69
W2LNQ	31450-34-175	W8UIW	9620-26-74
W9ZVT	29845-47-127	W9QLF	9620-26-74
W1KPD	29120-32-182	W6PDU	9605-17-113
W3CRW	28985-31-177	W2HXI*	9545-23-73
W2MUT	28320-32-177	W9BPU**	9100-26-60
W3CWG	27440-28-186	W9FDQ	8580-22-78
W8WQ*	26400-32-155	W8BLP**	8300-20-83
W5KC*	25500-34-140	W8AXQ	7980-28-57
W2MIG	23490-29-152	W8TEP**	7780-18-77
W7HBC	23100-28-165	W6ITH	7760-16-97
W8MTQ**	22880-32-133	W3HTJ	7760-24-63
W3ILZ	22620-29-156	W8BYM*	7590-23-66
W4GNF⁴	22560-32-141	W9AEJ*	7590-22-59
W9UTL	22500-30-140	W4FIJ**	6930-21-56
W2LXT**	21700-23-145	W8ROA	7250-25-58
W3GRT	21375-25-171	W8OQV*	7150-22-65
W5IKP**	21285-33-119	W8NFF	6990-24-58
W2KVE**	21000-30-130	W4FIJ**	6930-21-56
W9GWL	20800-40-103	W6RZY	6860-14-98
W9BRD*	20100-30-134	W9YTV*	6600-22-60
W9CWP	19800-30-132	W1AAR	6300-14-80
W1LCH**	19575-27-145	W8FKO*/⁵	6100-20-61
W9JOL	19040-34-112	W3IQN	5830-22-53
W3IWM*	18620-28-123	W9YKR**	5700-20-47
W9MUX*	18450-30-113	W9BXJ	5670-21-54
W2JKH	18000-24-140	W1FWH	5520-16-59
W4HER**	17220-28-113	W8MFF	5250-25-42
W9JWT	17100-38-90	W1KKS*	5100-17-50
W9HRH	16800-32-105	W9EQK**	5040-19-52
W8PBX**	16660-23-119	W9EGQ**	5035-19-43
W8AQ*	16500-30-100	W1CRP*	4770-18-43
W1EJF*	15985-23-129	W6IWS**	4640-16-48
W2ASH*	15820-29-113	W1TO	4590-17-44
W9MBI	15400-28-210	W7ILR	4590-17-54
W3HXV	14850-30-99	W2MOY*	4500-15-50
W8LCY*	14700-23-95	W8SVC*	4500-20-45
W1LTB**	13875-25-101	W8PNJ	4305-21-41
W3BXE*	13875-25-101	W3ASQ	4180-19-44

* Transmissions by c.w. only.

** Transmissions by both 'phone and c.w.

(Stations not marked by asterisks used 'phone only.)

¹ W9RBI opr.

² Stanford Radio Club, W1DMY and W6HJT, oprs.

³ Delaware Valley Radio Assn., W3ITU, opr.

⁴ Operated by members of Greensboro Radio Club.

⁵ HQ's staff member; not competing.

W4DIA**	4140-18-36	W9MRQ*	1160-8-19
K4DTH	4095-21-39	W2KZG	1120-7-32
W4CSP	4025-23-35	W9OHA/5*	1150-10-13
W2FRL*	3910-17-46	W9EZF**	1110-6-27
W9FUY**	3900-12-65	W9BWO	1100-10-12
W8VBY*	3800-19-40	W9CIU	1040-8-16
W9LTW*	3710-14-43	W8BTO	1035-9-23
W9RVM	3705-13-47	W9WUU	1035-9-13
W1JEA	3485-17-31	W3FSP*	1000-8-15
W6PBV*	3450-15-36	W2APM*	945-7-17
W9YBV**	3400-20-34	W3IPE**	700-7-20
W8SNA**	3360-14-38	W9BIN	675-5-17
W9QOJ	3240-12-44	W2MVR	630-7-18
W1BFJ	3020-13-48	W1BGJ**	490-7-14
W9SJT*	3000-15-30	W9DLK	480-8-12
W8IHC	2880-16-36	W6NHK	420-3-28
W2HSP*	2800-16-35	W9DKH*	375-5-5
W2CEJ	2750-11-50	W6EY	360-3-15
W9FA*	2730-13-32	W6QQZ	260-2-16
W9AB*	2590-14-27	W1MLG	225-3-5
W9NMY	2470-13-28	W9RRO	225-5-9
W2AJS**	2400-15-32	W1LWA*	210-3-4
W9LWL	2200-11-40	W7IHK	180-4-9
W9GHD	2145-11-29	W8VW*	120-4-6
W2DOG**	2035-11-27	W8UUV	75-1-5
W6RH*	1885-13-29	W9IYA*	75-5-1
W8VNG	1760-16-22	W7CVN	60-1-2
W8KTA	1680-14-24	W7HAM*	20-2-2
W6GSS	1620-12-27	W9BHT*	20-2-2
W9ILR*	1595-11-29	W2NCV	15-1-3
W1EWN	1450-10-29	W8QEC	5-1-1
W4HGB	1170-13-18	W1TSS**j	55125-35-305

28-Mc. W.A.S. Party Results

THOUGH conditions on the 28-Mc. band were poor, the "ten meter" gang turned out in fine style for their WAS party the week-end of March 7th-8th-9th. Many were operating both 'phone and c.w., combing the band from end to end to make every possible contact.

Don Wallace, W6AM, top scorer with 18,165 points, also led in number of states worked (21) and number of contacts (163). Really a triple victory! W1DLY and W6AK each worked 20 states followed by W6BQR 18, W8SDD 17, W6NHK 16 and K4DTH 15. Following W6AM's lead in number of contacts were W2MYH with 117 and W2LHF with 110, W6BQR 97, W4ASE 81, W6AK 79, W2BMK 79, W1DLY 73, W6NHK 69, W4FIJ 64.

Leaders in their respective call areas were: W1DLY 7,300, W2MYH 7,020, W3IWM 1,750, W4FIJ 4,810, W5KC 540, W6AM 18,165, W7HHH 1,700, W8SDD 4,250, W9TH 3,300.

Comments

"Hope the contest will be an annual occasion." — W8FGV. "Would like to see more c.w. on ten meters." — W9QEC. "Hope we have another try." — W8IOT. "Enjoyed the contest very much." — W4ASE. "Quite a number of stations heard on c.w." — W2BMK. "A most enjoyable week-end's work." — W4FIJ. "Worked all the stations I could hear except one." — W9OFL. "Lots of fun." — W6IWU.

Scores, 28-Mc. W.A.S. Party

W6AM	18165-21-163	W8SDD**	4250-17-50
W6AK	8900-20-79	W2BMK	3950-10-79
W6BQR	8730-18-97	W4ASE	2645-9-81
W1DLY	7300-20-73	W6QQZ	2630-11-56
W2MYH	7020-12-117	W6PQ	2575-13-55
W6NHK	5520-16-69	W8TWT	2485-15-41
W8LHF	5500-10-110	W9TH!	3300-11-50
W4FIJ**	4810-13-64	W8KWI**	3185-13-39

(Continued on page 104)



ARMY-AMATEUR RADIO SYSTEM ACTIVITIES

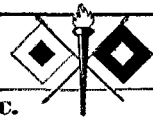

War Department, Office of the Chief Signal Officer, Washington, D. C.

THE temporary and gradual allocation of 3650 to 3950 kc. for use by the Army during the present emergency was recently announced by FCC. The rapid expansion of the Air Corps training program has resulted in an urgent need for additional frequencies in the medium-high frequency spectrum. Most of the AARS nets and other important amateur services operate in the 3500-4000-kc. band, but the new military pilot training program is a vital component of the defense plans of the country. From the considerations of the equipment available and the number of frequencies required for this essential defense activity, it was considered necessary to assign 300 kc. for this purpose.

The Chief Signal Officer feels that the enterprise and skill for which the American radio amateurs are noted will enable them to quickly readjust themselves to the new emergency allocations in a manner that will maintain their operations in the AARS and other amateur networks. This will provide for the continued self-training of amateur radio operators interested in being prepared for possible emergency communication or defense exigencies.

REALLOCATIONS OF AARS NETS

APPROXIMATELY 70 different AARS army, corps area, and state nets will be affected when 3650-3950 kc. are made available to the War Department. These nets comprise 65.3% of all Army-Amateur nets in the 3500-4000-kc. band. They are distributed among corps areas as follows:

	C.W. Nets	'Phone Nets	Total Nets
Army Net.....	1	-	1
1st Corps Area.....	6	1	7
2nd Corps Area.....	1	4	5
3rd Corps Area.....	8	-	8
4th Corps Area.....	9	5	14
5th Corps Area.....	4	-	4
6th Corps Area.....	3	1	4
7th Corps Area.....	8	-	8
8th Corps Area.....	6	2	8
9th Corps Area.....	9	2	11
Total nets affected.....	55	15	70

A total of 54 separate frequency channels in the 3650-3950-kc. band now is occupied by these 70 nets. In addition, about 56 ARRL traffic nets likewise will be affected by this reallocation. It is planned to coordinate these AARS net frequency changes with the ARRL Communications Manager to minimize interference between AARS and ARRL nets.

The following factors should be considered by all concerned in connection with the contemplated reassignments of these AARS nets:

a. In the reassignment of c.w. nets to the 3500-3650-kc. band, two or more state nets in a corps area should be assigned to the same net frequency on a shared-time basis.

b. Use the 1750-1900-kc. part of the 160-meter band and the 7000-7250-kc. portion of the 40-meter amateur band for c.w. net frequencies as the distances involved and other factors permit.

c. The present 15 AARS 'phone nets in the 3900-3950-kc. band should be assigned to the 3950-4000-kc. portion. The 73 'phone nets now in the 1800-1900-kc. band can be transferred to 1900-2050 kc. This may necessitate two or more state 'phone nets in a corps area using the same channel on a shared-time basis. The number of 'phone nets should be held to a minimum.

RESULTS OF ZCB LOCATION CONTEST HELD JUNE 2, 1941

EIGHT HUNDRED AND SEVEN members of the Army-Amateur Radio System participated in the ZCB (intercommunication) Location Contest held on June 2d, which inaugurated the continuance of regular operations throughout the summer. Each Army Amateur endeavored to contact as many other members as possible and exchanged messages giving his city, state and corps area. Ten points were allowed for each contact which resulted in the exchange of location messages. Additional credits were granted for the number of different states, corps areas and army departments, outside the continental limits of the United States, that were worked.

O. H. Baker, W9VBQ, 1824 Barker Avenue, Lawrence, Kansas, scored 495,900 points, the highest individual score. He worked 95 Army-Amateur stations in all nine corps areas and 29 states, as well as Alaska. John Reed, W6IOJ, 7521 Lankershim Blvd., North Hollywood, Calif., was second with 414,400 points based on 104 contacts with Army Amateurs in 8 corps areas, including 25 states and Alaska. Guy H. McClaine, W9CEB, Hayward, Wis., was third with 338,256 points as the result of working 70 stations in 9 corps areas including 28 states and Alaska.

The Ninth Corps Area won this competition between the corps areas. Army-Amateur members in the Ninth (Washington, Oregon, California, Montana, Nevada, Idaho, Utah and Alaska) ran up a total of 3,177,064 points based on a 72.4% participation factor of its 359 members. The Second Corps Area (New York, New Jersey and Delaware) was second with 1,375,649 points from 49.7% of its 179 members. Third place went to the Sixth (Michigan, Illinois and

Wisconsin) with 1,355,216 points based on 42.9% activity of its 289 members.

Detail results follow:

SUMMARY OF REPORTS

C.A.	Member-ship	Number Participating	C.A. Points	C.A. Activity %	Final C.A. Score	C.A. Standing
IX	359	260	4,388,210	72.4%	3,177,064	1
II	179	89	2,767,905	49.7	1,375,649	2
VI	289	124	3,159,012	42.9	1,355,216	3
III	125	69	2,150,010	55.3	1,177,896	4
VIII	260	88	2,653,692	33.8	896,948	5
VII	166	49	989,910	29.6	293,013	6
I	214	59	792,419	27.6	218,708	7
V	193	39	932,918	20.2	183,449	8
IV	386	90	696,470	7.8	54,325	9
	2171	807	18,510,546	37.2%	8,737,268	

CORPS AREA WINNERS

C.A.	Station	Contacts	Score	City	State
I	W1KCT	63	90,720	Dedham	Mass.
	W1AZW	77	84,896	Pittsfield	Mass.
	W1EPE	47	59,220	No. Easton	Mass.
II	W2MLW	100	233,064	Elizabeth	N. J.
	W2JKH	86	193,500	Shamokin	N. J.
	W8SBV	85	191,250	Elnira	N. Y.
III	W3GKO	109	262,926	Philadelphia	Pa.
	W8OKC	106	256,608	Shamokin	Pa.
	W3CIQ	81	196,830	Hagerstown	Md.
IV	W4JU	50	103,500	Jacksonville	Fla.
	W5IGW	51	93,840	Greenville	Miss.
	W4FJR	41	65,772	Anastasia	Fla.
V	W8PZA	76	157,248	Cleveland	Ohio
	W8HDL	79	149,310	Mansfield	Ohio
	W8SFI	64	120,960	Mingo Jet.	Ohio
VI	W9OEB	70	338,256	Hayward	Wis.
	W9DIR	113	315,270	Portage	Wis.
	W8SCW	69	173,880	Detroit	Mich.
VII	W9VBQ	95	495,900*	Lawrence	Kans.
	W9KCO	85	182,736	Iowa City	Iowa
	W9OZN	85	159,744	Udall	Kans.
VIII	W6DDJ	71	306,720	Beaumont	Texas
	W5CEZ	61	115,668	Ponca City	Okla.
	W5GFT	64	89,600	Enid	Okla.
IX	W6IOJ	104	414,400	N. Hollywood	Calif.
	W6FII	106	311,640	San Francisco	Calif.
	W7HZG	80	299,376	Pomeroy	Wash.

* Highest individual score.

FALL ARMY-AMATEUR ZCB CONTEST

ANOTHER Army-Amateur ZCB (intercommunication) Contest to initiate the start of AARS Fall activities is scheduled for Monday, September 8th. This contest will follow the general rules of those held in the past. Army-Amateur stations will endeavor to contact as many other AARS members as possible and exchange a brief message, in the regular prescribed form. This message is to contain the date of the present AARS appointment and state and corps area location of the transmitting station.

The general call "ZCAA" will be used to contact Army-Amateur stations during the contest period which will be on September 8th from 5:00 P.M. to 3:00 A.M. local standard time. Only contacts with other AARS members may be counted in this contest, which will be a competition between corps areas as well as between individual stations. Each corps area's score will be multiplied by its activity percentage, to be based on the

ratio of participating members to the total corps area membership, in order to determine the final corps area score. Details of scoring, multiplication factors allowed, etc., will be announced in subsequent weekly ZCVA messages.

All active Army-Amateur stations are expected to participate. It is hoped that many other amateurs will listen in on the night of September 8th and be interested enough to write the Signal Officer in their respective corps areas for information on the AARS.

WWV Schedules

IMMEDIATELY after the standard frequency station WWV of the National Bureau of Standards was destroyed by fire November 6th last, a temporary transmitter was established in another building and partial service was begun. The service has now been extended, although still with temporary equipment. It is on the air continuously at all times, day and night, and carries the standard musical pitch and other features. The radio frequency is 5 megacycles per second.

The standard musical pitch carried by the broadcast is the frequency 440 cycles per second, corresponding to A above middle C. In addition there is a pulse every second, heard as a faint tick each second when listening to the 440 cycles.

(Continued on page 98)

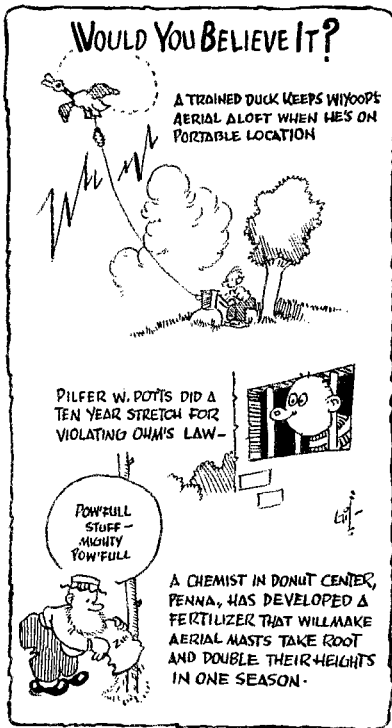



HINTS AND KINKS FOR THE EXPERIMENTER

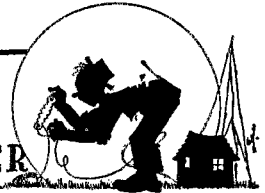

ADAPTING THE 6L6 "GRID-PLATE" OSCILLATOR FOR FUNDAMENTAL AND HARMONIC OPERATION

THE "grid-plate" crystal oscillator is very popular because it will stand loading to a degree that would prevent the operation of a straight pentode or tetrode oscillator. It will key smoothly under these adverse load conditions and, best of all, it will work with most any old crystal.

The circuit is sometimes suggested for harmonic operation but in the majority of cases the only result is disappointment. Unless a crystal of extremely high activity is used, there is seldom satisfactory harmonic output. Even with very active crystals, it is usually impossible to key the oscillator when the plate circuit is tuned to a harmonic. In various issues of *QST* and the *Handbook*, a very excellent solution to the problem has been set forth, namely, the changing of the crystal oscillator from the "grid-plate" circuit for fundamental operation to the Tri-tet circuit to obtain harmonic output. This may be accomplished either with a switch as described in W1LJI's article in March, 1939, *QST*, or by means of plug-in coils as presented in the article by W1TS in December, 1940, *QST*.

In the Hints and Kinks section of January, 1940, *QST*, the writer pointed out that the use of a small capacity, connected between the grid and cathode of the "grid-plate" oscillator would greatly improve the harmonic output. The circuit then acts exactly like the regular Tri-tet and the

output compares very favorably with it. With the Tri-tet the cathode coil must be removed from the circuit when it is desired to operate on the crystal frequency. In the case of the "grid-plate" oscillator, the extra grid-to-cathode capacity must be cut out. Fig. 1 shows how this simple change may be made with a s.p.s.t. switch which may be of either the toggle or rotary type.

In a small oscillator-transmitter built by the writer, shifting from 80 to 40 meters and tuning the rig was done with a single knob. The plate tank circuit was designed to cover both bands with a single coil. One band was reached near the maximum setting of the condenser and the other band near the minimum end. The condenser was of the type with a shaft at both ends of the rotor. A toggle switch was coupled by a spring coupling device to the rear shaft of the tuning condenser so that as the condenser was turned toward maximum or minimum the switch was operated and the proper circuit was in use for either fundamental or harmonic operation. — *Ed Preston, W3CSE.*

REPUNCHING SOCKET HOLES WITH ACCURACY

WE OFTEN find it necessary, after having selected a punch and knocked out a hole in a chassis, to make this hole larger so as to accommodate an electrolytic condenser or tube socket of larger dimensions. An easy, quick and accurate way of accomplishing this feat is to keep on hand a knock-out from each of your various punches. Then, say you punch a three-quarter-inch hole and find a larger hole necessary. All you need do is re-fit the three-quarter-inch knock-out, place the larger punch in the starting hole and punch away.

This method is particularly successful with screw-type punches, such as the Greenlee. Try it on a piece of scrap and see for yourself how simple it really is.

— *Thomas B. Moseley, Fort Worth, Texas.*

AUDIO ATTENUATOR FOR NC100 AND 101 RECEIVERS

MY NC100X receiver has a rated audio power output of 10 watts which is entirely too much for a small room. When the gain is turned down to a comfortable level, however, a certain amount of hum and distortion is introduced.

To overcome this, I inserted a small "T" pad

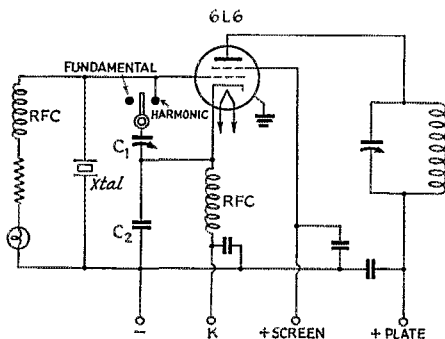

Fig. 1 — Circuit diagram of the "grid-plate" oscillator for improved harmonic output.

C₁ is a 70-to-88- μ fd. mica trimmer, while C₂ is 250- μ fd. fixed. RFC is a standard 2.5-mh. r.f. choke. Other values are usual for this type of circuit.

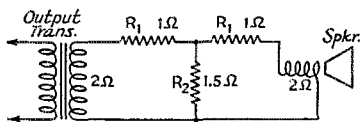
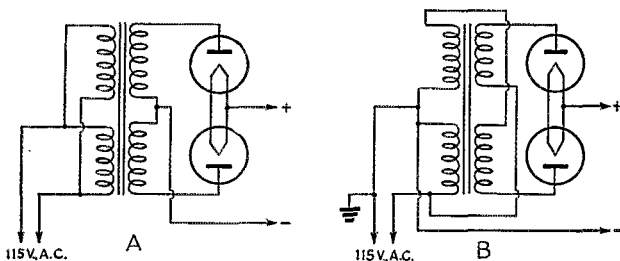

Fig. 2 — Circuit for "T" attenuator to maintain quality audio from NC100 and NC101 receivers at low-output levels. Values shown are for a two-ohm voice coil.

between the output transformer and voice coil as shown in Fig. 2. The results were remarkable. The quality is very much improved and the hum is no longer noticeable. Although the tubes are still working near maximum output, the speaker does not blow me out of the room!

Fig. 3 — Connection suggested by W3EZL for boosting pole transformer voltage.



The resistance values shown in Fig. 2 are selected to give a 10-db. attenuation with the 2-ohm speaker furnished with the NC100 and 101 receivers. Two-watt resistors are capable of dissipating the required power. I used two 3-ohm units in parallel to obtain the 1.5-ohm value.

Resistor values for 10-db. attenuation with other impedances may be determined from the following equations:

$$R_1 = 0.52Z \quad R_2 = 0.7Z$$

where Z is the speaker impedance.

— J. B. Hill, Jr., W9OPJ.

SIMPLE TREATMENT FOR B.C.I.

INTERFERENCE to local b.c. receivers may be eliminated easily by connecting a series-tuned wave trap from the second-detector grid to ground. This does not affect the tuning appreciably at any frequency nor the sensitivity of the receiver.¹

In case the set uses diode rectification, the trap may be connected across the last intermediate plate or grid to ground, but be sure the condenser will not break down under the normal plate voltage or you may have a set to replace.

Antenna wave traps have been useless in most of my cases, but this really is effective.

— Ellery Plotts, Chicago, Ill.

¹ This will hold true only if the capacity is sufficiently small to produce appreciable reactance at broadcast frequencies. The capacity should be no larger than will permit retuning of the circuit with the trimmer condenser. Somewhat larger capacities will be permissible for the 3.5- and 1.75-Mc. bands. — Ed.

HIGHER VOLTAGE FROM POLE TRANSFORMERS

I OFFER for publication an idea which will give many amateurs an opportunity to increase power by merely changing a few connections.

Many amateurs use 2300/1150- 115/230-volt pole transformers as a source of power for their high voltage rectifiers. With the connection used by most amateurs, the output voltage is 1000 with choke input and 1250 with condenser input. By a rearrangement of connections, as shown in the sketch of Fig. 3, the rectified voltage can be increased to 1125 with choke input and 1375 with condenser input. This increase in voltage will

normally result in an increase of 10 per cent in power input.

With these changes in connections, the capacity of the transformer is reduced. However, in most cases, the transformer is much larger than the load requires. Distribution transformers have excellent regulation, usually less than 3 per cent at full load. A further advantage is that the power company ground is utilized.

— Chas. W. Carter, W3EZL.

OPERATING KINK FOR SUPERHET RECEIVERS

IN A superhet receiver, the high-frequency oscillator beats with the incoming signal to produce a resultant signal of a frequency equal to that to which the i.f. amplifier is permanently tuned. This principle is well known. It is, of course, possible to receive simultaneously signals differing appreciably in frequency by the use of two high-frequency oscillators, each tuned to produce the required i.f. beat.

I make use of this idea in an arrangement which makes it unnecessary to retune the receiver when engaged in a "three-way" QSO with two other local hams. The signal from one of these stations is tuned in in the usual manner. An external local oscillator is then used to beat against the signal from the second station to produce the same i.f. If the strength of the signals from the second station and the local oscillator are sufficient, it will not be necessary to provide direct coupling between the local oscillator and the mixer. I use an old regenerative detector as the oscillator and

capacity couple its grid to the antenna terminal of the superhet receiver. All that is necessary then is to tune the regenerative-receiver oscillator until the second signal appears at the same setting of the superhet receiver and it is unnecessary to retune the superhet to receive either signal although they may be on frequencies in different parts of the band.

The scheme may not work so successfully on more distant stations nor on local signals with superhets having a lot of preselection, but it is worth trying. — *J. C. Nelson, W8FU.*

ANOTHER SINGLE-SWITCH CONTROL SYSTEM

IN THE diagram of Fig. 4 a simple throw of the switch automatically disconnects the transmitting antenna from the receiver and throws it into the transmitter antenna tank system. It also disconnects the receiver for transmitting and throws the transmitter plate voltage transformer

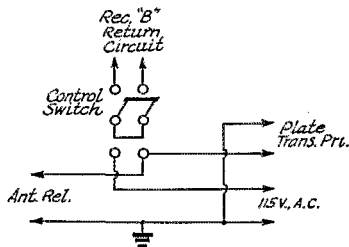

Fig. 4 — W8FAZ's single-switch control system

into operation. A flip back disconnects the transmitter power and antenna, turns on the receiver and connects the antenna to the receiver. Thus, a single switch performs all the operations for changing between transmitting and receiving position.

For duplex work, the antenna relay must be discarded and a separate antenna introduced to the receiver but, otherwise, the operation remains the same, provided a separate send-receive switch is located on the receiver in parallel with the connections marked "Rec. B."

A double-pole double-throw mercury contact switch will serve the purpose best, especially in the case of a 'phone transmitter where a silent change-over is desired. A single pole double throw antenna relay switch can be used where such arrangements are necessary, but these refinements are all up to the operator and the conditions of his station set-up. — *Joseph Zelle, W8FAZ.*

COMBINATION CODE-PRACTICE OSCILLATOR AND KEYING MONITOR

FIG. 5 shows the circuit diagram of a code-practice audio oscillator which may be converted for use as a keying monitor by a flip of the switch. This is a useful combination, since the

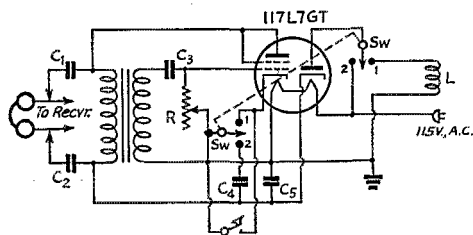

Fig. 5 — Circuit for combination code-practice oscillator and keying monitor.

- C_1, C_2 — 0.02 μ fd.
- C_3 — 0.002 μ fd.
- C_4 — 20 to 40 μ fd. electrolytic, 200-volt.
- C_5 — 0.1 μ fd., 200-volt.
- R — 0.1 meg. variable.
- SW — D.p.d.t. toggle switch.
- L — Pick-up link (see text).

unit may be used for code practice without the transmitter running by sending to one's self or by keying in unison with a received signal from a tape transmitter. This practice has often been suggested as an excellent means of improving the correct formation of characters and is readily done with W1AW's transmissions of QST texts.

When the unit is used for code practice, the switch is thrown to position 2 in which 115 volts from the line is fed to the plate of the rectifier, the additional filter condenser, C_4 is connected across the output of the rectifier and the key is connected in the circuit.

When the switch is thrown in the opposite direction, the line voltage is removed from the plate of the rectifier, the key is short-circuited and the extra filter capacity is removed. Plate voltage for the oscillator is now obtained from a pick-up loop, L , coupled to one of the transmitter stages. Thus, no keying connection is required when the oscillator is being used as a keying monitor because the oscillator operates only when the transmitter is being keyed.

The output of the oscillator is coupled to the headphones through a pair of condensers, C_1 and C_2 . C_2 should be connected to the side of the headphones which is grounded. This may be determined easily by interchanging the connections to the headphones. With the wrong connection, very little, if any, signal will be heard. If a 'phone plug which leaves the 'phone tips exposed is used, it is a simple matter to make the necessary connections by means of clips.

The pitch of oscillation may be adjusted by varying the value of R . Only one connection for the 115-volt line is shown. The return is made by a connection to an actual ground, such as a water pipe or the station ground, as indicated in the diagram. If the power plug is inserted in the socket in the wrong direction, there is no danger of blowing a fuse, should the chassis be grounded. Of course, no supply voltage will be obtained unless the plug is inserted correctly.

— 1st Lt. J. M. Lattig, W9QJR/5.



CORRESPONDENCE FROM MEMBERS

The Publishers of *QST* assume no responsibility for statements made herein by correspondents.

AMEN

38 Mansfield Ave., Shelby, Ohio

Editor, *QST*:

At the last regular meeting of the Intercity Radio Club your July editorial entitled "Fritz" was read and appreciated by all present.

It is at the direction of our Club's president that I am writing you to express concurrence and approval of your thoughts of tightening up to suppress by exposure any such bootlegging or violations of the FCC laws that may come to the knowledge of any of our membership.

This Club adds its distinct "amen" to your forceful editorial.

— E. L. Heck, W8PO, Acting Sec'y,
Intercity Radio Club

Editor, *QST*:

533 Main St., Danville, Va.

Amen "Fritz," July editorial, *QST*: Amen!

You were too mild, and I only wish you had wielded the "big stick" with all that I know you have in you. . . . This is no time for any horseplay, and I hope you will ram home the thought of "constant vigilance" on the part of the amateurs of this country. . . . May God give us men.

— W. T. Gravelly, W3BZ

HAM LICENSE EARNS RESPECT

Btry. "D," 12th Bn., 4th Trg. Regt., F.A.R.C.,
Fort Bragg, N. C.

Editor, *QST*:

. . . As you can see by my address, I'm in the Army. . . .

Being a ham gets me on special field details . . . and I miss plenty of "dirt" details. Fine business, OMI! I've been in one month, and am already qualified to operate any of three field transmitters.

Being licensed gets respect from non-com and officer alike. I can't begin to tell you how much my license and operating knowledge means to me. . . .

— Pvt. James Martin, W5IYD

"KEEP 'EM FLYING"

Hancock, Wis.

Editor, *QST*:

The War Department is, it seems, encouraging civilians to scuttle old, time-worn phrases such as "good-bye," "so-long," "down the hatch," "here's how" and others to be replaced by the national defense slogan, "Keep 'em flying." This slogan is intended not only to keep the importance of aviation before the public, but also to make everyone conscious of the entire national defense effort. If used freely, the phrase would not only do these things but would also develop valuable public morale.

Amateurs throughout the nation have formed the habit of ending QSOs with "73 es hpe cul" or some variation with the same general idea.

Amateurs have done and will continue to do much for our country in national defense during this emergency. However, it seems to me we could do even more by adopting the War Department's slogan. . . .

In other words, why not "73 es keep 'em flying"?

— Clement R. Coggin, W9SHN

ASSET

60 Merritt Ave., Dumont, N. J.

Editor, *QST*:

I consider my membership in the ARRL one of my best assets in amateur radio and would not allow my membership to lapse even if it cost five times the present cost. I am a firm believer in organization and can appreciate the fine work that the League is doing. Amateur radio might be in a sorry state now if it weren't for the work of the League in keeping amateur radio up with the National Defense. . . .

— Henry Spillner, W2NGY

CODE PROFICIENCY

235 E. 68 St., New York City

Editor, *QST*:

A month ago I could hardly copy 5 w.p.m. on the mill. Now I can copy over 20 w.p.m. Soon hope to reach 35 w.p.m., just through listening to W1AW practice schedules. . . .

— L. C. Brewer

Editor, *QST*:

2651 Puunui Ave., Honolulu, T. H.

. . . I want to express my appreciation for this very fine program to help improve the sending and receiving of the amateurs. . . . We did have some QRM on your signal; after all, Honolulu is quite a long way from Hartford! However, your signal was coming in RST 599X. I am a member of the YLRL. . . .

— (Mrs.) Helen L. Firth, K6TCW

Editor, *QST*:

51 Grant St., Bangor, Maine

. . . Being an old soldier and ham who has got away from the code I feel that I should begin to get back. I am somewhat rusty so this is my first try for a certificate. I believe every ham should get one no matter what the speed.

This is fine work the ARRL is doing and should like to see you keep it up. I have one thing I want to mention and that is through *QST* to ask the hams to keep off W1AW's frequency when the test goes on. . . .

— P. L. Sprague

Editor, *QST*:

15 "D" St., Lowell, Mass.

. . . This splendid code practice and proficiency award is doing a swell job in getting some of the 'phone men back to their first love.

I have been a 'phone man a number of years, mostly on the u.h.f. bands, but I hope to get back in the swim again by copying your code practice runs. . . .

— George Cowgill, W1OQ

Editor, *QST*:

411 Triangle Ave., Dayton, Ohio

. . . I have been a ham for some eight or nine years and I find to my chagrin, as evidenced by the enclosed copy, that my usual method of rag-chewing without actually taking

(Continued on page 88)



F. E. HANDY, WIBDI, Communications Mgr.

J. A. MOSKEY, W1JMY, Asst. to the Coms. Mgr.

U.h.f. Nets . . . Let's Have More. In a number of cities where civilian defense plans have been to the fore amateur radio networks functioning on the ultra highs have been made an important part of the plans. In some instances these nets collaborate with the police, in some with the fire department, in some directly with the local defense council. Besides "just hamming" on u.h.f., we here and now call on all u.h.f. workers to recommend one of your local group direct to your Section Communications Manager (address, page 4) for appointment as either a PAM or Emergency Coördinator. Then arrange some regular u.h.f. tests. Operate as a net with him as NCS. It will be his responsibility to follow the principle established in the ARRL Emergency Corps for many years in building communications facilities to fit the particular needs of the local community.

There is no question but what u.h.f. apparatus, especially portable and portable-mobile self-powered rigs (vibrapacks and genemotors recommended), will be of the highest value in event of actual defense needs. Such equipment can be deployed as the necessities of the moment require.

Here in Connecticut in past emergencies, the u.h.f.'s proved capability for city-to-city work up and down the river valley. Spot frequency nets connecting nearby towns all over the U.S.A. . . . provision to put a mobile rig at a strategic half-way point for relaying . . . better provision in rigs amateurs are now building for A-2 for use in record message work or under any conditions that need it . . . these possibilities should not be overlooked in a single place where there are amateurs. All Emergency Coördinators are being asked to make sure their local committees and plans include u.h.f. and the self-powered variety, too.

On Changing Network Frequencies. The biggest operating news is, of course, the FCC's temporary release by special order of 3650-3950-kc. frequencies over a period of months for military pilot training needs. The first FCC order, due about September first, besides clearing 3.8-3.9 Mc. for the War Department provides 1.8-1.9 Mc. for A-1 (c.w.) work only, and opens 7250-7300 kc. to voice work to take care of any 'phones that have to move. Later orders concerning other parts of 3650-3950 kc. are expected late in the year. The first FCC special order clears some 160-

meter frequency for A-1 and some 40-meter frequency for A-3 with one purpose only in mind, to take care of existing amateur activity in such a way that we may render an unimpaired amateur service.

All traffic nets are asked herewith to have their NCS report network operating days and time, frequency used, number of net stations, and area served to ARRL. The League is continuing its system of registering all such information so on request it may advise of prior registrations, recommend time sharing possibilities for avoiding conflicts, or frequencies as needed.

Daylight exemptions (expected in FCC orders) can help amateurs in three-fourths of the nation. However, this device helps the isolated rag-chewer more than network operators since evening is the time for most net meetings, the greater number having vocational daytime responsibilities.

All short jump ARRL Section nets should operate in the 160-meter territory now to be exclusively for A-1 work. Where a move from 3800-3900 kc. is required at once ask ARRL to advise of the prior registrations made with us on 1750-1900-kc. frequencies to help in selecting a frequency.

Elsewhere in this *QST* will be found technical information concerning locked-oscillator circuits. Since 1825-1900 kcs. is harmonically related to 3650-3800 kc., the Communications Department urges on all netters using crystals in 3650-3800 kc. (part of which is sure to be lost to night operation at least in further FCC orders) the thought that net operations be established on the lower frequency which is just half your present control frequency by one of these methods!

The changes will necessitate higher efficiency in our use of all frequency bands concerned. No FCC regs are contemplated at present to prohibit rag chewing. Both "160" and "80" ought to become equally good in actual use for the usual mixture of traffic and rag-chewing. In RMNITE QSO W8DSS suggests that greater use of "160" for section nets should actually make for better communications, less trouble from "skip effect" on the cold December and January nights when the locals get too weak. The ARRL Trunk Lines have greater need for 3.5-Mc. frequencies than any section nets for long hop work cross country is their nightly practice. At any rate, there is bound to be increased congestion in the 3500-3650-kc. sector with the natural tendency of displaced amateurs to move in that direction. That

makes 1750-1900 kc. a most attractive interference-free band.

Traffic networks going to "160" please register your plans right away with ARRL. In addition to maintaining net registrations from u.h.f. nets right down through the spectrum for consultation, we shall hope to start an honor roll listing of 1750-1900-kc. traffic nets in next *QST*. There are plenty of frequencies for net registration but, rather than use time sharing or locate 2 kc. from existing 3.5-Mc. networks, the logical thing to do is to set up on 1.8 Mc. just as early as possible before the rush starts. All netters: Through your NCS please send us your current activity plans, and ask us for information now on tap about other networks. Certain frequencies can be duplicated in use (say in Maine, Kansas and California) without time sharing being required, by use of ARRL as a clearing house!

Don't Miss the Code Proficiency Frolic.

The dates are September 12th-13th-14th and 19th-20th-21st. If you have your CP ticket, follow the announcement elsewhere in this issue. More CP frolics may come along. To get the CP certificate necessary to take part just follow the W1AW qualifying run schedule. To get fixed up for the next, send in copy on one of the two monthly runs for checking.

Battery-Powered Equipment Test Coming

. . . Oct. 18th-19th. Amateur radio needs more sets with handles on 'em, with 5-to-30-watt finals for complete self-powered operation and easy transportability. This test will have two separate divisions. There will be one score list for points made on ultra highs, another for low frequency operating, you can report in either or both. This is advance warning to get your vibrapacks and genemotors ready and be sure your 6-12-v. storage cells are charged. The June F.D. has taken us places in the gas-generator big set-up field. This October shindig is aimed at individual-class lighter weight equipment, no gas generators this time. Here's a chance to convert a F.D. set or develop a new defense-type rig of the practical battery-operated portable variety that will work from the car battery or set up anywhere. All set? See you in it.

Trainee Traffic . . . Everybody Help. Latest data on amateurs at certain posts follows this section. Also consult our initial list of stations (page 34, Aug. *QST*) and get in on this phase of amateur radio. Many amateur networks are now resuming. Under SCM-RM-PAM leadership many new nets are coming into being. We ask each net member particularly to study the "word to network leaders" in the August *QST* "trainee" article and to play a definite part in the plans as there explained. TU.

— F. E. H.

ARTICLE CONTEST

The article by Mr. Ero Erickson, W9HPJ, wins the CD article contest prize this month. We invite entries for this monthly contest. Regarding subject matter, we suggest, that you tell about what activity you find most interesting in amateur radio. Here you will find an almost limitless variety of subjects. Perhaps you would like to write on working for code proficiency, Emergency Corps planning, traffic work, working in Section Nets, Phone and Telegraph operating procedures, holding a League appointment, working on radio club committees, organizing or running a radio club, the most interesting band or type of ham activity, or some other subject near to your heart.

Each month we will print the most interesting and valuable article received. Please mark your contribution "for the CD contest." Prize winners may select a bound *Handbook*, *QST* Binder and League Emblem, six logs, eight pads radiogram blanks, DX Map and three pads, or any other combination of ARRL supplies of equivalent value. Try your luck!

Shock—What To Do If . . .

BY ERO ERIKSON, W9HPJ*

AFTER nearly ten years of amateur radio operating and messing (exactly) around lethal voltages and not knowing precisely what to do in case of accident, I had the very good fortune of attending an American Red Cross First Aid class. With this course of instruction came the acquaintance with shock and the assurance that in case of a serious accident the right thing would be done and perhaps save a life.

"Shock" is a term used to describe a condition in which all the activities of the body are greatly depressed. The shock familiar to all amateurs needs very little describing. "Shock," familiar to all first aiders, becomes important to the layman when it is revealed that it is frequently the cause of death. Its seriousness is generally overlooked by those outside of the medical profession, and the uninitiated are apt to think it almost silly to heed advice of lying down and keeping warm to treat for shock when less critically injured. There is some doubt as to what exactly happens in case of shock. However, a number of well-defined symptoms are always present. It could be described as an "all gone" feeling. Perhaps you remember the feeling you had when you mashed your thumb while chiseling out that transformer hole in a chassis. Unless you "can take it" you probably felt weak and nauseated and sort of "gone" for a few minutes. You were suffering from a mild case of shock, O.M.

Most injuries are followed by some degree of shock. If the injury is severe (and electrical shock requiring attention surely is), the nervous system receives an "insult," resulting in the nerves losing control of the blood vessels. There is a stagnation of blood mostly in the blood vessels around the abdomen. These vessels relax, lowering the blood pressure. The pressure reduces so much that the supply of blood is so low that this insufficient amount does not fill the heart (pump) at each cycle. This is the reason for the weak pulse. To make this insufficient supply do for the whole system the heart pumps faster. Hence, the weak and fast pulse. The brain is not supplied with enough blood, causing other recognizable symptoms.

In serious injury shock can be recognized by a pale face, cold perspiration, fast and weak pulse, chill, vomiting, irregular breathing and a general disinterest in surroundings. In electric shock where unconsciousness is involved it is ever present and must be dealt with to insure safe recovery.

To treat for shock keep the following in mind: Heat, position and stimulants (not alcohol). Due to the poor circulation, a person suffering from shock loses heat. The

*7135 Irving Park Road, Chicago, Ill.

additional loss of heat further complicates matters causing additional shock. Therefore, it is important to keep the victim warm in both treating and preventing shock. The injured person should be well covered with a blanket and heat applied when possible by means of hot water bottles, heated bricks, or anything warm. When resuscitating a victim, do so through a blanket providing you are certain (through previous practice) that it will not hinder your rescue work. Bear in mind that in case of unconsciousness the victim is unable to tell you if he is being harmed, so carefully guard against burning.

Since there is a lack of blood pressure, it is very important that the victim be kept lying down. In this way gravity can help in circulating the blood from the vessels of the abdomen. By all means keep the person lying down in order to relieve any strain on the heart that would result from activity while in this condition. Heart failure may result from too early rising after severe shock. Let the doctor decide when he comes, what to do.

When conscious, give the victim coffee, tea, warm milk or aromatic spirits of ammonia (a teaspoon in $\frac{1}{2}$ a glass of water). Don't attempt to give an unconscious person a drink.

The foregoing has dealt with shock generally. To boil it down to our own ham shack, let's see what happens in electric shock. When you receive a serious jolt, the current may pass through the breathing center of your brain with the result that the muscles responsible for your breathing cease to receive nervous impulses. Your breathing stops suddenly, but if the shock was not severe your breathing center will recover soon enough and you will start breathing without "passing out." In electric shock unconsciousness is complete and demands resuscitation. Artificial respiration should be started at once. It should be carried on continuously until the victim is revived. Keep level-headed. Due to the strain of the situation, further injury can be caused unconsciously due to over-anxiety in administering artificial respiration. The victim will occasionally become rigid in a short while due to the paralyzing effect of the current. This should not be confused with rigor mortis or as an indication to cease resuscitation. Stay right there with it even if it takes hours.

If you don't know how to apply artificial respiration, dig out your back issues of QST right now and LEARN. Better still, contact your local Red Cross Chapter and they will be glad to tell you when classes are available. It would be more than distressing not to be able to help a victim of electric shock, especially if it happened to be one of your close friends. Switch to "Safety" by knowing what to do after electric shock.

A.R.R.L. HEADQUARTERS OPERATORS

W1AW, ARRL Headquarters:
 Hal Bubb, "Hal," Stn. Eng. and Chief Opr.
 George Hart, "Geo," 2nd Opr. See others, below.

The following calls and personal signs belong to members of the ARRL Headquarters gang:

W1AL, J. J. Lamb, "jim"
 W1BAW, R. T. Beaudin, "rb"
 W1BDI, F. E. Handy, "fh"
 W1CBD, C. B. de Soto, "de"
 W1DF, George Grammer, "gg"
 W1EH, K. B. Warner, "ken"
 W1GS, F. C. Beekley, "beek"
 W1INF, ARRL Headquarters Operators Club
 W1JEQ, Vernon Chambers, "vo"
 W1JFN, A. L. Budlong, "bud"
 W1JMY, J. A. Moskey, "joe"
 W1JPE, Byron Goodman, "by"
 W1JTD, Hal Bubb, "hal"
 W1LVQ, L. John Huntoon, "jh"
 W1MEC, W. J. Fricke, Jr., "bill"
 W1MFA, Harold K. Isham, "hi"
 W1NJM, George Hart, "geo"
 W1NKC, J. R. Buckler, "jeem"
 W1SZ, C. C. Rodimon, "rod"
 W1TS, Don Mix, "don"
 W1UE, E. L. Battery, "ev"

On Using "Q" Signals

THERE's been a lot of talk about over-use of abbreviations in amateur operating, especially in regard to using c.w. abbreviations when operating 'phone. My beef is in regard to the use or rather, the lack of correct use of the Q signals. By far the majority of hams know a minimum of Q signals, at most QRR, QRX and a few others and that's about all! What's worse, they usually don't know the exact usage of these signals. For traffic handling, and especially in the event of an emergency, when time is at a premium, valuable minutes can be saved by using Q signals. After all, that's what they are for — a universal language with an exact, literal interpretation for each signal. Some have slight variation in meaning, according to the combination, but usually have one meaning and only one meaning. If all operators were thoroughly familiar with the exact meaning of most of the Q signals, traffic or emergency communication could be dispatched with the greatest possible speed.

There aren't so terribly many Q signals to be learned, and they're in all the handbooks and many other radio publications. While there's no special point in learning those having to do with direction-finding, weather, etc., it wouldn't hurt to learn them while you're at it. Who knows, they might be of use in some circumstances you don't anticipate. At least learn those that can be of use in the usual run of traffic handling and learn those regarding distress traffic, by all means. There are only three or four — QSR, QUF and, of course, QRR. You can create snappy traffic-handling not only by increasing your code speed but you can also speed it up by knowing the literal meaning of Q signals.

— Caldwell Smith, W5FKW

CORRECTION ON CHECKING MESSAGES

The text on page 9 is correct but the "Examples" are in error. To simplify ARRL (and AARS) checking of messages arbitrary rulings are followed.

- (1) In counting figures a group of five digits or less counts as one word.
- (2) Radio call signals sent as one group also count as one word, though in all other cases of mixed letters and figures each letter and figure counts as a word.

Those who received the first copies of the booklet *Operating an Amateur Radio Station* without the correction sheet should correct page 9 examples as per the examples below to take into account the two above points correctly incorporated in the text of the book.

Examples:

10000000 (figures)	2 words
Ten million (words)	2 words
5348 (figures)	1 word
67.98 (figures)	1 word
64A2N (not a call)	5 words
64 A 2 N	4 words
45 $\frac{1}{2}$	1 word
W1AW (radio call)	1 word

1.75-MC. STATIONS NEEDED TO SEND CODE PRACTICE

Many beginning amateurs find "learning the code" their greatest stumbling block. They call upon licensed amateurs to help them master the dots and dashes but often there are chaps who are unable to get in touch with nearby hams. Each active radio season ARRL sponsors a program of Code Practice on the "160 meter" band. Operators working on this band are invited to cooperate in this worthwhile work. We were all beginners once and, if we will but think back, we will recall that assistance in getting started was quite welcome. During the past several years the 1.75-Mc. stations sending code lessons have helped hundreds learn the code. This season we would like to have more stations engaged in our program. Just send us the schedule you will

(Continued on page 68)

Trainee Traffic Stations

LAST month we invited listing of amateur stations at training schools, camps, cantonments, etc. A postal card addressed to the Communications Department with call, address, frequency, hours, and operator names will enable us to continue listings. Information just received is passed along as follows:

W1LOZ/4 (14,350 kcs.) — This station is at Camp Blanding, Fla.

W2LWB/4 — John A. Chinchio, Co. C, 68th A. R., Fort Benning, Ga., has free message center facilities for his operating.

W3HZK/4 (7214 kc.) — Pvt. L. R. Hampton, Hq. Co., 67th A. R., Ft. Benning, Ga., wants W1 and W3 skeds. He already works W2ANW, W2LSD, W2LZR, W8RKR and W9BRD. He can QSP camps in Florida, Alabama, Georgia, North and South Carolina, Texas, Mississippi and Tennessee.

W3JCY/K4 (7250 kc.) — This station is at Ponce Air Base, 22nd Pursuit Squadron, Ponce, P. R.

W4FCW — Capt. Chas. E. McArthur, M. C. 121st Inf., Ft. Jackson, S. C., schedules W4EMT at Camp Croft, ties in with the S. C. Net each Sunday and reports lots of traffic.

W4HSI — Pvt. R. C. Seoville, Hq. Co., 28th Inf., Fort Jackson, S. C.

W4HVV — Geo. C. Wetmore, 2d Bn. Hq., 192d F. A., 43rd Div., Camp Blanding, Fla.

W4HEV — Sgt. Martin Hunsucker, Fort Jackson, S. C., has a fine traffic set-up and a 300-watt station.

W5JWK — Lt.-Col. Robert C. Bohannon, Div. Signal Officer, 37th Div., Camp Shelby, Miss.

Meet the S.C.M.'s

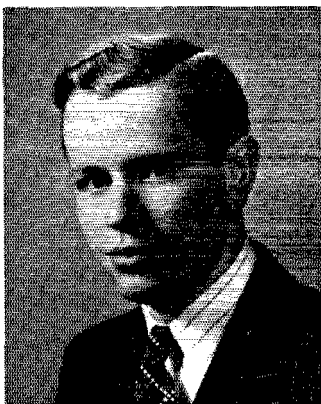

W5GNV

John R. Sanders, S.C.M., Arkansas, is most often heard on 3507 kc. The transmitter at W5GNV is a 150-watt outfit with 6L6G-809-T40 modulated by T20's, Class B, and capable of operation on 1.75, 3.5, 7, and 14 Mc. 3.5- and 7-Mc. "Zepp" antennas are used. For emergency operation there is an SW3 and a vibrapack powered portable transmitter. W5GNV was first licensed in 1937 and assisted with flood communication work in that year. S.C.M. Sanders is Activities Manager of the Moarky Radio Club and a member of the Midsouth Radio Amateur Association and the Greater Little Rock Amateur Club. He is also interested in photography and high-fidelity recordings and, as recreation, swimming and tennis are favorites. His working hours are occupied as a radio operator for the Arkansas State Police Department.

Brass Pounders' League

(June 1st—July 15th)

Call	Orig.	Del.	Rel.	Extra Del. Credit	Total
W7EBO	91	191	1778	175	2235
W6ROZ	150	145	1590	137	2022
W5FDR	240	307	794	280	1621
W6PGB	293	325	352	306	1276
W5OW	146	95	962	40	1243
W9JMG	27	56	1003	9	1095
W2SC	53	157	783	87	1080
W2SC*	44	114	761	68	987
W3BWT	95	75	717	68	955
W2MLW	41	351	216	339	947
W3HAL	16	10	690	98	814
W9KXR	420	341	29	0	790
W6LUJ	241	270	2	266	779
KAIHQ	313	159	148	150	770
W3GKO	17	34	651	22	724
W3HAL*	86	65	506	56	713
K7HZM	0	0	696	0	696
W6IOX	11	29	624	29	693
W9BNT	26	138	491	20	675
W9MIN	47	34	573	13	667
W3AOC	57	70	475	54	656
W9UFH	53	208	198	188	647
W9DIR	28	82	439	75	624
W5MN	66	124	326	108	624
W6RBL	26	180	390	100	616
W4PL	3	25	554	25	607
W2BO	42	51	436	32	561
W4HEV	481	34	6	34	555
W9ILH	14	67	414	32	527
W3FJU	22	39	418	26	505

MORE-THAN-ONE-OPERATOR STATIONS

Call	Orig.	Del.	Rel.	Extra Del. Credit	Total
KAIHR	1158	1139	6	996	3292
W3USA	134	51	306	51	1049

These stations "make" the B.P.L. with total of 500 or over. One hundred deliveries + Ex. Del. Credits also rate B.P.L. standing. The following one-operator stations make the B.P.L. on deliveries. Deliveries count.

W8FR, 196	W2LZR, 139	W3FGJ, 108
W6RGO, 166	W7GVH, 133	W6TVU, 107
W2CGG, 165	W2KI, 130	W2AYJ, 106
W8KWA, 164	W2NCY, 130	W5BE, 102
W6NRP, 153	W6LLW, 113	W9FJN, 100
W5DDJ, 150	W9ZQP, 112	More-than-one-opr.
W2LPJ, 140	W9VEE, 111	WIAW, 127

A.A.R.S.

Call	Orig.	Del.	Rel.	Extra Del. Credit	Total
WLMH (W6CDA)	10	13	833	4	860

MORE-THAN-ONE-OPERATOR

WLM(W3USA)	328	190	2033	190	2741
------------	-----	-----	------	-----	------

A total of 500 or more or 100 deliveries + Ex. D. Cr. will put you in line for a place in the B.P.L.

* May-June.

Hamfest Schedule

September 7th, at Atlanta, Ga.: The Atlanta Radio Club will hold its Annual Hamfest on Sunday, September 7th, at Adams Park near Atlanta, Ga. Everyone is invited to attend. Further information may be obtained by writing Russell A. Law, W4FKN, 595 Kelly St. S. E., Atlanta, Ga.

September 7th, at San Rafael, Calif.: The Eighth Annual Hamfest of the Marin Radio Amateurs will be held at McNear's Beach, near San Rafael, Marin County, Calif., on Sunday, September 7th. An invitation is extended to all. Come and enjoy a big time! Communicate with F. I. Deetken, 16 Entrata Ave., San Anselmo, Calif., for additional details.

(Continued from page 64)

follow in sending code practice, being sure to give your frequency (as near exact as possible) and hours and days you will transmit. Please state also on what date you will start transmissions and what date you will conclude same. Code practice stations usually conduct lessons throughout the entire fall-winter season. Hints on how to conduct code practice by radio are sent to all volunteers. The schedules of all 1.75-Mc. code practice stations are mailed to each would-be amateur requesting same — and hundreds of these requests are filled yearly. What say, fellows? Will you lend a hand?

W9HCC CODE PRACTICE

Effective September 1st W9HCC at Wayzata, Minn., is expanding the number of its tape-sent code practice transmissions. Look for W9HCC's simultaneous transmissions on:

3532 kcs. } 8:30 to	{ Tuesdays 20 and 25 w.p.m.
7058 kcs. } 9:30 p.m. CST	{ Thursdays 20 and 25 w.p.m.
14312 kcs. }	{ Fridays 30 w.p.m.

The Month in Canada

A. H. Keith Russell, VE9AL, formerly CGM, has been promoted to Wing Commander and now commands No. 4 Wireless School at Guelph, Ontario. Congratulations! On his staff are twelve former amateurs, and in addition to Keith there are two other officers, Sq. Leader A. Walmsley, VE4EV, and F/O L. S. Caveney, VE3KH. The names and calls of the others are as follows:

Cpl. H. Dyson, VE3ME-4BW; Cpl. H. J. Widop, 4AGW; Cpl. W. H. McNaughton, 4IM; Cpl. J. W. Wilkes, 3HR; Cpl. D. A. Page, 3BBH; Cpl. W. C. Sellars, VOIT; Cpl. H. B. Lambe, 3UV; AC1, R. S. Lorch, 3AXD; LAC, W. A. Amendola, 3ARR; LAC, H. R. Sanderson, 3AHW; LAC, N. G. Reidford, 4ANH; LAC, E. J. Hamerton, 5MX.

I quote from Keith's letter: "... So you can see that we have a fairly representative amateur body in this school. The same would apply to No. 1, 2 and 3 schools, as I know I had a number of amateurs under my command at Calgary."

We have been informed that P/O R. J. Renison, formerly a Toronto amateur, is now a prisoner of war in Germany. Any ham wishing to write should address him as follows: "Pilot Officer Robert J. B. Renison, RAF, No. 1131 British Prisoner of War, OFLAG, IXA, Germany." Put in the upper left hand corner of the envelope: "Prisoner of War Post, Kriegsgefangenen Post" and in the lower left hand corner: "Postage Free, Gebuhrensfrei." On the flap at the back type your name and address with the word "Sender" above it. Do not seal the envelope when you put it in the mail, as it is censored at Ottawa. The letter should, of course, contain no information of any military value, but I am sure that Bob would be very cheered up to have a letter from some of the lads who may remember him on the air.

We will be glad to hear from more of the chaps from the various Training Centers in Canada.

— Alex Reid, VE2BE

QUEBEC—VE2

FROM SCM Lin Morris, 2CO:

It is with deep regret that we report the passing at Ste. Agathe of Alphy Blais, 2AC, after a long struggle against a

wasting illness. Right until the last AC's courage and faith sustained him. A former SCM, Alphy was a pioneer on 28 Mc. more than a decade ago and it remained his favorite band.

HP was in Montreal for a few days and QSO'd DU and CO. Jack would like any hams passing through Megantic to drop in on him. FV says he is so busy he has no time for ham radio — even if there was any. CR has returned to Toronto, having taught some of his old friends a thing or two about poker. AY is doing important work at Ottawa.

Condolences to DR on the death of his father in Sweden. Bill returned home from Halifax for a flying visit and dropped in on BE. Ex-2BH has accepted a commission in the Navy. 3DC was in Montreal briefly. FQ has returned from Ontario and is now located at St. John's, P. Q. LC moved from Malton and is now with the Dept. of National Defence at Ottawa, where he worked with JN.

VE2 hams were shocked to hear of the untimely death of Commander F. O. Stredder, ex-2HK, who passed away at Halifax after a short illness. "Doc" had been on active service with the Navy since the outbreak of war. GE saw his old friend 5TD (ex-2CX) on a business trip that took him to Vancouver. CS is instructing RCAF radio mechanics at McGill. HP is doing radio work during the summer. CR returned to Montreal from Toronto for a month.

Our old friend Bill, W2BNX, is back at Belmont Park for the summer and reports meeting many G's there. CO recovered sufficiently from a back injury to play golf with DU. IT has been transferred out west. DR left for Halifax, having obtained his commission in the RCN. BK came home from Camp Borden on a short leave. FO is now located at Washington, D. C.

ONTARIO—VE3

FROM Len Mitchell, 3AZ:

AHA, who recently moved to Toronto with Dominion Skyways, has been transferred to Montreal. HF has also gone to Montreal, where he has accepted a position with the Department of Transport. LL has become a grandfather for the first time. ATP, who is employed by the Bell Telephone Company, has been in Western Canada for two and one-half months assisting in the installation of a new carrier system. KJ is spending his spare time building high fidelity amplifiers.

ADB has taken to model trains as a hobby. He has a double track complete with block system around Junior's room — and blames it on Junior. ARW is patiently waiting to get on the air again, while AGW still keeps his equipment in clear view waiting for the big day. DS has recently taken unto himself a wife and is teaching her the code in anticipation of post-war activity. Congrats!

ST, who enlisted with the RCCS, is back from England and at the present time is instructing in Kingston. AD and FB, who enlisted with the RCAF and went to England early in the war, are also back in Canada instructing, the former at Halifax. At the time of writing it is not known exactly where FB is located. KA is with the Third Division Signals, Sussex Detachment.

ALBERTA—VE4

As 4GE, SCM for Alberta, does not have time to contribute news, 4LQ has undertaken to collect the dope for Alberta. Alberta hams, wherever you may be, are invited to send along any notes of interest to LQ. Address dope to W. W. Butchart, 10740-107 Street, Edmonton, Alberta. Here is his first installment:

The list of Alberta hams serving in the Forces is a long and impressive one, and we are justly proud of these boys who have seen their duty and offered themselves into the service of their country. To each and every one we say 73 and CUL.

ANH is giving "wireless" instruction in Calgary with the RCAF. AHY is with the RCCS at Borden and says that tanks really do get him down at times! He came home on furlough a month or two ago; the Army certainly must feed the boys well! Ron Williams, ASE, is with the RCAF



RADIO EQUIPMENT is undergoing a trial by fire in World War II. Never before has radio been used on such a scale in war, and never have results been more vital. In key stations in this emergency, performance and reliability alone are important, and no alibis are accepted.

* * * * *

When the HRO was introduced more than six years ago, it was eyed with some misgivings by many amateurs. There were thoughts that it was too advanced in design, that such precision in manufacture was unnecessary, that plug-in coils were obsolete. It took a little time for the rumor to spread that the HRO was a "hot set." After a while it became almost monotonous the way there was always an HRO in the picture of the prize winner. So the HRO got a Reputation.

But commercial purchasers were even slower to see anything here that might interest them. Wherever there was a tough radio job to be done, new specifications were drawn up for a special receiver to suit the particular job. This was sound policy, based on past experience. And after all, the HRO was just an "amateur receiver." But gradually the HRO won the confidence of men who had to have the right answer, not just in this country, but throughout the world.

We wish we knew and could tell you where all the HRO's have gone. Maybe some day we will be able to, but by then it will no longer be news. We can tell you where a few of them went, for what has been published cannot be a secret. Recently G5NI sent us a copy of the British magazine "Picture Post." Illustrating an article entitled "Inside the Admiralty" was a half-page picture with the caption: "The Wireless Room: Where the Navy's Voice is Heard. From this room the Admiralty controls the Fleet's movements throughout the world. To this room comes the SOS of a torpedoed vessel, the call of a commander for instructions." In this picture, before the tense operators, stand a row of HRO's. You may have seen the picture, for it also appeared in the Saturday Evening Post for July 12.

We think that picture shows the hottest spot in radio in the world today.

W. A. READY





The New MALLORY
Volume Controls are
the answer to custom
set builder's prayers!

The new Mallory Replacement Volume Control is not just an improved control . . . it is NEW in every detail and in every particular. To the highest degree it is an exclusive Mallory development.

Like many other drastic changes in design and function, the development of a really efficient, rugged, long-lived volume control brought up problems which could not be quickly solved even with Mallory's unlimited facilities for research and experimentation. Literally years of painstaking work have gone into the perfection of this entirely NEW volume control to give it every factor of strength, precision and smoothness that has been needed for so long but never before available. It incorporates every wanted quality feature for quality set building. Be sure to see one and try one today.

P. R. MALLORY & CO., Inc.
INDIANAPOLIS INDIANA

Cable Address—PELMALLO

Use
P. R. MALLORY & CO. Inc.
MALLORY
 APPROVED
 PRECISION PRODUCTS

"somewhere in England." Ken Currie, ATJ, is with the RCCS overseas. ASY is with RCCS at Ottawa, and spent his furlough here a couple of months ago. LG started out as signal officer with an Edmonton Reserve Army unit, and now holds the same post with Edmonton Fusiliers (A). AGZ joined the RCAF to become a Wireless technician, and is now training at Edmonton.

Remember 4PH? The same PH of DX fame? Well, Don is with No. 2 Air Observers School in Edmonton, flying an Anson. VE5NB is also at No. 2 AOS as radio op. AAC is instructing in flying at No. 16 Elementary Flying Training School. ZL is on active service, but we are not advised as to what branch of the service he has entered. Gordon Anderson, who obtained his license about a month before hostilities began, is somewhere in England with the RCCS. Ex-4WH, formerly of Innisfail, is working as radio op for No. 2 AOS at Edmonton. XE is CSMI with RCCS in Alberta, and makes Edmonton his headquarters. Dick's YL operates the Provincial Govt. Forestry Service Station in Edmonton. She got her ticket shortly after war began, and can she handle that rig now! (And do we envy her!)

ADD and ADW operate communications equipment for No. 2 AOS in Edmonton, and they both show a steady interest in the Northern Alberta Radio Club, which, by the way, carries on quite nicely, in spite of the war. EZ, formerly one of the "Vegreville Gang" is flying instructor at No. 16, EFTS in Edmonton. LQ is Signalling Sergeant with Edmonton Fusiliers C. A. (R) and has gone in for home movies as a new hobby. LQ moved his QTH to the North Side, and thus his two 50-foot sticks had to be taken down. ATH works for the Provincial Govt. and has joined the plutocrats. (He drives a '29 Ford.)

Which brings us down to the Edmonton YLs. Yes, we still have some YLs around, and we can say quite truthfully that, were it not for their interest in the NARC, the club would be defunct. Mary of WH is operating a forestry station up at Edson and we do not see her very often. Hilda, the other half of WH, is still in Edmonton, and is one of two reasons that the local NARC members turn out to meetings, picnics, etc. The other reason is our Mickey, WY; between the two of them they manage to get the gang together every so often.

ART is station engineer at CKUA and will be at the new transmitter if and when it gets in operation. ALO of 160-meter fame is flying for Canadian Airways, Training Ltd., and has moved his wife and family to Edmonton. VJ is still relief op at CFRN, and is still very much interested in photography. EA is going in for home processing of movies. HM and photography go hand-in-hand. WX of Calgary still pounds brass for CP Telegraphs. GE, our erstwhile SCM, got married a year or so ago and reports have it that there is a junior op on the scene. How about some dope from you, Stu?

Remember AEV, Alberta's Envious Villain? Well he has a junior YL op about a year and a half old now, and if that kid doesn't win a beauty contest one of these days we miss our guess. Norm longs for "the good old days" when he could insult anyone and everybody by way of his 100-watt corn roaster on 160 and 75. JP blossomed out with a junior YL op also, and we think she takes her good looks from her OM. BW is Officer Commanding "E" Troop, Cavalry Signals C. A. (R), in Edmonton, by the way, and he has XA and AEA under his wing! AKK sat on a hot soldering iron out at CFRN a month ago and he says he still hates to sit down! AH is building himself a new shack out near CFRN.

How about sending in some dope, fellahs? Shoot it in to 4LQ right away, and let's keep this ole column hot with news about the VE4s. It's up to you, gang. Say, by the way, how about some dope from erstwhile 4GD? Watsa, Jim?

MAILBAG

EXCERPTS from correspondence received at Hq:
 From 3CP, Kingston: ". . . You might also give a memo to CBD that 1LB and the cooperator of 4ACF are here at the Canadian Signal Training Center with myself, and 3SD is at Ottawa on radio work, all with commissions as lieutenants. 3AU is overseas with the Royal Canadian Corps of Signals."

From 4UK, Regina: ". . . Our club died out for want of members but we left all our records with the Radio Inspector so we can always get them when we need them (and we will need them sometime!)."

Get the *MOST!* ★ OUT OF AMATEUR RADIO

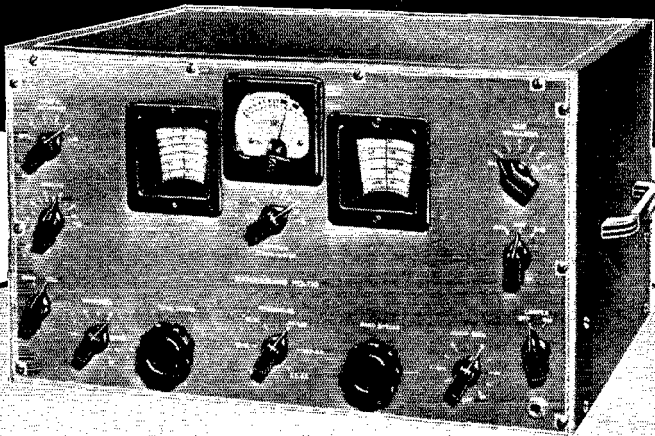

WITH AN "HQ-120-X"

MAKE your hours on the air carefree and enjoyable with an "HQ-120-X." Because the "HQ" is easy to operate, you'll find you can relax; copy faster, and thoroughly enjoy every QSO. Every control functions accurately and reely — you can't tire when you operate an "HQ-120-X." Technically the "HQ-120-X" has every feature essential to a modern ham station: variable crystal filter; calibrated band-spread; antenna compensator, noise limiter, and many others. Many commercial operators use

"HQ" receivers because they know ease of operation is just as important as sensitivity and selectivity. The "HQ-120-X" has all three. To thoroughly enjoy "ham" radio, use an "HQ-120-X." Your nearest dealer will be glad to arrange a demonstration.

HAMMARLUND MFG. CO., Inc.
424 West 33rd St., New York City
Please send 16 page "HQ" booklet.

Q-9

Name

Address

City.....State.....



Canadian Office:
41 West Ave. No., Hamilton

HAMMARLUND

SOLAR

A CHAIN IS ONLY AS STRONG AS ITS WEAKEST LINK

Make every condenser "link" in your circuits strong . . . standardize on SOLAR for safety!

Send for our new Catalog No. 11 and other literature

SOLAR Mfg. Corp.
Bayonne, N. J.

From 3ADU, Winnipeg: ". . . Has anyone any news of 3ABW, last heard of 'over there', and 3AEJ or 3AAW? I would be pleased to hear from anyone at the QTH c/o TCA, Winnipeg."

From 2OL, Asbestos: ". . . 2KL at last reports was a lieutenant with the 1st Pioneer Bn., RCE, serving in England. Was married in Theford, P. Q., before going overseas about a year ago. . . . Your correspondent is still at the same old grind trying to produce asbestos fibre."

From Mrs. J. A. Wadsworth, Victoria: "Please note new address for 5ZM. . . . Bill as you probably know went overseas with the 1st Division (Royal Canadian Artillery). He was given a commission in the RAF and is now Pilot Officer. . . . Seems to be doing well and making the best of things."

4AT, late of Goyan, Sask., writes that he is now a civilian D/F operator at the RCAF Navigation School at Rivers, Man.

5CS reports that he is pounding brass as lance-corporal with the RCCS "somewhere in Nova Scotia." His officer commanding is Lt. Col. J. W. Ellen-Thorpe, 4FE.

CU next month.

— C. B. D.

Handle Your Traffic on 160!

(Continued from page 14)

for parasitic oscillations. On the whole, we don't advocate the idea very heartily, but offer the suggestion simply as something that may be done — provided you can get away with it — when other means can't be used.

Incidentally, don't put too much faith in a push-pull final as a means of getting rid of a second harmonic. There's plenty of it with a Class-C amplifier, and it can very easily be coupled to the antenna through capacity between the tank and antenna coils. With *any* type of final, use inductive coupling to the antenna in preference to any form of direct or capacity coupling; this is one of the most important steps to be taken in the suppression of harmonic radiation.

So much for tank circuits. This harmonic proposition also is tied in with the antenna and the method of feeding it, so let's get along to

Antennas

Here's the subject that's probably the biggest sticker for the 80-meter man. It has its nasty problems, yet it is also a fact that almost anything that's tunable will radiate — not really well, perhaps, but often with surprisingly good results. Maybe we can approach the thing best from the viewpoint of what we don't want the antenna to do. There are at least two things in this category — we don't want it to radiate harmonics and we don't want it to cause avoidable BCL QRM. Both these things can be accomplished to a degree. The second harmonic can be suppressed by making the antenna short-circuit it, and the simplest type of antenna that does this is a grounded affair a quarter wavelength long. A single wire having a total length of 120 to 130 feet from ground connection to open and fulfills this specification. Antennas shorter than 100 feet or so will want parallel tuning, as shown in Fig. 5, but since this length is getting into the region of a quarter wavelength at 80 meters it may want to radiate at the second harmonic. It will be better to stay above a 100 feet overall length, unless it is

All-Out for Defense

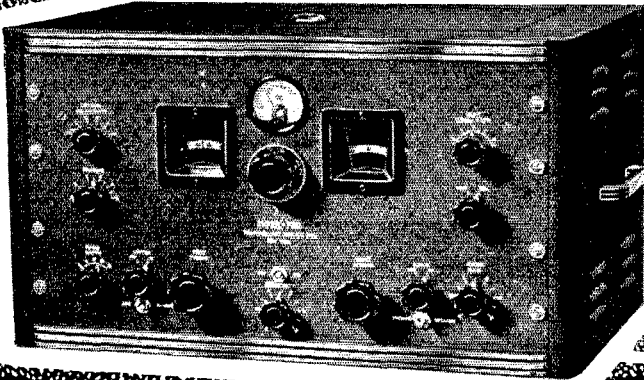

SUPER PRO "SERIES - 200"

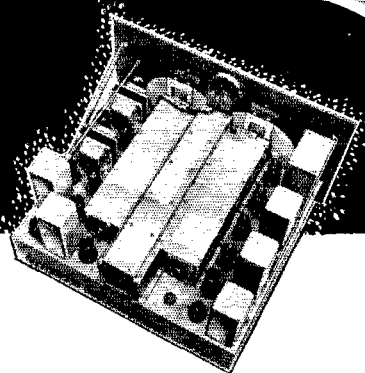

DEFENSE COMES FIRST with Hammarlund. Naturally we are sure you, as good Americans, will overlook the difficulty in obtaining some of our products. We are not forgetting you. Every possible effort is being made to supply your needs, but most important to both of us are the needs of our government.

THE "Super Pro" has always been a fine receiver. It has won the highest praise from leaders in every branch of radio communications. We of Hammarlund are always striving to do a better job and changes are continually being made wherever performance can be improved. That is why the "Super Pro" continues to be the leader. In it you are sure of complete satisfaction. Particular attention is paid to the performance life of our products: they don't age. You'll find Comet-Pros (10 years old) working today just as well as they did when they came off the production line. "Super Pros" may be a little hard to get right now but they are worth waiting for.

HAMMARLUND MFG. CO. Q-9
424-438 W. 33rd St., New York City
Please send "Super Pro" Booklet
Name.....
Address.....
City.....State.....

Canadian Office:
41 West Avenue No., Hamilton



HAMMARLUND

EXPORT DEPARTMENT, 100 VARICK ST., NEW YORK CITY

STANCOR

OFFERS TWO NEW
TRANSMITTER KITS •

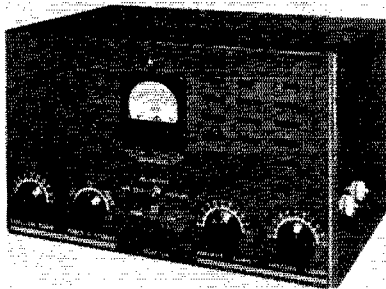

MODEL 69 designed particularly for "Amateur" use incorporating many excellent features. Rated at 60 watts final amplifier input . . . works all bands from 10 to 160 meters . . . crystal controlled . . . operates either phone or CW. New type transformers are used which are factory mounted on the self-contained chassis with the sockets and other components. Wiring harness is furnished to facilitate wiring. Kit price includes cabinet and meter. Amateur net price. **\$62.50**



MODEL DC-3 an extremely compact, lightweight radiophone transmitter designed for aircraft, marine, emergency, or any other amateur portable application where the source of power is 6 or 12 volts D. C. This transmitter measures 6" x 6" x 6", entirely self-contained with vibrator power supply and variable antenna loading system. One or two crystal controlled channels between 2 MC and 6.5 MC are available and are selected by the band-switch on the panel. Antennae as short as 15 feet can be used. Rated at 12 watt input to final stage. Amateur net price. **\$31.50**

Write for descriptive literature



STANDARD TRANSFORMER

• CORPORATION •
1500 NORTH HALSTED STREET . . . CHICAGO

first ascertained that no harmonic is being fed to the antenna. A suitable coupling coil will be 3 inches in diameter and have 20 turns or so of No. 12 wire, tapped every few turns for easy adjustment, and the condenser for series tuning may have a capacity of 250 μ fd. Ordinary receiver type spacing will do for moderate power. For parallel tuning with a short antenna somewhat more spacing will be desirable, but less capacity is necessary. In fact, the condenser may be omitted entirely and the coil alone used for loading; the tuning will not be as finely adjustable, but with taps every few turns this will be no handicap. The antenna coil may be inductively coupled to the final tank coil or link-coupled to it, whichever is more convenient. The main thing is to have a coil with enough turns, adjustable in fairly small steps.

A single wire of this sort may be vertical, horizontal, or partly both. A mostly vertical antenna will do better at the longer distances and will put out a better ground wave, while a mostly horizontal antenna will have a rather poor ground wave but will be good for short and moderate distances at night when signals are reflected from the E layer. Purely from the radiation standpoint, a vertical is a better all-around antenna on this band, but unfortunately it will also raise more of a rumpus in broadcast receivers. With the image situation the way it is, the horizontal may be the better bet, particularly since traffic handling will mostly be over moderate distances and at night.

What about the old 80-meter antenna? Chances are it's a 130-footer (or in that neighborhood), horizontal, and fed with tuned feeders either at the end or the center. Several things can be done about it. If it's center fed, with feeders 40 to 70-odd feet long, the feeders can be tied together and the whole thing worked against ground. It will work quite well that way, too. Or it can simply be operated as a partially-folded half-wave 160-meter antenna, in which case series or parallel tuning will be required depending upon the feeder length; feeders less than about 60 feet will take parallel tuning, longer feeders series tuning. The tapped antenna coil will be helpful in finding the right amount of coil to use. Both these systems are shown in Fig. 6. With the coupling circuit adjusted for 160 meters, the second is not likely to radiate well at 80 meters, since 80-meter operation would call for parallel tuning. The harmonic could be transferred by capacity coupling, in which case the feeders would radiate it, but this can be reduced by using loose coupling, coupling to a grounded part of the final tank coil, and by a Faraday screen. The construction of these screens is described in the *Handbook*, and installing one is always a good investment in harmonic suppression.

The end-fed antenna, or 80-meter Zepp, is more of a problem. A great deal depends on the feeder length. Tying the feeders together and working against ground with series tuning is practicable if the feeders are not too long — not longer than 40 feet, say — and provided a short ground lead can be obtained. From the harmonic standpoint,

Sweepstakes Winners

WHO USED THE

Meissner

SIGNAL SHIFTER

TO PILE UP

**Outstanding
Scores**

IN THE
ARRL

**Eleventh
Sweepstakes
Contest**

Why
★ *Not*

- Avoid QRM?
- Be sure YOUR QSO's are 100%?
- Spot YOUR signal where it will count?
- Make sure that YOU are always out in front?
- Enjoy VFO advantages with a pure T9X note?
- Help relieve congested bands?
- Place YOUR call on the *Honor Roll?*

★ —*Get YOUR Signal Shifter NOW?*

Well over half of the sectional winners in the Eleventh ARRL Sweepstakes Contest employed variable frequency operation—and nearly a third of these have been verified as Meissner Signal Shifters! We can't help but take a certain measure of pride in this achievement—to have such an appreciable percentage of those who came out on top crediting the performance of this instrument with at least a portion of their success! Now is the time to get YOUR Signal Shifter and start training for one of those top scores. See your Jobber AT ONCE!



Write for Free Catalog Today!

Address Dept. Q-9

Meissner MT. CARMEL ILLINOIS

"PRECISION-BUILT PRODUCTS"

MATCHED POWER!

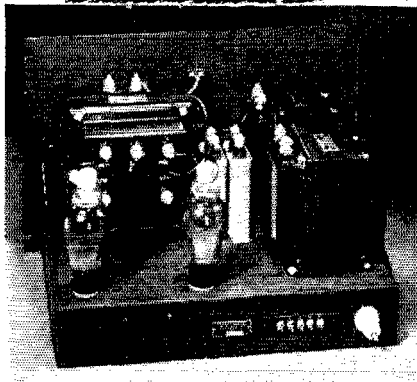

Thordarson Matched Power Supplies provide amateurs with any of the direct current voltages required in amateur radio work. Thordarson dual power supply transformers are especially designed for transmitters having low-voltage exciter and high-voltage final amplifier stages on the same chassis. All Thordarson Matched Power Supplies deliver the rated voltage and current safely and dependably.

Ask your Thordarson distributor for Transmitter Guide No. 344 E, 15c list. This guide offers you a wide choice of units from a small 20-Watt CW transmitter to larger and more elaborate rigs for the advanced amateur. Send for bulletin SD464. Illustrates transmitter kits from the 20-Watt CW to a 55-Watt phone 80-Watt CW unit.



THORDARSON

ELEC. MFG. CO.

500 W. HURON ST., CHICAGO, ILL.

TRANSFORMER SPECIALISTS SINCE 1895

however, this is not too good, since the system as a whole will approach a length of three quarter-wavelengths on 80 meters and consequently will radiate on that frequency. It would be wise to check the second harmonic with a station some distance away, preferably at night. If the harmonic is of such strength as to be capable of causing interference, it will be safer to shorten the top to make the system near a quarter wavelength long over all (including the ground lead) and use series tuning. Alternatively, additional wire could be put in the system to make the overall length (again including the ground lead) a full wave at 160 meters, so that on the second harmonic a voltage loop will appear at the ground. This will take parallel tuning, and a fairly high-*C* coupling circuit will short-circuit the 80-meter high-voltage point to ground, thus preventing second-harmonic radiation. Or the antenna can be saved for 80-meter work and a separate one put up for 160.

There are too many antenna systems to discuss modifying all of them. In most cases working against ground will be the most practical method, remembering that an overall length of about a quarter wavelength — 125 feet, more or less — is in the optimum region. If the antenna is centered, connecting the feeders together as one wire cuts the top length about in half, in effect, since the two halves are simply put in parallel when this is done. Other suggestions for 160-meter antennas will be found in the *A.R.R.L. Antenna Book*, although these were designed chiefly with efficient radiation, rather than harmonic suppression and b.c.l. QRM, in mind. If we seem to over-emphasize this harmonic question, it is simply that we decidedly need to be aware of it; ham harmonics will stick out like sore thumbs in the 3650-3950 region after the migration is complete. It is taking no more than reasonable precautions to use circuits and antennas which will reduce them as much as possible, and the same goes for checking for them on the air after the new setup is in operation.

This discussion would not be complete without a word or two about grounds. Matter of fact, it would be hard to say more than a word or two — aside from burying a lot of metal (which is hard work and gets you into trouble with the family for digging up the lawn, even if you could get the metal) there seems to be no choice but the old reliable cold water pipe. If you can get to it where it goes into the ground without having to run too long a lead, so much the better. We think, though, that the chap on the second or third floor may end up with more antenna and less ground lead by hooking on the cold water pipe in the bathroom, or as a second best, connecting to a radiator in a hot-water heating system. The house piping usually has considerable extent and its capacity to ground makes it act somewhat like a counter-poise, thus short-circuiting the long metallic path to actual ground. As a final admonition, we'll repeat one that's been in the books just about ever since there were books on radio — scrape the pipe clean and make a good tight connection!

NOW! ON EASY TERMS!

Newark offers the Skyrider SX 28 by

hallicrafters

pay only \$44.88 down, add 6% carrying charge, and take 8 months to pay the balance

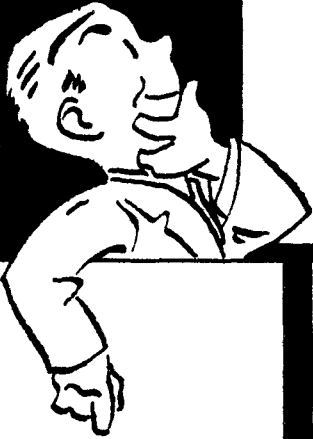

High Voltage Power TRANSFORMERS



Newark's larger volume of amateur business makes this unmatched value possible. Made by one of the largest transformer manufacturers. These husky transformers have a place in every Ham Rig. Guaranteed. As illustrated.

Choice of Two Filament Types

No. 4140 — 600-0-600 V. — 200 Ma. Filaments: 7.5 V.C.T. — 3A. — 5.0 V.C.T. — 3A. — 2.5 V.C.T. — 10 A. Wt. 8½ lbs. \$2.85

No. 4240 — 600-0-600 V. — 200 M.A. Filaments: 6.3 V. — 4 A. — 6.3 V. — 3 A. — 5.0 V. — 3 A. Wt. 8½ lbs. \$2.85

DISPLAY YOUR CALL LETTERS

Your call letters in GOLD on your ham shack door or auto window will look mighty fine!

10c

Big, shadowed decalcomania letters nearly 2" high. Send dime for yours today. Don't forget to give your call letters.

SEND FOR THIS FREE BOOK

Our latest issue, with illustrations, descriptions and lowest prices on thousands of bargains. Sets, parts, supplies and accessories of all the better makes. No ham should be without his NEWARK CATALOG. It's FREE!

WRITE TODAY!

ORDER DIRECT FROM THIS AD!

BUY NOW BEFORE PRICES ADVANCE!

Cash Price \$179.50

(less speaker)

Terms \$17.84

Per Month for Eight Months

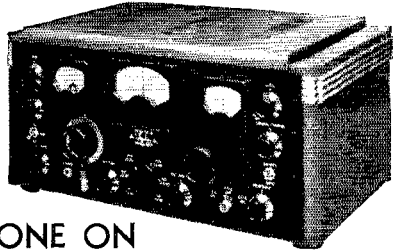

BE FIRST TO BUY ONE ON NEWARK'S NEW 6% TIME PAYMENT PLAN

Regular PM 23 speaker in metal cabinet. \$15.00

★ ★ NATIONAL NC-200 ★ ★

\$43.62 Down, \$17.34 Cash Price \$174.50 Complete per month for 8 months

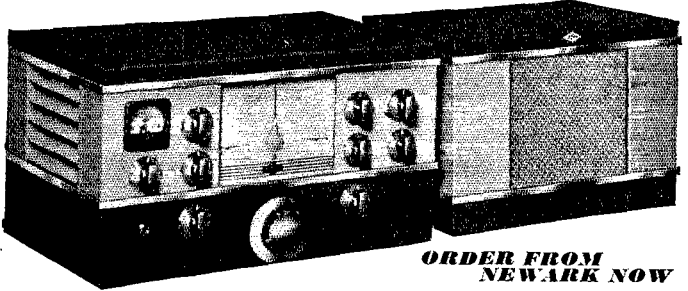

ORDER FROM NEWARK NOW

Send down payment and credit references with your order. Immediate shipment from stock on hand, as soon as credit is approved.

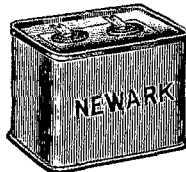

OIL FILLED — OIL IMPREGNATED FILTER CONDENSERS

The lowest price NEWARK has ever featured . . . on a condenser value that already has made thousands of friends for us! Quality-built by reliable maker. Guaranteed at rated voltage.

Mfd.	Volts DC.	Size	Price
1	1000	x 3½ x 1½	\$.59
18.3	1000		2.15
2	2000	4¼ x 3½ x 1¾	1.50
8	2000	5 x 3½ x 3¾	2.75
4	3000	5 x 3½ x 3¾	3.75

As low as 59c

NEWARK

Electric Company
323 W. MADISON ST.
Dept. Q CHICAGO, ILL.

Now In Stock

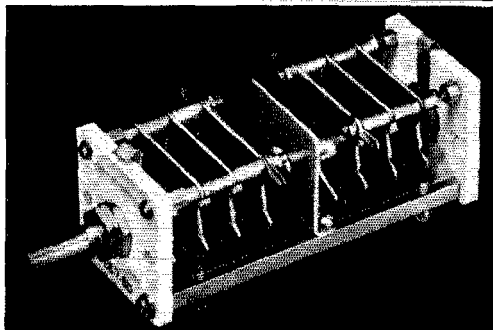

CARDWELL U.H.F. MIDGET TRANSMITTING CONDENSER TYPE ES-7-SD

Suitable for 2½- and 5-meter Transmitters up to 250 watts input, plate modulated.

AIRGAP.....	.140"
PLATES.....	.040" thick aluminum, buffed.
CAPACITY per SECTION.....	7 mmf. max.—3.5 mmf. min.
LENGTH (Over end plates).....	3½½"
INSULATION.....	Isolantite
AMATEUR NET PRICE.....	\$2.64

In these difficult days of enforced priorities, with stock cards showing zero, CARDWELL users may be interested in this list of stock items which can be shipped from stock. Bear in mind that dual section units, parallel connected, are effectively single section units of twice the capacity of a single section. Thus an MT-50-GD is equivalent to an MT-100-GS.

ALSO A LIMITED STOCK OF

"X" TYPE STANDARD		BAND SPREAD TRIM-AIRS	
XG-25-XS.....	\$2.31	EU-25-100-AF.....	\$1.98
XC-18-XS.....	2.97	EU-50-100-AF.....	2.16
XC-40-XS.....	4.29		
XC-65-XS.....	5.61	MIDGET FIXED AIR CONDENSERS	
"M" TYPE MIDWAYS		ER-75-FS.....	\$1.02
MR-50-BS.....	1.86	ER-100-FS.....	1.29
MR-70-BS.....	1.95	ER-300-FS.....	1.98
MR-25-BD.....	2.88	EU-50-FS.....	.90
MR-70-BD.....	3.24	EU-80-FS.....	.93
MT-20-GD.....	3.66	EO-150-FS.....	1.74
MT-50-GD.....	4.20	BALANCED U.H.F. DUAL	
TRIM-AIR MIDGETS		JP-48-ND.....	\$10.74
(With stub shaft, screw driver slotted. Not for knob)		U.H.F. "N" TYPE SINGLE	
ZR-10-AS.....	\$.84	NP-100-DS.....	\$3.09
ZR-15-AS.....	.84	Plenty of "JB" Jack Bases, Flexible Couplings, all Brackets, "ARL" ROTOR LOCKS, 804-A Inductance Clips and "MN" Mycalex Bars.	
ZR-25-AS.....	.93		
ZR-35-AS.....	.99		
(Full shafts)			
ES-7-SD.....	2.64		
ET-30-ADI.....	2.70		

ALL PRICES QUOTED ARE NET TO AMATEURS
FIRST COME—FIRST SERVED

THE ALLEN D. CARDWELL MANUFACTURING CORPORATION
83 PROSPECT STREET • BROOKLYN NEW YORK

Does the whole thing look too difficult? We think not. Certainly the advantages of more reliable short-distance work, negligible fading, and less QRM are worth whatever trouble it may be to change over, compared to taking the line of least resistance and moving into the remaining 150 kc. on 80. At this part of the sunspot cycle it would have been a good idea anyway, and now with more exclusive c.w. territory available the opportunity's too good to be missed.

Radio Control

(Continued from page 17)

Any account of the radio phases of the 1941 Meet would be less than half complete if it dealt only with the radio-controlled models. The work of the Chicago Area Radio Club Council in providing two-way radio communication and radio patrol cars to reclaim models that drifted away was one of the outstanding features of the Meet — made all the more important by the fact that this was the largest model meet in history, with over 2000 contestants, no less than 180 officials (timers, processors and judges), spectators by the tens of thousands, and a flying area of several square miles.

Major credit for the organization of the radio communications system goes to M. Warren Clark, W9YDV. Here is his own account of the work:

"The amateurs of the Chicago area again demonstrated the usefulness of ham radio and their willingness to cooperate in helping other groups of hobbyists by their participation in the recent Fourteenth Annual National Model Airplane Championships Meet held at 79th St. and Keeler Ave. in Chicago July 1-5, 1941. At the request of the cosponsors of the meet, the Chicago Park District and the Chicago Times, under the jurisdiction of the Chicago Area Radio Club Council there was set up a working organization to provide communication for the meet officials wherever requested and in particular to assist in recovering lost models.

"This was accomplished to the complete satisfaction (and in some instances amazement!) of the officials, contestants and public by the employment of twenty-two licensed amateurs and nine non-ham workers, with ten cars equipped with 2½-meter rigs and a central control station.

"In the twenty-four hours of flying time something like three hundred planes were recovered. These were either returned to their rightful owners after satisfactory proof of ownership had been presented, or were returned to the control station for later claiming by the contestants. In addition, there were untold numbers of planes saved from disappearance by the mere fact that the radio division cars were on the job patrolling the area along with the squad cars, for those interested in obtaining planes by shady methods were discouraged by the sight of persons on the spot to prevent such acts.

"In addition to this spotting, locating and retrieving of lost planes, communication was main-

Get the Jump with G-E Tubes

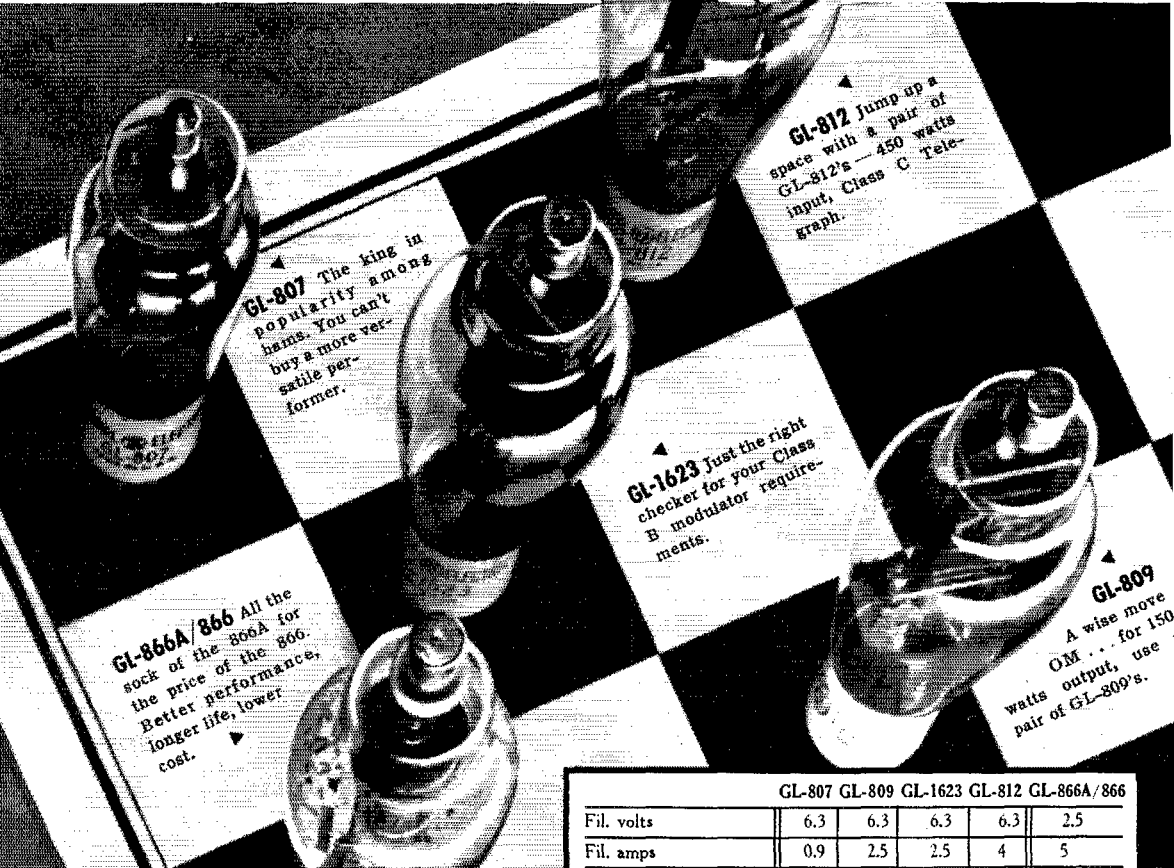

▲ **GL-807** The king in popularity among hams. You can't buy a more versatile performer.

▲ **GL-812** Jump up a space with a pair of GL-812's — 450 watts input, Class C Telegraph.

▲ **GL-1623** Just the right checker for your Class B modulator requirements.

▲ **GL-866A/866** All the sock of the 866A for the price of the 866. Better performance, longer life, lower cost.

▲ **GL-809** A wise move OM... for 150 watts output, use pair of GL-809's.

Man, Look at This Performance!

Take a look at the savings, too! Here are tubes that put sock in your rig without socking your pocketbook.

Next time you buy choose from G.E.'s complete line of amateur types—priced low, unsurpassed in value. Measure the difference yourself.

	GL-807	GL-809	GL-1623	GL-812	GL-866A/866
Fil. volts	6.3	6.3	6.3	6.3	2.5
Fil. amps	0.9	2.5	2.5	4	5
Amplification factor	8†	50	20	29	
Max. freq. mc. at reduced ratings	125	100	100	100	
Max. plate volts*	750	1000	1000	1500	10,000 Max. inverse peak plate volts
Max. plate milliamps	100	100	100	150	0.25 amp. average plate current. 1.0 amp peak
Driving power, watts*	0.2	3.8	3.1	6.5	
Max. plate input*	75	100	100	225	
PRICE	\$3.50	\$2.50	\$2.50	\$3.50	\$1.50
Input Watts Per Dollar	21.4	40	40	64.3	

*Class C Telephony-ICAS Ratings †Grid-Screen



Bulletin GEA-2021B gives you complete dope on G-E Pyranol capacitors; GEA-3315B, on G-E transmitting tubes. Get copies from your dealer or write General Electric, Section 161-26, Schenectady, N. Y.

GENERAL ELECTRIC



E. H. Rietzke
Pres. CREI

Are You

"PINNED DOWN" INTO A ROUTINE JOB?



Radio **JOB**s are many —
Radio **CAREERS** are few!

Right NOW is the time to take the "question mark" out of your future in radio! Prepare now for an IMPORTANT career in the expanding radio industry.

For more than 14 years CREI has been helping ambitious professional radiomen toward **CAREERS** in radio . . . not mediocre jobs that are available to partially trained men . . . but **CAREERS** that will be even more important in the years to come. The man who equips himself now with a thorough foundation of technical radio knowledge is the man who has **INSURED** his future in radio.

"CREI TRAINING BUILDS INTO THE PROFESSIONAL RADIOMAN A USABLE, WORKING KNOWLEDGE OF PRACTICAL RADIO ENGINEERING. IT DEVELOPS THAT SURE CONFIDENCE IN HIS OWN ABILITY WHICH ENABLES HIM TO GO AFTER THE BETTER JOBS — AND GET THEM."

CREI Training is preparing others for better paying jobs — WHY NOT YOU?

Everywhere in radio you will find that employers recognize CREI training. The CREI graduate or student is usually selected for the more important, responsible duties when a choice is to be made. You'll find CREI students in broadcasting, CAA, FCC, radio manufacturing, aviation radio maintenance, Army, Navy, marine radio, police radio, radio servicing, and many other branches of radio, all preparing for the inevitable opportunity that will bring them increased responsibilities at increased pay.

WRITE FOR FACTS TODAY!

Our **FREE BOOKLET** and personal recommendations may hold the answer to your future success. Write today and please state briefly your background, education and present position.



CAPITOL RADIO ENGINEERING INSTITUTE

Dept. Q-9, 3224 16th St. N. W., Washington, D. C.

tained between the radio control flying pit and the headquarters tent.

"At the control station, which was located in the press tent close to the official headquarters tent and the p.a. platform, the rig consisted of a pair of 6J5Gs in a long lines circuit, modulated by a pair of 6V6GTs in class B, running approximately 45 watts input. The antenna used was a half-wave copper tube lashed to a bamboo pole, which was in turn lashed to a tent pole and fed with a 2-inch open line, delta matched. The receiver was a 6J5GT super-regenerative detector feeding a 6C5-6K6GT audio system. All this was powered by a 1-kw. gas driven generator. The same antenna was used for both transmitting and receiving. The equipment, exclusive of the power supply, was constructed by W9VEZ.

"The mobile rigs consisted for the most part of assorted transceivers driven by dry battery, motor-generator and vibrator sources. Some were of the home-grown variety and others of the "commercial" type. We recommend that anyone who undertakes such a job stay away from transceivers as far as possible, however. While they worked out satisfactorily up to about 1½ to 2 miles, after that the signals dropped so that consistent communication was impossible either from the transmitting or the receiving standpoints. Of course it should be mentioned that receiving conditions at the control station were none too good, the audible noise of the hundreds of model engines humming away and the QRM set up by their ignition systems causing a constant roar in the receiver. On the other hand, when a different type of rig was used in the car, consisting of an oscillator installed in a can on the roof or hood of the car with the antenna fastened directly to the can, modulated by a modulator-receiver combination inside the car, good communication was possible over distances up to eight or ten miles with very small input power.

"Now for the personnel who gave up a possible three-day Fourth of July weekend vacation in order to carry on this fine work. All were under the direct supervision of M. Warren Clark, W9YDV, the meet radio officer, who was chosen by the Chicago Area Radio Club Council to handle the affair. He in turn obtained the services of Norm MacConnell, W9TXU; George Fenton, W9SXZ; Thomas Bohnsack, W9PEQ; Leslie Morey, W9KBO; Lawrence A. King, W9BZK; Gerald J. Easley, W9LHX; Al Knodell, W9TLQ; John Disch, W9VEZ; Harry L. Hale, Jr., W9MCM; R. V. Danner, W9BYG; William Schallmo, W9YZX; E. F. O'Hare, W9PIU; Ted Piecko, W9TMT; Dean Baker, W9HZQ; Earl Moorman, W9ZYL; George Ashton, W9PNV; William Shaw, W9UIG; Richard Acker, W9TOK; Roland McCune, W9UKU; Joe Haenly, W9FIB; Francis Harris, W8UKS; and the non-hams: Bob LaPorte, John Earhart, Marian Knodell, daughter of W9TLQ, V. R. Danner, father of W9BYG, Stanley Kowalezyk, Leonard Novak, Dick Bardo, Dean Baker, Jr., son of W9HZQ, and Art Zunker. All put in valuable time and their efforts were much appreciated.

Get on the Ultra Highs

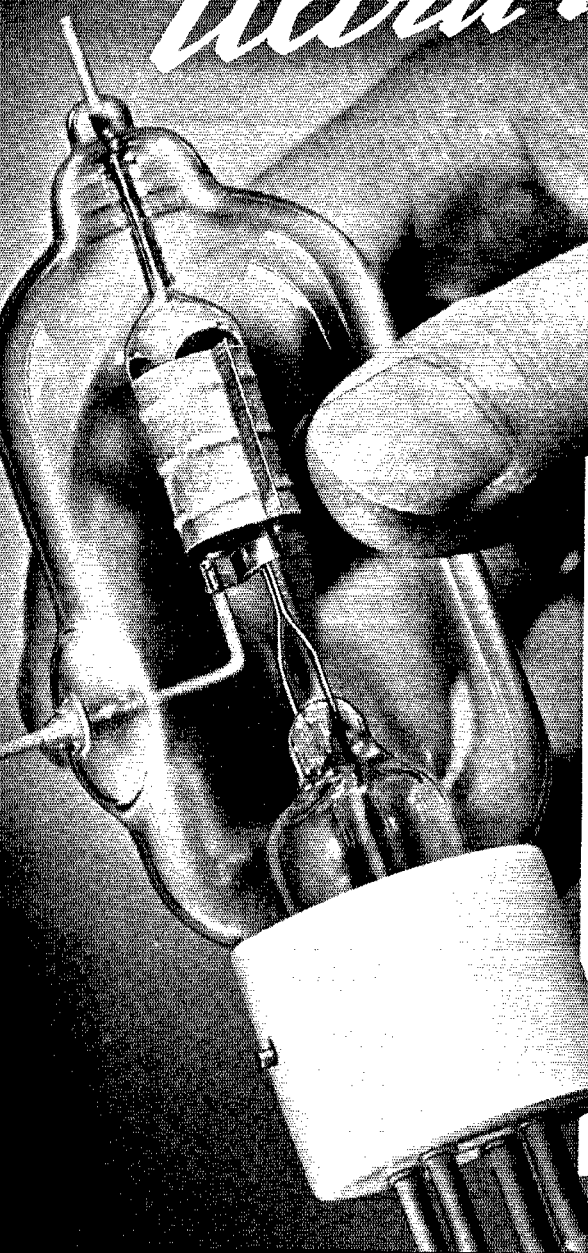

with Eimac 35TG tubes

The inherent characteristics of Eimac 35TG make it ideal for work on the Ultra High Frequencies. Low interelectrode capacities, extremely high electrical efficiency plus great stamina and long life under the most grueling performance are features which demand your consideration. Couple these features with Eimac's exclusive, unconditional guarantee against premature failures which result from gas released internally and the extremely low first cost . . . \$6.75 net . . . and you have the answer for both economy and results.

Eimac tubes are in use today in some of the most important communications systems throughout the world. Leading engineers use and recommend them.

Follow the leaders to

Eimac **TUBES**

and get better results for less

TEL-McCULLOUGH, INC. • SAN BRUNO, CALIFORNIA, U. S. A.

Export Agents: Frazar & Co., Ltd., 301 Clay Street, San Francisco, California, U. S. A.

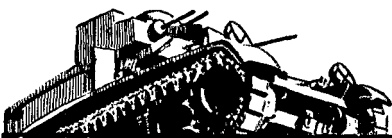

for defense... emergency... or amusement

2½ METER

PORTABLE—MOBILE—FIXED STATION

DK-3 TRANSCEIVER



UNUSUALLY LOW PRICED radiophone transmitter and receiver with special VARIABLE ANTENNA COUPLING that permits use of maximum power while transmitting, and enables flexible receiver control. Effective range is from 2 to 30 miles depending upon terrain. Only two inexpensive tubes required.

DK-3—11" x 11" x 4½" in size, self contained in carrying case, less batteries and tubes, list price (subject to amateur discount)... **\$32.00**

HIGH POWER—2½ METER

MOBILE or FIXED STATION

MRT-3 TRANSCEIVER

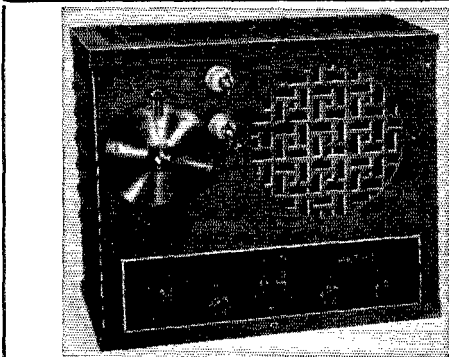

20 WATTS INPUT; rugged and compact; low priced; ideal for use in automobile, truck, boat or airplane; simple to install and operate; satisfactory operating range from 5 to 50 miles, depending upon terrain and antenna.

● For mobile operation: Any standard 300 volt, 100 MA Vibrator power supply with filter added ● For fixed station: Any good AC power supply having an output of 300 volts at 100 MA and 6.3 volts at 3.5 amperes ● Antenna coupling is mounted on Polystyrene rod and can be varied by pushing in or out ● Tubes required, HY-75, 6C5, and 6L6 (or 6V6).

MRT-3—9" x 8" x 4" in size, with self-contained P.M. Dynamic speaker, less tubes and power supply, list price (subject to amateur discount)... **\$49.00**

ABBOTT

INSTRUMENT, INC.

8 WEST 18 STREET

NEW YORK, N. Y.

"Too much cannot be said to commend such work, for it accomplishes several objects at one time: proving occupancy and use of the ultra-high bands, which is sorely lacking in most localities; giving experience and training to the operators which may prove valuable for other and more serious work; lending assistance to other groups of hobbyists and showing the public at large that amateurs and amateur radio are worthwhile. The Chicago Area amateurs thank the sponsors of the meet for the opportunity to do something really worthwhile and for their friendly cooperation prior to and during the meet, and the Chicago Area Radio Club Council wants to thank publicly all those who worked hard and long to make this affair another feather in the cap of amateur radio and another milestone in the trail of good deeds well done."

A 56- and 112- Mc. Converter

(Continued from page 22)

10.2-Mc. i.f., the oscillator range, to cover 56 to 60 Mc., will be from 45.8 to 49.8 Mc., and this may be checked on another receiver, if available. If not, probably it will be necessary to use actual signals in the band for the purpose, which also will involve having at least the mixer hooked up. With the circuit specifications given, the oscillator padding condenser should be sent at about half scale. The inductance of L_5 may be adjusted by closing up or opening out the turn spacing, which can be done within limits without moving the ends of the coil. Once the right range is secured the turns should be cemented in place. An alternative method of adjusting the inductance is to make the coil slightly large in the first place and then cut it down with a shorted turn of wire which may be slid along the coil form. A limited range of inductance variation can be secured by this method. A copper plug inside the form, variable in position with respect to the coil, also could be used, but requires a more elaborate mechanical arrangement for satisfactory adjustment and good mechanical stability.

The oscillator tickler, L_6 , should be adjusted to give stable oscillation without squegging. This will be evidenced by a whole series of signals instead of one, and can be cured by reducing the feedback, either by using a smaller number of tickler turns or by moving the tickler farther away from the plate coil. Incidentally, the oscillator should have a good steady d.c. note, if means are available for listening to it in another receiver. For this check to mean anything, the receiver used also should introduce no modulation on incoming signals.

Once the oscillator range is set, the mixer should be lined up to match. To do this, have the r.f. tube in its socket, but connect a resistor of a few hundred ohms from its grid to ground instead of using L_1 . The mixer primary, L_4 , must be in place, since it will have some effect on the tuning range of L_3C_2 . Connect the r.f. output leads to the doublet posts on the communications receiver, set the latter to 10.2-Mc., and adjust



This Valuable ENGINEERING DATA AND PROPERTY CHART Is Yours on Request!

EVERY man who uses electrical insulating materials, chemical ceramics—in fact any ceramic parts for technical applications, and every research laboratory will find this Property Chart of value. It will be sent free on request.

The chart contains exact data on the physical properties of the most frequently used ceramic compositions of the American Lava Corporation. It gives the predominant physical characteristics such as: specific gravity, density, volume, water absorption, chemical resistance, color, softening temperature, resistance to heat (safe limit for constant temperature), hardness, linear co-efficient of thermal expansion, tensile strength, compressive strength, modulus

of rupture, resistance to impact, thermal conductivity, dielectric strength, volume resistivity at various temperatures, T_e values, dielectric constant, power factor, loss factor and capacity change per $^{\circ}\text{C}$ between $20\text{-}80^{\circ}\text{C}$. The chart also contains graphs which give valuable information on physical characteristics which are difficult to reduce to figures, such as linear thermal expansion, dielectric strength and volume resistivity at varying temperature.

This chart is strictly an engineering tool. All data have been carefully compiled and checked over a long period of time.

The chart portrays most forcibly an outstanding advantage of ALSiMAG. In using ALSiMAG the engineer is not limited to one or two ceramic materials. ALSiMAG offers a wide variety of ceramic compositions of controlled and definitely determined physical characteristics for your application. ALSiMAG is economically custom made into size, shape and form indicated by your requirements.

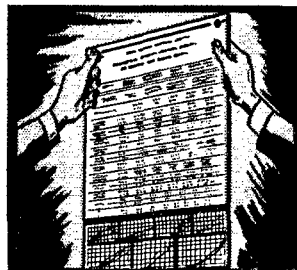
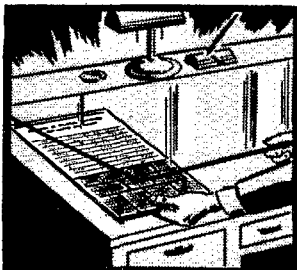
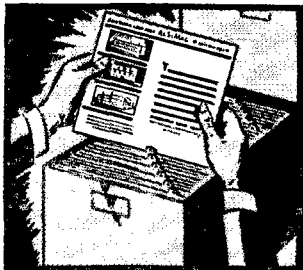

This convenient file size chart may also be used under desk glass or hung on wall

This advertisement is not a solicitation of business as custom made ALSiMag is sold direct to the manufacturers. However, if a Property Chart is of interest to you we will be glad to send a copy without charge if you will address: Research Staff, American Lava Corporation, Chattanooga, Tennessee.

ALSiMAG

Trade Mark Reg. U. S. Pat. Off.

FROM CERAMIC HEADQUARTERS

AMERICAN LAVA CORPORATION • CHATTANOOGA • TENNESSEE

CHICAGO • CLEVELAND • NEW YORK • ST. LOUIS • LOS ANGELES • SAN FRANCISCO • BOSTON • PHILADELPHIA • WASHINGTON, D. C.

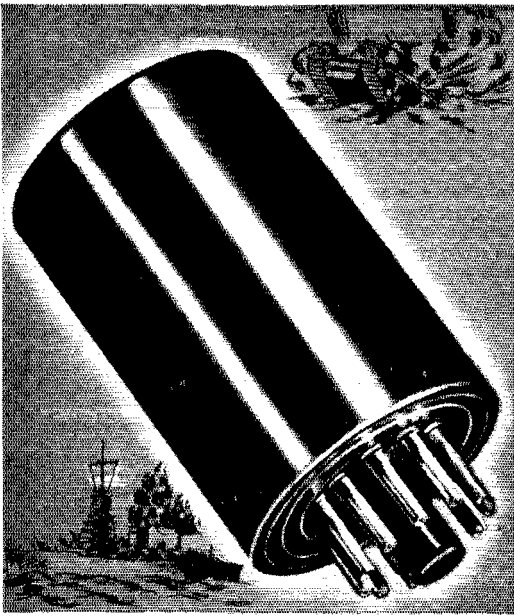

SUBMERSION-PROOF

To Meet Specifications of

ARMY and NAVY

FOR IMMEDIATE DELIVERY

KENYON is perhaps the only transformer manufacturer in the industry with a stock of **SUBMERSION-PROOF TRANSFORMERS** on hand.

This is all the more remarkable when it is considered that Kenyon Tube Base Transformers meet the rigid specifications of both the U. S. Army and Navy.

A trend toward specialization in this type of construction for both Standard and Submersion proof operation has made this possible.

FEATURES

- Frequency Response with no D. C. in windings plus or minus 2 DB, 30-20,000 cycles.
- Light in weight . . . average only 5 oz.
- Compact . . . A real space saver for portable, mobile or aviation equipment!
- Solves Production Problems . . . Wire up equipment and just plug in transformers!
- Can be furnished with positive locking device!
- Absolutely Water tight . . . because of Kenyon's exclusive construction and manufacturing process!
- Alumilite Finish on Case . . . prevents corrosion, makes unit impervious to moisture, stands 200 hour salt spray test!

Our Engineering Department will be glad to assist with your transformer problems. New 1941 Catalog of all stock items sent on request

KENYON TRANSFORMER CO., Inc.

840 BARRY STREET

NEW YORK, N. Y.

Cable Address: "KENTRAN"—New York

C_{16} for maximum hiss, with the oscillator tube out of its socket. Then replace the tube and with the oscillator set for 56 Mc., adjust the trimmer, C_4 , for maximum hiss; reset the oscillator to 60 Mc. and readjust C_4 . If more capacity is needed at C_4 , the inductance of L_3 is too large; if less, L_3 is too small. Make an appropriate small change in the inductance and try again; continuing the process until C_4 peaks at the same setting at both ends of the band. The inductance of L_3 may be adjusted by the means described above.

When this process is finished, C_4 should be well in the air-dielectric portion of its range. Should the movable plate be close to the mica, L_3 is considerably too small. However, this would be accompanied by reduced tuning range on C_2 , and it is doubtful if high padding capacity would permit full band coverage.

It is not likely that the tracking will be perfect over the whole band, since the higher C of the oscillator circuit gives it a slightly different tuning curve from the low- C mixer circuit. The mistracking is small, however, and a compromise trimmer adjustment which gives good performance over the whole band is readily secured. The usual series tracking condenser could be used in the oscillator circuit, if desired, but the complications did not seem justifiable in this case.

At this point it is possible to adjust the primary, L_4 , for maximum gain if a signal generator, or a test oscillator with some 5-meter harmonic output, is available. Connect its output across the temporary resistor in the grid circuit of the r.f. stage and try different numbers of turns at L_4 for maximum signal. This coupling does not seem to be very critical, however, so long as the number of turns is in the region specified in the table. It is best to use the smallest number of turns which gives good gain, since this means looser coupling, hence better selectivity in the mixer circuit and lessened tendency for the r.f. stage to oscillate.

The r.f. stage is aligned in just the same way as the mixer circuit. First alignment should be with nothing connected to the antenna posts, since under these conditions the grid-circuit Q is highest and if the stage is unstable oscillation will show up immediately. Oscillation is a distinct possibility, even after care has been used in providing as much electrostatic shielding as possible between the grid and plate circuits. Magnetic coupling between the two coils is unlikely if the mixer coil is boxed in as shown in the top-view photograph. Should oscillation occur, reduce the size of L_4 until the stage is stable; in the unit illustrated, one more turn on L_4 will make the r.f. stage oscillate, although it settles right down and does not even seem to be regenerative when an antenna is connected. With the primary (L_4) finally used, there is a slight amount of regeneration, identifiable as a somewhat exaggerated peaking in the r.f. stage, with the antenna disconnected. This disappears completely with any sort of antenna load on the r.f. tuned circuit.

The procedure for adjusting the 112-Mc. coils is similar to that described above for 56 Mc. It

Hard to Get

COMPONENTS FOR BROADCASTING STATIONS

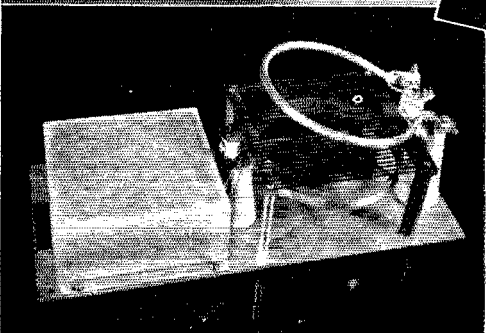
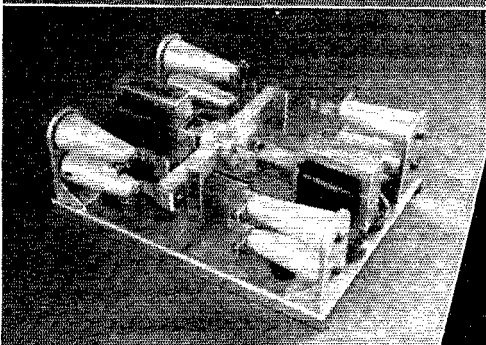
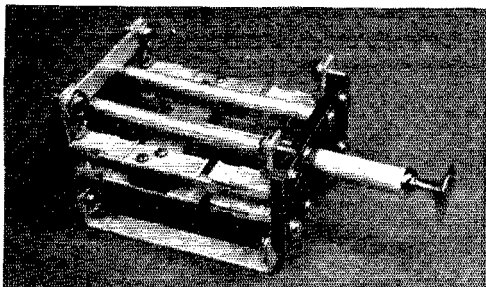

Above is illustrated an R. F. Make-Before-Break Switch for inserting and removing a meter without breaking the circuit. The R. F. Contactor uses knife-type contacts and requires no holding current. The Isolation Transformer is used to feed sampling lines and for remote metering. Shown also is a terminal and safety gap for Johnson 2% inch concentric line.

Much of Johnson's business consists of the design and manufacture of special components for specific applications. Johnson Engineers are thoroughly familiar with all phases of radio transmission and will be glad to assist you with your problems with no obligation to you. Write them today.

ASK FOR THE NEW CATALOG 967J



E. F. JOHNSON CO.

WASECA, MINNESOTA
EXPORT: 25 WARREN ST., NEW YORK, N. Y.

"MANUFACTURERS OF RADIO TRANSMITTING EQUIPMENT"

RADIO TRAINING



FOUNDED IN 1909

PORT ARTHUR COLLEGE, a non-profit-making educational institution, offers a practical radio operator's course at the lowest tuition price in its history. Each radio graduate receives two months' actual operating experience at the college's commercial broadcasting station KPAC. This station is equipped with the latest type 1000 watt high fidelity RCA transmitter — 1250 kc. — directional antenna system. KPAC operates in new modern studios located on the campus.

The college has never advertised jobs or positions in lieu of education. Today it is well known there is a shortage of radio operators in every branch of radio; particularly flight and ground operators for airlines in America and South America — marine operators for ships traveling coastwise and foreign — geodetic-geographic research — broadcast stations — the Army and Navy — other positions in many departments of the United States Government. Therefore, we believe it is good common sense to mention that Port Arthur College is the sole radio school in America which owns a commercial broadcasting station with commercial advertising representatives in New York, Chicago, San Francisco, and many of America's leading cities, with active membership in the National Association of Broadcasters, and Broadcast Music Incorporated. Through these contacts the college receives from the broadcast industry alone more calls for radio operators than it is possible to supply.

AUTHORIZED TO TEACH RCA TEXTS
If interested, write for Bulletin R

PORT ARTHUR COLLEGE
PORT ARTHUR (World-Known Port)
TEXAS

UP TO THE MINUTE

The License Manual

is always kept up to the minute. When you read this a new edition incorporating all of the recent changes will be off the presses and on sale. We insert correction sheets whenever there is a change in the amateur regulations which cannot be incorporated in the printing of the LICENSE MANUAL. To keep abreast of amateur regulations, have a copy of the up-to-date LICENSE MANUAL in your shack at all times.

25c postpaid {no stamps, please}

THE AMERICAN RADIO RELAY LEAGUE, INC.
West Hartford, Connecticut

is desirable to adjust the oscillator coil so that the trimmer C_6 does not need resetting when changing bands; some control over the oscillator inductance can be secured by adjusting the coupling between L_5 and L_6 . We adjusted the 112-Mc. oscillator circuit without reference to the 56-Mc. coils, trying only to get twice the tuning range of the 56-Mc. set (because the range in the r.f. and mixer circuits is twice as great in kilocycles when the frequency is doubled, assuming the same trimming capacity) and, luckily enough, came out with a coil which worked at the same setting of C_6 . This is not quite as coincidental as it may sound, since there is a fairly considerable range of adjustment on C_6 which, while moving the band around on the dial, still keeps it within range. This is a result of the smaller bandspread on $2\frac{1}{2}$ meters.

It can be anticipated that the operation on 112 Mc. will be the same as on 56 Mc.; at least it turned out to be so in our case. No special troubles developed, and the circuits responded to the same treatment as was given them on 56 Mc. Oscillation in the r.f. stage readily can be eliminated by adjustment of the mixer primary, L_4 , without sacrifice of effective gain.

Wave Paths

(Continued from page 27)

be explained without having to assume multiple refractions, it is well to realize that the possibility exists. Since more than two masses must be present for multiple skip the probability of such skip is not very great. For maximum distance the masses must be spaced over a relatively large area, and this condition would require a high general ionization of the layer. This would more likely take place during the peaks of sunspot activity. Probably the more usual case would be a combination of type *C* double skip and a single skip.

The u.h.f. amateur has an excellent opportunity now to advance the knowledge of five-meter skip. With few ionospheric sounding stations in operation, the existence of most of the sporadic *E*-layer masses is known only by reports from amateurs. If each operator can determine the approximate direction and wave angle of each station heard or worked, and will send the data to some central point for analysis, much useful information can be gathered.

A 50-, 100- and 1000- kc. Oscillator

(Continued from page 34)

the 50,000-ohm value should be satisfactory in most cases.

The 1000-kc. harmonics can be identified by checking stations that are heard near where the harmonic is heard. Once it is decided which 1000-kc. harmonic is being heard, the oscillator can be switched to the 100-kc. range, reset to WWV, and a signal should be heard where the harmonic from the 1000-kc. oscillator was heard before. This will

Every **OHMITE** part does its Duty



THERE is no question of dependability when Ohmite Units are on the job in Amateur Communications or National Defense. Brown Devil Resistors, Dividohms, Dummy Antennas, Parasitic Suppressors, Chokes, Rheostats and other Ohmite Parts . . . they're all veterans of service in the rigs of the nation — all engineered for fullest efficiency to safeguard performance in all climates under all kinds of operating conditions. Ask your Jobber or send for free Catalog 18.

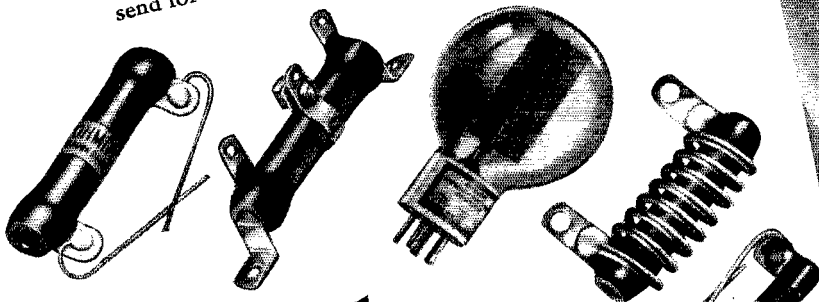

OHMITE EXPANDS FACTORY AND FACILITIES

HERE, at Ohmite, a new addition has been erected, factory space has been doubled, production facilities have been greatly increased — everything possible is being done to assure a continuous supply of Ohmite Parts for everyone's needs.

OHMITE MANUFACTURING COMPANY
 4865 Flournoy Street Chicago, U.S. A.

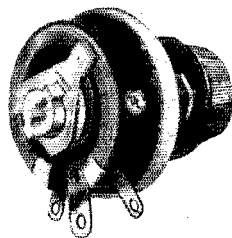

SEND 10¢ FOR OHMITE OHM'S LAW CALCULATOR

Be Right with **OHMITE**

RHEOSTATS • RESISTORS • TAP SWITCHES

2½ is "HOT"

More and more amateurs are meeting on the 2½ meter band . . . not only "open" for portable and mobile operation, but great for FUN and, if needed, for emergency. Get one or both of the sets below . . . We can ship AT ONCE from stock on hand.

New ABBOTT DK-3 PORTABLE MOBILE TRANSCEIVER for 2½ METERS

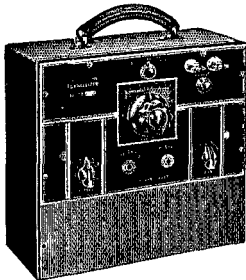

\$18.82

less accessories

Range 2 to 39 miles. Size 11 x 11 x 4½. Self contained battery operated model in carrying case.

★ Set of tubes, 6G6G and 6J5GT, RCA \$1.13

★ Set of fresh Burgess Batteries \$4.31

★ Universal 820 receiver-mike headset \$5.88

ABBOTT MRT-3 For mobile or fixed station. 30 w. input. lots of "sock." Only 9 x 3 x 4. Built in speaker. Less tubes and power supply **\$28.81**

★ Tube kit HY75, 6C5, 6V6, \$5.35

★ Mallory Vibropack, 300 v. 100 MA, with tube . . . \$13.06

ORDER NOW PRICES ARE ADVANCING RAPIDLY

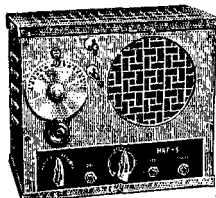

. . . SAVE MONEY

NEWARK ELECTRIC COMPANY

323 W. Madison St., Dept. Q, Chicago, Ill.

identify the harmonic from the 100-kc. oscillator, and any particular harmonic near that frequency can be identified by counting the 100-kc. intervals between it and the known 1000-kc. multiple. The 50-kc. oscillator will, of course, have harmonics that fall on the 100-kc. harmonics and also halfway between. It is a good plan to check the 100- and 50-kc. oscillators by counting the number of signals from them that can be heard between the points on a receiver range where the 1000-kc. harmonics occur, to insure that the oscillator ranges are correct and to familiarize one's self with the use of the gadget. When the signal is strong it can be found even without the b.f.o. of the receiver on, but when it is weak (in the high-frequency ranges) weak-signal c.w. technique must be used, and the gain of the receiver must be set near maximum and the b.f.o. should be turned on. A receiver once calibrated by the oscillator can be used to identify the harmonics in the future, if the receiver retains its calibration to any reasonable degree. If the receiver is a superheterodyne it can be used to monitor and check the frequency of the transmitter, otherwise a separate monitor will have to be calibrated from the oscillator and used to check the transmitter frequency.

The oscillator surprised us a bit with its stability, and even at 30 Mc. the note is not too rough nor is the signal too broad for zero beating.

— B. G.

Correspondence

(Continued from page 61)

down the text of conversations has left me sadly lacking in the art of receiving code. . . .

I intend to brush up on this matter of writing down everything received and see if I can improve. This try was an eye opener to me and your program in this direction is one of the best things that you can do. . . .

— Robert St. John, W8JJV

432 Western Ave. N., St. Paul, Minn.

Editor, QST:

The code practice from W1AW is the finest program that the League has ever sponsored. I do not think that enough credit can be given you for the fine work. In my case, it has raised my code speed from practically nil to where I can now copy 35 w.p.m. on a "stick," and has encouraged me to purchase a "mill" and start over again to get my speed to the same level with the machine. I now possess a radio-telegraph second-class commercial ticket, something that a year ago was almost visionary. I give the League's program absolute credit for getting me to the point where I can honestly claim to be an operator.

However, in all good things there seems to lurk the proverbial "nigger in the woodpile." . . . Here is my gripe. Why the devil can't the fellows on the 7-Mc. band keep their d—d rigs off of W1AW while the code practice transmissions are being sent? For the past two weeks there have been only about three nights that it has been possible to get them solid. It seems as though some of these numbskulls park their e.c.o.'s right smack on top of W1AW. My receiver has a fairly effective quartz filter, but even that is not enough. There are a lot of people outside of ham circles who copy these transmissions, and I am wondering what their opinion of ham radio in general is when they get this interference from the very ones who should be taking advantage of these practice sessions.

I am a fairly old timer, and I remember the blacklist that QST had back in 1920, when some of the fellows QRMD the old BuStan transmissions. I think it is about time that any fellow QRming W1AW on the code transmissions should get into QST via the same route. . . .

Get out the big stick, Ed, and crack down on these dopes.

— A. Frank Vowles, W9BBL

LEARN THE WIRELESS CODE AT HOME

INSTRUCTION BOOK FREE WITH EVERY SET

Make your spare moments count now! Learn the wireless code with a Signal Wireless Practice Set. Set consists of key and high frequency buzzer mounted on a mahogany finished wood base equipped with binding posts. The code is printed on a plate fastened to the base between the key and buzzer. Adjustable buzzer. Price of instrument illustrated is \$3.40 list. If your jobber cannot supply you, order direct.

SIGNAL ELECTRIC MFG. CO.
MEMONINEE, MICHIGAN

Established 1892

SIGNAL



ACTUAL
SIZE

TAYLOR 866 JR. RATINGS

Filament Voltage (A.C.), 2.5 Volts
Filament Current 2.5 Amps.
Max. RMS A.C. Volts, 1250 Volts
Max. D.C. Current per pair
(choke input) 250 M.A.

The 866 Jrs. have long filled a real need for intermediate power requirements where the receiving type full wave rectifiers will not stand up and where the power capabilities of Taylor's famous 866/866A are not necessary. The small size of the 866 Jr. is another feature that will prove of great advantage in the layout of compact power supplies.

Over
35,000

Taylor

866 JR.
Sold to Date!

For Only
\$100

TRIED AND APPROVED BY AMATEURS

The design of Taylor's famous 866 Jr. was suggested by amateurs and built specifically for their use. The thousands sold to date attest its wide acceptance.

3 OUTSTANDING FEATURES

1. The shield and anode of Taylor's 866 Jr. are made of pure Svea metal which eliminates any possibility of filament poisoning due to loose carbon.
2. The cathode of the Taylor 866 Jr. is a multi-strand (mesh) filament which has approximately twice the emitting area of the ribbon type.
3. The Taylor 866 Jr. is designed with all leads coming out of the base, thus simplifying and keeping all wiring neatly below the chassis.

SEE YOUR PARTS DISTRIBUTOR
TODAY FOR TAYLOR TUBES.

"More Watts Per Dollar"

Taylor **HEAVY CUSTOM BUILT** DUTY Tubes

TAYLOR TUBES, INC., 2341 WABANSIA AVE., CHICAGO, ILLINOIS

Station Activities



HUDSON DIVISION

EASTERN NEW YORK — SCM, Robert E. Haight, W2LU — KWG just returned from maneuvers, but has nice traffic total. JRG was appointed chairman of Fire Defense Committee of his town, and plans 112 Mc. for emergency rig. Traffic totals for RNY have reached a new low. What's wrong, boys? Is the nice weather getting you down? Let every ORS and OPS report next month and show the boys we're still alive. JRG reports BVE is Chief Radioman in charge of control tower at new U. S. Navy aviation field at N. Y. C. EGI is his assistant. MHW received visit from MRL, MEL and NZO of Bronx. The Middletown boys are hot on 112 Mc. Two boy scouts, NBE/2 and MUX of Jersey City, are camping at High Point, operating on 1.75, 3.5 and 7 and 112 Mc. E.N.Y. welcomes KMH of White Plains, who reports for the boys. He feels W. P. has been missed in the columns, and comes to the rescue. Thanks, OB. Your report is welcomed. AAD is active on 112 Mc., and welcomes contacts. ACD is breaking the ice and coming down on 112 Mc. KMH also follows suit. HMM is pounding brass for Uncle Sam's Navy at Pearl Harbor. KMH is teaching his mother code, and promises her ticket soon. KMH and HMO visited Headquarters. LQU is burning up 112 Mc. with 200 watts. NAD is new ham located at Coxsackie, N. Y. He joined EC boys and is using UTC SX80 transmitter and Sky Champion S20A on 3.5 Mc.

Traffic: W2KVG 86 JRG 11.

NEW YORK CITY AND LONG ISLAND — SCM, Ed. L. Baunach, W2AZV — MYI is out for ORS in a big way. IKAT recommends KOA for OPS. NZV is a new station in Queens Village. LR is now serving full time with the Navy. OCK is a new station at Soundview Ave., Bronx. LYC is taking cryptography course in AARS. IOP is preparing for fall operation with three new rigs. BGV is NCS for Saturday night section of AARS NY 80 Net. KTA is new member of AARS. JF's antenna is down for the summer, but can be heard from WAR or W3USA. LUD has been called by Navy. NAZ is looking for volunteer radio instructors for American Woman's Voluntary Services. LPJ is working in the Brooklyn Navy Yard, and would like to hear if any more of the gang work there also. BO and LBI have been recommended for AI Ops Club. MNF is now located at 156 Adams Street, N. W., Washington, D. C. AZV and DOG spent their vacations traveling through the state of Pennsylvania. LXZ sends in his highest traffic total since using low power on the d.c. mains. The hot weather has not stopped EYS from operating on 7240. HGO is busy at his summer location in Setauket. EC is busy listening and looking for violations and notifying the offenders by radio and mail. FAQ has just installed a new 1941 Meissner Signal Shifter to drive T220's. JDG and JZX have been rebuilding and have added 6AG7, 807, T200 driver for the TW150 rig. JBL is working portable on 112 Mc. BCS and MSS are experimenting on 112 Mc. LZR got a Shure crystal mike, and is building modulator for occasional 'phone qso's. NLQ is busy moving. The boys at FJV are getting ready for the fall. NDQ returned from his 33-day vacation, and made a few 112-Mc. contacts while operating portable mobile. BWC manages to be on 3545 daily at 7 p.m. MSS got Class A. MIE is operating portable in Massapequa for the summer. The Section Net will get under way this fall on 3710 kc. nightly at 8:30 p.m. It is very important that we have a large number of members, and all stations in the Section are invited to join. New York is a very vital spot in National Defense, and we must have a perfect emergency communication system.

Traffic: W2SC 1080 BO 561 LPJ 385 LZR 285 AYJ 203 KI 178 BGV 132 AZV 92 BWC 79 JZX 72 DW 65 DBQ 60 EYS 39 IXZ 36 NAZ 33 LGK 29 MZB 25 LYC 18 GF 13 BGO 12 LR-LBI 11 ADW 7 NDQ 6 FF 5 DOG 4 FAQ 3 HGO-LUD 2 EC-KTA 1. (May-June: SC 987.)

NORTHERN NEW JERSEY — SCM, Edward Gursky, Jr., W2LMN — PAM: LXI. RM's: BZJ, CGG, IYQ. Section Net: 3630 Kc., 8:30 p.m. to 9:30 p.m. DST, daily, except Sunday. NJE received his Class A. The AARS 'Phone Net gang met at EKKU's, and showed their military leanings by shooting off his collection of antique guns. MRJ bought a new mill, and is learning to use it. NCY rebuilt his rig on chassis in place of the old breadboard. JKH is

acting NCS on the NNJ AARS 'Phone Net in the absence of KXD. BPK is active on 28-Mc. 'phone. LVT has built a new all-band rig. HIE, who is in the Navy, was home recently for a short visit. The Livingston Radio Club is going in for uh emergency gear. IQG has been called by Uncle Sam. JT had an emergency operation recently, and I'm sure the gang joins me in wishing him a speedy recovery. 1KFN/2 received the call 20CC, and is on 3.9- and 112-Mc. 'phone. MRJ received an active AARS appointment. KHA is home from school for the summer, and is hiding behind the call 9SAG. JBY, IMX and ISW are at the Naval Reserve Radio School at Noroton, Conn. HHY, IDH and IMQ are at Ft. Monmouth. CEJ was released from the hospital after a three-week session from an eye injury. ITD is another of the collegians who is home for the summer vacation.

Traffic: W2MLW 947 MNT 309 (WLNW 36) CGG 207 NCY 204 JUU 83 ANW 79 MRJ 75 KSR 56 MNO 33 EKU 12 NJE 21 MIG 20 IZV 4 LMN 3 (May-June: W3JKH 5 NDL 4.)

ATLANTIC DIVISION

EASTERN PENNSYLVANIA — SCM, Jerry Mathis, W3BES — W3EJU is still plugging away at c.w. Vacation, rebuilding and experimenting keep BXE busy. EWR changed NC101X over for combined battery and a.c. operation and is working on emergency transmitter. AQN has 1.75-Mc. 'phone on 2025 kc. with 50 watts; works 500 miles. INH worked K5AY with 40 watts on 7 Mc. and got S7, has T40 on with 160 watts. AOC is back in BPL. PA-1 AARS net continues through summer with good support from members. ZF is back on 7 Mc. GKO was 3rd CA winner in ZCB contest. UQM is trustee of the NYA station, W8VYC, at Wilkes-Barre. They expect to be on 3.5-Mc. c.w. shortly. WAS is new ham in Plymouth. FXZ vacationed on Lake Champlain this summer and has emergency receiver along to copy AARS drills. BRZ bought microphone and preamplifier and received QSL from KC4USA. 8ATF and 3DXC reported via radio.

Traffic: W3GKO 724 3AOC 856 3FUJ 505 3INH 2 3BES 1 8UQM 32 3HCT 11 3DRO 12 3FMF-3AQN 40 3EWR 10 3BXC 12 3DXC 13 8ATF 8.

MARYLAND-DELAWARE-DISTRICT OF COLUMBIA — Hemann E. Hobbs, W3CIZ — CDQ has a new transceiver for AEC use. 2MIY is now located in D. C. She and 3DCQ took part in the FTS/YLRL party. GBB has relinquished his job as "sparks" on S.S. *Santa Ana* and is back on with 20-watt 1.75-Mc. 'phone and 350 watts on 7-Mc. c.w. and would like to QSO the gang. DRD started to solder a gas tank with unexpected results which put him in the hospital for several days. The tank was for use on FD at W3HC/3. He is OK now and ready for the next contest but doubt if he could be persuaded to repair another tank. FE is back on 7 Mc. for first time in seven years. JHW moved again. PV has completed his cryptography course. CXL has been changed to W3USA and is on 14,230 from 12:30 to 3 p.m. daily and on 7010 late afternoon. Western Md. ARC will soon move to new permanent club room and their club station, IWR, will be in operation.

Traffic: W3BKZ 101 BWT 995 CIZ 414 DRD 18. FE 17 FFN 3 JHW 2 AQV 3 PV 38 USA 1042 (WLM 2741) HAL 814 HWJ 2. (May-June: W3HAL 713.)

SOUTHERN NEW JERSEY — SCM, Lester H. Allen, W3CCO — Ass't SCM and AARS Liaison R.M., W3ZI — Regional Coördinator in charge of Emergency Coördination, W3BAQ — R.M.'s: 3BEI, BYR, ITU — PAM, 3EUIH — Section Net Frequencies: OPS 1980 kc. (Thurs. 8 p.m. EST), ORS 3700 kc. (Tues., Thurs., and Sat. at 8 p.m. EST). We all look forward to putting in a big fall and winter operating season. Your SCM is checking through the records for dead wood and will replace with new material. If you have been inactive get on the ball as South Jersey has a job to do and we need everyone's support. The 'Phone Net on 1980 will get under way on Sept. 4th at 8 p.m. All members are requested to be on deck for this occasion. The 3700 ORS Net will begin its winter session on Sept. 2nd and continue throughout the season as listed above. Several section activities are in the making at the present time for the coming winter season such as Field Day, QSO and ORS/OPS contests with prizes for the high scorers, and an AEC meeting is being planned. More OPS and ORS are needed, and if you are not already a member of our family, drop me a line and I shall be glad to send along application blanks. W3JKH is new AEC member. HYT applied for AEC. GZS and FAX have been recommended for OPS. HEO is on 3.9-Mc. 'phone. IFT is at Lakehurst Naval Air Station and can check anyone's frequency if they will advise him a

few days beforehand. He would like to hear from the Section members. FMR is doing a little 112-Mc. work. JOL is new call in Trenton. GRW reports from Miami that he is aboard the SS Seminole, WCXN, and usually listens for the SJ gang during his free time. OQ is quite busy with National Defense work but finds time for OBS work. JNO is new call in Trenton. HTP enlisted in the Navy. GHK in the Army. Good luck, fellows. ISY is doing a bit of operating aboard an oil tanker. ZI reports from Fort Benning; he is on maneuvers testing field equipment. HKO left our Section and is working at Fort Monmouth. HAZ received his 35 w.p.m. Code Proficiency endorsement. IOK is at the Brooklyn Navy Yard. IOW is at Fort Clayton, C. Z., and keeps up with the latest dope by reading the Section column. Tony would like to hear from a few of the boys in the Section. His QTH is Signal Co., Aircraft Warning P., Fort Clayton, C. Z. GMY is busy with traffic on 3.5 Mc. and is doing fb job on ORS Net. FXV has a variarm exciting an 807 and working FB. AVJ reports plenty of traffic for this time of year. ACC is getting the rig in shape for coming OPS schedules. JBU rebuilt to 50 watts and is now using a 3-tube converter for receiving. ASQ has been doing a little short skipping on 28 Mc. CUD, GOI and VX are experimenting on 112 Mc. during spare time. HDJ is staying on 56 Mc. these days trying to get a W7 contact so that he will have all districts. The South Jersey Radio Assn. held its 25th Anniversary Banquet in Camden with 250 persons in attendance. BAY was toastmaster. QV, Atlantic Division Directors, ASG, and your SCM were speakers. The DVRA under the direction of BAQ, participated in the Trenton Soap Box Derby by taking care of official timing via 112 Mc. EUH, CCO, ITU and ZI's son were the operators. The demonstration by DVRA was commended by Trenton city officials and leading citizens. At a recent SJRA meeting Lt. Col. Matthews outlined the plans for civil defense and explained how amateur radio will participate. Mr. Matthews also credited amateur radio as being a key factor in national defense. EWF is now at Lakehurst Naval Station. VX is installing f.m. and a.m. transmitters along Pennsylvania's new super highway. EED changed QTH. LT is now working portable in Trenton. IZT is NCS for the Mosquito Net. CFB schedules his brother, LFM, every Sunday and will move any traffic going to Western N. Y. Until next month, 73.

TRAFFIC: W8BZX 148 HAZ 145 BYR 121 OQ 100 AVJ 70 EWK 62 AQ 62 HPX 57 FMR 50 CCO 44 ITU 41 GMY 29 IMY 17 HDJ-HKY 15 CFB 14 JBU 10 ASQ 9 BEI 8 HYT 7 IZT 5 ABS 4 CWG 3 FXV 2 ACC-GHR 1 WLNF 23.

WESTERN NEW YORK — SCM, Fred Chichester, W8PLA — The bulk of activity in the section this month centers around AARS. Our State Radio Aide, FCG, resigned July 1st after a term which saw many changes in our net. Guy did a fine job of bringing the net up to where it is today and is to be congratulated. BJO was promoted to the SRA job and your SCM was appointed NCS of the 3.5-Mc. net with KYR as NC2. Clara has been assigned the call WLNU. So many new members have been added, as a result of the War Department questionnaire, that it was found impracticable to include them all in a one-night drill. Consequently, we now have a net operating on 3520 kc. nightly except Sunday, with a different group of operators each night. The following are acting as NCS for these nets: BJO, KYR, PLA, FCG, UXT, EEN. The AARS net is still functioning on 7040 kc. with RKM as NCS. New nets have been formed on 1.75- and 3.9-Mc. 'phone with RGH and NTK respectively as NCS. The following are new ORS: MC, UBU, DII and MLM. TEP is at Boy Scout Camp working fixed portable. SOT is back on again. EAP had a bolt of lightning hit his rig and will be off the air for a while. VNQ applied for ORS. PLA is working fixed portable from Conesus Lake for the summer. On July 13th, the RARA held a picnic at Brookview Park. About 125 turned out for the occasion. TEX demonstrated the alertness of the Monroe County AEC by having his emergency power handy when the PA system failed. WGG is a new call in West Bloomfield. Don has a nice signal on 1.75-Mc. 'phone. BCP, new president of RAR, has just finished a new rig. VUY is working fixed portable at Lake Ontario. RQX has just finished a receiver and transmitter for television on 56 Mc. RGA is giving 14 Mc. a go for a while. FFL has just finished an fb 1.75-Mc. portable and is using it on emergency net schedules. MNW, FUG and FEN are keeping army traffic flowing smoothly through Rochester. UPH kept schedule with Denver on 7 Mc. one night and handled

traffic for three hours. DFN and FNT both have new 813's. TUQ won the prize at the RARA picnic, a portable transmitter kit. CSE and family visited 4FCU while vacationing in the South. DSS expects to join the radio section of the New York Guard. RMR, RTX and CG are new AARS. BCL signed up with AEC. AUY is crystal controlled on all bands but 56 Mc. on down. QGN, PSQ, ROU and FAL were home from camp over the Fourth. SVZ is rebuilding and expects to be on the air soon with a hundred watts.

TRAFFIC: W8MC 32 RKM 93 VFG 33 FUG 11 BJO 200 CSE 52 FCG 50 VNQ 6 AIE 83 AOR 20 DSS 46 KYR-EUY 21 MNW 9 BLO 4 PLA 252 AQE 47 UXT 150 JTW 99.

WESTERN PENNSYLVANIA — SCM, E. A. Krall, W8CKO/WLQL — Ass't SCM in charge of ORS Activities, W8KWA, Ass't SCM in charge of EC, W8AVY. RM's: NCJ, TOJ, KUN. PAM's: BHN, RBI, GJM. We regret the resignation of JSU as ORS. He has accepted a position in Newark, N. J., and would like to hear from his friends. Even though KWA is as busy as the proverbial paperhanger, he manages to handle a goodly proportion of traffic. RM TOJ took part in July RM net. NCJ announces a new silent mill at his QTH, says the XYL has been copying press with it. He says the W. Pa., ORS net meets nightly except Sat. and Sun. at 6:30 p.m. DST with TOJ as NCS and NCJ as alternate. Although net session is usually over at 7 p.m. one of the NCS watches the net frequency until 8 p.m. to clear newcomers or latecomers. MJK will be on for the rest of the summer. PER reports quite frequently on the net. TWI is home from college. OKK has plans for rebuilding rig. UUZ is a new contact at Uniontown and promises to do good work. RAT would like to hear from the boys interested in f.m. experiments. TTD reports activity in AEC work. PX manages to keep traffic moving on 'phone. BWP reports WDK and WCV are ex-W9's. Glad to hear from RBI. How about some traffic OM? RIS reports 28 Mc. is starting to pick up. TOJ sends the following net report: Net session, 23. Number of stations reporting, 118. Average number stations per session, 5.1. Traffic handled on net, 166. Average number of messages per session, 7.21. OK, fellows. Let's get our shoulders to the wheel and establish some sort of record for the coming month. We can do it if we try hard enough.

Traffic: W8KWA 210 NCJ 185 MJK 139 PER 63 CKO 60 TWI 55 JSU 47 OKK 26 UUZ 19 RAT 12 TTD 11 IOH 9 PX 8 BWP 5 KUN 2 HUZ 2.

NEW ENGLAND DIVISION

CONNECTICUT — SCM, Frederick Ellis, Jr., W1CTI — WIAW has a nice total for hot weather. Hal and Geo. sure keep mighty busy. MGC is working 10 hours a day, earning money for college. MBW is on 7106 kc. after a tull of 3 months, during which time he put up a new shack. EAO and ON are working on a net for Sunday mornings on 3950 kc. NKC reports for INF and says they have been working "DX" on 56 Mc. HYF visited MWN, NLX, JEC and BCG. GB remote controlled five transmitters, 500 feet from the receivers in the June Field Day. Excellent results were obtained. Full details of this unique setup are to be found in the July issue of *Haywire*. The New Haven Amateur Radio Ass'n bulletin. Fresh paint is being spread at CBA. Some of the boys can swing a brush better than a bug! CBA is again publishing *Hamonics*. BCG is acting editor and printer. MWN is the new editor of the *Barograph*, published by the Bridgeport Amateur Radio Ass'n. The July issue came out with a brand new cover in colors. All those interested in 1.75-Mc. cw work please drop the SCM a line at once.

Traffic: W1AW 453 MGC 173 TD 128 NCV 14 EAO-DGG 3 INF-GC 2. (April-May: W1UE 188; May-June: W1UE 41.)

MAINE — SCM, Ames R. Millett, W1BAV — New EC for Bar Harbor is AUC. EZR has old appointment back as ORS. LOZ/4 is on at Camp Blanding, Fla., QH is on active duty in the Navy and about ready to shove off from Boston. NR is one of the ons at Fort Williams. KYT is on duty with the Navy. COV, HYH, GLZ and KCL will operate on 112 Mc. with the Norway Home Guard on summer maneuvers. IIA and xyl, JEB, have moved to Auburn. EZR joined AEC and is active on 3.5, 7 and 112 Mc. IFF is working in Bath. GKJ is right in the thick of things with all the summer visitors at Old Orchard Beach. Some of the gang that have dropped in on him are: 2HRN, 2AGM, 2KTR, 2NJO, 8TWT and 1HWY. TO is plenty busy but finds time to get in with AARS regularly. The Knox County gang deserve a swell hand for the ham picnic. It was a great success and

(Continued on page 98)

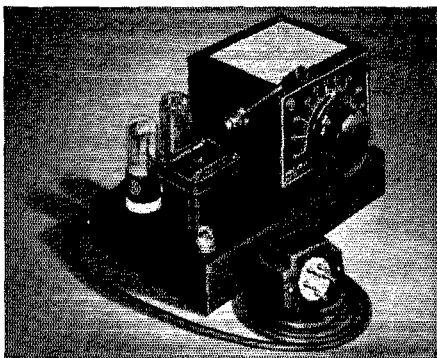

THE RICE-VARIARM

was described in detail in a comprehensive article by Henry E. Rice, Jr., in the January issue of QST. The Millen commercial models are:

No. 90700 has fundamental oscillator frequency range of from 3500 to 3650 Kc. "Convenient-to-change" taps on amplifier and link coils provide for output on 80 or 40.

No. 90701 is the same as No. 90700 except fundamental oscillator frequency range of from 1750 to 2000 Kc., providing for output on 160 or 80.

JAMES MILLEN
150 EXCHANGE ST.



MFG. CO. INC.
MALDEN, MASS.

In QST 25 Years Ago

(Continued from page 53)

marked 'G.' Thereafter, the inspiring young Edison will transmit enthusiastically to himself, while you will be left to gleefully watch your filament flicker as Pekin roars into the phones."

The San Francisco Radio Club was unable to march in the Preparedness Day Parade when the latter was disrupted by a bomb explosion on Market Street, killing six persons. A new world's record for airplane communication was established July 27th when Captain (now Colonel, retired) C. C. Culver worked 114 miles from a plane to the station of Dr. R. O. Shelton in San Diego. Alvin Spencer, of Magnolia, Ill., contributes a list of calls heard up to 700 miles, thereby giving birth to the famous institution of "Calls Heard," which the editor hails as a fine idea.

The Seefred brothers, 6EA, provide QST's first description of a 'phone transmitter. It is a 60-cycle spark rig running on a lampbank with a carbon microphone in the ground lead and with the gap replaced by an arc made of two dry-cell carbons. "The arc must be of a purple-blue color to get the best results. If the arc turns to a white glare, it shows the carbons are burning." Nothing is said about the 60-cycle gargle.

New Transmitting Tubes

HYTRONIC LABORATORIES announce two new transmitting beam tetrodes. The HY65 is similar to the 6L6G except that it is well-shielded for r.f. applications and has an instant-heating filament, rather than the indirectly-heated cathode. The HY67 is a larger tube with carbon plate designed to operate at higher plate voltages.

Typical Operating Conditions — Class-C Telegraphy

HY65	
Filament voltage	5.7 to 6.6
Filament current (amps.)	0.8 at 6 volts
Amplification factor	100
Mutual conductance (micromhos)	2300
Input capacitance (μfd.)	9.5
Grid-plate capacitance (μfd.)	0.12
Plate dissipation (watts)	10
Plate voltage	450
Screen voltage	200
Grid bias (volts)	-45
Plate current (ma.)	63
Grid current (ma.)	3
Driving power (watts)	0.5
Power output (watts)	19

HY67	
Filament voltage	5.7 to 6.6 or 11.4 to 13.2
Plate dissipation (watts)	65
Plate voltage	1250
Screen voltage	300
Grid bias (volts)	-300
Plate current (ma.)	175
Grid current (ma.)	10
Driving power (watts)	1.5
Power output (watts)	152

UNCLE SAM NEEDS YOU!

* LEARN CODE NOW! *

FUTURE DRAFTEES ATTENTION! A rapid rise in rank along with a corresponding increase in pay is guaranteed you *when* you can qualify as a trained code operator in Uncle Sam's Communications divisions. BE ON YOUR TOES — get ahead of the other fellow — start learning code now by the easy, practical CANDLER way *right in your own home!*

DON'T DELAY—CLIP AND MAIL THIS COUPON NOW!

CANDLER SYSTEM COMPANY

Dept. Q-9, DENVER, COLORADO

I am interested in preparing myself for the Army, Navy, or Commercial Communications field. Please rush me my FREE copy of the 52-page BOOK OF FACTS.

NAME _____

ST. and NO. _____

CITY _____ STATE _____

★ ★ ★ ★ ★ ★ ★



POWER WIRE WOUND RESISTORS



BUILT TO OUTLAST A LOT OF RIGS

IRC Cement Coated Power Wire Wound Resistors are built to do a job. They're built to do it better and longer than any other resistor type you've ever used before. They stand the overloads. Heat — even much more than 250° C. — does not cause them to deteriorate. Actual tests show their amazing superiority under moist or salt air conditions. Years of field service in the nation's most exacting jobs prove their durability beyond any question of doubt. *They will not let you down!*

*All Fixed and Adjustable Sizes and Ranges—
10 to 200 Watts*

POSITIVE PRESSURE CONTACT ELIMINATES ADJUSTABLE RESISTOR TROUBLES

The recently developed Type X band now supplied at no extra cost on all IRC adjustable resistors of 25 watts and up assures smooth, fool-proof adjustment. No oxida-

tion or corrosion at point of contact — no wire damage or breakage. Don't fail to ask your jobber to show you this important and exclusive IRC feature!

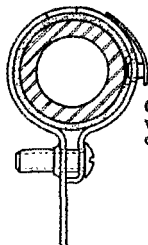

Cross section view of band on resistor.

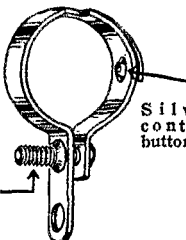

Threaded band — no loose nut.

Silver contact button.

Extra heavy steel band with flexible section for easy installation on resistor.

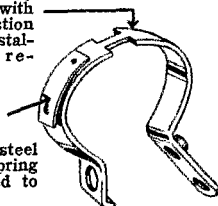

Stainless steel contact spring spot welded to band.

INTERNATIONAL RESISTANCE CO., 401 North Broad St., Philadelphia, Pa.

MAKERS OF RESISTANCE UNITS OF MORE TYPES, IN MORE SHAPES, FOR MORE APPLICATIONS THAN ANY OTHER MANUFACTURER IN THE WORLD

(Continued from page 89)

hats off to RU and the boys. Everybody is hollerin' for another. LML still bats 'em out for the AARS. MFK is operating from summer camp at Raymond on 3.9 Mc. MYM/LJW worked fixed portable from camp Androscoggin. BAD is on 3.5-Mc. c.w. and still going strong. NGV is on 7-Mc. c.w. and 1.75-Mc. 'phone during the summer, and has completed compact vibrapack job for QRR work. Let's all get into this thing, gang, and see if we can't get every last ham in the State to at least sign up with ARRL. With conditions the way they are, we certainly need the unity of League membership. We need more nets like the Sea Gull and PTN. FBJ, the PAM responsible for the Sea Gull, and GOJ, the organizer of PTN, are sterling examples of PAM and RM. We have got the right gang in this State if we can just get the thing started. What say, fellers, let's have more of this swell organizing. GVS, KOU and GE are a team you ought to listen to some time. Those boys don't waste any words unless it is GVS when he tries to cut down some of my lengthy 'phone contacts. I wonder who has the dope on the new handle "Pappy," for KKZ besides CMO. It comes to my attention that a good many of the gang in inquiring about AARS do not know just whom to contact. It will expedite any inquiries if you address them WICFO, 107 Mabel St., Portland, Me. The gang at the Rockland hamfest had a swell opportunity to see some fine 112-Mc. portable mobile operation between JCT from Malden, Mass., and LBH from Methuen, Mass. FQ and his xyl were also at the picnic. Although BDI was vacationing, he was good enough to drop in on the gang and everyone had the opportunity to meet our fb Communications Mgr. Last minute reports are that the new Northern Maine Emergency Net has just started and is going strong on 1.75-Mc. 'phone at 7 p.m. They certainly deserve a great big hand and we will be only too glad to issue net certificates to the boys. AFAL is operating portable one from Seal Harbor this summer on 1.75 Mc. LZI has his class A. FB, George.

Traffic: W1MYM/LJW 12 FBJ 14 LNI 20 CMO 2 AI 3 MFK 9 GMD 18 LKP 15 LML 68 TO 28 EZR 1 BAV 22 KKZ 6. AARS: W1FAP 28 FJP 27 GE 32 GHT 38 GVS 119 IJF 54 IST 40 KOU 103 LML 45.

EASTERN MASSACHUSETTS — SCM, Frank L. Baker, Jr., W1ALP — The AEC still is the high point of interest. Remember, EC's, if you can, sign anyone up in the Corps, whether he is in your town or not, get him to join, as this helps the cause and some other EC. Add these new EC's to your list and note changes: MMM, New Bedford; KYX, Somerville; LZW, Quincy; MAL, Wayland; LSD, Waltham; JIS, Rockland; PZ, Lynnfield; ZK, Brockton; MQO, Middlesex County. This makes over 80 EC's now. Keep them coming. We still need more for some cities and towns. Who will help us out? New ORS: MJK, KKO, MDV (our first y!) and MZE. New OPS: MPP (another y!) and DJ. MCR applied for ORS and LYH for OPS. Brockton Radio Club held its 6th Annual Outing at Robbins Pond. LUG got married and moved to Readville. Luck to you and xyl. HNV is forming an Emergency Fire Alarm net to work with the Boston Fire Dept. If you are willing to help out, write him or KTE, the Boston EC. What say you hams in Boston? How about joining the AEC? The largest city in the State has a very small number of members. HX moved to Melrose. LO is moving to Stoneham. MTV is in Maine at boys' camp for the summer. JMS is now K4GXV and is on about 7145 kc. Luck to you, OM. DJ is NCS of N.E. 56 Mc. net on Thurs. at 8 p.m. MDN is quite active on 56 Mc. MGQ has new vertical. IVX has schedule with W8SMS on 14-Mc. 'phone. BSA has new 112-Mc. rig. MQX is on 28 Mc. with HT-9. ZZZ is building new 3-element beam. MKN is in Norway, Me. MMM is building new rig for 'phone and hopes to have 400 watts on all bands. Eastern Mass. and South Shore Clubs are working on New England Division Convention and Boston Hamfest, scheduled for October, probably about the 18th. Watch QST for further dope. HUV is still doing some observing work on the bands. AQR, MCK and LQQ are now back in Boston. KGW is now K5AV and also a married man. Luck to you and xyl. BXC keeps schedule with K5AH. AAR has 130 watts on 112 Mc. NAV worked KF6JEG/KG6. MJK is going to visit hams in Detroit and Miami in Aug. and Sept. AGX will be on 112 Mc. MDV worked 7 Mc. in FTS and YLRL contest. MCR keeps schedule one night a week with W4GBV. NKW has worked 23 States with 20 watts; wants Vermont. EHT is busy as our REC. LBH has pair of HK 54's. HIL received card from K6OFW. His 'phone on 14 Mc. is working fb. KH gets home once in a while from Wash., D. C. HSB, IDV, ITG and RP joined the CAR at Norwood Airport. IXI has 2-element

beam for 14-Mc. 'phone. NFQ has TZ40's on 28-Mc. 'phone. AGR is on 1.75-Mc. 'phone. Norfolk County Club bought a portable 112-Mc. transceiver. BNJ joined the Mass. State Guard Signal Co. KON took the ARP course. MJE is active on 28-Mc. 'phone and 3.5-Mc. c.w. MMU and xyl visited MJE. MQE is active on 28-Mc. 'phone. KMQ, now in Brockton, is on 3.5-Mc. c.w. CCZ is back on 56 Mc. on Cape Cod. EHT worked two W5's in Texas on 56 Mc. SI worked W6OVK on 56 Mc.

Traffic: W1BDU 216 BXC 185 AKS 169 (WLGO 36) JCK 130 (WLGV 20) LWH 92 (WLGf 163) AAR 83 EMG 81 (WLGf 18) KCT 68 HWE 43 MJK 32 AGX 31 BMO 28 KXU 25 MDV 20 MDU 15 MCR 9 IVX-KTE 6 KKO 4 NKW 3 EHT 2 ALP-BAP 1 EPE 73 MPT 3. (May-June: W1JLK 5 LBH 2.) 2½ AARS Net: W1BHL 30 EYR 59 LWI 70 MBS 9 MMY 20 MON 145 MQH 69 QD 14 MIG 26. North Shore 10 fone AARS Net: W1AGX 31 HWE 43 JFS 35 LVZ 86 MQE 16 KMQ 44. Other AARS Nets: W1HIL 4.

Traffic: 80.CW AARS NET: W1EPE 263 FGT 17 FRO 21 MAN 9 TY 84. 160 Phone AARS NET: W1LGH 21 MOJ 36 KYN 40 MNW 29 HA 9 BWJ 5 NFZ 12 MJO 8 CCL 30 AHP 29 EXU 22 LSA 91 KRR 5 MNW 37 KYN 15 BWJ 26 MOJ 28 LGH 15 AAL 22 MLZ-AHP 8 IYU 19 LSA 65 KRR 6.

WESTERN MASSACHUSETTS — SCM, William J. Barrett, W1JAH — Pres leads the parade again with good summer score. BIV is making a habit of being high man. MIM has nice total as result of representing CMS in the CA net. Nice going, Lee. AZW keeps busy with AARS work. BNL has 112-Mc. setup for use in car or as packet, and is now working on 56-Mc. f.m. job. MND sends in first report as ORS. NKN applies for ORS. KZU reports NNY, ex-2NGN, now active on 28 Mc. in Springfield. AJ had nice visit from Sam Moody of NY 1 AA with whom he maintained schedules for years. He also had calls from IOR and MGE. Ralph switched to a 47 osc. after cracking his WMS crystal. DUZ says he will be active this summer for first time in years. John visited NNL at Hudson, N. Y., where latter is spending summer. KJK has everything set to go except skywire. J1T is doing swell job in getting emergency program underway in Pittsfield. LUA visited JAH. 73.

Traffic: W1BIV 161 (WLGN 48) MIM 109 AZW 99 (WLGd 26) LUA 68 HNE 60 KZS 56 JAH 35 (WLGH 19) MND 26 BVR 25 (WLGA 65) FOI 24 MKR-MBT 20 MYZ 18 FNY 15 ICW-LHW 14 ADF-JWV 11 MJP 10 BWY 5.

NEW HAMPSHIRE — SCM, Mrs. Dorothy W. Evans, W1FTJ — MUW visited ENU recently and ran into a regular hamfest while there. NMB is new ham in Nashua. MMG is building an e.o.o. Guess he intends to give us some competition in coming contests. Hi. NEC has a new YL harmonic at his house. Congratulations! LSN is still active on 56 Mc. and reports 13 states and 80 different stations contacted on that band so far this year, some of them having been worked mobile. JCA heard from JBA and MZV and says that the boys are traveling around with the Navy. Your SCM would like to hear from you fellows with Uncle Sam. Please drop a line regarding your doings, where you are, etc. 8UUW/1 is operating at Camp Hackmatack this summer and expects to be there until the end of August. Thanks for sending in the report, Bill. We like to hear from visiting hams here as well as those from our own State. AVJ has moved his family to Silver Lake at Tilton for the remainder of the summer. APK has been making f.m. tests from Cannon Mountain for the State Police.

Traffic: W1JKH 40 MMG 30 8UUW/1 10 ICEA 7 HFO 6.

RHODE ISLAND — SCM, Clayton C. Gordon, W1HRC — CPV reports formation of a Radio Club at the State Armory in Pawtucket. It's named the "Rhode Island State Guard Amateur Radio Society." Bill Donnelly, Secretary of W1AQ, now holds the call W1NMY and is on 3.5-Mc. c.w. with e.o.o. The PRA gang are going in strong for 112 Mc. portable-emergency work. JEZ is encouraging the boys to build the equipment since it has been brought to his attention that the Providence Fire Department wants available one set for each of their 39 Fire Stations "in case." JP, DDD, LYE and ETD are in the Radio Div. of the "CAR." This unit hopes to replace the Air Arm of the National Guard. From HEN and MTA at Fort Adams comes the following: "Thought you might like to know that we are now running the Army Radio Station here at the Fort. We also have a rig running on 3637 and 7161 kc. and can be found on any hour of the morning before 12, and any night after 6, on one or the other of those frequencies. We'll be very

glad to work any of the gang with the idea of getting off some traffic for the boys here at the Fort." Westerly hams are showing considerable interest in 112 Mc. INN and NJZ have Abbot DK-3's. BDS has a home built transceiver in his car, and MOK is using separate transmitter and receiver with HY 615's. AGJ is collecting parts for a transceiver. KCG bought a transceiver from 2NRL, but traded it off to BOS for low frequency receiver. W2NRL of Freeport, L.I., N. Y., has been made an honorary member of the Westerly Radio Club. KRQ recently visited the Westerly Radio Club. Bill has a rig on the air in Glens Falls now and schedules the home town boys.

Traffic: W1CPV 85.

VERMONT — SCM, Clifton G. Parker, W1KJG — NDB has moved to new quarters at 1 Bank St., Barre, and is covering traffic on 3.5 and 7 Mc. Burlington Amateur Radio Club is very active and at present busy with plans for State Convention to be held at Burlington on October 4th. The boys have a fine program shaping up and are looking forward to a good turn-out from the Vermont gang. Be sure to reserve the date! MZO is new amateur in Brattleboro and has registered in AEC. ADB, GNF, HRC and KVV visited at FSV. KVV is now a Sgt. at Camp Blanding and was recently married. Congratulations, OMIMMU secured Class A. EKU, NDL, CGV, MMV and MJU in the Barre area are still working hard to contact more fellows on 112 Mc. KUY, MJU, MMV and MLJ recently made a trip to the summit of Mount Washington for 112-Mc. try-out. NDB is busy remodeling his exciter unit and has new full-wave 3.5-Mc. Zepp on 50-ft. sticks. He also found time to get his CP certificate. AVP suffered an accident resulting in a broken rib and has been on the shelf temporarily. He reports AVP, GQJ, ITJ, AZV and AD as on 3.9-Mc. 'phone net Sunday mornings regularly. AD reports FD work-out with emergency transmitter and has a converter permanently attached to his car radio with plug-in coils for various bands. GAE has resigned position at WCAX and will leave for position with U.S. Airways Comm. at Dillon, Montana. Sorry to have you leave us, Jim, and best wishes of the gang in your new work. Burlington Amateur Radio Club is busy with plans for a complete emergency station at club shack and for portable power unit mounted on trailer. Vermont traffic net on 3860 kc. will be reinstated on daily schedule at 8 p.m. September 8th. It is time now to be thinking about the newcomers and new ORS to fill in the gaps caused by the various boys leaving for the Army, Navy, etc. Your SCM has plenty of blanks and will be pleased to use them promptly.

Traffic: W1AD 20 NDB 19 MLJ 4.

DELTA DIVISION

ARKANSAS — SCM, John R. Sanders, W5GNV — Ass't SCM, Ed. Beck, W5GED. With the national situation becoming increasingly urgent and the Services crying for operators, this fall should see more active amateurs than ever, most of them on the air with the idea of advancing operating technique. The League urges participation in any type of activity contributing toward improvement in operating ability. The formation of traffic nets, both 'phone and c.w., on all usable bands, is being carried through as rapidly as possible. In keeping with this program, may I urge all amateurs in this Section who are considering consistent operation this winter to drop me a card stating most used band, general operating time, power, and amount of co-operation that may be expected of you as a net member. Even if your amateur activity hasn't included much traffic work previously, try and figure in a sizeable amount of it this season. Plans for section nets on as many bands as possible are now under way. If you can participate in even a limited way, please let the SCM hear from you. JIC is doing a fine job rounding up AEC members in the Ft. Smith area. HLW is experimenting on 112 Mc. FWD got NC 200, and has a beam on 14 Mc. now. GWT has new final on 28 Mc. JDJ is about to enter with a kw. JYU and KDL are new calls at Ft. Smith. HYS is looking for chokes for his 811 modulator power supply. IYW and several others at Ft. Smith are working 112 Mc. GUA is a new papa, a fine boy we hear. PX is active on 14 Mc. KBK is among the latest arrivals at Camp Robinson. HAI is again voicing himself on 1.75 Mc., and is all set for fall. IGM has our sympathy in the recent loss of his father and grandfather. HDR is located at Scott Field in the Radio School. FDW is all set to go on c.w. Look around 7200 and QSO the L.R. Club. FXO

is back in Little Rock, and will be on soon. KAN is a new call on the air. The op is an old ham dating to spark days. FRV is back on 1.75-Mc. 'phone during school vacation. JJA visited GED while in L.R. FZH is occasionally heard on 1.75 Mc. INO is revamping his 7-Mc. rig, and will double power. EKD is rebuilding into rack and panel job. IRY is getting gratifying results from his receiver since he overhauled it, and has decided to do the same to his rig. HOT left the Section and has settled in Houston, Tex. IZK and CFQ have done the same, their new home being Dallas. GED is considering a concrete floor for his shack since ordering 200-odd pounds of power transformers. ENH is working on the L.R. Club rig, and received a visit from DZE, now of Okla. City. GNV is in a new home, is building new rig. IHC, our EC for the North, is still at camp in Rolla, Mo. EA still finds time to schedule the AARS. JWJ is on 7 Mc. at Camden and has joined AEC. JKT, EHG and IWL, all of Ft. Smith, have joined the AEC. BMI returned from his vacation, on which he visited League Hq. and W1AW.

Traffic: W5FWD 18 EA 8 JIC 5 GED 3.

LOUISIANA — SCM, W. J. Wilkinson, Jr., W5DWW — W5HHV is working on emergency net organization. ABK, IHB, BSR, DEL, IYG, ESG, EGG and JFR are all active. DMR also reported activity. ERV was visited by K6QOM. HHI received Class A. IYL will increase traffic. HUY reports for Winnsboro. JEY and JMK assisted in FD work. HEJ keeps traffic on move. HEK also handles traffic. HQY is active in AARS. BN entered hospital for operation. A speedy recovery. OM. FHH has new rig. GKJ is taking aircraft service course in Miami, Fla. IGQ has new zepp. HBY will soon be OPS. IWY is trying schedule with DAQ.

Traffic: W5HHV 3 IYL 7 HEJ 84 HEK 11 IWY 5 DWW 177.

MISSISSIPPI — SCM, S. Benton Cain, W5EGE — HZP is having transformer trouble. JZS and JWF are new at Holly Springs. DFK insists on trying to build bug. EGE spent three weeks in North Carolina visiting hams and vacation spots. EKV handled the SCM job until his return. EGE, DEJ/WLRV, HTL and JKR are keeping up AARS 3.5/7-Mc. C.W. Net during the summer. HQC took trip far north as Kansas. CQJ unbends once in a while and wows the 1.75-Mc. boys with an FB sig. Gulf Coast Storm Net is still active Sunday, 7:30 a.m., and Wednesday, 6:30 a.m. HRX, as alt. NCS, has been running the works lately. The 1.75-Mc. AARS 'Phone Net is meeting all summer. GPR is still handling the reins. FSX and JWI dropped in from La. and visited the boys along the Gulf Coast recently. AFV moved to Pascagoula. DLA is NCS of Gulf Coast Shrimp Net. HRX has Class A. Congrats, Red. ANP works 1.75- and 3.9-Mc. 'phone. HAD visited California and some 28-Mc. folks out that way. JHS is activities mgr. of Gulf Coast Amateur Radio Ass'n. JSH is completing new 1.75-Mc. rig with 30 watts input. HRW is rebuilding. ESE finally worked a few microbes out of his 1.75-Mc. 'phone, and now sounds like he should. DFK works 'em early in the morning. VJ is still active after these many years on 3.9-Mc. 'phone. JTL has nice sig. on 1.75-Mc. 'phone from Vicksburg. — Dick, W5EKV.

Traffic: W5EGE 55 DEJ 28 HTL 31 JKR 5 HRX 4 EKV 22.

TENNESSEE — SCM, M. G. Hooper, W4DDJ — W4BDB sent in ORS for endorsement. AEE made a couple of recommendations for appointment with his report. FB, Harry. Yours truly visited EAL. Nice lay-out Dick has there. GLL comes through with the following: "GRR is active on 28-Mc. 'phone. HSU is new ham in Memphis. VT now operates 14-Mc. 'phone. FCF and HJJ came back from New Orleans with commercial 2nd telegraph tickets. FXE not only modulates 1.75-Mc. 'phone but is featured star on local B.C. Memphis has at least one real ham: GPV, whose handle is B. T. Ham. Hi! SW is in charge of NYA National Defense Radio School, and has secured a number of his graduates jobs." DWB promises to dig up something in Knoxville by next issue. EUT at Pickwick Dam was formerly 2EBZ of Brooklyn, N. Y. He has with him 2LXL and ex-4DTL. He says that the Pickwick Dam Radio Club has been formed and has eight members. FB, Ed. DWB has several schedules daily and a nice traffic report for a newly appointed ORS. HKQ of Springfield is EC for that vicinity and wide awake. CBA is alternate NCS for Tenn. AARS Net for summer and has been assigned call WLRX. PL filed a short report and went to Hot Springs, Ark., to shed a case of rheumatism. We wish you all luck, Benton.

Traffic: W4PL 607 DWB 354 AEE 25 CBA 24.

This "PRECISION" Instrument is built to withstand abuse and rough handling in services to which compact instruments are routinely applied, as in radio service, amateur radio, trouble shooting, etc. . . .

NEW "PRECISION" SERIES 834

31 Range AC-DC compact circuit tester

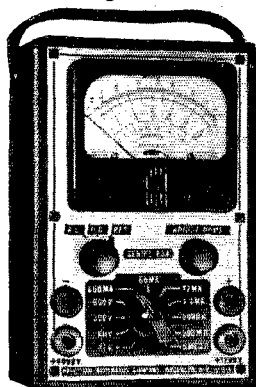

- 6000 Volts ● 600 MA
- 5 Megohms ● 70 DB

★ All ranges self-contained — NO EXTERNAL multipliers or batteries ● 6 AC — 6 DC — 6 output voltage ranges — 12/60/300/600/1200/6000 V. ● 1000 ohms per volt ● 4 current ranges — 1.2/12/60/600 mills ● 3 resistance ranges — 0-5000/500 M/5 Megs ● 6 DB ranges from -10 to +70 DB ★ All measurements from ONLY TWO pin jacks except 1200 and 6000 volts ★ New type, extra large, easy reading 400 microampere rectangular meter ★ 1% multipliers and wire wound bobbins ★ Overall size only 7" x 4½" x 3".

An INCOMPARABLE "PRECISION" value at only \$19.95 net. WRITE FOR "PRECISION" CATALOG 42-Q describing more than 40 radio and electrical test equipment models . . . Tube Testers, Combination Tube and Set Testers, AC-DC Multi-range Testers, Vacuum Tube Multi-range Testers, Signal Generators, Industrial Circuit Testers, etc.

PRECISION TEST EQUIPMENT
Standard of Accuracy SEE THEM AT YOUR JOBBER
PRECISION APPARATUS COMPANY
 647 Kent Avenue Brooklyn, New York
 Export Div.: 458 Broadway, New York, U. S. A.—Cable: Morhanex

RADIO TECHNOLOGY



RCA Institutes offer an intensive course of high standard embracing all phases of Radio and Television. Practical training with modern equipment at New York and Chicago Schools. Also specialized courses in Aviation Communications, Radio Servicing and Commercial Operating.

Illustrated Catalog on request.

RCA INSTITUTES, INC. Dept. ST-41

A Radio Corporation of America Service

75 Varick St., New York 1154 Merchandise Mart, Chicago

RADIO

ENGINEERING, broadcasting, aviation and police radio, servicing, marine radio telegraphy and telephony, Morse telegraphy and railway accounting taught thoroughly. 48 weeks' engineering course, equivalent to three years of college radio work. School established 1874. All expenses low. Catalog free.

DODGE'S INSTITUTE, Day Street, Valparaiso, Indiana

Be a MASTER Radioman

Get your training at home under personal supervision of A. R.



Nilson, noted technical radio author. Low-cost home-study radio communication courses can fit you for job, advancement, or license examinations. Send for Free booklet, "What The Modern Radioman Must Know."

NILSON RADIO SCHOOL, 51 East 42nd St., New York

SICKLES COILS

ALL TYPES OF RF AND IF WINDINGS

Manufactured by

F. W. SICKLES COMPANY

P. O. Box 920

Springfield, Mass.

Antennas for Domestic Work

(Continued from page 48)

out very satisfactorily and which is not critical involves the use of a wire a half-wavelength long bent into a shape which will bring the center with its current loop at the point where it will do the most good. Starting at the far end of the wire, a quarter wavelength, or half of its total length, should be measured off. This is the point which should come at the top of the vertical section. The measured-off section simply forms the loading required to place the current loop where we want it. Since it does not form an essential part of the radiating system, it may be stretched out horizontally from the top of the support for the vertical section or, better yet, folded back and forth upon itself three or four times. This provides some measure of cancellation in the horizontal section with consequent increase of current in the vertical portion. With the center of the wire at the top of the vertical section, which should be as high as possible, the wire drops vertically to a point five or six feet off the ground where it is fastened to an insulating anchor. The remainder of the wire is used as the lead to the transmitter where it may be voltage fed. The arrangement is shown in Fig. 9. If the transmitter is close to the bottom end of the vertical section, the remainder of the wire may be folded to take up the length.

A vertical antenna is sometimes frowned upon because it has been accused of creating more b.c.i. than the horizontal type. This can probably be explained by the fact that radiated power at the useful lower angles is almost entirely absent in the case of the horizontal antenna. In other words, it seems probable that a vertical antenna with much less power would do as good a job or better than the horizontal and cause no more interference.

While much of the foregoing may sound rather complicated, it really isn't so tough and familiarity with the various factors involved will often help in putting your signal where you want it instead of spewing it all over vast vacant areas where there are no receivers to pick it up.

In the Services

(Continued from page 45)

at NPG in San Francisco. Ensign Savage, 4GRB, is watch officer at NAR, Key West, Fla. Lt. Wahl, 9HED, is communications officer of the McCawley.

No, we're not being partial to the Navy. Capt. Mathewson, 3FJ, commands the 176th Infantry, Ft. Meade, Md. Lt. Burghardt, 9BJV, has communications work with the 34th Sig. Co., Camp Claiborne, La. Major Rawlinson, 4FYB, is Asst. Adjutant of the 31st Division, Camp Blanding, Fla., and Lt. Nash, 4CQY, is attached to the 117th F. A. there. Capt. Snyder, 2DVC, commands the Hq. Co., 518th M. P., Bn. Ft. Jay, N. Y. In charge of a specialist battery training radiomen at Ft. Bragg, N. C., we find Capt. Austin, 4GXM. Lt. Daly, 9ZRA, has

FOR AMATEUR REBUILDING PROGRAMS

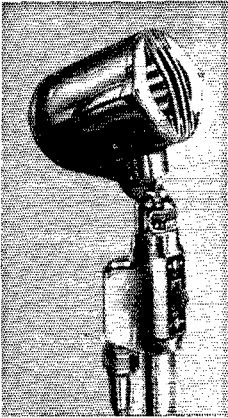

When so ordered N-80 Microphone may be had with On-Off Switch, as illustrated. This is known as Model N-80S. List Price \$20.00.

N-SERIES MIKES FOR VOICE RANGE FREQUENCIES

● Under the New Emergency Regulations, thousands of Hams will take advantage of new privileges and move to new frequencies. Astatic Model N-80 Voice Range Crystal Microphone is ideally suited to such usage, with an output level -49 db below one volt per bar and rising response to 3,500 cycles.

Complete with concentric cable connector and 25-ft. low capacity cable. All chrome finish.

List price \$17.50

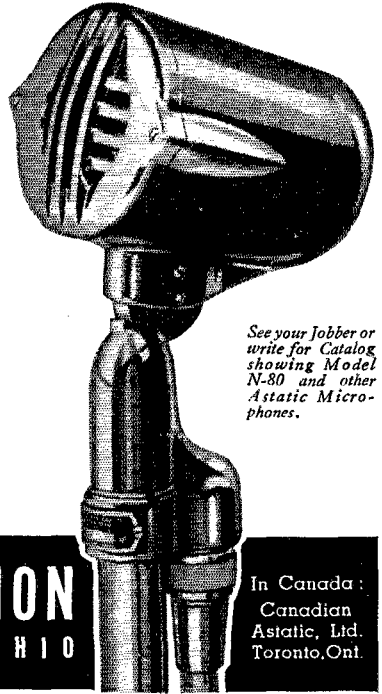

See your Jobber or write for Catalog showing Model N-80 and other Astatic Microphones.

ASTATIC

THE ASTATIC CORPORATION

Licensed Under Brush Development Co. Patents

YOUNGSTOWN • OHIO

In Canada:
Canadian Astatic, Ltd.
Toronto, Ont.

LEARN RADIO • TELEVISION

60-page catalog on request. Oldest, largest and best equipped in New England. New classes now forming. Write for new catalog.

MASS. RADIO SCHOOL

18 Boylston Street Boston, Massachusetts

RADIO COURSES

Start September

RADIO OPERATING ● BROADCASTING ● CODE
RADIO SERVICING ● TELEVISION
● ELECTRONICS — 1 year day course; 2 years eve.
Day and Evening Classes — Booklet upon request

NEW YORK YMCA SCHOOLS

4 West 63rd Street, New York City

AMATEUR RADIO LICENSES

Day and Evening Classes in Code and Theory
HOME STUDY COURSES

Reasonable, Efficient and Thorough, Hundreds of Licensed Students Now on the Air

American Radio Institute, 1123 Broadway, New York, N. Y.

COMMERCIAL RADIO INSTITUTE

A radio training center for over twenty years. Well equipped. Excellent faculty. Practical resident courses in Radiotelegraphy, Broadcast, Servicing, Television, Aeronautical, Drafting, Mathematics, Industrial and Studio Technique. Placement bureau. Fall term Oct. 6. Send for catalog, Dept. B.

38 WEST BIDDLE STREET, BALTIMORE, MARYLAND

VERSATILE!
DOUBLE INPUT
DOUBLE OUTPUT
PINCOR
DYNAMOTORS

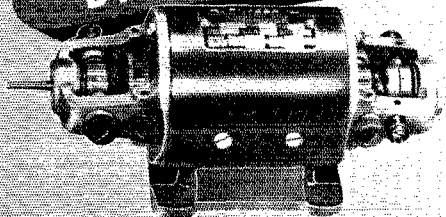

Pincor double input and double output Dynamotors prove Pioneer's leadership in today's fast-moving developments in aircraft and other vital radio equipment. One unit for both receiving and transmitting. Saves cost, space and weight. Available in numerous voltage combinations and ratings. Consult our engineers. Send for NEW Pincor Dynamotor Catalog.

PIONEER GEN-E-MOTOR
CHICAGO, ILLINOIS

Export Address: 25 WARREN ST., N. Y., N. Y. Cable: SIMONTRICE, N. Y.

PINCOR Products

Many tests that
can't be made with
any other meter!

**RCP 661
Electronic
Multitester**



Here's a real "pro" job for you. This instrument has 26 vacuum tube operated ranges, with input impedance as high as 160 megohms, an input capacity of only .00005 mfd. Make all essential measurements on AM, FM and television receivers, oscillators and amplifiers, AVC and AFC circuits — many tests that can't be made with any other meter! Actually, you're getting four complete electronic instruments in one compact, advanced vacuum tube meter. And all for only \$34.95, at your nearest RCP dealer.

A NEW FREE CATALOG describes the complete line of dependable, lowest-cost-for-quality RCP test equipment. Send for your copy today — it's FREE!

RADIO CITY

PRODUCTS COMPANY, INC.

88 PARK PLACE • NEW YORK, N. Y.

**RCP
dependable
TEST
instruments**

CRYSTALS by HIPOWER

The Hipower Crystal Company, one of America's oldest and largest manufacturers of precision crystal units, is able to offer the amateur and manufacturer attractive prices because of their large production and the exclusive Hipower grinding process. Whatever your crystal need may be, Hipower can supply it. Write today for full information.

HIPOWER CRYSTAL CO.

Sales Division—205 W. Wacker Drive, Chicago
Factory—2035 Charleston Street, Chicago, Ill.

LEARN CODE

the way you'll be using it
by **SOUND**



The best way to learn to read code is by listening to code. The best way to learn to send code is by hearing your own sending repeated back to you. With the new All-Electric Master Teleplex Code Teaching Machine, you learn code the natural, easy, fascinating way. Only instrument ever produced

which records your sending in visible dots and dashes — then SENDS BACK your own key work at any speed you desire. That's why practically every school teaching code uses TELEPLEX. We furnish complete course, lend you All-Electric Master Teleplex, give you personal instruction with a MONEY BACK GUARANTEE — all at a surprisingly low cost per month. Write today for FREE catalog Q. 8. No obligation.

**“HAM”
SPECIAL**

Standard Teleplex—a highly efficient code teacher using heavy specially prepared waxed paper tape, having two rows of perforations. Write for Free folder “Q.T.S.”

**TELEPLEX CO. 107 Hudson St.
Jersey City, N. J.**

supervisory duties with the 147th F. A., at Ft. Ord, Cal. Lt. Pryor, 4BYX, is signal officer at Camp Wheeler, Ga., and Lt. Lowery, 4DQW, is signal officer at MacDill Field, Fla.

Both from the training and refresher schools and from the ranks of amateur radio direct come the gang who are assigned to operating work and thus form the mainstay of communications systems. At the Naval Air Station, Lakehurst, N. J., there are Rawlins, 3HQL; Johnson, 8OMR; Plankenhorn, 3JHP; Fisher, 3IFT; Geigher 3ATL; Dalling, 3BLN, and Gallagher, 3EBO. RM3c Kerney, 6ONX, is assigned to the *Mississippi*. The *New York's* radio crew include RM2c Anderson, 1DJO; RM3c Scott, 3HOJ; Mann, 8SEI, and Walczak, 8DWW; and aboard the *Concord*, in Pacific waters, are RM1c Cawdrey, 6IRS; Buckles, ex-7EKD; RM3c Shonebarger, 8STAR; Dardani, 6RAS; Blunkin, 2MIF, and “strickers” Nash, 6FWK; Bozcek, 8ONZ, and Fordice, 6SBZ. On the east coast we find RM3c Zaverence, 2NJH, operating on the *Memphis*; RM1c Calvert, 3CMV, on the *Hamul*; RM3c Buford, 4GQR, on flying boat *VP-56*; and RM3c Miles, 5JOS, on the *Benson*. When reporting aboard the *Overton*, Goldberg, 2HKU, was issued gas mask No. 73, and another SWL and radio-man issued No. 88! In the Pacific fleet there are CRM Cole, 6SAQ, RM1c Costantino, 6RYA, and RM3c Russell, 9ZMP, aboard the *Mugford*; RM1c Bells, 6FNP, on the *Winslow*; RM3c Harper, 9UEX, on the *Jarvis*; RM3c Van Vorst, 6MSW, on the *Ralph Talbot*; RM3c Lanham, 9PGA, on the *Patterson*; RM2c Kirk, 8LST, on the *Phoenix*; Clark, 6KRO, aboard the *Portland*; Leighton, 6KHK, on the *Pruitt*; and Bovee, 6LDM, aboard the *Amythse*. RM2c Cotal, 6KEC, supervises df. work at the Navy's Eureka, Cal., station. RM3c Gilbert, 7QA, operates at Seattle headquarters. RM2c Sandstrom, 1BNO, is assigned to the Naval Air Station at Quonset Pt., R. I. RM1c Conner, 3HCE, operates a radio beacon aboard a coast guard light-ship off Richmond, Va. “Striker” Cobb, 6TWW, has been assigned to the *Brooklyn*.

Conscript Schiffman, 2MPM, has duties with the 31st Signal Platoon, Mitchell Field, N. Y. Pvt. Snell, 6HFH, does telephone work for the 8th Sig. Svc. Co., Ft. Ord, Cal. Hall, 5GWD, and Williams, 5FA, are in 2nd Bn., 142 F. A., at Ft. Sill, Okla. Doing maintenance work at Ft. Benning, Ga., is Pvt. Williams, 4ASB. The 102nd Cavalry (Essex Troop) now on active service at Ft. Jackson, S. C., include Capt. Howland, 2JOC; Lt. Parker, 2GFG; Sgts. Aridas, 2GOK; Fort, 2GBY; Hill, 3GEF; Wolf, 2FSQ, and Pvt. Williams, 2IMJ, all of whom keep in touch with home through schedules with 2CGG in Livingston, N. J. Cpl. Sinclair, 9ZZH, Pvts. Wrablick, 9HIY, and Maggio, 9EIW, are serving with the 33rd Sig. Co. at Camp Forrest, Tenn.

BUY ON EASY TERMS · MAIL ORDERS PROMPTLY FILLED · WRITE FOR FREE CATALOG

We Can Deliver!

Anticipating the enormous demand existing today, we placed record breaking orders months back to take care of . . .

Your Needs

The largest inventory of parts and receivers is now on hand for prompt shipment . . .

**HALLICRAFTERS · NATIONAL
RME · HOWARD · HAMMARLUND
RECEIVERS**

Liberal Time Payments Arranged

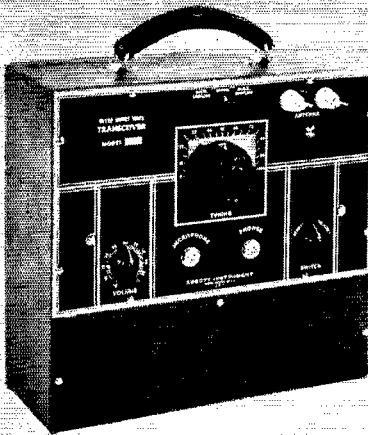

DK-3

- Abbott Portable Transceiver..... \$18.82
- Set of tubes 6G6G, 6J5GT..... 1.10
- Set of Burgess batteries..... 4.31
- Universal handset..... 5.88

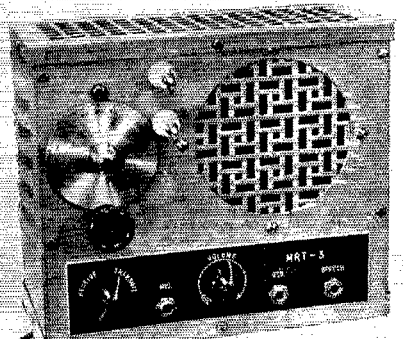

MRT-3

HIGH
POWER
ON
2½ METERS

MRT-3 \$28.81

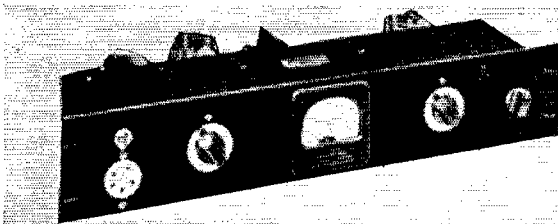

- Millen 50 watt transmitter exciter, including one set of coils.
\$37.50
(additional coils, first set — \$3.00)

- Tube kit HY75, 6C5, 6L6..... \$5.05
- Hand microphone..... 5.88

The RADIO SHACK
167 WASHINGTON ST., BOSTON, MASS., U.S.A.

MIDLAND SCHOOLS

RECOGNIZED specialists in training qualified men for Airline Radio Operating, Radio Maintenance and Broadcast positions. Training supervised by expert instructors released to Midland by major Airlines and directed by a nine Airline Advisory Board. One hundred per cent of qualified graduates employed from coast-to-coast. Contractors to the U. S. Army Signal Corps.

INVESTIGATE

before you enroll. Send for your free copy of our profusely illustrated and colorful 58-page booklet and training outline, prepared through the cooperation of many Airlines. No obligation.

Midland Schools

29th Floor, Power and Light Building
Kansas City, Missouri

"Frequency-Halving" Oscillators

(Continued from page 47)

from our experience with these circuits, we think most of them will work. We suggest Fig. 3 as a starter, using a 7N7 or 6SN7 and keying the cathode or negative lead of the s.e. oscillator. You'll be treating yourself to real break-in keying on 160 meters with your present 80-meter crystal.

U. S. A. Calling

(Continued from page 45)

the same as mentioned in previous announcements in this column concerning Ensign commissions. Please note a college degree is not a requirement of this appointment. Again ARRL is collecting names, and interested and qualified persons should drop Hq. a postcard with name and address, and brief résumé of qualifications.

Code Proficiency Award

(Continued from page 49)

minute. Besides this special practice material ARRL official messages "to all radio amateurs" are sent by tape at 8:30 p.m. and midnight E.S.T. at one of the three lower speeds, giving opportunity for additional practice. Opportunity for getting the League's Code Proficiency Certificate Award or to try out for a silver endorsement sticker (for demonstrating increases from the original word speed certified) will be given in the next qualifying runs, as follows:

Aug. 18th (Mon.) 9:45 p.m. E.S.T. (Text at 10 p.m. E.S.T.)
Sept. 7th (Sun.) 1:30 p.m. E.S.T. (Text at 1:45 p.m. E.S.T.)
Sept. 20th (Sat.) 9:45 p.m. E.S.T. (Text at 10 p.m. E.S.T.)

ARRL aims to extend code proficiency certificate recognition at *some* speed above government license requirements to every FCC amateur licensee. Copy the test text at the best speed you can. Underline the *full minute* of perfect copy necessary to qualify at any speed. Tell us if you copied by ear without help except for your pencil or mill (mention which used), and if you are working for first certificate or endorsement. Send in copy and statement. We will check your paper with the official tape, then advising you of success or failure, sending any appropriate award or advices within about thirty days from the date of any *qualifying* run.

— F. E. H.

WWV Schedules

(Continued from page 57)

The pulse lasts 0.005 second, and provides an accurate time interval for purposes of physical measurements.

The 440-cycle tone is interrupted every five minutes for one minute in order to give the station announcement and to provide an interval for the checking of radio measurements based on the standard radio frequency. The announcement is the call letters (WWV) in telegraphic code.

The accuracy of the 5-megacycle frequency, and of the 440-cycle standard pitch as transmitted, is better than a part in 10,000,000. The



For Delicate and Precise Laboratory Equipment . . .

Used extensively by broadcast stations and electrical laboratories. DAVENOIL leaves no residue of dirt or sticky gum. Available in small bottles with applicator or in 8 oz., 16 oz., and gallon containers.

THE DAVEN COMPANY
158 SUMMIT STREET • NEWARK, N. J.

BLUEPRINTS

MANY blueprints are involved in the manufacture of crystal units. Yet, there is not a single detail drawing for the quartz crystal. That's because blueprints are not enough! The correct finishing of quartz crystals is much more involved than the simple process of machining a material in accordance with dimensions and notations on a drawing. Vital to final performance characteristics is the individual skill of experienced specialists—and skill cannot be shown on a drawing.

Every possible advantage of research, scientific production and personalized craftsmanship is taken in the manufacture of Bliley Crystals. That's why Bliley Crystal Units are generally acknowledged to be the best. Choose a "Bliley" the next time you buy and find out for yourself!

are not enough!

BLILEY ELECTRIC COMPANY
ERIE, PENNSYLVANIA

BLILEY CRYSTAL UNITS

RADIO OPERATING QUESTIONS & ANSWERS

Nilson & Hornung's new edition covers all FCC commercial license exam elements. Standard handbook 20 years. \$2.50, postpaid. Money back if not satisfied and book returned in 10 days. Send check or money order . . . not cash. *Free circular on request.*



NILSON RADIO SCHOOL, 51 East 42nd St., New York



No. 211 Flyweight Receiver

▶ RADIO CONTROL ◀

National Champion Jim Walker uses RCH receivers, transmitters and antennae. *Ask your dealer or send 10c for illustrated Instruction Manual.*

RADIO CONTROL HEADQUARTERS, INC.
330 West 42nd Street New York City

EASY TO LEARN CODE

It is easy and pleasant to learn or increase speed the modern way — with an **Instructograph Code Teacher**. Excellent for the beginner or advanced student. A quick and practical method. Available tapes from beginner's alphabet to typical messages on all subjects. Speed range 5 to 40 WPM. Always ready, no QRM, beats having someone send to you.

MACHINES FOR RENT OR SALE

The **Instructograph Code Teacher** literally takes the place of an operator-instructor and enables anyone to learn and master code without further assistance. Thousands have used and endorse the **Instructograph System**. Write today for full particulars and convenient payment and rental plans.



INSTRUCTOGRAPH COMPANY

4709 Sheridan Road, Chicago, Illinois

Representative for Canada:

Radio College of Canada, 54 Bloor St. West, Toronto

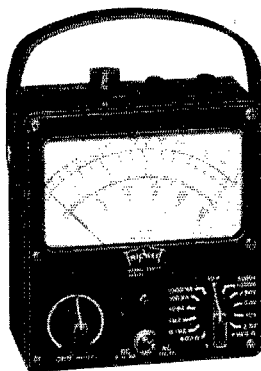

New

WIDE RANGE PORTABLE VOLT-OHM-AMMETER

TRIPLET

MODEL 625-T
AMATEUR NET PRICE
\$22.00

★

DC Volts 0-2.5-10-50-250-1000-5000 at 10,000 Ohms per Volt. AC Volts 0-2.5-10-50-250-1000-5000 at 1000 Ohms per Volt. DIRECT CURRENT 0-100 Microamperes; 0-1-10-100 Milliampers; 0-1-10 Amperes.

RESISTANCE 0-400 Ohms (shunt type circuit); 0-40,000 Ohms and 0-4 Megohms (series type circuit). Self-contained batteries for all resistance ranges. Model 625-T, Complete with all accessories. Amateur Net Price . . . **\$22.00**

Write for Catalog — Section 259, Harmon Avenue

THE TRIPLET ELECTRICAL INSTRUMENT CO.
Bluffton, Ohio

CANNON

SOUND

PLUGS and RECEPTACLES

now stocked in

NEW YORK



We are pleased to announce that we have been appointed distributors of Cannon sound plugs and receptacles and will carry a complete stock of this equipment.

This action of the Cannon Electric Development Company, Los Angeles, California, was prompted by their desire to assure fulfillment of their customers' requirements in these uncertain times. Here is additional evidence of Terminal's record of regular and reliable delivery of essential radio materials in the face of trying conditions.

TERMINAL Radio Corp.

68 West 45th St. • 80 Cortlandt St.
2 stores in NEW YORK CITY
Vanderbilt 6-5050 • Cable: TERMRADIO

time interval marked by the pulse every second is accurate to 0.000,01 second. The 1-minute, 4-minute, and 5-minute intervals marked by the beginning and ending of the announcement periods are accurate to a part in 10,000,000. The beginnings of the announcement periods are so synchronized with the basic time service of the U. S. Naval Observatory that they mark accurately the hour and the successive 5-minute periods; this adjustment does not have the extreme accuracy of the time intervals, but is within a small fraction of a second.

★ New Receiving Tubes ★

BCA ANNOUNCES five new receiving tubes.

The 6SL7GT is a high- μ twin triode identical in characteristics to the 12SL7GT, except for heater voltage and current ratings.

The 1631 is similar to the 6L6, except for heater ratings of 12.6 volts and 0.45 amp. and a plate-dissipation rating of 16 watts.

The 1632 is similar to the 25L6, except for heater ratings of 12.6 volts, 0.6 amp., plate dissipation of 5.5 watts and transconductance of 900 μ mhos.

The 1633 is a twin-triode amplifier similar to the 12SN7GT except for heater ratings of 25 volts, 0.15 amp. It is designed for applications critical as to matching of the triode units.

The 1634 is a twin-triode amplifier similar to the type 12SC7, but designed for applications more critical as to matching of the two triode units.

Strays

In answering the door one day, a W3 was confronted by an elderly gentleman who said he was on the trail of a fellow by the name of Edward Victor Henry who was causing him no end of trouble on his little radio. Having searched fruitlessly over a period of two months, making inquiries of his neighbors and of any persons whom he thought might have some knowledge of radio, looking through the telephone directory, call books and technical magazines, he was just about to give up when he noticed an article in a local paper on ham radio. At last he succeeded in locating one ham. So, on writing W3GUB (who used a little deduction), he found that the noise-maker was W3EVH who lives only fifty feet away. Was he surprised to learn that the handle was Archie and not Edward Henry! — W3EVH.

—♦♦♦—
The Philadelphia Council of Veterans of Foreign Wars sponsored an air show on the 29th and 30th of June. It featured "Squeak" Burnett, internationally known stunt flier, with Buddy Batzell, smoke writer. The Ultra High Frequency Club of Philadelphia was chosen to furnish radio communication, it being the third time the club had done radio work at air meets. The boys who took part were: W3FIE, W3GPX, W3DJ, W3FWL, W3FOD, W3AZT and W3GOM. W3FIE and W3GOM experienced their first flight when they took 112-Mc. equipment up to give the audience a ship-to-ground demonstration. 112 Mc. has proved better than 56 Mc. for this kind of work due to the convenience of transceivers. Incidentally, there are about 30 fellows on 112 Mc. in and around Philadelphia, and we would appreciate any DX calls. — W3GOM.

★ ★ ★ ★ ★ ★

The radio amateur's handbook

THE STANDARD MANUAL OF AMATEUR
RADIO COMMUNICATION



1941

PUBLISHED BY THE
AMERICAN RADIO
RELAY LEAGUE

\$1 IN CONTINEN-
TAL U. S. A.

The Handbook tells the things which are needed for a comprehensive understanding of Amateur Radio. From the story of how Amateur Radio started through an outline of its wide scope of the present — from suggestions on how to learn the code through explanations of traffic-handling procedure and good operating practices — from electrical and radio fundamentals through the design, construction, and operation of amateur equipment — this book covers the subject thoroughly. It includes the latest and the best information on everything in Amateur Radio.

\$1 postpaid in Continental U.S.A.

\$1.50 elsewhere

Buckram bound edition, \$2.50

American Radio Relay League, West Hartford, Conn.

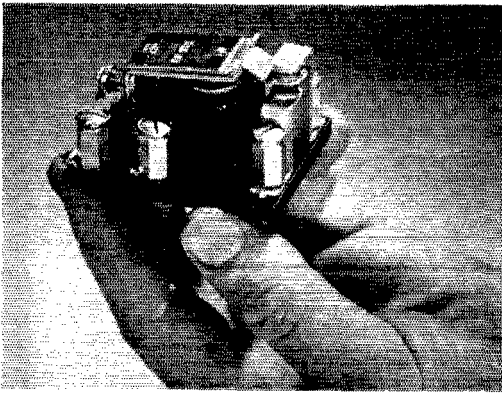

THIS RELAY HUSKIER, COSTS LESS

The design of this compact Ward Leonard single pole heavy duty relay is simplicity itself. It is sturdily built yet there is not an ounce of material in it that is not essential to efficient performance. Measures only 1 7/8" x 2 5/8". Will control 3/4 h.p. on 115-230 volts. Described in Bulletin 105.

WARD LEONARD ELECTRIC COMPANY

41 South Street, Mt. Vernon, N. Y.

AMATEUR

TYPE PR-X IN
"ALSIMAG" HOLDER
40-80-160 M. BAND
ONLY.....\$3.00

PETERSEN RADIO CO., Council Bluffs, Iowa



COMMERCIAL

WRITE US
FOR PRICES

Fast Service

Do YOU want to be a Government radio operator?



Why not learn to be an operator quickly and easily with the Ayers Automatic Code Machine all electric. 50,000 words practice tapes available, low monthly rental. Tapes for Mac Autos, Recording slips and Recording inks.

Write AYERS AUTOMATIC CODE MACHINES
711 Boylston St., Boston, Mass.

Wanna Swap Crystals?

OKAY. A lot of other hams do, too. The new regs cause a lot of moving around. Here's a cheap way of finding a chap who wants yours and has one you want.

See the paragraph at the end of Hamads. It explains how to do it in a very few words which at 7¢ per word costs very little.

West Gulf Division Convention

Dallas, Texas, September
13th-14th

THE fifteenth annual West Gulf Division Convention, sponsored by the Dallas Amateur Radio Club, is to be held Saturday and Sunday, September 13th and 14th, at the Hotel Adolphus in Dallas. A brief outline of the program given below indicates a good time in store for everyone, and the Dallas club extends a most hearty welcome. Registration \$2.50. For further information and reservations, write E. M. Shook, W5IT, 227 West Woodin Blvd., Dallas.

Saturday morning: registration and preliminaries. Saturday afternoon: technical talks, demonstrations and League organization meeting. For the ladies, an ice show, prizes, and shopping. Saturday evening: dancing. Sunday morning: church of one's choice. Sunday afternoon: entertainment, quiz show, technical talks and code speed test. For the ladies, sight-seeing trip and refreshments. Banquet at 4:00 P.M., with speeches, awards and balloting.

The Secret of Good Sending

(Continued from page 87)

will develop the rhythmic sending of the automatic, which is music to the soul of any radioman. But it requires study and continual application. When we attain correct spacing nothing will drive us back to the incorrect ways, because we will then be sending code as it should be sent.

Developing Rhythm

Before attempting to form actual characters you must develop the correct "rhythm" of making dots and dashes. Rhythm should not be confused with "swing." Swing has no place in good sending. An operator with swing in his fist is the one you hear who makes some dashes longer than others, puts his own peculiar emphasis on certain parts of characters, etc. There is, for example, a certain swing called a "sea-going" swing because it reminds one of the roll of a ship! Avoid any form of swing. Rhythm, on the other hand, is the correct roll of dots and dashes.

Correct dot-rhythm may be developed by sending a series of dots, at an even, moderate rate of speed. In practicing this exercise it is helpful to repeat to yourself, aloud preferably, a

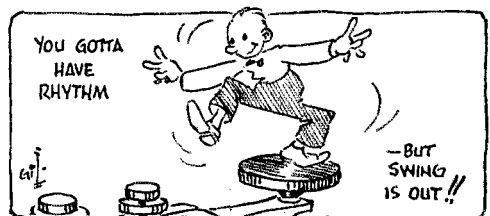

Where to buy it

A directory of suppliers who carry in stock the products of these dependable manufacturers.



ALBANY, N. Y. Uncle Dave's Radio Shack 356 Broadway
ATLANTA, GEORGIA 265 Peachtree Street
 Radio Wire Television Inc.
BOMBAY, INDIA Eastern Electric & Engineering Company
BOSTON, MASS. Radio Shack 167 Washington Street
BOSTON, MASS. 110 Federal Street
 Radio Wire Television Inc.
BRIDGEPORT, CONN. Hatry & Young, Inc. 177 Cannon Street
BRONX, N. Y. 542 East Fordham Rd.
 Radio Wire Television Inc.
BUFFALO, N. Y. 1531 Main Street
 Dymac
BUTLER, MISSOURI 211-215 N. Main Street
 Henry Radio Shop
CHICAGO, ILL. 833 W. Jackson Blvd.
 Allied Radio Corp.
CHICAGO, ILL. 901-911 W. Jackson Blvd.
 Radio Wire Television Inc.
CINCINNATI, OHIO 1103 Vine Street
 United Radio, Inc.
DETROIT, MICH. 325 E. Jefferson Ave.
 Radio Specialties Co.
DETROIT, MICHIGAN 11800 Woodward Ave.
 Radio Specialties Co.
HARTFORD, CONNECTICUT 227 Asylum Street
 Radio Inspection Service Company
HOUSTON, TEXAS 1021 Caroline Street
 R. C. & L. F. Hall
INDIANAPOLIS, INDIANA 34 West Ohio Street
 Van Sickle Radio Supply Co.
KANSAS CITY, MO. 1012 McGee Street
 Burstein-Applebee Company
LITTLE ROCK, ARKANSAS 409 W. 3rd Street
 Beem Radio Company
NEW HAVEN, CONN. 1172 Chapel Street
 Hatry & Young, Inc.
NEW YORK, N. Y. Harrison Radio Co. 12 West Broadway
NEW YORK, N. Y. 100 Sixth Ave.
 Radio Wire Television Inc.
NEWARK, N. J. 24 Central Ave.
 Radio Wire Television Inc.
READING, PENN. 404 Walnut Street
 George D. Barbey Company
SCRANTON, PENN. 519-21 Mulberry Street
 Scranton Radio & Television Supply Co.
WASHINGTON, D. C. 938 F Street, N. W.
 Sun Radio & Service Supply Co.

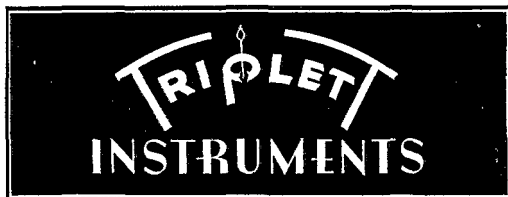

ALBANY, N. Y. Uncle Dave's Radio Shack 356 Broadway
ATLANTA, GEORGIA 265 Peachtree Street
 Radio Wire Television Inc.
BOSTON, MASS. Radio Shack 167 Washington Street
BOSTON, MASS. 110 Federal Street
 Radio Wire Television Inc.
BRIDGEPORT, CONN. 177 Cannon Street
 Hatry & Young, Inc.
BRONX, N. Y. 542 East Fordham Rd.
 Radio Wire Television Inc.
BUFFALO, N. Y. 1531 Main Street
 Dymac
BUTLER, MISSOURI 211-215 N. Main Street
 Henry Radio Shop
CHICAGO, ILLINOIS 833 W. Jackson Blvd.
 Allied Radio Corp.
CHICAGO, ILL. 901-911 W. Jackson Blvd.
 Radio Wire Television Inc.
CINCINNATI, OHIO 1103 Vine Street
 United Radio, Inc.
HARTFORD, CONN. 203 Ann Street
 Hatry & Young, Inc.
LITTLE ROCK, ARKANSAS 409 W. 3rd Street
 Beem Radio Company
MINNEAPOLIS, MINNESOTA 1211 LaSalle Avenue
 Lew Bonn Company
NEW HAVEN, CONN. 1172 Chapel Street
 Hatry & Young, Inc.
NEW YORK, N. Y. 100 Sixth Avenue
 Radio Wire Television Inc.
NEWARK, N. J. 24 Central Ave.
 Radio Wire Television Inc.
READING, PENN. 404 Walnut Street
 George D. Barbey Company
WASHINGTON, D. C. 938 F Street, N. W.
 Sun Radio & Service Supply Co.

Listings on this page do not necessarily imply endorsement by QST of the dealers or of other equipment sold by them.

★ SUN-SATIONAL SEPTEMBER SPECIALS!

The Fastest Selling
COMMUNICATIONS RECEIVER
IN TOWN !!

Echophone COMMERCIAL

**EC-1
COMPLETE
\$24.50**

(Price Effective Aug. 1st)

- 6 TUBES
- 3 BANDS
- BUILT-IN SPEAKER

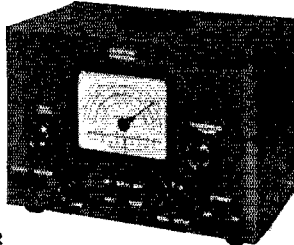

Here's the greatest little communications receiver at, oh, such a very low price. Tunes from 545 Kc. to 30.5 Mc. (550 to 9.85 meters) on 3 bands, with electrical bandspread on each.

Shipped Directly on Receipt of \$5 Down, Balance C.O.D.

HICKOK 3 1/2" THERMO-COUPLE AMMETERS

JUST A FEW LEFT!

SINGLE RANGE to 5 Amps. SPECIAL \$3.95
DUAL RANGE to 5 Amps. SPECIAL \$4.45
Never before priced so low! Surface mounting type

IT'S TERRIFIC!

VERTROD COMMUNICATIONS RECEIVING ANTENNA—MODEL 200

Amazing — is the word describing the interest created in this complete all-wave coverage antenna for we're literally swamped with orders for this newest of antennae creations. From far and wide they've flocked in — for this antenna is open to behold. Covers 5 to 550 meters with one unit consisting of two adjustable 0' di-poles, antenna and set matching transformers, patented L-C resonator.

AMATEUR NET PRICE — less mast **\$12.64**
3-section, 10 ft. galvanized iron mast \$4.41

See our Aug. QST ad. for complete description or send for circular

STANCOR FULLY CASED FILAMENT TRANSFORMER

DUAL WINDING — 7500 VOLTS INSULATION

2 1/2 VOLTS at 10 Amps. } SPECIAL
10 VOLTS at 4 Amps. } **\$1.76**

ONLY A FEW LEFT AT THIS PRICE — SO HURRY!

BIG BARGAIN BULLETIN

Send for circular 103 listing sensational savings on new, used and traded-in equipment — ham receivers, tuners, test instruments, amplifiers, record changers, etc. Priced low for immediate clearance. Write today.

NEW YORK'S OLDEST "HAM" HOUSE

SUN

RADIO CO.

212 Fulton Street, Dept. QA New York

Cable Address: SUNRADIO NEW YORK

series of evenly spaced "di's"; thus: "Di-di-di-di-di-di-di-di," etc. Continue this for two or three minutes, keeping your sending in time with your vocal efforts. Avoid speeding up as you send this series of dots; keep at an even rate for the entire period. Aim to make all dots the same length. Check yourself occasionally to see if the wrist is actually moving. If you find that the fingers or the whole arm are doing the work, stop, and start over again. When you feel that you have a good grasp on this dot-rhythm, try making some figure 5's, using exactly the same rhythm and speed you used for the long series of "di's." Simply repeat to yourself, "Di-di-di-di-di," and make this with the key simultaneously. Repeat this several times. Then try H's, S's, I's and E's, always using the same rhythmic wrist action. Keep the speed constant at all times, and keep the speed low until you have completely mastered the dot-rhythm. After a reasonable period of practice as outlined, you should be making dot-characters that are perfect.

Correct dash-rhythm may be developed similarly by making a series of dashes at an even rate, repeating to yourself at the same time, "Dah-dah-dah-dah-dah-dah-dah-dah," etc., and continuing for two or three minutes at a time. In these exercises always consider two things: (1) "Is my wrist flexible?" (2) "Am I keeping my speed even?" When you have become accustomed to the dash-rhythm, try making the numeral zero, repeating "Dah-dah-dah-dah" to yourself at the same even, steady pace you used for the series of dashes. Then make some O's, M's and T's in the same manner, making all dashes as near the same length as humanly possible, and keeping the speed down.

Proper rhythm may also be developed by sending a series of dots-and-dashes (di-dah-di-dah-di-dah-di-dah, etc.) and similarly a series of dashes-and-dots (dah-di-dah-di-dah-di-dah-di-dah-di, etc.), aiming at all times to keep all dots the same length, all dashes the same length and all spaces between the same length.

Scores, 28-Mc. Party

(Continued from page 54)

K4DTH**	3075-15- 41	W5KFC	540- 4- 17
W2BYM	2795-13- 43	W5FSP	520- 4- 16
W8ADY**	2640-16- 33	W6OIF	490- 7- 14
W2HF	1960- 8- 49	K4HHR	408- 9- 9
W8FGV	1925-11- 35	W3CCO	390- 6- 13
W3IWM	1750-10- 25	WINBI	350- 5- 14
W7HHH	1700-10- 24	W9BBS*	240- 3- 6
W3BVE	1650-10- 33	W1CQ	225- 3- 5
W4HTR	1625-13- 25	W5QR	220- 4- 11
W4EHT	1595-11- 39	W6IWL	310- 6- 7
W3EVT*	1485-11- 27	W6SGB	200- 5- 8
W8SJJ	1485-11- 27	W1LSW	165- 3- 11
W9QJC	1450-10- 19	W1BDU	130- 2- 13
W7UQ 1	1440- 9- 32	W9FDQ	130- 2- 13
W5IOT*	1400-10- 18	W5QMN	120- 2- 2
W7TO	900- 5- 12	W5OKK	70- 1- 4
W4GGR	950-10- 19	W1LVZ	65- 1- 3
W1FMV	935- 7- 17	W4DAE	65- 1- 3
W1EEB	855- 9- 19	W9AMM	60- 1- 1
W6RWV	805- 7- 13	W3HLQ	50- 2- 5
W6CHV	770- 7- 12	W5EKV	40- 1- 8
W1LQQ	660- 4- 33	W6PYA	30- 1- 6
W9OEL	660- 6- 12	W1FZU	10- 1- 2
W1HSB	600- 8- 15	W1TS**2	3120-12- 42

¹ University of Idaho Radio Club, W7HYI, opr.

² HQ's staff member; not competing.

PRICES?

No matter what happens to prices — here at Harrison our large scale purchasing and our tremendous stock enable us to continue to give you the lowest possible prices at all times.

It pays to buy from Harrison!

DELIVERY?

With production facilities already greatly over-taxed, deliveries are falling behind more every day. But, we anticipated this "Back-order Era" and placed protective orders many months ahead. Right now we have more receivers, parts, tubes, etc. *on hand* than at any time in our busy sixteen year history!

You get faster delivery from Harrison!

TRIAL?

When you buy anything from Harrison it has to be entirely satisfactory or you don't keep it. Try out your next receiver for ten days without charge or obligation by ordering it from us.

You get 100% cooperation from Harrison!

TRADE-IN?

By fair dealing we have built up the largest Reconditioned Receiver business in the world! We have a ready market for your old set, and that means we can give you the very best trade-in allowance. (We also buy receivers, transmitters, etc., for cash.)

You get the best deal at Harrison!

TERMS?

Certainly! Charge Account or Easy Payment Plan. Buy your Receiver, transmitter, parts, etc., on our easier terms at lowest cost.

Your credit is good at Harrison!

GUARANTEE?

Everything is "guaranteed," but your best guarantee is the integrity of the person with whom you deal. Here at Harrison we go far beyond the standard warranty in order to please you!

You get a square deal from Harrison!

I'll be looking for your order!

73,
BILL HARRISON, W2AVA

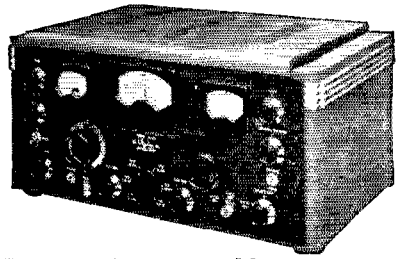

hallicrafters Super Skyrider

Model SX-28. "Tops" in performance. 15 tubes, 2 r.f. stages, calibrated bandspread, etc. Covers .55 to 42 mc.

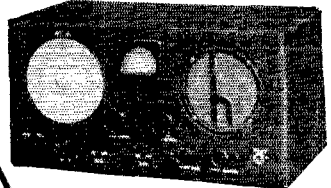

hallicrafters Sky Buddy

Model S-19-R. A six tube that offers good results for a moderate price. .545 to 44 mc with continuous electrical bandspread.

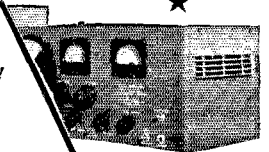

hallicrafters Super Defiant

Model SN-25. Has all the features of sets selling for nearly twice as much!

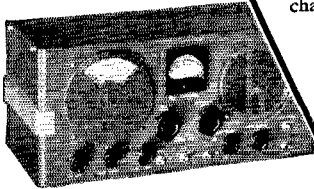

hallicrafters Sky Champion

Model S-20-R. Excellent value. Nine tubes, noise limiter, preslector stage, .545 to 44 mc, bandspread, etc. Socket for battery or vibro-pack operation.

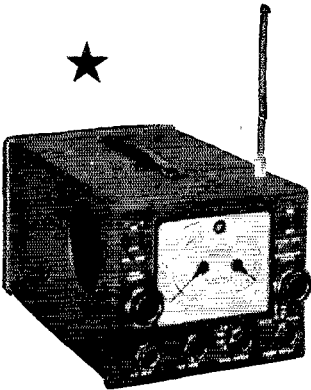

hallicrafters Sky Traveler

Model S-29. You can take it with you! Works on self contained batteries or any AC or DC line. Built-in telescoping antenna. 9 tubes, .542 to 30.5 mc, bandspread, internal speaker, battery re-charger.

It's **HARRISON** for
hallicrafters and SERVICE!

HARRISON RADIO CO.

12 WEST BROADWAY • NEW YORK CITY

WOrth 2-6276

WHY PAY MORE?

WHEN YOU CAN BUY ALL THESE FEATURES FOR LESS!



\$24.50

MODEL EC-1

Here's your opportunity to have all these communications features at this remarkably low price! Six tubes. Tunes from 550 kc. to 30 mc. on three bands. Electrical bandspread on all bands. Beat frequency oscillator. Self-contained PM dynamic speaker. AC/DC operation — 115/125

volts. Bandspread logging scale. Complete isolation for headphones through phone circuit transformer. Dial calibrated in megacycles with all important service bands indicated. You can buy all these communications features in the Echophone Model EC-1 for only \$24.50.

Echophone

COMMERCIAL

"The Ears of the World"

ECHOPHONE RADIO CO.

201 East 26th Street, Chicago, Illinois

HAM-ADS

(1) Advertising shall pertain to radio and shall be of nature of interest to radio amateurs or experimenters in their pursuit of the art.

(2) No display of any character will be accepted, nor can any special typographical arrangement, such as all or part capital letters be used which would tend to make one advertisement stand out from the others.

(3) The Ham-Ad rate is 15¢ per word, except as noted in paragraph (6) below.

(4) Remittance in full must accompany copy. No cash or contract discount or agency commission will be allowed.

(5) Closing date for Ham-Ads is the 25th of the second month preceding publication date.

(6) A special rate of 7¢ per word will apply to advertising which, in our judgment, is obviously non-commercial in nature and is placed and signed by a member of the American Radio Relay League. Thus, advertising of bona fide surplus equipment owned, used and for sale by an individual or apparatus offered for exchange or advertising inquiring for special equipment, if by a member of the American Radio Relay League takes the 7¢ rate. An attempt to deal in apparatus in quantity for profit, even if by an individual, is commercial and all advertising by him takes the 15¢ rate. Provisions of paragraphs (1), (2), (4) and (5) apply to all advertising in this column regardless of which rate may apply.

Having made no investigation of the advertisers in the classified columns, the publishers of *QST* are unable to vouch for their integrity or for the grade or character of the products advertised

* * * * *

Gear is short. You can sell your old and extra gear through Ham-Ads.

* * * * *

QUARTZ — direct importers from Brazil of best quality pure quartz suitable for making piezo-electric crystals.
Diamond Drill Carbon Co., 719 World Bldg., New York City.

QSL'S, Cartoons. Free samples. Theodore Porecher, 7708 Navajo, Philadelphia, Pa.

CALLBOOKS — Full edition now on sale containing complete up-to-date list of radio hams throughout entire world. Single copies \$1.25. Canada and foreign \$1.35. Radio Amateur Call Book, 610 S. Dearborn, Chicago.

COMMERCIAL radio operators examination questions and answers. One dollar per element. G. C. Waller, W5ATV, 6540 Washington Blvd., Tulsa, Okla.

QSL'S — Brownie, W3CJI, 1725 Frankenfield Ave., Allentown, Pa.

TELEPLEXES, Instructographs bought, sold. Ryan's, Hannibal, Mo.

QSL'S, SWL'S. 100 — 3 color — 75c. Lapco, 344 W. 39th, Indianapolis, Ind.

TRANSMITTING headquarters on latest Stancor, Thordarson and other kits — commercially wired at low cost. New 70 watt transmitter kits complete only \$35 — speech amplifier modulator up to 80 watts at \$25 — up to 150 watts \$49.50. Genuine Utah ham transformers at less than 1/2 original cost. New HY25's at 99¢. New HY31's at \$2.95. Easy terms. Write Leo, W9GFQ, today.

CRYSTALS: famous P.R., mounted in latest Aismag 35 holders — 40, 80 meter PR-X, 160 meter PR-Z \$3, 40, 80 meter PR-Z (low drift) \$3.50; 20 meter PR-20 \$4.50; unconditionally guaranteed. Immediate shipment. Quality blank 70¢. Wholesale Radio Labs., Council Bluffs, Iowa, W9GFQ.

LEO, W9GFQ, offers the hams more and better deal always. Lowest terms without red tape on all new and used equipment. Free trial, personalized service. Write for big free ham bargain catalog and used receiver list. Wholesale Radio Labs., Council Bluffs, Iowa.

Quickest delivery on NC-200's, 45's, SX-32's and other receivers. Largest stock of ham equipment in country. Write for dope on new low-priced transmitting kits to Leo, W9GFQ, Council Bluffs, Iowa.

SALE — Peak Preselector, 9 to 200 meters. A-1 condition. \$10. W3CFB.

SELL, HK54 amplifier, TZ40 modulator, two power supplies for above, SX11 receiver with spkr. You name your price. Will sell whole or in part. W1JUL.

LATEST SW3, new 6.3 v. tubes, 6 sets coils, National pwr pack, \$12.50 f.o.b. Jimmy Speer, PAA, Brownsville, Texas.

QSL'S? — SWL'S? America's finest. Samples? W8DED, Holland, Mich.

SELL — Hallicrafters S-29 used few months. \$35 cash. James Lawless, 27 Sasfras St., Providence, R. I.

WANTED — Used NC-44. Describe, stating age, condition, price. G. L. Danforth, 4 Larchmont St., Danvers, Mass.

2 1/2 or 1 1/2 meter 21 element square corner beam complete \$10. High Frequency Engineering Co., Lorain, Ohio.

RADIO operators wanted for the merchant marine no previous experience necessary must have commercial license wages range from \$150 to \$250 monthly. Write The Radio Officers Union, 265 West 14th St., New York, N. Y.

SWAP xmttr for revr. W9BAY.

WANTED code practice machine, state make, condition, and price. Box 463, Wilmington, Mass.

WANTED twenty men over 17. Genuine interest in Aviation Radio maintenance and operation. Contact George Pasquale, W8OQU, Air Communications Chief, Airport Control Station KOFI, Old Richards Field, Kansas City, Mo.

SELL 275 watt phone — CW transmitter, complete in Parmetal 66" cabinet. Arranged for remote or direct control. Contains antenna relay and matching system. High quality speech amplifier. Same as transmitter page 38 Taylor Tube Manual except speech amplifier in place of low frequency RF chassis. Contains over \$300 of high quality parts. Complete with tubes and remote control box. \$150 cash. M. H. Price, 144-16 35th Ave., Flushing, N. Y.

QSL'S. Finest. Samples. Maleco, 1805 St. Johns Place, Brooklyn, N. Y.

OLD QST'S — April 1924 through April 1926 except June 1925. Sell — trade all or separate. David Cowie, Box 751, Alexandria, Va.

PHONE monitor — field strength meters. Keying monitors. Guaranteed. Inexpensive. W2BCP.

PONY relays, novel form, Bunnell No. 570, display stock, 20 ohms, price \$3.49. Scientific Exchange, Brooklyn, N. Y.

QSL'S — Samples. Edw. Reider, Pleasant Hill, Mo.

WANTED: Volume 1 QST and other issues prior to 1920. W1EWF, Dick Dunham, River Ridge, Hanover, N. H.

TRANSMITTER, like new. 200 watts. Hallicrafters receiver. Any offer considered. W2MDT.

THE late H. V. Seaman W3CVL's equipment for sale. Hammarlund Super Pro and 807 xmitter all in Bud sectional rack. Photo. W3FIT, Stockholm, N. J.

QSL'S & SWL'S — Fritz, 1213 Briargate, Joliet, Ill.

MARINE 18-B special — table model, bandswitching 20, 40, 80; output 260 watts CW; 70 watts phone. Complete; tubes, xtls, crystal mike. Used very little — \$465 when new — best offer takes it. Box 638, 316 Huntington Ave., Boston, Mass.

CRYSTALS, commercial or amateur; aircraft, police, defense projects, marine, etc. A complete line of dependable crystal units is available for commercial services. Over a period of years, Eidson commercial crystals have a record of 70.7% repeat sales — satisfaction set that record. Send for catalog. Amateurs: those unbeatable T9 40 and 80 meter crystals still sell for only \$1.60. 160's temporarily discontinued. T9 spot frequencies 40 or 80 meter bands now \$2.50 or \$3.60 with T9 holder. Order from Eidson's, Temple, Texas, or dealers previously listed.

WANTED — Rek-O-Kut. W9JWM.

WANTED — Commercially built 500 or 1000 watt transmitter, New York City or vicinity. Write details to W2LVZ.

HOME built freq. meter and power pack for sale. Write W8KJ for details.

CRYSTAL-swap Hamads should use the following standard form. Simply say: the frequency of your crystal, its make and type, the frequency (or between what frequencies) you want, your call. For instance: 1890 Bliley LD2 — 1817-1823. W1KH, means W1KH has an 1890 kc. Bliley type LD2 he wants to swap for some crystal between 1817 and 1823. For so long as there is considerable demand for crystal-swap Hamads, this explanation will appear each month.

SALE: Modernized 150 watt factory fone xmitter, \$150. W5EKY.

THAT ULTRA-HIGH GEAR OF YOURS
MAY GET OUT MORE SUCCESSFULLY IF
CONNECTED TO A

Good Antenna

AND GOOD ANTENNAS ARE CERTAINLY
DESCRIBED IN THE "ANTENNAS FOR
THE U.H.F." CHAPTER OF THE HAND-
BOOK.



- ★ **MERCHANDISE** . . . You name the article you want and the chances are that we can reach for it on our shelf. Frankly, we anticipated the growing shortages of materials a long, long time ago, and realizing that our National Defense Program would place a strain upon the manufacturing facilities of most of the reputable suppliers of radio equipment, we placed the bulk of our orders *BEFORE* commercial production "jammed."
- ★ **PRODUCTS** . . . of more than 80 of the country's leading radio equipment and parts manufacturers are listed in our 340-page catalog.
- ★ **OUR SHOWROOMS and OUR STOCK ROOMS** . . . have been enlarged to facilitate servicing your requirements.
- ★ **IF WE HAVEN'T** it in stock . . . and **NOBODY** can claim to have **EVERY** product on hand, we'll darn near break our necks to get it for you.
- ★ **PRICE DISCOUNTS** to amateurs are being maintained at the same standard level.
- ★ **CAMERAS and CAMERA ACCESSORIES** . . . are in a separate department, but attractive trade-in allowances or "swap" deals can be arranged on camera for radio or radio gear for camera equipment. What have you?
- ★ **YOUR CONTINUED PATRONAGE** . . . is valued above anything else. **YOU** are the one we aim to please.

LET HARVEY'S BE YOUR DEPENDABLE SOURCE OF SUPPLY

You'll Find Satisfaction!

W2IJJ • W2LJA • W2PL • W2KWY

OUR *Best* VALUE IS OUR RECORD OF LOYAL SERVICE

HARVEY

Radio Company of New York

103 WEST 43rd STREET • NEW YORK, N. Y.

CABLE ADDRESS: "HARADIO"

New LOW PRICE

With the co-operation of our suppliers, we have designed and worked out the radiogram blank in more economical form. Effective July 1 we will be able to supply these with the same number of blanks (100) per pad to sell for **20c** rather than 25c.

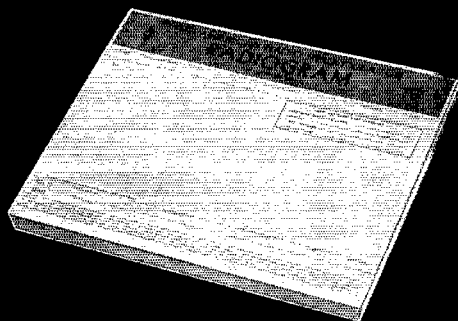

OFFICIAL RADIOGRAM FORMS

The radiogram blank is designed to comply with the proper order of transmission. It has a strikingly-new heading that you will like. Radiogram blanks, 8 $\frac{3}{8}$ x 6 $\frac{1}{2}$, lithographed in green ink, and padded 100 blanks to the pad.

20¢ per pad, postpaid

(No stamps, please)

*American Radio
Relay League, Inc.*

WEST HARTFORD, CONNECTICUT

Your Nearby Dealer Is Your Best Friend

Your nearby dealer is entitled to your patronage. He is equipped with a knowledge and understanding of amateur radio. He is your logical source of advice and counsel on what equipment you should buy. His stock is complete. He can supply your needs without delay. His prices are fair and consistent with the high quality of the goods he carries. He is responsible to you and interested in you.

One of these dealers is probably in your city — Patronize him!

ATLANTA, GEORGIA

Radio Wire Television Inc.
265 Peachtree Street
"The World's Largest Radio Supply House"

HOUSTON, TEXAS

R. C. & L. F. Hall
1021 Caroline Street (C 0721)
"Specialists in Amateur Supplies"

BALTIMORE, MARYLAND

Radio Electric Service Co.
3 N. Howard St.
Everything for the Amateur

NEWARK, N. J.

Radio Wire Television Inc.
24 Central Avenue
"The World's Largest Radio Supply House"

BOSTON, MASS.

Radio Wire Television Inc.
110 Federal Street
"The World's Largest Radio Supply House"

NEW YORK, N. Y.

Radio Wire Television Inc.
100 Sixth Avenue
"The World's Largest Radio Supply House"

BUFFALO, NEW YORK

Radio Equipment Corp.
326 Elm Street
W8PMC and W8NEL — Ham service and sound equipment

NEW YORK, N. Y.

Harrison Radio Company
12 West Broadway
Harrison Has It! Phone WO 0rh 2-6276 for information or rush service

BUFFALO, NEW YORK

Dymac Radio
1531 Main Street — Cor. Ferry
Owned and operated by Hams for Hams GA. 0252

PHILADELPHIA, PENNSYLVANIA

Eugene G. Wile
10 S. Tenth Street
Complete Stock of Quality Merchandise

HARTFORD, CONNECTICUT

Radio Inspection Service Company
227 Asylum Street
What do you want? We have it. Radio exclusively

PROVIDENCE, RHODE ISLAND

W. H. Edwards Company
85 Broadway
National, Hammarlund, Hallicrafter, Thordarson, Taylor, RCA

HARTFORD, CONNECTICUT

Hatry & Young, Inc.
203 Ann Street
Stores also in Bridgeport and New Haven

SCRANTON, PENNSYLVANIA

Scranton Radio & Television Supply Co.
519-521 Mulberry Street
Complete Stock of Quality Amateur Supplies

YOU CAN BE SURE
WHEN YOU BUY FROM

QST

ADVERTISERS

“Advertising for *QST* is accepted only from firms who, in the publisher’s opinion, are of established integrity and whose products secure the approval of the technical staff of the American Radio Relay League.”

Quoted from QST’s advertising rate card.

Every conceivable need of a radio amateur can be supplied by the advertisers in QST. And you will know the product has the approval of the League’s technical staff

Index to Advertisers

	PAGE
Abbott Instrument, Inc.	80
American Lava Corporation	81
American Radio Institute	95
Amperex Electronic Products, Inc.	Cov. 2
Astatic Corporation, The	95
Ayers, N. C.	102
Bliley Electric Company	99
Candler System Company	90
Capitol Radio Engineering Institute	78
Cardwell Mfg. Corp., Allen D.	76
Centralab	5
Commercial Radio Institute	95
Daven Company, The	98
Dodge’s Institute	94
Echophone Radio Company	106
Eitel-McCullough, Inc.	79
General Electric Company	77
Hallcrafters Company, The	1, 2
Hammarlund Mfg. Company, Inc.	69, 71
Harrison Radio Company	105
Harvey Radio Company	108
Henry Radio Shop	111
Hipower Crystal Company	96
Instructograph Company, The	99
International Resistance Company	91
Johnson Company, E. F.	83
Kenyon Transformer Company, Inc.	82
Mallory & Company, Inc., P. R.	68
Massachusetts Radio School	95
Meissner Mfg. Company	73
Midland Radio & Television Schools, Inc.	98
Millen Mfg. Company, Inc., James	90
National Company	Cov. 3, 67
New York YMCA Schools, Inc.	95
Newark Electric Company	75, 86
Nilson Radio School	94, 99
Ohmite Mfg. Company	85
Petersen Radio Company	102
Pioneer Gen-E-Motor Corp.	95
Port Arthur College	84
Precision Apparatus Company	94
RCA Institutes, Inc.	94
RCA Mfg. Company, Inc.	Cov. 4
Radio City Products Company, Inc.	96
Radio Control Headquarters, Inc.	99
Radio Shack, The	97
Sickles Company, F. W.	94
Signal Electric Mfg. Company	86
Solar Mfg. Corporation	70
Standard Radio Parts Company	108
Standard Transformer Corp.	72
Sun Radio Company	104
Taylor Tubes, Inc.	87
Teleplex Company	96
Terminal Radio Corp.	100
Thordarson Electric Mfg. Company	74
Triplett Elec. Instr. Company, Inc.	99
United Transformer Corp.	112
Ward Leonard Electric Company	102
Wholesale Radio Laboratories	101
Yaxley	68



. . . so you are going to get a receiver. . . .

There are hundreds of places you can get a good communications receiver right in your own neighborhood, so there must be *some reason* why we (way down here in Butler) are the very largest distributor in the country. Maybe it's because you get personal service directly from the boss. Maybe it's because you get prompt shipment from the world's largest stock of all makes and models of amateur communications receivers. Maybe it's because you get easy terms with nobody

**WORLD'S LARGEST DISTRIBUTOR
OF AMATEUR RECEIVERS**

in the deal but you and me. Maybe it is because you get the best trade-in value for your old receiver here. Or maybe because I ship everything on a 10-day free trial.

But, anyway, write me and I will help get the best receiver for your money and see that you are 100% satisfied.



FOR BETTER
DELIVERIES

•
ANOTHER

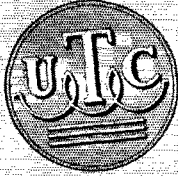

PLANT

Added facilities in another UTC plant now bring the size of UTC to thirty times that in 1933. This new plant assures a continuance of UTC's fine delivery record.



For Better Products ... Continuous Research



As an organization founded on research and design ingenuity, the UTC research laboratories are unusually fine. A continuous research and development program is maintained to improve the quality and dependability of UTC products. In addition, customers' problems and their solutions are handled by a competent staff of application engineers.



UNITED TRANSFORMER CORP.

150 VARICK STREET ★ NEW YORK, N. Y.

EXPORT DIVISION: 100 VARICK STREET NEW YORK, N. Y. CABLES: "ARLAK"



NC-45

THE NC-45

Series valve noise limiter with automatic threshold control.
Improved AVC Circuit.
Eight tube superheterodyne circuit.
Full vision dial with separate bandspread condenser.
Tone control.
CW Oscillator.
Four range coil switch, 550 KC to 30 MC.
Three models—for batteries, for AC-DC and for AC only.

Amateur Net Price \$57.50
including speaker and tubes

THE NC-200

Sensitivity better than one microvolt.
Series valve noise limiter.
Improved crystal filter with rejection ratios as high as 10,000 to 1.
Stability 3 parts in 100,000 for 20 volt line fluctuation.
AC line or portable operation.
Speaker in matching cabinet.

Amateur Net Price \$159.50
without speaker

NC-200

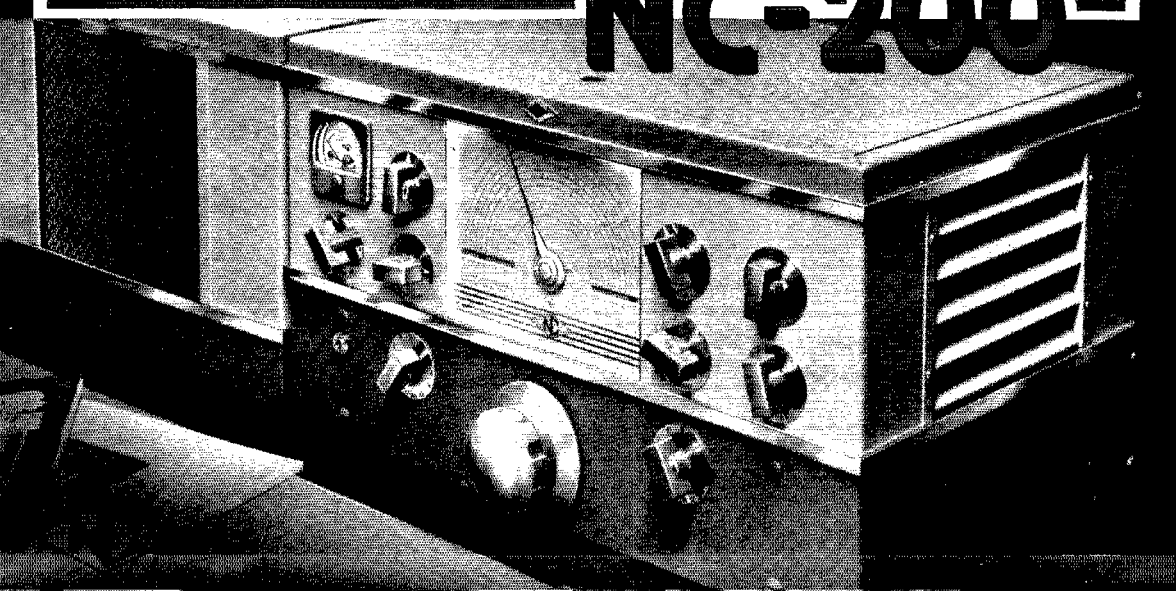

**HANDLES
300 WATTS INPUT
AT 5 METERS!**

Two RCA-8005's give class C phone power output of approximately 340 watts under ICAS rating in this Push-Pull R-F Power Amplifier, described in detail in the new RCA Guide for Transmitting Tubes. Price 25c from your RCA Parts and Equipment distributor.



RCA-8005

Transmitting Triode *De Luxe*

(RADIO FREQUENCY AMPLIFIER AND CLASS B MODULATOR) **\$700**
Amateur Net

Of the same physical dimensions as the famous 809 and 812, the new RCA-8005 Transmitting Triode De Luxe can handle a third more plate input than the 812 and three times that of the 809!

Compared with the popular 203-A, the RCA-8005 costs 30% less, gives higher power output and can be used at full ratings at much higher frequencies. Its ability to handle a full input of 300 watts* at 5 meters not only sets a new high

for a tube of this input rating, but paves the way for the design of compact new transmitters of exceptional effectiveness.

A single tube in class C telegraph service will handle 300 watts* input and deliver about 220 watts of power with less than 8 watts of grid drive. In plate modulated service, it will take 240 watts* with only 9 watts of grid drive. In self-rectifying oscillator circuits, such as used in therapeutic devices, two 8005's (ccs) are capable of delivering an output of 250 watts when the circuit efficiency is 75%. A pair of 8005's can easily be driven by either an 807 or an 809.

This remarkable performance is due to a number of recently developed design features which make the RCA-8005 a truly de luxe tube in every sense of the word. Its hard-glass bulb is capable of withstanding unusually high temperatures. Its molybdenum anode has the famous RCA Zirconium coating, assuring exceptional heat-dissipating qualities and getter action. Its ceramic plate cap insulator minimizes corona discharge. Its metal-shell base has special ceramic insulation. An extra heavy-duty 32.5-watt thoriated-tungsten filament assures an enormous emission reserve.

In brief, from plate cap to socket pin, the RCA-8005 is constructed for outstanding performance and dependability. It is a tube you can count on to deliver the goods under the most severe conditions—in all classes of service.

*RCA ICAS Rating



Transmitting Tubes

PROVED IN COMMUNICATION'S MOST EXACTING APPLICATIONS

RCA MANUFACTURING CO., Inc., Camden, N. J. • A Service of The Radio Corporation of America

For Canadian prices write to RCA Victor Company Limited, Montreal

