

february, 1940
25 cents

QST

devoted entirely to

amateur radio



The T-100 Design—An Effective Low-Cost F. M. Transmitter

COLLINS 51 F

The 51F Receiver is composed of a number of units or sub-assemblies such as the r-f section pictured to the right. These units are arranged and quickly interconnected at the factory to form several additions to or adaptations of the basic super-heterodyne circuit.

By this method of receiver unit assembly you pay for only those features which you want.

In furnishing you with a 51F receiver it is only necessary that we know what facilities you require. You can also consider the following optional features:

- Rack or table mounting cabinet.
- Remote control facilities.
- Crystal controlled or self controlled h.f. oscillator.
- Crystal controlled or self controlled h.f. oscillator.

By making the set to order for a pre-determined frequency and for a particular type of operation it is possible to obtain performance much superior to that of a general purpose receiver.

Where the frequency is seldom changed Collins 51F Fixed Tune Receiver will do a bang-up job for you.

Frequency Range: 1.5 mc to 20 mc.

Selectivity: Total band width 3 kc at 6 db down and 18 kc at 60 db down.

Sensitivity: 2 microvolts, 30% modulated at 400 c.p.s. for 50 milliwatts output and 6 db signal to noise ratio.

Automatic Gain Control: Audio output variation less than 3 db with signal input 5 microvolts to 0.1 volts.

Image Rejection: 95 db at 5000 kc.

Power Output: 500 milliwatts into 500 or 8 ohm resistive load.

Audio Squelch Circuit: Electronic circuits can be provided to disable the audio channel in the absence of received signal.

Hum: Less than 6 microwatts at any gain control setting.

Power Requirements: 115 volts 50/60 cycles a.c. with self contained rectifier and filter unit.

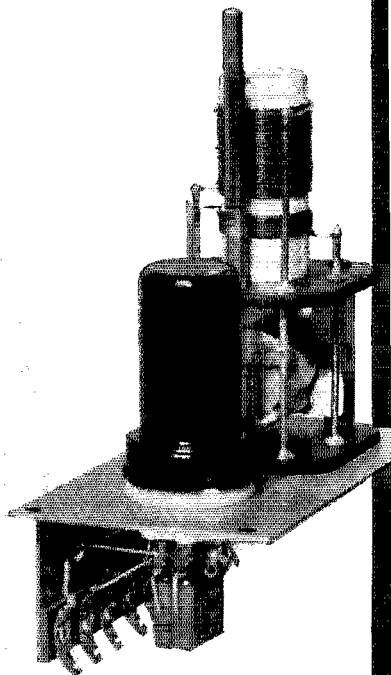

COLLINS RADIO COMPANY

CEDAR RAPIDS, IOWA

NEW YORK, N. Y.: 11 WEST 42 STREET

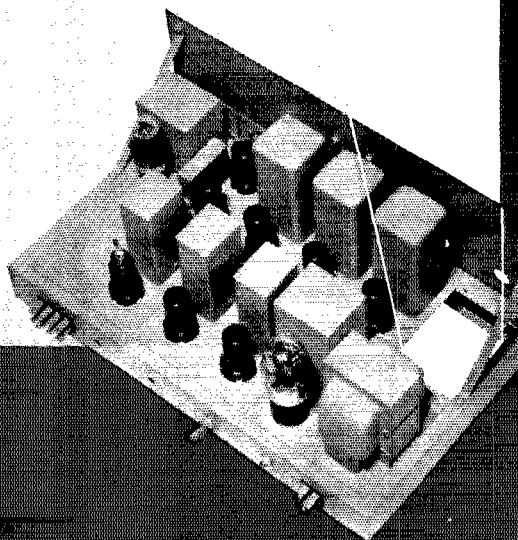
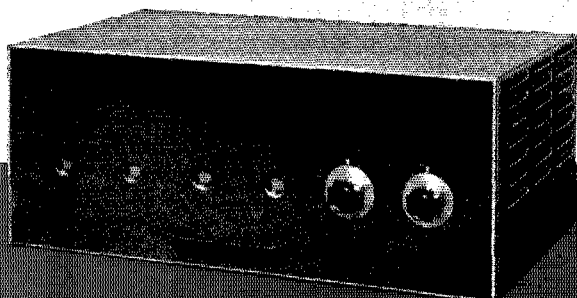

fixed tune receiver

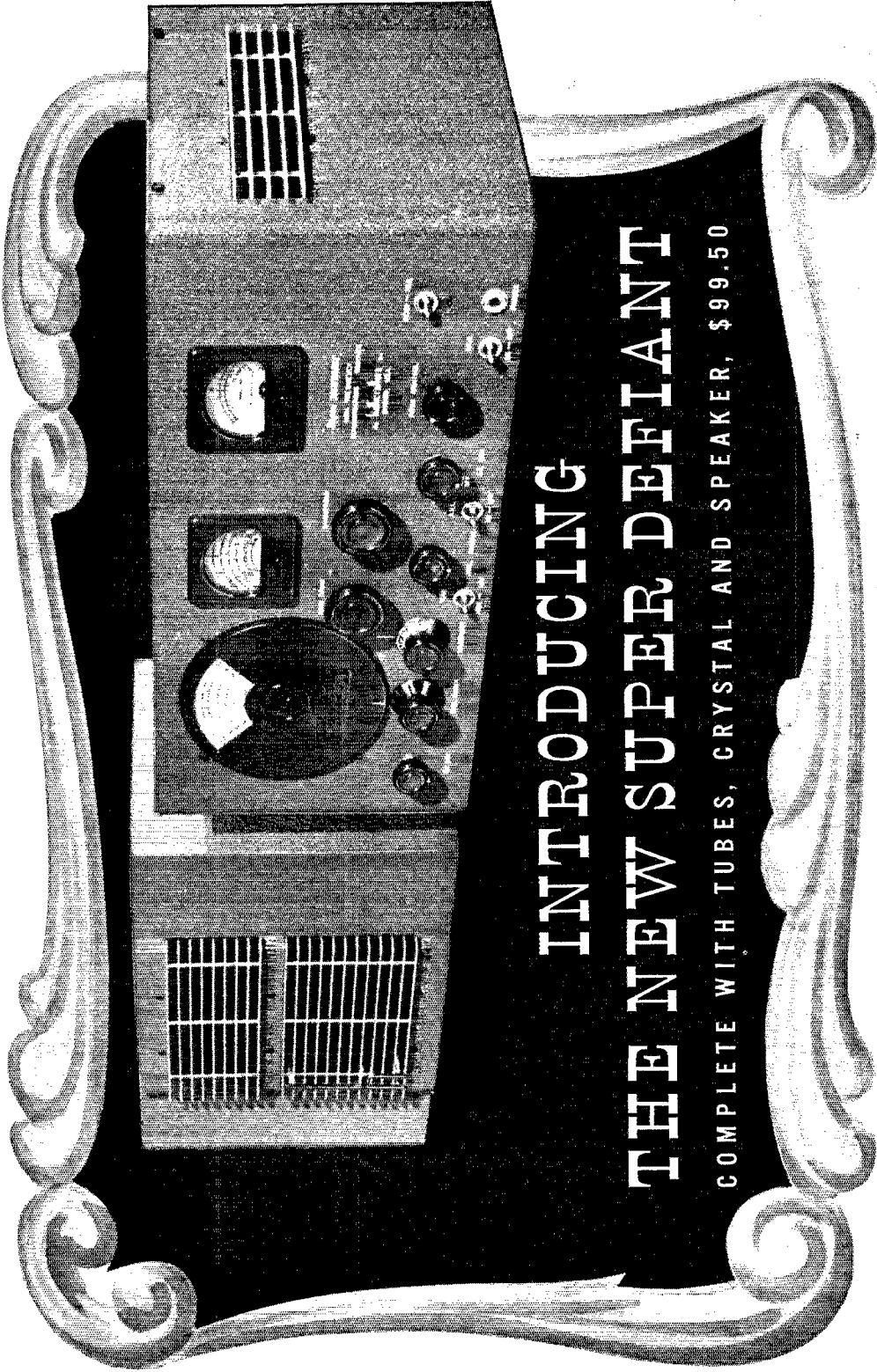

INTRODUCING
THE NEW SUPER DEFIANT

COMPLETE WITH TUBES, CRYSTAL AND SPEAKER, \$99.50

MORE PRESELECTION • MORE AND BETTER AUDIO



THE LATEST DEVELOPMENT IN COMMUNICATIONS SCIENCE

A communications receiver with all the essentials of the famed Super Skyrider (SX-17) . . . but selling at a far more modest price!

A communications receiver with the fundamentals of the popular Skyrider Defiant . . . but with MORE PRESELECTION and MORE and BETTER AUDIO!

Those were the answers when we asked hundreds and hundreds of amateurs all over the world what more we could do to satisfy the amateurs' needs. We are very proud to be able to present a receiver that precisely fits those qualifications . . . the new Hallicrafters SUPER DEFIANT.

It gives superlative amateur performance, yet sells COMPLETE WITH CRYSTAL, SPEAKER and 12 TUBES for only \$99.50. You can see it at your Jobber's TODAY.

W. J. Halligan

the hallicrafters inc.

CHICAGO, U. S. A.

"WORLD'S LARGEST BUILDERS OF AMATEUR COMMUNICATIONS EQUIPMENT"

FEBRUARY 1940

VOLUME XXIV

NUMBER 2



STAFF

Editorial

KENNETH B. WARNER, W1EH
Editor and Business Manager

CLARK C. RODIMON, W1SZ
Managing Editor

GEORGE GRAMMER, W1DF
Technical Editor

DONALD H. MIX, W1TS
BYRON GOODMAN, W1JPE
Assistant Technical Editors

EDW. P. TILTON, W1HDQ
Contributing Editor, U.H.F.

VERNON CHAMBERS, W1EQ
Technical Information Service

JAMES J. LAMB, W1AL
Research Engineer, A.R.R.L.

Advertising

F. CREYNEY BEEKLEY, W1GS
Advertising Manager

CHARLES BRUNELLE
Asst. Advertising Manager

Circulation

DAVID H. HOUGHTON
Circulation Manager

RALPH T. BEAUDIN, W1BAW
Asst. Circulation Manager



OFFICES

38 La Salle Road
West Hartford, Connecticut

Subscription rate in United States and Possessions and Canada, \$2.50 per year, postpaid; all other countries, \$3.00 per year, postpaid. Single copies, 25 cents. Foreign remittances should be by international postal or express money order or bank draft negotiable in the U. S. and for an equivalent amount in U. S. funds.

Entered as second-class matter May 29, 1919, at the post office at Hartford, Connecticut, under the Act of March 3, 1879. Acceptance for mailing at special rate of postage provided for in section 1103, Act of October 3, 1917, authorized September 9, 1922. Additional entry at Concord, N. H., authorized February 21, 1929, under the Act of February 28, 1925. Additional second-class entries to cover sectional editions authorized March 20, 1935.

Copyright 1940 by the American Radio Relay League, Inc. Title registered at United States Patent Office.

QST

devoted entirely to

AMATEUR RADIO

PUBLISHED, MONTHLY, AS ITS OFFICIAL ORGAN, BY THE AMERICAN RADIO RELAY LEAGUE, INC., AT WEST HARTFORD, CONN., U. S. A.; OFFICIAL ORGAN OF THE INTERNATIONAL AMATEUR RADIO UNION



CONTENTS

| | |
|--|-----|
| Editorial | 9 |
| Splatter | 10 |
| Instant Band-Change With Push-Button Control <i>Leon Linn, W9LHF</i> | 11 |
| Lop-sided Speech and Modulation . . . <i>George Grammer, W1DF</i> | 14 |
| Compact Battery Receiver for Station or Portable Use <i>Don H. Mix, W1TS</i> | 18 |
| A Practical 112-Mc. F.M. Transmitter <i>Byron Goodman, W1JPE</i> | 22 |
| What the League Is Doing | 26 |
| 1.75-Mc. W. A. S. Party | 28 |
| A Deflection and Video Chassis for Television Reception <i>Howard C. Lawrence, W2IUP</i> | 29 |
| A Regenerative Preselector With Output Metering Bridge <i>H. O. Tulen, W9PYQ</i> | 32 |
| "Wired Wireless" for Remote Control . . . <i>John Evans Williams</i> | 34 |
| Experience Speaks | 37 |
| WWV Schedules | 37 |
| Dixie Jones' Owl Juice | 37 |
| 12th A.R.R.L. DX Competition <i>F. E. Handy, W1BDI</i> | 38 |
| A.R.R.L. QSL Bureau | 41 |
| Quote and Unquote | 42 |
| U.H.F. Contest and Relay | 43 |
| Building and Tuning a Three-Element Beam <i>Harold Ulmer, W6EPM</i> | 44 |
| Silent Keys | 48 |
| Naval Communication Reserve Notes | 49 |
| On the Ultra Highs <i>E. P. Tilton, W1HDQ</i> | 50 |
| Results of U.H.F. Relay Number 2 <i>Joseph A. Moskey, W1JMY</i> | 52 |
| Another Approach to High Power <i>J. A. McCullough, W6CHE</i> | 54 |
| Navy Day — 1939 | 58 |
| Correspondence Department | 59 |
| Hints and Kinks <i>Novel Second-Detector Circuit — Blocked-Grid Oscillator Keying — A Flat Line for the Laxy-H Antenna — Calibrated B.F.O. as an Aid in Frequency Measurement</i> | 60 |
| I.A.R.U. News | 62 |
| Ham Shacks <i>W9NLP, W9SZW, SU1AM, ZLIMR</i> | 64 |
| Operating News | 66 |
| Brass Pounders' League | 69 |
| How's DX? | 70 |
| Safety ABC's | 122 |
| Hamads | 123 |
| QST's Index of Advertisers | 126 |

ON THE FACE OF IT

these capacitors are twins

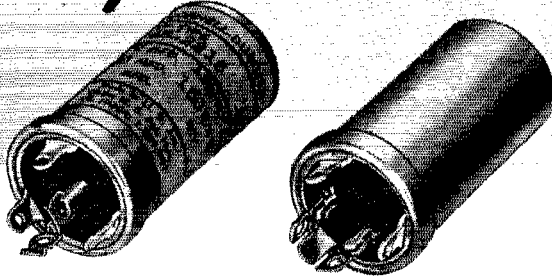

but

... inside, it's a different story. Inside, experience tells. In selection of materials, assembly of parts, quality of components, the Cornell-Dubilier capacitor is outstanding. Consider the C-D Midget Type UP — the smallest can type electrolytic capacitor made. This unit is hermetically sealed in aluminum can with positive terminal lugs

on a Bakelite insulating cover. Equipped with projecting tongues for mounting in vertical position. Exceptionally low leakage and power factor. Especially dependable in operation over wide temperature variations. Available in single, dual and multiple combinations at all popular voltage ranges. Next time, specify C-Ds. Your dealer will appreciate it. For he, too, knows the difference. Type UP's described in catalog No. 175A free on request.

Product of the world's largest manufacturer of capacitors

MICA · DYKANOL · PAPER · WET & DRY ELECTROLYTICS

you can rely on

CORNELL-DUBILIER
a great name in capacitors



**CORNELL-DUBILIER
ELECTRIC CORPORATION**

1013 Hamilton Boulevard, South Plainfield, New Jersey

Cable Address: "CORDU"

Cathode Modulation

BY *Stancor*

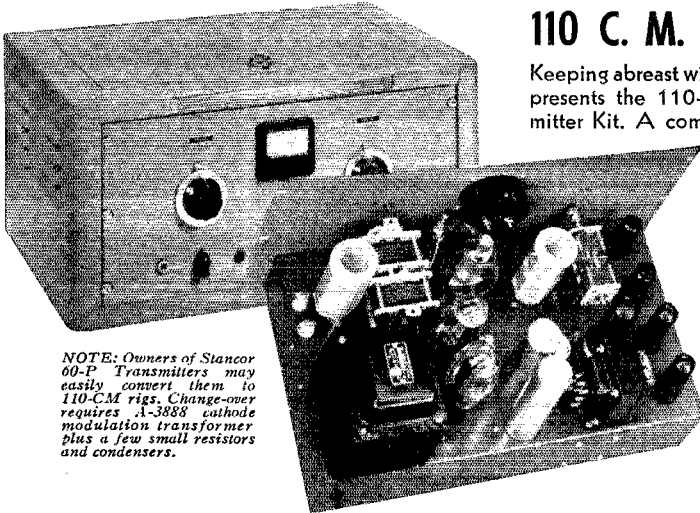

NOTE: Owners of Stancor 60-P Transmitters may easily convert them to 110-CM rigs. Change-over requires A-3888 cathode modulation transformer plus a few small resistors and condensers.

110 C. M. TRANSMITTER KIT

Keeping abreast with popular developments, Stancor presents the 110-CM Cathode Modulated Transmitter Kit. A completely self-contained, 110 watt crystal controlled phone-CW rig capable of producing a signal with a real "wallop." Two inexpensive manufactured plug-in coils are used for each band. R.F. amplifier employs new RCA 812 tube. Simplicity of design and detailed instructions make construction easy.

YOUR NET COST **\$48.75**

AND TWO NEW CATHODE MODULATION TRANSFORMERS

A-3888 — 250 M A

For modulating R.F. amplifier inputs up to 250 watts. Eight output impedances from 150 to 2500 ohms available.

YOUR NET COST **\$2.55**

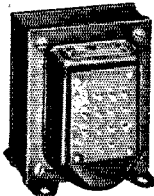

A-3889 — 450 M A

For modulating R.F. amplifier inputs up to 600 watts. Eight output impedances from 150 to 2500 ohms available.

YOUR NET COST **\$3.60**

ASK YOUR NEAREST STANCOR DISTRIBUTOR OR WRITE FOR HIS NAME



STANDARD TRANSFORMER

• CORPORATION •

1500 NORTH HALSTED STREET . . . CHICAGO

Section Communications Managers of the A.R.R.L. Communications Department

All appointments in the League's field organization are made by the proper S.C.M., elected by members in each Section listed. Mail your S.C.M. (on the 16th of each month) a postal covering your radio activities for the previous 30 days. Tell him your DX, plans for experimenting, results in phone and traffic. He is interested, whether you are an A.R.R.L. member or get your *QST* at the newstands; he wants a report from every active ham. If interested and qualified for O.R.S., O.P.S. or other appointments he can tell you about them, too.

| | | | |
|---|---|--|---|
| ATLANTIC DIVISION | | | |
| Eastern Pennsylvania Maryland-Delaware-District of Columbia | W3BES | Jerry Matlus | 5132 Haverford Ave. 9701 Monroe St. Silver Spring P.O. 704 Quinton Ave. |
| Southern New Jersey Western New York Western Pennsylvania | W3CIZ W3CZO W8PLA W8OFO | Hermann E. Hobbs Lester H. Allen Fred Chichester Kendall Speer, Jr. | Linden, Maryland Trenton Sonyea Lowber |
| CENTRAL DIVISION | | | |
| Illinois Indiana Kentucky Michigan Ohio Wisconsin | W9RMM W9QG W9ARU W8DPE W8AQ W9UIT | Leslie M. Dickson Noble Burkhardt Darrell A. Downard Harold C. Bird E. H. Gibbs Aldrich C. Krones | Edelyn Farms R. 1, Box 1 116 N. Longworth Ave. R.F.D. 2 408 Broad St. 2702 So. 46th St. |
| DAKOTA DIVISION | | | |
| North Dakota South Dakota Northern Minnesota Southern Minnesota | W9WWL W9YOD W9IGZ W9VNO | Anton C. Theodos Dr. A. L. Russek Edwin L. Wicklund Millard L. Bender | c/o American Cafe R.F.D. 3 608 N. Huron Ave. |
| DELTA DIVISION | | | |
| Arkansas Louisiana Mississippi Tennessee | W5ABI W5DWW W5EWD W4DWS | H. E. Vette W. J. Wilkinson, Jr. Jewell W. Cole William Harold Walker | 4415 West 12th St. 1523 Laurel St. c/o City of McComb Water Dept. 1901 Cedar Lane |
| HUDSON DIVISION | | | |
| Eastern New York N. Y. C. & Long Island Northern New Jersey | W2LU W2AZV W2GVZ | Robert E. Haight E. L. Baunach Joseph P. Jessup | 511 Third Holmes St. 102 Central Ave. 131 California St. |
| MIDWEST DIVISION | | | |
| Iowa Kansas Missouri Nebraska | W9PJR W9UEG W9OUD W9DI | L. B. Vennard Melvin D. Kirby Miss Letha Allendorf William J. Bamer | P. O. Box 304 1015 W. 3rd St. |
| NEW ENGLAND DIVISION | | | |
| Connecticut Maine Eastern Massachusetts* Western Massachusetts New Hampshire Rhode Island Vermont | W1CTH W1IFE W1GAG W1JAH W1BFT W1HKC W1KJG | Frederick Ellis, Jr. H. W. Castner Carroll O. Peacor William J. Barrett Carl B. Evans Clayton C. Gordon Clifton G. Parker | 19 Merrill Rd. 147 Church 24 Governor Rd. 239 Columbia St. 163 South Main St. 70 Columbia Ave., Gaspee Box 357 |
| NORTHWESTERN DIVISION | | | |
| Alaska Idaho Montana* Oregon Washington | K7BNA W7EMT W7CPY W7DNF W7FCG | Leo E. Osterman Carl Eichelberger Rex Roberts Harold W. Johnston W. Beale | Customhouse Route 2 Box 1088 800 Jackson St. R. 4, School Ave. |
| PACIFIC DIVISION | | | |
| Hawaii Nevada Santa Clara Valley East Bay San Francisco Sacramento Valley Philippines San Joaquin Valley | K6ETF W6BIC W6BFW W6T1 W6CIS W6MDI KA1GR W6KUT | Francis T. Blatt Edward W. Helm Elbert Amarantes Horace R. Greer Kenneth E. Hughes Vincent N. Feldhausen George L. Rickard Edwin A. Andress | 837 16th Ave. 509 Claremont St. 454 Washington St. 414 Fairmount Ave. 622-46th Ave. 113 South Quincy St. Box 849 2921 North Van Ness Blvd. |
| ROANOKE DIVISION | | | |
| North Carolina South Carolina Virginia* West Virginia | W4GYB W4BOE/ANGT W3GWQ W8OXO | W. J. Wortman Edward Ferguson Frank S. Anderson, Jr. W. D. Tabler | P. O. Box 566 1213 College St. 4703 New Kent Ave. 238 Watson Ave. |
| ROCKY MOUNTAIN DIVISION | | | |
| Colorado Utah-Wyoming | W9EHC W7CLG | Carl C. Drumeller Ernest E. Parshall | 819 East Dale St. Satt Creek Electric Plant |
| SOUTHEASTERN DIVISION | | | |
| Alabama Eastern Florida Western Florida Georgia West Indies (Cuba-Isle-of-Pines- Porto Rico-Virgin Islands) | W4DGS W4PEI W4AXP W4AGI CM2OP | James F. Thompson Carl G. Schaal Oscar Cederstrom Leland W. Smith Mario de la Torre | 12 Clanton Ave. Waucoma Apts. Lakeview Hotel Swand St. & Bruce Ave. 2010 Pennsylvania Ave. Escobar 110 (Altos) |
| SOUTHWESTERN DIVISION | | | |
| Los Angeles Arizona San Diego | W6MQM W6KMM W6JRM | Ralph S. Click Marson B. Hull Howard K. Breedlove | 1038 Milwaukee Ave. 617 North Fourth Ave. R. 2, Box 636 |
| WEST GULF DIVISION | | | |
| Northern Texas Oklahoma Southern Texas New Mexico | W5DXA W5GPT W5MN W5EN1 | Lee Hughes Russell W. Battern Horace E. Biddy Dr. Hilton W. Gillett | 125 N. Main St. 431 South Buchanan 1746 Schley Ave. |
| MARITIME DIVISION | | | |
| Maritime | VE1DQ | A. M. Crowell | 69 Dublin St. |
| ONTARIO DIVISION | | | |
| Ontario | VE3SG | F. H. B. Saxon | 302 Lee Ave. |
| QUEBEC DIVISION | | | |
| Quebec | VE2CO | Lindsey G. Morris | Apt. 6, 4510 Girouard Ave., N.D.G. |
| YANALTA DIVISION | | | |
| Alberta British Columbia | VE3GE VESHP | C. S. Jamieson J. Hepburn, Jr. | 581 W. Riverside Drive 335 Foul Bay Road |
| PRAIRIE DIVISION | | | |
| Manitoba Saskatchewan | VE4AAW VE4SY | A. W. Morley Arthur Chesworth | 747 McMillan Ave. 1071 4th Ave., N. W. |

* Officials appointed to act until the membership of the Section choose permanent S.C.M.s by nomination and election.

Pick These Pairs for Performance

For 110-watt Phone Output —

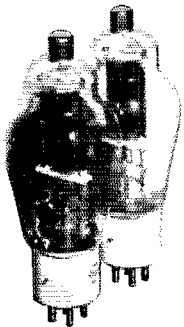

GL-809

CCS* rating

*As Class B modulators
(2 tubes)*

| | | |
|----------------|--------------------------|-----------|
| 50..... | Mu..... | 20 |
| 750..... | Plate Voltage..... | 750 |
| 200 mils..... | Plate Current (max)..... | 200 mils |
| 2.4 watts..... | Driving Power..... | 10 watts |
| 100 watts..... | Output Power..... | 110 watts |
| \$2.50..... | Price, each..... | \$2.50 |

GL-1623

ICAS rating

*As plate-modulated Class C
r-f amplifiers (2 tubes)*

For 240-watt Phone Output —

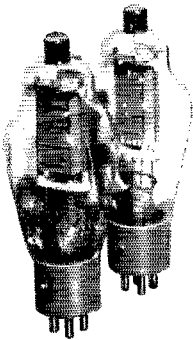

GL-811

CCS* rating

*As Class B modulators
(2 tubes)*

| | | |
|----------------|--------------------------|-----------|
| 160..... | Mu..... | 29 |
| 1250..... | Plate Voltage..... | 1250 |
| 200 mils..... | Plate Current (max)..... | 250 mils |
| 7.5 watts..... | Driving Power..... | 12 watts |
| 175 watts..... | Output Power..... | 240 watts |
| \$3.50..... | Price, each..... | \$3.50 |

GL-812

ICAS rating

*As plate-modulated Class C
r-f amplifiers (2 tubes)*

**The GL-809's and GL-811's may be operated slightly below their CCS ratings to avoid overmodulation.*

General Electric has been developing and manufacturing top-quality radio transmitting tubes since 1913. Now we offer a wide range of tube types for amateur service—priced low and unsurpassed in value. Bulletin GEA-3315 lists the complete G-E transmitting-tube line, together with technical data and prices. Get a copy from your dealer, or write to General Electric, Radio and Television Department, Schenectady, N. Y.

GENERAL ELECTRIC

900 28

THE AMERICAN RADIO RELAY LEAGUE

Directors

| | |
|---|---------|
| <i>President</i> | |
| EUGENE C. WOODRUFF | W8CMP |
| 234 W. Fairmount Ave., State College, Pa. | |
| <i>Vice-President</i> | |
| GEORGE W. BAILEY | W1KH |
| 74 Webster Road, Weston, Mass. | |
| <i>Canadian General Manager</i> | |
| ALEX REID | VE2BE |
| 169 Logan Ave., St. Lambert, P. Q. | |
| <i>Atlantic Division</i> | |
| WALTER BRADLEY MARTIN | W3QV |
| Box 612, Roslyn, Pa. | |
| <i>Central Division</i> | |
| R. H. G. MATHEWS | ex-W9ZN |
| 4534 Dover St., Chicago | |
| <i>Dakota Division</i> | |
| FRED W. YOUNG | W9MZN |
| 107 Hanover St., Mankato, Minn. | |
| <i>Delta Division</i> | |
| E. RAY ARLEDGE | W5BI |
| P.O. Box 286, Pine Bluff, Ark. | |
| <i>Hudson Division</i> | |
| KENNETH T. HILL | W2AHC |
| 115 Willow St., Douglaston, L. I., N. Y. | |
| <i>Midwest Division</i> | |
| FLOYD E. NORWINE | W9EFC |
| 7405 Hiawatha Ave., Richmond Heights, Mo. | |
| <i>New England Division</i> | |
| PERCY C. NOBLE | W1BVR |
| 37 Broad St., Westfield, Mass. | |
| <i>Northwestern Division</i> | |
| RALPH J. GIBBONS | W7KY |
| c/o United Air Lines, Portland, Ore. | |
| <i>Pacific Division</i> | |
| J. L. McCARGAR | W6EY |
| 66 Hamilton Pl., Oakland, Calif. | |
| <i>Ryanoke Division</i> | |
| H. L. CAVENES | W4DW |
| State College Station, Raleigh, N. C. | |
| <i>Rocky Mountain Division</i> | |
| GLEN R. GLASSCOCK | W9FA |
| 2164 So. Corona St., Denver | |
| <i>Southeastern Division</i> | |
| WILLIAM C. SHELTON | W4ASR |
| Box 652, Daytona Beach, Fla. | |
| <i>Southwestern Division</i> | |
| CHARLES E. BLALACK | W6GG |
| 1273 Main St., El Centro, Calif. | |
| <i>West Gulf Division</i> | |
| WILLIAM A. GREEN | W5BKH |
| 801 Ross St., Abilene, Texas | |

THE AMERICAN RADIO RELAY LEAGUE, INC., is a non-commercial association of radio amateurs, bonded for the promotion of interest in amateur radio communication and experimentation, for the relaying of messages by radio, for the advancement of the radio art and of the public welfare, for the representation of the radio amateur in legislative matters, and for the maintenance of fraternalism and a high standard of conduct.

It is an incorporated association without capital stock, chartered under the laws of Connecticut. Its affairs are governed by a Board of Directors, elected every two years by the general membership. The officers are elected or appointed by the Directors. The League is non-commercial and no one commercially engaged in the manufacture, sale or rental of radio apparatus is eligible to membership on its board.

"Of, by and for the amateur," it numbers within its ranks practically every worth-while amateur in the nation and has a history of glorious achievement as the standard-bearer in amateur affairs.

Inquiries regarding membership are solicited. A bona fide interest in amateur radio is the only essential qualification; ownership of a transmitting station and knowledge of the code are not prerequisite. Correspondence should be addressed to the Secretary.



HIRAM PERCY MAXIM, FIRST PRESIDENT

Officers

| | |
|---|---|
| <i>President</i> | EUGENE C. WOODRUFF, W8CMP |
| | State College, Pa. |
| <i>Vice-President</i> | GEORGE W. BAILEY, W1KH |
| | Weston, Mass. |
| <i>Secretary</i> | KENNETH B. WARNER, W1EH |
| | West Hartford, Connecticut |
| <i>Treasurer</i> | ARTHUR A. HEBERT, W1ES |
| | West Hartford, Connecticut |
| <i>Communications Mgr.</i> | F. EDWARD HANDY, W1BDI |
| | West Hartford, Connecticut |
| <i>General Counsel</i> | PAUL M. SEGAL |
| | 1026 Woodward Building, Washington, D. C. |
| <i>Address all general correspondence to the administrative headquarters at West Hartford, Connecticut.</i> | |

"IT SEEMS TO US—"

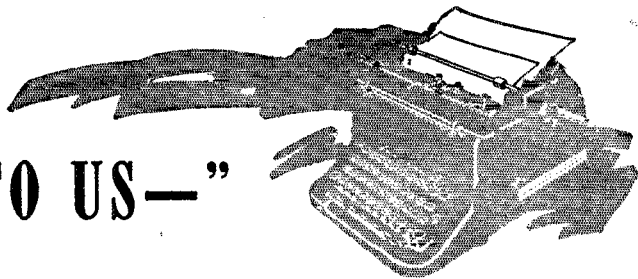

AMATEUR radio is embarking now upon a course of experimentation designed to show what applicability frequency-modulated voice transmission has to the amateur service. What we most need and hope for is the coöperative interest of a considerable number of $2\frac{1}{2}$ -meter experimenters who will build f.m. apparatus for their own stations and give it an actual working-out under practical operating conditions. From our own work with a couple of transmitters and a couple of receivers, we know that the gear performs very well. Just how wide-band f.m. will work out on the amateur bands is another question. The outlook is very encouraging, but the real story won't be told until a number of such stations get on the air simultaneously in the same community.

An encouraging outlook, we say, and you'll agree when you see how simple, compact and inexpensive the f.m. transmitting apparatus is. It certainly shames plate modulation. It is a natural for portable and mobile work. It almost completely eliminates electrical interference. And for good-quality voice transmission it is not going to take up as much spectrum space as we feared a couple of years ago when we didn't know so much about it. As George Grammer pointed out last month, excellent results can be obtained with an "excursion" of 25 kc. or an emitted band width of 50 kc., and that means that there is room in the $2\frac{1}{2}$ -meter band for eighty such transmitters operating locally without interference. It leads us to think of the possibility of having part of our 5-meter band opened to f.m. For instance, the quarter of this band from 59 to 60 Mc. would accommodate twenty such channels, and the ignition rumpus on this band is so much more severe that the benefits would be even more welcome.

Space in the $2\frac{1}{2}$ -meter band for eighty local transmitters. That presupposes that they are neatly spaced in frequency, one after the other through the band. Suppose they aren't. Suppose some of them overlap or are on the same frequency; what then? Well, there's the rub: we don't actually know. Two f.m. signals of about the same strength and on about the same frequency are supposed to produce hash, much the same as in a.m. But whenever one signal is about twice as strong as interfering signals, even on exactly the same frequency, the strong signal takes command of the re-

ceiver and the weaker signals are supposed to disappear completely. This sounds swell. But suppose one of the weaker signals is the one you want—what then? Well, we think the answer lies in the use of rotatable directive antennas, which are easy to build for the u.h.f. and which naturally would be of tremendous assistance in building up the weak wanted signal and in reducing the strong unwanted signals, so that the wanted signal "takes hold." Of course when the two lie along the same line . . . (Dots denoting shrugs.) But things are never perfect in amateur operating and we don't believe any of us would survive the shock of knowing that interference-free operation had actually been attained.

The ultra highs have always been a delightful field for the experimenter. With the fascination of f.m. compounded, it becomes doubly intriguing. Most of the radio world is now talking f.m.—not only the broadcasters but the police, aviation and marine people, and so on—and the Federal Communications Commission has just announced informal hearings to be held the end of February to adduce data that will aid in determining the future of f.m. in the broadcasting service. F.m. is a field in which we hams do not intend to be left behind. At Headquarters we're helping by building and presenting apparatus that you can readily build. But Headquarters can't make "field tests" with dozens of stations in simultaneous operation in the same city. That's where you 112-Mc. u.h.f. men come in. If you'll get going, and develop an operating technique, and report your observations, we'll know in a very short while just how much improvement f.m. offers us in practice; whether this 2:1 ratio is a godsend or a curse for our purposes; whether the rotary beam gives us back the ability to communicate with almost any station within range; whether the results look good enough to extend to the 5-meter band.

This very month you are witnessing amateur radio tackling a new problem—that of determining the applicability of f.m. to congested-band operation. Ours of course is an institutional attack. The sifting of collected amateur opinion, as those opinions take form through practical experience, will tell the answer. We invite all amateurs who enjoy the fascination of a new field to join in the work and report their results.

K. B. W.

★ SPLATTER ★

In "Quote and Unquote," which we are introducing to a waiting world, we will endeavor to present various sidelights on radio, of interest to our readers, that might not otherwise find their way into *QST*'s pages. Our initial effort tells about the amazing radio "terrain clearance" indicator used in aerial navigation and also a new development in reducing input capacity variations in vacuum tubes with changes in grid potential.

Our Cover

This shows in almost life-size fashion Goodman's latest creation in the realm of frequency-modulated transmitters. It will be noticed, upon a comparison between this shot and those within the article, that By was really ambitious at the time the cover was taken, and was operating considerably higher in frequency than 112 Mc. A new set of pipes corrected this in short order.

We are going ahead in this new field as fast as we can. At the moment we are working on a companion unit for the transmitter — a receiver that is practical for the ham constructor.

MOBILE F.M.-A.M. TESTS SHOW F.M. SUPERIORITY

MEASUREMENTS with signal generators give useful information, but are sort of cold, statistical things lacking the romance of actual communication. We knew from lab tests that frequency modulation really does a job in noise reduction, but that wasn't enough. So we fixed up a flea-power m.o.p.a. mobile outfit, arranged it so that the same carrier could be either frequency- or amplitude-modulated, and sent it out on the road, listening alternatively to the two types of modulation with receivers set up in a noisy location.

Results confirmed the most optimistic expectations. With the car going straightaway from the receiving point and over fairly level ground, a readable f.m. signal could be obtained at distances in the order of four or five times that at which the a.m. signal was just strong enough to be understood through the noise. (Yes, the a.m. receiver had the usual type of second-detector noise limiter in operation.) The f.m. signal at any distance was practically free from any type of noise except receiver hiss — the latter being the limiting factor when the carrier dropped down so low that it could not operate the limiter. The carrier strength at this point was not sufficient to make an impression on the "S" meter in the a.m. receiver over the noise level already registering.

At points where the a.m. signal could just be understood through the machine-gun background, the f.m. signal was, of course, completely free from interference — the kind of reception provided by a.m. only when the car was practically in the back yard.

There's no question about it — f.m. has what the city-dwelling u.h.f. man needs!



The oldest and youngest?

We don't know whether this is the "McCoy" or not, but it does represent, as far as we know, the oldest and one of the youngest if not the youngest licensed Amateur Radio Operators in the U. S. A.

The old fellow is Charlie R. Stedman, W9CAB, age 82, and the youngster is Ralph Taylor, W9FTV, age 11. Young Taylor received his license November 18, 1939, which is the reason for W9CAB's hearty congratulations pictured herewith.

Now the Denver gang, proud of their famous pair, would like to know of any licensed amateur operators who exceed these two extremes of age.

FEEDBACK

P. 52, December QST

In formula $Z = \frac{2P}{I^2}$, I should have been cathode current in amps.

P. 54, Fig. 1, December QST

In the 83 power supply there should be a connection from right side of C_{h4} to top of R_7 .

Instant Band-Change With Push-Button Control

*Mechanical Ganging for Motor-Driven
Stage Switches*

BY LEON LINN,* W9LHF

THE ideal amateur transmitter would be one with a kilowatt of power input, instantly changeable from one band to another, and operating on all frequencies in each band. Like all things, the ideal may not be economically achieved, so we are forced to compromise on some of these features. The transmitter pictured in this

* P. R. Mallory & Co., Inc., Indianapolis, Ind.

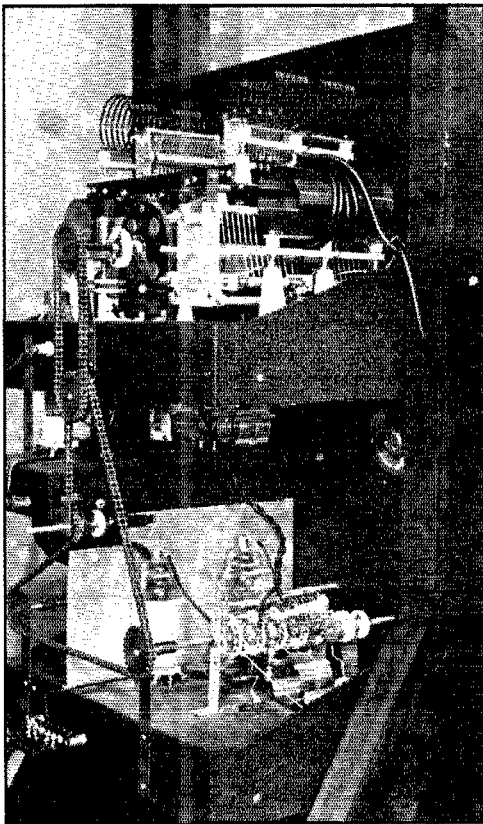

A close-up of the chain-ganged switches for push-button band-changing. Ordinary bicycle chains and sprockets are used to provide the mechanical linkage between switches on the various stages. The driving motor is mounted below the small chassis which projects to the rear at the left from the final-amplifier panel.

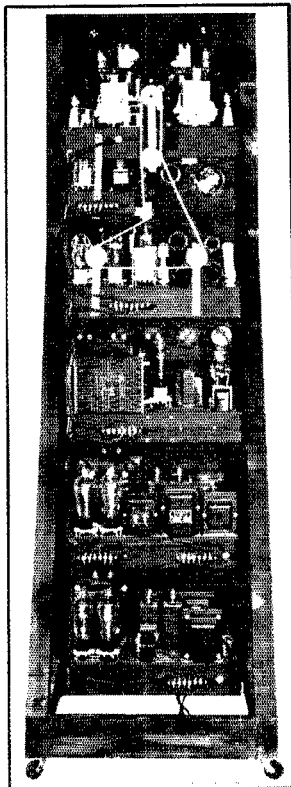

A rear view of the complete transmitter. Except for the switching arrangement, standard circuits are used throughout. Even though there is no necessity for getting behind this rig to change coils, the safety precaution of covering the power terminals would be added protection.

article makes possible, we believe, at least the major portion of this ideal. It has a power input of 450 watts and makes possible practically instantaneous band change.

In all modern broadcast receivers some method of push-button station selection is utilized. The same method is used for band changing in this transmitter, since this type of switch is readily available.

Band Switching

The type of switching system used for instantaneous band-changing naturally is closely related to the tube and circuit line-up in the r.f. section. Since the primary requirement in this case was operation in any of the four lower-frequency 'phone bands (160, 80, 20 and 10 meters) the r.f. end was designed to make the switching as simple as possible without sacrificing excitation or output at the highest frequency.

The r.f. section starts with two RK-34 dual-triode high-frequency tubes used as oscillators and doublers. The buffer consists of two RK-39's operated in push-pull, and the final is two RK-38's in push-pull. These particular tubes were chosen because they seemed the right size and type for this selected power. At the same time, they are operated well within ratings.

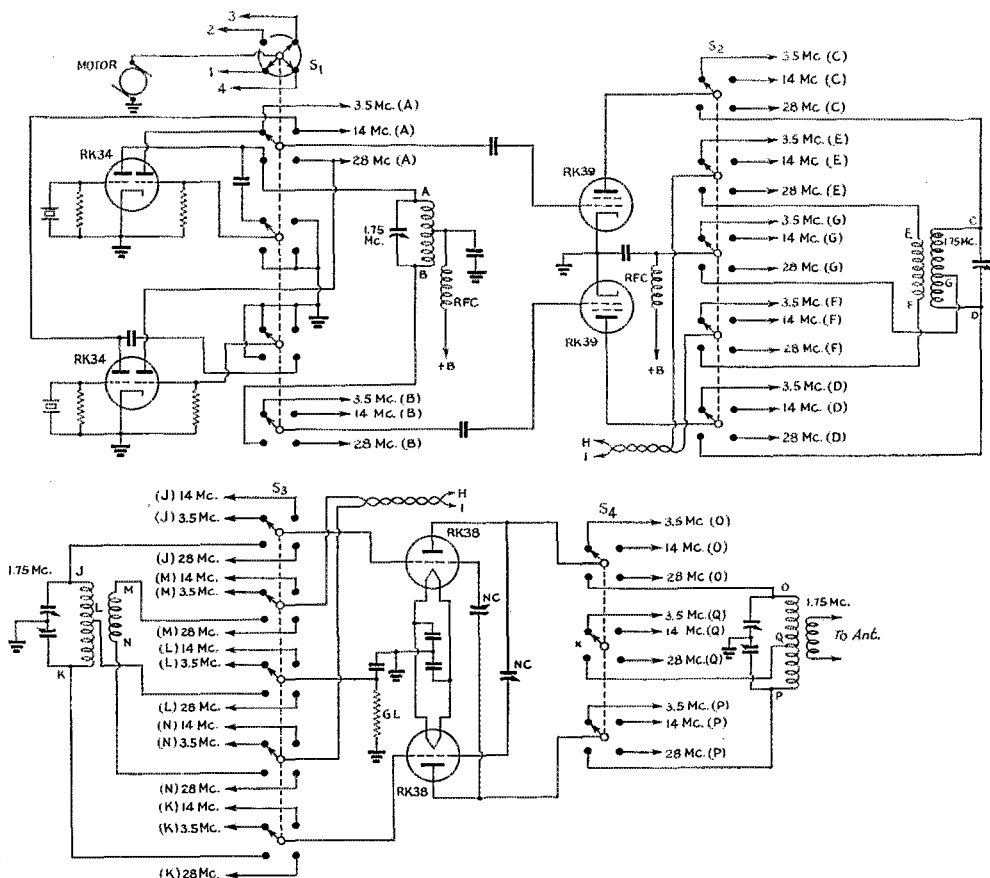

Fig. 1 — Essentials of the band-switching circuit. For simplicity, only one tank circuit is shown for each stage; switch connections for the others are indicated by the arrows, with letter designations showing the connections corresponding to those of the 1.75-Mc. tank. Switches S_1 , S_2 and S_3 are Yaxley Type 165-C; S_4 is a specially-constructed switch, details of which are given in Fig. 3. A special switch section is used for motor control in S_1 , as described in the text. Plate voltage for the final is fed to the arm of the center section (x) of S_4 , through an r.f. choke.

One triode section of the upper RK-34 in the simplified diagram, Fig. 1, has its plate permanently connected to the 1.75-Mc. oscillator tank; similarly, one section of the lower RK-34 is connected to the 14-Mc. tank. These sections are the oscillators, using 1.75-Mc. and 14-Mc. crystals respectively. Only one tube is in use at a time, and for operation at the crystal fundamental the oscillator in use is connected to the grids of the buffer stage. For 3.5-Mc. work, the second section of the upper RK-34 is used as a doubler; similarly, for 28 Mc. the second section of the lower RK-34 is put into operation.

Three five-gang, four-position ceramic switches are used for selection of the proper coil and condenser combination for each band. These and the final tank switch are connected together with sprockets and bicycle chain so that one motor revolves them all at once in synchronism. Since no four-position, 90-degree indexing switch that

would handle the power was available for the final tank circuit (S_4), it was necessary to build this part by hand. It is made of bakelite wafers and copper contacts. The switch wafers measure four inches wide by six inches high and $\frac{1}{4}$ inch thick. The contacts are copper discs $\frac{3}{4}$ inch in diameter held in place by a screw and insulated from the bakelite by ceramic beads. Each switch arm consists of five pieces of phosphor bronze $\frac{1}{2}$ inch wide by 2 inches long fastened together with 6-32 screws. The leaves are bent at the end to a 45-degree angle and filed flat so that they ride smoothly over the contacts. At the other end of

Push a button and you're on the band you want! A novel idea for mechanically coupling circuit switches to give instantaneous band change.

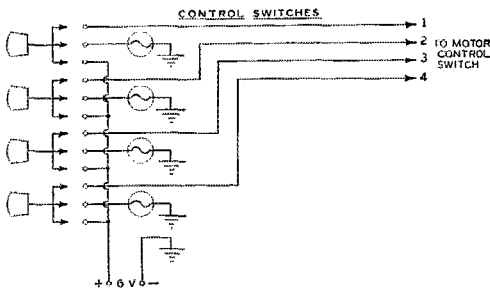

Fig. 2 — The push-button control circuit. The pilot lights indicate the band in use. The motor, from a small electric fan, operates from 6 volts d.c. in W9LHF's installation. The switch is a Yaxley 2184.

the arm is fastened a 1-inch disc for making the stationary contact; it is constructed in the same way as the arms. Small collars with a $\frac{1}{4}$ -inch hole and a set screw are soldered to the arms so that the shaft may be fastened to the arms. The shafting is bakelite, broken up by ceramic couplings.

The motor used is one taken from a cheap oscillating fan. The shaft normally used for oscillating is used in this case as a switch drive.

A special shorting-type switch section on S_1 (that at the top in Fig. 1) is used for motor control. When the desired control circuit (1, 2, 3, or 4) is closed the motor rotates until the gap in the shorting ring opens the circuit as it passes the active contact. The motor then stops and the indexing device on the switch insures proper seating of the switch contacts. The push-button control circuit is shown in Fig. 2. Pilot lights show the band in use.

To eliminate re-tuning when changing bands,

separate tuning condensers are used in each stage for each band. It would be practically impossible to proportion the inductances in each stage so that they could all be tuned with the same capacity. Another great advantage of separate tanks is that optimum L/C ratios can be maintained throughout.

To make tuning simple, separate antennas are used for each band. Since this is common practice in many ham stations, this feature does not seem objectionable. However, if the same antenna is to be used with two or more bands, it is suggested that a separate switch, operated manually, be used. Antenna coupling to each band is by means of a link inside each tank coil at the center.

General Construction

Since construction of the transmitter is entirely straightforward and no trick circuits are used, it should be unnecessary to describe circuit details. The transmitter should not be a great deal more expensive than one of similar power made to operate on one band only. The only real increase in cost is in the drive mechanism and additional condensers.

As shown in the photographs, the oscillator and buffer stages are mounted on one chassis, while the final is entirely separate. This has a number of advantages, chiefly that of eliminating interstage coupling. It was necessary to install a shield between the oscillator and buffer to prevent interstage coupling; without it the buffer would oscillate. Also, it will be noticed that holes are cut in the final amplifier chassis to allow the plate caps of the final tubes to come through, thus making it possible to isolate completely the grid

(Continued on page 108)

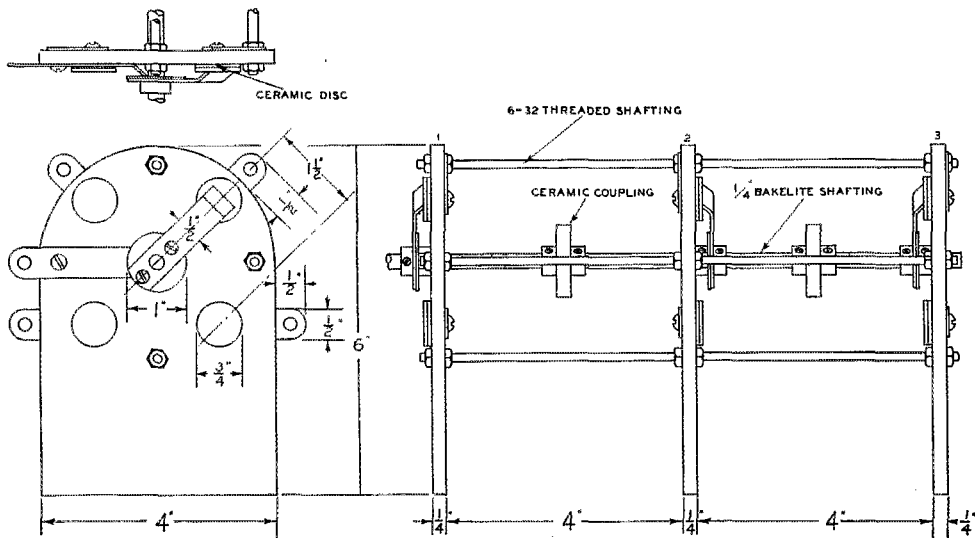

Fig. 3 — Details of the home-constructed band-switch (S_{w4} of Fig. 1) for the final stage.

Lop-Sided Speech and Modulation

Voice-wave Polarity and Its Effect on 'Phone Transmitter Operation

BY GEORGE GRAMMER,* WIDF

IN THE course of some years of observations of speech wave-forms in broadcasting it was found that voice wave-shapes, particularly from male voices, consistently have greater peak amplitudes on one side of the axis than the other. The interesting fact, as disclosed in a recent report on this work,¹ is that this "lop-sidedness" is always in the same direction. The shape of the wave will be carried through the speech amplifier intact provided the frequency characteristic is flat within reasonable limits, and provided the phase shift in the amplifier is proportional to frequency.

The original work was carried out with high-fidelity microphones of a type seldom seen in amateur stations, and it is of interest to investigate the effect of amateur-type microphones on the lop-sidedness of the wave. Fig. 1 summarizes the results of tests with three different crystal microphones commonly used by amateurs. No. 1 is a good grade of public-address microphone with a reasonably flat frequency characteristic. No. 2 is a highly-popular "communications" type in which the frequency characteristic is designed to accommodate the ordinary voice and to drop out the unessential frequencies. No. 3 is a high-output microphone with a somewhat restricted frequency range, its "quality" falling between the ordinary single-button carbon mike and the one here labelled No. 2. The six sets of data labelled "A" to "F" inclusive were taken on six individuals with a representative range of speaking voices. The numbers along the abscissas do not represent a particular scale, but are key numbers for the various vowel sounds given under the drawing. The ordinates show the ratio of the higher peak to the smaller.

These peak ratios were obtained by direct observation on a calibrated oscilloscope, using a two-stage resistance-coupled amplifier which was checked for flatness of frequency response and for linearity of phase shift with frequency. Because of the transient nature of the oscilloscope pattern a great many measurements were made on each sound for the purpose of averaging out observational errors — and also to average the ratios on a given sound, since the pattern changes considerably with slight changes in intonation or in

pitch. A change in peak ratio of fifty or even one hundred per cent is not uncommon, depending upon just how the speaker voices the sound. However, the highest ratio observed in any case was of the order of 2.5:1 and (with one or two relatively insignificant exceptions in the case of microphone No. 3) never dropped below 1.

It is quite apparent from Fig. 1 that the microphone has a marked effect on the peak ratio; also, the same sounds spoken by the same person will give different ratios with different microphones. In the case of microphones Nos. 1 and 2, the peak ratios are of the same order of magnitude, but there is for the most part only a random relationship between the ratios and the sounds. With No. 3, the ratio is uniformly nearer 1 with all voices. Since Nos. 1 and 2 sound about alike on voice, while No. 3 to the listener has obviously poorer quality, the conclusion may be drawn that the poorer the microphone the less lop-sided its output. Also, the data for Nos. 1 and 2 may be grouped and taken as representative of the performance of good amateur crystal microphones, while No. 3 can be assumed to be typical of the cheaper units. For the latter, the maximum ratio is about 1.5:1 and, depending upon the voice, may average considerably nearer unity. For the former, the maximum is about 2 and the majority of sounds will give a ratio of 1.5 or more.

As a general rule, the long vowel sounds are more symmetrical than the short vowels, and it also appears (this is not included in the data, but was observed separately) that the long vowels have the higher energy content. If the speaker endeavors to maintain a uniform voice level, as judged by the effort expended in talking, the actual peaks will be higher on long than on short vowels, although the peak ratios will be higher on the latter. Practically, this means that the sounds which hit the transmitter the hardest are the ones which are most symmetrical. However, to maintain such a level accurately in communication would mean that more attention would have to be paid to the level than to the message content, which would be extremely difficult. As a result, one may easily find himself saying such a word as "hit" with considerably more force than "hope" in the course of a sentence or two. While it is possible to avoid going above a predetermined intensity in order to keep within normal modulation limits, it hardly seems feasible to exercise selectivity, conscious or unconscious, with respect to vowel sounds in relation to intensity.

* Technical Editor.

¹ Hathaway, "Effect of Microphone Polarity on Percent-age Modulation," *Electronics*, October, 1939.

Modulation

A peak ratio greater than unity naturally will limit the amount of power that can be put into the side bands. Fig. 2-A shows the classic picture of 100% modulation with a sine-wave signal, or pure tone. The up-peak reaches the maximum value of twice the carrier amplitude and the down-peak reaches zero, the same distance in the opposite direction. With 100% modulation in either direction as a limit, a lop-sided wave-shape such as that shown in Fig. 2-B will swing twice as far in one direction as the other. Voice wave-forms are very far from being so simple, but this wave-form will suffice for purposes of illustration. The larger peak could extend downward and the smaller upward—that is, the modulation pattern could be turned upside down—without changing the conditions at all.

If things are arranged so that the larger peak swings in the up direction, and the output of the modulator is increased so that the down-peak reaches the zero axis while the up-peak extends upward above 100% modulation the necessary distance to preserve the wave-shape, the condition shown in Fig. 2-C is reached. Here the carrier

Peaks in voice waves extend farther in one direction from the axis than the other. With lop-sided speech, more effective modulation can be obtained by increasing the up-modulation percentage beyond 100%, but the process lacks appeal because of poor economy. An experimental investigation discloses the advantages of a different method of attack.

is being fully utilized, and since the peak ratio of the modulating signal is 2:1, there is a 2:1 increase (6 db) in side-band amplitude in Fig. 2-C as compared to 2-B. The case would be different if the larger peak had extended in the downward direction, since an increase in modulating signal beyond 100% downward modulation would immediately cause cut-off of part of the peak, so that the wave-shape would not be preserved. The proper polarity can be obtained by examining the modulated signal with an oscilloscope and, if wrong, by reversing the connections to the modulator output transformer secondary. The same result will be secured by reversing any other pair

Fig. 1 — Peak ratios of various sounds with different speakers and different microphones. The length of each line represents the ratio of the largest peak on one side of the axis to the largest peak on the other. Sounds are identified by the numbers along the abscissa. (1) a as in "pay"; (2) aw in "paw"; (3) a in "bar"; (4) a in "pat"; (5) e in "be"; (6) e in "men"; (7) i in "hide"; (8) i in "hit"; (9) ing; (10) o in "go"; (11) o in "gone"; (12) u in "you"; (13) u in "but"; (14) oo in "boot".

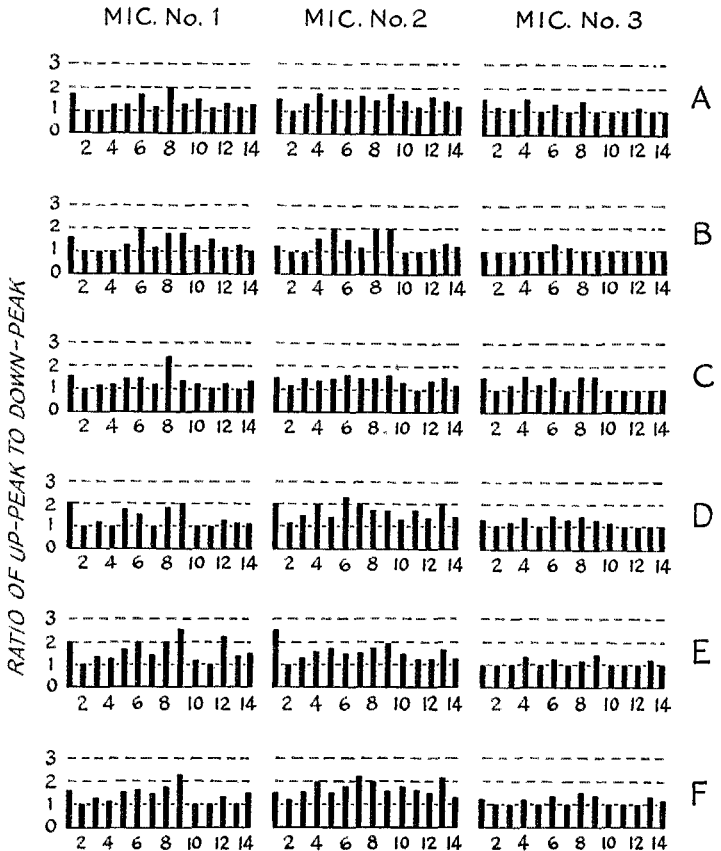

of transformer-winding leads in the speech amplifier, or by reversing the leads from the microphone itself when this is possible. The modulation transformer secondary is usually most convenient.

A necessary corollary of this system is that the

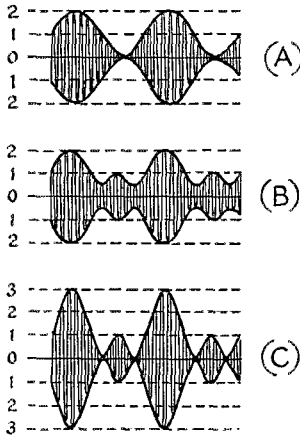

Fig. 2—(A) Normal modulation with a pure-tone signal; (B) modulation with a lop-sided signal, limited to 100% in one direction; (C) modulation limited to 100% downward, unlimited upward.

modulation in the up direction must exceed 100% (in the case of a wave-shape with a 2:1 peak ratio, the up-modulation will reach 200% with the down-modulation set for 100%)—and 100% modulation is the limit set by the amateur regulations. As a regulatory measure this is undoubtedly intended to prevent unnecessary side-band splatter, and not to prevent full utilization of the carrier as a means of transmitting intelligence. For identical modulating wave-shapes, the number of side bands and their relative intensity will be exactly the same no matter how far the up-peaks extend beyond 100%, just so long as the down-peak does not cross the zero axis and thus cause complete cut-off of r.f. output for part of the time. This can be— and has been— checked experimentally by means of a selective receiver and a constant tone modulating signal of lop-sided waveform. There is, of course, an increase in side-band power as the modulation is increased, but the signal occupies no more space.

This being the case, it becomes of interest to look into the mechanics—and economics—of pushing the up-modulation beyond the 100% mark, disregarding for the moment such things as regulations and the question of definition of percentage of modulation when both up- and down-peaks are taken into account. Fig. 3 shows an ideal modulation characteristic of a plate-modulated stage, with plate voltage plotted against plate current in arbitrary units. The curve also would represent r.f. output current against either of the two quantities mentioned. With 1

representing the carrier, 2 represents the up-peak with 100% modulation, the power at this point being four times the carrier power. Normally the curve would extend only this far, since if the up-modulation is limited to 100%, the shape of the curve beyond the 100% point is of no particular interest. The 100% point therefore represents a design limit in choosing operating conditions (with a little more as a factor of safety) and is the point on which tube ratings, excitation, bias and so on are based. Also, for 100% modulation, the modulator must meet the familiar condition of supplying half as much audio power as there is d.c. plate input to the modulated stage.

Let's look first at the audio requirements. The fact that the average power in speech is about half that in a sine wave of the same peak amplitude is no doubt well known to most amateurs, but there are still many who find it hard to appreciate that the modulator, nevertheless, must be capable of just as much output for one type of wave-shape as the other. This comes about because the necessity exists for meeting the same peak demands in both cases. It is equally true here, and a modulator capable of aiding in the production of a modulated wave of the type shown in Fig. 2-B must be equally capable of producing the wave shown in 2-A, even though the actual power in the former is considerably smaller. That is, the peak output is the same in both cases, and peak output is the determining factor in all design considerations except average plate dissipation. The latter is smaller in the case of Fig. 2-B, since the average output and input are lower than with a sine signal.

In modulation we are dealing with amplitudes, and power varies as the square of the amplitude. If the modulating signal has a 2:1 peak ratio, and the modulation is increased from the type shown in Fig. 2-B to that in Fig. 2-C, the amplitude of the modulating signal has been doubled. Therefore, if a certain amount of audio power is necessary to produce Fig. 2-B, then four times

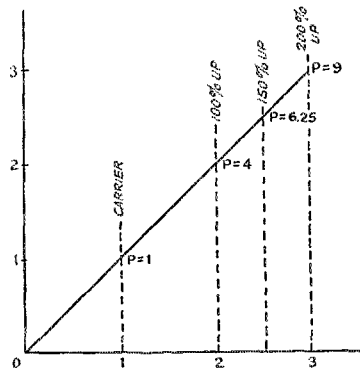

Fig. 3—Ideal modulation characteristic of a Class-C amplifier, showing ratio of peak power to carrier power for various degrees of upward modulation.

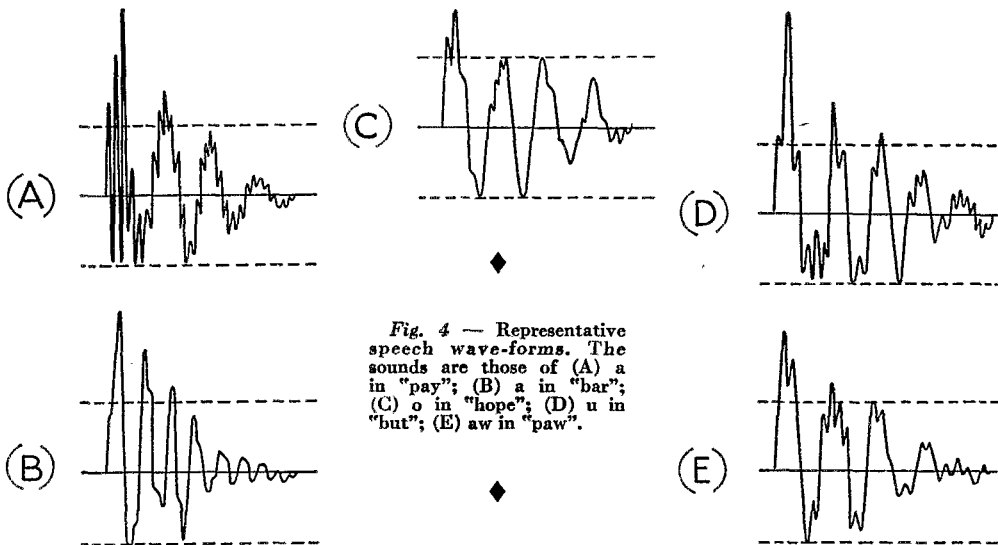

Fig. 4 — Representative speech wave-forms. The sounds are those of (A) a in "pay"; (B) a in "bar"; (C) o in "hope"; (D) u in "but"; (E) aw in "paw".

that power will be required to produce Fig. 2-C. Or, to take a numerical example, if the Class-C stage has an input of 100 watts, a modulator capable of 50 watts output will suffice for modulation such as is shown either in Fig. 2-A or 2-B, but an audio capability of 200 watts will be requisite for Fig. 2-C. The ratio of audio power required will vary as the square of the up-modulation percentage. For a signal peak ratio of 1.5:1, where the up-modulation reaches 150%, 2.25 times as much audio power capability will be required. The word "capability" is used throughout here because the actual power used depends upon the wave-shape, but the peak requirements are inflexible.

To handle the increased amplitude of the modulating signal, the range of linear operation of the Class-C amplifier must be extended. To give the type of operation shown in Fig. 2-C with a signal having a peak ratio of 2:1, the amplifier must be capable of being modulated linearly 200% in the upward direction. This means that the modulation characteristic must extend linearly for three units in Fig. 3 instead of two, and the peak power output becomes nine times the carrier power instead of four times. The power ratio would be 6.25 for 150% modulation, as shown.

Taken together, these things mean that application of the system shown at Fig. 2-C to an existing transmitter is out of the question. Few amateur transmitters, unless the builder has been ultraconservative in running everything far below ratings, are capable of being modulated appreciably above 100%. This is particularly true of the audio system, as has been pointed out before in these pages.² Many, in fact, cannot even be modulated 100%, because proper allowance

has not been made for losses. Consider, for example, the common practice of buying a pair of Class-B tubes rated at say 250 watts audio output to modulate a carrier of 500 watts. The Class-B output transformer is of course not perfect, and even allowing the probably high figure of 90% for transformer efficiency the modulation will flatten off at 95%, unless the rated operating conditions are exceeded. A factor of safety of at least 10% to 20% is necessary to do the job of 100% modulation adequately, and that is probably as much spare power as the average well-designed amateur transmitter has. Since the peak emission of the tubes is fixed, and usually is given full consideration by the manufacturer in setting plate-current ratings for reasonable tube life, about the only way left for getting the increased audio power necessary is to increase the plate voltage proportionately. For a signal peak ratio of 2:1, or four times the audio power, this means an increase of four times in plate voltage which, if the tubes will stand it,

(Continued on page 86)

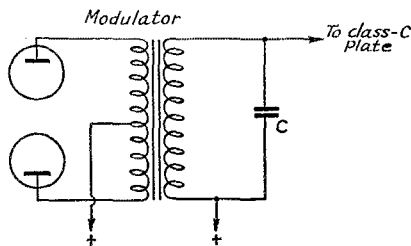

Fig. 5 — Simple condenser filter to cut off higher audio harmonics. The value of C may be between 0.002 and 0.006 μ fd., the smaller capacities being used for the larger load resistances.

² Fortune, "Phone 'Splatter,'" QST, January, 1939.

Compact Battery Receiver for Station or Portable Use

Regenerative Receiver with Semi-Tuned R.F. Stage Using the New Peanut Tubes

BY DON H. MIX,* WITS

ALTHOUGH it is true that recent years have brought about the universal acceptance of the superheterodyne receiver in amateur work, nevertheless there yet remains for the regenerative receiver a definite place which no superhet has quite been able to fill. Take, for instance, the case where minimum weight and volume and maximum service hours from light-weight batteries are important factors, or the case of the beginning amateur with limited resources to whom initial cost may be of prime importance. Now if the prospective ham can build at low initial cost a receiver which will serve him well through his days of apprenticeship and yet be built so as to be useful for other purposes when the eventual superhet replaces it as the station receiver, it is not a temporary expedient, but

* Assistant Technical Editor.

something well worth while. The receiver shown in the accompanying photographs has been designed with just this in mind. Although sacrificing few, if any, of the features or little of the performance of full-sized tuned r.f. regenerative receivers, it is completely self contained and sufficiently compact and light in weight to serve admirably in portable and emergency service.

It has been possible to economize appreciably in volume by departure from the most commonly seen forms of construction. The use of new miniature tubes, themselves small in size, operating efficiently from batteries also of small dimensions, has also contributed in no slight measure to the goals of compactness and light weight. Although parts mounted on a horizontal chassis may occupy little space in themselves, much waste space above the chassis is difficult to avoid because the

panel must be of sufficient size to accommodate convenient controls. In this receiver, the equivalent space has been made useful by mounting the parts horizontally on a vertical sub-panel. The space which would normally come above the receiver components now comes to the rear where use may be made of it in housing the batteries required for operation.

Circuit Considerations

It is pretty safe to say that the most often recalled curses of the time-honored two tuber are the effects upon frequency stability and adjustment of regeneration caused by antenna movement and body-capacity. Years ago we used to find an extremely effective remedy for these annoyances in the use of a coupling tube — an untuned r.f. amplifier preceding the detector. With the tubes then available, however, these advantages were offset to a considerable extent by a sacrifice in selectivity and the increase in noise always associated with reduction in selectivity. Reduction in selectivity came about by the broadened tuning of the antenna circuit aggravated by blocking of the carefully-adjusted regenerative de-

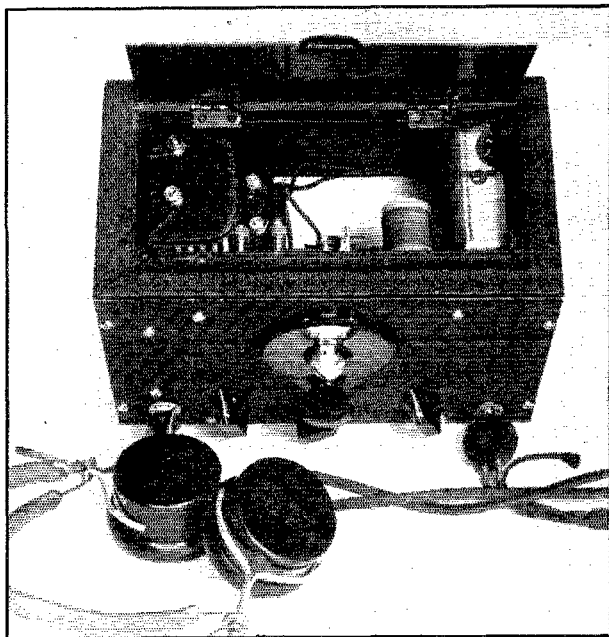

The cabinet, only 9 by 6 by 5 inches, has ample space for the "A" and "C" batteries on the left and the single 45-volt "B" battery required to the right. Controls along the bottom of the panel left to right are the battery switch, regeneration control, antenna-circuit tap switch and band-set condenser.

Here is a simple and compact receiver in which battery space is made available in the cabinet by a departure from the usual form of construction. The semi-tuned r.f. stage isolates the detector from antenna and capacity effects, making it ideal for either home station or particularly for portable work.

detector by the strong off-frequency signals delivered to it by the r.f. stage. As a consequence, we have seen little of this type of amplifier for some time. However, since then, the variable-mu tube, which is a much better performer under these conditions, has been developed. In this receiver, the input tube is helped along by the use of a tapped antenna coil and a fixed condenser which may be connected in series or parallel by a simple arrangement of a pair of jack-top binding posts and a grounding banana plug. This serves to keep the antenna circuit somewhere near resonance and, at the same time, provides a means of knocking down to reasonable levels those signals which would otherwise block up the regenerative detector.

Aside from the foregoing, there is little on which it is necessary to comment so far as the circuit shown in Fig. 1 is concerned. The 1T4 r.f. amplifier is coupled to the detector, also a 1T4, through a small 50- μ fd. fixed capacity. The tuning system provides general coverage with band spread at any point. C_4 is the band-spread condenser controlled by the main tuning dial, while C_5 is the band-set condenser. The system is designed to give nearly full-scale spread on the amateur bands. Regeneration is supplied by a plate-circuit tickler and controlled by adjustment of screen voltage. The detector is impedance-coupled to the 1S4 pentode audio amplifier. It might be well to point out here that no idea should be entertained that a saving may be made by the substitution of

resistance coupling. It may be possible to get away with such an arrangement after a fashion with tubes operating with considerable difference between screen and plate voltages, but these small tubes are designed to operate with 45 volts on both screen and plate. The use of resistance coupling will drag the plate voltage down below that of the screen and utterly ruin the performance of the detector.

Construction

The receiver is built to fit a standard cabinet (ICA No. 3825) 9 by 5 by 6 inches. The sub-panel on which most of the components are mounted is a piece of one-sixteenth-inch aluminum $5\frac{1}{2}$ inches square. Steel may be substituted although it takes a little more elbow grease in cutting the holes. The layout with dimensions is shown in Fig. 2. The drawing shows the side which faces the front panel. The holes shown include those required to pass wiring through the sub-panel.

After all hole centers (or at least those marked "X") have been marked and punched, each center should be drilled out with a small-size drill. Those marked "X" should be transferred to the back of the front panel by placing the sub-panel face down on the back of the front panel and marking with a scriber from the back. The sub-panel should be clamped to the front panel in a central position with respect to the sides of the front panel and with the lower edge of the sub-panel one-sixteenth inch above the lower edge of the front panel. After these holes have been transferred, they may be enlarged to the specified sizes. Fig. 3 shows the drilling required in the front panel. Those holes shown in dashed lines are the ones which are transferred from the sub-panel, while those shown in solid lines are additional holes required for mounting the headphone jack, the battery switch, the audio choke and the dial mounting screws. The latter may be drilled most accurately by spotting the centers with the tem-

Fig. 1 — Circuit diagram of the compact portable.

- C_1 — 50- μ fd. mica.
- C_2 — 0.01- μ fd. paper.
- C_3 — 50- μ fd. mica.
- C_4, C_5 — 100- μ fd. ultra-mid-g-
et variable (Hammarlund HF100).
- C_6 — 100- μ fd. mica.
- C_7 — 0.25- μ fd. paper.
- C_8 — 0.01- μ fd. paper.
- C_9, C_{10} — 100- μ fd. mica.
- R_1 — 1 megohm, $\frac{1}{2}$ -watt.
- R_2 — 25,000-ohm potentiometer (linear scale).
- R_3 — 0.25 megohm, $\frac{1}{2}$ -watt.
- J — Single-circuit jack.
- Sw_1 — 11-point tap switch.
- Sw_2 — 2-circuit, 6-position switch connected as described in text.
- L_1, L_2 — See coil chart.
- L_3 — 500 henrys, 5 ma., audio choke (UTC R22).

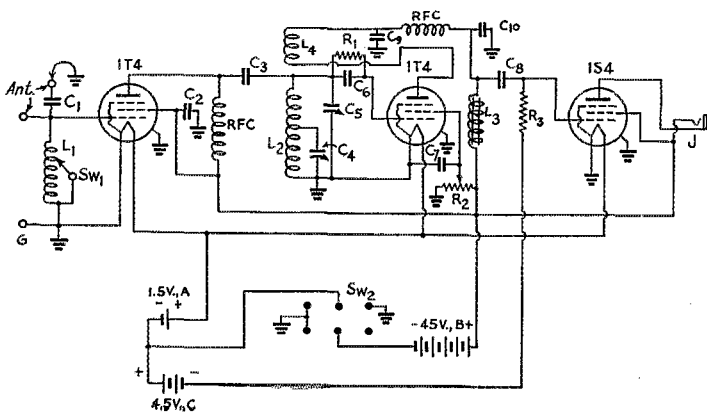

plate (which comes with the dial) after the shaft hole has been drilled.

In mounting the parts on the sub-panel, be sure to get them on the right side. The tube sockets used are made by Amphenol and are fastened in with clamping rings. In mounting the antenna terminal strip (National) a fibre lug strip with two terminals, one grounding, should be placed under each mounting screw. A similar lug strip is fastened at the small hole to the right (Fig. 2) near the bottom edge.

Referring to the photograph of the back of the sub-panel the detector plate-circuit r.f. choke at the top is fastened between the plus "B" coil-socket terminal and one of the lug strips. The two filter condensers, C_9 and C_{10} may be seen at either end of the choke. The amplifier r.f. choke is fastened between plate terminal of the tube socket and the second lug strip. The tubular condenser along the left-hand edge is the amplifier screen by-pass C_2 . The large tubular condenser along the bottom edge is the detector screen by-pass. Its larger capacity is required to eliminate contact noises of the regeneration-control potentiometer.

The r.f. amplifier coupling condenser C_3 is connected directly between the respective plate and grid terminals of the r.f.-amplifier and detector-coil sockets. The detector grid condenser and leak are supported between coil-socket and tube-socket terminals. The audio coupling condenser is the tubular condenser at the center. The lug strip near the lower edge serves to anchor the battery end of the audio-amplifier grid resistance and as a grounded support for C_7 . The small holes near the variable condenser stators are for leads from the stators to the coil-socket terminals. Two holes are also provided for passing through the wires to the potentiometer terminals; the third terminal is grounded. The antenna tuning condenser C_1 is soldered between the two antenna terminals.

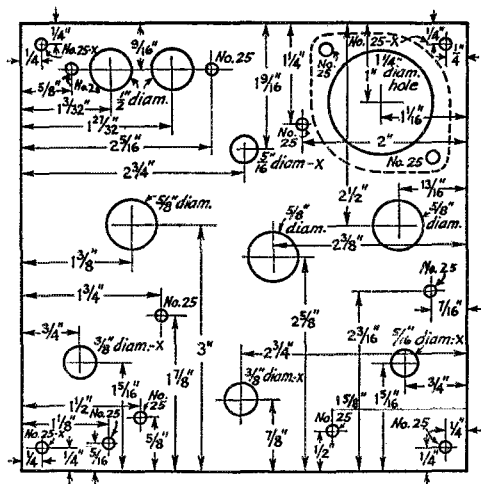
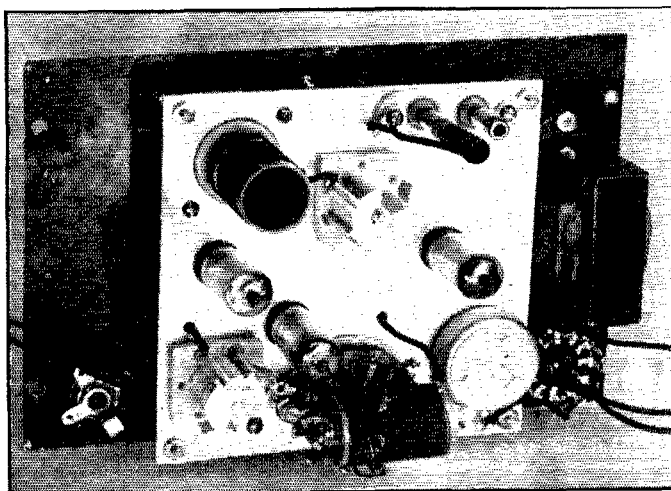

Fig. 2—Sub-panel layout. The piece is $5\frac{1}{2}$ inches square. The holes marked "X" are those which are transferred to the front panel.

The headphone jack and battery switch are wired in with leads a few inches long to reach the mounting holes when the double panel is assembled. The battery switch used is a two-circuit six-position rotary type connected as a double-pole double-throw switch. Only two pairs of stationary contacts are used; a third pair is blank for the "Off" position. It is connected so that both "A" and "B" batteries are disconnected when the switch is thrown to the left, the "A" battery is on but the "B" off when in the central position and both batteries are on when the switch is thrown to the right.

Leads to the batteries should be made long enough so that connections may be made before placing the receiver in the cabinet. The lead terminals of the audio coupling choke should also be



The completed receiver ready to slip into the cabinet. The r.f. amplifier tube is to the right, the detector tube to the extreme left and the audio pentode below. The detector hand-set condenser and regeneration control are on either side of the switch and tapped coil in the antenna circuit along the bottom edge of the sub-panel. The plug-in detector coil is in the upper left-hand corner to one side of the main band-spread tuning condenser. The terminals in the upper right-hand corner are for antenna connections. Mounted on the front panel to the left is the headphone jack and the battery switch and audio coupling choke on the right. The leads are for battery connections.

soldered in with slack leads at the two top lug strips. The small tubular shields at the centers of the sockets should be wired to the grounded side of the filament circuit. Each variable-condenser shaft is fitted with a metal extension shaft. Before mounting the sub-panel, the wiring should be checked carefully, since alterations are not made easily later.

The sub-panel is fastened to the front panel by means of long 6/32 machine screws with one-inch spacers at the four corners. The dial should be mounted before joining the two panels. The headphone jack, battery switch and audio choke may then be fastened in place on the front panel. It should be remembered that the jack must be insulated from the panel. After the two panels have been fastened together, the shafts may be cut off at the appropriate length.

Coil Winding

The detector coils are wound on Millen one-inch-diameter five-prong forms. The dimensions given should be followed as closely as possible, otherwise the tuning ranges may be shifted.

The band-spread tap on all but coil No. 5 is made by making a loop three or four inches long and passing the loop through a previously drilled hole in the form at the appropriate point. The loop is pulled tight inside the form and the winding continued. After the winding is complete, the insulation is removed for most of the length of the loop and both wires passed through the band-spread pin. On coil No. 5, it will probably be easier simply to scrape the wire at the appropriate

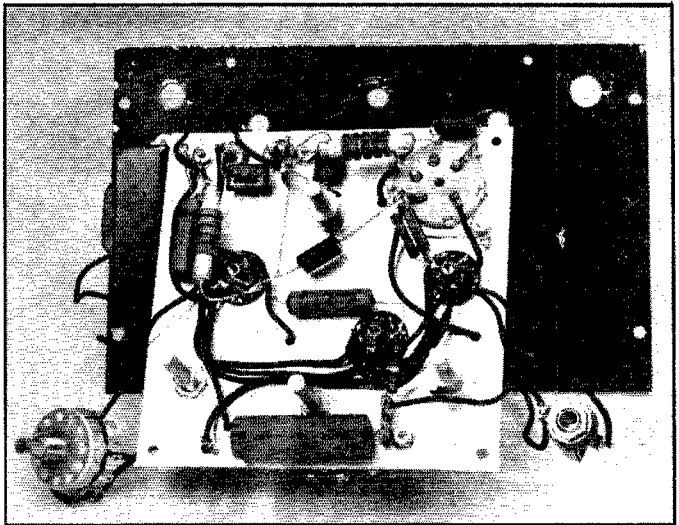

Inside view of sub-panel. The various components are identified in the text.

COIL CHART

| Coil No. | Freq. Range Kc. | Band Included | Total Turns | B.S. Tap | |
|----------|-----------------|---------------|-------------|----------------------|----------|
| | | | | L1 Turns from Bottom | L2 Turns |
| 1 | 1300- 3000 | 1.7 Mc. | 73 | 38 | 12 |
| 2 | 2700- 6100 | 3.5 Mc. | 33½ | 15½ | 9 |
| 3 | 5800-12,000 | 7 Mc. | 15½ | 4½ | 7 |
| 4 | 10,500-22,500 | 14 Mc. | 8½ | 1¾ | 6 |
| 5 | 19,500-40,000 | 28 Mc. | 3½ | ¾ | 5 |

Coils Nos. 1, 2, and 3 wound with No. 28 d.s.c., turns on Nos. 2 and 3 spaced to occupy a length of one inch, and 1¼ inch on No. 1.

Coils Nos. 4 and 5 are wound with No. 22 d.s.c., No. 4 to a length of 1 inch, No. 5 to a length of ¾ inch. L1 coils are wound below and in the same direction as L2. On coil No. 1, tickler is wound as second layer over lower end of grid winding. See text for further information.

point and solder a single tap wire at that point.

Both grid and tickler windings should be made in the same direction. The top of the grid coil should go to the grid condenser, the bottom of the grid winding to ground, the top end of the plate winding to the detector plate r.f. choke and the bottom end of the plate winding to the plate. The tickler coil should be wound close to the bottom of the grid winding. In the case of coil No. 1, the tickler should be wound as a second layer over the lower end of the grid winding. It may be held in place with Duco cement.

The antenna coil is wound on a similar form without pins. It is mounted on one of the switch assembly screws by means of a piece of No. 12 wire bent to form an angle support with a loop at each end for the mounting screws. The

(Continued on page 106)

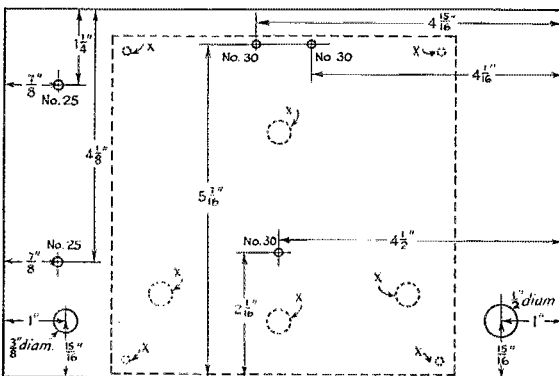

Fig. 3 — Drilling dimensions for the 9 by 6 panel.

A Practical 112-Mc. F.M. Transmitter

Complete Transmitting Equipment for Frequency Modulation

BY BYRON GOODMAN,* WIJPE

WHEN simple tests showed that f.m. was to play an increasingly-important rôle in amateur u.h.f. communication,¹ we started looking around for a simple way to obtain a stabilized f.m. transmitter on 112 Mc. Although our tests had showed that it is feasible to use an ordinary self-excited plate-modulated oscillator working on $2\frac{1}{2}$ meters for the purpose — utilizing the f.m. coincident with the amplitude modulation — it isn't exactly the right way to do it, and we wanted to start off with something that was right. We're glad we did, because the final result greatly exceeded our expectations.

There are several points about this f.m. business that are particularly appealing. First off, of course, is the imagination-stimulating thought of being able to work weaker signals through man-

made noise (and consequently greater distances) with f.m. than with amplitude modulation. Second, there is the utter simplicity of the transmitter, with its lack of high-powered modulators and, what is more important, critical adjustments. Many a u.h.f. transmitter has had modulation troubles because of the lack of excitation, improper loading of modulator and modulated amplifier, regeneration, and all of the other familiar bugs. Contrast that with a f.m. transmitter, which requires *no* modulator power and, for quality, only that the audio circuits be linear and that the deviation (in frequency) be proportional to the amplitude of the modulating signal, and symmetrical about the carrier. Further, only the amount of output is determined by the excitation — the quality is fixed once the oscillator has been modulated.² The antenna loading affects only the output and the final tube efficiency, and anyone who can get output from a multi-stage c.w. transmitter can adjust a f.m. transmitter.

* Asst. Technical Editor.

¹ Grammer and Goodman, "F.M. in Amateur Communication," *QST*, Jan., 1940.



The Circuit

In arriving at the tube line-up for the transmitter, we used the usual procedure of working back from the final stage. Since this was to be a low-powered affair, we decided that two or three watts output on $2\frac{1}{2}$ meters would be a good start. The RK-34, a double triode with the plate leads out of the top, looked like a logical tube for the frequency. Rated at 80 ma. at 300 volts, it looked like it might deliver two or three watts as a tripler, at reduced input. We decided on a tripler as the final tube because it could be connected push-pull, for the symmetry so

² A third requirement is that all of the circuits be capable of passing the wide-band signal without attenuation over the range, but this is no problem with the order of deviation used here. — Ed.

This view of the transmitter shows the construction of the coils. The coil in the rear left-hand corner is the oscillator plate coil; the coil in the center front is the tripler grid coil, mounted on Victrol bushings. The oscillator grid coil is mounted inside the shield can. The metal tube at the right of the shield can is the 6L7 modulator; the tube to the left of the can is the oscillator.

There doesn't seem to be any doubt but that you're going to be hearing plenty about f.m. from now on. For those anxious to get in on the ground floor, the transmitter described here shows how simple it is to get started, since it requires no more additional equipment than a 300-volt supply and a microphone to furnish 5 to 6 watts of f.m. on 112 Mc. No big modulators, no critical adjustments — well, read it for yourself.

important in the u.h.f. range. We were delighted to find that the tripler worked much better than had been expected, and efficiencies on the order of 35 per cent were obtained when tripling to 112 Mc. — but more about that later.

As can be seen from the circuit diagram in Fig. 1, the transmitter starts out with a T21 electron-coupled oscillator, doubling in the plate circuit. The grid circuit of this e.c.o. can be tuned from 9.33 to 9.67 Mc., which gives 18.66- to 19.33-Mc. output in the plate tank. The grid circuit is frequency-modulated by a 6L7 reactance modulator connected across the tuned circuit. The audio voltage is introduced at the No. 3 (injection) grid in the same fashion as was described in the previous article.¹ A gain control across the speech input determines the amount of frequency deviation available, although the deviation also depends on the L/C ratio of the e.c.o. grid circuit, as will be explained later. The plate circuit of the e.c.o. is capacity-coupled to a T21 doubler which furnishes 37.33- to 38.66-Mc. energy to drive the tripler. The grid circuit of the RK-34 tripler is link-coupled to the doubler stage, to balance the input circuit of the tripler. Further balance is maintained by not grounding the rotor of the grid tuning condenser, C_4 . The push-pull RK-34 tripler uses a conventionally-tuned grid circuit, but its plate circuit uses a quarter-wavelength line of copper tubing which apparently gives a quite high- Q tank and contributes considerably to the efficiency of the stage as a tripler. Output from the tripler is obtained from a hairpin-type coupling coil mounted

A complete 112-Mc. f.m. transmitter which, with a 300-volt power supply, gives 6 watts output.

A quarter-wavelength line is used for the 112-Mc. tank, and the load is coupled in through the pick-up loop. Controls, from left to right, are meter switch, oscillator plate tuning, doubler plate tuning, tripler grid tuning, oscillator tuning and audio gain. The microphone connector can be seen at the right rear of the chassis.

close to the closed end of the quarter-wavelength line.

Because a 300-volt plate supply is used throughout, it is possible to connect the screen of the T21 doubler directly to the cold end of the tank circuit and eliminate a dropping resistor and a by-pass condenser. It was found that the cathode resistor of the RK-34 required no by-pass condenser, nor was one needed at the cold end of the quarter-wavelength line used in the plate circuit of the tripler stage.

A meter switch is provided for metering the oscillator plate circuit, doubler grid circuit, doubler plate and screen circuit, tripler grid circuit and tripler plate circuit. This is a tremendously handy gadget which enables currents to be read as quickly as the switch can be turned, and it is quite valuable during tuning. None of the circuits take over 100 ma., and that range of meter is suggested.

Construction

The transmitter is built on a chassis of $\frac{1}{8}$ -inch aluminum, bent to form a "U" with $2\frac{1}{2}$ -inch sides. The top of the chassis measures 6 by 12 inches. Bending the sides gives the chassis sufficient rigidity, and no additional bracing is required even though the oscillator is self-excited. Reference to the photographs will give a clear

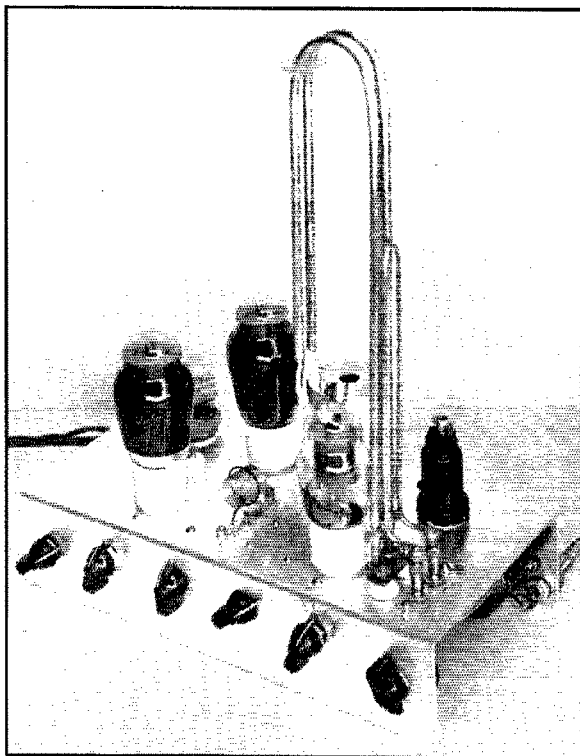

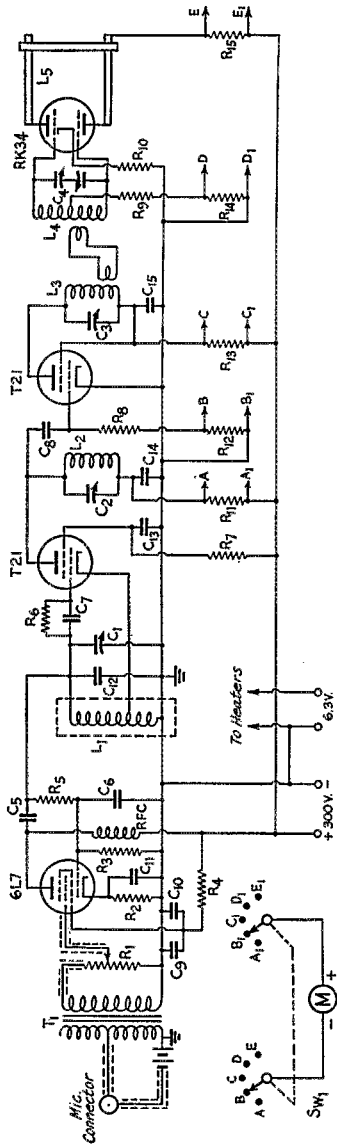

Fig. 1 — Wiring diagram of the complete f.m. transmitter.

- C1 — 50- μ fd. midget variable condenser (Hammarlund HF-50).
- C2 — 15- μ fd. midget variable condenser (Hammarlund HF-15).
- C3 — 15- μ fd. double-spaced midget variable (Hammarlund HF-15-X).
- C4 — 25- μ fd. each section dual midget variable (Carowell ER-25-AD).
- C5 — 250- μ fd. postage-stamp mica.
- C6 — 3- μ fd. (National M30 with screw out. Mounted on brass pillar).
- C7, C8 — 100- μ fd. postage-stamp mica.
- C9 — 8- μ fd. 450-volt electrolytic.
- C10, C11 — 0.01- μ fd., 400-volt paper.
- C12 — 150- μ fd. silver-mica condenser (Sickles Silvercap).
- C13, C14, C15 — 0.002- μ fd. postage-stamp mica.
- R1 — $\frac{1}{2}$ -megohm volume control.
- R2 — 300 ohms, $\frac{1}{2}$ -watt.
- R3 — $\frac{1}{2}$ -megohm, $\frac{1}{2}$ -watt.
- R4 — 30,000 ohms.
- R5 — 45,000 ohms.
- R6 — 150,000 ohms.
- R7 — 12,000 ohms.
- R8 — 60,000 ohms.
- R9 — 25,000 ohms, 10-watt wire-wound.
- R10 — 500 ohms, 10-watt wire-wound.
- R11, R12, R13, R14 — 25 ohms, $\frac{1}{2}$ -watt. (Resistors 1-watt unless otherwise mentioned.)
- Sw1 — 2-circuit, 5-position rotary switch.
- T1 — Double-button microphone transformer with only half the primary winding used (UTC S-6).
- T2 — 600V transformer.
- T21 — 600V transformer.
- T22 — 600V transformer.

- L1 — 8 $\frac{1}{2}$ turns No. 18, wound on 1-inch diameter form and evenly spaced to occupy 1-inch winding length. Cathode tap 2 $\frac{1}{4}$ turns from ground end.
- L2 — 13 turns No. 18, wound self-supporting to have $\frac{3}{4}$ -inch diameter and spaced to occupy 1-inch winding length.
- L3 — 7 turns No. 18, wound self-supporting to have $\frac{3}{4}$ -inch diameter and spaced to occupy 1-inch winding length.
- L4 — 10 turns No. 18, wound self-supporting to have $\frac{3}{4}$ -inch diameter and spaced to occupy $\frac{7}{8}$ -inch winding length.
- L5 — Two 21-inch lengths of $\frac{1}{4}$ -inch copper tubing spaced $\frac{1}{4}$ inch. The tubing is bent to form a half loop 2 inches wide. Coupling loop is of $\frac{1}{8}$ -inch diameter tubing, and is bent in form of hairpin extending up along L5 for 7 inches.
- The coupling loops between L3 and L4 are single turns of No. 18.

idea of the distribution of parts, and no lengthy description is necessary. The oscillator tuning condenser C₁ is fastened directly to the chassis, and condensers C₂ and C₃ are mounted on National XS-6 lead-through bushings which support the condensers but insulate them from the chassis. To retain short leads in the oscillator and still make the panel controls symmetrical, it was necessary to offset the extension shaft controlling C₁, but one of the new Millen 39001 flexible couplings does a good job of turning the corner without backlash. Condenser C₄ is mounted on the two end-plate spacing bars and, fortunately, lines up with the other shafts. Panel bushings are used on the two extension shafts to keep the controls rigid.

The oscillator coil is wound on a 1-inch diameter bakelite form (Millen 45000 or National XR-2) and is supported above the chassis by a half-inch brass sleeve over the mounting screw. The shield for the oscillator coil was made by cutting down an old straight-sided, 2-inch diameter tube shield. The oscillator plate coil, L₂, is self-supporting and is mounted on the base of an old coil form which has been cut off at the bottom and plugs into a tube socket. The doubler plate coil, L₃, is also self-supporting and mounts on the National Victron type TPB bushings. We threaded the two that take the ends of the coil, and secured the coil with nuts over these threads, but the coil might just as easily have been soldered to the posts. The link coils coupled to L₃ and L₄ are soldered to two more Victron bushings and are self-supporting.

The final tank circuit is made of quarter-inch copper tubing spaced $\frac{1}{4}$ inch. It is supported at the base by a copper strap in which two holes have been drilled to take the tubing and the tubing has been soldered in. If one soldering iron won't furnish enough heat for the job, borrow another and run them both on the work. The tubing should first be straightened, and

A view underneath the chassis shows the location of parts. The microphone transformer is at the lower right, right next to the microphone connector. The small 3- μ fd. condenser used in the modulator can be seen to the left of the transformer, and directly above is the oscillator tuning condenser. The power cable runs out the back of the set at the lower left-hand corner; the twisted pair taken out the same hole goes to the meter.

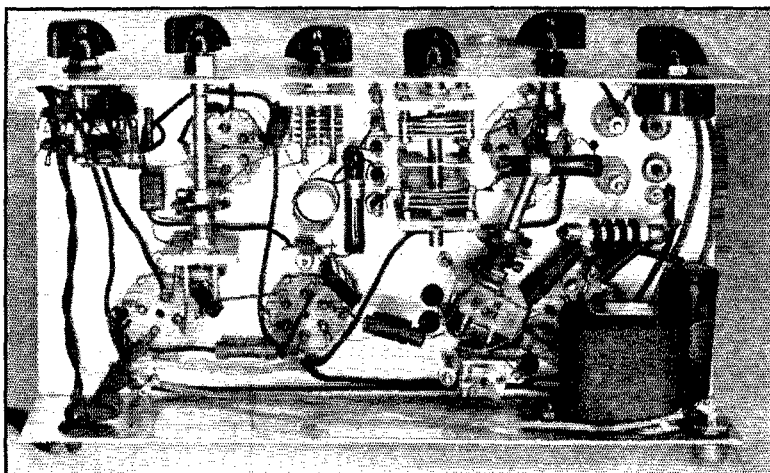

cleaned with polish if you want it to look shiny. After the tubing has been soldered to the strap, two National metal-tube grid caps can be run down the tubing to the copper strap and soldered together when in position near the strap so that their spacing will be correct. The tubing can then be bent over in a loop so that the ends will come down near the plate caps of the RK-34. The copper base strap at the bottom of the tank is supported by bolting it to two feed-through bushings. The grid caps used to connect to the RK-34 are connected to the end of the tank by inch lengths of flexible copper braid soldered to the grid caps and the copper tubing. The flexible connection is to be preferred to a more rigid one in case of expansion or other strains on the RK-34.

The hairpin coupling loop is made of $\frac{1}{2}$ -inch copper tubing bent to the proper shape and soldered to two banana plugs which fit into jack top binding posts such as the National FWA. The binding posts are mounted on a Victron strip and, besides affording a support for the coupling loop, make convenient terminals for the antenna wires or link line to a following stage. Coupling is adjusted by bending the loop away or towards the tank line until the proper loading is obtained.

The wiring of the transmitter is a relatively simple matter and, because of the way the parts are laid out, should not prove particularly difficult. One side of the heaters of the tubes is grounded to the chassis. The power supply leads are brought out at the rear of the set through a rubber bushing — one wire for *B* minus and the grounded side of the heaters, a second for *B* plus and a third for the other side of the heaters. The fourth wire of the cable goes to the microphone battery, if a carbon microphone is used. A twisted pair goes to the meter. The leads from the microphone jack and from the volume control to grid and transformer are shielded to avoid any r.f. pick-up. The $\frac{1}{2}$ -watt resistors used in the

metering circuits are mounted directly on the two-gang, five-position switch used for meter switching.

Tuning

If the coil dimensions have been followed, no trouble should be experienced in adjusting the frequency range of the transmitter. The 6L7 and two T21's should be placed in their sockets and a power supply giving about 250 volts should be connected to the set. A 300-volt supply could be used, but it is well to adjust the coils at a lower voltage. An all-wave receiver is quite handy for checking the frequency of the transmitter and will save considerable time in adjusting the circuits. When the power is applied and the meter switch set to read oscillator plate current, a dip should show as the oscillator plate circuit is tuned through resonance, indicating oscillation. The all-wave receiver should be tuned to 9.5 Mc. and it should be possible to pick up the signal by tuning the grid circuit of the e.c.o. When it has been ascertained that the grid circuit will tune the range 9.3 to 9.7 Mc., the oscillator plate circuit range should be checked by tuning for a dip in current over this range. The T21 doubler should be in the socket at this time because the input capacity is high, and if the coil is adjusted with the following tube out of its socket, it will be found that the circuit will not tune to resonance when the doubler tube is plugged in.

When the oscillator coils have been adjusted to cover their proper ranges, the meter should be switched to the doubler plate circuit and resonance checked here. Then, with the RK-34 in the socket but with the plate-voltage wire disconnected at the base of the plate tank, the RK-34 grid circuit should be checked for resonance by watching the RK-34 grid current. It will be found that the T21 plate circuits tune broadly but the

(Continued on page 108)

★ WHAT THE LEAGUE IS DOING ★

ELECTION RESULTS

As a result of the 1939 elections the A.R.R.L. has one new director, one old director returned to office, and six new alternate directors.

In the Southeastern Division, where the incumbent, Mr. Adams, was not a candidate for reelection, William C. Shelton, W4ASR, becomes the new director, winning over James F. Thompson, W4DGS. Mr. Shelton has been an assistant director of the division, is the president of the Halifax Amateur Operators Club, and was S.C.M. for East Florida in 1937. He is employed in the long lines department of the A. T. & T. A ham since 1930, he is an A.A.R.S., O.P.S., O.B.S. and O.O. The figures:

| | |
|--------------------|-----------|
| Mr. Shelton | 127 votes |
| Mr. Thompson | 104 votes |

Although not running for reelection as director, Mr. Adams, W4EV, easily won the election for alternate director, by 163 votes to 69 for J. M. Smith, W4CNZ.

Alexander Reid, VE2BE, was reelected Canadian General Manager over Loris S. Russell, VE3PL, by 236 votes to 253. Leonard W. Mitchell, VE3AZ, of Toronto, becomes the new alternate Canadian General Manager, defeating the incumbent, Alexander Larivière, VE2AB, by 347 to 177. Mr. Mitchell is a barrister by profession and has had an active career in amateur radio since 1924.

In a close and spirited election in the Atlantic Division, Herbert M. Walleze, W8BQ, becomes the new alternate director. An old-timer in the game since 1912, Mr. Walleze has been very active and is a former S.C.M. for Eastern Pennsylvania. He is employed in the communications section of the Pennsylvania Power & Light Company. The voting:

| | |
|-------------------------------------|-----|
| Mr. Walleze | 261 |
| Elmer A. Krall, W8CKO | 255 |
| Elizabeth M. Zandonini, W3CDQ | 251 |

A vacancy for alternate director in the Dakota Division was filled by the election of Adolphus A. Emerson, W9ITQ, Minneapolis. Mr. Emerson is an operating engineer for construction machinery for the city of Minneapolis. Before his election he was an assistant director of his division and in 1938 was president of the Minneapolis Radio Club. The figures:

| | |
|-------------------------------|----|
| Mr. Emerson | 74 |
| Ernest C. Mohler, W9ADJ | 69 |
| Earle Thornburg, W9EU | 35 |

Samuel C. Wallace, W9FAM, of Clarks, Nebraska, becomes the new alternate director of the Midwest Division, having won handily over Wilfred B. Hoaglin, W9MME, 262 to 82. Mr.

Wallace, the S.C.M. for Nebraska for many years until last year, and the manager of Trunk Line L, is local agent for the Union Pacific Railroad.

WASHINGTON NOTES

UNDER present conditions the F.C.C. is doing no fooling about the enforcement of amateur regulations. Herewith a few items worth noting:

The rules require the log to show the name of the operator. This may be written opposite the notation of each transmission. But this is a lot of work, so the F.C.C. permits the amateur to make one general statement that all operation is by him except as otherwise noted, and then it is necessary only for visiting operators to sign the log. The A.R.R.L. log book is designed with a space on its inside front cover to accomplish this convenient blanket signature. Many amateurs have neglected to sign their names in this space, or anywhere else in the log, and are being picked up for it. Take a tip and see that your log is signed.

The bad habit seems to be developing of dropping the prefix "W" or "K" in the hurry to sign calls, particularly in 'phone work. The F.C.C. has declared war on this practice and is telling its monitoring stations to get after the hams who do it. The prefix is an essential part of the call and its omission constitutes "signing a false call." You may drop your aitches (or stitches, YL's) but not your prefix. Put it in and save a ticket.

Some foreign amateurs, able now only to receive, are writing W hams asking for one-way transmissions. Do not be misled into doing this. Sorry but, international conditions being what they are, it must not be done, no matter how innocent the news.

The F.C.C. says that the use of phonetics, such as the Western Union word list which the League uses, is okay for the pronouncement of the call letters of 'phone stations.

F.C.C. has issued a newspaper release announcing that it contemplates a survey of the amateur radio service, to provide additional information which will permit the Commission "to meet any amateur problems which may arise in connection with neutrality and national defense and other emergencies, as well as with normal regulation." It contemplates a questionnaire of several pages — description of apparatus, biographical information, normal operating practices, etc. We understand that funds have not yet been made available for the survey, and it is uncertain whether it will eventuate. However, League headquarters are informed on the matter and can tell

all amateurs that this survey, if it materializes, will not constitute any form of "persecution" and that the data are not being requested for the purpose of embarrassing us in any way. It is simply that the Commission does not have all the data it needs to answer questions on what amateur radio is actually doing with its facilities. They make such surveys of other services frequently, and we know that any collection of data on the amateur service will thoroughly support our position.

By the time these lines are in print, the second Inter-American Radio conference at Santiago de Chile will be well under way. A.R.R.L. is being represented there by Assistant Secretary Arthur L. Budlong. The United States has sent a strong delegation, and it is expected that there will be no difficulty about maintaining all amateur facilities in the Americas. More news next month.

SPECIAL ELECTION NOTICE

To all A.R.R.L. members of the West Gulf Division:

YOU are hereby notified that a special election is about to be held in the West Gulf Division to elect an alternate director to fill the vacancy left by the death of W. H. Burt, W5BRC. The election will be for the unexpired remainder of the 1939-1940 term, plus the next regular term of two years, 1941-1942, as provided in By-Law 24.

If more than one eligible candidate is named, voting will take place during the month of March, 1940, on ballots that will be mailed from the headquarters office in late February.

Nomination is by petition. Nominating petitions are hereby solicited. Your attention is invited to the pertinent portions of the Constitution and By-Laws of the League, a copy of which will be mailed any member upon request. Ten or more A.R.R.L. members residing in the West Gulf Division may join in nominating any eligible West Gulf member of the League as a candidate. The following form is suggested:

Executive Committee

The American Radio Relay League
West Hartford, Conn.

We, the undersigned members of the West Gulf Division, hereby nominate W5..., of, as a candidate for alternate director from this division for the remainder of 1940 and for the next following full term of 1941-1942.

(Signatures and addresses)

The signers must be League members in good standing. The nominee must have been both a member of the League and a licensed radio amateur operator for a continuous term of at least four years immediately preceding receipt by the Secretary of his petition of nomination, except that a lapse of not to exceed ninety days in the

renewal of the operator's license and a lapse of not to exceed thirty days in the renewal of membership in the League, at any expiration of either during the four-year period, will not disqualify the candidate. He must be without commercial radio connections: he may not be commercially engaged in the manufacture, selling or renting of radio apparatus normally capable of being used in radio communication or experimentation, nor commercially engaged in the publication of radio literature intended, in whole or part, for consumption by licensed radio amateurs. Further details concerning eligibility are given in By-Law 12. His complete name and address, and call, should be stated. All petitions must be filed at the headquarters office of the League in West Hartford, Conn., by noon E.S.T. of the 20th day of February, 1940. No member shall append his signature to more than one petition. To be valid, a petition must have the signatures of at least ten members in good standing. Petitioners are urged to have an ample number of signatures, since nominators are frequently found not to be members in good standing.

Balloting will close at noon, April 1, 1940, and the successful candidate will take office as soon as the result can be determined.

All the powers of the division director are transferred to the alternate director in the event of the director's death or inability to perform his duties. This election therefore constitutes an important part of the machinery of self-government in A.R.R.L., and members are urged to take the initiative and file nominating petitions immediately.

For the Board of Directors:

K. B. WARNER,
Secretary

November 13, 1939

AMATEUR EXAMINATIONS FOR 1940

THE Federal Communications Commission will give amateur examinations during 1940 on the following schedule. Remember this list when you need to know when and where examinations will occur. Where exact dates or places are not shown below, information may be obtained, as the date approaches, from the Inspector in Charge of the district. No examinations are given on national or state holidays. All examinations begin promptly at 9 A.M., local time, except New Orleans, Honolulu and Winston-Salem at 8:30 A.M. and as may be noted below.

Boston, 7th floor Customhouse: Daily except Thursday.
New York City, 748 Federal Bldg., 641 Washington St.,
Tuesdays, Thursdays and Saturdays.
Schenectady, N. Y.: Some time in March, June, September and December.
Philadelphia, 1200 Customhouse: Class A, daily; Class B, Wednesdays and Saturdays.
Baltimore, Fort McHenry: Wednesdays and Saturdays.
Norfolk, Va., 402 New P. O. Bldg.: Class A, daily; Class B, Fridays and Saturdays.

Winston-Salem, N. C.: February 3rd, May 4th, August 3rd, November 2nd.
 Atlanta, 411 Federal Annex: Tuesdays, Fridays and Saturdays.
 Nashville: February 16th, May 17th, August 16th, November 15th.
 Miami, 314 Federal Bldg. (P. O. Box 150): Tuesdays and Saturdays.
 Jacksonville, Fla.: May 25th, November 23rd.
 New Orleans, 326 Customhouse: Mondays, other days by appointment.
 Little Rock: April 16th, September 10th.
 Galveston, 404 Federal Bldg.: Wednesdays and Saturdays.
 Dallas, 302 U. S. Terminal Annex Bldg.: Tuesdays.
 Oklahoma City: January 27th, April 27th, July 27th, October 26th.
 San Antonio: February 17th, May 25th, August 17th, November 16th.
 Albuquerque: April 6th, October 5th.
 Los Angeles, 1104 Rives-Strong Bldg.: Wednesdays and Saturdays.
 Phoenix, Arizona: Some time in April and in October.
 San Francisco, 328 Customhouse: Class A, daily; Class B, Mondays and Saturdays.
 Portland, Oregon, 207 New U. S. Courthouse: Fridays and Saturdays.
 Boise, Idaho: Some time in April and in October.
 Seattle, 808 Federal Office Bldg.: Fridays.
 Butte, Montana: Some time in May and in November.
 Spokane: Some time in May and in November.
 Denver, 504 Customhouse: First and second Saturdays of each month.
 Salt Lake City: Some time in March and in September.
 Billings, Montana: Some time in April and in October.
 St. Paul, 927 Main P. O. Bldg.: First and third Saturdays of each month; other days by appointment.

Bismarck, N. D.: No announced dates; consult Inspector in Charge at St. Paul.
 Kansas City, 927 U. S. Courthouse: Fridays and Saturdays; other days by appointment.
 Des Moines: January 12th-13th, April 12th-13th, July 12th-13th, October 11th-12th.
 St. Louis: February 9th-10th, May 10th-11th, August 9th-10th, November 8th-9th. Where date is a Friday, exams begin at 12 noon.
 Chicago, 246 U. S. Courthouse: Saturdays.
 Detroit, 1025 New Federal Bldg.: Saturdays.
 Cleveland: Some time in January, April, July and October.
 Cincinnati: Some time in February, May, August and November.
 Columbus, Ohio: Some time in March, June, September and December.
 Buffalo, 518 Federal Bldg.: First and third Saturdays of each month; other days by appointment.
 Pittsburgh: Some time in March, June, September and December.
 Honolulu, Aloha Tower: Mondays and Saturdays.
 Other Hawaiian points: Hilo, January 20th and August 7th, Lihue, February 16th and August 15th, Kaunakakai, July 22nd, Lanai City, July 23rd, Wailuku, July 24th.
 Washington, F.C.C. Headquarters: Thursdays; other days by appointment.
 San Juan, Puerto Rico, 303 Ochoa Bldg. (P. O. Box 294): By appointment.
 Savannah, 208 Post Office Bldg. (P. O. Box 77): By appointment.
 Tampa, 203 Post Office Bldg.: By appointment.
 San Diego, 503 New California Bldg.: By appointment.
 Juneau, Alaska, 7 Shattuck Bldg. (P. O. Box 2719): By appointment.

1.75-Mc. W.A.S. Party

Feb. 17th-18th

It's a fraternal activity for testing stations and giving the band a thorough workout. You can see for yourself how many states can be worked in a given time using a transmitter on the 160-meter band only. *Rules:* Simply work other 160-meter stations; exchange signal reports and the name of the state you are located in. List in three columns the *time*, the *call* of the station worked, and his *state*. These facts can be cross checked as logs are received at Hq., of course. A given station may be worked but once for contest credits.

Add the number of stations, or count *one each* for contacts, and multiply the result by the number of *different states* worked. (The District of Columbia will also count for Maryland.) This product will be your score. The activity is open to all amateurs, wherever located.

All contest or party operations must take place in *any twenty* hours of the following 33-hour period:

| <i>Starts</i> | 160-Meter Party | <i>Ends</i> |
|--|------------------------|--|
| 3 P.M. PST, 4 P.M. MST, 5 P.M. CST or 6 P.M. EST, SAT-URDAY, Feb. 17th | | 12:01 A.M. PST, 1:01 A.M. MST, 2:01 A.M. CST or 3:01 A.M. EST, MONDAY, Feb. 19th |

We're gradually overcoming the tendency of some of the gang who haven't used the 160-m. band, to under-rate its capabilities. It's good for coast-to-coast work at the right times. Last year W4BPD worked 36 states, and W9UWL worked 37, just in the short period of the party. You will be surprised to see how many you can bag. A.R.R.L. is sponsor of this activity dedicated to the enjoyment of all 160-meter operators. All who are interested are encouraged to try this W.A.S. Party. Let us know how you make out.

— P. E. H.

Simplified and Inexpensive Unit for Use with Any Suitable R.F. Chassis

A Deflection and Video Chassis for Television Reception

BY HOWARD C. LAWRENCE,* JR., W2IUP

THE beginning of regular scheduled television broadcasts in the New York area and the prospects of similar scheduled broadcasts in several other areas has greatly increased the interest of amateurs in this field. Many of them have built receivers so that they can obtain first hand experience in a field in which many things must be considered that can be neglected in ordinary sound radio. Many experimenters want a relatively simple and inexpensive receiver, yet one that will give clear pictures easily viewed. The television video and deflection chassis to be described was designed with this in mind.

A three-inch picture tube was selected as being a reasonable compromise between cost and picture size. The picture is large enough for two

* RCA Manufacturing Co., Inc., Camden, N. J.

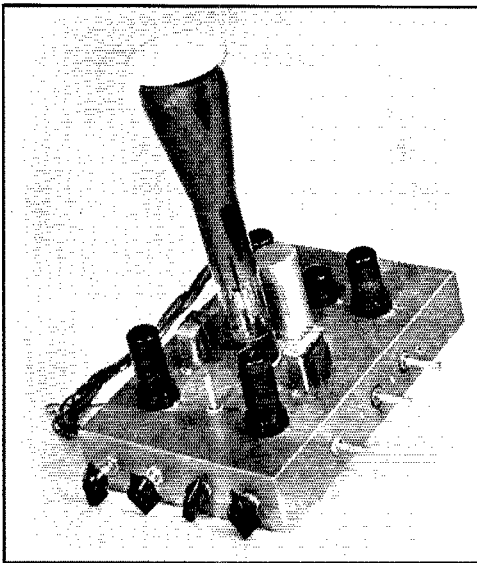

Using an ordinary oscilloscope tube, this video and synchronizing unit is inexpensive and simple to build. It can be fed from any type of television r.f. end the builder prefers to use.

A low-cost and relatively simple chassis-type outfit including sweep oscillators and amplifiers, synchronizing separator and amplifier, video amplifier and picture tube. Low-voltage operation with a three-inch tube simplifies the insulation problem.

people to view with ease. Definition is such that with a good i.f. and r.f. system movie subtitles and other small print can be read. The particular

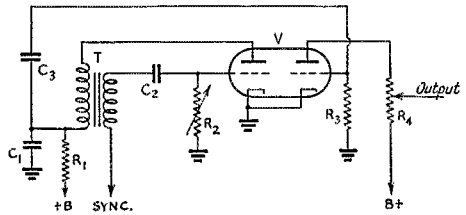

Fig. 1 — Basic circuit of sweep oscillator and amplifier.

tube used allowed resolution down to over 250 lines on the standard test pattern. This unit can be fed either from the second detector or first video stage of any of the many r.f. and i.f. units that have been described to date.¹ The input signal must be of negative polarity. That is, the voltage corresponding to a bright portion of the picture must be negative.

Sweep Circuits

The simplicity of the sweep circuits is the chief recommendation for this unit. Fig. 1 shows the basic sweep circuit used. It will be noted that there are very few parts. Tube V can be of any of the sharp cutoff double triodes now available. Both the 6F8G and the 6N7 have been used successfully. The 6F8G has the advantage that it draws more plate current as an amplifier and therefore is capable of greater output at lower plate voltages. The 6N7 has the advantage that it is a single ended metal tube and is slightly smaller physically. Transformer T is one of the special television sweep oscillator transformers of which there are several on the market today, and which are now quite reasonable in cost (\$1.75 list).

The left-hand part of tube V is the oscillator. The polarity of the transformer T is such that it

¹ QST, April and May, 1938, December, 1938, January, 1939.

causes the tube to start oscillating. This oscillation, however, is accompanied by a flow of grid current through the grid resistor R_2 and develops a negative bias on the grid of the tube and on the grid condenser C_2 , blocking the tube and cutting off the plate current. The charge on C_2 then slowly leaks off capacitor C_2 through resistor R_2 until a point is reached at which the tube can again start oscillating. The cycle then repeats.

During the time that the tube is oscillating it

is drawing plate current. This plate current flows through R_1 , causing a voltage drop that appears across C_1 . When the tube is blocked the charge leaks off C_1 , allowing the capacitor to become more positive. The charge leaks off at an exponential rate determined by the product of R_1 and C_1 , the time constant of the circuit. If the ratio of the time constant R_1C_1 to the period of oscillation,

$$\left(\frac{1}{\text{sweep frequency}} \right)$$

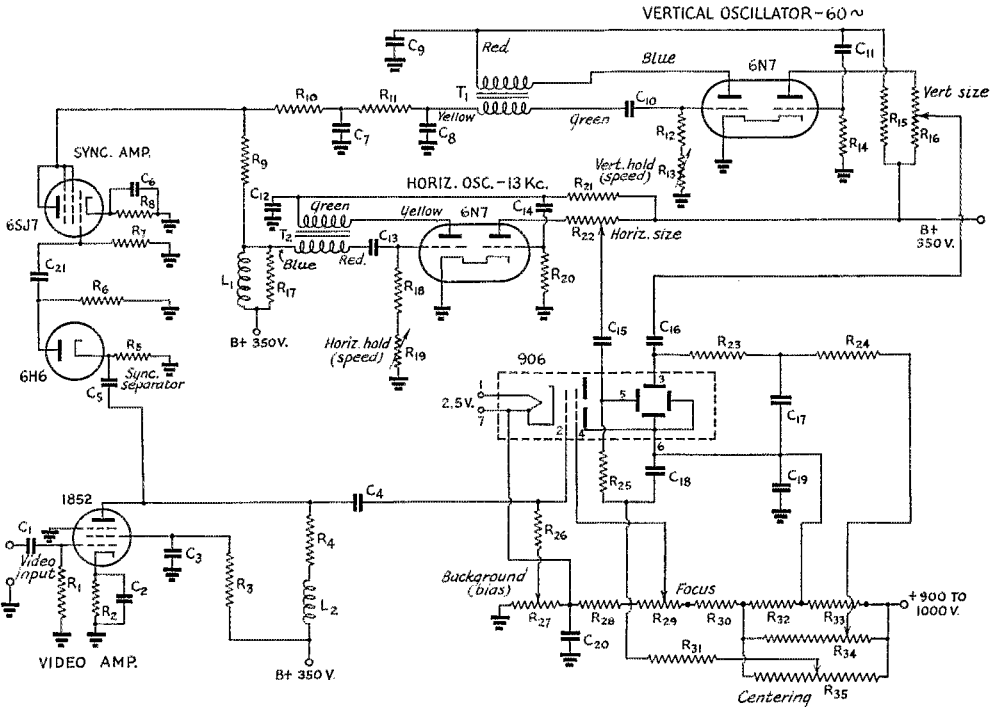

Fig. 2 — Circuit diagram of the video and sweep unit.

- | | | |
|---|---------------------------------------|---|
| C_1 — 0.25- μ fd. 400-volt paper. | R_2 — 150 ohms. | R_{26} — 0.5 megohm. |
| C_2 — 50- μ fd. 25-volt electrolytic. | R_3 — 60,000 ohms. | R_{27} — 50,000-ohm potentiometer. |
| C_3 — 4- μ fd. 350-volt electrolytic. | R_4 — 3000 ohms. | R_{28} — 0.25 megohm. |
| C_4 — 0.1- μ fd. 400-volt paper. | R_5 — 200,000 ohms. | R_{29} — 0.5-megohm potentiometer. |
| C_5 — 0.01- μ fd. 400-volt paper. | R_6 — 10,000 ohms. | R_{30} — 0.5 megohm. |
| C_6 — 10- μ fd. 25-volt electrolytic. | R_7 — 0.25 megohm. | R_{31} — 50,000 ohms. |
| C_7 — 0.003- μ fd. 400-volt paper. | R_8 — 2500 ohms. | R_{32} — 100,000 ohms. |
| C_8 — 0.01- μ fd. 400-volt paper. | R_9 — 10,000 ohms. | R_{33} — 100,000 ohms. |
| C_9 — 0.25- μ fd. 400-volt paper. | R_{10} — 10,000 ohms. | R_{34} — 0.5-megohm potentiometer. |
| C_{10} — 0.001- μ fd. 400-volt paper. | R_{11} — 10,000 ohms. | R_{35} — 0.5-megohm potentiometer. |
| C_{11} — 0.05- μ fd. 400-volt paper. | R_{12} — 2 megohms. | L_1 — 300-turn coil (RCA No. 33541, with resistor removed). |
| C_{12} — 0.01- μ fd. 400-volt paper. | R_{13} — 2-megohm potentiometer. | L_2 — 75-turn coil (RCA stock No. 33538). If possible the exact number of turns on this coil for each particular receiver should be determined by experiment. |
| C_{13} — 0.001- μ fd. 400-volt mica. | R_{14} — 10 megohms. | T_1 — Vertical oscillation transformer (RCA Stock No. 32898). |
| C_{14} — 0.001- μ fd. 400-volt paper. | R_{15} — 0.5 megohm. | T_2 — Horizontal oscillation transformer (RCA Stock No. 32899). |
| C_{15} — 0.001- μ fd. 1000-volt paper mica. | R_{16} — 0.25-megohm potentiometer. | All fixed resistors $\frac{1}{2}$ watt IRC insulated. |
| C_{16} — 0.1- μ fd. 1000-volt paper. | R_{17} — 3500 ohms. | All potentiometers small Clarostat carbon units. |
| C_{17} — 0.25- μ fd. 200-volt paper. | R_{18} — 10,000 ohms. | |
| C_{18} — 0.25- μ fd. 200-volt paper. | R_{19} — 50,000-ohm potentiometer. | |
| C_{19} — 0.5- μ fd. 1000-volt oil-filled paper. | R_{20} — 2 megohms. | |
| C_{20} — 0.5- μ fd. 150-volt paper. | R_{21} — 100,000 ohms. | |
| C_{21} — 0.1- μ fd. 400-volt paper. | R_{22} — 100,000-ohm potentiometer. | |
| R_1 — 0.25 megohm. | R_{23} — 1 megohm. | |
| | R_{24} — 50,000 ohms. | |
| | R_{25} — 0.5 megohm. | |

is made sufficiently large the discharge current will be essentially a sawtooth. The amplitude of this sawtooth will be greater if either C_1 or R_1 is smaller, but will be approximately constant regardless of the values of R_1 and C_1 so long as their product is the same. However, there are some other considerations. The larger R_1 the smaller the plate voltage applied to the oscillator and the smaller the plate current. If R_1 is made too large there will not be enough plate voltage to make the tube oscillate. The values shown for C_1 and R_1 in the low-frequency oscillator represent a compromise which gives a capacitor, C_1 , of reasonable size.

The sawtooth appearing across C_1 is then coupled through C_3 to the grid of the right-hand side of V_1 , which serves as an amplifier. C_3 must be large enough to transmit the lowest frequency components of the sawtooth. The amplifier side of the tube obtains its grid bias from the grid current flowing through R_3 on the positive peak of the sawtooth. This causes the tip of the sawtooth to be flattened very slightly, but this flattening occurs well within the region that is blanked out by the blanking pulses of the transmitter and is therefore not objectionable. The load resistor R_4 on the amplifier should be large enough to give sufficient gain, yet not so large that any of the high frequency components of the sawtooth are lost. The largest load that can be used on the high-frequency sweep is about 100,000 ohms.

The amplitude of the output is first set to be a little larger than needed by adjusting R_1 and is then controlled by R_4 . R_1 could be made variable and R_4 fixed, but this would cause the frequency and size controls to interlock, a change in size often throwing the picture out of sync. Controlling the size by means of R_4 does not affect the shape of the horizontal sawtooth because the control is in a relatively low-impedance circuit.

Other Circuit Elements

The video stage is a conventional 1852 video amplifier with high-frequency inductance compensation in series with the plate load. Much better compensation can be obtained by using a

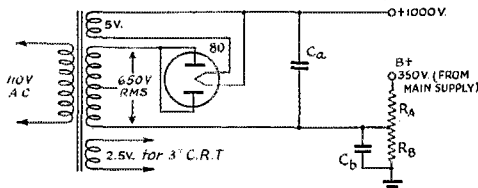

Fig. 3 — A suitable power supply for the cathode-ray tube can be made from a cheap broadcast receiver power transformer.

T — Any small power transformer giving upwards of 650 volts r.m.s. across the complete winding.

C_a — 0.5 μ f. 1000-volt.

C_b — 4 μ f. 300-volt electrolytic.

R_a, R_b — 100,000 ohms. In some cases it may be desirable to make R_a smaller to get a higher output voltage.

combination of series and shunt compensation² but successful use of this method requires the use of test equipment not available to most experimenters. Use of this latter method allows compensation to the same frequency with nearly double the plate load and therefore more gain.

A 6H6 diode separates the sync from the video. The sync is then amplified by a 6SJ7 amplifier connected as a triode. A low-pass filter keeps the high-frequency sync out of the low-frequency sweep, while the high-frequency sync appears across the inductance L_1 in the plate load.

The voltage divider for the cathode ray tube is conventional and needs little comment. It may be advisable to alter the size of some of the filter capacitors in this part of the circuit, since a well-filtered "B" supply will not require as much filtering in this part of the circuit as will a poorly-filtered supply.

One of the cheapest ways of obtaining the high voltage for the cathode ray tube is to connect a broadcast-receiver power transformer to a half-wave rectifier as shown in Fig. 3. A small transformer rated at 325 volts each side of centertap will give 800 or 900 volts in this sort of circuit. By adding this to part of the "B" voltage used to supply the other parts of the chassis the necessary 1000 or so volts may be obtained.

Mechanical Construction

This unit was constructed on a 7- by 11- by 2-inch steel chassis. Focus, background (brightness), and the two hold (speed) controls were brought out on one end of the chassis. The vertical size control is on top of the chassis while the centering and horizontal size controls are on one side. One side of the chassis is free of controls so that it can be bolted to an r.f. and i.f. chassis to form a complete unit. Small Clarostat potentiometers were used to save space. Since the centering controls are operating at a potential considerably above that of the chassis it was considered desirable to insulate them by first mounting them on a small piece of Masonite which is then bolted to the chassis. Precautions should be taken to see that the wiring of the two sweep oscillators and their amplifiers is separated as much as possible so that these circuits do not interact and cause poor interlace of the picture. The wiring of the video amplifier should be such that the capacity to ground of leads carrying video voltages is as low as possible.

Operation

Operation of this unit is the same as has been described in previous articles and so need not be repeated here. Should it be found that the sweeps are synchronizing only on parts of the picture, adjustment of R_5 to a larger value will clear up the trouble.

² Seeley and Kimball, "Analysis and Design of Video Amplifiers," Part 2, *RCA Review*, January, 1939.

A Regenerative Preselector With Output Metering Bridge

BY H. O. TALEN,* W9PYQ

A PRESELECTOR is generally designed to provide some gain as well as selectivity, whether built into a receiver or provided as a separate piece of equipment. The preselector described below was developed with a somewhat different purpose in mind—to incorporate a noise limiting device as close to the antenna as practical, providing a maximum of protection for high-selectivity circuits in subsequent stages of the receiver.

In the January, 1939, issue of *QST* a "signal metering valve" was described, consisting of the combination of a grid-leak-biased amplifier and a cathode resistor-biased amplifier with the output circuits connected in opposition, so as to limit peak voltages passed through the amplifier and give some degree of automatic gain control. The circuit, using a double triode, is shown in Fig. 1.

Briefly, its functioning depends upon the relative biases applied to the grids. The bridge circuit formed by the two plate-cathode impedances and the two halves of the output coil is ordinarily in balance when equal biases are applied to the grids, and no signal appears across the output coil. In operation, the bridge is unbalanced by slightly overbiasing triode B, allowing signals to come through. Strong signals are partially rectified by the triodes, resulting in increased bias on triode A and decreased bias on triode B, and tending to balance the bridge and reduce the signal output. Noise voltage peaks are limited,

* 5532 Tennessee Ave., St. Louis, Mo.

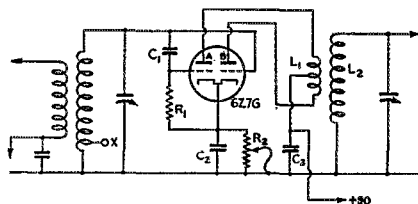

Fig. 1 — The "signal metering valve" circuit, using a double triode. The coils have the usual constants for interstage applications; in the output circuit, L_1 has three turns each side of center-tap, L_2 14 turns total, for operation in the 14-Mc. band. Other constants are as follows:

C_1 — 100 μfd .

C_2 — 250 μfd .

R_1 — 1 megohm.

R_2 — 5000-ohm variable.

X — Tap for negative feedback, about $\frac{3}{4}$ turn from cold end. C_3 can be returned to this point instead of ground for stabilization.

if negative, by plate current cut-off of triode A, and if positive, by the substantially constant difference in plate currents of the two triodes.

Regenerative Detector with Stabilization

By a simple rearrangement of the apparatus, the double triode and its output circuit was converted into a regenerative grid-leak detector combined with a Class-C negative feedback amplifier. The modified circuit is shown in Fig. 2. The output was fed into a two-stage audio amplifier. The bias control shown was the least noisy of a number of arrangements tried, and gives a satisfactory range if the proper combination of plate voltage, plate resistor and bleeder resistor (R_b) is used. Regeneration is controlled roughly by the antenna coupling condenser and then by adjustment of the bias control.

With triode B disconnected or biased beyond plate current cut-off, the receiver behaves like an ordinary regenerative set. If made to oscillate, and the grid biases are then made nearly equal by adjustment of the bias control, the oscillations will cease because of the degenerative feedback from the latter triode on positive voltage swings. The circuit accomplishes electronically the same effect as the manually-controlled feedback compensator described in *QST* for March, 1938.

The most interesting adjustment of the receiver relates to reception of 'phone signals. In an ordinary regenerative detector operating just below the point of oscillation, it is not unusual for a modulation peak or static pulse to throw the circuit into oscillation, whereupon the regeneration must be reduced materially before a stable condition is restored.

With the compensating arrangement of Fig. 2, regeneration may be carried nearer to the critical point without instability. If advanced to where transient peak voltages cause oscillation, the circuit quickly stabilizes itself without readjustment of the controls. This action occurs automatically as long as triode B supplies enough power to

One usually thinks of a preselector as a signal booster and an image reducer, but W9PYQ has adapted his "signal metering" principle to a preselector which results in noise reduction as well as the usual advantages.

Fig. 3 — Regenerative preselector with metering bridge.

- C₁ — 100 μ fd.
- C₂, C₃, C₄ — 0.005 μ d.
- R₁ — 1 megohm.
- R₂ — 300 ohms.
- R₃ — 5000-ohm bias control.
- R₄, R₅, R₆ — 5000 ohms.
- R₇ — 50,000-ohm variable.
- R₈ — 1000 ohms.

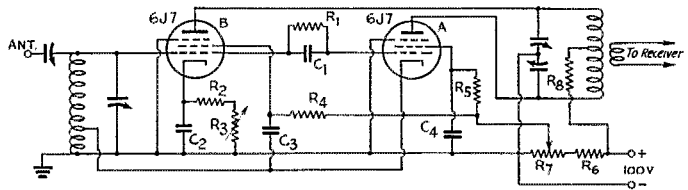

offset the effect of positive voltage swings coming from the antenna or built up by regeneration.

The performance of the receiver compares favorably with that of a t.r.f.-regenerative set and is less critical. Regeneration can, of course, be advanced to the point where the circuit oscillates vigorously. In this condition, triode B seems to contribute little except harshness of control, i.e. it is more difficult to keep the circuit barely oscillating unless triode B is eliminated by over-biasing its grid.

It may be noted that, with the same plate voltage on both triodes, there is no ordinary setting of the controls where the amplification of the two tubes will be equal and the outputs will cancel. The reason appears to lie in the fact that the

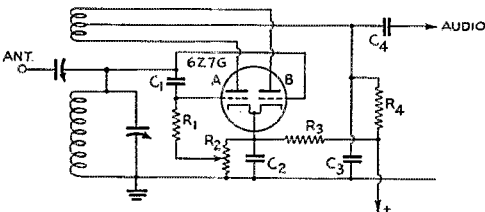

Fig. 2 — Stabilized regenerative detector circuit.

- C₁ — 100 μ fd.
- C₂ — 0.005 μ d.
- C₃ — 0.001 μ d.
- C₄ — 0.05 μ d.
- R₁ — 1 megohm.
- R₂ — 500-ohm potentiometer for bias control.
- R₃ — 100,000 ohms.
- R₄ — 150,000 ohms.

effective amplification in a stage using feedback is given by

$$\frac{\text{Amplification without feedback}}{1 - (\text{Per Cent Feedback} \times \text{Amplification without feedback})}$$

This resultant amplification is always above normal for triode A with its positive feedback and is always below normal for the negative feedback triode B, ignoring possible phase shifts.

Regenerative Preselector

The self-stabilizing feature of the regenerative circuit discussed above, in combination with the signal metering valve described in the January, 1939 *QST*, presents some interesting possibilities as a preselector for a superheterodyne or other type of receiver.

In order to explore these possibilities, the

arrangement shown in Fig. 3 was built up. Two 6J7 tubes were used and, to permit coupling the preselector to a National 80X super through a low impedance link, a tuned output circuit was provided. The input and output circuits were separately shielded.

Analysis of Fig. 3 is simplified by considering the control grids, cathodes and screen grids as equivalent to the triode elements shown in Fig. 2. Since independent cathode connections were available in the pair of pentodes, negative feedback from pentode B was obtained by connecting its screen and cathode through condensers to the cathode and screen, respectively, of pentode A, thereby avoiding the necessity of a separate negative feedback winding on the input coil. This portion of the circuit performs in much the same fashion as the stabilized detector described above, and contributes the higher signal levels deemed essential for proper functioning of the remainder of the circuit.

The plates of the pentodes are connected to opposite ends of a center tapped winding, which is tuned by a split-stator condenser. It is possible that an untuned coil closely coupled to a tuned circuit would work as well or better. Any coupling which may occur between the plate and the input circuits of the preselector does not appear to be sufficient to prevent a relatively complete cancellation of output from the two tubes upon appropriate setting of the cathode and screen voltage controls.

The tuned circuits included in the experimental set-up covered a range from 14 Mc. to 21 Mc., containing a wide variety of signals and a full complement of disturbances from static, automobiles, oilburners, therapy and X-ray machines, power line clicks, etc.

An "S" meter was used in connection with the National 80X receiver and provided an invaluable aid in judging the performance of the preselector. In addition, a neon bulb (with resistor removed) was connected across the output transformer of the receiver and was kept in plain sight to give a rough check on static and auto-ignition disturbances.

The superheterodyne receiver used is equipped with amplified a.g.c., and it is comparatively easy to observe the rising noise level on 'phone or broadcast signals which fade deeply. As long as the signal level stays up within the range of the a.g.c. action of the receiver, the background noise

(Continued on page 118)

"Wired Wireless" for Remote Control

How to Build a Carrier Current Transmitter and Receiver

BY JOHN EVANS WILLIAMS,* W2BFD

REMOTE control is something that most amateurs have contemplated at one time or another. The reason, in some cases, is lack of space for the array of apparatus produced by the inevitable station expansion; in other instances remote control seems the only feasible solution to the antenna problem. There have appeared some excellent articles on this subject, enabling operation of complete hand-switching transmitters including changing frequency, keying and modulation, at any distance to which wire facilities may be extended. But — and here's the hitch — if the

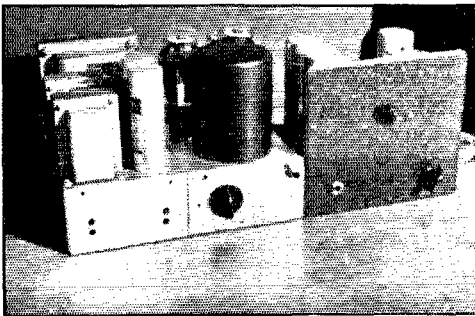

The complete control outfit is quite compact. The three units shown are the power supply (left), transmitter (center), and receiver (right).

distance is more than a few hundred feet the majority of amateurs will justly balk at stringing wires. It often happens that a suitable location for the transmitter cannot be obtained within a convenient distance of the control point, and while one can always lease wires from the local telephone company the rental is generally prohibitive.

There is a system of remote control widely used by commercial utilities companies that does not seem to have attracted much attention in amateur circles. This system is "carrier current", or, as it is more commonly known, "wired wireless". While it may sound complicated, carrier current control is nothing more than application of a few watts of r.f. power of relatively low frequency to the electric light mains. This r.f. power will traverse the power line while the latter is doing its normal job and can be detected at surprising distances with good signal strength. If the oscillator is well shielded and feeds the line with a balanced circuit, radiation will be negligible. This is similar

to the manner in which radiation from Zepp feeders is cancelled by currents flowing in opposite directions in the two wires.

There follows here a description of a "wired wireless" system which has demonstrated its ability to perform satisfactorily over a distance of more than three city blocks in operating a relay, and more than three quarters of a mile as an intercommunicating telephone system — this in a crowded suburb of New York. In rural sections it is possible that transmission could be effected over several miles. Several systems can be operated on different frequencies without interference.

While more efficient transmission can be effected on comparatively low carrier frequencies around 20 kilocycles (as ascertained by the writer with half a dozen different models of transmitters) it was not considered worth the difficulty or expense to obtain large inductances and capacities necessary to tune to these frequencies. The final model shown in the photograph uses a channel frequency of 175 kc. This permits using inexpensive i.f. transformers of the type popular in receivers a few years ago as the tuned circuit elements in the receiver. Likewise, ordinary b.c. receiver r.f. coils and variable condensers can be adapted as transmitter tank circuits without a great deal of work.

The Receiver

The receiver needs but little special comment, since it is simply a broadcast-band superheterodyne receiver with the r.f. and mixer stages removed and the 110-volt a.c. line coupled to the input of the i.f. amplifier. A new first i.f. transformer primary is used to match the extremely

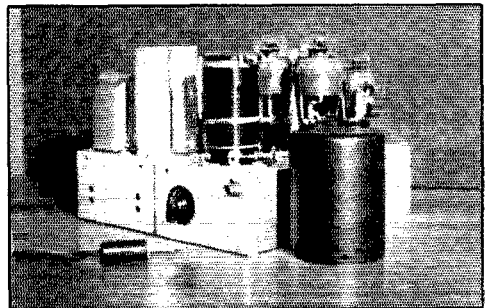

The transmitter and power supply. The shield is removed from the amplifier tank coil to show its construction.

*3806 61st St., Woodside, N. Y.

Fig. 1—The carrier current receiver circuit.

- C₁, C₂, C₄—0.1- μ fd. paper.
- C₃—4- μ fd. electrolytic.
- C₅—1 μ fd.
- C₆—0.004 μ fd.
- C₇—0.01- μ fd. mica.
- R₁—10,000-ohm potentiometer (gain control).
- R₂—300 ohms, 1/2-watt.
- R₃, R₅—100,000 ohms, 1-watt.
- R₄—25,000 ohms, 1-watt.
- R₆—7000 ohms, 1/2-watt.
- T₁—Rebuilt 175-kc. i.f. transformer (see text).
- T₂, T₃—175-kc. i.f. transformer (interstage).
- T₄—Audio transformer, 10,000 ohms to grid.

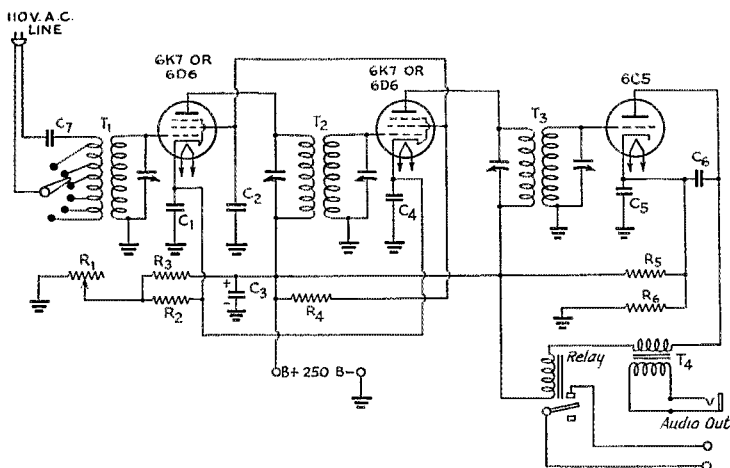

low impedance of the line to the grid of the first i.f. tube. The wiring is shown in Fig. 1. Several of the writer's earlier models were nothing more than 175-kc. b.c. receiver chassis stripped down as mentioned, but for compactness the final model was built on a small 5 by 6 inch chassis with a 7 by 7 panel. The knob in the center of the panel is the gain control; the jack is for the audio output, and the remaining control is the rotary switch which selects the proper tap on the impedance-matching transformer to secure series resonance with the line isolating condenser.

The construction of the input transformer is simple. The primary coil of a standard interstage 175-kc. i.f. unit is removed (be careful not to damage the secondary or disturb the setting of its trimmer) and the primary trimmer is disconnected and left unused. Over the secondary is slid a snug-fitting cardboard, fibre or bakelite tube about an inch and a half long. Fourteen turns of No. 16 wire are wound on this tube, taking off taps at the 6th, 8th, 10th and 12th turns from either end. If resonance cannot be achieved with the switch on any of the taps, the value of the line isolation condenser (C₇) should be altered until resonance will occur when 10 turns of the primary are used. It might be mentioned in passing that the optimum primary inductance-to-capacity ratio varies somewhat depending on the outlet, in the electric line, into which the receiver (or transmitter) is plugged. In general, it may be said that

the nearer the electric meter the lower the impedance the line presents to the high-frequency energy. This requires less inductance and a higher value of capacity. A good match will improve the signal-to-noise ratio in the receiver and result in more efficient transfer of power in the case of the transmitter.

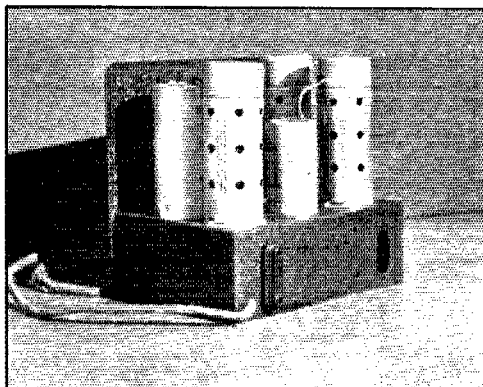

A rear view of the receiver, showing the arrangement of tubes and i.f. transformers.

At the time of photographing, the receiver shown had a.v.c., but this was later eliminated in favor of the simpler system diagrammed. The a.v.c. prevented proper operation of the relay by bringing up the background noise when the transmitter carrier was removed. Transformer rather than resistance coupling was used out of the power detector as this permits a relay current of several milliamperes on a fairly weak signal. At W2BFD this relay has been utilized to operate a step-switch selector controlling up to 48 individual operations at the remote station.

If you want to control a transmitter at a point too far away to make stringing wires practicable, and if hiring a telephone line is too expensive, the equipment described in this article may be the answer. Good for intercommunicating as well as remote control.

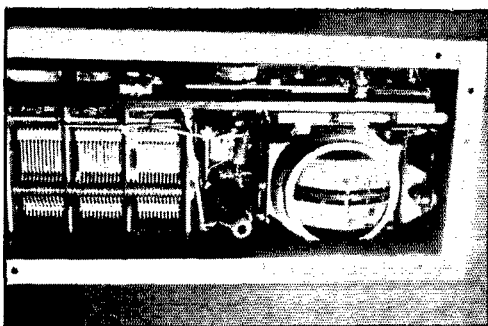

Looking into the bottom of the transmitter chassis. The variometer at the right and amplifier tank tuning condenser at the left occupy most of the below-chassis space.

The Transmitter

The carrier transmitter was also subjected to considerable experimentation before arriving at the circuit shown in Fig. 2. It is suggested that mounting the transmitter on a larger chassis would make the wiring job easier, but the writer wished to keep the controlling equipment as small as possible because lack of space was the main reason for not having the radio transmitter itself in the house. The transmitter is of the m.o.p.a. variety utilizing a high-*C* Colpitts oscillator circuit very popular in shipboard and other long-wave transmitters. If the control is to be used for a c.w. transmitter and no modulation is to be applied to the carrier transmitter, the neutralizing condensers may be eliminated. The tendency of self-oscillation in the amplifier is very slight at the frequency at which this system operates. The oscillator tank inductance is a variometer, using fixed mica condensers to complete the tank. These variometers may be procured quite reasonably from dealers in old junked t.r.f. broadcast receivers and have an inductance of approximately 750 microhenrys. The one illustrated came from a Bosch radio, but there were quite a number of sets of this vintage that also used variometers suitable for this system.

The amplifier output transformer is made of a coil (and its shield) from an old Stromberg Carlson "Treasure Chest" receiver, but for the convenience of those amateurs who may not be able to obtain this coil its construction will be described. On a 2½-inch form are wound 100 turns of No. 18 gauge wire. Over this is placed a single layer of empire cloth and the winding is then con-

tinued downward for 77 turns. These 177 turns constitute the plate winding for the paralleled 6L6's. The secondary winding is placed in the remaining space below the end of the primary and consists of 15 turns of No. 12 wire tapped at the 6th, 8th and 10th turns. The tank condenser of the amplifier is a three-gang 350- μ fd. per-section condenser with all three sections paralleled to give a maximum capacity of over 0.001 μ fd.

One point that must be stressed in the construction of both transmitter and receiver is the need for maintaining very low resistance in the line coupling circuits. In the writer's case rewinding the transmitter output coil with No. 18 instead of No. 12 wire reduced the radio-frequency current in the line from 3½ to 1 ampere as measured with a thermoammeter. Also, the leads carrying the r.f. to the line should be of flexible wire equivalent to No. 10 gauge.

It is absolutely essential that the transmitter be thoroughly shielded and its chassis well grounded to prevent radiation. The transmitter described here produced barely noticeable interference in a broadcast receiver using 175 kc. i.f.'s plugged into the same electric power outlet and placed 3 feet away from the transmitter on the same bench.

No attempt will be made to describe the modulator or power supply as they are entirely conventional. The audio amplifier delivers between 10 and 15 watts of audio to the Class "C"

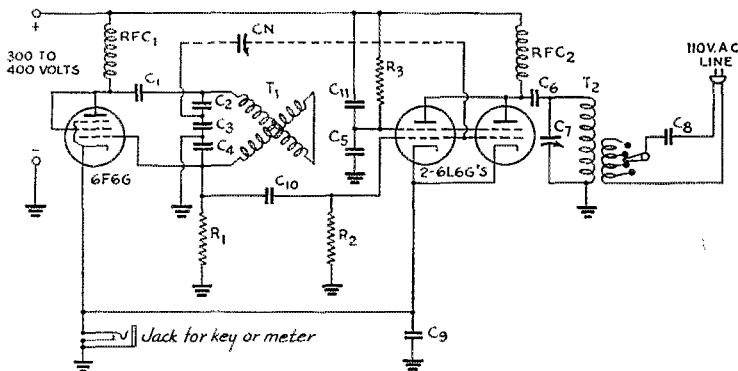

Fig. 2 — The 175-kc. transmitter circuit.

- C₁, C₆ — 0.006- μ fd. mica.
- C₂, C₃, C₄ — 0.01- μ fd. mica.
- C₅ — 0.02- μ fd. paper.
- C₇ — 3-gang 350- μ fd. b.c. condenser, all sections in parallel.
- C₈ — 0.015- μ fd. mica.
- C₉ — 0.1- μ fd. paper.
- C₁₀ — 0.006- μ fd. mica.
- C₁₁ — 0.2- μ fd. paper.
- C_n — Neutralizing condenser, optional (see text).
- R₁ — 30,000 ohms, 1-watt.
- R₂ — 50,000 ohms, 1-watt.
- R₃ — 6000 ohms, 20-watt, wire-wound.
- T₁ — 750-mh. variometer (see text).
- T₂ — Rebuilt b.c. r.f. coil (see text).
- RFC₁, RFC₂ — 250-mh. i.f. choke.

6L6's. The power supply delivers 400 volts at 150 ma. No doubt most amateurs will want to use whatever equipment that may be kicking around the shack.

To tune up the transmitter, a wire laid near the transmitter variometer is connected to the antenna post of a broadcast receiver set at 700 kc. and the oscillator tuned until a signal is picked up. This should be the fourth harmonic of the carrier frequency. To verify that the harmonic is really the 4th, tune the b.c. receiver to 875 and 1050 kc. If the 5th and 6th harmonics are heard at these points one can be reasonably certain that the transmitter is operating on the correct frequency. After tuning the oscillator, the amplifier tuning condenser is rotated for minimum plate current as indicated on a 0-150-mil meter plugged into the key jack. The output is now connected up to the line through its series resonating condenser and the tap switch rotated while observing a 0-5 ampere hotwire or thermocouple meter temporarily inserted in the line. Lamps will not be satisfactory substitutes for the meter because of the resistance introduced into the circuit. If maximum output current obtains with all 15 turns of the output coil connected in the circuit the size of the series condenser should be increased. If maximum current is obtained with only 6 turns the series condenser should be reduced in value.

Neutralizing can be accomplished by any of the time-tried methods. If the lamp loop method is used it is necessary at these low frequencies to use about 20 turns in the loop in contrast to the single turn needed at high frequencies.

EXPERIENCE SPEAKS

A wooden feeder spreader which has been boiled in paraffin may be made even more waterproof by allowing it to cool after boiling and then dipping the cold spreader momentarily in the hot paraffin. This produces a thin outer coating which sheds water much more effectively. — *W90GN*.

WWV Schedules

EXCEPT for the special broadcasts of WWV using 20 kw. as described below, WWV is now running a continuous schedule (day and night) on 5000 kc. with a power output of 1 kw. This continuous transmission is modulated with the standard pitch in music, 440 cycles per second.

Each Tuesday, Wednesday and Friday (except legal holidays), the National Bureau of Standards station, WWV, transmits with a power of 20 kw. on three carrier frequencies as follows: 10:00 to

11:30 A.M., E.S.T., on 5000 kc.; noon to 1:30 P.M., E.S.T., on 10,000 kc.; 2:00 to 3:30 P.M., E.S.T., on 20,000 kc. The Tuesday and Friday transmissions are unmodulated c.w. except for 1-second standard-time intervals consisting of short pulses with 1000-cycle modulation. On the Wednesday transmissions, the carrier is modulated 30% with a standard audio frequency of 1000 c.p.s. The accuracy of the frequencies of the WWV transmissions is better than 1 part in 5,000,000.



DIXIE JONES' OWL JUICE

IF Y'ALL'LL lissen lemme tell ya sumpn. It ain't nothin' much, just sumpn to talk about. There's a lotta diff between battin' hamgrams around and handlin' real meessages that somebody's paid good munny to have sent. For instance, away back yonder I use to be a op at Nome where it cost 38¢ a word, with a 10-word minimum, to send a message only to Seattle. So a guy owed ya \$3.80 the minnit he walked in the door. Ya didn't munky with nobody's meessages at them figgers. Ya sent what it said and the jasper at the other end put down whatcha sent and it got somewhere and said sumpn and further and more it said what it said to start with. But these dang hamgrams by the time they been through six relays they ain't going nowhere and they don't make no sense. What I do is bull 'em back like they ought to be. After I patch 'em up I betchy they make more sense than they did when they started.

— *W4IR of the Dixie "Squinch Owl"*

Strays

Clipped by W9ZCC from a newspaper:

Adrian, Minn. — The Adrian City Council is going to see what can be done in the way of passing an ordinance to eliminate radio interference. City Clerk F. J. Forckenbrock has communicated with the League of Municipalities to ascertain the nature of an ordinance which will call for *capacifiers* on all electrical appliances.

W8QAN says, "Frequently we are confronted with the job of applying a nut to a bolt in one of those obscure corners where only a single finger and no ordinary pliers will fit. A drop of paste or glue may be used on the end of the finger to temporarily hold the nut, and the parts may easily be screwed together."

12th A.R.R.L. DX Competition

March 15th-16th-17th and 22nd-23rd-24th

BY F. E. HANDY* WIBDI

TO TAKE PART

W's: Swap RST² Report,³ contact number (001, 002, etc.) and name of your state, with those outside the U.S.A. (per Rule 3a and 3c) and with other W's (per Rule 3b and 3c). Full swaps count 100 points each and 5 points each respectively, times country-lic. area multiplier. Submit log per Rule 2.

All Other Amateurs: Swap RST² Report,³ contact number (001, 002, etc.) and name of your country, with U.S.A. amateur stations (per Rule 4a-b). Full swaps count 5 points. Sum of such points times possible 48-state multiplier gives score. Submit log per Rule 2.

THE time for the annual chance at the DX currently on the air is at hand. Since not so much international DX is available as in previous years, some modifications in the rules for this activity are necessary to insure a good volume of operating fun, and give a chance at the DX that is available. All *outside* the mainland U.S.A. will attempt a "worked all states" objective-multiplier. Week-end periods to concentrate on contest operations, and some credit for a limited amount of domestic work to fill otherwise empty periods with interesting contacts appears to offer the best chance for an interesting operating activity. Getting new countries and U. S. licensing areas (9 possible) will add to one's multiplier for U.S.A. stations.

The operating will not be spread out over 9 days as usual, but will take place in two week-end periods so the DX available at a given time will not be too thin for best enjoyment. For the same reason there will not be two periods for 'phone

and telegraph participation, but contestants may take part in either method they choose, and submit results for listing by the chosen mode. Each operating group will be considered by itself. Telegraph ops will be competing only with each other; those who use voice will be competing with others using voice and not with the telegraphers. Two similar awards will be available in each A.R.R.L. Section and each country . . . separate tie-holder medallion awards for the best 'phone, and the best telegraph participation.

Contest Exchanges

A number followed by the geographical location of the station will be exchanged in proof of QSO. The first numerals shall constitute the Readability³ — Strength³ and Tone³ reports of the station to which the number is sent. The last three figures of each group exchanged will give the progressive number of the contact (001, 002, 003, etc.). Following the whole serial number group each station will give the name of state or country in which it is located. Try to make a complete exchange each way with each station.

The Contest Period

The exact local starting and ending time for our DX competition is given in the table below. There is no time limit except the starting and stopping time.

Mark logs "C.w. station work," or "Phone work." The transmitter must be kept on either c.w. or 'phone for all contacts submitted constituting any one entry. It is unethical to shift to c.w. to call a station, or send numbers, when taking part in a 'phone status (and vice versa). Likewise, whistling of code for numbers (or similar means) is regarded as improper. Counting of consecutive numbers, spelling of the letters that constitute

* Communications Manager, A.R.R.L.

¹ 6:01 P.M., C.S.T., March 15th or 22nd, see discussion under "the contest period."

² For R-S-T definitions of "readability, strength and tone" in that order: See 1940 A.R.R.L. Handbook, page 428, or Operating an Amateur Radio Station, page 12.

³ In 'phone exchanges only two numerals will be given, the first the "readability" and the second the "strength." In other words, telegraph entrants will send and receive six figure groups, and 'phone entrants, five figure groups.

⁴ QHM — Will start to listen at *high* frequency end of band and tune toward *middle* of band.

QMH — Will start to listen in the *middle* of the band and tune toward the *high* frequency end.

QLM — Will start to listen at the *low* frequency end of the band and tune towards *middle* of band.

QHL — Will start to listen on the *high* end of the band and tune toward the *low* frequency end.

⁵ Phone operators should *not* use Q code when a few properly chosen words will state where they will be listening first! The idea also is to make the 'phone report part of the five numeral groups, so it will be quite unnecessary to say "readability" and "strength" or other indication before the first two numbers in the serial number group.

⁶ Two awards ('phone and c.w.) will be made in each U.S.A. A.R.R.L. Section, likewise in each other country (prefix-determined locality).

⁷ This QST carries a complete list of the Sections of the A.R.R.L. Field Organization.

⁸ Consult the list of call-prefixes for *different countries of the world* as given in The Radio Amateur's Handbook (1940), page 441. This will be used as the official list.

⁹ See C.C. Rules 1, 2, 3, etc. page 74, January 1940 QST.

| <i>Time</i> | <i>Starts</i> | <i>Ends</i> |
|----------------------------------|-------------------------------------|------------------------------|
| Greenwich | March 16th (23rd) 0001 (12:01 A.M.) | 18th (25th) 0159 (1:59 A.M.) |
| A.S.T. (60th Meridian) | March 15th (22nd) 8:01 P.M. | 18th (25th) 12:59 A.M. |
| E.S.T. (75th Meridian) | March 15th (22nd) 7:01 P.M. | 17th (24th) 11:59 P.M. |
| C.S.T. (90th M.) | March 15th (22nd) 6:01 P.M. | 17th (24th) 10:59 P.M. |
| M.S.T. (105th M.) | March 15th (22nd) 5:01 P.M. | 17th (24th) 9:59 P.M. |
| P.S.T. (120th M.) | March 15th (22nd) 4:01 P.M. | 17th (24th) 8:59 P.M. |

numbers, using word lists from the Handbook, etc., are regarded as the proper voice methods. Two separate entries can be submitted (one 'phone, one c.w.) but most will choose to enter in one favored method.

Disqualifications

Amateurs of all nations must work in the frequency bands assigned them or may themselves forge arguments to be used against them at future conferences where binding regulatory agreements are made. To protect amateur rights and to enforce sportsmanship, Rule 11 has been written. Observance of amateur frequency band assignments is expected of participants in all localities. Violations of government regulations will again be penalized by any necessary disqualifications.

The monitoring cooperation of the F.C.C. itself is requested. Operators known to have been logged by the F.C.C., reported by qualified Official Observers, or otherwise indicated to the judges by evidence satisfactory to them as contravening Rule 11, will be disqualified. The interest of all amateurs in their frequency bands and in sportsmanship in operating requires enforcement of government regulations and contest rules by impartial action of the award committee in the matter of disqualifications, as in many years past.

Operating Hints

Listening is the first essential. You have to hear them before you can work them. Tuning specifically "from the middle to the end" as well as "from either end toward the middle" should be a useful practice. Crowding the band edges is just an invitation to be disqualified! Operating points, personal efficiency, and the "man behind the station" (most of all) count! W hams not wanting to show themselves "lids" will avoid all use of "CQ DX." No distant stations will waste time answering such calls when one call from "outside" will bring hundreds of answers from more efficient operators. All stations should try to work BREAK-IN for real operating efficiency. Hams outside the U.S.A. urge more speed, asking us to send the number along first, before anything else. U. S. amateurs approve continued use of CQ by all stations in remote localities, but plead that these CQs be made short — with so many U.S.A. stations competing for each one! CQs will be used by W's only when looking for W's to fill quotas for that part of the score. A directive CQ such as CQ6, CQ1 etc. will be best. CQ DX is "out" for W's. Remotely located participants: Please sign often in CQs or calls. Use QHM, QML, QLM, QMH for each sub band segment as a calling indicator. You have it in your power to make W's answer where you want to receive them!

Awards

Each operator's main competition comes from amateurs in his immediate A.R.R.L. Section in the case of W stations,* and in the case of all other amateurs it comes from the individual operators in their country or locality using the same prefix.† The awards are for the operator running up the best record for each territory under the Rules. Comparison of scores between remote Sections and points is not indicative because of the different conditions under which stations work. Stations in all localities* need only take part on the dates announced and report results at the end of the tests to receive credit in QST, and be eligible for awards.

There are separate awards for the c.w. winner and the 'phone winner, for each country, and likewise for each A.R.R.L. Section. Try your luck and DX, and report results!

All operators in the same country † will be in competition with each other — and similarly each A.R.R.L. section-boundary circumscribes a competing group. DX-transmission characteristics being the same for all operators in each award-area, and in each period, the chances of being a winner depend on operating ability and stations and are equally fair to all.

Club Participation

To encourage local participation additional certificate awards (besides the A.R.R.L. Section awards) will be made through each club where three or more individual club members take part. For a club to rate a c.w. winner's certificate award on behalf of the club group, at least three reports from c.w. club-member participants must be sent to Hq. Similarly a club 'phone winner's certificate will be issued only when three 'phone entries mentioning the club have been received. Reports must be made direct to A.R.R.L., West Hartford, mentioning the name of the club, to be eligible for the affiliated-club-award. Entrants who mention their club will be eligible for both club and Section awards.

The sum of the scores of all club participants ('phone and c.w.) may be added, and reported by the club secretary, to count for the club itself. A genuine gavel, with engraved sterling silver band, is offered as an award to that club whose officers or activities manager submits the greatest collective score in A.R.R.L.'s 12th DX Competition.

Added Rules

- Contest work must all take place in the contest period.
- Logs must include date, time of QSO, call of station worked, serial numbers exchanged, location and other information required, tabulated neatly with the claimed score. (See the log examples for required data.)
- Scoring: U.S.A. (a) For each completed two-way exchange with DX in foreign localities (using prefixes other than W), including Alaska, Hawaii, Philippine Ids., Cuba, Porto Rico, etc., 100 points; 50 points only shall be counted if information in one direction only is transmitted. There is no quota on stations in foreign prefix localities. (b) For each completed two-way exchange with other W's to the number of credits herein specified there may be claimed 5 points. Each received serial number counts 3 when receipted for. Each serial number sent and properly receipted for counts 2. For this part of the score not more than three different completed contacts (or partial exchanges with more stations to give equivalent credits) per licensing area per frequency band may be claimed for each of the nine U.S.A. licensing areas. (3 stns. × 3 bands × 9 lic. areas × 5 pts. ea. = 405 pts. as maximum obtainable. The theoretical possible multiplier is equivalent to 27 countries.) (c) Multiplier. The total of points obtained in accordance with the provisions of the two paragraphs above may be multiplied by a number consisting of the number of countries (prefixes) worked added to the number of W licensing areas worked, for determining the final score. The multiplier is increased by working countries and U.S.A. licensing areas in each frequency band, the same country or area adding again to the multiplier when worked on a different amateur frequency band. After three U.S.A. stations have been worked per band per district by W's, more W's may be contacted only to increase point credits to the amount lost in any part exchanges.
- Scoring: All amateurs in localities other than U.S.A., including K4-6-8-7, KA-, KB-, KC-, KD-, KE-, KF-, KG-, KH-. (a) For each completed two-way exchange with W's

LOG, 12TH A.R.R.L. DX COMPETITION (Example from W9 —)

C.W. Entry

March 1940

(Logs from W's show for each band)

A.R.R.L. Section (for W's):.....

Call Signal.....

Name.....

Address.....

Transmitter Tubes.....

Input (last stage)..... watts

Receiver.....

Antennas.....

| CLAIMS SUMMARY..... | Bands | | |
|---------------------------------------|-------|----|----|
| | 7 | 14 | 28 |
| *Nr. U.S.A. Stns. Wkd..... | 2 | 4 | 1 |
| Nr. Outside — U.S.A. Stns. Wkd..... | 1 | 5 | 3 |
| Total | 3 | 9 | 4 |
| *Nr. U.S.A. Lic. Areas Wkd..... | 2 | 2 | 1 |
| Nr. Countries ⁷ QSOed..... | 1 | 4 | 3 |
| Multiplier | 3 | 6 | 4 |

(*Logs from "others," show in this part of the log only "Nr. U.S.A. Stns. QSOed" and "Nr. U.S.A. States QSOed" in place of four listings.)

| Date | Time | Station Worked | Country ⁹ or Lic. Area | Multiplier Record of New Countries ⁹ and Lic. Areas for Each Freq. Band | | | Serial Numbers | | Points |
|----------|---------|----------------|-----------------------------------|--|----------------|----|----------------|----------|--------|
| | | | | 7 | 14 | 28 | Sent | Received | |
| March 15 | 6.03 p | J2JJ | Japan | | 1 | | 569,001 | 458,001 | 100 |
| " 15 | 6.50 p | W6QQL | 6 (Nevada) | 1 | | | 589,002 | 577,009 | 5 |
| " 15 | 9.08 p | W9FS | 9 (Kentucky) | 2 | | | 599,003 | 588,024 | 5 |
| " 16 | 8.49 a | YU7LX | Yugoslavia | | | 1 | 566,005 | | 50 |
| " 16 | 3.22 p | K6FAZ | Hawaii | | | 2 | 579,006 | 578,157 | 100 |
| " 16 | 3.54 p | CX1FB | Uruguay | | | 3 | 589,007 | 589,043 | 100 |
| " 16 | 5.00 p | W4QN | 4 (Florida) | | 2 | | 589,008 | 568,065 | 5 |
| " 16 | 5.08 p | W9PGS | 9 (Colorado) | | 3 | | 568,009 | | 2 |
| " 16 | 5.30 p | W9VDY | 9 (Wisconsin) | | 3 ⁹ | | | 238,098 | 3 |
| " 16 | 5.55 p | W9FS | 9 (Kentucky) | | 3 ⁹ | | 559,010 | 559,132 | 5 |
| " 16 | 6.32 p | W9TB | 9 (Illinois) | | | 4 | 599,011 | 599,074 | 5 |
| " 16 | 7.05 p | K4DTH | Puerto Rico | | 4 | | 589,012 | 569,257 | 100 |
| " 17 | 10.58 p | LU5AN | Argentina | | 5 | | 576,013 | 588,098 | 100 |
| " 22 | 7.08 p | KP6DHW | Phoenix Ids. | | 6 | | | 368,047 | 50 |
| " 24 | 10.35 p | CE4AD | Chile | 3 | | | 569,014 | 589,109 | 100 |
| " 24 | 10.55 p | LU2CW | Argentina | | 6 ⁹ | | 579,015 | 569,100 | 100 |

Different countries¹⁰ QSOed.... 8

Multiplier = 3 + 6 + 4 = 13

S30

Score: 830 × 13 = 10,790

I hereby state that in this contest I have not operated my transmitter in any manner contrary to the regulations of my country for amateur radio stations; also that the scoring points and facts set forth in this log and summary of my contest work are correct and true

Signature.....

⁹ Column heading as shown is for W's. Change headings to "U.S. A. States" on all other reports. A progressive record of the number of new multipliers is kept in the 7-14-28 columns. A multiplier entry is made for each station worked but the figure increases numerically only as additional new prefixes or licensing areas (new states for non-W participants) are added on a certain band. The last notation in each column added to similar notations in the other columns gives the multiplier. Counting indications in each of these columns gives the number of contacts on each band to set down in the claims summary in the log heading.

W-stations in excess of a W's quota for a particular band and licensing area, may be worked only to permit exchanges sufficient to compensate for partial credits produced by any one-way exchange. The score in the sample log might be increased by one more two-way exchange with a "9" on 14 Mc. to compensate for partial exchanges with W9PGS and W9VDY, for example.

¹⁰ Different USA states worked in all bands, in the case of outside USA reports.

(U.S.A.), you may claim 5 points. Each received serial number counts 3 when received for. Each serial number sent and properly receipted for counts 2.

(b) Multiplier. The total of points obtained as above may be multiplied by a number consisting of the number of states of the United States contacted (a possible 48). This multiplier may be increased by additional exchanges of contest data, with amateur stations in the same states, but on additional frequency bands. Add one to the multiplier for each state worked on each different frequency band. Stations in

the District of Columbia count for Maryland. See maps of the U.S.A. for location of the 48 states.

5. The same station can be worked in more than one band, but no claims of W's in excess of quota points can be granted. Cross band work does not count in this contest.

6. All entrants agree to be bound by the Rules and Contest Announcement and the regulations of their licensing authority. In a contest of this magnitude, no correspondence can be entered into regarding Award Committee Decisions.

7. The highest scoring individual operator's score is the

**Contest represents "Worked all States"
Opportunity to DX:**

U.S.A. Hams will work foreign amateurs only in those countries not included in any proclamation of neutrality of the President of the United States as per Century Club rules.³

W-DX for W's will be part of each W score, under scoring quotas — there will be no quotas for others than W's.

A chromium tie holder (with engraved medallion) will be given each c.w. and each voice A.R.R.L.-Section⁶ winner, and each country⁷ winner.

There's a Gavel Trophy for the winning Club score.

official score for all awards. Other operator scores must also be submitted separately if more than one operator worked a station. The station score (all points by all countries) may be stated for purposes of comparison, but will not have official significance in making awards. The use of a second operator for aiding in reception (as in spotting stations) or transmission is prohibited, and shall constitute grounds for disqualification.

8. Bands: Contest activity claims will be confined to work accomplished in the 7-, 14- and 28-Mc. amateur bands.

9. Logs must be marked for "phone" or "c.w." with work in a single entry all by one transmission method for a score claim. (Separate entries may be made for each method if desired. This is optional.) The stations contacted for claims may be using either radiotelephone or radiotelegraph — but entries must each consist of voice work only, or telegraph transmitter work only, on the part of a given operator submitting score.

10. Reports and logs from participating stations must be received at A.R.R.L. Hq. from all U.S.A. stations on or before noon, April 15, 1940, to be considered for awards. From all outlying localities, reports must be received on or before May 27, 1940. Play safe . . . mail your report immediately at the end of each contest period to avoid delay and insure that your results are credited in QST. Show your claimed-score in full, following a tabulation of points in the log-form indicated with this announcement.

11. Disqualification: Violations of government regulations will be penalized by disqualification of entries. Indications of false log entries will be penalized similarly. Evidence from cross checked logs, from qualified Official Observers and other sources must only be satisfactory to the committee on awards, in such cases. Any operation off-frequency or outside the amateur frequency band limits established by international agreements (and in the U.S.A. by the F.C.C. for various types of amateur work) during the period of the contest will constitute ground for disqualification. Contacting amateurs in any nation included in a proclamation of neutrality of the President of the United States or excluded under any Century Club⁸ rule also will be grounds for disqualification.

12. The entries received after the competition will be passed upon by an A.R.R.L. Award Committee whose decision will be final in all cases.

Warning!

Good notes, not ragged ones are advisable. The F.C.C. monitoring station personnel are acquainted with the dates of our DX contest, and will be on the job. You do not want to be disqualified! Nor do you wish discrepancy reports for poor notes and overmodulated signals! Better lose out in some operating hours rather than jeopardize your amateur standing. Let's make it a contest with *no bad signals*.

Competitors are requested to submit lists, even if they only show a small score to support claims made in logs from other stations.

★ **A.R.R.L. QSL BUREAU** ★

FOR the convenience of its members, the League maintains a QSL-card forwarding system which operates through volunteer "District QSL Managers" in each of the nine United States and five Canadian districts. In order to secure such foreign cards as may be received for you, send your district manager a standard No. 10 stamped envelope. If you have reason to expect a considerable number of cards, put on an extra stamp so that it has a total of six-cents postage. Your own name and address go in the customary place on the face, and *your station call should be printed prominently in the upper left-hand corner.*

- W1 — J. T. Steiger, W1BGY, 35 Call Street, Willimansett, Mass.
- W2 — H. W. Yahnel, W2SN, Lake Ave., Helmetta, N. J.
- W3 — Maurice Downs, W3WU, 1311 Sheridan St., N. W., Washington, D. C.
- W4 — G. W. Hoke, W4DYB, 328 Mell Ave., N. E., Atlanta, Ga.
- W5 — James F. Manship, W5ALE, 910 So. Boston, Tulsa, Okla.
- W6 — Horace Greer, W6TI, 414 Fairmount Ave., Oakland, Calif.
- W7 — Frank E. Pratt, W7DXZ, 5023 So. Ferry St., Tacoma, Wash.
- W8 — F. W. Allen, W8GER, 324 Richmond Ave., Dayton, Ohio.
- W9 — Alva A. Smith, W9DMA, 238 East Main St., Caledonia, Minn.
- VE1 — L. J. Fader, VE1FQ, 125 Henry St., Halifax, N. S.
- VE2 — C. W. Skarstedt, VE2DR, 236 Elm Ave., Westmount, P. Q.
- VE3 — Bert Knowles, VE3QB, Lanark, Ont.
- VE4 — George Behrends, VE4RO, 186 Oakdean Blvd., St. James, Winnipeg, Manitoba.
- VE5 — H. R. Hough, VE5HR, 1785 First St., Victoria, B. C.
- K4 — F. McCown, K4RJ, Family Court 7, San-turce, Puerto Rico.
- K5 — Norman F. Miller, K5AF, 15th Air Base Squadron, Albrook Field, Canal Zone.
- K6 — James F. Pa, K6LBH, 1416D Lunalilo St., Honolulu, T. H.
- K7 — Jerry McKinley, K7GSC, Box 1533, Juneau, Alaska.
- KA — George L. Rickard, KA1GR, P. O. Box 849, Manila, P. I.

Strays

Upon completing a contact with W5AAO of Abilene, Texas, W5CJS was called by W9NQH, Abilene, Kansas. It appears as though the transmitter at 5CJS is attempting to "Work All Abilenes."

★ QUOTE AND UNQUOTE ★

THE RADIO ABSOLUTE ALTIMETER

ONE of aviation's greatest bugaboos has always been the accurate determination of an aeroplane's altitude at any instant. The normal altimeter, which operates on barometric principles, indicates only the height above sea level; but it is just as important, if not more so, that the pilot know his exact height above the terrain below him. Thanks to an ingenious application of radio principles, it is now possible for a pilot to know his instantaneous height above ground, in any type of country, throughout a range of 50 to 5000 feet. The indication of altitude is independent of changes in air pressure, temperature inversions, humidity, cloud layers and other variable factors in the weather, and the instrument requires no adjustment by the pilot.

The Western Electric Absolute Altimeter, developed by the Bell Telephone Laboratories, indicates altitude above the terrain by sending a radio wave to the ground and timing the interval required for it to reach the ground and return to the plane after reflection from the ground. The frequency of a low-powered transmitter is varied from 420 Mc. to 445 Mc. and return at the rate of 60 times per second. Since the swing is 25 Mc., the rate of change of frequency is $2 \times 60 \times 25 \times 10^6 = 3 \times 10^9$ cycles/second. Depending on the height above the reflecting medium (terrain below the aeroplane), there will be a constant difference between the frequency of the transmitter and the reflected signal, caused by the finite time interval required for the radio energy to reach the ground and be reflected back. The reflected signal, as well as some of the signal direct from the transmitter, is fed into a special u.h.f. diode rectifier, and the frequency of the resultant beat note is measured by a frequency meter which is mounted on the instrument panel of the plane. The frequency meter is calibrated directly in alti-

tude, so the pilot reads his height above ground directly from the instrument. For a plane one-half mile above ground, the time required for the signal to reach the ground and be reflected back is

$$t = \frac{2 \times 0.5 \text{ (miles)}}{186,000 \text{ (speed of radio)}} = 0.0000054 \text{ second}$$

The difference frequency from the output of the detector is $f = 3 \times 10^9 \times 0.0000054 = 16,200$ cycles/second, which works out to be about 6 cycles per foot of altitude.

The equipment can be mounted at any convenient point in the aeroplane, since both transmitting and receiving antenna are fed by concentric lines. The antennas are of the half-wave concentric-line type and are mounted coaxially under the wing of the ship, one on either side of the fuselage. The antennas are housed in streamlined plastic cases.

The radio altimeter will not indicate the height above objects having a relatively small area, and passing over a building or similar object will cause only a momentary dip on the meter. Very rough ground will produce sufficient irregularity in the reflected wave to cause the meter needle to swing back and forth over a small arc on the scale of the meter.

COMPENSATING TUBE INPUT CAPACITANCE VARIATION

WHEN the gain of a tube is varied by changing the d.c. potential on the grid, as in r.f. and i.f. amplifiers, the input capacity of the tube changes. In cases where the tube is connected across a relatively low- C circuit, the effect of this input-capacitance change is to detune the circuit. This is particularly noticeable in r.f. amplifiers working at high frequencies, where the C is necessarily low, or in selective multi-stage i.f. amplifiers, where the effect is to change (broaden out)

Fig. 1 — Circuit of the compensated i.f. amplifier.

- C₁, C₂, C₃, C₄, C₅ — 0.01 μfd.
- R₁ — 500,000 ohms, ½-watt.
- R₂ — 333,000 ohms, ½-watt.
- R₃ — 200 ohms, ½-watt.
- R₄ — 1000-ohm gain control.
- R₅ — Sufficient to give 15-volt drop with total receiver current passing through it — 150 ohms for 100-ma. total current, etc.

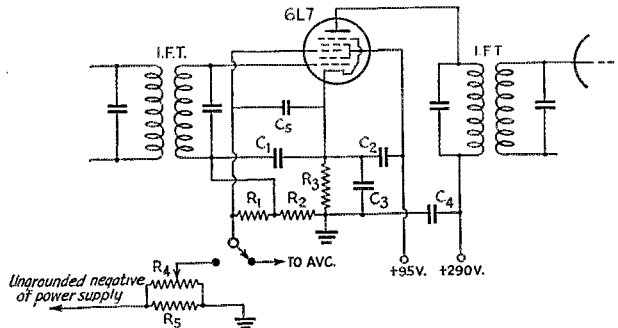

the selectivity at any gain control setting except the one used when the amplifier was aligned.

A recent paper¹ points out how this undesirable characteristic can be eliminated by using a 6L7 tube for the amplifier and feeding the control voltage to the No. 3 (injection) grid as well as the No. 1 (control) grid. The voltages must be in the proper proportion, and a $\frac{3}{5}$ ratio of control voltage on the control and injector grids has been found to be correct for a cathode resistor of 200 ohms. Other ratios, although giving some correction, give less desirable results.

A practical circuit, applicable to any i.f. amplifier, is shown in Fig. 1. As can be seen from the diagram, the control potentials for the control and injector grids are obtained from a voltage divider (R_1, R_2) which properly proportions the voltages. The input capacitance remains substantially constant over an a.v.c. potential of from 0 to 12 volts. It was observed that the 6L7 has a tendency to overload with signals above 0.5 volts when the control-grid d.c. potential is higher than -13 volts, so the system must be used within a range of a.v.c. potentials which will insure freedom from overload at the input signal levels employed.

When manual gain control is used, some provision for maintaining the voltage proportion is required, and this is most simply done by controlling the gain as shown in Fig. 1. The normal variable cathode resistor cannot be used.

¹Farrington, "Compensation of Vacuum Tube Input Capacitance Variation by Bias Potential Control," RMA Engineer, Nov. 1939.

U.H.F. Contest and Relay

February 10th-11th

HERE'S a contest that should help all hams to roll up some Marathon points (another way of saying work new u.h.f. DX) at the same time a thorough winter test of the capabilities of each of the u.h.f. bands is made possible! Read the success of the last u.h.f. contest elsewhere in this issue and make sure you get in on this one! Some of those scoring well in the last such affair suggest a wider use of c.w. and m.c.w. in these activities. Its instant use in the last, when some DX was noted coming through was significant, and identification of your signal and copiability of your test message may be thus improved.

Scoring Contacts: List all different stations worked in the contest period, which is February 10th (Saturday), 3 P.M. local time, to February 11th (Sunday), 7:59 P.M. local time. Beside the calls show the *location* of these stations, obtained as you work them, for points claimed. For 56-60 Mc. work for stations

Under 25 miles, score 1 point
25 to 75 miles, score 2 points
75 to 250 miles, score 5 points
Over 250 miles, score 10 points

For contacts made with one's transmitter on 112-116 Mc., score *two times* the above credits. For contacts using transmitter frequencies above 224 Mc. assigned by the F.C.C. to amateurs, score *ten times* the credits given in the table above.

For originating and sending a five-to-ten-word test message, specifically addressed to remote sections of the country, as in September and November activities (one such message only may be started per station), and mailing copy *with handling data* to Hq., 10 additional points may be credited. Likewise, for relaying such messages away from the starting point and submitting copies, count 3 points each, *1 for receiving by radio, 2 for each relay onward*. Reply messages and third party messages are welcomed — counting but 1 point for the originating stations, they will receive the usual counts when handled by relaying stations. Operators subject to the difficulties and inconveniences of working at field locations under portable designation may multiply the sum of their contact and relaying scores by *two*.

U.H.F. Certificate Award: Each participant who sends a "stations worked" list, with message copies attached, and a claimed score, will receive a special A.R.R.L. certificate showing his score and how many stations were worked in this activity.

After you get your test message off, your aim is to see how many you can work, what u.h.f. DX you can hear and raise, how many test messages you can push along, etc. For example of message and information on handling data see page 33 of September *QST*.

We hope to see states represented in the next report that did not get in on September or November activities. Any u.h.f. bands can be used, 56, 112, or 224 Mc., etc., as you choose, and we'll report back to all who take part the full extent of the success in each frequency band group. Terminal stations, each starting an u.h.f. "msg," and each holding one or more that cannot be relayed on, at the end of the relay, are especially urged to see that we get reports of these promptly, so that full message histories may be made up . . . and once again we'll report to you on the routes of the most successful messages. Luck in the contest.

— F. E. H.

Strays

W2DSV reminds us that a 21-inch azimuthal map with good detail is obtainable from the Hydrographic Office, U. S. Navy for thirty cents. It is known as Number 5199 and is centered on Washington, D. C.

— — — — —

"The other day we actually had a would-be ham inquire if the Marconi Auto-Alarm were a radio device used in automobiles." — *VESSA*.

Building and Tuning a Three-Element Beam

Complete Details on a Practical Home-Made Rotary

BY HAROLD ULMER,* W6EPM

ABOUT a year ago I decided to put up a Q-fed antenna and later convert it into a "Q beam." Looking over the good places to hang the antenna, I noticed a light pole with only a street lighting circuit attached to it. This seemed like just the support for a real antenna that any little gust of wind would not take down, and soon the "Q" was doing its stuff.

No more thought was given to the antenna until my neighbor across the street, a trouble shooter for the local power company, knocked on the door and said he had orders to cut down the antenna and let it fall in the yard. I immediately went scouting around and got in touch with a friend in the company who said that some poles were for sale which were of no value for line work but were considered good "fire wood." The enormous price was three cents per foot!

This was almost too good to be true, but my friend promised to pick out a good one and have it available in about two weeks. I borrowed some digging tools and had the hole ready the very next day and that afternoon, while I was at work, my friend 'phoned and said the pole was lying in the yard. That was really more than had been expected, but I bought a gallon of creosote on the way home and painted the base of the 40-foot pole.

That evening I went to see a close friend who happens to be a blacksmith. We looked at every picture of every rotary beam antenna in all the magazines and handbooks until we found one using a Model T Ford rear end and decided on that. Because we are right on the coast, we decided the greased bearings were just what we wanted, and that very evening we scouted around until we found what we wanted.

We first operated on the rear end by cutting off one axle at the edge of the differential casting. This end of the casting was covered with a plate to keep the grease in the housing, and then the sawed-off axle was jammed by welding two of the small differential gears together so that the untouched axle would move freely and with no differential effect. A nut put in the gears will also jam them satisfactorily, but welding can be relied upon not to jump out of place as a nut might do.

Next, a piece of 7½-inch water pipe was purchased from the city water company. The rear end was the right size that would set in the pipe nicely and a disc, with a hole large enough to take the sawed-off end of the differential, was made

and welded about 6 inches from the end of the piece of pipe. The differential was then welded in eight places — four around the end of the pipe and four around the internal disc. With this welding, any four places can break and the antenna will not come down. The pipe was slipped over the end of the pole and fastened by eight 3-inch lag screws.

When the rear end was in place, some of the fellows "who raise poles for a living" were kind enough to come by and see that the pole was put up properly.

The cross beam for the elements was the next thing for consideration. First it was necessary to decide on a good method of getting to the ends of the cross beam for adjustments. Thanks to W9HLF,¹ it was decided to make a strong cross beam and pivot it on two bolts in the ends of a turn table mounted where the car wheel used to go. The cross beam was made of two 18-foot lengths of 2 by 4, separated by six short lengths of 2 by 4, making the boom 4 inches high, 6 inches wide and 18 feet long. The turn table was made by first tearing apart the old wheel until only the hub remained. Then a piece of ¼-inch sheet iron 8½ inches by 14 inches was bolted and welded (safety first!) to this hub. Two pieces of 1 inch by 2 inch channel iron 3 feet long were welded to the plate and half-inch holes were drilled in the ends. The pieces must be at least half the thickness of the boom longer than the plate, to make it possible to tip the boom. Small blocks of ¾-inch iron 2 by 5 inches were welded at the ends of the channel iron to furnish additional side support to the boom. It is a very simple matter to remove either bolt and, by using hooks (five-foot pieces of thin-wall iron conduit with a hook at one end and a loop at the other) with ropes tied on the ends, it is possible to pivot the boom on the remaining bolt. The tipping is

¹ Moore, "Supporting the Rotary Beam," *Radio*, March, 1939.

If you have gazed long and longingly at the rotary-beam ads but your purse didn't agree with your desires, you might be interested in some of the ideas in this story. You may not be quite as fortunate in your choice of friends as is W6EPM, but that shouldn't hold you back too much.

* 302 N. Clementine, Oceanside, California.

done by one person on the ground pulling on the rope on the side of the turn table from which the pivot bolt has not been removed.

My good neighbor insisted that he help me when it came to climbing the pole, since he was experienced at that work. That sounded fine, so his offer was put to good use. The way the parts were arranged it was possible for just the two of us to put the cross beam up.

The turn table was made secure at the top of the pole in the same manner as if it were the wheel which belonged there, and we were then ready for the cross beam. We fastened a small block and tackle to the top of the pole, and while I did the hoisting my good neighbor guided the cross beam in to its resting place and put the bolt through the two channel irons and beam. We were then ready to put on the cross arms and elements.

The cross arms used were of 2 by 4 pine 8 feet long and were fastened to the cross beam by 3-inch lengths of 3-inch angle iron $\frac{1}{4}$ -inch thick. The elements were mounted through the holes in some type P18 insulators. In case this is an unfamiliar type to some of you, the type P18 is the kind used to tie the service lines on at the edge of houses near the meter box. They can be secured at most electrical supply houses and are very good for supporting beam elements because of their strength and the fact that they have a

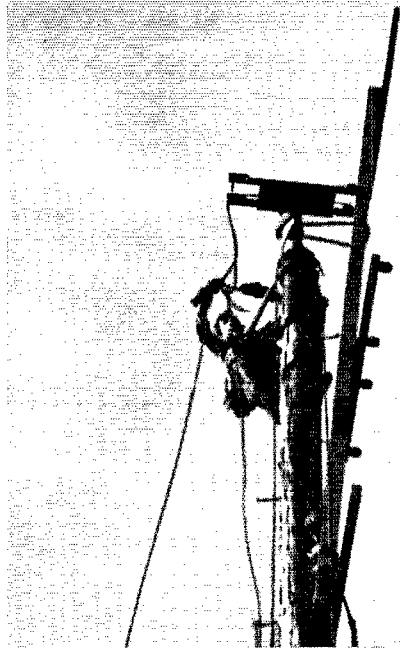

The boom is raised by block and tackle after the cradle is in place on top of the pole. In this view, the boom is on the way up and a rope is being tied to the boom so that it can be pulled into place over the cradle.

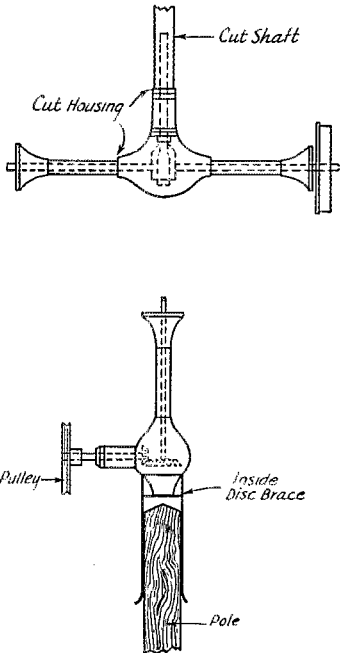

Fig. 1 — The rotary mount for the antenna cradle is made by cutting an old Model T Ford rear end as shown in the top drawing and welding it in a section of pipe as shown in the lower drawing. The pipe is then fitted over the pole and fastened with lag screws.

single screw mounting. There is a single hole through the insulator which will take either $\frac{1}{2}$ - or $\frac{3}{4}$ -inch pipe, depending on the size insulators purchased.

The elements in this antenna were made of the new thin-wall hard-drawn copper water pipe and, using the "streamline" fittings, a neat layout is possible. We used a section of $\frac{1}{2}$ -inch pipe, then a piece of $\frac{3}{8}$ -inch pipe, and the last 6 feet of each half section was some $\frac{1}{4}$ -inch dural pipe which happened to be on hand. This type of element has some sag but is fine electrically, and the cost was only about \$9.00 for the six sections. Iron conduit was considered at first because of its rigidity, but it was impossible to get it plated at a poor man's price. To put it up without plating was simply out of the question, after our experience with iron for shielding in a transmitter. Iron proved to be a very poor conductor of r.f., as indicated by different r.f. potentials all over the shielding which was supposed to be at ground potential. That may be a word of warning to anyone thinking of using iron pipe for r.f. purposes.

Now that the antenna was all up, we couldn't wait to give it a check — even before the rotating gear was finished. The first step was to take the old Q-fed flat-top and put it in a vacant lot about 130 feet away and about 6 feet in the air. A thermogalvanometer was borrowed and put in the center of this antenna and, with the rig on low power, we checked the meter while rotating the antenna. We were very disappointed — the first

reading was 10 on the front side and 8 on the back. This showed us, of course, that the tables used for element calculation could not always be depended upon, and it also indicated that any of the already-cut-and-pretuned commercial beams cannot always be "on the nose." Again my good neighbor volunteered to go up the pole and adjust the element lengths. The first step was to lengthen the reflector 1½ inches — the meter went to 20, showing that we were going in the right direction. After about two hours of adjusting, we found the reflector approximately 15 inches longer (7½ inches each side of center), the antenna okay, and the length of the director not to be very critical at all, so it was decided that the formulas were okay on the antenna and director. The antenna was tuned for 14,300 kc.; the director length is 32 feet, the antenna length is 33 feet 5 inches, and the reflector length is 35 feet 8 inches.

The feed line is brought down to the end of a 42-inch bracket mounted half-way down the pole. The bracket is pivoted on a 9-inch iron angle which allows the bracket to swing around the pole for about 300° rotation, effectively preventing the feeders from tangling at any time during the rotation of the antenna system.

Results

The final results were very pleasing. With the transmitter at about 800 watts input the meter went off scale with a bang — probably about 150, if the meter had read that far — on the front side but on the back side, with a full kilowatt, the meter read less than ½ of one division, showing a ratio of at least 300 to 1.

The next step was to get the standing waves off the feeder. The conventional Y-matched impedance formula should be approximately correct or a good place to start at least. Most articles say to use a neon lamp to check the voltages along the feed line, but this is a little difficult with enameled wire, so a wavemeter type indicator was used, using the conventional coil, condenser and lamp in series. This type is the best, because it is cheapest, and if you drop it you don't

lose much. This part is important, because it is generally necessary to fasten a 10- or 15-foot stick to it in order to follow the feeders. If the point on the Y where the feeders connect can be reached, it is simple to tell which way to move the tap on points of the Y to the antenna. If the indicator lamp gets dimmer as you move down the feed line from the junction, the tap-on points on the antenna should be nearer the center. If the lamp gets brighter as you move away from the junc-

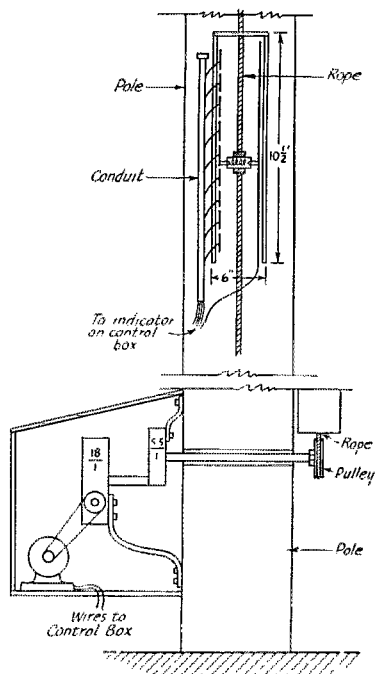
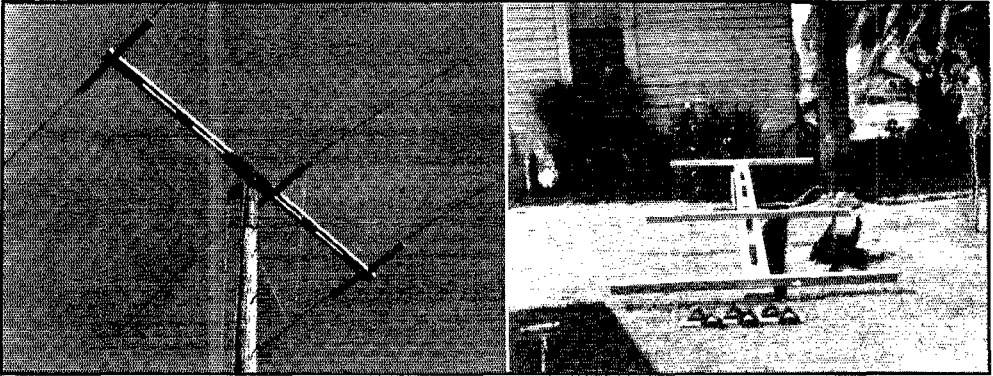

Fig. 2 — Two views of the pole, showing the direction indicator (above) and the rotating mechanism (below). The direction indicator uses a sliding contact fastened directly to the control rope. The contacts, in turn, are wired to the 16 dial lamps shown in Fig. 3.

The rotating mechanism, mounted on the side of the pole, uses an old washing-machine motor and reduction gears.



The 3-element beam is mounted on a turntable made from an old automobile rear-end and is rotated by a motor fastened near the base of the pole. Delta match is used between the feed line and the radiator and, by supporting the feeders away from the pole by a bracket (not shown), it is possible to rotate the beam through 380° without tangling the feeder. Two ropes, broken up by egg insulators, support the feed line at the bottom of the delta section.

The steel cradle to support the boom and the brackets that hold the cross-arms to the boom are shown in the picture at the right.

tion, the taps on the antenna should be moved out farther from the center of the antenna. Our final adjustment was $53\frac{1}{2}$ inches each side of the center. Incidentally, this feeder adjustment should be the very last adjustment because every other change will affect the distance between taps on the antenna. This type of feeder was selected because of the low resistance of the antenna on a three-element beam. When a center matching arrangement is used, it is necessary either to use two Q sections or slip rings and a J section. Slip rings were considered undesirable because if even one ohm resistance is introduced by the connection, approximately $\frac{1}{8}$ of the power is wasted in a 7-ohm antenna. The current at this point is of the order of 10 amps with 1 kilowatt input, so the connections have to be good or else avoided.

Rotating the Beam

The antenna was far from finished though, because we wanted it to be completely controlled from the operating position in the shack. We first mounted a 12-inch pulley on the drive shaft of the rear end and put a $\frac{1}{2}$ -inch rope over the pulley.

It would turn and stop nicely from the ground, so we next bored a hole directly through the pole large enough to take a piece of $\frac{3}{4}$ -inch water pipe. This was for the bearing of a $\frac{3}{4}$ -inch shaft on which a 3-inch pulley was mounted to turn the rope belt. A 12-inch piece of heavy coil spring was tied in the rope to take care of the expansion and shrinkage due to the moisture the rope absorbs at night, and the rope given two wraps on the small pulley to prevent slipping. This gave a ratio of 4:1 through the two pulleys, and with $3\frac{3}{4}$ -to-1 in the rear end, we had a total ratio of 15:1. We next looked up the local washing machine repair man, and for \$3.50 we obtained two wringer gear boxes and gears with as high a ratio as possible. One turned out to be an 18-to-1 gear out of an old Maytag machine, and the other was $5\frac{1}{2}$ -to-1 out of an unknown machine. This now made our ratio 1485-to-1, which is not bad for \$3.50, plus a dollar to the local machine shop to connect the two gears together and to the $\frac{3}{4}$ -inch shaft. All we had to do now was to use a 1-to-1 pulley and drive the gears with a $\frac{1}{4}$ h.p. washing machine motor. We ran in 4 wires from the motor to make it reversible — it is only necessary to reverse the starting winding leads to the power leads and any induction motor becomes a reversible motor.

We could now drive the antenna in either direction but didn't know where it was pointed. A lot of book research was conducted but none of the ideas suggested seemed to suit our needs, so it was necessary to look at the situation from a different angle. We found out that the rope moved about $10\frac{1}{2}$ feet for a complete revolution of the antenna. That meant that if we had indicators or contacts on the rope, we could have an indicator on the operating table. We made a trough out of wood 6 inches wide, 3 inches deep and $10\frac{1}{2}$ feet long, and then measured the exact travel of the rope and cut 16 pieces of brass linoleum binder

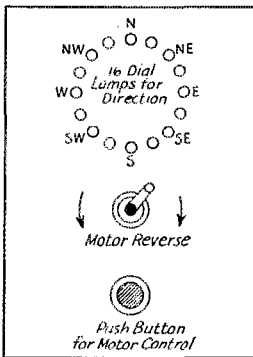

Fig. 3 — A sketch of the control box.

exactly 1/16 of the distance of travel. These 16 pieces were all mounted on one of the 3-inch sides of the box and connected to wires run to the operating table. The other side of the box had a single strip for the full length. This trough-like box was mounted on the side of the pole where the rope could run through the trough between the 16 pieces and the full length strip. A clamp was made to fasten to the rope and two spring brushes were mounted to make contact between the single strip and any one of the 16 contact strips. We now made a box and mounted our reversing switch, a push button to run the motor and 16 dial lamps in an equally divided circle about 4 inches in diameter. The 17 wires from the contact box were connected to the 16 dial lamps and a small transformer to light them and it was now possible to tell the position of the antenna in relation to the 16 points of the compass indicated by the dial lamps. It can be seen that there are 32 possible indications by the 16 lamps because two lamps will light at once when the brush is in the position where it passes from one contact to the next. This gives an accuracy of direction of one-half of $11\frac{1}{4}^\circ$ or $5\frac{3}{4}^\circ$ plus or minus. This is sufficient accuracy because the beam seems to be about 30° broad. This was determined during the adjusting procedure, because we found that if the beam were 15° off, the meter reading in the center of the receiving antenna dropped to half. Two extra contacts were considered to be used as safety lamps to indicate red when the antenna should be stopped to keep the feeders from wrapping around the pole. These were not used, however, and the two U-shaped stops were put on the pole for the rope to run through and a clamp put on the rope. The stops were set so that the travel between them is exactly enough to rotate the antenna 360° . It is then of course impossible to twist the feeders around the pole because the drive pulley slips when the stop is reached.

After the antenna was all tuned and could be turned at the operating table we didn't know where we wanted to point it, so we set out to make a simple direction finder. A 5-inch globe mounted on a long bolt through the center looked like a good possibility. This was disassembled and remounted so the bolt went through our city instead of the North Pole as is customary. On a piece of drawing paper, a $1\frac{1}{4}$ -inch circle was drawn and divided into 16 parts, each marked by its appropriate compass position — N, NNE, NE, ENE, etc. — and then pasted into position on the globe over our city. When the north-south axis lines up with the north and south poles, the rest of the points will be in their proper position. A stiff wire was soldered from the top to the bottom of the mounting bolt and made it possible to swing the globe so that any city in the world can be placed on the wire. Where the wire crosses the drawing paper marker, the direction of the desired city can be judged accurately to 2° or 3° .

In conclusion, it might be stated that whatever urge it takes to get started building a three-element beam, it certainly is worth-while. Thanks to my good friend, Alex Babics, who tuned the antenna and did all the climbing, and another good friend, Miles Rost, who took the pictures and helped in the meter reading, I was perhaps a little more fortunate than some might be in getting the work done. Needless to say the antenna will really put out a signal and everyone who hears it gives us flattering reports, but to get the results, be sure and adjust the elements to the proper lengths and don't take someone's word that they are just right, or the results will never be as good as can be obtained.

Strays

And as further evidence of something or other, we find this in the April, 1914, issue: "The Secretary of Commerce recently approved a penalty of \$25 to be collected from an amateur wireless operator in San Francisco, for a violation of the 15th regulation of the wireless act of August 13, 1912, in that the wavelength emitted by his wireless station exceeded by 370 meters the limit fixed by law for his class of station." We're luckier nowadays — they don't assess the 25 bux!

— • • • —

In an issue of *Modern Electrics* for one of the following years—1908, 1909, or 1910—I had an article published on the construction of a keying relay. I wonder if any of the old timers may have this magazine.

—Howard R. Darling, W1FZI

Silent Keys

It is with deep regret that we record the passing of these amateurs:

- Joe Barrett, W5BOG, Sulphur Springs, Texas.
- A. R. Cook, W7GCN, East Missoula, Montana.
- Homer M. Cooper, W8OIG, Woodsfield, Ohio.
- Sam W. Harry, W5ECJ, Dallas, Texas.
- Herman L. Hepp, W8UAE, Columbus, Ohio.
- John D. Lawson, VE4GD, Winnipeg, Man.
- L. A. Paulsen, W9MPT, Glenview, Illinois.
- Warren R. Rudd, W9QGKX, Sidney, Nebraska.
- Herman A. Schmidt, W2AEN, New York.
- Arthur R. Wixson, W9TOW, Ft. Collins, Colorado.



NAVAL COMMUNICATION RESERVE NOTES

The Eleventh Naval District

THE mission of the Naval Communication Reserve is to procure, organize and train the officers and men necessary for the expansion and operation of the Naval Communication Service in time of National Emergency.

The U. S. Naval Communication Reserve of the Eleventh Naval District came into active being in 1927 and has continued to make consistent progress in the procurement and training of officers and men under the leadership of several instructors and commanders of the organization.

The Eleventh Naval District comprises the Southern portion of California and the States of Arizona and New Mexico. The Naval Communication Reserve of this District is divided into four active Sections and further divided into Units. The administrative staff of the organization consists of the Commander, the Instructor (a regular Navy officer), the Executive Officer, Operations Officer, and officers assigned to duties as Educational, Recruiting and Supply.

The master and alternate master control stations, NDT and NDV, respectively, are the senior control stations of the District and are located in the Naval Reserve Armories at San Diego and Los Angeles. All Section Headquarters and control stations, and the majority of the Unit Headquarters and control stations are quartered in Federal or public buildings.

The master and alternate master control stations participate in the National drills conducted twice monthly by NPG on the frequencies of 8090, 4045 and 3475 kilocycles. Intra-District drills are also conducted by the master and alternate master control stations on Navy frequencies with the Section control stations. The Section control stations drill the Unit control stations weekly on Navy frequencies as do the Unit control stations drill the individual stations located at the homes of the personnel who are not required for the operation of the Unit control stations. Crystals for the Navy frequencies and such other available equipment are furnished the personnel for participation in these drills. This is the first competition year in which all drills on the air will be conducted exclusively on Navy frequencies. Operating conditions will closely simulate those to be found in the regular Navy circuits.

Efficiency competitions are conducted within the District between Sections on the same basis as the national competition between the Reserve

organizations of the Naval Districts. The competition year begins in September and ends in the early part of June. The remaining three months of the year are devoted to relaxation from drills and the formulation of plans for the following competition year.

Each enlisted man is required to complete an educational course available to him from the Naval Communication Reserve Educational Center, before he is considered for advancement in rating. Courses are primarily along radio and visual signaling lines and other subjects required of radiomen in the regular naval service. Correspondence courses are also available to the officers from the Educational Center located at San Francisco, serving the Eleventh Naval District. These courses consist of such subjects as Communications, Visual Signaling, Navy Regulations, Gunnery and Naval Customs. This District strives to train each officer and man to such a point that he could take his place in the regular Naval Service and carry out the duties required of his rank or rate. In the past, Naval Communication Reserve personnel cruising with the Organized Reserve on summer cruises, have been highly commended by their commanding officers for their attention to duty and the efficiency in which they carried out orders.

Officers and men of the Naval Communication Reserve are afforded an opportunity to perform training duty annually at shore stations and on combatant ships of the Navy when funds are available for pay and allowances. Training without pay is available to officers and men at any time consistent with availability of shore stations and ships for training purposes. Enlisted men performing training duty without pay on ships are furnished subsistence. In addition to annual training duty with pay and training duty without pay, the District training ship YP-34 is available to the Naval Communication Reserve for week-end and Sunday cruises at frequent intervals during summer months.

Immediately after the first shock of the earthquake in Southern California in 1933, the Naval Communication Reserve personnel manned Naval Reserve radio stations and assisted the local governments in obtaining relief and medical supplies for the stricken population of the earthquake area. These stations continued in operation until local telephone and telegraph communication facilities were restored. In March, 1938, the Naval Communication Reserve again served

(Continued on page 110)



ON THE ULTRA HIGHS



CONDUCTED BY E. P. TILTON,* W1HDQ

FREQUENT short-skip conditions on Ten, with skip-DX breaking out occasionally on Five; some really fine nights for local-range work; and too many nights when there was just "nothing doing" — thus, briefly, may 56-Mc. conditions for December be summarized. It was an interesting month, as winter conditions go, and only lack of activity at the right times in the right places prevented much more DX being worked.

Many of the gang who work both 28 and 56 Mc. took the hints that Ten offered in the form of short-skip sessions reminiscent of summer and dropped to Five to work their first skip DX in many a day. W4AUU of Macon, Ga., made December interesting for the year-round enthusiasts in a number of different areas. On Dec. 8th at 6:40* P.M. Jim worked W1KJT, Middletown, Conn., being heard by W1JAX, W1MHM, and W1LLL, the latter reporting W4AUU as being broad, as though from frequency modulation, a condition frequently reported on DX of this sort. At about 7:30, hearing W9's roaring in on 28 Mc., Jim went out in the dark and re-erected his Middle-West beam. Returning to the shack he knocked off in rapid succession W9's SQE, VHG, ARN, GGH, ZHB, FKC, SDJ, ZD, ANA, VWU, and TIO, the last being a cross-band QSO, with W9TIO on 28 Mc.

On Dec. 11th at 7:50, Jim worked W9ZHB and W8RGH, and on the 15th W5AJG was worked at 7:10. W4AUU is on nightly after 7 P.M. (E.S.T.) and all day Sundays. The rig is p.p. 35-T's at 300 watts, the antennas are lazy-H beams, and the receiver a Howard 450-A with DM-36 converter.

W9ARN, Bartonville, Ill., also did right well

*All time mentioned is local time for the station whose work is reported.

in December with W4's AUU, FPC, FKN, and FBH worked on Dec. 8th. Four W4's in Alabama were heard as harmonics from 28 Mc. on this date. With the low state of 56 Mc. activity in Alabama, Jack suggests that these boys might do well to try doubling in the final. Harmonics of two W5's in Texas were also heard. W4AUU was heard again on Dec. 11th, but with a weaker signal than on the 8th. Weak fading carriers suggestive of skip-DX were heard on several other nights. Jack's receivers include an RME HF-10 and a 69-DM-36 combination.

Hearing 28-Mc. skip as near as Arkansas on Dec. 8th, W9VWU, Topeka, Kansas, dropped to Five and worked W4FBH, W4MV, and W4AUU, and heard W4FKN, all of Georgia. These were all well off to the side of Johnny's 3-element close-spaced vertical beam which is aimed at W9ZJB in Kansas City.

In Oklahoma City, W5FYF noticed the short skip on Ten at 4 P.M. and worked W8RUE of Pittsburgh, Pa., at 5:40, followed shortly by W8CIR, who was the best ever heard by Vance on 56 Mc. W3RL was heard calling CQ but was not raised. Both 8RUE and 8CIR were worked again later, the band apparently going dead around 8:10, though Ten remained open for short skip until about 11, with a strong peak at 10:40 when stations as near as 350 miles were heard with strong signals. Vance runs 85 watts to an HK-24 on 59,476 kc. Note well that frequency, gang, and don't neglect the high end.

In addition to working W5FYF, W8CIR also heard W4AUU on Dec. 8th. Incidentally, it looks like Ed holds top honors for states worked, with a total of 29 in 8 call areas, to date. Ed is one of the few who excel at working both types of 56-Mc. DX, being holder of the 400-mile

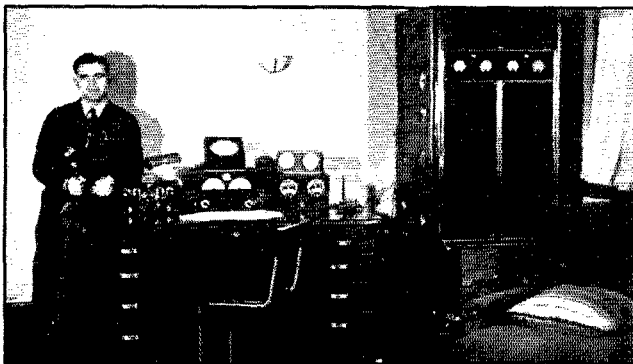

◆
One of the country's outstanding u.h.f. men is "Ed" Doherr, W8CIR of Alliquippa, Pa.
◆

record for local-range work. It's just possible that the 7-element Yagi shown in the accompanying photo has something to do with this.

In Pittsburgh, W8RUE works the DX with a T-21 doubler-final at 24 watts input. The antenna is a half-wave vertical, and the receiver a super-regen; yet Ted has 7 call areas to his credit!

On Dec. 15th W5AJG of Dallas, Texas, got in his first licks since October. At 4 P.M. Leroy began to hear harmonics of ten-meter W4's. At 6:10 W4AUU was worked with good sigs each way. Swinging around to the west, W6QLZ was worked at 7:30, followed by W6OVK at 8:20. W4FKN was heard but not worked.

W6OVK reports 5AJG as being subject to rapid but regular QSB, S9 to S5 in pulses of approximately five seconds duration. Jim pleads for more use of c.w., particularly when the band is suspected of being open. The rig at W6OVK is a pair of 809's at 140 watts on phone, with up to 300 available for c.w. The receiver is an acorn converter working into an NC-44 at 3 Mc.

W5FYF reports reception, on Dec. 15th, of the harmonic of a W4 in Mobile, Ala., who, though he was running only 50 watts on 28 Mc., was S7-8 in Oklahoma City on Five! Vance wishes there were some way to stimulate activity in his part of the country. There are many other fellows in the same predicament, and to them we suggest that they talk up 56-Mc. work during their QSO's on other bands, making a particular effort to interest others within a 100-mile radius in work on a regular schedule.

We freely admit that a real thrill comes from working stations in other sections of the country on Five. In the uncertainty of skip DX QSO's lies much of the lure of 56-Mc. work, yet we had plenty of fun on Five before the possibility of skip-DX was ever dreamed of. We insist that you fellows who wait for some sign of skip-DX before getting on Five are missing the real point of u.h.f. endeavor: the gradual extension of the reliable daily working range, through painstaking work on transmitters, receivers and, most important of all, antenna systems.

It is a recognized fact that station efficiency frequently has little to do with success in working skip-DX. The fellow with a half-wave vertical and a haywire rig often outclasses the owner of a fancy beam and a commercial-looking layout, for skip-DX "pays off" on operating. The type of rig, the sensitivity of the receiver, and the efficiency of the antenna have little to do with it, in most cases.

But when it comes to working a station well beyond the line of sight the results are almost directly proportional to the overall efficiency of the stations involved. A few more watts in the antenna; a slight improvement in the signal-noise ratio in the receiver; the added gain of a properly adjusted beam; all these factors mean

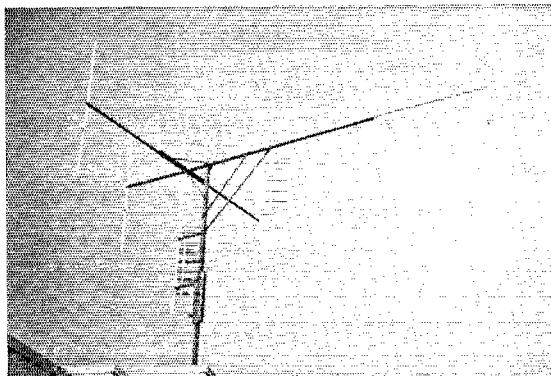

The seven-element Yagi at W8CIR

miles to the daily coverage or improvement in the signal at a distant point. It was to encourage greater effort along this line that a high multiplier was offered for contacts between 250 and 500 miles in the Marathon. Get just one other ham, preferably one located beyond the distance that can be worked with ease, to work with you on improving the daily results and we'll guarantee that you'll soon cease to worry whether there is going to be any skip-DX to-night or not!

HERE AND THERE:

A most welcome note from WIBPI tells of hearing W1's IUU, DXK, HDQ, DJ, LLL, LFS, KLJ, KEE, KJT, and W2MO during a period around 9:30 P.M. Dec. 12th. McKenzie, now located at Paxton, Mass., will be remembered by many as the fellow who was "DX" to so many W1's when WIBPI-W1XR held forth from the summit of Mt. Washington. In those days a pair of 71-A's served WIBPI well in his lofty perch. With the tuning condenser a bit farther out the call was W1XR. Happy memories, those, Mac! We'll all be glad to hear you on Five again.

An interesting interlude in an otherwise dull Sunday was provided by Art Lynch, W2DKJ, on Dec. 10th. Flying up the Conn. Valley with a two-watt rig under the call W2USA, Art worked every station that was on at the time in Western New England.

W2MO runs through a nightly stint with W1LL, Hartford; W1LFS, Bristol, Conn.; and W1KEE, E. Longmeadow, Mass., each night between 9 and 10 P.M. before his sked with W3DBC. Signals were excellent on several nights, notably Dec. 12th, 18th, and 19th. W1KLJ reports things good toward Boston on the 19th and passes along welcome news that W1SI (he of the kilowatt and 16-element beam) has tired of the fight on Ten and is returning to Five. Welcome home, John!

W2FBA (Albany) reports the band being kept alive by W2KLZ, Johnsonville; W8JHW, Waterford; W8EID, Greenwich; and himself. Bob's new concentric antenna, with a folded copper screen for the bottom section, outperforms his beam in all directions in local-range work. No check has yet been made on skip-DX.

A novel method for locating the position of the shorting bar on an antenna stub is turned in by W6AVR. He attaches stiff wires to a pilot lamp so that it may be shorted across the stub. To the wires is connected a length of twisted pair (anything will do as losses are of no importance) which is coupled to the transmitter just enough to light the lamp. This shorting bar, with the lamp in the center, is moved along the stub until the lamp goes out. The center of the

(Continued on page 67)

Results of U.H.F. Relay Number 2

W3AC/3 Again Top-Scoring Station—Skip-DX Furnishes Unexpected Thrill to Many Stations Taking Part

BY JOSEPH A. MOSKEY,* W1JMY

PARTICIPATION in the November 4th-5th u.h.f. "fray" exceeded our fondest expectations and ran about four times that of the September affair. A much greater volume of traffic was handled and message routes functioned smoothly. Scores submitted were somewhat higher and the general cry after the fracas ended was, "Let's have more contests of this type!" If this increased activity is any indication of the great things to be expected in future relays, 1940 should see intensified interest in the "ultra-highs" and many excellent message routes established. Although conditions in general were conceded to have been better than usual, we're inclined to believe that the persistent efforts of our u.h.f. boys alone will account for record-breaking accomplishments in each relay to come. Keep up the good work, fellows! We're rooting for you.

Boston to Chicago on "five!" That's the trip taken by the message which covered the greatest distance via normal hops, not involving extended ray paths so far as is known. At 7:45 P.M. E.S.T. on the 4th, W1HXP at Newton Centre, Mass., about eight miles from Boston, started a message, addressed to W9VHG, which reached its destination, Glenview, Ill., at 10:41 P.M. C.S.T. on the 5th by way of the following: W1HXP-W1HDQ-W3AC/3-W3BKB-W3HWN-W8CIR/8-W8EUO/3-W8CIR-W8MDA-W8CVQ-W9VHG.

Right on the heels of W1HXP's message followed one from W1KIK/1, addressed to any Chicago station, which arrived at W9VHG 10:44 P.M. on the 5th. It was originated at 3:41 P.M. on the 4th, and followed a route slightly different from that of W1HXP, namely: W1KIK/1-W1HDQ-W2COT-W3HOH-W3FBH-W3FQS-W3BKB-W8CIR/8-W8EUO/3-W8CIR-W8MDA-W8CVQ-W9VHG.

Traveling over the east-west path to W9VHG also were three messages from the New York City area, and one from the Philadelphia area. W2GXS's, addressed to W9ZJB, travelled W2GXS-W2LAL-W2MO-W3BKB-W8CIR/8-W8EUO/3-W8CIR-W8MDA-W8CVQ-W9VHG. W2LXC's, addressed to any California station, travelled W2LXC-W3HOH-W3FBH-W3FQS-W3BKB-W8CIR/8-W8EUO/3-W8CIR-W8MDA-W8CVQ-W9VHG. W2MKF's, addressed to W9BNX, travelled W2MKF-W2LAL-W3HOH-W3FBH-W3FQS-W3BKB-W8CIR/8-W8MDA-W8CVQ-W9VHG. W3BZJ's, addressed to

W9VHG, went via W3BZJ-W3BKB-W8CIR/8-W8EUO/3-W8CIR-W8MDA-W8CVQ-W9VHG.

The fact that all of the messages which got through to W9VHG followed the same basic route would indicate that the success of this record-making circuit was due wholly to the enthusiastic endeavor of the operators participating and not to any combination of unusual conditions or "breaks." To all you who aided in making this system function in the manner it did, our sincerest congratulations on a job well done!

As in the last relay, the bridging of the gap between W3HWN and W3BKB at Harrisburg and York, and W8CIR at Aliquippa might not have been accomplished but for the commendable efforts of amateurs who were possessed of enough interest in, and enthusiasm for u.h.f. work to travel considerable distances to set up their portable-mobile stations at elevated locations. W8CIR left Aliquippa and, with W8DZS as assistant operator, set up 8CIR/8 atop Tuscarora Summit near McConnellsburg, Pa. W8EUO, with W8QBN as 2nd operator, meanwhile placed his portable-mobile set-up on Savage Mountain in Maryland. W8BHY had been left in charge of the home station at W8CIR, and by 7:00 P.M. on the 4th the circuit, W8CIR/8-W8EUO/3-W8CIR, which was to carry traffic across the mountains



The 65-foot fire tower used to support the di-pole antenna at W8CIR/8, Tuscarora Summit, Pa.

*Communications Department, A.R.R.L.

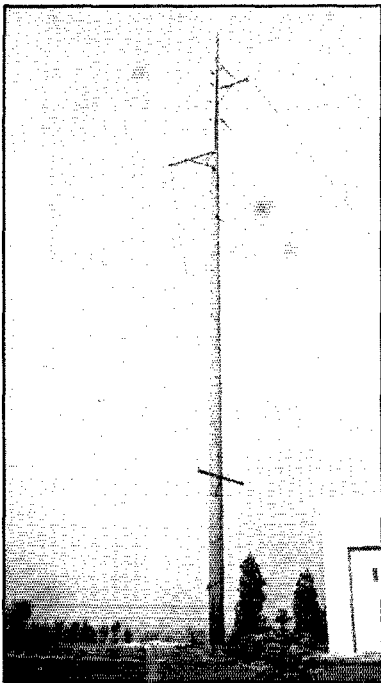

Three half-waves in phase atop the 85-foot "stick" at W8CIR pushed messages a distance of 210 miles (the longest hop in the Boston-Chicago route), to W8MDA in Ann Arbor, Mich.

which run through Central Pennsylvania was in working order. Working portable from a mountain top isn't as easy as it sounds . . . at least not when the calendar says it's November! During the night a heavy snow fell at both Savage Mountain and Tuscarora Summit. This made receiving conditions quite difficult at W8CIR/8 due to the severe snow-static that resulted. W8DZS and W8CIR left their portable location at 2 A.M. to return in the morning after five hours of welcome sleep in McConnellsburg. Severe road conditions were encountered on the trip back up the mountain, and SCIR says in his report of activity during the relay, ". . . after getting a good start, we were able to bounce, slide, and slip our way up . . . and arrived with the clutch in the car smelling like a rubber boot that had been left on a hot stove." At Savage Mountain, condi-

tions were just as bad, and W8EUG writes, "By morning everything was covered with about a foot of snow, making our camp on the mountain top anything but pleasant. We had the time of our lives on the relay, snowstorm and all, but for the next relay we would much prefer the good ole summer time to go mobile."

This relay saw a surprisingly large number of messages reaching their destinations, and we list below some of the more notable of the routes which they followed:

One from W8LKD to "Any East Coast Station," travelled W8LKD-W8CIR-W8EUG/3-W8CIR/8-W3RL-W3EEN-W3DBC-W3CUD-W2MO-W2KKE-W2HYJ.

One from W8CIR/8 to W1BDI travelled W8CIR/8-W3RL-W3EEN-W3KB-W2MO-W2AMJ-W1KLJ-W1INF-W1BDI.

One from W3GGR/3 to W1HDQ travelled W3GGR/3-W3CGV-W3CUD-W2AMJ-W1CLH-W1HDQ. An answer returned via W1HDQ-W2AMJ-W3CUD-W3GGR/3.

Addressed to "any Boston station," W3RL's test message went via W3RL-W3EEN-W3DBC-W3CUD-W2AMJ-W1KLJ-W1EHT (Boston). W1EHT'S reply travelled W1EHT-W1KLJ-W3AC/3-W3HOH-W3AXR-W3CUD to W3DBC who received it too late Sunday night to relay it on to W3RL.

One from W1LSN, Exeter N. H., to "any New York station," went via W1LSN-W1MDN-W1UI-W1MJ-W1KLJ-W2MO-W2COT to W2IDV, who sent a reply by way of W2IDV - W2COT - W2MO - W1HDQ - W1HXP - W1EKT-W1EHT-W1MJ-W1LSN.

Addressed to W1MBE, one from W2LAL travelled W2MO-W1KHL-W1HDQ-W1HXP. From HXP, it was taken "special delivery" (a 75-mile automobile trip!!!) by W1JGA, who returned with W1MBE's answer which was sent via W1HXP-W1HDQ-W1CLH-W1KTF-W2CLA-W3AC/3-W2MO-W2AMJ-W2LAL.

A third party message originated at W1MJ was delivered by W2LAL after having travelled W1MJ-W1KLJ-W2MO-W2LAL. The answer returned via W2LAL-W2MO-W1KHL-W1HDQ-W1HXP-W1EKT-W1EHT-W1MJ.

One from W2LEG to W1HDQ travelled W2LEG-W2BAD-W2LXC-W2LAL-W2GHV-W1KTF-W1CLH-W1KLJ-W1HDQ. W1HDQ's answer returned through W1HDQ-W1KLJ-W3AC/3-W3HOH-W2COT-W2LEG.

W3DBC, W3AWM, W3IHW, all located in Washington, D. C., originated messages to ARRL which reached HQ. via the following circuits:

W3DBC-W3CUD-W2AMJ-W1LL-L1INF.

W3AWM-W3DBC-W3CUD-W2AMJ-W1LL-L1INF.

W3IHW-????-W1KTF-W1CLH-W1KLJ-W1BDI.

In addition to the above, other messages travelling lesser distances reached their destinations over the routes given below. The last named station is in each case the station to which addressed, or in the case of third party messages, the delivery point.

W1LFF-W1KLJ-W1INF; W1KH-W1EHT-W1KLJ-W1INF; W1EHT-W1HXP-W1HDQ-W1INF; W1JOZ-W1LHZ-W1KSB; W1BDI-W1KLJ-W3AC/3-W2MO-W2BAD-W2HYJ; W1KTF-W2LXC-W2KKE; W1KTF-W2IDV-W2COT-W2BS-W2LRE; W2MKM-W2LAL-

(Continued on page 112)

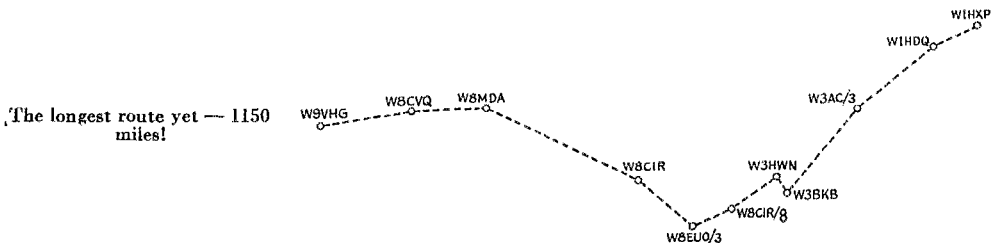

Another Approach to High Power

Push-Pull-Parallel Operation of Medium-Voltage Tubes

BY J. A. McCULLOUGH,* W6CHE

LIKE the transmitter of many amateurs, the writer's has gone through various transition periods, starting with a single 10 and ending with a kilowatt. Being close to the "fads and fancies" in amateur design and having built a number of so-called "high power" transmitters, the advantages and shortcomings of various schemes have been appreciated. One of the biggest objections in going to "high power" has been the necessity for discarding expensive tubes and parts and purchasing other more expensive components. It was felt that, if a little thought were given to the original equipment, a greater degree of flexibility in transmitter design could be obtained, and the transition from low power to high power could be made without discarding parts and at such times as the purse would permit.

The general idea of the transmitter described here is that the original layout of the transmitter will be sufficiently large to hold a one-kilowatt arrangement, but at the same time it allows the builder to start with an input of 250 watts or less. The final tank condenser should have spacing capable of withstanding plate modulation with 1500 volts on the tube or tubes. For 250 watts, a single 75T is used in the final, and another 75T is added for 500-watt operation. For 1000-watt operation, two more 75T's are added, making the final amplifier a push-pull-parallel affair. For the squeamish who visualize trouble from parasitic oscillations occurring with this arrangement, it is safe to say that no trouble will be experienced from this source if proper precautions are taken to prevent symmetry of the grid and plate leads of the paralleled tubes. The plate lead is not brought off the midpoint between the tubes but rather from one tube, with a second wire connecting the two plate terminals together. The grids are paralleled in the same manner but the grid lead is connected to the tube opposite that to

which the plate lead is connected. The power requirement of 810 ma. at 1500 volts (150 ma. for the doubler and amplifier and 600 ma. for the final) presents a somewhat different problem from that to which the amateur is accustomed but the answer is comparatively simple. Assuming that we are making the transition from low to high power, we must already have on hand a 1500-volt power supply good for about 600 watts. In order not to discard any of this equipment, we merely parallel another 1500-volt 600-watt power supply for the kilowatt rig. These supplies should be exact duplicates and are paralleled at the d.c.-output point. Considering the rectifier tubes' limitations and the lack of suitable high-current chokes, plus the availability of the smaller sizes of plate transformer, the actual economy of the scheme is obvious, and even more so when considering the older idea of using a complete new supply when high power is obtained by going to higher plate voltages. As a point of academic interest, there is very little difference in cost between a 1-kw. plate supply whether the output voltage be 1500 or 3000 volts, although the ability to obtain the final result on the "installment plan" is a point in favor of the low-voltage supply. The fact that the driver tubes operate at the same plate voltage as the final makes unnecessary a separate supply for them.

The transmitter described here is designed primarily for 20 and 40 meters and is capable of 100% plate modulation. Being modern, it must be capable of break-in operation and also must operate without retuning over a good portion of any one band, by simply setting the exciter frequency. The lineup finally selected was a 35T doubler-amplifier, 35T amplifier and 75T's in the final. The choice of tubes was dictated by the use of one power supply for the entire transmitter. Only four tank circuits are used in the transmitter: the grid circuit of the 35T doubler-amplifier, the plate circuit of the 35T doubler-amplifier, the plate circuit of the 35T amplifier and the final amplifier plate tank circuit. All of the circuits are low C so that the Q or "sharpness" of the circuits will be low, and the transmitter operates, without retuning or serious loss of output, over about 150 kc. in the 14-Mc. band and slightly less on 7 Mc.

The Circuit

Link coupling is used between the electron-coupled oscillator circuit and the grid of the first

Push-pull-parallel operation of tubes has several advantages that have been overlooked because of the fear of trouble from parasitic oscillations and cumulative tube capacities. This story points out the advantages and shows how to avoid the possible spurious oscillations.

*Eitel-McCullough, Inc., San Bruno, California.

35T. The output of the exciter unit (an X-EC) is a little less than five watts and the output is on 40 meters. If the transmitter was to be used only on 40 meters, a single 35T operating as a straight amplifier would provide enough excitation to the final amplifier but, since 20-meter operation was also desired, a 35T doubler was added. Ten-meter operation is obtained with the second 35T operating as a doubler, although the excitation to the final amplifier will not be as high as on 20 and 40 meters. The second 35T is capacitively coupled to the doubler stage, and it should be noted that the grid connection is only 1 turn from the center of the coil. This point gives maximum output from the driver as well as maximum efficiency. The first 35T tube is plate neutralized for amplifier operation, although the split plate circuit would be unnecessary if this tube were used only as a doubler.

The second 35T is inductively coupled to the final amplifier and needs a word of explanation. Capacitive coupling was tried at first and worked well except that it was practically impossible to obtain equal grid currents in the push-pull final, and a fundamental-frequency parasitic oscillation showed up when the excitation was removed and the bias reduced to the point where plate current would flow. If normal bias were used, the existence of this parasitic would not be detected and for all intents and purposes would have "gotten by," but parasitics can't be tolerated if clean pure signals are desired. It is often impossible to balance every stray capacity to ground when using a metal chassis, with the result that a lack of symmetry exists in attempting to use the plate coil of the driver tube for the grid coil of the final amplifier tube. The common-coupling setup makes possible a condition for oscillation. This particular type of parasitic oscillation has been present in other transmitters that the writer has seen and so a word on the "cure" is in order. Probably no trouble of this type would have oc-

curred if link coupling had been used but this would have required another circuit, which we were trying to eliminate. The same results were obtained by placing a second coil within the driver plate coil, to give close inductive coupling. The blocking condensers were retained along with the parallel feed, giving an excellent method of metering each grid circuit. This arrangement required no center tap to the coil and easy adjustment of the coupling coil was possible. The number of turns on the coil determines the coupling to the driver, while the position of the coil in relation to the center of the plate coil determines the distribution of excitation in each half of the push-pull final, as indicated by the grid current. It is the writer's belief that very few push-pull amplifiers have equally divided excitation, and this usually is responsible for any uneven heating of the tubes. For this reason it is considered essential that provision be made to meter individually each grid circuit in any push-pull amplifier. Link coupling is no cure for unequal grid currents, and it is a fallacy to meter the common grid return and assume that both grids are being excited alike. Another unorthodox stunt used in the final amplifier is the omission of by-pass condensers from the centers of the grid and plate coils and also from the filaments themselves, with the tuning condenser left "floating." The result is that the tubes are always balanced and more complete neutralization is possible. This same stunt has been tried on other push-pull amplifiers with equally gratifying results.

A word about the relation of the driver coil and the final amplifier coils. It is preferable that these coils be shielded from each other but, if this is not possible, they should be at right angles to each other. The reason for this is that apparent neutralization is obtained with the neutralizing condensers at some setting that does not correspond to the tube capacity because the inductive relation of the two coils causes a partial inductive

◆

The push-pull-parallel kilowatt transmitter, shown next to the X-EC frequency-control unit to illustrate the compactness of the transmitter.

The tank circuit for the link from the X-EC is on the back of the chassis. The buffer-doubler is on the left of the chassis towards the front; the cluster of tubes directly to the rear of this stage is the bias rectifier and bias regulator tubes. The second 35T buffer is mounted at the rear of the chassis, behind the buffer tank circuit, and drives the four 75T's which make up the push-pull-parallel final amplifier.

◆

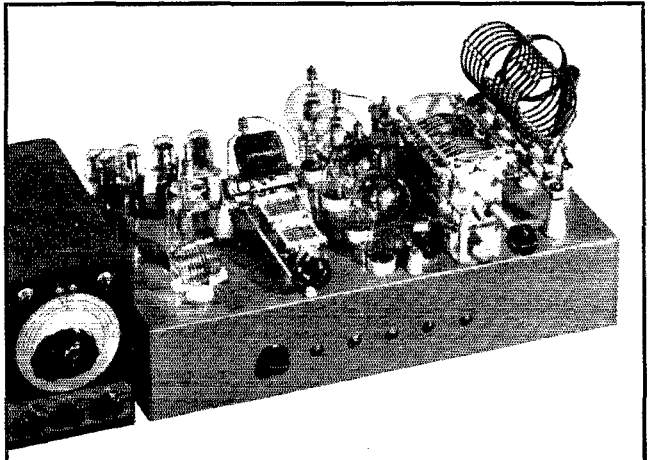

neutralization, with the result that although apparent neutralization is obtained a tendency is present to oscillate parasitically at the fundamental frequency. This tendency is greatest at the low-frequency end of each band, where the inductive feedback is greatest. This inductive feedback will also make necessary a readjustment of the neutralizing condensers when changing bands; no such readjustments are necessary in a setup where inductive feedback is absent.

Keying and Bias

Oscillator keying is used and bias must be supplied to all stages. The new regulator tubes, VR105 and VR150, are a happy answer to the bias problem. Instead of using a large power supply having a heavy bleeder to obtain some degree of bias voltage regulation, the new regulator tubes are connected in series with the grid return of the stage to be biased. A very inexpensive power supply is used, capable of supplying 5 to 10 ma. of current and having a voltage of at least 30 volts more than the voltage drop of the regulator tubes. A 0.1- to 0.25-megohm resistor is connected between the tube and the d.c. voltage and effectively limits the current drain to a few

ma. but still allows the tube to ionize. Additional current, such as that rectified by the grid, does not change the value of this voltage. In this particular transmitter, a single VR150 supplies bias for the two 35T's and three VR150's in parallel are used for the final amplifier, where the grid current will run around 120 ma. for the four tubes. These regulator tubes, like the tubes to the final, can be added as needed. Any number of independent bias supplies can be created from a common source of d.c. since the series resistors effectively isolate the various units. It is also possible to use a VR105 at one spot and a VR150 elsewhere.

Overloads

Overload protection is one thing that probably most amateurs consider a luxury but which actually should be given first consideration in a transmitter. Tubes have been designed to withstand tremendous overloads but, so far, the tube manufacturers cannot prevent emission from other electrodes of the tube should they be heated to incandescence. One common tube failure is the destruction of the filament because of overheating of the grid structure to the point of

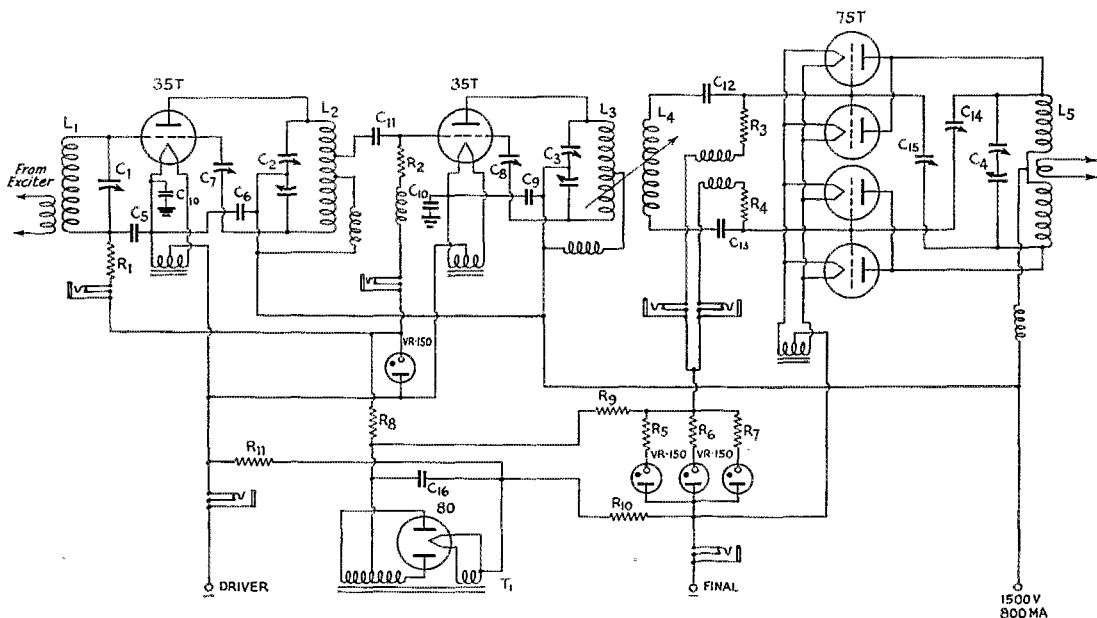

Fig. 1 — Circuit diagram of the push-pull-parallel transmitter.

- C₁ — 100- μ fd. midget (Hammarlund).
- C₂ — 35- μ fd. dual double-spaced midget (Hammarlund).
- C₃ — 50- μ fd. dual (Johnson).
- C₄ — 30- μ fd. dual (Johnson 70DD70).
- C₅, C₁₀, C₁₂, C₁₃ — 0.002- μ fd. mica.
- C₆, C₉, C₁₁ — 0.002- μ fd. mica, 500-volt.

- C₇, C₈, C₁₄, C₁₅ — Neutralizing condensers (Bud).
- C₁₆ — 1- μ fd., 400-volt.
- R₁ — 15,000 ohms, 3-watt.
- R₂ — 3000 ohms, 10-watt.
- R₃, R₄ — 3000 ohms, 25-watt.
- R₅, R₆, R₇ — 50 ohms, 2-watt.
- R₈, R₉, R₁₀, R₁₁ — 100,000 ohms, 2-watt.

- T₁ — Small broadcast replacement transformer.
- Separate negative leads are shown to illustrate where the overload breakers are placed. Both leads are tied together on the other side of the breakers and go to the common negative of the power supply.

primary emission. The polarity of the filament with respect to the grid is such that the filament becomes bombarded by the electrons from the grid and is sometimes destroyed. The plate circuit should have an overload device set for opening at 75% current overload, and this overload should not only open the plate supply to the final amplifier but also to the driver stage as well. The reason for the latter is that, when the plates are heated to incandescence, the grid structure may likewise be heated, particularly if it is being driven hard. The thermal inertia of the grid structure may be such that the overheated grid will continue to emit even after the plate power has been removed and, because of continued excitation, the destruction of the filament may take place. The instant removal of the excitation prevents this. Only one plate supply is used for final and driver in this transmitter and the problem is somewhat simplified. Separate overload relays are used for the driver and final amplifier stages, although both relays break the same circuit. The overload relays will pay for themselves several times over the first time they have to kick out.

Performance

This transmitter is the smoothest operating rig that the writer has ever used, and the performance leaves little to be desired. As measured, the plate efficiency is close to 85%. A constant check on this is obtained because there is a rise in plate voltage when the current is reduced (key up condition). The voltage rises from 1500 to 1650, and the increase is enough to overcome the fixed bias and allow a total of 100 ma. of plate current to flow through the four tubes of the final amplifier, forcing them to dissipate a total of 165 watts in their plates. When the transmitter is operating with 1000 watts input the tubes actually cool off, indicating that they are dissipating less power than 165 watts. Since the plate tank circuit doesn't heat during long periods of leaving the carrier on, it is a good indication that not much power is used in heating up the coil or condenser and consequently most of it is being delivered to the antenna.

The comparatively low value of capacity in the final amplifier seems to cause no difficulty, as there is no apparent harmonic radiation and the circuit loads in the normal manner. It should be pointed out, however, that such low C should only be used in well-balanced push-pull amplifiers and that the output should be delivered to a purely resistive load. Lines having standing waves should be terminated in a separate $L-C$ circuit at the transmitter. The transmitter can be very easily loaded to 1 ampere of plate current, although this is over the tube's ratings. 1500 watts input is considerably more than allowed by law and is merely mentioned to show that the transmitter is "loafing" at a kilowatt. The normal value of grid current to the final is 30 ma. per tube, or a total

of 120 ma. for the four tubes, although a wide variation of grid current does not make an appreciable difference in performance.

On the Ultra Highs

(Continued from page 61)

area where the lamp remains out is the point at which the permanent shorting bar is soldered in place.

It looks like most of the West Coast gang have forsaken 56 Mc. for 2½, and little is being heard from W7, with 7GBI off for rebuilding. That 250-TH should be going again shortly. We hear practically nothing from the Pacific Northwest. What say, fellows? Let's hear what goes on in W7.

From W8NZ, via K6MVV on 28 Mc., we learn that the following Michigan W8's are active each Monday and Tuesday between 8 and 9 p.m.: CVQ, Kalamazoo, 58.02; MDA, Ann Arbor, 58.03; LMP, Caledonia, 56.8; QDU, Detroit, 56.01; and NZ, Battle Creek, 56.77.

W9ZJB and W9VWU are attempting to promote a Wichita-Chicago relay. Over sixty mimeographed letters have been sent to stations along the route and several promises of cooperation have been received. This noble effort should add considerably to the distance covered by our "To any West Coast Amateur" messages in the next u.h.f. Relay. Vince and Johnny maintain regular skeds between Topeka and Kansas City, beams at each end making reliable communication possible.

W9WYX reports that many of the gang around Denver have rigs on 56 and 112 Mc., but that a telephone call is usually required if any u.h.f. work is contemplated.

W5CFQ and W5HCQ of Fort Smith, Ark., have a 200-watt rig on 56 Mc. W8DTB, Randolph, Utah, is talking of going to Five. K6MVV has a DM-36 for his RME-69 and is listening regularly for sigs from the mainland some 2200 miles away. On every hand one hears evidence of a growing interest in 56 Mc. possibilities. With most of the DX stations throughout the world silenced by war conditions and much of the appeal of operation on the lower frequencies thus lost, we have a strong suspicion that u.h.f. work is due for a considerable increase in popularity in 1940. To you fellows on Ten and Twenty who are tiring of the endless battle of heterodynes that is 'phone operation on these bands, may we suggest that you trim those coils a bit, hook up a converter to that communications receiver, and drop down to Five occasionally? Here, at least, you will find that it is still possible to have a "one hundred per cent. QSO," even if it may not be with the far corners of the earth!

112 MC.:

Did any of you pass over that article by Grammer and Goodman in the January issue? If you did, dig it out and read over that frequency-modulation dope carefully, and don't forget the article by Prof. Noble in August *QST* also. That's gold in them thar pages!

Before the advent of the stabilization requirements the 56-Mc. enthusiast was caught in a "vicious circle" which prevented much real progress. Many adopted stabilization, through the use of crystal control or other means, but they knew full well that full benefit of this step could not be realized as long as the super-regenerative receiver remained in general use. Conversely, the development of the 56-Mc. superhet was retarded by the fact that, in its most effective form, it was useless for reception of a goodly portion of the signals heard.

The step to f.m. technique for either reception or transmission involves no such high-principled martyrdom to a cause. The f.m. system looks to us like a "natural" for 2½. For the advanced experimenter who has shied away from 112-Mc. work because it meant reversion to the discarded technique of modulated oscillators and super-regen receivers, frequency modulation represents a fine opportunity for some real contributions to amateur progress; a chance to do some interesting work in a new field without sacrificing that most essential ingredient of all amateur work: com-

(Continued on page 63)

Navy Day—1939

FIVE HUNDRED AND SIXTY-SEVEN participants submitted copies of the 1939 Navy Day message, transmitted at approximately 25 words per minute from stations NAA (Washington) and NPG (San Francisco) on October 27th. It was the fifteenth consecutive year that A.R.R.L. has conducted a Receiving Competition based on a message from the office of the Secretary of the Navy.

Letters of appreciation from the Navy Department are being forwarded to the 189 operators who made perfect copy, 33.3 per cent of all participants.

The message was copied in forty-seven states (all but Idaho), the District of Columbia, Alaska, Canal Zone, Hawaii, Bermuda, and four Canadian provinces (Manitoba, Ontario, Saskatchewan and Quebec). Several ship operators submitted copies, including WIBZO aboard the S.S. *Olney*, in the Pacific Ocean, off the coast of Mexico, and W6OVG southbound from Rio de Janeiro, Brazil, on the S.S. *Argentina*.

A table showing participation by Naval Districts, indicating the number of N.C.R. members submitting copies, etc., is presented for the general information of all and to show the relative standings of the various Districts; 54 per cent of the participants were members of the Naval Communication Reserve.

The Honor Roll lists all contestants by Naval Districts in two groups, those making perfect copy, and all others. Congratulations to the letter-winners! The usual cases of carelessness in recopying, and poor guesswork when portions were missed, were noted. Had our warning to all operators to submit their original copies been

heeded, there would have been more winners. Next time, gang, send your original copies — do not attempt corrections!

— E. L. B.

(Continued on page 84)

1939 NAVY DAY MESSAGE

It is my pleasure to transmit a message of greeting in celebration of Navy Day. I am gratified to learn that the Naval Reserve in all Naval Districts has opened its armories and reserve air bases to the public in celebration of the Navy's day at home to the public. Each year a receiving competition has been conducted in which amateur and commercial operators have participated. Likewise the officers and men of our Naval Communication Reserve have contributed their share to the success of Navy Day by participation in the receiving competition. It is a source of pride that the Navy Department has an efficient and willing reserve of communications experts to aid in national calamities and emergencies. I commend the Reserve for the improvement made in Naval radio communication procedure and the interest taken in all phases of radio communication. I extend personal best wishes as well as that of the Navy Department to our American radio operators and am confident that the good work will continue.

CHARLES EDISON

Acting Secretary of the Navy

(This is the text of the message transmitted from NPG.)

| Naval District | Number of Participants | | | Number Making Perfect Copies | | | % Perfect Copies | Number of Copies Submitted | | |
|----------------|------------------------|-------------------------|-------|------------------------------|-------------------------|-------|------------------|----------------------------|--------|-------|
| | N.C.R. ¹ | Non-N.C.R. ¹ | Total | N.C.R. ¹ | Non-N.C.R. ¹ | Total | | Of NAA | Of NPG | Total |
| First..... | 14 | 24 | 38 | 4 | 6 | 10 | 26.3 | 33 | 7 | 40 |
| Third..... | 69 | 50 | 119 | 24 | 9 | 33 | 27.7 | 110 | 15 | 125 |
| Fourth..... | 23 | 20 | 43 | 11 | 5 | 16 | 37.2 | 36 | 7 | 43 |
| Fifth..... | 4 | 11 | 15 | 2 | 2 | 4 | 26.6 | 15 | — | 15 |
| Sixth..... | 4 | 5 | 9 | 1 | 2 | 3 | 33.3 | 5 | 4 | 9 |
| Seventh..... | 4 | 9 | 13 | 3 | 6 | 9 | 69.2 | 11 | 3 | 14 |
| Eighth..... | 34 | 15 | 49 | 17 | 5 | 22 | 44.8 | 25 | 34 | 59 |
| Ninth..... | 47 | 82 | 129 | 12 | 23 | 35 | 27.1 | 65 | 75 | 140 |
| Eleventh..... | 13 | 29 | 42 | 6 | 14 | 20 | 47.6 | 2 | 40 | 42 |
| Twelfth..... | 25 | 24 | 49 | 12 | 10 | 22 | 44.8 | 1 | 48 | 49 |
| Thirteenth... | 20 | 28 | 48 | 2 | 12 | 14 | 29.1 | 3 | 46 | 49 |
| Fourteenth... | — | 2 | 2 | — | 1 | 1 | 50. | — | — | 2 |
| Fifteenth..... | 1 | — | 1 | — | — | — | — | 1 | — | 1 |
| Miscellaneous. | 1 | 9 | 10 | — | — | — | — | 5 | 6 | 11 |
| Totals..... | 259 | 308 | 567 | 94 | 95 | 189 | 33.3 | 312 | 287 | 599 |

¹ The number of N.C.R. and non-N.C.R. member participants was determined as accurately as possible by examination of copies received.



CORRESPONDENCE FROM MEMBERS

The Publishers of *QST* assume no responsibility for statements made herein by correspondents

NEW YEAR'S RESOLUTION

Ironwood, Mich.

Editor, *QST*:

I herewith submit a New Year's Resolution for radio manufacturers:

"We hereby resolve that, during the coming year, we will, without stint or reservation, get back to sane engineering principles in the design and construction of our product;

"That we will again refresh our memories on the virtues of what used to be called, in the good old days of radio, a 'tuned r.f. stage or two ahead of the first detector,' and that we will acquire the money for building same by the total and complete elimination of the goofy loop, the wave-magnetizer, wave hooker, etc.;

"That we will relegate push-buttons to the typewriters, and in their place spend a little jack on real tone quality;

"That we will so build our product that we will find it unnecessary to exaggerate and to make questionable claims in our advertising;

"That we will quit kidding the long-suffering radio listener on 'television connections,' and other spurious thingamajigs that the average dealer has to explain away, instead of explain;

"Last but not least, that we will spend our enthusiasm on attempting to educate the public to better radios at fair prices, instead of atrocities at atrocious prices.

"S'help us."

— L. W. Van Slyck, W9EMB

CATHODE MODULATION

Barnes Bldg., Muskogee, Okla.

Editor, *QST*:

... W2FZQ and W2GNL stated in the December issue of *QST*, "... It is plain that we were the originators of both the name and the method of application of cathode modulation."

I recalled that in my radio library, prior to its destruction by fire in 1936, there was a book or manual on commercial radio operating, and in it was mentioned, among other methods, a system known as center-tap modulation. This book was printed about 1927.

I then decided to check with a reliable source just who did invent this system and I found out that the idea of inserting the modulating source in the cathode lead of a radio-frequency amplifier is disclosed in U. S. Patent 1,573,282, issued to John Stone. The application was filed November 23, 1923, and the patent was assigned to A. T. & T. after it was granted on February 16, 1926.

So, you see, this puts the origination of cathode modulation back to 1923, and if anybody knows of an earlier development of this system, let them speak.

— Lester Harlow, W6CVO

188 Linden Blvd., Brooklyn, N. Y.

Editor, *QST*:

I could not help smiling to myself at the claims made by W2FZQ and W2GNL in their letter to *QST*, as well as to the references made to the claims of Mr. F. C. Jones. Why, it seems only yesterday that I and hundreds of other amateurs were using cathode modulation way back in 1921, 1922 and 1923, when we put our telephone company mikes in series with the center-tap in our 5- to 50-watt c.w. rigs in order to modulate our oscillators for 'phone operation. Also,

if my memory is correct, Dr. deForest used center-tap or cathode modulation as well as absorption (or loop) modulation in 1916 at his radiophone station in Kingsbridge, N. Y. The present resurrection of cathode modulation is probably due to the desire of various radio manufacturers to increase their transformer and other equipment sales.

— David Talley, W2PF

THEY MIGHT, AT THAT

321 N. Lombard Ave., Oak Park, Ill.

Editor, *QST*:

Now that so many of our DX brethren across the seas are off the air, maybe they'll have a chance to catch up with those "wl sure QSL and QSL OM."

— Marwin Gonsior, W9ANS

73 CUL

605 West St., Wausau, Wis.

Editor, *QST*:

Regarding W9RCC's letter in December *QST*, what this ham business needs is a new Q signal meaning, "Will you stick around and chew the rag after I give you RST, QTH, wx, rig, name, age, life history and a few other conversation openers, or are you one of these '73 cul' boys?" It would sure save a lot of time now wasted trying to stir up a rag-chew with some of these chaps.

— Ira A. Williamson, W9RLB

CORRECTED CORRECTION

Harlinger, Texas

Editor, *QST*:

After reading the letter written by W9GZF in December *QST*, I don't imagine that W4EWK would appreciate being blamed for a mistake that I made myself.

In connection with the picture "Grand Jury Secrets," I wrote W6PCV congratulating him because he was responsible for the authenticity of the details in the film.

— H. H. Bowers, Jr., W5EWZ

FIRE INSURANCE RADIO CLAUSE

188 Linden Blvd., Brooklyn, N. Y.

Editor, *QST*:

I was very much interested by the letter from Mr. Worrell, W8SKW, in December, 1939 *QST* on the subject of fire insurance. For the past several years I have had my fire insurance policies indorsed with a statement to the effect that permission is granted to install amateur radio transmitting equipment of 100 watts. In addition, I had the Board of Fire Underwriters inspect my station when it was first set up in my present location and received a certificate of inspection — cost \$1.50 — which, together with the indorsement in my fire insurance policy, covered any loss by fire of my radio equipment.

However, the fire insurance companies must be more cognizant of the amateur at the present time because, when I recently received my new fire insurance policy, I discovered the following new standard clause:

"Privilege Granted: for other insurance . . . to use fuel oil system; to install and operate radio receiving and transmitting apparatus. . . ."

(Continued on page 84)



HINTS AND KINKS FOR THE EXPERIMENTER



NOVEL SECOND-DETECTOR CIRCUIT

A NOVEL circuit which should interest receiver experimenters is shown in Fig. 1. A 6H6 diode used as the second detector of a superheterodyne receiver is arranged as a voltage doubler.

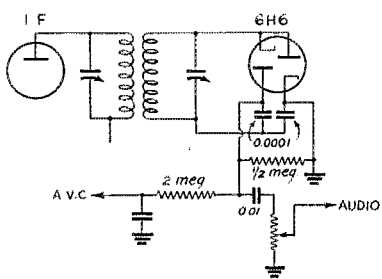

Fig. 1—A novel second-detector circuit using a voltage-doubling circuit.

I have used this circuit with very pleasing results. It is especially effective in cases where greater automatic volume control is found to be desirable. It also produces slightly more audio output than the usual arrangement.

— Allistair Towle, Mount Royal, Que.

BLOCKED-GRID OSCILLATOR KEYING

THE CIRCUIT of Fig. 2 shows an arrangement for blocked-grid keying which, while somewhat limited in application, requires no extra supply for blocking voltage and has a certain advantage when battery bias is used. Its chief application is in the case of a keyed oscillator

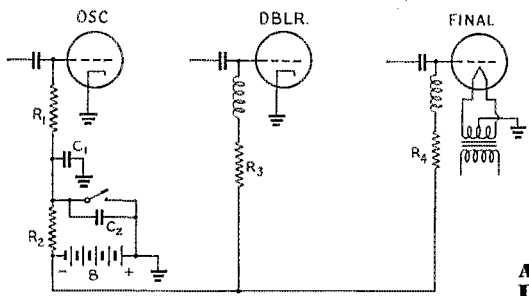

Fig. 2—Circuit for obtaining grid blocking voltage for keyed oscillator from amplifier bias supply.
 R₁, R₂, R₃— Usual grid leaks.
 R— Keying resistance, adjust according to text.
 C₁— Oscillator grid-leak by-pass, 0.01- μ fd. paper.
 C₂— Lag condenser, adjust according to text.

where some form of fixed bias is already provided for plate-current cut-off of following stages. The amount of fixed bias required for amplifier cut-off will in most cases be sufficient to block the oscillator.

When batteries are used for amplifier bias, their service life is dependent chiefly upon the rectified grid-current flow, the life being approximately the same as though the battery were being discharged at the rate of grid-current flow. In this circuit, this effect may be offset by adjusting the resistance R_2 so that the discharge current through the resistance with the key closed equals the grid current. The condenser C_2 should be adjusted to produce the desired amount of lag for click elimination. Its value will depend upon the resistance of R_2 , a larger value being required with low values of resistance for a given amount of lag. The scheme may also be applied in buffer or doubler keying in cases where the fixed bias required for plate-current cut-off of a low- μ final

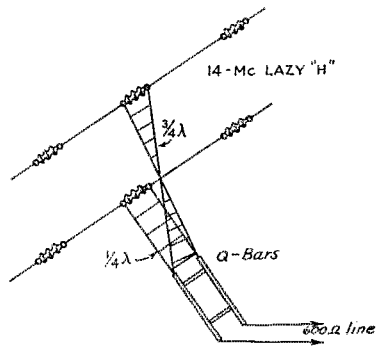

Fig. 3—Arrangement by which 6M6RG obtains a flat 600-ohm line with Lazy-H antenna.

amplifier is sufficient to block a high- μ buffer or doubler. The circuit works very well with a keyed e.c.o. In this case, the use of C_1 at the oscillator is important to eliminate frequency variation by keying leads.

A FLAT LINE FOR THE LAZY-H ANTENNA

IN the article on feeder adjustments which appeared in September *QST*,¹ the difficulty of adjusting a matching stub for a perfectly flat line

¹ Goodman, "A Few Feeder Considerations," *QST*, Sept., 1939.

was mentioned. The principal reason given was that the stub shows pure resistance only at its ends and not at the point at which the line is attached unless the stub is detuned slightly.

To eliminate this, the arrangement shown in Fig. 3 has been used at GM6RG with a Lazy-H antenna. Individual matching sections are connected to upper and lower sections of the antenna. The one for the upper section is transposed and is three-quarters of a wavelength long to bring its lower end down to meet the one-quarter wavelength section attached to the lower antenna section. A "Q" matching section is then used between the two open-wire matching sections and the 600-ohm line. When the "Q" section is correctly adjusted, the line will be terminated in a pure resistance. The impedance at the antenna end of the "Q" section will be about 15 ohms.

— Bryan Groom, GM6RG

CALIBRATED BEAT-FREQUENCY OSCILLATOR AS AN AID IN FREQUENCY MEASUREMENT

PROVIDED the amateur stays within certain boundaries, he satisfies the legal requirements of frequency adjustment. Some, however, may wish to know just how far they are inside the band limits, or their deviation from some reference point within the band and within the range of audibility. Many amateurs have constructed a 100-kc. oscillator for band-edge locating or a frequency-checking device similar to the one described by Grammer in *QST*² giving 10-kc. points in all bands. Doubtless a simple means of determining accurately the difference between a signal of known frequency and one of unknown frequency when the latter lies within 5 kc. or so of the former would be welcome.

There are many ways of using auxiliary apparatus for this purpose. However, the simple expedient of calibrating the beat-frequency oscillator of a superheterodyne receiver provides a reliable frequency deviation indicator without the necessity for additional equipment. The principle upon which this depends is that all carrier frequencies within the range of the receiver are converted to an intermediate frequency which is a constant. If the main tuning dial is tuned to zero beat with a reference signal of known frequency, f_0 , and signals on adjacent frequencies f_1 , f_2 , etc., exist within the audio range, they will evidence themselves by beat notes. The pitch of these beat notes is the deviation of the respective frequencies from f_0 , the known frequency. Without touching the main tuning dial, the beat-frequency oscillator may be adjusted to zero beat with the adjacent frequency in which case the angular variation of the b.f.o. control may be used as a measure of the frequency deviation.

The usual beat-frequency oscillator control is

²Grammer, "A New Type of Frequency-Checking Device," *QST*, June, 1938.

not calibrated, but the indicator may easily be fitted with a calibrated scale marked directly in frequency. Proceeding with an example, a HRO receiver was found to have a 4400-cycle variation of beat frequency. This range could be increased or decreased by substituting a control condenser of different value. The b.f.o. dial was removed and replaced with a semi-circular scale of brass with a radius of $1\frac{1}{8}$ inch mounted on the condenser-shaft bushing and a bakelite pointer was placed on shaft (see Fig. 4). A piece of No. 16 wire was soldered around the scale area to hold a paper scale and pyralin or celluloid cover. Reference zero was placed at the center of the scale, splitting the 4400-cycle variation into two 2200-cycle ranges labelled positive and negative to correspond to deviation above or below the reference point. This was done as a matter of convenience, since it does not alter the total range and, in situations where the 2200-cycle range is insufficient, the b.f. range may be expanded by remembering that the frequency is additive from a reference point.

It would be well to check the b.f. padding condenser and, if necessary, adjust it so that with the pointer adjusted to the mid-scale zero position, the b.f.o. is oscillating at exactly the receiver's i.f. This will assure greatest sensitivity with b.f. at zero reference position and the r.f. portion of

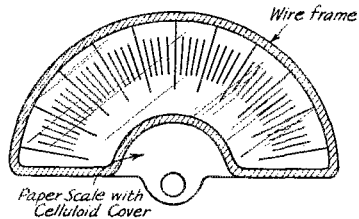

Fig. 4—An improvised b.f.o. scale for calibration as an aid to close frequency measurement.

the receiver tuned on the nose of the incoming signal.

Those having continuous-range receivers will find calibration relatively simple, using WWV transmissions. The evening 5-Mc. emission with 440-cycle modulation was used here. The receiver is first tuned exactly to the 5-Mc. signal and the b.f.o. *padding* set to zero beat with the carrier while the b.f.o. control is set at the mid-point zero of the scale. Care must be exercised in this adjustment not to tune to one of the side bands; this may be checked every ten minutes when there is a break in the 440-cycle modulation for announcements. The b.f.o. pointer is then slowly rotated in the direction of positive deviation and, where the locally-generated b.f.o. frequency zero beats with the 440-cycle side band, a point is placed on the scale. Proceeding past this point, a second mark is made at the setting of the 880-

(Continued on page 98)

★ I. A. R. U. NEWS ★

Devoted to the interests and activities of the

INTERNATIONAL AMATEUR RADIO UNION

Headquarters Society: THE AMERICAN RADIO RELAY LEAGUE, West Hartford, Conn.

MEMBER SOCIETIES

American Radio Relay League
Asociația Amatorilor Romani de Unde Scurte
Associazione Radiotecnica Italiana
Canadian Section A.R.R.L.
Československá Amatérská Vysílač
Deutscher Amateur Sende-und-Empfangs Dienst
Esti Raadio Amatooride Ühine
Experimental Radio Society of Egypt
Experimenterende Danske Radioamatører
Federation des Emetteurs Belges
Irish Radio Transmitters Society

日本アマチュア無線聯盟 Japan
Liga Colombiana de Radio Aficionados
Liga Mexicana de Radio Experimentadores
Magyar Rövidhullámú Amatőrök Országos Egyesülete
Nederlandsche Vereeniging voor Internationaal Radioamateurisme
Nederlandsch-Indische Vereeniging Voor Internationaal Radioamateurisme
Newfoundland Amateur Radio Association
New Zealand Association of Radio Transmitters
Norsk Radio Relæ Liga

Polski Związek Krotkofalowcow
Radio Club de Cuba
Radio Club Venezolano
Radio Society of Great Britain
Rede dos Emissores Portugueses
Reseau des Emetteurs Francais
Reseau Luxembourgeois des Amateurs d'Ondes Courtes
South African Radio Relay League
Suomen Radioamatööriilitto r.y.
Sveriges Sändareamatörer
Unión de Radioemisoros Españoles
Union Schweiz Kurzwellen Amateure
Wireless Institute of Australia

NEW CUBAN REGULATIONS

Now that Cuban amateurs are back on the air, let us take a look at their new regulations promulgated by the Secretary of Communications on November 18th. Although we have not heard of any general reaction among the Cubans themselves the new regulations seem, in general, quite satisfactory when compared with those of other countries.

To be eligible for amateur licenses, an applicant must be over 16 years of age and must have been a resident of Cuba for five years. Licenses, issued for a two-year period, are of two classifications: Class A, for amateurs interested only in telegraphy, and Class B for those wishing to work both 'phone and c.w. A code speed of 12 words per minute must be demonstrated in both cases, as well as sufficient knowledge of technical matters and amateur regulations.

Cuban amateurs have the use of all amateur frequencies provided for under the Cairo table. For radiotelephone work, the sub-bands of 1800-2000, 7000-7100 and 14,000-14,250 kc. are available. A newly-licensed amateur, during his first

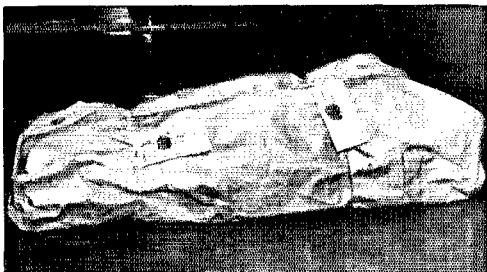

This photo from E.D.R.'s journal "OZ" shows the transmitter of OZ2ED under government seal.

year of operation, may work only on 160, 80 and 40 meters, and may not use more than 50 watts final input; then, after securing proper authorization, he may use all bands and may increase his power up to 500 watts.

Other items provide the desirable restrictions on out-of-band operation, tone-modulated telegraphy, filtered plate supply, etc., but there is one other we hope will not have to be invoked — it empowers the department of communications to close down all amateur stations in case of a national emergency.

NETHERLANDS

WE HAVE previously reported the shut-down of PA amateurs on August 30th. Although the N.V.I.R. had hoped its members would be allowed to continue experiments with such things as crystal oscillators, upon investigation it was found that the use of amateur transmitters was prohibited without exception. Then another blow fell: in November, all amateur transmitting apparatus was confiscated by the military authorities. The action was not so hasty nor haphazard as several previous cases of confiscation in other countries; all amateurs were given receipts, and the N.V.I.R. has received assurance that the apparatus will not be used but will be carefully stored by the government.

As their licenses have not been cancelled, PA amateurs hope for an immediate return to the air when hostilities cease.

LUXEMBOURG

WE HAVE received official confirmation from the *Reseau Luxembourgeois* that LX amateurs were closed down in September. The R.L. point out that any stations now on the air using the prefix "LX" are pirate stations.

ESTONIA

WHILE all amateur stations were closed down by the authorities on October 17th, the E.A.R.U. reports that this was a measure of precaution of a temporary nature only, and on November 3rd the government authorized the resumption of amateur transmissions, subject only to special approval from police headquarters for each individual station.

Estonia and Hungary thus appear to be the only European nations which at the present writing permit amateur operation.

HERE AND THERE

NORWEGIAN amateurs, whom we have previously reported as being closed down in September, were subsequently required to dismantle all transmitting antennas. While amateur regulations provide for sealing of transmitting equipment as the only alternative to confiscation, the N.R.R.L. was successful in convincing authorities that neither course of action was necessary. . . . OZ amateurs were not quite so fortunate — as can be seen from the accompanying illustration. . . . Colombia and Honduras have followed Argentina, Chile and others in a proclamation of neutrality, with special attention paid to communications. We are not aware at the moment of the details with respect to amateurs, but the Colombian government has assured its *aficionados* that the action is not to be interpreted as an unfriendly act but is merely a means of insuring the country's neutrality. . . . Mexico and Uruguay are reported to be forming new communications laws. Of Uruguay it is said that the proposed legislation provides for licenses for private stations but under very rigid regulations. . . . In Argentina, communications work by several amateurs was highly important in the finding of noted personages lost in an aeroplane, and the event was highly publicized. The *Radio Club Argentino*, realizing that such activities are the best possible argument for the continued existence of amateurs, is working toward the eventual establishment of a government-affiliated emergency network. . . . The *Liga Mexicana de Radio Experimentadores* is planning its ninth convention in May, to be held in the city of Mexico. To make visits of foreign amateurs as enjoyable as possible, short trips to points of interest in and about the city are being planned.

On the Ultra Highs

(Continued from page 57)

munication with the other fellows on the band. The frequency-modulated transmitter may be received perfectly on the super-regen, while the receiver designed for f.m. use does an excellent job on the unintentionally frequency-modulated signals now prevalent on 2½.

After years of experience with super-regen receivers for all u.h.f. work, the quality of signal obtainable with a receiver of the type described by Grammer and Goodman is a revelation. Even the lowly transceiver sounds sur-

prisingly good, if a good mike is used. We have f.m. equipment under construction for use at Wilbraham and hope to have more to say as the result of personal experience shortly.

WIKSB sends along a list of 57 calls which are heard frequently in Eastern New England. He also lists five calls known to be bootleg. Do we have to put up with this, fellows? He also reports that many believe about half of the gang to be outside the band. What, no freq-meters?!

WILTZ has been doing some work from an Aerona, flying between New Haven and Meriden Airport, where W1GYT has a 112-Mc. rig with the antenna atop a 52-foot airway tower. The plane rig was an Abbot DK-2 while the rig at W1GYT consisted of a pair of 76's modulated with 42's.

The portability of 2¼-meter equipment lends it readily to all sorts of public-service applications. At a recent "open house" at Columbia University, portable rigs stationed around the campus handled traffic, with the Columbia Radio Club, W2AEE, as control station.

A very complete report from W2MLO lists calls of 61 stations regularly active in the New York area. More are coming on every night and everyone is apparently having a grand time of it. The receiving tubes are taking a terrific beating, and well they may, at current prices! Among the transmitting tubes in use the HK-24 and RK-34 lead the pack. Stable-frequency transmission and superhet receivers are practically non-existent; it appears. MLO reports several, including KDB, TY, KTW, EKC, and GZ firing up for ¾ meter work.

The W6's are going "great guns" on 2¼ with plenty of work up to 100 miles. W6RVL (ex-6UP), one of the most active, sends along a list of 32 stations, with the equipment used by each. On this list are several former 5-meter men who have changed to 2¼ in order to take advantage of the growing activity there. W6KYT reports that a recent QSO with W6RVL (both are located in Los Angeles) was the first between these two since eighteen years ago when they worked each other on spark. They were 6BQR and 6UP then! We note a number of two-letter calls in these 112 Mc. reports. 2¼ and the other u.h.f. bands seem to have a special appeal for many "old-timers" who see little of interest in the eternal QRM struggle on the lower frequencies.

224 MC.:

THIS month's mail contains three references to 1¼-meter work. W8GU sends along an interesting summary of the work done recently by the gang around Erie, Pa. With 40 watts output, supplied by a pair of 834's in a tuned-plate tuned-filament oscillator, and a 6-element antenna, the signal has been heard at a distance of 52 miles from Erie. A series of dead spots observed at intervals of 11 miles around the transmitter brings up some interesting problems to be investigated on this frequency.

W9WYX has been traveling around listening to his rig with mobile receiving equipment and reports several interesting observations, including a selective fade which is not observed on 2¼ or 5 in the same area. We believe that it is not correct to assume that 1¼ will follow the familiar patterns of 56 and 112 Mc. The tremendous difference in frequency makes anything possible. Don't forget, it's as far (in frequency) from 2¼ to 1¼ meters as it is from 112 Mc. to the audio range!

W1AIY, one of the earliest of the W1's to work on Five, has been using 224-Mc. equipment for several years to transmit weather signals from his shack to his home some hundred yards away. Up to now, Al has never had a chance to listen to anything else in the way of 224-Mc. sigs and would welcome the opportunity. With an excellent location atop Southington Mountain, near Waterbury, Conn., Al is in a position to do some real pioneering in the 1¼-meter field, as he did in the early days of Five.

AND ABOUT THAT U.H.F. MARATHON

AS MOST of you read this, the month of January will be just about over and it will be time to send in that

(Continued on page 108)

HAM



SHACKS

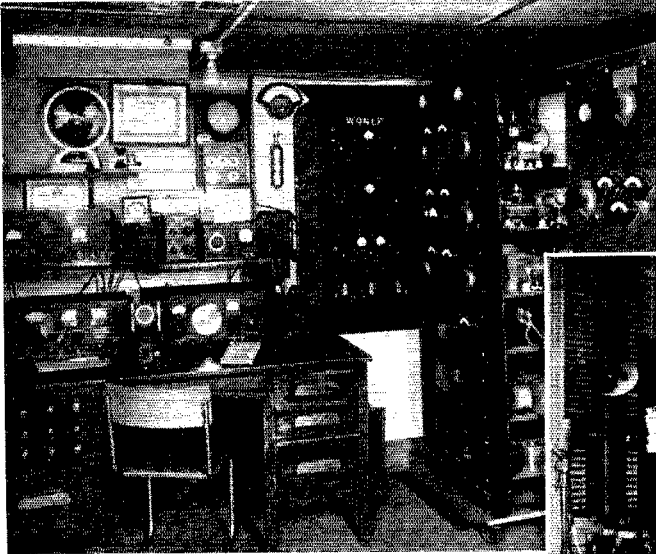

W9NLP, Chicago, Ill. ↗

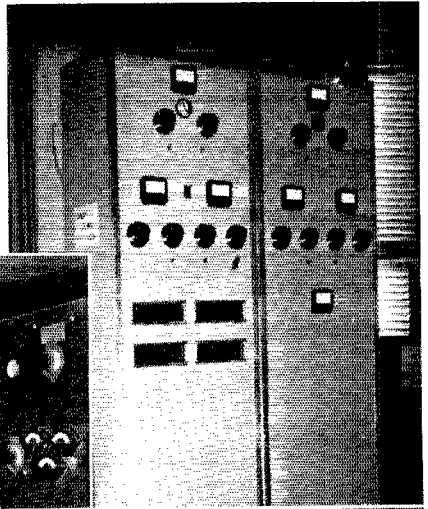

SU1AM, Heliopolis, Egypt ↗

← W9SZW, Chicago, Ill.

ZL1MR, Auckland, N. Z. ↘

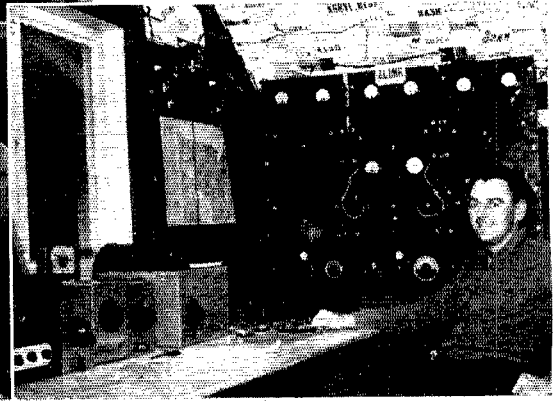
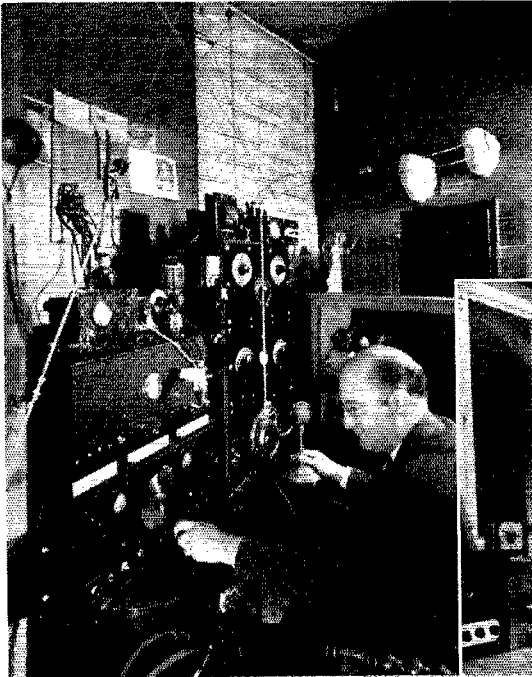

W9NLP

W9NLP is a familiar call to most 'phone operators. It is the call of Rolly Long's station in Chicago. The equipment is quite extensive, consisting of a separate high-power transmitter for each of the high-frequency 'phone bands, a pair of receivers and various pieces of monitoring and checking gear.

The transmitter built into the wall at the center of the photograph is the 14-Mc. rig with a push-pull 250T final modulated by Class-B 203A's. The final is driven by an exciter employing a 47 oscillator, and 801 and T55 doubler stages.

The large rack to the immediate right is the 4-Mc. outfit with 3 parallel-connected 852's in the final. The 852's are driven by a 203A and modulated by HD203A's. Excitation for the 203A is provided by a 47 oscillator and 801 buffer.

The next rack to the extreme right is the 29-Mc. transmitter. A pair of push-pull 100T's in the final is driven by a pair of 6L6's and an RK-20. The final is modulated at 400 watts input by Class-B T55's.

Not shown in the photograph is an 800-watt transmitter for the 1.8-Mc. band. The tube line-up in this unit includes a 47 oscillator, 801, and T55 driving a pair of 203A's parallel-connected modulated by Class-B 203Z's.

Each modulator has its own push-pull 2A3 driver, and any two transmitters may be operated simultaneously.

The two receivers at the operating position are the Hallicrafters SX25 and 17. Above the receivers is a Hallicrafters HT-6 all-band transmitter and homemade battery receiver held in readiness for any possible emergency. A large oscilloscope is built into the wall above the operating position.

Separate antennas are provided for each transmitter. A Marconi is used on 1.8 Mc., a Zepp on 4 Mc. and 2-element rotaries on 14 and 29 Mc.

W9NLP was one of the outstanding performers in the Ohio River Valley flood in 1937.

W9SZW

WHEN he isn't busy yanking defective molars from the depths of a yawning patient, Dr. Philip Weintraub likes to try yanking signals from the depths of the loudspeaker plugged into his Hallicrafters SX17. The shack is located in a penthouse 110 feet above the ground, which W9SZW says helps a lot in working DX from Chicago.

To the right of the receiver is a table rack containing separate transmitters for the 56-, 28- and 1.8-Mc. bands. The 56- and 28-Mc. rigs each consist of 6J5G oscillator, 6L6 driver and a single 809 final operating at 35 to 40 watts input. The low-frequency transmitter has a push-pull T20 final driven by a 47 crystal oscillator and 59 buffer. Any of the finals may be modulated by the

59 Class-B modulator and speech amplifier over the receiver.

Dr. Weintraub not long ago had the unique experience of escaping death or serious injury only by the fact that he happened to have a small transmitter in operation in his office when he was confronted with a pair of gunmen bent on relieving him of his supply of dental gold. He was bound and gagged and thrown into an air-tight closet. It happened, however, that the 'phone rig was running at the time. The proceedings were picked up by several listeners who notified police who arrived in time to release him on the point of suffocation. It's small wonder that Doc says that ham radio is a great game!

SU1AM

THE photograph in the upper right-hand corner of the opposite page shows the latest transmitter at SU1AM, the station of H. H. Prince Abd El-Moneim at Heliopolis, Egypt. The receiving position is shown below. The transmitter is particularly interesting for although it looks like a manufactured job, it was designed and built from American-made components by SU1RO. It is designed for either 'phone or c.w. operation in any amateur band from 7 to 56 Mc. inclusive.

The lower row of dials in the left-hand unit are tuning controls for the exciter unit which consists of an 802 Tri-tet oscillator with 3.5-Mc. crystals, an 807 first doubler to 7 Mc. and an 807 second doubler to 14 Mc. Above this unit is a stage with a single 808 which may be coupled to the output of either doubler stage by a link line. This stage feeds the push-pull 808 amplifier in the top section of the right-hand unit. In shifting to 28, 14 or 7 Mc., coils in only the last two stages need changing.

For 56-Mc. output, the output of the second 807 doubler is fed into another 808 doubler in the lower section of the right-hand unit which drives a separate push-pull amplifier with 809's.

The lower portions of the two units contain power supplies for each stage, the Class-B 808 modulator and 6L6 driver.

On the operating table next to the ACR-175 receiver is a control box containing switches, key and microphone jacks and speech amplifier.

It will be recalled that SU1AM was the African link in the 1939 all-continent round-table contact which took place in the record-breaking time of one minute and fifty seconds.

ZL1MR

AS ENTHUSIASTIC a DX man as ever hit the key (and sneaked a few whispers into a mike when his friends weren't looking) is Ron Barnes, ZL1MR at Auckland, New Zealand. He's wearing that broad smile because he's just received his DXCC certificate of which there are only two others in all New Zealand.

(Continued on page 122)



OPERATING NEWS

F. E. HANDY, WIBDI, Communications Mgr.

E. L. BATTEY, WIUE, Asst. Communications Mgr.

Surveillance. It continues of the utmost importance to United States amateurs to see that every F.C.C. regulation for the amateur service is scrupulously observed. It will be recalled as reported in November *QST* that F.C.C. issued a definite warning to all amateurs to this effect. As the war involves more nations and areas or becomes a more bitter struggle, the neutrality responsibilities of radio amateurs are greater than ever.

Word reaches us that two amateurs were visited by F.C.C. inspectors recently when rumored that these amateurs were to engage in some one-way international transmissions. Both hams got a severe lecture because they had not signed their names in their log book, and received a definite warning about the impropriety of sending one-way transmissions requested of them by an off-the-air ham in a foreign country! These individuals came uncomfortably close to losing their licenses! While F.C.C. has hauled many a U. S. amateur on the carpet for answering b.c.l. fan letters by radio, etc., such a matter is much more serious now. Addressing remarks internationally as contemplated, whatever the intent, simply will not be condoned at this time. It invites heavy penalties on the amateur and restrictions for the whole amateur body. There must be none of it. A.R.R.L. Official Observers have had the matter called to their attention, so necessary self-policing is already in effect in addition to the government surveillance again revealed in the above.

Another tip: See that your log is signed, and is in every other respect complete as to every *CQ sent* (per Sec. 152.45 of regs.). The F.C.C. can and may shut you down just as completely for a violation of one's legal responsibilities on either if these points as for other things. Date and time of each transmission (call, test, or otherwise) must be logged, and following all contacts the signing-off-time must be entered. We have been amazed and somewhat shocked both in visiting amateurs and in checking logs sent us in connection with various activities to see how often logs show inadequacies, and to which F.C.C.-required message files are sloppily kept. It's time to heed warnings or to thank one's own self for possible F.C.C. trouble. Be familiar with and abide by all our F.C.C. regulations. Follow A.R.R.L.'s neutrality code and recommendations to avoid work with any unneutral, belligerent, or unauthorized stations. Do your part to see that there is absolutely no improper or irresponsible operation in any part of the amateur radio fraternity!

The 3rd U.H.F. Contest (Feb. 10th-11th) is dedicated to the interest of the high frequency operator and the development and occupancy of the u.h.f. regions. For those now submitting Marathon scores for January it's a chance to EXTEND the 1940 QSO list very definitely. For the chap who has been resting on laurels it's a fine opportunity to get a good START in the Marathon.

The 160-meter W.A.S. Party (Feb. 17th-18th) adds points and interest to the operation of the low frequency amateur operator this month. The January League-Member Party was a honey. Here we have its counterpart in another short activity of maximum simplicity in which every ham is invited to take part. There is no distinction between c.w. and 'phone. Either or both may be used. There are sure to be some requests to endorse W.A.S. tickets for "all on 160" after this event. We suggest in consideration of the other fellows desire, that all who originate written confirmations indicate the band on which contact was established (and the mode). Certificate endorsements are given on request, but only on what is shown by written evidence from the parties contacted.

About A.R.R.L.'s March DX Competition: Necessity is the mother of invention, it is said. Years ago we tortuously worked out MR^2/T (miles relays squared divided by time) as a formula for judging the relative excellence of multi-hop message relays across our continent. Now stern necessity (lack of DX) has forced us to devise a *W equivalent* equal to working 27 countries. This was something needed to balance what otherwise might prove a dull or at least unbalanced activity due to the curtailed number of legitimate foreign amateur stations. We are hopeful that the fixed quota of domestic DX which becomes part of the W scores has been happily chosen. Only experience with it will tell us if the empirically determined values are too small or too large. Comment from actual users who enter the fray will be required to make any future adjustments in scoring.

Let us express the fervent hope that the year to come will see some measure of restoration of international amateur activity so that radical operations on our time tested plans of activity will not be necessary, and a return to old time DX plans will be possible.

The DX contest rules are published one month before the contest, as usual, to reach all who can participate. The rules will not be repeated next

month. We have until March 15th to get our stations ready! For amateurs in other lands there will be no VE's to work this year. Since missing VE call areas will not help multipliers, we have changed the basis for the multiplier (to compensate) to the 48 states of the U.S.A. so that remotely located stations will have a direct W.A.S. opportunity as well as a greatly increased multiplier possible, in the coming affair. Information exchanged in all cases, will be limited to the signal report — QSO number, and the location. Comment and suggestions are invited from all participants with their reports.

— F. E. H.

ANNOUNCING NEW CONTEST:

SEND YOUR ARTICLE ON "MOST INTERESTING BAND"

The article by Anita Calcagni Bien, W8TAY, wins the C.D. article contest prize this month.

For the next several months we are inviting articles for the C.D. contest based on various individuals' ideas of "the most interesting frequency band." Practically every operating amateur has a "favorite" band, one that he would swear by to the bitter end. What is *your* favorite? Although more and more operators are using all bands, most of us feel that one of them stands out above the others as the ideal operating territory. Jonathan Eddy, W1LAU, Pleasant Valley, Conn., suggests that it would be interesting to give each ham an opportunity to tell just why he considers his "pet band" the absolute "tops." We invite contributions based on this very excellent idea.

Send in your article on why such-and-such-a-band is, in your opinion, the best available. Each month we will print the most interesting and valuable article received on this subject. Please mark your contributions "for the C.D. contest." Prize winners may select a 1940 bound *Handbook*, *QST* Binder and League Emblem, six logs, eight pads radiogram blanks, DX Map and three pads, or any other combination of A.R.E.L. supplies of equivalent value. Try your luck. Send your contribution to-day!

How NOT To Operate

BY ANITA CALCAGNI BIEN,
W8TAY*

AFTER reading the helpful, inspiring article by Carl C. Drumeller, W9EHC, in November *QST*, I decided to do a bit of concentrated listening on the Ham Bands and more than infrequently my ears were assailed with the following:

"Sorry K ---, but I didn't hear a word you said on the last part of your transmission as some darned YL was yapping away at some galoot." (The so-called "YL" was K ---'s XYL who had been doing an excellent job of trying to make an impression on the apologetic and crestfallen W8.) That Op really belongs in the diplomatic corps. . . . "Man, oh Man, but you're in a hot spot. If you have another xtal., suggest you dust it off and use it." (That came from the real "co-operative" spirit. The idea of retaining the frequency for oneself is sound, but it is better to keep the other fellow worried even if you aren't honest enough to admit you can't hear another heterodyne

*Y.L.R.L., 1062 E. 78th St., Cleveland, Ohio.

within 20 kc. He MAY take the hint and move.) . . . The fertile brained individual who thought he was a burlesque M.C. "Hope to see more of you also in the future, Ardetha. Hi! Jack (Ardetha's hubby), guess you know it's all in fun. Ha, ha." . . . "QSB on your sig. You took a dive several times and we missed most of that." (Why admit it was pure inattention that made him miss the comments emanating from the other end? It was background QRM of the visitors that kept him better interested. After all, he has shown them that the rig can perform.)

The late ham who made certain in every QSO that the boys all knew he wasn't a young tyro — No Siree! (He was in radio when Hector was a pup and he is the guy that discovered "Center Tapped Inductance" and suggested to DeForest certain tube properties, etc. Oh, yeah!) . . . "Sorry, Old Man, but there is something wrong with my heat oscillator, so will have to sign off." (The Fone man who has lost his CW ability — or never had much of it — and ashamed to admit it to the CW station who finally raised said F.M. --- Maybe someone called Fone Man up on telephone.) . . . The op who was making sugary comments about W --- since he happened to be on W ---'s frequency and W --- is an "observer." (You never can tell. Hi.) . . . The crusading ham who forgot he was just removed from the B/L ranks of another band and was waging verbal warfare with present B/L's QRMing his frequency. (Also heard Ex-B/L receive compliments on his code ability despite his "newness" to the band. Who said it pays to wait until you get your ticket?) . . . The ham who asked for a candid report and then pronto insulted the other's receiver and intelligence when criticism received was adverse to his liking.

The grateful "friend" ham No. 1, who was hedging and making up excuses to avoid doing a favor for No. 2 ham after No. 2 had spent 4½ hours one Sunday P.M. to help No. 1 put up an array in a blizzard. (Sunny days are for golf and taking YL's for drives, but wifey hasn't forgot you left the dishes to be wiped and she missed the show that afternoon, and it was a picture she had waited 6 months to see.) . . . The fellow op who dreams of KW rigs and big DX and then in QSO neglected to tell the boys he was still living in a world of dreams when he proceeded to outline his rig, power, receiver, etc. (He'll always give the boys on the air a treatise on cathode modulation, etc., yet he avoids sitting near you in ham gatherings for fear his ego will be sorely deflated, since he couldn't answer by reading out of the *Handbook*.) . . . The retortor who invariably opened up with "100% OM . . . all but the handle and the report and would you mind repeating the QTH again . . . believe it is BLABLAHVILLE," (100%!) . . . The ham who called "CQ" on 75 and rebroadcast it on 160 and then carried on his QSO with a DX station for the edification of his local pals on 160 while they frantically sought same DX. (Sooo, that's how he works 'em!) . . . Another upright member of the ham gang would always get a YL to call CQ as bait and then would not even let the poor gal tell her name or telephone number to the duped individual who came back. (Those QSO's were quickly terminated and the boys no doubt put a black ring around his call.)

Those who ate, ranted, snorted and yawned into the mike. "Ho-hum — what'll we talk about?" (This is a most effective method of bolstering BGL opinion of hams. It will take more than several earthquakes and floods and the combined efforts of all the conscientious hams to counteract this stigmatization. If they didn't have anything to talk about, why block the receiver of some poor romantic housewife when her pet soapuds orator is making an appeal to his ladylove?) . . . The fellow who got so enmeshed in his own verbiage that he neglected to answer pertinent questions but always demanded answers to his own, however personal. (He is usually the same person who talks and talks after you've definitely and emphatically stated you MUST run along. He'll even neglect to sandwich in his station's call to keep up with rules and regulations. They were only made to be broken anyway.) . . . The "fast" code man behind the mike who was being ribbed when he stated he copies all the news reports "SOLID" — 35 wpm — yet failed to recognize his own call at 18 or maybe 13 w.p.m. . . . The Romeo who was always

making a sked with a brother ham when he heard there was a sister, cousin or something wearing skirts in the shack. (Usually she proved to be lop-eared or bow-legged, but then — there's always that chance of "One in a Million," so he would QRT and get galvanized into action, purportedly to see brother ham's rig.)

Last but not least was the self-appointed "Major Dummo" who was always attempting to marshal into line everyone's carrier on the frequency he was working. What right have others to his channel, hence the resultant derogatory comments about anyone operating in close proximity who is too smart to be ensnared. What's the difference whether or not anyone called wanted to get into a round table? The individuals so inveigled were led to believe it was they with whom the M.D. wished to QSO. Soon they found they were kept dangling on the hook for a lengthy space of time, impatiently awaiting their reports and turn to sign off, while "Major Dummo" as customarily (IT'S A HABIT) searches the band for more bait, missing most of the comments of others but QRMing transmissions in the round table in his efforts to get DX lined up. He'll send all a card anyway and give them an S-9 plussety plus report, and some of the boys will feel duty-bound to reciprocate. (Maybe their receivers were on the frits that day. It's a thought.) After all, some states ARE hard to contact, so what the heck.

Ninety-nine per cent of the amateur operators and SWL's prefer not to listen to the "poisonality" ham but keep tuned (either for prospective QSO or for a pleasant eavesdrop) to the frequency of the operators who merit the bigger and better orchid award, while the remaining 1% (?) wonder why no one seemingly hears their calls. Funny, they just worked a guy about the same distance away. Very funny.

BRIEFS

A joint meeting of the Michigan Emergency Net and the QMN Net (Mich. traffic net) was held December 17th at the Barracks of the State Police at East Lansing, for the purpose of coordination between the State Police and the two nets.

On December 11, 1939, the Society of Amateur Radio Operators, Inc., elected new officers for 1940. Norton De Wolfe, W6CBX, was unanimously elected to the office of President. W6AEX is the new Vice-President; W6IMA, Communications Manager; W6QVI, Secretary; W6OKQ, Treasurer. President De Wolfe appointed W6GPY and W6ZF to the Board of Directors to complete the Directorship. W6ZF also was given the duties of Publicity Manager. After the election, much interest was voiced in the coming A.R.R.L. Field Day in June. Committees have been formed to study all preparations and to work in close cooperation with C.M. W6IMA. It was decided a group of men in a committee would be responsible for each band used, equipment, power supplies, logs, etc. To make certain all preparations for the June F.D. would be successful, it was resolved

to participate in a Society Field Day in April. This is to ascertain all the pitfalls in equipment, power supplies, antennas, locations, and general tactics in communication. — W6ZF.

U.h.f. note: W9VHG and W9ZJB are asking help in getting a relay route organized from Kansas City to Chicago and Glenview, Ill. "Dud" at W9VHG writes, "The dead spot is from Kirkwood, Mo., to Peoria, Ill. Vince is lined up from Topeka to Kirkwood, and this end from Peoria to Glenview is pretty well established." How about some u.h.f. station operators at intermediate points getting in touch with VHG or ZJB at once to aid in extending the relay routes February 10th-11th?

SOM Feldhausen, W6MDI, had a thrilling experience during the "SS." He was busy in this activity and tuning "90" when he intercepted an appeal on 3615 kc. for immediate assistance for the State Game and Fishing Commission survey vessel *Bluefin*, which was in a sinking condition off Coronado at 3:37 A.M., November 12th. He immediately worked W6QNK at Salinas, who phoned the Coast Guard station at Monterey. The sinking and rescue of the *Bluefin* was reported in the papers a day or two later.

"I once had an experience which I have never told because I wouldn't have believed it myself, and since I was new on the air at that time, and anxious to have a good reputation. I'll tell it now as it might give someone else the courage to relate a similar experience. During my first winter on the air I was enthusiastic enough to set my alarm for the middle of the night to get up and work some DX. About three o'clock one morning I hooked a station in New England. He said that a blizzard was in progress. A strong wind from the NE seemed to be increasing as his sigs were getting stronger. They began blocking my receiver, and had to take off the antenna to read him. That did no good, so I asked him to take off his antenna from the transmitter, which he did, and I still received him like a local. He turned off the buffer and final and keyed the oscillator, but still came in S9 — on my two-tube blooper with no antenna. Unbelievable as it seems, our theory was that the wind was blowing his sigs across country. I noticed the room getting very cold in spite of the heater going full blast. I got up and put on an overcoat. When I picked the cans up again they were too cold to keep on. I began to hear a peculiar rattle in the fones, and just then little white stones began to pop out. They were in two sizes and in combinations as in code. Small ones dots, large ones dashes. It had become so cold back East and the wind so strong that sigs were freezing and being blown out here. When they piled up to my knees I decided to sign off and start digging out." (P.S. Don't believe everything you hear!)

— W6BPP, in the "Tattler,"
The Bell Club (Calif.)

The W9LDH "Sweepstakes Special" QSL

On November 30, 1939, the Muskegon (Mich.) Area Amateur Radio Club placed on exhibit at the local Hobby Show an operative 1.75-Mc. 'phone station, the property of W8ODM. This station was in operation for three nights, during which time 95 messages were originated and relayed. Also on display were several pieces of equipment belonging to various club members. Much interest was shown in the exhibit by the public. Among the amateurs taking part were W8ODM, W8NZU, W8DAQ, W8TBP, W8GSC, W8BBH, W8TWN and W8SAY.

On the night of December 9, 1939, W8PLA started a roundtable with W6MUC and W9JUO. It ended up with the addition of W1HSW, W2LCB, W4DIJ, W5EGP and W7FIJ/7; all districts but the third.

A bit of real low power work is reported by W2GVX, operating portable in Maine. He was in contact with W8RCQ on 14 Mc. while RCQ was using 1 watt input to a 6L6 (7-Mc. crystal, 14-Mc. plate coil, 135 volts on plate). Signals were S6. RCQ dropped the voltage to 22 (S5) and finally to 9 volts, the lowest at which the crystal would oscillate. Signals were then S3-4.

Byron Crowell, W9WLT, set up his 250 watt 14-Mc. 'phone at the grounds of the Southern Iowa Fair and Exposition held at Oskaloosa from September 2 to 7, 1939. The purpose was to educate Johnny Q. BCL as to the merits of amateur activities. Approximately 30,000 persons visited the ham exhibit; 150 contacts were made in 27 states, 7 Canadian provinces, 6 countries and 4 continents. Many contacts were fed into the public address system serving a large portion of the Exposition grounds. The outstanding feature of the five-days' operation was a round table between W8USA, W9WLT and W2USA on September 4th. The three fairs exchanged official greetings. OM Crowell did all the operating at W9WLT, and extends thanks to all the hams worked who cooperated in putting over a good demonstration of amateur radio.

The Wisconsin Valley Radio Association, Inc. (Wausau, Wis.) is sponsor of a Wisconsin Valley Net on 3775 kc., the frequency used by the Wisconsin State Net. Drill periods are Tuesday evenings at 6:00 o'clock CST. The purpose of the net is to provide amateurs in the Wisconsin Valley with a communications system which will tie in with existing A.R.R.L. and A.A.R.S. networks. Emphasis is placed on emergency preparedness. The area embraced consists of the following counties: Ontonagon and Gobeble in Michigan, and Ashland, Iron, Vilas, Oneida, Price, Taylor, Lincoln, Langlade, Clark, Marathon, Shawano, Wood, Portage, Sawyer and Waupaca in Wisconsin. Amateurs in this area are invited to get in touch with Walter Kerswill, W9LED, 221 Fourth Ave., N., Wausau, Wis., for further information.

The Seventh Annual Hamfest of the Fox River Valley Affiliated Radio Clubs was held at Round Lake, Wis., on June 25, 1939. There were 247 in attendance, representing 43 communities in the area. The hamfest was jointly sponsored by the Fond du Lac Amateur Radio Club, Two Rivers Radio Amateurs and Sheboygan Radio Amateur Club.

On September 6, 1939, W6PKN, San Francisco, handled an urgent message regarding flood conditions for W6NIZ, Earp, Calif. The message, destined for Denver, was put on W.U. wires by W6PKN. With all 'phones and roads out in the area, W6NIZ was transmitting important information regarding local reservoir, which was in danger of spilling over.

W5GUU reports an active Mississippi Army Amateur Emergency Network operating on 1925-kc. 'phone each Tuesday from 7:00 to 8:00 p.m. CST. W5GPR, at Greenville is the control station. There are 17 stations signed up at present and more are coming in all the time. The Louisiana Army Amateur Emergency Net, with W5BQD as control, starts operations at 8:00 p.m., following the close of the Mississippi Net. The cooperation of non-net-stations in avoiding QRM on 1925 kc. during the hours these nets operate will be appreciated by all members.

O.B.S.

The following is a supplement to the list of A.R.R.L. Official Broadcasting Stations in October QST (page 76): W3ATF, W3HAZ, W5AZB, W8JRL, W9ERV, W9FWN, W9GMB, W9HIC, W9RGK, W9WVQ.

Brass Pounders' League

(November 16th-December 15th)

| Call | Orig. | Del. | Rel. | Extra Del. Credit | Total |
|-------|-------|------|------|-------------------|-------|
| W3EML | 73 | 178 | 1182 | 155 | 1588 |
| W9YXH | 59 | 111 | 1102 | 51 | 1323 |
| W8GZ | 15 | 21 | 1170 | 15 | 1221 |
| W5FDR | 263 | 204 | 486 | 180 | 1133 |
| W2SC | 47 | 276 | 525 | 276 | 1124 |
| W3CIZ | 32 | 94 | 858 | 89 | 1073 |
| W5MN | 25 | 106 | 820 | 84 | 1035 |
| W6IOX | 16 | 45 | 890 | 40 | 991 |
| W6DH | 31 | 121 | 761 | 71 | 984 |
| W6PGB | 67 | 59 | 759 | 58 | 943 |
| W4IR | 24 | 76 | 760 | 46 | 906 |
| W6RBQ | 29 | 67 | 687 | 67 | 850 |
| W5CEZ | 56 | 116 | 652 | 14 | 838 |
| W9NFL | 27 | 20 | 778 | 11 | 836 |
| W4FCU | 37 | 21 | 757 | 18 | 833 |
| W7EBQ | 17 | 60 | 706 | 40 | 823 |
| W9ILH | 11 | 26 | 752 | 14 | 803 |
| W9QIL | 322 | 58 | 380 | 43 | 803 |
| W3HRS | 19 | 104 | 480 | 104 | 707 |
| W2HMJ | 26 | 48 | 626 | 4 | 704 |
| W8BJO | 0 | 0 | 703 | 0 | 703 |
| W1LWH | 27 | 52 | 525 | 6 | 610 |
| W6PCP | 160 | 158 | 127 | 150 | 595 |
| W9EKQ | 8 | 15 | 556 | 9 | 588 |
| W4CXV | 40 | 38 | 460 | 29 | 567 |
| W6IMI | 33 | 156 | 227 | 138 | 554 |
| W1INU | 77 | 88 | 356 | 0 | 521 |
| W6LUJ | 72 | 193 | 58 | 191 | 514 |
| W3GJY | 32 | 18 | 442 | 18 | 510 |
| W9QXO | 86 | 17 | 394 | 12 | 509 |
| W2GVZ | 59 | 100 | 275 | 68 | 502 |

MORE-THAN-ONE-OPERATOR STATIONS

| Call | Orig. | Del. | Rel. | Extra Del. Credit | Total |
|---------|-------|------|------|-------------------|-------|
| KAIHR * | 795 | 574 | 800 | 573 | 2742 |
| KAIHR | 854 | 525 | 690 | 486 | 2555 |
| W5OW | 284 | 227 | 1380 | 129 | 2020 |
| KAIHQ | 527 | 240 | 686 | 234 | 1687 |
| W3BWT | 33 | 82 | 725 | 75 | 915 |
| W5OW | 60 | 118 | 351 | 113 | 642 |
| W9BNT | 27 | 84 | 415 | 20 | 546 |
| W3CXL | 7 | 19 | 505 | 2 | 533 |

These stations "make" the B.P.L. with total of 500 or over. One hundred deliveries + Ex. Del. Credits also rate B.P.L. standing. The following one-operator stations make the B.P.L. on deliveries. Deliveries count.

| | | |
|--------------|--------------|--------------|
| W2IOP, 300 | W8ASW, 155 | W2KI, 122 |
| W9GMT, 258 | W6NRP, 153 | W1KIN, 117 |
| W9ESA, 245 | W9UN, 151 | W5CVQ, 112 |
| W9ESA, * 244 | W3HRS, * 146 | W6HSA, * 104 |
| W6MQM, 237 | W6EJA, 140 | W6OQH, 104 |
| W2ITX, 204 | W8KWA, 137 | W1KZT, * 103 |
| W8IHR, 197 | W6NLL, 133 | W6EWB, 103 |
| W1FFL, 185 | W5GFT, 132 | W1JCK, 101 |
| W7APS, 172 | W1KCT, 126 | |

A.A.R.S.

MORE-THAN-ONE-OPERATOR STATION

| Call | Orig. | Del. | Rel. | Extra Del. Credit | Total |
|-------------|-------|------|------|-------------------|-------|
| WLM (W3CXL) | 197 | 198 | 3994 | 91 | 4480 |

A total of 500 or more or 100 deliveries Ex. D. Cr. will put you in line for a place in the B.P.L.

* October-November.

Code Practice

Add the following to January QST list (page 76) of amateur stations transmitting code practice:

| Station | Frequency | Days | Hours |
|---------|---------------------|----------------|--------------------|
| W2MOY | New York 1813 kc. | Mon. & Wed. | 5:00-6:00 P.M. EST |
| | | Tues. & Thurs. | 3:00-4:00 P.M. EST |
| W6BEZ | California 1850 kc. | Wed. & Fri. | 9:00 P.M. PST |

How's DX?

HOW:

CONDITIONS and certain other factors (which we can't mention by name on account of our strict neutrality) are getting together to make it very difficult for Jeeves' faithful master to put together a decent column. Those certain other factors are something we haven't much say in, but conditions are something we've been expecting to take a dive. Unless we're completely wrong, in a few years the gang will be looking back to the banner years of '36, '37, '38 and '39 as vintage DX years on 20. This doesn't mean that conditions will be so poor that it will be impossible to work DX — it simply means that a little more time and work will be required. Further, it means that 40 should come back into its own as a DX band, if we can wrest it away from the runway-bug merchants.

Some fellows have written in asking if it's OK to send cards to some of the gang in the belligerents whom they owe cards to, as suggested last month. We see no reason why anyone shouldn't send cards — if they aren't delivered, they aren't delivered, but it's certainly worth the effort to keep up some of our foreign friendships.

On the other hand, maybe we're overly pessimistic about this DX stuff. You won't believe it (and we don't either) but it was in a newspaper so it must be true. The Minneapolis Times-Tribune for December 25, 1939, carries a photo of W9VXZ being operated by a Mr. Thomas J. Casey, with several friends standing around admiring the proceedings (as well they might). Speaking of the Christmas Eve exploits of the station and how greetings were exchanged with foreign hams, the caption says, "Earlier in the morning and during the night Casey had exchanged greetings with VK3LA in Melbourne, Australia; J2NF, Tokyo, Japan; ZSSM, Natal, South Africa, and GM8CN, Peeblesshire, Scotland." This column has recorded low-power, and even no-power, records, but this is the first time we've had the honor of recording a near WAC with three of the stations non-existent. Live and learn, we always say.

WHERE:

THIS chap TA1AA presents us with a bit of a mystery. Just after we'd smugly tagged him a phoney, cards start coming through from the guy via ON4HS, who says TA1AA was quite OK and that cards can be forwarded via ON4HS. So we eat humble pie, but with salt on it. The further dope is that TA1AA is now in Syria signing AR8AZ

... W4BMH tells us about **EEQ1** (7260 T8) who says he is in Barcelona and to QSL via EA3CI ... W8JSU received a letter from CNSAS who says that French Soudan has been given the separate prefix of F88. There is a fellow there who was on, 3.5 Mc. mostly, but after the war he may be active on some of the other bands ... There is still the controversy about AC4JS and whether or not he is in Tibet. Latest dope is that **XUSMI** (14,400) asked **AC4JS** (14,400 T9) why he used AC4 when he is really in Kansu Province in China, and JS answered that all the natives there were Tibetans. That's a reason, but not a very good one ... W2BHW scared up **EA9CM** (14,400 T9) and **PK5JT** (14,300), who gave his address as care of Radio Station, Balikpapan, Papan, Dutch Borneo. PK4KS checks that address ... More controversy is dragged up over **LX1SS** (14,320 T9). LX1AB, the LX QSL Manager, writes to say that all LX amateurs have been closed down, and that any LX stations on the air are foreign pirates. On the other hand, LX1SS has come through with cards and can be QSL'd via W1FRU. You pays yer money and you takes your chance.

WHEN:

THERE won't be much 80-meter DX this season, for a very good reason, but W2DW scared up **CM6AC** (3695 T4) for the only DX reported on that band.

The 7-Mc. followers are in hot and heavy, and report stuff that compares with anything the 20 gang can produce ... W2VG worked **EA9CM** (7050 T8), and W9CWW got **HA4H** (7020), **HA5D** (7030), **HA8C** (7160), **J3FJ** (7100) and **YS2LR** (7005) ... W6OAN adds **ZPIAB** (7100 T7), **LU8DM** (7045 T9), **K4DTH** (7020 T9) and **VE7AC** (7010 T7) who claims to be at Baffin Island ... W9ZDS mentions **K6QIU** (7170), **K6PKH** (7190) and **K6QMC** (7225) in passing ... W2BHW worked **KAIHR** on 40 and has been trying to click with **XUSMI** (7150), but no go. Lindy has heard the XU, but can't seem to break through the noise over there.

Both W4MR and W8JIW nominate, for the rarest thing in ham radio, a c.w. signal on 28-Mc. Mebbeeso, which makes **HC1VT** (28,040), **LU9AX** (28,080) and **OQ5AB** (28,300) very rare indeed.

This month's is the leanest pickings we've ever seen on 20, and we hate to have to share our disappointment with
(Continued on next left-hand page)



The very well-known 28-Mc. phone station of Kenneth Bryan, K6M V V, at Waiialua, Oahu, T. H. The input is less than 100 watts to the pair of 801's in the final, but the signal always sounds like about ten times that much.

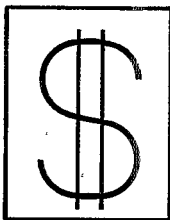

FROM time to time we have shown pictures of amateur stations on our cover page in *QST*. Many of these were from stations that we had visited, others from photos that our good friends had sent us. As you may have guessed, some of these were assembled as models for the photographer. This was all right as far as it went, but we should like to go further. We want still more pictures of real stations, showing how National equipment helps to make a good rig better, and we want a story to go with them. It seems to us that the best way to get this material is to ask the readers of *QST* for it, and to make it worth their while we have decided to offer prizes and other inducements.

Many radio amateurs are also skillful amateur photographers. We know because we've had examples of their skill. However, we are not counting on this, because taking a picture of this sort, suitable for reproduction, does offer some difficulty. Consequently, we plan to have an artist make a drawing of each picture that we use. After all, this competition is for radio men, not photographers.

We want pictures of all sorts of stations. Flea-power breadboard affairs are just as interesting as one kilowatt commercial-looking jobs, provided they are well thought out and well built. (The judges probably will not give a prize for anything that looks like a mouse's nest.) Pictures of portables will be well received, particularly if set up "on location." In short, we have no preference for any particular kind of rig, — with one exception. Extra consideration will be given wherever thought and effort has been spent to make the station *safe*.

To go with each picture, we should like a brief description which we can publish. This should include whatever details you think would be of interest to another amateur. If you have been successful in sweepstakes or DX Contests, or have done some good emergency operating, tell about it, of course. But if you specialize in traffic handling, or experimenting or just rag chewing, don't think it is not interesting. We want to know what sort of work you do with your National equipment, and what results you get.

So far we have talked only about what we get out of the contest. This is what you get: first of all, there is a first prize of one hundred dollars, a second prize of fifty dollars, and five prizes of ten dollars each, all cash money. Second, to each contestant whose material we use, though he may not win a cash prize, we will send a thousand QSL cards, printed in two colors with a picture of his station on them, reproduced from the original drawing. With the cards, we will send the plates from which they were printed.

There are not many rules. The contest is open to any amateur except our own employees. The contest closes July 1, 1940. No pictures or other material will be returned. Pictures must be at least 4 x 5 inches in size (you can have small negatives enlarged inexpensively). We reserve the right to make changes in the wording of the description you send in, though for the most part we plan to use it as is. The judges' decision as to prizes is final, of course. Oh, yes, about the judges — an impartial tribunal not connected with National in any way and not participants in the contest will act as judges. (We are not sticking out *our* necks.)

W. A. READY



Knights in armor all looked tough

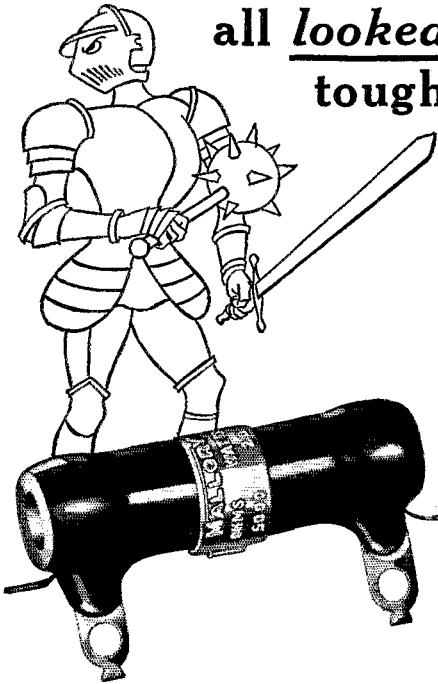

In ye olden days, knights in armor all looked tough. Their appearance in boiler plate suits depended on the skill and artistry of the blacksmith. But beneath these coverings of steel, fought the knight that rescued the fair lady, and the blackguard who plotted the downfall of a throne.

What is the connection with Mollory Vitreous Resistors? These resistors are the great armored knights of radio. Their resplendent glossy blue coats indicate superior appearance and inner true quality. Their gleaming exterior proclaims care and precision workmanship. Underneath the tough non-corrosive protective coating is a resistance element that is accurate and durable, and gives finer performance. For appearance and for dependability, experienced radio engineers depend on Mollory Vitreous Resistors, because the use of these resistors stamps apparatus with the hall-mark of quality and discriminating engineering. Do not have blackguards in your rig—demand Mollory Vitreous Resistors.

There is a Mollory Vitreous Enameled or Truvolt Resistor for every transmitting application. See them at your Mollory-Yaxley Distributors.

P. R. MALLORY & CO., Inc.
INDIANAPOLIS INDIANA
Cable Address—PELMALLO

Use

P. R. MALLORY & CO. Inc.
MALLORY
APPROVED RADIO
PRECISION PRODUCTS

Use

YAXLEY
APPROVED RADIO
PRECISION PRODUCTS

you but, as Ling Po (or was it Confucius?) said, "Ham doesn't find DX when no DX to find, unless ham get picture in newspaper." (See *How's DX?*, February, 1940, Part I, paragraph 3.) W4EPT scared up EA7AV (14,400 T8), CX2AJ (14,400 T6), and OX1CX (14,400 T9), while W6MUS comes through with UK6KA (14,375 T6), IIR (14,400 T9), H8SD (14,400 T7), HA4H (14,400 T9), U6KY (14,400 T6), J8CG (14,400 T9) and UK9AN (14,400 T5) W9CWW is back, this time with XU7A (14,365), US1B (14,400), and KB6RWZ (14,360), and W8JIW adds KAILB (14,260), IINZ (14,400), OQ5AB (14,280) and OQ5IM (14,370) W8QVF has a few frequencies — some of them look like they go back a few months, but we'll list them just in case: XUOA (14,400 T8), XUORK (14,360 T9), XU6K (14,250 T9), XUSWS (14,400 T9), J2KN (14,400 T9), J2OV (14,400 T9), J3FJ (14,400 T9), J3FZ (14,400 T9), J8CH (14,360 T9), KAIMN (14,380 T9), KAIJK (14,325 T9), PK1TM (14,365 T9), PK1XZ (14,370 T9), EA5A (14,400 T4), U9BC (14,400 T9), U6ST (14,400 T8) and U9ML (14,400 T9).

'PHONE:

There's even less on 'phone than there is on c.w., and the only report we have is from W6ITH, who lists PY2AK (28,270), HH2PO (28,300), KAILZ (28,255), XUSAM (28,245) and K7GTP (28,520).

WHO:

If you worked HA7YL and didn't get a card, W2EQS will be glad to forward yours to her. Yes, she's a YL and definitely on the photogenic side, from the picture we saw of her J2MH (14,400 T7) needs Maine for WAS, K6Q YI could use Maine, Delaware and Wyoming

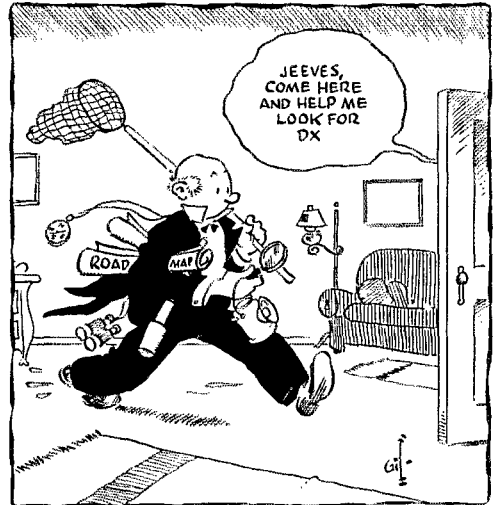

JEEVES

for the same reason, and all HXSD (7090 T7) needs is Idaho W2JB deserves a lot of credit for his WAC and 69 countries from an S7 noise level QTH — one block off Broadway Received a nice Christmas card from ex-OE1FH, apparently established in Australia now VP1BA, G8KP and V87RA write in to say that they have answered all pending QSL's, but will be glad to send another to anyone whose got lost G8KP needs cards from the fellows he worked in Utah, Idaho and North Dakota to complete his WAS The Bridgeport, Conn., gang (W1APA, W1ACV and cronies) is planning another DX Round-Up, for February 24th. We hope they have better luck filling their meeting place than we've had filling the column this month "Yes, Jeeves, I know I promised you a vacation, but some DX might come through. After all, W9VXZ seems to work it."

— W1JPE

Commercial performance!

SERIES

"200"

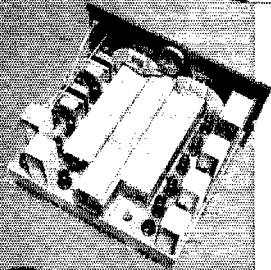

**SUPER
PRO**

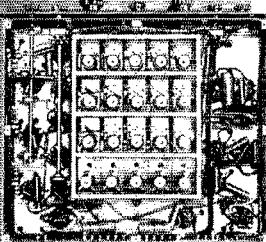

THE "Super-Pro" has, for years, been widely used in commercial services where performance must be "tops" and unvarying from day to day. Every "Super-Pro" is built for continuous duty, maximum stability, and high sensitivity with a minimum of background noise. That is why professional operators prefer "Super-Pro" receivers. The new "Series 200" Super-Pro with its improved noise limiter, adjustable "S" meter, and variable selectivity crystal filter has set a new high in receiver performance. Other important features include two R.F. stages, three variable selectivity I.F. stages, etc., all described in detail in a 16-page technical bulletin available on request at your dealer's or direct from factory.

**MAIL
COUPON
TODAY!**

Canadian Office:
41 West Ave., No.,
Hamilton, Ont.

Hammarlund Mfg. Co., Inc.
424 West 33d St., N. Y. City

Q-2

Please send new "Super-Pro" booklet.

Name.....

Address.....

City.....State.....

HAMMARLUND

29 RANGES including
3000 VOLTS AC-DC

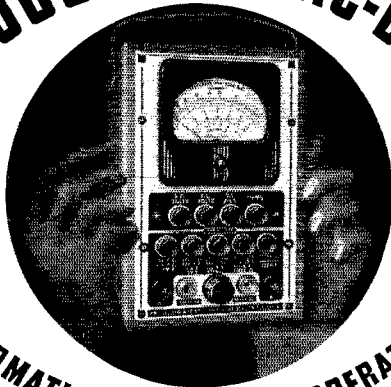

AUTOMATIC PUSH-BUTTON OPERATION

The popular "PRECISION"
Series 870 MULTI-RANGE TESTER

offers a simplified method of complete push-button circuit and range selection, making available ALL AC and DC MEASUREMENTS, except the 3000 volt AC-DC range, from ONLY TWO polarized tip jacks.

FEATURES

- * 29 RANGES . . . COMPACT
- * D.C. VOLTAGE RANGES at 1000 ohms per volt: 0 to 6/30/300/600/1200 and 3000 v.
- * A.C. VOLTAGE RANGES at 500 ohms per volt: 0-12/60/600/1200 and 3000 volts.
- * D.C. CURRENT RANGES: 0-1.2/12/120/600/1200 milliamperes.
- * RESISTANCE RANGES: 0-5000 ohms (20 ohms at center of scale) 0-500,000 ohms (powered by self contained battery) 0-5 meg-ohms (powered by external battery).
- * DECIBEL RANGES: -10 to +64 DB. ODB (-10 to +16 DB) +14 DB (+4 to +30 DB) +34 DB (+24 to +50 DB) +40 DB (+30 to +56 DB) +48 DB (+38 to +64 DB).
- * OUTPUT METER INDICATIONS on Five A.C. voltage ranges: 0 to 12/60/600/1200 and 3000 v. AC.
- * D.C. CURRENT MEASUREMENTS OF LEAKAGE IN ELECTROLYTIC CONDENSERS.
- * QUALITATIVE PAPER CONDENSER TESTS.
- * LARGE SIZE 3 INCH D'ARSONVAL TYPE METER.
- * WIRE WOUND SHUNTS 1% ACCURACY.
- * MATCHED METALIZED MULTIPLIERS 1% ACCURACY.

Net Price, complete with 3 v. battery \$17.95

More than 40 models in the PRECISION 1940 LINE . . . 15 Mutual Conductance Tube Tester and Set Tester models ranging in price from as low as \$29.95 . . . 16 Multi-Range Tester models from as low as \$10.95 . . . Signal Generators from \$24.95, etc. . . . See them at your local distributor. . . .

Ask for the PRECISION TEST EQUIPMENT 1940 CATALOG

PRECISION TEST EQUIPMENT
Standard of Accuracy SEE THEM AT YOUR JOBBERS

PRECISION APPARATUS COMPANY
647 Kent Avenue Brooklyn, New York

Export Division: 458 Broadway, New York City, U. S. A.
Cable Address: Morhanex

MEMBERS, DX CENTURY CLUB

| | | |
|---------------------|---------------------|----------------------|
| W5GRL 147 | G5BD 115 | F8RR 104 |
| W2GT 146 | W9KA 114 | W3BEN 104 |
| W8CRA 145 | G5RV 114 | W1GDY 104 |
| G6WY 145 | W8BKP 114 | W1GCX 104 |
| W2GW 143 | W1WV 114 | W2BMX 104 |
| W2GTZ 142 | W2DC 114 | W8LFE 104 |
| W1TW 141 | G2DH 114 | G6KPK 103 |
| G2ZQ 141 | G5BY 114 | W8KKG 103 |
| W6KIP 140 | W2CJM 113 | J2JJ 103 |
| W9TJ 140 | W4DRD 113 | W5CUJ 103 |
| W8DFH 139 | W2DSB 113 | W3KT 103 |
| W1SZ 137 | W3BES 113 | W1ZI 103 |
| ON4AU 137 | W8MTY 113 | W8DOD 103 |
| W3EMM 136 | W2GRG 113 | W9NNZ 103 |
| W6CKW 135 | G6CL 112 | W2GNQ 103 |
| W1TS 134 | W6GAL 112 | W4IO 103 |
| W1LZ 133 | W3EVT 112 | W3AGV 103 |
| W5VV 133 | W3GAU 112 | W3GEH 103 |
| G6RH 132 | W1ADM 112 | W4CXY 102 |
| W8BTI 132 | W8QXT 112 | W8AU 102 |
| W4BPD 132 | W6FZL 111 | W8OKO 102 |
| W8DHC 131 | W2AAL 111 | W1FTR 102 |
| W2BHW 131 | W1DUK 111 | VE2EE 102 |
| W5BB 130 | VE2AX 111 | W2BXA 102 |
| W3CHE 130 | ON4UU 110 | W1GNE 102 |
| HB9J 129 | PA0XF 110 | W8BVD 102 |
| W8OSL 129 | W9UM 110 | W2ZZ 102 |
| W2CMY 129 | W2AER 110 | L8UBN 102 |
| W8ADG 128 | W8IWI 110 | F8RJ 101 |
| W1FH 128 | W5QL 110 | VK3KX 101 |
| W3EVP 128 | W2IYO 110 | W6DOB 101 |
| W80QF 127 | W3DDM 109 | SU1WM 101 |
| W9KG 126 | W6FZY 109 | W8EUY 101 |
| W2UK 126 | W3FQP 109 | W1CC 101 |
| W2HHF 126 | W6HX 108 | SU1SG 101 |
| W9ARL 125 | ZS2X 108 | G5MK 101 |
| W2ZA 125 | HB9BG 108 | W4MR 101 |
| W1DF 124 | HB9CE 108 | W6GHU 101 |
| W2JT 124 | VK3QK 108 | W8BAM 101 |
| W8DWW 123 | W2CBO 107 | W8HWG 101 |
| W8LEC 123 | G5BJ 107 | W6KWA 101 |
| W4CEN 123 | VK2DG 107 | W8JAH 101 |
| D4AFF 123 | VE3QD 107 | W1RY 101 |
| W8NJP 122 | W7DL 107 | W4EQK 101 |
| W9TB 122 | W6MVK 107 | VK6SA 101 |
| W3EDP 121 | W1BXC 107 | W9VDY 101 |
| W5KC 121 | W1IAS 107 | L7UAZ 101 |
| W8JMP 120 | W6AHZ 107 | G6NF 100 |
| J5CC 120 | G2TR 106 | W6KRI 100 |
| W2GVZ 120 | W1CH 106 | W9UQT 100 |
| W3FRY 120 | W3AG 106 | VK2ADE 100 |
| W9GDH 119 | W6TJ 106 | ZL1GX 100 |
| W1JPE 119 | W1BGY 106 | HB9X 100 |
| W1BUX 118 | G2MI 106 | W9RCQ 100 |
| ZL1HY 118 | W2VY 106 | ZL1MR 100 |
| W9ADN 118 | W2OA 105 | PA0QF 100 |
| W9FS 118 | G5QY 105 | W8BSP 100 |
| W7AMX 117 | VK3CX 105 | D3BMP 100 |
| W9PST 117 | W9CWW 105 | W8JTW 100 |
| W1AXA 117 | W1ICA 105 | W9LBE 100 |
| W3EUV 116 | W2IOP 105 | W4CCH 100 |
| W2BYP 116 | W4TO 105 | W8KTW 100 |
| W6ADP 115 | W8LYQ 105 | W5ASG 100 |
| W9EF 115 | W9RBI 105 | W8JIN 100 |
| VK5WS 115 | W2AV 105 | W8QDU 100 |
| W2CYS 115 | W2ARB 105 | Radio-telephone |
| W4CYU 115 | E1SF 104 | W2AZ 103 |
| W1HX 115 | W1ZB 104 | W6OCH 100 |
| | W4AJX 104 | |

The following have submitted proof of contact with 75-or-more countries: W8AAJ, W9AJA 99; W2ALO, W2EJ, W6ADT 98; G6GE, W1AVK, W1IOZ, W2JME, W4TP, W8LZE 97; W2CTO, W8BOX 86; F8LX, F8SAB, G8XL, W3AIU, W3EMA, W8IQB, W8PQQ 95; W3A00, W3FLH, W3GHD, W8CJJ, W9BEZ 94; G8ZO, ON4GK, PA0QZ, W3WC, W3OP, W4TZ, W6FRZ, W8MEK, W9TT 93; SP1P, W8DMB 92; W8CJY 91; D8CSC, G6YR, ON4FE, SP1AR, W1CBZ, W8LAY, W9JDE, W9OVU 90; W1KHE, W2CUQ, W8AAT 89; G2DZ, W1DOW, W2BZB, W3JAM, W9PFS 88; G8TG, PY2DN, VK3GH, W6QPB, W8JFC, W9AEH, W9VKF 87; W1BGC, W8DAE, W9ETH 86; VE2TY, W4CFD, W6CK, W8LD, 85; SM6WL, W1BFT, W6AM, W8BWB 84; E1AJ, OZ7CC, VE2GA, W2AWF, W2FLG, W8DTB, W6KUT, W8NLZ, W8BFG, W8BWC 83; W1EWD, W3AYS, W8OUK 82; W9QY 81; G3BS, W1BPN, W2BNX, W2HTY, W8BYN, W8EPE, W4OG, W8CED, W8DGP, W8ITK, W8DIB, W9CKB, W9GMV 80; W5EUI, W4ZZ, W8UDV, W8MRW 79; W3DRD, W4EFP, W8EYN, W9YNB 78; LA2X 77; PA0JMR, W8BBS, ZE1JI 76; W1EH, W4AHF 75.
Radio-telephone: W2GW 99; W4CYU 94; W2IXY 91; G5RV 89; W3EMM 86; W8LFE 84; W1AKY 81; W2IKV 80; W1ADM 78; W2GRG 75.



Prewired

HIGH VOLTAGE TRANSMITTER POWER SUPPLY

*H*ERE is a Millen transmitter power supply unit that will be a credit to any shack. Heavy steel baffle welded in base isolates input line circuits from high voltage leads. Has insulated safety output terminal, AC input terminal block, tube sockets, safety rectifier caps, etc. All prewired and punched for THORDARSON CHT transformers. Unit complete except for tubes, filter condensers, bleeder, transformers and chokes. Panels are standard fine grain black wrinkle finish in $\frac{1}{8}$ " steel. Standard relay rack punchings and sizes. The foundation units are made by the JAMES MILLEN MFG. CO. and sold by your Parts Distributor. Engineered to use the following THORDARSON CHT transformers:

FOUNDATION Unit No. 80201 uses T15C37, T15C46 and T11F53 and provides a choice of:

T-15P13 To deliver 750 or 600 volts at 300 ma
or T-15P14 To deliver 1000 or 750 volts at 300 ma
or T-15P15 To deliver 1250 or 1000 volts at 300 ma
or T-15P17 To deliver 1500 or 1250 volts at 300 ma
Foundation Unit No. 80205 uses T15C37, T15C46, T11F53 and T15P19 to deliver 2500 or 2000 volts at 300 ma.

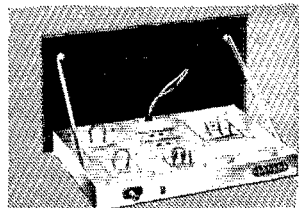

THORDARSON

ELEC. MFG. CO., CHICAGO

"TRANSFORMER SPECIALISTS

45th Anniversary
SINCE 1895"

CARDWELL CONDENSERS

For Commercial Application

Whether simple modifications of flexible standard assemblies (1), or developmental designs requiring extreme accuracy of execution (2),

CARDWELLS "Fill The Bill"

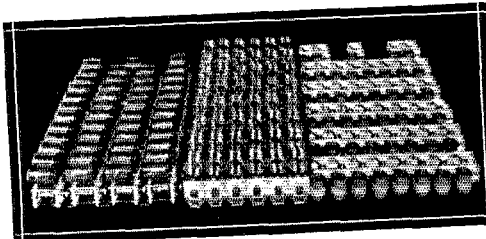

(1) These "TRIM-AIR" Midgets were chosen for severe portable-mobile use by the police department of a wide-awake Michigan municipality because CARDWELLS are

DEPENDABLE!

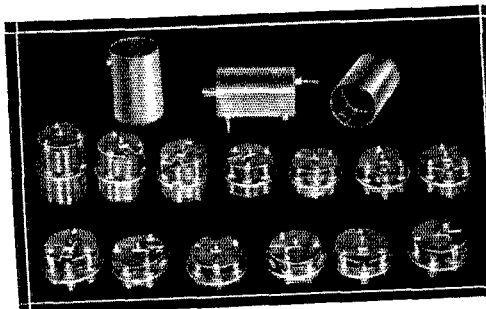

(2) A group of gold plated capacity standards of special design, made of a low temperature coefficient of expansion metal, for the largest laboratory in the world. They are mechanically and electrically

ACCURATE!

FLASH!

For Frequency Modulation Receivers, the new CARDWELL triple Trim-Air Type ER-10-A.T.

Amateur Net. \$1.80

**THE ALLEN D. CARDWELL
MANUFACTURING CORPORATION**
83 PROSPECT STREET, BROOKLYN, NEW YORK

BRIEFS

On November 4th the Toledo (Ohio) Waite High School football team played Peabody (Mass.) at Peabody. The play-by-play results were relayed from Peabody to Toledo by ham radio and announced over loud speaker at the football field in Toledo. Operators handling the set-up were W1AKS, W1IBF, W1JNF, W1KMQ, W1IO, W1KZK, W1GGV, W1GRV, W1HBL, W8JEX, W8BZO, W8PYR, W8SOM, W8SNQ and W8OFW.

W8NUV and W4EIU dropped in on W5DEW (Port Arthur, Texas) for a visit. In the course of rag chewing W4EIU suggested that his parents, who live in Badin, N. C., might be listening in since in a previous letter they had mentioned hearing W5DEW. The operator at DEW suggested that W4EIU try a blind call to W4EIT (who operates on 7 Mc.). This accomplished, the receiver was adjusted for 7 Mc., and in came the signal of W4EIT without the bandspread dial on the RME being moved from where it had been left. W5DEW was transmitting on 14 Mc. and W4EIT, who is in Badin, N. C., just happened to listen on 14 Mc. to see what was going on. The first signal heard was W5DEW calling W4EIT. Mental telepathy must have been doing its stuff that day!

A discussion at a meeting of the Intercity Amateur Radio Association (St. Thomas, Ontario, and neighboring cities) concerning the conduct of some amateurs on the air resulted in the following resolution:

"We the members of the Intercity Amateur Radio Association having at various times heard fellow amateurs in the 'phone portions of the various bands transmit stories of a questionable nature, use profanity, and otherwise conduct themselves in such a way as to displease anyone hearing them, and as, due to the increasing use of all-wave broadcast receivers, it is felt that such conduct is certain to turn public opinion against the amateur and endanger our continued use and enjoyment of the bands we now possess, it is hereby resolved, —

"That we as individuals do pledge ourselves to keep our transmissions free of any objectionable matter.

"That we as individuals do also pledge ourselves to report, in confidence, any objectionable transmissions we may hear, with the necessary log data, to our district Radio Inspector, whose cooperation we hope to obtain. It is hoped that the Radio Inspector on receiving a number of complaints from various amateurs will warn the offender in a friendly manner that his conduct is causing complaint, and if, after the warning, complaints are still received will take such further action as he may think advisable."

Conscience

The story is told of a ham who, on his day off, went hunting. A terrible storm came up. He looked about for shelter, but there was none. It began to rain in torrents so he crawled into a hollow log. It fitted snugly. The rain lasted for hours and the water soaked through the wood. The log swelled and the hollow grew smaller. When the storm was over, the hunter could not get out. He stretched and strained to no avail; he was held tight.

Like a drowning man, he saw his whole life flash before him, especially his mistakes. He realized what a rat he had been — how he had refused help many times to his younger brethren; how he had speeded up his bug when he knew the other fellow could not copy fast sending; how he had refused to QSP when to do so would have troubled him but little; how he had deliberately hogged net frequencies; how he had swooped up and down the band with his rac e.c.o., spoiling many a DX QSO; how he had tested for hours during emergency traffic; how he had solemnly sworn to QSL, with no intention whatsoever of doing so; how he had invited his drunken friends to speak and sing over his mike; in fact, thinking back, he could remember but few times when he had displayed the true amateur spirit.

And, believe it or not, when he saw himself in his true light for the first time, he felt so small that he was able to crawl out of the log without difficulty

— W8OXO.

(Continued on next left-hand page)

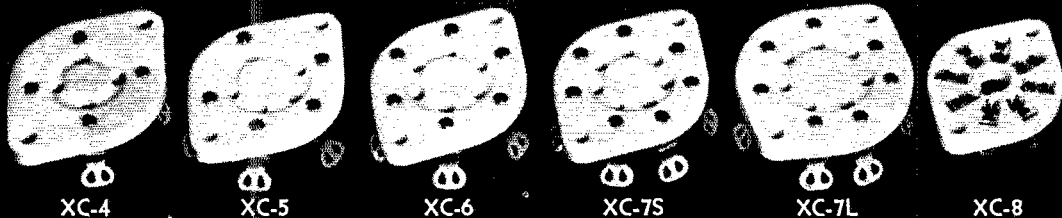

National wafer sockets are available for all types of receiving tubes. They have exceptionally good contacts with high current rating, resulting in long trouble-free service. All models have a locating groove to make tube insertion easy, with the exception of the Octal socket which has a central locating hole. All have low-loss ceramic insulation of the best quality. **Type XC Wafer Socket, List Price \$.60, any type.**

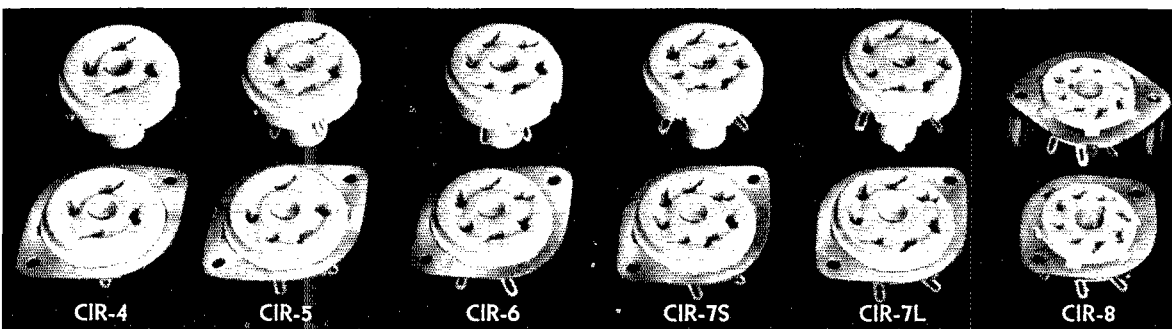

Type CIR Sockets feature a contact that grips the tube prong for its whole length and a metal ring for six-position mounting. The sockets for the glass type tubes are supplied with a standoff insulator that allows center mounting for breadboard layouts. The Octal socket is supplied with two metal standoffs. All have low-loss ceramic insulation of the best quality. **Type CIR Socket, List Price \$.40, any type.**

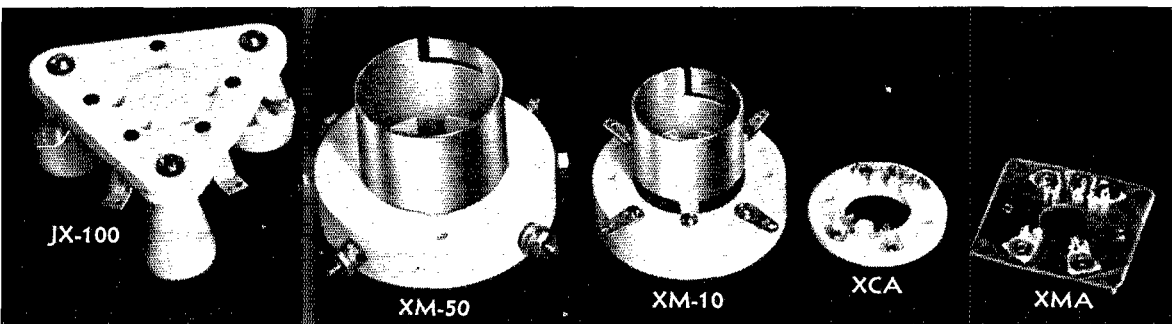

JX-100. A wafer type socket of low-loss ceramic for power pentodes such as the RK-28 and the RCA-803. As illustrated, Type JX-100S, List Price \$3.60. Same but without standoffs, **Type JX-100, List Price \$3.00**

XM-50. A "fifty watt" metal shell socket with heavy side wipe contacts and low-loss ceramic insulation. **Type XM-50 Socket, List Price \$1.75**

XM-10. A heavy duty metal shell socket for tubes having the UX base. Rugged, positive contacts are used and insulation is fine low-loss ceramic. **Type XM-10, List Price \$1.25**

XCA. A low-loss socket for acorn triodes with contacts of improved design. **Type XCA, List Price \$1.50**

XMA. This socket for pentode acorn tubes is built on a square copper base with built-in bypass condensers for stable high frequency operation. It uses the same improved contacts as the XCA. **Type XMA, List Price \$2.00**



Old Man Centralab, in a nostalgic mood, dug up this famous "ad" of five years ago with this trenchant remark,

"It's as true today as it was then . . . you've got to be Centralab-equipped if you want to do a decent and satisfactory replacement job."

So be sure to have plenty of Centralab Radiohms, Fixed Resistors, and Wave Band Switches on hand for every service job.

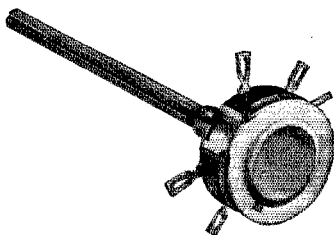

Centralab

DIVISION OF GLOBE-UNION INC.
MILWAUKEE, WIS.

The Philippine Express Net will schedule the training ship *California State*, WTDDQ, during its 1940 cruise. WYWG will maintain daily 14-Mc. schedules, and other P.E.N. members will divide the 7-Mc. schedules. When the ship reaches the Atlantic, the eastern end of the net, of which W3HRS is control, will take over 7-Mc. schedules. Traffic for the *California State* may be routed via P.E.N. — W6PGB.

The Dallas Amateur Radio Club was sponsor of the most successful exhibit of amateur radio equipment ever shown at the Texas State Fair, which is the largest State fair in the world. The club station, W5IME, was on the air during the entire period of the fair.

Betty Chow, W6QMW, has been doing some research on the accomplishments of her brother, W6MVK, and has uncovered some interesting claims. She believes MVK made the DX Century Club in a shorter time after getting his license than any other member (elapsed time, 3 years, 11 months). He was licensed August 16, 1935; license not received until October 5, 1935. On March 12, 1936, he was awarded a W.A.S. certificate, about five months after getting on the air. He received the second certificate for "working all California counties," an award of the Oakland Radio Club. This was 3 years, 3 months after being licensed. W6QMW would like to know if anyone challenges these claims for W6MVK.

W1DQK, North Troy, Vt., and W4DOE, Memphis, Tenn., were instrumental in reuniting two sisters who had been separated without knowledge of each other's whereabouts for 33 years. W4DOE called W1DQK one evening last November to inquire for a friend (one of the sisters) if any information was available on her sister, whom she had heard indirectly was living in North Troy. W1DQK located the party in question and arranged a schedule when the two sisters visited the respective ham shacks and actually talked to each other — after 33 years! It was one of those things that make amateur radio the worthwhile hobby it is!

Coincidence: On Dec. 8, 1936, W9YWE called CQ on 7260 kc. at 12:30 p.m. and was answered by W9VLN. Reports exchanged were YWE 579, VLN 589. On October 23, 1939, at 12:30 p.m., W9YWE's CQ on 7260 kc. was again answered by W9VLN, with the same reports exchanged. A case of "same time, same station!"

New F.T.S. Stations

The following calls should be added to the list of Forty Traffic System stations which appeared in January *QST* (page 80): W1CSC DJC EJU EOF FGC IBF KOO KPB KVB LEA LHT MAN MCA W2KOR KRF KXB KYD LLX LWS LWY JVK/3 W3DQZ FHD FHN FQA GIX GJY GUV GXR GYX HFF HHS HPE HSN HZK IBR IGN W4CQR EST GBS GDD MA W5ARF CGW DNX FJM FYU HAG HNF W6NGS OWL QKB QPN W7GPP WY W8AXZ CJL DYB IVC IWS KZO LDI MAE NAB NER OKD QCH QKY QQB QYR RBH RJC RLI RUC TJ TNN W9ABE BWQ CSZ EWT GRA KZI LPA LZL MGI NGS OUQ QVA RLU VQE ZDC ZUM ZVJ ZYR.

Information on joining the F.T.S. may be obtained from Nils Michaelsen, W2LSD, 55 Temple Street, Harrison, N. Y. Anyone operating 7 Mc. and having an interest in traffic handling is eligible for membership.

W9MGN Analyzes DX Contest Results

IRVING LAUMAN, W9MGN, has been up to his ears in figures of late, conducting an extensive arithmetical research on the results of U. S. c.w. contestants in the 1938 and 1939 A.R.R.L. DX Contests, as reported in *QST*. His purpose was to attempt to throw light on which of several arbitrarily chosen areas dividing the United States is "best" (Continued on next left-hand page)

ABOARD the "Continental Clipper!"

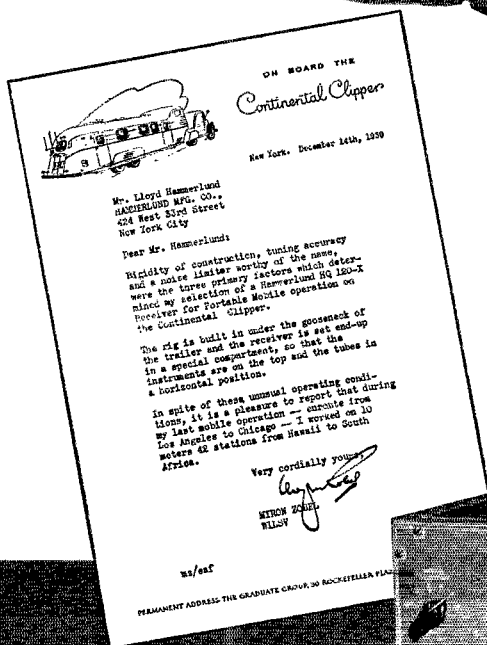
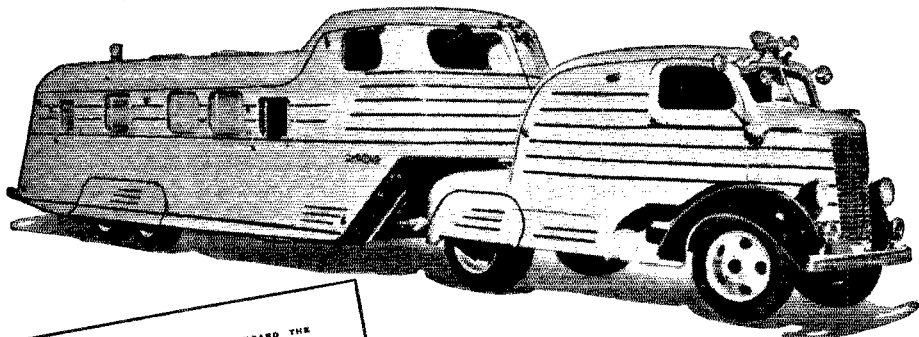

IN selecting the "HQ-120-X" for use on the "Continental Clipper," Mr. Zobel, W1LSV, knew he was getting quality merchandise backed by years of engineering in the communications field. The "HQ-120-X" in this case, as in many others, has proved its superiority with outstanding performance under adverse conditions. The low noise level and high sensitivity of the "HQ-120-X," together with a very effective noise limiter, made this excellent 10-meter DX possible. Make particular note how many stations you contact who are using Hammarlund "HQ-120-X" receivers. This great popularity is proof of its effectiveness.

Send for "HQ" booklet

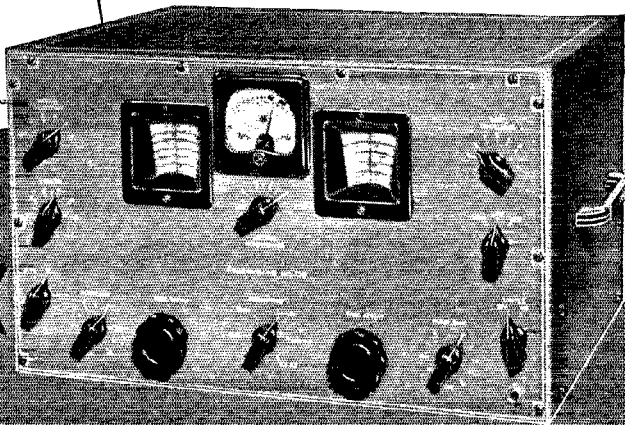

the
HQ-120-X



HAMMARLUND MFG. CO., INC.
424-438 WEST 33rd ST., NEW YORK



Canadian Office: 41 West Ave., No., Hamilton, Ont.

FOR THOSE WHO WANT THE BEST

A NEW 25 WATT* with GRAPHITE ANODE HY30Z

Setting a new standard in

VALUE QUALITY PERFORMANCE

Zero-bias for Class "B" modulator — Grid-leak bias on R.F. — Easiest of all to drive. Same outstanding design features as employed in the now famous HY40 and HY51 series.

Continuous-Service RATINGS*

Filament (thoriated tungsten) . . .6.3 volts @ 2.25 amps.

Plate input. . . .850 max. volts and 90 max. ma.

Plate dissipation.25 maximum watts

HY30Z \$2.50 Net

*All Hytron ratings are based on continuous-service operation for long life and most-efficient performance.

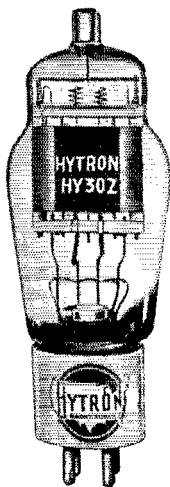

Ceramic base
Lava insulation

GET PEAK PERFORMANCE FROM YOUR RECEIVERS —

USE HYTRON CERAMIC-BASE "GT" BANTAMS† in all CERAMIC SOCKETS

| | |
|----------------------------|----------------------------|
| 6A8GTX. \$.95 net | 6K8GTX. \$1.30 net |
| 6J5GTX.95 net | 6SA7GTX. 1.05 net |
| 6J7GTX.95 net | 6SJ7GTX. 1.05 net |
| 6K7GTX.95 net | 6SK7GTX. 1.05 net |

Hytron GTX tubes are specially-selected for use in high-frequency circuits where maximum gain and stability are necessary. Interchangeable with metal and "G" types.

† Tradename registered

HYTRON LABORATORIES



A DIVISION OF THE HYTRON CORP.

23 DERBY ST. SALEM, MASS.

MANUFACTURERS OF RADIO TUBES SINCE 1921

for DX." Realizing the existing sectional differences in conditions, A.R.R.L.'s policy in its DX Contests for many years has been to make separate awards to the leaders in the various sections, instead of attempting to determine a "national winner." We recognize that it is not possible to "equalize" conditions enough to select any one station as the national winner. W9MGN's efforts ended in a very interesting tabulation, showing points-per-hour and per cent ratings for each of several arbitrary geographical areas in the '38 and '39 contests.

In the table are indicated the points-per-hour average for all contestants in each given area, and a per cent rating for each area as compared with the "general points-per-hour average" of all U. S. c.w. participants. The composition of each area is as follows: (A) Maine, N. H., Vt., E. Mass., W. Mass., Conn., R. I., E. N. Y., N. Y. C.-L. I.; (B) E. Pa., N. N. J., S. N. J., Md.-Del.-D. C.; (C) Va., N. C., S. C., Ga., E. Fla.; (D) W. Fla., Ark., La., Miss., Ala., Tenn., Okla., N. Tex., S. Tex., Kans., Mo., Colo., N. Mex.; (E) W. N. Y., W. Pa., Ohio, Ind., Mich., Ill., Wis., W. Va., Ky.; (F) N. Minn., S. Minn., N. Dak., S. Dak., Iowa, Nebr., Mont.; (G) Idaho, Ore., Wash.; (H) Entire W6 call district.

| Area | Points per Hour 1938 | Points per Hour 1939 | Per Cent Rating 1938 | Per Cent Rating 1939 |
|----------------------|----------------------|----------------------|----------------------|----------------------|
| A. | 380 | 440 | 122 | 129 |
| B. | 314 | 341 | 100.6 | 100.3 |
| C. | 536 | 681 | 172 | 200 |
| D. | 335 | 346 | 107 | 102 |
| E. | 256 | 275 | 82 | 81 |
| F. | 93 | 103 | 30 | 30 |
| G. | 188 | 166 | 60 | 50 |
| H. | 307 | 322 | 98 | 98 |
| General Average. . . | 311.7 | 340.5 | 100 | 100 |

W9MGN notes that the relative positions of all areas are the same for both '38 and '39. The rating line-up is C, A, D, B, H, E, G, F. In drawing conclusions from the above tabulation, operating ability of participants and station capabilities must also be considered since some areas have a higher percentage of "blood and thunder" DX men (the real to-the-death DX-ers) than others. This factor would, of course, affect the standings. Also, some areas have a very high percentage of "ordinary" participants (not out for too-high scores), which tends to drag down the average.

Some additional interesting points brought out by W9MGN's labors are the fact that the United States c.w. participants who submitted logs in the 1939 contest operated a total of 26,773 hours, in the 1938 contest 29,975 hours; scores from these participants totalled 9,115,913 in 1939, 9,342,981 in 1938.

28-Mc. Round Table

Beginning at 7:10 P.M. and closing about 2:03 A.M. (Nov. 28th-29th), a 28-Mc. round table, ably conducted by W9FXB as master of ceremonies, included the following fifty-nine stations on voice: W9QDA JN RSQ UZ EJF PEI GZK OFO YUC POP AI QLD GA ROP ZCN TMT JII YRR BLI HZQ ABL DFS NQN CAH LFU WCD OUX YSV IUX NHF FIG TLR EBQ ZHB AUK TMH ADF PRC NN WBB CXV EMD BEK WDM YLV UOV UWQ FEN AR ZEQ MAY PDO CMC NHL AAV WIF DFS and W9PYP. This was the "round table to end all round tables" for the 28-Mc. season. W9FXB was initiated royally, since two weeks prior he received his licenses.

ELECTION NOTICES

To all A.R.R.L. Members residing in the Sections listed below: (The list gives the Sections, closing date for receipt of nominating petitions for Section Manager, the name of the present incumbent and the date of expiration of his term of office.) This notice supersedes previous notices.

In cases where no valid nominating petitions have been received from A.R.R.L. members residing in the different Sections in response to our previous notices, the closing dates for receipt of nominating petitions are set ahead to the dates given here- (Continued on next left-hand page)

HOW GOOD?

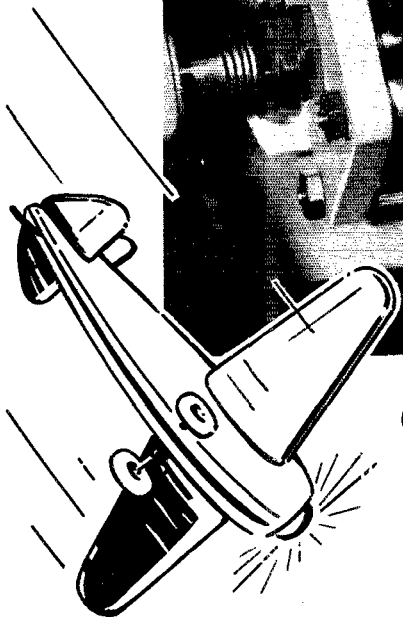
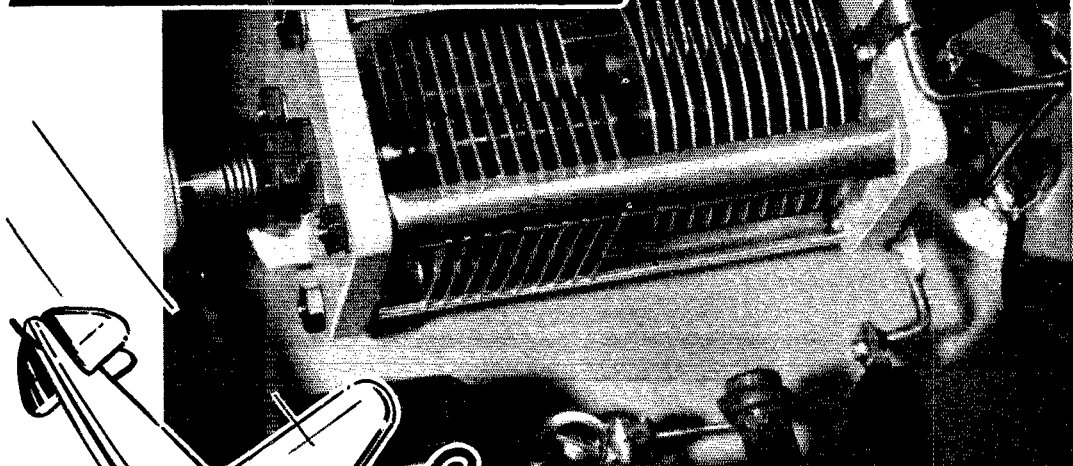

Engineered to meet GOVERNMENT AIRCRAFT REQUIREMENTS!

WE DESIGNED and built this new TYPE H Condenser specifically for government aircraft radio, and it has more than fulfilled every exacting requirement. Although introduced to the general public only a few months ago, it has already been widely adopted by manufacturers and amateurs and has become one of the most important of the large Johnson Condenser line.

IMPORTANT

TO ASSURE the success of your rig, be guided by the experience of thousands all over the world who enjoy trouble-free operation with JOHNSON CONDENSERS. There is a Johnson Condenser for nearly every purpose from the little "postage stamp" Type J to the large Type C with power handling capacity for the largest amateur transmitter, and the well known unique (tubular) Type N Neutralizing Condenser. Catalog 966J describes them all. Ask your Johnson distributor or write us direct for your FREE copy.

HERE ARE THE REASONS

- RUGGED: built to "stay put" under severe service conditions.
- LIGHT: built for flight and just as handy for portables.
- SMALL: no excess bulk, fits in easily even under chassis.
- STEATITE END PLATES: avoids short-circuit "loops."
- SINGLE HOLE MOUNTING: or bracket mounting on any of four sides.
- ECONOMY: all these advantages at very reasonable cost.

TYPE H SINGLE SECTION

| Cat. No. | Capacity** | | Spacing (Inches) | List Price |
|----------|------------|------|---------------------|---------------|
| | Max. | Min. | | |
| 25H15* | 24 | 4 | .030" | \$2.00 |
| 35H15* | 35 | 5 | .030" | 2.05 |
| 50H15* | 52 | 6 | .030" | 2.15 |
| 70H15* | 71 | 7 | .030" | 2.25 |
| 100H15* | 101 | 8 | .030" | 2.35 |
| 150H15 | 150 | 9 | .030" | 3.15 |
| 250H15 | 250 | 11 | .030" | 3.60 |
| 25H30 | 26 | 8 | .080" | 2.60 |
| 35H30 | 35 | 9 | .080" | 2.70 |
| 50H30 | 50 | 10 | .080" | 3.00 |
| 70H30 | 70 | 12 | .080" | 3.40 |

TYPE H DUAL SECTION

| Cat. No. | Capacity** | | Spacing (Inches) | List Price |
|----------|------------|------|---------------------|---------------|
| | Max. | Min. | | |
| 35HD15 | 35 | 5 | .030" | \$4.20 |
| 50HD15 | 52 | 6 | .030" | 4.40 |
| 70HD15 | 71 | 7 | .030" | 4.60 |
| 100HD15 | 101 | 8 | .030" | 4.90 |
| 35HD30 | 35 | 9 | .080" | 4.80 |
| 50HD30 | 70 | 12 | .080" | 5.25 |

* Single End Plate

** Capacity per section



E. F. JOHNSON CO.

WASECA, MINNESOTA

EXPORT: 25 WARREN ST., NEW YORK, N. Y.

"MANUFACTURERS OF RADIO TRANSMITTING EQUIPMENT"

"The Leader"

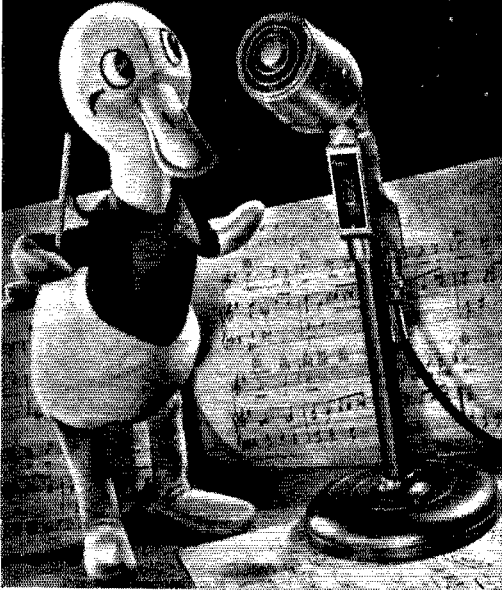

Electro-Voice Model 630 Dynamic MICROPHONE

Tilttable for directional or non-directional pick-up. Rugged construction. Impervious to heat, temperature changes, rough handling and salt air. Chromium and light gunmetal finishes. Three-contact locking connector, 20 ft. load capacity cable, on-off switch and tilting stand mounting.

- ★ **FREQUENCY RESPONSE:** 40-9000 c.p.s. with rising characteristic on upper end of curve.
- ★ **OUTPUT:** -56 db. (open line). Standard output impedances include Hi-Z, direct-to-grid.
- ★ **VOICE COIL:** Hard drawn aluminum wire for lightness, insulated with Polystyrene.
- ★ **MAGNETIC CIRCUIT:** Large alnico magnet with Armco magnetic iron pole pieces
- ★ **DIAPHRAGM:** Heat treated Durev.
- ★ **TRANSFORMER:** Built-in in all models except 50 ohm. Core material has extremely high permeability.

630-GM (gunmetal) list price..... **\$25.00**

630-C (chromium) list price..... **27.50**

See this new "630" at your local radio parts distributor. Write for complete details.

ELECTRO-VOICE MFG. CO., Inc.

1239 SOUTH BEND AVENUE
SOUTH BEND, INDIANA

Export Division: 100 Varick St., New York, N. Y.—Cables: "Arlab"

with. In the absence of nominating petitions from Members of a Section, the Incumbent continues to hold his official position and carry on the work of the Section subject, of course, to the filing of proper nominating petitions and the holding of an election by ballot or as may be necessary. Petitions must be in West Hartford on or before noon of the dates specified.

Due to resignations in the Alaska, Montana and Eastern Massachusetts Sections, nominating petitions are hereby solicited for the office of Section Communications Manager in these Sections and the closing date for receipt of nominations at A. R. R. L. Headquarters is herewith specified as noon, Thursday, February 15, 1940.

| Section | Closing Date | Present SCM | Present Term of Office Ends |
|------------------|---------------|-------------------------------|-----------------------------|
| Alberta * | Feb. 1, 1940 | C. S. Jamieson | Feb. 18, 1940 |
| Alaska | Feb. 15, 1940 | Leo E. Osterman (resigned) | |
| Montana | Feb. 15, 1940 | G. A. Woodhouse (resigned) | |
| Eastern Mass. | Feb. 15, 1940 | Larry Mitchell (resigned) | |
| Philippines | Feb. 15, 1940 | George L. Rickard | Oct. 15, 1938 |
| Indiana | Feb. 15, 1940 | Noble Burkhardt | Apr. 15, 1939 |
| Idaho | Feb. 15, 1940 | Carl Eichelberger | June 15, 1939 |
| San Diego | Feb. 15, 1940 | Howard K. Breedlove | Dec. 16, 1939 |
| Brit. Columbia * | Feb. 15, 1940 | J. Hepburn, Jr. | Dec. 20, 1939 |
| Virginia | Feb. 15, 1940 | Charles M. Waff, Jr. | Jan. 17, 1940 |
| Washington | Apr. 1, 1940 | W. Beale | Apr. 15, 1940 |
| Kentucky | Apr. 1, 1940 | Darrell A. Downard | Apr. 15, 1940 |
| Alabama | Apr. 1, 1940 | James F. Thompson | Apr. 15, 1940 |

* In Canadian sections nominating petitions for Section Managers must be addressed to Canadian General Manager, Alex Reid, 169 Logan Ave., St. Lambert, Quebec. To be valid such petitions must be filed with him on or before the closing dates named.

1. You are hereby notified that an election for an A. R. R. L. Section Communications Manager for the next two-year term of office is about to be held in each of these Sections in accordance with the provisions of the By-Laws.

2. The elections will take place in the different Sections immediately after the closing date for receipt of nominating petitions as given opposite the different Sections. The Ballots mailed from Headquarters will list in alphabetical sequence the names of all eligible candidates nominated for the position by A. R. R. L. members residing in the Sections concerned. Ballots will be mailed to members as of the closing dates specified above, for receipt of nominating petitions.

3. Nominating petitions from the Sections named are hereby solicited. Five or more A. R. R. L. members residing in any Section have the privilege of nominating any member of the League as candidate for Section Manager. The following form for nomination is suggested:

(Place and date)

Communications Manager, A. R. R. L.
38 La Salle Road, West Hartford, Conn.

We, the undersigned members of the A. R. R. L. residing in the Section of the Division hereby nominate as candidate for Section Communications Manager for this Section for the next two-year term of office.

(Five or more signatures of A. R. R. L. members are required.)

The candidates and five or more signers must be League members in good standing or the petition will be thrown out as invalid. Each candidate must have been a licensed amateur operator for at least two years and similarly, a member of the League for at least one continuous year, immediately prior to his nomination or the petition will likewise be invalidated. The complete name, address, and station call of the candidate should be included. All such petitions must be filed at the headquarters office of the League in West Hartford, Conn., by noon of the closing date given for receipt of nominating petitions. There is no limit to the number of petitions that may be filed, but no member shall sign more than one.

4. Members are urged to take initiative immediately, filing petitions for the officials for each Section listed above. This is your opportunity to put the man of your choice in office to carry on the work of the organization in your Section.

— F. E. Handy, Communications Manager

ELECTION RESULTS

Valid petitions nominating a single candidate as Section Manager were filed in a number of Sections, as provided in our Constitution and By-Laws, electing the following officials, the term of office starting on the date given.

| | | |
|------------------|---|---------------|
| Western New York | Joseph Frederick Chiches- ter, W8PJA | Dec. 6, 1939 |
| Southern Texas | Horace E. Blödy, W5MN | Dec. 23, 1939 |
| Louisiana | W. J. Wilkinson, Jr., W5DWW | Jan. 2, 1940 |

In the West Virginia Section of the Roanoke Division Mr. W. D. Tabler, W8CXO, and Mr. Robert Ramey, W8PBR, were nominated. Mr. Tabler received 84 votes and Mr. Ramey received 45 votes. Mr. Tabler's term of office began November 21, 1939. The new S. C. M. is to be complimented on this fine showing of confidence and support of the majority of the members and his program will be supported by all clubs and amateurs in the Section.

In the Connecticut Section of the New England Division Mr. Frederick Ellis, Jr., W1CTI, Mr. Gilbert F. Williams, W1APA, and Mr. Edmund R. Fraser, W1KQY were nominated. Mr. Ellis received 138 votes, Mr. Williams received 48 votes and Mr. Fraser received 44 votes. Mr. Ellis' term of office began December 13, 1939.

In the Wisconsin Section of the Central Division Mr. Aldrich C. Krones, W9UIT, and Mr. Karl E. Medrow, W9AKT, were nominated. Mr. Krones received 120 votes and Mr. Medrow received 112 votes. Mr. Krones' term of office began December 18, 1939.

300 Watts Tested
 -40 Watts Rated

260 Watts
 * SAFETY FACTOR

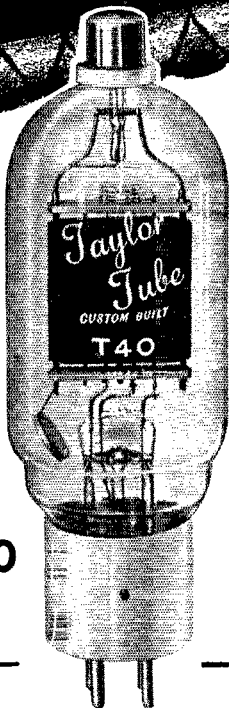

\$3.50

TAYLOR TUBES believes that a Transmitting Tube should be able to stand up to a 1000% temporary overload without injury to any of the elements.

*A GOOD EXAMPLE: Every Taylor Wonder Tube—T-40 and TZ-40—is factory tested at 300 Watts plate dissipation. The conservative plate dissipation rating is 40 watts, making your SAFETY FACTOR 260 WATTS. This extremely high SAFETY FACTOR is due to the famous "Processed" Carbon Anodes. Suppose a tube in the T-40 class, using a nickel anode, is rated at 40 watts and the nickel anode will melt at 150 watts plate dissipation, your SAFETY FACTOR would be only 110 watts.

The Taylor margin of extra safety is of vital importance, as many tubes are ruined in tuning up amplifiers. (When a stage goes out of resonance, the plate current soars, resulting in plate dissipation far in excess of the tube's normal rated dissipation.) It is obvious then, that the tube with the highest SAFETY FACTOR represents by far the greatest value in protection of your investment. The same SAFETY FACTOR Standards are provided for in all Taylor Carbon Anode Tubes.

TAYLOR'S BIG 1940 TUBE
 MANUAL & CATALOG NOW READY

Send us five cents in stamps or coin and it will be mailed direct from the factory, or at your parts distributor FREE. Contains new circuits, technical data, tube uses, building information, etc.—a real up-to-the-minute storehouse of valuable information.

"More Watts Per Dollar"

T-40 and TZ-40 NEW RATINGS!

Filament volts7.5 V.
 Plate Voltage1500 V.
 Plate Current150 MA.
 Plate Dissipation40 W.

REMEMBER—The melting point of carbon is 3527° C., compared to nickel's melting point of 1452° C., and that carbon radiates heat many times faster than a smooth metallic surface.

Recommended by Leading Parts Distributors

Taylor HEAVY CUSTOM BUILT DUTY Tubes

TAYLOR TUBES, INC., 2341 WABANSIA AVE., CHICAGO, ILLINOIS

POCKET SIZE A.C. and D.C. VOLT-OHM-MILLIAMMETER

MODEL 666-H

Size:
3 1/16"
x 5 7/8"
x 2 1/8"

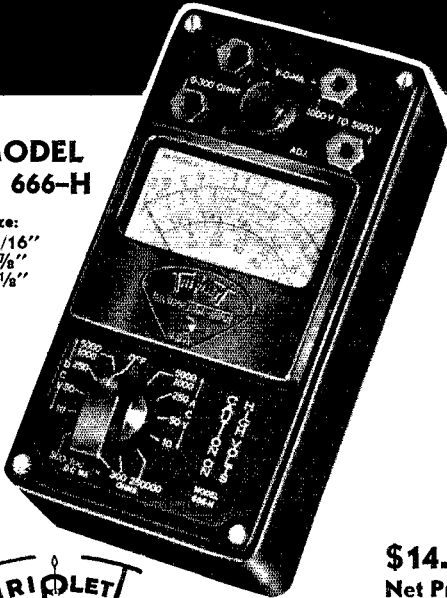

\$14.50
Net Price



5000 VOLTS SELF-CONTAINED

● With RED DOT Lifetime Guaranteed Measuring Instrument. Ranges: AC-DC Voltage at 1000 ohms per volt 0-10-50-250-1000-5000, DC Milliamperes 0-10-100-500; Resistance 0-300 ohms shunt type, 10 ohm reading at center scale; 0-250-000 ohms, series type, 3700 ohms at center scale. Higher resistance measurements by using external batteries. Complete in molded case, completely in-

ulated. Exclusive Triplet Low Loss Selector Switch. Handtest and most compact tester built expressly for the Amateur trade. Indispensable for setting up a new circuit or peaking up the old one. Also the "best friend" when something goes wrong. Net Price.....\$14.50

Model 666 — same case as above — reads to 1000 volts AC and DC. Net Price..\$14.00

Triplet Manufacturers a Complete Line of Precision Panel Instruments in 21 Styles — 2" to 7" Round, Square, Fan and Twin Cases

INVESTIGATE THESE AND OTHER OUTSTANDING VALUES

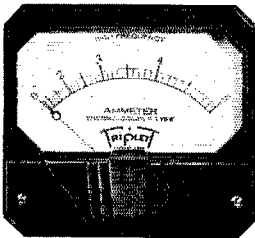

THERMO AMMETERS

● Model 446 with Front illumination. Four-inch square modernistic Instrument featuring extra long scale. Same case style available for ammeters, milliammeters, microammeters, voltmeters, millivoltmeters, etc., AC and DC.

WRITE FOR CATALOG

SECTION 252

HARMON AVE.

THE TRIPLET ELECTRICAL INSTRUMENT CO.

Bluffton, Ohio

Correspondence Department

(Continued from page 59)

No doubt, the above standard clause will appear in new fire insurance policies in all cities and will cover the average amateur's equipment. Of course, all equipment and wiring has to conform with the Board of Fire Underwriters regulations as in the past. . . .

— David Talley, W2PP

Navy Day — 1939

(Continued from page 58)

1939 Navy Day Honor Roll Letter Winners

First Naval District: W1ABG W1BB W1CWZ N1FJS W1FSV W1HSA N1RZ R. M. Archibald, F. D. Robinson, R. S. Smith. *Third Naval District:* N2ALD W2AVS W2BNJ N2BZJ W2CJI W2CJX W2CRK N2EPJ N2GRJ W2GUP N2HJT W2HMJ W2JQG W2ISJ W2JQE W2KC/FNY N2KDU N2KEZ W2KFB N2LC W2LET W2LR N2MQ W60VG W6QUO N8BPJ W8CSK N8GZX W8PWU J. R. Arkinstall, L. A. Byam, Jr., L. G. Forbes, W. A. Young. *Fourth Naval District:* N2DDV N3HNY W3HQQ W8FUV N8FUV W8KTS N8MOT W8NCJ N8OKS N8OML N8QEN W8RHE N8RQ N8TJI A. J. Mroczka, Beth Rosenberg. *Fifth Naval District:* N3EEN W3HGV W3IJJ L. P. Munford. *Sixth Naval District:* W4DW W4EBA W4FFH. *Seventh Naval District:* W4AFC N4AGR/FML W4ALJ W4EFM W4EIH W4EZ W. E. Dort, Wm. C. Howes, P. F. Paeglow. *Eighth Naval District:* W4ABY N4CRP N4DGC W4DQW W4EYQ W6AMO W6ABD W6BKH W6BRQ W6BRV W6CEE N6CEZ W6DLZ N6FAJ N6GJW W6IAC W6JZR W6RH R. D. Clark, R. E. Clarke, C. H. Young, J. M. McCoy. *Ninth Naval District:* W1GKM N8BKM W8BON W8EGX W8HS W8QLO W8SQE W8TKW N9AKT N9BP N9CB N9EMN N9FQ W9FWS W9GMV W9HDP W9JQZ W9KCG N9MFM W9NFL W9OUR W9PPS W9QJW N9QJD W9RQB W9RLB W9SWC W9UJW W9WIN N9ZHD W9ZQW J. W. Bronson, J. G. Broudy, S. C. Garcia, G. W. Sosebee. *Eleventh Naval District:* W5ENI W5HPV W6AM W6DTY W6GBN W6ISG W6IZ W6JLU W6LJW W6LUJ W6MFS N6MHX N6MLJ N6NDF W6QAC W6QNJ W6QPN W6QXW W6RXM C. T. Cooner. *Twelfth Naval District:* N6ADB W6AOA W6AWN W6BOY W6CLV W6CUZ N6FCX N6GKO N6MCS W6MCO W6BKB N6PBV W6PTF N9GLI W9LQO W9LZA N9SBB W. Halton, F. M. Hoehn, A. Moorehead, J. R. Thomas, F. Zerlang. *Thirteenth Naval District:* W7ABO W7AXJ W7CYU W7ESV W7FE W7FFP W7GEB W7HFY W7HUG W7SJ W7WU W7WY P. Barina, E. P. Olsen. *Fourteenth Naval District:* W6OLU/K6.

The remaining 378 participants on the Honor Roll follow, listed by Naval Districts, alphabetically and numerically.

First Naval District: W1ADL W1AJK W1AKS W1AUN W1BDV W1BGA N1BL W1BTA W1BWR W1BZO N1CAB W1HWE N1IBE W1IUQ W1JAH W1KH W1KIE W1KIN W1KJK W1LMJ W1LRO W1OR W1QE W1WV C. P. Baldwin, H. R. Deschene, W. A. Mackenzie, H. A. Spencer. *Third Naval District:* N1BQL W1BYW W1DRN W1HSL W1IKE W1IKJ W1IYB W1KQY N1MY N1QV N2ATU W2AUP W2AZM N2BAI W2CQB W2DIJ W2ECT W2EGI W2EGU W2EWR N2FFN W2FAR W2FEL W2FRZ N2GBD W2GBJ W2GP W2GQR W2GTA W2GVZ N2HAV W2HBO W2HCO W2HGO W2HPT N2HYD W2ICJ W2IDY N2IEA W2IUO W2JAI W2CJY W2JFB N2JTK N2JVX W2KIG W2KMZ W2KOR W2KQD N2KRG W2KRK W2KUW W2KZD N2LA W2LBI W2LCD N2LDS W2LFR W2LLE W2LOQ N2LU W2PY N3FAK W8ABX W8AHO W8CQV W8DOD N8EWP N8FU N8GWY N8JQZ W8KXA N8NVC W8NVE W8PK N8PSM W8QJB W8RKM W8SBV H. W. Bartsch, C. W. Erickson, S. Gasparovitch, W. C. Howard, W. S. Kalisty, J. H. Kolb, S. Wolf. *Fourth Naval District:* W3ADE N3AOA N3BCZ W3BIP W3BZX W3DDX W3EFH W3FEG N3FI N3FJK W3FKT N3FQS W3GWE W3HEJ W3QM W3UT N8AVK W8EU W8KXS N8MDB W8OEM W8OLI W8QBK W8QID W8SZF W. R. Faries, P. F. Long. *Fifth Naval*

(Continued on next left-hand page)

This IDEAL RECEIVING LAYOUT

...You Can Start It With A \$29⁹⁵

PROTECTED INVESTMENT!



The Ideal Receiving Layout—Howard Preselector with Loop, Model 437 Receiver with Carrier Level Meter and Crystal Filter, the Frequency Monitor and External Speaker.

HOWARD *Progressive Series Plan*

ENDS "TRADE-IN" LOSSES

Here's the plan that amateurs everywhere have been waiting for. This new HOWARD PROGRESSIVE SERIES PLAN enables you to build up your receiver layout as finances permit—it means more and better equipment as you go along WITHOUT KEEPING YOUR MONEY "TIED UP" in first models. It works like this. MODEL 435, illustrated at right, may be purchased first . . . it's a grand number for a starter. Use this a while . . . then return it to the HOWARD factory for conversion to MODEL 436—a receiver that you will rave over. Later, as you accumulate some extra cash, MODEL 436 can be sent back for conversion to the advanced MODEL 437 and you'll have a receiver that is "tops." Conversion can be made to MODEL 437 from either MODEL 435 or 436 for only slightly more than if you had purchased MODEL 437 in the beginning. A simple plan—but a good one for you.

ONLY HOWARD HAS THE PROGRESSIVE SERIES PLAN

You want a complete receiving layout for your money . . . this is the sure way to get it. The various accessories shown above can be bought at any time or as you progress from model to model. The complete 15 tube ideal receiving layout with all accessories gives you three R. F. Stages, four tuned R. F. Circuits, two Iron Core I. F. Stages, Directional Loop, as well as many other desirable features. Export prices slightly higher.

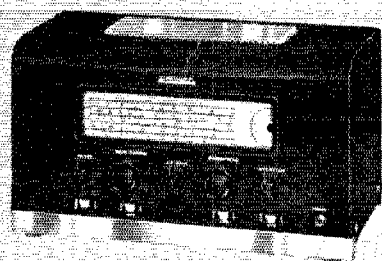

MODEL "435" \$29⁹⁵
SIX TUBES

THE BASIC UNIT OF THE
HOWARD PROGRESSIVE SERIES

START TODAY!

Now is the time to start the ideal receiver layout! With the HOWARD PROGRESSIVE SERIES PLAN you are assured of a protected investment and elimination of "trade-in" losses. This is the first time any manufacturer has built his program around his customers' requirements.

See This Layout at Your Distributor or Write the Factory

HOWARD RADIO COMPANY

1731-35 Belmont Ave., Chicago, Ill. Cable Address: HOWARDCO., U.S.A.

America's Oldest Radio Manufacturer

UNBEATABLE SPRAGUE VALUES

The Dot
Changes Color



KOOLOHM RESISTORS . . . A development as revolutionary to resistors as the airplane was to transportation! Wires touch but do not short. Amazing non-inductive units sold at lowest prices ever. All values dissipate full wattage rating. Automatic overload indicator as illustrated above. Moisture-proof, heat-proof. Will not chip or break. Ask your jobber for Koolohms. Catalog free.

NOT A FAILURE IN A MILLION

The most famous condensers ever made — and still the fastest selling "by-pass" units on the market. Cost little, do a big job. Famous Sprague "inner seal" moisture protection and many other features. All ranges — at your jobber's.

SPRAGUE TC TUBULARS

TOPS IN PERFORMANCE TOPS IN SAFETY

Four outstanding features make Sprague Transmitting Condensers safest and best to use. (1) Lifeguard Insulation Caps protect you from shock at terminals; (2) Terminals are insulated from cans for twice the working voltage or more; (3) Metal cans may be grounded automatically through mounting clamps; (4) All condensers are oil-impregnated and oil-filled (not oil-impregnated and wax-filled) with SPRACOL the 500 degree flash protection oil.

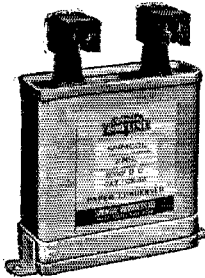

(Unconditionally guaranteed.)
(Round or Rectangular types.)

SPRAGUE PRODUCTS CO., North Adams, Mass.

UNMATCHED SPRAGUE QUALITY

District: W2CTT W2JVK N3CMV W3FE W3FWC N3GFV W3HHT W3HTX W3IGX W8ORD W8TNC/RFP. Sixth Naval District: W4AGI W4CQ N4ETE W4EVZ W4GJM C. D. Harris. Seventh Naval District: K4KD W4CRT W4EPV E. W. MacDowell. Eighth Naval District: N4DJS W4EKO W4EV W4FOK W4FTG W5ADZ W5AQW W5AWT N5BAM W5BRR W5BUE W5BYC W5CWW W5DAQ W5DEO W5GWO W5HGG W5HQS W5IHM W9RTN E. L. Alkire, E. N. Cox, C. W. Cranford, G. Kohler, H. Lee, W. M. Monroe, C. B. Trevey. Ninth Naval District: W1BOD W1MES W2HHG N8ARR N8BKE W8FKF W8GIY W8HSW W8IET W8IHR W8KPL N8LKP N8LST N8LXA W8LYZ W8MTE N8MWS N8NDL W8PO N8PYW W8PZL N8QQY W8QXZ W8ROX W8RFF W8RVK W8SWH W8SSL W8TNN W8TVK W8TYH W9ABS N9AGQ W9AIR W9AYH W9BQM W9BRY W9DI W9DLH W9DPO W9EDQ W9EGQ N9EGS W9END N9FFD W9FVG W9FWW N9FYX W9GM N9GWF W9GY W9HPJ W9HPQ W9HTU W9JPS W9KIK W9KPA N9KTK W9KUI W9KUR W9NGS W9NYW W9OEB W9ORU W9OUD W9PBI W9QMA W9QOA W9QUY W9RKV W9SEB N9SO W9SQT W9TDO W9UKV W9VFM W9VNN W9YQY W9YTV W9YZE N9ZZX W9ZCH N9ZGB N9ZRM N9ZUO W9ZWI W9ZYM Reida Gabrielson, W. D. Henry, P. G. Hill, R. W. Martin, W. R. Pueschel, C. P. Snyder, C. X. L. Westlund. Eleventh Naval District: W5ETM W5GSD N8ALO W6DCJ W6DQZ W6ELC W6FJK W6GTM N6HOS W6KOL W6LXQ W6MTS W6MXN W6NRP N6NYN W6RNB W6TE W6WV W7GME W9HIT R. B. Riddell, R. A. Wood. Twelfth Naval District: W6BFF W6BYS N6CHL W6CVR W6DJQ W6EEH W6EQY W6EY W6FYR N6GUR W6HSA N6LMZ W6NDY W6NGY W6OGJ W6OWV W6PGH W6PMY W6QPM W6QQU W7BAT W9JWC N9RS C. E. Armistead, P. W. Gentine, R. E. McCarthy, J. S. Prichard. Thirteenth Naval District: N7ACE W7AND N7ANN W7ANU W7BMB W7CKG W7CZY W7DJJ W7EBS W7EKW W7EQC W7EWT W7EYZ W7FHY W7FRS W7GCA N7GEV W7GNJ W7GVH W7GKW W7HD W7HIU W7HLL W7HRM N7SY N7TK W7WC H. E. Daugherty, J. V. Ellis, D. W. Graf, H. G. Halleck, D. R. Hutton, L. F. Jordan. Fourteenth Naval District: K6NSD. Fifteenth Naval District: E. W. Lockwood (NY1AA). Miscellaneous: K7AIF K7DOS K7EOH VE2AY VE2JG VE3AJN VE3GT VE4AJC VE4UN VP9X.

Voice Wave Polarity

(Continued from page 17)

means a new and bigger plate supply along with more driver power, better insulation, and probably new coupling components. That, or a new modulator system giving the requisite output at more reasonable voltages.

Much the same considerations apply to the Class-C stage. Unless the tubes have been operated conservatively, the chances are against their being able to deliver peaks of nine times the carrier power, simply because of filament emission limitations. However, assuming that it is possible, greater driving power becomes necessary. The usual limit of Class-C operation is an operating angle of 180 degrees (cut-off bias) at the modulation peak, or twice carrier plate voltage. In the case of 200% upward modulation, the bias should be set for cut-off at three times the carrier plate voltage. In turn, this means that the bias should be about 50% higher than the correct value for 100% modulation. The grid current will be about the same in both cases, since, while it may be necessary to drive the grid somewhat more positive to cause more plate current to flow, the

(Continued on next left-hand page)

W6GRL

Contacts more foreign countries than any other amateur station in the world

All contacts verified — See QST Century Club ratings

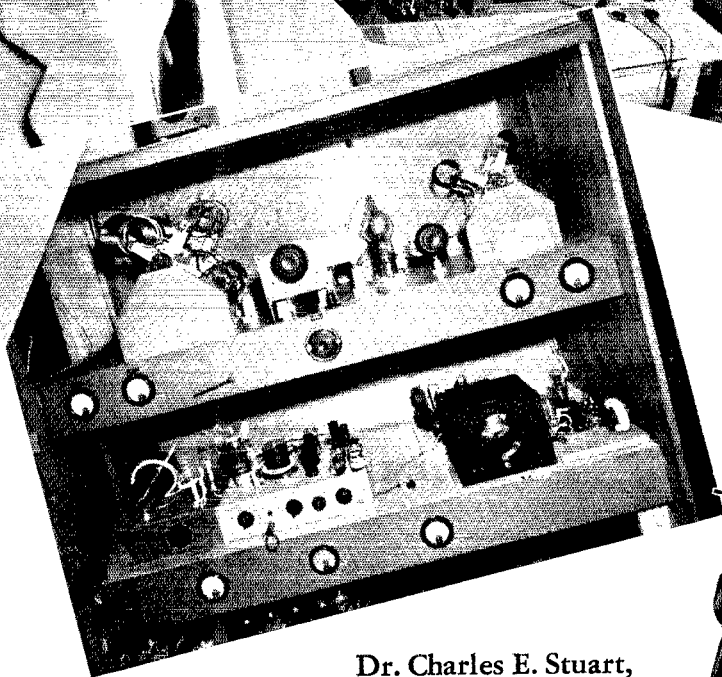

Dr. Charles E. Stuart, (affectionately known as "Doc") is perhaps the best known radio amateur in the world. His fine, clean-cut sigs and record breaking DX results can be traced directly to the pair of Eimac 250T tubes in the final of his transmitter. "Doc" is on the air regularly operating both phone and CW... a schedule with him and you'll understand why amateurs who use Eimac tubes stand the best chance of stepping out ahead of the crowd on the amateur band.

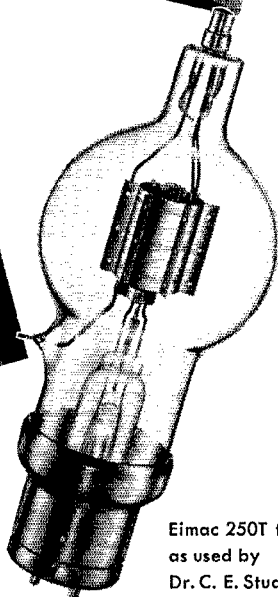

Eimac 250T tube as used by Dr. C. E. Stuart

Eimac
TUBES

EITEL-McCULLOUGH, Inc.
San Bruno, California

Mims News

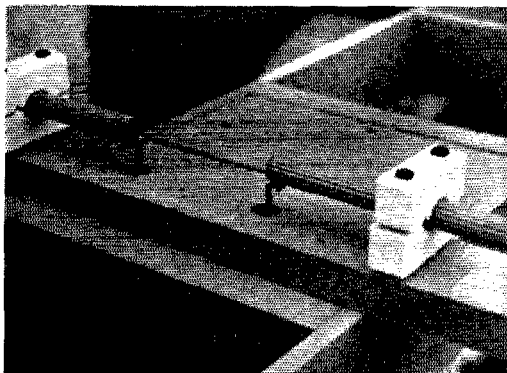

ELEMENTS and INSULATORS

- Finely Corrugated
- Tensile Steel
- Copper Plated
- Tapered Telescope
- Triple Coat
- Synthetic Enamel
- Minimum Sag
- Low R-F Resistance
- Rugged and Novel
- Design Porcelain
- White Glaze Finish
- No Metal Contact
- Easily Mounted
- Positive Support
- Locking Faces
- Makes Tuning Easy

Dear OM's:

The Gadget to the right is the Dual Array Selector relay. It is mechanically latching with electrical resetting. A single pulse to either solenoid shifts the transmission line to the other array. Its quarter inch silver contacts are rated for 15 amps. The price complete is \$17.50 or the unit less housing, etc. is \$11.50. Shipment is made immediately on receipt of your distributor's order.

Since getting settled into our new plant, all orders have been shipped within three days' time and over 75% on the day the order is received. Place your order with your distributor now.

73,

M. P. MIMS, W5BDB

See Your Distributor

MIMS RADIO CO.
SIGNAL SQUIRTER
PRODUCTS
TEXARKANA ARK. TEX.

period during which grid current flows will be somewhat smaller. On the whole, an increase in driving power of the order of 50% or more would be necessary. Many transmitters have an ample reserve of driving power, but many do not. In any event, the grid dissipates 50% more heat, continuously, and a hot grid frequently leads to emission troubles. The filament emission question could be dodged by increasing the plate voltage, lowering the plate current to maintain the same carrier input, and rematching the modulator to the Class-C stage, providing the tubes and tank condenser will handle the increased voltage without breakdown. Again a new power supply comes into the picture.

It is true that neither peak currents nor peak voltages reach the levels they would if normal design methods were used to provide a carrier for the larger modulator. However, still sticking to the 2:1 signal peak ratio, the voltages and currents are equivalent to those that would occur if the power input were increased 2.25 times, maintaining the same plate-circuit resistance. We doubt if the average ham transmitter would be capable of more than doubling its power without a breakdown somewhere. Boiled down, it seems that to make a bigger noise in the world a bigger transmitter is necessary. There is, of course, very little novelty in that thought. Operation of the type shown in Fig. 2-C is not something which can be applied to any existing transmitter, but requires redesigning and rebuilding along markedly ample lines.

Operating on the Signal

All this naturally leads to the question: If the regulations permitted, and the means were at hand for redesigning and rebuilding to meet the requirements imposed by operating the transmitter as in Fig. 2-C, would it be worth the trouble? We think not. There are other means of making full use of the carrier.

As mentioned earlier, the preservation of the peak ratio depends upon the audio amplifier's having the proper frequency and phase-shift characteristics. If, without changing the energy content of the wave, by varying one or both of these two it becomes possible to make the peak ratio close to unity at the output of the modulator despite a high ratio at the output of the microphone, an increase in side-band power equivalent to that given by the enlarged lop-sided modulation of Fig. 2-C can be obtained. A shift in phase alone is capable of doing it without changing the "quality" of the signal, since, under most circumstances, the ear is insensitive to changes in phase. Changing the frequency characteristic also is promising, since elimination of some of the frequency components in the wave will change its shape. As a general proposition, there will be a tendency to approach unity peak ratio when the phase or frequency characteristic of the amplifier is changed simply because this process makes the phase relationships between the various frequency components more or less random while the high peak represents a rather special case. There arises,

(Continued on next left-hand page)



**THE RECEIVER:
WHY YOU SHOULD
BUY IT:**

It's the new HALLICRAFTERS SUPER DEFIANT, Model SX-25

You owe yourself the enjoyment and convenience of a modern receiver! Engineering advances have made possible much better reception at lower cost. The SX-25 certainly proves this — two stages of preselection, drift compensated oscillator, automatic noise limiter, calibrated bandspread, six-step crystal filter, twelve tubes, good audio response and sock, and many more worth while features —

all for only **\$99.50** complete!

WHERE TO BUY IT:

From me, because you can be sure that I'll do everything I can to make you glad you dealt with me. And that means *after*, as well as *before* the sale is made!

I've arranged to have plenty of these FB receivers all ready for immediate shipment right from here or from Hallicrafters. Prompt Service!

HOW TO BUY IT:

Send me your order and I will deliver your receiver without any delay. You can send the full amount; or just a deposit, with the balance C.O.D.

Or buy it on my EASY PAYMENT PLAN. It's one of the *easiest* in the country! A down payment of only \$14.90 brings you the complete receiver. Then pay \$7.50 for twelve months (or \$6.44 without the speaker). I can arrange other easy terms on this or any other Receiver, Xmitter, Kit, parts, etc.

And if you want to trade in your old set, I guarantee to give you as good or better an allowance as you can get *anywhere!*

Remember! — With my TEN-DAY FREE TRIAL you don't keep it unless you like it.

I'll be looking for your orders and letters.

Tax es 73,

BILL HARRISON, W2AVA

Authorized Factory Distributor of

**ALL AMATEUR RECEIVERS,
TRANSMITTERS, KITS, TUBES, PARTS,
AND EQUIPMENT**

FREE BUYING GUIDE

★ If you usually buy by mail, write for my new free Amateur Buying Guide. You'll find its 164 pages a real help in making up your orders. And I will ship those orders *within four hours!*

Since 1925 — "Harrison has it!"

HARRISON RADIO CO.

12 WEST BROADWAY • NEW YORK CITY

WOrth 2-6276

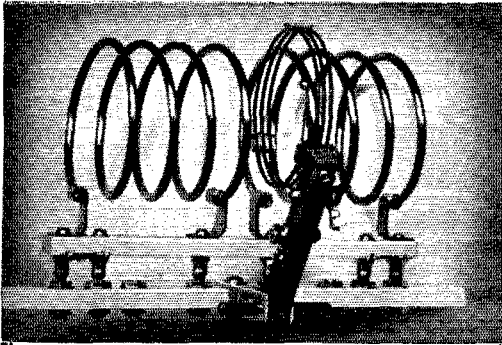

Now! 500-WATT VARIABLE LINK AIR INDUCTORS!

THE new B&W Type TVH 500-watt Variable Link Coils are designed for optimum L/C ratios from 10 to 160 meters with condensers of the Cardwell XE-160, 70-XQ or FEX types; or by combining 50-50 split stator condensers in conjunction with 25 and 50 mmfd. fixed air or vacuum condensers for all-band operation.

The 10-meter TVH and the TVH Base Assembly are illustrated above. 20, 40, 80 and 160-meter TVH's are also available. All feature a novel plug and jack arrangement which makes proper capacity selection automatic. They're the "hottest" arrangements for those 500-watt rigs you've ever seen — and the coolest coils! Send for details — or see them at your jobber's. (Ask him to show you the new TA and HDA Antenna Coils, too!)

BARKER & WILLIAMSON

Radio Manufacturing Engineers • ARDMORE, PENNSYLVANIA

IF you would like the personal coaching of the man who trained the "75 w.p.m. code men" — send the coupon. He will make a speed artist out of you — or refund the modest fee.

IF you would like to copy several words behind on a mill without fuss or worry, that same internationally known expert will coach you — and guarantee you get the results you want.

IF you are new as a Ham, but would like to start off with an expert's rating — the Junior Course of Instruction will start you off on the right foot.

WALTER CANDLER
has trained thousands of experts, including the present World's Champion and Runner-up. His coaching is *personal and guaranteed*.

FREE "Book of Facts"
— an interesting book — describing the course in detail will be mailed to you *without obligation*. Write TODAY!



CANDLER SYSTEM CO.
DEPT. Q-2 ASHEVILLE, N. C.

therefore, an averaging effect which tends to iron out irregularities. Conversely, a wave starting with unity peak ratio, such as those from microphone No. 3 in Fig. 1, often tends to show an increase in peak ratio after passing through a frequency- or phase-distorting amplifier.

The chap with an inexpensive microphone appears to have an advantage over his higher-quality brother, since the voice energy turned out by his microphone is more symmetrical at the start. Hence he can modulate his carrier more fully. However, it is rather difficult to evaluate this advantage since the energy content of the outputs of the two microphones is not likely to be constant, because of differing response curves.

Phase and frequency shifting are only one answer, and really belong in another subject to be considered in an early issue. There is a simpler, but highly effective, alternative method. Its application goes back to the nature of the speech wave-form.

Fig. 4 gives drawings of several speech waves sketched directly from oscilloscope patterns. (Photographing is difficult because no voice can hold an unvarying wave-shape long enough to permit a good exposure with the trace fine enough to show detail.) Subject to minor inaccuracies inevitable in making a pencil reproduction of a continually changing pattern, they are nevertheless typical of the speech wave-forms observed with practically every type of voice when the horizontal linear sweep oscillator of the 'scope is locked in at the fundamental voice frequency. Each pattern represents one complete cycle. Although different voices differ considerably in the patterns they produce, they all turn out to be alike in producing but one or two really high peaks per cycle, these occupying a comparatively small part of the time of the cycle. These drawings all have been made to the scale of a down-peak of unity, indicated by the lower dashed line. The abscissa for up-peaks of unity is represented by the dashed line above the solid zero axis.

Now the energy in the wave is determined by the area enclosed between the curve and the zero axis. It is obvious from inspection of the drawings that in all the waves the energy in the up-peaks beyond the unity peak ratio line is very small indeed compared to the total energy in the whole cycle. (The waves shown, incidentally, represent as varied types as could be obtained.) It was suggested by K. B. Warner³ that, since the energy in the part of the wave above a 1:1 ratio is so small, it should do no harm simply to chop off the peaks, thus turning the wave into one with unity peak ratio. This could and would modulate the carrier 100% in the normal way. After all, it does seem a bit unreasonable to have to provide four times the power capability in the modulator simply to take care of a peak which contributes only a few per cent to the total speech energy. In the ideal case where practically no energy is

³ Along with the thought that most of us probably are doing it already anyway, in the attempt to keep the average modulation level as near 100% as possible, which is no doubt perfectly true.

(Continued on next left-hand page)

DOWN GO DOWN PAYMENTS!

Orders as low as \$25 for sets or parts now included as Newark's astonishing NEW LIBERALIZED CREDIT PLAN offers Lowest Down Payments.

Most Popular Priced Sets
Heretofore Sold for Cash Only
NOW as low as \$5.90 down!
* * * * *
All Previous Down Payments
NOW SLASHED IN HALF!
* * * * *

Only 10% DOWN on purchases of \$50 or more.

Only 20% DOWN on purchases of \$25 to \$50. Add 6% carrying charge to balance and divide into monthly payments as desired up to 12 months and providing no monthly payment is less than \$5.00.

IMMEDIATE SHIPMENT as soon as credit is approved. Entire transaction complete in one week. **FIGURE YOUR OWN DOWN PAYMENT AND EASY TERMS** from prices listed below. Include all the sets and parts you need and **ORDER TODAY DIRECT FROM THIS AD**, enclosing only the small down payment.

AEROVOX

Oil-impregnated and Wax-Filled in Rectangular Metal Cans

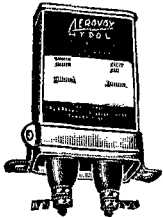

Discontinued by AeroVox. Closing out at these low prices While Stock Lasts!

Recommended for use where economy is a necessity. Come Complete with Universal Mounting bracket as illustrated.

Type 1011 — 1000v. D.C.W.
Mids. L.W.D. Net
1 2 1/4 x 1 13/16 x 1 1/16 \$1.08
2 4 x 1 13/16 x 1 1/16 1.47
4 4 1/4 x 2 3/8 x 1 3/16 1.96

Type 1511 — 1500v. D.C.W.
14 x 1 13/16 x 1 1/16 \$1.43
2 4 1/4 x 2 3/8 x 1 3/16 1.96
4 4 1/4 x 3 3/8 x 1 1/4 3.18

Type 2011 — 2000v. D.C.W.
Mids. L.W.D. Net
1 3 1/4 x 2 3/8 x 1 3/16 \$1.72
2 4 x 3 3/8 x 1 1/4 2.40
4 4 x 3 3/8 x 2 1/4 4.56

Type 3011 — 3000v. D.C.W.
1 4 1/4 x 3 3/8 x 2 1/4 \$2.45
2 4 1/4 x 3 3/8 x 3 3/16 4.85

CABINET BARGAIN
Complete with front panel to match. Only \$2
Black crackle finish, heavy gauge metal. Hinged top, floor, 12 1/2" high, 19" wide, 11 1/2" deep. Just right for an office table, model 102. For that mobile 102-X-1.
Chassis to fit this cabinet, 10" x 17" x 3".
80c

YOUR CALL LETTERS IN GOLD! 10c
Big slowdown decautomation letters nearly TWO DOLLARS high. Put them on your FAXES. SHACK door, auto window, etc. Send time for yours today. Be sure to give your call letters.

FREE!
NEWARK'S BIG NEW 84 page Catalog
Thousands of items for the Ham. Sets, parts, accessories and supplies fully illustrated and described, with lowest prices.

NATIONAL

NC101X or NC101XA
WITH NEW NOISE LIMITER

National NC101X, NC101XA, and NC100XA are now equipped with noise limiter at no extra cost!

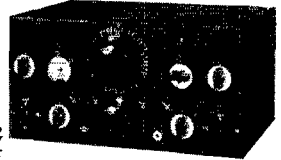

Choice of Direct Reading or Micrometer Dial. **\$129.00** Cash Price.

OTHER RECEIVERS AVAILABLE ON OUR FAMOUS 6% TIME PAYMENT PLAN

ALL SETS COMPLETE READY TO USE

Shipped in Brand New Original Unopened Factory Cartons. Order Direct from this Ad. Include sets and parts in same order, on Newark's Time Payment Plan.

| | Cash Price |
|--------------------|------------|
| NATIONAL NC100XA | \$142.50 |
| NC44 | 49.50 |
| NC80-81X | 99.00 |
| HRO DeLuxe | 179.70 |
| RME 70 | 138.60 |
| 99 | 152.88 |
| 70DB20 Combination | 181.80 |
| HAMMARLUND HQ120X | 138.00 |
| HALLICRAFTERS | |
| SX 24 | 81.50 |
| SX 23 | 127.50 |
| Sky Buddy | 29.50 |
| S-20-R | 49.50 |
| Sky Rider 510 | 69.50 |
| Sky Rider Marine | 64.50 |

Oil Filled, Oil Impregnated FILTER CONDENSERS

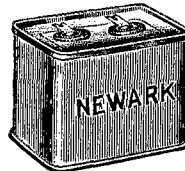

Now only **\$1.00**
1000 v. DC. 2 infd. 2 1/4 x 1 1/4 x 1 Weight 1/2 lb.

Guaranteed at rated voltages

| DC Volt | Mfd. | Size | Wt. | Price |
|---------|------|-----------------------|------------|--------|
| 2000 | 2 | 4 7/8 x 3 1/2 x 1 1/4 | 1 1/2 lbs. | \$1.50 |
| 1250 | 3 | 3 1/2 x 3 1/4 x 1 1/4 | 1 1/2 lbs. | \$1.25 |
| 1500 | 3 | 5 x 3 1/4 x 1 1/4 | 1 1/2 lbs. | 1.50 |
| 1500 | 4, 4 | 5 x 3 1/4 x 1 1/4 | 1 1/2 lbs. | 1.75 |
| 1500 | 5 | 3 3/4 x 3 1/4 x 1 1/4 | 1 1/2 lbs. | 1.90 |
| 2000 | 5 | 5 x 3 3/8 x 3 3/8 | 2 1/2 lbs. | 2.75 |

These are well-known makes and only a few left of each.

* * * * *
Complete JAMES MILLEN line NOW IN STOCK
ORDER DIRECT FROM THIS AD TODAY

NEWARK

Electric Company

323 W. MADISON ST.
Dept. Q CHICAGO, ILL.

BROWNING Components for FREQUENCY MODULATION RECEPTION IN STOCK AT HARVEY'S

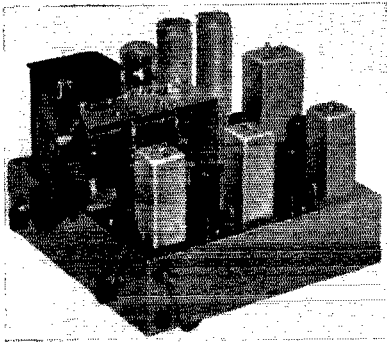

Receive Frequency Modulation Stations On Your Present Receiver

Browning Frequency Modulation Adapter consisting of RF, IF, and detector system, may readily be connected to the audio amplifier of your receiver and placed in your present console. You can also readily construct a complete receiver. All that is needed is the BL-3000A, BL-40T, and a few additional components.

WIRED IF AND DETECTOR SYSTEM — 3 Mc. broad-band IF amplifier consisting of a portion of the RF amplifier and mixer circuit, two IF stages, limiter, detector system, and output volume control with a.c. switch, built on 10 1/4" x 9 1/4" x 2 1/4" chassis with all holes punched for RF Tuner, power supply and push-pull audio power amplifier. IF amplifier wired and carefully aligned.
Type BL-3000A (less tubes) — *Amateur Net Price*.....\$24.90

HIGH FREQUENCY TUNER — High frequency RF Tuner, wired, and aligned. Consists of a tuned antenna circuit, one stage of radio frequency amplification, and an oscillator circuit. Frequency range from approximately 40 to 54 Mc.
Type BL-40T — *Amateur Net Price*.....\$11.70

INDIVIDUAL COMPONENTS AVAILABLE FOR CONSTRUCTING BROAD-BAND 3 MC. IF AMPLIFIER AND FREQUENCY MODULATION RECEIVER:

3-Mc. IF and Detection Transformers with band widths of 200 Kc. for High Quality noiseless reception.

3-Mc. broad-band Interstage IF transformer — BL-3M — *Amateur Net Price*.....\$1.20

3-Mc. Detection transformer (air tuned) — BL-3D — *Amateur Net Price*.....\$3.75

(The IF amplifier, limiter and detector system requires three Type BL-3M and one Type BL-3D transformers.)

4" Sun-Ray Finish, nickel silvered vernier drive dial for Tuner. Type BL-40V — *Amateur Net Price*.....\$2.10

Chassis — 10 1/4" x 9 1/4" x 2 1/4" with holes punched for RF Tuner. (BL-40T), 3-Mc. broad-band IF amplifier, power supply, and audio amplifier. Type BL-100C — *Amateur Net Price*.....\$2.70

WRITE FOR DETAILED LITERATURE

MARION METERS

3-Inch, square bakelite case; 0-1 MA. Ideal for field strength indicator, output meter, R meter, etc. Also available with 2500 DC V. scale. *Amateur Net Price*.....\$2.85

POLYSTYRENE

| | |
|----------------------------|-----|
| 4 x 4 x 1/16..... | 48c |
| 4 x 4 x 1/8..... | 54c |
| 4 x 4 x 3/16..... | 59c |
| 4 x 4 x 1/4..... | 59c |
| 2 ounce bottle cement..... | 29c |
| 4 ounce bottle cement..... | 39c |

★ W2KWY, W2LJA, W2BQL, W2IJL ★

OUR *Best* VALUE IS OUR RECORD OF LOYAL SERVICE

HARVEY

Radio Company of New York

103 WEST 43rd STREET • NEW YORK, N. Y.

CABLE ADDRESS: "HARADIO"

lost by clipping the peak, this procedure would give an increase in side-band power equal to that given by operating the transmitter as shown in Fig. 2-C — 6 db for a peak ratio of 2:1.

Least holy hands of horror be raised at the thought of the distortion that will result from such clipping, we hasten to say that, in the first place amateurs are — or ought to be — interested in communication rather than broadcasting, and second that it takes a keen ear for distortion to detect any difference in the quality. In fact, the reaction of the listener often is that a modulated wave with chopped speech sounds better, probably because the actual modulation is considerably increased when chopping is employed. Using an output meter on the receiver for measurement, the average increase in audio output when chopped vs. unchopped speech is used (both being limited to 100% modulation) is about 4 db with normal talking, which seems quite reasonable in view of the varying peak ratios encountered.

The modulator, of course, is simply one designed according to normal principles of 100% modulation; no extra audio power is necessary, nor does the Class-C amplifier have to be touched.

Side Bands

Peak-clipping brings up the question of whether new side bands are introduced because of the change in wave-shape. Because of the varying nature of speech it is difficult to make any conclusive observations on this, although consideration of the original wave-shape would lead to the assumption that the reverse is likely to be true, especially if the peaks are not chopped off sharply but are more nearly "rounded off." Again checking with a selective receiver, no difference could be detected. To obtain some data, it was necessary to resort to the lop-sided tone mentioned earlier. This represented a rather drastic case, since the peak to be clipped off was much broader than those encountered in speech. Careful checking showed that the original tone had side bands out to the 8th harmonic, but that the clipped signal had them out to the 12th. However, it was easy to confine the clipped wave to the channel space occupied by the original signal, by the simple process of filtering out the higher harmonics with a condenser across the secondary of the modulation transformer, as shown in Fig. 5. This may not be wholly necessary for speech, but it is a good thing to use as a precautionary measure. The value of capacity required will depend upon the circuit conditions, but usually will be in the vicinity of 0.002 to 0.006 μ f. It should be a mica condenser rated to stand the r.m.s. output voltage of the modulation transformer, which is 70% of the d.c. plate voltage on the Class-C stage. An even better scheme is to build out the modulation transformer as described a few months ago in *QST*,⁴ a method which gives a marked cutoff at whatever upper frequency limit may be chosen.

⁴ Bain, "Better Phone Operation without Splatter," *QST*, September, 1939.

(Continued on next left-hand page)

the new hallicrafters Super DEFIANT model SX-25

*FEATURES of the New Super DEFIANT
model SX-25*

- TWO STAGES PRESELECTION ● Separate calibrated bandspread dial ● Compensation in oscillator circuit for frequency stability ● Automatic noise limiter
- SIX-STEP VARIABLE SELECTIVITY COVERING WIDER RANGE FROM EXTREME CRYSTAL TO HIGH FIDELITY ● Push-pull output ● S. meter calibrated in "S" and DB units

● *General Comments:* The two RF Preselection stages provide exceptionally high image and signal to noise ratios. The push-pull output stage furnishes 8 watts of audio at the 5000 ohm terminals. This power combined with the wide range of frequency response obtained by greater expansion of IF stages provides high fidelity reproduction in the broadcast band and better performance throughout the higher frequency ranges.

Complete with TUBES, CRYSTAL and PM 23 SPEAKER, net to amateurs..... **\$99.50**

... for a full measure of value and an extra measure of service ...

HARVEY RADIO COMPANY

103 west 43 Street

New York, N. Y.

Cable Address: HARADIO

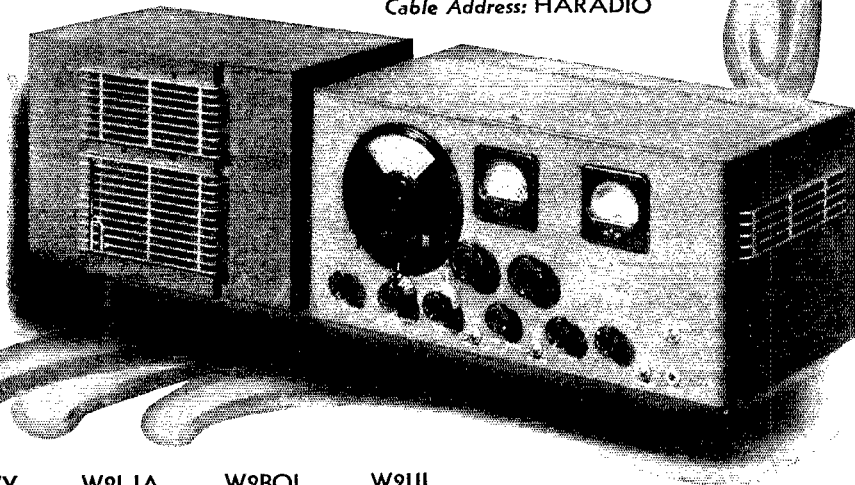

W2KWY

W2LJA

W2BQL

W2IJL

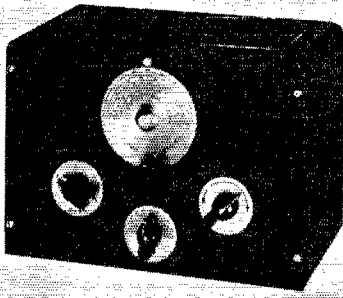

MORE SIGNAL LESS NOISE

- Using an 1852 tube, a gain of 1000 or more and image rejection ratios of 500 or more may be obtained
- Coverage from 1.6 to 64 MC with band switching
- Electrical bandspread ● Regenerative circuit with exceptionally smooth control ● Built-in filament transformer ● May be used as Short Wave Converter
- Completely wired and tested, Type 5DXP, Net Price \$16.50, less tube ● Also available in kit form, Type 5DXK, Net Price \$13.50 complete except for tube ● Send for Bulletin 103-A

BROWNING LABORATORIES WINCHESTER, MASS.

TILTING HEAD—REMOVABLE CABLE SET ON THE NEW TURNER 22D DYNAMIC

The mike for the man who wants the most for his money. Fully shielded for ham use, and rugged enough for the toughest P.A. job.

Only
\$20.00
List

High Impedance with 8-ft. cable set Add \$1.50 for 25-ft. cable set Deduct \$1.50 for 50 ohm model Get both style and performance at low cost, with this trouble-free operation Turner mike. A amazingly low feed-back. Packed with wiring diagrams and chamollette mike bag to protect the rich satin chrome finish. Looks twice the price, and gets Broadcast quality reports.

Level
—54DB
Range
40-8000
cycles

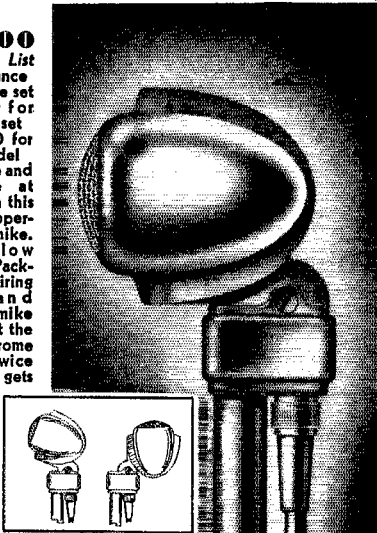

Send for Free Mike Catalog

THE TURNER CO. 904 17th St. N. E.
Cedar Rapids, Iowa

There are two important things to keep in mind about peak-clipping, or limiting. It *must* be done in the audio system, so that any new side bands, if they exist, can be filtered out before reaching the Class-C stage. Also, utilizing non-linearity in the Class-C stage for peak chopping is against the regulations since it constitutes modulating an amplifier in excess of its modulation capability. Second, the polarity of the modulating signal must be such that the up-modulation peak is clipped. On the down side it is too likely to cross the axis and cut off the carrier, producing side bands that cannot be filtered out. Correct polarity, as already mentioned, is simply a matter of output-transformer secondary connections.

The ordinary saturating type of limiter circuit can be employed for peak clipping, but in many cases it will not even be necessary to install one of these. A very effective scheme is to make use of the flattening-out of the modulator above its peak output capacity, which is simply a question of making sure that the modulator is not capable of swinging the carrier more than 100% in the up direction. As pointed out, this will already be the case in the majority of amateur transmitters. If there is an excess of audio power available, the Class-C input can be increased to consume the whole output at 100% modulation, or else the modulator plate-to-plate load resistance can be increased to give the desired effect. The latter is done most simply by increasing the primary-to-secondary turns ratio of the output transformer.

It is necessary, of course, to have an oscilloscope, preferably one with a linear sweep, to check and set operating conditions. Connect the transmitter to a dummy antenna, couple the 'scope and get an unmodulated carrier of suitable size on the screen. It is advisable to calibrate the screen, which can be done by ruling five uniformly-spaced parallel lines on a piece of cellophane from a cigarette package and fastening it over the face of the tube. With no r.f. input, adjust the 'scope and the cellophane so that the horizontal trace on the screen coincides with the center line of the calibration. Next, adjust the r.f. input to the vertical plates of the 'scope until the unmodulated carrier exactly fills the space between the first line above and the first line below the center line. The two outer lines then represent the limits of 100% upward modulation. Downward modulation of 100% is of course represented by the modulated wave's touching the center line.

Now speak into the microphone and watch the screen closely. If the microphone and amplifier are fairly good it will be found that, with low percentages of modulation, the modulating wave-shape obviously extends farther in one direction than the other. If the longer peak does not extend toward the 100% up-modulation line but travels toward the center or zero line, the modulator output transformer connections should be reversed. In making this test be sure to use a small percentage of modulation so that any flattening-off effects which may be present in the modulator or r.f. amplifier do not confuse the results.

(Continued on next left-hand page)

BUY *the new Super Defiant* from Bob Henry, W9ARA

DURING the last ten years I have sold more than 10,000 amateur receivers. I have satisfied my customers and won thousands of new customers everywhere. And I have learned what receivers amateurs like. The SX-25 Super Defiant is such a receiver. Write to me for complete technical information on it or any other set.

Write me about your wishes and I will help you get the right receiver and will personally cooperate with you to see that you are 100% satisfied.

YOU get ten day free trial — you don't buy unless you are satisfied.

YOU get 6% terms financed by me with less cost — less red tape — quicker delivery.

You get big trade-in for your set — describe it and I will tell you its value.

You get prompt shipment in factory sealed carton from the world's most complete stock of receivers. Or shipment from factory if you prefer.

Write me about your wishes. I will send full information. Or send me your order and I guarantee you can't buy for less or on better terms elsewhere.

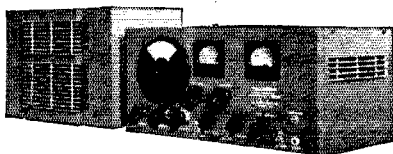

**Prompt shipment of the SX-25
and other sets on ten day trial**

| Model | Cash Price | Down Payment | 12 Monthly Payments |
|--------------------|------------|--------------|---------------------|
| SX-25 complete.... | \$99.50 | \$19.90 | \$7.03 |
| S20R complete..... | 49.50 | 9.90 | 3.49 |
| SX-24 Defiant..... | 69.50 | 13.90 | 4.90 |
| SX-23..... | 115.50 | 23.10 | 8.16 |
| SX-17..... | 137.50 | 27.50 | 9.71 |
| Skyrider 5-10..... | 69.50 | 13.90 | 4.90 |
| HT-6..... | 99.00 | 19.80 | 6.99 |
| HT-1..... | 195.00 | 39.00 | 13.78 |

SIMILAR TERMS ON ALL OTHER HALLICRAFTER EQUIPMENT

I have a complete stock of all amateur receivers, transmitters, kits, antennas, tubes, crystals, parts of all sorts. Send to me for amateur apparatus at the lowest net wholesale price in any catalog or ad. Your inquiries and orders invited.

Bob Henry
W9ARA

HENRY RADIO SHOP
BUTLER, MISSOURI



SPOT

for FEBRUARY

**2 1/2 VOLT — 10 AMP
FILAMENT TRANSFORMERS**

10,000 Volt Insulation
Bracket Mounting — Standard
Construction — Fully Guaranteed
Quantity Limited at this Price!

75¢

KENYON CATH-O-DRIVE Modulation Kits

Model 50 — 5 Watts of audio to modulate 50 watts of RF input. Essential Kit, consisting of all transformers and chokes, punched chassis and cover..... **\$18.37**
Model 150 — Foundation Kit, as above..... **22.32**
Model 600 — Foundation Kit, as above..... **34.43**
Get your copy of handy circular, showing schematic diagrams, list of parts and prices.

MEISSNER DE LUXE SIGNAL SHIFTER

Variable Frequency Exciter Unit.
Voltage regulated and temperature compensated.
Provides stability comparable to crystal control.
Permits quick shift and full coverage of every band — 10, 20, 40, 80 and 160.
Completely wired and adjusted (less tubes)..... **\$44.05**

Browning FREQUENCY MODULATION

Build your Own Frequency Modulation Tuner or Receiver. All parts in stock.
Also available assembled and wired.
Write for your free copy of interesting circuit diagram and price list.

BLILEY XTALS

Our large stock assortment of Bliley Crystals permits you to choose practically any spot frequency you desire in the Ham Bands.
Every type in stock — BC-3, HF-2, LD-2, VF-1, B-5, CF-1, SMC-100.
Free — Bliley list and Amateur Band Chart.

WARD LEONARD ANTENNA RELAYS at Reduced Prices

Mycalex Insulation — 110 V AC Coil — Large, widely spaced contacts — D.P.D.T..... **\$4.75**
As above, and with 2 extra contacts for transmit-receive power..... **\$6.47**
At these reduced prices you can afford to get the best!
Descriptive Ward Leonard circular on request.

NEW PRODUCTS AT SUN

Hallicrafters Super Defiant Receiver
Howard Progressive Series Receivers
Kenyon Cathode Modulation Kits
Hammarlund "200" Super Pro
National (Improved) NC101XA
Frequency Modulation Receivers

All receivers, transmitters and parts are available on Sun's easy terms at lowest charges anywhere.

SEE IT AT SUN

SUN SERVICE

Sun Radio is manned by experienced Amateurs and technical men. We are here to serve you in every way possible. You will find us pleased to render technical assistance on receiving, transmitting and special problems.

☆ EXPORT ORDERS SOLICITED
☆ MAIL ORDERS PROMPTLY FILLED



RADIO CO.

212 Fulton Street, Dept. DT New York

Cable Address: SUNRADIO NEW YORK

Next, having polarized the output transformer correctly, and having found a word which gives a definitely lop-sided wave, increase the gain while speaking the same word into the microphone until down-peak of the wave just touches the zero axis, giving 100% downward modulation. Observe the up-peak at the same time. Probably it will have flattened off considerably as compared to its shape at low modulation. If it flattens off close to the line representing 100% upward modulation, all is well and the only thing remaining to be done is to connect a condenser across the modulation transformer secondary. If the flattening occurs well above the 100% line, either increase the Class-C input or the modulator load resistance, as already described, until the desired condition is reached. If the flattening occurs below the line the transmitter cannot be modulated 100%, which may be caused either by insufficient excitation for the r.f. amplifier or by insufficient audio output. The remedies for these ills are not within the scope of the present story, having been covered many times in *QST* and the *Handbook*.

Obviously, similar methods may be applied to the other types of modulation. Present space does not permit going into detail, so it must suffice to repeat that the peak clipping must be done in the audio system, that simple filtering should be provided to take out any possible extra side bands introduced by the chopping, that the output transformer polarity should be chosen as described, and that the adjustment must be carried out with an oscilloscope. The picture on the face of the 'scope will look the same for any type of modulation. Unquestionably many transmitters already are being so modulated — many even with considerably more drastic peak chopping — and for those we can close with this advice: No one will worry much about what you do to your voice wave-shape so long as you don't make it take more than its share of space in the spectrum. Be sure you don't do your chopping by modulating in excess of 100% downward. Put in an audio filter to wipe out those side bands several kilocycles away from the carrier. You'll get plenty of modulation, and the other fellows won't get monkey chatter.

Strays

Television experimenters in the vicinity of Cincinnati will be interested in the fact that the operators of WLW have applied for a construction permit for a 1000-watt television transmitter.

A bad case of transient parasitics in an 807 stage, which were raising havoc in the form of clicks in the b.c. band, was cured by W8KWA by means of a 0.005- μ d. by-pass condenser from the cold end of the grid-circuit r.f. choke to ground by-passing the grid leak.

Another "ham" has joined the ranks of amateur radio. This time it's Henry Hamm of Youngstown, Ohio, who has drawn the call of W8TAD. — W8FRY.

TERMINAL

IS PLEASED TO ADD THE

NEW hallicrafters SX25

to its complete stock of

hallicrafters RECEIVERS

New Hallicrafters Super-Defiant, Model SX25 — 12 tubes, 2 stages preselection, separate calibrated band-spread dial, automatic noise limiter, six-step variable crystal selectivity, "S" meter, push-pull audio output, PM speaker. Complete... **\$99.50!**

TERMINAL, New York's leading **hallicrafters distributor**, invites you to SEE and HEAR the SX25 at BOTH TERMINAL stores!

TERMINAL RADIO CORP.

68 West 45th Street

▪ 80 Cortlandt Street

NEW YORK CITY



GROSS CB-250 RADIOPHONE TRANSMITTER

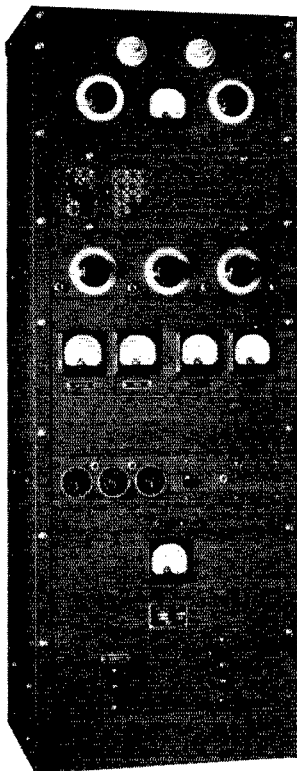

R.F. Line Up — 42 oscillator, 6L6G buffer, two Taylor TZ-40's amplifier. *Speech Amplifier* — 6C5, 6N7, 6N7, two 42's. *Modulator* — Two TZ-40's, separate power. *Power Supply* — Two 866 Jrs, one 83. *Antenna Unit* — Self contained antenna tuning unit. *Frequency Coverage* — 1.7, 3.5, 7, 14, 30 mc. *Power* — Radiophone and CW 250 watts input. *Cabinet* — Floor model, extremely compact size, finished in rich gray wrinkle lacquer.

Write for descriptive literature giving full details.

Profit by getting our prices before buying your Transmitter

GROSS RADIO, INC.

51 Vesey Street

New York

Cable Address: GROSSINC

The RADIO AMATEUR'S LICENSE MANUAL

Going after your first ham "ticket"? You need the manual for its instructions on where to apply, how to go about it in the right way — and, most important of all, for the nearly 200 typical license exam questions and answers.

Already licensed? The manual is still necessary for its dope on renewal and modification procedure, the Class A exam (with typical questions and answers), portable procedure, etc.

ALL the dope on every phase of amateur licensing procedure, and, of course, the complete text of the new regulations and pertinent extracts from the basic radio law.

25c postpaid (No stamps, please)

THE AMERICAN RADIO RELAY LEAGUE

West Hartford, Connecticut

Hints and Kinks

(Continued from page 81)

cycle side band. Depending upon the possible signal voltage ratios and aural sensitivity, a third point may be found at 1320 cycles. Returning to reference zero, this position should then be rechecked and, proceeding in the negative direction, similar points are determined. The Wednesday WWV emissions may be used to determine 500-, 1000- and 2000-cycle points.

Since a great many amateurs possess receivers which skip the WWV frequencies, they must utilize auxiliary apparatus for calibration, preferably a laboratory b.f.o. oscillator having good wave form or, as second choice, an audio oscillator. Either unit must be accurately calibrated. In this method, the receiver is first tuned exactly to some steady carrier of good quality and frequency stability, such as the crystal oscillator of the transmitter, and the b.f.o. is adjusted to zero beat at mid-scale as previously described. The audio oscillator is fed simultaneously into the headphones, or a separate speaker for each may be used. Starting with zero, the audio oscillator is set at 100-cycle points and at each setting, the b.f.o. is carefully adjusted to zero beat with the audio oscillator signal. The b.f.o. scale is marked at each 100-cycle point.

Provided an accurate source of audio frequency is available, some may prefer this second method of calibration. The continuously variable source of frequency makes for full-scale calibration and is more flexible than using 440 or 1000 cycles with their harmonics.

With either method, sufficient points should be found to determine the full-scale calibration. The appearance of the scale depends on the shape of the b.f.o. condenser plates. If the 440-, 880- and 1000-cycle points are equally spaced around the scale, the intermediate points may be determined on a straight-line basis. If, on the other hand, sections of the scale display a tendency to cramp several hundred cycles and other portions spread out the same range, a continuously variable source of frequency should be used for calibration, or the b.f.o. condenser replaced with a unit having more straight-line characteristics. Of course, the receiver itself should have good short-time frequency stability and not be subject to appreciable frequency change with a sudden change in line voltage. A voltage-regulated supply for the receiver is preferable.

The receiver with the desired set of coils in place should be allowed to warm up several minutes before calibration or before using this feature as described later. Since some volume or sensitivity controls cause slight frequency changes as they are varied, it is advisable not to alter this adjustment while making frequency measurements.

At this point it might be well to point out that it is possible to get a 5-kc. check point between the 10-kc. divisions supplied by the multivibrator. It is generated within the receiver and its accuracy is equal to that of the control unit of the

(Continued on page 118)

A PAIR OF ACES

that are always "High"

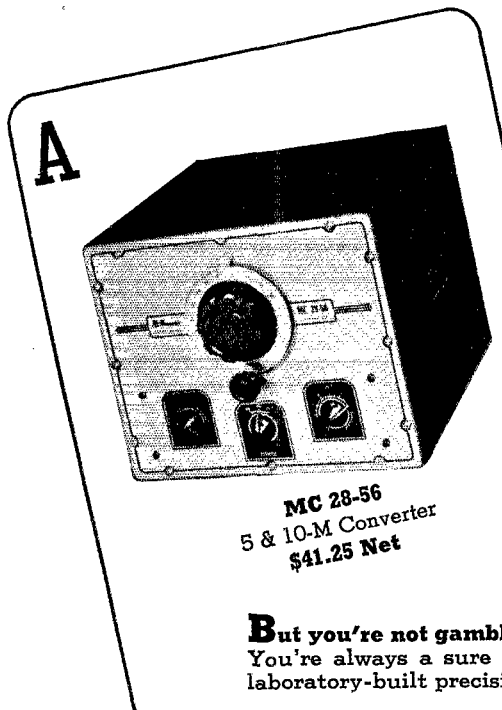

MC 28-56
5 & 10-M Converter
\$41.25 Net



Signal Booster
High-Gain Preselector
\$38.25 Net

But you're not gambling when you buy Meissner!
You're always a sure winner when you use these laboratory-built precision instruments.

You can't be beaten on 5- and 10-meter reception when you use this high-gain converter in front of your present short-wave receiver! A super-het circuit with 1852 RF amplifier, 1852 Mixer and a high-C 6F6 Oscillator with VR-150 voltage-regulated "B" supply provide maximum frequency stability with an average gain of 20-Db. Three-gang, precision-tuned, ceramic-insulated condenser; vernier control of oscillator frequency for fine tuning. Output frequency is adjustable between 6.9 and 7.4 mc. RF Gain Control is provided and provisions are made for connection of separate, high-efficiency antennas for 5-meter, 10-meter and general short-wave coverage; selector switch incorporated with band-switch. Completely assembled (less tubes) and wired; laboratory-adjusted for maximum efficiency. A real instrument for the High-Frequency enthusiast!

TIME PAYMENT PLAN

Either of the instruments described above, as well as many other Meissner products, may be easily purchased on the Meissner Time Payment Plan. Ask your Parts Jobber for details or write direct to the address below.

This four-band Preselector will put you way out in front when it comes to dragging in the weak sigs under difficult conditions. Its average 40-Db gain will make an R-1 or R-2 sig sound like an R-9 plus! Two stages of precision-tuned RF amplification with 1852 type tubes; three-gang, ceramic-insulated condenser also tunes output coupling stage which is matched to the average input impedance of the receiver. Complete coverage from 1,600 to 31,000 kc; accurately calibrated 7¼-inch linear dial scale. Incorporates Compensator and Gain controls and a switch to transfer the antenna directly to the receiver when desired. Furnished completely assembled (less tubes), wired and laboratory-adjusted for peak performance. Bring in those DX sigs you have been passing up; order your Signal Booster today!

WRITE FOR FREE CATALOG

Dozens of other products of interest to the progressive Amateur are described in the big 48-page Meissner catalog. Send for your free copy at once—just clip the lower portion of this ad, write your name and address in the margin and mail on a penny postcard.

Dept. Q-2

 **Meissner** MT. CARMEL ILLINOIS

"A FAMOUS NAME FOR TWO DECADES"

Station Activities



ATLANTIC DIVISION

EASTERN PENNSYLVANIA — SCM, Jerry Mathis, W3BES — 3AGV has the Frankford Radio Club record W.A.S. of 21 hours, 29 minutes. 3BRZ and 3HXA received their W.A.S. tickets. 3BXE and 3KT have well e.c.o. emergency rigs going with single 802 oscillators. 3DRQ worked 30 sections on 3.9-Mc. 'phone in the SS with low power. 3EEW gave up his last crystal for a 1 1/2-kw. transformer, so gangway, 7 Mc. 3FJU, new O.O., made out well in the frequency measuring tests. 3FPC, P.A.M., is about ready with his 1/2 kw. 3.9-Mc. 'phone. 3FXZ required 5 Asian contacts to get her W.A.C. 3GHD is upholding the DX reputation of the Frankford Radio Club. 3GHM is playing with a new vertical. 3GKO is "flooded with traffic." The first test of the 4-watt rig at 3GYK netted a station in Minnesota on 3.5 Mc. 3HFE assisted 3QV in erecting a rhombic aimed at the South Pole. 3HRS likes the new R.C.A. 812's. 3HYD is operating the State Armory station, 3DAB, on 1.75-Mc. The York Road Radio Club has new officers: 3QV, pres.; 3HFE, vice-pres.; 3AJF, treas., 3ALB and 3AKB, secys. The Frankford Radio Club's new officers: 3FRY, pres.; 3BES, Vice-Pres. and Activities Manager; 3CHH, treas.; 3BXE, secy. Director Martin, 3QV, appears to have fully recovered from his operation, for which we are thankful. The local F.C.C. office is demonstrating its ability to apprehend the "bootleggers" hereabouts. Club secretaries, your club news is QST news; advise your S.C.M. of your activities. Thank you.

Traffic: W3ADE 92 3AGV 1 3AKB 263 3BES 15 3BXE 3 3DXC 20 3EEW 51 3EFH 53 3FML 1588 3FJU 9 3FPC 2 3FRY 1 3FXZ 8 3GHM 3 3GJY 510 3GKO 486 3GYK 19 3HFE 2 3HQE 12 3HRS 707 3HXA 6 3HYD 3 3HZK 35 3HZV 18 3IAY 12 3IBG 5 3KJ 2 3NF 85 3QV 14 3RR 3 3ATF 75 8EU 1 8FLA 80 8HKS 11 8RZK 29 8ASW 390 8LZD 106. (Oct.-Nov.): W3BL 6 3EFH 23 3GJY 380 3GUB 2 3HFE 1 3HRS 235 3LAY 15.)

MARYLAND-DELAWARE-DISTRICT OF COLUMBIA — SCM, Herman E. Hobbs, W3CIZ — 3BWT: Chief R.M. 3CXL R.M. Sixteen of the Balto gang attended the hamfest in Washington in Nov. EKZ expects to be on 28 Mc. with 500 watts. The M. & K. Club of Balto voted to change its name to Baltimore Amateur Radio Association. FPK has new 350-watt transmitter. Mr. DeSoto visited with the local hams of Washington and Baltimore and gave us some very interesting talks. BHE is building "QST" Runt-60 for emergency use. BHE reports a QSO with OL, who has been off the air for years. The A.A.R.S. Md. Net is flourishing, and will add three new members shortly. BKZ will bring them up in the way they should keep schedules. CDQ has a weekly schedule with 8CMP. ECP is with us again; the Drs. couldn't find anything more wrong, so they let him go.

Traffic: W3BWT 915 BHE 7 BKZ 191 CIZ 1073 CDQ 9 ECP 94 EZN 3 HUM 161 HQU 113 ICT 46 CXL 533 (WLM 4480).

SOUTHERN NEW JERSEY — SCM, Lester H. Allen, W3CCO — Ass't SCM and A.A.R.S. Liaison R.M.: Ed. G. Raser, W3ZI — R.M.'s: 3BEI, 3BYR, 3EUI — P.A.M.: 3GNU: Section Net frequencies: O.R.S. 3700 kc. O.P.S. 1980 kc. New appointments: ABS, AEJ and IIC O.P.S.; ATF and HAZ O.B.S.; HPX O.R.S.; EUH R.M.; ZI A.A.R.S. Liaison R.M. HAZ is the latest to achieve W.A.S. after chasing Nevada for better than 6 months. DRL, the Trenton Naval Reserve station, is in full swing in its new quarters at the Trenton Post Office Building; CCC holds down the majority of watches. Congratulations to HVO, Southern New Jersey's only YI operator, on her very efficient and FB test with WXED. Very well done, Pauline. The Delaware Valley Radio Assn. held its Christmas Party at the regular Dec. meeting; holiday music was furnished by BWF and his orchestra. An interesting meeting of all amateurs in the Trenton area was held Dec. 9th, when Clinton B. DeSoto gave a very interesting talk on "League Happenings." The South Jersey O.R.S. Net has been rolling along very nicely. Traffic scores have jumped four-fold. The boys responsible for this achievement have been AVJ, BEL, BYR, BZX, CCC, DNU, EFM, EWK, GMY, HLV, HMR, IHD, VE and ZI. New members are

always welcome. IHD has traffic outlets to Canal Zone, West Coast, New England and the South. BZX is consistently high traffic man for this Section. 6LZY is new member of the Greater Camden Amateur Radio Assn. Welcome to our Section. Doc. BYK has been assisting CZN in running down bootleggers in the Camden area. AYZ, pres. of G.C.A.R.A., moved recently to Phila. CFS is quite busy lining up contacts for the W.A.S. award. GNU reports working portable in Easton, Pa., with portable-emergency rig; also the Official Phone Station Net got under way Jan. 9th, with GNU and EUH at the helm. BAQ is trying a little 3.5-Mc. e.w. after being on 'phone for 10 years. AVJ has a very interesting side hobby, that of grinding crystals. 2DBF is operating portable from Evansville. Welcome to South Jersey, Ed. 3IIC is kicking out FB on 1.75-Mc. 'phone. IHO has one of the finest signals on 1.75-Mc. 'phone and uses only 90 watts input to a pair of '10's. ABS reports working all districts on 1.75-Mc. 'phone with his new rig. FMR worked 4EPW's rig while in St. Petersburg, Fla. FWK is busy gathering up traffic totals for ole South Jersey. HPX is doing a mighty fine job with the Army Amateur System. BEI is building a portable rig, using a pair of '10's. IAM is newest amateur in Flemington.

Traffic: W3BZX 387 EFM 240 (WLNJ 17) Z1 178 DNU 141 BYR 118 (WLNJ 5) IHD-GRS 105 VE 78 HKO 65 FUR 63 BEI 59 IIC 50 FMR 49 CCC 46 CCO 46 CFS 39 GRW 35 GNM 30 HAZ 29 ATF 27 ASQ 25 HLV-OQ 24 HPX 24 GUS 23 AVJ 21 EWK 20 FBM 18 IHO 11 HSL 10 AEJ 9 ABS 8 GNU 7 HMK 6 CYY-KY 5 CZN 4.

WESTERN NEW JERSEY — SCM, Fred Chichester, W8PLA — R.M.'s: BJO, CSE, DSS, FCG, P.A.M.: CGU, E.C.'s: GWY, RGA, RVM, SBV. Section Net frequency: 3720 kc. BJO made the B.P.L. with a dandy score. Nice work, Kenzie. NMJ is rebuilding and expects to have 400 watts on 1.75-Mc. 'phone when finished. PSQ is back on 3.5-Mc. e.w. MVQ comes into net occasionally with traffic. KCA, of Kenmore, is on 7 Mc. after a year lay-off. RMR, who has been working some nice DX on 7 Mc. with a Signal Shifter and T20 final, has just finished putting the rig on metal. SVQ expects to be on soon with a portable in Calif. SUY took unto himself a bride, but gets on 56 Mc. occasionally. GWY is getting back into harness again and turns in a nice traffic score. PCN has new junior op.; the handle's Jim. Congrats, Ott. QUN has enlisted in the U.S.C.G. and is stationed on the *Tahoma*, with headquarters at Cleveland. TOG, SBV and DZC took part in the A.R.R.L. Copying Bee. RTW and TXB held 28-Mc. QSO's with a lad on a ship in the Gulf of Mexico. OCY and NOU have added to their list of new states worked. The Sidney Amateur Radio Club has been organized with TEW as pres. and KKP secy. Other members are IUR, FOB, JKR, BQJ, 2JFH and 2CDM. 7 and 1.75 Mc. are popular with the new hams in Buffalo, TWZ being heard on 7 Mc. and TZO, UDD and UEP on 1.75 Mc. CL is now in circulation again, following a trip down the aisle. IUF has been working schedules with the ship WCFT. KYR is off on a trip to Florida and Calif. NWH succeeds MQX as pres. of KBT Radio Club. Buffalo Five-Meter Club is making plans for some "2 1/2-meter" work. LJD got his feeders all tangled up in a recent wind storm. DHU spent a few days in Utica and visited BGO, CTX, AU and LUQ. Press of business forced CSE to give up the S.C.M. job, but he has consented to stay on as R.M.

Traffic: W8BJO 703 CGU 13 CSE 90 FCG 165 JQE 373 JTT 61 PLA 204 RKM 240 SBV 130 SZK 182.

WESTERN PENNSYLVANIA — SCM, Kendall Speer, Jr., W8OFO — Asst. S.C.M. in charge of Emergency Co-ordination, W8AVY. All stations in Western Penna. interested in traffic work and operating on the 3.5-Mc. band are requested to get in touch with 8QAN, Route Manager, concerning work in the W. Pa. O.R.S. Traffic Net. The net operates nightly except Sundays, and crystals are loaned gratis to those who will take a sincere interest and attend regularly. The Naval Communication Reserve is open for enlistments. Main requirements are an amateur license and passing the physical examinations. Southwestern Pennsylvania prospective recruits are invited to drop in at the Naval Armory any Monday or Thursday evening, or drop a letter to the Commanding Officer, Lieut. B. P. Williams, N8ZD, Room 504, Old Federal Bldg., Smithfield Street, Pittsburgh. KWA made B.P.L. on deliveries.

Traffic: W8KWA 380 YA 175 CMP 174 NCJ 123 PX 66 NDE 50 MJK 49 QAN 48 RIT 16 OFO 12 RAP 10 OUT 6 RAT 5.

ROANOKE DIVISION

NORTH CAROLINA — SCM, W. J. Wortman, W4CYB — Greetings! in a New Year, gang. DLT is new N.C.S. on Trunk Line "C." Any traffic North or South can be handled over this line very FB. AKC had receiver trouble for two weeks, but landed in second place traffic slot for this month. EDA is new chief op at N.C.N.G. Armory in Oxford (4ECH). EDA says, thanks to A.R.R.L. QSL Bureau he has some cards from now extinct DX. BMR has new 28-Mc. amplifier and a changeover from one beam to another in an instant. DGV has all cards for W.A.S., but his main interest now is low power on 7 Mc. EY reports fifteen straight contacts on 28-Mc. 'phone the night of Dec. 8, 1939; used 90 watts to a pair of HK-24's. TJ is working 3.5 and 7 Mc. with a QSL-40. DOR worked three W6's on 1.75-Mc. 'phone with 15 watts. QI works 3.9-Mc. 'phone. BBS has new T-55 P.P. amplifier going. AAK has been having lots of fun straightening up a new shack and a new QTH. DDT works all bands with P.P. 801's. FBO and FLT are working 1.75-Mc. 'phone with low power. COC and AYA are on 7 Mc. CYN is back on 3.9-Mc. 'phone with a T-55. EMV finished W.A.S. with 1DQ as R.L. contact. BYA had K6DV as a visitor, and worked two K6's and a K7 on 28 Mc. BIL is about to be heard again on 14-Mc. 'phone, with about 125 watts to a T40. EYH has a new 90-foot tower, and needs help to install a 3-element beam and tune it up. Greensboro seems to be wide open with activity; reorganized club has CS as pres., Len Smith (NC) as vice-pres., AIT treas., AEL secy., and AJT activities mgr. Visitors are welcome to the club at 1406 Glenwood Ave. any time. 1.75-Mc. 'phone fever high with low power and ZH, QO, AJT, AIT, EIW, FLT, FYO, all on. Many of the gang have been sick, physically; some mentally, and lots from an activity standpoint. We sympathize with the first, ask the second to come up to our town, and the third to perk up, make 1940 count for something! And we would be very pleased to hear about all activities. All the best and good luck in 1940.

Traffic: W4DLX 71 AKC 67 ECH (EDA) 52 BMR 11 DSY 8 DGV 7 DGU 5.

SOUTH CAROLINA — SCM, Ted Ferguson, W4BQE/ANG — GMO is new Lancaster ham. Welcome, OM. FFO has regular schedules with DMX. CZA is as busy as ever with T. L. "C" and A.A.R.S. Net. COL will have new rig on soon. EPJ operates mostly 3.9-Mc. 'phone. CQU reports "same old schedules" with DXF and 1LMQ. FMZ can be heard pounding away on 3.5 Mc. AFQ is doing a nice job as Official Observer.

Traffic: W4FMZ 40 CQU 25 AFQ 14 FNC 13 EPJ 12 EJK 11 FFO 10 EXJ 7 CUS 6 EHF 2.

VIRGINIA — Acting SCM, Frank Anderson, Jr., W3GWQ — HNX, IHV, HBO, GTF, FOU and CFV comprise the Southwest Virginia Net on 1.75-Mc. 'phone. Any stations in their part of the state wishing to join are asked to get in touch with HNX. BIG thanks all who assisted in keeping channel clear for traffic during the recent snow emergency in Shenandoah. HME is on 28 Mc. ELJ is back in Covington. GTS schedules HDQ/4 in Puerto Rico daily. IFZ is active in A.A.R.S. as alternate S.N.C.S. and would like to hear from any c.w. station in Va. that is interested in handling traffic.

Traffic: W3IHN 11 GTS 38 BIG 41 ELN 104 (Oct. 16th-Nov. 15th) 3HNX 1 BIG 3 FEM 5 FMY 8 IHN 43 GTS 259 IFZ 267 (Nov. 16th-Dec. 15th).

WEST VIRGINIA — SCM, W. D. Tabler, W8OXO — The S.C.M. thanks those who reported this month, but would like to have more reports from the southern end of the state. PHY has new T-W-150 final. TCP is back on 7 Mc. QBS/8 runs 4 watts to pair of '01A's and works all districts. West Virginia interest and activity is going up: A.A.R.S. 3700-Kc. Net has several new members; Section Net on 3770 meets at 7 P.M. each night except Sunday, with GBF and DYB alternating net control; it has fifteen members, and invites membership. The S.C.M. would appreciate the club secretaries advising him of their present officers, and any changes. New Charleston ham: UEB. BTV has two beautiful 75-ft. cedar sticks. Latest claim for record windjamming: TOK and TJY in 1.75-Mc. 'phone QSO for 7 hours and 43 minutes. New 1.75-Mc. 'phone net on 1878 kc. has TOK, TJY, TQU, SES, TUV, KCY, PNR, ATT, QWM, TRU and UEB, and invites new members. KXB bought new home, with two rooms for ham radio. Oh, me! West Va. and Virginia hams had bull session at home of 31FL, Marion, Va., with 8SKD, SHUK, 9L8T, 3HBO, 3G CZ, 3IHY, 3HNX, 3FOU and the host. ORD is experimenting with television. QQR has T240 final. Huntington unit of N.C.R.

is EZR-PSR-PTJ-QQR. MLW is rebuilding final stage. TGH, PMA and ETX have new receivers. DFA cathode modulates P.P. 809's on 28 Mc. UER, new Clarksburg ham, is one of the ops at WSWV, State Police station. KRU is building a kw. final for 3.5 Mc. SZV, TTA, HTM of Ohio and KXQ of Pennsylvania visited Allen and Sumptine at PME/TID, Bethany College. Page Mr. Ripley: PME has a listening public on 1.75-Mc. 'phone, and gets complaints ONLY when he misses a schedule — the B.C.L.'s finds his QSO's so interesting they watch for his schedules.

Traffic: W8OXO 288 DYB 229 LIJ 76 PSR 59 GBF 39 DFC 37 BTV 27 EHA-TNC 18 JM 16 KEE 11 TID-TOK 8 QBS/8 7 PHY 4 LCN-PMA/8 3 KSJ 2 SKD 1.

HUDSON DIVISION

EASTERN NEW YORK — SCM, R. E. Haight, W2LU — Welcome, HZJ, to our Section. Congrats to your excellent traffic activities. KXF wants checker players to click with him. MHW takes over T.L. "G" from KXF. BEW completed remote control system. KRF reports for Mt. Vernon boys. KRF is running 25 watts input to 6L6 crystal on 7244 kc.; he is member of F.T.S. Net. LEV has left us for the Bronx. LRP is on 1940-kc. 'phone. LQT is a student at M.I.T. LLU tried 1834-kc. 'phone. MJV desires to get in traffic net on 7 Mc. MOU joined A.E.C. 73 — W2LU.

Traffic: W8HZJ 196 KWG 142 KXF 113 MHW 74 LU 48 BEW 18.

NEW YORK CITY AND LONG ISLAND — SCM, Ed. L. Baunach, W2AZV — MLE and JGC are now O.R.S. LYG is out for O.R.S. ITX and LR are on Trunk Line "L" and can take any traffic for the West Coast through the Section Net. EXR schedules the Ohio, W.N.Y. and N.H. State nets daily on 3730 kc. LXX has neglected 28-Mc. LBK has been looking for more power on 28 Mc. LOK moved to 392 Van Buren St., Brooklyn. The active members of the Suffolk R.C. are on the high end of the 1.75-Mc. 'phone band, and are on daily at noon calling themselves the "Fishermans Net." The following can now be heard: ADW, BFA, DOG, KOA, LEB, LNU, LVB, LVN, LXQ, FCH and ICPL. HNY, president of the club, is getting active on "2¼." CHK is working on an oscilloscope. MLE's new rig is 6L6 crystal oscillator and 6L6 final with 45 watts input, 'phone 6C5 and 6L6 modulator for local QSO's. HGO received his Silverstone twelve receiver and says it works FB. LGK is using self-powered emergency rig with .375 watts input on the Section Net. LID has been around visiting ham shacks. KI would like to hear from anyone using commercially built job on the 3.5-Mc. band. IOP is on 3.5 Mc. regularly. KYV is completely rebuilding his rig to use 6L6-HY61-HY40 P.P. AEU received his A.A.R.S. appointment. The call of the Teumen Radio Club is MQU; it is on nightly on 1814 kc. HBO is on every Sunday morning on the Tu-Boro R.C. Net; 1940 officers of the club: pres., HVD; vice-pres., KYV; secy.-treas., HBO, LPJ, president of the Queens Radio Amateurs Club, is looking for members; get in touch with him at 6079 68th Road, Ridgewood. The 73 Club now has permanent quarters at the Jumel School, 870 Riverside Drive (corner 160th St.); meetings are held the second and fourth Wednesdays of every month at 8 P.M. Everybody interested is invited to attend meetings and become a member. For further information get in touch with CWP, SV, AHZ, DGJ, FWX, HDG and LIW are on "2¼ meters." EVZ has a new HQ120X. IDJ moved to Lynbrook. KPM is experimenting with television. Ex-BT, now DRK, rejoined the S.R.R.C. after a sojourn in Bermuda as VP9B. MFW is trying e.c.; he is ex-4FDM. DLT is using 6L6-807 rig. TY is experimenting on "75 cm."

Traffic: W2SC 1124 HMJ 704 IOP 305 ITX 231 (WLNW 116) IZR 215 LR 140 KI 130 AXZ 109 JGC 93 PF 87 AZV 86 LPJ 83 EXR 63 CHK 39 AEU 34 GDF 29 EC 23 LBI 27 LGK 16 MLE 15 AA 14 ADW 13 KYV 12 LID 11 CYB 10 MT 9 LOQ 8 PL 7 CIT 6 ELK 5 BGO-HGO 4 HBO-GRJ 3 DLR-DOG-AZM-CLA 2 DMM-HJT 1 (LPJ 169 Oct.-Nov.).

NORTHERN NEW JERSEY — SCM, Pat Jessup, W2GVZ — R.M.'s: BCX, BZJ, CGG, GVZ, MHP. P.A.M.: HNP. Section net freqs.: 3630 and 7070 kc. JME is new O.P.S. The private war between GSA and JKH resulted in a GSA victory. ZA is trying for a 'phone W.A.S. to hang alongside his c.w. DX C.C. LAG picked up the rig and walked to a new QTH in same town. IQM is active again. KTR and HZY gave up traffic work in favor of other activities. IZP joined A.E.C. BSZ is active on 7 and 3.5 Mc. The Freehold Amateur Radio Club has been formed with BSZ,

(Continued on page 104)

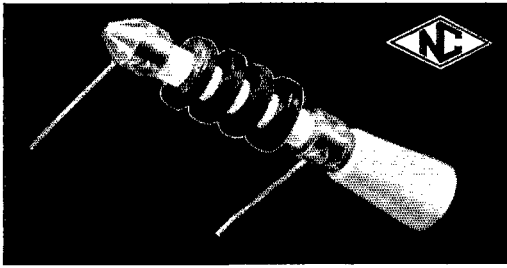

Similar to the well known R-100 Choke in electrical characteristics, the newer R-100U Choke is equipped with a removable standoff insulator for chassis mounting. For pigtail mounting, the insulator may be unscrewed and used for other purposes. Both are rated at 125 MA and have an inductance of $2\frac{1}{2}$ mh. List Price R-100, \$.50. List Price R-100U, \$.60 with standoff.

For currents up to 300 MA (Inductance 1 mh) two additional chokes, R-300 and R-300U, are available. They are not illustrated, but are similar to the smaller chokes described above. List Price R-300, \$.50. List Price R-300U, \$.60 with standoff.

NATIONAL COMPANY, INC.
MALDEN, MASS.

Instant Band Change

(Continued from page 13)

circuits from the plate circuits, which makes neutralization quite simple.

The modulator uses a pair of TZ40's with 1250 volts on the plates and 4 volts bias on the grids, driven by a pair of 2A3's operating Class-A push-pull. The two lower racks make up the power supplies, of which there are three. One has an output of 1500 volts at 300 ma. for the final, another 1250 volts at 300 ma. for the modulator, and a third 550 volts at 250 ma. for the oscillator, doubler, buffer, and audio driver. These supplies, using Thordarson components, are conventional in design.

Tuning Up

Probably the most logical band to tune first is 14 Mc. Press the appropriate button and allow the motor to rotate the switches to proper position. Simply tune the oscillator tank, buffer tank and final grid tanks to resonance; then, in the usual way, carefully neutralize the final. Be very sure that all r.f. is out of the tank, as we don't want to change neutralizing-condenser settings when changing bands.

When completely neutralized, apply plate power and adjust the final tank condenser. When first applying plate power, it is a good idea to connect a resistor in the plate lead to reduce power and prevent possible damage to tubes. Go through the same procedure for all the other bands, except for neutralizing. Be sure, however, to check neutralization on each band. For 10-meter 'phone it will be necessary to use an additional crystal, since a 20-meter 'phone crystal will not be in the 10-meter 'phone band.

While a transmitter of this type may require greater care in construction and may cost somewhat more, this is certainly justified in view of the flexibility of operation. By quick band change, your enjoyment of ham radio will be greatly increased and you can work on bands to which you otherwise only listened. This transmitter was evolved after several preliminary trials and represents the best of four arrangements tried.

On the Ultra Highs

(Continued from page 63)

first monthly report of u.h.f. activity. To simplify reporting we suggest that a set of log sheets for this purpose be kept alongside the regular log, and whenever a new station is worked enter the dope on this sheet, making a carbon copy for your own records. At the end of the month send this log, together with your observations of u.h.f. conditions, suggestions for the column, photos, etc., to Headquarters as your monthly report.

The rules of the 1940 Marathon, given in detail on page 26 of the January QST, were designed to give everyone a chance, regardless of the extent of local activity. We want to know what is going on in all branches of u.h.f. work in every section of the country. We most earnestly urge everyone who works a single station on any u.h.f. band to send in his report. The tremendous volume of correspondence received by your conductor indicates an ever-growing interest in all phases of u.h.f. endeavor. By your complete and regular reporting of your activity you will assist us mightily in presenting the whole interesting story of u.h.f. history in the making. Let's go places in 1940!

"FB" reports on the new type HFM

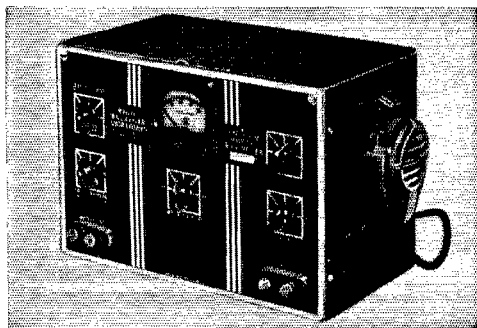

Amateurs, expeditions and others in many countries find the Type HFM ready to deliver whenever needed. Special attention to details and the use of impregnated or oversized parts make this the outstanding job for dependability.

- Six bands with two crystals
- 36 watt input to final RK-49
- 100% plate modulated phone
- Instantly interchangeable for 6 volt or 110 volt power supplies

Net to Amateurs..... \$57.60

Write for bulletins listing complete new line

RADIO TRANSCIVER LABORATORIES
8627 115 STREET RICHMOND HILL, NEW YORK CITY
CABLE ADDRESS: "RATRALAB", NEW YORK

DEPENDABLE

You can depend on Bliley Quartz Crystal Units for reliable operating characteristics and conformity with latest engineering and manufacturing developments. That's because they are deliberately built that way. Correct design is supported by exacting manufacturing standards and the application of rigid inspections during each processing operation. As a final check, each crystal unit is subjected to exacting tests in a loaded oscillator where definite requirements for activity, power and keying must be met.

The LD2 Crystal Unit is an outstanding example of Bliley built-in dependability. This popular mounted crystal for the 80- and 160-meter bands has a frequency drift of less than 4 cycles/mc./°C. and is a highly active oscillator. It can be obtained from your Bliley Distributor for only \$4.80 (within ± 5 kc. of specified frequency or choice from stock). For complete descriptive information, ask for Circular A-7.

BLILEY CRYSTALS

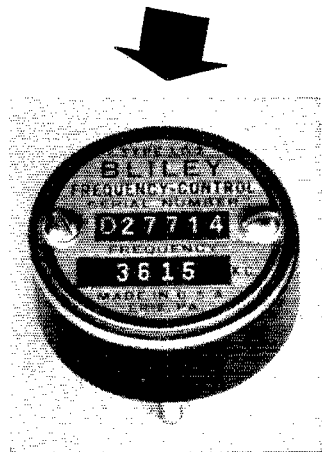

GAMMATRON PIONEERED TANTALUM ANODES

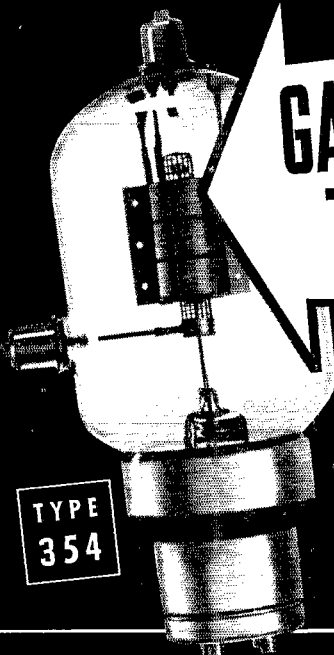

WHAT DOES THIS MEAN TO YOU?

GAMMATRON pioneered tantalum as an anode and grid material when it was relatively unknown to radio engineers. Today it is recognized by leading radio men as a superior material for those purposes. As a pioneer in the field, GAMMATRON engineers have naturally taken the lead in tantalum tube design. Methods of processing have been developed which provide a tube far superior to that originally introduced many years ago. It is natural, then, that GAMMATRON should offer fine transmitting tubes today of great ability to stand overload without release of gas, superior ultra-high-frequency performance, and large power capabilities.

WRITE FOR DATA ON
ALL GAMMATRON TUBES

HEINTZ AND  KAUFMAN
SOUTH SAN FRANCISCO LTD. CALIFORNIA U.S.A.

(Continued from page 101)

pres.; Walter Hampton, vice-pres.; Edward Spuler, secy.; Raymond Baggitt, treas. Meetings are held Tues. at 7:30 a.m., with code and theory classes, and a club station will soon be on the air. KHA is looking for 112-Mc. stations to work from Columbia Univ. GQM moved to Roselle Park, and works 1.75- and 3.9-Mc. 'phone. IYU built FB television receiver and is working on a 250-watt 3.9-Mc. 'phone job. JC joined U.C.A.R.A. and is going to stir up the ether again. AGH is training a T200 to take 500-700 watts on 1.75-Mc. 'phone. U.C.A.R.A. meets Monday nights at Elizabeth Y.M.C.A. JRU has new 150-watt QRM machine. N.N.A.R.C. beat Irvington Club in a side contest in the SS. HLC is putting up a 1.75-Mc. antenna. LVT is active in Bloomfield. AOG is off due to auto accident. Speedy recovery to you, OM. HNP had a fire in the shack. Happy New Year.

Traffic: W2GVZ 502 (WLNI 24) CGG 353 5HUH/2 205 LMN 166 HCO 156 HQL 86 (WLNK 68) KMI 73 LXI 33 JDC 32 GHQ 15 IYQ 14 BZJ 12 JRU 6 (Oct.-Nov.: CGG 250 KTR 3).

NEW ENGLAND DIVISION

CONNECTICUT — SCM, Frederick Ellis, Jr., W1CTI — Exceeding all previous Conn. QSO Parties the Dec. 9th-10th get-together went over with a bang. Invitations were mailed to all licensed Conn. amateurs (971 in all). So far reports have been received from 46 Nutmeggers, and results indicate that everyone had a swell time. TS worked 76 stations in 44 post-office designations for a score of 6688. UE worked 78 stations in 37 post-office designations for a score of 5772. Many friendships were renewed over the air, new stations worked, and records broken. We will try to have a bulletin published showing all reported results, to be sent those that reported. CTI remains as S.C.M. for another term. Many thanks for your confidence. AW leads in traffic handling; the combination of Hal and Geo. is hard to beat. EAO was fourth best measurements in the December O.O. frequency measuring test. Congratulations for fine showing, Ray. ITI continues with T.L. "C" on Tuesday and Nutmeg and A.A.R.S. nets. Speaking of nets — New members are joining the Nutmeg Net on 3640 kc. all the time. Get a 3640 kc. rock or e.c.o. and join in with a bunch of real traffic handlers. Twenty-five on the list now — who is next? KKS worked 69 stations in the QSO party. JTD sneaks up on the nets and trunk lines to swipe a little more traffic. Flash! CJD, Gil himself, is back in amateur radio. Left the sea, got married and took part in Conn. QSO Party. Congratulations, and it sure is nice to have you back home again, OM. The 28-Mc. 'phone at GB is going full blast. GB is still looking for club-to-club contacts on 7 or 3.5 Mc.; schedules with other Conn. clubs preferred. TS put up extended double Zepp for 14 Mc. and a lazy H for 28 Mc.

Traffic: W1AW 642 ITI 193 KKS 176 CTI 125 UE 124 TS 113 JQD 75 BCG 72 KYQ 49 LUN 34 JTD 30 LVQ 24 KSJ 21 MEC 20 ES 15 KFN-LQK 13 BDI 12 TD 6.

MAINE—SCM, H. W. Castner, W1HIE—Your S.C.M. wishes all of you a most Happy New Year. As the winter months come on us, we have a lot of interesting activity. The boys up along the Kennebec have a fine net. Those fine fellows around Penobscot Bay have their Seaweed Net. The boys in the A.A.R.S. are at it, hammer and tongs. The N.C.R. never was so active and the Pine Tree Net is growing all the time. Many of you who followed the Katahdin incident when Donn Fendler was lost will be interested in reading the book "Donn Fendler." Mr. Fendler, Sr. and Mrs. Kibling, W2HXQ, are taking steps to have an addition to the volume to credit all the radio activity. They are going to see that all this fine work of fellows like DHH, LYK, HSD, GMM and all the rest, is written up, that their excellent public service may be preserved to the everlasting credit of Amateur Radio. Your S.C.M. has a recent letter from "Kay," W2HXQ, with the utmost praise for what official Maine stations contributed in this affair. BGZ is comm'l op. on the S.S. *Frango*; he sent a card from Norway. You fellows who have been kind enough to lay off 3597 at 7:30 p.m., week nights, for the Pine Tree Net can listen for the signal "QNF"; that means the net is free; when you hear the Control Station say that, it is OK to blast again. Through organization we can offer deliveries of traffic in Maine to the following places: Bath, Waterville, Easton, Damariscotta, Lewiston, Boothbay Harbor, Rumford, Millinocket, Madison, Rockland, Kittery, Augusta, Hancock, Portland, Castine, Camden, Wiscasset, Ellsworth, East Parsonsfield, Old Orchard,

Farmington, Orono, Boothbay and Machias. Why not take advantage of this excellent coverage, fellows? We have in Maine 11 R.M.'s, 30 O.R.S., 5 P.A.M.'s, 16 O.P.S., 15 E.C.'s, 4 O.B.S. and 1 O.O. This makes a grand total of 82 official appointments. CBV is having good luck with a rotary beam on 14 Mc. AKR has new HQ-120 receiver. FNL built an e.c.o. BNZ is operating on the Trawler *Triton*. QH and "MII" (ex-BFZ) visited HGP in Northampton, Mass. FZD has an HY-40 in the final of his new e.c.o. It is reported that LCQ is in Conn. AWR is active in N.C.R. KYS has a fine new rig and is going to town on 28 Mc. EJS is going to build himself a better rig. GGF is enjoying 28 Mc. FZD will be with an HY-40 final. FZW stays on 28 Mc. FQJ is "a-tearin'" up the ether with that fine rig on 1.75 Mc. LHX is another of the old reliable 1.75-Mc. 'phone boys. LPR has gone into the Coast Guard. We wish you lots of luck, Mike. RU is building a new rig with 807 final. Many of you boys may remember old EF at Stonington; he is now 3HTE at Pan American Airways in Baltimore; "AI" is on 3.5 Mc. and likes to QSO the old gang. JCP is pres. of the U. of M. Radio Society. We hear KNJ. JTH is doing a fine job helping out EBY in emergency preparation. BDI was in Augusta, Dec. 2nd, RM-Nite, using a 6L6 final with 20 watts, and worked some of the gang. KTN is giving 3.5 Mc. a whirl. MKF is new Millinocket ham. KVK is going to help ZZC in the Railroad Net. GXY has that new rig going, and it sounds fine. I heard JPC way up there in Limestone. If any of you fellows are looking for Utah, I have a letter from W6PKB, who wants Maine schedules; he is on 3560, 7175 and 14350 kcs. and wants c.w. schedules. LBT is comm'l op. on the *City of New York*. LWX joined the League. MAP is building. FVX works some fine DX on 14 Mc. CFO sends another report on the A.A.R.S. and says, "Several new members doing fine." IOM is S.N.C.S. and is organizing a State 7-Mc. Net. LML added another tube. FAP has new "home-brewed" receiver. AMR is active in A.A.R.S. and the local club. GE paired down that doublet and is getting out better. IST belongs to both nets, and acts as tie-in. KMM has been acting as S.N.C.S., and enjoys it. Traffic in the Maine A.A.R.S. from Nov. 5th to Dec. 10th shows the following splendid totals: AMR 34, BTA 37, CFO 211, EFR 46, FAP 159, GE 92, GVS 145, IOM 14, JLF 30, IST 71, KMM 44, KOU 270, LAP 33, LIC 47, LML 126, LMQ 25, a total of 1384 in about 30 days. KOU enclosed his open rack rig in Masonite and put in an 809. I am very happy to announce that the "Future President" arrived at the home of FJP, weighing 8 lbs., 10 oz. Congratulations from all of us, John. EOP built a new rack and panel job. LIP is on 1.75 Mc. with 20 watts. FIV is rebuilding. LWG is "Batting it out" on 3551 kc. I received a great stack of Christmas cards from many of you, for which I am very sincerely thankful. BNC is building a new shack out in the shed. Traffic of Official Stations: IIE 65, GXY 15, KVK 7, LRP 90, LIC 52, KLH 22, DHH 7, LML 121, IQZ 43, KMM 75, FBJ 27, LMQ 18, INW 302, IBR 21, LVG 3, HSE 47, JCT 9; a total of 914. Altogether too many reports come in just under the dead line, and I sincerely ask you to get reports in the mail on the 16th so that we may receive them in time.

Traffic: W1HIE 65 GXY 15 KVK 7 LRP 90 LIC 52 KLH 22 DHH 7 LML 121 IQZ 43 KMM 75 FBJ 27 LMQ 18 INW 302 IBR 21 LVG 3 HSE 47 JCT 9.

EASTERN MASSACHUSETTS — SCM, Larry Mitchell, W1HIL — Ass't S.C.M.'s: 1JYY, 1GAG. Chief R.M.: 1JYY. P.A.M.: 1GAG. Chief E.C.: HXE. New E.C.'s: BZQ; JSM, DXR, LGY, LBH, JKR, GWA, BMO, HUV, LSW. Prospective O.P.S.: SS, LEU, Well, gang, 18 out of 22 O.R.S. reported this month. Not bad, not good. Let's make it 100% now! The XYL and Jr. op. join me in thanks to the many who sent us Christmas and New Year greetings. HIL has new 'scope, crystal mike and 6-ft. relay rack. JGQ is working on frequency standard. LMB says LTC, LEU and he have new 4-element beams. DNL ups power to 300 watts. GFW is trying beam. AJA is going up to 500 watts. LEU reports for first time. SI worked HA1K on 28 Mc. LO is working on 3-element beam. IAV is back on the air. SS reports working 91 stations on 112 Mc. from Dec. 1, 1938 to Dec. 1, 1939. Let's hear from some more of you 112-Mc. men. LBW reports he heard HA1J on 3.6 Mc., Nov. 30th, and wants to know if it is the real item??? BMW reports from the U.S.S. *Davis* at Galveston, Tex. Nice letter from FLZ at 540 W. Wilson Ave., Glendale, Calif.; says GWK is operating portable marine off Texas, also IIM, CWI, IXL, JZE, KSF, LMB, W V, MCX, IPA all S9 on 28 Mc. out in sunny Calif.; he expects to be on 28 Mc. by end of Jan.

EMG reports for A.A.R.S. EPE now has WLGs call. Following are active in A.A.R.S.: 3.5-Mc. C.W. Net: EMG/WLGF, EPE/WLGS, FSL, HFJ, HRE, IUW, JCK/WLGV, JSM, KCT, LPX, LWH, QA, SM and TY. 56-Mc. 'Phone Net: AGX, GRV, HWE, JFS, JRM, KMQ, KWR, KZK, KZL, LBS. 1.75-Mc. 'phone: AAR, AHP, CCL, CLE, COL, DHX, DKS, FGR, HA, HIL, IKK, JMJ, JNU, KGW, KPW, KVO, KYN, LIY, MBF, PI. EMG wants more stations along the N. H. line. This is a fine active group of hams. Anyone interested in joining A.A.R.S. contact EMG for details. LWH, JCK and KCT make B.P.L. LWH, EPE, AKS, JCK, JSM, KCT, KMQ each handled over 200 messages this month. Very fine work, men!! KMJ reports MJG from W. Mass. now in Danvers, on North Shore A.A.R.S. Net. Welcome, Alice. BDU handled lots of Christmas traffic. JNU reports JMW now pres. of M.V.A.R.C. Lots of activity on 112 Mc. among M.V.A.R.C. members. AAR is at new QTH: 56 Johnson St., W. Roxbury. KH talked before Eastern Mass., South Shore and M.I.T. clubs. IBF ran up 28,458 in SS. GCU has new Jr. op., born Nov. 15th. GOU has 46 states confirmed on 28 Mc. WV worked VU2XX, 122nd country, PZ6ZK, L23rd; also worked HA1K and HC2CC on 28-Mc. 'phone; has new Browning frequency meter and monitor. LNN reports MJS new Attleboro ham. MEZ is on 1.75-Mc. 'phone with 6 watts. LNN and DCH are active on 7 Mc. HGK is on 28 Mc. with 25 watts 'phone. KVB, an O.R.S. from Vermont, is now located in Arlington Hts. Welcome to Eastern Mass., Dick, Fellows, I am sorry to say this has to be my last report as your S.C.M. Thanks for your fine cooperation. It has been a pleasure to work with all of the gang in the Section. Please cooperate with your acting S.C.M., W1GAG, Carroll O. Peacor, 24 Governor Road, Stoneham. Send all reports to him in the future. I regret I have to give up the work, but business must come first. Again, my thanks, good luck, DX and best wishes to the Eastern Mass. Section. Long may it prosper!! — Larry.

Traffic: W1LWH 610 EPE 377 (WLGS 9) AKS 354 JCK 303 (WLGV 125) JSM 280 KCT 220 KMJ 213 BDU 175 JYJ 162 EMG 153 (WLGV 50) KZT 137 HWE 92 LBY 81 FSL 51 JNU 44 AAR 39 KH 25 FWT 24 BB-IBF 17 LMO 16 KTE 14 GCU 7 LQV 5 KVB-WV 4 LNN 2. (Oct.-Nov.: W1AAR 211 KZT 173 GCU 8.)

WESTERN MASSACHUSETTS — SCM, William J. Barrett, W1JAH — BIV is building portable-emergency exciter for 6 volts d.c. or 110 a.c. operation with crystal switching. IOT maintains his high traffic average. JAH attending meeting of Pittsfield Radio Club. IOR and the Worcester gang are working hard on plans for the coming N. E. Div. Convention. BKG confines activities mainly to A.A.R.S. schedules. AZW is new R.M. DUZ has been doing swell job as control of the 1.75-Mc. 'Phone Net. BVR has been reappointed First Corps Area Radio Aide, A.A.R.S., for one year from Jan. 1st. AJ had nice visit from LLN and his dad. DCH has new 812 final on 3.5, 7 and 14 Mc. KRX is recuperating now, and is back on the air. KON moved to East Mass. Incidentally, Alice is now MJE. Congrats. KJK has been having a real workout getting the 803 final to behave. COI expects to rebuild main rig to use 1000-volt tubes; his latest antenna is vertical 3-element semi-rotary. LDE worked a few new states on 28-Mc. 'phone. Congratulations to HDQ on his appointment as u.h.f. contributing editor to QST. Ed says he will be glad to schedule anyone on 28 Mc. who may be interested in discussing u.h.f.

Traffic: W1BIV 249 IOT 215 (WLGN 128) JAH 241 (WLGH 33) EOB 208 IOR 138 BKG 83 AZW 77 DUZ 68 LDV 57 BVR 34 (WLG 152) FOI 24 AJ-LJF 20 DCH 9 KRX 5 KZU 4 KJK 2.

NEW HAMPSHIRE — SCM, Carl B. Evans, W1BFT-DMD — Phillips Eketer Academy Radio Society plans to get on 28-Mc. 'phone. BN is on 7112 kc. Sunday mornings only. KIN has a new shuek 24 ft. by 25 ft. on top of a garage. JNC and JSL are on 112 Mc. The Nashua Mike & Key Club held Annual Meeting and banquet on January 11th. HUD has a new Mackey. The Manchester Radio Club is installing a new Mims DeLuxe 28-14 Mc. Signal Squirtor on its tower. LBD is rebuilding in a new deluxe closed-in type rack. MAS has a new crystal mike. Attention is called to the U.H.F. Marathon announced in Jan. QST, page 26. Let's have some representation from the N. H. Section. Be sure to send your monthly reports in to A.R.R.L., even if you only work a few stations. BST has a new RME frequency expander. BFT has a new 50-ft. antenna pole in his back yard which, eventually, will support a rotary beam for 28 and 14 Mc. N.H.N. has been quite active on 3840 kc.

nightly at 6:30 p.m., with ten or more stations checking in regularly. FB, and let's keep it up. Remember that this net is our basis for emergencies. Experience gained during regular net means faster and more efficient handling of emergency traffic. Make it a point to check in at least one night each week so you will be acquainted with net operation.

Traffic: W1KIN 454 FFL 415 CRM 176 BFT 142 JGI 128 KBU 108 IVU 84 GMM 75 ICS 74 ANS 67 FX 49 IDY 58 JDP 37 RWF 34 JKH 32 DMD 29 LNG 27 IP 26 CEA 20 KKK 19 JBM 11 EAL 8 ITF 6.

RHODE ISLAND — SCM, Clayton C. Gordon, W1HRC — Please note that HRC is now located in Warwick. In order to avoid delay in receiving your reports, please also add to the address the words "Edgewood Station." My sincere apologies for missing report last month. JNO has a "2½-5-10" crystal rig with T55 final for 'phone and i.c.w. partly completed, and is on c.w. with a T55 to keep the fist in oiled-up condition. BVI has rack and panel now. CAB has new antenna, and spends all his time on U.S.N.R. circuits. DDY has new rig working, and now turns to "2½" and O.O. work. JEZ tells of a new radio club being formed in Barrington High School, and the P.R.A. has invited them to join its Radio School on Thursday nights in the Providence Y.M.C.A. annex. JP is carrying the torch for "2½" and trying to sell the local gang on it. LWA has completed the exciter of the new rig using 6K7G e.c.o., 6L6 buffer. MJL is new Class "A" ham in Providence. MEK had a great time working DX on 3.5 Mc. in SS. DBA is coming on "2½" from Scituate with HK24 in final and using HY615 super regen. receiver. KCS is remote-controlling his two rigs and remodeling his cellar for an operating room. EOF has gone e.c.o. KOG is now a papa (should have been in last month's report if there had been one); 15 pounder, too. KKE and his 812 had 2-hour QSO with LCL and LCS on 1.75 Mc. LDL spent nearly two years looking for Del., and then picked up three of them in the SS. BIT has been heard on 1.75 Mc. JAR, HEB, HJB and HRZ have 28-Mc. rag-chews at 10 p.m., and like the local gang to bust in on them.

Traffic: W1INU 521 INT 129 GTN 124 LLD 117 KOG 107 CPV 98 LAB 97 KWA 86 IEG 82 KYK 67 BOY 48 KIV 25 LCV 24 LQG 18 KKE 17 DDY 11 JDX 9 HRC/1 4 EOF 4.

VERMONT — SCM, Clifton G. Parker, W1KJG — Winners in Vt.-QSO Party were KOO, first, and MCQ, second. A good many stations operated during this activity. A further Vermont QSO Party will be conducted this winter if the Vermonters are interested. KOO wins choice in standard tube (6L6 G or equivalent) and MCQ wins 100 QSL cards. KOO has Signal Shifter running to a TZ-40, with FB results. MFL is Burton P. Brown, Dept. of Elec. Engr., U.V.M., Burlington; he advises of fine new outfit at Communications Laboratory; Burton is ex-W9ODF, formerly located at Denver, Colo. All amateurs are welcome at the Laboratory in Williams Science Hall. JLF has broken loose on 3.5 Mc. again with his lonely '45. KTB is now Class A and is on 14- and 3.9-Mc. 'phone, besides much action on 3.5-Mc. traffic nets. JRU built up small emergency 'phone outfit per recent QST, and finds it gives tough competition to his larger rig. LBJ is using cathode modulation and goes to town on 1.75 Mc. FSV is back on 3.5-Mc. traffic nets after long absence, and is making up for lost time. KXL is at home in Johnson, and expects to operate from there until March, when he will be back at St. Albans. IDM has moved into FB new filling station at Hardwick. All Vermonters who have not done so are urged to register in basic or supporting division of A.E.C. Considering our relatively small numbers, we have a good percentage of registrations now — we should have more! Register, even though you do not have complete emergency-powered rigs. How about it, gang? Reports have come in much better recently, but we still lack information on gang in southern end of Section. A meeting is planned, to be held during the winter, of the various Emergency Coördinators relative to fitting together the emergency set-up in this Section. Coördinators, please jot down your particular suggestions and problems and present them for discussion. Information now at hand indicates that a 56-Mc. amateur station is being planned for Mt. Mansfield at Stowe, the highest point in the state; some preliminary observations and plans have already been made. This project, when completed, will undoubtedly be welcome news to quite a few of the Vermonters who would like to give 56 Mc. a modest whirl.

Traffic: W1KTB 167 KJR 165 FSV 136 KJG 92 KIE 51 KOO 40 LRL/1 26 MCQ 7 JVT 4.

PINCOR

A
SIZE
FOR
ANY
JOB



DYNAMOTORS

Pincor Dynamotors are as much "at home" on tough jobs as on ordinary ones. No wonder they are specified by governmental and commercial users universally for air craft, marine and broadcast service, police units, sound systems, auto radios, etc. Available in a wide variety of types and frames for any requirement. Highest efficiency and regulation. Capacities: 10 to 850 watts. Input, 6 to 110 volts; output, up to 1750 volts.

Specify "Pincor" — and be sure of thousands of hours of dependable, quiet service. Mail coupon for complete information.

PIONEER GEN-E-MOTOR CORP.
CHICAGO, ILLINOIS

Export Departments: 25 Warren St., New York, New York
Cable Address: SIMONTRICK, New York

Pioneer Gen-E-Motor Corp., Chicago, Ill.
Dept. K-GB, 466 W. Superior St., Chicago, Ill.
Please send information on Pincor Dynamotors,
Motor Generators and special power supply units.

Name

Address

City.....State.....

Half-Wave in Phase

by **PREMAX**

Much energy which is shot up into the air on other aerials is pulled down and shot out in more desirable directions when half-wave antennas are operated in phase as shown in Fig. 12. Here two Premax Verticals are stacked one above the other.

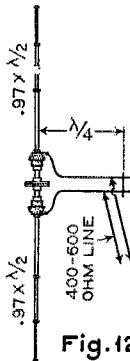

Fig. 12

Premax Vertical Radiators Are Adaptable to Any Antenna System

Where space is limited and efficient antennas are desired, the Premax Telescoping Vertical Radiators are unsurpassed. Write or ask your jobber for Premax Technical Bulletin H-3 which illustrates 22 types of verticals, all of which are easy to erect with Premax standard units.

PREMAX PRODUCTS

Division Chisholm-Ryder Co., Inc.

4020 HIGHLAND AVE. NIAGARA FALLS, N. Y.

Compact Battery Receiver for Station or Portable Use

(Continued from page 21)

taps are made by simply forming a long loop at the position of the tap and removing the insulation and twisting the loop at the base. The joint is made permanent with a small drop of solder not too close to the winding. The taps should be staggered about the coil to give greater separation.

A hole should be drilled in the upper left-hand corner of the cabinet so that the antenna wire may be passed through to the inside. A grounding terminal should also be provided near the bottom.

The batteries should be placed in the cabinet before the receiver. The "B" battery consists of a single 45-volt Eveready "Mini-Max" unit (No. 482). In this case, a Burgess No. 4FA 1.5-volt "A" battery and small 4.5-volt "C" battery were used. To prevent the batteries from shuffling about, they are held in place simply by wedging a short section of "2 by 2" in at the center. Connections to the batteries are most easily made before the receiver is placed in the cabinet. Although it is possible to change tubes without removing the receiver, it will save a little maneuvering by also putting the tubes in beforehand. The plug-in coil socket is mounted where the coil is readily available for changing. A small screwdriver used as a lever will help in getting the coils started after the battery switch has been turned to the "Off" position. Coils are easily plugged in by pressing with two fingers, with the thumb on the front panel.

The operation is, of course, similar to that of any regenerative receiver. The detector should go into and out of oscillation quietly without "plopping" or howling. After a signal has been tuned in, the tap switch may be rotated until the best signal is obtained. If the signal is too strong and blocks the detector, it may be reduced by detuning the amplifier with the tap switch. Whether series or parallel tuning should be used will depend upon the antenna dimensions and the band in use. The best arrangement may be found easily by trial. For series tuning, the plug hangs loose and the antenna is connected to the terminal with C_1 in series. For parallel tuning, the grounding plug is inserted in this terminal and the antenna connected to the other.

The pentode stage should give plenty of head-phone volume. There should be no evidence of antenna swinging, body capacity or other forms of frequency instability as long as the signal is kept down to a level which does not overload the detector.

If the receiver is to be used for portable work, a handle may be fastened across one end of the cabinet and the lid fitted with a catch.

~~Strays~~

A new beat oscillator with cord and adapter plug for use with all-wave broadcast receivers is now obtainable from General Electric Company in kit form.

Dorothy Hall,
W2IXY
Springfield,
Long Island,
N. Y.

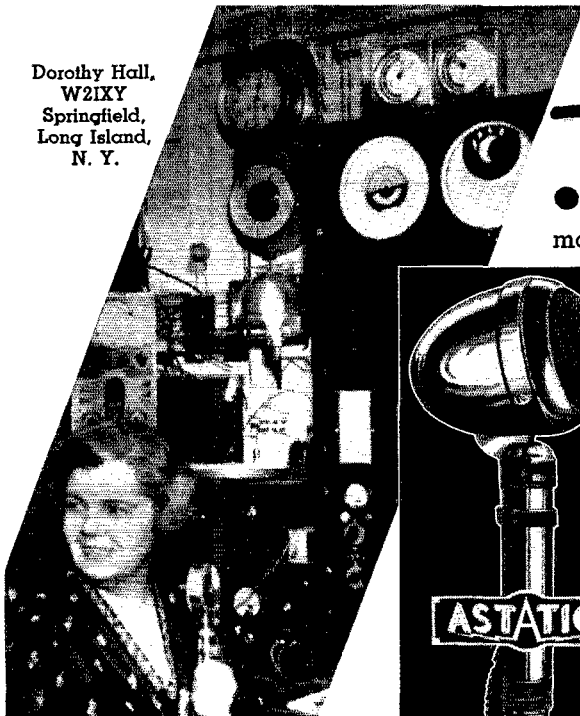

Built for Tomorrow

● Engineering efficiency, geared to modern progress and demands, makes

your Astatic Microphone an instrument of tomorrow as well as today. It is designed for faithful performance and constructed for long, dependable service. See the Astatic line of microphones and pickups at your radio jobber's or write for catalog.

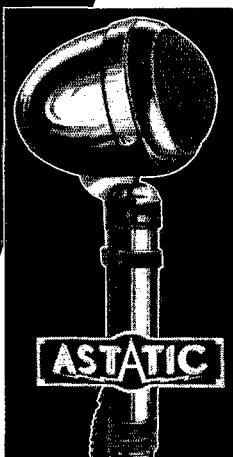

T-SERIES CRYSTAL MICROPHONE
Wide-Range and Voice-Range Models \$25.00

ASTATIC MICROPHONE LABORATORY, Inc., YOUNGSTOWN, OHIO

Licensed Under Brush Development Co. Patents

BRAZILIAN QUARTZ CRYSTAL

Largest and most varied stock of Brazilian quartz crystals in the United States. Finest quality suitable for manufacturing piezo-electric crystals, lenses, and prisms. Shipments received regularly from our Brazilian Branch. Also in stock tourmalines for making crystals to control the higher frequencies and quartz for fusing purposes.

BRAZILIAN TRADING CO., INC.

377 Fourth Ave., New York City

Murray Hill 4-2891

110 VOLTS AC Katolight Plants

Anytime, Anywhere! with

Have special plant for operating radio receivers and transmitters. Close voltage regulation. Full 350 watts AC and 100 watts at 6 volts. Filtered and shielded.

Amateur's price—JRA3, 350 watt **\$67.50**

Amateur's price—JRS5, 550 watt **97.50**

Other sizes up to 10,000 watts.

"Ask your jobber"

KATOLIGHT, Mankato, Minn., U.S.A.

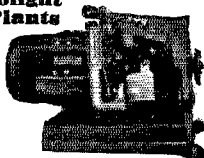

● TELEGRAPHY—TELEVISION—TELEPHONY ●

AVIATION

TRANSRADIO

PRESS

TELETYPE

TYPEWRITING



PRACTICAL

EXPERIENCE

STUDIO —

TRANSMITTER —

ANNOUNCING

The major technical training equipment owned by Port Arthur College and in operation on the college campus consists of 1000-Watt High Fidelity RCA Transmitter of latest design, operating on 1220 kc. with a directional antenna system, two-way Television Transmitter and Receiver, Latest Type RCA Marine and Airways transmitter installation complete; SOS Automatic Alarm; Marine Direction Finder; Trans-radio Press Receiving Equipment, and Laboratory complete where students assemble composite transmitters, amplifiers, audio amplifiers, R.F. amplifiers, etc.

Port Arthur College pioneered the teaching of Radio with classes in 1909, and for thirty years has maintained an active Employment Bureau for the placement of its graduates.

If interested in details about Radio Course, write for Bulletin R

PORT ARTHUR COLLEGE ■ PORT ARTHUR (World-Known Port), TEXAS

M & H

HAS THE

New SX25

SUPER-DEFIANT

Two Stages of Preselection
High Fidelity, Push-Pull
Audio. Calibrated Band
Spread with Band Set Index.

PRICE
COMPLETE \$99.50

Sold on convenient deferred
payment plan. Trade in
your old set now.

Try the friendly, expert serv-
ices of our licensed amateur
staff.

W3AGV W3BES
W3DMQ W3GML

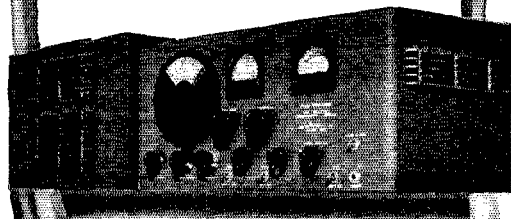

M. & H.

SPORTING GOODS CO.

512 MARKET STREET
PHILADELPHIA, PA.

Branch:

1709 ATLANTIC AVE.
ATLANTIC CITY, N. J.

A Practical 112-Mc. F.M. Transmitter

(Continued from page 25)

RK-34 grid circuit tunes quite sharply. When grid current is obtained in the RK-34 (of the order of 10-12 ma. with 250 volts on the T21's), plate voltage can be applied to the RK-34 and the slider moved up and down until the RK-34 plate current dips sharply. The slider has plate voltage on it, so move it with a small piece of wood or some other insulating material and keep one hand in your pocket. With the oscillator on 9.5 Mc. and the other circuits tuned to the proper harmonics, the resonance dip should be obtained with the slider about one inch from the bottom. Any great discrepancy from this indicates that the wrong harmonic has been picked up somewhere along the line, but no serious trouble should be encountered if the coil data have been followed. The cathode resistor prevents the plate current from running too high in the off-resonance condition and should not be omitted from the circuit.

When all circuits have been found to resonate, the 300 volts can be applied to the set and, if everything is working properly, you should run about 100 ma. screen and plate current on the T21 doubler, and 12 to 15 ma. grid current on the tripler and, with no load, the tripler plate current should be about 20 ma. A small dial lamp connected to the coupling loop should light up brilliantly. In our set-up, we found that we could couple the final up to about 60 ma. plate current before the output refused to increase with increased loading, but at this input the output was about 6 watts, indicating excellent efficiency for the tripler at this frequency. Loadings will change the tuning of the final tank slightly, so it is well to retune after each increase in loading. It is easier to change the frequency of the transmitter to the new final tank frequency than it is to change the tank tuning, and a little practice will illustrate the point.

When the rig is putting out well, it is only necessary to connect a single-button microphone to the connector and put the microphone batteries in the circuit. If a lower-output microphone is used, a stage of amplification will be required, and the output of the amplifier can be coupled to the modulator through a 200- or 500-ohm line. Listening to the signal on as high a harmonic as the all-wave receiver will go should yield a signal that, when modulated, is just not quite understandable but which obviously is being spread out quite a bit under modulation. With no modulation, a T9 signal should result, and if any ripple is present it must be eliminated or else there will be bad hum on the carrier. Our particular oscillator worked out to be rather clean and no trouble was experienced with hum. However, if ripple does show up, more filter can be added to the power supply and a 0.1- μ f. condenser connected between oscillator heater and ground.

The linearity and deviation of the modulator-

(Continued on next left-hand page)

SX-25 Tops by Hallicrafters

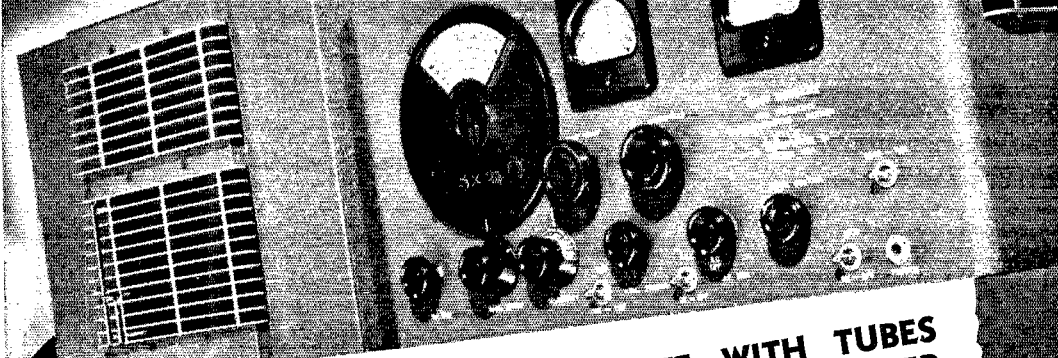

\$99.50

**RECEIVER COMPLETE WITH TUBES
CRYSTAL AND 10" PM23 SPEAKER**

OUTSTANDING FEATURES . . .

- ★ Compensation in oscillator circuit for frequency stability
- ★ DC operation socket — battery or vibrapack
- ★ Automatic noise limiter
- ★ Six step variable selectivity covering wider range from extreme CW crystal to high fidelity
- ★ 5 meter calibrated in "S" and DB units

FREQUENCY COVERAGE

Overall Range 540 kc to
42 mc in 4 bands as follows

- 1 — 540 kc to 1700 kc
- 2 — 1.7 mc to 5.1 mc
- 3 — 5.0 mc to 15.5 mc
- 4 — 15.1 mc to 42 mc

Separate calibrated bandsread
dial for the 10, 20, 40, and 80
meter amateur bands, affording
frequency meter tuning on these
bands.

Controls: RF Gain, Selectivity
Switch, Crystal Phasing, Audio
Gain, Pitch Control, Main Tuning
Control, Bandsread Tuning
Control, ANL Switch, Hi-Lo
Tone, Send-Receiver Switch and
BFO Switch.

The 2 RF Preselection stages provide exceptionally high image and signal to noise ratios. The push-pull output stage furnishes 8 watts of audio. This power combined with the wide range of frequency response obtained by greater expansion of IF stages provides high fidelity reproduction in the broadcast band and better performance throughout the higher frequency ranges.

LIBERAL TIME PAYMENT PLAN

Model
SX-25

Down Payment
\$14.92

Per Month for 12 Mos.
\$7.47

The RADIO SHACK
167 WASHINGTON ST., BOSTON, MASS., U.S.A.

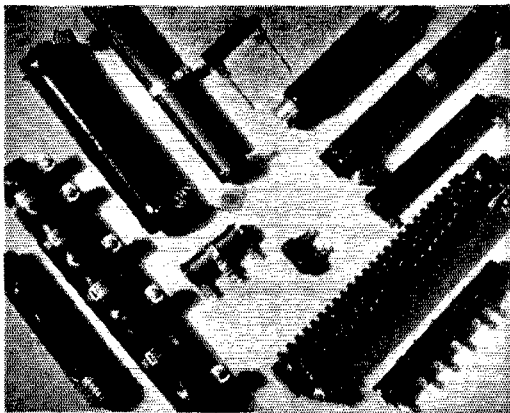

RESISTOR DATA

The Ward Leonard line of resistors is complete so includes all sizes and all ratings in fixed and adjustable types.

Send for circular 507. It not only gives Resistor data but other valuable dope for the ham.



WARD LEONARD

ELECTRIC COMPANY

41 South Street, Mt. Vernon, N. Y.

Piezo-Electric Crystals Exclusively

- Quality crystals of all practical frequencies supplied SINCE 1925. Prices quoted upon receipt of your specifications.

Our Pledge: **QUALITY FIRST**

SCIENTIFIC RADIO SERVICE

"The Crystal Specialists Since 1925" University Park, Hyattsville, Md.

READ AND SEND CODE

Learn Easily at Home
This Quicker Way

No experience needed. Beginners read code quickly, copy accurately. If already an op, speed up your wpm with this approved, amazing, all Electric Master Teleplex Code Teacher. Only instrument ever produced which records your sending in visible dots and dashes on specially prepared paper tape — then sends back your own key work at any speed you wish. Fascinating, fool-proof — get results because you learn by HEARING as well as SEEING. That is why thousands agree this method is surest and quickest. While not designated standard equipment, Teleplex is used at many U. S. Army Posts, Naval Training Stations. We furnish Complete Course, lend you the New All Electric Master Teleplex, and personal instruction with a MONEY-BACK GUARANTEE. Low cost, easy terms. Write today for folder Q-2, no obligation.



'HAM'
SPECIAL

Standard Teleplex — a highly efficient code teacher using heavy specially prepared waxed paper tape, having two rows of perforations. Write for Free folder "Q.T.2."

TELEPLEX CO., 67-68 Park Place, New York

In Canada, Write

Canadian Electronic Institute, Toronto, Ontario

oscillator can be checked by disconnecting the volume control from the No. 3 grid of the 6L7 and connecting a 1½-volt dry cell between this grid and ground. The grid should first be grounded and the frequency checked, then 1½ volts positive placed on the grid and then the battery reversed to place 1½ volts negative on the grid, and the frequency noted in each case. If the deviation is the same in both cases (approximately), it is a good indication that the oscillator is properly modulated. For 1½ volts, and measuring the deviation at 9.5 Mc., the deviation should be about 1200 cycles. This indicates that the deviation will be about 2000 cycles for a grid swing of 2½ volts, which is what is needed for a deviation of 25 kc. at 114 Mc. The grid swing cannot be made much more than 2½ volts because the grid has only 3 volts bias (obtained from the drop across the cathode resistor of the 6L7), and it is not advisable to swing the modulator grid positive.

If it is desired to increase the available deviation, it is only necessary to increase the L/C ratio of the oscillator by decreasing the fixed condenser C_{12} and increasing the turns on L_1 to the point where it again tunes to 9.5 Mc.

If the 6 watts output isn't enough to satisfy the experimenter after a few evenings' operation, an amplifier can be added and tuned in the usual way, without regard for the amount of drive. Unlike a Class-B amplifier for amplitude modulation, the f.m. amplifier need only be tuned for maximum output. A small u.h.f. tube like the HK-24 or 35T should make an excellent amplifier to follow this rig.

NCR-Notes

(Continued from page 40)

the local governments and the local chapters of the American Red Cross when the worst flood in the history of Southern California carried away telephone and telegraph lines and washed out highways leading into nearly all cities and towns. Naval Communication Reserve stations were again manned and remained in operation as long as they could serve the community in which they were located. Through arrangements with the American Red Cross, all Sections and Unit stations in the stricken areas report to the local chapters when a disaster occurs and offer their communication facilities and any other assistance they can render. That the Naval Communication Reserve has proven to be of great value to the local Governments and the Red Cross during disasters is evidenced by the letters of commendation from city officials and the Red Cross. Since the last two major disasters in the Eleventh Naval District, Section and Unit control stations have been or will be equipped with emergency power supply to meet future emergencies and disasters.

3 BRAND NEW AMPLIFIERS

FEATURING CATH-O-DRIVE Modulation

The instantaneous success of the new KENYON Cath-O-Drive Amplifiers is merited for here are units which may be built easily and at a saving in cost which is really remarkable. Although featuring Cath-O-Drive Modulation, each unit features interchangeability of output transformers to make them UNIVERSAL . . . for Plate Modulation or P.A. Work.

THE KENYON "50" Foundation Kit rated at 5 watts Class A, net. \$18.75

THE KENYON "150" Foundation Kit rated at 15 watts Class AB, net. \$22.78

THE KENYON "600" Foundation Kit rated at 60 watts Class AB₂, net. \$35.13

The required Kenyon Transformers and Parmetal Punched Chassis and Cabinets as well as literature, parts list and circuit diagrams are available at your jobbers. If he does not yet have his supply, write us direct.



KENYON TRANSFORMER CO., Inc.

840 BARRY ST., NEW YORK, N. Y.

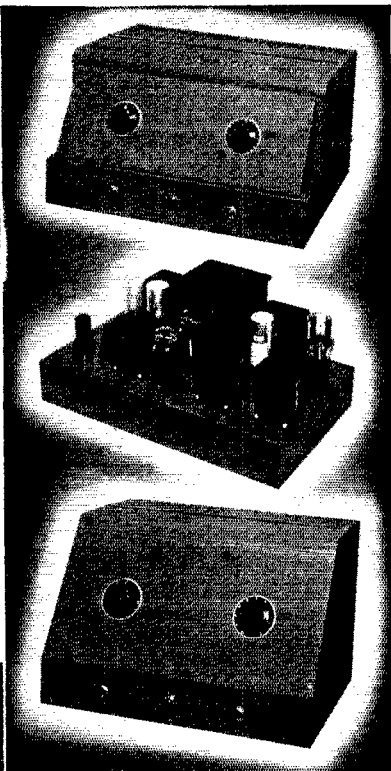

LEARN RADIO-TELEVISION

60-page catalog on request. Oldest, largest and best equipped in New England. Write for new catalog.

MASS. RADIO SCHOOL

18 Boylston Street

Boston, Mass.

SICKLES COILS

SECURE A COPY OF OUR NO. 939 CATALOG FROM YOUR JOBBER

F. W. SICKLES COMPANY

300 Main Street

Springfield, Mass.

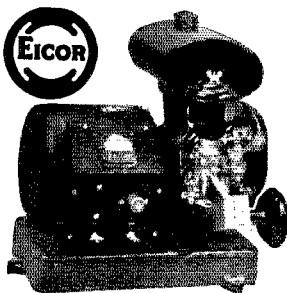

NEW ELECTRIC PLANTS

Plenty of power at low cost! Matchless Dependability. Complete line from 300 to 2000 Watts AC and DC.

Write Today for Data

EICOR Inc.

513 SOUTH LAFLIN STREET CHICAGO, U.S.A.

A GOOD NAME GOES A LONG WAY

Ken-Rad Radio Tubes will give the best performance because they are the product of the highest standards in the industry.



Ken-Rad Radio Tubes

KEN-RAD TUBE & LAMP CORPORATION - OWENSBORO, KY.

Manufacturers of all types of radio tubes and Ken-Rad Electric Lamp Bulbs

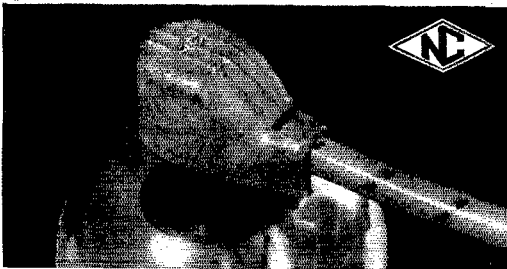

SAFETY PLATE GRIP

The Type SPG Safety Plate Grip is of molded R-39 and is an important aid to safety when using 866's or other tubes having 9/16" diameter caps. The conductor opening is large enough to receive high tension (spark plug) cable, but an insulated bushing is supplied for smaller wire. Type SPG, List Price, \$.35

NATIONAL COMPANY, INC.
MALDEN, MASS.

SUPER ACTIVE



HIPOWER

**LOW DRIFT
CRYSTAL UNITS**



LOOK! LOOK!
GENUINE LOW DRIFT
"EMERALDS"
AT "X" CUT PRICES

Now get stability plus higher activation with these new sensational crystal units. The entire ham band is talking about Hipower "Emeralds." Because of large production facilities and exclusive Hipower grinding methods, these low drift cut units meet every test of usage, accuracy and price.

| | |
|-------------------------------|---|
| SEND FOR CATALOG TODAY | <p>160 — 80 — 40 meter bands \$3.35</p> <p>20 meter band..... 5.50</p> |
|-------------------------------|---|

Ask your parts distributor about Hipower "Rubies." These jewels of crystal craftsmanship — priced reasonably — meet commercial standards at true amateur prices.

Newark, Chicago, Radio Parts, Madison & Milwaukee, Kerrs Radio Shop, El Paso, Tex., Radio Electric Service Co., Baltimore, Md., Walder Radio & Appliance Co., Miami, Florida.

HIPOWER CRYSTAL COMPANY
2035 CHARLESTON ST. CHICAGO, ILL.

U. H. F. Relay Number 2

(Continued from page 85)

W2IDV-W1HDF-W1INF; W2ACR-W2BAD-W2IDV-W2KKE-W1KTF-W1KLJ-W1CLH-W1EEI; W2QA-W1KTF-W1KLJ-W1BDI; W2KLB-W2LAL-W2GHV-W1KTF-W1CLH-W1KLJ-W1HDQ; W2IXE-W2COT-W2MO-W1KLJ-W1HDQ; W2EKC-W3HOH-W3AC/3-W1HDQ-W1BDI; W2IXE-W2LXC-W1KTF; W2CQF-W2ILK/2-W2MO-W3BZJ-W3CGV-W3GGR/3; W2HEL-W2COT-W2MO-W3HVK-W3CGV; W2LRE-???-W2ILK/2-W3AC/3-W1HDQ; W2OU-W3CUD-W3DBC; W3HJQ-W3DBC-W3CUD-W2AMJ-W1LLL-W1INF; W8NF-W3AC/3-W1IJ-W1INF; W8DYE-???-W3HOH-W2COT-W2CLA-W1KTF-W1CLH-W1PHN; W3HBS-???-W3HOH-W2COT-W2CUZ-W1CLH-W1CCF; W3HVK-W3FQS-W3FBH-W2IDV-W1HDQ; W3HHO-W3FQS-W3FBH-W3CGV-W3GGR/3; W3FQS-W3FBH-W3CGV; W3CUD-W3DBC; W2ABJ-W3DBC-W3CUD; W8LMP-W8RKE-W8CVQ-W9VHG; W1DJ-W1KLJ-W3AC/3-W2MO-W2LEG-W2BAD.

For the information of participants whose messages did not reach delivery points, we present the following tabulation:

| Starting Station | Traced To | Starting Station | Traced To |
|------------------|-----------|------------------|-----------|
| W1EKT..... | W3BZJ | W2IBR..... | W3HWN |
| W1MDN..... | W1KLJ | W2MCF..... | W3BKB |
| W1IJ..... | W3BKB | W3HPX..... | W1HDQ |
| W1ANA..... | W1KLJ | W3GIZ..... | W1JLI |
| W1JLI..... | W3BKB | W3HPD..... | W1BDI |
| W1KJL..... | W3HWN | W3HOH..... | W1BDI |
| W1KJC..... | W3BZJ | W3DBC..... | W1KLJ |
| W1MDV..... | W3BZJ | W3FMZ..... | W1KLJ |
| W1KXK..... | W1JLI | W3DBG..... | W3CGV |
| W1CLH..... | W3HWN | W3FHJ..... | W8CIR |
| W1FBX..... | W1JLI | W3IHI..... | W1KTF |
| W1LLL..... | W3DBC | W3AIF..... | W2MO |
| W1LOV..... | W3BZJ | W3ABQ..... | W2MO |
| W1LJV..... | W3BZJ | W3GQK..... | W1HDQ |
| W2EAM..... | W1KH | W3AC/3..... | W3DBC |
| W2IZP..... | W1HXP | W3CGV..... | W3BZJ |
| W2IDV..... | W1KIK/1 | W3IHD..... | W1KIK/1 |
| W2COT..... | W1LSN | W1JPA/3..... | W1HDQ |
| W2CMO..... | W1KLJ | W8IDU..... | W3FBH |
| W2MCF..... | W1BDI | W8EEN..... | W3RL |
| W2ADW..... | W3GGR/3 | W8FSI..... | W3HVK |
| W2BAD..... | W8MDA | W3GEF..... | W3HVK |
| W2MBU..... | W3GGR/3 | W3CQS..... | W1KTF |
| W2CLA..... | W3BKB | W3BKB..... | W8LKD |
| W2LAL..... | W3DBC | W3IDS..... | W8MDA |
| W2BZS..... | W3AXR | W3FBH..... | W8MDA |
| W2HYJ..... | W3DBC | W3GMZ..... | W3CUD |
| W2AMJ..... | W8CIR | W3FIS..... | W3EUA |
| W2KKE..... | W3GGR/3 | W3EUA..... | W3GGR/3 |
| W2MO..... | W8LKD | W8EUD..... | W1KTF |
| W2IKD..... | W1KTF | W3CVQ..... | W8MDA |
| W2IDV..... | W1HDQ | W8NFM..... | W8CVQ |
| W2LST..... | W3BKB | W8TCG..... | W8MDA |
| W2IUV..... | W3BZJ | W8LNV..... | W8MDA |
| W2ILK/2..... | W3GGR/3 | W8TBN..... | W9LLC |
| W2KDV..... | W3BZJ | W8RUE..... | W8LKD |
| W2CUZ..... | W3GGR/3 | W8SPY/8..... | W8CIR |
| W2KNV..... | W3HWN | W9RGH..... | W8MDA |
| W2BS..... | W1KTF | W9VHG..... | W8MDA |
| W2QA..... | W3GGR/3 | W9ZEO..... | W9LLC |
| W2IQQ..... | W3HWN | W9VWU..... | W9ZJB |
| W2LIC..... | W3GGR/3 | W9ZJB..... | W9VWU |

Sky-Wave Routes

Late afternoon of the 4th saw 56-Mc. "wide open" from points in Illinois, Missouri and Wisconsin to the W1 and W2 districts. For about an hour the band was a veritable "madhouse" with messages flashing back and forth between the first and ninth call areas. A message from W9GGH to W1LLL travelled W9GGH-W3BZJ-W2MO-W2AMJ-W1KTF-W1KLJ-W1BDI-W1LLL. Others from W9BHT, W9LLC and W9CJB, addressed to ARRL arrived via W9ZHB-W1LFS-W1LLL-W1INF. An answer to W9LLC's returned all the way through W1INF-W9ZHB-W9LLC. Another to HQ from W9ARN went via W9RGH-W9ZHB-W1LFS-W1LLL to W1INF. One from W9RGH to W2JOA was delivered by telephone at W2IDV after having been

(Continued on next left-hand page)

THE SENSATIONAL NEW HALLICRAFTERS SUPER DEFIANT

Never before have we seen a combination quite like this — all the essentials of the SX-17 Super Skyrider *plus* the basic design of the best selling Skyrider Defiant. Selling WITH CRYSTAL, SPEAKER and TUBES for only \$99.50.

MORE PRESELECTION • MORE AUDIO

Better signal-to-noise ratio. Better crystal action. Better output. Better frequency stability. Better variable selectivity. Better "S" meter. Frequency Meter Tuning on the amateur bands. Just about every feature you can name!

*Come in and see it. Sold in all
our stores on Time Payments*

RADIO ELECTRIC SERVICE CO.

West Philadelphia Store, 5133 Market St. 7th and Arch Sts., Phila., Pa.
North Broad St. Store, 3145 No. Broad St.

Camden Store, 811 Federal St.
Easton Store, 9 No. 2nd St.

Allentown Store, 1042 Hamilton St.
Wilmington Store, 219 W. 8th St.

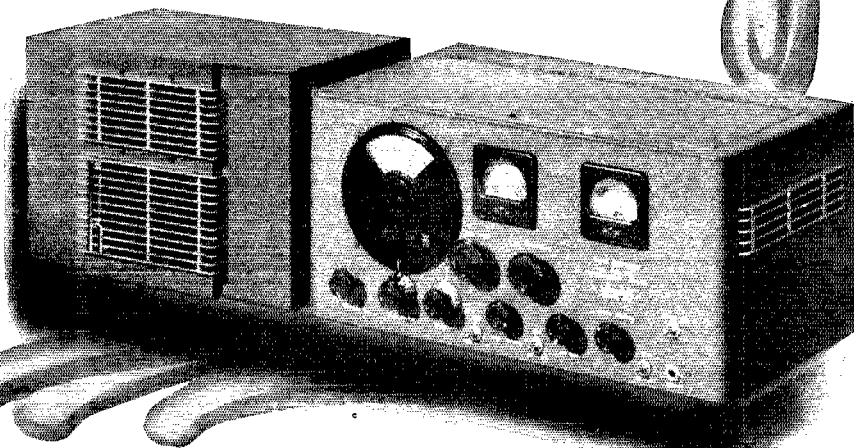

OHMITE RESISTORS

Specified by
Prominent Designers
and Manufacturers

... in the new Browning Exciter Kit ... in the Frank C. Jones new "Cathode Modulation" system ... in hundreds of other important applications ... Ohmite resistors are on the job! Get this extra efficiency for your rig. Ask your Jobber for "Brown Devils," "Dividohms," Rheostats and other Ohmite parts.

Write Today for Catalog 17
OHMITE MFG. CO.
4864 Flournoy Street, Chicago, U. S. A.

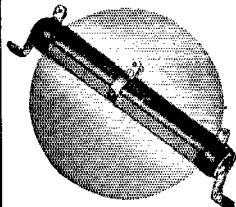
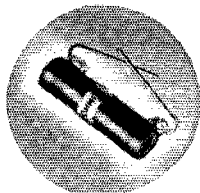

OHMITE

RHEOSTATS RESISTORS TAP SWITCHES

PRECISION CRYSTALS

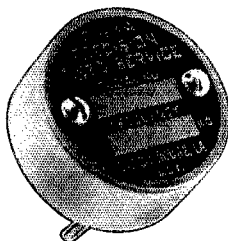

Highest quality crystals carefully prepared for dependable performance.

Low frequency drift Type 4-A unit plugs into tube socket, 40, 80 or 160 meter bands, within 5 kc. of your specified frequency — \$4.00. Calibration 0.03%.

'X' cut in Type 4 holder — \$3.50.

Crystals for commercial requirements quoted on at your request. Now in our Tenth year of business.

PRECISION PIEZO SERVICE

427 Asia Street

Baton Rouge, La.

EASY TO LEARN CODE

It is easy and pleasant work to learn the modern way — with an Instructograph Code Teacher. Ideal for the beginner or advanced student. Many tapes available ranging from alphabet for beginners to typical messages on all subjects. Speed range 5 to 40 WPM. Always ready, no QRM, beats having someone send to you.

FOR SALE OR RENT

STANDARD with 10 tapes and book of instructions, A. C. motor \$24.50
With spring-wound motor \$18.50
JUNIOR with 5 tapes and book of instructions (not rented) \$12.00

RENTAL Standard with 10 tapes and book of instructions \$3.00 first month, \$2.25 each additional month. References or \$10 deposit required. All rental payments may be applied on the purchase price should you decide to buy the equipment.

Write for details today

INSTRUCTOGRAPH COMPANY

Dept. Q, 912 Lakeside Place, Chicago, Illinois
Representative for Canada:
Radio College of Canada, 54 Bloor St. West, Toronto



sent from RGH through W9ZHB-W9CLH-W2AMJ-W2IDV.

112-Mc. Activity

From reports submitted, it is apparent that 2½-meter activity is definitely increasing in certain sections of the country. Several logs covering operation during the relay were received from 112-Mc. stations in the Boston, New York, Los Angeles and San Francisco areas. A few messages reached delivery points over routes shown below:

W1LMU-W1SS-W1MDV; W1COL-W1SS-W1LMU; W1MDV-W1SS-W1FIK; W1BHL-W1SS-W1MDV; W1PI-W1SS-W1MDV; W1LIO-W1SS-W1LEM; W6OFU/W6W6QUF-W6RVL; W6KSX-W6CFI-W6RVL.

For those 2½-meter operators whose messages did not reach delivery points, we present the tabulation below:

| Starting Station | Traced To | Starting Station | Traced To |
|------------------|-----------|------------------|-----------|
| W1SS | W1LEM | W6NSC | W6SAE |
| W1LMU | W1GCU | W6AQJ | W6KWH |
| W1LEM | W1GCU | W6VB | W6OJB |
| W1KKJ | W1GCU | W6CFI | W6RRS |
| W2MLO | W2BZB | W6LJS | W6NJJ |
| W2BZB | W2LFL | W6MHB | W6NJJ |
| W2LJJ | W2BZB | W6NJJ | W6OMC |
| W2HCL | W2MLO | W6OMC | W6LJC |
| W2MES | W2BZB | W6OJ | W6OFU/6 |
| W2KTW | W2BZB | W6BIK | W6PRQ |
| W2JND | W2BZB | W6SAE | W6CFI |
| W2LFL | W2BZB | W6LSC | W6CFI |
| W6LQM | W6RRS | W6PTR | W6RVL |
| W6KWH | W6RVL | W6RMZ | W6RVL |
| W6RSN | W6PRQ | W6RVL | W6RSS |
| W6NGQ | W6OFU/6 | W6QUF | W6HPD |

Reactions

"These relays are fine and really revive the old time spirit. The enthusiasm of the fellows was inspiring and did a lot to improve activity." — W3RL. "It was a swell contest and should prove that five can be used for emergency work, as well as for short haul traffic. We are interested here in establishing a five meter relay net along the Atlantic Coast." — W3FBH. "The QSO's I had with W6OMC on Kings Mt. were the best 112-Mc. dx contacts I had ever made. The distance was approximately 30 miles. My rig is an RK34 long line oscillator with about 5 watts input. The antenna is a vertical 3 element rotary." — W6NJJ. "It was great fun, and I certainly hope you will have more u.h.f relays. One every two or three months will take in all conditions and seasons and give us a better analysis of the 5 meter band." — W1CLH. "Home QTH is Pasadena, but worked in the contest from Sunset Ridge in Altadena, elevation about 1200 feet." — W6LQM. "W3RL and W3DBC really did hard work to make it a success." — W3EEN. "This relay was certainly bigger and better around Boston than the first one. W1HDQ and W1KJL deserve great credit in linking the Boston area with outside." — W1HXP. "I hope soon to have fifth stations on around the Bay. Keep up the Field Days and Relays." — W6OMC. "The activity around the New York area was surprising ... haven't heard or worked as many stations since the new regs went into effect a year ago." — W2GHV. "May I thank you for the best time I've had in amateur radio in years? The 58-Mc. band is too valuable a band to let stagnate as it has for the last few months. We need much more activity." — W2IDV. "Compliments are due W8CVQ and W8CIR for the large number of messages they handled, and to W8CIR for his trip to the mountains through 10 inches of snow and a 50-mile wind." — W8MDA. "Signals are generally more consistent here than they ever were on 5 (locally). W2JND best dx so far (about 25-27 miles) with R2 sigs at both ends. The main difficulty seems to be lack of activity in this area, although the Long Island gang deserves a lot of credit for sticking with the band." — W2BZB. "As Unit Commander of the 'five-meter net' of the Third Naval District, I assure you that several of us consider the five-meter band as important, from a real communication angle, as any of the other bands. It would do your heart good to hear a group of more than twenty earnest lads carry on a drill on ICW in true Navy style every Friday night." — W2LXE. "Five-meter conditions were good until early Sunday evening, rapidly becoming poorer as the evening progressed. It was great sport and created

(Continued on next left-hand page)

IT'S ALL IN THE HANDBOOK

CONTENTS

Frontispiece:
HIRAM PERCY MAXIM MEMORIAL STATION, WIAW
THE AMATEUR—HIS CODE OF ETHICS

| | | |
|------------|---|-----|
| | INTRODUCTION | 9 |
| Chapter 1 | STORY OF AMATEUR RADIO | 15 |
| Chapter 2 | GETTING STARTED | 22 |
| | PRINCIPLES AND DESIGN | |
| Chapter 3 | ELECTRICAL AND RADIO FUNDAMENTALS | 48 |
| Chapter 4 | RECEPTION OF RADIO SIGNALS | 71 |
| Chapter 5 | TRANSMITTER DESIGN | 88 |
| Chapter 6 | MODULATION | |
| | CONSTRUCTION AND ADJUSTMENT | |
| Chapter 7 | WORKSHOP PRACTICE | 103 |
| Chapter 8 | CONSTRUCTION OF RECEIVERS | 108 |
| Chapter 9 | TUNING AND ADJUSTING RECEIVERS | 134 |
| Chapter 10 | CONSTRUCTION OF TRANSMITTERS | 144 |
| Chapter 11 | POWER SUPPLY | 180 |
| Chapter 12 | MODULATION EQUIPMENT | 202 |
| Chapter 13 | COMPLETE TRANSMITTERS | 213 |
| Chapter 14 | KEYING AND B.C.I. ELIMINATION | 221 |
| Chapter 15 | ADJUSTMENT OF PHONE TRANSMITTERS | 232 |
| Chapter 16 | MEASUREMENTS AND MEASURING EQUIPMENT | 243 |
| Chapter 17 | EMERGENCY AND PORTABLE STATION ASSEMBLY | 258 |
| Chapter 18 | TUBE CHARACTERISTICS AND MISCELLANEOUS DATA | 273 |
| Chapter 19 | | 286 |
| Chapter 20 | | 294 |
| | ANTENNAS | |
| Chapter 21 | ANTENNA FUNDAMENTALS | 334 |
| Chapter 22 | R.F. TRANSMISSION LINES | 341 |
| Chapter 23 | LONG-WIRE ANTENNAS | 355 |
| Chapter 24 | MULTI-ELEMENT DIRECTIVE SYSTEMS | 364 |
| Chapter 25 | ANTENNA CONSTRUCTION | 371 |
| | ULTRA-HIGH FREQUENCIES | |
| Chapter 26 | INTRODUCTION TO U.H.F. | 378 |
| Chapter 27 | RECEIVING EQUIPMENT FOR 28- AND 56-MC. | 380 |
| Chapter 28 | 28- AND 56-MC. TRANSMITTERS | 389 |
| Chapter 29 | 112 MC. AND HIGHER | 400 |
| Chapter 30 | ANTENNAS FOR THE U.H.F. | 416 |
| | OPERATING AND TRAFFIC HANDLING | |
| Chapter 31 | OPERATING THE STATION | 422 |
| Chapter 32 | REGULATIONS AND DATA | 438 |
| | INDEX | 449 |

Price
\$1 postpaid in
Continental U. S. A.
\$1.25 postpaid elsewhere
Buckram bound edition, \$2.50

American Radio Relay League
West Hartford, Conn., U. S. A.

NEW!

Hallicrafters SUPER DEFIANT

- More Preselection
- More and Better Audio
- Better Signal-to-Noise Ratio
- More Usable Sensitivity
- Improved Crystal Action
- Push-Pull Output
- Six-Step Variable Selectivity
- Better Frequency Stability
- S and DB Meter
- 10, 20, 40, 80 Meter Band Spread
- 540 kc to 42 mc Coverage
- Twelve Tubes

Complete with Crystal,
Speaker and Tubes

\$99.50

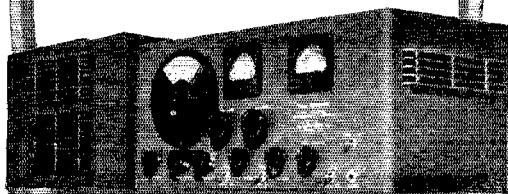

SUN RADIO CO.

212 Fulton Street
NEW YORK CITY

a lot of interest. There was more activity on five than there has been in three months." — W1EKT. "Highlights of the relay at W2LAL: The good fortune of being able to deliver a message and get a reply within one hour after it was filed at the originating station . . . a reply to a message I started, addressed to WIMBE, which we received in 5 hours after it was started on Cape Cod." — W2LAL.

SCORES—NOVEMBER U.I.F. CONTEST AND RELAY

(Figures show number of stations worked and score.)

| | | | | | |
|--------------|----|-----|--------------|----|----|
| W3AC/3..... | 40 | 408 | W2HYJ..... | 19 | 39 |
| W1HDQ..... | 41 | 209 | W1MJ..... | 10 | 37 |
| W2MO..... | 45 | 201 | W2LXC..... | 12 | 37 |
| W1KIJ..... | 37 | 199 | W1JLI..... | 10 | 34 |
| W3HOH..... | 34 | 199 | W1DJ..... | 17 | 32 |
| W8CIR/8..... | 6 | 158 | W3RL..... | 6 | 32 |
| W2COT..... | 35 | 156 | W2CUZ..... | 5 | 31 |
| W2AMJ..... | 29 | 130 | W1KH..... | 15 | 30 |
| W3BZJ..... | — | 130 | W2CLA..... | 11 | 29 |
| W3FQS..... | 37 | 124 | W2KKE..... | 11 | 29 |
| W1LLL..... | 20 | 102 | W2QA..... | 14 | 29 |
| W3FBH..... | 17 | 102 | W9LLC..... | 5 | 29 |
| W3BKB..... | 8 | 98 | W1KSB..... | 14 | 28 |
| W2ILK/2..... | 22 | 96 | W2MEU..... | 12 | 28 |
| W9VHG..... | 11 | 92 | W2BZB..... | 8 | 27 |
| WISS..... | 31 | 90 | W1MDN..... | 5 | 26 |
| W3CUD..... | 6 | 90 | W2MLO..... | 13 | 26 |
| W8CIR..... | 9 | 86 | W3EEN..... | 4 | 26 |
| W8CVQ..... | 8 | 86 | W6OJB..... | 7 | 26 |
| W9ARN..... | 11 | 86 | W8LMP..... | 6 | 26 |
| W1CLH..... | 12 | 82 | W2LEG..... | 11 | 25 |
| W1INF..... | 24 | 80 | W1KHL..... | 13 | 24 |
| W6RVL..... | 21 | 77 | W1LFD..... | 18 | 24 |
| W2IDV..... | 33 | 75 | W8SPY/8..... | 3 | 24 |
| W1HXP..... | 18 | 70 | W2HEL..... | 11 | 22 |
| W6QUF..... | 21 | 67 | W8NFM/8..... | 1 | 22 |
| W8DBC..... | 8 | 66 | W8RKE..... | 6 | 22 |
| W1KIK/1..... | 12 | 64 | W2KNV..... | 11 | 21 |
| W3CGV..... | 6 | 61 | W6LQM..... | 3 | 19 |
| W3HVK..... | 13 | 58 | W1HUV..... | 10 | 18 |
| W1EKT..... | 20 | 56 | W2TXE..... | 4 | 18 |
| W1EHT..... | 16 | 55 | W6PRQ/6..... | 7 | 18 |
| W8EUO/3..... | 2 | 55 | W2BS..... | 2 | 15 |
| W2BAD..... | 20 | 54 | W2LST..... | 5 | 15 |
| W6OMC/6..... | 6 | 52 | W6NJJ..... | 2 | 14 |
| W6NGQ..... | 17 | 50 | W2IUU..... | 3 | 13 |
| W2GHV..... | 16 | 48 | W2MES/2..... | 3 | 13 |
| W2LAL..... | 10 | 48 | W3GMZ..... | 3 | 13 |
| W1BDI..... | 9 | 45 | W3HHC..... | 3 | 13 |
| W1IJ..... | 11 | 44 | W9VWU..... | 1 | 13 |
| W2KTW/2..... | 5 | 44 | W9ZJB..... | 1 | 13 |
| W8MDA..... | 4 | 43 | W1LFP..... | 2 | 12 |
| W3NF/3..... | 5 | 42 | W8RUE..... | 2 | 12 |
| W9GGH..... | 6 | 42 | W6PDW..... | 5 | 6 |
| W2KDV..... | 20 | 41 | W2JND..... | 4 | 4 |
| W8LKD..... | 4 | 40 | W8PIK..... | 1 | 1 |
| W1LSN..... | 8 | 39 | | | |

Hints and Kinks

(Continued from page 98)

frequency standard in use. As the receiver is tuned between two strong 10-kc. points it will be noticed that the beat note from one 10-kc. point increases up the scale, then a second note decreases in frequency until it drops to zero at the second 10-kc. point. Midway between the two points there is a narrow region in which one note is increasing from 4995 to 5000 cycles and the second note decreasing from 5005 to 5000 cycles. In this range there is a distinct waxing and waning of the two signal intensities and a definite point may be located where this pulsing slows to zero and determines the 5-kc. mark.

When making a measurement, the receiver with the beat frequency oscillator adjusted to the

(Continued on next left-hand page)

IN STOCK! THE SENSATIONAL NEW HALLICRAFTERS SUPER DEFIANT

More preselection — more and better audio — better signal-to-noise ratio — more usable sensitivity — improved crystal action — push-pull output — six-step variable selectivity — better frequency stability — S and DB meter — 10, 20, 40, 80 meter bandsread — 540 kc to 42 mc coverage — twelve tubes.

CONSOLIDATED RADIO CORPORATION

612 ARCH STREET

PHILADELPHIA, PA.

Complete with Crystal,
Speaker
and Tubes
\$99.50

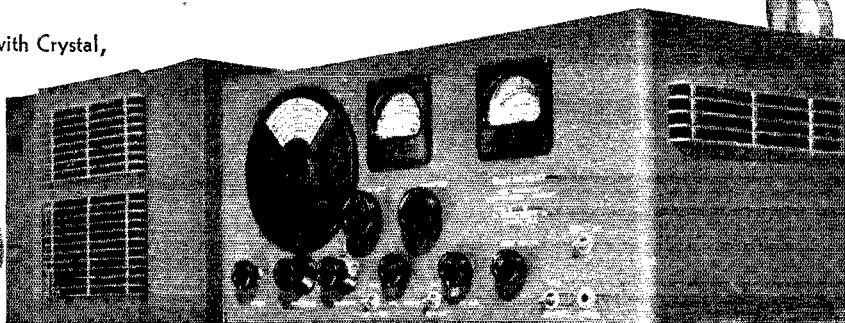

9 years

**COMMERCIAL CRYSTAL GRINDING EXPERIENCE
IS REPRESENTED IN MONITOR CRYSTAL UNITS**

*It will pay you
to inquire!*

MONITOR
Radio Products Co.
1134 MISSION ST., SOUTH PASADENA, CALIF.



MONITOR
TEMPERATURE CONTROL
50° C.

MONITOR

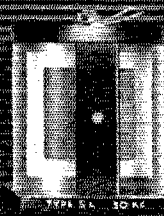

AIRCRAFT • MARINE • POLICE • AMATEUR • FREQUENCY STANDARDS

Quality above all



TRANSMITTING CAPACITORS

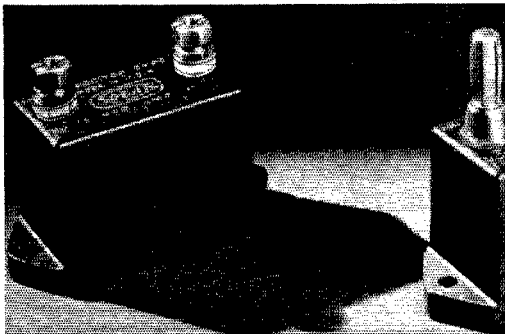

TYPE XS Transmica High-Voltage Capacitors — current-carrying; low corona losses; utmost permanency; humless. **Quality Above All** assures High Q.

Catalog Upon Request

SOLAR MFG. CORP.
Bayonne, New Jersey

**THERE'S
ANOTHER
MAN
WAITING FOR
YOUR JOB!**



- You can insure your future by training now for a better job in

RADIO & TELEVISION ENGINEERING

■ It's your job today, to train for a better job tomorrow! The radio industry is crammed with "pretty good" men. That's why your boss can afford to be "choosy" in selecting men for important jobs. He knows that there is always another man waiting for your job. It's up to you to make good or give way to the next fellow. You must be technically trained to hold and improve your present position. A few minutes in looking over our spare-time study courses in Practical Radio and Television Engineering may prove vital to you and your future in radio. Send for details today!

**Write for Free copy of
"The CREI Tested Plan"**

48 interesting pages with scores of photographs and complete outline and description of CREI radio and television courses.

Capitol Radio Engineering Institute
Dept. Q-2, 3224 16th Street, N.W., Washington, D. C.



mid-scale zero position, is tuned to the nearest 10-kc. or 5-kc. point as just described. This provides an indication of frequency to within ten (or five) kilocycles. Of course the signal being observed may obligingly fall into one of these standard frequency points, but it generally happens that there will be something left over — a beat note, which may be reduced to zero by adjusting the calibrated b.f.o.

The reading of the b.f.o. in relation to the nearest multivibrator check point then completes the measurement.

Used in connection with a 100-kc. calibrator only, the ranges in which accurate measurements may be made are necessarily restricted to plus and minus the b.f.o. range at each 100 kc.

Amateurs using spot frequencies can locate themselves with respect to any other station sharing that approximate frequency. If the frequency of any one transmitter in the group is accurately known, the others may determine their own frequency from this "marker." Likewise the amateurs working close to one of the standard frequency transmissions as listed in *QST*, may determine their deviations therefrom.

In any system of frequency measurement the voltage ratios of the signals being compared is quite important for the production of good beat notes or definite null points. The prevention of receiver blocking on strong local signals, or amplification of weak distant signals are individual problems. In the case of weak signals, the best solution is to pass back and forth over the broad null region several times and estimate its center.

— Stanley R. Fund, W9IBG

Regenerative Preselector

(Continued from page 55)

is not bothersome; also, transient disturbances are somewhat less noticeable with an S-7 signal or better, since the overall gain of the receiver is then materially reduced.

Operation of Preselector

Coupling the preselector to the receiver, and using only the regenerative pentode, permits bringing the majority of signals up to a comfortable level and removes the tendency toward image interference. Regeneration may be carried to the critical point, thereby overloading the receiver on otherwise moderate signals. Oscillation in the preselector completely blocks the super.

After the negative-feedback pentode is inserted in the preselector, the regeneration control becomes less critical. Swinging the bias control of the second tube slowly from one end to the other (about 0.4 to 1.3 volts on the cathode), discloses a very definite null point where the outputs of the two tubes cancel. All that is heard from the loudspeaker is a slight tube noise, plus an occasional barrage of ignition noise from cars passing within a few yards of the equipment.

Starting from the null point, the bias control may be swung either way, whereupon the output

(Continued on next left-hand page)

Where to buy it

A directory of suppliers who carry in stock the products of these dependable manufacturers.



ALBANY, N. Y. Uncle Dave's Radio Shack 356 Broadway
ATLANTA, GEORGIA 265 Peachtree Street
 Radio Wire Television Inc.
BOSTON, MASS. Radio Shack 167 Washington Street
BOSTON, MASS. 110 Federal Street
 Radio Wire Television Inc.
BRONX, N. Y. 542 East Fordham Rd.
 Radio Wire Television Inc.
BUTLER, MISSOURI 211-215 N. Main Street
 Henry Radio Shop
CHICAGO, ILL. 833 W. Jackson Blvd.
 Allied Radio Corp.
CHICAGO, ILL. 901-911 W. Jackson Blvd.
 Radio Wire Television Inc.
CINCINNATI, OHIO 1103 Vine Street
 United Radio, Inc.
DETROIT, MICH. 325 E. Jefferson Ave.
 Radio Specialties Co.
DETROIT, MICHIGAN 11800 Woodward Ave.
 Radio Specialties Co.
HARTFORD, CONNECTICUT 227 Asylum Street
 Radio Inspection Service Company
HOUSTON, TEXAS 4021 Huey Street
 R. C. & L. F. Hall
JAMAICA, L. I. 90-08 166th Street
 Radio Wire Television Inc.
KANSAS CITY, MO. 1012 McGee Street
 Burstein-Applebee Company
NEW YORK, N. Y. Harrison Radio Co. 12 West Broadway
NEW YORK, N. Y. 100 Sixth Ave.
 Radio Wire Television Inc.
NEWARK, N. J. 24 Central Ave.
 Radio Wire Television Inc.
READING, PENN. 404 Walnut St.
 George D. Barbey Company
SPRINGFIELD, MASS. T. F. Cushing 349 Worthington St.
WASHINGTON, D. C. 938 F Street, N. W.
 Sun Radio & Service Supply Co.

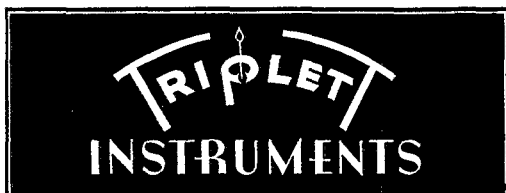

ALBANY, N. Y. Uncle Dave's Radio Shack 356 Broadway
ATLANTA, GEORGIA 265 Peachtree Street
 Radio Wire Television Inc.
BOSTON, MASS. Radio Shack 167 Washington Street
BOSTON, MASS. 110 Federal Street
 Radio Wire Television Inc.
BRONX, N. Y. 542 East Fordham Rd.
 Radio Wire Television Inc.
BUTLER, MISSOURI 211-215 N. Main Street
 Henry Radio Shop
CHICAGO, ILLINOIS 833 W. Jackson Blvd.
 Allied Radio Corp.
CHICAGO, ILLINOIS 95 North Franklin Street
 Electric & Radio Supply Co., Inc.
CHICAGO, ILL. 901-911 W. Jackson Blvd.
 Radio Wire Television Inc.
CINCINNATI, OHIO 1103 Vine Street
 United Radio, Inc.
JAMAICA, L. I. 90-08 166th Street
 Radio Wire Television Inc.
LITTLE ROCK, ARKANSAS 409 W. 3rd St.
 Beam Radio Company
MINNEAPOLIS, MINNESOTA 1124-26 Harmon Place
 Lew Bonn Company
MUSKOGEE, OKLAHOMA 204 No. Twelfth Street
 Home Radio Mart
NEW YORK, N. Y. 100 Sixth Avenue
 Radio Wire Television Inc.
NEWARK, N. J. 24 Central Ave.
 Radio Wire Television Inc.
READING, PENN. George D. Barbey Co. 404 Walnut Street
WASHINGTON, D. C. 938 F Street, N. W.
 Sun Radio & Service Supply Co.

Listings on this page do not necessarily imply endorsement by QST of the dealers or of other equipment sold by them.

Prompt Delivery
on the New

SX-25

Super Defiant
Receiver

DOWN PAYMENT

ONLY **\$10.00**

AND TERMS TO
SUIT YOU

**DON'T MISS
THE BEST BUY OF
THE SEASON**

Mark Your Order for the
Personal Attention
of W3DQ.

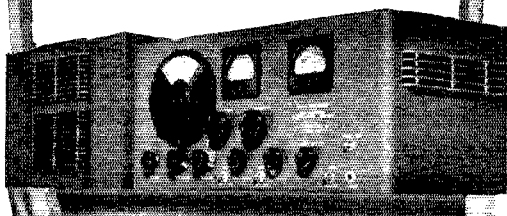

**DELAWARE
RADIO SALES
COMPANY**

405 Delaware Avenue
Wilmington, Delaware

bridge becomes unbalanced and signals can come through. Increased bias places the preselector in the a.g.c. region, and decreased bias places it in the volume expansion region described in the previous article.

Fading is offset partly in the preselector and partly in the receiver proper. The compensation seems to be most effective when the regenerative gain of the preselector is well advanced (approximately 20 to 25 volts on the screen grids of the pentodes), and part of the output is cancelled out in the bridge.

The bias control is usually set so as to give a small fraction of a volt more bias on pentode B than is required to nullify the preselector output. The bias control and regeneration control are interdependent but neither of them is especially critical. After the approximate settings are found, only the regeneration control need be touched when tuning from one station to another, and then only for widely varying signal levels.

With a little jockeying of the controls it is possible to put an S9 signal into the receiver, with signal limiting action such that most transient peak voltages do not exceed the signal modulation appreciably. The neon bulb across the speaker transformer ceases to flash on such transients although they may still be heard in the loudspeaker with much reduced energy. They do not "commit suicide" and leave holes in the signal sequence as with the Lamb "noise silencer," although a series of noise pulses may decrease in volume due to the a.g.c. action of the preselector and receiver. If the signal fades out more or less completely the noise level comes up noticeably, and static impulses may be amplified enough to ignite the neon bulb, which incidentally does a fair enough job of shorting the speaker during such disturbances.

As a further check on performance, a four-pole double-throw switch was wired in to change the antenna from the preselector to the receiver, and to cut out the preselector. Signals from a powerful commercial telegraph station were tuned in and brought up to the point where the neon bulb flashed regularly from the transients of the signal, with the preselector cut out. The flashing could be stopped completely by cutting in the preselector, properly adjusted. The switch facilitated comparison of selectivity and gain with and without the preselector. It is quite apparent that regeneration contributes very materially to both selectivity and gain.

In the reception of weak signals it is not always practical to limit the noise peaks to the modulation level of the signal without losing some signal volume. However, it is ordinarily feasible to limit transients to something less than the voltage which would drive the final audio stage to capacity. Similarly, in c.w. reception the preselector output may be cut down so that the crystal filter is not bounced around so much on strong signals and transients, even with the receiver gain well advanced.

Construction of a preselector embodying the circuit described above does not present any

(Continued on next left-hand page)

A Complete Line of
HALLICRAFTERS
EQUIPMENT **ALWAYS**
IN STOCK!

Marine Radiotelephone

The new transmitter-receiver (Model HT-8). Small, compact. Operates on 5 marine frequencies. Powered by 12, 32 or 100V DC and 110V AC.

The Famous Sky Buddy

The most communications receiver we have ever seen for **\$29.50**

The Sky Champion

The communications "buy" of the year. All essential features and most of the luxuries . . . for **\$49.50**

The New Super Defiant

A superlatively fine deluxe communications receiver. Sells COMPLETE WITH CRYSTAL, SPEAKER AND TUBES, **\$99.50**

RADIO PARTS DIST. CO.

726 Boush Street • Norfolk, Virginia

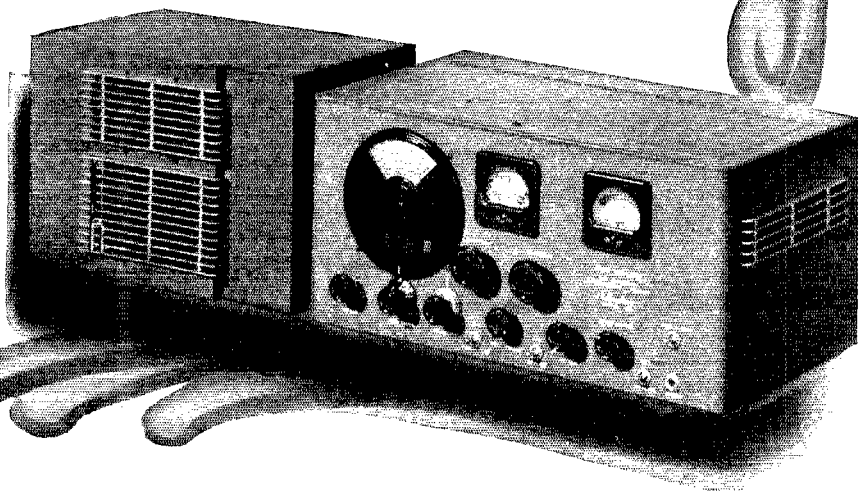

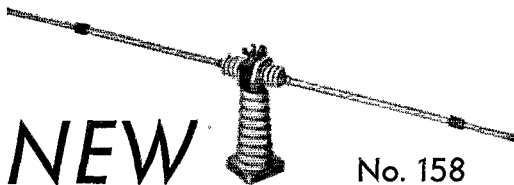

NEW

No. 158

HALF WAVE ADJUSTABLE DOUBLET ANTENNA

(Range 82 mc. to 145 mc.)

Can be used as a vertical or horizontal doublet. Can also be rotated to any angle for any degree of polarization. Impedance at center 72 ohms, matched by EO1 cable. Aluminum alloy tubing permits outdoor mounting. Special tapered lock bushings hold each section in place simply by turning and pushing down. A 4 1/2" insulator provides mounting for the two 1/4 wave sections.

- No. 158 — 2 1/2 meter doublet antenna.
 Net to amateurs \$1.80
- No. 159 — 5-meter doublet antenna \$2.40

Complete line of popular BIRNBACH products available at all leading distributors.



RADIO TECHNOLOGY



RCA Institutes offer an intensive course of high standard embracing all phases of Radio and Television. Practical training with modern equipment at New York and Chicago schools. Also specialized courses and Home Study Courses under "No obligation" plan.

Illustrated Catalog on request

RCA INSTITUTES, INC. Dept. ST-40
 A Radio Corporation of America Service

75 Varick St., New York 1154 Merchandise Mart, Chicago

Be a Champion with a Genuine VIBROPLEX "CHAMPION"

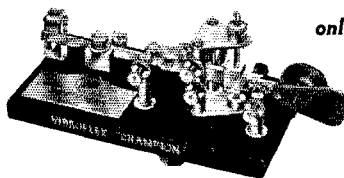

only \$9.95

At Your Dealer's

Standard size black base. Chromium finished top parts. Equipped with 3/16" diameter contact points. Furnished without circuit closer, cord and wedge.

A "STAR" Performer

Like all true champions, this new Vibroplex "CHAMPION" defies competition. Handsome in design, sturdily built and a "STAR" performer... the "CHAMPION" is our answer to the demand for a BUG of established quality, proved sending ability and assured ease of operation at a price within the reach of everyone. Designed primarily for the amateur, professional operators will find the "CHAMPION" amply qualified to give an expert account of itself on any assignment. See the "CHAMPION" at your dealer's to-day. If he cannot supply you, write or order direct from us. Money order or registered mail. Write for illustrated catalog.



The BUG trade mark identifies the Genuine Vibroplex

THE VIBROPLEX CO., Inc.

832 Broadway

New York, N. Y.

problems materially different from those ordinarily encountered. Plug-in coils or coil switching can, of course, be used to cover two or more bands. The biasing and regeneration controls may be rearranged in a variety of ways and could include the use of a portion of the a.g.c. bias from the receiver proper to operate the output metering bridge. Coupling to the antenna may be by any of the conventional methods. Careful shielding is a requisite if any substantial reduction of noise from local sources is expected.

ZLIMR

(Continued from page 65)

Ron is not what one would call an old-timer, since he broke into the game with a 2A5-46 rig on 80 as recently as late '36. But he has certainly made up for lost time. His latest outfit, shown in the photograph, is streamlined for DX-contest work. There are separate transmitters for each of the DX bands any one of which may be switched to the single power supply in an instant by a switching system. A similar line-up is used in each. It consists of a 36 e.c.o., 6L6 crystal oscillator, 6L6 doublers, T20 driver and HK54 driver. An input of 100 watts has never been exceeded. Separate antennas are also provided for each transmitter. On 7 and 14 Mc., the antennas are semi-vertical half-wave Zepps running at an angle of about 30 degrees, which he has found by numerous tests to be most effective. On 28 Mc., the full-wave antenna is also semi-vertical.

A seven-tube homemade superhet with pre-selector is used on 14 Mc. and an ACR-175 on 7 and 28 Mc.

Ron is a traffic officer so he can tell you how to get to ZLIMR, should you ever journey to N. Z. Winner in several DX contests, he has had over 5000 DX contacts with 3500 different stations, 2400 of them being W's. So he's probably better known in the states than in Auckland.



**ALWAYS
 Be
 CAREFUL**



★ ★ ★

- (A) Kill all transmitter circuits completely before touching anything behind the panel.
- (B) Never wear 'phones while working on the transmitter.
- (C) Never pull test arcs from transmitter tank circuits.
- (D) Don't shoot trouble in a transmitter when tired or sleepy.
- (E) When working on the transmitter, avoid bodily contact with metal racks or frames, radiators, damp floors or other grounded objects.
- (F) Keep one hand in your pocket.
- (G) Develop your own safety technique. Take time to be careful.

★ ★ ★

Death Is Permanent!

HAM-ADS

(1) Advertising shall pertain to radio and shall be of nature of interest to radio amateurs or experimenters in their pursuit of the art.

(2) No display of any character will be accepted, nor can any special typographical arrangement, such as all or part capital letters be used which would tend to make one advertisement stand out from the others.

(3) The Ham-Ad rate is 15¢ per word, except as noted in paragraph (6) below.

(4) Remittance in full must accompany copy. No cash or contract discount or agency commission will be allowed.

(5) Closing date for Ham-Ads is the 25th of the second month preceding publication date.

(6) A special rate of 7¢ per word will apply to advertising which, in our judgment, is obviously non-commercial in nature and is placed and signed by a member of the American Radio Relay League. Thus, advertising of bona fide surplus equipment owned, used and for sale by an individual or apparatus offered for exchange or advertising inquiring for special equipment, if by a member of the American Radio Relay League takes the 7¢ rate. An attempt to deal in apparatus in quantity for profit, even if by an individual, is commercial and all advertising by him takes the 15¢ rate. Provisions of paragraphs (1), (2), (4) and (5) apply to all advertising in this column regardless of which rate may apply.

Having made no investigation of the advertisers in the classified columns, the publishers of *QST* are unable to vouch for their integrity or for the grade or character of the products advertised.

QUARTZ — direct importers from Brazil of best quality pure quartz suitable for making piezo-electric crystals.

Diamond Drill Carbon Co., 719 World Bldg., New York City.

USED receivers. Bargains. Cash only. No trades. Price list 3¢. W3DQ, Wilmington, Del.

QSL'S. Free samples. Printer, Corwith, Iowa.

CALLBOOKS — Winter edition now on sale containing complete up-to-date list of radio hams throughout entire world. Also world prefix map, and new time conversion chart. Single copies \$1.25. Canada and foreign \$1.35. Radio Amateur Call Book, 610 S. Dearborn, Chicago.

QSL'S — By W8NOS — 13 Swan St., Buffalo, N. Y.

WHY not get better deal? Used receiver list free. W9RA, Chi-Rad, 415 So. Dearborn St., Chicago.

QSL'S, all colors, cartoons, snappy service. Write for free samples today. W1BEF, 78 Warrenton, Springfield, Mass.

CRYSTALS: police, marine, aircraft, and amateur frequencies. Descriptive catalog. Ham Crystals, 1104 Lincoln Place, Brooklyn, N. Y.

MACAUTO code machines: low monthly rental 50,000 words practice tapes. Write N. C. Ayers, 711 Boylston St., Boston, Mass. Granite 7189-W.

CLOSING out — Navy surplus — thousands sold — GE dynamotors 24/750 volt 200 mils, \$15; Westinghouse 6-15 volt 500 watts, \$8; 500 cycle 500 watt with exciters, \$8. List. Henry Kienzle, 215 Hart Blvd., Staten Island, N. Y.

QSL'S, Maps, Cartoons. Free samples. Theodore Porcher, 7708 Navahoe, Philadelphia, Pa.

TWO CW three hundred watt transmitters in handsome cabinet. One eighty, other forty and twenty; completely remote controlled. Write W3DD.

1000 watt G.E. transformers 1100-2200-4400 volts each side c.t. Guaranteed. \$13.50. Dawson, 5740 Woodrow, Detroit, Mich.

CRYSTALS, mounted, 80-160, \$1.25. V-cut 40, \$2.25. R9 Crystals, 338 Murray Ave., Arnold, Pa.

QSL'S — samples. Brownie, W3CJI, 523 No. Tenth St., Allentown, Pa.

CRYSTALS — police, marine, aircraft, amateur. Catalog on request. C-W Mfg. Co., 1170 Esperanza, Los Angeles.

QSL'S — SWL's. 100, 3 color, 75¢, Lapco, 344 W. 39th, Indianapolis, Ind.

RADIO kits — \$3.95 up. Complete. Single band; all-wave; 5-10 tubes. Radio and parts catalog — free. McGee Radio, P-2035, K. C., Mo.

CRYSTALS in plug-in heat dissipating holders. Guaranteed good oscillators. 160M — 80M, \$1.25. (No Y cuts.) 40X, \$1.65. 80M vari-frequency (5 kilocycle variance) complete, \$2.95. State frequency desired. C.O.D.'s accepted. Pacific Crystals, 1042 S. Hicks, Los Angeles.

FB7A — powerpack — four sets bandspread coils, \$32.50. W3KJ.

CRYSTALS: famous P.R., mounted in latest Aismag 35 holders — 40, 80 meter PR-X, 160 meter PR-Z, \$3; 40, 80 meter PR-Z (low drift), \$3.50; 20-meter PR-20, \$4.50; unconditionally guaranteed. Immediate shipment. Wholesale Radio Labs., Council Bluffs, Iowa, W9GFQ.

CLEAN xtals mean better transmitter performance. Use xtal Kleener, an organic solvent that really cleans. Made by a chemist. Large 4 oz. bottle, 50¢ postpaid. W9LBJ, 1012 Greenwood Ave., Maywood, Ill.

HIGH quality speech amplifier, modulator, and power supply in one unit. Neat construction. Uses 1 — 6J7, 1 — 6C5, 2 — 6C5's, 2 — 6L6's, 1 — 5Z3. Will fully modulate 100 watts input. Thordarson transformers. Complete, less tubes and mike, \$38.95. Write. Pope Elec. Co., W4DMZ, Marion, Ala.

QSL'S? **QSL'S?** (Modernistic? Cartoons? Photographic?) Patronize the ham. Samples? W8DED, Holland, Mich. (Bliley crystals?)

SELL — DM36-70 — \$26, or what have you? W2MT.

CRYSTALS: zero cut. New low drift mounted units. Exact freq. 160 — 80 — 40 meters, \$2.50 postpaid. Our tenth year of satisfactory service. Fisher Lab., 4522 Norwood St., San Diego, Calif.

GIL cartoon **QSL's**. Complete new line. Samples. W1CJD, Gildersleeve, Conn.

QST'S for sale, both pre-war and post-war, reasonably priced. W9VKF, Minneapolis, Minn.

SELL HRO Sr. Complete, Gross CW 80 transmitter, many extras, \$135. Consider Hallcraft Marine part trade. W2KRX.

TELEPLEXES, Instructographs, meters bought, sold. Ryan's, Hannibal, Mo.

SELLING out: best cash offer. RME-70 with built-in DB-20-70, as new. Also CB-55 transmitter complete with tubes, D-104 xtal mike, coils, and xtals. Inquiries answered. W3HCQ.

SEND to me for any amateur equipment in any catalog or advertisement. I will give you service and cooperation you can't get elsewhere. I guarantee you can't buy for less or on better terms elsewhere. Your orders and inquiries invited. W9ARA, Buld er, Mo.

RECONDITIONED guaranteed receivers. Practically all models. Same guarantee as new receivers. Free trial. HRO's, \$129; RME-69's, \$89; NC81X's, \$59; SX-24's, \$49; Breting 14's, \$49; SX-12 Skyriker Commercial, \$44; NC44's, \$34; Breting 9's, \$34; Sky Champions, \$29; National One-Tens, \$29; Howard 430's, \$17.50; Sky Buddies, \$15; FB7's, \$9; SW3's, \$6; many other models. Terms. Write for free list. W9ARA, Butler, Mo.

SLIM pocketbook? Slim prices put that rotary within reach. Husky, he-man rotators, aluminum elements, selsynchronous indicators, everything needed. Bulletins, photos, handbook, quarter. Rotary Array Service; W8ML.

SELL HRO, special gray finish, six months old; home built pack, \$145. Also Mims 20 rotary, indicator, half list. W2AEB.

DOUGLAS modulation transformers. Match all tubes. 50 watts audio, \$4.95 pair; 100 watts audio, \$7.75 pair. Postpaid in U. S. One year guarantee. Stancor cathode modulation transformers, \$2.55 and up plus postage. Write W9IXR, Rice Lake, Wis.

SELLING 1 kw. CW PP-250TH Eco-xtal xmitter whole or part. SX11 Skyriker. W9HFF.

QSL'S. Large variety. Samples. W2AEY, 338 Elmora, Elizabeth, N. J.

FBXA with preselector, all coils — 10 to 160 meters. National power supply — A-1 shape — also used RK23 — RK20 — 841 tubes. Best offer accepted. W1HJI, Manchester, N. H.

NEW tube bargains — 210's, 801's, 841's — \$1. each. 211's, \$3.50 each. 32's, 33's, 34's, 36's, 37's, 38's, 39-44's, 1A6's, 112A's, 48's, 57's, 58's, 75's, 77's, 78's, 85's; metal or glass 6A7's, 6A8's, 6F6's, 6J7's, 6K7's, 6L7's, 6R7's — all 35¢ each postpaid. Amdico, Clearfield, Pa.

REBUILDING? Need relay racks? Sturdily constructed for amateurs. Your saving exceeds 30% at our introductory prices. W2CMI design. Write F. B. Meinikheim, 613 Main St., Toms River, N. J.

SELL: Bassett HFA-1000 CWF CW-fone xmitter. PP-T200 final amplifier — 822 modulators. 2500 volt supply. Complete with accessories. W9ZDO.

QSL'S. Finest designs. Samples. Maleco, 1805 St. Johns Place Brooklyn, N. Y.

TRADE: cylinder phonograph, 250X microscope, and chemist's slide rule. Want bug, Gardiner-Levinger sender, Gordon DX clock, sextant, or what? Lewell Hickman, Redkey, Ind.

T9 crystals: Twice as good — half the cost. For all round smooth performance use T9 crystals. They are fracture-resisting, dependable and fully guaranteed. 40 to 80 meter bands, \$1.60 postpaid, close frequency choice. T9 ceramic holders, \$1. C.O.D.'s accepted. Send for commercial folder. Sold by: Frank Mayer Co., Corpus Christi, Texas; Henry Radio Shop, Butler, Mo.; Pembleton Labs., Ft. Wayne, Ind.; Frank Anzalone, 375 W. 46th, N. Y. C.; Radio Doc, 721 S. Main, Los Angeles, Calif.; Valley Radio Distributors, Appleton, Wis.; Hieronymus Radio, 88-34 209th, Queens Village, N. Y.; Radio Atlas, Tampico, Mexico; and Edison's, Temple, Texas.

GOVERNMENT contract and standard parts at big bargains. Direction finders, loops, receivers, portable transmitters, etc., etc. Send for list. Amdico, Clearfield, Pa.

HALLICRAFTER SX-24, new, \$57.50. Also new Hammarlund HQ-120X, with speaker, \$107. W2EXR.

HRO wanted. Also 1000 ft. of guy wire and 200 strain insulators. W1JZD, 12 Commonwealth, Boston, Apt. 407.

SELL — trade: best offer. 155 back issues QST. Want 6 DC/110 AC inverter. Carl Howe, Tyler, Minn.

WANTED: 1 kw. Class C amp. Tubes, coils, and power supply. Write W8SNZ.

RECEIVERS guaranteed reconditioned at low prices. Free trial on terms to suit you. Write for list and other bargains. W9GFQ, Leo, Council Bluffs, Iowa.

WANTED: More amateurs to get acquainted with a real Ham house. Send for exclusive ham catalog. New cathode modulator for inputs up to 500 watts, only \$20, with tubes complete. Write Leo W9GFQ today. Wholesale Radio Labs., Council Bluffs, Iowa.

SACRIFICE. Complete transmitter, 450 watts CW, 250 watts phone, cabinet, \$200. Photo. Trade \$50. Bausch and Lomb microscope, want typewriter. A. Harrison, W9OJL, Carthage, Mo.

WANTED: Rider's Manuals. W8ECX.

NEW 100TH, RCA-801's; 913, 203A, 1750 volt supply. Best offer takes. W9VQZ, Denver.

SELL: Skyrider Defiant, matching speaker, \$50.; perfect. 819 Blair, Flint, Mich.

TRANSMITTER new rack-panel 250 watts, phone—CW, 6A6, 807, PP-TZ40's, modulators, TZ40's, mike, speech, complete. Best of parts, Weston, National, Stancor, etc., \$125. W3ARR.

HAMMARLUND HQ—120 for sale. Like new. \$90. H. Mandell, 1314 Gr. Concourse, Bronx, N. Y.

TRANSCIEVER — 2½, 5, 10 complete, metal tubes. K. Merian, Healdsburg, Calif.

NATIONAL FB7 receiver with preselector attached; 20—40—80 meter band spread coils, National power supply and Dynamic speaker. Perfect condition. Thirty dollars. W1CTX.

RACKS — \$4.95 up. Schaaf, 4741 Byron, Chicago.

QSL'S. Samples. W9RUJ, Auburn, Neb.

Prong-Base Midget ELECTROLYTICS

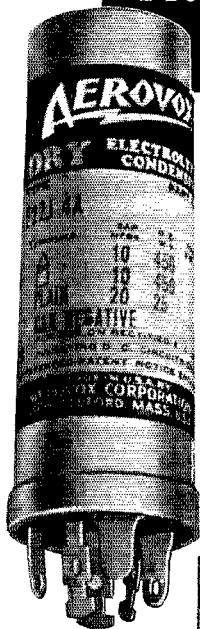

Illustration is slightly smaller than actual size.

● Yur dam tootin' — these jobs may all look alike but there's a heap of difference beneath the label, can, base.

While achieving reasonably compact size and low price, AEROVOX Series F prong-base midgets contain an honest-to-goodness dry electrolytic section with nothing vital subtracted to meet a size or price. Approximately twice the foil area for a given capacity and voltage, to insure long life. No ultra etching or tricky foil. No skimping on separators. Just a real AEROVOX electrolytic in new clothes.

Quite an array of single- and dual-section units now available in all popular working voltages.

Catalog . . .

1940 edition. More pages, more items, more choice. Ask local supplier for copy — or write direct.



RADIO

ENGINEERING, broadcasting, aviation and police radio, servicing, marine radio telegraphy and telephony, Morse telegraphy and railway accounting taught thoroughly. 48 weeks' engineering course, equivalent to three years of college radio work. School established 1874. All expenses low. Catalog free.

DODGE'S INSTITUTE, Day Street, Valparaiso, Indiana

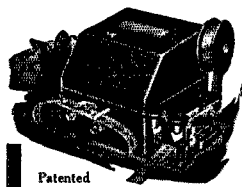

A Perfected AUTOMATIC SENDER

Postpaid in U. S. A. **\$12.50**

Patented

Sends up to 70 words a minute. Motor driven. Built-in tape perforator. Uniform spacing. Excellent practice medium for beginners. Complete with practice tape covering Alphabet, Numerals, Word combinations and ample supply of blank tape. Speed up your receiving. Full operating instructions. If your dealer can't supply, write us.

\$13.50
West of
Denver

FULLY GUARANTEED

GARDINER-LEVERING CO. Haddon Heights, New Jersey, U. S. A.

RADIO COURSES

New Classes Now Starting

RADIO OPERATING ● BROADCASTING ● CODE
RADIO SERVICING ● TELEVISION
● ELECTRONICS — 1 year day course; 2 years eve.
Day and Evening Classes — Booklet upon request

NEW YORK YMCA SCHOOLS
4 West 63rd Street, New York City

THIS EXPERT WILL HELP YOU PASS THE NEW RADIO EXAMS



Newly-written, low-cost, home-study courses under supervision of Arthur R. Nilson, twenty years co-author of technical radio books. Fit yourself for the new license examinations — Radio Telephone Operator 1st or 2nd class and Radio Telegraph Operator's permit, used in the Aeronautical, Forestry and Police services and Broadcasting. Thousands of professional radiomen use Nilson and Hornung textbooks to keep up to date. Now Arthur R. Nilson will give you direct, detailed lessons, step by step.

SEND FOR FREE 16-PAGE BOOKLET "What The Modern Radioman Must Know." Make this step toward your successful radio career . . . now!

NILSON RADIO SCHOOL
51 East 42nd St., New York, N. Y.

Please send me without obligation, your booklet "What The Modern Radioman Must Know."



Name _____
Address _____
City _____ State _____ Q-2

Your Nearby Dealer Is Your Best Friend

Your nearby dealer is entitled to your patronage. He is equipped with a knowledge and understanding of amateur radio. He is your logical source of advice and counsel on what equipment you should buy. His stock is complete. He can supply your needs without delay. His prices are fair and consistent with the high quality of the goods he carries. He is responsible to you and interested in you.

One of these dealers is probably in your city — Patronize him!

ATLANTA, GEORGIA

Radio Wire Television Inc.
265 Peachtree Street
"The World's Largest Radio Supply House"

JAMAICA, L. I., NEW YORK

Radio Wire Television Inc.
90-08 166th Street (Merrick Road)
"The World's Largest Radio Supply House"

BALTIMORE, MARYLAND

Radio Electric Service Co.
3 N. Howard St.
Everything for the amateur

NEWARK, N. J.

Radio Wire Television Inc.
24 Central Avenue
"The World's Largest Radio Supply House"

BOSTON, MASS.

Radio Wire Television Inc.
110 Federal Street
"The World's Largest Radio Supply House"

NEW YORK, N. Y.

Radio Wire Television Inc.
100 Sixth Avenue
"The World's Largest Radio Supply House"

BRONX, NEW YORK

Radio Wire Television Inc.
542 East Fordham Road
"The World's Largest Radio Supply House"

NEW YORK, N. Y.

Harrison Radio Company
12 West Broadway
Harrison Has It! Phone WO 2-6276 for information or rush service

BUFFALO, NEW YORK

Radio Equipment Corp.
326 Elm Street
WBPMC and WBNEL — Ham, service and sound equipment

PHILADELPHIA, PENNSYLVANIA

Eugene G. Wile
10 S. Tenth Street
Complete Stock of Quality Merchandise

BUFFALO, NEW YORK

Dymac Radio
1531 Main Street — Cor. Ferry
Open Evenings GA. 0252

PROVIDENCE, RHODE ISLAND

W. H. Edwards Company
85 Broadway
National, Hammarlund, Hallicrafter, Thordarson, Taylor, RCA

HOUSTON, TEXAS

R. C. & L. F. Hall
4021 Huey Street (W 9-2713)
"Specialists in Amateur Supplies"

RICHMOND, VIRGINIA

The Arnold Company
Broad at Harrison St.
W3EQQ — "The Virginia Ham Headquarters" — W3FBL

YOU CAN BE SURE
WHEN YOU BUY FROM

QST

ADVERTISERS

“Advertising for *QST* is accepted only from firms who, in the publisher’s opinion, are of established integrity and whose products secure the approval of the technical staff of the American Radio Relay League.”

Quoted from QST’s advertising rate card.

Every conceivable need of a radio amateur can be supplied by the advertisers in QST. And you will know the product has the approval of the League’s technical staff

Index to Advertisers

| | |
|--|--------------------------|
| Aerovox Corp. | 124 |
| Astatic Microphone Laboratory, Inc. | 107 |
| Barker & Williamson | 90 |
| Birnback Radio Company | 122 |
| Biley Electric Company | 103 |
| Bluff City Distributing Company | 113 |
| Bonn Company, Lew. | 107 |
| Brazilian Trading Company | 120 |
| Brill Company, W. D. | 120 |
| Browning Laboratories, Inc. | 94 |
| Candler System Company | 90 |
| Capitol Radio Engineering Institute | 118 |
| Cardwell Mfg. Company, Allen D. | 76 |
| Centralab | 78 |
| Chicago Radio Apparatus Company | 93 |
| Collins Radio Company | Cov. 2 |
| Consolidated Radio Corp. | 117 |
| Cornell-Dubilier Electric Corp. | 4 |
| Delaware Radio Sales Company | 120 |
| Dixie Radio Company | 121 |
| Dodge’s Institute | 124 |
| Elcor, Inc. | 111 |
| Eitel-McCullough, Inc. | 87 |
| Electra Distributing Company | 121 |
| Electro-Voice Mfg. Company | 82 |
| Freck Radio & Supply Company | 109 |
| Gardiner-Levering Company | 124 |
| General Electric Company | 7 |
| Gross Radio, Inc. | 98 |
| Hall, R. C. & L. F. | 117 |
| Hallicrafters, Inc., The | 113 |
| Hammarlund Mfg. Company, Inc. | 73, 76 |
| Harrison Radio Company | 89 |
| Harvey Radio Company | 92, 93 |
| Heintz & Kaufman, Ltd. | 103 |
| Henry Radio Shop | 95 |
| Hipower Crystal Company | 112 |
| Howard Radio Company | 85 |
| Hytronic Laboratories | 80 |
| Instructograph Company | 114 |
| Johnson Company, E. F. | 81 |
| Kato Engineering Company | 107 |
| Ken-Rad Tube & Lamp Corp. | 111 |
| Kenyon Transformer Company, Inc. | 111 |
| M & H Sporting Goods Company | 108 |
| Mallory & Company, Inc., P. R. | 72 |
| Massachusetts Radio School | 111 |
| Meissner Mfg. Company | 99 |
| Millen Mfg. Company, Inc., James | Insert |
| Mims Radio Company | 85 |
| Monitor Piezo Products Co. | 117 |
| National Company, Inc. | Cov. 3, 71, 77, 102, 112 |
| New York YMCA Schools | 124 |
| Newark Electro company | 91 |
| Nilson Radio School | 124 |
| Ohmite Mfg. Company | 114 |
| Pioneer Gen-E-Motor Corp. | 106 |
| Port Arthur College | 107 |
| Precision Apparatus Corp. | 74 |
| Precision Service | 114 |
| Premax Products | 106 |
| RCA Institutes, Inc. | 122 |
| RCA Mfg. Company, Inc. | Cov. 4 |
| Radio Electric Service Company | 113 |
| Radio Mfg. Engineers, Inc. | 127 |
| Radio Parts Company | 113 |
| Radio Parts Distributing Company | 131 |
| Radio Shack, The | 109 |
| Radio Specialties, Inc. | 113 |
| Radio Supply & Engineering Company | 109 |
| Radio Transceiver Laboratories | 102 |
| San Francisco Radio Company | 96 |
| Scientific Radio Service | 110 |
| Shuler Supply Company | 96 |
| Sickles Company, F. W. | 111 |
| Solar Mfg. Corp. | 118 |
| Southwest Radio Supply | 108 |
| Specialty Distributing Company | 116 |
| Sprague Products Company | 86 |
| Standard Radio Parts Company | 120 |
| Standard Transformer Corp. | 5 |
| Sun Radio Company | 96, 116 |
| Taylor Tubes, Inc. | 83 |
| Teleplex Company | 110 |
| Terminal Radio Corp. | 97 |
| Thordarson Electric Mfg. Company | 75 |
| Thurow Radio Distributing Company | 120 |
| Triplett Electrical Instrument Company, Inc. | 84 |
| Turner Company | 94 |
| United Transformer Corp. | 128 |
| Vibroplex Company, Inc., The | 122 |
| Ward Leonard Electric Company | 110 |
| Wenger Company, E. C. | 108 |
| Wholesale Radio Laboratories | 97 |
| Wilson, Willard S. | 120 |
| Yaxley | 72 |
| Zack Radio Supply Company | 117 |

RME

TIME WILL TELL

IS CHOSEN BY THE P. F. D. ★

The Portland (Oregon) Fire Department maintains a complete disaster truck, prepared for any type of trouble. This truck has been specially outfitted with over 12 tons of all types of emergency and rescue apparatus, from a complete power plant to a miniature hospital. Streamlined, yet ruggedly constructed, this unit stands for dependability when the "chips are down." Every piece of equipment which it carries must be tested and retested for complete insurance against failure at a crucial moment.



NUMBERED among the many tried and proven pieces of apparatus which this unit contains, is one of our RME-69 communication receivers. We are more than gratified at the recognition of the trust which is placed in our receiver in providing vital communication where human lives and millions of dollars of property are at stake.

THE true reputation and integrity of a company is fashioned from the service which it renders to its patrons. RME counts among its hundreds of satisfied customers many expeditions and special services, whose very success depends almost wholly on the dependability of their apparatus.

THOSE of you who have had the opportunity for close examination of RME construction methods **KNOW** the reason why our units are chosen; to those who have not had this opportunity of close inspection . . . let us send you our complete literature with details of our receivers and expanders.

★ PORTLAND FIRE DEPARTMENT

Radio Mfg. Engineers, Inc.

One-eleven Harrison Street

Peoria, Illinois

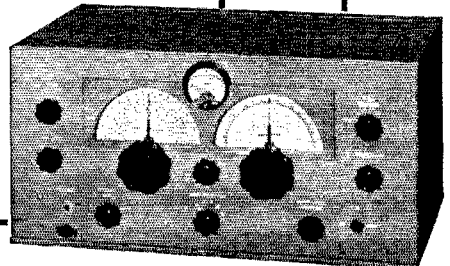



VARITONE

FOR GREATER EFFICIENCY, THE VT-10

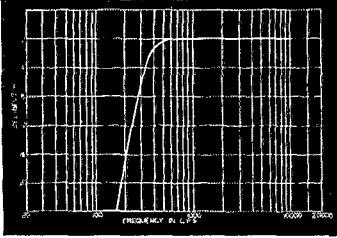

HIGH PASS

The high pass portion of the VT-10 is ideal for eliminating hum and rumble and adding crispness to speech.

The VT-10 is the band pass filter used in the Cathode Modulated transmitter described on page 52 of Dec. QST.

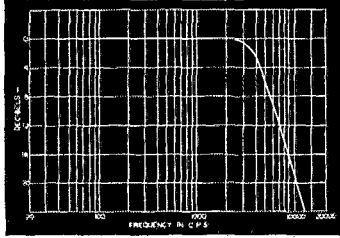

LOW PASS

The low pass portion of the VT-10 reduces parasitic noises and minimizes possibility of over-running sidebands.

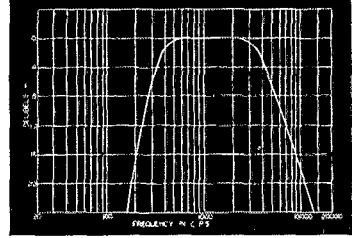

BAND PASS

The VT-10 connected for band pass eliminates unnecessary frequencies greatly increasing efficiency and reducing QRM.

FOR GREATER FIDELITY, THE VT-1, 2, 4

The UTC Varitone Audio Unit is the Only Transformer of Its Kind Giving Continuously

Variable Low End, High End, or Low and High End Equalization. The Varitone permits full control of the frequency response of any audio amplifier or receiver. Using this device, tone correction can be affected for defects in acoustic conditions or overall audio response.

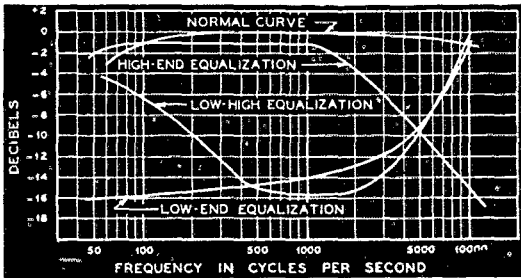

VT-1 — This Varitone is incorporated with a universal audio transformer. Two primaries are provided. One is suitable for working from a single or double button microphone a low impedance pickup, or a line; the other primary is designed to work out of the plate of a tube or from a high impedance pickup. The secondary winding is center-tapped and is equally suitable for working into one or two grids. Net price **\$5.10**

VT-2 — The VT-2 is a Varitone control unit, incorporated with an impedance matching device so that it can be connected directly across a 200 or 500 ohm line, or low impedance pickup or mike, or in shunt with the plate circuit of any triode or a high impedance pickup. The circuit is not changed in any other way. The VT-2 is solely an addition for tone correction. The original audio circuits are not disturbed. Net price **\$3.60**

VT-4 — The VT-4 is a complete self-contained wired unit including a variable control so arranged that with the control at one end high fidelity performance is effected by the increase of low and high frequencies, and with the control at the other end the low response is reduced to diminish static, line noises, and heterodyne whistles. The unit is connected directly from plate to B plus of first audio triode. This unit is designed to work in the plate circuit of low impedance tubes such as 01A, 12A, 30, 31, 26, 27, 37, 55, 56, 85, 262A, 864, 57 triode, 6C6 triode, 77 **\$3.60**

VT-10 — Band pass filter for amateur service removes unnecessary low and high frequencies, reducing QRM, increasing efficiency and intelligibility. Connects in plate circuit of triode. Net Price **\$6.00**

UNITED TRANSFORMER CORP.

Write: COMMUNICATIONS DIV. ★ 150 VARICK ST. ★ NEW YORK, N. Y.
EXPORT DIVISION: 100 VARICK STREET NEW YORK, N. Y. CABLES: "ARLAB"

QST for February, 1940, EASTERN Edition

PRINTED IN U. S. A.
RUMFORD PRESS
CONCORD, N. H.

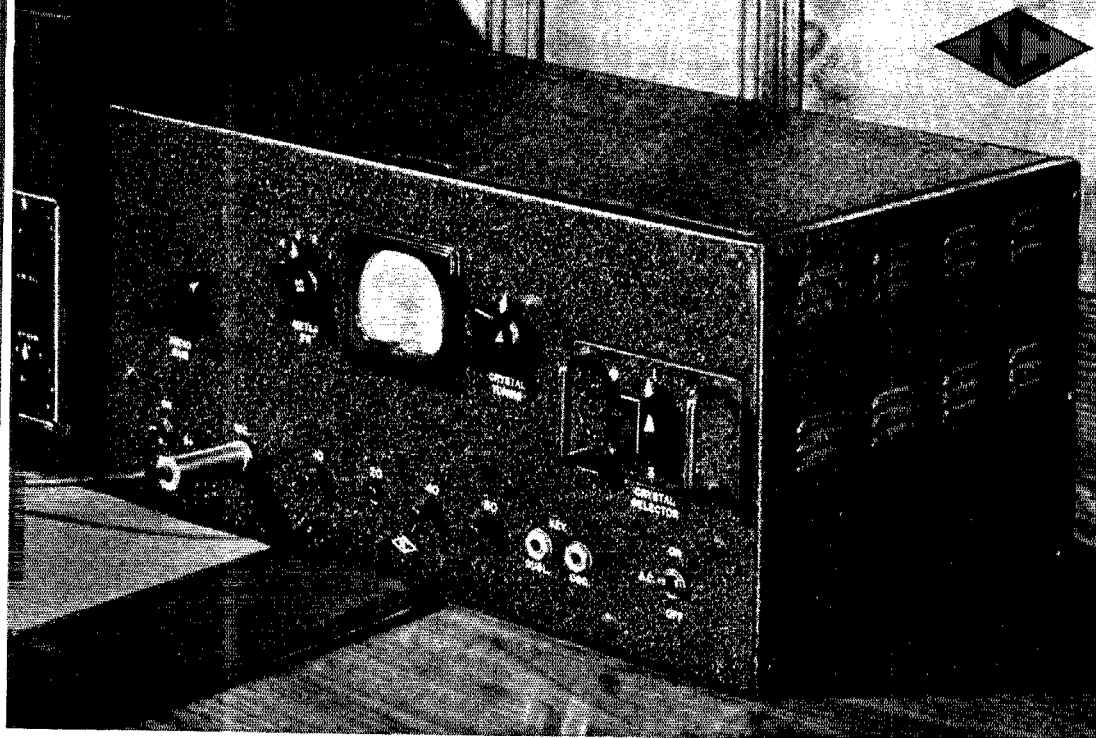

EITHER of the fine units shown on this page contributes generously to the art of fine operating. The NTE Exciter-Speech Amplifier shown above is the heart of a fine transmitter, combining a crystal controlled multi-band exciter with a high fidelity 10-watt speech amplifier. The NTX-30 below is a complete CW transmitter in itself, with 30 watts output, conservatively rated. Terminals are provided for connecting an external amplifier for phone operation.

Both units are similar. Both have a push switch for band selection. Both have panel control of crystal frequency. Both have a meter for circuit adjustments. Both combine outstanding versatility with moderate price.

NATIONAL COMPANY, INC.
MALDEN, MASS.

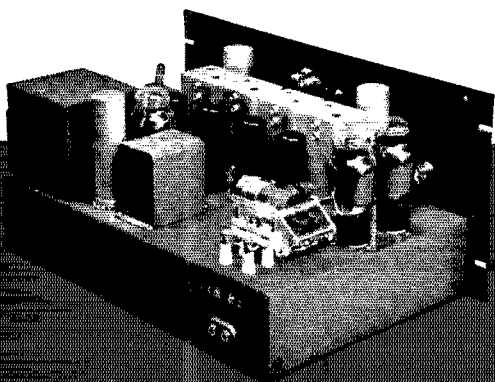

The List Price of the NTX-30 Transmitter is \$195.00. The List Price of the NTE Exciter-Speech Amplifier is \$215.00. Prices given are for table model complete with coils, tubes and crystal holder, but without crystal, for operation on four bands. There is a slight additional charge for relay rack mounting.

A SMASH HIT!

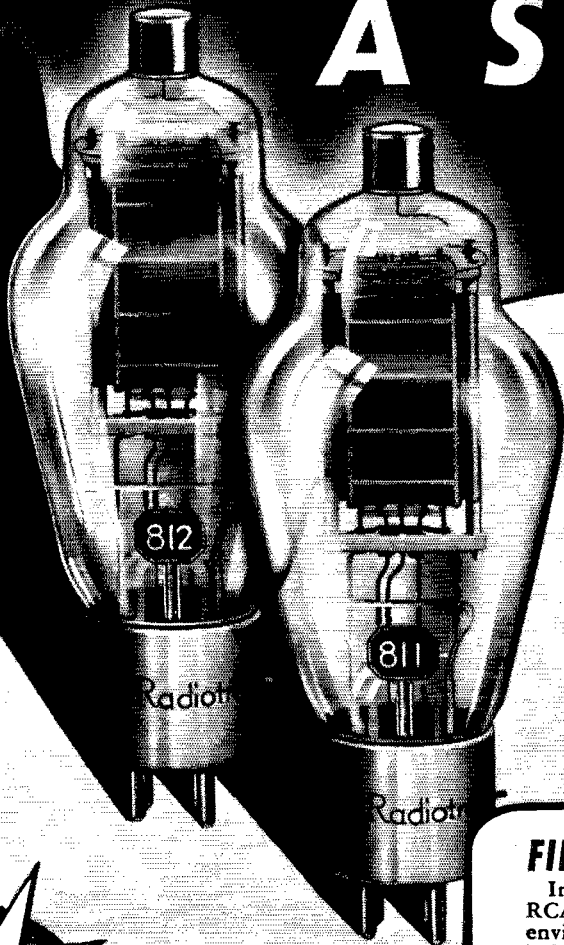

RCA-811 • RCA-812

High- μ Triode Medium- μ Triode

Plate voltage 1500 V.

Plate input 225 W.

Plate dissipation 55 W.

Amateur Net \$3.50 each

Above ratings are the new RCA ICAS Ratings (Intermittent Commercial and Amateur Service). Write for bulletin.

FIRST IN SALES

In a few short months, RCA-811's and RCA-812's have crashed through with an enviable sales record—the finest of any RCA Power Tube for an equal period of time.

FIRST IN PERFORMANCE..

Think of it! . . . 240 watts phone output with two \$3.50 tubes! Yet this is only one of the many amazing possibilities of these remarkable tubes.

FIRST WITH ZIRCONIUM-COATED ANODE . . .

Runs cleaner and cooler at full ratings. Gives instantaneous protection against gassing on overloads.

FIRST WITH MICANOL BASE

New low-loss type. Has excellent insulation qualities at high frequencies, together with low moisture-absorption characteristics.

FIRST IN VALUE

Watt for watt, dollar for dollar, RCA-811's and RCA-812's establish new highs for dependable economy.



RCA MANUFACTURING
CO., INC., CAMDEN, N. J.
A Service of the Radio
Corporation of America.

Radio Tubes

FIRST IN METAL—FOREMOST IN GLASS—FINEST IN PERFORMANCE

DESIGNED for APPLICATION

MODERN SOCKETS for MODERN TUBES! Long flashover path to chassis permits use with transmitting tubes, 866 rectifiers, etc. Ideal for mounting on rugged thick cast aluminum chassis now being used on much of the better commercial equipment. Long leakage path between contacts. Contacts are type proven by hundreds of millions already in government, commercial and broadcast service, to be extremely dependable. Sockets may be mounted either with or without metal flange. Mount in standard size chassis hole. All types have barrier between contacts and chassis. All but octal also have barriers between individual contacts in addition.

See These New Sockets at Your Dealer's Today

JAMES MILLEN
150 EXCHANGE ST.



MFG. CO. INC.
MALDEN, MASS.

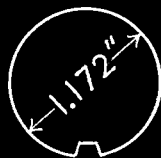
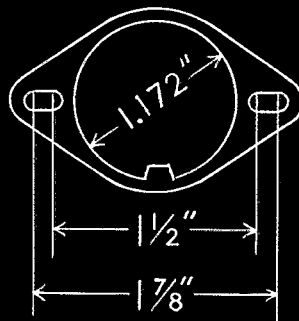
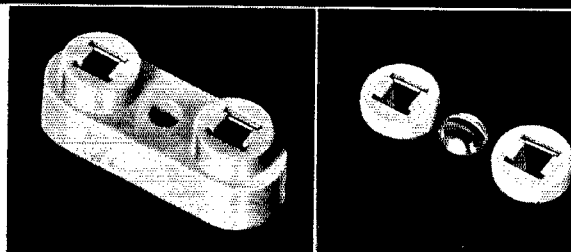

P. A. B.

| | | |
|---|------|------|
| 4 | 1/4 | 3/8 |
| 5 | 1/4 | 3/8 |
| 6 | 3/16 | 7/16 |
| 8 | 1/4 | 3/8 |