

**QST** 

devoted entirely to

# amateur radio

September  
1935  
25 cents



# The 202-A TRANSMITTER

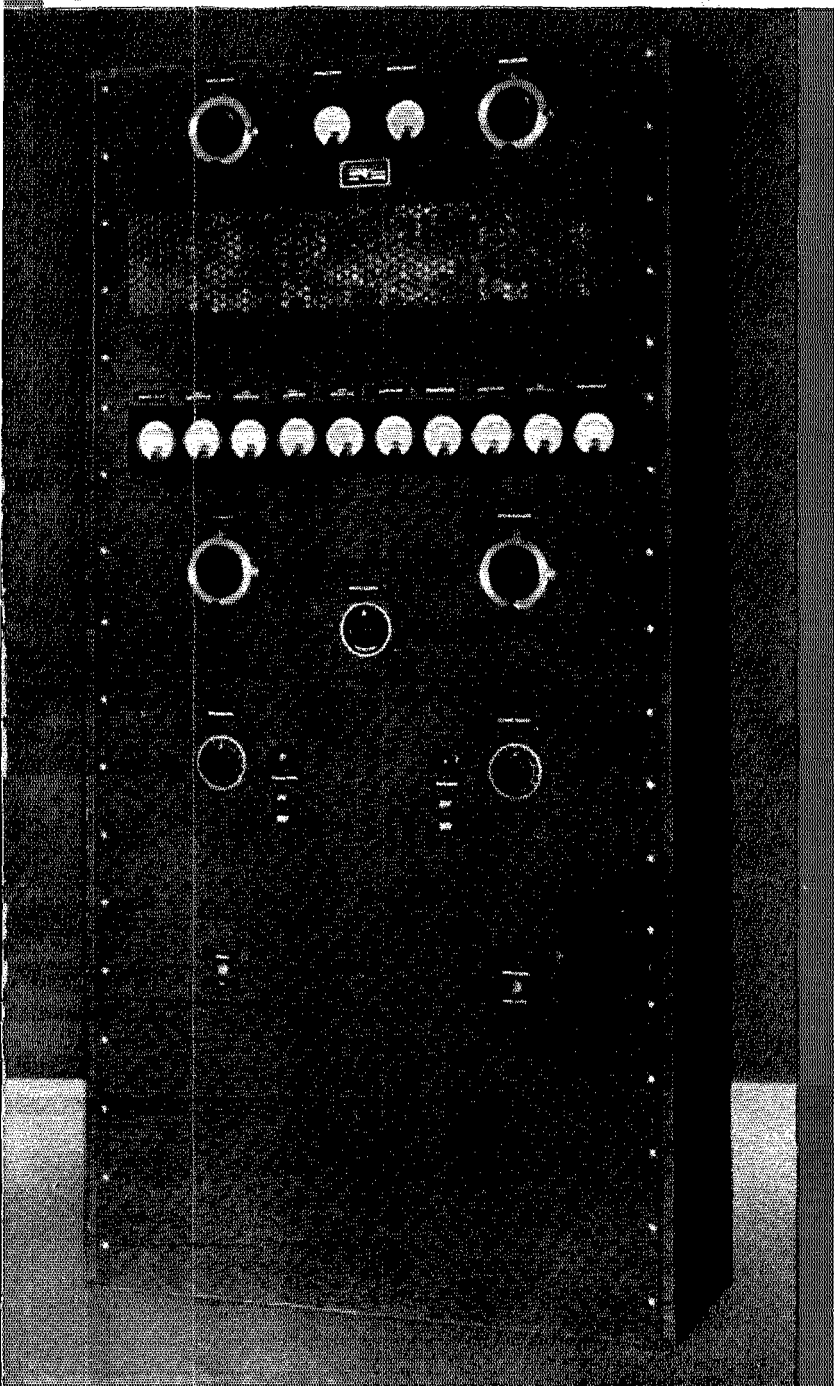

**T**HE 202-A is an impressive addition to the series of standard COLLINS transmitters. It is a high level modulated transmitter with a maximum plate input of one kilowatt. The first production units are being supplied to amateurs who want the finest and most powerful station obtainable. The 202-A will undoubtedly find numerous other applications in the high frequency broadcast and communications field.

**E**VERY possible refinement has been embodied in this new COLLINS product in its new style cabinet — full remote control — rapid frequency shift — local or remote operation — high output efficiency — frequency range 1500 kc. to 30,000 kc. — complete metering — simplified controls — numerous protective devices — large factor of safety. All these features contribute toward excellent performance and dependability.

**C**ORRESPONDENTS are invited with those who wish more complete technical details.

The 45-A, a radically different low-cost transmitter, will be announced in the next issue of QST.

## Collins Radio Company

CEDAR RAPIDS

New York

11 West 42nd St.



IOWA, U. S. A.

Mexico City

Edificio "La Nacional"

# COMING THRU

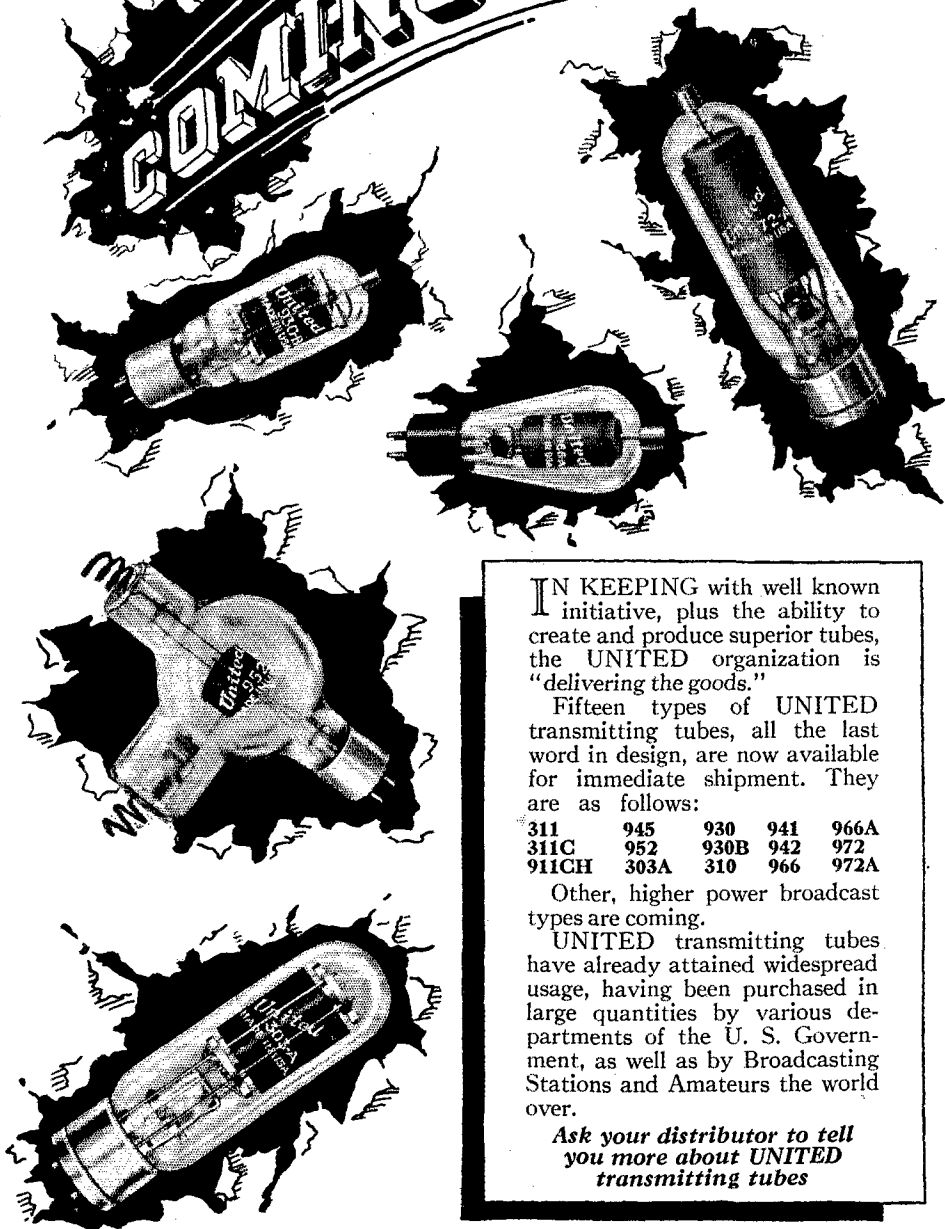

IN KEEPING with well known initiative, plus the ability to create and produce superior tubes, the UNITED organization is "delivering the goods."

Fifteen types of UNITED transmitting tubes, all the last word in design, are now available for immediate shipment. They are as follows:

311	945	930	941	966A
311C	952	930B	942	972
911CH	303A	310	966	972A

Other, higher power broadcast types are coming.

UNITED transmitting tubes have already attained widespread usage, having been purchased in large quantities by various departments of the U. S. Government, as well as by Broadcasting Stations and Amateurs the world over.

*Ask your distributor to tell you more about UNITED transmitting tubes*

**UNITED ELECTRONICS COMPANY**  
42 Spring Street — Newark, N. J.

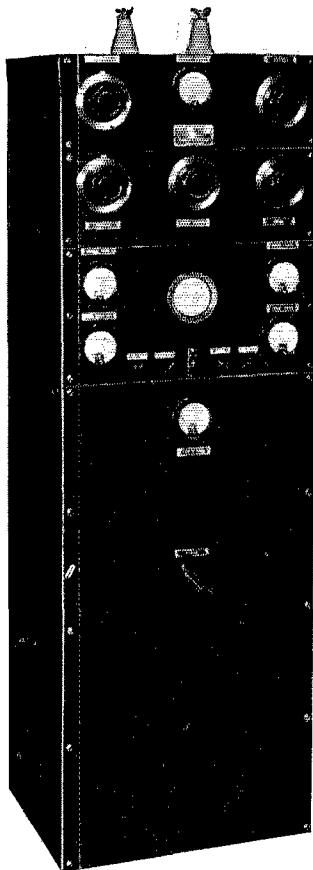

THE IDEAL ANSWER  
to the New Regulations



# THE MARINE 140-B

with BUILT-IN

CATHODE RAY OSCILLOSCOPE

and many other "Exclusive" MARINE Features

The new regulations of the Federal Communications Commission require that adequate means for checking overmodulation of every amateur transmitter shall be employed.

• • •

The built-in Cathode Ray Oscilloscope is designed for this specific use. By means of the Oscilloscope an accurate check is kept, thereby maintaining 100% modulation at all times.

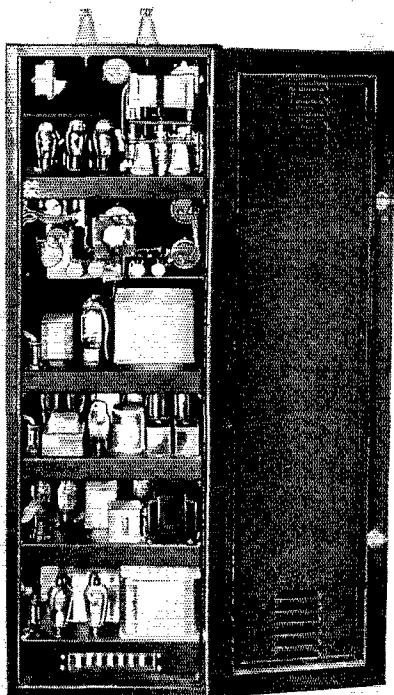

REAR VIEW 140-B

Showing the wrinkle finished steel cabinet with rear door, R.F. Unit, Cathode Ray Oscilloscope, Class B Audio Unit, Speech Equipment, Bias, Cathode Ray, Crystal, Buffer and High Voltage Supplies. For the sake of photographic clarity the Oscilloscope pick-up coil and the Antenna Matching Network coils are not shown.

We manufacture a complete line of transmitters for all purposes

## Technical Data

**POWER OUTPUT** — Conservative rating, 100 watts.

**FREQUENCY RANGE** — Standard — 15,000 Kc. to 1500 Kc.

**CATHODE RAY OSCILLOSCOPE** — At a glance, over or under modulation or distortion can be detected. Used as a percentage of modulation indicator, it is possible to maintain 100% modulation. Either trapezoidal or envelope figures can be had.

**PERMANENT NEUTRALIZATION** — The transmitter is permanently neutralized at the plant before leaving. Changing from one band to another or using different antennas will have absolutely no effect on the neutralization.

**HIGH FIDELITY AUDIO CHANNEL** — The speech amplifier has a frequency response of 30 to 10,000 cycles, + or - 1 1/2 D.B., with a gain of 125 D.B. which makes it ideally suited for use with a Crystal microphone.

GENERAL OFFICES AND PLANT  
124-11 - - 101st Avenue  
RICHMOND HILL, N. Y.  
Telephone: Cleveland 3-2400

**BIAS SUPPLIES** — Absolutely no batteries of any kind required.

**ANTENNA IMPEDANCE MATCHING NETWORK** — Capable of efficiently matching and transferring energy from the final stage to the antenna.

**AUTO TRANSFORMER** — Tapped in 5 volt steps from 90 to 130 volts so that the transmitter can be used with full efficiency on any line voltage.

**CABINET** — The MARINE 140-B transmitter is housed in a steel broadcast station type cabinet rack with detachable hinged rear door and is finished in a baked wrinkled enamel. The Bakelite panel finish is optional. Gloss, satin or wrinkled may be had.

**GUARANTEE**  
One year unconditional Guarantee

**DESCRIPTIVE LITERATURE** — Send stamp for descriptive folder with detailed information and photographs. You will be astounded at what we are offering at such an extremely moderate price.

# MARINE RADIO

## C O M P A N Y

EXPORT DEPARTMENT  
15 LAIGHT STREET  
NEW YORK, N. Y.  
Cable Address: "Arlab"

See You Saw It in QST — It Identifies You and Helps QST



# QST

Published monthly, as its official organ, by the American Radio Relay League, Inc., at West Hartford, Conn., U. S. A.; Official Organ of the International Amateur Radio Union

devoted entirely to

# AMATEUR RADIO

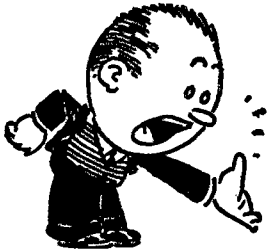

Editorials . . . . .	11
Roanoke Division Convention . . . . .	12
Coming Examinations for Amateur Operator License . . . . .	12
Plate Modulation of Pentodes . . . . . <i>George Grammer</i>	13
An All-Purpose S.S. Superhet with Turret-Type Automatic Coil Changing, <i>Part II</i> . . . . . <i>Charles Fisher, W3FX</i>	17
Technical Topics . . . . .	21
What the League Is Doing . . . . .	22
DX Contest Results . . . . . <i>E. L. Battey</i>	24
A New Ultra-High-Frequency Transmitter . . . . . <i>Ronald King</i>	30
A Frequency-Lock Multi-Vider . . . . . <i>J. A. DeYoung, W1HHW</i>	32
A.R.R.L.'s Field Day, 1935 . . . . .	34
Army-Amateur Notes . . . . .	37
A Flexible E.C.-Controlled Transmitter, <i>Alpha Learned, W1FUB</i>	38
Amateur Radio Stations . . . . . <i>W3AAJ, W1BPX, W8GHA</i>	40
Experimenters' Section . . . . .	42
AN AUDIO OUTPUT STAGE FOR THE REGENERATIVE S.S. RE- CEIVER — BLOCKED-GRID KEYING — DUPLEX 'PHONE — TWO-BAND U.H.F. TRANSCEIVER	
I.A.R.U. News . . . . .	45
Operating Notes . . . . .	47
Correspondence Department . . . . .	57
Silent Keys . . . . .	72
Dakota Division Convention . . . . .	72
The Hudson Division Convention . . . . .	78
A New Filter-Speaker . . . . .	80
A.R.R.L. QSL Bureau . . . . .	82
Midwest Division Convention . . . . .	84
Standard Frequency Transmission . . . . .	90
WWV Schedules . . . . .	90
Ham-ads . . . . .	91
QST's Index of Advertisers . . . . .	94

SEPTEMBER  
1935

VOLUME XIX  
NUMBER 9

Kenneth B. Warner (Secretary, A.R.R.L.), *Editor-in-Chief and Business Manager*; Ross A. Hull, *Associate Editor*; James J. Lamb, *Technical Editor*; George Grammer, *Assistant Technical Editor*; Clark C. Rodimon, *Managing Editor*; David H. Houghton, *Circulation Manager*; F. Cheyney Beekley, *Advertising Manager*; Ursula M. Chamberlain, *Assistant Advertising Manager*.

*Editorial and Advertising Offices*  
38 La Salle Road, West Hartford, Conn.

Subscription rate in United States and Possessions and Canada, \$2.50 per year, postpaid; all other countries, \$3.00 per year, postpaid. Single copies, 25 cents. Foreign remittances should be by international postal or express money order or bank draft negotiable in the U. S. and for an equivalent amount in U. S. funds.

Entered as second-class matter May 29, 1919, at the post office at Hartford, Connecticut, under the Act of March 3, 1879. Acceptance for mailing at special rate of postage provided for in section 1103, Act of October 3, 1917, authorized September 9, 1922. Additional entry at Concord, N. H., authorized February 21, 1929, under the Act of February 28, 1925.

Additional second-class entries to cover sectional editions authorized March 20, 1935

Copyright 1935 by the American Radio Relay League, Inc.  
Title registered at United States Patent Office.

# The Lightning OHM'S LAW Calculator

*A running-mate for the  
Lightning Radio Calculator*

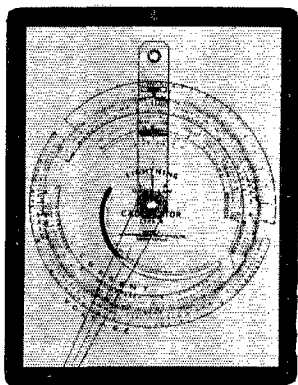

Gives direct-reading answers to calculations involving current, resistance, voltage and power, with scales for resistance of copper wire and additional supplemental scale for calculating decibel gain or loss. Answers three separate kinds of problems: Finding value of current, voltage, power or resistance, when any two are known; finding resistance or voltage drop in any wire or circuit or resistor; finding decibel gain or loss in amplifiers or circuits.

- ✓ *Quick*
- ✓ *Accurate*
- ✓ *Versatile*
- ✓ *Simple*

**\$1.00** *postpaid  
anywhere*

**American Radio Relay League, West Hartford, Connecticut**

# hallicrafters *Introduce*

## the 1936 Super Skyrider WITH DUO-MICRO BAND SPREAD AND 9 METAL TUBES

The 1936 Super SKYRIDER uses the NEW Metal Tubes to *full* advantage. Elimination of noisy tube shields, reduced inter-electrode capacitances and the advantage of shorter leads, make possible greater gain and fewer circuit complications.

In keeping with the policy of the HALLICRAFTERS to always be first with worthwhile engineering developments, the NEW Super SKYRIDER incorporates a specially designed Iron Core intermediate frequency system—this for the first time in any amateur receiver. Crowded amateur bands demand a new order of selectivity. Iron core I. F.'s is the answer. The special system used in the NEW Super SKYRIDER also insures greater sensitivity and a signal to noise ratio that is UNATTAINABLE with an air core system.\*

In the re-design of the Super SKYRIDER, HALLICRAFTERS engineers have achieved an efficient five band coverage of all wave bands from 7.4 to 550 meters (41,000 to 540 KC.), made possible through an antenna circuit that is in each case tuned to the low frequency end of each band.

A stellar feature of the NEW Super SKYRIDER is the duo-micro-vernier band spread system, affording unequalled accuracy of logging, combining electrical band spreading and micro-vernier tuning in an exclusive and distinctive dial. The vernier and main tuning dial are illuminated by a novel means.

Full provision is made for the use of either the doublet or the conventional types of antennae.

\*See Technical Article P. 36 August Q. S. T. Magazine.

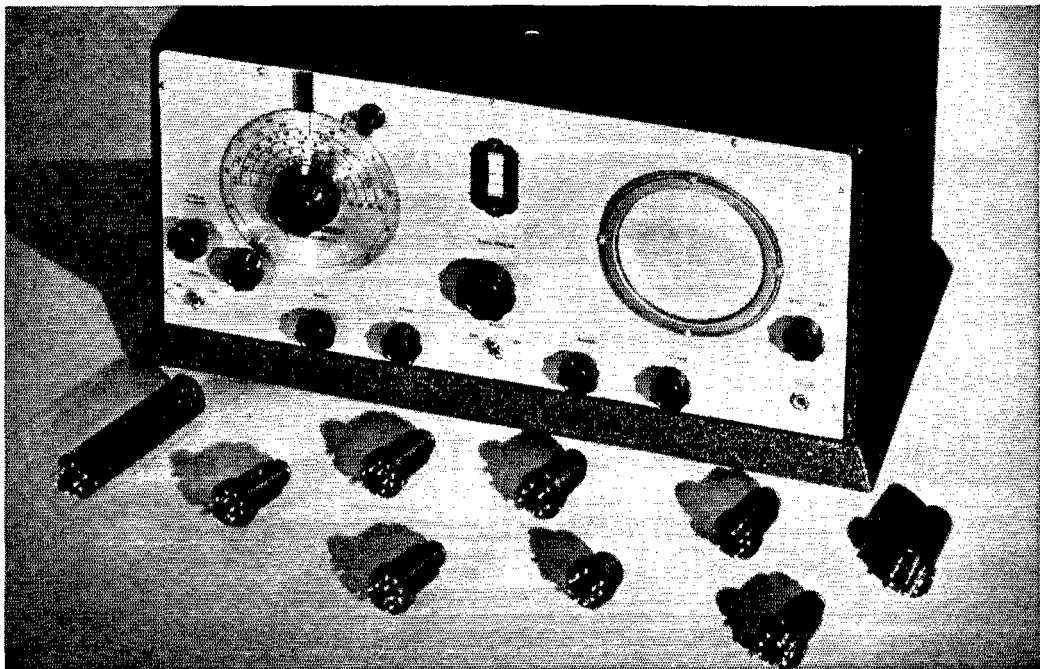

WRITE OR WIRE FOR COMPLETE INFORMATION

# the hallicrafters

3001-Z Southport Avenue, Chicago, Ill., U.S.A.

Cable Address: "LIKEX NEW YORK"

Say You Saw It in *QST*—It Identifies You and Helps *QST*

# This Season we are Featuring the hallicrafters

1936 Super  
**SKYRIDER**  
and the NEW  
**SUPER-7**

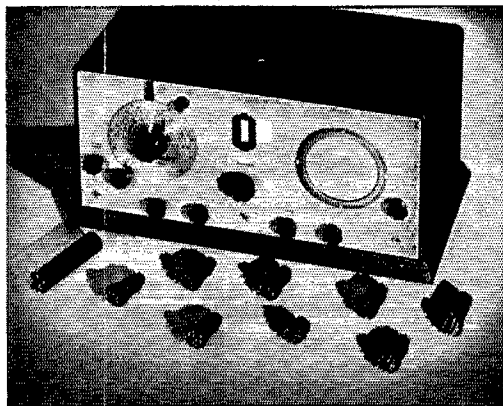

The 1936 Super SKYRIDER uses the NEW Metal Tubes to full advantage. Elimination of noisy tube shields, reduced inter-electrode capacities and the advantage of shorter leads, make possible greater gain and fewer circuit complications, especially effective in short wave reception.

In keeping with the policy of the HALLICRAFTERS always to be first with worthwhile engineering developments, the NEW Super SKYRIDER incorporates a specially designed Iron Core intermediate frequency system — this for the first time in any amateur receiver. Crowded amateur bands demanded a new order of selectivity. Iron core I.F.'s is the answer. The special system used in the NEW Super SKYRIDER also insures greater sensitivity and a signal to noise ratio that is UNATTAINABLE with a corresponding air core system.\*

In the re-design of the Super SKYRIDER HALLICRAFTERS engineers have achieved an efficient five band coverage of all wave bands from 7.4 to 550 meters (41,000 to 540 K.C.), made possible through an antenna circuit that is in each case tuned to the low frequency end of each band.

A stellar feature of the NEW Super SKYRIDER is the duo-micro-vernier band spread system. Unequaled accuracy of logging is afforded by this system which combines electrical band spreading and micro-vernier tuning in an exclusive and distinctive dial. The vernier and main tuning dial are illuminated by a novel means.

Full provision is made for the use of either the doublet or the conventional types of antennas.

\*See Technical Article P. 36 August QST Magazine

SUPER-SKYRIDER, complete with 9 metal tubes... \$79.50  
With crystal (model 5x9)..... 89.50  
SUPER-7 complete with tubes..... 49.50

### SHIPPED PREPAID

If Full Purchase Price Accompanies Your Order  
WRITE FOR LITERATURE

## MARINE RADIO COMPANY

Eastern Distributors

124-11 101st Ave., Richmond Hill, New York

Telephone: CLevland 3-2400. Cable Address: "Elecmarine."



This Season we are Featuring the  
**hallicrafters**  
1936 Super SKYRIDER  
and the NEW Super — 7

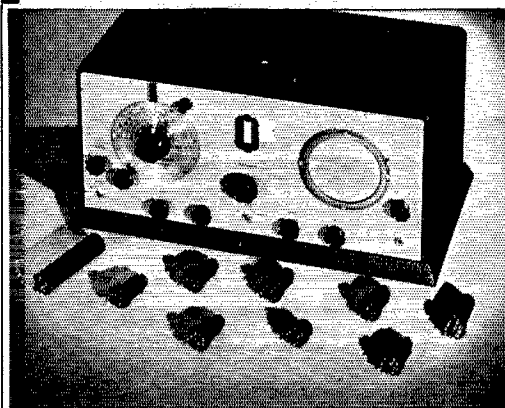

COME IN AND SEE  
ONE OR WRITE FOR  
LITERATURE

List Price \$135.00  
Your Price \$79.50 net

## HENRY RADIO STORE

211 N. Main St. BUTLER, MO.

This Season we are Featuring the  
**hallicrafters**  
1936 Super SKYRIDER  
and the NEW Super-7

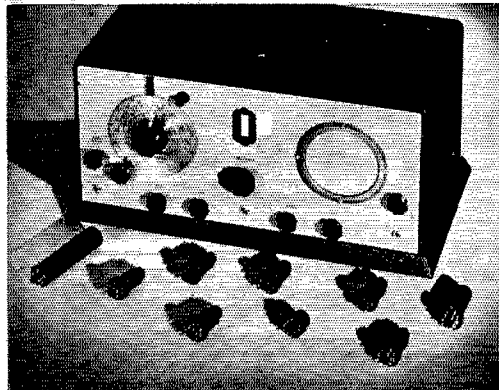

List Price \$135.00 Your Dealer Price \$79.50 net  
WRITE FOR TIME PAYMENT DEAL

## LEW BONN COMPANY

Rex Munger, W9LIP — Sales Engineer

2484 University Ave., St. Paul, Minnesota

"THE FRIENDLY HAM SUPPLY HOUSE"

This Season we are Featuring the  
**hallicrafters**  
 1936 Super SKYRIDER  
 and the NEW Super-7

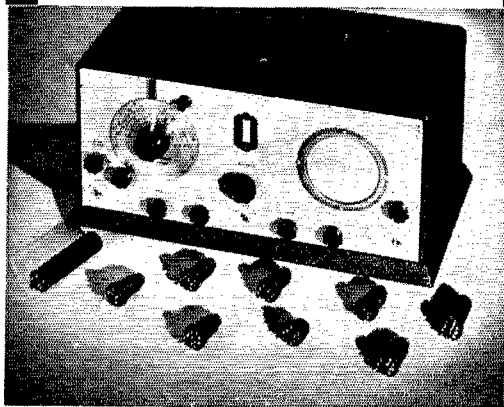

COME IN AND SEE ONE OR WRITE FOR LITERATURE  
 List Price \$135.00  
 Your Price \$79.50 net

**THE RADIO SHACK**  
 46 BRATTLE STREET  
 BOSTON, MASS.

This Season we are Featuring the  
**hallicrafters**  
 1936 Super SKYRIDER  
 and the NEW Super-7

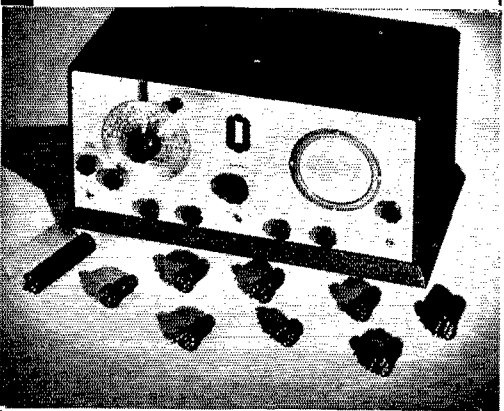

List Price \$135.00 Your Price \$79.50 net

**TRI-STATE**  
 RADIO EQUIPMENT CO.  
 403 Penn Avenue Pittsburgh, Penna.

This Season  
 we are Featuring the  
**hallicrafters**  
 1936 Super  
**SKYRIDER**  
 and the NEW SUPER — 7

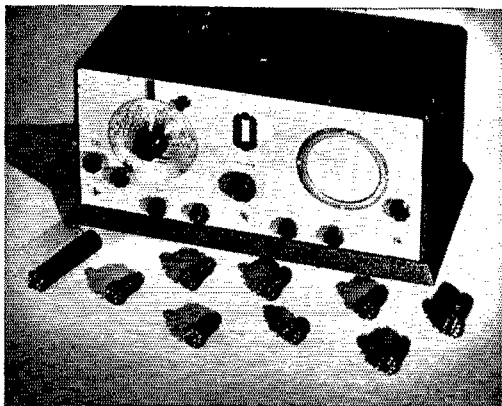

The 1936 Super SKYRIDER uses the NEW Metal Tubes to full advantage. Elimination of noisy tube shields, reduced inter-electrode capacities and the advantage of shorter leads, make possible greater gain and fewer circuit complications, especially effective in short wave reception.

In keeping with the policy of the HALLICRAFTERS always to be first with worthwhile engineering developments, the NEW Super SKYRIDER incorporates a specially designed Iron Core intermediate frequency system — this for the first time in any amateur receiver. Crowded amateur bands demanded a new order of selectivity. Iron core I.F.'s is the answer. The special system used in the NEW Super SKYRIDER also insures greater sensitivity and a signal to noise ratio that is UNATTAINABLE with a corresponding air core system.\*

In the re-design of the Super SKYRIDER, HALLICRAFTERS engineers have achieved an efficient five band coverage of all wave bands from 7.4 to 350 meters (41,000 to 340 K.C.), made possible through an antenna circuit that is in each case tuned to the low frequency end of each band.

A stellar feature of the NEW Super SKYRIDER is the duo-micro-vernier band spread system. Unequaled accuracy of logging is afforded by this system which combines electrical band spreading and micro-vernier tuning in an exclusive and distinctive dial. The vernier and main tuning dial are illuminated by a novel means.

Full provision is made for the use of either the doublet or conventional types antennae.

Your price \$79.50, time payment \$88.00, \$28.00 down, \$12.00 per month With Crystal, time payment \$99.50, \$29.50 down, \$14.00 per month.

\*See Technical Article P. 36 August QST Magazine.

**List Price \$135.00**  
**Your Price \$79.50 net**

Come in and see one—or write for literature

**DELAWARE**  
**RADIO SALES CO.**  
 405 Delaware St., Wilmington, Del.

**This Season**  
 we are Featuring the  
**hallicrafters**  
*1936 Super*  
**SKYRIDER**  
 and the NEW  
**SUPER-7**

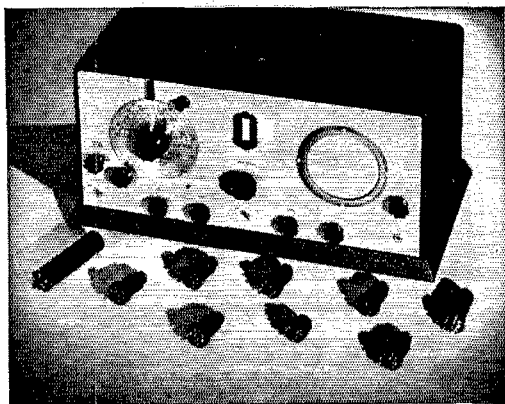

The 1936 Super SKYRIDER uses the NEW Metal Tubes to full advantage. Elimination of noisy tube shields, reduced inter-electrode capacities and the advantage of shorter leads, make possible greater gain and fewer circuit complications, especially effective in short wave reception.

In keeping with the policy of the HALLICRAFTERS always to be first with worthwhile engineering developments, the NEW Super SKYRIDER incorporates a specially designed Iron Core intermediate frequency system — this for the first time in any amateur receiver. Crowded amateur bands demanded a new order of selectivity. Iron core I.F.'s is the answer. The special system used in the NEW Super SKYRIDER also insures greater sensitivity and a signal to noise ratio that is UNATTAINABLE with a corresponding air core system.\*

In the re-design of the Super SKYRIDER HALLICRAFTERS engineers have achieved an efficient five band coverage of all wave bands from 7.4 to 550 meters (41,000 to 540 KC.), made possible through an antenna circuit that is in each case tuned to the low frequency end of each band.

A stellar feature of the NEW Super SKYRIDER is the duo-micro-vernier band spread system. Unequaled accuracy of logging is afforded by this system which combines electrical band spreading and micro-vernier tuning in an exclusive and distinctive dial. The vernier and main tuning dial are illuminated by a novel means.

Full provision is made for the use of either the doublet or the conventional types of antennas. Write or phone for special time payment plan.

\*See Technical Article P. 36 August QST Magazine

COME IN AND SEE  
 ONE OR WRITE FOR  
 LITERATURE

List Price \$135.00  
 Your Price \$79.50 net

**MIDWEST  
 RADIO MART**

520 S. State Street CHICAGO, ILLINOIS

*The New*  
 (SIXTH EDITION)  
**LICENSE  
 MANUAL**  
 WITH THE  
**FOLLOWING CHANGES**

★ Corrected text of the amateur regulations up to date, including amendments made June 18th at the request of the Board.

★ Corrected answers to all the representative examination questions relating to regulations, where the same are changed by the amendments to regulations made June 18th.

★ Corrections in the text concerning permissible 'phone bands and portable privileges, as have been amended by these changes June 18th.

★ Additions to the text about licensing, to incorporate the existing arrangements in Alaska, Puerto Rico and Hawaii, the right to have code tests administered by government radiotelegraph operators; and a similar paragraph extending to cripples the right to have their material dictated or typewritten.

★ Several notable changes in the way of improved answers to sample questions in the Class-A 'phone examination, bringing them in line with the modern engineering concept of modulation.

★ Several other improved answers to typical questions appearing in the Class-B-C examinations.

IT LEAVES THE JOB COMPLETELY UP TO DATE IN EVERY RESPECT.

VALUABLE ALIKE TO THE BEGINNER AND THE ALREADY-LICENSED.

**25 Cents Postpaid**  
 (No stamps, please)

*The . . .* (No. 9 in the series entitled The Radio Amateur's Library)  
**AMERICAN RADIO  
 RELAY LEAGUE**  
 West Hartford, Connecticut

## Section Communications Managers of the A.R.R.L. Communications Department

All appointments in the League's field organization are made by the proper S.C.M., elected by members in each Section listed. Mail your S.C.M. (on the 10th of each month) a postal covering your radio activities for the previous 30 days. Tell him your DX, plans for experimenting, results in 'phone and traffic. He is interested, whether you are an A.R.R.L. member or get your QST at the newsstands; he wants a report from every active ham. If interested and qualified for O.R.S., O.P.S. or other appointments he can tell you about them, too.

Eastern Pennsylvania  
Maryland-Delaware-District  
of Columbia  
Southern New Jersey  
Western New York  
Western Pennsylvania

W3EZ  
W3BAK  
W3ZX  
W8DSP  
W8CUG

**ATLANTIC DIVISION**  
James M. Bruning  
Edgar L. Hudson  
Carroll D. Kentner  
Don Farrell  
C. H. Grossarth

339 W. Lancaster Ave.  
1107 Park Ave.  
213 Hickok Ave.  
261 N. Ralph Ave.

Haverford  
Laurel, Delaware  
Collingswood  
Syracuse  
Emsworth

Illinois  
Indiana  
Kentucky  
Michigan  
Ohio  
Wisconsin\*

W9WR  
W9TE  
W9AUI  
W8DVH  
W8CIO  
W9ATO

**CENTRAL DIVISION**  
Fred J. Hinds  
Arthur L. Braun  
G. W. Mossbarger  
Kenneth F. Conroy  
Robert P. Irvine  
E. A. Cary

6618 West 34th St.  
5211 Brookville Rd.  
Box 177  
7538 E. Robinwood Ave.  
5508 Northcliffe Ave.  
3397A N. 23 St.

Berwyn  
Indianapolis  
Camp Taylor  
Detroit  
Cleveland  
Milwaukee

North Dakota  
South Dakota  
Northern Minnesota\*  
Southern Minnesota

W9OEL  
W9PFI  
W9IIE  
W9DEI

**DAKOTA DIVISION**  
Hartwell B. Burner  
Mike G. Strahon  
R. C. Harshberger  
Francis C. Kramer

601 S. Grange Ave.  
1200 Fauquier St.  
W. Bluff St.

Hope  
Stout Falls  
St. Paul, Minnesota  
St. Charles

Arkansas  
Louisiana  
Mississippi  
Tennessee

W5ABI  
W5DWV  
W5CWO  
W4BBT

**DELTA DIVISION**  
H. E. Velte  
W. J. Wilkinson, Jr.  
J. H. Weems, Jr.  
Merrill B. Parker, Jr.

2918 West 15th St.  
1624 Allen Ave.  
P. O. Box 244  
1912 Oak St.

Little Rock  
Shreveport  
State College  
Chattanooga

Eastern New York  
N. Y. C. & Long Island  
Northern New Jersey

W2LU  
W2AZV  
W2FOP

**HUDSON DIVISION**  
Robert E. Haight  
E. L. Baunach  
Charles J. Hammersen

1080 Helderberg Ave.  
7823 10th Ave.  
92 Claremont Ave.

Schenectady  
Brooklyn  
Verona

Iowa  
Kansas  
Missouri\*  
Nebraska

W9LEZ  
W9FLG  
W9CJR  
W9FAM

**MIDWEST DIVISION**  
Phil D. Boardman  
O. J. Spetter  
J. Dewey Mills  
Samuel C. Wallace

325 Kirkwood Blvd.  
305 Western Ave.  
Green St.

Davenport  
Topeka  
Mount Vernon  
Clarks

Connecticut  
Maine  
Eastern Massachusetts  
Western Massachusetts  
New Hampshire  
Rhode Island  
Vermont

W1CTI  
W1CDX  
W1ASI  
W1BVR  
W1AVJ  
W1HRC  
W1ATF

**NEW ENGLAND DIVISION**  
Frederick Ellis, Jr.  
John W. Singleton  
Joseph A. Mullen  
Percy C. Noble  
Robert Byron  
Clayton C. Gordon  
Harry Page

19 Merrill Rd.  
73 Allen St.  
218 Jamaicaaway  
32 Broad St.  
12 Humphrey St.  
206 California Ave.  
R. 1

Norwalk  
Wilton  
Jamaica Plain  
Westfield  
Concord  
Providence  
Hinesburg

Alaska  
Idaho  
Montana  
Oregon  
Washington

K7PO  
W7NH  
W7AAT  
W7AMF  
W7LD

**NORTHWESTERN DIVISION**  
Richard J. Fox  
Nellie H. Hart  
O. W. Viers  
Frank L. Black  
Niilo E. Koski

Box 301  
Box 6  
P. O. 265  
1502 McPherson St.  
5822 E. Green Lake Way

Ketchikan  
Twin Falls  
Red Lodge  
North Bend  
Seattle

Hawaii  
Nevada  
Los Angeles  
Santa Clara Valley  
East Bay  
San Francisco  
Sacramento Valley  
Arizona  
Philippines  
San Diego  
San Joaquin Valley\*

K6EWQ  
W6BIC  
W6BPT  
W6BMW  
W6ITV  
W6SG  
W6DVE  
W6LVG  
KALX  
W6EOP  
W6CRF

**PACIFIC DIVISION**  
Atlas O. Adams  
Edward W. Heim  
Rowell C. Brown  
Charles J. Camp  
Harold J. Burchfield  
Alan D. Whittaker, Jr.  
Geo. L. Woodington  
C. C. Day  
Newton E. Thompson  
Harry A. Ambler  
Vernon C. Edgar

21st Infantry Brigade  
716 West Sixth St.  
120 N. El Molino Ave.  
318 Hawthorne Ave.  
2940 106th Ave.  
78 Elinor Ave.  
716 Redwood Ave.  
"La Posta Quemada"  
P. O. Box 849  
4101 Hamilton St.  
Henrietta Substation, Box 195

Schofield Barracks  
Reno  
Pasadena  
Palo Alto  
Oakland  
Mill Valley  
North Sacramento  
Vail  
Manila, P. I.  
San Diego  
Lemoore

North Carolina  
Virginia  
West Virginia

W4OG  
W3BRV  
W8KKG

**ROANOKE DIVISION**  
H. S. Carter  
Neil E. Henry  
Dr. Wm H. Riheldaffer

115 Crafton St.  
1017 Knight St.

Winston-Salem  
Lynchburg  
Lost Creek

Colorado  
Utah-Wyoming

W9FA  
W6GQC

**ROCKY MOUNTAIN DIVISION**  
Glen Glasscock  
Arty W. Clark

1171 Detroit St.  
260 So. 9th West

Denver  
Salt Lake City, Utah

Alabama  
Eastern Florida  
Western Florida  
Georgia-So. Carolina-Cuba-  
Isle-of-Pines-Porto Rico-  
Virgin Islands

W4KP  
W4BCZ  
W4MS  
W4CE

**SOUTHEASTERN DIVISION**  
L. D. Elwell  
Philip A. McMasters  
Edward J. Collins

1066 Waverly St.  
731 Arlington Ave.  
1517 East Brainard St.  
SC.P53.  
C.C.C. Camp Lawrence

Tarrant  
St. Petersburg  
Pensacola  
Effingham, S. C.

Northern Texas  
Oklahoma  
Southern Texas  
New Mexico

W5BII  
W5CEZ  
W5ADZ  
W5CGJ

**WEST GULF DIVISION**  
Richard M. Cobb  
Carter L. Simpson  
Bradfield A. Beard  
Joseph M. Eldodt

Box 185  
2010 So. 4th St.  
2030 Quenby Road

Dodd City  
Ponca City  
Houston  
Chamita

Maritime

VE1DQ

**MARITIME DIVISION**  
A. M. Crowell

69 Dublin St.

Halifax, N. S.

Ontario

VE3GT

**ONTARIO DIVISION**  
S. B. Trainer, Jr.

4 Shorncliffe Ave.

Toronto

Quebec

VE2EE

**QUEBEC DIVISION**  
Stan Comach

780 Brault Ave.

Verdun, P. Q.

Alberta  
British Columbia

VE4GD  
VE5AC

**VANALTA DIVISION**  
J. Smalley, Jr.  
R. K. Town

611 1st Ave., N. W.  
1754 Graveley St.

Calgary  
Vancouver

Manitoba  
Saskatchewan

VE4BG  
VE4EL

**PRAIRIE DIVISION**  
A. J. R. Simpson  
Wilfred Skaffe

71 Thelmo Mansions  
2040 McTavish St.

Winnipeg  
Regina

\* Officials appointed to act until the membership of the Section choose permanent S.C.M.'s by nomination and election.



# The American Radio Relay League



THE AMERICAN RADIO RELAY LEAGUE, INC., is a non-commercial association of radio amateurs, bonded for the promotion of interest in amateur radio communication and experimentation, for the relaying of messages by radio, for the advancement of the radio art and of the public welfare, for the representation of the radio amateur in legislative matters, and for the maintenance of fraternalism and a high standard of conduct.

It is an incorporated association without capital stock, chartered under the laws of Connecticut. Its affairs are governed by a Board of Directors, elected every two years by the general membership. The officers are elected or appointed by the Directors. The League is non-commercial and no one commercially engaged in the manufacture, sale or rental of radio apparatus is eligible to membership on its board.

"Of, by and for the amateur," it numbers within its ranks practically every worth-while amateur in the nation and has a history of glorious achievement as the standard-bearer in amateur affairs.

Inquiries regarding membership are solicited. A bona fide interest in amateur radio is the only essential qualification; ownership of a transmitting station and knowledge of the code are not prerequisite. Correspondence should be addressed to the Secretary.

## DIRECTORS

<i>President</i>	HIRAM PERCY MAXIM.....W1AW
	Box 216, Hartford, Conn.
<i>Vice-President</i>	CHARLES H. STEWART.....W3ZS
	St. David's, Pa.
<i>Canadian General Manager</i>	ALEX REID.....VE2BE
	169 Logan Ave., St. Lambert, P. Q.
<i>Atlantic Division</i>	EUGENE C. WOODRUFF.....W8CMP
	234 W. Fairmount Ave., State College, Pa.
<i>Central Division</i>	EDWARD A. ROBERTS.....W8HC
	2699 Endicott Rd., Shaker Heights, Cleveland
<i>Dakota Division</i>	CARL L. JABS.....W9BVH
	1822 James St., St. Paul, Minn.
<i>Delta Division</i>	M. M. HILL.....W5EB
	P. O. Box 14, Natchitoches, La.
<i>Hudson Division</i>	KENNETH T. HILL.....W2AHC
	115 Willow St., Douglaston, L. I., N. Y.
<i>Midwest Division</i>	H. W. KERR.....W9DZW-W9GP
	Little Sioux, Iowa
<i>New England Division</i>	G. W. BAILEY.....W1KH
	74 Webster Road, Weston, Mass.
<i>Northwestern Division</i>	RALPH J. GIBBONS.....W7KV
	3933 N. E. 76th Ave., Portland, Ore.
<i>Pacific Division</i>	S. G. CULVER.....W6AN
	2962 Russel St., Berkeley, Calif.
<i>Roanoke Division</i>	H. L. CAVENESS.....W4DW
	State College Station, Raleigh, N. C.
<i>Rocky Mountain Division</i>	RUSSELL J. ANDREWS.....W9AAB
	1867 So. Lafayette St., Denver, Colo.
<i>Southeastern Division</i>	BENNETT R. ADAMS, JR.....W4APU
	1512 Grove Place, Homewood, Ala.
<i>West Gulf Division</i>	WAYLAND M. GROVES.....W5NW
	c/o Humble Pipe Line Co., Neches, Texas

## OFFICERS

<i>President</i> .....	HIRAM PERCY MAXIM, W1AW
	Hartford, Connecticut
<i>Vice-President</i> .....	CHARLES H. STEWART, W3ZS
	St. David's, Pennsylvania
<i>Secretary</i> .....	KENNETH B. WARNER, W1EH
	West Hartford, Connecticut
<i>Treasurer</i> .....	ARTHUR A. HEBERT, W1ES
	West Hartford, Connecticut
<i>Communications Mgr.</i> ...	F. EDWARD HANDY, W1BDI
	West Hartford, Connecticut
<i>General Counsel</i> .....	PAUL M. SEGAL, W3EEA
	1010 Shoreham Building, Washington, D. C.

Address all general correspondence to the executive headquarters at West Hartford, Connecticut

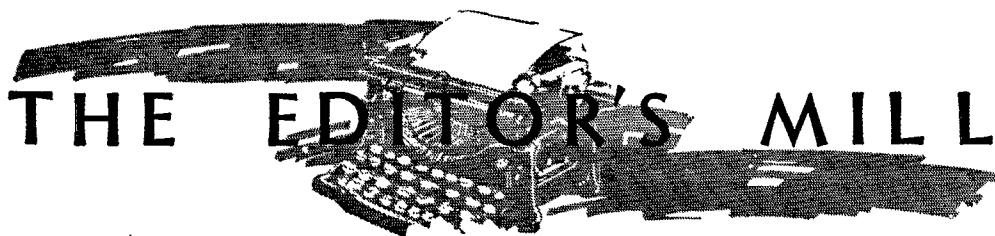

# THE EDITOR'S MILL

IT IS of course a fundamental of the federal government's administration of amateur radio that it assigns to all radio amateurs certain bands of frequencies and then permits the amateurs to operate at will within those bands. We have a few regulations stipulating the minimum acceptable qualities of our signals, regulations which we have actually sought in our own good: requiring stable signals, the use of direct-current power supply, freedom from parasitics, and so on. Each of us is required to have a clean signal and to take up no more space in the spectrum than is required with good engineering practice. We mustn't interfere with other services nor broadcast entertainment nor send false signals, nor engage in indecent or profane language. But aside from those things we are pretty much our own masters. We can operate all day and all night if we wish and in any place in any amateur band. No one has an exclusive channel, interference is the rule rather than the exception, and we are left strictly to our own devices to organize our internal economy as we see fit.

The American amateur has long displayed a very remarkable ability to cooperate with his fellows, to coordinate his activities with those of other amateurs so that all may obtain the maximum benefit from the pursuit of the art. One of the chief functions of our A.R.R.L. is to act as a medium for the improvement of our mutual operating conditions. It provides the required machinery for studying our situation, collecting ideas, passing them around for examination, and agreeing upon courses of conduct and methods of operating that will minimize our troubles and provide us the most enjoyment. There are few rigid rules within the fraternity of amateur radio, inside the limiting figures of our frequency bands. Although we have constantly demonstrated the incalculable values of cooperation, we are essentially an aggregation of individualists. And as such we sometimes drift into bad operating habits, which, being copied by others, result in our being more or less collectively foolish.

When a considerable number of us commence employing an unwise operating procedure we all pay the penalty in increased interference and mutual annoyance. There are so many of us these days that a small contribution of unnecessary interference from each of us amounts to a considerable portion of the unbelievable bedlam

in our bands. Conversely, a little care on each individual's part and a tremendous improvement is evidenced. Our A.R.R.L. Board at its last meeting gave consideration to these subjects and pointed its official finger at three unwise common practices in amateur radio which ought to be eliminated, and issued a plea to all amateurs that they give their cooperation to the elimination of these evils. Only one of these undesirable operating practices is illegal and that one in actuality a questionable case. Permitted by our regulations, these are things that we will cure only by our own willingness and determination to effect a cure:

First, we use the wrong bands frequently. Thereby we cause an immense amount of needless QRM. East Coast stations working amongst each other ought not to be roaring signals on the West Coast, and vice versa. When they are, it shows that the wrong band was used. The wrong band was used because someone found it too much bother to shift to another band more suitable for short-distance work, and instead continued on his old adjustment despite the obvious fact that the band used did not lay down the best signal to his correspondent and that it did cause severe and unnecessary interference between fellows communicating from coast to coast. This is but a single example in a list that every amateur can amplify for himself from his own experience. We all know which bands work best for the work we have in mind. The difficulty has simply been that in the past it has taken some minutes of time and effort to shift to another band. Any of us would willingly shift to the proper band if it were instantly available. In the last year or so we have gained a lot of knowledge on arrangements for rapid band-shifting in transmitters. *QST* has presented numerous articles on the subject, will have more. The A.R.R.L. Board urges members of the League to equip themselves for speedy band-changing and to employ the same to the reduction of our interference problem.

Second, we don't trim our power to the requirements. Almost every amateur station has just one power adjustment—its maximum. The 40-wattter is always 40 watts, the kilowatt fellow is always 999.9. The reason we need S5 signals now is because everybody else is trying to be S5, and when everybody does that the signals reach for hundreds or thousands of unnecessary miles, with attendant unnecessary interference. We

never stop to think that when conditions make a signal perfectly readable at any moderate strength, there is no need for it to be S5. The Board of Directors urges every amateur to equip his station with means for reducing power and then in each QSO to crank down the watts to those just necessary to insure good communication. A rich improvement in operating ease is certain to follow the general adoption of this recommendation.

Third, we test on our radiating antennas. Sure, we have the right to, for all amateur radio is a great experimental school. But we ought not to, in our own interests. When 15,000 amateurs are testing, the other 15,000 can't do much communicating. Transmitters can be tuned up and tested on non-radiating or dummy antennas. Remember how much harder you gnash your

teeth over testers than you do over more legitimate interference? Well, that's how you make some other fellow feel when you test. The League Board therefore recommends and urges that all amateur transmitters be equipped with dummy antennas for testing purposes that do not require radiation.

We can add another suggestion that we believe valuable: that local traffic be handled on 56 mc. rather than on 3.5 or 1.75. Faster, less interference experienced and less interference made.

It is strictly up to us whether we get any improvement in these respects. The appeal is to our sense of cooperation and our pride in doing jobs well. *QST* bespeaks an acceptance of the Board's recommendations by all amateurs and points out that the job starts with the individual, the reader of these lines, you!

K. B. W.

---

## Roanoke Division Convention

October 5th and 6th—Hotel Charlotte,  
Charlotte, N. C.

ONCE again the Charlotte Amateur Radio Association is sponsoring the divisional convention and the program prepared by the committee has one point in view—a convention to be remembered by those attending. John L. Reinartz, well known to the amateur fraternity, will be present with new ideas. Roy C. Corderman, of Washington, D. C., will represent the A.A.R.S. Frank Key of our own division, who always has something interesting to say, has promised to come. A.R.R.L. Headquarters is sending A. A. Hebert, treasurer-fieldman. Director H. L. Caveness with all the SCM's is coming with the intention of getting acquainted with everybody. There will be plenty of entertainment and a most cordial invitation is extended to the ladies. Registration fee is \$3.00 for the men and \$2.00 for the ladies. Gordon S. Smith, Convention Secretary, 1716 Thomas Ave., Charlotte, N. C., will furnish further information on request.

---

## Coming Examinations for Amateur Operator License

FOLLOWING is a schedule of examinations for amateur operator license to be held by F.C.C. inspectors during October, November and December at points other than their home offices. Where dates or exact addresses are not shown, write the Inspector in Charge of the district headquarters as noted. All examinations begin promptly at 9:00 a.m. local time. For schedule of the examinations held at the district offices themselves, and the addresses thereof, see the listings under this heading in either June or July *QST*.

Little Rock, Ark., some time in October. Particulars from Inspector at New Orleans.

Phoenix, Ariz., some time in October. Details from Inspector at Los Angeles.

Boise, Idaho, some time in October. Details from Inspector at Portland, Ore.

Billings, Mont., some time in October. Details from Inspector at Denver.

Des Moines, Iowa, October 25th and 26th. Details from Inspector at Kansas City.

Cleveland, Ohio, some time in October. Details from Detroit.

Winston-Salem, N. C., November 1st and 2nd. Details from Norfolk.

Nashville, Tenn., November 15th. Details from Atlanta.

Jacksonville, Fla., November 15th. Details from Miami.

Oklahoma City, Okla., some time in November. Details from Dallas.

Butte, Mont., some time in November. Details from Seattle.

Spokane, Wash., some time in November. Details from Seattle.

St. Louis, Mo., November 22nd and 23rd. Details from Kansas City.

Cincinnati, Ohio, some time in November. Details from Detroit.

Troy, N. Y., some time in December. Details from New York City.

San Antonio, Texas, some time in December. Details from Dallas.

Columbus, Ohio, some time in December. Details from Detroit.

Pittsburgh, Penna., December 19th, 20th and 21st. Details from Buffalo.

# Plate Modulation of Pentodes

## Linearity—Operating Conditions—Modulator Requirements

By George Grammer\*

THE ease with which pentode-type power tubes can be used for radiotelephony by introduction of the audio frequency in the suppressor grid circuit has more or less masked the fact that these tubes can be plate-modulated as well. A contributing factor has been the lack of definite information on pentode plate modulation—specifically, what to do with the second and third grids in the tube—although it is true the manufacturers have given a set of curves and operating conditions for the RK20.

If pentodes can be successfully plate-modulated—and they can—the chief point of interest, in comparing their performance with that of plate-modulated triodes, is whether or not the excitation requirements are still as low as with ordinary c.w. operation. To determine this, and also to find what were the optimum operating conditions for plate modulation, we set up an experimental amplifier rig in which various types of pentodes could be used. It was arranged so that the modulation could be applied to the screen and suppressor grids as well as the plate, so that combinations of plate and either one or both of the other elements readily could be tried. The resulting modulation characteristic was then checked on the oscilloscope so that the set of operating conditions giving optimum linearity could be determined by simple measurement.

It has been known for a long time, of course, that the only way successfully to plate-modulate a screen-grid type tube is to apply the audio frequency to both plate and screen. It seemed reasonable enough to believe that this would apply to pentodes as well, since the plate current is more sensitive to changes in screen voltage than in plate voltage. The tests confirmed this; skipping a detailed description of what was done, we can say that in general, modulation of the plate and screen in proper proportion will give a characteristic equally as good as that of a plate-modulated triode. Also, modulation of the suppressor, either with the plate or with both plate and screen, is not only unnecessary but at times unde-

sirable. The suppressor may be operated either at zero voltage or a fixed positive voltage, depending upon the type of tube used. From the data obtained it seems necessary to differentiate between tube types in this respect. Operating conditions of the smaller tubes such as the 802 and RK23-25, differ somewhat from those obtaining for the RK20, RK28 and 803.

### MODULATION OF SMALL PENTODES

A typical circuit diagram for plate and screen modulation of tubes of the 802-RK23-RK25 type is shown in Fig. 1. From an r.f. standpoint the circuit is the same as would be used for c.w. work; in the supply circuits, the screen voltage is obtained from the plate source through a dropping resistor,  $R$ . While a voltage divider could be used, it is not recommended since it would increase the load on the modulator and do no particular good so far as the modulation characteristic is concerned. The modulation transformer secondary is introduced in series with the common supply lead to the plate and screen, the screen dropping resistor being on the set side of the transformer secondary. Plate and screen by-pass condensers,  $C_2$ , should be of the order of 0.001  $\mu\text{f.}$ —large enough to provide a low-impedance path for the r.f., but still not so large as to affect the high-frequency audio response. The suppressor by-pass,  $C_1$ , should be 0.002 or larger, since the tube may have a tendency to oscillate if the suppressor is not thoroughly by-passed to the cathode, especially if the shielding is not complete.

An optimum value for the dropping resistor,  $R$ , is about 25,000 ohms. Using a plate-supply voltage of 600, the screen current under the operating conditions to be specified later will be of the order of 20 milliamperes, giving a drop of 500 volts and leaving 100 volts d.c. on the screen. Higher d.c. screen voltage does not seem to be of any particular value, actually causing a slight reduction in output, although leaving the modulation characteristic unaffected. The characteristic is likewise unchanged with lower screen

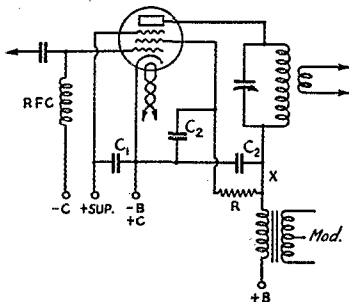

FIG. 1—PLATE AND SCREEN MODULATION CIRCUIT FOR USE WITH TUBES OF THE 802 AND RK23-25 TYPE

The screen dropping resistor must be on the tube side of the modulation transformer secondary winding. The by-pass condensers marked  $C_2$  should be about .001  $\mu\text{f.}$ ,  $C_1$  .002  $\mu\text{f.}$  or larger.

\* Asst. Technical Editor.

voltage (i.e., a higher value of dropping resistor), but the output power again drops.

The optimum suppressor voltage depends to some extent on the excitation available. If the excitation is ample—"ample" in this case means much less than required by a triode of equivalent output—the suppressor can be operated at about 100 volts without affecting the linearity. The high suppressor voltage is advantageous from a power output standpoint. With low excitation the suppressor voltage should be reduced. With the suppressor at zero the tube can be modulated linearly with less than one milliamperes control-grid current, control-grid bias being from a 22-volt battery. Power output under these conditions is of the order of ten watts. The excitation power is very small; the tube actually was driven by a 47 crystal oscillator with only 120 volts on the plate, the input to the oscillator being only about one watt. On the whole, the suppressor voltage does not have a very great effect; chiefly, it influences the linearity under certain critical excitation conditions. If the excitation is readily adjustable, the suppressor may be operated anywhere between 0 and 100 volts positive with good results, slightly more power output being obtained at the higher figure.

Control-grid bias is not critical. A 22-volt battery is entirely satisfactory for linear operation. More bias may be used, requiring a corresponding increase in excitation. It is not necessary to use a battery, however; a grid leak of about 2000 ohms will give equally good results. The rectified grid current either with the 2000-ohm leak or 22-volt battery will run between 10 and 20 milliamperes at optimum excitation. It is not critical in this region, but both too-low and too-high excitation will cause a departure from linearity. For this reason it is desirable that the excitation be readily adjustable, either by a coupling control such as a tap on the exciter tank, or by voltage control on the exciter.

A typical set of operating conditions for these tube types (all give identical performance) is as follows:

Plate voltage	600 d.c.
Plate current	50 ma.
Suppressor voltage	50-100 d.c.
Screen dropping resistor	25,000 ohms
Screen current	20 ma.
Grid voltage	- 22 (or 2000-ohm leak)
Grid current	10-20 ma.
Power output	15-20 watts

The plate current should be adjusted, by means of antenna coupling, to 50 ma., approximately, the plate milliammeter being inserted at X on the diagram. The plate current should not change during modulation. If it kicks, either one of two things may be the case: the audio swing may be too great or the characteristic may not be linear. The remedy for the former is obvious, while the latter can be cleared up by adjustment of the excitation.

It is interesting to note that while all the tubes tried (several samples of each type) showed uniform characteristics when modulated on both plate and screen, one particular tube gave a linear characteristic when modulated on the plate alone, probably because of some individual peculiarity. This performance could not be duplicated in any of the other tubes.

#### THE RK20

The same series of tests run through on several RK20 tubes gave the same order of results, showing that optimum operation was obtained with combined plate and screen modulation. With the RK20, however, the suppressor is preferably operated at zero voltage. Using the circuit shown in Fig. 2, positive suppressor voltage has practically no effect on the output or linearity. In another type of circuit to be described later, positive suppressor voltage caused the characteristic to take a bad bend.

Using a 1000-volt plate supply (the manufacturer's rating for plate modulation is 900 volts) the optimum screen dropping resistor again was found to be in the neighborhood of 25,000 ohms. Under these conditions the screen current averaged 35 to 40 milliamperes, giving an effective d.c. screen voltage of about 200 volts. Somewhat lower than rated screen voltage seems to be the inevitable result of using a screen dropping resistor. However, the output is about the same as with fixed screen voltage for c.w. operation.

Control-grid bias and excitation are again not critical, although there is an optimum region. Fixed bias of 22 or 45 volts can be used, or the bias can be obtained from the flow of grid current through a leak of about 10,000 ohms. With proper excitation the grid current will be of the order of 5 to 10 milliamperes, the larger value with the lower bias voltage. The modulation characteristic is the same with either method of biasing. Either too much or too little excitation can cause a departure from linearity, the criterion being the steadiness of the plate current, in the absence of an oscilloscope. The excitation power required is of the order of one or two watts.

To compare the RK20 with a triode of equivalent rating, the set-up was changed slightly so that an RK31 could be used in its place as a neutralized triode. Although the power output from the two tubes was the same and the modulation characteristics were identical, the triode required considerably more excitation than the pentode. Expressed in amateur language, the RK20 could be excited fully with a 47 oscillator with about 300 volts on its plate; in fact, it was not necessary to load the oscillator to its full output. With the RK31, however, it was necessary to use 450 on the plate of the oscillator and to take out all the power it was capable of giving.

The oscillator inputs were about 6 watts and 18 watts, respectively.

Adjustment is much the same as with the smaller tubes. The antenna coupling is adjusted to make the plate draw about 80 milliamperes. A typical set of operating conditions is:

Plate voltage.....	1000 d.c.
Plate current.....	.75 ma.
Suppressor voltage.....	0
Screen dropping resistor 25,000 ohms	
Screen current.....	.35 ma.
Grid voltage.....	-22 to -45
	(or 10,000-ohm leak)
Grid current.....	.5 to 10 ma.
Power output.....	50 watts (app.)

There should be no change in plate current with modulation. The screen current likewise should be steady.

#### HIGH-POWER TUBES

The high-power tubes, the RK28 and 803, are capable of being operated satisfactorily under similar conditions. Ratings have been placed on the RK28 only for 1500 volts plate, although we have used the tubes at 2000 volts without running into difficulties.

However, for the same d.c. input, plate modulated service is harder on the tube than c.w., so it may be that the life would be adversely affected to some extent when operated at full plate voltage. The 803 has not carried recommendations for this type of work, but the tube operates well. A typical set of operating conditions for the two tubes at 1500 and 2000 volts is given below:

Plate voltage.....	1500	2000 d.c.
Plate current.....	110	150 ma.
Suppressor voltage.....	45	45 volts
Screen dropping resistor	40,000 ohms	
Screen current.....	35	45 ma.
Grid voltage.....	-90	-90 (or
		20,000-ohm leak)
Grid current	10 to 15 ma.	
Power output.....	125	200 watts (app.)

The figures given above are subject to slight variation with the two types. The 803 takes slightly higher grid current than the RK28 for the same power output and linearity. The screen currents also may vary somewhat, although they will be in the region specified. Again the plate current should be constant with modulation.

#### MODULATOR REQUIREMENTS

Since both screen and plate must be modulated, it is obvious that some of the audio output of the modulator will be consumed in the screen circuit, where it is "wasted" in the sense that no r.f. output results therefrom, although it is vitally necessary to give linear performance. In pentode transmitting tubes the screen current usually has a value from one-third to one-half that of the

plate current, although the screen voltage of course is much lower than the plate voltage. However, when screen power is taken from the plate supply, a considerable amount of power, both d.c. and audio, is consumed in the dropping resistor. The total power, both d.c. and audio, consumed in the screen circuit may be as much as half the plate input.

In the circuits of Figs. 1 and 2, therefore, the d.c. power consumed in the plate and screen circuits is the terminal voltage of the plate supply multiplied by the sum of the plate and screen currents. In the case of an RK20, for instance, these currents will be 75 and 35 ma., respectively, at 1000 volts. The d.c. input is therefore 110 watts. Of this power, 75 watts is the d.c. input to the plate, 35 watts the input to the screen circuit. The screen itself takes about 7 watts, the other 28 being used up in the dropping resistor. The audio power supplied by the modulator divides in the same proportions. The modulator

must supply audio power, on a pure-tone basis, of 55 watts, half the total input, although only 37.5 watts is taken by the plate and 3.5 watts by the screen itself. The other 14 watts is dissipated in the dropping resistor.

Using the operating conditions previously specified, the audio power required to plate-screen modulate a single 802 or RK23-25 would be 21 watts, since the plate and screen circuit inputs would be 600 volts multiplied by 50 plus 20 milliamperes, or 42 watts. This is on a pure-tone basis. A pair of 46 tubes would be capable of doing the job satisfactorily. The equivalent load impedance of the r.f. tube would be 600/.07, or 8560 ohms. Since the optimum load impedance for the Type 46 at this order of power output is about 5800 ohms plate to plate, the primary-to-secondary impedance ratio of the output transformer should be 5800/8560 ohms, or 0.677 to 1. This corresponds to a turns ratio, total primary to secondary, of 0.823 to 1. The modulator tubes can be operated at 400 volts. On the speech basis discussed in August *QST*, the same pair of tubes, operated at 500 volts as described,<sup>1</sup> could be used to modulate two of the small pentodes in parallel or push-pull.

For the RK20, a modulator consisting of a pair of graphite-plate Type 10's operated at 600 volts would be required, since the modulator has to supply 55 watts. The load impedance is 9000 ohms, approximately, and the plate-to-plate

<sup>1</sup> "Greater Economy in Class-B Modulator Design for Speech." *QST*, August, 1935.

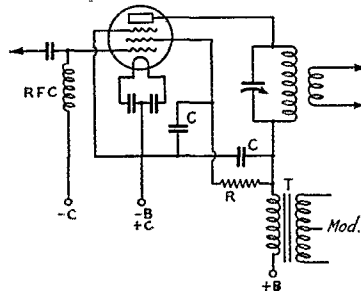

FIG. 2—A TYPICAL CIRCUIT FOR FILAMENT-TYPE PENTODES SUCH AS THE RK20, 803 AND RK28

Screen and plate by-passes should be about .001  $\mu$ fd. The value of the screen dropping resistor, R, is discussed in the text.

load on the modulator should be 8000 ohms. The impedance ratio is therefore 8000/9000, or 0.89 to 1, total primary to secondary, calling for an output transformer having a primary-to-secondary turns ratio of 0.943 to 1. This is again on a pure tone basis. Two RK20's would require a modulator having an output of somewhat over 100 watts. Several types of tubes, such as the 800, RK18, RK31, and 830-B, are capable of outputs of this order. The output transformer ratio can readily be calculated as above, using the rated load impedance for the particular type of modulator tube chosen. The load represented by the pentodes will of course be just half that of one tube alone, or 4500 ohms.

In the case of the higher power pentodes, the RK28 and 803, the audio power required will depend upon the operating plate voltage. On the 1500-volt, 110-ma. basis, the screen should take about 35 ma., making the total d.c. input approximately 220 watts. The pure-tone audio power required is therefore 110 watts. A pair of RK31's, 830-B's, or 100-watt type tubes can easily supply the power.

With 2000 volts on the plate, the plate and screen currents total 195 ma. representing a total d.c. input of 390 watts. A pair of 838 tubes will modulate this input nicely. Ordinary output transformers designed to work into a 10,000 ohm load from 203-A or 838 tubes will be close enough in turns ratio to work with entire satisfaction.

#### CONSERVING AUDIO POWER

From the foregoing it is apparent that a good deal of audio power must be used up in the screen dropping resistor. This is pure waste, since the only function of the resistor is to keep the screen voltage near the proper operating value. At least four-fifths and possibly more of both d.c. and audio power supplied the screen circuit is lost in the dropping resistor and not in the screen itself. The power lost in the screen grid is fairly low even in the high-power tubes.

The logical step to take in eliminating the waste of power is to get rid of the dropping resistor. This can be done quite readily by supplying the d.c. screen power from a low-voltage supply—from the oscillator or a buffer power pack, for instance—and introducing the audio frequency in the screen circuit through the medium of a second output winding on the modulation transformer. Since the audio power taken by the screen grid is only about 10% that taken

by the plate, the extra drain on the modulator tubes should not affect their operation very greatly, even if the screen winding is ignored in computing the load on the audio tubes.

To try out this method of swinging the plate and screen of a pentode, the coöperation of the Thorarson Electric Mfg. Co. was secured in making up a transformer having two output windings, multi-tapped to fit various types of pentodes and Class-B tubes. A typical circuit diagram using this type of transformer is shown in Fig. 3. It is necessary, of course, that the two output windings be poled correctly so that the voltage increases on plate and screen simultaneously. Tests have shown that the modulation characteristic with this type of coupling is equally as linear as with the dropping resistor.

A considerable saving in the d.c. and audio power results from its use—to say nothing of the elimination of a "high-powered" dropping resistor. A quite husky resistor is required to drop the voltage for even the smaller pentodes, while a power-dissipating capacity of about 100 watts is required for the RK28 and 803 at full plate voltage.

The number of turns on the screen winding of the transformer should bear the same relation to the turns on the plate winding that the d.c. screen voltage bears to the d.c. plate voltage. In other words, if the d.c. plate voltage is 1000 and the screen voltage 200, the screen winding should have 20% as many turns as the plate winding. This is a maximum figure; it should not be exceeded since a larger number of turns would cause the screen voltage to be zero over a portion of the cycle on the down-swing instead of reaching zero only for an instant. If the relation is exact, the screen voltage will swing to twice its d.c. value at the same instant the plate voltage swings to twice its steady value. However, it does not seem to be necessary to swing the screen over as wide a range as the plate, relatively speaking. Screen modulation to the extent of 75% seems to be ample. This simply means that the audio swing on the screen is not at all critical, so it should be possible to build a transformer having slightly less than the maximum usable number of turns and thereby have a unit which will fit a number of different operating conditions. With less than complete modulation of the screen, also, the audio power used in the screen will be reduced, further lightening the load on the modulator.

(Continued on page 35)

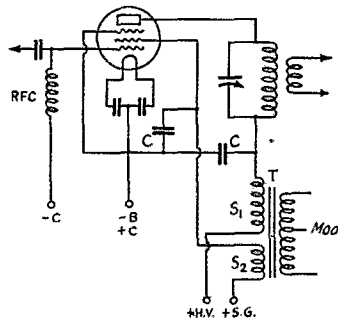

FIG. 3—MODULATION OF PLATE AND SCREEN THROUGH A SPECIAL OUTPUT TRANSFORMER HAVING AN AUXILIARY WINDING

A considerable saving in both d.c. and audio power results from the use of this type of transformer, since the power loss in the screen dropping resistor is eliminated.



# An All-Purpose S.S. Superhet With Turret-Type Automatic Coil Changing

Combining the Efficiency of Plug-in Coils and the Convenience of Switching

In Two Parts—Part II†

By Charles Fisher,\* W3FX

**A**LL coils, except those for the standard broadcast range, are wound on bakelite tubing, which was the only insulation available in the form required for this job. With these forms performing so satisfactorily, it is wondered whether special "low-loss" insulations would improve the performance to any extent.

A set of purchased universal-wound coils is used for the broadcast band. These are supported by the bus-bar leads to the bakelite mounting of Fig. 4C. It would probably be just as easy to wind these coils on one-inch tubing, and many hams probably would not want to bother with the broadcast range at all. The coils used were designed for an i.f. of 465 kc., so a few turns had to be removed from the oscillator grid coil to suit the i.f. of approximately 500 kc. The tickler was also cut down considerably. One or two turns were also removed from the r.f. and first-detector grid coils.

The 4- and 7-mc. coils are wound on  $1\frac{1}{2}$ -inch diameter tubing, while the 14- and 28-mc. coils are wound on 1-inch tubing. Fig. 4A shows the details of the coil forms. The coil leads are soldered to five 6-32 brass or nickel-plated brass screws which are placed in line along the length of the tubing. The threaded ends of these screws should be filed bright so they will take solder easily. A slight notch filed in the end helps to hold the wire in place. Before each screw is put through the tubing, a nut is tightened up against the head to raise the head higher. The screw is then put through the tubing, a nut placed on the inside and tightened up. If the inner screws are slightly longer than the outer ones the soldering will be made easier. The leads of the 28-mc. grid coils are not soldered inside because the wire is too heavy to thread through. The wire is simply looped around between the screw head and a washer, and tightened up. The tap is soldered to the proper turn on these two coils. The entire job could no doubt be made easier by extending the screw heads about  $\frac{1}{4}$ -inch and soldering the leads right to the threaded part of the screw outside the

tubing. But this would require more clearance within the shields and would necessitate making them longer and higher.

In winding the grid coils, it is best to start at the tap. Calculate how much wire will be required and cut off a piece of that length plus a couple of feet extra. Drill the holes in the bakelite tubing for the leads to pass through. Now scrape off the enamel where the tap should be, tin the wire, bend it double, and thread it through the hole in the tubing provided for the tap. Now solder it to the outside screw. Then wind the longest end

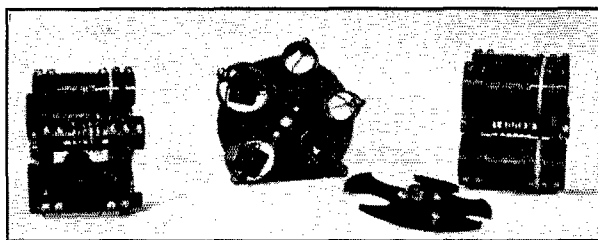

THE COMPLETE COIL ASSEMBLIES ARE READILY REMOVABLE

first. The writer fastened the end of the wire to a door knob, then wound the wire on the tubing while walking toward the door. When the proper number of turns has been wound, the wire is scraped or cleaned with emery cloth where it will contact the screw, and is threaded through the tubing and soldered to the screw. The other end from the tap is then wound in like manner. If the spacing is uneven, the turns can be slipped slightly until the spacing is nearly uniform. Then the windings can be doped with collodion or other coil dope but this had better not be done until the coils have been adjusted in operation. Collodion applied sparingly makes a good coil cement. The windings for  $L_1$  and  $L_2$  are bunch wound between the screws as shown in Fig. 4A. A few drops of collodion cement holds them in place.  $L_3$  is wound between the grid turns of  $L_4$ , starting at the ground end. Where a tracking condenser is used, the ground end of the oscillator grid coil is soldered to screw "X" and the tracking condenser is mounted inside the coil between the screws "X" and "Y", small moulded

\* 447 Chestnut Street, Pottstown, Pa.

† The first part appeared in August QST.

condensers being used. Two or three in parallel may be needed to build up the right capacity. The capacities required are larger than usual, probably because of the rather long leads from the oscillator coil and the higher minimum capacity of two tuning condenser units. The 4-mc. r.f. and first-detector coils are almost close-wound. The coil table gives the approximate lengths of the windings.

It will be seen from the coil table that the 1.4-mc. and 28-mc. oscillator coils are wound with

Now for the coil assembly. From a  $\frac{3}{16}$ -inch bakelite panel, cut six discs four inches in diameter. This can be done with a circle cutter. Then lay out one of the discs as shown in Fig. 4B. The exact spacing between the coils is not critical but the idea is to get fairly equal spacing. Four or five holes can be made, according to what is desired. Even if only three or four bands are desired, the assembly might as well be made for five. They are bound to be wanted sooner or later.

These also can be cut with a circle cutter but a better job will result if the discs can be taken to a machine shop where the holes can be made with a counter-bore. In either case the discs should be bolted together through the center and the pilot holes drilled through all six at once so they will all be exactly alike. Flanged bushings having a  $\frac{1}{4}$ -inch hole and setscrews must be provided on each disc, one on each side. A small pulley made for a  $\frac{1}{4}$ -inch shaft can be used and part of it cut away if too large. The hole should be made to take the shaft very freely, so the assembly will go together easily.

The coil forms should fit tightly into the holes in the disc. Most bakelite tubing seems to be a few thousandths oversize, which is a help. In the assembly shown, the forms are made

ever so slightly egg-shaped as they are pushed into the discs. *The forms are not fastened in any other way and they will not move out of position.* It is surprising how quickly this entire assembly can be taken apart and put together. It was done many times while finding the proper number of turns for the coils.

The discs are spaced just far enough apart to fit snugly within the shield boxes. This keeps the entire assembly in position. The coil groups are placed in the shields, the brass rod is pushed through, the set screws tightened up, and there you are. A large knob is needed on this shaft as it turns rather hard when the coils come in contact with the springs. The knob was made from an old 4-inch dial by sawing and filing away the outer part.

The spring contact assembly is shown in Fig. 5. Some may think these contacts will not make good connection with the screw heads, but in four months not one bit of trouble has been

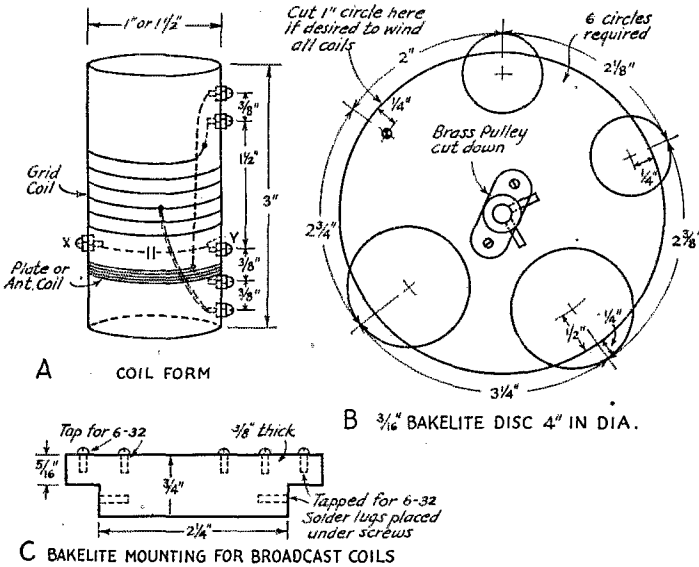

FIG. 4—COIL FORM ASSEMBLY DETAILS

All forms are of bakelite tubing. Contact screws are all 6-32. Screw "X" is used only in oscillator coils having a tracking condenser (see coil table). The lower end of the winding is then soldered to "X" instead of to "Y". The plate turns of oscillator coils are wound between the grid turns. The coil forms are held in the bakelite disc by snug fit, without use of other fastening. This makes them quickly removable for alteration of windings.

the same number of turns. In the 28-mc. range the second harmonic of the oscillator is used to beat with the incoming signal in order to overcome interlocking—and the 2A7 refused to oscillate properly at 28-mc., anyway.<sup>1</sup> To reach 30 mc. the oscillator must tune to 15,250-ke., the second harmonic of which is 30,500 kc. The higher frequency required for the 30-mc. range is secured by slightly wider spacing between turns. In all cases the tickler should be spaced as evenly as possible between the grid turns. Some of the bakelite was cut out of the r.f. and first detector forms of the 30-mc. range by drilling and filing, leaving about six slats around which the wire is wound. This was done in an attempt to lower losses at the highest frequency.

<sup>1</sup> A separate oscillator tube, coupling to the No. 1 grid of the 2A7, is suggested for overcoming this difficulty and also for giving somewhat better stability than is usual with the 2A7 oscillator. Circuits of this type are given in Chapter Five of the A.R.R.L. Handbook.—EDITOR.

experienced. If they become dirty, the entire assembly can be removed in about two minutes and they can be cleaned easily. Bronze more than 0.010-inch in thickness should not be used because the combined pressure of fifteen contacts becomes quite great.

Before the copper boxes are fastened to the chassis, the coil assembly should be set up with coils in it for at least one range. The contact spring assemblies should now be held on the chassis and moved about while rotating the coil assembly until the spot is found where a satisfactory contact is obtained. Then the two holes can be marked on the chassis through the holes in the bakelite strip. It should be remembered that the boxes will raise the springs about  $\frac{1}{32}$  inch. The boxes are held down by two screws near the left corners and by the contact assembly. The chassis holes can be drilled first and the boxes can be marked through these holes. The coils should be about  $\frac{3}{4}$  inch above the base when in the operating position. The spring bronze can be obtained from a machine shop, although possibly not in the desired width; but it can easily be cut down. All plate and grid leads from the r.f. coils are run above the base, so holes for these should be drilled in the ends of the boxes in line with the respective contacts. Holes for the other leads should be drilled

both regeneration and adjustable coupling, providing a very selective circuit.<sup>2</sup> The coupling is not intended to be continuously adjustable, but

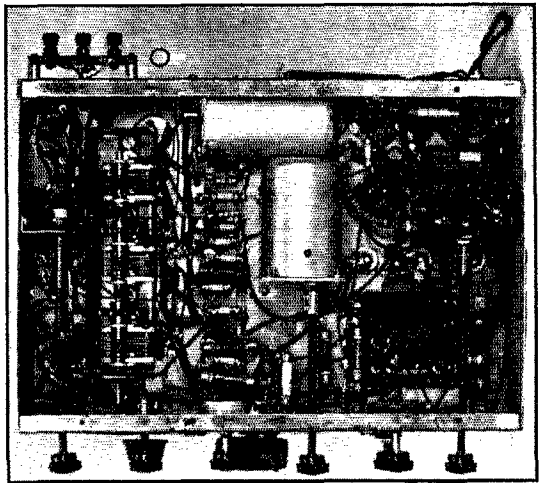

UNDERSIDE OF CHASSIS

The hand-spread gang condenser with geared drive is at the left.

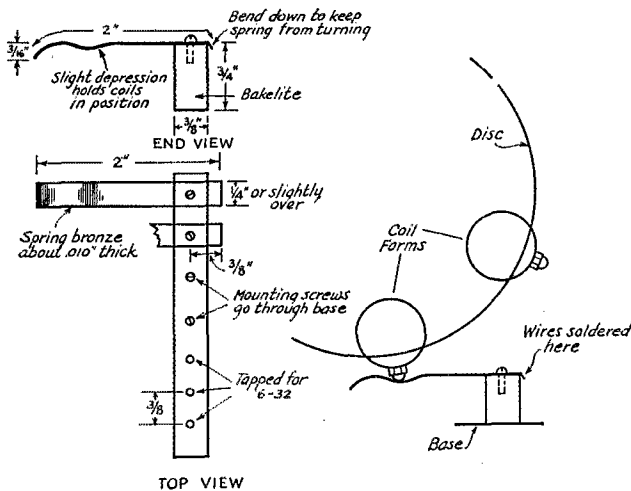

FIG. 5—ILLUSTRATING THE COIL CONTACT ASSEMBLY

As an alternative to the  $\frac{3}{8}$ -by- $\frac{3}{4}$ -inch contact mounting strip, a  $\frac{1}{4}$ -inch thick strip could be used and mounted on small stand-off insulators. Or individual tiny stand-offs might be used for each contact spring.

through the bottoms of the boxes and through the base.

#### THE I.F. STAGES

The intermediate frequency used is approximately 500 kc. The first i.f. stage incorporates

is meant to be set near the critical point and left that way. Additional selectivity is then provided by the controllable regeneration.

$T_2$  and  $T_3$  can be standard 500-kc. transformers, or they can be made by using one-millihenry coils and 100- $\mu$ fd. air-type padding condensers as described previously in *QST* and in the *A.R.R.L. Handbook*. Fig. 6 shows the details of  $T_1$ . It was constructed from a mica-compression tuned transformer designed to operate at 465 kc., the mica tuning condensers being discarded and 100- $\mu$ fd. Hammarlund air padding condensers used instead. The unit now tunes to 500 kc. with the condensers about half meshed. After discarding the mica condensers, the wooden dowel was sawed through between the plate and grid coils. Enough of the dowel was then sawed off so that the plate coil could be rotated. The grid coil is fastened rigidly while the plate coil is adjustable. If the nut is fairly tight against the bakelite, the screw can be rotated a quarter-

turn or so and will hold the position. An extra  $\frac{3}{4}$ -inch length of dowel is fastened to the grid

<sup>2</sup> See description of the regenerative type S.S. receiver in April, 1933 *QST*, and in Chapter Five of the *A.R.R.L. Handbook*, eleventh and twelfth editions.

dowel by a wooden pin stuck in holes through the dowels.

The tickler coil,  $L_7$ , was bunch wound over one layer of paper wrapped around the dowel. It was doped and when dry the paper was pulled out. The coil could then be slid along the dowel. It should be spaced so that the tube is very close to the point of oscillation with the regeneration control at maximum. It must be connected with the proper polarity of course. This is all covered in the *Handbook*. After the proper spacing is found, the coil can be cemented to the dowel.

The shield for this assembly is made from sheet copper and measures  $2\frac{1}{4}$  by  $2\frac{3}{8}$  by  $5\frac{1}{2}$  inches high. Flanges are bent at the bottom for mounting. The base of the shield is cut from  $\frac{1}{16}$ -inch aluminum, to which the transformer unit is fastened by means of the bracket. The  $\frac{3}{32}$

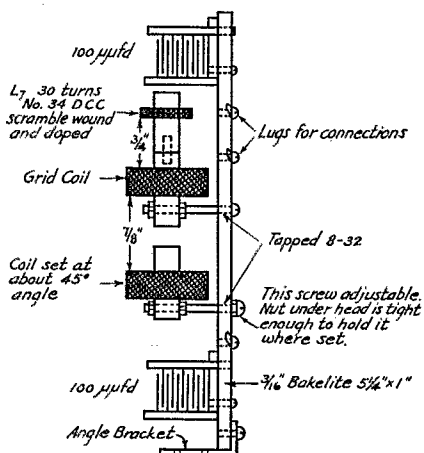

DETAILS OF THE REGENERATIVE FIRST I.F. ASSEMBLY

The copper shield can enclosing the unit is  $2\frac{1}{4}$  inches by  $2\frac{3}{8}$  inches by  $5\frac{1}{2}$  inches high.

mounting screws are placed up through the base,  $\frac{1}{2}$ -inch bushings slipped over them, and the nuts are tightened down on the bushings. The assembly and shield are then put in place and held down with additional nuts. This makes it possible to remove the shield to adjust the tickler, reverse leads, etc., without the mounting screws dropping out. Holes are drilled in the shield in line with the condensers and plate coil adjusting screw so that these can be adjusted with the shield in place.

$T_4$  was also made from a 465-kc. mica-tuned transformer with the mica condensers discarded. The unit is plate-tuned with a  $75\text{-}\mu\text{fd}$ . mica trimmer plus a two-plate midget variable condenser which is controlled from the front panel. The assembly is fastened to an aluminum base bent into an angle on one edge for mounting under the subpanel. An aluminum coil shield fits over the

assembly. The two-plate midget must be insulated from the aluminum base on which it is mounted. The  $75\text{-}\mu\text{fd}$ . trimmer is so mounted that it can be tuned through a hole in the shield.

#### AUTOMATIC VOLUME CONTROL

This a.v.c. system has been used in various forms by several manufacturers.  $C_{12}$  is a  $1\frac{1}{2}$ -inch length of copper braid pulled tight over the lead

TABLE OF VOLTAGES			
Measured with 300 v. 1 ma. meter from cathodes			
	Plate	Screen	Osc. Anode
R.F.	200	90	
1st Det.	220	70	170
1st I.F.	210	90	
2nd I.F.	210	90	
2nd Det.	135	80	120
Audio	250	265	
A.V.C.-24A	50*	17	

All voltages measured with volume control at maximum and no signal.

\* Measured at voltage divider end of  $R_{24}$ .

Voltage across entire divider at full load is 280 volts.

from  $T_3$ , the braid being soldered directly to one contact on  $SW_4$ . This capacity is large enough to apply sufficient signal on the 24-A grid, yet not large enough to detune the secondary of  $T_3$  when  $SW_4$  is thrown.  $C_{12}$ ,  $SW_4$  and  $R_{24}$  are mounted within a small copper box, and  $SW_4$  is controlled from the front panel. A.v.c. and regeneration cannot well be combined in the first i.f. tube, so this tube is not controlled.

It will be seen that the grid returns of three tubes pass through  $R_{23}$  to get back to the cathodes. The plate current of the 24-A also passes through  $R_{23}$ . When a signal is applied to the grid of the 24-A, plate current flows, creating a bias voltage across  $R_{23}$ .  $R_{21}$  is the manual r.f. gain control.  $R_{22}$  depends somewhat upon the 24-A tube and the voltages obtained from the voltage divider, although a value of about 150 ohms is correct. It should be large enough to cut off plate current in the 24-A when  $R_{21}$  is set at maximum. A 0-1 d.c. milliammeter connected in the plate circuit can be used to check this. Strong stations in the broadcast band drive the 24-A plate current up to 0.1 ma. With  $R_{21}$  set at minimum, the current is about 0.15 ma. With the antenna disconnected and no signal, the current should not change with the a.v.c. switch either way. Closing  $SW_4$  cuts out the a.v.c. action, but  $R_{21}$  still controls the gain.  $SW_3$ , when closed, reduces the gain to a point where the operator can listen to his own transmitter with the antenna disconnected. This a.v.c. works quite well on code reception, but the receiver's sensitivity is reduced somewhat because of the signal from the beat oscillator.

#### WIRING NOTES

The plate and grid leads from the r.f. coils are run above the base and taken through the base at the tube sockets. The r.f. and first-detect-

(Continued on page 64)

### Frequency Modulation

Although more familiar to us amateurs as an undesirable accompaniment to amplitude modulation, particularly in radiotelephone transmitter operation, frequency modulation in its unadulterated form has attracted interest, even in higher technical circles, at recurrent intervals during the last fifteen years or so. In fact, there was a time when it was speculated by some of the higher-ups of the day that frequency modulation might be the ultimate; that it might supplant amplitude modulation entirely; even that it might provide more economy in use of the frequency spectrum. For, it was argued, might not adequate modulation be obtained by "wobbling" the carrier only slightly? And could not a wobble of, say, but 500 cycles, be made to satisfy requirements then met by 10 times as much frequency occupancy with amplitude modulation? Unfortunately, attention first from the mathematical analysts and later from experimental runners-downers found the all-important flaw in this argument and demonstrated conclusively that *the band-width required for frequency modulation is at least as great as for equivalent amplitude modulation*. Worse yet, frequency modulation has an inherent distortion, under classical conditions, its character being such that the degree involves not just the amplitude of the modulating signal, but rather the frequency of the modulating signal as related to frequency variation of the radio carrier. The "index" of frequency modulation, which corresponds to the simple "factor" or "percentage" familiarly associated with amplitude modulation, is equal to the absolute shift (plus or minus) of the carrier frequency, divided by the modulation frequency. Hence it varies inversely as the modulation frequency, even though the modulating signal amplitude be constant.

### Major Armstrong

With frequency modulation thus requiring proportionately greater slices of the frequency spectrum per station and demanding more complicated equipment for both transmission and reception than amplitude systems in their present state of development, but without promising compensation sufficient to warrant adoption, the future of pure frequency modulation has not been very bright either for program broadcasting or for amateur 'phone—*on the lower-frequency bands*. But, enter television, the ultra-high frequency bands, and Major Edwin H. Armstrong, the pre-war amateur who made regeneration work to revolutionize radio communication. The already-wide band requirements of television and adapta-

bility of the u.h.f. region make the lesser spectrum economy of frequency modulation a secondary consideration. On the other hand, the greater receiver band-width imposed and the reduced amplification per stage which are inevitable make the noise problem one of major importance. Here it is that Major Armstrong finds justification for frequency modulation, as he explained to us during a recent visit to A.R.R.L. headquarters. By employing frequency-modulated transmission and suitable receiver circuits for properly translating frequency back to amplitude modulation (as must be done, since present detection devices are amplitude operated), a worth-while improvement in signal-noise ratio and, consequently, in effective receiver sensitivity, is claimed.

Although considerable non-technical press publicity has been given to the development, up to the present time no authoritative information on the details involved has been released in this country. And the Major has assured us that no details are to be divulged prior to presentation of his paper before the I.R.E. this fall. However, as not unusually occurs with announcement of American developments through the European connections of their sponsors, foreign reports would seem to be somewhat more illuminating than the domestic releases so far available. Our esteemed English contemporary, *Wireless World* (June 14 issue), apparently on good authority although not specifying the source, reported as follows:

"Major Armstrong attacks the problem first at the transmitting end, where he replaces the usual amplitude-modulation by a system of frequency-modulation. Having once produced a frequency-modulated sub-carrier, he increases the spread of the resulting sidebands by a process of repeated frequency-multiplication, until they cover a much wider area than the normal 10 kc/s used in ordinary broadcasting. Although such a system is, of course, unthinkable in the more congested parts of the ether, it is, at all events for the time being, practicable in the fairly uncrowded region below 10 metres.

"Valve noise, being of the nature of an amplitude variation, is limited to the usual 10 kc/s band on each side of the carrier, which is relatively insignificant, by contrast with the frequency-spread of the transmitted signal.

"For reception Major Armstrong uses a circuit of the superhet type with a second-detector stage consisting of two valves fed in parallel from the IF amplifiers. The input circuit of one detector has a reactance characteristic which varies from

(Continued on page 74)

# What the League Is Doing

League Activities, Washington Notes, Board Actions—For Your Information

**Election Notice** To all members of the American Radio Relay League residing in the Dominion of Canada, Atlantic Division, Dakota Division, Delta Division, Midwest Division, Southeastern Division, Revised Pacific Division (old Pacific Division minus portion now constituting Southwestern Division), Southwestern Division (the counties of Imperial, Inyo, Los Angeles, Mono, Orange, Riverside, San Bernardino, San Diego, San Luis Obispo, Santa Barbara and Ventura of the State of California, and the State of Arizona).

You are hereby notified that, in accordance with the constitution, an election is about to be held in each of the above-mentioned regions to elect both a member of the A.R.R.L. Board of Directors and an alternate thereto. In the case of the Dominion of Canada the election is to choose a Canadian General Manager and an alternate Canadian General Manager, for the 1936-1937 term. In the case of the United States divisions except the Southwestern, the election is to choose a division director and an alternate division director for the 1936-1937 term. In the case of the Southwestern Division the election is to choose a division director and his alternate for the single year 1936. Your attention is invited to Sec. 1 of Article IV of the constitution, providing for the government of A.R.R.L. by a board of directors; Sec. 2 of Article IV, defining their eligibility; By-Laws 11 to 21, providing for the nomination and election of division directors, and By-Law 12 providing for the simultaneous election of an alternate division director; By-Laws 25 to 31 providing for the nomination and election of a Canadian General Manager, and By-Law 26 providing for the simultaneous election of an alternate Canadian General Manager. Copy of the constitution and by-laws will be mailed any member upon request.

Voting will take place between November 1 and December 20, 1935, on ballots which will be mailed from the headquarters office in the first week of November. The ballots for each election will list, in one column, the names of all eligible candidates nominated for the office of director by A.R.R.L. members residing in that region; and, in another column, all those similarly named for the office of alternate. Each member will indicate his choice for each office.

Nomination is by petition. Nominating petitions are hereby solicited. Ten or more A.R.R.L. members residing in any one of the above-named

regions have the right to nominate any member of the League residing in that region as a candidate for director therefrom, or as a candidate for alternate director therefrom. No person may simultaneously be a candidate for the office of both director and alternate director. A separate petition must be filed for the nomination of each candidate, whether for director or for alternate director. The following form for nomination is suggested:

(Place and date)

*Executive Committee*

*The American Radio Relay League  
West Hartford, Conn.*

*Gentlemen:*

*We, the undersigned members of the A.R.R.L. residing in the ..... Division [or in the Dominion of Canada], hereby nominate ..... of ....., as a candidate for director [or for alternate director, or for Canadian General Manager, or for alternate Canadian General Manager, as the case may be] from this region for the 1936-1937 term [in the case of the Southwestern Division, for the year 1936].*

(Signatures and addresses)

The signers must be League members in good standing. The nominee must be a League member in good standing and must be without commercial radio connections: he may not be commercially engaged in the manufacture, selling or renting of radio apparatus or literature. His complete name and address should be given. The nominees for Canadian General Manager and alternate thereto must be Canadians. All such petitions must be filed at the headquarters office of the League in West Hartford, Conn., by noon of the first day of November, 1935. There is no limit to the number of petitions that may be filed, but no member shall append his signature to more than one petition for the office of director and one petition for the office of alternate director. To be valid, each petition must have the signatures of at least ten members in good standing.

Present directors from these areas are as follows: Dominion of Canada, Mr. Alex Reid, VE2BE, St. Lambert, P. Q., Canadian General Manager; Atlantic Division, Dr. Eugene C. Woodruff, W8CMP, State College, Pa.; Dakota Division, Mr. Carl L. Jabs, W9BVH, St. Paul, Minn.; Delta Division, Mr. M. M. Hill, W5EB, Natchitoches, La.; Midwest Division, Mr. H. W. Kerr, W9DZW-W9GP, Little Sioux, Iowa; Southeastern Division, Mr. Bennett R. Adams,

Jr., W4APU, Homewood, Ala.; Pacific Division, Mr. S. G. Culver, W6AN, Berkeley, Calif.; Southwestern Division, no director at present. No alternate directors at present exist from these areas.

These elections constitute an important part of the machinery of self-government in A.R.R.L. They provide the constitutional opportunity for members to put the direction of their association in the hands of representatives of their own choice. Members are urged to take the initiative and file nominating petitions immediately.

*For the Board of Directors:*

K. B. WARNER,  
*Secretary*

August 15, 1935.

### **Argument for the Amateur**

The Cairo Committee of the Board of Directors continues its studies, with a mass of ideas and suggestions under consideration, but we have no advice of specific decisions arrived at in the past month. The Chairman, Dr. Woodruff, writes for *QST* the following argument for the amateur as seen by the Cairo Committee:

The points usually advanced in favor of the radio amateur having a place in the spectrum seem reasonable and sufficient but, after all, are not fundamental and wholly convincing. These minor arguments come under two headings: first, contributions to the progress of the science and art of radio; second, service to the rest of mankind in the exercise of the art under special conditions.

Contribution to progress on the part of the rank and file of amateurs at times has been questioned. Given individuals of limited resources, lacking training in research, and of an average degree of maturity precluding a suitable background, it is sometimes wondered how such individuals can compete to any advantage with the trained experts in the laboratories of the universities and larger factories. Of course such wondering may be due partly to an arrogant assumption of superiority on the part of the critics, and to that extent are fallacious. However, granting that there are some grounds for such criticisms, there still remain many matters of development in any art that are completely solved only when repeated attempts are made under a great variety of conditions, especially under conditions that arise when resources do not permit an exact copying of apparently successful procedures. This is especially true in the art of radio. Likewise there are many tests the success of which depends on a large mass of statistical data. The numbers and wide distribution of the amateurs, and the great variety of conditions under which they operate, make them of special value in these connections.

Under the head of service to the rest of mankind come such items as Army and Navy Net

activities and emergency work in connection with storms, floods, and such like. These matters are not to be belittled in importance, yet they are not wholly indispensable.

A third talking point often advanced for amateur activity is the "hobby" plea. But pursuit of a hobby for the fun of it, for the thrills and the "kicks," is not an argument in any way. It is simply an incentive.

The major argument for the amateur's existence, however, is implied in the expression "Citizen Radio." In this there is a two-fold implication:

First, the citizen is an individual. Whatever contributes to the development of independence, initiative, resource and ingenuity is the best of schools for the individual, especially as in this school the pupil must be his own teacher. Second, the citizen is a member of the social group. Whatever contributes to securing for the group the minimization of the individual as a "social problem," and whatever furthers the contributions of the individual to the welfare of the group, such may be of incalculable value. The happiness, security and effectiveness of the social order depend upon the security, effectiveness and happiness of its component parts, the individuals.

Group support of individual activity is a sort of insurance for the group, an insurance of peace and security, and as such amateur radio deserves the very limit of support by the rest of mankind. In return, each amateur operator should check his individual activities and see that they measure up to the standards hereinbefore mentioned.

**Alaska** Amateurs in Alaska who have difficulty in locating a notary public to administer the oath in connection with amateur applications will be interested to know that to the list of officials in Alaska authorized to administer oaths there may be added the commanding officers of vessels of the Coast Guard.

### **Our Cover Illustration**

**WE GRABBED** the shot this month in the lab. on the bench where Ross Hull is doing some development work on ultra-high-frequency receivers. The interesting feature is the picture on the oscilloscope of super-regeneration in full swing. The quench frequency is the heavy and relatively smooth trace. Superimposed on it is the envelope of the oscillation period at the signal frequency. It can be seen that the super-regenerative detector breaks into oscillation slightly after the peak in the quench frequency swing and continues to oscillate for a brief portion of the quench cycle. This trace, of course, is only one of an almost endless variety available. It is, though, an honest-to-goodness un-faked

*(Continued on page 72)*



# Results A.R.R.L.'s 1935 DX-Contest

By E. L. Battey, W1UE\*

**T**HE sporting event of the year for the DX-minded amateur is the A.R.R.L. International QSO Party. The "Seventh International Relay Competition," March 9-17, 1935, was the greatest contest ever held in the history of amateur radio. New records galore, greater participation, fellowship with brother hams all over the globe, endless possibilities for good oper-



ZS6AF, POPULAR SOUTH AFRICAN STATION

ating fun, all made the 1935 DX-fest the most outstanding QSO-get-together in the annals of our hobby.

1490 operators are represented in the final tally of scores—1069 in the United States and Canada, 421 in 65 foreign countries and outside localities! It is estimated that stations were active in more than 90 foreign countries. The figure 1490 represents only those operators whose work in the contest was actually reported to headquarters. There were hundreds more who effected DX QSO's as a result of the contest but who did not report their accomplishments. It is conservatively estimated that total participation in the "Seventh International," including both the reporters and the non-reporters, was at least 2500!

Scoring was essentially the same as in previous years, serial numbers being exchanged to confirm contacts (which counted a possible three points each), total points being multiplied by the num-

\* Assistant Communications Manager.

ber of countries worked (in the case of VE/W participants) and by the number of W/VE licensing districts worked (in the case of foreign and outside locality contestants). One change in the scoring system was an addition of a band-factor, depending on the number of different frequency bands on which a given transmitter was operated for participant's contest contacts; 500, 1000, 2000, 4000 or 8000 points were added to the score for successful number exchanges on one, two, three, four or five different amateur bands. The second change was the addition of a Time Limit. For more than 90 hours of operation a compensating factor was applied to the score. For example, if a station operated 100 hours the Grand Total Score was multiplied by the fraction  $\frac{90}{100}$  to give the corrected score. This factor was initiated to permit operators to enjoy the DX possibilities to the maximum throughout the nine-day period without causing serious loss of sleep, working hours, irregular and hasty meals, etc. At the same time, an operator could operate the entire nine days (24 hours per day) and then correct his score as indicated to equalize his work with the work of those unable to put in the full time.

## HIGH W/VE SCORES

The highest score, national and foreign, was made by W3SI, Charles G. Meyers, Harrisburg, Pa., who rolled up the breath-taking total of 40,808 points!! He made 234 contacts with 56 countries in all continents! This is an all-time record in DX contests and a feat indeed. W3SI, we salute you!

In addition to W3SI's achievement, we are proud to report the commendable performance of numerous other "W's," who surely made a name for their stations: W2BHZ scored 36,650 points on the strength of 241 contacts in 50 countries! W1SZ burned holes in the ether to 210 stations

in 54 countries for a total of 35,588! A record in its own right is the work of W6GRL, who absolutely squeaked all previous west coast contest claims with 35,250 points—231 contacts in 50 countries!! The one remaining claimant of a 30,000 score is W2UK whose 185 QSO's in 54 countries brought him the glory of 30,646!

Other record scores are W1FH 29,162, W9IJ



ZL2LQ READY FOR ACTION

28,324, W9TB 26,530, W6CXW 25,092, W2BXU 23,050, W8CNZ 22,164, W8CTE 20,694, W2BYP 19,934, W8ZY 19,680, W2AIW 19,066, W9AEH 18,888, W1BPX 18,877, W2GJK 18,335, W6AWA 18,170. The highest scoring "VE" is VE2AX—15,406. Seventy-eight W and VE scores went over the 10,000 mark!

Included in W3SI's achievements is credit for working the greatest number of countries—56. Each of W2DC's contacts was with a different country, and he made 55 QSO's! W1FH, W1SZ and W2UK each worked 54 countries. W2BWF worked 51, W2BHZ, W2BXU and W6GRL 50 each, W1BUX 48, W9IJ and W9TB 46 each, and W2GJK 45. Twenty other hams worked stations in 40 or more countries.

Normally west coast scores do not run quite as high as those in other sections of the country. Good 14-mc. conditions this year enabled the W6's and W7's to snag more countries than is usually the case. W6GRL's score was fourth high in the W/VE group and fifth high world score. Other high W6 and W7 scores will be of interest: W6AWA 18,170, W7BB 16,940, W6GRX 16,732, W6ADP 13,540, W7BYW 10,550, W6AHZ 10,156. W6GRL worked 50 countries, W6CXW 38, W6GRX 36, W7BB 36, W6AWA 34, W7DL 31, W6ADP 30.

W2BHZ made the greatest number of QSO's, 241, followed by W3SI 234, W6GRL 231, W6CXW 216, W1SZ 210, W9IJ 201, W9TB 189, W2UK 185, W1FH 169, W6AWA 169, W8CNZ 163, W2AIW 158, W8ZY 158, W4CBY 158, W8CTE 154, W1BPX 153, W6GRX 152. Forty-eight other contestants made more than 100 contacts.

The highest scoring station in each W/VE district: W1SZ, W2BHZ, W3SI, W4CBY, W5AFX, W6GRL, W7BB, W8CNZ, W9IJ, VE1EA, VE2AX, VE3WA, VE4DU, VE5BI.

Certificate awards are being made to the highest scorers in each A.R.R.L. Section within the United States and Canada and in each foreign country and outside locality.

#### HIGH FOREIGN SCORES

Significant, perhaps, is the fact that the leading score outside of the W/VE group was made by a YL! Miss Judy Leon operating HC1FG led the lads a merry race to the tune of a 35,782 total!! She worked 810 stations in all 14 W/VE districts. Better not tell your YL's about this, OM's, or you might not hear the last of it! Excellent work, HC1FG. Next in line is X1AY—777 QSO's, 14 districts, 34,326 grand total—and "grand" is the

right word! Going along down the list we find ON4AU, 24,030 points, 395 contacts, 14 sections; EA4AO, 23,504—607 QSO's, 12 districts; X2C, 22,860—500 QSO's, 14 districts; K6HLP 21,604—588 QSO's, 12 districts; and X1AA 20,707, X1AX 20,408, ZL4AI 19,927, D4BAR 18,870, F8FC 18,080, F8EX 17,246, CT2BK 17,236, VK3GQ 17,210, ZL3AN 16,490, VK7RC 16,301, X2N 16,288. Others over 14,000, in order of scores: CM2JM, X1AM, ZL2BN, K4KD, G5BY, VK3MR, FM8BG, K6ESU. Fifteen others had scores above 10,000. In all, 40 foreign scores were over 10,000.

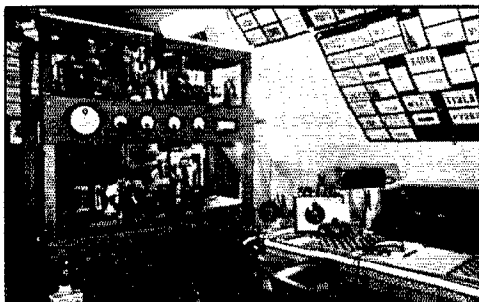

D4BIU, WELL-KNOWN DX STATION

All 14 W/VE districts were worked at CM2JM, CX1CG, D4BAR, F8EX, F8FC, HC1FG, ON4AU, X1AM, X1AY, X2C, VK7JB and ZL2LQ. Twenty-two other participants worked 13 districts.

HC1FG "beat the world" at number of contacts—810! X1AY was a comparatively close second with 777. Then we find EA4AO 607, K6HLP 588, X2C 500, CT2BK 492, X1AA 486, X1AX 474, ZL4AI 463, X2N 451, ZL3AN 414, F8FC 409, EA3EG 408, D4BAR 403, EASAF 403, VK3GQ 397, VK7RC 396, ON4AU 395, F8EX 373. Others making over 300 QSO's, in order: ZL2BN, CM2JM, VK3KX, K4KD, VK3MR, X1AM, FM8BG, VK2NS, ZL2GQ, G5BY, K6CGK, K6ESU, D4BIU. Twenty-eight others had more than 200 contacts.

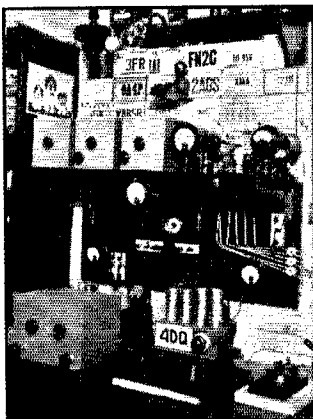

LU4DQ DID HIS SHARE

The highest scoring station in each continent: Africa—FM8BG, 14,384. Asia—J2GX, 8345. Europe—ON4AU, 24,030. North America (not including W/VE)—X1AY 34,326. Oceania—K6HLP, 21,604. South America—HC1FG—35,782.

The popular and recognized "DX bands"—7- and 14-mc., were the mainstays of all contest-

ants. The special credit for work on other bands, however, caused many to sally forth to explore other territory—1.75-, 3.5- and 28-mc. Three different bands were used by 130 operators. Of these three bands, 14- and 7-mc. constituted two, and in practically every case 3.5-mc. was the third band. In the case of X1AY, however, he successfully transmitted his serial number to W9TJ on 28-mc! W9TJ was transmitting on 14—listening on 28-mc. The only one of the 1485

operators participating who successfully used five bands was ON4AU. W9TJ gave ON4AU a 28-mc. contact in the same manner that he helped X1AY. ON4AU also worked W3EKV and W2ATT on 3.5-mc., and W1BB on 1.75-mc. These contacts added to his work on 7- and 14-mc. entitled him to add 8000 points to his score—for work on five bands! Contacts on four bands were established by G5BY, VE1EA, W1BB, W1CLX and W6AHI. In addition to contacts on 7- and

### SCORES

(Station first-listed in each Section and Country is winner for that territory, unless otherwise indicated. . . . Number of countries-prefixes (in case of W/VE participants) and number W/VE Districts worked (in case of non-W/VE participants) is given with the score. . . . Likewise, the number of frequency bands on which successful contacts were made is listed. . . . Asterisks denote stations not entered in contest, reporting to assure that stations they worked get credit. . . . Example: W3SI 40808-56-3, or Final Score 40808, number of countries 56, number of frequency bands 3 . . . )

<i>Connecticut</i>		W1GLF 3768-16-2	W1DMD 7562-27-3
W1SZ 35588-54-3 <sup>1</sup>	W1AXA 3567-17-2	W1AVJ 7488-23-3	
W1TS 13844-42-3 <sup>1</sup>	W1IAS 3277-23-2	W1EPC 5758-26-2	
W1AVY 11545-37-2 <sup>1</sup>	W1CWBZ 3091-17-2		
W1CEG 9170-38-2	W1LX 2957-19-2	<i>W. Mass.</i>	
W1DXL 6800-29-2	W1IBD 2645-15-1	W1ZB 11652-33-3	
W1DGC 6676-28-3	W1GHQ 2575-15-2	W1CC 10892-38-3	
W1EWD 5930-29-2	W1AQH 2480-20-2	W1ZD 8840-30-3	
W1AFB 5550-25-3	W1AGA 2175-7-3	W1CLX 7762-22-4	
W1EBO 4197-23-2	W1KH 2162-6-3	W1EBF 2785-17-2	
W1DGG 3982-21-2	W1ZI* 1944-16-2	W1DA 2640-20-1 <sup>1</sup>	
W1NI 3337-19-2	W1DPI 1820-15-1	W1DLL* 1310-15-1	
W1DIO 3060-20-2	W1CCA 1780-12-2	W1CQR 1108-6-2	
W1IED 2785-17-2	W1LQ 1663-13-2	W1PPP 812-8-1	
W1CNU 2530-18-2	W1NA 1652-16-1	W1AFU 670-10-1	
W1IOW 2485-15-2	W1EBR 1510-10-2	W1CGY 655-5-1	
W1DBU 2429-11-3	W1AER 1372-12-1	W1HRV 548-4-1	
W1CJD 2360-16-2	W1DDO 1279-9-2	W1IOZ 536-3-1	
W1CSC 2106-14-2	W1KM 1264-8-2	W1LET* 524-2-1	
W1AMZ 2027-3-3	W1CBN 1144-6-2	W1DYA* 518-2-1	
W1CZ 2027-13-2 <sup>2</sup>	W1PET* 1080-5-2		
W1FUY* 1936-12-2	W1AGF 1048-4-2	<i>Vermont</i>	
W1FUP 1550-14-1	W1HDV* 1012-2-2	W1EZ 5404-23-3	
W1MK 1528-11-2	W1BRB 959-9-1	W1ELR 1840-12-2	
W1DMK 1273-7-2	W1CRK 950-9-1	W1ZZG 548-4-1	
W1WR 1216-8-2	W1HIO 830-10-1		
W1HPI 1120-5-2	W1DRC 820-8-1	<i>Rhode Island</i>	
W1ZL 1075-5-2	W1GCG 614-6-1	W1CAB 2701-21-2	
W1GVK 1024-3-2	W1DIR 626-6-1	W1HRC 1012-2-2	
W1ACV 1012-2-2	W1HML 620-6-1	W1GTN* 503-1-1	
W1CUN 884-9-1	W1HCH* 572-4-1		
W1GOP 521-3-1	W1IGX 560-4-1	<i>N. Y. C. - L. I.</i>	
W1BGJ 518-2-1	W1SW 548-4-1 <sup>3</sup>	W2BHZ 36650-50-2 <sup>3</sup>	
W1BDI* 503-1-1	W1DJK 544-4-1	W2UK 30646-54-2	
W1UE* 503-1-1	W1BLU 540-4-1	W2BWF 17881-51-2	
	W1FDN* 527-3-1	W2ETM 14420-44-2	
	W1PR* 527-3-1	W2BSR 11578-43-2	
	W1DU 503-1-1	W2HHG 10834-33-2 <sup>2</sup>	
		W2BHT 8175-35-2	
		W2BEF 7630-34-3	
		W2DLO 5125-25-2	
		W2ECU 4198-26-2	
		W2CUL 4174-23-2	
		W2EHL 3860-22-2	
		W2EYB 3362-18-1	
		W2CYO 3304-24-2	
		W2GFI 3200-20-1	
		W2GEF 3176-17-2	
		W2GKR 2932-21-3 <sup>2</sup>	
		W2GUR 2615-19-2	
		W2CCZ 2504-12-3	
		W2FSK 2056-12-2	
		W2OC* 2036-17-1	

W2CYN 1966-14-2	W2SQ 986-9-1	W3VF 626-6-1
W2ETG 1756-14-2	W2PNV 981-13-1	W3BXE 608-6-1 <sup>2</sup>
W2GRA 1648-12-2	W2DTR 980-10-1	W2BBK 548-4-1
W2GXS 1600-10-2	W2ADP* 860-9-1	W3TC 545-3-1
W2BRE 1540-10-2	W2DWH* 824-9-1	W3AJV* 518-2-1
W2CGB 1466-14-1	W2HTZ 752-9-1	W3BGO 515-1-1
W2AYJ 1440-10-2	W2EYZ 661-7-1	W3AZT 506-1-1
W2ARY 1424-11-1	W2GSW 575-5-1	W3ETB 503-1-1
W2DHH 1410-10-2	W2DJB 560-4-1	W3FGB 503-1-1
W2GP 1360-8-2	W2DLF* 548-4-1	W3EWU 503-1-1
W2CSO 1336-8-2	W2GCV 545-5-1	W3DJI 503-1-1
W2EMJ 1306-9-2	W2GER* 530-2-1	W3EFH 503-1-1
W2FPT 1288-8-2	W2GVR* 524-3-1	W3EAN* 503-1-1
W2DKF 1240-8-2	W2AWU 512-2-1	W3EHZ 502-1-1
W2BWD 1168-7-2	W2DJT* 512-2-1	
W2DOG 1147-7-2	W2CCG* 503-1-1	
W2AOD 770-9-1		<i>So. New Jersey</i>
W2BJ 764-8-1	<i>E. New York</i>	W3CDO 15592-38-2
W2GDU 670-5-1	W2BYP 19934-42-3	W3CKT 14360-40-2
W2AEP 620-5-1	W2CBO 14464-41-3	W3COP 8922-34-2
W2DTL 608-6-1	W2OA 12856-39-2	W3AUI 7080-38-2
W2CKQ 580-5-1	W2C 11075-35-3	W3NK 6752-24-3
W2BPD 548-4-1	W2CJM 9810-65-2	W3AIR 3508-22-2
W2BXW 548-4-1	W2DSB 4976-24-2	W3EDP 3178-22-2
W2DYF* 548-4-1	W2AWT 3728-22-3	W3BPT 2955-17-2
W2GVC 536-3-1	W2AFR 3553-23-2	W3DOK 2515-15-2
W2APZ* 512-2-1	W2CGO 2260-15-2	W3ECO 2030-10-2
W2GZS 512-2-1	W2EMK 2008-16-2	W3CBR 1966-14-2
W2EW 512-2-1	W2AEW 1819-21-2	W3VE 1936-13-2
W2EW 512-2-1	W2ACY 1193-11-1	W3ATL 1210-7-2
W2DIN* 508-2-1	W2EWD 600-5-1	W3CRY 1112-9-1
W2DJP 504-1-1	W2L 575-5-1	W3ELG 1080-5-2
W2GES 503-1-1	W2ZLQ 527-3-1	W3BGN 840-10-1
W2CHK* 503-1-1		W3FO 824-9-1
W2FRK* 503-1-1	<i>E. Penna.</i>	W3DBD 788-8-1
	W3SI 40808-56-3	W3DAU 626-6-1
	W3EUV 13635-35-2	W3EGE 548-4-1
	W3BES 13430-35-2	W3CLN* 502-1-1
	W3EJO 11569-39-2	
	W3BLQ 9720-40-2	<i>Virginia</i>
	W3AQI 7301-32-2	W3CHE 14981-41-2
	W3BET 5670-30-2	W3CCU 11944-36-2
	W3BRU 4542-22-2	W3AG 11630-42-1
	W3VC 4360-20-2 <sup>2</sup>	W3APJ 10078-34-2
	W3DBX 10480-20-2	W3EMA 9412-34-3
	W3EJO 3825-25-3	W3BWA 9400-35-2
	W3BPY 3365-15-3	W3BSB 5216-24-3
	W3CZO 3208-24-2	W3EMK 5212-27-2
	W3KT 2854-18-2	W3BEK 4500-25-2
	W3BQP 2838-18-2	W3AFA 2339-13-2
	W3CHH 2768-17-2	W3EBK 1798-14-2
	W3U 2434-14-3	W3ADD 1635-15-1
	W2DEW 4942-27-2	W3CGR 1163-13-1
	W2DNG 4744-26-2	W3ELJ 1148-12-1
	W2WC 3548-18-3 <sup>1</sup>	W3EVT 1044-4-2
	W2DZA 3376-22-2	W3EY 896-11-1
	W2CWC 2808-16-2	W3EAP 647-7-1
	W2BGE 2755-15-2	W3EJZ 548-4-1
	W2GVZ 2440-16-2	W3DAM 527-3-1
	W2CAY 2378-14-3	W3ELC* 324-2-1
	W2ASY 2292-17-2 <sup>2</sup>	W3EKW 506-1-1
	W2GRG 2095-15-2	
	W2FEL 1990-15-2	
	W2CQV 1980-14-2	
	W2GFI* 1960-15-2	
	W2MJ 1864-12-2	
	W2FBS 1714-14-2	
	W2CJG 1540-10-2	
	W2GGE 1405-9-2	
	W2ARB 1362-12-1	
	W2CZB 1297-9-2	
	W2ABS 1151-7-2	
	W2HZR 1150-5-3	
	W2AKR 1048-4-2	
	W2AGX 1039-12-2	
	W2HHR 1036-3-2	
		W3QM 682-7-1 <sup>2</sup>
		W3BYO 1168-7-2

14-mc. their "other-band" contacts were as follows: G5BY worked W1BB on 1.75-mc. and a number of amateurs on 3.5-mc. VE1EA worked G2II on 1.75-mc. and VO4Y on 3.5-mc. W1BB's first two QSO's in the contest were with ON4AU and G4BY on 1.75 mc. and he later worked VP5CC on 3.5 mc. W1CLX's contacts were with VO2C on 1.75-mc. and VP6MO on 3.5-mc. On 1.75-mc. W6AHI worked K6CRU and on 3.5-mc. K6BJP. ON4VO's work in the contest was confined to the 3.5-mc. band; he worked 11 stations

with 58 watts input. VK3ZC, using a single '45, worked W6NT on 3.5-mc. ZL2BH, using 45 watts input, got a report of R6 on 3.5-mc. from W9IEL. EA4AO was heard knocking 'em off in "one, two, three" fashion on 3.5-mc. one night of the tests.

### CLUB AWARDS

The special certificates offered to the highest scoring station on each A.R.R.L. affiliated club where three or more individual members took

W3AFU 1126-6-2	Tennessee	W6NW 2894-19-1	W6EWC 2227-11-1	W6DZE 848-6-1	Washington
W3CYO* 1048-4-2	W4SW 6284-24-1	W6DAA 1516-12-2	W6FRD 2140-12-2	W6JDY 572-3-1	W7BB 16940-36-3
W3CWE 920-10-1	W4OI 3352-14-2 <sup>12</sup>	W6BNO 1358-13-1	W6CVV 1770-11-2		W7DL 9897-31-2
W3LX 788-8-1	W4FP 2952-16-2	W6HGO 1315-5-2	W6HXU 1656-8-2	East Bay	W7ALZ 5063-17-2
W3EVF 710-7-1	W4CPS 1630-10-2	W6PCB 1282-6-2	W6BLS 1648-6-2	W6ATW 9540-20-2	W7AVL 4840-20-2
W3VJ 608-6-1	W4WT 1594-9-2	W6CPU 1225-5-2	W6KHV 1612-9-2	W6T 7216-16-3	W7BX 2258-10-2
W3ETT 600-4-1	W4DDF 773-7-1	W6BFX 1027-3-2	W6IOJ 1611-11-1	W6AHI 6970-15-4	W7BZY 2008-12-2
W3ER* 575-5-1	W4AY 512-2-1	W6SXS 801-7-1	W6JWL 1590-10-2	W6FMU 6902-26-2	W7DXZ 1981-8-2
W3CDQ 572-4-1		W6WDI 524-2-1	W6WQ 1432-8-2	W6FMY 2782-11-2	W7AYO 1820-11-1
W3EUJ 545-3-1	W. Florida		W6KZH 1408-8-2	W6W 1837-9-2	W7ACY 1777-7-2
W3EGN 536-3-1	W4AUW 3919-21-2	Arkansas	W6LN 1391-9-1	W6EJA 1400-10-1	W7EOR 1525-7-2
	W4CDE 2095-15-2	W5ASG 4990-21-2	W6IOX 1342-6-2	W6IFP 1392-8-2	W7BTZ 1144-4-2
	W4BGA 1496-12-1	W5ZF 4618-18-2	W6BLX 1144-6-2	W6CBE 860-8-1	W7EBW 1089-4-2
Ga.-S.C.		W5BXN 4249-19-2	W6LX 1096-4-2	W6DHS 689-7-1	W7BST 787-7-1
W4CBI 17120-41-2 <sup>10</sup>	Alabama	W5BGG 2747-9-3	W6GMC 900-8-1	W6DVB 503-1-1	W7CAB* 632-4-1
W4BBP 12470-37-2	W4BOU 2649-17-2	W5BDB 2482-19-2	W6HG 773-7-1		W7BFW 545-4-1
W4BPD 1020-27-2	W4AQ 1957-11-2	W5EIP 1280-8-2	W6FKZ 764-8-1	San Diego	W7ERT 536-3-1
W4BRG 9040-32-3	W4ACJ 1125-5-2	W5BDW 1256-12-1	W6CPG 743-9-1	W6HEX 8820-22-3	W7BTD 530-3-1
W4YC 7188-26-2		W5BXM 1155-5-2	W6SN 783-9-1	W6IY 5454-17-2	W7TZ 527-3-1
W4AUN 4888-24-2	Oklahoma	W5EOP 1006-1-2	W6DQZ 680-6-1	W6KBD 5104-19-2	W7ADU 524-3-1
W4CPZ 2316-14-2	W5AFX 14309-33-3		W6GJ 625-5-1	W6BAM 4240-18-2	W7AQ 518-2-1 <sup>15</sup>
W4BCR 527-3-1	W5QL 10425-29-2	Louisiana	W6JH 575-3-1	W6GTM 3388-12-2	W7LD 518-2-1
W4CDH* 506-1-1	W5CAL 2887-17-2	W5CYI 3550-17-2	W6JN 567-9-1	W6FOM 1517-9-1	W7QI* 518-2-1
	W5CXE 1832-8-2 <sup>13</sup>	W5DAW 1282-7-2	W6DN 542-3-1 <sup>16</sup>	W6BYX 1144-6-2	W7DQX* 512-2-1
	W5BSU 1621-9-2	W5BMM 1096-4-2	W6LRN 542-3-1	W6LDJ 1063-3-1	W7CNM 503-1-1
	W4CJG 516-2-1	W5KC 1072-4-2	W6GK 536-3-1	W6LTX 572-3-2	W7BCS 503-1-1
		W5DGB 1036-3-2	W6BQQ* 503-1-1	W6ISG* 512-2-1	W9LFI 503-1-1 <sup>20</sup>
		W5BZR 689-6-1	W6KTQ* 503-1-1		
	So. Texas	W5CVV 668-7-1		San Joaquin V.	Idaho
	W5EBT 11980-30-2	W5BDJ 590-5-1	San Francisco	W6CLP 7531-22-2	W7BYW 10550-25-3
	W5JC 11334-26-3	W5EY* 590-5-1	W6AWA 18170-34-2	W6ASV* 1468-9-2	W7CHT 3610-15-2
	W5VY 7532-23-2	W5EEZ 581-3-1	W6GFB 3758-14-2	W6FZA 1392-7-2	W7BLT 2462-11-3
	W5AFV 4478-21-3		W6IBQ 2628-11-2	W6DQR* 1280-10-1 <sup>18</sup>	W7KG 608-3-1 <sup>21</sup>
	W5MS 4355-15-1	Mississippi	W6DJI 2452-11-2	W6BNN 1129-3-2	W7ACD 327-3-1 <sup>22</sup>
	W5REX 1627-13-1	W5DXG 3065-15-1	W6CIS 2404-12-2	W6GZU 1120-5-2	
	W5BCU 1360-8-2	New Mexico	W6FPU 2122-11-2	W6GGI 830-6-1	Oregon
	W5BDI 1315-7-2	W5AAX 2512-12-2	W6CAL 1825-11-2	W6JPU 650-5-1	W7AMX 829-3-2
	W5DMS 1120-4-2	W5AAC 2404-9-2 <sup>24</sup>	W6JMR 1715-15-1		W7BUB 5780-18-2
	W5CKB 1052-4-2	W4CA 2404-9-2 <sup>24</sup>	W6WU 1360-8-2	Arizona	W7BPF 4456-18-2
	W5HX 1048-4-2	W5CJP 1300-5-2	W6JQJ 1320-8-2	W6DRE 3352-16-2	W7AO 4324-14-3
	W5DTQ 1027-3-2	W5ELL 1072-4-2	W6JJS 1189-7-2	W6IY 2017-9-2	W7MD 2300-10-3
	W5ARO 1010-10-1		W6ASG* 620-5-1	W6LZU 836-7-1	W7DWQ 2017-9-2
	W5CUT 864-7-1	Los Angeles			W7AHS 1648-8-2
	W5CET 830-6-1	W6GRL 35250-50-2 <sup>28</sup>	Santa Clara V.	Sacramento V.	W7WL 1462-7-2
	W5BND* 731-7-1	W6CXW 25092-35-2 <sup>28</sup>	W6AHZ 10156-27-2	W6GDJ 2752-12-2	W7APG 1414-9-2
	W5CS 668-6-1	W6GRX 16732-36-2	W6RQY 7028-22-2	W6KYO 1768-8-2	W7DAA 1384-6-2
	W5BBR* 603-6-1	W6ADP 13540-30-2	W6DSZ 5641-21-2	W6LGD 1120-4-2	W7BNC 1306-6-2
	W5EBN 527-3-1	W6AUX 8968-24-2 <sup>26</sup>	W6HB 4636-18-2	W6GCM 581-3-1	W7MH 1244-8-1
	W5BJ 512-2-1	W6KRI 6764-22-2	W6HJT 3445-17-2	W6GZY 503-1-1	W7ERA 700-5-1
	W5DTJ* 509-1-1	W6KIP 6368-21-3	W6DRU 3080-10-3	W6LZE 503-1-1	W7LL 614-4-1
	W5EPM 503-1-1	W6JKH 5020-20-2	W6AOD 2800-15-2		W7BMA 550-5-1
		W6JJI 4956-16-2	W6LES 1448-7-2	Utah-Wyoming	W7CK 512-2-1
	No. Texas	W6PZL 4400-20-2	W6LXJ 1384-8-2	W6VJ 1320-5-1	W7HD* 503-1-1
	W5EAM 7600-20-3	W6AM 2749-11-2	W6YL 1252-7-2 <sup>27</sup>	W7ADF 860-6-1	
	W5JHM 6272-24-3	W6FAT 2740-15-2	W6JKB 1135-5-2	W6FRN 797-9-1	Montana
	W5ATF 5050-27-2	W6FT 2530-17-2	W6BOP 1063-3-2	W7CY 572-4-1	W7AOD 2440-12-2
	W5IF 4255-21-2				

<sup>1</sup> The Conn. award goes to W1AVV since HQ members and stations (W1SZ and W1TS) are not eligible. <sup>2</sup> Aero Radio Club. <sup>3</sup> Phillips Academy Radio Club. <sup>4</sup> W1EFM opr. <sup>5</sup> Central Mass. Radio Assn. <sup>6</sup> Claimed score indicated is subject to modification, and no award can be announced in the NYC-LI section pending receipt and examination of station log as to the exact number of hours operation in the contest. <sup>7</sup> Station score. "X" 5738. "LC" 2656. <sup>8</sup> Three ops. <sup>9</sup> Station score. ops. W3CCK ABC ERU EIV UF BKV BML. <sup>10</sup> Portable in Phila. <sup>11</sup> Station score, 106 hours, 10 mins; "BZ" 17420-96 hrs, 10 mins; "BOB" 563; "RMJ" 564. <sup>12</sup> Winston-Salem Amateur Radio Club. <sup>13</sup> W4ABT opr. <sup>14</sup> Two ops. W4ABY & W4OI. <sup>15</sup> Station score. ops. W5CXE BJV CVJ DRE ELLV. <sup>16</sup> Portable in Santa Fe. <sup>17</sup> Station score. "H. Sasaki" 20786. "Sam" 522. <sup>18</sup> Portable in San Jacinto. <sup>19</sup> Station score. ops. W6HCL KZG HZV CSI. <sup>20</sup> Two ops. "WIM" & "PR". <sup>21</sup> Yakima Amateur Radio Club; W7BZU opr. <sup>22</sup> Portable in Seattle. <sup>23</sup> Two ops. W7DKY ERF. <sup>24</sup> Claimed score. This station log with several others of the contesting stations in Section and Club competitions has been called for examination by the Award committee, in verifying the true figure of hours of station operation on exactly the same basis as other logs of contesting stations. Final score subject to modification in accordance with the number of hours established for the log. <sup>25</sup> Station operated 104.5 hours. <sup>26</sup> Denison University Radio Club; W8ANJ, opr. <sup>27</sup> Station score. "BFYF" 2868. "S1W" 1690. <sup>28</sup> Two ops. W8DPS DNE. <sup>29</sup> Two ops. "HUG" & "WJG". <sup>30</sup> Station score. "ART" 2456. "LIL" 1410. <sup>31</sup> Portable in Winnetka. <sup>32</sup> Three ops. "RP". "LM" & "WB". <sup>33</sup> Two ops. W9PV & OQP. <sup>34</sup> Two operators. "FR" & "LU". <sup>35</sup> Three ops. W9HUZ, RVK & NFA. <sup>36</sup> W9OGT opr. <sup>37</sup> Station score. "LVD" 1637. "LEO" 536. <sup>38</sup> Two ops. W9SJK & EPK. <sup>39</sup> Two ops. W9PUC & TFF. <sup>40</sup> Victoria Short Wave Club; VE5HP opr. <sup>41</sup> Two ops. FM8EG & FM8CL. <sup>42</sup> Two ops. F5EX & F5EQ. <sup>43</sup> Two ops; one opr. 5873. <sup>44</sup> Two ops. "VIL" & "DW". <sup>45</sup> Station score. "ER" 629. "CC-W7AQ" 536. "CA" 506. <sup>46</sup> LUSBAJ operator. <sup>47</sup> Two ops. "GW" & "CW". <sup>48</sup> Two ops. W2GKR & DJM. <sup>49</sup> Station operated 93 hrs, 30 mins. <sup>50</sup> Station operated 92 hrs. <sup>51</sup> Lansdowne Radio Assn.; W3EMR & EQV, ops. <sup>52</sup> Two ops. "EW" & "LW". <sup>53</sup> Two ops. W3EJU & EEB. <sup>54</sup> Two ops. W6AUX & CNX. <sup>55</sup> W8FEY opr. <sup>56</sup> W9AER opr. <sup>57</sup> University Amateur Radio Club; W9DBW opr. <sup>58</sup> Two ops. F8FC & F8EB. <sup>59</sup> Four operators. W2ZA, W2KM, W2CJJ, W5BBB. <sup>60</sup> Three operators. W6GRL, W6QD, "ADB".

part and submitted scores are being awarded in 20 clubs. The winners and their clubs are as follows: W1CBZ, Radio Operators Association of New Bedford, Mass.; W2AIF, Memorial Radio Club of Englewood, N. J.; W2BXU, The Original Tri-County Radio Association (Rahway, N. J.); W2CBO, Schenectady (N. Y.) Amateur Radio Association; W3BES, The Frankford Radio

Club, Philadelphia; W3DLY, Beacon Radio Amateurs, Philadelphia; W3EBK, Richmond (Va.) Short Wave Club; W3EVW, Lansdowne (Pa.) Radio Association; W4OG, The Winston-Salem (N. C.) Amateur Radio Club; W4ZP, The Nashville (Tenn.) Amateur Radio Club; VE5JC, Victoria Short Wave Club; W8CJJ, Elmira (N. Y.) Radio Amateur Association;

W7BVI 1420-4-2	W8DIO 515-3-1	W9KA 3730-21-2	W9ERH 570-5-1	W9JMB 1100-5-2	Saskatchewan
W7BYE 610-4-1	W8GDU 512-2-1	W9FO 3601-17-2 <sup>20</sup>	W9SQC 503-1-1	W9CWG 1048-4-2	VE4HG 1483-7-2
W. Penna.	W. New York	W9PST 3115-21-2	Wisconsin	W9DWD 875-5-1	VE4JV 1160-5-2
W8CNZ 22161-44-2	W8EUY 9326-37-3	W9OVU 3053-23-1	W9GIL 10014-28-2	W9LDH 612-4-1	VF4BF 1120-5-2
W8CTE 20691-43-2	W8CJJ 7150-30-2	W9RKR 2496-17-2	W9IHL 9856-36-2	W9PNK 572-4-1	VE4CV 1024-2-2
W8DHW 11619-41-2 <sup>21</sup>	W8FVF 5234-22-3 <sup>22</sup>	W9IPP 2401-18-2	W9BIB 4982-21-3	W9LEZ 512-2-1	VE4H 503-1-1
W8HWE 10348-38-2	W8PDS 4975-25-2 <sup>23</sup>	W9LCO 2200-16-2	W9MRW 4888-24-2	W9IO 512-1-1 <sup>24</sup>	Alberta
W8HET 5488-24-2	W8DCX 4825-25-2	W9LW 2022-14-2	W9RIR 4570-24-2	So. Minnesota	VE4HK 1392-8-2
W8AAT 5209-23-2	W8JV 3916-18-2	W9APE 2014-13-2	W9GHN 3346-23-2	W9BTV 4382-19-2	VE4EO 524-2-1
W8FTM 4822-26-2	W8FQS 3280-19-2	W9AZP 1975-13-2	W9CGT 2394-17-2	W8SBO 2428-17-2	British Columbia
W8AZG 3020-21-1	W8CPO 3244-17-2	W9MKX 1840-12-2	W9CCO 2131-13-2	W9DMA* 1738-13-2	VE5BI 3290-10-2
W8HWU 2474-21-1	W8ERZ 3020-17-3	W9JYZ 1825-11-2	W9QMG 1627-11-2	W9CYA 1480-10-2	VE5EJ 3206-11-3
W8MQQ 2364-11-2	W8LDA 2510-10-3	W9AFO 1780-13-2	W9PTC 1549-9-2	W9PEV 1357-7-2	VE5EQ 3122-11-3
W8BSF 2280-16-2	W8BFG 2383-14-2	W9TBX 1588-12-2	W9LW 1509-14-1	W9GNU 1288-6-2	VE5E8 2120-10-2
W8JMP 1744-12-2	W8MAH 1256-12-2	W9RO 1570-10-2	W9FAW 1469-7-2	W9FKR 1248-8-2	VE5EH 1840-7-2
W8EUO 1600-10-2	W8JQV 1764-8-2	W9JNB 1450-10-2	W9JFM 1369-9-2	W9SKJ 1010-6-1 <sup>25</sup>	VE5FG 1830-10-2
W8LKE 1396-14-1	W8KZH 1264-8-2	W9JTH 1381-8-2	W9FHU 1168-7-2	W9PDL 554-3-1	VE5HC 1708-12-2
W8DVS 1300-8-2	W8FYH 1203-7-2	W9MGN 1345-5-2	W9RRT 1076-4-2	W9MZL 536-3-1	VE5JC 1616-8-2
W8CIR 1250-8-2	W8BQJ 1202-9-1	W9CVI 1319-13-1	W9OVS 1067-9-1	No. Minnesota	VE5KB 1504-9-2
W8ILL 1100-12-1	W8ADG 1144-6-2	W9FFQ 1252-7-2	W9HGE 1063-3-2	W9PUC 2888-8-3 <sup>27</sup>	VE5EC 1420-7-2
W8ALO 950-10-1	W8IGV 1120-5-2	W9RHK 1252-4-2	W9NZY 1027-3-2	W9BMC 572-4-1	VE5EE 1180-5-2
W8DKL 560-4-1	W8TOT 1076-12-1	W9RDT 1252-7-2	W9MUI 1009-1-2	W9WNY 515-1-1	VE5EH 1168-4-2
W8PT 548-4-1	W8AKX 1060-4-2	W9NPW 1252-7-2	W9EPQ 950-10-1	W9OGZ 512-2-1	VE5HS 668-4-1
W8KZU 530-2-1	W8MDE 905-9-1 <sup>28</sup>	W9KJE 1210-7-2	W9SLF 500-5-1	So. Dakota	VE5KZ 503-1-1
W8LTA 527-3-1	W8CPI 860-8-1	W9SOW 1180-5-2	W9HYM 536-3-1	W9HHW 2386-11-2	AFRICA
W8KAZ 512-2-1	W8AYD 836-8-1	W9PNE 1130-5-2	W9DJQ 527-3-1	W9HJU 1513-9-2	Algeria-FM8
Ohio	W8BJH 800-10-1	W9NHP 1072-4-2	W9RPU 521-3-1	W9POQ 512-2-1	FM8BG 14384-12-3 <sup>29</sup>
W8ZY 19680-40-2	W8CVJ 590-5-1	W9RHE 1063-3-2	W9JCW* 503-1-1	Nebraska	Canary Islands-EA8
W8BT1 11592-32-2	W8JUV 590-5-1	W9FGT 1060-4-2	Kansas	W9BFE 5401-27-2	E8AA1 13947-11-2
W8BCT 10213-37-2	W8GWW 584-4-1	W9MSC 1054-3-2	W9PV 10016-28-2 <sup>31</sup>	W9GDE 5141-21-2	E8AA2 5576-9-1
W8LEA 9964-36-2	W8ADV 536-3-1	W9DWR 1036-2-2	W9BFZ 5401-27-2	W9EEN 3320-20-2 <sup>32</sup>	E8AA3 3328-8-2
W8RAN 7848-82-2	W8JTT 512-2-1	W9NDB 1008-2-2	W9EER 716-6-1	W9EEL 2548-12-2	Madeira-CT3
W8DGP 6394-31-2	W8CZP 503-1-1	W9BRC 1004-12-1	W9EFL 608-6-1	W9DFY 1108-4-2	CT3AB 5110-10-2
W8ARO 6335-28-2 <sup>34</sup>	Michigan	W9RQC 700-4-1	W9EFA 548-4-1	No. Dakota	U. of So. Afr.-
W8CBC 6200-26-2	W8DHC 8222-30-1	W9NBM 668-6-1	Colorado	W9JZJ 503-1-1	ZS/ZT/ZU
W8NV 5760-23-2	W8AYC 6560-24-3	W9HPO 628-8-1	W9FY 9020-27-2	Maritime	ZS2A 4900-10-2
W8SG 5520-22-3 <sup>35</sup>	W8LBC 3856-21-2	W9KKE 605-5-1	W9FYF 4580-22-2	VE1EA 3873-27-1	ZT1R 4330-10-2
W8VZ 4912-24-2	W8DED 3736-24-2	W9SAN 800-4-1	W9GJF 581-3-1	VE1DR 3672-17-1	ZTSR 1932-8-1
W8KOL 3184-22-2	W8GQB 3142-21-2	W9EUL 590-5-1	W9GJG 572-4-1	VE1DQ 3240-20-3	ZS1C 1882-9-2
W8ENA 2860-20-2	W8DVB 2159-19-2	W9KHD 560-4-1 <sup>36</sup>	W9GJH 560-4-1 <sup>37</sup>	VE1DT 661-7-1	ZT6K 1448-7-2
W8FQZ 2800-20-2	W8WUD 2152-16-2	W9KID 548-3-1	W9GJS 1552-6-2	VE1FT 527-3-1	ZUGP 1318-8-1
W8BNC 2476-18-2	W8CYW 1982-19-1	W9GIZ 545-3-1	W9PGS 548-3-1	VE1GL 527-3-1	ZTHH 1244-8-1
W8NFP 2432-18-2	W8GTF 1798-14-1	W9RJM* 548-3-1	W9DYP 1300-5-2	VE1IA 15406-42-2	ZUGF 1166-7-1
W8KXC 2365-13-2	W8LRQ 1729-9-2 <sup>38</sup>	W9RJM* 548-3-1	W9DQD 572-4-1	VE1IG 12868-33-3	ZS6A 1060-7-2
W8GCV 1812-16-1	W9CSI 1540-12-2	W9NJR 518-2-1	W9NIT 512-2-1	VE2AA 3601-21-2	ZUIT 665-5-1
W8DJJ 1741-15-2	W8ND 1430-10-2	W9NWN 512-3-1	Missouri	VE2BE 3178-18-2	ZUGB 662-6-1
W8GDH 1538-12-2	W8TK 1065-5-2	W9NFB 512-3-1	6062-22-2 <sup>39</sup>	VE2BR 1540-10-2	Z8U 536-3-1
W8HFE 1528-11-2	W8MTP 1012-2-2	W9NFD 512-3-1	W9LLN 1924-13-2	VE2BU 1150-5-2	Z8X 536-3-1
W8BRQ 1507-13-2	W8BTK 704-8-1	W9NFB 512-3-1	W9GCH 1684-12-2	VE2CG 1075-5-2	ZT5Z 506-1-1
W8HDF 1340-10-2	W8HSH 716-8-1	W9DQV 512-3-1	W9TJ 1336-7-2	VE2BB* 614-6-1	Tunisia-FM4
W8KC 1324-9-2	W8XCM 370-5-1	W9LZJ 509-1-1	W9LBB 1192-6-2	VE2DE 635-5-1	FM4AB 4843-9-2
W8HGC* 1216-6-3	W8IDG 556-4-1	W9CPD* 503-1-1	W9LEQ 1063-3-2	VE2AP 569-4-1	FM4AF 3629-7-1
W8ICA 1168-6-2	W8DXV 345-3-1	Indiana	W9GCB 1924-13-2	VE2GE 548-6-1	Kenya-VQ4
W8CZR 1162-6-2	W8KE 327-3-1	W9AEH 18888-43-2	W9GCH 1924-13-2	Ontario	VQ1CRL 2236-8-1
W8BMC 1160-8-3	W9CE 506-1-1	W9IUT 16686-37-2	W9TJ 1684-12-2	VE3WA 3860-22-2	VQ1CRO 2124-8-1
W8WU 1144-6-1	W8KPL 503-1-1	W9AUT 4890-17-3	W9LBB 1336-7-2	VE3GH 3070-23-2	Egypt-SU
W8CBI 1090-5-2	West Virginia	W9PAO 4476-22-2	W9LEQ 1192-6-2	VE3BC 1216-6-2	SU1CH 1828-6-2
W8BRB 1065-5-2	W8KGL 5174-23-3	W9JQ 2210-19-1	W9MND 1063-3-2	VE3BT* 1084-4-2	SUIRO 1390-6-2
W8FEP 1018-4-2	W8FVU 1576-12-2	W9SOT 1882-14-2	W9NNZ 1013-9-1	VE3J 1015-3-2	So. Rhodesia-ZE1
W8MOK 1027-3-2	W8HGA 1536-14-1	W9JJP 1567-9-2	W9GJ 878-7-1	VE3ACS 1027-3-2	ZE1JB 1692-8-1
W8LBM 1027-3-2	W8AZD 1445-15-1	W9SPB 1457-9-2	W9MZF 695-5-1	VE3QI* 647-7-1	Morocco-F8M
W8EJE 1027-3-2	W8KLO 668-4-1	W9KGB 1432-9-2	W9NEV 692-4-1	VE3HT 518-2-1	FF8MQ 1624-6-2
W8JXY 950-10-1	W8KIU* 560-4-1	W9GEG 1396-11-2	W9GUN 614-6-1	VE3ER 512-2-1	Nigeria-ZD
W8BXM 920-7-1	Illinois	W9HUV 1360-10-2	W9KEI 561-4-1	Manitoba	VE4DU 1600-10-2
W8BQ 860-9-1	W9LJ 28324-46-2	W9LKI 1360-10-2	W9NKS 524-2-1	VE4IB 625-5-1	VE4BU 625-5-1
W8JVV 788-8-1	W9TB 26530-46-2	W9ELK 1336-8-2	W9EBE 512-2-1	VE4K 608-6-1	Madagascar-FB8
W8KXC 770-5-1	W9MTP 12328-32-2	W9AMM 1189-7-2	W9SAA 512-2-1	VE4SH 512-2-1	FB8C 530-2-1
W8KPB* 675-6-1	W9MPL 9869-28-3	W9CKY 1132-4-2	W9SNN 512-2-1	Iowa	
W8JEA 644-6-1	W9DKU 9256-32-2	W9SDW 1105-5-2	W9KTC 503-1-1	W9AZZ 4850-25-2	
W8AAJ 644-6-1	W9DRN 7665-31-2	W9ALE 662-6-1	Iowa	W9FDL 4346-17-3	
W8FGC 626-6-1	W9MAL 7076-27-3	W9EGQ 512-2-1	W9ABE 2547-17-2	W9AFL 2547-17-2	
W8NAB 625-5-1	W9BMD 5928-22-2	Kentucky	W9HQA 2428-17-2	W9HAC 2428-17-2	
W8ALQ 572-3-1	W9AFN 5950-26-2	W9FLL 12730-20-3	W9MCO 2420-10-3 <sup>34</sup>	Manitoba	
W8LCO 560-4-1	W9PLH 5461-24-2	W9PLM 12484-33-2 <sup>30</sup>	W9NTA 1819-9-2 <sup>35</sup>	VE4IB 625-5-1	
W8DCO 560-4-1	W9CES 3907-19-2	W9GGB 2625-13-2	W9PZO 1232-8-2	VE4K 608-6-1	
W8CBF* 554-2-1	W9GRV 3772-22-2	W9BGA 1027-8-2	W9CGY 1180-6-2	VE4SH 512-2-1	
W8GER 551-3-1					

W7AYO, Yakima (Wash.) Amateur Radio Club; W8ENA, The Massillon (Ohio) Amateur Radio Club; W8ERZ, Finger Lakes Transmitting Society, Auburn, N. Y.; W9AFN, South Town Amateur Radio Association, Chicago; W9FLH, Central Illinois Radio Club, Bloomington; W9GDH, Heart of America Radio Club, Kansas City, Mo; W9GIL, The Milwaukee (Wis.) Radio

Amateurs' Club; W9KA, The Illinois Bell Telephone Radio Club, Chicago. Two members in many other clubs reported. Awards are made only when three or more club members report. If the secretary of any A.R.R.L.-affiliated club

(Continued on page 68)

ASIA				
<i>Japan-J</i>	D4BUF	1225-5-2	G2TR	578-3-1
J2GX	D4BKH	1180-4-2	G5FN	534-2-1
J2HG	D4BHH	1067-7-1	G5OJ*	503-1-1
J2JJ	D4BTU	1010-2-2		
J2JL	D4BCC	968-6-1	<i>Irish Free State-FI</i>	
J3CX	D4BFF	746-6-1	FIAB	8546-11-243
J2JK	D4BKK	740-5-1	FI6F	1916-8-2
J3FC	D4BKK	735-5-1	FI8D	1792-6-2
J2JX	D4BLU	692-4-1	FI8F	1783-9-2
J4CF	D4BMG	665-5-1	FI9F	580-4-1
J2KQ	D4BKK	645-5-1	FI9D	527-3-1
J3CZ	D4BRF	512-2-1	FI9G	503-1-1
J6CP	D4CFF	522-2-1	FI9G	503-1-1
J3DZ	D4BPR	512-2-1		
	D4BBL	512-2-1		
	D4BBI	512-2-1		
	D4BDT	509-1-1		
	D4BAU	508-1-1		
	D4BOC	503-1-1		
	D4BAC	503-1-1		
	D4BBC	503-1-1		
Hong Kong-VS				
VS6AH		4969-9-2		
VS6AS		856-3-1		
VS6AO*		506-1-1		
China-XU				
XU8AG		836-2-1		
XU8ST		542-2-1		
XU8CB		509-1-1		
Manchukuo-MX				
MX2B		683-2-1		
MX2A		624-2-1		
Palestine-ZC6				
ZC6FF		632-4-1		
EUROPE				
Belgium-ON				
ON4AU		24030-14-5		
ON4RX		8872-13-1		
ON4FE		5345-11-2		
ON4MH		4820-9-1		
ON4SD		4762-11-2		
ON4ZA*		2660-10-2		
ON4HM		2411-13-1		
ON4MAD		2295-7-2		
ON4DS*		2124-7-2		
ON4GU		1256-6-1		
ON4NC		1115-5-2		
ON4VO		665-5-1		
ON4DX		635-5-1		
ON4HC		608-4-1		
ON4GK		564-4-1		
ON4CC*		512-2-1		
Spain-EA				
EA4AO		23504-12-3		
EA3EG		13573-11-2		
EA4AV		6570-10-2		
EA4BM		4328-8-2		
EA4AP		2928-7-2		
EA5AF		2104-8-2		
EA1AM		1945-7-2		
EA7AO		1640-5-2		
EA2BG		1166-6-1		
EA3CZ		950-5-1		
EA3CI		554-3-1		
EA4BU		548-4-1		
EA3CQ		505-1-1		
Germany-D				
D4BAR		18870-14-3		
D4BIU		10900-11-2		
D4BDR		8228-11-2		
D4BMJ		6159-13-3		
D4CAF		5608-12-2		
D4BPN		4740-10-3		
D4UAO		2492-6-2		
D4BBN		1890-11-2		
D4BUK		1945-9-2		
D4BPI		1645-6-2		
D4BGK		1354-6-2		
D4BKN		1315-5-2		
D4BBU		1235-5-2		
D4BUN		1225-5-2		
D4BKH		1180-4-2		
D4BHH		1067-7-1		
D4BTU		1010-2-2		
D4BCC		968-6-1		
D4BFF		746-6-1		
D4BKK		740-5-1		
D4BLU		692-4-1		
D4BMG		665-5-1		
D4BKK		645-5-1		
D4BRF		512-2-1		
D4CFF		522-2-1		
D4BPR		512-2-1		
D4BBL		512-2-1		
D4BBI		512-2-1		
D4BDT		509-1-1		
D4BAU		508-1-1		
D4BOC		503-1-1		
D4BAC		503-1-1		
D4BBC		503-1-1		
FR8FC		18080-14-29*		
FR8EX		17246-14-39*		
FR8TQ		10076-12-3		
FR8PZ		8670-13-2		
FR8V*		5806-8-3		
FR8V		4608-11-2		
FR8AL		4220-10-3		
FR8JL		3745-9-2		
FR8PK		3421-7-3		
FR8AR		2484-7-2		
FR8RQ		2312-8-2		
FR8GG		2120-8-2		
FR8DS		2024-2-3		
FR8TM		1090-5-2		
FR8SW		1016-2-2		
FR8VT		976-7-1		
FR8GS		885-5-1		
FR8NE		829-7-1		
FR8ZI		604-4-1		
FR8DT		568-4-1		
FR8WK		564-4-1		
FR8FW		554-3-1		
FR8DU		540-2-1		
AZ6BK		17236-11-2		
Great Britain-G				
G5BY		14860-12-4		
G6NJ		10097-11-2		
G2NH		8632-12-2		
G3RH		8228-12-3		
G5LA		7252-12-2		
G6RV		5540-10-3		
G5VL		5314-11-3		
G5YG		5256-11-3		
G5BD		3665-9-3		
G6LK		3617-11-3		
G2BM		3583-9-2		
G2DZ		2953-9-2		
G2PL		2813-7-2		
G2KZ		2790-10-1		
G5JT		2588-8-1		
G6NF		2496-8-2		
G6XN		2336-8-2		
G6GS		2204-8-1		
G2IO		1715-9-1		
G6CL		1567-9-2		
G2UO		1516-8-1		
G2OA		1268-8-1		
G5BP		1231-6-2		
G2MJ*		1224-4-2		
G5UW		1211-9-1		
G2ML		650-5-1		
G2PN		506-3-1		
G2WQ		584-4-1		
G5XB		578-3-1		
H8BJ		6220-10-3		
H8BK		1784-7-2		
H8BY		518-2-1		
Netherlands-PAO				
PA0UV		6080-10-3		
PA0RP		5932-12-2		
PA0XG		5339-9-3		
PA0DC		3548-9-3		
PA0CFE		3500-10-2		
PA0AZ		2384-7-2		
PA0GQ		2427-7-3		
PA0FLX		2360-6-3		
PA0XF		1832-8-2		
PA0OK		1126-5-2		
PA0HG		1072-3-2		
PA0HR		1064-4-2		
PA0NP		1036-3-2		
PA0WR		782-6-1		
PA0VB		620-5-1		
PA0WD		372-3-1		
PA0CH		515-3-1		
PA0DA		512-2-1		
PA0RN		512-2-1		
PA0SM*		503-1-1		
North Ireland-GI				
GI6TK		4650-10-3		
GI6YW		3304-8-3		
GI5QX		2078-7-2		
GI5UR		1215-5-2		
Portugal-CTI				
CT1GU		4450-10-2		
CT1ZZ		1688-6-1		
Norway-LA				
LA1G		4058-11-2		
LA2G		710-6-1		
Austria-OE				
OE3FL		3574-11-2		
OE7JH		3232-7-3		
OE1CM		2105-5-3		
OE1ER		2000-8-2		
OE7EJ		1960-8-2		
OE8DK		1230-5-1		
OE1EK		503-1-1		
Hungary-HAF				
HAF3D		3121-9-2		
HAF2D		2001-7-2		
HAF3H		1576-8-2		
HAF8D		1474-6-2		
HAF9G		1357-7-2		
HAF4H		625-5-1		
HAF5C		556-4-1		
VK7JH*		860-8-1	CM2FA	7325-11-2
VK3MX		857-7-1	CM2OP	3011-9-1
VK2TO		844-8-1	CM2RP	1908-8-1
VK5ZC		844-8-1	CM2AD	1172-8-1
VK3XF		795-6-1	CM2MG	724-6-1
OZ7KG		1252-6-2		
OZ3FL		560-4-1		
VK2AS*		787-7-1	<i>Porto Rico-K4</i>	
VK7PA*		728-6-1	K4KD	14960-12-3
VK2SK		680-5-1	K4SA	8800-12-2
VK6CP		680-5-1	K4BU	6610-11-2
VK4EI		680-6-1		
VK3JO		668-7-1		
VK4GK		665-5-1	<i>Martinique-F3</i>	
VK2YW		527-3-1	F3MTD	9107-11-2
VK2NH		524-2-1	<i>Newfoundland-VO</i>	
VK4JH		503-1-1	VO4Y	8110-10-3
VK3YK		503-1-1		
OH5NR		926-6-1	<i>New Zealand-ZL</i>	
OH3NP		830-6-1	ZLAA	19927-13-3
			ZL3AN	16490-13-1
			ZL2BN	15131-13-2
			ZL2CQ	13272-13-2
			ZL2JQ	11388-14-2
			ZL1GX	10288-12-2
			ZL1AR	9592-12-2
			ZL2KI	9100-12-2
			ZL2KJ	8536-12-2
			ZL2OW	7252-12-2
			ZL2CK	4586-11-2
			ZL2GS	4564-11-2
			ZL1AA	4148-13-1
			ZL2MM	3100-11-1
			ZL2DS	3192-11-1
			ZL2BH	3211-11-2
			ZL3HK	2026-9-1
			ZL1HD	1913-9-1
			ZL4DB	1877-9-1
			ZL2LT	1812-8-1
			ZL1DV	1800-10-2
			ZL3JA	716-6-1
			ZL1HY	703-7-1
			ZL3CU	605-5-1
			ZL4BT*	518-2-1
			ZL3GR	506-1-1
OCEANIA				
Hawaii-K6				
K6HLP		21604-12-2		
K6ESU		14168-13-3		
K6CGK		12120-11-3		
K6AUG		9623-11-3		
K6AJA		9501-13-3		
K6JPD		8664-13-1		
K6IBW		8095-11-2		
K6HZI		5710-10-1		
K6AKP		3308-8-1		
K6LGG		2147-9-1		
K6CRU		1054-3-2		
K6JFT		788-6-1		
K6PJP		770-5-1		
Australia-VK				
VK3RC		17210-13-3		
VK7RK		16301-13-2		
VK3MR		14728-13-2		
VK3KX		13912-12-2		

# A New Type Ultra-High-Frequency Transmitter

By Ronold King\*

THE modern ultra-high-frequency transmitting system consists, in general, of a modulated oscillator, a primary radiator, and a more or less elaborate array of secondary antennas to serve as directors or reflectors. Although a system of this sort may be made highly directional, its construction is not simple, it occupies much space, and it is not convenient where portability is desired. A new type of loop transmitter,<sup>1,2</sup> on the other hand, incorporates in a single, extremely compact unit a multi-oscillator and a directional antenna system. Its construction, moreover, is very simple, and its directional characteristics are of a useful form. In the following brief discussion the construction and the operation of two typical working models will be considered.

In Figs. 1-4 are shown photographs and circuit diagrams

of two laboratory models which have been used for experimental and demonstration purposes. Model A (Figs. 1 and 3) is the original design; it operates on a carrier wavelength of 293.6 cm. Model B (Figs. 2 and 4) operates on 176.6 cm.; it uses four of the "acorn" type 955 tubes. The circuits for the two models are essentially the same, although they differ somewhat in appearance. The oscillating-radiating part of each consists of a square of brass tubing connected at each corner to the plate and grid of a triode as shown in the diagrams. Under proper operating conditions each triode introduces a negative resistance into the circuit, and in this way sustains undamped oscillations around the square. Mathematical analysis<sup>1</sup> shows that the input (plate-grid) resistance of each triode will be negative

if sufficient mutual inductance is provided between the grid and plate connections. In the case of model A (Fig. 1), the rather long parallel conductors from the tube base through the 56 bulb

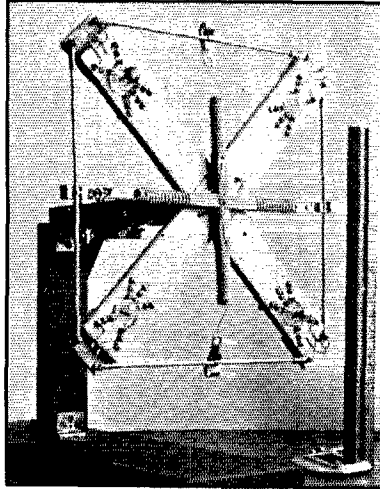

FIG. 2—MODEL B TRANSMITTER  
Dimension of square, 24 cm.; grid-plate coupling coils, one turn, diameter 1 cm.

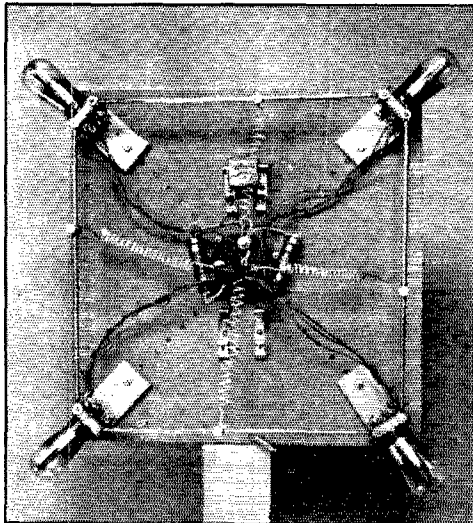

FIG. 1—MODEL A TRANSMITTER  
Length of sides of square of conductors 35 cm.

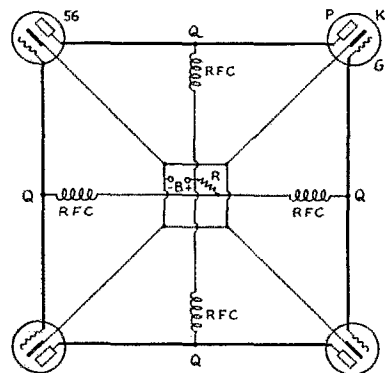

FIG. 3—CIRCUIT DIAGRAM OF MODEL A TRANSMITTER

Q=electrical center of each side; C=choke coils; R=3,000 ohm resistor. Heater connections are not shown. These are brought to the center with the cathode leads.

<sup>1</sup> R. King, "A Loop Transmitter," Phil. Mag., Vol. 19, 1935.

\*Department of Physics, Lafayette College, Easton, Penna.



to the electrodes provide this coupling. The somewhat different construction and mounting of the 955 tubes in model B (Fig. 2) requires the inser-

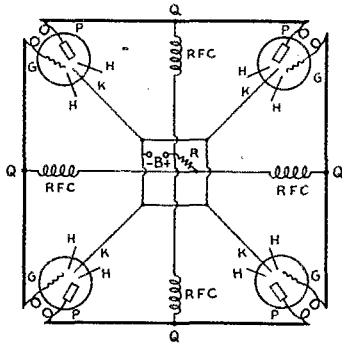

FIG. 4—CIRCUIT DIAGRAM OF MODEL G TRANSMITTER

Notation as for Fig. 2. Heater terminals of tube denoted by H, but connections not shown. R = 20,000 ohms.

tion of single-turn coupling coils in series with each tube.

The frequency of the oscillations is determined by the dimension of the square, by the reactance of any lumped impedance in series with it, and by the input (plate-grid) reactance of each triode. It is to be noted that the four parts or segments of the oscillator between the points Q

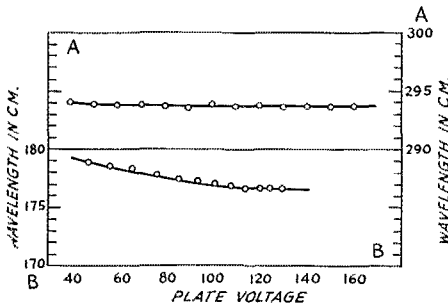

FIG. 5—WAVELENGTH CHARACTERISTICS OF THE TWO LOOP TRANSMITTERS  
Model A above

must be kept electrically similar. The frequency equation is <sup>2</sup>

$$\omega L + 4X = 0$$

Here  $\omega = 2\pi f$ , L is the inductance of the entire square, and X is the lumped reactance, including the triode, in series with each quarter of the square. The calibration characteristics of Fig. 5 reveal that the generated wavelength is practi-

cally independent of the plate voltage even over the low-voltage range here plotted. This means that when plate circuit modulation is used (and both models were successfully modulated in this way) distortion due to simultaneous frequency modulation is inappreciable.

The non-oscillating part of the circuit may be arranged in several ways. That shown in Fig. 2 and 4 is perhaps the most convenient. In this the only connection to the grids of the tubes is through a resistor connected between +B and the grid sides of the square. The size of this resistor depends upon the type of tube used. The 56 tubes operate best with R between three and four thousand ohms. The 955's, on the other

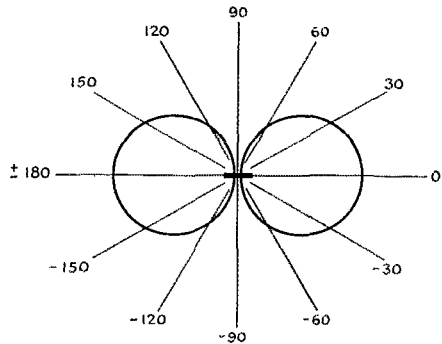

FIG. 6—FIELD PATTERN OF THE LOOP TRANSMITTER

The plane of the square is perpendicular to the paper and along 0,180. The amplitude of the electric intensity in any direction is proportional to the chord of the circle cut off by the line drawn from the center in the desired direction.

hand, must have a resistor in the neighborhood of 20,000 ohms. Both types of tubes will oscillate, though somewhat less stably, without resistor and with the grid connections jointed directly to -B in a more conventional way.

The directional properties of the loop transmitter are best brought out by the field characteristics of Fig. 6. From these it is clear that the transmitting patterns of the loop transmitter are entirely similar to the receiving characteristics of the familiar loop receiving antenna. A maximum energy is radiated in all directions in the plane of the square (the irregularities due to the square shape disappear in the wave zone), while zero energy is radiated at right angles to the plane of the square. Since the transmitter is very compact (model A has an overall dimension of 18 inches, model B of 10 inches), it is readily transported and rotated into whatever direction it is desired to transmit.

The power output of the device depends upon the type of tube used, and upon the fraction of a wavelength represented by the dimension of the

(Continued on page 39)

<sup>2</sup> R. King, "A New Type Radio Transmitter for Short Waves," Bulletin American Physical Society, Vol. 10, No. 2, part 1, p. 7. Presented at the Washington Meeting of the Society, April 25, 1935.

# A Frequency-Lock Multi-Vider

An Interesting Circuit for Multiplying and Dividing High Radio Frequencies

By J. A. DeYoung,\* W1HHW

IT IS a well-known fact that frequencies can be doubled or tripled, etc., but above the second harmonic the output falls off rather badly. As is also known, frequencies can be divided, as by the multivibrator, for low frequencies which have been described previously in *QST* and elsewhere.

The interesting fact about the circuit described here, however, is that it will give controlled frequencies either *above* or *below* the fundamental control frequency. With a crystal oscillator at 40 meters, one can obtain harmonics at 40, 20, 13.33, 10 or 8 meters and sub-harmonics of 40, 80, 120, 160, or 200 meters. This may sound fantastic, but it is true, especially regarding the sub-harmonics.

It can be seen from Fig. 1, the control oscillator may be of any type, such as crystal, electron-coupled or magnetostriction oscillator, etc. In this circuit the crystal oscillator is a Type 47 tube and the "changer" is a Type 46 tube. The Type 46 works very well and has sufficient output to drive any moderate-power amplifier.

The output from the controlled oscillator feeds the screen grid of the 46 tube through a condenser which is not critical. A 100- $\mu$ fd. condenser will work for all the amateur frequencies. The screen grid is brought to the cathode or ground through a choke. This choke should have a low d.c. resistance but it should have high impedance at the frequency of the oscillator. An 8-millihenry G. R. choke worked well at 40 to 80 meters, but a choke of less inductance could be used, as for instance, about 120 turns of No. 28 d.s.c. wire on a  $\frac{1}{2}$ -inch dowel. The rest of the circuit is nothing more than a form of the Hartley self-excited oscillator.

## DIVIDING FREQUENCY

First we will describe the action that takes place as the circuit is used as a sub-harmonic generator. The 46 tube has two grids. With either grid at zero potential, the plate current is quite low. If we have a crystal oscillator putting out a frequency of 4 mc. and the frequency lock is tuned to the second sub-harmonic (2 mc.), it can readily be seen that the screen grid on the 46 tube must go positive two times every time that the control grid goes positive. But the control grid is negative during one of the positive peaks on the

screen grid and the tube is blocked. Thus one of these positive peaks on the screen grid has no effect upon the output frequency and the controlled oscillator gives the output frequency a kick every cycle though the output is at *half* the frequency of the controlled oscillator.

The wave-forms in Fig. 2 show how the second sub-harmonic is in step with the controlled frequency. Fig. 3 shows the third sub-harmonic in step. At the points marked "X" in Figs. 2 and 3 the frequency lock gets a kick working either at a harmonic or at a sub-harmonic. For sub-harmonics Curve A is the sub-harmonic and Curve B is the oscillator frequency. For harmonics, Curve A is the oscillator frequency and Curve B is the harmonic. It can, of course, be used as a fundamental frequency lock. Since the frequency lock is an oscillator, no neutralizing is required. The tuned-grid tuned-plate oscillator may be used, but this

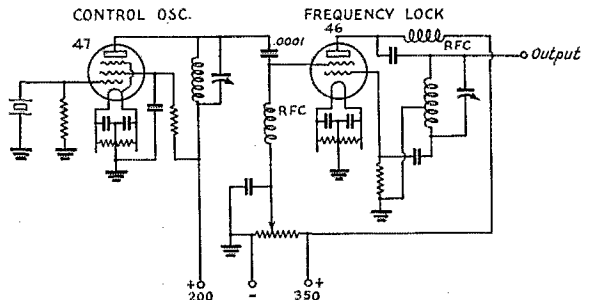

FIG. 1—FREQUENCY LOCK CIRCUIT

requires another tuning element and may need some capacity connected between the control grid and plate to make it work. Plate voltage of 350 volts on the frequency lock and about 90 volts on the second grid makes a satisfactory working arrangement. Too high a voltage on the screen grid will make the output of the frequency lock dip down when it locks at the harmonic or sub-harmonic. The apparatus will work with no voltage on the screen grid, but the output is considerably less.

Thus far, only harmonics and sub-harmonics have been mentioned, but other controlled frequencies have been obtained, such as two-thirds, three-fourths, one and one-third, or one and one-half times the fundamental frequency. The outputs of these frequencies do not have the amplitude of the harmonics or sub-harmonics. In Fig. 4 it can be seen why this takes place; the output

\*Cruft Laboratory, Harvard University, Cambridge, Mass.

frequency gets a kick at the points marked "X." From a 120-meter crystal a controlled frequency of 180, 160, 90 or 80 meters can be obtained as well as the harmonics and sub-harmonics. By

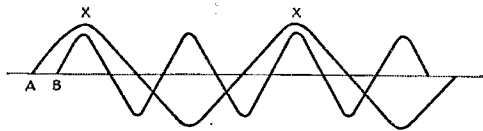

FIG. 2

replacing the r.f. choke in the screen grid of the frequency lock with a tuned circuit which resonates with the controlling frequency, the output is increased slightly.

#### FURTHER POSSIBILITIES

Two or more of these frequency locks could be used in cascade to get a much higher harmonic or sub-harmonic; for example, possibly 80 meters to 5 meters, with two tubes. Five-meter output to



FIG. 3

excite a 5-meter amplifier should be easily obtainable, from a 40-meter crystal Tri-tet oscillator with a 20-meter output, by letting the frequency lock operate on the fourth harmonic, or 5 meters. (How does this sound to the 5-meter gang?) With proper tuning condensers, the frequency lock is not at all critical to tune.

With some indicator to show the action, such as a pilot lamp with one or two turns of wire placed near the coil of the frequency lock or a milliammeter in the grid of the amplifier, a great increase in output will be noticed when the frequency is tuned through a harmonic or sub-harmonic. It may be well to mention here that if too great a load is placed on the frequency lock it may refuse to oscillate, especially when operat-

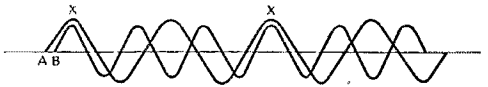

FIG. 4

ing above the third harmonic or sub-harmonic with no positive voltage on the screen grid. This will not occur if there is some positive voltage on the screen grid.

When the frequency lock is driving an amplifier there is no danger of the amplifier drawing too much plate current from lack of excitation when

the screen grid of the frequency lock has a positive voltage applied to it, as the frequency lock is always exciting the grid of the amplifier at some radio-frequency. Care should be taken, however, to prevent radiation when the frequency lock is not locked to the desired frequency.

The coupling condenser should be of less capacity if the output frequency has a tendency to upset the oscillator. The ideal coupling circuit would consist of a choke or impedance from the screen grid to cathode which has high impedance to the control oscillator frequency and low impedance to the frequency of the frequency lock. Thus the screen grid will be at or near the r.f. ground potential of the frequency lock.

The 47 and 59 type tubes have also been tried, but very little difference was noticed, so the 46

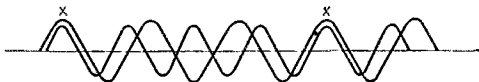

FIG. 5

type was used. It is a simpler tube to use and will stand a fairly high voltage on the plate.

This circuit has been used at frequencies from 15 kc. to 30,000 kc. and it worked well throughout this range. However, it seems that the system is not limited to this range. The 46 type of tube may easily be adapted to the 5-meter range, but it has not been tried at the time of this writing.

The values of the component parts of Fig. 1 depend, of course, upon the range of frequencies at which it is desired the system should work.

## Plate Modulation of Pentodes

(Continued from page 16)

With a transformer of this type the chief disadvantage of pentode plate modulation, the extra power capacity required of the modulator with the screen dropping-resistor method, is overcome to the extent that the audio power taken by the screen circuit can safely be neglected. From this standpoint the pentodes are placed on a competitive basis with triodes. The ease with which the pentodes can be excited gives these tubes a very definite advantage over triodes. Plate efficiencies compare favorably with those obtainable from three-element tubes as ordinarily operated in modulated service. It is expected that suitable output transformers will be made available in the near future. All in all, it appears that even in the plate-modulated field, long held almost exclusively by three-electrode tubes, the pentodes have something definite to offer.

# A.R.R.L.'s Field Day, 1935!

**T**HE Third Annual F. D. proved itself the "best yet." More hams than ever before took part, and many new groups. Higher scores as well testify to the fact that equipment and operating technique has been improved, based on the experience of former years. More of us are better equipped to render public service in a communication emergency than ever before!

Field Day rules were given in detail on page 22, June 1935 *QST*. Any amateur frequency could be used, voice or telegraph at will, from a portable station in the field. The object was to work as many other stations as possible between 4 p.m., June 8th, and 7 p.m., June 9th. According to the



W6CSO/6, W6HLF, W6HAQ AND W6ERT

Commissary, 80-meter tent and 5-meter tent of the United Radio Amateur Club's winning set up.

reports, the Field Day gang considered the 80-meter and 40-meter telegraph bands the most effective for all-around communication using portables. A large number divided operating time between these two bands, and some used 5-meter 'phone to get extra points and fun. Analysis of logs indicates the division of operation approximately as follows: 53%-80-meters; 32%-40-meters; 12%-5-meters; 2%-20-meters; 1%-160-meters.

"Winning" an A.R.R.L. Field Day is no easy accomplishment, as many who surpassed last year's best records now realize! The United Radio Amateur Club of Wilmington, Calif., has the honor of again topping the list of contacts for 27 hours of portable operation. This work was in competition with 30 other clubs and many more individual ham groups. Equipment and plans were perfected as a result of experience in previous outings testing individual capability for emergency communications operation. W6CSO/6 used two sets, a 41-'10 on 80-meters (6C6 and 37 receiver) and P.P. 112A's modulated by a pr. of 41's on 5 meters (super-regen. receiver), powered by batteries and a gas-driven 500 v.d.c. generator. Nearly one-third the 124 QSOs were made on 56 mc. W6CSO/6 was located half way up the north slope of the Palo Verde Hills, 5 miles

south of Lomita, elev. 600 feet, and 10 miles from the Torrence oil fields. Due to mutual QRM the two rigs were not operated simultaneously. The photo of the excellent setup shows what thorough advance planning of portable equipment and operation can do, as attested by the 1116 point score!

W5EHM/5, operating from the highest point near Dallas, was kept on the air for the whole period by hourly shifts, in spite of sun and blistering heat. 103 QSOs resulted, all but one 5-meter contact, on 7 mc. Best reports were from the 8's and 9's worked. Two m.g. sets from car radios provided the power. A Tri-tet with two 42's push-pull, and TNT 45's were both used at different times. The sky wire was supported on 24-foot poles. A score of 927 attests to the wonderful performance of this station, which all but took the lead from our California friends.

W4NC/4, at Hanging Rock Mountain (30 miles from Winston-Salem, N. C.), with a 700-watt power supply (gas-driven) to light the scene of operations, wins the honor of making the highest eastern score, 783 points, for the Winston-Salem Amateur Radio Club. 87 stations were worked, a schedule for operating being posted for each ham. A 59-46 line-up working on 7 mc. was used throughout, with SW3 receiver. All hands had a big time camping out, too. W8YC/8, Buckeye Shortwave Radio Association, Akron, Ohio, had three 80-meter c.w. rigs and two 5-meter 'phone sets and made next highest score. W3QV/3 en-



THE CREW AT W8CHM/8

Left to right, W8BKI, W8SCHM, W8DMF, W8BLE, ex-W8CBS, and W8OBN.

camped 25 miles north of Philadelphia and ran W4NC/4 and W8YC/8 a close race for eastern honors and represented the York Road Radio Club. A 47-46 set was used at W3QV/3, with a duplicate held in reserve as W3AJF/3. Contending with a rain that handicapped field work all over Pennsylvania and New England (making the expression "you're all wet" popular with the gang), the operators stuck to the rig nobly on 3553 and 3610 kcs., making 83 contacts for 747 points!

The South Cleveland Radio Club, W8CMB/8, operated on 1.7, 3.5, 7 and 56 mc., working 2, 35, 31 and 12 stations respectively, or a total of 80 contacts for 720 points. W8LZF, W8IKP, W8IBE, W8LEM, W8KZX, W8NZZ, W8LJV, W8LYQ, W8LYO, W8ICS, W8LXR and W8LWO participated with W8CMB in the fine records made by this station.

Canada was represented by six different groups reporting in the Field Day. The Hamilton (Ont.) Amateur Radio Club, VE3KM, made the most outstanding VE score, using both 3.5- and 7-mc. equipment, making 66 contacts with truly portable equipment for a total of 594 points! A dozen or more licensed operators pushed the key at VE3KM. Other VE work is recorded under the following calls: VE3GT, 360 points from 40 QSOs; VE3TM, 160 points, 40 QSOs; VE3GI, 116 points, 29 QSOs; VE3SG, 52 points, 26 QSOs; VE2CO, 12 points, 4 QSOs.

W8KWN/8, portable in every respect, was kept on the air near Cambridge, Ohio, by four operators. Genemotor power to TNT '10 on 3.5 mc. and to TNT '45s on 7 mc. resulted in 64 contacts and 576 points. W9AIU/9, the Egyptian Radio Club's station, was all set to put the event in the bag—same location as last year. There was trouble with the gas-driven generator and delays in getting going. 61 stations were worked for 549 points, and the club plans to be back stronger than ever next year. W9LED/9, representing the Wausau Radio Operators Club (Wisconsin), used 3.5 mc. exclusively, six members setting up the equipment on Rib Mt. Two 71A's in a battery-powered crystal rig made 61 contacts, 549 points score, in spite of terrific QRN, rain and wind



W9SUJ/9 KEEPS AN EYE ON THE LINE VOLTAGE DURING THE 27-HOUR CONTINUOUS RUN

storms. W9NTW/9, using a vibrator-transformer set for the Northeast Iowa Ham Club and a pair of 89's, was also operated by W9RDK and W9MXC and worked practically all districts. Made 59 QSOs, 531 points. W9SUJ/9 represented Chicago on the air in the Field Day. Six hams with W9MIR's 47-'10 crystal rig run from W9ORO's 250-watt alternator (home built from a Ford generator) got on location, set up in two hours, and by continuous 3.5-mc. operation

made one of the high scores—85 QSO's, 510 points. W9KWP/9-W9KJY also did excellent field work on 3.5. and 14 mc. in this area.

56-mc. rigs were used exclusively by four participants and incidental use of 5-meters was noted in many reports. W1HDQ/1 made 49 contacts, W1FGC/1 44, W6AM/6 39 and W2DWW/2 14, all exclusively using this band, and HDQ's work being the most outstanding. —F. E. H.

FIELD DAY PARTICIPATION

Club Station		QSOs	Score
W6CSO/6	United Radio Amateur Club <sup>1</sup>	124-A*	1116
W4NC/4	Winston-Salem Amateur Radio Club, Inc. <sup>2</sup>	87-A	783
W8YC/8	Buckeye Shortwave Radio Ass'n	84-A	756
W3QV/3	York Road Radio Club <sup>3</sup>	83-A	747



W3QV/3 WITH EQUIPMENT IN CAR (LICENSE VY73) MADE A LEADING SCORE

Left to right: W3ERF, W3EWO, W3DMF, W3ETM, W3BWQ, W3BYS and W3AJF.

W8CMB/8	The South Cleveland Radio Club <sup>4</sup>	80-A	720
VE3KM	The Hamilton Amateur Radio Club <sup>5</sup>	66-A	594
W9LED/9	Wausau Radio Operators Club <sup>6</sup>	61-A	549
W9AIU/9	Egyptian Radio Club <sup>7</sup>	61-A	549
W9NTW/9	Northeast Iowa Ham Club <sup>8</sup>	59-A	531
W8AAR/8	Trico Radio Club <sup>9</sup>	56-A	504
W8MMN/8	The Akron Progressive Short Wave <sup>10</sup> Radio Ass'n	50-A	450
W9EMN/9	Christian County Amateur Radio Ass'n <sup>11</sup>	50-A	450
W9MZN/9	Southern Minnesota Radio Ass'n <sup>12</sup>	27-B	438
W8AMP/8	South Hills Brass Pounders and Modulators <sup>13</sup>	94-A	376 T
W9SAT/9	The Hyde Park Radio Club <sup>14</sup>	41-A	369
W9LWY/2	Spring Valley Radio Club <sup>15</sup>	40-A	360
W9TPS/9	Fond du Lac Amateur Radio Club <sup>16</sup>	40-A	360
W4AZF/4	Tampa Amateur Radio Club <sup>17</sup>	59-A	354 T
W8DKG/8	West Akron Radio Club <sup>17</sup>	48-AB	347
W9EHC/9	Pikes Peak Amateur Radio Ass'n <sup>18</sup>	44-ABC	334 t
W9GTK/9	Amateur Radio Fraternity of St. Louis <sup>19</sup>	36-A	324

Club Station	QSOs	Score
WIHUX/1	73 Radio Club of Franklin County <sup>20</sup>	34-A 306
W9AND/9	Ogle County Radio Traffic Ass'n <sup>22</sup>	29-A 261
W8CDE/3	Bluefield Amateur Radio Club <sup>21</sup>	31-AB 255
W9KWP/9	Chicago Radio Traffic Ass'n <sup>23</sup>	21-A 189
W2FJV/2	Northern Nassau Wireless Ass'n <sup>24</sup>	64-BC 184 T
W8KYC/8	Marietta Amateur Radio Society <sup>25</sup>	30-B 180
W1FTS/1	Hoosac Valley Radio Club <sup>26</sup>	37-B 148 T
W3ECI/3	Philadelphia Wireless Association <sup>27</sup>	10-A 90
W9NIU/9	Starved Rock Radio Club <sup>28</sup>	14-AB 76 t
W1DJC/1	Hartford County Amateur Radio Ass'n <sup>29</sup>	8-A 72
W9AIW/9	Hi-Freaks Radio Club <sup>30</sup>	19-AB 56 T-r
VE3SG-VE3LJ	Queen City Amateur Radio Club <sup>31</sup>	26-B 52 T-R
W1BKQ/1	Worcester Radio Ass'n <sup>32</sup>	5-AB 36
VE2CO	Montreal Amateur Radio Club <sup>33</sup>	4-A 12 T-R

INDIVIDUAL AND GROUP SCORES

W5EHM/5	W5ENE-W5EZC-W5ESC-W5DYH-W5EHM	103-A 927
W8KWN/8	W8KVX-W8NBM-W8MQA-W8KWN	64-A 576
W9SUJ/9	W9ORO-W9SUD-W9RZU-W9SUJ-W9MIR-Gus	85-B * 510
W8RB/8	W8RB-W8MHM-W8LZK-W8EME	80-B 480
W8DMK/8	W8DRW-W8DMK	79-A 474 T
W1HDQ/1	E. P. Tilton	49-A 441
W1FGC/1	Robert M. Slavin	44-A 396
VE3GT	VE3JT-VE3GT	40-A 360
W1IOC/1-WICME/1	W. T. Silver, E. S. Davis	40-A 360
W8CHM/8	W8BKI-W8HIU-W8SCHM-W8DMF-W8BLE-W8CBS	39-AB 339
W9NGG/9	W9TLC-W9MKS-W9NGG	37-A 333
W9KGG/9	W9OVU-W9KGG	36-A 324
W8KZL/8	Bud Keller	34-A 306
W8HZJ	Edward L. Miller and W8ID-W8ENO-W8PO-W8FWO	31-A 279
W3DPK/3	W3CZI-W3DCS-W3CDY-W3DPK	28-A 252
W6AM/6	Don C. Wallace	39-B 234
W9AB/9	W9CRZ-W9AB	23-A 207

W8EET/3 and W3DZZ 47B 188T; W9CHM/9 (W9PFX-W9UNF & E. H.) 57ABC 170; VE3TM (VE3RO VE3QK VE3WX VE3WJ) 40AC 160 t; N9BC-W9BC/9 (N9KIT-N9RXT-N9RVV) 24A 144T; W4CA/5 35B 140T; W2DWW/2 14A 126; N2BNJ/2 20B 120; VE3GI (VE3WB-VE3LK) 29B 116T; W5AI/2 17A 102T; W5SP/5 (W5QA W5DKF W5DYU W5CYU W5DQW) 30A 90RT; W8FFL/8 23B 46RT; W3NE/3 13 QSOs; W9RHT/9, W9LIP/9, W9GBN/9, W9BKX/9, W9HQQ/9, W9MZN/9 each 5A 45; W1IAV/1 13A 39RT; W8DLU/8 and W8FYH 4A 36; W3EKM/1 (W1UE W1BLQ W1SG W1RHW W1BDI) 4A 36; W9TIL/9 (W9UNN) 3A 27; W1GVV/1 and W1FYO-T; W8ECC/8.

\* The "power classification" used in computing the score is indicated by A, B, or C after the number of QSOs shown. A indicates power up to and including 20 watts (multiplier of 3); B indicates power over 20 up to and including 60 watts (multiplier of 2); C indicates over 60 watts (multiplier of 3). More than one letter means that, at different times different power inputs fell within different classifications. An E or T after the score indicates that receiver or transmitter were supplied from the public mains; no indication after scores where work was entirely inde-

pendent of mains, r or t is used where only part of operation used main supply.

Club operators: 1 W6DIS, W6HBC, W6LHQ, W6LPG, W6DBF, W6LLA, W6CWK, W6MED, W6ERT, W6LFL, W6CIP, W6CSO, W6IZT, W6LPE, W6HAQ, W6EEL, 2 W4RA, W4ABT, W4AHE, W4CXF, W4CYA, W4CFR, W4BOB, W4DG, W4AI, W4CGY, W4OG, W4CKJ, 3 W3BY8, W3QV, W3ETM, W3ERF, W3AJF/3, W3EEL, W3DMF, W3EWO, W3BWQ, W3ESE, W3RM, W3CTE, 4 W8CME, W8LZE, W8IKP, W8IBE, W8LEM, W8KZZ, W8NZD, W8LJV, W8LYQ, W8LYO, W8ICS, W8LXR, W8LWO, 5 VE3AMZ, VE3QD, VE3HO, VE3GZ, VE3ADF, VE3WO, VE3EM, VE3RM, VE3VZ, VE3XT, VE3IG, VE3ADJ, VE3IA, W8RQM, W8LED, W8JIE, W8CFT, W8PEO, W8PRM, 7 W8DZU, W8DZG, W8RFN, W8DJG, W8LWH, W8RJJ, W8RCQ, W8PYO, W8RXV, W8FYZ, W8BLL, W8KEH, 8 W8NTW, W8OHK, W8SWZ, 9 W8RDK, W8MXX, 9 W8AAR, W8JLG, W8VJ, W8RRH, W8IBU, W8DOA, 10 W8KAY (Art and Bob) W8NHJ, W8LBT, W8MDJ, W8NLE, 11 W8KFS, W8RMLN, W8LIV, W8SMD, W8RKS, 12 W8RET, W8LPL, W8GVN, W8BKX, W8HQG, W8MZN, 13 W8CNZ (LS and MN), W8AIG, W8LCI, W8CKO, W8AMP, Wm. Martin, 14 operators, 15 W2ENK, W8LWY, W2HLR, W2HYC, 16 W9DJA, W9JCW, W9GVF, W9RTE, W9TFS, 17 W8LKB, W8KND, W8NEY, W8MEL, W8CQJ, W8DKG, 18 Several operators, 19 W9LLN, W9NNF, W9GSO, W9GTK, W9HYV, W9TZZ, W9RUU, W9KOA, W9NDC, W9NBE, W9SLO, W9KIK, W9LTH, 20 W1CDX, W1HUX, W1EY, W1IDN, W1PNG, W1IEH, 21 W3AAF, W8ODE, W8EWM, W8KBU, W8KCB, W8EET, W8MCR, W8MCL, W8ING, W8MCP, W8NAU, W8MCZ, W8NLE, W8CFT, W8AND, W9LOL, W9GFY, W9JTC, W9SXT, W9AAV, W9AWD, 22 W9KJY and W9KVE, 23 W2AOL, W2AIL, W2DPQ, W2AYJ, W2HQJ, Fred Johnson, Ted Miller, 24 W8VZ, W8CKE, W8KJG, W8FJA, W8PSR, 25 W1LR, W1GWR, W1FK, W1LQ, W1JAH, W1JG, W1JAD, 26 W8EFT, W8AKG, W8ERE, W8EHI, W8VJG, W8VJY, W8YB present & 5 swis, 28 W9NTU, W9IEP, Geo. Keith, 29 W1FSE, W1DJC, W1APJ, W1NI, W1DSY, W1JN, W1EAO, 30 W9KEP, W9HRG, W9KXG, W9LKG, W9CRI, W9AIW, 31 VE3LI, VE3WK & YF, VE3SG & YF, VE3GE, VE3WT, VE3WU, 32 W1DIE, W1LOT, W1BNL, W1LZW, W1DG, W1DDI, W1BAU, W1Rar, Roseland, 33 VE2CO, VE2GE, 34 W4DGN, W4BNR, W4DIM, W4BOT, W4CTS.



VE3TM OPERATING PORTABLE VE3QK ON 7 MC.

Lots of fun! Real test of portable sets. My portable now WAC, WAD and about WAS! (worked all Sections A.R.R.L.). Suggest credits for Sections next year.—W4CA/5.

Never in our life had a better time. All night party pounding brass, and popping corn. Had a pint of ice cream each and coffee, and bacon and eggs. Zowie. Found a big spider in our tent . . . size of a tea cup with eyes that gleamed. Will be waiting for 1936 F.D.—O.C.R.T.A., W9AND/9.

Worked from Cedar Lakes, 30 miles south of St. Louis. A-battery trouble resulted in many short transmissions. Had to change bats on the m-g and use surges from the dead bats. We learned plenty, and promise to triple our score next year.—A.R.F. of S.L., W9GTE.

The food and paraphernalia would have supplied an army . . . we had reserve sets in case of equipment failure. Club had a picnic dinner Sunday, a fine sunny day. QRN heavy, but it was a fine success. Everyone is waiting for the next.—W.R.O.C., W9CPT.

Sets on 80 and 40 were used, one operator listening for a CQ so as soon as the other set was finished he could go on the air. Gas-driven generator caused some interference. Hope no rain next time.—W8CHM.

Six 5-meter rigs added to the F.D. fun, besides our main sets on 40 and 80 meters taking power from a gasoline-driven alternator.—S.M.R.A., W9HQG.

(Continued on page 60)

# Army-Amateur Notes

**T**HE Army-Amateur Radio System was organized "to provide additional channels of radio communication throughout the continental limits of the United States that may, in time of emergency, be used to augment or replace the land lines, both telephone and telegraph, that might be seriously damaged or destroyed by flood, fire, tornado, earthquake, ice, riot, or insurrection." Although it has many times, during the period of its existence, fulfilled the provisions under which it was organized, including the one above, it was not until recently that any part of the system had to prove in advance that it was ready to meet an emergency.

This test was applied to various organizations in the state of Florida which were expected to render emergency communication should conditions arise similar to those experienced during September 1926. It was during the 1926 hurricane and the hectic days that followed that the people of Florida first appreciated the value of the radio amateur to the community. Among those upon whom this fact was impressed was the Roebing estate of Lake Placid, Florida. They not only realized the value of the amateur but they recognized the need for better equipment and organization than was available during that hurricane.

Soon thereafter they established a fixed amateur station at Lake Placid under the call W4LS and obtained an amateur to act as technician and operator. No expense was spared in establishing the best possible station. A portable station was established in an "Aerocar" trailer. Accommodations for living in the trailer were provided for four men. The facilities so established were tested periodically in the field and kept ready for immediate use. All went well until the Federal Communications Commission changed its license requirements. Under the new regulations an amateur station license must be held by an amateur operator. The Roebing estate could not obtain such a license. This situation made it impossible for the estate to continue the operation of the emergency

station. It was decided that the equipment would be presented "to the group best showing to the satisfaction of the donor its ability to make the proper use of the donation."

Many organizations, including various radio clubs, military and naval units, Red Cross units, etc., presented their credentials and offered records of past performance as proof of their ability to operate the emergency stations. After very careful consideration of all of the facts in the case, the Lake Worth Radio Club of Lake Worth, Florida, was chosen as having the best plan of organization to meet future emergencies and the best record for having met past emergencies. All of the equipment, both fixed and portable, was thereupon presented to the club as an outright gift.

The Lake Worth Radio Club operates the station under the call W4AWO. As WLRO the station is operated as state net control station in both the c.w. and 'phone nets of the A.A.R.S. The operators, who are members of the A.A.R.S., are J. G. Graham, W4CNT; A. Litschauer, W4ACZ; F. G. Carroll, W4OK; George P. Aldridge and James W. Exline. Mr. Aldridge, who is president of the club, has been appointed chairman of the communications section of the South Florida Red Cross Safety Committee.

The total value of the gift is \$10,000. In addition the club previously owned equipment valued at \$3,000. The fixed station has been installed in the storm-proof auditorium, capable of withstanding 250-mile-per-hour winds. It consists of a 'phone station on 75 meters, a c.w. station on 40 or 80 meters, all capable of operating at full 1 kw. power. Special power lines have been installed from the city light-

ing plant to the auditorium. The portable equipment consists of two complete stations: one in the Aerocar, which can be operated on the 75-meter 'phone band or on either 80 or 40 meters c.w.; the other in another trailer can be operated on 80 or 40 meters c.w. Both trailers are equipped with gasoline-engine-driven generators.

*(Continued on page 60)*



**THE AEROCAR IS EQUIPPED WITH ALL MANNER OF RADIO APPARATUS AS WELL AS FIRST AID KITS, COOKING UTENSILS, BEDDING AND EQUIPMENT NECESSARY TO SUSTAIN A CREW OF FOUR DURING EMERGENCIES**

# A Flexible E.C.-Controlled Transmitter

By Alpha Learned,\* W1FUB

**A**MATEURS may be interested in the following description of the outfit at W1FUB in which a calibrated e.c. oscillator is so used as to permit transmission on any desired frequency in the 14-, 7- and 3.5-mega-cycle bands. The diagram of Fig. 1 gives the complete circuit. A 24-A tube is used as the e.c. oscillator and at all times operates on the 160-meter band with its plate circuit tuned to the second harmonic, the strength of oscillation being controlled by a panel knob which varies the plate voltage from 0 to 300. In operation this knob is advanced until sufficient excitation is obtained; that is, until further advance causes

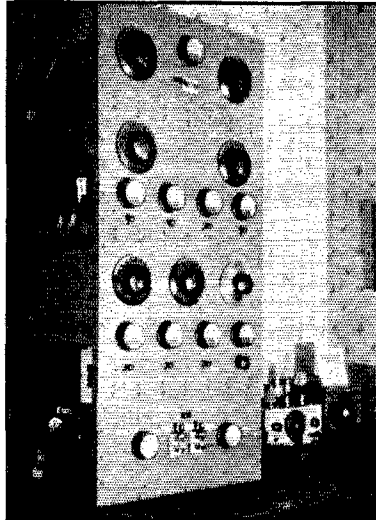

no increase in final output. The oscillator and its plate circuit are individually in boxes of rugged all-steel construction to insure frequency stability. The oscillator box is built of one-eighth-inch sheet stock, held together at all edges by quarter-inch square rods and plenty of machine screws.

**THE CALIBRATED ELECTRON-COUPLED OSCILLATOR GIVES THIS TRANSMITTER UNUSUAL FLEXIBILITY WITH HIGH STABILITY AND PROVIDES FULL DIVERSIFICATION IN USE OF FREQUENCIES IN THREE AMATEUR BANDS, AS OUTLINED IN THE TEXT**

The oscillator frequency-shift control is the precision National dial at the right in the lower row

\* Member of the Committee on Experimentation of the Providence Radio Association, Inc., Providence, R. I.

Variable condensers having well-centered and widely-spaced plates are used in the oscillator to

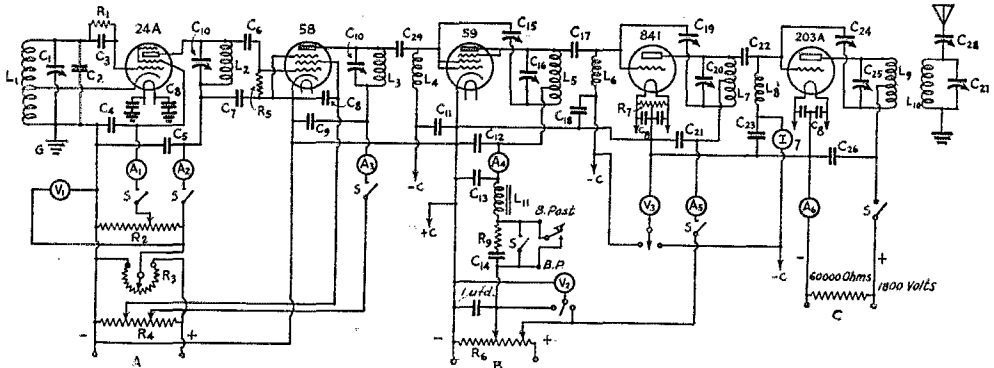

FIG. 1—CIRCUIT OF THE TRANSMITTER USING A CALIBRATED ELECTRON-COUPLED OSCILLATOR

- |   |  |                             |                                       |                                       |
|---|--|-----------------------------|---------------------------------------|---------------------------------------|
| L <sub>1</sub> —22 μh., tuned to 160-meter band always          | L <sub>10</sub> —Same as L <sub>3</sub>  | C <sub>13</sub> —2-μfd.     | C <sub>29</sub> —100-μfd.             | V <sub>2</sub> —0.750 d.c. volt-meter |
| L <sub>2</sub> —16 μh., tuned to 80 meter band always           | L <sub>11</sub> —5 henries   | C <sub>14</sub> —0.5-μfd.   | I <sub>1</sub> —0.5 ma. d.c. meter    | V <sub>3</sub> —0.150 d.c. volt-meter |
| L <sub>3</sub> —16, 4 or 1.5 μh., on 80, 40 or 20 meters        | C <sub>1</sub> —100-μfd. variable  | C <sub>15</sub> —50-μfd.    | I <sub>2</sub> —0.15 ma. d.c. meter   | R <sub>1</sub> —50,000 ohms           |
| L <sub>4</sub> —R.f. choke                                      | C <sub>2</sub> —350-μfd. variable condenser, set properly and shaft then removed | C <sub>16</sub> —250-μfd.   | I <sub>3</sub> —0.15 ma. d.c. meter   | R <sub>2</sub> —15,000 ohms           |
| L <sub>5</sub> —Same as L <sub>3</sub>                          | C <sub>3</sub> —250-μfd.   | C <sub>17</sub> —100-μfd.   | I <sub>4</sub> —0.50 ma. d.c. meter   | R <sub>3</sub> —10,000 ohms, variable |
| L <sub>6</sub> —R.f. choke                                      | C <sub>4</sub> —0.02-μfd.  | C <sub>18</sub> —0.1-μfd.   | I <sub>5</sub> —0.150 ma. d.c. meter  | R <sub>4</sub> —15,000 ohms           |
| L <sub>7</sub> —Same as L <sub>3</sub>                          | C <sub>5</sub> —0.01-μfd.  | C <sub>19</sub> —50-μfd.    | I <sub>6</sub> —0.400 ma. d.c. meter  | R <sub>5</sub> —75,000 ohms           |
| L <sub>8</sub> —R.f. choke                                      | C <sub>6</sub> —100-μfd.   | C <sub>20</sub> —250-μfd.   | I <sub>7</sub> —0.100 ma. d.c. meter  | R <sub>6</sub> —25,000 ohms           |
| L <sub>9</sub> —Slightly greater inductance than L <sub>3</sub> | C <sub>7</sub> , C <sub>8</sub> , C <sub>9</sub> —0.002-μfd.                     | C <sub>21</sub> —0.002-μfd. | V <sub>1</sub> —0.500 d.c. volt-meter | R <sub>7</sub> —75-ohm, c. t.         |
|   | C <sub>10</sub> —250-μfd.  | C <sub>22</sub> —100-μfd.   |                                       | R <sub>8</sub> —20-ohm, c. t.         |
|   | C <sub>11</sub> —0.1-μfd.  | C <sub>23</sub> —0.5-μfd.   |                                       | R <sub>9</sub> —300 ohms              |
|   | C <sub>12</sub> —0.002-μfd.  | C <sub>24</sub> —50-μfd.    |                                       | S—S.p.s.t. switch                     |
|   |  | C <sub>25</sub> —100-μfd.   |                                       |                                       |
|   |  | C <sub>26</sub> —0.004-μfd. |                                       |                                       |
|   |  | C <sub>27</sub> —100-μfd.   |                                       |                                       |
|   |  | C <sub>28</sub> —50-μfd.    |                                       |                                       |
- 24-A cathode tap and 59, 841 and 203-A neutralizing taps at about one-third total turns from end of coil.  
C<sub>13</sub>, L<sub>11</sub>, R<sub>9</sub> and C<sub>14</sub> constitute the key-click filter.  
By varying C<sub>13</sub>, the so-called "bell" tone may be adjusted to suit the operator.



reduce changes in capacity due to any vibration or movement. The reason for this can be understood by considering a simple condenser consisting of one rotor plate midway between two stator plates. If the rotor plate moves slightly towards one of the stator plates the total capacity will be

The tabulated data show typical operation on the 7-mc. band, the various currents being approximately the same on 14 and 3.5 mc. except for the oscillator which usually runs with plate voltage of 250 and 100 volts on 14 and 3.5 mc.,

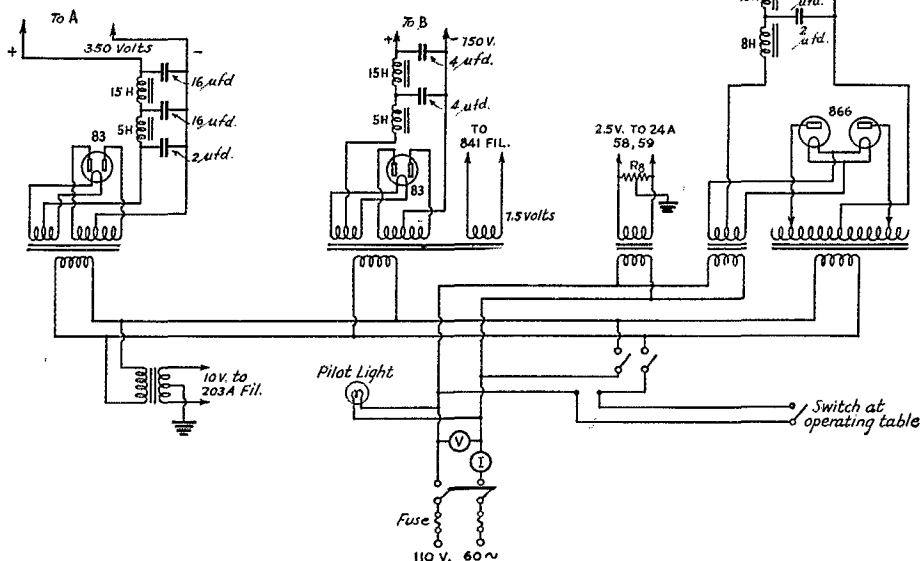

FIG. 2—POWER SUPPLY WITH OUTPUT CONNECTIONS TO TRANSMITTER  
Meters on the 110-volt 60-cycle line are 0-150 a.c. voltmeter and 0-10 a.c. ammeter.

### Typical Voltage and Current Values at 7 mc.

Tube	Plate Ma.	Plate voltage
24-A	2.5	160
58	8.5	250
59	30	350
841	60	650
203-A	240	1800

24-A screen current 1.2 ma., screen voltage 96 volts.  
203-A max. grid current with antenna removed, 90 ma.

unchanged, for the capacity increase on one side is balanced by a decrease on the other side. However, if the rotor moves very close to one stator, then the total capacity will increase, for the capacity of one side is increased greatly and the capacity of the other side is decreased only slightly. Also, these condensers are of comparatively high capacity (total max. 500  $\mu$ fd.), so that any unavoidable change will be a small part of the whole. No temperature control or compensation is used since tests indicate that the total fundamental frequency drift from cold to hot is but slightly more than one kilocycle.

The 58 buffer tube acts as a straight amplifier, doubler or quadrupler, and is equipped with grid-leak bias in an attempt to take advantage of the vari-mu feature of this tube, whereby the amplifying power increases as the bias (excitation, in this case) decreases. The following stages are straight amplifiers with battery bias.

respectively. When transmitting on 3.5 mc. a final input of 450 watts may be obtained with as little oscillator screen input as one-fourth of a milliampere at fifteen volts. The original 24-A has never left its socket and it is apparent that long tube life may be obtained, unless the set is operated on 14 mc. a great deal. This is important because it is somewhat of a task to make an accurate frequency calibration. The oscillator was calibrated from WWV by the method described in past issues of *QST*.

The set is far from being a perfect model to be copied in detail by others, but amateurs interested in this type of transmitter can and will, I hope, build better ones. Improved methods and the use of some of the newer tubes such as the 802 should make possible a more powerful yet less complicated transmitter.

### Strays

A glued strip of yearly labels (marked from 1919 to 1938) is now being furnished with each *QST* binder. The labels are attractive, and may be easily cut and placed in the date space provided for on the binder. Free upon request to those having binders without labels.



# Amateur Radio STATIONS



## W3AAJ, Richmond, Va.

**B**OB EUBANK, W3AAJ, has long been an active and well-known member of the Communications Department field organization, while his *QST* contributions probably have made him equally well-known to *QST* readers not participating in organized activities. A ham since 1914, holding a commercial first ticket since 1922, he was for many years SCM for Virginia, resigning just recently, and holds appointments as ORS and Chief Route Manager for Virginia. Another of the gang who make radio their profession as well as hobby, Bob is Transmitter Chief at WRVA, the Edgeworth Tobacco Station at Richmond, and was instrumental in having code practice lessons sent out over that station in past seasons.

W3AAJ's station layout is shown in the accompanying photograph. The frame-mounted transmitter consists of a 47 crystal oscillator working at 350 volts, a 46 doubler and 10 buffer, both operating from the same 500-volt supply, and a Western Electric 242-A power amplifier. Input to the 242-A is 175 watts from a power supply using 866 rectifiers. In the photograph, the power supplies occupy the two lower panels, oscillator and doubler-buffer the third, power amplifier the fourth, while the top panel contains an antenna matching network of the type described by Collins. The antenna is the vertical arrangement originated by W3AAJ and described in *QST* for March of this year.

The receiving equipment includes a National FBXA used in conjunction with a Peak pre-selector. A monitor sits on top of the receiver, while a frequency meter is between the receiver and transmitter. The station works on the 20-, 40- and 80-meter bands.

W3AAJ has been awarded a public service certificate for work during storm emergencies in Illinois and Maryland. He also holds the rank of Lieutenant in the USNR.



W3AAJ

## W1BPX, South Brewer, Maine

**A**N UNASSUMING but highly effective DX getter is the layout of W1BPX, owned by Paul D. Palmer, South Brewer, Maine. Using a power input running between 200 and 300 watts to a 203A, depending on the frequency, this station had 17 contacts with Asia during the past winter, which is something to make most of New England, where Asian signals are nearly as rare as comets, prick up its ears. Blame it on "location" if you will, nevertheless W1BPX is the man who's been doing the work.

The transmitter occupies the frame to the left of the operating table. Starting out with a 7-mc. 47 crystal oscillator, the second stage uses a Type 10 tube as a doubler. This in turn excites a buffer stage using an RK-18 with 750 volts on the plate. The final is the aforementioned 203A, link-coupled to the buffer. Oscillator and buffer are run at 300 and 400 volts, respectively, from one power supply. The last two stages are supplied from a 1200-2400-volt center-tapped



W1BPX

pole transformer used with a pair of 866's and a filter consisting of six  $\mu$ fd. and a double choke. W1BPX's receiver is a duplicate of the set

described in January, 1933, *QST*, the constructional work having been done by W1EBJ. The owner swears by its DX-getting ability. The transmitting antenna, a 7-mc. Hertz, single-wire fed and 60 feet high, also is used for receiving.

W1BPX went on the air in August, 1931, and after six months of alternating between 3.5 and 7 mc. went down (or is it up?) to 14 mc., where most of the work has been done since. WAC was made in 1932 with a 10 Hartley, and since then 72 countries have been worked. Palmer attends the University of Maine and is an amateur astronomer as well as radio amateur. W1BPX expects to spend considerable time on 28 mc. this summer, with the particular ambition of working Europe on that band.

### W8GHA, Harrison, Mich.

W8GHA is the station of the 677th Company, C.C.C., located at Camp Harrison, P-113, Harrison, Mich. It is under the charge of Robert E. Kearney, 1st Lt. Engr-Res., formerly 2FB, and since its installation in January of this year, has made many contacts in different parts of the U. S. and Canada on 160-meter 'phone.

The photograph gives a general view of the station. The transmitter is of frame and panel construction, equipped with an r.f. end having

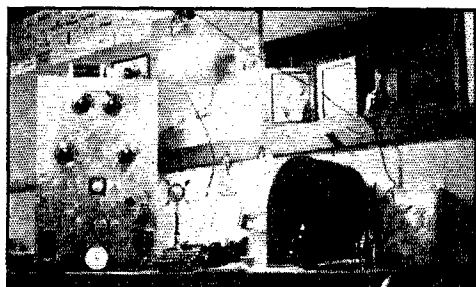

W8GHA

a 47 crystal oscillator, 46 buffer, and a pair of 46's in parallel in the final amplifier. Speech equipment includes a crystal microphone working into a 57 first stage, resistance-coupled to a 56 which in turn is transformer-coupled to a 46 Class-A amplifier driving a pair of 46's in Class B. Normal power input to the Class-C stage is 40 watts.

The antenna system at W8GHA is a 243-foot Hertz, end fed, 67 feet high at one end and 45 feet high at the other. It is supported at the high end by a 40-foot pipe mounted on top of a water tank, and at the other by a similar pipe 20 feet long on top of a telegraph pole. The antenna length is chosen to be resonant at the operating frequency, 1929 kc.

The receiver shown in the photograph is a model 89 Philco used chiefly for monitoring. Communication is usually carried on with a Patterson PR-10.

Schedules are kept with W8HZV, Camp Huron-Hayes, Clinton, Mich., and with W8AEQ, at Camp Fife Lake, Fife Lake, Mich. The latter is the northernmost camp of the Fourth Forestry District, while Camp Harrison is the southernmost, and constant daylight 'phone contact has been maintained between W8AEQ and W8GHA, an arrangement which has proved very satisfactory to the District Commander and the Company Commanders concerned. Outside traffic can be cleared through the Army-Amateur net, of which W8AEQ is a member. In general operation, the station has contacted stations as far west as California, south in Texas and east in Maine.

A 20-meter c.w. transmitter is under construction. W8GHA would appreciate reports from other C.C.C. camps hearing its signal. Lt. Kearney has formed a radio class in the camp, and several of those enrolled are about ready to take their ham examinations.

### A New Type Ultra-High-Frequency Transmitter

(Continued from page 31)

square. Since it is desirable to have this as large as possible, tubes with small input (plate-grid) capacitance should be used. In the usual case at short waves, for which the dimension of the square  $a$  is less than a sixth of a wavelength, the radiation resistance is given by the expression

$$R_r = 20(2\pi a/\lambda)^4 \text{ ohms}$$

with the wavelength generated. The radiation resistance of model A is about 14 ohms; that of model B only 4 ohms. High-frequency currents approaching an ampere are possible in model A with plate voltages of 200 volts or more. For large power output, however, more powerful tubes than the 56 type might well be used, though a much larger plate-grid capacitance might reduce their advantage at the shorter wavelengths.

Numerous modifications in the design and construction of the loop type transmitter are readily imagined. For example, there would seem to be no reason why six tubes arranged in a hexagon, or any number of tubes suitably spaced around a circle or regular polygon might not be used. It is probable that grid-plate coupling coils would be necessary in such cases even with 56 type tubes. However, no attempt will be made in this article to do more than outline the construction of the working models. Further developments are left to the ingenuity of the experimentally inclined reader.



## An Audio Output Stage for the Regenerative S.S. Receiver

Several months ago I constructed the regenerative single-signal superheterodyne described in the eleventh edition *Handbook* but found that while the set functioned just as the data said it would, the total gain was not sufficient to bring in all signals with the sock I desired. Naturally, before building the set I had carefully planned the layout, making it similar to that shown in the *Handbook*; I did not, therefore, leave any additional space where another tube might be added.

The obvious solution in such a case as this would be to substitute another tube for the 2A5 used as a second detector, and then use the 2A5

chassis and also crowded things considerably. However, the problem was solved by using one-half of a 53 as the second detector and the other half as beat oscillator. Since the beat oscillator is coupled to the second detector, this was the logical combination of circuits. The whole audio and second-detector end of the receiver was then wired as shown in Fig. 1. It was found that the audio output was many times greater with this arrangement than when the 2A5 was used as a combination audio and second detector tube.

The circuit of the beat oscillator half of the 53 differs considerably from the former circuit using a 57. The connection that formerly went to the 57's cathode is grounded and the connection that

was grounded is coupled through  $C_1$  to the plate of the oscillator half of the 53. The grid connection is the same except that the lead is brought out under the chassis. It was found that both parts of the tube worked very well with their common cathode grounded and there was therefore no necessity for inserting cathode bias.

There is really nothing unusual about the rest of the circuit, and the diagram is self-explanatory. The oscillator coupling condenser was made in this instance of about five inches of twisted wire with the dead ends insulated and the other two ends soldered to the two grids of the 53. This was found to give very good results since it did not overload the second detector but still produced a very good beat note.

I am convinced that this change will be welcomed by fellows having one of these receivers, as the gain in audio volume is well worth the trouble.

—Lewis Van Arsdale, W9NQV

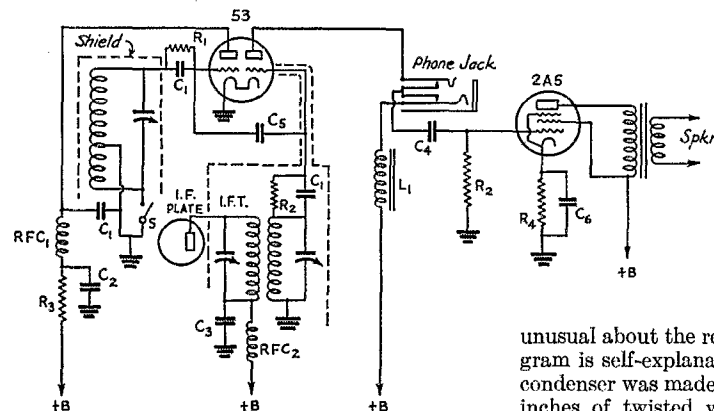

FIG. 1—THIS CIRCUIT MAY BE USED TO ADD AN AUDIO OUTPUT STAGE TO THE REGENERATIVE S.S. RECEIVER

It requires no additional sockets or major changes in the wiring. A 53 is substituted for the beat oscillator tube in the original circuit, combining the functions of second detector and beat oscillator in one bulb. The 2A5 then becomes a straight audio amplifier.

- $C_1$ —250- $\mu$ fd. mica condenser.
- $C_2$ —1- $\mu$ fd. paper condenser.
- $C_3$ —.01- $\mu$ fd. paper.
- $C_4$ —.01- $\mu$ fd. mica.
- $C_5$ —Approximately 25  $\mu$ fd. (homemade).
- $C_6$ —10- $\mu$ fd. low-voltage electrolytic.
- $R_1$ —50,000 ohms.
- $R_2$ —1 megohm.
- $R_3$ —2500 ohms, 5-watt.
- $R_4$ —400 ohms, 2-watt.
- RFC1—60 millihenry choke.
- RFC2—10 millihenry choke.
- $L_1$ —400-henry audio choke.

as a straight audio amplifier, but this would have necessitated drilling another socket hole and this in turn would have ruined the appearance of the

## Blocked-Grid Keying

If separate power supplies are used for the exciter and final amplifier stages, blocked-grid keying of the final can be accomplished quite easily without any auxiliary equipment except an inexpensive resistor and possibly a by-pass

condenser. The idea is simply to use the exciter plate supply to furnish blocking bias for the amplifier.

An arrangement used by Peter Fakkema, W7AJ, with a two-stage transmitter consisting of a 59 Tri-tet oscillator and 10 amplifier, is shown in the upper diagram of Fig. 2. With the key open, the 300 volts from the oscillator supply is connected in series with the amplifier grid return to filament center-tap through the high resistance  $R$ .  $R$  is 100,000 ohms or more; its value is not critical, but it should be high.  $R$  acts in the combined capacity of a very high-resistance grid leak for the amplifier when the key is open and as a current-limiting resistor for the 300-volt supply when the key is closed. With the key closed, the amplifier grid bias is supplied solely by the regular grid leak. The filament by-pass condensers,  $C$ , should be capable of standing the oscillator plate-supply voltage.

A somewhat similar scheme has been used by the editor for some time with the general-purpose transmitter described in January 1935 *QST*. In

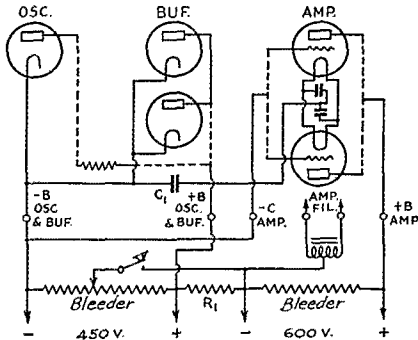
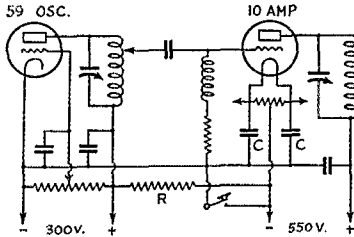

FIG. 2—BLOCKED-GRID KEYING SYSTEMS USING EXCITER PLATE SUPPLY FOR BLOCKING BIAS

$R$  and  $R_1$  are high resistances of the order of 50,000 to 250,000 ohms.  $C$  and  $C_1$  are insulating condensers having a rating of about 1000 volts for low-power transmitters.

this case the low-voltage supply for the oscillator and buffer tubes supplies both operating and blocking bias for the final stage. The lower circuit diagram of Fig. 2 shows the essential details. With the key open, the grids of the 801 amplifier tubes get the full 450 volts of the low-voltage supply through  $R_1$ , a 50,000-ohm 2-watt resistor.

With the key closed, that part of the low-voltage bleeder between negative and the tap to which the key is connected serves as a combined grid leak and bias supply. A few slight changes are necessary in the circuit diagram given on page 17 of January *QST*. The grid leak,  $R_3$ , should be removed and a separate bias terminal brought out. For insulating purposes a fixed condenser should be connected in the common r.f. line between the final and exciter stages, as shown at  $C_1$  in Fig. 2 herewith. In operation, the tap on the low-voltage bleeder should be set to cut off the amplifier plate current with excitation removed; when

excitation is applied the bias will increase beyond cut-off because of the flow of grid current through the biasing portion of the low-voltage bleeder.

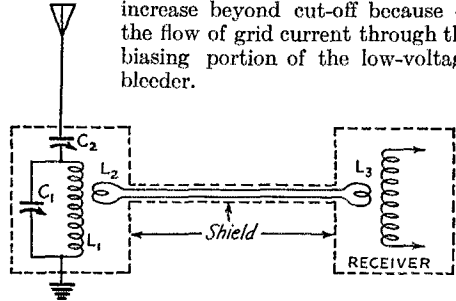

FIG. 3—SHIELDED INPUT TUNING CIRCUIT FOR WORKING 'PHONE DUPLEX

$C_1, C_2$ —250- to 350- $\mu$ fd. variable condensers.

$L_1$ —35 turns No. 30 d.c.c. wire, double spaced, on  $1\frac{1}{2}$  plug-in form.

$L_2$ —2 turns No. 26 rubber-covered wire wound over  $L_1$ .

$L_3$ —Antenna input coil on receiver (must be disconnected from chassis).

The connection between  $L_2$  and  $L_3$  is made through a two-wire shielded cable about a foot long.

Key thumps can be eliminated quite readily with these keying arrangements. A filter consisting of two air-core chokes, connected in series with each key terminal, with a 1- $\mu$ fd. by-pass condenser across the chokes on the line side, has been very successful. The chokes were simply windings from some old 30-kc. i.f. transformers, or some 80-mh. chokes of the type used in receivers.

## Duplex 'Phone

There comes a time in every ham's life when he feels the urge to have a two-way QSO for test purposes. There are so many details when reporting through a test transmission that most of the substance is forgotten. Regular duplex operation is not very desirable in our present crowded 'phone bands, however, especially when the transmitter is left on continuously, hence I suggest the following method to be used for test purposes only. A direct reply is obtained on each test and much time is saved.

Dig down in that old junk box and get a pair of

250- or 350- $\mu$ fd. variable receiving condensers of the broadcast type, also two dials and a 1½-inch diameter coil form for the plug-in coil. The system is, no doubt, applicable to any band, the frequency being about proportional to the number of turns for other bands, hence the plug-in coil. The specifications given under Fig. 3 apply to the 160-meter 'phone band.

and trying is necessary for specifications given herewith. It really works!

—Art Miller, W9CPW

### Two-Band U.H.F. Transceiver

Fig. 4 is the circuit diagram of a 5- and 2½-meter transceiver which has been used successfully by Eric W. Crusier, W2DYR. Its unique features are the elimination of the special audio-microphone transformer usually required by transceivers, and the provision of a method of monitoring the transmissions. W2DYR writes:

"The vital difference between this and the ordinary transceiver circuit is that no special combination mike and audio transformer is necessary so that the same tube may be utilized as both a modulator and audio amplifier. The circuit is simple and the parts required are of the variety that are usually found in a ham's junk box. The tubes used are a 56 oscillator-detector, and a 56 modulator-amplifier. 27's and 37's will undoubtedly give good results. However, on 2½ meters super-regeneration was only obtainable with certain tubes (evidently

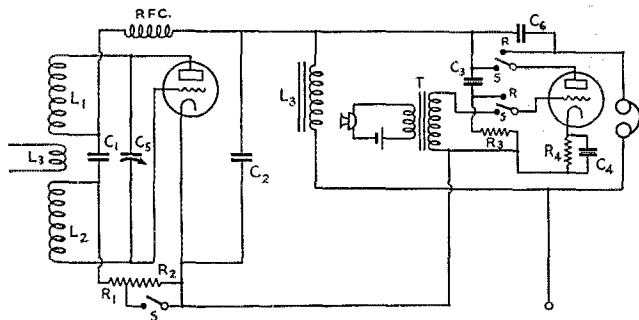

FIG. 4—A TRANSCEIVER CIRCUIT WHICH REQUIRES NO SPECIAL TRANSFORMER

- C<sub>1</sub>—100  $\mu$ fd.
- C<sub>2</sub>—0.006  $\mu$ fd.
- C<sub>3</sub>—0.01  $\mu$ fd.
- C<sub>4</sub>—10  $\mu$ fd. electrolytic.
- C<sub>5</sub>—5 meters: 20- $\mu$ fd. midget variable; 2½ meters: two half-inch copper discs mounted so spacing can be varied.
- C<sub>6</sub>—250  $\mu$ fd.
- R<sub>1</sub>—7000 ohms, 1 watt.
- R<sub>2</sub>—100,000 ohms, 1 watt.
- R<sub>3</sub>—300,000 ohms, 1 watt.
- R<sub>4</sub>—2500 ohms, 1 watt.
- RFC—For 5 meters, 4 feet of wire wound on ¼-inch dowel; for 2½ meters, 2 feet of wire wound on ¼-inch dowel.
- L<sub>1</sub>, L<sub>2</sub>—5 meters: 7 turns, ¾-inch diameter; 2½ meters: 3 turns, ¾-inch diameter.
- L<sub>3</sub>—1 turn, ¾-inch diameter.
- L<sub>4</sub>—30-henry choke.
- T—Single-button microphone transformer.

Two turns of No. 20 rubber-covered wire are used for the pick-up coil, L<sub>2</sub>, placed one-third of the way down from the antenna on L<sub>1</sub>. Connections from L<sub>2</sub> run through a shielded two-wire cable to the antenna coil of the receiver. The antenna coil on the receiver should be disconnected from ground. Good shielding of both receiver and duplex system is essential; the shielded cable connects the common grounds. The length of the antenna is more or less optional, depending upon working conditions of the transmitter and duplex system in general. In my particular case a five-foot vertical wire was used, affording excellent selectivity without much decrease in signal level. However, up to twenty feet of antenna has been used without trouble from transmitter blocking.

The system is tuned by using the regular long receiving antenna connected directly to one side of the open antenna coil of the receiver. After the desirable station has been tuned in, the gain control of the receiver is advanced slightly and the long antenna disconnected, leaving the duplex system in operation. The condenser C<sub>1</sub>, across L<sub>1</sub>, is rotated slowly until maximum signal strength is obtained. C<sub>2</sub> is set at approximately half capacity and tuned for sharpest signal after desired frequency is obtained. No cutting

some of the newer models with solid plates and spiral heaters).

"To change from 'send' to 'receive' requires no more switching than in the ordinary transceiver, and a double-throw triple-pole jack-type switch does the whole job. Provision is made in the circuit so that the signal can be monitored while transmitting.

"When used on 2½ meters the tuning condenser which proved most satisfactory was one improvised from two small copper discs about ½-inch in diameter, one stationary and the other soldered to a screw and mounted so the distance between the two could be varied."

Condenser C<sub>6</sub> makes possible monitoring of the transmissions. A small amount of audio signal gets through C<sub>6</sub> to the 'phones, although with the small capacity specified the power consumed is so small as not to affect the modulation. C<sub>6</sub> has no effect on the operation of the set as a receiver.

### Strays

W9EGQ varies the well-worn CQ story by reporting the BCL who asked him where station LOCC, whom everybody seems to be calling, is located!

# • I. A. R. U. NEWS •

Devoted to the Interests and activities of the

## INTERNATIONAL AMATEUR RADIO UNION

President: H. P. MAXIM

Vice-President: C. H. STEWART

Secretary: K. B. WARNER

Headquarters Society: THE AMERICAN RADIO RELAY LEAGUE, West Hartford, Conn.

### MEMBER SOCIETIES

American Radio Relay League  
Associazione Radiotecnica Italiana  
Canadian Section, A. R. R. L.  
Československí Amatérský Vysílač  
Deutscher Amateur Sende-und-Empfangs  
Dienst  
Experimenterende Danske Radioamatører  
Irish Radio Transmitters Society  
日本アマチュア無線聯盟  
Liga Colombiana de Radio Aficionados

Liga Mexicana de Radio Experimentadores  
Nederlandsche Vereeniging voor Internationaal Radioamateurisme  
Nederlandsch-Indische Vereeniging voor Internationaal Radioamateurisme  
New Zealand Association of Radio Transmitters  
Norsk Radio Relæ Liga  
Polski Związek Krotkofalowcow  
Radio Society of Great Britain

Rede dos Emissores Portugueses  
Reseau Belge  
Reseau des Emetteurs Français  
South African Radio Relay League  
Suomen Radioamatöörlitto r.y.  
Sveriges Sandareamatörer  
Unión de Radioemisores Españoles  
Union Schweiz Kurzwellen Amateurs  
Wireless Institute of Australia

Conducted by Clinton B. DeSoto

### Internationally-Minded:

Few better expressions of the fundamental practical importance of organization, not only national but international, in amateur radio have been made than the following editorial excerpted from the June, 1935, issue of "Break-In," official organ of the N.Z.A.R.T.:

"Webster in his well-known dictionary defines an amateur as 'one who is attached to or cultivates a particular pursuit, study, or science from taste without pursuing it professionally.' That this is correct, the Radio Amateurs need not be told.

parent. Ask a disinterested person what he understands by the term 'Radio Amateur.' You will be surprised at the answers you receive. Think over the replies and then ask yourself whether you are doing your utmost to correct these misapprehensions. Do the people who listen to you on the air, and in person, think you are a trifler or tinkerer?

"What can be done to stop these misapprehensions that the general public have? We suggest that as a start you correct any faults you have in your pursuit of the greatest hobby of all. Help the other amateur who does not realize what he is doing.

Tactfully draw his attention to his transgression and unconsidered remarks, that may be offending and doing untold harm. Then get all you know and contact to become 'radio-minded' and join N.Z.A.R.T. We will need the support of the general public throughout the world, if we are to carry weight at the International Convention to be held in Cairo in 1937. As a start in this campaign, you will realize that we cannot claim 100% representation of the Radio Amateurs whilst one remains outside N.Z.A.R.T. All must be members. We are and will be fighting for more privileges, wider bands of frequencies, fewer restrictions, more

recognition, and all the other vital matters that affect the welfare of all Amateurs. Your Ham friends are letting you down whilst they do not belong to our Association. Be Internationally-minded. You may not like some of our habits, but the big thing is that you are joining I.A.R.U.



THE PRETORIA (SOUTH AFRICA) GANG

"Unfortunately, like many other words in the English language, the true meaning of the word has been lost to many. They construe the word amateur to mean 'one who is a novice; one who is new, unskilled, or inept at an art or science.' That this is also true is indisputable and only too ap-

and B.E.R.U., the two bodies which do carry weight."

We heartily endorse these remarks as applying not only to the N.Z.A.R.T. but to all societies and all amateurs everywhere.

### Bolivia:

From L. H. Tejada F., who is now working c.w. and 'phone on the high-frequency end of the 14-mc. band under the call CP4ANB, comes the following information concerning present-day amateur regulations in Bolivia:

1. Two kinds of licenses are issued, amateur and experimental. Amateur stations use the prefix CP3 and experimental stations the prefix CP4.

2. The maximum power allowed amateur stations is 100 watts output. The power of experimental stations can be any value, subject to authorization by the *Dirección de Correos y Telégrafos*.

3. All Madrid treaty bands are allowed.

4. All amateur stations are required to observe quiet hours between 2100 and 2400 Bolivian Standard Time (0100 to 0400 G.T.). This does not apply to experimental stations.

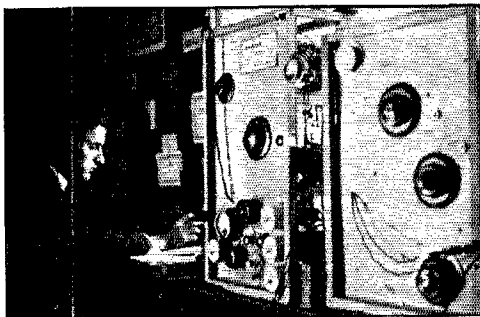

HB9Y, ARTHUR V. WATTENWYL, ZURICH, OUTSTANDING 3.5-MC. DX STATION

On the air first in 1931, HB9Y's initial QSO was with an LU. Now, four continents have been worked on 80 meters; South America and Oceania are needed for WAC on that band. Two '10's in the final deliver 100 watts to a 40-meter Hertz. HB9Y seeks 3.5-mc. skeds with stations everywhere.

5. It is prohibited to exchange messages with stations of other countries which do not permit such exchanges.

### General:

Mostly on DX:

On June 23rd ON4AC, Réseau Belge's secretary, was QSO W6GRX. This was not unusual, but W6GRX said he had not been to bed for the last 24 hours and was very tired. His wife had, a couple of hours before, given birth to a son. The OM, needing some rest himself, had turned on his transmitter! ON4AC changed over to voice

and, QSA5 R8 on the speaker, felicitated Mrs. W6GRX on the happy event, the message being relayed direct to the hospital. (Tnx, ON4CC.)

VQ4CRP will henceforth be silent. S. G. Fisher has been transferred to Mozambique, and as soon as he is settled will be on with a new CR7 call. (Tnx, W1GDY.)



F8RR, OWNED BY E. BONAMY, LES PIEUX (MANCHE)

30 watts input to the final of a CO-BA-PA, Heising modulation and Hertz antenna.

W. B. Scofield, W2DIB, sends the following Japanese frequencies, noting that these stations hold rather closely to the values shown: J2GX, 14,292 kc.; J2HG, 14,373; J2CN, 14,285; J2LB, 14,302; J2LU, 14,356; J2ME, 14,296; J2CL, 14,327; J2LK, 14,362; J3DE, 14,348; J5CC, 14,368; and J5CE, 14,342 kc. He mentions other frequencies, as well: SU1RO, 14,290 kc.; PK3ST, 14,316 kc. Which, from the man who worked WAC twice in one day last June, sounds good enough.

A new station in Iraq, reported worked by W9NNZ—YI2AT, 14,390 kc., at Kirzog.

W9FJR completed his 33rd J QSO in two weeks' time, thirty minutes a day, in early July—"I have read QST so long that I always thought J stations were hard to work!"—it's a long, long way from New England to South Dakota, OM!

TF3G, Box 756, Reykjavik, Iceland, usually operates near 14.3 mc., with an r.a.c. note, writes W1HUO.

ZL4CH is now visiting W6MDJ, who issues a standing invitation to all foreign hams to visit him—a good time guaranteed. The QRA is Norman Isherwood, 2732 Humboldt Ave., Oakland, Calif.

CN is now the official prefix for Morocco. F3 and F8 are restricted to continental France, and, as reported last month, FA is assigned to Algeria, FT to Tunis.

### QSL Bureaus:

In response to numerous requests, we will henceforth publish the list of QSL bureaus of the world twice annually, in the April and September

(Continued on page 76)





# OPERATING NEWS



Conducted by the Communications Department

F. E. Handy, Communications Manager

E. L. Battey, Asst. Communications Manager

## A.R.R.L.'s Emergency Corps—Join Now

AT LEAST one amateur station in every community should be equipped with auxiliary station equipment for use in emergency. For real preparedness such equipment should be designed to operate from power supplies other than the regular a.c. or d.c. lines. Although it is true that much of the most valuable emergency work is done using equipment operating directly from a.c. or d.c. mains, it must be remembered that the "stricken area" itself is usually without current from the power company. This means a wait until lines are repaired. "Waits" are inexcusable in emergencies. Communication should be established at the earliest possible moment. To guard against delays the "emergency set-up" must operate from auxiliary power, and the operator must at all times know where he can secure the auxiliary power (if he does not have emergency power himself, arrangements can usually be made with local hardware dealers, radio stores, etc., for the loan of batteries when the need arises).

The "A.R.R.L. Emergency Corps," of which this is the first announcement, will comprise those amateurs who have available at their stations transmitting and receiving equipment suitable for use in an emergency, and capable of operating from power auxiliary to regular a.c. or d.c. mains. All amateurs are invited to enlist at once in this "Corps." The only requirement is the possession of enough emergency equipment to make a complete station, capable of being set up in a short time.

How to join the "A.R.R.L. Emergency Corps": Every member of the Corps will be required to "register" at headquarters on the emergency equipment available at his station. Appointment to the Corps will remain in effect only during the time when such equipment is on hand and in operating condition. To join simply send a post card to the Communications Department, A.R.R.L., West Hartford, listing what emergency equipment you have (transmitter, receiver, frequency band(s) it works on, auxiliary power—whether on hand or whether arrangements have been made to secure power quickly if emergency arises). If your application proves OK, you will be issued a membership card, and your availability will be registered on a headquarters record.

Fine emergency work in Nebraska, Colorado and other midwest points included many ham stations recently—reported in August QST. A Western N. Y. flood (40 lives lost, millions damage) with hams filling the communications gaps is being featured in our Hartford papers as we write. Our A.R.R.L. Field Days have stressed "emergency preparation" and stimulated development and trial of successful portables. Now we aim to go further.

Every member of the "A.R.R.L. Emergency Corps" will be expected to make known his availability for emergency communication to local Red Cross officials, railroads, military units, police departments, representatives of press associations and the like. All Corps stations should be on record with such organizations and other competent authorities so that they will be called upon to assist when emergency communication is necessary.

The goal of the "A.R.R.L. Emergency Corps" is: AN AMATEUR RADIO EMERGENCY STATION IN EVERY COMMUNITY!! Will you help us achieve that aim? Amateur Radio as an emergency communication system is invaluable. Every red blooded ham should want to

do his part! Send your application to the Emergency Corps as soon as possible. We need you! And your community needs you!! Clubs working in the interest of amateur radio and their communities have a real opportunity in this field too, and we shall be glad to enroll club stations in the A.E.C.!

## Briefs

Major H. J. Connors, U. S. Army, of Schofield Barracks, Hawaii, was reported as missing and possibly dead by the press on July 15th. Discovering the rumor, Major Connors on July 18th desired to relieve the minds of relatives in Laurel, Md. He filed a message with K6DV/WVQB, it was relayed by W6GXM/WLMI to W3CXL/WLM and 'phoned from there. An answer was returned via the same route, total time for round trip being nine minutes! Another feather in amateur radio's "public service cap"!

## Hams Afloat

Add to the news on "Sparks" in August QST: W4AKH is operator on the S.S. *Fairfax*, KGCE, W4UX sails with the S.S. *Magmaric*, KOJS. In the radio shack on the Yacht *Vanda*, WGDS, you will find W4AEM. W1ABF is Sparks aboard the S.S. *Dorothy Bradford*, sailing out of Boston to Cape Cod and vicinity. W1BNC had a pleasant chat with ABF recently and reports the rig on the *Bradford* is a 2-kw. spark, the receiver an SW3! W9BBP is pounding brass on the Steamer *Ishpeming*, KFLL. All amateurs who are ship operators are invited to send in the dope on their activities.

In the 1935 C.M.T.C. Signal Company at Fort George G. Meade, Md., there were fifteen hams! Count 'em: W3DZV EVV EWJ FIF W8KPU NFS LBD IFB KUK KJV KTI LOQ GSH NFV ASW.

Multi-way QSO's are quite popular these days. W2EEG tells of a seven-way one on 56-mc. 'phone recently. It started with W2HPD's CQ, which was answered by five stations. HPD got them all and designated the order in which they should come back. A good evening of rag-chewing followed, during which still another station entered the get-together. The participants were W2HPD GKP IPY IAG EEG GNL and GIT.

A three-way confab was enjoyed on July 13th by W9BFH, 3990 kc.; W9ECF, 1974 kc.; and W9FWY, 1910 kc. W9FWY relayed W9ECF to W9BFH and BFH to W9ECF. W9ECF worked break-in while BFH and FWY worked duplex.

## K6BAZ Operator on Schooner Kinkajou

The Dr. Dana Coman Scientific Expedition has sailed from Honolulu on the Schooner *Kinkajou*, W0FV, for the Jarvis, Howland and Baker Islands. Kenneth L. King, K6BAZ, is radio operator with the party, which consists of fourteen. W0FV will operate on 8220 kc. for amateur contacts. Schedules have been arranged with K6GAS, K6KEF, K6BAZ and W5AJO. K6BAZ portable will operate on one of the above-mentioned islands for two months while the expeditioners explore. Watch for W0FV on 8220 kc. and K6BAZ on amateur frequencies. Please report any reception or contacts to A.R.R.L.

Mr. Castle's contribution wins the C.D. article contest prize for this month. Each month we aim to print the most interesting and valuable article submitted on the subject of amateur organization, or operating activity. Contributions on any phase of amateur communication activity are solicited, and may win you a bound Handbook, six logs, message files, blanks, or equivalent credit toward a combination of different A.R.R.L. supplies. Let us have your article, and mark it "for the C.D. Contest," please.

—F. E. H.

## Why Is an O.R.S.?

By Robert Castle, W8BTT\*

EVERY once in a while when talking with some operator that is more or less new in the game but who has been heard consistently, and who seems to have a good sound, workable understanding of radio communication as it is practised by the amateur the subject of his becoming an O.R.S. is brought up. In some cases the operator seems reluctant to consider the matter. He proffers as an excuse the fact that he doesn't have the necessary time; and besides putting his transmitter in the O.R.S. class would impose limitations and remove liberties that he now enjoys. He says amateur radio is his hobby—he is in the game because of the enjoyment that he gets out of it—he believes that if he compels himself to conform to any rules in regard to operating his transmitter his enjoyment will disappear and he will have destroyed the very reason for the existence of his radio apparatus.

It is an argument that is a little hard to answer with a few dots and dashes on the spur of the moment. The other side of the question cannot be put in such a direct and simple form. But there is another side, and one that should receive consideration.

He says he is in amateur radio because of the enjoyment he receives—because of the satisfaction he experiences when he sits down to the key that he has been unable to get in any other way. He thinks this enjoyment varies in direct proportion to the amount of freedom he has as to when and how he can operate. But is this actually a fact? Does it put an end to the pleasure to follow a few rules? Is not also part of the pleasure in radio dependent on using operating time efficiently to communicate? In having worthwhile connections with reliable known operators, as well as making chance QSO's?

In the evening, or whenever you have spare time on your hands, do you ever sit down to the key and wish there was something more interesting to do than spend a few hours in hello-goodbye QSOs; QSOs, that outside of a difference in location of the other fellow, signal strength, and perhaps slight changes in WX conditions, will be identical to the previous one hundred or so that you have tabulated in the log book? I know that every real amateur never fails to get a thrill when he hears his call coming back to him through his receiver and when he copies down the name of some distant place together with the description of his signals. That is what makes a man stay with it for years and still have the enthusiasm of a beginner. But I also know that every real amateur is on the lookout for anything that will increase his interest in radio. Making your station an O.R.S. will do this. It will add to your self-satisfaction. It will, and rightly so, make you think you are doing something important. Yet all the enjoyment that was present before will still be there.

A few restrictions are often just what a man needs to show him the best way to conduct his affairs and start some good habits. Anything that is worth doing is worth doing well. That was said a long time ago and is widely quoted, yet it takes some of us quite a while to realize the amount of truth that is packed in that statement. Did you ever hang up some piece of apparatus or gadget in your receiver, in order to save the time it would take to put it in right, and then have the signals disappear every time someone moved around in the house? Then after putting up with it for a time, finally fixing it up right and ever afterward wondering

\* Swanton, Ohio.

why you didn't do it that way in the first place? I think something of this nature has happened to all of us.

Do you think that when the Federal Communications Commission first issued an order compelling amateur operators to keep a log of their transmissions that many operators of reasonable experience found this a burden and made complaints? I don't. Most of us discovered, long before the Commission came out with this order, that keeping a log was a very sensible and convenient thing to do. They were doing it as a matter of course when orders were received that it must be done. The same is true of O.R.S. operators. Any conscientious traffic handling operator who has his station appointed an O.R.S. continues operating and hardly realizes that he is conforming to certain regulations. He naturally got into the habit of handling traffic the O.R.S. way before the appointment. It is the most logical method the A.R.R.L. can think of. The League is not trying to impose a burden—simply working towards highest efficiency. Official recognition (as O.R.S.) is extended by S.C.M.s to those who can qualify as good operators and "reliables" in handling traffic.

In regard to not having time. Of course there are some who, because of their work or other reason, do not have much time to transmit. But those who find it possible to be on the air two or more times a week have the time to be O.R.S. The thing they must do is make this time count. By setting aside certain periods during the week for operating it is easy to keep other things from interfering. Then, if a few good traffic schedules are maintained in conformation with these operating periods, the amount of traffic handled during a month's time will reach a sizeable figure.

Handling traffic is an excellent method of increasing code speed and obtaining a knowledge of how messages are set up and transmitted. The A.R.R.L. message is not radically different from the commercial form. Recently the A.R.R.L. official check was made the same as regular land count—the text-only check. Not long ago they were having a convention in a nearby city. An amateur station had been built for the occasion and messages were solicited. For several hours I kept track of this station, sending out an endless stream of traffic. The messages were sent at a good fast speed, but I heard no repeats. A message would be sent out—the station would stand by for an OK—a few seconds later they would start on the next message. The preamble of these messages was abbreviated until it was meaningless to the inexperienced, yet it contained all the information for the proper handling of the message. This traffic was being handled with a speed that it seemed could not be bettered. It was being handled by O.R.S.

To those operators who are past the experimental stages in amateur radio—those who have had about enough ordinary operating and who are beginning to look around for something that has some importance attached to it—I would recommend their applying for appointment as Official Relay Stations.

## DX Notes

THOSE amateurs who have been inquiring about the authenticity of the VU2CP they have been working will be interested in information received from the secretary of the Indian Radio Amateurs' League. Mr. U. S. Jayaswal of Muzaafarpur, India, who is the legal holder of VU2CP, advised the I.R.A.L. secretary that he has not been on the air for some time, and that some one must be pirating his call. . . . Cards for unknown VU and CR3 stations may be sent via the QSL Bureau, Indian Radio Amateurs' League, Satya Sadan, Santa Cruz, India. . . . W2CQX recently worked his 110th country. . . . W3MG reports QSO with ZB11, Malta, at 6:00 p.m. EST, May 21st; frequency about 14,280 kc. . . . IIIQ was worked by W3MG, May 25th, at 6:45 p.m. EST, and is reported coming through consistently just outside the high-frequency end of the 14-mc. band. . . . Add to the many hams who have worked EA4AO on 3.5 mc.—W8FKO. . . . U3AG and U4LD were worked by W9NBM, Rock Island, Ill., around 10:00 p.m. CST on June 4th and 15th respectively. U3AG was on approximately 14,380 kc., U4LD on 14,300 kc. . . . W5EKV, Brookhaven, Miss., claims a QSO, the "long-way-around," with J2CL on 14 mc. . . . W6DTB, Randolph, Utah,

worked eight Europeans in five countries in three hours on 14 mc. between 10:30 p.m., May 8th, and 1:30 a.m., May 9th. . . . W8KKG in West Virginia says to tell the gang that 14 mc. is hot for Europe and Asia between 2:00 and 4:00 a.m. EST. J7CJ was heard by W8KKG on 'phone working a W7 about 3:50 a.m. EST. W8KKG worked K6JPD at 3:30 a.m. and J2CN at 2:45 a.m. . . . With only 15 watts input, W8WQ worked VK2EO at 2:00 a.m., June 17th. . . . W3UVA worked VK2EO "both-ways-around" twice on 14 mc. and once on 7 mc., all within one week without a schedule of any kind. . . . European QSOs from the west coast have been extremely plentiful of late. During June W6CUH had 142 QSO's with 66 different Europeans. On the 22nd alone he had 23 European QSO's, 17 being during the evening. F8EO had 240 west coast QSO's during June! This was all on 14 mc. W6CUH has worked Europe almost every hour of the day from 7:00 a.m. to 11:30 p.m. . . . A nice bit of DX work is reported by W3AMP, Trenton, N. J. From May 2nd to June 8th, 38 days straight, he had at least one contact with a station on a continent other than his own each day. Every continent was worked, contacts being with 30 countries, all on 14 mc. Japan was worked four times. . . . W3AMP reports YT7VH, Belgrade, Jugoslavia, putting a T8 signal through on the 14,400-kc. end of the band. . . . Between April 28th and June 2nd, W3AMP made six contacts with Japan. He QSO'ed Russia three times, U3VC, April 6th, U6AH, May 15th, U1CR, May 17th. . . . W8EPE suggests that stations outside of W and VE make more use of the high frequency end of the 7-mc. band, avoiding the highly congested low-frequency end. . . .

A message from G5GQ via W3EJO, W9RSO and W1EAO reports a new Siamese station, HS1A, worked there August 1st. Frequency, 14,100 kc. Crystal p.d.c. note. . . . W2GOX advises that ZL2RY is enroute to the Union of

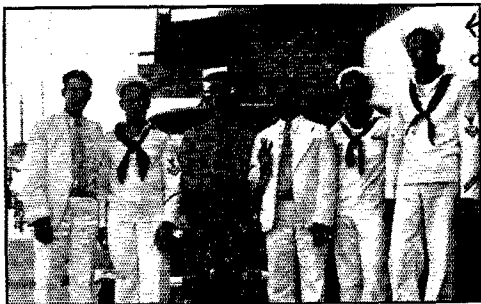

GUAM GREET'S YOU!

Left to right: OM2BC, OM2LD, OM1TB, OM2PI, OM2LD and OM2RX.

South Africa where he will go on the air as a ZS. . . . W7BB, operating under the call K7BC at Mist Harbor, Alaska, has recently WAC'ed. Stations QSO'ed for W.A.C. from K7BC: VK2OJ, XU3ST, U8AG, ZC6AL, W7DL, LU4BC. . . . On July 11th, 8:00 a.m. EDST, W1TS worked a rare one—VR4BA, Solomon Islands, d.c. note on 14,325 kcs. . . . The following list of Asian frequencies, compiled by W8BTI, are submitted by W8MAB: J2LK 14,372 kc., J2LB 14,304, J2GX 14,316, J3DP 14,178, J2LU 14,116, J2GW 14,290, J2KJ 14,150, J2HG 14,370, J5CE 14,340, VS6AG 14,274, XU6F 14,325, XU8AL middle of 14-mc. 'phone band, self-excited. . . . W8MAH reports the frequencies of active Russian stations: U1CN 14,420, U3RS 14,420, U3AG 14,430, U6AH 14,300, U1CA 14,410, U3VB 14,370, U3QE 14,370, U2NE 14,380, U3DI 14,270, U3CT 14,420. . . . On the morning of July 13th, for over one hour W2FLG worked VR4BA, who was using only 3 watts input! He was QSA5 R8 at W2FLG. . . . W1BOR, Rangeley, Maine, worked ZL2GN on 3510 kc., July 3rd, at 3:30 a.m. ET. That's DX! . . . Some notes from W8MAH: ZE stations are on 14 mc. between 1:30 and 4:00 p.m. . . . VQ4CRO has been coming through almost daily on 14,090

kcs. with a T9X note between 1:30 and 4:00 p.m. EST. . . . VQ8A has been heard close to 14,370 kcs. He was heard between 1:30 and 3:00 p.m. . . . F8MZ was heard to say he is located near Casablanca, Morocco. He has a rather rough signal in the 14-mc. band. . . . ZB1E's frequency is about 14,320 kcs. . . . SU1KG is to be heard around the high-frequency end of the 14-mc. 'phone band with a d.c. signal from about 4:00 p.m. to 6:00 p.m. EST. . . . YT7VN has been heard on approximately 14,120 kcs., d.c. note, after 4 p.m. EST. . . . SX3A is on occasionally with hissy i.c.w. between 14,240 and 14,300 kcs. . . . W5BNO worked FT4AG, Tunis, at 11:55 p.m. CST, July 18th. Note was d.c., frequency about 14,380 kcs. . . . FT4AG is on about this same time every day. . . .

## 28-mc. Activities

Interest continues high in "ten-meter" work, although conditions have been rather sketchy from mid-July. The fact is, however, that the band may open up anytime and bring on the excellent performance that took place during June and early July. The real 28-mc. men are sticking with it. Despite the fact that the band may open up for only very short periods some days, hardly a single day passes but what some communication is accomplished. And when a really good day comes along anything can happen.

Refer to page 52, August QST, for dope on the Loving Cup offered by the Lakewood (Ohio) Radio Club to the first radio amateur who Works All Continents on the 28-mc. band after September 1, 1935. Oil up your gear and go after it!

W9BVI had a short QSO with VK2EP on July 19th at about 7:00 p.m. CST. W2GKR has a weekly schedule with E18B. G5LA is anxious to make schedules on 28 mc. with any U. S. stations. W2FL, QSO G5LA, reports that G5LA heard W1CCZ on August 1st between 1955 and 2030 GT. About August 20th G2TM will resume his schedules of automatic sending on 28 mc. He transmits from 1200 to 1230 GT and also from 1630 to 1730 GT, listening for replies after each of these periods. On June 16th FASBG heard W1AVV, W2CPA, W8MQO and W1DF. Those operators having a regular schedule for operation on "ten" are asked to send us their line-up. W5EHM is on 28,016 kc. daily at noon and in the evening from 6:00 to 7:30 p.m. CST. HB9J, the only Swiss station on 28 mc., had worked 27 stations in ten countries up to the last report. W6RH worked VK2EP several times in early July. VK2EP has a beam pointed in the direction of U.S.A. with 200 watts input, 'phone and c.w., on 28,010 kcs. W9RGH has an automatic transmitter on 28,308, which he runs daily between 6:30 and 7:00 p.m. CST. W5EHM heard TI2RC on July 14th. W9FFQ on July 14th heard LU3DH and LU9BV. W4AJY worked VK2EP on July 13th and 14th. During the first two weeks of July W5WG heard 75 different stations on 28 mc. W1CUN reports hearing VK2EP, ZL2BN, ZL2GQ and W6VQ on July 13th. Among those working VK2EP are W6VQ, W9NY, W9FM, W4AJY, W9GBJ. W1AVV worked D4KPJ on July 8th. The approximate frequencies of several DX stations heard on 28 mc.: VK2EP 28,020 kc., LU1EP 28,090, D4KPJ 28,300, LU9BV 28,095, LU3DH 28,600, OA4J 28,000-281,000 (self-excited).

Who will be the first "ten-meter" W.A.C.?

## West Coast Hamfests

The Oakland Radio Club will be host to one of the greatest gatherings of amateurs ever to assemble under one roof in Northern California when the A.R.R.L. Tri-Section Hamfest is called to order on Saturday evening, September 28th.

The program includes the best food money can buy, several hundred dollars' worth of valuable prizes, good speakers and a general FB time. One dollar covers everything. The meeting will convene at the Ashmes Temple, 13th and Harrison Sts., Oakland. Advance reservations are suggested due to the fact that the banquet will be limited to only 600. Write Charles Ziegler, 1322 60th Ave., Oakland, Calif., sending remittance to cover your reservation. All those received by September 25th will be privileged to participate in a special prize drawing.

The Marin Radio Amateurs will hold their second annual picnic and hamfest at McNeers Beach, near San Rafael, Calif., on September 15th. All amateurs are invited. Full details may be obtained from W6SG, 79 Elinor Ave., Mill Valley, Calif.

## QRR—New York Flood

**B**ETWEEN the hours of 10:00 p.m., Sunday, July 7th, and 1:00 p.m., Monday, July 8th, 8.2 inches of rain fell in the Finger Lakes region of New York State. Loss of about 40 lives and property damage of over \$5,000,000 was the grim cost of the inevitable floods.

Ithaca, N. Y., was right in the thick of the worst of the storm. W8BOA of that city lost no time in getting his 1.75-mc. 'phone on the air, followed shortly by W8MBW on



TYPICAL VIEW, DESTRUCTION TO HIGHWAYS

3.9 mc. W8BOA communicated with the local Red Cross Chapter and was very shortly busily engaged in handling messages for the flood-stricken (many homeless) people, who were anxious to relieve the anxiety of relatives. W8KXR, who was located in a lowland part of the city, was delayed in getting his 1.75-mc. 'phone on the air by the high waters, which routed him from his home about 2:30 a.m. He helped materially when he finally was able to return to his shack. W8KXR heard W8CYQ calling the flood area with messages for Ithaca. Contact was established and the traffic promptly delivered. This traffic had come from Kentucky on c.w. to W8GWT, Penn Yan, who turned it over



W8CYQ ACTED AS ONE OF THE EMERGENCY STATIONS

to W8CYQ, also in Penn Yan, for relay to Ithaca. W8KBW, Ithaca, cooperated as much as possible.

W8BLP of Geneva provided an excellent outlet for Ithaca traffic, handling quantities of important messages from W8BOA and relaying them over land wires. In addition, W8RL and W8MBZ of Buffalo, W8BIH, Elmira, W8NJY, Warsaw, W8CYQ, W8BLP, W8KXR, W8KBW and W8BOA formed a 1.75-mc. 'phone network and performed

in veteran style. They hunted down missing persons and lost aeroplanes, forwarded descriptions of road and bridge conditions, and helped generally in the rescue work. Watkins, Glen, Elmira and Hornell had no telephone or telegraph communication; the network was on the job for forty-eight hours, when the lines were again established.

W8AAC gave valuable service at W8BOA and W8MBW in making personal contacts with message addressees. W8NXQ of Syracuse took traffic from Ithaca stations as did W8LIM, W8LDA, W8CQY, W8BHI, W2HYF and W8AGU on 3.9 mc., and W8MXQ and W8NVM on 1.75 mc. W8MJT worked with W8BOA in incoming traffic. Others cooperating included W3LT, W8LHC, W1GYA and W1BXK. W8EOL, one of Ithaca's amateurs, didn't have the chance to help out—the first floor of his home was completely inundated!

On the evening of July 8th, W2EGF, O.R.S. and A.A.R.S., worked W2BCX, also O.R.S. and A.A.R.S., and stated that he was in communication with W8BHK, O.R.S. at Bath, N. Y., which town was without lights, gas, or telephones. W8BHK was operating on battery power. This information was forwarded with help from W8GUC/WLTC to WLM, A.A.R.S. Washington control station, from where a special message (ZLVA) was sent to all Army Amateurs requesting that they keep the vicinity of W8BHK's and W2EGF's frequencies QRM-free. First Corps Area A.A.R.S. were standing by on the special 3497.5-ke. frequency to render all assistance possible. W8BHK and W2EGF maintained regular hourly schedules, much traffic being relayed from W2EGF to W2BCX. Later, especially the following days, the 9th and 10th, W2BCX handled traffic direct with W8BHK. W8DSS, W2AIZ and W2DXO also helped out with traffic from W8BHK. By July 10th conditions were much better and relief communication was wound up that evening. W2SC/WLN on July 8th was put on the air by W2PF, who sent a QST to all amateurs asking them to keep the 3500-3600-kcs. channel, where the emergency work was taking place, clear. A.A.R.S. W8BME and W8CSE cooperated in monitoring transmissions from W8BHK. W2EGF copied a press report from W8BHK for the Schenectady papers about 1000 words in length! Other stations cooperating and standing by in the emergency included W1BVR/WLG, W2BZZ/WLMG, W2GGE, W8BSP and W3AKB/WLQB.

It pays to be prepared! Little did the amateurs concerned in the New York State flood emergency work expect that they would be called upon to provide communication. It may be *you* next time!! Build that emergency gear now!

## Briefs

The motorboat regatta under the auspices of the Oakmont Boat Club and the *Pittsburgh Sun-Telegraph* at Oakmont, Pa., was the scene of some interesting 56-mc. work. The patrol boats, judges' stand and the pits were all equipped with 56-mc. transceivers and the races were reported via 56 mc. to the judges' stand. Members of the Amateur Transmitters Association of Western Pennsylvania cooperated with the Regatta officials in this effort to make the race more interesting to the spectators.

"Believe it or not," W6JTV can hear no first district stations at his address. But when he takes a receiver as close as four blocks away, the "ones" roll in FB!

Did you see W5UE's QSL in the Universal News Reel showing the airplane endurance test at Meridian, Miss.?

W5QI, Hazen, Ark., moved his rig from a tornado cellar to another location across town. When he started moving, a frog jumped out of his tool box. Midway between his new location a 12-inch lizard hopped out. As soon as he reached the new QRA and was setting his tool box down, a 6-foot rattlesnake came through another crack. That was too much! He called in W5FB and the Chief of Police, armed to the teeth with high-powered rifles to make a thorough inspection. Nothing else was found; however, W5QI feels

leery every time he puts on the headphones, expecting some beast to crawl out into his ears!

A schedule with VE1IN, Bowdoin College Ornithological Expedition at Kent's Island, Bay of Fundy, is reported by W1JL, West Acton, Mass. VE1IN is heard mostly on 3515 and 3860 kcs. using c.w. and 'phone.

While on a visit to A.R.R.L. HQ's and operating at W1MK, W2AYN received a message he himself had sent to MK several days before! Hi.

### Amateurs Locate Stranded Yacht

At about 10:00 o'clock on the morning of July 5th, W4GQ heard an SOS on the 7-mc. amateur band. It was being sent by a station signing VE3FL, which turned out to be the Canadian ketch *Casarco Fifth*. W4GQ established communication and learned that the party had been adrift off the south coast of Cuba for seven days, that the boat was leaking badly and had a woman on board who was critically ill. W4GQ telephoned WOE, the Radiomarine Corp. of America station at Palm Beach, and gave them the complete information. WOE immediately notified the Cuban government, U. S. Coast Guard, and broadcast information to shipping which might be in that vicinity. The Cuban Navy dispatched several vessels in search of the *Casarco* and, on July 7th, located and towed her to port.

CM2AC was tuning over the 7-mc. band on July 7th about 9:30 a.m. when he heard a p.d.c. signal on about 7150 kc. calling CQ and signing VE3FL. Expecting merely a QSO with Ontario, CM2AC answered. Communication established, imagine his surprise to copy "Hr Yacht Casarco 5 miles S E of Cape Corrientes Have been waiting for coast guards for three days All well on board but drinking water running low If you have a fone will you call them and ask how soon we may expect them will QRX while you call." CM2AC promptly called the Navy headquarters where he knew they had been trying to reach the yacht by wireless for several days. Passing along all the information he had received and asking for a reply, he received the following, which he relayed to VE3FL: "Tell them the gun-boat *Santa Clara* will get after them forthwith." The woman, who had been reported ill, was now well again, the trouble being "too much sun."

A real thrill for W4GQ and CM2AC, this incident is the kind that helps amateur radio maintain its high place in the public esteem! FB!

Upon receiving the certificate for Southern Minnesota in the 1934 Sweepstakes Contest, W9DMA has won four major A.R.R.L. contests in a row in his Section. And it was done with not over 25 watts into the antenna from a self-excited rig. W9DMA won the 1933 Sweepstakes, 1933 DX Contest, 1934 DX Contest and 1934 Sweepstakes awards in the Southern Minnesota Section.

During the camp period of the H.Q. Co., 3 Bn., 145th Infantry at Camp Perry, Ohio, W8LVV/8 handled traffic between Akron and the encampment. Set up at the camp W8LVV/8 maintained schedules with W8KLEH and W8HCS. Service was excellent; answers to messages were often delivered within five minutes of the starting time. A total of 85 messages went through W8LVV/8 from July 7th to 21st. W3CLEH, on the same frequency as W8KLEH, helped out in relaying from W8LVV/8 when skip prevented solid copy at W8KLEH. Operators at W8LVV/8 were W8EVI, W8IMC, W8FKY, W8OJE, W8LVV.

W3DGN portable was operated from Camp Morris, N. J., during the summer encampment there. Seven operators kept a 1.75-mc. 'phone rig active. The final stage employed a 211D and the lads stepped out in fine shape.

VK3LN of Melbourne, Australia, has been touring the States, visiting many hams en route. While in Washington he stopped in at W3ZD to attempt a QSO with home. Tuning over the 14-mc. band, a real thrill greeted VK3LN when he heard an R7 signal calling "VK3LN de VK3MR"! It was

his buddy back home. QSO was established between W3ZD and VK3MR and more than an hour and a half of communication followed, an experience long to be remembered by VK3LN. While in N. Y. C., VK3LN maintained communication with VK3MR through W2GOX.

## Milwaukee "Bootleg" Situation Under Control

By H. C. Kaetel\*

IN EVERY major city of the United States the licensed amateur has come face to face with the peculiar species of individuals who think they *do not* need a license. It is not this writer's intention to go into the reasons why unlicensed stations should not be permitted to operate or to explain why the operation of "bootleg stations" is detrimental to amateur radio. The reasons are all too apparent. We amateurs in Milwaukee were faced with such a situation. During 1933 and 1934 not less than forty or fifty unlicensed transmitters using some fifty to sixty borrowed or "home-made" calls were in regular operation in Milwaukee in the five-meter band alone. Occasionally one of these bootleggers would get nerve to move into one of the lower frequency bands. Call stealing was a common practice. Many times different groups in Milwaukee raised their voices in protest! Our good friend Inspector Hayes at Chicago could do little for us, his explanation in his letter to the author under date of March 6, 1935, reading in part:

"From an official standpoint, we must state that it is the duty of every citizen to report to the authorities any violation of the law. . . . It is impossible with limited personnel to observe all violations and we must rely to a great extent upon reports received from others. . . . It is, however, difficult to obtain authority for the expenditure of the necessary time and money.

"We have received rumors and reports of operation of unlicensed stations on the ultra-high frequencies from every large town in the district and a correction of this condition would be extremely difficult without the aid of the licensed amateurs."

The Kilocycle Club of Milwaukee determined to launch a campaign against the bootleggers. When the Board of Directors of the Kilocycle Club announced that it seriously and determinedly was going after the owners of illegally operated stations the results were surprising. Even stations of non-members were heard night after night warning bootleg stations to get off the air. Licensed stations were heard signing with bootleg stations to be free of criticism of working them. Station after station was dismantled. A few stragglers promptly received a visit from the Kilocycle Clubs Directorate. The campaign was a success, Milwaukee was free of unlicensed amateur radio stations. The next thing was a means of keeping it that way.

Keeping the bootlegger off the air is easier than most readers might expect. Members working a station on the five-meter band for the first time invariably ask for the exact location of the new station. A visit to the address discloses whether or not there is such a station and whether or not it is licensed. If no address is given, in response to a direct request it is assumed that the station is being operated illegally. If the station proves to be a phoney the members of the club observe its operations and combine information and clues. Sooner or later the operator of the unlicensed station slips up on his conversation and dishes out ample data leading to his identity! To date it has never been necessary to resort to the direction finder or field strength meter.

When Mr. Gallagher of the Chicago office of the Federal Communications Commission visited Milwaukee on the 22nd of June of this year, he promptly called on Mr. William Brossmann, W9EQP, at the latter's office and together the two made the rounds of a couple of dozen Milwaukee ham

\* W9SNK, Chairman Publicity Committee, The Kilocycle Club of Milwaukee.

shacks. At the end of the day and about fifty miles of travel they had uncovered no evidence of bootleg operation in the city and had received some dope regarding two "suspicious" stations in one suburban section. This condition is truly amazing and one is led to wonder how many other cities of 700,000 can report similar conditions.

The most outstanding piece of work in this field accomplished by the Kilocycle Club was the running down of the Milwaukee 20-meter bootlegger who used the call OK1AA in ARRL's contest this spring. This station was heard working stations in all districts and exchanged contest numbers with many. Was that chappie ever surprised when the Kilocycle Club delegation called on him? The case is now in the hands of the Commission.

When the Kilocycle Club Board of Directors hit any stubborn case where an operator will not listen to reason evidence is gathered together. There's one most excellent place to present it for action. That is the office of the local Federal District Attorney who is charged with law enforcement.

## BRASS POUNDERS' LEAGUE

(June 16th-July 15th)

Call	Orig.	Del.	Rel.	Total
W6GXXM	70	141	1494	1705
W9RYD	-----	-----	1471	1471
W3BND	103	102	680	885
W6TAM	165	253	286	704
W7BVE	11	12	616	639
W7AYO	60	77	464	601
W7CQI	49	52	461	562
W6HDV	149	140	236	525
OM2RX	240	136	140	516

### MORE-THAN-ONE-OPERATOR STATIONS

KA1HR	481	377	906	1764
K6DV	54	26	554	634
W6LPH	368	160	-----	528

These stations "make" the B.P.L. with totals of 500 or over. Many "rate" extra credit for one hundred or more deliveries. The following one-operator stations make the B.P.L. for *delimiting 100 or more messages*: the number of deliveries is as follows: Deliveries count!

W6GHD, 194	W6RJ, 116	W1GVV, 102
W61GA, 158	W2CHK, 113	VE5LX, 101
W9LEZ, 134	W6JTV, 106	More-than-one
W8CTO, 122	W3BWT, 105	W6HRH, 256
	KA1AN, 102	

### A.A.R.S. STATIONS

Call	Orig.	Del.	Rel.	Total
WLMF (W9RYD)	-----	-----	614	614

### MORE-THAN-ONE-OPERATOR STATIONS

W7QB (K6DV)	362	89	648	1099
WLM (W3CXI)	100	35	768	953

A total of 500 or more, or just 100 or more deliveries will put you in line for a place in the B.P.L.

## O. B. S.

The following is a supplement to the list of A.R.R.L. Official Broadcasting Stations in October QST (page 49): W2AMB, W3DNG, W3DNU, W4CZA, W4DDF, W5EHM, W7AVM, W7BNX, W8CFU.

## National Highlights

THE most outstanding bit of communications work reported for this issue is the performance of amateurs in the New York State Flood in July. A story on their part in the emergency appears elsewhere in Operating News.

When this appears in print the summer season will be winding to a close, and amateurs should be thinking of radio more actively again. As is always the case during July and August, much time was spent in rebuilding and planning the new rigs for fall. Many operators went on "active duty" at National Guard camps, R. O. T. C. encampments, training cruises with the N.C.R. etc. Several instances of communication provided by amateurs between various N. G.,

Boy Scout, etc., camps and the homes of the campers have been reported. Much valuable assistance has been rendered à la 56 mc. at boat races, regattas, and the like. Vacations have in most cases been spent and the "home stations" are again being oiled up for action. Let's go!

W3GS, S.C.M. Easton Pennsylvania, gave a fifteen-minute talk on amateur radio and the activities of the A.R.R.L. over station WHAT, Philadelphia, on July 16th. The main purpose of the talk was to impress upon B.C.L.'s the importance of amateur radio by stressing emergency work, message handling, etc. Amateurs should embrace every opportunity to talk up amateur radio, talks over broadcast stations being one of the best means of spreading the gospel.

The Ham Fiesta at San Diego went over very well and every one seemed to enjoy the fun. A few of the activities and the winners: Tug o'War ('phone vs. c.w.), won by the 'phone men, 56-mc. hidden transmitter hunt, won by W6LRC. Ladies Audition Contest, won by the YF of W6LIP. QRM Copying Contest, won by W6BKZ. First prize for portable gear went to W6IMU. An interesting talk was made by the radio inspector, Mr. Linden. W6USA was visited by almost every one and a few of the lucky ones got to operate it. The gang is now looking forward to the Pacific Division Convention at Los Angeles, Aug. 31, Sept. 1st and 2nd.

K7PQ, Alaska S.C.M., has announced an S.C.M.-hour for contacts with Alaska stations only, to be held from 8:30 to 9:30 P.S.T. each Monday night, on the 7-mc. band. K7TVF schedules KA1HR daily. The Brass pounder, edited by W7LD, Washington R. M., now includes activities in the Montana and Idaho sections. Plans are being considered to make this paper cover the entire Northwestern Division. A "spot frequency" net is being organized by the Montana S.C.M.. W7AAT, W7CWY schedules K6BFI tri-weekly. During the first six months of 1935 W7AYO had over 2000 QSO's, nearly 500 of them over 8000 miles DX.

W5EJZ had a 1.75-mc. 'phone in operation at a high school exhibition in Dallas, Texas. The semi-annual hamfest of the Guadalupe Valley Radio Club was held on the Guadalupe River near Ceuro, Texas, the night of July 13th with about 50 in attendance. W4ACB, Western Florida R.M., is conducting a Sectional QSO contest through the "Sawnee Review," section bulletin. W4KB, Valparaiso, Fla., is issuing a newsy sheet called the "Dope Bucket." September 1st will be Hamfest Day in Charleston, S. C. where North Carolina, South Carolina and Georgia hams will meet for a big time. W4BBV, Assistant S.C.M. for Georgia, has started the ball rolling for a State Net to begin about October 1st.

W1GKC handled traffic for the A.E.F. Convention at Rockland, Maine. W2GOX received a 900-word article for QST by radio on 14 mc. from VK3MR. W3DBG invites DX traffic; he is on the air daily from 6:00 to 7:00 a.m., 7260 kc. W3AAJ and W3BRY are lining up a contest for the Roanoke Division, to start September 1st. W8HD, West Virginia S.C.M., has retired after four consecutive terms. W8KKG will carry on. The North Carolina "floating club" had a bang-up July meeting under the auspices of the Wilmington Club.

A hamfest at Pueblo, Colo., was enjoyed by 175 hams. Sixty persons attended the Utah Amateur Radio Club hamfest. The Framingham (Mass.) Radio Club on July 4th maintained a 56-mc. press network for athletic events at the Chamber of Commerce celebration and two-way airplane to ground contact. W1FIY and W1FCZ did the aircraft work while W1JAT and W1DDM covered the ground end. W1FIY cleared message traffic on 3.5 mc., with W1FPO, W1GMD and W1DDM as relief operators. W1LCO, W1BWJ, W1IVL, W1JBH, W1JQA and W1DDM reported events to W1JAT, the net control. W1RE took a message from K4DDH, 'phoned it and delivered answer in 15 minutes!

The Nevada Amateur Radio Association held a picnic at Zephyr Cove, Lake Tahoe, on July 21st. W6GHD has daily schedules with OM1TB and VK6MO. W6AQO was winner of the Oakland Radio Club's 28-mc. contest. This club has now announced a new 28-mc. contest to run through September. W6AYV operated a portable at the San Francisco

Boys' Club summer camp. The annual North Dakota A.A.R.S./A.R.R.L. picnic was held at Hope with thirty registered. Many amateurs attended the La Crosse (Wis.) Radio Round-up.

W5ASF, Ponca City, Okla., transmits code lessons from 6:00 to 6:30 p.m. each Monday, Tuesday, Wednesday and Thursday; a new class starts October 1st. W5DNE, Sherman, Texas, reports that an Amateur Radio Exhibit will be installed at the Red River Valley Fair, September 30th-October 5th. Both 3.5- and 7-mc. rigs will be in operation. W9FM and YF, W9SLG, announce the arrival of a Junior operator on July 23rd. The Northern Wisconsin Wireless Association held a hamfest at Superior on July 14th.

## STATION ACTIVITIES CENTRAL DIVISION

ILLINOIS—SCM, Fred J. Hinds, W9WR—ERU is off the air due to bad '04A. TWL is on with a 71A-flea power, WC is on 28 mc. Rig at SMD has more bugs than his dog "Spot." ITA worked three new countries. STG is touring Yellowstone Park. OKZ has YL-itis. CGV is on 7 mc. with 225 watts. KMN schedules California after finishing new rig. RVB is getting ready for Class "A." IEP visited DBO while on tour. ITL has nine-pound junior op., according to KXE. IYA is A.R.R.L. again. FB, Farming keeps ACU busy. TZI has new rig with '10's in final. PIO is putting 825's in final. The heat keeps EZV from activity. PFJ wants Model "T" Ford to visit neighboring hams. BRX has new 14-mc. antenna, two half waves in phase, fed by 600-ohm line, matched with quarter-wave stub. New YL at NXG, born July 9th. PNE is losing antenna, so will build new one for fall work. DOU's ear lost breath on way home from Starved Rock Hamfest. Hi. CHM is back on the air. COW is pounding brass at TTE while rebuilding his own rig. KJY, the big traffic man, is rebuilding for fall work—watch out for him. MJE reports Marquette Radio Club on rampage on 56 mc. LZU has another hobby—buying cars. THB of Little Egypt applied for O.P.S. He reports lot of activity in Egyptian Amateur Radio Society. Wedding bells soon for GFY and JTC with AND not far behind. TAQ gave up when MIN came on with '03A. TXQ is now O.R.S. PUJ is on with high power, WR is running around in circles. After getting super started at SHP, his transmitter went on the fritz. KSD is all swelled up—with poison ivy. 8GBG is pounding brass at HQH while on honeymoon. UEU is now O.B.S. FO has new hobby—rifles with telescopic sight.

In memory of a departed pal and one of the finest hams who ever lived.

Ora J. Barnes, W9RPT  
Mt. Morris, Illinois  
—“Ogle County Radio Traffic Assn.”

Traffic: W9CGV 260 DOU 87 (WLT 2) ENH 76 FO 27 DDU 25 PSP 24 RAQ 23 KEH 22 DBO-NXG 14 STG 13 DPD 11 CUH-MCC 10 HQH-KHD-KXE 9 WR 7 ANQ 5 FTX-RVB 4 BPU-EVJ-JU-NHE-NUF 2 ILH 1 AND 6.

INDIANA—SCM, Arthur L. Braun, W9TE—SFG delivered a six-pound girl for TE. OEC spent month's vacation in N.W. TGC moved to new QRA. SUR has new ant. SAF works K6 on schedules regularly. JZA gets out fine thru QRM. RLA has new YL jr. op. LKI was heard in New Zealand on 14-mc. 'phone. EHQ is getting bugs out of new rig. HSF is doing fine as O.P.S. GQG is QRL A.A.R.S. work. HUV worked U1 for his best DX this month. DEJ got his PA0UB card at last. GFS is new O.B.S. TBM has "tk-in" control now. SDQ took Class "A" exam. IU is out for O.R.S. cup. SPB worked U2 for DX. UT is on with 46's after four years of rebuilding. ODH is doing fine with traffic. JHQ and DET are rebuilding. AXH is changing bias supply. SNQ has hat in ring for O.R.S. LLV is ready to have the knot tied. UUK and UZQ are new at Ind'pls. SOT worked about thirty countries with '10 in final. SOV is traveling in Europe. JIP and SOT are selling paper products. TE is planning 56-mc. rig. MQQ is DXing on 7 mc. LCA is giving grid bias mod. a try. AEA reports fine results on

56 mc. EKD repaired high voltage transformer. KLA is planning new 1.75-mc. 'phone. KPE likes his 53 in Class B for 'phone.

Traffic: W9TGC 16 DHJ 22 GFS 2 TBM 8 SDQ 4 IU 26 SPB 2 ODH 14 AXH 4 HUO 50 JHQ 37.

MICHIGAN—SCM, Kenneth F. Conroy, W8DYH—There is no doubt about the summer damper being on things! Plans of rebuilding and changing for a big season of traffic activity are underway at most of the stations in this Section. One spot nets will be rather numerous, and perhaps it'd be a good idea if we pick a common frequency for all of our Michigan one-spot nets and have one real net instead of numerous small nets. Hw? The Michigan Nines handled almost as much traffic as the Eights. The boys down this way had better be looking to their laurels! FB, W9's! Michigan Nines: Joseph Lessard, Box 223, Munising, Assistant S.C.M. —9TTY (10 watts input) handled message with 9RIU, Isle Royale, that caused the U. S. Coast Guard to take an MD out to meet a Conservation Dept. boat in mid-lake—the Conservation boat was carrying two men who had been hurt in a plane crash. The men got to the hospital okay. FB, boys. DDK offers to trade his fountain pen for a mill anybody! POX is back from Fla. The Misses PCU were presented with a nice new Vibroplex by the Conservation Dept. at the recent U.P. Convention. CSI has a portable at Laurium to keep the fist in shape. HSQ is going to build a superhet. OZM and Miss TQT are just like that!! Luck. RIT and EXT are seeking YL's now that their "steadies" turn 'em down! Tom, CE, moans the summer QRN not giving his high-power rig a chance. Hi. EQV reports that CEX has more time to pound brass now that OZM and EQV are together. XYL GJX reports a new commercial-looking crystal rig at last. She reports URB a new YL at Escanaba. TYS is now handling WX report between Marquette and Calumet where it is broadcast from WHDF. IOV is still on chicken farm and aches to get mitts on key. RHM and PDE are getting things lined up for a one-spot U.P. Net. FB. SQB sends the S.C.M. a few petals from his rose bushes to prove that he is going places in the contest he has with the PCU's —winner gets a chocolate cake—too bad if PCU wins! Michigan Eights: CSR is "Group-Control" station for the Detroit Area for 6000-8000-ke. survey and will handle all Michigan until someone willing to split up the work can be found out-state. Some of the fellows enlisted are: 8FTY KNT CEU (Detr.), ECI (Pontiac), 9SQB (Winona). Work on 56 mc. by following: ARR CEV IUP FEE IKZ IZV NAP CSR CYX IFE AKN (Detr.), QF (Saginaw); MWU KOX LIK LKW BDR CFZ RP and MRP in Ann Arbor. AKN is now at new QRA: 5034 Lakeview, Detroit. GUN left Detroit, now at 1865 Wood St., Muskegon. OEL's first transmitter will be a 500-watt job! QF is experimenting with beam antenna and hopes to work Detroit on 56 mc. CMP, Director Atlantic Division, is summing at Bay View with CIK as his call. NUL sends his first report and looks like a very promising traffic man. ICM says he's gonna marry Rita and move to Stinky Hollow! DED, a former anti-7-mc. man, says that 7 mc. is best for rag-chewing! BJ says p.m. fishing is okay, but he won't get out of bed in a.m. for any fish! IOR is trying to make a big garden help support his eleven jr. operators! LFA worked G2SA on 7 mc. MDF (?) reports from Mt. Clemens. DPE is working more and more hams into his C.C.C. Net. FB. MGQ wishes his '10s would stand up like FJL's do—200 watts input! IFD is big traffic man this time, operating a 6A6 TNT, 13 watts input, at "Y" camp. LZV is organizing a 'Phone Net and would like to hear from all 'phone men in Michigan. DSQ is playing that ancient amateur radio game known as "Blowie," tubes, filter condenser, etc.! EBQ will gladly swap a Model "T" for pair of 800's, receiver and transmitter power supplies. FWU is trying to tame his fist—says it has gone wild. LSF is becoming a great anti-summer QRN man—an itching fist is something hard to subdue. Stand-by for the big hamfest given by the D.A.R.A., October 13, 1935. About 1000 hams from Michigan, Ohio, Illinois and points east, north, south and west!

Traffic: W81FD 78 ICM 12 DED 11 MRP 9 GQS 6 FX 4 BJ-EGL-IOR 3 IUP-LFA-MDF 2 DPE-MGQ-MYG 1. W9TTY 36 DDK 25 TYS 22 PCU 19 GJX 12 CSI 10 CEX-RIT 4 HSQ-OZM-SQB 1.

OHIO—SCM, Robert P. Irvine, W8C10—AGL operated from Camp Perry during summer training of O.N.G. MQO is increasing power. LZK handled QRR to A.P. news from 5DRY about tornado. WE is back on 3806 kc. after trying for DX on 7 mc. MXH wants O.R.S. NAL is new O.R.S. (YL). ISK's best DX last month—two K6's. HMH is tearing the old rig down and rebuilding. LJV finally worked Asia, VU1Q, June 14th, at 6:10 p.m. E.S.T. Buckeye Short Wave Radio Club is on 1.75 'phone with call ODDJ. KFQ cancelled for the summer. MQC heard QRR from CZP July 8th. MZX is new reporter from Celina. New jr. operator at BKE. RN is still on KFNN. BAH went on U.S.N.R. cruise with U.S.S. *Wilmington*. BRQ is using RK-20 to drive a '52 on 14 mc. JOU was visited by JTI and MMN. OCM wants information on A.A.R.S. EME is back on the air. FGC is back from vacation. MFV, new reporter from Vandalia, expects to be on the air soon with a pair of Eimac 150-T's in the final. LAU has a job at last. KLN, new reporter from Maumee, is at Ft. Sheridan, Ill., with the Signal Corps. R.O.T.C. Camp. FKW, new reporter from Youngstown, wants O.R.S. MDZ, new reporter from Newark, is using Collins 4-A on 3550 kc. NVA will work portable for the summer at Lakeside. LJV is new reporter from Cleveland. APC sends his report in the form of a bulletin. KEV came home from a game of golf to find his antenna taken down and nicely coiled up and laying on his porch; it originally hung in a tree that was removed by the city. 'Phone Report (by 8HMS, Chief P.A.M.) BYF went on two weeks' fishing trip to Glennie, Mich., and took 1.75-mc. 'phone and 3.5-mc. c.w. portable rigs along. LIQ is new O.P.S. at Cleveland. JTW is operating on 14-mc. 'phone. GDC is with C.C.C. Camp at Natural Bridge, Ky. JFC has new 55-ft. tower.

Traffic: W8C10 165 (WLHC 14) AGI 161 MQO 77 LZK 35 LCY 34 WE 32 MXH-NAL 30 ITR 11 JFZ 10 ISK 9 HMH 7 LJV-KIM 5 KFQ 4 MQC-MZX 3 AQ 2 BKE 1. W8UW (WLHI 110).

#### DAKOTA DIVISION

NORTH DAKOTA—SCM, Hartwell B. Burner, W9OEL—JZJ is high traffic man this month with total of 31 OEL lost sky wire in tornado and has completely rebuilt. Annual A.A.R.S.-A.R.R.L. picnic was held at Hope Community lake with 30 registered. HJC gave the gang dope on A.A.R.S. for coming season. Meeting was climaxed by the drawing of prizes. New O.P.S. application: HHN. BTJ operated portable at Shoreham, Minn.

Traffic: W9JZJ 3 OEL 1.

SOUTH DAKOTA—SCM, Mike G. Strahon, W9PFI—RM, W9OQV. FOQ and CFU are assembling parts for 'phone rigs. GYG lost his new mast. FLO found out that 3.5 mc. is no good for summer. DRB and RWE took 56-mc. transceivers to National Guard Camp. BLZ, DRY, RWE, AJP and PFI picked up their 56-mc. rigs and drove over to ALO for an all-day visit. ALO worked 81XM on 28-mc. 'phone. He reports very little QRM on 28 mc. Bill and Bob Mattison are two new hams at Brookings. Their calls are U8H and SUI. DGR reports a new YL in the immediate family and that he will leave us about Sept. 1st to teach at Marshall, Mo. Plan to attend the State A.R.R.L. Convention at Pierre, Aug. 31st and Sept. 1st. Let's start off the fall season at the biggest and best hamfest ever held in South Dakota.

Traffic: W9CFU 3. FOQ 3.

NORTHERN MINNESOTA—Acting SCM, R. C. Harshberger, W9JIE—SCM, W9OMI is located temporarily at Fort Snelling. Continue sending reports to his home address at White Bear Lake. FYA, MCF, IOG, OMI, IPN, OOO and GBN hold a continuous hamfest at C.C.C. headquarters company at Fort Snelling, while they are waiting to be assigned to camps as ops. UJZ has new super. IGZ is busy farming. LSC is spending vacation at Kensington. LAY worked K6 with 16 watts input to a pair of '33s. OWU, OOV and OTW attended Wapeton, N. D., meeting. They all received prizes. OWU has variable angle of radiation antenna à la Reinartz. JIE has been working in last three months on 14 mc.; results: 10 "J" QSO's, 19 VK and KA, K6, PK, VS6. HRB is using 56-mc. transceiver in airplane.

Traffic: W9OWU 1 LAY 2 IGZ 1.

SOUTHERN MINNESOTA—SCM, Francis C. Kramer, W9DEI. DHP attended the Atlantic Division Convention while on his vacation. W9TQG has been off the air because of blown filter, YL-itis, and Ford-itis! AIR says five hours of commercial oping a day is bad for amateur oping. BN continues to handle most of the section's traffic. BTW cut his W.A.C. time to less than a day, and recently worked his 61st country. RHT has trouble trying to work 14mc. LJV is servicing radios in Albert Lea. RKG after camp at Snelling was heard to sing: "There's something about a soldier"! HGN after working five continents in six days wants to trade rig for a used car! AGO has an 841A final on 28 mc. DMA's first QSO with his new '03A rig netted him a ZL who reported him R9. ITQ is an old 56-mc. stand-by for the twin city gang. FMA will welcome any Minn. hams visiting Seattle this summer. ELA broke BTW's W.A.C. record with a total elapsed time of 12 hours 45 min. Who will be the So. Minn. station to break this record? PDL is making plans for the fall traffic. Southeastern Minn. hams, send PDL a list of your schedules. EKV is reported using automatic transmissions on 28 mc. FNK is a proud papa; he is making plans for a father and son station! GLE after getting his transmitter going now has his receiver troubles. Oh me! YC is inactive during summer vacation. RAU returned from Hollywood, and is now on 3.9-mc. 'phone. OGU is thinking of high-power 'phone. BKK has little time for oping. BXC receives many foreign heard cards from his 14-mc. 'phone signals. DEI spends most of his time on 28 mc. MZN spends his vacation in Iowa. GFA reports less QGM since FNK moved to town. FCS will be on the air this fall with a new rig. KDI took his commercial exam. Don't forget to join the Dakota Division Radiophone Ass'n. Many So. Minn. amateurs attended the La Crosse Radio Round Up. Don't forget the Dakota Division QSO party to be held this fall. EXTRA—MXW showed up DEI on a trout fishing expedition! Let's have more reports next month.

Traffic: W9BN 215 DEI 36 PDL 16 RHT 10 TQG 2.

#### MIDWEST DIVISION

IOWA—SCM, Phil D. Boardman, W9LEZ/WLUD—9ABE, 9CWG, 9HCH, 9HMM, 9LCX—RM's, 9AED—PAM. Not much activity these days with that mercury bubbling out the top, and conditions very poor. When you read this report the worst will be over, so let us all get set for

The Kansas Section is saddened by the passing of Karl Keller, W9BDB, who was killed in a fall from the fifth floor of a Wichita building. An active operator during the World War, his ham radio experience dates back to pre-spark days. W9BDB was one of Kansas' most active and popular amateurs, well known as a Chief Radioman in the N.C.R. and a charter member of the Wichita Amateur Radio Club. His passing will be deeply felt.

a big winter season. Now is the time to send in that O.R.S. or O.P.S. application. LEZ received first DX QSL cards. NNM has grid modulated 'phone working. AWH scheduled Boy Scout camp. NDN is putting the 242A into service. JXO handled Boy Scout camp traffic with a '12A in Hartley. CWG is rebuilding for fall activity. HMM is working in Davenport. UZY is new ham in Dubuque. IQR is putting in a '52. SQL will have crystal rig soon. UOX is new ham in Storm Lake. ACL has turned fisherman. LZI is vacationing in West Virginia. HAQ is having good luck with an RK-20 on 28 mc. HJA is working 28-mc. 'phone. TNY is talking of a half kw. 1.75-mc. 'phone. AZZ is experimenting on 56 mc. RPA is playing "pianner" in night club. NJD prefers foam to QRN. DFZ is a rabid baseball fan.

Traffic: W9LEZ 384 (WLUD 34) NNM 130 AWH 57 NDN 32 JXO 29 CWG 10.

KANSAS—SCM, O. J. Spetter, W9FLG—9KG and 9IOL, R.M.'s. BYV, GWI, and KLY attended ham-meet at Dodge City. KG has been on 14 mc. since April and has made W.A.C. and worked 54 countries in that time. OKH is on the air at Manhattan where he is spending the summer. TTR reports new calls in Iola: TTR and TTS, brothers, and TXA. IQI has TRS on 7 mc. in Hiawatha. OAQ reports new calls in Leavenworth: UIZ, TAE, UMZ, and UPK.



NI is getting ready for camp to open the traffic season. The K.V.R.C. is working hard on the biggest and best State convention ever staged. Watch for dates and dope. FLG is still in the throes of building and rebuilding. MUY worked a ZL and a CM on 7 mc.

Traffic: **W9MUY-BYV 8 RIZ 6.**

MISSOURI—Acting SCM, J. D. Mills, W9CJR—RYD leads the Section; he is building new shack, new receiver, and a new rig with 251A in final! TGN has new HRO and is holding daily schedules with ZL2KI. KEI is keeping regular O.B.S. schedules. NNZ still has DX fever. AIJ is having troubles "galore." KEF is on with new P.P. RK20 rig and says it's hot stuff, KCG, exponent of flea power, used ham radio to "thumb" a ride to Moberly picnic. OLC has been way down in Mexico visiting Mex. hams. HUN is now manager for service station. AWC is planning to take Class "A" exam. BTD got W.A.C. on 14 mc., including six "J's." SHV blew 841. PVW is constructing new 56-mc. transceiver. LVA is off the air to move QRA. AZL is trying out 56-mc. Tri-tet. MLR, after being QRL B.C. service and blown filter, gets back on the air, and is the only Boonville ham now active. Big North-Missouri ham picnic was held at Moberly, July 4th, with DIC as the perfect host; good attendance from over most of State and very enjoyable time was had. DIC is attending the National Boy Scout Jamboree at Washington, D. C., and took along a 46-mc. transceiver. DHN enjoyed meeting the gang at Moberly. EFC drove a lotta niles, detoured, rode the ferry and spent most of July 4th—at the Moberly picnic. Former S.C.M. C. R. Cannady, 9EYG, resigned and CJR has been appointed Acting S.C.M. CJR will try to maintain the high standard of handling Missouri's affairs, that has been set and kept by EYG. Sorry to lose EYG, and here's wishing him the best of luck, 'n' everything.

Traffic: **W9RYD 1471 (WLMF 614) TGN 32, KEI 12, NNZ 59, EYG 306, DIC 9.**

NEBRASKA—SCM, Samuel C. Wallace, W9FAM—RUJ has new transmitter working on 1.75-mc. 'phone and 3.5-mc. c.w. DGL is taking a little vacation, going up to Seattle, Wash., and making a sort of circle, coming back via El Paso, Tex. KQX spent the Fourth with MGJ in the hills north of North Platte and played with 56 mc. EHW is rebuilding getting ready for fall. IGF is still working on crystals. DMY installed 59 Tri-tet and says it works very FB. DMY sends following reports: JEE has new home-made super receiver which is mighty fine. IEO has built up transmitter, using 59, '46, 801 and '03A final. FGS is working a service job for both radios and electric refrigerators and is located at Bellville, Kans. TNN's folks moved to Detroit so we might hear him from there most any time. TQD is really going to put Fairbury on the map. KVB, on account of being a brakeman on the C.R.I. & P., is not home to be on the air regularly. FJL and PLO (brothers, and same outfit) use class B mod., and an '03A final. KPA has his transmitter all torn down and is on the fence as to just what his plans are; figuring on going to Denver, if he can land some sort of a job there. BBS reports the North Platte hams planning on a hamfest along about Sept. 1st. CRB received a very FB letter from Frank M. Scott relative to the Republican Valley flood. FWW is planning on joining the Army. FWC stopped in to see the S.C.M. on his way to Omaha to try to join the Army. FAM got the old rig rebuilt and it works pretty fair.

Traffic: **W9RUJ 10 DGL 2.**

#### WEST GULF DIVISION

NORTHERN TEXAS—SCM, Richard M. Cobb, W5BII—DXA is buying a new R.C.A. 838. CPB worked a European on 14 mc. and will be on N.C.R. cruise Aug. 24th to Sept. 4th. COK will operate 56-mc. 'phone in Chicago Aug. 15th to Sept. 15th. EUZ was on 1.75-mc. 'phone during exhibition at high school in Dallas. EEW has new rig with a 211 final. CPT and CPB visited the Naval Reserve boys in Dallas and took exam for Class "A." IA is helping the S.C.M. with plans for an improved section not for traffic. DNE is new O.R.S., he will handle fair traffic from 9IRE in August. BII is working traffic schedules on 7 and 3.5 mc. EHM is now O.R.S. and O.B.S. Listen for his Official Broadcasts on Mon., Wed., Fri., at 7:00 a.m. on 3515 kc. and 8:00 p.m. on 7030 kc. BKH reports ENR

from South Texas is in Ballinger with FB portable. FBQ worked his first two W7's and also first QSO with a YL (90UD). NW, our director, is back in Neches and on 7 mc. regularly. Hopes to see the gang at Corpus Christi Convention Aug. 16th-17th. EMG is active in Clarendon and plans to try 59's for high power. EFC is going on 1.75-mc. 'phone. EEF is on 14 and 7 mc. with push-pull '01A's. QU graduated from Texas A. and M. AAD is home from school in Arizona and has turned the cellar into a swell ham shack. RH will have new transmitter on 7 and 14 mc. as soon as the antenna is up. ANU is going to Miss. with AVF. Summer activity is light, but we want to be ready for a big time this fall. Section officials are to be appointed. Four R.M.'s, a 'Phone Activities Manager, O.B.S. and O.O. are needed. You fellows who are actively interested in section affairs are eligible.

Traffic: **W5DXA 77 CPB 64 COK 48 EUZ 39 EEW 34 CPT 29 IA 18 DNE 9 BII 64 EHM 8 BKH 4 FBQ 2.**

OKLAHOMA—SCM, Carter L. Simpson, W5CEZ—BJG leads the Section in traffic and blew his plate transformer. AMT helped BJG with WX schedules while CEZ was on vacation. CEZ visited several of the boys in Chicago while on vacation. EXZ wants traffic for his neck of the woods. BDJ visited PP while on vacation and was in turn visited by 6LEL. CVA is preparing to go to National Guard Camp. DQM is doing some work on 7 mc. and is running two daily schedules. ASF conducts code practice on 1.75 mc. for the local C.C.C. radio class. BAR is making plans to attend college in the fall. New stations reporting are FFC, Mulhall; FFK, Seminole and FDU, Boise City. FDU has FB7A and a new rig with 211 final. DDW had to return his new receiver to the factory for repair. COA applies for O.R.S. EYH wants to build up code speed and apply for O.R.S. AIR has been busy helping move police radio transmitter and has been working some DX during the wee hours. QL has a pair of '04A's on 28 mc. and worked an LU. ATD, who just finished a nice relay rack job, is spending his vacation in New Mexico. ARB has a sweet relay rack job almost completed. Here's some sad news for the Oklahoma gang to think about, Oklahoma's traffic report for the month June 16th to July 15th is the lowest in over two years. Let's do something about that. Report to your S.C.M.

Traffic: **W5BJG 70 AMT 59 CEZ 41 (WLJC 30) EXZ 18 BDX 15 CVA 12 DQM 10 ASF 7 BAR 3.**

SOUTHERN TEXAS—SCM, Bradfield A. Beard, W5ADZ—BEF carries five traffic schedules. DWN on 7360 kc. wants schedules with 5th and 4th districts; operators are DWN, DLZ, DYA, ETP. ADZ was in hospital for two weeks. EKN worked K6LBH. MN was back on soon with Collins 30FX. ENR took 59 Tri-tet portable on his vacation. EPE and EPP, brothers, are both using '45's P.P. at Wink, Texas. AVF is working DX on 14 mc. CUJ worked 50 Europeans during his two weeks vacation! EOO is going after radiotelephone first. BUB is interested in photography. AMJ is changing back to 7 mc. AHW is back in town for short vacation from ship job. Houston Amateur Radio Club will have new portable 'phone-c.w. rig going soon. Send that envelope to New Orleans. DX cards await you. BHO and FDR were the guests of Mr. and Mrs. EDM while in Beaumont. BYB worked two K6S using pair of '10s on 14-mc. 'phone. EUO has worked all districts. FY is rebuilding. EWI is QRL with s.s. super. FBC is constructing very FB rack and panel job. RA is QRL beer business. DJA and BKL are QRL tomato business. EUR and EJY visited with Guadalupe Club. PC threatens to be all set to go in the very near future on 3.5 c.w., 4- and 14-mc. 'phone. BTK is on 7 and 3.5 mc. and active in the Storm Net. ENX is trying to pick up speed. L. R. Bowen, brother of ELE and EYA of Greenville, is about ready for membership in the G.A.R.C. BEH is coming on with a 50-watter. EOI is contemplating on new rig. CPR is practicing on bug. DTB works hard for the Galveston Club. Gone but not forgotten—The Semi-Annual Hamfest of the Guadalupe Valley Radio Club was held on the Guadalupe River near Cuero, Texas, the night of July 13th with 33 members and approximately 15 visitors present. A very FB goat and beef barbecue was served. A "Bull-Session" was enjoyed until the small hours of the morn'.

Traffic: **W5BEF 38 DWN 35 ADZ 14 EKN 7 MN 5.**

## CANADA

### MARITIME DIVISION

**MARITIME**—SCM, A. M. Crowell, VE1DQ—Nova Scotia: HH keeps schedules on week-ends. BZ is away at camp with the P.E.I. Light Horse. EY has a new YL op. Congrats, O.T. HX is with No. 2 Signal Company. DB sold his rig and is going to rebuild for the fall. IA is busy gardening. CE's brother passed the exam. AQ, GY and FQ spent an interesting day last month working 56 mc. "yacht to shore." EX speared AR8MO. GH has a new ACR136. FN has been putting the 860 thru its paces on 14 mc. AX is going steel rack and panel. AW keeps the 3.9-mc. 'phone band hot. DQ is again hitting the 14-mc. band and awaiting new receiver. Newfoundland: VO1W has '59 osc. and '59 inverted amp. pushing a pair of '46's with about 50 watts into 'em. VO4Y, VO1P, VO1H, VO1I and VO1W had a little hamfest at the Newfoundland Hotel. VO1H got a new FBXA. VO1I got married. 4BBV and party were recent visitors in Halifax.

Traffic: VE1HH 6 EX 4.

### ONTARIO DIVISION

**ONTARIO**—SCM, S. B. Trainer, Jr., VE3GT—IC moved to Forest. AAG applied for O.R.S. WR is with R.C.C.S. at Camp Borden. SG spent a week there, too. 9AL's portable at Stoney Lake is working FB. SZ is QRL on ex-run runner "Harry H." AFR blew a rectifier. Amateur Radio has come to the fore in Kirkland Lake, with a new club formed and many stations waiting for licenses. XU is working 7, 14 and 28 mc. and reports KJ, IX, AEL, and ABE all on 28 mc. MX is rebuilding some more. SS reports for first time; he likes to QSP and copy press. DU has worked all W except W1 and W7 on 28 mc. AU is chasing bootleggers. FB, VD schedules a G6 at 5 G.M.T. on 7 mc. with much success. JT has cancelled all but one schedule. WK is doing his best to keep schedules going thru terrific heat. QU still has junk shoppe. AEZ is trying Tri-tet. BO is going high class. ADF uses all bands. PO is chasing DX. QE is awaiting unlimited 'phone license. VZ is on 66 mc. QD listens on "ten." OJ is trying high frequencies. ABW is on the air for schedules only. VA has moved. GG gnashes his teeth for summer schedules as the gang QRT one by one. TY reports for the first time. Thanks! GT is hopelessly trying to find time to rebuild.

Traffic: VE3XU 1 SS 4 DU 22 AU 9 JT 27 VD 3 WK 28 VZ 30 ABW 36 GT 3 VEBEAL 2.

### QUEBEC DIVISION

**QUEBEC**—SCM, Stan Comach, VE2EE—BU's young daughter is home again from the hospital. We hope she improves rapidly. BE joined the Maritime gang in merrymaking at a recent Halifax Convention. A fine bunch of fellows, says Alec. AP, CX, and JK had a fine time recently out at BB. IE and BG are away on their well-earned vacation. GA is now using Class "A" modulation as is FG. Both of these boys are getting across the pond in great shape. HT added a pre-selector to his Comet Pro. EE is building one for ex-IDE, who will be with us in the fall. Ex-3CJ, now 2KK, is on the air using the bedspring as a counterpoise. BO is building a 'phone for 1.75 mc. BK in the mountains schedules JK in Montreal with 8 watts input on 3.5 mc. GO is adding more power. FQ is operating HR and schedules DG and EE. LA is operating on 14 mc. CS is putting out a nice signal on 7 mc. G2KB of Rugby, England, paid a visit to this Section and spent two days with the S.C.M. He visited quite a few shacks, including DG, HT, BE, BG, GA and CA. CH is over the pond now and listening to the gang here chewing the rag on 14 mc. 7DHF graced the S.C.M.'s home with her presence as did 9PGS and his dad. Those O.R.S. and O.P.S. who have not reported for the past three months can automatically exclude yourselves from the ranks by not reporting next period. Fair warning!

Flash—HR, Anticosti Island, makes W.A.C.  
Traffic: VE2BU 36 GO 3 JK 24 EC 8 LA 3 AB-HT 2.

### VANALTA DIVISION

**ALBERTA**—SCM, J. Smalley, Jr., VE4GD—The hamfest at Calgary on July 12th was the biggest of its kind in this part of the country, with over 125 sitting down to the

banquet. 7ABT and 7MZ were the only "W" fellows present. GE and GG won the doubles in the local tennis tournament. LX has gone 'phone using grid modulation, but he still sticks by the Traffic Net. QK was the lucky man at the hamfest, carrying off the major prize. AW says DX or no DX; he isn't spending another winter in northern B. C. Sixty below is just too cold. Heard cards from VK are the order of the day with HQ, CY, and LA on 14-mc. 'phone. WJ bought KG's rig and will be heard on 7 mc. ST is all smiles over his new super. QH and QG have been hitting the high spots on 7 mc. Will somebody please give KO a Collins and save him the worries of what to and what not to build? Several Edmonton stations are away for the summer leaving most of the work to EA, BW, BV, HM and EC. FI and HW still chase DX, but the DX doesn't seem to chase them.

Traffic: VE4BZ 136 LX 110 GE 36 QK 29.

**BRITISH COLUMBIA**—SCM, R. K. Town, VE5AC—Quite a number of you have overlooked reporting. If you are interested in seeing your activities mentioned here, please send the S.C.M. a report on or before the 16th of every month. DB is again at the Y.M.C.A. camp with KC at the key. LX, CV and others are helping out at the Vancouver end. KB took a transmitter up to the church camp at Ocean Park, OM and EU taking his Vancouver traffic. ID is active now. FN heard VK5EP on 28 mc. both 'phone and c.w. HN is heard often on 14 mc. JP makes nice traffic total from Y. Camp. MK always has time to handle traffic. DB promises to make B.P.L. LX is first VE5 to make B.P.L. in a long time. FB, EU handled traffic from Ocean Park Camp. GI is working a few Europeans on 14 mc. DZ has an '03A now and hopes to break the W.A.C. records. EP is trying to get a defunct '03A to work. OM, an old-timer, gets back in the game. FG has certainly put ham radio on the map with his timely messages. Very FB. AC's final blew up.

Traffic: VE5JP 84 MK 21 DB 240 LX 164 EU 73 KB 138 GI 34 DZ 7 JL 46 AD 10 EP 25 OM 54 FG 38 AC 29.

### PRAIRIE DIVISION

**MANITOBA**—SCM, A. J. R. Simpson, VE4BG—TV is holding down the summer schedules of AG during AC's vacation. ED is a new station on 3.5 mc. QV is on 3.9-mc. 'phone. MJ suffered a bad piece of luck when he popped most of the tubes in his transmitter. AP of Foxwarren and XK of Tiperrary are still active. VV of Binscarth is perking right along. LO is to be heard on 3.5 mc. CG is doing some rebuilding. MW is rebuilding rig putting an RK-20 in the final. IP will be out of Winnipeg for few weeks at summer camp. GC is on again after rebuilding. MV has a new RK-20. KU is to be heard no more. NI reports that XYL received Certificate of Proficiency, so that station now has two qualified operators.

Traffic: VE4IP 36 AG 68 TV 7 BG 2.

**SASKATCHEWAN**—SCM, Wilfred Skaife, VE4EL—VU is taking a trip and visiting hams at Spokane, Seattle, Vancouver, Edmonton and Regina Beach. VY is building c.c. rig for low powered 1.75-mc. 'phone. NE is rebuilding receiver and transmitter. GA had visit from 9CHG from Noonan and Miller from Regina. UL had long QSO with 2 watts input, over 160 miles. XM is using t.r.f. receiver with good results. TN is building neat 28-mc. rig. QZ and UH are QRL vacation at Manitou Lake. PE is visiting East. UD cracked crystal. IK comes to Saskatoon. Welcome, OM. PQ is going strong on 7, 14 and 28 mc. EL is getting very interesting data on single feed Hertz and getting out nicely on 14-, 3.9- and 1.75-mc. 'phone. EB left set on for 36 hours with no results. Boy, what luck! FW is now operating 7CH at Dundurn Camp. Let's go, gang, for a lively season of radio!

Traffic: VE4CM 142 UL 26 EL 6.

## Briefs

At 5:30 p.m., April 14, 1935, W1AH answered a CQ from W2AIW. A check of logs revealed that they had QSO'ed before on April 14, 1925, at 5:10 p.m., exactly ten years to the day and hour!



# CORRESPONDENCE

The Publishers of QST assume no responsibility for statements made herein by correspondents

## Register Transceivers When Sold?

Newport, Tenn.

Editor, QST:

It is . . . quite unfair for those amateurs, who have gone through the procedure of obtaining their "ticket" to have these violators [bootleggers] practically take the 56-mc. band from them. I know that the F.C.C. is doing all it can to catch and prosecute every unlicensed station, but without the complete coöperation of every amateur and the jobbers of 56-mc. equipment this will never be accomplished to any efficient degree.

I doubt if more than a small percent of these frequency usurpers have any knowledge whatever of the technical end of radio which would enable them to assemble their own 56-mc. transceivers, and with this idea in mind it looks as if the matter could be helped greatly by making it compulsory for every purchaser of this equipment to file with the particular jobber or radio dealer offering transceivers or any transmitting equipment, the call of the station and the license registration number, which would be furnished to the F.C.C. by these jobbers and dealers each week or not later than every two weeks. Other calls could be supplied by the would-be-violator, but not the registration number. I am sure this method of handling transmitting equipment would certainly reduce the trouble we are now experiencing. It has been entirely too easy for just anyone to secure the fundamental components necessary for a transmitter during the past several years. I know that if enough effort is put forth this could be done by anyone who is determined to operate. Without possessing a license he can obtain the necessary equipment regardless of the restrictions, but this would necessitate the pulling of strings here and there, and the general run of these would-be-amateurs have neither the pull nor the initiative for such effort.

—John F. Stanbery, W4DPI

## Use the Whole Band

34 Union St., Uniontown, Penna.

Editor, QST:

I notice that the A.R.R.L. is beginning to put on an intensive campaign to acquire more frequencies for amateur use at Cairo in 1938. Now this is an excellent plan, and I am very much in

favor of it, but in the meantime why not use all the available frequencies?

It seems that some of the "brethren" think that the 7-mc. band is only 150 kc. wide! They park themselves in one end or the other of the band, and never even think of tuning down to the other end for a QSO. It is hard to blame them for this, for under present conditions it is almost unheard of for a station on 7005 to work another on 7295. But why not? After all the band is a good 300 kc. wide, so why not tune over the whole band after that lusty CQ? Of course it is wise to start at your own end, but don't forget that there are fellows on the other. On 14 mc. the condition is even worse because of the 'phones in the middle. We have tried it here, and we find that fellows can be worked across the 'phones. So come on, OM's, and let's use all of the kilocycles we have!

—Lawrence Sheetz, WSMII

## Dog-Pile

1634 Madison St., Denver, Colo.

Editor, QST:

Like a pebble in one's shoe that the wearer aggravatingly puts up with for a certain length of time before removing, the following letter contains thoughts which have been rolling around in my mind for quite some time now, and which at last have been penned. . . .

Have you ever as a youth been in a shouting contest with a group all yelling at the same time and someone at about fifty-foot distance trying to judge who has the mightiest pair of lungs? Have you ever played "dog-pile" and tried to be the last one on the heap; or have you ever enjoyed that twosome game with a baseball called "burn-out"?

If you have never engaged in any of these youthful antics, a fair substitute for them all can be experienced by trying to communicate at any time these days on any of the amateur radio bands while operating in the United States or near-by countries.

Feeling that the high-powered signal is the only one possible to push through the interference of many medium-powered signals, the fortunate few amateurs these past years have greatly increased the output of their transmitters. Unfortunately the amateur bands will accommodate only a limited number of kilowatt or near-kilowatt

signals, and seemingly that condition of complete accommodation was long ago reached; so that at the present time the average chap with his medium-powered station must content himself with letting the big fellow enjoy the once well-distributed hobby.

It seems unfortunate that the trend toward more selective and sensitive receivers has not been more pronounced than that toward more high-powered transmitters, both to keep the expense of owning and operating an amateur station more nearly within the reach of the average youth and also to permit a greater number of interested young men to enjoy this fascinating hobby of ours. . . .

This strange-looking picture can be changed into a much more interesting one, I believe, if we all take part in a so-called "super-receiver and lower-powered transmitter" campaign, and thereby keep the hobby open for the greatest amount of enjoyment for the greatest number. . . .

—Karl T. Dreher, W9WO

## Buggy Bugs

23 Forest Road, Madison, N. J.

Editor, QST:

Would somebody please tell me why some people who don't know any more about a bug than I do insist upon using one? The result is the most unreadable mess that can be heard.

—Henry Ernst, Jr., W3FMA

## No Codeless Exam

West Palm Beach, Fla.

Editor, QST:

It seems to be the opinion of a few amateurs that the A.R.R.L. should take it upon itself to petition the F.C.C. to remove the code requirement from the examination of those persons desiring to operate in the U.H.F. bands—these ultra-high-frequency fans who are too lazy to put forth a little effort to learn enough code to pass the regular amateur examination. You certainly can't call it anything but laziness, as plenty of people who are of no more than average intelligence pass this examination every day.

It has been said by one of the amateur proponents of this move that these people do not desire to become amateurs or engage in amateur work. Why, then, insist that the A.R.R.L. take it upon themselves to fight for special privileges for those who have no desire to be amateurs? It is an organization of, by and for the amateurs, and as a member and licensed amateur I stand opposed to any such movement.

Recently I talked with a radio service man who desires to get on the air on 'phone and it is his opinion that there should be no code requirement for those who do not wish to operate in the c.w. bands. I know dozens just like this fellow. And I'm here to say that if the code requirements were removed from the examination of those desiring to operate only 'phone, these fellows would move into our bands by the hundreds. If they don't want to become amateurs let them form an organization of their own and petition the F.C.C. at their own expense.

—Herbert Heath, W4UE

## Topics of Conversation

53 East 7th St., Holland, Mich

Editor, QST:

. . . The usual c.w. contact these days does not consist of very interesting chatter. Usually the fellow says he is using so much power, etc., which is OK to mention. He tells you your signal strength and then perhaps the weather and then signs off with a couple 73's. Now I think this sort of contact is very uninteresting indeed. In the first place the contact is too short because the conversation is too "rubber-stamp" like.

. . . What can we talk about to have a real interesting contact? Here are a few things that really should be interesting to talk about to the other fellow: Your age and occupation, married or single, and perhaps a mention of how many kids you have if you're married. Hi! Then you can go on and talk about some of your gals you had and a few interesting notes on them.

Then there's your other hobbies besides amateur radio. Perhaps two fishermen can get together and fight out who caught the biggest one. A couple of golfers can chat on who's the best or two baseball bugs can say who was the best player they ever saw.

For the more serious-minded fellow a chat on life itself can be found very interesting. What you think of mankind. Your religion, and if not, then your ideas might make a good topic. Some fellows may have had breaks in life while others may have little or nothing and I know from personal experience that a few helping and kind words from another ham hundreds of miles away will help you face the world and its troubles with a better outlook.

We need more intimate and "human-interest" contacts. The subject of "radio" becomes monotonous to the fellow who has been on the air for a few years and the beginner will find other subjects interesting too, so let's have a little other chatter besides radio this fall and winter.

—Rus Sakkers, W8DED

## Re QRZ

1330 W. King St., York, Penna.

Editor, QST:

I think QRZ is abused.

If one calls "CQ," and then listens for an answer, hearing a station and only copying part of the call letters, then the station calling CQ should send "QRZ."

I do not believe you should QRZ after you QSO someone.

Most of the stations I hear abuse QRZ and never CQ. As said in QST in the past, QRZ should never be used in place of CQ.

I have been using the following rule for many years:

Call CQ three times, sign three times or less, repeat for two or three times.

And every QSO I try and make an enjoyable one—one that my fellow amateurs will never forget. . . .

—Paul L. Stumpf, W3AQN

## Killing the Goose that Laid the Golden Egg

204 East Ave., Olean, N. Y.

Editor, QST:

After reading articles pro and con concerning the activities of the A.R.R.L. with regards to past convention and treaty meetings, particularly in connection with amateur frequency allotments, I gather from what I read that if the A.R.R.L. is permitted to continue in their present path there will be no such thing as an amateur place in the spectrum at all.

Now, if this is true why does the A.R.R.L. continue the chiseling away of ham frequencies? As I understand it, the A.R.R.L.'s support depends on transmitting amateurs and numerous S.W.L.'s, all deeply interested in short-wave communication. Is—in plain language—the League killing the goose that laid the golden egg? . . . Would anyone with an ounce of common sense cut off the limb they were sitting on?

. . . I may be all wrong, but—there appears to be something deeper than what has appeared on the surface in these printed statements concerning the activities of the A.R.R.L. I'm not trying to tell anybody anything, but there are a few questions I would like to have someone straighten me out on. I believe that we do need more space in the bands in which we now operate, but I don't believe that a Ballyhoo

(Continued on page 60)



LAST MARCH we mentioned that much interest is being shown in I.F. transformers having variable coupling as a means of controlling selectivity. This idea is particularly interesting to us, because as far back as May 1933 we advertised variable coupling as a feature of our earliest model air-dielectric-tuned I.F. transformer. In this unit, the adjustment was made by a screw which moved the coils closer or farther apart.

This scheme was abandoned by us in later models, because we felt that it was not particularly desirable. Its only virtue is its ability to act as a selectivity control and this we feel can be better accomplished by other means. Its disadvantages are numerous, among them being the mechanical complication of changing coupling by a panel control, and the pronounced effect of the adjustment on gain and other circuit constants.

Variable selectivity presents a problem quite different in broadcast receivers than in communication receivers. In the former, the aim is "High Fidelity," which requires a sub-normal selectivity. In amateur receivers, the object is to eliminate interfering signals which necessitates abnormally high selectivity. Because of this difference, two entirely different types of control are desirable.

The most advanced thought on variable selectivity for broadcast receivers inclines toward some form of non-mechanical semi-automatic device. A number of schemes have been suggested for doing this, and it is probable that these will be incorporated in some of the newer receivers for the coming season. In one system, the coupling is controlled by the strength of the received signal, on the theory that strong local stations can override interference by mere volume, and consequently do not require complete elimination of unwanted signals by high selectivity. The controlling circuit is similar to a conventional AVC circuit, but is operated by the audio signal rather than the carrier. Of the many schemes suggested for obtaining the actual selectivity change without moving parts, only one will be mentioned; namely, connecting a variable load resistance across one of the I.F. transformers. This is quite practical if a specially designed I.F. transformer is used. Since the plate resistance of the 58 varies with the suppressor voltage applied, this tube may be used as the variable load resistor.

To come back to amateur receivers, however, the control should be in the direction of increased selectivity, not decreased. We think that the only practical answer to this is the Single Signal Filter, such as used in our communication receivers and discussed in detail on this page last March. In this filter, a knob on the front panel gives a variable admittance to the I.F. amplifier of from several kilocycles down to a few cycles.

We realize keenly that it is unwise to say that any development is valueless, and we do not wish to be dogmatic about it. However, we believe our comments above pretty well sum up the situation as matters stand. So for the present anyway, we will stick to fixed coupling. It seems the best way, particularly as it gives us the assurance that after they leave the factory, our I.F. units will stay at the optimum coupling value for best gain and selectivity.

JAMES MILLEN



# Now DECIBEL METER KIT

*By Triplett*

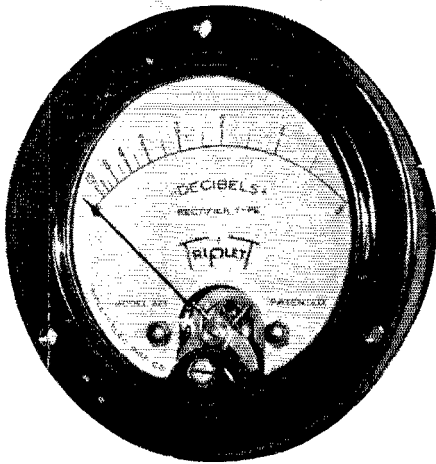

Decibel Meter

## To Increase Meter Range —Use New Triplett Decibel Meter Kits!

THESE new Decibel Meter Kits increase range from up 6 to up 42 decibels. For 500 ohm input line. Furnished for either constant or non-constant impedance. The use of a decibel kit facilitates immediate adjustments and elimination of distortion.

No. 150 Decibel Meter Kit — Non-constant Impedance

Includes:

Triplett 3" meter, 2-deck selector switch, 9 wire wound multipliers with Bakelite mounting board, hook-up wire, blue prints and instructions. Complete — \$21.67, Net to dealers.

No. 200 Decibel Meter Kit — Constant Impedance  
Similar to No. 150 but with Triplett 3" Constant Impedance Decibel Meter. Complete — \$23.50 Net to dealers.

The above kits are also supplied with Triplett 2" Decibel Meters at \$1.00 net each less than above prices.

Kits are easy to assemble — all parts marked to correspond with blue prints.

### TRIPLETT ELECTRICAL INSTRUMENT CO.

180 Main Street

Bluffton, Ohio, U. S. A.

Triplett Electrical Instrument Co.  
180 Main St., Bluffton, Ohio

Gentlemen:

Please rush me at once more information about the new Decibel Meter Kits and your new catalog describing the 1936 line of Triplett instruments and testers.

Name.....

Street.....

Town..... State.....

## Correspondence Department

(Continued from page 58)

Army of Indignant Coxey's marching up to Washington for more space will get us anywhere at all. . . .

—Bruce H. Ganoung, W81YL

## Restrictions and Hormones

2543 South Avers Ave., Chicago, Ill.

Editor, QST:

During a lull in my office hours, I took several copies of QST from my bookcase, and interested myself in several technical articles and the "Correspondence Section." The outstanding subjects that surprised me were the number of hams that wish more restrictions placed upon themselves, by different means. I made a survey of several copies of QST, and found the following "desires" of hams.

1. Restriction of "lids."
2. Unlimited c.w. licenses.
3. Restriction of 40-meter band.
4. Restriction of power to 100 watts.
5. 'Phone versus c.w.

Now, in my estimation, as well as that of many thousands of other hams, I sincerely believe that we have about as many restrictions in ham radio as we can shoulder. I, and I hope all of us, try to abide by the present restrictions, laws, etc., as truthfully as we can.

Why, in the sacred name of ham radio, do these grudge-bearing, jealous, insidious cry babies continually howl and cry about the other fellow? Just because someone has means to get a high-power rig, can receive code faster and better than the next one, or is slower and goes into the 40-meter band, or is a beginner, or has a good 'phone rig, why should some other fellow start the age-old nefarious feelings of human nature, i.e., jealousy, grudge, envy, etc., to function against this type of ham?

Certainly, in this country of ours, we do not want to carry on age-old trends of thought. Our present desire is to bring about social harmony, without grudges and all the other rot.

The trend of science in our field has given us better frequency stabilization, better transmitters, and the latest development in receivers is really a scientific achievement. Why not take advantage of the knowledge that is easily obtainable, and apply it to our stations?

. . . I suggest that these fellows who wish to have a lot of restrictions consult a good psychiatrist, and see if they do not have a disturbance of their psychic faculties, or if their pituitary glands are up to par. . . .

—Dr. E. S. Burger, W9CHH

## Army-Amateur Notes

(Continued from page 37)

The A.A.R.S. is proud to have the Lake Worth Radio Club as a part of its Florida organization, and there is no doubt that the club will in the future as it has in the past live up to the slogan Army Amateurs Render Service.

—W3ZD

## A.R.R.L. Field Day

(Continued from page 36)

Tests were run as low as ten watts with no decrease in signal strength. Worked 79 stations in 7 U. S. districts.—W8DMK/8.

W9OKY/9 was located on Cheyenne Mountain, 9200-ft. elev. with three rigs and a transceiver run from dynamotor power and batteries.—P.P.A.R.A., W9EHC.

Decided to put Toledo on the map in the F.D. Used W8RB due to fine swing, W8EME's transmitter, W8MHH's and W8LZK's receiver and rented a 300-watt gas-driven alternator. QSOed 80 stations in 17 states and Canada. Enjoyed every minute.—W8EME.

# Hark Ye, 'PHONE MEN!

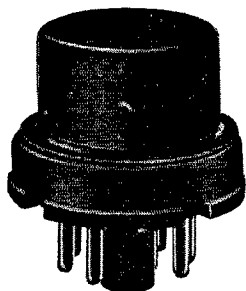

ACTUAL SIZE

## THE NEW ALL-METAL TUBE

The new tubes — “sealed in steel” — invented and perfected by General Electric engineers — have many improved electrical characteristics. Here are a few of the highlights.

1. More effective shielding allows higher I.F. gain with stability.
2. Higher I.F. gain means—greater signal on diode, less harmonic distortion on high modulation—less audio gain required, quieter operation.



## THE NEW GENERAL ELECTRIC RADIO WITH ALL METAL TUBES

MAIL COUPON FOR DETAILS

General Electric Company,  
Bridgeport, Conn.

Attention: Sales Promotion Section R-159:

Please send me complete details regarding General Electric Radios with the All-metal Tubes.

Name.....

Street Address.....

City..... State.....

The 1936 General Electric Radio with new all-metal tubes brings to amateur operators the latest advancement in radio science and engineering. Its fidelity and crisp clear-cut reproduction is far in advance of the field.

MODEL A-82 . . . An all-purpose receiver, scientifically designed for the many exacting demands of modern amateur stations. The following outstanding features will appeal to all hams.

- Air Trimmers—provide better calibration stability
- Sliding-rule Tuning Scale—easy to read as a ruler
- Improved A.V.C. due to higher I.F. gain.
- 5 Watts undistorted output delivered to 10 in. high-quality dynamic speaker.
- Frequency coverage 140-410 and 540-19,500 KC in 4 bands.
- CW oscillator may be added.

# GENERAL ELECTRIC

## RADIO

MERCHANDISE DEPARTMENT, GENERAL ELECTRIC COMPANY, BRIDGEPORT, CONNECTICUT



## *If all the copies of QST were put end to end—*

but why put 'em that way? Why don't you put yours side by side in a nice QST binder. Then your QST file looks like what it really is — a library of the best radio amateur dope in the world. Twelve copies, and the yearly index go in each binder. Then your copies of QST are where you want them — when you want them. A sturdy binder finished in rich, wine colored, Du Pont Fabrikoid. Waterproof, oilproof, wearproof, troubleproof, 100 proof.

**\$1.50** each, *postpaid*

*(One set of yearly labels (1919-1938) now  
provided with each binder)*

## **American Radio Relay League**

**West Hartford**

**Connecticut**

Q.C.A.R.C. operated VE3SG/VE3LJ at Beaver Tourist Camp, West Hill, Ont., 12 miles east of Toronto. Operators VE3WK, VE3SG, VE3GR, VE3WT, VE3WU.

A 75 a.h. storage battery and a 200-volt Genemotor in series with an auto-vibrator type supply gave us 48 contacts and successful F.D. operation at Turkey Lake.—W.A.R.C., W8DKG.

Our 40-meter set was operated from a cabin at the western summit of the Mohawk Trail. Club members had a good time and wish it was scheduled bi-annually.—H.V.R.C., W1FTS-W1IJR.

M.A.R.C. was represented by VE2GE and VE2CO in the F.D., June 8th. A club picnic followed on June 9th.

Heavy rain made us change location plans at the last minute. Both enjoyed the contest very much and we alternated operation every 1½ hours. It showed us what could be done in case of emergency.—W8EZT-W3DZZ.

Cleared a road to a cabin at Windy Ghoul, N. H., on a rocky point overlooking Boscawen. Revamped our set, and got going in spite of rain. Tho marooned, W1CME made it perk. Ours was a hectic but triumphant expedition. Thanks to Mr. Blake and W1DMD for the loan of genemotors.—W1IIC.

40 QSOs from Scotland Hill, Spring Valley, N. Y., from W9LWY. We used two batteries and a six-volt rotary converter.—S.V.R.C., W2ENK.

Dial was alive with 5-meter answers all the time. It was fine idea. 39 stations, many 50 miles away and one 75 miles away were worked from Mt. Wilson with set permanently installed in car.—W8AM.

49 QSOs for 441 points on 56 mc.! Had a neck-and-neck race with W1FGC/1; while our batteries were running low theirs were still plenty hot. Many points on less than 1 watt on 56 mc. Make it just before full moon next year so we have the light to work by—and a break from the weather man, please. Worked from Sweetman Mt. (1503 ft.) and Mt. Wachuset (2250 ft. elev.) with rig in Austin car. With hundreds of sigs heard we combed the bands for the reliables, parked on stations until they were clear, and got more QSOs than by calling CQ.—W1HDQ.

Our antenna was 8 ft. high at most! Operated from set in car at park in city (3550 kc.) using dynamotors. 20 QSOs and enjoyed F.D. immensely, but the visitors were a problem. Suggest "CQ FD" call next year.—N2BNJ.

A grand time! Had 14 QSOs on 56 mc. in spite of the rain. Looking forward to next year.—W2DWW/2.

The antenna was only 6 ft. high. One operator was kept busy wiping the antenna dry. Had 24 fine contacts. Will never miss another Field Day.—N9KIT.

Had a rescue party to look for one member who got lost in the woods. Field Day FB, why not have it oftener?—W9TPS.

VE3GI with VE3WB and VE3LK at Long Branch was housed in a summer cottage, antenna surrounded by trees, QRM from horseshoe pitching, we worked 29 stations.—VE3GI.

Casualties, broke a crystal. Location, cow pasture hill. Power, 5 dynamotor watts. QRM, cows and horses. Wx, FB. Success, 21 QSOs. Operators W9KWP and W9KJY.

Hand generator, five operators and a 5-meter rig in Green Hill Park, Worcester, put the Worcester Radio Ass'n in the running.—W1BKQ.

Starting from scratch a 7-mc. current-fed antenna was put up and working in less than a half hour.—VE3SG. 130 miles from club Headquarters, but our 1.8-kva gas-driven generator had to be put aside in favor of regular mains, due to poor regulation and hash in the receiver.—W2AOL.

At 2 a.m. in a teeming rain a new antenna was put up, and the grind began in earnest. At the close a disheveled but happy crew had 94 contacts.—W8AMP.

Our first experience. 50 contacts, and next time will do better. Set up in open flat country, running antenna to 90 foot silo, got 12 watts from dynamotor. Contest was thoroughly enjoyed.—C.C.A.R.A., W9EMN/9 W9KPS.

Score limited by conditions; all equipment battery-operated; an unforgettable experience. Used a 24-volt m.g. and station in a tent near Highland Lake, Winsted, Conn. Waiting now for next F.D.—H.C.A.R.A., W1DJC-W1APJ-W1FSH.

Two tents, power from two genemotors. Weather fair but cool (especially at 2 a.m.). All six oprs. 15 to 18 yrs. old. Many visitors. 50 QSO's. An enjoyable time and all eager for another F.D.—T.A.P.S.W.R.A., W8JTI-W8MMN.

This has been our greatest effort in portable operation. Made 6 contacts on 56-mc. 'phone, 3 on 7 mc. and 47 con-



# NEW! MODERN! CERAMIC PARTS FOR • MODERN • TRANSMITTERS

**B**EGINNING with the original Stand-Off a decade ago, **JOHNSON CERAMICS** have been designed to do their particular job **better than it has ever been done before** » » » Likewise — each of these newest Johnson products will perform its appointed task **better!** See them at any Authorized Johnson Distributor — or write for Special Bulletin.

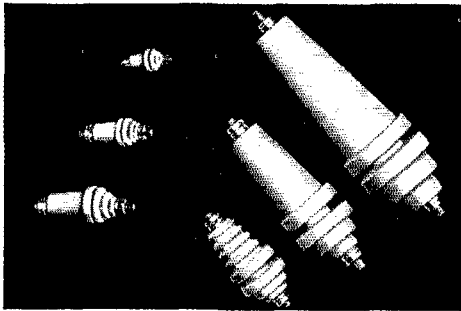

A new series of **Thru-Panel Insulators**, uniform in size with the new Metal-Base Stand-Offs, completes the range of models available from **Johnson** in this popular style. Especially useful for transmitter terminals. Available in plain and "Jack-Types," with white or brown glaze. Furnished complete with resilient gaskets, insuring freedom from breakage.

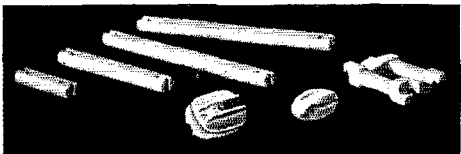

New **Feeder Spreaders** in 2", 4" and 6" lengths, accurately molded of high-quality low-absorption porcelain, will solve many transmitting and receiving antenna-system problems. Included is a new heavy-duty Commercial-Type Spreader.

A new "Cruciform" shaped **Strain Insulator**, designed especially for high-frequency applications, has unusually low capacity, long leakage path and high mechanical strength — yet weighs less than one ounce!

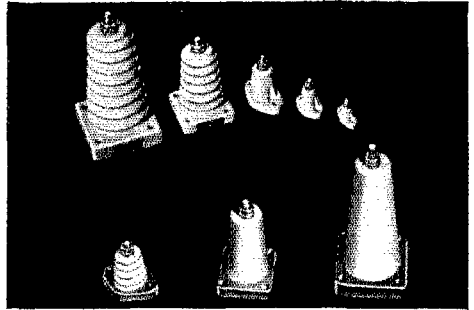

These new **Metal-Base Stand-Off Insulators** (in foreground) eliminate breakage in mounting! Available in 1 $\frac{3}{8}$ ", 2 $\frac{3}{4}$ " and 4 $\frac{1}{2}$ " heights with plain or "Jack-Type" hardware. Included is a "Bee-Hive" with a unique oval metal-base requiring a minimum of mounting space. Available in white or brown glaze.

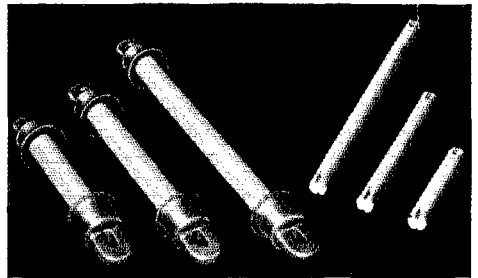

**Commercial-Type Antenna Insulators**, with special corrosion-resistant aluminum alloy end-fittings, are ideal where highest mechanical strength is important. Insulation is highest quality Wet-Process porcelain 1 $\frac{1}{2}$ " in diameter. Supplied in three lengths with leakage distances of 8", 12" and 18".

An improved "250-Watt" **Socket Set** with "Safety-Cup" plate terminal is the newest addition to the **Johnson** line of superior transmitting sockets. These sockets are standard equipment with well-known commercial transmitter manufacturers, yet cost surprisingly little!

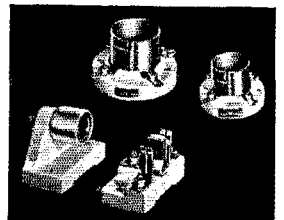

A new high-quality commercial-type socket for the new **RK-28** and **RCA 803 Pentodes** will be available shortly.

**E • F • JOHNSON COMPANY**  
MANUFACTURERS OF RADIO TRANSMITTING EQUIPMENT  
WASECA • MINNESOTA • U. S. A.

Available from Authorized Johnson Distributors

# The New

(SIXTH EDITION)

# LICENSE MANUAL

WITH THE

## FOLLOWING CHANGES

★ Corrected text of the amateur regulations up to date, including amendments made June 18th at the request of the Board.

★ Corrected answers to all the representative examination questions relating to regulations, where the same are changed by the amendments to regulations made June 18th.

★ Corrections in the text concerning permissible 'phone bands and portable privileges, as have been amended by these changes June 18th.

★ Additions to the text about licensing, to incorporate the existing arrangements in Alaska, Puerto Rico and Hawaii, the right to have code tests administered by government radiotelegraph operators; and a similar paragraph extending to cripples the right to have their material dictated or typewritten.

★ Several notable changes in the way of improved answers to sample questions in the Class-A 'phone examination, bringing them in line with the modern engineering concept of modulation.

★ Several other improved answers to typical questions appearing in the Class-B-C examinations.

IT LEAVES THE JOB COMPLETELY UP TO DATE IN EVERY RESPECT.

VALUABLE ALIKE TO THE BEGINNER AND THE ALREADY-LICENSED.

25 Cents Postpaid  
(No stamps, please)

The . . . (No. 9 in the series entitled The Radio Amateur's Library)

## AMERICAN RADIO RELAY LEAGUE

West Hartford, Connecticut

tacts on 3.5 mc., 56 in all in spite of poor radio conditions.—T.R.C., W8AAR.

Had various antenna difficulties, but enjoyment was had in the course of the contest and we are looking forward to participation in the next F.D.—W1GJV/W1FYO.

28 contacts from the Blue Mts. near Lebanon, Pa., using pr. of 112A's and a dynamotor.—W3DPK.

We are firm F.D. fans in spite of temperature extremes. A 36 and 42 final was used working several other portables. An enjoyable week-end! We'll be there for the next.—W9CRZ/W9AB.

A very FB test using low power, results far above our expectations from a set up in thick woods. Suggest all power be limited to 25 watts. Got a big kick from working my pal W9NIU at a camp. Will be back next year in the same old spot and make the big boys take notice.—W9NGG, W9TLC, W9MKS.

Six operators worked two hour shifts. We had one of the best times we know of in radio. Hope to be first next year.—H.P.R.C. (MK).

A fine antenna was put up in the rain. Used a battery-operated transmitter and had a whale of a time, same as last year.—P.W.A., W3ECI.

Transmitter was in an automobile at the top of Bass Hill. Ten watts (genemotor) on two '71A's and 34 QSOs.—W1CDX-W1HUX 73 R.C. of F.C.

Memories: The last minute rush to get set. Satisfaction in getting T9X reports from our little NTN. Night. The frozen fist. Hayfever. Dozing off with an R9 signal. Attempted speed in the last hour QSOs. Results? A fair score, 34 QSOs, a block of "tired" batteries and a world of fun.—W8KZL.

It was gratifying to know we actually had efficient equipment that would work consistently in case of emergency. VE3QK built it, VE3TM supplied the power, VE3RO the eats, VE3WX the antenna, and VE3WJ moral support as well as operating.—VE3TM.

We had several visitors, and the gang expect to get much use out of the portable this summer. A good time was had by all, and we look forward eagerly to the next Field Day.—W8HZJ.

We had a wonderful time in the contest. In our opinion there should be a multiplier for each BAND worked. In case of emergency more than one band might be useful for continuous contact. How about a multiplier next year?—Leon Bergren, Hi-Freaks Radio Club.

VE3JT and I set up on a high hill 50 miles N.N.W. of Toronto (Alton). Left the rope in the tree so wouldn't have to climb it next year. Will bet our total mileage on the 40 QSO's is more than any other rig in the test, 14,000 miles with '71A, each QSO averaging about 350 miles using both 3.5 and 7 mc. Worked two on one CQ as a fitting finale. Only had 8 watts from Utah car power pack.—VE3GT.

Following precedent we encamped at Hamlin Lake, near Ludington, Mich. It was a thrill to contact the gang back home. Hard to decide whether the F.D. or the S.S. is most fun. Had a whale of a good time, and we plan big for next year.—S.R.R.C. Nic, W9NIU.

## An All-Purpose S.S. Superhet With Turret-Type Automatic Coil Changing

(Continued from page 20)

tor grid leads emerge from the shields under the variable condenser where they are soldered to lugs on the stators. The leads to the grid caps are soldered to lugs on the top ends of the stators. The high-frequency oscillator plate lead is shielded but a piece of rubber tubing is first put over the wire and then the braid over that to keep the capacity to ground at a minimum. The plate and grid by-pass condensers are mounted within the shields. All r.f. and i.f. grounds are run to a group of lugs held by the screws which hold the rear end of the variable condenser. All ground points are connected by a No. 14 wire. All cathode and screen resistors and by-passes are supported directly by their respective socket terminals. The

## DELUXE DIALS AND FLUTED KNOBS

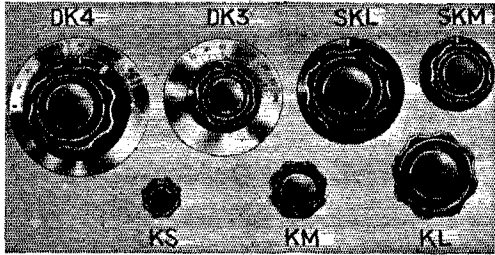

These are the trimmings you have noticed of late on the finest equipment, now available at these prices. Dial plates made of circular finished solid nickel silver, not plated brass or aluminum. Fluted knobs are finest quality genuine bakelite.

DK-3. 3 1/4" Dial and Knob.....	\$ .70
DK-4. 4" Dial and Knob.....	\$ .85
SKM. Medium 2" Knob with skirt.....	\$ .27
SKL. Large 3" Knob with skirt.....	\$ .36
KS. Small Knob.....	\$ .15
KM. Medium Knob.....	\$ .21
KL. Large Knob.....	\$ .27

### KEYING RELAY

will operate on one dry cell. Can be used as Single Pole Single Throw or Single Pole Double Throw. Sturdy construction, has 1/2" diameter Solid Silver Contacts. Compares favorably with expensive types. Special..... **59c**



### THE NEW BARR DB3 CLASS B MODULATED 5 METER TRANSCEIVER

We were surprised at the marvelous value offered in this transceiver, just as you will be when you own one of them.

PRICE **\$16.20** less tubes, batteries and accessories. Bulletin on request.

### THORDARSON CASED TRANSFORMER

600 volts each side of C.T. 200 MA 2 1/2 V. 10 amps. C.T., 5 V. 3 amps. 7 1/2 V. 3 amps. C.T. **\$2.45**

**THORD. CHOKE 12 H 250 MA.....\$1.95**

### GUARANTEED TUBES ISOLANTITE TOPS

800 Carbon Plate.....	\$4.90
866.....	\$1.25
866-A 10,000 volts inverse Peak.....	\$1.85
203-A Carbon Plate.....	\$8.45

### GROSS CASED POWER TRANSFORMERS

650 v. ea. side C.T. 350 ma. fila. 2-7 1/2 v C.T. and 1-5 v will give 500 v with choke input using 83 or 5Z3 tubes. You can run your entire R.F. and class B off this trans.....	\$5.50
750 v. ea. side C.T. 300 ma. fila. 2-7 1/2 v C.T. and 1-5 v.....	\$5.65
750-1000 v. ea. side of C.T. 300 watts, \$6.65	
850-1350-1500 v. ea. side of C.T. 400 watts.....	\$8.75
(the ideal job to give 750-1000-1250 v D.C. with choke input)	
850-1350-1500 v. ea. side of C.T. 550 ma.....	\$12.50
1500-2000 v. ea. side of C.T. 800 watts, \$11.70	

### EIMAC UNSURPASSED TRANSMITTING TUBES!

Performance — Ruggedness  
Power — Price

50-T Output 75 to 250 watts.....	\$13.50
150-T Output 150 to 450 watts.....	\$24.50

### CASED FILAMENT TRANSFORMERS FOR EIMAC TUBES

Cased 5 volts CT 12 Amps.....	\$2.95
Cased 5 volts CT 20 Amps.....	4.95

### HEINTZ & KAUFMAN HK-354 GAMMATRON

150 WATT Plate Dissipation... **\$24.50**

### WHILE THEY LAST ONLY FEW LEFT CASED FILTER CONDENSERS

OIL IMMERSSED silver cased filter condensers with stand off insulators.

Cap.	DC Working Voltage	Price
2 mfd.	1000	\$ .95
4 mfd.	1000	\$1.65
1 mfd.	1500	\$ .95
1 mfd.	2500	\$1.95

## PEAK X-4 10 WATT 5 METER X-MITTER

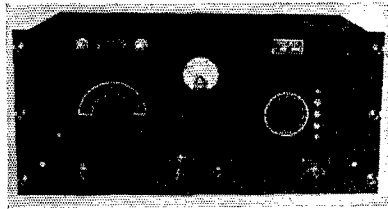

- Two stages of audio amplification
  - Class B modulation
  - Unity coupled oscillator
  - Input gain control
  - Milliammeter to read oscillator and modulator current
  - Communications switch
  - For double or single button mike
  - Encased complete in steel cabinet, less power supply, beautifully finished in black crackle
  - Any specified ultra-high frequency to order
  - Amateur net \$29.70 complete, less tubes and power supply
- PEAK X-3P POWER SUPPLY** heavy duty 300 volts at 200 ma. Amateur net..... **\$23.40**

**PEAK R-2 RACK** for above. Amateur net..... **\$6.00**

**PEAK P-11 PRE-SELECTOR** operates on any type receiver. Enthusiastic owners can tell you of the marvelous S.W. reception in store for users of the P-11. Amateur net. **\$19.80**

**PEAK Q-5, 2 1/2-5-10 meter** five-tube Super-het receiver. Amateur net..... **\$21.60**

**PEAK M-2 MONITOR** is necessary with any radio telephone x-mitter. Amateur net..... **\$19.80**

Complete descriptive data now awaiting your request

### GROSS CRYSTAL CONTROL TRANSMITTER

CW-25 Transmitter kit 25-30 watts. With one set of coils, **\$14.95**  
(see August QST p 67) (Catalog on Request)

### THE NEW PATTERSON PR16 RECEIVER

**PR16C** In Metal Cabinet complete with Tubes, Speaker and Crystal. **\$95.70**  
**PR16** same as above without crystal. **\$89.70**

Ready for delivery about Sept. 1st

### NEW!! HOYT BAKELITE CASE HOT WIRE ANTENNA METER

3 1/4" Across Flange, Mounts through 2 1/2" hole. Scale Length 1 3/4". Ranges: 0/1.5; 0/3; 0/5 Amps. **\$3.50**

### Natural Bakelite Grooved Plug-In Coil Forms

2 1/4" Diameter — 38 Grooves

4 Prong.....	.55c
5 Prong.....	.60c
6 Prong.....	.65c

### HEAVY DUTY ANTENNA KNIFE SWITCH

Single Pole, Double Throw 100 Amperes, 5" Break..... **\$1.45**

20% DEPOSIT WITH ALL C. O. D. ORDERS

REMIT BY M. O. INCLUDE POSTAGE

Cable Address: GROSSINC

**GROSS RADIO, INC., 51 VESEY STREET, NEW YORK CITY**



When it's tough sailing Skipper Serviceman, be nonchalant . . . steer by Centralab. For Centralab Controls are built to "take it" in all kinds of weather . . . under all sorts of adverse conditions. It's smooth sailing under sunny skies if you stock up with CENTRALAB Radiohms for each and every replacement job, which invariably work "better than ever before." Smooth, silent, safe, sure and certain . . . no wonder they are the choice of servicemen who "are in the know."

Write or see your jobber for the new, revised, accurate  
CENTRALAB VOLUME  
CONTROL GUIDE

## Centralab

Division of  
Globe-Union Mfg. Co.  
Milwaukee, Wis.



Every Radio Service Man  
should be a member of the  
Institute of Radio Service Men

# Centralab

CRL

## RADIOHM

plate and grid filter resistors are mounted on a strip of bakelite fastened to the screws which hold down the contact assemblies. A four-prong tube socket is mounted on the rear wall, to which the speaker connections are wired. The leads from the coil taps to the midget condensers are No. 18 push-back wire.  $C_6$  is soldered to the bottom stator lug on the oscillator section of the variable condenser.

#### LINE-UP AND OPERATION

For lining up the set a good modulated oscillator and output meter are desirable, but the station monitor and a 0-1 d.c. milliammeter will serve very well. The milliammeter is connected in the B+ lead to the second detector plate. This plate current is about 0.25 ma. under no signal conditions. The 2A7 works quite well as a second detector, although with the a.v.c. cut out it will overload on strong signals. But of course the volume is more than desired before the overloading takes place, and since a.v.c. is nearly always used for voice reception, this condition is not troublesome.

The i.f. circuits are tuned as in any other super. The coupling of  $T_1$  is set at maximum, the regeneration control at minimum, and the a.v.c. is cut out. After the i.f. circuits have been tuned, and while the oscillator is still coupled to the grid of the first detector, the plate coil of  $T_2$  is turned until the output suddenly drops. Just where it starts to drop is the desired coupling. This occurs at an angle of about 45 degrees in the writer's set. The tuning condensers may need a slight readjustment after this is done.

In tuning the r.f. circuits, inductance trimming is used to make all ranges track. One range is peaked by adjusting the trimmers on the large variable condenser. The midget condensers should be at minimum capacity and the large condenser tuned just slightly within the amateur band for the peaking process. Then, if the circuits do not track with the oscillator over the entire range, a different tracking condenser value is needed. Now go to another range and see if the same position of the trimmers peaks this range. If not, the end turns of the coils are pushed closer together or separated as may be required until this range peaks with the trimmers set the same as for the previous range. All the ranges are adjusted in the same way. Of course a small difference in the setting of the trimmers can be tolerated. *If all ranges can be peaked with not more than one-eighth of a turn variation in the setting of the trimmer screws, the sensitivity will be excellent.* It should be remembered that the oscillator coils are adjusted to tune just higher than the edge of the amateur band. A different lay-out or the use of different parts might require a slight change in the number of turns on the coils. Unless the signal oscillator used is well shielded, direct pick-up may make it hard to peak on the higher frequencies. In some cases background noise can be used to advantage in finding the peak, especially at the high-frequency ends of the ranges.

The overall gain of this receiver is more than can usually be used. All in all, its performance

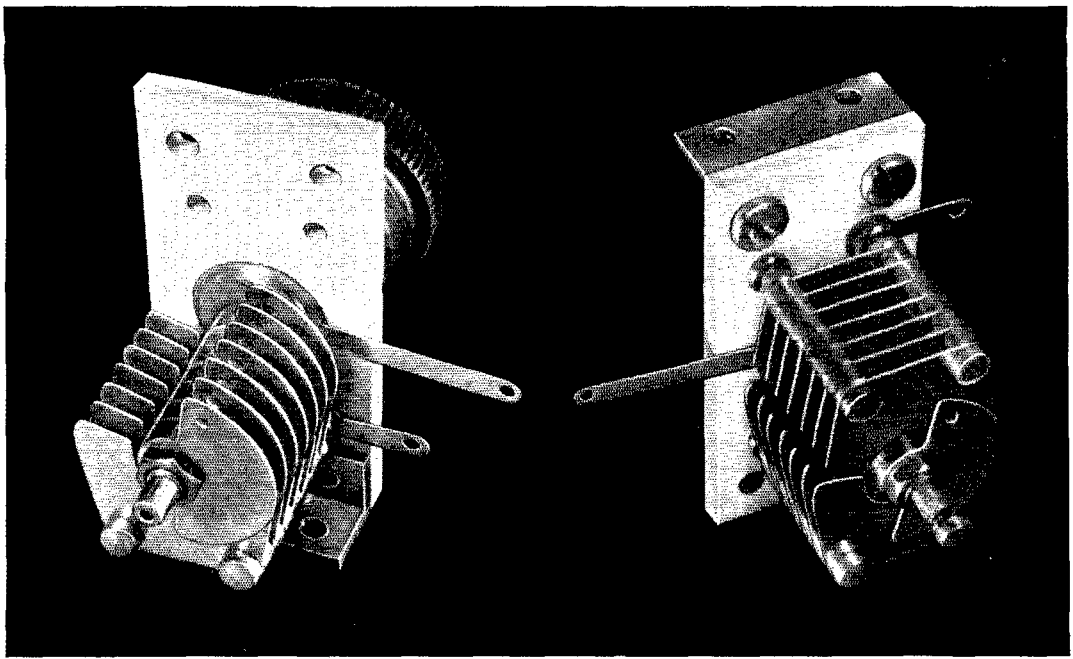

## ULTRA MIDGET CONDENSERS

Ultra High Frequency, Ultra Small Size, these new condensers are ideally suited for use in padding and neutralizing, and for tuning high frequency receivers. They are particularly suitable for Fixed-Tuned exciter stages of band-switching transmitters.

A balanced-stator model is also available, in which two stators act upon a single rotor. Connections are usually made to the two stators only, eliminating the rotor contact, shortening leads, and reducing minimum capacity. There are of course various other specialized uses to which this balanced unit may be put.

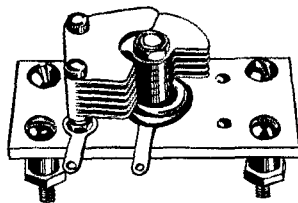
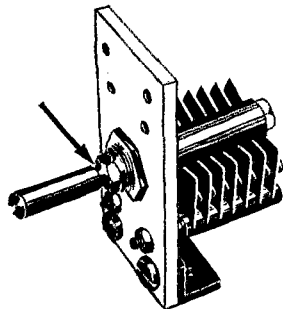

The small size of the new Ultra Midget Condensers simplifies efficient layout and effective shielding. They can be mounted inside small coil-shield cans. The shaft extension is long enough for a conventional knob or dial, but may be readily cut off at the groove provided for this purpose. (See arrow at left.) A hexagon head is provided so that adjustments can be made with a 'socket wrench when the shaft is not used.

The new condensers can be mounted either by the angle foot shown above, or by spacers and bolts direct to the panel, as illustrated below.

Capacity	Symbol	Net Price	Capacity	Symbol	Net Price
Single-Spaced			Double-Spaced		
15	UM-15	\$ .75	25	UMA-25	\$1.11
35	UM-35	.90	Balanced Stator, Single-Spaced		
50	UM-50	.96	25	UMB-25	1.11
75	UM-75	1.02			

NATIONAL CO., INC.



MALDEN, MASS.

# MAKE SURE OF A CLEAR SIGNAL EQUIP WITH **ASTATIC**

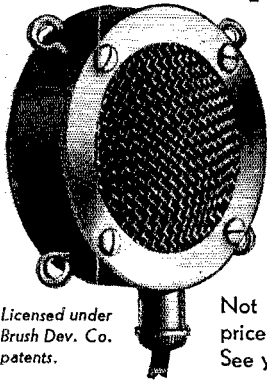

Licensed under  
Brush Dev. Co.  
patents.

To insure a clear signal in spite of QRM equip your transmitter now, with this remarkable modern microphone. The D-104 Astatic Crystal Microphone will give you long, faithful, dependable service too.

Not only that but it's low in price and fully guaranteed. See your jobber today.

**ASTATIC**  
**CRYSTAL MICROPHONES**  
ASTATIC MICROPHONE LABORATORY, INC.  
YOUNGSTOWN, OHIO  
"Pioneer Manufacturers of Quality Crystal Products"

WRITE AT ONCE FOR OUR  
**TIME PAYMENT PLAN**  
on the New **BROWNING SET**  
**DELAWARE RADIO SALES CO.**  
405 Delaware Avenue Wilmington, Delaware

## HAMS! IMMEDIATE DELIVERY ON

**TOBE** Amateur Communication Receivers  
We are Headquarters for all nationally known lines. Everything for the HAM. Come in and "talk it over," with W2AQQ (Bill Filler).  
**SUN RADIO CO., 227 Fulton St., New York, N.Y.**

A  
COMPLETE  
28 or 56 MC.  
MOBILE  
and  
PORTABLE  
STATION

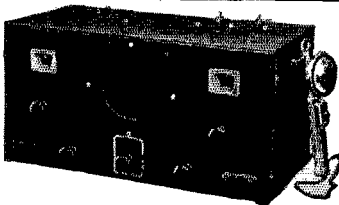

**TR-6A6. TWIN-TRIODE DUPLEX TRANSMITTER-RECEIVER UNIT**  
Push-Pull Oscillator—Class B Modulator—Tuned R. F. Receiver  
Integral Dynamic Speaker  
WRITE FOR BULLETIN C  
**RADIO TRANSCIEVER LABORATORIES**  
86-27—115th Street, Richmond Hill, N. Y.

is highly satisfactory. It does not have a "five-foot" dial and may not equal some of the manufactured jobs, but it is believed that it compares very well with most of them.

## DX Contest Results

(Continued from page 29)

where an award has not been made will notify us of three members who took part in the contest and reported, we will gladly award a certificate to the highest scorer promptly upon receipt of the information.

### GENERAL ITEMS

777 and 852 were popular serial number choices. X1AY received 777 from thirty-nine stations, 852 from twenty-four. G5BY worked 82 stations on the second day of the tests, his best total for one day in any contest. HC1FG's contest log gets longer and longer; this year it arrived in one piece, 13 feet, 2 inches long! ZELJB reports that Southern Rhodesian amateurs were prohibited from operating on 7-mc. at the time of the contest, a restriction which they hoped to soon have lifted. ZS2A observed that 95% of the stations calling him made their calls much too long. An encouraging highlight was the improvement in signals over previous years. Several foreign contestants remarked that about 95% of all W's and VE's heard were using crystal control. EI9F lays claim to having the most outstanding signal heard—by the B.C.L. next door!

W8AYD's first QSO, FM4AB, made him W.A.C. Many operators worked all continents during the contest. W1SZ worked seven ZL's and VK's in one hour. An odd one: VE2DR heard OE1ER and HB9J coming through on practically the same frequency. They were both sending their numbers to W stations at one and the same time; OE1ER sent 111444, HB9J sent 444111. Hi. Preamble to any contest alibi: "I would have done better if . . ." VE5HQ's biggest kick was raising PY1AW on AW's first CQ of the contest. W9DQD derived his serial number from the calls of the first three J's he ever worked; in 1934 he used the first three ZL's, and in 1933 the first three VK's. W1SI snagged Asia after trying for ten years; result—W.A.C. One afternoon at about 5:30 C.S.T. W9BQM heard all continents in two minutes without touching the dial: J2GX, F8FC, ZD2C, LU2FC, K6IBW, CM2AN. The Rettysmith and the Wouff Hong would be much too tame a punishment for the blackguards who bootlegged the calls of OK1AA, ZS2A and G6RB!

W9CPD worked K6KEF on 3.9 mc. 'phone. ZL2BN (c.w.) made contacts with 14-mc. 'phones, W6DZH and W2ZC. F8FC did the same with W8GLY and W2ZC. Greatest disappointment at W9MV was hooking K6KJM only to find he was operating portable in Connecticut. W9ELL QSO'd 60% of stations heard and 90% of countries heard. W8KPL claims the title of the most persistent ham in the contest—he called 200 DX stations and had one QSO to show for it! A special award of QSL cards is being made to the W/VE highest scorer, W3SI, by W8DED. For transmitting W7MH used the 300-foot vertical antenna of broadcast station KOIN! W6FMU heard 47 countries in all. W5ARO worked VK3OC, who was using the same serial number he was—737. W2AER had a two-way 14-mc. 'phone QSO with K6FJF, who did much work on 'phone.

### ODE TO A LOW SCORE

Oh, I'd like to have broken the blasted necks  
Of the W stations that CQ'd DX;  
And I've placed on my list of Super-Pests  
The VE stations that CQ'd Test.

Oh, I swore at those "dyed-in-the-wool" deceivers,  
The foreign stations without receivers.  
But, although I groaned and cursed and sighed  
'Twas a grand contest, and I'm glad I tried.

—W6IPF

VO4Y's contacts averaged one every six minutes—205 stations in 34 hours at the key. QMH, QML, etc., although not used as generally as they should have been, proved helpful to those using them. These valuable abbreviations speed things up considerably when widely used. K4KD

**Greater  
BAND  
SPREAD**

INCLUDES  
THE PRE-ADJUSTED,  
PRE-ALIGNED TOBE TUNER

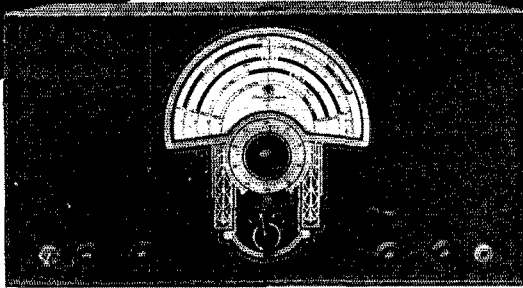

**Less  
NOISE**

EXCLUSIVELY FOR  
160-80-40 & 20  
METER AMATEUR BANDS

## **TOBE** AMATEUR *Communication* RECEIVER

**A** AMATEURS! Here's the receiver you've dreamed of owning — at a price that makes ownership possible! Its band spread is a sensation and a revelation. Its superior signal-to-noise ratio is an accomplishment of greatly advanced circuit design. Its many practical operating features contributed by many amateurs will thrill all "Hamdom."

Its low cost is due solely to the fact that the amateur is required to build part of this job himself — a simple task, for the TOBE TUNER comes completely wired and pre-aligned. Enthusiastic testimonials from critical amateurs concur in the opinion that here is a *real* communication job giving the finest tuning control obtainable — regardless of price — plus sensitivity, selectivity and low noise level!

### TUNING RATE AND SPREAD

The table below gives an accurate analysis of the band spread of the TOBE Amateur Communication Receiver. To appreciate these extremely important features read May 1935 *QST*, pages 20-28.

Band	Tuning Rate	Calibration Spread
160	26.5Kc	2 Kc
80	30 Kc	3.4Kc
40	18 Kc	2.0Kc
20	17 Kc	3 Kc

### THE DISTINCTIVE AMATEUR BAND DIAL

Lays out each of the four bands over a wide area and clearly shows C.W. and phone sections. The limits and sections of each band are indicated in Kc. The operator can tell at a glance the band he is listening on, type of reception, and whether he is going up or down in frequency. Polar index lines permit logging of stations for reference.

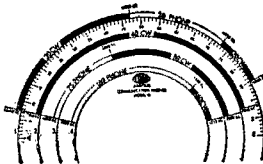

### 12 FEATURES OF THIS NEW REMARKABLE RECEIVER!

1. SUPERIOR signal-to-noise ratio permits DX reception even on the loud speaker.
2. ABSOLUTE single tuning control.
3. TOBE SUPER TUNER comes already wired and adjusted.
4. NO PLUG-IN coils.
5. EFFICIENT PRE-AMPLIFICATION on all bands.
6. FULL VISION DIAL calibrated for all bands.
7. SENSITIVITY on all bands 1 microvolt or better.
8. TRIPLE TUNED double band pass, I.F. filter (6 tuned circuits) assures high selectivity.
9. AUTOMATIC and manual volume control.
10. MANUAL I.F. gain control.
11. SMOOTH BEAT FREQUENCY oscillator for CW reception.
12. MECHANICAL AND ELECTRICAL design of TUNER and arrangement of parts permits maximum R.F. gain with stability and low noise level.

See your jobber or dealer at once. Listen to this marvelous receiver . . . or write us direct for complete parts list, specifications, diagrams, prices, etc.!

### NEW TOBE ACCESSORIES FOR THE AMATEUR!

Realizing the need of amateurs for the highest quality parts for set building at a price they can afford to pay, TOBE has focused its sixteen years of radio experience on this field with the result that a complete line of accessories similar to those illustrated is being developed.

A complete line including variable and fixed coupling air and mica tuned I.F. transformers; high, medium and standard "Q" LITZ wound coils; beat frequency oscillators with air trimmers with

adjustable beat note, new type air trimmers and padders for complete range of capacities.

- (1) TOBE air trimmers and padders, finest mechanical construction, Isolantite mountings.
- (2) TOBE variable coupling I.F. transformer, panel controlled, arranged for ganging, air tuned.

Call at once at your jobber or dealer to see these highest quality parts, or write us direct for complete details to Dept. Q-95.

**TOBE DEUTSCHMANN CORP.**  
Canton, Massachusetts  
Export Dept: 105 Hudson St., New York, N.Y.

# The Lightning Radio Calculator

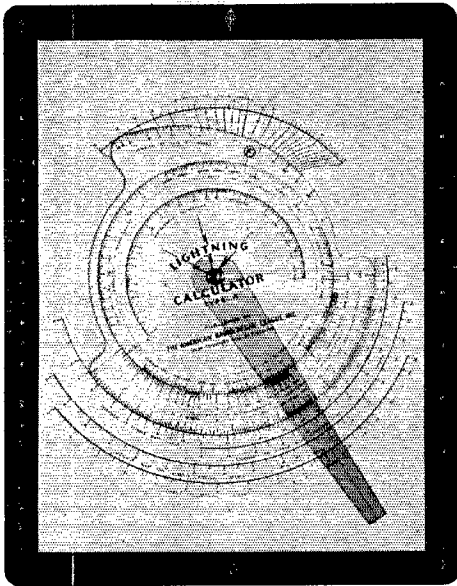

- ✓ Quick
- ✓ Accurate
- ✓ Versatile
- ✓ Simple

The most useful gadget  
you ever owned

Postpaid \$1 anywhere

American Radio Relay League, Inc.  
West Hartford, Conn.

worked W1TS and W4TS, W2AEW and W9AEW, W3SI and W4SI, and numerous other equally coincidental combinations. 888 was the most popular serial noted at K4KD. One of the youngest operators—CM2OP, age 14 years. VP4TA advises that all Trinidad amateur station calls contain the letter "T," for example: VP4TA, VP4TG. Other VP4's are in British Honduras, about 1600 miles away. CEIAP worked his first W5 in three years of operation. LU1EP worked W9AFN; his next contact was W9NFA. Hi. Not helping DX work a bit on 7-mc. in Buenos Aires were 50 to 60 stations operating 'phone, reports LU9BV. OM2AA raised VE4LK, whose signals swung in during a brief rain squall, only to have him disappear entirely with the passing of the rain. The contact between W4SW and ZL4AI was the shortest ZL4LI has ever experienced—it lasted not much more than fifteen seconds. ZL4AI commends W4SW for unusually snappy operating. Out of 414 stations worked ZL3AN found only two (W4SW and W2CLM) who used "break-in." You are overlooking an operating time-saver, if you neglect to equip your station for break-in operation. ZL3JA heard F8PK on 3.5-mc. during the tests. W3OP was worked by VK7RC the "long way around." The number 777777 was sent from VK7RC about twenty-four times. VK3ML had a newly erected 70-foot mast do a loop-the-loop to earth.

CQ's on the part of W/VE contestants were a waste of time, and a veritable "pain" to nearly all concerned. Foreign contestants do not, as a rule, look for CQ's, they call them and look for answers. The successful scorers in the W/VE group refrained from CQ-ing. Those making all their contacts by "calling" stations, not CQ included: W1DUK, W2AIF, W3OP, W3EPR, W4AAQ, W6JMR, W8ZY, W8VZ, W8CTE, W3YC, W4CA. As an indication of how the first two days of the contest compared with the others: E18B worked 116 stations in the first two days and only another 116 during the following seven days. The Award Committee thanks the hundreds who sent extremely neat logs; it helped, believe us. W6FZL, in reporting, says, "Headaches, backaches, power bills, BCL interference, black coffee, white coffee, indifferent coffee, filaments, bottles, hums, dials, lights, CQ DX, CQ Test, blah. Gee, it was swell." That about sums it up. Hi. Approximately 81% of the stations heard at W5EBT were worked.

VE3WA wonders what the neighbors thought, if they saw him up on the roof at 3:00 a.m. repairing his antenna. W9FYY made W.A.C. three times during the fray. K6AJA worked 39 states and Canadian provinces. W8ZY used short calls for all contacts—called five times, signed four times. The clock in W3COP's shack stopped at exactly the closing time of the contest—couldn't take it! Hi. W3AG WAC'ed in one day. Such a strain and shock was it for W3BWU's rig to make him his one contact the 2000-volt transformer went up in smoke immediately afterwards. W2CUQ, in a vaudeville act, rushed back and forth from the theatre to his home at every available opportunity in order not to miss the rare ones. The first station QSO'd by W1AKR put him in line for W.A.C.—it was VK2XJ. W1EPC worked 70% of the stations heard. During the height of the contest friendly (?) B.C.L.'s cut both feeders on W1HML's skyhook!

W1CUN doesn't know which gave him the greatest kick—nailing ZC6FF and VS6AH, or getting an R7 report from PK3BM. That is a difficult decision! The QSO GB5Y-W1WV made W1WV eligible for the T.B.T.O.C. Club. A member of the South Bay Amateur Association (west coast DX group) has won the Los Angeles award in DX contests for six consecutive years: 1930 W6CUH, 1931 W6AQJ, 1932 W6EGH, 1933 W6CUH, 1934 W6QD, 1935 W6GRL. The outstanding low power work of the contest was by CT2BK, without a doubt—30 watts input! for 492 contacts!! All we need now, according to W8LVV, is a National Holiday for the duration of the tests. Check! W9IJ heard 357 stations in 54 countries. W6GRL worked VK's, ZL's and J's at the rate of six, seven and eight per hour. G6RB made 20 contacts on 3.5 mc., 10 of them in one hour and a half.

Previous to the contest VK2BW had never worked a "Yank"; at the close he could show 40 to his credit. VK3YK made but one QSO but that was with VE2EE while using 180 volts B batteries, at 20 mills plate current. PA0QQ, equipped only for 56-mc. at the start of the mêlée, couldn't resist the urge and got going on 14-mc.—using the 56-mc. antenna. Later he rigged up an antenna for 7 and 3.5-mc. using a combination of the B.C.L. and 56-mc. skywires. You can't keep a good DX man down. Hi. ON4AU beat all his own



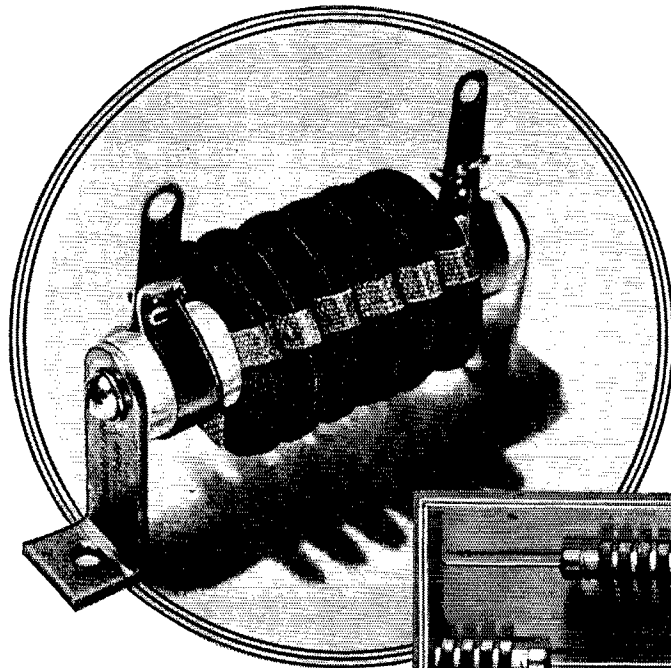

CH-500  
TRANSMITTER  
CHOKE

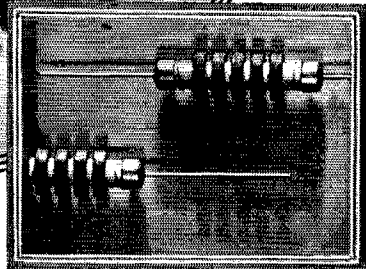

CH-X R.F. CHOKE

# For CHOKE EFFICIENCY, Rely on HAMMARLUND

**T**HE Hammarlund "CH-500" Heavy-Duty Transmitter Choke delivers its highest useful impedance (*more than 500,000 ohms*) in the 20, 40, 80 and 160-meter amateur bands. Inductance 2.5 mh. Distributed capacity less than 1.5 mmf. DC resistance 8 ohms. Maximum recommended DC (*continuous*) 500 ma. Isolantite core, with *no metal through center*. Mounts with a single machine screw, with brackets removed. \$1.75 each.

The Hammarlund "CH-X" R.F. Choke is the smallest and lightest made. Its features are *exclusive*. Only  $\frac{1}{2}$ " x  $1\frac{1}{2}$ ", it is small enough for restricted spaces and so light that the tinned copper leads are ample support.

Leads extend *straight* from the end caps. This makes for neater wiring.

Tinned copper end caps are small, thin and so spaced that distributed capacity to adjacent coils is at a minimum. Five moisture-proof, lattice-wound pies of high impedance. Inductance 2.1 mh. Carries 125 ma. Isolantite core. Priced so low it can be used generously wherever R.F. filtering is desirable — such as detector plate circuits, all B+ leads, grid leads, etc. Only 75c each.

*Mail Coupon for Complete Catalog  
of Quality Radio Equipment*

Canadian Office:  
41 West Avenue North,  
Hamilton, Ontario

HAMMARLUND MANUFACTURING CO.  
424-438 W. 33rd St., New York

Check here for New General Catalog.  Check here, and attach 10c, for New 32-page Short-Wave Manual.

Name .....

Address .....

..... Q-9

For Better Radio  
**Hammarlund**  
PRECISION  
PRODUCTS

# EIMAC

TRANSMITTING TUBES ARE  
**UNSURPASSED**

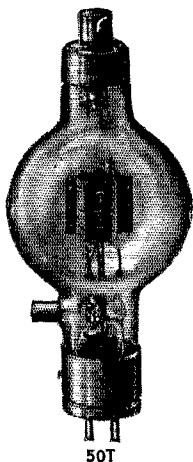

Modern Design  
means . . . . .

- Elimination of stem puncture.
- Elimination of insulator breakdown.
- No possibility of turning gassy.
- Low interelectrode capacities and low lead inductance and resistance.
- High transconductance.
- Low grid current.
- Superlative performance and long life.

Modern design means far more than just bringing the plate lead out of the top of the tube.

50T — \$13.50 150T — \$24.50

AT YOUR DEALER  
"COMPARE AND REFLECT"

**EITEL-McCULLOUGH, INC.**  
SAN BRUNO, CALIF.

## The **CT-60** TRANSMITTER or DRIVER

An RK-20 TRI-TET for 3-band operation featuring crystal control, complete band switching and with provision for phone operation

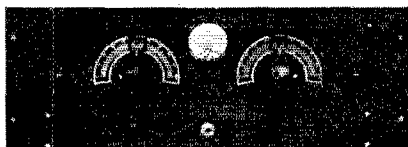

As a transmitter, the CT-60 will deliver 50-60 watts into the antenna, and as a driver will excite a higher powered amplifier up to 400 watts input on the crystal fundamental. Modulated in the suppressor grid with CT-60M modulator, a 15-watt carrier may be had in the 160- and 75-meter phone bands.

Write for descriptive circular

### CT-60 TRANSMITTER

Model A, 160-80-40 meters . . . . . **\$33.00**  
Model B, 80-40-20 meters . . . . .  
RK-20 tube tested in set . . . . . **\$15.00**

### CT-60M MODULATOR

Model X for crystal microphone . . . . . **\$16.80**  
Model C for carbon microphone . . . . .  
Set of tested tubes . . . . . **\$1.43**

AVAILABLE IN NEW ENGLAND FROM YOUR DEALER. OTHERS ORDER DIRECT

**HARVEY RADIO LABORATORIES**  
12 Boylston Street Brookline, Mass.

previous records for fast QSO's when he raised a station, exchanged numbers and signed off, all within two minutes, forty seconds. A heavy a.c. power leak on the last day of the contest stirred plenty of excitement among the hams in W2GVZ's town; the power company trouble-shooter was also a ham, so all was fixed in record time! In the case of unsatisfactory results at some stations, it was not the "unfinished symphony," it was the "unfinished super"! Number heard most at W9FO—852; we wonder if all using that number used an 852 tube. Says W2BGE, "The competition is getting so keen nowadays that when you work a station you feel you have taken him away from about fifty other hams." W1DXL received the numbers 333333, 444444, 777777 and 888888—enough to make a fellow dizzy. "Most lasting impression received during contest: That sickening feeling in the pit of your stomach when your best DX QSO comes back calling CQ again when you sign to him for the first time!"—W4BRG. W1SZ heard a total of 63 countries! W5NW WAC'd in 18 hours. W5HX used only a single 112A, 300 volts B batteries, for all his work. Of interest to all is the power used by W3SL, world-high scorer: 1 kw. on 7 and 14-mc., 250 watts on 3.5-mc. W9IU worked 18 Oceania stations in one evening, 15 in another and 14 another. The D.A.S.D., German amateur society, told its members to take part in the contest as much as possible. One member thought this was an "order," but he was sick during the tests so he took his log to his doctor who attested his sickness on it! D1B.U was the first DX QSO for more than 30 W's.

## **Strays**

W3CWE wants to thank the ham who is bootleggin' his call for DX and out-of-the-way states, but wishes said ham would try just a bit harder for Asia and Africa so he can be WAC!

W9TE says it's bad enough when the OW talks back, but when a Heising choke talks back, that's the last straw!

## Our Cover Illustration

(Continued from page 23)

photograph of the gear in actual operation. Incidentally, the ultra-high frequency development work has resulted in definite achievement. In the past year more than a dozen different superheterodynes have been built. All of them served chiefly to impress us with the severe limitations of the conventional super for u.h.f. work. Recently, the problem has been attacked from a different angle and the latest experimental receivers, involving an entirely unconventional principle, have given us something to get excited about. After further proving of the new type of receiver, we plan to "shoot the works" in an early issue.

## 1935 Mid-American-Dakota Division Convention

THE 1924 Dakota Division Convention was hailed as one of the finest amateur conventions ever held, but when delegates to the Mid-American-Dakota Division Convention, held at Minneapolis May 3rd, 4th and 5th, pointed their automobiles homeward it was everywhere acknowledged that the 1935 convention was second to none in providing entertainment and features of interest to the attending amateurs.

Registration began early Friday, May 3rd, when VE4GA from Regina signed up to take honors for coming the longest distance—almost

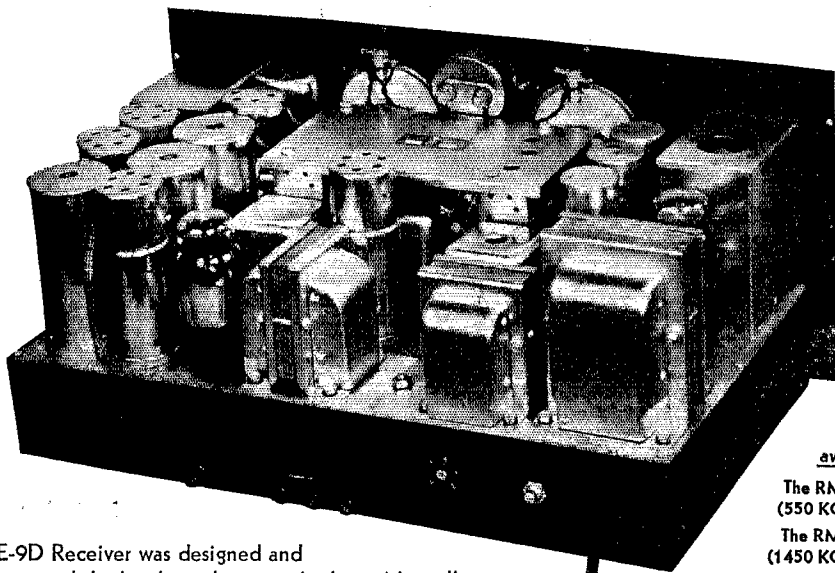

*The models  
available are:*

The RME-9D Standard  
(550 KC to 23,000 KC)  
The RME-9D Special  
(1450 KC to 32,000 KC)

**T**HE RME-9D Receiver was designed and built for amateurs. It had to be right to satisfy them. Naturally, every conceivable condition encountered in the daily contacts between stations was given careful consideration.

We do not care to broadcast in glowing terms what the RME-9D will do. You, as an owner, are privileged to draw your own conclusions. Remember, we guarantee that every receiver shipped must satisfy, and we have satisfied hundreds of amateurs.

**RADIO MFG. ENGINEERS, INC. 313 Bradley Avenue, Peoria, Illinois**

# YOU CAN DEPEND ON G-E PYRANOL CAPACITORS

**T**HEY'RE inexpensive, too, and scientifically designed. Years of experience in manufacturing capacitors for leading broadcast and short-wave communication stations and the government are built into them. Big, cumbersome capacitors need no longer use valuable space in your transmitter. Nor do you have to worry about fire — Pyranol won't burn. You can use more voltage — G-E Pyranol capacitors will stand continuous operation up to 10 percent above rated d-c. voltage. They make possible better signals and have longer life. Get them from your dealer. Radio Department, General Electric, Schenectady, N. Y.

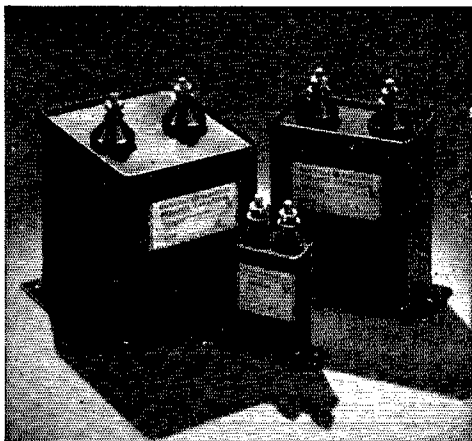

360-101

**GENERAL**  **ELECTRIC**

Say You Saw It in QST — It Identifies You and Helps QST

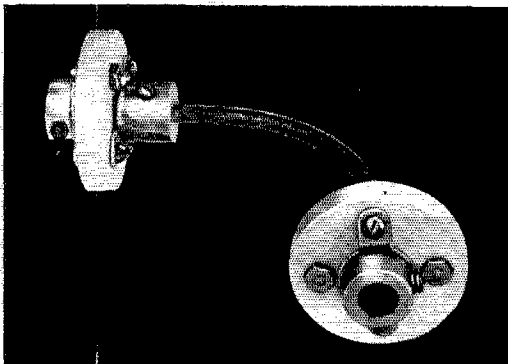

**FLEXIBLE SHAFT COUPLING:** This new and extremely useful gadget combines Isolantite insulation with a short length of flexible shafting. It provides a driving means between offset shafts, or shafts at any angle up to 90 degrees. It virtually eliminates alignment problems. The shafting is of the highest quality (not speedometer cable), reducing backlash to an almost imperceptible amount. It is not recommended for high precision drives however. It is available with plain hubs without insulation, as well as with the Isolantite insulation illustrated above. Hubs take  $\frac{1}{4}$  inch shaft.

Net Price, as illustrated \$ .75  
 Net Price, plain hubs \$ .36

**NATIONAL COMPANY, INC.**  
**MALDEN, MASS.**

## NEWARK'S SETS FOR EVERY AMATEUR

Newark's deferred payment plan, available to everyone in the U.S.A. makes it easy for you to own a

**NATIONAL HRO  
 HAMMARLUND PRO  
 HAMMARLUND SUPER PRO  
 SUPER SKYRIDER  
 RCA ACR-136  
 RME9D**

All of these sets on display at our Chicago store, 226 W. Madison St. Come in or write for details.

### NEWARK BARGAINS!!

Oil filled — Oil Impregnated Filter Condensers

2 mfd. 1500 V. DC $4\frac{1}{2}$ x $2\frac{3}{4}$ x $1\frac{1}{4}$ .....	\$1.20
2 mfd. 2000 V. DC $4\frac{3}{4}$ x 5 x 1.....	1.50
6 mfd. 1500 V. DC 5 x $3\frac{3}{4}$ x $2\frac{1}{2}$ .....	2.25
8 mfd. 2000 V. DC $4\frac{1}{2}$ x 5 x 3.....	2.75

### Newark Paper Filter Condensers

These condensers are canned with porcelain Standoffs  
 Every One Guaranteed!

1 mfd. 1000 V. DC.....	56c
1 mfd. 1500 V. DC.....	66c

## NEWARK ELECTRIC COMPANY

"FASTER SERVICE — BETTER BARGAINS"

226 W. Madison Street  
 Chicago, Illinois

1500 miles, mostly over mud-filled roads. Trips to the Tribune building to view the A.P. Wire-photo apparatus and to the telephone company's plant consumed most of the morning. In the afternoon the technical program got off to a flying start with a talk on transformers by Boyd Phelps, followed by A. R. Kahn on microphones and Frank Hajek on tubes. Evening found an open forum meeting in full swing with Director Carl Jabs presiding, with A.R.R.L. matters coming up for thorough discussion. A stag for the old-timers kept the plates hot until the early morning hours when the gang finally had to be shepherded out of the lobby of the West Hotel by the cleaners making their morning rounds!

Saturday morning Dr. H. E. Hardig of the University of Minnesota gave a mechanical demonstration of the operation of antennas and feeders which proved an eyeopener to the gang. The afternoon program opened with Henry Argento on tubes, followed by George Grammer, continuing the subject of antennas, after which most of the fellows began to think they were going to have scalloped antenna leadin for the main banquet dish! At a noon session organized by Dr. Burton T. Simpson, W8CPC, fifty 'phone men signed up for the Dakota Division Radio-telephone Association, electing W9JDO president. A showing of A.R.R.L. and Dakota Division hamfest movies finished off the afternoon.

At the banquet Friday night, Rex Munger, W9LIP, as toastmaster, and Ted Hediger, W9FK, as master of ceremonies, assisted by popular entertainers from the Twin City broadcasting stations, put on a rapidly-moving show which made three hours seem like as many minutes, giving the 500-odd hams, YL's and XYL's never a chance for a dull moment. Special prizes for the ladies were drawn after the entertainers were reluctantly allowed to go, followed by the big event—the drawing for the grand prize, a complete 100-watt c.w.-'phone transmitter. The lucky winner, John Talen of Ogiwie, Minn., had just taken his exam during the convention—a swell send-off for a new ham!

An unusually large prize list ranging from crystals to superhet receivers kept the gang over for the drawing on Sunday morning. In the afternoon a golf tournament at the Westwood Hills Country Club, won by W9EAB, completed the three-day program. The 584 hams who registered at the convention went home with the firm conviction that the Twin Cities gang had put over a convention that couldn't be beat. All credit to the hard-working committee, made up of leading members of the Minneapolis Radio Club and St. Paul Radio Club.

### Technical Topics

(Continued from page 21)

zero at, say, 50 kc/s below the IF frequency to a positive value for higher frequencies; whilst the input reactance of the (other) second detector varies from zero at a point, say, 50 kc/s above the IF frequency to a negative value for lower frequencies.

**EXTREMELY LOW DRIFT**

**GREATER ACTIVITY**

**GUARANTEED OPERATION**

**IMPROVED HOLDER**

**40-80-160 METER BANDS**

**COST only \$4.80**

**RMA**

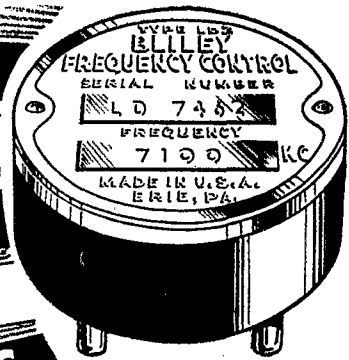

**LD-2 UNIT**

See the new Bliley LD-2 Crystal Unit at your dealer's today.

It's the most efficient crystal on the market at anywhere near the price. Bliley Electric Co., Erie, Pa. \*Under 8 cycles per megacycle per °C.

# BLILEY LD-2 CRYSTAL UNIT

## REMEMBER

ONLY UNTIL AUGUST 31

To take advantage of the special offer of membership-subscription and a copy of the twelfth edition of the "Handbook" for

**\$3**



### Here's Real Value!

Sound engineering... honest quality... mass production... economy... no wonder AEROVOX round-can X-mitting Condensers outlast all others. These genuine oil-filled units, with high-tension terminals, are built for rough going, longest service life, and those slim 1935 ham pocketbooks. Available in 1000 v. 1, 2 and 4 mfd.; 1500 v. 1 and 2 mfd., and 2000 v. 1 and 2 mfd. Compare quality and price before you buy!

**DATA** New 1935 catalog covering condenser and resistor line, on request. Also sample copy monthly Research Worker.

# AEROVOX

**CORPORATION**  
73 Washington St. Brooklyn, N. Y.

**Radio Engineering Complete in Telegraphy-Telephony**



**Studio Technique and Transmitter Operating Experience Guaranteed**

**KPAC**

**500-Watt 1260 Kilocycles**

IN 3 to 7 months we train you to secure Commercial Telegraph Second-class, and Radiotelephone First-class government licenses. Course consists of Wireless Code, Radiophone, Microphone-Studio Technique, Service, Police, and Aeronautical Radio. We are authorized to teach RCA texts. At completion of course you receive practical studio technique experience in our commercial broadcast studios located in administration building, and experience as an operator on K-P-A-C (500-Watt Commercial transmitter located on the campus and owned and operated by the college), and WPA, 4000-Watt Commercial Wireless Station. If interested, write for Bulletin R.

**PORT ARTHUR COLLEGE**

**Port Arthur (world-known port) Texas**

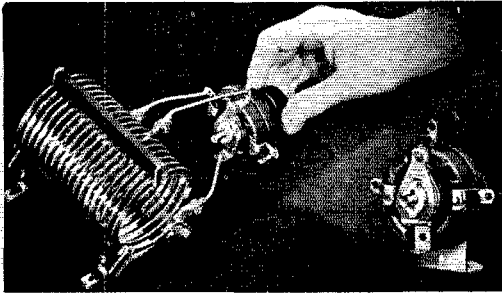

## Choose Your Wave-Length with

# OHMITE BAND-SWITCH

(Patents Pending)

SEND FOR  
CATALOG 14  
JUST OFF  
THE PRESS!

Twelve pages of live data and information about the new resistors and rheostats now available for amateur use in transmitters and receivers.

Don't let a crowded wave band keep you off the air because it's too much trouble to change coils and re-tune. Switch from one band to another with a flick-of-the-wrist — by using OHMITE Band-Switches on your control panel! Bulletin 104 gives diagrams for all basic transmitter circuits. Write for your copy today.

**OHMITE MANUFACTURING COMPANY**  
631 N. Albany Avenue CHICAGO, ILL.

## PYRANOL

2MFD-2000 VOLT

(Operating)

### FILTER CONDENSERS

Impregnated and filled with Pyranol. We rate these at 2000 volts working and we know of cases where they are in use at a 50-75% overload. Made by one of the world's largest manufacturers of electrical apparatus.

● **UNSOLICITED—READ IT.**

The Pyranols we bought from you 8 months ago going strong at 200% overload . . . Please send us 1 more.  
J. T., Ben Lomond, Calif.

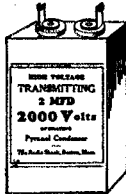

**Guaranteed Unconditionally  
For 2 Years**  
No Restrictions as to use!

**\$2.90**

<b>VT 203A</b> Graphite <b>\$9.00</b>	<b>INTERNATIONAL PLATE TRANSFORMERS</b> Outstanding for Value. 750 and 1000 volts each side of c.t. at 300 mills. Cased completely in steel, crackle finish. Model 2000 . . . \$5.95 Model 3000 — Same in appearance, 750-1000-1500 each side of c.t. 300 mills . . . \$8.95 <i>We know of nothing that equals the value received in these two items.</i>	<b>2.5V-12A 866 TRANS.</b> <b>\$1.25</b>			
<b>R. C. A. 860 (used)</b> <b>\$12.00</b>		<b>PEAK 5M SUPER</b> <b>\$21.60</b>			
<p align="center"><b>UNDENIABLY EXCELLENT! BROWNING AMATEUR RECEIVER</b></p>					
<p align="center"><b>\$41.40</b></p> <p align="center">UNWIRED</p> <table border="0"> <tr> <td>866's Heavy Duty \$1.00 Each</td> <td>Mail Orders Filled—Include Postage</td> <td>Baldwin Type "C" Phones \$2.50</td> </tr> </table> <p align="center"><b>THE RADIO SHACK</b> 46 Brattle St. Boston, Mass.</p>			866's Heavy Duty \$1.00 Each	Mail Orders Filled—Include Postage	Baldwin Type "C" Phones \$2.50
866's Heavy Duty \$1.00 Each	Mail Orders Filled—Include Postage	Baldwin Type "C" Phones \$2.50			

"The two detectors are arranged so that their response to the frequency-modulated signal is cumulative, though they act in opposition on the relatively-narrow band of amplitude 'interference' due to valve noise. The latter is therefore substantially balanced out, and the receiver operates with much higher HF gain than is normally practicable."

\* \* \* \*

Although a conclusive judgment as to the ultimate utility of this latest Armstrong development in practical amateur work would be premature at this time, the evidence at hand (including the Major's own comments to us) convinces us that, while it might some day find use in amateur 'phone on 56 mc. and higher frequencies, it will not be practicable for the lower frequencies. On 160, 80 and 20 it seems quite clear that present systems of amplitude modulation, and derivatives thereof, will continue to hold sway. Of course *QST* will have the authoritative details in due time, following a promised practical demonstration by the Major himself and permission to release the information. In the meantime, advanced amateurs interested in studying the frequency-modulation background involved will find plenty to chew on in the following selected references:

J. R. Carson, "Notes On the Theory of Modulation," *Proc. I.R.E.*, Feb., 1922.

B. van der Pol, "Frequency Modulation," *Proc. I.R.E.*, July, 1930.

H. Roder, "Amplitude, Phase and Frequency Modulation," *Proc. I.R.E.*, Dec., 1931.

J. G. Chaffee, "The Detection of Frequency Modulated Waves," *Proc. I.R.E.*, May, 1935.

A. Hund, *High-Frequency Measurements* (McGraw-Hill), Chap. XIV.

—J. J. L.

## I.A.R.U. News

(Continued from page 46)

issues of *QST*. It is to the addresses following that cards intended for the countries shown are to be sent. Corrections, additions, or deletions to or from this list will be welcomed.

Algeria: See France.

Argentina: Radio Club del Argentina, Rividavia 2170, Buenos Aires.

Australia: W.I.A. Federal QSL Bureau, George W. Luxon, VK5RX, 8 Brook St., Mitcham, South Australia.

Austria: O.V.S.V., Willy Blaschek, Bahngasse 29, Klosterneuburg.

Azores: See Portugal.

Belgium: Reseau Belge, 312 Rue Royale, Brussels.

Brazil: L.A.B.R.E., Caixa Postal 26, São Paulo.

British West Indies: Ian C. Morgan, "Southlands," Warwick East, Bermuda.

Canada: A.R.R.L., West Hartford, Conn., U. S. A.

Ceylon: G. H. Joliffe, VS7GJ, Frocester, Govinna; or A. M. Rahim, "Rillington," Wellawatte, Colombo.

Chile: Luis M. Desmaris, Casilla 761, Santiago de Chile.

China: I.A.R.A.C. Box 685, Shanghai.

Colombia: L.C.R.A., Apartado 330, Bogota.

Cuba: Pedro Madiedo, calle Santa Rosa, Buen Retiro, Marianao, Habana.

Czechoslovakia: C.A.V., Post Box 69, Praha I.

Denmark: E.D.R., Post Box 79, Copenhagen K.

Dominican Republic: Dr. Enrique de Marchena, Apartado Postal 912, Santo Domingo.

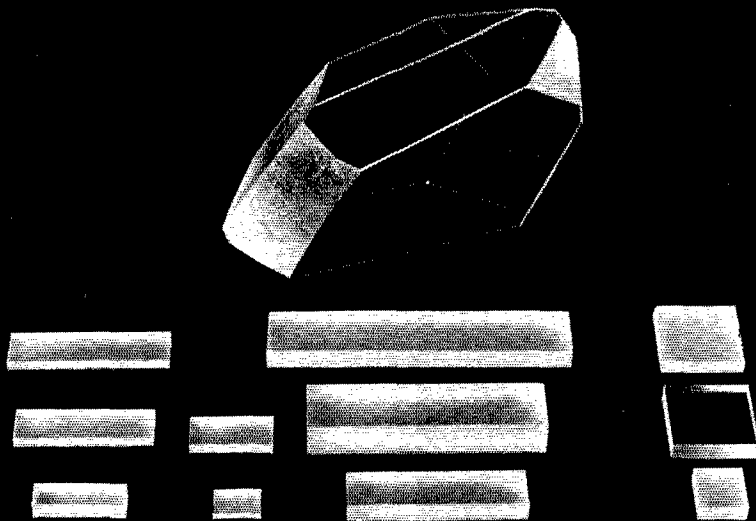

Write for Bulletin 103 describing ISOLANTITE Holders, "AT" Cut Crystals, etc.



**PREMIER CRYSTAL LABORATORIES, Inc.**  
53 PARK ROW, NEW YORK CITY, U.S.A.

THE FIRST RADIO SCHOOL IN AMERICA

**PHILADELPHIA SCHOOL  
OF  
WIRELESS TELEGRAPHY**

1533 PINE STREET PHILADELPHIA, PA.

INVEST WISELY NOW

TRADE "GO-DEVIL" MARK

**AUTOMATIC TRANSMITTING KEY**

LIST \$10.00 **\$6.00** INCLUDES POSTAGE

**A. H. EMERY POUGHKEEPSIE, N. Y.**

**LEARN RADIO** New Classes Now Forming! Send for 40-page catalog, explains

fully. 190 licensed graduates placed in past 3 years in broadcasting, shipping, police radio, aviation, etc. We teach all branches. Oldest, largest and best equipped school in New England. Equipped with Western Electric sound and broadcasting equipment and RCA marine transmitter. Course prepares for United States Government telegraph or telephone license.

MASS. RADIO SCHOOL, 18 Boylston Street, BOSTON

**FASTEST WAY  
TO LEARN  
CODE**

Easy, Fascinating,  
**LEARN by EAR**  
to be a Good Op!

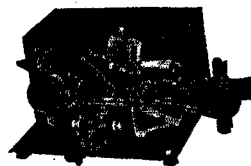

**MASTER TELEPLEX**  
"The Choice of Those Who Know"

The New **MASTER TELEPLEX** Code Teaching Machine is exactly what thousands are looking for. No experience needed. Ideal for beginners—steps up w.p.m. for all ops. Only instrument ever produced which records your sending in visible dots and dashes on copper tapes—then sends back your own key work. You actually **HEAR** the dots and dashes, any speed you want. You learn code the way you'll be using it—by **FREE SOUND!** Complete Code Course included, no extra charge. Used by U. S. Army, Navy, R.C.A., **BOOK** A. T. & T. Co., and others. Low cost, easy terms, **Money-Back Guarantee.** Send now for booklet Q-33, no obligation. Postcard will do.

**TELEPLEX COMPANY**  
76 CORTLANDT ST. NEW YORK, N. Y.

**IMMEDIATE DELIVERY  
FROM RECEIVER HEADQUARTERS**

NATIONAL HRO.....	\$167.70
RME9Ds.....	112.50
RCA ACR-136 complete.....	69.50
BRETING 12 complete prepaid.....	93.00
SUPER PRO complete.....	164.64
PR-16 complete prepaid (when available).....	89.70
ALL COLLINS transmitters at lowest prices	

HALLICRAFTERS new SUPER-7 \$49.50 complete prepaid, new nine tube Super-Skyrider with metal tubes, broadcast band, crystal filter \$79.50 complete prepaid.

**TRADE IN YOUR RECEIVER OR TRANSMITTER**  
We specialize in amateur transmitting apparatus and receivers. Write for our time payment plan. Complete stock of all RCA, Eimac, Taylor transmitting tubes at lowest prices. Your used apparatus taken in trade.

Every inquiry and order is personally attended to by Robert Henry, W9ARA; an active amateur for ten years; graduate E.E. from M.I.T.; and owner of Henry Radio Shop selling amateur apparatus for six years. Your orders are valued and appreciated. Write for any information.

**HENRY RADIO SHOP**  
211-215 North Main St. Butler, Missouri

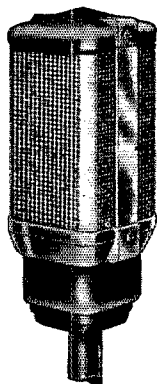

for REAL  
Microphone  
Performance  
try the  
**MU-X**

The new Mu-X, Turner's latest development in multiple crystal microphones, is setting a new standard of microphone performance and value. Here for the first time extreme sensitivity and flat frequency response are combined in an instrument which will stand a lot of abuse. Available for either push-pull or single grid input with 4, 6 or 8 crystal units. Priced lower than any instrument of similar characteristics. Licensed under patents of the Brush Development Company.

Write for descriptive literature  
and prices

**THE TURNER COMPANY**  
Cedar Rapids, Iowa, U. S. A.

Dutch East Indies: N.I.V.I.R.A., J. M. van Heusden, Ir., Burg., Coopsweg 28, Bandoeng.  
Egypt: F. H. Pettitt, Catholic Club, Mustapha Barracks, Alexandria.  
England: R.S.G.B., 53 Victoria St., London S.W. 1.  
Estonia: V. Suigusaar, Hobe t. 4, Pernau.  
Finland: S.R.A.L., Pohjola, Box 42, Helsinki.  
France: R.E.F., 6 square de la Dordogne, Paris 17<sup>e</sup>.  
Germany: D.A.S.D., Schweinfurthstr. 78, Berlin-Dahlem.  
Guam: Foster D. Brunton, 62 Santa Cruz St., Agana.  
Haiti: J. D. Poindexter, Pan-American Airways, Port-au-Prince.  
Hong Kong: H.A.R.T.S., Box 651.  
Hungary: National Union of Hungarian Short-Wave Amateurs, VIII, Mátyás-tér 6, Budapest.  
India: B. M. Tanna, Ismail College, Jogeshwari, Bombay; or John G. McIntosh, Baghjan T.E., Doom Dooma P. O., Assam, Northern India.  
Iraq: L. A. C. Lewis, No. 1 A.C.C., R.A.F., Hinaidi, Baghdad.  
Irish Free State: H. Riley, 58 Belmont Ave., Donnybrook, Dublin. (Cards for Northern Ireland go to R.S.G.B., England.)  
Italy: c/o A.R.R.L., West Hartford, Conn., U. S. A.  
Jamaica: Cyril M. Lyons, 2-B North St., Kingston.  
Japan: J.A.R.L., Box F-77, Tokyo.  
Java: Th. F. Leyzers (vis), Van Heutz Boulevard 2, Batavia, Centuz.  
Yugoslavia: Stephen Liebermann, Meduluceva 9, Zagreb.  
Kenya: George F. K. Ball, Box 721, Nairobi.  
Latvia: A. Karklin, 2 Lenca dz. 8, Riga.  
Lithuania: L. R. M., Post Box 100, Kaunas  
Luxembourg: J. Wolff, 67 Avenue du Bois.  
Madeira: See Portugal.  
Malaya: Reginald J. Bee, Malayan Public Works Service, Kuala Kangsar, Perak, Federated Malay States.  
Mexico: I.M.R.E., Sinaloa 33, Mexico City.  
Morocco: A.A.E.M., BP 50, Casablanca.  
Netherlands: N.V.I.R., Post Box 400, Rotterdam.  
New Zealand: N.Z.A.R.T., P. O. Box 517, Dunedin.  
Norway: N.R.R.L., P. O. Box 2253, Oslo.  
Palestine: D. Winslow, Royal Air Force, Ramleh.  
Peru: Radio Club Peruano, Apartado 538, Lima.  
Poland: P.Z.K., Bielowskiego 6, Lwow.  
Porto Rico: Francis M. McCown, Family Court No. 7, Santurce.  
Portugal: R.E.P., Rua Primerio de Dezembro 33-3, Lisbon.  
Roumania: Dr. Alex Savopol, Radio Club Craiova, Rosetti 6, Craiova; or Lieut. ing. F. Dinescu, Ecole Polytechnique, Bucarest.  
Salvador: J. Frederico Mejia, 7a Calle Poniente 76, San Salvador City.  
South Africa: S.A.R.R.L., P. O. Box 7028, Johannesburg.  
Spain: U.R.E., Apartado 262, Madrid.  
Sweden: S.S.A., Stockholm 8.  
Switzerland: U.S.K.A., Neu Allschwil near Basle.  
Trinidad: Frank A. Herbert, 29 Reid Lane, Belmont.  
Tunis: See France.  
Uruguay: U.S.W.C.G., Box 37, Montevideo.  
U.S.S.R.: C.B.S.K.W., Karuninskaa pl. 2/5, Moscow.

COMPLETE DESIGNS OF  
**20** Transmitters

12 tested transmitter R.F. section designs! 8 modulator and speech amplifier designs!

Outputs ranging from a little fellow on which the O.W. can learn, to big ones comparing in every way with the best broadcaster.

Circuit, and complete parts specifications of transformers, inductances, and all other component parts.

One of the most complete and thorough handbooks on transmitter design ever printed!

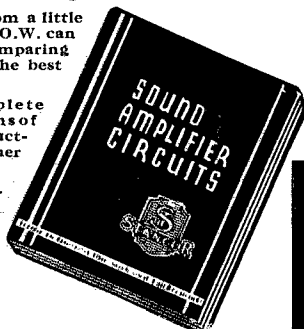

**FREE!**

VALUABLE REFERENCE BOOK

This advertisement and 12¢ IN STAMPS, to cover mailing expenses, will bring your FREE copy of this valuable Reference Book. There is no obligation.

**Standard Transformer Corp.**  
856 Blackhawk St., CHICAGO, ILL.



**The Hudson Division Convention**

THE tenth annual Hudson Division Convention held at the Hotel New Yorker, June 1st, will go into amateur radio history as the largest affair held in the division. With 800 people milling around the exhibitor's booths it was like hunting for the proverbial needle in the haystack if one desired to locate a friend.

For a one-day convention Chairman Roy R. Neira, W2EVA, and his committee had prepared a program so filled up with events it was almost impossible to keep up with everything. Ross Hull, associate editor, *QST*, brought the very latest of his experiments on Ultra-High-Frequency Developments. Among the prominent speakers were noted Ed. Glaser, W2BRB; Arthur H. Lynch, W2DKJ; I. A. Mitchell,



# All Because He Didn't Have a SQUIMDUFFIT on his

## WOTUMACALIT

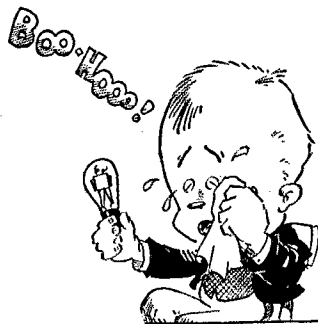

THE reason he didn't was because he didn't know any better. True, he should have known. He had read *QST* for years. But *QST* hadn't spoken of it recently — they thought everybody knew it. Of course it was in the Handbook. Everything about amateur radio is in the Handbook. But he was trying to get along without a Handbook. Don't waste *your* money on mistakes. *Postpaid anywhere.*

SEND YOUR DOLLAR TODAY FOR YOUR COPY

# The Radio Amateur's HANDBOOK

(268 PAGES—237 ILLUSTRATIONS)

- P.S. If you're feeling particularly gaudy you can have the Handbook in stiff buckram binding with solid gold lettering for two dollars

THE AMERICAN RADIO RELAY LEAGUE, West Hartford, Conn., U. S. A.

*The New*  
**OHM'S LAW  
 LIGHTNING  
 CALCULATOR**

➔ See Page Four

## RADIO ENGINEERING



RCA Institutes offers an intensive course of high standard embracing all phases of Radio. Practical training with modern equipment at New York and Chicago schools. Also specialized courses and Home Study Courses under "No obligation" plan.

Illustrated Catalog on request.

**RCA INSTITUTES, INC.** Dept. ST-35  
 75 Varick St., New York 1154 Merchandise Mart, Chicago  
*Recognized Standard in Radio Instruction Since 1909*



## NEW 1936 CATALOG YOURS for the ASKING

This CATALOG illustrates a complete line of Radio Parts for the amateur. Our Goal for this fall — "BETTER MERCHANDISE AT LOWER PRICES"

**BUD RADIO INC.** Cleveland, Ohio  
*Please send me your latest catalog FREE*

Name .....

Address .....

City .....

QST 9-35

## ▶ RADIO CODE ◀

*is easy to learn with*

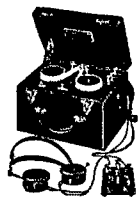

## INSTRUCTOGRAPH CODE TEACHER

It's practical and costs little. It sends perfect code — at the speed you want, fast or slow. And you practice at home at whatever time suits you best. With each Instructograph, sold or rented, comes Book of Instructions written by an expert operator; it shows you how to practice to best advantage, just as an instructor would do. If you want to acquire the code or increase your speed of — write TODAY for descriptive folder and attractive new terms. There's no obligation.

**INSTRUCTOGRAPH COMPANY — Dept. Q9**  
 912 Lakeside Place Chicago, Illinois

*Representatives for Canada*

**RADIO COLLEGE OF CANADA, LTD., 863 BAY ST., TORONTO.**

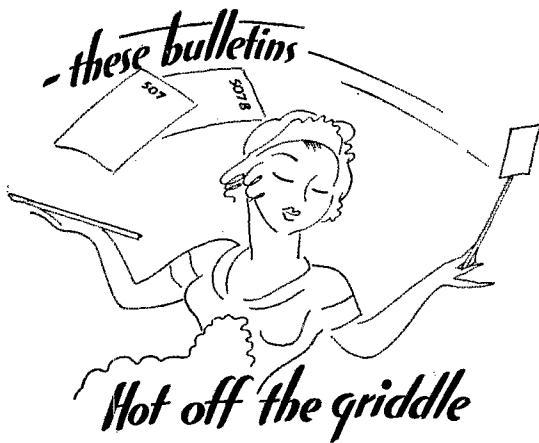

There's a Ward Leonard resistor, relay and rheostat for your every purpose . . . for whatever circuit you use . . . rated for whatever watts and ohms you require. These new bulletins just off the press give all technical data, help you compute resistance values, etc. Send coupon now or write us your requirements.

**WARD LEONARD ELECTRIC COMPANY**  
41 South Street, Mount Vernon, N. Y.

Please send me Bulletins 507 and 507B.

Name.....Call.....  
Street.....  
City.....State.....Q

## HOW IS YOUR SUPPLY OF IDEAS?

If they ever run low, make sure that you have a copy of HINTS & KINKS handy. It is chock full of money-saving ideas and stunts of interest to you. There are many times when you will find it invaluable. The price is 50c post-paid.

**AMERICAN RADIO  
RELAY LEAGUE**

West Hartford

Connecticut

United Transformer Corporation; R. Purinton, W2IGU, Raytheon Production Corporation; H. P. Rockwell, Weston Electrical Instrument Corporation and Mr. W. W. Jablon, Hammarlund Mfg. Co.

The Open Forum was conducted by Director Kenneth T. Hill, assisted by F. E. Handy, Communications Manager, A.R.R.L. Roy. C. Corderman, W3ZD of Washington, D. C., as radio aide to the Chief Signal Officer talked on A.A.R.S. matters.

The big event of any Hudson Division convention is the banquet and entertainment. The honors go to Jack Garretson, W2AOM, for furnishing the entertainment and the food was most satisfactory.

The guest speakers at the banquet were: Col. Alvin C. Voris, U. S. Army; Lieut. E. S. Sarsfield, U. S. Navy; A. A. Hebert, treasurer, A.R.R.L.; F. E. Handy, A.R.R.L.; and the three former directors, Dr. L. J. Dunn, Dr. A. Lafayette Walsh and B. J. Fuld. Director Kenneth T. Hill acted as toastmaster.

After the banquet prizes were distributed, followed by dancing until morning.

—A. A. H.

## A New Filter-Speaker

AMATEURS of some years' standing will remember the peaked audio filters which, before the era of single-signal reception, were widely used for the purpose of increasing selectivity in c.w. reception. A new loud-speaker using a mechanical resonator for the "peaking" effect, recently marketed under the name of the "El-Me-Ac Postselection Filter-Speaker," operates on much the same general principle. The El-Me-Ac unit is a loud-speaker which resonates sharply at a frequency of approximately 1000 cycles and can be coupled directly into the plate circuit of any receiving power tube, being especially effective when used in connection with pentode-type output tubes. The 1000-cycle resonator is a small cylinder which obtains its filter characteristics from the materials of which it is composed and the manufacturing treatment it undergoes. Because the filter is mechanical rather than electrical, the resonance curve is extremely sharp. It is actuated by being placed in the field of a high-inductance coil which is connected in the plate circuit of the receiver output tube.

Because of the peaking action of the speaker, beat notes of the order of 1000 cycles come through without reduction in strength, while noise and tones of other frequencies are greatly attenuated, thus improving selectivity and the signal-to-noise ratio. The effect of using the speaker is much the same in sound as that obtained when the crystal filter is switched in a single-signal receiver, although there is of course no elimination of the "other side of zero beat" since the speaker works entirely in the audio circuit. The audio selectivity is such that stable signals having power-supply modulation can be

# THORDARSON

# High Voltage Power Supply

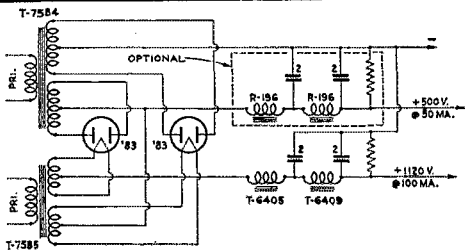
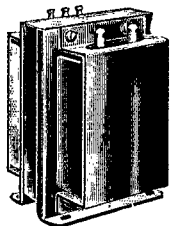

High voltage at low cost! A new THORDARSON circuit utilizing two 83 tubes provides 1120 volts at 150 M.A., or 500 volts at 300 M.A.—or two separate 500 volt, 150 M.A. outputs. A tapped circuit as illustrated provides 500 volts at 50 M.A. and 1120 volts at 100 M.A.

Send for sheet No. SD-226

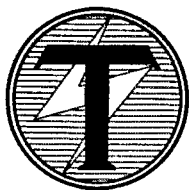

## New Amateur Catalog 343

Technical specifications and prices on every THORDARSON Transformer designed for amateur and commercial transmitters and associated microphone and monitoring circuits. Ask your THORDARSON distributor for Catalog 343.

## THORDARSON ELECTRIC MFG. COMPANY

500 W. Huron Street, Dept. B, CHICAGO, ILLINOIS



### New Littelfuse Catalog

SEND FOR YOUR FREE COPY

Big valuable and indispensable book tells about Instrument, Hi-volt, Neon, Aircraft, Auto Fuses; Indicators, Etc. Write today.

Littelfuse Labs., 4509 Ravenswood Avenue, Chicago, Illinois

"The Crystal Specialists Since 1925"

### PIEZO-ELECTRIC CRYSTALS

Guaranteed Accurate to BETTER than .01%

### SCIENTIFIC RADIO SERVICE

UNIVERSITY PARK, HYATTSVILLE, MD.

**INCREASED SENSITIVITY  
BETTER TONE**

*—with this new microphone...*

Here is a single button carbon type microphone that is extremely sensitive yet that has a very good frequency response. You no longer have to put up with an insensitive "mike" to obtain good tone. The high efficiency of this new Stromberg-Carlson microphone enables reduction of amplifier gain for an equivalent degree of modulation or output volume. Available in the two models illustrated.

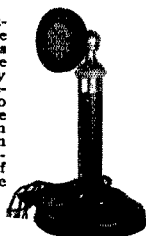

Full particulars on request

No. 6  
\$8.50

STROMBERG-CARLSON TEL. MFG. CO.  
Rochester, N. Y.

No. 5  
\$12.00



Mr. E. H. Rietzke, President of CREI and originator of the first thorough course in Practical Radio Engineering.

## "WE DEAL IN MEN'S FUTURES!"

Our interest in CREI students and graduates goes far beyond textbooks. We are interested in giving to Radio, men who are Technically-Trained and equipped to step into authoritative positions. Opportunity knocks when least expected. Yours may come tomorrow. Would you be qualified for it? Now, is the time to begin CREI training... it's your best reference for a good job!

**RIGHT NOW . . . WRITE NOW FOR FREE ILLUSTRATED CATALOG**

This booklet will answer every question and fully describe our courses and 3 plans of study . . . as well as show you how easy it is to pay for them.

**ONE YEAR RESIDENCE SCHOOL**  
Begins Sept. 23 — Write for Details

**CAPITOL RADIO ENGINEERING INSTITUTE**  
14th and Park Road, N. W. Dept. Q-9  
WASHINGTON, D. C.





# Accepted

**BY HAMS THE  
WORLD OVER**

Because of their "DEPENDABILITY" . . .

Thousands of hams demand  
**CORNELL-DUBILIER MICA — OIL — ELEC-  
TROLYTIC AND PAPER CONDENSERS.**

Thousands of hams figure that C-D capacitors  
are their best bet.

*Doesn't this prove to you that C-D's can stand  
the gaff?*

Why not join this army of loyal C-D followers and cast aside  
your condenser worries? C-D condensers are unconditionally  
guaranteed for one year.

Next time your rig requires new capacitors, get the  
condensers with twenty-five years of experience be-  
hind them and eliminate your condenser troubles.

Write for your copy of latest 1935 Catalog 128

**CORNELL-DUBILIER**  
CORPORATION  
4373 BRONX BOULEVARD  
NEW YORK

## RADIO COURSES

**RADIO OPERATING:** Prepare for Gov't License Exam. ●  
**RADIO SERVICING:** Including Short Wave ● **AMATEUR  
CODE** ● New Course in **RADIO ELECTRONICS;** All Day  
One-Year Course Starts September 23.

*Resident Courses — Write for Booklet*

**NEW YORK YMCA SCHOOLS** 4 West 63rd Street  
New York City

## PRECISION CRYSTALS



Crystal Holder—\$1.00

**NEW** low temperature coeffi-  
cient crystals accurately pre-  
pared for maximum power output  
and frequency stability. These  
crystals have a frequency drift of  
only  $\frac{1}{2}$  or less than that of 'X'  
cut crystals. Be sure of your trans-  
mitter frequency — use **PRE-  
CISION CRYSTALS.** These crys-  
tals ground to within 0.1% of your  
specified frequency and calibrated

accurately to within 0.03% are priced as follows: 1750,  
3500 and 7000 kc. band — \$3.50 each. Plugin holder —  
\$1.00. Jacks for holder — \$.15 pair.

The 'AT' cut crystal recently developed has a tempera-  
ture coefficient of practically zero. 'AT' cut crystals  
within 0.1% of your specified frequency and calibrated  
to within 0.03% are priced as follows: 1750 and 3500 kc.  
bands — \$6.00 each. Holder — \$1.00. Jacks for holder  
— \$.15 pair.

Crystals and ovens for commercial use quoted on at your  
request. When ordering our product you are assured of  
the finest obtainable. Now in our sixth year of business.

**PRECISION PIEZO SERVICE**  
427 Asia Street Baton Rouge, La.

made to sound like pure d.c. The speaker requires  
no field excitation, and can be connected directly  
in the plate circuit of the output tube without a  
coupling device. It can be used with any type of  
receiver having a power stage.

The El-Me-Ac speaker is shipped in kit form,  
the kit including the necessary speaker parts  
and the wooden sides for a containing box which  
also is roughly resonant at 1000 cycles. The new  
speaker is manufactured by the El-Me-Ac  
Company, P. O. Box 72, Brighton Station,  
Boston, Mass.

## A.R.R.L. QSL Bureau

**F**OR the convenience of its members, the League  
maintains a QSL-card forwarding system  
which operates through volunteer "District QSL  
Managers" in each of the nine U. S. and five  
Canadian districts. In order to secure such fore-  
ign cards as may be received for you, send your  
district manager a standard No. 8 stamped en-  
velope. If you have reason to expect a consider-  
able number of cards, put on an extra stamp so  
that it has a total of six-cents postage. Your own  
name and address go in the customary place on  
the face, and *your station call should be printed  
prominently in the upper-left-hand corner.* When  
you receive cards, you should immediately fur-  
nish your QSL manager with another such en-  
velope to replace the used one. List of managers  
follows:

W1—Allen W. Jones, W1NW, 1626 Common-  
wealth Ave., Boston, Mass.

W2—H. W. Yahnel, W2SN, Lake Ave., Hel-  
metta, N. J.

W3—R. E. Macomber, W3CZE, 418 10th St.,  
N. W., Washington, D. C.

W4—B. W. Benning, W4CBY, 520 Whiteford  
Ave., Atlanta, Ga.

W5—E. H. Treadaway, W5DKR, 2749 Myrtle  
St., New Orleans, La.

W6—C. E. Spitz, W6FZQ, Box 1804, Phoenix,  
Ariz.

W7—L. Q. Kelly, W7BPC, 4919 So. Prospect  
St., Tacoma, Wash.

W8—F. W. Allen, W8GER, 324 Richmond  
Ave., Dayton, Ohio.

W9—George Dammann, W9JO, 319 Sherman  
Ave., Evanston, Ill.

VE1—J. E. Roue, VE1FB, 84 Spring Garden  
Rd., Halifax, N. S.

VE2—W. H. Oke, VE2AH, 5184 Mountain  
Sights Ave., N. D. G., Montreal, P. Q.

VE3—Bert Knowles, VE3QB, Lanark, Ont.

VE4—Dr. J. J. Dobry, VE4DR, Killam, Alberta.

VE5—E. H. Cooper, VE5EC, 2024 Carnarvon  
St., Victoria, B. C.

K4—F. McCown, K4RJ, Family Court 7, San-  
turce, Puerto Rico.

# The 1936 Season Is Starting! LEEDS Always Leads with Leaders

## IT'S A KNOCKOUT!!

The new Tobe-Deutschmann communications receiver, including pre-selection, 90 degree band spread, ample sensitivity, excellent selectivity with S S reception, using regeneration in the 1 F stage, quality parts throughout. Wonderful results at the crowded amateur bands can now be yours at a remarkably low cost. Complete kit of parts... **\$41.40**  
 Wright DeCoster 8" speaker, with speaker cabinet... **\$5.00**  
 Complete kit R C A tubes... **\$3.60**  
 Black crinkle finish receiver cabinet... **\$4.80**  
 Careful wiring and testing job by Leeds for lazy hams **\$6.00**

**LEEDS LEADS** as the only distributor in the country, handling GENERAL RADIO Amateur accessories and laboratory apparatus. *Bulletin No. 936 mailed on request.*

We carry a complete stock of NATIONAL products. 40% discount to the amateur.

OHMMET 3-point band switch, type T503, Special... **\$1.75**

HAMMARLUND XP-53 coil forms, 1 1/2" diameter; 4 prong... **.21c** 5 prong... **.21c** 6 prong... **.24c**

MYCALEX socket for RK-28 and 803 tubes... **\$1.90**

POLYMET tubular electrolitic condensers, compact; 450-volt units. 2 mfd... **.25c** 4 mfd... **.35c** 8 mfd... **.39c**

BAKELITE PANELS — for sizes and prices see Aug. QST.

LEEDS X cut 160- and 80-meter Crystals **\$2.25** — 40-meter **\$3.25**; within 1/10 of 1% of specified frequency; unconditionally guaranteed to satisfy the most critical.

Flat type dustproof crystal holder, mounted with G.R. plugs, complete with 2 G.R. jacks... **\$1.00**

Monitor dustproof crystal holder fits UV socket... **\$1.00**

HILL all brass adjustable holder, ideal for 40-meter crystals... **\$1.65**

TRIMM 2,000 ohm phones **\$1.80**. 4,000 ohm, **\$2.25**. Featherweight **\$5.88**. FROST 2,000 ohm **\$1.45**. 3,000 ohm **\$1.65**. DX 20,000 ohm imp... **\$2.65**

WESTERN ELECTRIC PHONES type P-11 **\$3.95**

PIEZO Astatic crystal microphones; type D-104, **\$13.23**

Real buys in Transmitting tubes, backed by LEEDS usual guarantee of 100% satisfaction.

*203-A	\$8.45	†*801	\$2.95	*852	\$11.50
†210-11F	1.75	†*830	6.75	*860	21.50
866	1.50	†*830-B	7.25	†*865	8.45
*211	8.45	†*838	11.75	866-A	1.95
†304-A	9.45	†841	2.45	872	11.75
†800	7.25	845	11.50	872-A	13.25

\* Graphite Anode Tubes † Isolantite Base

Tubes Shipped by Express Only

We lead the field with low priced, high quality oil immersed condensers.

2 mfd. capacity only. D.C. working voltage. 1,000 volts — **\$1.45**; 1,500 volts — **\$2.00**; 2,000 volts — **\$2.45**.

We lead the field in merchandising standard relay racks and panels. LEEDS table racks, 35" high, 20" wide for use with 19" panels.

Type RAD with complete set of drilled and tapped mounting holes... **\$8.95**

Type RAU same size as RAD, less mounting holes... **\$5.45**

LEEDS 19" RACK PANELS crystalline finish on one side and dull black finish on the other. All panels are 3/8" thick.

Aluminum			Steel		
No.	Width	Weight Price	No.	Width	Weight Price
PA1	1 3/4"	2 lbs. \$1.65	PS1	1 3/4"	2 lbs. \$1.05
PA2	3 1/2"	3 " 1.85	PS2	3 1/2"	4 " 1.20
PA3	5 1/4"	3 " 2.15	PS3	5 1/4"	6 " 1.30
PA4	7 "	4 " 2.35	PS4	7 "	7 " 1.35
PA5	8 3/4"	5 " 2.45	PS5	8 3/4"	8 " 1.45
PA6	10 1/2"	6 " 2.55	PS6	10 1/2"	10 " 1.55
PA7	12 1/4"	7 " 3.00	PS7	12 1/4"	11 " 1.70



World Wide Service to Amateurs  
 45 Vesey Street  
 New York City  
 Cable Address, "RADLEEDS"

To Get Started in Amateur Radio obtain a copy of

## HOW TO BECOME A RADIO AMATEUR

(No. 8 in the A.A.R.L. series entitled The Radio Amateur's Library)

Completely done over in 1935 style, telling all about amateur radio and describing the latest equipment.

- push-pull crystal transmitter
  - handspread receiver
  - simplest of monitors
- giving modern operating instructions

The fourth edition of "How to Become a Radio Amateur" marks another milestone in amateur development. Universally recognized as the standard elementary guide for the prospective amateur.

25c postpaid anywhere  
 (no stamps please)

The American Radio Relay League

West Hartford, Connecticut

### PANELS — BAKELITE — RUBBER — ALUMINUM

All Sizes Cut to Order BAKELITE TUBING & RODS  
*Drilling, Engraving & Special Work*  
 ALUMINUM CANS — Stock sizes. Special sizes, made to order.  
 ALUMINUM CHASSIS — Threaded brass studs for 6/32 screws.  
 Length from 1/4" to 6" — price 5c to 30c.

Insulating bushings for all size shafts or Bakelite — 15c  
 Bakelite Tubing Threaded to Specifications  
**UNITED RADIO MFG. CO.** Est. 1923  
 191 Greenwich St., New York

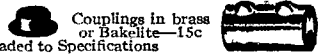

## Sound-Cell Type Wide-Range CRYSTAL MICROPHONE

### SHURE MODEL 78H

● A conveniently small, demountable Wide-Range Crystal Microphone for high-quality sound reproduction. Contains a genuine Brush Sound-Cell — no diaphragms or other attachments to the crystal unit. Chromium plated overall. List price, including stand receptacle, sixty-five dollars.

Available from your Jobber

● The complete line of crystal, condenser, carbon microphones . . . and accessories.



### SHURE BROTHERS COMPANY

Manufacturers of Microphone Headquarters Telephone  
 Engineers DELaware 8-101  
 215 WEST HURON ST. CHICAGO, ILLINOIS

# YOUR AMATEUR or COMMERCIAL TICKET GUARANTEED!

The Fastest Radio Operator of all time and the youngest Radio Operator in the world are CANDLER trained. They and all the fast amateurs and commercial operators whom CANDLER has trained read code as easily as they do book print and make accurate "mill" copy by touch at high speeds.

**You Don't Need to be  
Embarrassed**



Many Amateur and Commercial ops, humiliated by their inability to "hit the ball," have come to CANDLER in confidence, and after a few weeks' personal coaching and specialized training have won the respect and admiration of all for the excellence of their work.

THE CANDLER SYSTEM offers specialized training and personal coaching for the fellow who wants to become an Amateur, and for the Amateur who wants to become a commercial radio operator. This exclusive SYSTEM has stood the acid-test of 24 years and is generally known to have trained many of the most skilled and fastest Morse and Radio operators in the business.

Ted McElroy has written the interesting story of how he became the fastest Radio op. of all time through CANDLER training. It will be sent to you without obligation together with the new *BOOK OF FACTS* for Radio Operators.

New Address:

**CANDLER SYSTEM CO.**  
DEPT. Q-9 ASHEVILLE, NORTH CAROLINA

## PEAK PRODUCTS set a NEW STANDARD in RADIO COMMUNICATION PEAK 5 meter TRANSMITTER

PEAK X-4 — 10 watt carrier, 100% class B modulation Oscillator & Modulator metering. Excellent quality. List \$49.50. Amateur. Net. . . . . \$29.70

PEAK X-3P — 200 M.A. Heavy Duty power supply for X4. Conservatively rated, highest quality components. List \$39.00. Amateur. Net. . . . . \$23.40

X-4 and X3P units come in standard 19" rack panels with cabinet.

R-2 Rack for above units. List \$10.00. Amateur. Net. . . . . \$6.00

Write for Bulletins on PEAK Q5 — 2½, 5 and 10 meter superhet receiver. PEAK M2 Aural Radiophone Monitor. PEAK P-11 Preselector.

### EASTERN RADIO SPECIALTY CO.

Mfrs. of PEAK PRODUCTS

1845 Broadway Dept. B New York, N. Y.

## New BIRNBACH 5-METER ANTENNAS

5 Models — \$1 to \$5.25

**H**IGHLY-EFFICIENT quarter and half-wave antennas for portable transceivers, beam arrays or stationary use. 5 Models: — 2 to 6 extensible sections with threaded end for stand-off insulator, or flat end for panel mounting as illustrated — \$1.00 to \$5.25 list. Ask Birnbach about special antennas for all ultra high-frequency transmission and reception.

Write Dept. Q-9 for Details

**BIRNBACH RADIO CO., Inc.**  
145 HUDSON STREET NEW YORK CITY



156

## Midwest Division Convention

**F**RIDAY and Saturday, April 26th and 27th, was the time; the Hotel Savery III, the place; the event—the annual Midwest Division Convention. Hams to the number of almost 500 from all over the corn belt division swelled the attendance to make this one of the largest and most successful Midwest Division conventions ever held.

After an opening morning devoted to registration, getting acquainted, and license examinations for those who needed them, the convention proper got under way early Friday afternoon with Chairman Frank J. Sadilek of the Convention Committee bidding all hams welcome. The opening talk on a varied technical program was given by George Grammer, of A.R.R.L. Headquarters, who discussed antenna fundamentals; H. F. Gulliver followed with an exposition of a.c. operated amplifiers of the high-gain, high-fidelity type. After a brief recess the technical program was resumed by Kendall Clough, who described the use of the cathode-ray tube in analysing the performance of transmitters and amplifiers. Transformers, with particular reference to power-supply systems, was the subject covered by Boyd Phelps, who gave the closing talk on the first afternoon's program. Friday evening was given over to an A.R.R.L. business meeting, at which League affairs were thoroughly discussed, the meeting being capably handled by a committee headed by Guy Wilson, W9EL. As the mystic hour of midnight approached, timorous candidates were initiated into the mysteries of the Royal Order of the Wouff Hong, with the aid of a cast made up of members of the Des Moines Radio Amateurs Association.

Saturday morning saw a resumption of license examinations and meetings of various groups, including the Naval Reserve, conducted by Lt. Charles H. Morgan, the A.A.R.S., conducted by Director Kerr, and the organization of a Midwest Division Radiophone Association with the cooperation of W8CPC. After lunch the technical meetings continued with George Grammer talking on Tri-Tets, then a discussion of the theory and application of the cathode ray tube by B. C. Burden, with a demonstration of equipment and actual use of the tube which kept the interest of the gang at top pitch. Fred Schnell followed with a practical and entertaining talk on transmitter efficiency, and the program was closed by a discussion and demonstration of the velocity microphone by the RCA representative.

The banquet, held on Saturday evening, was under the toastmastership of Dr. G. W. Fox of Iowa State College. Features were a talk by Louis R. Huber on the amateur's place in the radio picture and short remarks by a number of other speakers. With the food safely put away came the big event—the drawing of prizes. A numerous and varied collection of prizes, with an HRO as the chief attraction, sent many hams home with just that extra bit of satisfaction which, added to that already generated by the

(Continued on page 80)

# Variable Condensers

FOR over 20 years General Radio has been engaged in the manufacture of high-grade laboratory-quality variable air condensers, thousands of which are being used by amateurs. The complete line of General Radio condensers includes everything between the 15  $\mu\text{f}$  midget and the laboratory standard with quartz insulation.

The Type 756-A Double Section condenser, illustrated at the right, was designed particularly for amateur frequency meters and for tuning units where a dual, adjustable band-spread capacitance is required.

Bulletin 936 describes all of the General Radio condensers. Write for a copy!

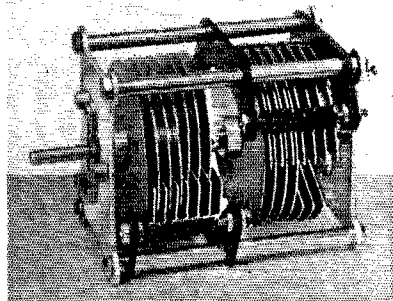

**Type 756-A Variable Condenser**

Double section, adjustable band-spread . . . maximum 225  $\mu\text{f}$ , minimum 140  $\mu\text{f}$  per section . . . straight-line frequency plates . . . small-section hard-rubber insulation correctly placed in weakest field . . . extremely low losses . . . rigid construction . . . maximum voltage 1,500 peak . . . weight 2 pounds . . . Price: \$5.00 (In U. S. and Canada).



## GENERAL RADIO COMPANY

30 State Street

Cambridge A, Massachusetts

# EVERYTHING FOR THE HAM

DISTRIBUTORS

c - q  
de  
W5CXQ

DISTRIBUTORS

R.C.A.  
Arlab  
Alden  
Federal  
Aerovox  
Mallory  
Belden  
Hammarlund  
ClaroStat  
Carron  
Universal

866 TUBES  
1.95

R.C.A. 803  
PENTODE TUBE  
34.50

R.C.A. 802  
TUBE  
3.90

OHMITE BAND  
SWITCHES  
1.80

CARBON RESIS-  
TORS ALL SIZES  
5c EACH

AEROVOX  
2MFD 2000V  
3.90

AEROVOX  
100,000 OHM  
200 WATT  
2.10

AEROVOX  
.002 1000V  
MICA  
27c

NATIONAL  
RADIO  
DESIGN  
1.00

I.R.C.  
Kester  
Burgess  
Sprague  
Electrad  
Yaxley  
Turner  
National  
Supreme  
Thordarson  
I.C.A.

RCA DeForest Transmitting Tubes

# SHULER SUPPLY CO.

NEW ORLEANS, LA.

SERVING THE SOUTH

# Radiolab's Amateur Buying Guide -Now Ready-

Written *By* Amateurs For  
Amateurs — Its Pages Include —

- Thousands of items required by Amateurs, at the lowest wholesale prices.
- "1936" products of every nationally known manufacturer of "Amateur" equipment — illustrated — described — priced.
- Three new Amateur Transmitters interestingly described.
- Three new Modulator Units for converting C.W. Transmitters to Phone Transmitters.
- Description of a new "A" cut Crystal Unit which may be attached to your present Oscillator; permitting changing frequency 25 k.c. at 14 m.c. in calibrated stages at no loss in output.
- The "1936" line of ATLAS METAL Racks, Panels and Boxes.
- "1936" Communication Receivers fully described and priced.
- "POLYIRON" I.F. Transformers. An outstanding development. The guide gives specifications and prices.
- The new Transmitting Pentodes and Class "B" Audio Tubes—described fully and priced.
- New Speech Amplifiers using Crystal Microphone Input.
- This carefully compiled "Buyers Guide" will be promptly sent to Amateurs, Dealers and Servicemen.

## Radio Laboratories

1515 Grand Ave.,

Kansas City,  
Mo.

Mail the Coupon  
Get a Copy



Clip This Request Coupon. Hurry It Along to

**RADIO LABORATORIES**

1515 Grand Ave., Kansas City, Mo.

Please Send Your New "Buying Guide" At  
Once, to

Call Letters.....

Check Classification Below

Amateur

Dealer

Serviceman



# Where to buy it

A directory of suppliers who carry in stock the products of these dependable manufacturers.

**ASTATIC**  
*Crystal Microphones and Pickups*  
 ASTATIC MICROPHONE LABORATORY, Inc. YOUNGSTOWN, O.  
*Pioneer Manufacturers of Quality Crystal Products*

- CHICAGO, ILL. 833 West Jackson Blvd.  
 Allied Radio Corporation
- CHICAGO, ILL. 601 W. Randolph St.  
 Pioneer Automotive Supply Co.
- KANSAS CITY, MO. 1012-14 McGee St.  
 Burstein-Applebee Company
- ST. LOUIS, MO. 1100 Pine Street  
 Walter Ashe Radio Company
- ST. PAUL, MINN. 2484 University Ave.  
 Lew Bonn Company

**Super SKYRIDER**  
  
 the hallicrafters

- BUTLER, MISSOURI 211-215 N. Main Street  
 Henry Radio Shop
- CHICAGO, ILLINOIS 415 S. Dearborn Street  
 Chicago Radio Apparatus Company
- CHICAGO, ILLINOIS 520 S. State Street  
 Midwest Radio Mart
- CHICAGO, ILLINOIS 226 W. Madison Street  
 Newark Electric Company
- FARGO, N. D. 123 Broadway  
 Dakota Electric Supply Company
- KANSAS CITY, MO. 1012 McGee Street  
 Burstein-Applebee Company
- OMAHA, NEBRASKA 2855 Farnam St.  
 Radio Accessories Company
- ST. LOUIS, MO. 927 Pine Street  
 Gordon Radio Company
- ST. PAUL, MINN. 2484 University Ave.  
 Lew Bonn Company

**E.F. JOHNSON COMPANY**  
 MANUFACTURERS OF  
**RADIO**  
 TRANSMITTING EQUIPMENT  
 WASECA, MINN.  
 U.S.A.

- CHICAGO, ILLINOIS 226 W. Madison Street  
 Newark Electric Company
- CHICAGO, ILL. 520 S. State Street  
 Midwest Radio Mart

- CLEVELAND, OHIO 2073 West 85 Street  
 Northern Ohio Laboratories
- DETROIT, MICHIGAN 129 Selden Avenue  
 Radio Distributing Company
- FARGO, NORTH DAKOTA 123 Broadway  
 Dakota Electric Supply Co.
- GRAND RAPIDS, MICH. 235 Market Street, S. W.  
 Radio Distributing Company
- LA CROSSE, WIS. 131 South 6th St.  
 SOS Radio Supply Co.
- MOLINE, ILL. 1420 5th Ave.  
 Bengston's Radio Store
- WINNIPEG, CAN. 310 Ross Ave.  
 Electrical Supplies, Ltd.

**NATIONAL**  

**RADIO PRODUCTS**
  
 NATIONAL COMPANY, INC., MALDEN, MASS.

- BUTLER, MISSOURI 211-215 N. Main Street  
 Henry Radio Shop
- CHICAGO, ILLINOIS 520 S. State Street  
 Midwest Radio Mart
- CHICAGO, ILLINOIS 833 W. Jackson Blvd.  
 Allied Radio Corporation
- CHICAGO, ILLINOIS 415 S. Dearborn Street  
 Chicago Radio Apparatus Company
- CHICAGO, ILLINOIS 226 W. Madison Street  
 Newark Electric Company
- CINCINNATI, OHIO 633 Walnut Street  
 Steinberg's, Inc.
- CLEVELAND, OHIO 2073 West 85 Street  
 Northern Ohio Laboratories
- COLUMBUS, OHIO 178 N. 3rd Street  
 Hughes-Peters Electric Corp.
- DAYTON, OHIO 140 E. 3rd Street  
 Burns Radio Company
- DES MOINES, IOWA 1212 Grand Avenue  
 Iowa Radio Corporation
- DETROIT, MICHIGAN 171 E. Jefferson Ave.  
 Radio Specialties Company
- GRAND RAPIDS, MICH. 235 Market Street, S. W.  
 Radio Distributing Company
- INDIANAPOLIS, IND. 316 N. Illinois Street  
 State Distributing Company
- KANSAS CITY, MO. 1012 McGee Street  
 Burstein-Applebee Company
- KANSAS CITY, MO. 1515 Grand Avenue  
 Radio Laboratories
- LOUISVILLE, KY. 911 W. Broadway  
 P. I. Burks & Company
- MILWAUKEE, WIS. 332 W. State Street  
 Radio Parts Company

# Where to buy it

A directory of suppliers who carry in stock the products of these dependable manufacturers.

**OMAHA, NEB.** 9855 Farnham Street  
Radio Accessories Company

**PARIS, FRANCE**  
J. C. Balouzet, De Tigny, 6, Avenue Hoche

**PEORIA, ILLINOIS** 707 Main Street  
Klaus Radio & Electric Company

**ST. LOUIS, MO.** 1100 Pine Street  
Walter Ashe Radio Company

**ST. PAUL, MINN.** 2484 University Avenue  
Lew Bonn Company

**WINNIPEG, CAN.** 310 Ross Ave.  
Electrical Supplies, Ltd.

**LOUISVILLE, KY.** 715 S. Seventh Street  
Universal Radio Supply Company

**PEORIA, ILL.** 707 Main Street  
Klaus Radio & Electric Company

**TOLEDO, OHIO** 1013 Jefferson Ave.  
Baumgardner Distributing Co.



**RCA AMATEUR RADIO EQUIPMENT**  
RCA Victor Division of RCA Manufacturing Co., Inc.



**RCA de Forest RADIO TUBES**  
RCA Radiotron Division of RCA Manufacturing Co., Inc.

**BUTLER, MO.** 211 N. Main St.  
Henry Radio Shop

**CHICAGO, ILL.** 226 W. Madison Street  
Newark Electric Company

**CHICAGO, ILL.** 833 W. Jackson Blvd.  
Allied Radio Corporation

**CHICAGO, ILL.** 520 S. State Street  
Midwest Radio Mart

**CINCINNATI, OHIO** 633 Walnut Street  
Steinberg's, Inc.

**CLEVELAND, OHIO** 2073 West 85 Street  
Northern Ohio Laboratories

**CLEVELAND, OHIO** 1301 Superior Avenue  
Cleveland Distributing Co.

**DETROIT, MICHIGAN** 129 Selden Avenue  
Radio Distributing Company

**DETROIT, MICH.** 171 E. Jefferson Ave.  
Radio Specialties Co.

**FARGO, NORTH DAKOTA** 123 Broadway  
Dakota Electric Supply Co.

**FLINT, MICH.** 203 W. Kearsley St.  
Shand Radio Specialties

**GRAND RAPIDS, MICH.** 235 Market Street, S. W.  
Radio Distributing Co.

**KANSAS CITY, MO.** McGee at 23rd Street  
Moser & Suor, Inc.

**KANSAS CITY, MO.** 1012 McGee Street  
Burstain-Applebee Company

**LA CROSSE, WIS.** 131 South 6th St.  
SOS Radio Supply Co.

**BUTLER, MO.** 211 N. Main St.  
Henry Radio Shop

**CHICAGO, ILL.** 520 S. State Street  
Midwest Radio Mart

**CHICAGO, ILL.** 226 W. Madison Street  
Newark Electric Company

**CHICAGO, ILLINOIS** 833 W. Jackson Blvd.  
Allied Radio Corporation

**CHICAGO, ILLINOIS** 415 S. Dearborn Street  
Chicago Radio Apparatus Company

**CINCINNATI, OHIO** 633 Walnut St.  
Steinberg's, Inc.

**CINCINNATI, OHIO** 111 East 5th Street  
Krauss Radio Stores, Inc.

**CLEVELAND, OHIO** 2073 West 85 Street  
Northern Ohio Laboratories

**CLEVELAND, OHIO** 610 Huron Road  
Goldhamer, Inc.

**COLUMBUS, OHIO** 178 N. 3rd Street  
Hughes-Peters Electric Corp.

**DAYTON, OHIO** 140 E. 3rd Street  
Burns Radio Company

**DES MOINES, IOWA** 1212 Grand Avenue  
Iowa Radio Corporation

**DETROIT, MICHIGAN** 1326 E. Congress Street  
Aitken Radio Corp.

**DETROIT, MICHIGAN** 129 Selden Avenue  
Radio Distributing Company

**DETROIT, MICH.** 171 E. Jefferson Ave.  
Radio Specialties Co.

**FARGO, N. D.** 123 Broadway  
Dakota Electric Supply Company

# Where to buy it

A directory of suppliers who carry in stock the products of these dependable manufacturers.

GRAND RAPIDS, MICH. 235 Market Street, S. W.  
Radio Distributing Company

MADISON, WISC. 201 E. Washington Ave.  
Taylor Electric Co.

MILWAUKEE, WISC. 720 N. Jackson St.  
Taylor Electric Co.

PEORIA, ILL. 707 Main Street  
Klaus Radio & Electric Company

ST. PAUL, MINN. 2484 University Ave.  
Lew Bonn Company

TOLEDO, OHIO 1014 Madison Avenue  
Aitken Radio Corp.

YOUNGSTOWN, OHIO 325 West Federal Street  
Ross Radio Company

*Microphone Headquarters*



**SHURE BROTHERS COMPANY**  
CHICAGO, ILLINOIS

CHICAGO, ILL. 520 S. State Street  
Midwest Radio Mart

CHICAGO, ILL. 226 W. Madison Street  
Newark Electric Company

CHICAGO, ILL. 833 W. Jackson Blvd.  
Allied Radio Corp.

CLEVELAND, OHIO 610 Huron Road  
Goldhamer, Inc.

DES MOINES, IOWA 1212 Grand Ave.  
Iowa Radio Corporation

DETROIT, MICH. 5027 Hamilton Ave.  
Rissi Bros.

DETROIT, MICH. 171 E. Jefferson Ave.  
Radio Specialties Co.

LOUISVILLE, KENTUCKY 911 W. Broadway  
P. I. Burks & Company

LOUISVILLE, KENTUCKY 715 S. Seventh Street  
Universal Radio Supply Company

ST. PAUL, MINN. 2168 Ann Arbor St.  
R. R. & G. W. Bauman Co.

TOLEDO, OHIO 1014 Madison Ave.  
Aitken Radio Corp.



**TRIPLLET**  
**INSTRUMENTS**

CHICAGO, ILL. 226 W. Madison Street  
Newark Electric Company

CHICAGO, ILL. 520 S. State Street  
Midwest Radio Mart

CINCINNATI, OHIO 633 Walnut Street  
Steinberg's, Inc.

CLEVELAND, OHIO 610 Huron Road  
Goldhamer, Inc.

DETROIT, MICH. 1326 E. Congress Street  
Aitken Radio Corp.

DETROIT, MICH. 5027 Hamilton Ave.  
Rissi Bros.

FARGO, N. D. 123 Broadway  
Dakota Electric Supply Co.

TOLEDO, OHIO 1014 Madison Ave.  
Aitken Radio Corp.

**United**  
**TRANSMITTING TUBES**

CHICAGO, ILL. 415 S. Dearborn St.  
Chicago Radio Apparatus Co.

CHICAGO, ILL. 226 W. Madison St.  
Newark Electric Co.

CHICAGO, ILL. 520 S. State St.  
Midwest Radio Mart

CLEVELAND, OHIO 2073 West 85th St.  
Northern Ohio Laboratories

DETROIT, MICH. 171 E. Jefferson Ave.  
Radio Specialties Co.

DOVER, OHIO 313 Factory St.  
The Kremer-Weber Co.

FARGO, N. D. 121-123 Broadway  
Dakota Electric Supply Co.

FLINT, MICH. 711 W. Dayton St.  
Wilke and Sessions

*Tomorrow's*  
**MAGNETIC SPEAKER**  
*Today!*

**The Revolutionary  
 New Wright-DeCoster  
 "Hyflux"**

The answer to the trade's demand for Quality at a Price

- **Manufacturers**
- **Distributors**
- **Sound Engineers**
- **Dealers**

WRITE FOR COMPLETE DETAILS,  
 SPECIFICATIONS, PRICES

**WRIGHT-DECOSTER, Inc.**  
 2259 University Ave. St. Paul, Minn.  
*Export Dept.: M. Simons & Son Co.*  
*Cable Address: SIMONTRICE, New York*

**GULF RADIO SCHOOL**

Radiotelegraphy Radiotelephony  
 Radio Servicing

SECOND PORT } 1007 Carondelet Street  
 U. S. A. } NEW ORLEANS, LA.

See Page Four

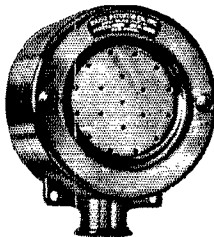

*The Superiority of Our*  
**DYNAMIC  
 MICROPHONE**

*Over Other Types Is  
 Mainly in Its Sensitivity*  
 No high gain preamplification required. No background noise. No Power Supply. AND THE **\$33**  
 PRICE .....

U. S. PATENTS PENDING

Send for Bulletin 3011

**RADIO RECEPTOR CO., INC.**  
 110 Seventh Ave., New York City

**Midwest Division Convention**

(Continued from page 84)

convention itself, made the 1935 Midwest Division Convention the kind that will live long in memory. The Des Moines Radio Amateurs Association and the Committee deserve congratulations for a well-handled and notably successful convention.

—G. G. W9DHP

**Standard Frequency Transmission**

Date	Schedule	Station	Date	Schedule	Station
Sept. 4	BB	W9XAN	Oct. 4	BB	W6XK
Sept. 6	BB	W6XK		A	W9XAN
	A	W9XAN	Oct. 5	BX	W6XK
Sept. 7	BX	W6XK	Oct. 6	C	W6XK
Sept. 8	C	W6XK	Oct. 11	A	W6XK
Sept. 13	A	W6XK	Oct. 18	B	W9XAN
Sept. 20	B	W9XAN		B	W6XK
	B	W6XK	Oct. 23	C	W9XAN
Sept. 25	C	W9XAN	Oct. 25	B	W9XAN
Sept. 27	B	W9XAN		A	W6XK
	A	W6XK	Oct. 30	BB	W9XAN
Oct. 2	BB	W9XAN			

**STANDARD FREQUENCY SCHEDULES**

Time (p.m.)	Sched. and Freq. (kc.)		Time (p.m.)	Sched. and Freq. (kc.)	
	A	B		BB	C
8:00	3500	7000	4:00	7000	14,000
8:08	3600	7100	4:08	7100	14,100
8:16	3700	7200	4:16	7200	14,200
8:24	3800	7300	4:24	7300	14,300
8:32	3900		4:32		14,400
8:40	4000				

Time (a.m.)	Sched. & Freq. (kc.)	
	BX	
6:00	7000	
6:08	7100	
6:16	7200	
6:24	7300	

The time specified in the schedules is local standard time at the transmitting station. W9XAN uses Central Standard Time, and W6XK, Pacific Standard Time.

**TRANSMITTING PROCEDURE**

The time allotted to each transmission is 8 minutes divided as follows:

- 2 minutes—QST QST QST de (station call letters).
- 3 minutes—Characteristic letter of station followed by call letters and statement of frequency. The characteristic letter of W9XAN is "O"; and that of W6XK is "M."

1 minute—Statement of frequency in kilocycles and announcement of next frequency.

2 minutes—Time allowed to change to next frequency.

W9XAN: Elgin Observatory, Elgin National Watch Company, Elgin, Ill., Frank D. Urie in charge.

W6XK: Don Lee Broadcasting System, Los Angeles, Calif., Harold Peery in charge.

**Schedules for WWV**

EACH Tuesday and Friday (except legal holidays), the National Bureau of Standards station WWV will transmit on three frequencies as follows: noon to 1:00 p.m., E.S.T., 15,000 kc.; 1:15 to 2:15 p.m., 10,000 kc.; 2:30 to 3:30 p.m., 5000 kc. These emissions are accurate to better than 1 part in five million at all times and are readily useful for calibrating amateur-band frequency meters by harmonics from an auxiliary 100-kc. oscillator, as described in previous QST articles (June and October, 1933; February, 1934).

# HAM-ADS

(1) Advertising shall pertain to radio and shall be of nature of interest to radio amateurs or experimenters in their pursuit of the art.

(2) No display of any character will be accepted, nor can any special typographical arrangement, such as all or part capital letters be used which would tend to make one advertisement stand out from the others.

(3) The Ham-Ad rate is 15¢ per word, except as noted in paragraph (6) below.

(4) Remittance in full must accompany copy. No cash or contract discount or agency commission will be allowed.

(5) Closing date for Ham-Ads is the 25th of the second month preceding publication date.

(6) A special rate of 7¢ per word will apply to advertising which, in our judgment, is obviously non-commercial in nature and is placed and signed by a member of the American Radio Relay League. Thus, advertising of bona fide surplus equipment owned, used and for sale by an individual or apparatus offered for exchange or advertising inquiring for special equipment, if by a member of the American Radio Relay League takes the 7¢ rate. An attempt to deal in apparatus in quantity for profit, even if by an individual, is commercial and takes the 15¢ rate. Provisions of paragraphs (1), (2), (4) and (5) apply to all advertising in this column regardless of which rate may apply.

Having made no investigation of the advertisers in the classified columns, the publishers of QST are unable to vouch for their integrity or for the grade or character of the products advertised.

**QUARTZ**—Direct importers from Brazil of best quality pure quartz suitable for making piezo-electric crystals. Diamond Drill Carbon Co., 719 World Bldg., New York.

**METER** and Microphone Repairs. Low prices. Estimates free. Quick repair service—broadcasting equipment, all electrical instruments. Sound Engineering Corp., 2200 Kinzie, Chicago.

**RADIO** engineering, broadcasting, aviation and police radio, servicing, marine and Morse telegraphy taught thoroughly. All expenses low. Catalog free. Dodge's Institute, Byrd St., Valparaiso, Ind.

100W General Electric transformers, 1100-2200-4400 each side center on 110. Sold hams right years. \$13.50. Dawson, 5740 Woodrow, Detroit.

**NATIONAL**—Hammarlund, Patterson used sets, 60% off list. W3DQ, 405 Delaware Ave., Wilmington, Del.

**QSLs**, SWLs. W8ESN, 1827 Cone, Toledo, Ohio.

**ENGRAVING** instrument panels exclusively since 1925. A. L. Woody, 189 West Madison St., Chicago, Ill.

**RACK** panel power supply, pure 1500V d.c., best parts, meter, \$25, or good shotgun. Receiver, \$9. Photographs. W1BSF.

**SELL**: Complete freq-monitor. Make cash offer. W8KLP. COMPLETE training amateur operator's licenses. \$1.50 weekly. New York Wireless School, 1123 Broadway, Watkins 9-2667.

100 quality QSLs, 75¢; stamp for samples. W5A1A, Watonga, Okla.

**BLILEY** crystals! Order from W8DED!

**QSLs!** World's finest! Samples? (Stamp) W8DED, Holland, Mich.

**LIFETIME** microphones! Catalog free from W8DED.

**QSLs**. New stuff! Printer, Corwith, Iowa.

**TRANSFORMERS** and low resistance chokes all Hilet unmounted at big savings. Also meters, etc. Send stamped envelope for lists. Leitch, Park Dr., W. Orange, N. J.

**AC-DC SW3**, bandspeed 20, 40, 80, power pack, tubes, \$25. W6KHV.

**FB7A** for sale. W2AVS.

**TRADE** new unused \$85. imported Austrian 30 piece draughting set for latest model single signal receiver, tubes, pack and coils for 20, 40, 80. Must be perfect condition. Give all details first letter. W6HL.

**SELLING** station, Comet-Pro, two xtal xmitters. Write for details. W2EVV, Bayside, Long Island.

**SELL**—transmitter parts. W8KQQ, Centre Hall, Penna.

**W3ASP** selling out. High quality xtal transmitter, receiver, monitor all complete. Very reasonable. Specifications. Prices on request.

**SWAP** or sell: Complete Barr DB3 and/or 5"x7" Kodak for receiver or what have you. W1IJJ.

**QSL** cards, two color, cartoons, message blanks, stationery, snappy service. Write for free samples to-day. W1BEF, 16 Stockbridge Ave., Lowell, Mass.

**SLIGHTLY** used All-Star, Sr. receiver, beat oscillator, crackle cabinet; complete, coils, tubes, power supply, cabinet mounted Magnavox dynamic speaker. Bargain first \$45.00 money order. F. B. McDonald, Jr., W4DMM, Waycross, Georgia.

**DX** and short wave fans "Toonrite" dial brings them in. 50¢ prepaid. "Toonrite," Babylon, N. Y.

**SELL** Gross Eagle 3, tubes, \$10. W5ENU, Box 424, Hobbs, N. Y.

**SELL** FB7A, nearly new, tubes, power supply, 4 sets band spread coils. First reasonable offer. W8MKL, R. M. Lichty, Route No. 1, Leighton, Pa.

**HOLDERS**—75¢, three \$2. While they last. Crystals. Blanks, 50¢. Faberadio, Sandwich, Ill.

**CALLBOOKS**—new Fall 1935 Radio Amateur Call Book, thousands of late W and VE calls, many pages of new DX QRAs and important changes in prefixes, is yours for \$1.25, or one year (four issues) for \$4.00. (In foreign countries \$1.35 and \$4.35, postpaid.) W9FO, 610 S. Dearborn, Chicago.

**QSLs**. W2SN, Helmetta, N. J.

**RECEIVERS**—new and used sold and traded in, as Hammarlund, National, Postal, International, etc. Schwarz Radio Service, Dumont, N. J.

**CRYSTALS**—"V" cut Zero Temperature Coefficient. Guaranteed drift less than Four Cycles °C. per million. 200% more output. Single Frequency Response. 160-80, within five kilocycles, \$3.25. Beautiful Machined Holders, \$1.00. Ham Crystals, 1104 Lincoln Place, Brooklyn, N. Y.

**EIMAC**, Raytheon, Cardwell, Biley, RME9-D, Super Sky-rider, Sargent, Patterson. Trade in your receiver. Southern Radio Supply, 209 Scott, Little Rock, Ark. Att'n W5VK.

**QSLs**. Best looking, finest quality. Free samples. Maleco, 1512 Eastern Parkway, Brooklyn, N. Y.

**HOLTZER**—Cabot motor-generator single unit 110 d.c. 110 a.c. 500 cycle, 250 KVA. Guaranteed, \$25. W6UC.

**CRYSTALS**, guaranteed oscillators, Y cut 80-160 meter bands, \$1. 450-500-kc. \$2. Blanks, 60¢. Herbert Addington, 2252 Le Clair Ave., Chicago.

**GENERAL** Electric dynamotors, 24/750 volts, 150 watts with filter, \$25. Two machines for 1500 volts, \$40. Westinghouse 27½/350 80 mills \$10. 6-15 volt 500 watt with propeller, \$10. 500 watt 500 cycle, 110-220 volts, \$7.50. Henry Kienzle, 501 East 84th St., New York.

**QSLs** bound with your name in gold. Card brings details. W9CWM, Lincoln, Nebraska.

**FOR sale**: Complete 160M phone transmitter and FB7 receiver. Photo, description and price to prospective buyer. W9KYD, Ashland, Neb.

**40 meter crystals**—\$1.50 within ten kilocycles, \$2.00 your specified frequency. Postpaid. Dependable "X" cut. Accuracy .05% or better. Guaranteed strong oscillators. \$1.00 plug-in holder free to first six orders received mentioning this offer, locals excluded. "Eldsons," South Fifteenth; Temple, Texas.

**SALE**: National ACSW5 receiver, 5830-AB power supply, 15-200 meter and 20, 40, 80 band spread coils. Collins 4A transmitter. Best offer over \$85. takes all. W3CH, Richardson Park, Delaware.

**SELL** ACSW3 with tubes, twenty and forty meter coils and power pack, \$19. cash. Like new. Henry Murphy, W2AXP, 255 Kipp Ave., Hasbrouck Heights, N. J.

**CRYSTALS**: Zero cut. Guaranteed to compensate at near zero without oven control. Your approximate frequency, 80 or 160 meters, \$1.85. ½ less drift than x cut, \$1.35 postpaid. Plug-in holders, 75¢. Fisher Laboratory, 4522 Norwood St., San Diego, Calif.

**FOR sale** or trade: First issue of QST Volume I, No. 1 and all succeeding issues up to 1922. All in good condition. Also other amateur radio publications under same dates. Want high grade camera similar to Graflex. Best reasonable offer accepted. M. C. Poor, 4833½ N. Paulina, Chicago, Ill.

**JANUARY** 1933 autodyne, National cabinet. Very reasonable. W9DQH.

**QSLs** on quality stock. Samples. 5-Meter Print, 1112 5th Ave., Escanaba, Mich.

**SW3** a.c. latest model, original carton, band spread 20-40-80 and 40-70 coils, \$22. cash. Dr. R. G. Tappan, 3435 Towanda Trail, Knoxville, Tenn.

**CLASS B** transformers—Universal for two or four 46s, 210s, 800s, RK18s, etc., \$7.75 pair postpaid. 70 watts audio from 46s, 100 watts from 10s. Write for details. W8UD, Douglas, Mich.

**AUTOMOBILE** call letter plates. Steel. 6"x12". Colors optional. 60¢ pair. W9AIN.

**QSLs!** Two color; 75¢ per hundred. Finest obtainable at any price. Free samples to Hams only. W2FJE, 145 Lafayette Ave., Brooklyn, N. Y.

SELL RCA receiver ACR-136, perfect condition, \$50. Preston Drake, 43 John St., Middletown, N. Y.

QSLs, 75¢ a 100, two colors. W9DGH.

SELL—rack and panel xmitter, 160-80-40, phone or c.w. 242A final, Class B modulated, complete with 3 power supplies, tubes and meters. Best offer. Also 851, 852, 511, meters, condensers, etc. Cheap. W1PZ, Joe Furrier, Lynnfield Center, Mass.

MISSOURI, Arkansas, Kansas, Oklahoma Hams—complete line amateur parts. O'Neill Tire & Battery Co., Joplin, Mo.

SELL or trade Supreme 333 deluxe analyzer, 85 tube tester. Want RCA carbon 03A. Ralph Senechal, Anamoose, N. Dak.

TRANSFORMERS—1250-850-0-850-1250, 170 ma. \$5.50. Mounted. Spear Mfg. Company, Waterville, Ohio.

QSLs, two color, 80 cents per hundred. F. Wood, Weyburn, Saskatchewan.

THREE 212Ds, \$5. each; 552 new, \$10; 560 used, \$8; Weston RF 0-10, \$5. Seyse, 83 St. James, Buffalo, N. Y.

GUARANTEED crystals, 160-80. 1" square, within two kilocycles, \$2.25. Less than 1", within 10 kilocycles, \$1.35. Blanks, odds and ends, five for \$1. William Threm, W8FN, 4021 Davis Ave., Cheviot, Ohio.

BUY your new receiver or trade in your old one for any make at Palmer's Trading Post, Route 1, Duluth, Minn. A.C. generators and everything in radio.

METERS—for your shack. Standard Supreme, Weston, Jewell, Triplett, etc. meters from 50¢ to \$4.50. All perfect, new and used. Send for free surplus stock list of hundreds of other items. Supreme Instruments Corp., Greenwood, Miss.

FOR sale—QST magazines from May 1924 to present date. Highest offer takes lot of 135 copies. Rubin Cohn, 43 Main St., Middletown, Conn.

\$1,000,000.00 appearance, performance. Relay racks, panels. QST specification power equipment. Edison Bs. Rectifier Engineering Service, 4337 Rockwood Rd., Cleveland, Ohio.

CRYSTALS—1" X, \$1.35. AT, \$2.50. Guaranteed. Write your needs. Wolverine Crystal Service, Calumet, Mich.

QUARTZ—finest quality, direct from our Brazilian branch, for manufacturing crystals. Largest assortment of sizes. Brazilian Importing Company, Inc., 6 Murray St., New York.

SELL used 852, \$7. W8CGC.

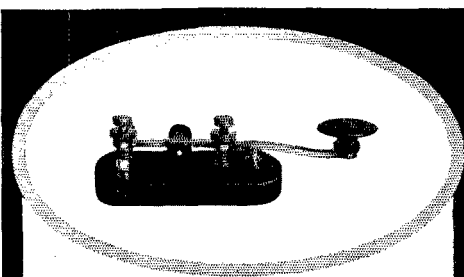

### AMATEUR WIRELESS KEY

For amateurs who want an inexpensive, high-grade wireless key, here is the proper instrument. It is equipped with a heavy, cast base, black finish, coin silver contacts, composition knob and nickel parts. The list price is only \$1.50.

The SIGNAL line of telegraph instruments, wireless keys and wireless practice sets is complete. Send for literature.

**SIGNAL ELECTRIC MFG. CO.**  
Menominee, Michigan, U. S. A.

**SIGNAL**  
MANUFACTURERS OF ELECTRICAL PRODUCTS

# To OUR READERS who are not A.R.R.L. Members

YOU should become a member of the League! That you are interested in amateur radio is shown by your reading of QST. From it you have gained a knowledge of the nature of the League and what it does, and you have read its purposes as set forth on the page opposite the editorial page of this issue. We should like to have you become a full-fledged member and add your strength to ours in the things we are undertaking for Amateur Radio. You will have QST delivered at your door each month. A convenient application form is printed below—clip it out and mail it today.

*A bona fide interest in amateur radio is the only essential qualification for membership*



### AMERICAN RADIO RELAY LEAGUE

West Hartford, Conn., U. S. A.

I hereby apply for membership in the American Radio Relay League, and enclose \$2 50 (\$3.00 outside of the United States and its Possessions, and Canada) in payment of one year's dues, \$1.25 of which is for a subscription to QST for the same period. Please begin my subscription with the ..... issue. Mail my Certificate of Membership and send QST to the following name and address.

.....  
.....  
.....

Do you know a friend who is also interested in Amateur Radio, whose name you might give us so we may send him a sample copy of QST?

.....

*Thanks*

# Your Nearest Dealer Is Your Best Friend

Your nearest dealer is entitled to your patronage. You can trust him. He is equipped with a knowledge and understanding of amateur radio. He is your logical and safe source of advice and counsel on what equipment you should buy. His stock is complete. He can supply your needs without delay. His prices are fair and consistent with the high quality of the goods he carries. He is responsible to you and interested in you.

Patronize the dealer nearest you—You can have confidence in him

## CHICAGO, ILLINOIS

Allied Radio Corporation  
833 West Jackson Blvd.

Complete standard lines always in stock—W9NRV—W9IBC—W9RZI

## CHICAGO, ILLINOIS

Chicago Radio Apparatus Company  
415 South Dearborn Street (Est. 1921)

W9RA and W9PST — Amateurs since 1909

## CHICAGO, ILLINOIS

Mid-West Radio Mart  
520 S. State Street  
All standard lines carried in stock

## CLEVELAND, OHIO

Northern Ohio Laboratories  
2073 West 85 Street  
Wholesale Distr. for National, Hammarlund, Thordarson, Cardwell

## DENVER, COLORADO

Inter-State Radio & Supply Co.  
1639 Tremont Place  
Amateur Radio Headquarters in the Rocky Mountain Region

## DETROIT, MICHIGAN

Radio Specialties Company  
171 E. Jefferson Avenue  
Ham Supplies — National & Hammarlund Sets and Parts

## DETROIT, MICHIGAN

Rissi Brothers  
5027-31 Hamilton Ave. at Warren  
W8KXK Manager Amateur Department

## FRESNO, CALIFORNIA

Ports Mfg. Co.  
3265 E. Belmont Ave.  
Wholesale: RCA-Thordarson-Bliley. All Standard Lines

## KANSAS CITY, MISSOURI

Burstein-Applebee Company  
1012-14 McGee Street  
"Specialists" in supplies for the Amateur and Serviceman

## KANSAS CITY, MISSOURI

Radio Laboratories  
1515 Grand Avenue  
Amateur Headquarters — Complete Stock — Quality Parts

## LOS ANGELES, CALIFORNIA

Pacific Radio Exchange, Inc.  
729-31 South Main Street

Most completely diversified stock of amateur equipment in the West

## MILWAUKEE, WISCONSIN

Radio Parts Company, Inc.  
332 West State Street  
Complete stock Nationally Known products

## ST. PAUL, MINNESOTA

Lew Bonn Company  
2484 University Avenue  
Rex L. Munger, W9LIP, Sales Engineer  
Radio Wholesaler Complete Stock

## SAN FRANCISCO, CALIFORNIA

Offenbach Electric Company, Ltd.  
1452 Market Street  
"The House of a Million Radio Parts"

## SIOUX CITY, IOWA

Warren Electric Co.  
Standard Lines and Discounts  
T. J. Morris, W9SSN, Mgr. Parts Dept.

## TORONTO, CANADA

A & A Radio Service Supply  
101 Queen Street, West  
Canada's foremost radio supply house

# You Are Protected When You Buy From QST Advertisers

“Advertising for QST is accepted only from firms who, in the publisher’s opinion, are of established integrity and whose products secure the approval of the technical staff of the American Radio Relay League.”

Quoted from QST’s advertising rate card.

Every conceivable need of a radio amateur can be supplied by the advertisers in QST. And you will know the product has the approval of the League’s technical staff.

For Your Convenience

## QST’S INDEX TO ADVERTISERS IN THIS ISSUE

Aerovox Corporation	75
Astatic Microphone Company	68
A.R.R.L. Application Blank	92
Binder	62
Handbook	79
Hints & Kinks	80
How to Become a Radio Amateur	83
License Manual	64
Log Book	87
Ohms Law Calculator	4
Radio Calculator	70
Birnbach Radio Company	84
Billy Electric Company	75
Bud Radio, Inc.	79
Burgess Battery Company	95
Candler System Company	84
Capitol Radio Engineering Institute	81
Central Radio Laboratories	66
Collins Radio Company	Cov. 2
Cornell-Dubilier Corporation	82
Delaware Radio Sales Company	7, 68, 85
Deutschmann Corporation, Tobe	69
Eastern Radio Specialty Company	84
Eitel-McCullough, Inc.	72
Emery, A. H.	77
General Electric Company	61, 73
General Radio Company	85
Gross Radio, Inc.	65
Gulf Radio School	90
Hallcrafters, Inc., The	5
Hammarlund Mfg. Company	71
Harvey Radio Laboratories	72
Henry Radio Shop	6, 77
Instructograph Company	79
Johnson Company, E. F.	63
Leeds	83
Low Bonn Company	6
Littelfuse Laboratories	81
Marine Radio Company	2, 6
Massachusetts Radio School	77
Midwest Radio Mart	8
National Carbon Company	96
National Company	59, 67, 74, Cov. 3
Newark Electric Company	74
New York V. M. C. A. Schools	82
Northern Ohio Laboratories	85
Offenbach Electric Company	86
Ohmite Manufacturing Company	76
Philadelphia School of Wireless Telegraphy	77
Port Arthur College	75
Precision Piezo Service	82
Premier Crystal Laboratory	77
Radio Laboratories	86
Radio Mfg. Engineers	73
Radio Receptor Corporation	90
Radio Shack	7, 76
Radio Supply Company	85
Radio Transceiver Laboratories	68
RCA Institutes, Inc.	79
RCA Manufacturing Company	Cov. 4
Scientific Radio Service	81
Shuler Supply Company	85
Shure Brothers Company	83
Signal Electric Manufacturing Company	92
Standard Transformer Company	78
Stromberg Carlson Telephone Mfg. Company	81
Sun Radio Company	68
Telex Company	77
Thordarson Electric Manufacturing Company	81
Triplett Electrical Instrument Corporation	60
Tri State Radio Company	7
Turner Company	78
United Electronics Company	1
United Radio Manufacturing Company	83
Ward Leonard Electric Company	80
Wright-DeCoster, Inc.	90



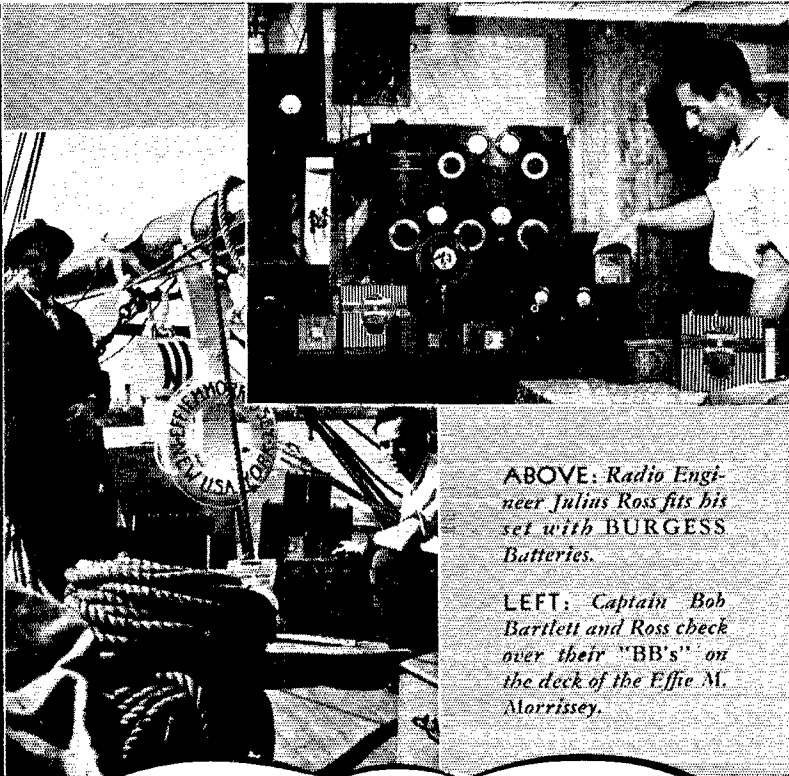

*ABOVE: Radio Engineer Julius Ross fits his set with BURGESS Batteries.*

*LEFT: Captain Bob Bartlett and Ross check over their "BB's" on the deck of the Effie M. Morrissey.*

## BURGESS BATTERIES

### *Go North on the Morrissey*

Into the far reaches of the Arctic seas, for her ninth voyage, sails the Effie M. Morrissey, under the strong hand of famous Arctic explorer Captain Bob Bartlett. In her radio room you'll find that BURGESS Batteries have once again been chosen. Significant is the fact that BURGESS Batteries are the repeated choice of explorers who can't afford to take chances—who stake their very lives on keeping in touch with the world they have left behind. Maximum power and fine performance, long life and all-around dependability are the qualities explorers depend on in BURGESS Batteries. These, too, are the qualities that lead "hams" who know batteries to use only BURGESS. Look for the black and white stripes. BURGESS BATTERY COMPANY, Freeport, Illinois.

# ≡ BURGESS ≡

Say You Saw It in QST — It Identifies You and Helps QST

6284 FEET UP!

46° BELOW ZERO!

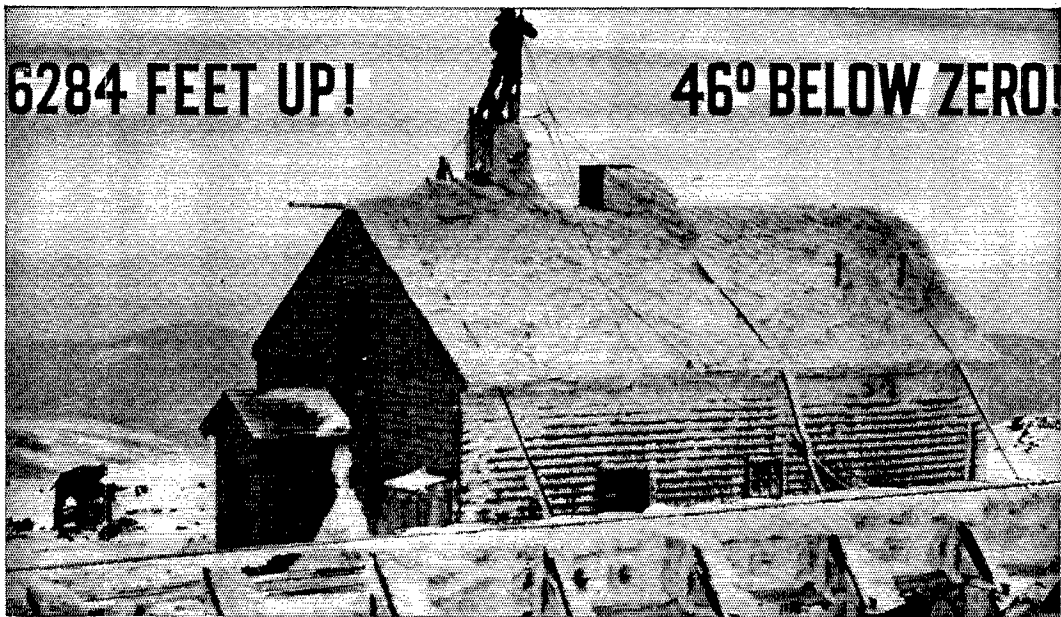

## Dependable Eveready Batteries furnish the push for New England's Highest Radio Station . . .

WIXR, at Mt. Washington Observatory, Gorham, N. H., has been pioneering ultra-high frequency research. Using frequencies in the region of 60 megacycles, they have communicated with a number of amateurs in that section. Eveready Batteries have played their usual dependable part in this work. "Mac" McKenzie, who has been operating WIXR, says:

"I powered our transmitting equipment with five parallel sets of five Eveready Layerbilts in series. These batteries have been used almost exclusively for our plate current and are now, after about 325 hours of service at 150 mils to a short circuit, barely showing signs of wear. When I say they are showing signs of wear, I mean that on peaks of modulation, the oscillator plate current (modulator and oscillator use the same batteries) drops off a couple of milliamperes. They have given us remarkable service.

"All our various radio receivers, from the 133 megacycle to the 113 kilocycle, including a couple of broadcast receivers, are powered with Eveready Batteries."

**NATIONAL CARBON COMPANY, INC.** General Offices: New York, N.Y. Branches: Chicago, San Francisco  
Unit of Union Carbide  and Carbon Corporation

# EVEREADY BATTERIES

THEY LAST LONGER

THEY'RE MORE DEPENDABLE

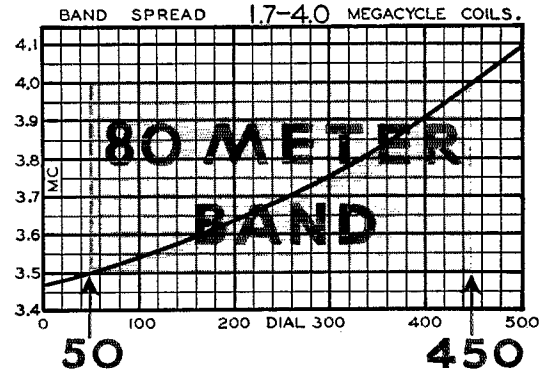
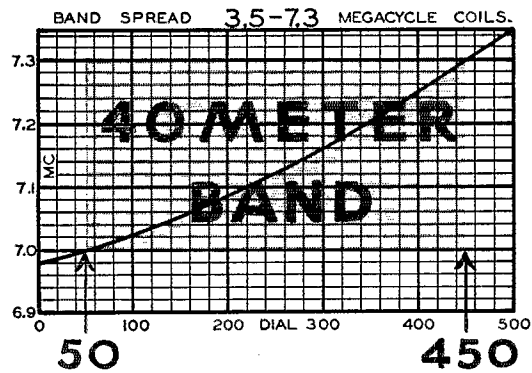
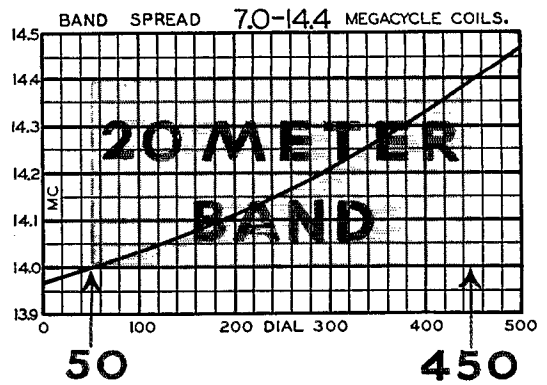
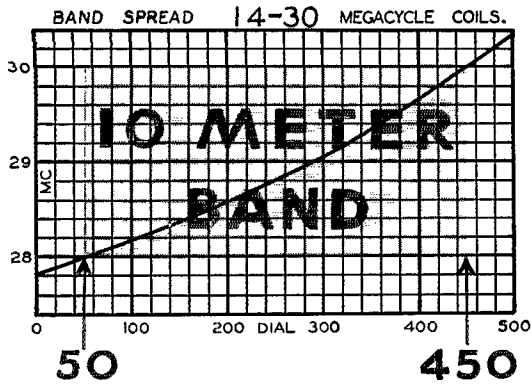

## YOU COULD MEMORIZE THIS BANDSPREAD

*Each band begins at 50 on the dial, exactly!*

*Each band ends at 450 on the dial, exactly!*

- Each HRO receiver is adjusted and calibrated to the above charts by comparison with crystal oscillators. In fact, so accurate is the adjustment, and so small the temperature drift (less than 0.2% under the worst conditions, normally much better) that the HRO provides a reliable check on transmitter frequency.

- The same HRO coils can be switched to general coverage ranges, with each range including two amateur bands, one at 50, one at 450 on the dial.

**NATIONAL**



**COMPANY**

# Here it is...RCA-803 A "HE-MAN" PENTODE

The RCA-803 fills a gap which has long existed in the transmitting tube line—the need for a really powerful transmitting pentode. Incorporating an electrical and mechanical design which assures the utmost reliability, the RCA-803 is ideally suited for such applications as: a suppressor-modulated 'phone transmitter; multi-band transmitters where neutralization would be troublesome; transmitters where the number of tubes is to be kept at a minimum.

The RCA-803 is immediately available from your RCA de Forest Distributor. Write for technical information.

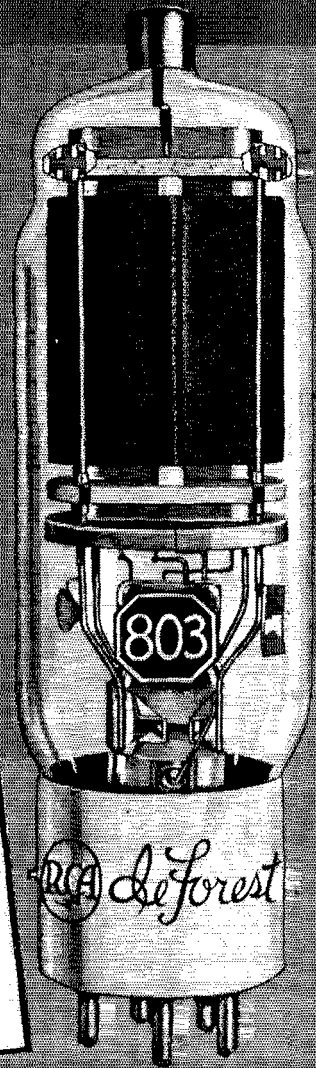

## CHECK THESE FEATURES

Dome Bulb

Rugged Construction

Precision Aligned Parts

125 Watts Plate Dissipation

Carbon Plate

50 Watts Carrier Output  
(Suppressor Modulated)

200 Watts Output  
(Class C Telegraphy)

Ceramic Base

Superior Insulation

Thoriated-Tungsten Filament

Easily Excited

No Neutralization

Amateur's Net Price, \$38.50

## AMATEUR RADIO SECTION

RCA RADIOTRON DIVISION

RCA MANUFACTURING CO., INC., CAMDEN, N. J.