

# QST

May, 1935

25 cents

devoted entirely to

# amateur radio

*In this Issue—*

**Details of  
New Receiver  
Circuits  
and Tubes**

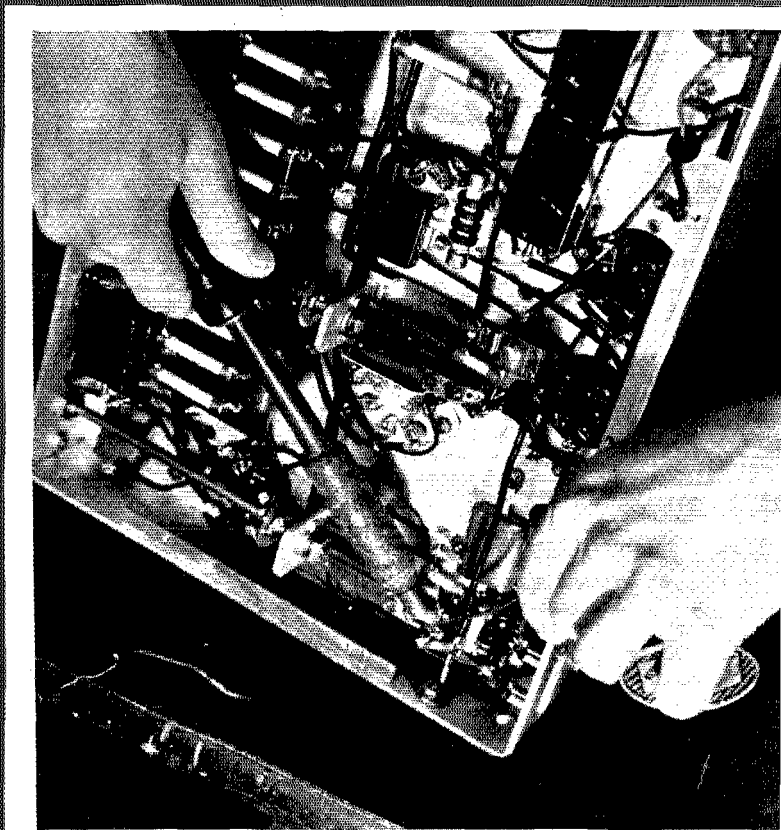

*Fidelity*

*Collins Type 300BA Transmitter*

*250 Watts Radiotelephone  
Low Amplitude*

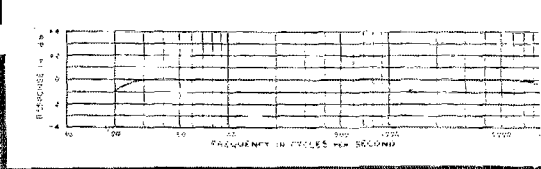

world-famous short-wave stations using Collins Type 300BA Transmitters:

- ✦  
HJ1ABB  
Barranquilla, Colombia
- ✦  
COC  
Havana, - - Cuba
- ✦  
CT1AA  
Lisbon, - - Portugal
- ✦  
OAX4B  
Lima, - - Peru
- ✦  
HC2ET  
HC2RL  
Guayaquil, - Ecuador
- ✦  
YV2AM  
YV5BMO  
Maracaibo, Venezuela

The Collins 300BA Transmitter has established a record in the field which is not made of apparatus across the short-wave demonstrates the

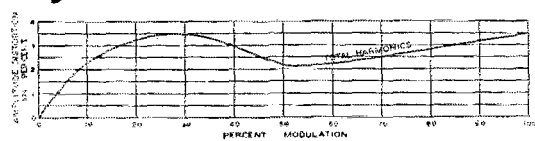

In listing the most popular short-wave stations, radio critics prefer the 300BA installations in preference to many others. In addition to broadcast applications the 300BA is widely used in commercial communication systems and deluxe personal stations. The careful, straightforward design, rigidly selected materials and craftsmanship signally qualifies this set for service where reliability is essential. The 1935 300BA Transmitter embodies all the excellent features of previous models together with many new refinements. The Class B amplifier assures unparalleled fidelity (see charts.) The 300BA is easily operated — hum is 60 decibels below program level. The pushbutton controls add to the simplicity and safety of operation. We are glad to furnish full details to those who appreciate

# COLLINS RADIO COMPANY

CEDAR RAPIDS,  
NEW YORK OFFICE

IOWA, U. S. A.  
11 WEST 42nd St

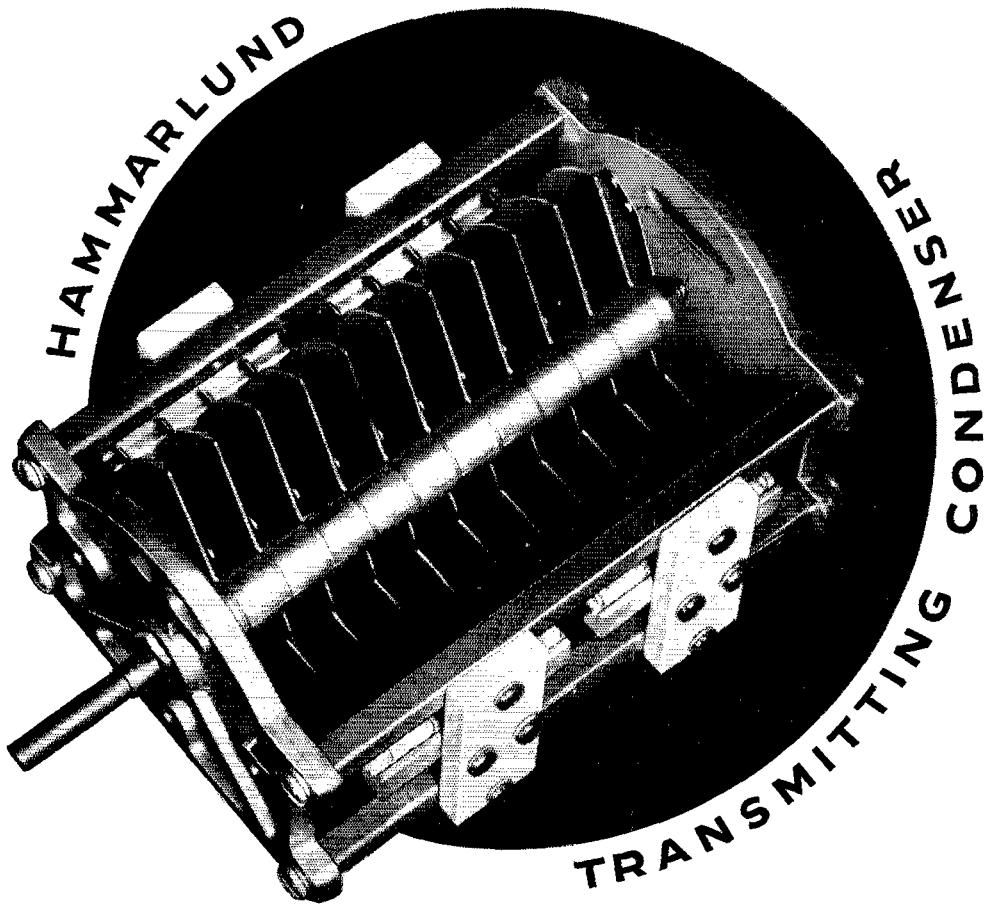

# ELECTRICAL EFFICIENCY plus BRUTE STRENGTH

**B**OTH frame and plates are "oversize," assuring greater rigidity and absolute steadiness of signal. Features usually associated with only the highest power transmitting condensers.

Heavy aluminum ends, four sturdy duralumin posts and Isolantite insulating cross-bars. Plates are wider spaced than usual and have rounded edges for greatly in-

creased voltages. Smooth bearings; self-cleaning contacts.

With a stator of the split-stator model (*illustrated*) connected to each side of the coil, the rotor is at ground potential. This permits mounting on a metal panel without insulation and reduces hand capacity.

Single and split-stator models; 18 capacity ratings. List prices, \$5.00 to \$18.00.



Canadian Office:  
41 West Ave. North,  
Hamilton, Ontario

**HAMMARLUND MANUFACTURING CO.**  
424 W. 33rd St., New York

- Check here for details of Transmitting Condensers.
- Check here for new General Catalog.  Check here and attach 10c, for new 32-page S-W Manual.

Name.....

Address.....

.....Q-5

For Better Radio  
**Hammarlund**  
PRECISION  
PRODUCTS

## Many Exclusive "Marine" Features

- ★ CATHODE RAY OSCILLOSCOPE
- ★ PERMANENT NEUTRALIZATION
- ★ BUILT-IN BIAS SUPPLY
- ★ HIGH FIDELITY AUDIO CHANNEL
- ★ ANTENNA MATCHING NETWORK

The **MARINE 140-B** transmitter is housed in a baked wrinkled enamel finish broadcast station type cabinet rack with detachable hinged rear door. Dimensions: 60" high, 19½" wide, 15" deep.

BAKELITE PANEL FINISH

Gloss, (Illustrated), Satin or Wrinkle optional

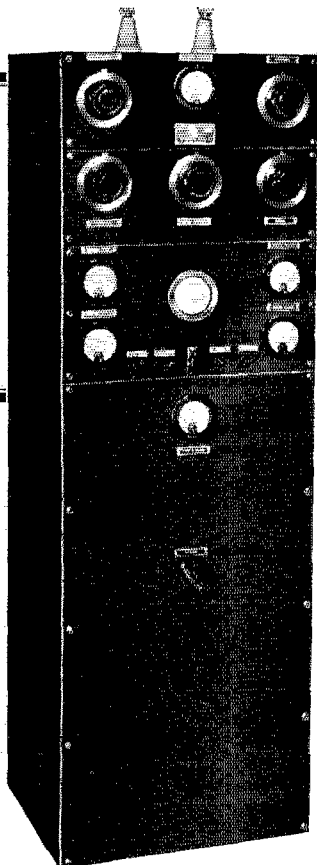

# MARINE 140-B

WITH BUILT-IN

## CATHODE RAY OSCILLOSCOPE

**H**ERE, at last, is a transmitter for the amateur, incorporating many exclusive MARINE features, formerly found only in the most advanced commercially designed equipment. Due to painstaking research and engineering we are able to offer this transmitter to you with a one year unconditional guarantee against mechanical or electrical defects. A broad statement? Not at all. For example — The power transformer has a rating of 800 milliamperes, yet rarely, if ever, will it be called upon to deliver more than one half ampere. The same margin of safety holds true for all transformers, chokes, condensers, resistors, etc.

The built-in **CATHODE RAY OSCILLOSCOPE** acts as a visual distortion and modulation percentage indicator, making it possible to maintain 100% modulation.

The **SPEECH AMPLIFIER** has a gain of 125 D.B. and a frequency response of 30 to 10,000 cycles + or - 1½ D.B. and is capable of driving the class B stage to its full output of 180 watts. The input is designed for use with a Crystal microphone, but with slight modification any type microphone can be used.

**PERMANENT NEUTRALIZATION** — The transmitter is permanently neutralized at the plant before leaving. This means that changing from one band to another or using different antennas will have absolutely no effect on the neutralization.

**SELF CONTAINED BIAS SUPPLY** — Absolutely no batteries of any kind required.

The **ANTENNA IMPEDANCE MATCHING NETWORK** is capable of efficiently matching any type of antenna in general use.

**POWER OUTPUT** — The conservatively rated power output on Phone or C.W. is 100 watts. Under actual working conditions it is possible to realize from 10% to 30% more output depending on the frequency used.

The **MARINE 140-B** transmitter has as one of its many features an **AUTO TRANSFORMER** tapped in 5-volt steps from 90 to 130 volts to take care of any line voltage variations. This transmitter is available for operation on any voltage or frequency.

**DESCRIPTIVE LITERATURE** — Send stamp for descriptive folder with detailed information and photographs. You will be astounded at what we are offering at such an extremely moderate price.

163-18 JAMAICA AVENUE  
JAMAICA, NEW YORK

**MARINE RADIO**  
C O M P A N Y

FORMERLY  
L. I. MARINE & ELECTRIC CO.  
See Additional "Ad" on Page 100



# QST

Published monthly, as its official organ, by the American Radio Relay League, Inc., at West Hartford, Conn., U. S. A.; Official Organ of the International Amateur Radio Union

devoted entirely to

# AMATEUR RADIO

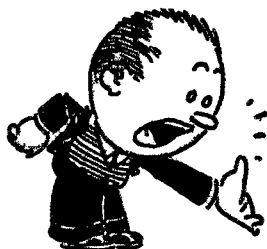

Editorials . . . . .	7
Atlantic Division Convention . . . . .	8
Hudson Division Convention . . . . .	8
Oklahoma State Convention . . . . .	8
International 28-Mc. Communication Again! . . . . .	George Grammer 9
New Class-B Tubes with 125-Watt Output Rating . . . . .	15
Real Results with a Simple Reflector System . . . . .	Henry E. J. Smith, CT8BK 16
What the League Is Doing . . . . .	18
A Tribute . . . . .	20
Looking Over Circuits of the New Superhets . . . . .	James J. Lamb 21
The V-Doulet Noise-Reducing Antenna . . . . .	H. A. Crossland 29
Progress in Ultra-High-Frequency Gear . . . . .	Ross A. Hull 30
DX-Contest Results . . . . .	33
New Type Metal-Shell Receiving Tubes Announced for Summer Appearance . . . . .	36
Receiver Selectivity Characteristics . . . . .	James J. Lamb 37
Acorn-Type Pentode Announced . . . . .	42
Matched Impedance . . . . .	Prof. Dr. Valadod Turnovanoff 43
A 1935 Version of the Original S.S. Superhet . . . . .	Eugene A. Hubbell, W9BRU 44
Sweepstakes Contest Results . . . . .	E. L. Battey 48
Push-Pull-Push Oscillator Circuits for 15-Watt Second Harmonic Output . . . . .	J. Stanley Brown, W3EHE 53
VK-Contest Results . . . . .	Robert H. Cunningham, VK3ML 56
With the Affiliated Clubs . . . . .	57
Experimenters' Section . . . . .	
PORTABLE 75-METER 'PHONE — SPEEDING UP ROUGH GRINDING — ANTENNA DIRECTIVITY — ANTENNA FILTER FOR RECEPTION — RECEIVER SWITCHING FOR VOLTAGE CHANGING — A CURE FOR RECEIVER HUM — SUGGESTIONS WANTED . . . . .	58
Amateur Radio Stations . . . . .	W7EAN, W8BIH, VE3VD, W2HBK 61
I.A.R.U. News . . . . .	63
Calls Heard . . . . .	65
Operating Notes . . . . .	67
Correspondence Department . . . . .	81
Standard Frequency Transmissions . . . . .	94
Schedules for WWV . . . . .	94
New All-Metal Crystal Holder . . . . .	94
Book Review . . . . .	96
A.R.R.L. QSL Bureau . . . . .	98
New Microphones . . . . .	98
Hamads . . . . .	123
QST's Index of Advertisers . . . . .	126

MAY  
1935

VOLUME XIX  
NUMBER 5

Kenneth B. Warner (Secretary, A.R.R.L.), Editor-in-Chief and Business Manager; Ross A. Hull, Associate Editor; James J. Lamb, Technical Editor; George Grammer, Assistant Technical Editor; Clark C. Rodimon, Managing Editor; David H. Houghton, Circulation Manager; F. Cheyney Beekley, Advertising Manager; Ursula M. Chamberlain, Assistant Advertising Manager.

Editorial and Advertising Offices  
38 La Salle Road, West Hartford, Conn.

Subscription rate in United States and Possessions and Canada, \$2.50 per year, postpaid; all other countries, \$3.00 per year, postpaid. Single copies, 25 cents. Foreign remittances should be by international postal or express money order or bank draft negotiable in the U. S. and for an equivalent amount in U. S. funds.

Entered as second-class matter May 29, 1919, at the post office at Hartford, Connecticut, under the Act of March 3, 1879. Acceptance for mailing at special rate of postage provided for in section 1103, Act of October 3, 1917, authorized September 9, 1922. Additional entry at Concord, N. H., authorized February 21, 1929, under the Act of February 28, 1925.

Additional second-class entries to cover sectional editions authorized March 20, 1935

Copyright 1935 by the American Radio Relay League, Inc.  
Title registered at United States Patent Office.

# 1935 ★ TWELFTH EDITION OF THE RADIO AMATEUR'S HANDBOOK

**S**WEEPING changes in short-wave radio technique have been made since publication of the last edition. These changes have called for a drastic revision of the book. The chapters devoted to apparatus design and construction have been rewritten all through, with new illustrations and new circuit diagrams. Needless to say, the new methods and technique which have so recently almost revolutionized ultra-high frequency working have been treated in full detail.

The twelfth edition is more than half as large again as the first edition. The chapter on receivers, for instance, has been enlarged and rewritten to cover all the recent developments; while the chapter on transmitters has been expanded to permit discussion of all the new methods devised during the last year. New circuits and layouts are given and a special attempt made to treat all possible problems which could be faced in designing or adjusting transmitting equipment. Drastic changes in circuit arrangements for the ultra-high

frequencies have meant a complete rewriting of the chapter devoted to that subject. New transmitters and receivers employing new circuits are described for all three of the ultra-high frequency bands. Full details are also given of directive antenna systems for these bands. All of the chapters have had their share of attention to bring the book up to the minute. The chapters on antennas, keying, power supplies, have all been revamped so that all equipment and circuits can truly be said to represent the best in current practice.

*In other words, our policy of leaving nothing in the book that does not represent the very latest practice has been maintained to the letter.*

**268 PAGES—237 ILLUSTRATIONS**

AT ANY PRICE, AN AMATEUR COULD  
ILL AFFORD TO BE WITHOUT IT

• *Postpaid*

**\$ 1**

(BUCKRAM BOUND, \$2.00)

**THE AMERICAN RADIO RELAY LEAGUE, INC.**  
WEST HARTFORD, CONNECTICUT

## Section Communications Managers of the A.R.R.L. Communications Department

All appointments in the League's field organization are made by the proper S.C.M., elected by members in each Section listed. Mail your S.C.M. (on the 16th of each month) a postal covering your radio activities for the previous 30 days. Tell him your DX, plans for experimenting, results in 'phone and traffic. He is interested, whether you are an A.R.R.L. member or get your QST at the newstands; he wants a report from every active ham. If interested and qualified for O.R.S., O.P.S. or other appointments he can tell you about them, too.

Eastern Pennsylvania Maryland-Delaware-District of Columbia Southern New Jersey* Western New York Western Pennsylvania	W3GS  W3BAK W3AZ W8D5P W8CUG	<b>ATLANTIC DIVISION</b> Jack Wagenseller  Edgar L. Hudson Carroll D. Kentner Don Farrell C. H. Grossarth	26 Meadowbrook Ave.  1107 Park Ave. 213 Hickok Ave. R. F. D. 3, Eicher Rd.	Llanerch, Upper Darby Laurel, Delaware Collingswood Syracuse Emsworth, Bellevue, Pa.
Illinois Indiana Kentucky Michigan Ohio Wisconsin	W9WR W9TE W9AUH W8D VYH W8CIO W9FSS	<b>CENTRAL DIVISION</b> Fred J. Hinds Arthur L. Braun C. W. Mossbarger Kenneth F. Conroy Robert P. Irvine Harold H. Kurth	6618 West 34th St. 5311 Brookville Rd. Box 177 7538 E. Robinwood Ave. 5508 Northcliffe Ave. 631 State St.	Berwyn Indianapolis Camp Taylor Detroit Cleveland Madison
North Dakota* South Dakota Northern Minnesota Southern Minnesota	W9OEL W9PFI W9OMI W9DEI	<b>DAKOTA DIVISION</b> Hartwell B. Burner Mike G. Strahon R. L. Rode Francis C. Kramer	601 S. Grange Ave.  W. Bluff St.	Hope Sioux Falls White Bear Lake St. Charles
Arkansas Louisiana Mississippi Tennessee	W5ABT W5DWV W5CWO W4BBT	<b>DELTA DIVISION</b> H. E. Vette W. J. Wilkinson, Jr. J. H. Weems, Jr. Merrill B. Parker, Jr.	2918 West 15th St. 1624 Allen Ave. P. O. Box 244 1912 Oak St.	Little Rock Shreveport State College Chattanooga
Eastern New York N. Y. C. & Long Island Northern New Jersey	W2LU W2AZV W2FOP	<b>HUDSON DIVISION</b> Robert E. Haight E. L. Baunach Charles J. Hammersen	1080 Helderberg Ave. 7823 10th Ave. 92 Claremont Ave.	Schenectady Brooklyn Verona
Iowa Kansas Missouri Nebraska	W9LEZ W9PLG W9EYG-JPT W9FAM	<b>MIDWEST DIVISION</b> Phil D. Boardman O. J. Spetter C. R. Cannady Samuel C. Wallace	325 Kirkwood Blvd. 305 Western Ave. Broadway at Ninth Green St.	Davenport Topeka Monett Clarks
Connecticut Maine Eastern Massachusetts Western Massachusetts New Hampshire* Rhode Island Vermont	W1CTI W1CDX W1ASI W1BVR W1AVJ W1QR W1ATF	<b>NEW ENGLAND DIVISION</b> Frederick Ella, Jr. John W. Singleton Joseph A. Mullen Percy C. Noble Robert Byron Albert J. King Harry Page	19 Merrill Rd. 73 Allen St. 218 Jamaicaaway 37 Broad St. 12 Humphrey St. 70 Metropolitan Park Dr. R. 1	Norwalk Wilton Jamaica Plain Westfield Concord East Providence Hinesburg
Alaska Idaho Montana Oregon Washington	K7PQ W7NH W7AAT W7AMF W7AYO	<b>NORTHWESTERN DIVISION</b> Richard J. Fox Nellie H. Hart O. W. Viers Frank L. Black Stanley J. Belliveau	Box 301 Box 6 Box 265 1502 McPherson St. Route 7, Box 387	Ketchikan Twin Falls Red Lodge North Bend Yakima
Hawaii Nevada Los Angeles Santa Clara Valley East Bay San Francisco Sacramento Valley Arizona Philippines San Diego San Joaquin Valley	K6EWQ W6EAD W6BFD W6BMW W6ZX W6SG W6DVE W6JF-W6QC K6IA W6EOP W6FFP	<b>PACIFIC DIVISION</b> Atlas O. Adams Keston L. Ramsay Howell G. Brown Charles J. Camp P. W. Dann Alan D. Whittaker, Jr. Geo. L. Woodington Ernest Mendoza Newton E. Thompson Harry A. Ambler Clyde C. Anderson	21st Infantry Brigade 1151 Buena Vista Ave. 120 N. El Molino Ave. 318 Hawthorne Ave. 1821 Chestnut St. 78 Elinor Ave. 716 Redwood Ave. 1434 East Madison St. P. O. Box 849 4101 Hamilton St. 931 Orange Ave.	Schofield Barracks Reno Pasadena Palo Alto Berkeley Mill Valley North Sacramento Phoenix San Juan P. I. San Diego Fresno
North Carolina Virginia West Virginia	W4QG W3BRY W8HD	<b>ROANOKE DIVISION</b> H. S. Carter Neil E. Henry C. S. Hoffmann, Jr.	115 Crafton St. 1017 Knight St. 100 20th St.	Winston-Salem Lynchburg Warwood, Wheeling
Colorado Utah-Wyoming	W9FA W6GQC	<b>ROCKY MOUNTAIN DIVISION</b> Glen Glasscock Arty W. Clark	1171 Detroit St. 260 So. 9th West	Denver Salt Lake City, Utah
Alabama Eastern Florida Western Florida Georgia-So. Carolina-Cuba- Isle-of-Pines-Porto Rico- Virgin Islands	W4KP W4BCZ W4MS  W4CE	<b>SOUTHEASTERN DIVISION</b> I. D. Elwell Philip A. McMasters Edward J. Collins  Bannie L. Stewart	1066 Waverly St. 212 9th St., North 1517 East Brainard St.  310 Orange St.	Tarrant St. Petersburg Pensacola  Georgetown, S. C.
Northern Texas Oklahoma Southern Texas New Mexico*	W5BII W5CEZ W5ADZ W5AOP	<b>WEST GULF DIVISION</b> Richard M. Cobb Carter L. Simmon Bradfield A. Beard Robert Shadden	Box 185 2010 So. 4th St. 2030 Quenby Road 1006 Orchard Place	Dodd City Ponca City Houston Albuquerque
Maritime	VE1DQ	<b>MARITIME DIVISION</b> A. M. Crowell	69 Dublin St.	Halifax, N. S.
Ontario	VE3GT	<b>ONTARIO DIVISION</b> S. B. Trainer, Jr.	4 Shorncliffe Ave.	Toronto
Quebec	VE2EE	<b>QUEBEC DIVISION</b> Stan Comach	780 Brault Ave.	Verdun, P. Q.
Alberta British Columbia	VE4GD VE5AC	<b>VANALTA DIVISION</b> J. Smalley, Jr. R. K. Town	611 1st Ave., N. W. 1754 Graveley St.	Calgary Vancouver
Manitoba Saskatchewan	VE4BG VE4EI.	<b>PRAIRIE DIVISION</b> A. J. R. Simpson Wilfred Skaife	71 Thelmo Mansions 2040 McTavish St.	Winnipeg Regina

\* Officials appointed to act until the membership of the Section choose permanent S.C.M.'s by nomination and election.

# The American Radio Relay League



• **T**HE AMERICAN RADIO RELAY LEAGUE, INC., is a non-commercial association of radio amateurs, bonded for the promotion of interest in amateur radio communication and experimentation, for the relaying of messages by radio, for the advancement of the radio art and of the public welfare, for the representation of the radio amateur in legislative matters, and for the maintenance of fraternalism and a high standard of conduct.

It is an incorporated association without capital stock, chartered under the laws of Connecticut. Its affairs are governed by a Board of Directors, elected every two years by the general membership. The officers are elected or appointed by the Directors. The League is non-commercial and no one commercially engaged in the manufacture, sale or rental of radio apparatus is eligible to membership on its board.

"Of, by and for the amateur," it numbers within its ranks practically every worth-while amateur in the world and has a history of glorious achievement as the standard-bearer in amateur affairs.

Inquiries regarding membership are solicited. A bona fide interest in amateur radio is the only essential qualification; ownership of a transmitting station and knowledge of the code are not prerequisite. Correspondence should be addressed to the Secretary.

## DIRECTORS

<i>President</i>	
HIRAM PERCY MAXIM.....	W1AW Box 216, Hartford, Conn.
<i>Vice-President</i>	
CHARLES H. STEWART.....	W3ZS St. David's, Pa.
<i>Canadian General Manager</i>	
ALEX REID.....	VE2BE 199 Logan Ave., St. Lambert, P. Q.
<i>Atlantic Division</i>	
EUGENE C. WOODRUFF.....	W8CMP 234 W. Fairmount Ave., State College, Pa.
<i>Central Division</i>	
EDWARD A. ROBERTS.....	W8HC 2699 Endicott Rd., Shaker Heights, Cleveland
<i>Dakota Division</i>	
CARL L. JABS.....	W9BVH 1822 James St., St. Paul, Minn.
<i>Delta Division</i>	
M. M. HILL.....	W5EB P. O. Box 14, Natchitoches, La.
<i>Hudson Division</i>	
KENNETH T. HILL.....	W2AHC 115 Willow St., Douglaston, L. I., N. Y.
<i>Midwest Division</i>	
H. W. KERR.....	W9DZW-W9GP Little Sioux, Iowa
<i>New England Division</i>	
G. W. BAILEY.....	W1KH 74 Webster Road, Weston, Mass.
<i>Northwestern Division</i>	
RALPH J. GIBBONS.....	W7KV 3933 N. E. 76th Ave., Portland, Ore.
<i>Pacific Division</i>	
S. G. CULVER.....	W6AN 2962 Russell St., Berkeley, Calif.
<i>Roanoke Division</i>	
H. L. CAVENESS.....	W4DW State College Station, Raleigh, N. C.
<i>Rocky Mountain Division</i>	
RUSSELL J. ANDREWS.....	W9AAB 1867 So. Lafayette St., Denver, Colo.
<i>Southeastern Division</i>	
BENNETT R. ADAMS, JR.....	W4APU 1512 Grove Place, Homewood, Ala.
<i>West Gulf Division</i>	
WAYLAND M. GROVES.....	W5NW c/o Humble Pipe Line Co., Neches, Texas

## OFFICERS

<i>President</i> .....	HIRAM PERCY MAXIM, W1AW Hartford, Connecticut
<i>Vice-President</i> .....	CHARLES H. STEWART, W3ZS St. David's, Pennsylvania
<i>Secretary</i> .....	KENNETH B. WARNER, W1EH West Hartford, Connecticut
<i>Treasurer</i> .....	ARTHUR A. HEBERT, W1ES West Hartford, Connecticut
<i>Communications Mgr.</i> ...	F. EDWARD HANDY, W1BDI West Hartford, Connecticut
◆	
<i>General Counsel</i> .....	PAUL M. SEGAL, W3EEA 1010 Shoreham Building, Washington, D. C.
◆	

Address all general correspondence to the executive headquarters at West Hartford, Connecticut



# THE EDITOR'S MILL

**T**HERE'S too much bootleg operation going on in the five-meter band. We licensed amateurs put up with all the inconvenience of government regulations and run the risk of being penalized when we violate the rules. We expect others to operate on the same basis. We could do a lot about the existing situation if we busied ourselves a little.

The tendency seems to be to wink at non-licensed operation on this band because it is more or less "local." The fact that its range is rather short should have nothing to do with it. The band is rapidly becoming occupied to the point of bothersome QRM and it doesn't take a prophet to tell what it's going to be like this summer!

As every ham knows, the trouble starts with the appeal to BCL imagination exercised by the inexpensive transceivers of the day. Most of the bootleggers are not interested in becoming radio amateurs but are simply enjoying the thrill of doing a little "radio broadcasting" on their own—and in our band! The F.C.C. has taken notice of this situation and hopped onto the mail-order catalog houses who offer these sets to the general public without the slightest intimation that a license and knowledge of the code are required; one catalog was found that even went so far as to state flatly that no licenses were necessary. The Commission has now received promises from these houses to state in their non-amateur advertising that licenses must be taken out. They have also devised an ingenious system for running down these unlicensed operators and are uncovering them by the dozen; most of them have never heard of the need for licenses and freely confess their sins. Local clubs can render a valuable service here by calling upon the dealers of their city, under the power of their goodwill, to explain to prospective purchasers the need for qualifying as amateurs. Finally, we lift an excellent suggestion from an article in *The A.T.A. News* of the Amateur Transmitters Association of Western Pennsylvania: "Either as a club or individually we can visit bootleggers, explain the advantages of obtaining a license, the penalties attached to illegal operation, the amateur's aim and point of view in this butting in, and, if necessary, wave the big stick."

It seems necessary for us to do something to clean up this unauthorized use of our frequencies,

and we know that the affiliated clubs can make effective use of the Wouff Hong if necessary. Out with the squatters before summer!

**I**S THE monitoring policy of the F.C.C. too severe towards amateurs? There have been some cases of amateurs caught several times for the same offense but under extenuating circumstances in each case which caused us to ponder whether possibly the enforcement was too rigid. A great part of amateur radio is experimentation. In experimental work it isn't always possible, for example, to get a good note the very instant a rig is put on the air. Suppose that, in the course of time, a fellow gets nabbed three times for having a bad note while engaged in experimental work: Ought he to suffer penalties?

We have thought about this quite a bit. Without meaning to sound pontifical about it, it seems OK to us. In the first place, the monitoring stations are endeavoring to concentrate upon habitual offenders and dish out some medicine for them. Then we must consider that we have this monitoring activity only for our own good, because we actually need it. The penalties are not particularly severe; perhaps they are not severe enough. Upon the first accusation the amateur is obliged to explain the circumstances. That is calculated to cause him to think out what caused the trouble and to bring home to him that he is under observation. Upon the second report for the same offense, but only for the same offense, he is obliged to cease operation during the most valuable hours of the day—when his offense would be most annoying to others—until he can check with another amateur and get the latter's certification that the trouble has been cured. Upon being cited a third time for the same offense he must cease all operation until he can adjust his set, secure a private test with one of the government monitoring stations assigned for the job, and get a clean bill of health again. It seems to us that the present state of our bands requires us to be just about that careful. If a fellow is cited on three occasions a month apart for the use of an a.c. note, it won't hurt him to have a check by a monitoring station even if the bad note came about through his mother's dusting the transmitter and displacing some of the knobs. That is to say, we ought to agree that that isn't an excuse and that in this day and time one has the obliga-

tion of knowing, before going on the air, that the knobs have not been displaced.

The monitoring stations are now devoting more of their time to 'phone operation. The greatest operating evil to-day, the one which makes the most serious subtraction from operating enjoyment in any of our bands, is overmodulation by 'phone stations. Everyone hears 'phones who, by their own statement, knowingly run at 175%

modulation because somebody tells them they are louder that way. Perhaps they are a little louder; they are also immensely broader. The 'phone bands are badly in need of more monitoring. Modulation in excess of 100% is in violation of the regulations. A little government attention to that regulation should do much to increase the enjoyment of 'phone operating.

K. B. W.

## Atlantic Division Convention

June 21st-22nd, at Hotel Syracuse, Syracuse, N. Y.

THE trek in the Division in June will be toward Syracuse, N. Y., ending at the Hotel Syracuse for the big two-day convention being sponsored by the Central New York Radio Club with the coöperation of other radio clubs in Central New York.

Efforts are being made to offer the most reasonable hotel rates, as low as \$1.50 per person, three in a room—with bath. The program shows that the committee is working towards making this convention one to be remembered by those attending and the best news is the admission fee: —\$2.50 for the men, and the OW's and YL's \$1.75 each which will include a theatre party. Naval Reserve and Army-Amateur meetings, technical talks, entertainments, gabfests and a general good time assured.

"Joe" Smith, W8AXC, General Chairman, 207 Court House, Syracuse, N. Y., is ready to answer all letters promptly for those desiring further information.

## Hudson Division Convention

June 1st at Hotel New Yorker, New York City

NEW blood has been injected in this year's convention committee and it will be reflected in the 10th Annual Division Convention. As a matter of fact, it will be a convention—"Hamfest"—Dinner—Dance and a short-wave radio exhibit. The program is replete with interesting events, and everything will take place on Saturday, June 1st, at the Hotel New Yorker, 8th Avenue and 34th Street. The doors for the convention will open promptly at 12 o'clock noon, and from then on there will be lectures, contests and club gatherings. The committee has planned something which will interest everybody, and it will all end with a banquet at which good entertainment will be given, followed by dancing until 4:00 a.m., which ought to please the "Boiled Owls." Believe it or not, the price, including everything, is only \$2.00. Let's make it the big-

gest convention ever held and show Director Kenneth T. Hill that we are all with him.

The chairman is Roy R. Neira, W2EVA, address 21-20 42nd Street, Long Island City, N. Y., with Jack Berliant in charge of entertainment and Bob Hertzberg, publicity—a good team.

## Oklahoma State Convention

(West Gulf Division)

June 8th-9th at American Legion Hall, Ponca City, Okla.

THE Key Clickers Club may be a small organization, but it knows how to stage a convention. The hams in the northern part of the West Gulf Division are cordially invited to come to Ponca City, Okla., on June 8th and 9th, and meet Director Groves, who will make his first appearance in an official capacity. A real good program has been arranged with many diversified events and the admission fee will be within the means of all.

Jacob P. Sinnes is the convention chairman and would like to hear from every one contemplating being present. His address is 1100 North Union St., Ponca City, Okla.

## In June QST!

Not just another vacuum tube but an entirely new practical transmitting type with different elements and characteristics will be disclosed for the first time in the June issue of *QST*. For good measure, there also will be described a complete c.w. and 'phone transmitter using the new bottles in every socket—and requiring a plate supply of only 110 volts d.c. for full output! An exclusive *QST* feature.

# International 28-Mc. Communication Again!

Four Continents Active on Ten Meters as New DX Records Are Made—  
Who Will Be the First to Work South America?

By George Grammer\*

**N**O DOUBT about it—the ten meter band is on its way back! We had an inkling of it back in the summer of 1933, when contacts over distances of 1000–2000 miles were quite common among the few hardy souls who stuck with the band. The fall of 1934 showed promise, too, but things did not really start to hum until this spring—and particularly during the last few weeks in March.

MARCH 23

On March 23d W6VQ worked ZL2GQ, VK3BW, VK3YP, VK2EP, VK3NM and ZL whose call could not be identified because of fading, making the first recorded contact between the U. S. and Australia-New Zealand in six years! VK2EP was using 'phone and was R9 at W6VQ, as were the others with the exception of the unidentified ZL. These stations all were worked between 3 and 5 p.m. P.S.T., the band going dead shortly after five o'clock. The same afternoon W9NY worked VK2LZ at 2323 G.T. (5:23 p.m., C.S.T.), the VK being the only signal heard in several hours listening, although commercial harmonics were coming through. W9FFQ, using a pair of 10's, worked ZL2GQ at 5:30 C.S.T. on the 25th. On the 27th W6VQ hooked up with KJTY, the S.S. *Jacob Ruppert*, the ship's position then being Lat. 41, S., Long. 113 W., 5000 miles south of Pacific Beach, for a solid four-hour QSO with R9 signals both ways.

MARCH 30

The next Saturday, March 30th, proved to be equally as good as the 23d, if not better. W6VQ again contacted several VK's and ZL's, although the details of the work have not been received, since this is being written only a few days later. Northern California put itself on the map when W6CAL worked VK2LZ, VK2EP, and J2HJ, as well as X1AY and a bunch of W's, the *J* contact being the first on record between this country and Japan! J2HJ was worked at 4:30 p.m. P.S.T., and after finishing with W6CAL also worked W6BNU before fading out. W6BNU in addition worked VK2LZ, ZL2GQ and ZL2BN, 'phone being used on the QSO with 2BN. On the same day W2TP hooked up with VK2LZ at 5:10 E.S.T.

\*Asst. Technical Editor, QST

for what we believe is the first contact between Australia and the east coast of the United States. W9FFQ also worked VK2LZ. That evening between 6 and 9 p.m., Central Time, W4TZ worked VK2LZ and VK4BB, and heard VK6EA, VK2EP, VK3HK, and ZL3AJ. Later ZL2BN, while working W4AJY on 14 mc., reported hearing W4MR and W4AJY on 28 mc., the former at 2200 G.T. and the latter at 2325 G.T. Through W2TP we learn that X1AY also worked VK2LZ on the 30th. VK2LZ seems to be the star Aussie station, working 14 W's in addition to X1AY,

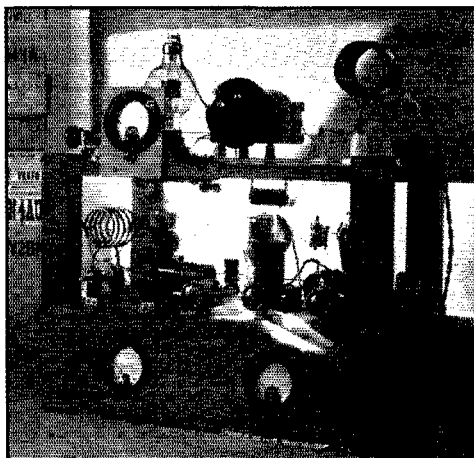

W6CAL'S CRYSTAL-CONTROLLED 28-MC. TRANSMITTER

An Eimac 50T with 100 watts input is used in the last stage.

this dope being received from W1BUX via VK2EL on 14 mc. X1AY, incidentally, has been knocking them off at a great rate, reporting over 30 QSO's with W stations during the last week in March—all with 60 watts input!

The DX work of course is in addition to plenty of intra-continent QSO's, mostly over distances of about 2000 miles or more.

So far very little has been heard from Europe with the exception of the work between ON4AU and W9TJ, who keep regular schedules and have QSO'd several times, as reported in the I.A.R.U.



News in April *QST*. ON4AU has been on ten since last October, has been heard by VE1DR, W2ARY, W8DJW, and W1CUN (this last on March 23d), and has worked VE3PT. His signals have been heard in Australia. ON4AU's present schedule calls for transmitting on 28,768 kc. between 1330 and 1345 G.T. (8:30 to 8:45 a.m. E.S.T.) with an input of 800 watts, the time being chosen because most successful contact has been maintained with W9TJ at this hour. At 1345 he listens for replies on 14 mc.

Further evidence that the band is getting into good shape is given by the fact that on March 17th VK3BW worked J2HJ, the time being 2400 G.T., and that several instances of DX reception have been reported. In October VE2AC heard LU8AL on 'phone (possibly a harmonic), in February W4TZ picked up ON4CSL's harmonic with good strength, VE2AC was heard in Australia in August, and W6VQ has been heard in Belgium.

From several sources we learn that 28-mc. activity is at a peak in Australia and New Zealand, with interstate QSO's being common. The evidence of the last two week-ends certainly supports it!

that has been done in the past on the 28-mc. band, since the activity has been confined to a small group of experimenters—the casual opera-

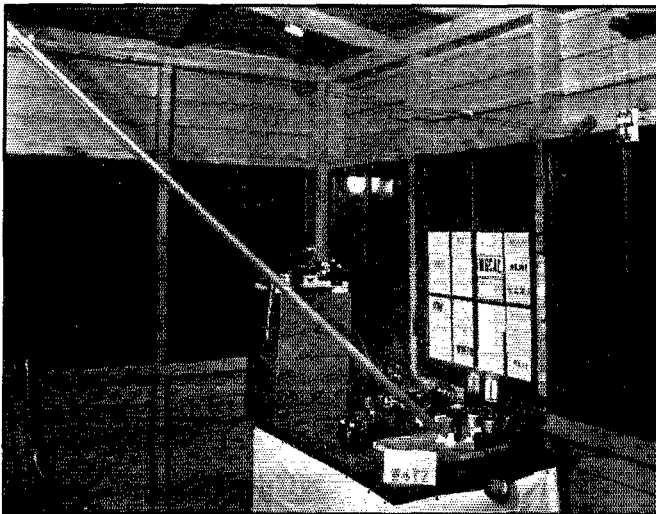

THE 28-MC. TRANSMITTER AT W4TZ, SHOWING THE PUSH-PULL FINAL AMPLIFIER WITH ITS HIGH-Q TANK CIRCUIT

The  $\frac{3}{4}$ -inch copper pipes, a quarter wave in length, run diagonally from the transmitter to the roof of the operating room.

tors quickly lose interest when results aren't immediately forthcoming. But a lot of DX has been worked on ten, as the following data, compiled from accomplishments reported in *QST*, will show.

The 28- to 30-mc. band was opened for general amateur communication in this country early in 1928. It was immediately put to work by the experimenters, although, as always, the rank and file was slow to get going. Inter-continent work followed immediately, the first DX QSO being between W2JN and F8CT. In the spring of 1928 a number of U. S. signals were heard in England and vice versa, while K6CFQ in Hawaii reported hearing a number of mainland stations, mostly on harmonics. The first Hawaii-U. S. contact, between K6DJU and W6DZL, took place in September of the same year; in the same month K6CFQ reported hearing W1XR, while K6CLJ was reported in Australia. October, 1928, saw many QSO's between England, Ireland and the U. S., outstanding being those between W6UF and G2OD and between W6UF and G2FN, the latter using only 8 watts input! Power apparently didn't mean very much when conditions were right, G6DH on 3 watts being heard by W2JN! In November W6UF worked ZL2AC for the first W-ZL contact, and at about the same time ZL2AC heard W1CCZ's

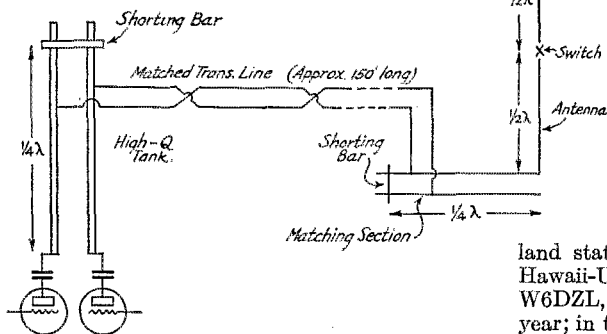

FIG. 1—THE HIGH-Q TANK CIRCUIT AND ANTENNA-FEEDER SYSTEM AT W4TZ

The tubes in the amplifier stage are parallel-fed to keep the high-voltage off the copper pipes. Condensers between tube plates and tank circuit are the ordinary blocking condensers, capacity not critical.

#### ANCIENT HISTORY

Fellows who have been in the game for only a few years probably aren't familiar with work

ten-meter signals. While several instances of reception of U. S. signals in Australia were reported during this period, the first record we have of two-way work between the two countries was on April 1, 1929, when W6BCS contacted VK3CP and VK3PM.

The early months of 1929 brought many new records. ZL2AC was heard by VE2AC, while ZL3AR's signals were heard in England. Things started picking up in South America, too, PY1AC and PY1AA reporting reception of several stations in the U. S. and England. India also was heard from, VT2KT working a number of English stations and one in Finland. On March 3,

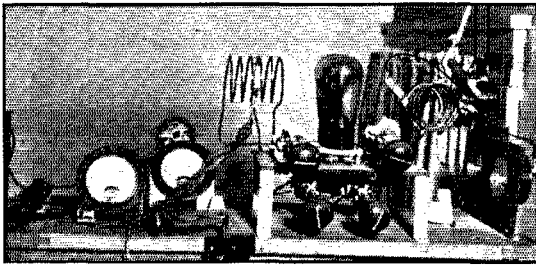

W9NY'S PUSH-PULL AMPLIFIER

*Nothing complicated here! The grid and plate inductances are wound with No. 10 wire, six turns in each coil with half-inch spacing between turns, coil diameter two inches. Split-stator condensers are used in both grid and plate circuits. Since the photo was taken a pair of 801's has been substituted for the 10's.*

1929, VT2KT worked VK5HG for the first India-Australia QSO. In February D4UAH worked ZS5C, using only 25 watts, and reported the 28-mc. signals of W2JN and W4NH, while KA1CM worked Australia and Japan. On May 12, 1929, the first Australia-Japan QSO's took place, when J2BY, using only a 201-A with five watts input, worked VK5HG, VK3BQ, and VK3PM. In October PY1AA was heard by D4YT, while ZT6C was heard by G6LL. ZT6C reported the signals of W2JN and W2AQB, and W2JN also was heard by ZS4N.

The year 1930 opened with the first QSO between the U. S. and South Africa when W2JN and ZS4M hooked up. ZS4M also reported working OH2NM and OZ7T. VT2KT had in the meantime moved to China where he put XU2UU on the air, working VK3BQ early in 1930. During this period W9EF and W2JN contacted OZ7Y, while PA0DW reported hearing a number of signals from the United States and Africa. To W6BAX goes the credit for the first U. S.-China QSO, XU2UU being worked on March 9, 1930. All U. S. districts except the 5th and 7th were heard in England in early 1930 during R.S.G.B. 28-mc. tests.

Conditions apparently took a turn for the worse during the summer of 1930, no more DX work being reported. A few faithful experimenters kept at it, but results were meager despite a number of

special tests. Nothing more until 1932 when a single report was received: W8DYY was heard by G5QA. On April 23, 1933, W5ATY reported working HB9B, while later in the year AC2BHH reported hearing W8TI for a few minutes during some special tests they had arranged. In July things started to pick up again with K4SA working W1CCZ and hearing W2TP; in May W4TZ was heard by K5AF. Later in the summer work over comparatively short distances came back, as outlined at the beginning of this tale.

Well, we've looked at the record—this summary has only hit the high spots—and it's not so bad. International DX on 28 mc. is not merely a possibility, it's an accomplished fact! We've got a job ahead of us to find out just how often "ten" is good, and when and where. Now is a good time to start—from all indications we're headed for the peak of good conditions, having passed through the depression. Get down there, gang!

#### WHAT KIND OF EQUIPMENT?

If this recital has stirred up any desire on the part of free spirits, not hog-tied to one or two pet bands, to get in on the 28-mc. work, the question of equipment naturally will come to the fore. What kind of transmitters, receivers and antenna systems are giving results on ten meters? In the first place, almost anything goes on this band—no d.c. regulations, no inhibitions about tone modulation, no cramping restrictions on 'phone operation, since the lower 500 kc., where nearly all the stations are working, is open to 'phone. Operation on 28 mc., unlike 56-mc. work, is readily

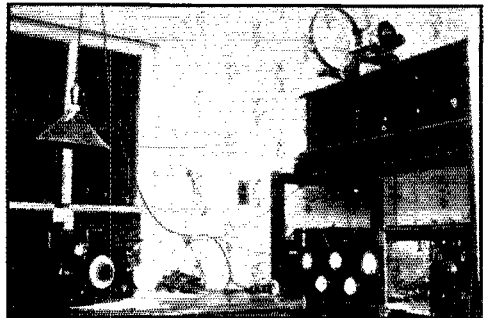

THE 28-MC. TRANSMITTER AT W9GFZ USES AN 852 IN THE ULTRA-AUDION CIRCUIT

*The single-turn tank coil of the set is visible at the upper right in the photograph. Power supply equipment is at the lower right, with the receiver on the operating table at the left.*

susceptible to the same sort of technique that is used on our regular communication bands—stable transmitters, selective receivers, beat-note reception and the like are the order of the day. Superhet and regenerative receivers both seem to be equally effective so far as picking up

signals is concerned, although the easier handling of the super—particularly lack of critical adjustments, freedom from hand-capacity effects and greater discrimination against man-made static—give it preference. Nevertheless a great many of the fellows working on ten are using quite simple receivers.

From the transmitting end, several alternatives present themselves. A self-excited oscillator designed especially for the band can be constructed, or, if the station already is equipped with a crystal-controlled 14-mc. transmitter, the last stage can be arranged to double to 28 mc. Or an additional stage can be rigged up for 10-meter output, either as a doubler or as a straight amplifier working out of a temporarily-doubling stage which ordinarily is a 14-mc. amplifier. Almost any of the small medium-size tubes will work well both as doublers and amplifiers at 28 mc., although the efficiency may not be comparable to that obtainable at lower frequencies.<sup>1</sup>

The favorite antenna among 10-meter workers seems to be a vertical or semi-vertical Hertz, either a half-wavelength or having two half-waves placed end-to-end and fed in phase. Both these arrangements tend to concentrate the radiation at low angles with the horizontal, which theoretically at least is desirable at the very high frequencies. On the other hand, plenty of other types of antennas have given a good account of themselves, some of them the ordinary antennas used in every-day work on lower frequencies.

To give an idea of the sort of equipment being used, we have collected data from some of the stations who have been doing consistent work. Looking over the photographs and descriptions of the rigs should give any experimenter enough suggestion to enable him to plan a 28-mc. layout.

<sup>1</sup>Besides the 28-mc. data in the current *Handbook*, crystal-controlled transmitters adapted for the band will be found described in the following *QST* issues: January, 1935, p. 16; October, 1934, p. 24; August, 1934, p. 27; December, 1933, p. 22; November, 1933, p. 10; October, 1933, p. 9; January, 1931, p. 11; April, 1930, p. 9. Data on oscillator-amplifier and self-excited transmitters appeared in *QST* for August, 1933, p. 18, and June, 1930, p. 21. Receiving kinks and descriptions of receivers suitable for the band will be found in the following *QST*'s: June, 1934, p. 9; November, 1933, pp. 15, 41 and 42; January, 1930, p. 21.

## W6VQ

COMPLETE dope on the apparatus at W6VQ unfortunately did not arrive in time to be included in this issue. However, W6VQ's transmitter is a self-excited oscillator using two Federal 108-A tubes in push-pull, operated with an input of one kilowatt from a 3000-volt, three-phase supply with half-wave rectification. Two antennas of he-man proportions are used—No. 1, 960 feet long and 40 feet high, runs in a north-east-southwest direction, and No. 2, 1250 feet long and also 40 feet high, is due east-west.

Two receivers are in use, a "doctored" SW3 and a National HRO. Lacking a photograph and more details at the moment, we'll have to postpone a complete description until a later issue. W6VQ, in addition to the DX work previously mentioned, has been putting an outstanding signal into the eastern part of the country and has worked practically all the eastern and middle-western 28-mc. stations. He is on the air every day and keeps automatic tape running for an hour or two, depending on conditions on the band.

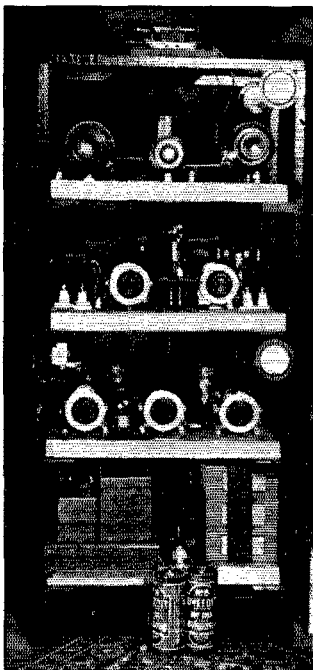

THIS FRAME-MOUNTED RIG IS THE 28-MC. TRANSMITTER AT W2TP

The 203-A in the final stage can be modulated by the speech equipment used on W2TP's 20- and 75-meter 'phone sets.

## W4TZ

W4TZ was put on 28 mc. for the first time in April,

1934, and was operated alternately between 14 mc. and 28 mc. until the end of June, when conditions made it necessary to dismantle the outfit for a time. Operation was resumed December 29th, of last year, this time wholly on 28 mc. Considerable work with different types of transmitters has been done in the first few months of this year, the latest—probably permanent—rig being shown in one of the photographs. This set is crystal-controlled, starting out with a 53 exciter unit (along the lines of the one described in October, 1934, *QST*, page 25) using a 7-mc. crystal. The 10-meter output of the exciter drives a 46 buffer which in turn drives a second buffer, an 860 which has seen most of its useful life. The final stage, link-coupled to the 860 driver, has an unusual tube combination in push-pull—according to Hunter, "a deactivated 203-A and a half-shot 211!" Of particular interest is the final stage tank circuit, a high-Q linear tank made from two quarter-wave sections of  $\frac{3}{4}$ -inch copper tubing. Each of the tubes is 8 feet 6 inches long,

the spacing between them being  $\frac{3}{4}$ -inch. The tank is tuned by a sliding shorting bar which in operation is 6 feet 4 inches from the plate ends of the tubes. A diagram of this arrangement and the antenna-feeder system is shown in Fig. 1. The matched feeders tap on the pipes 1 foot 6 inches from the shorting bar. At the far end the feeders

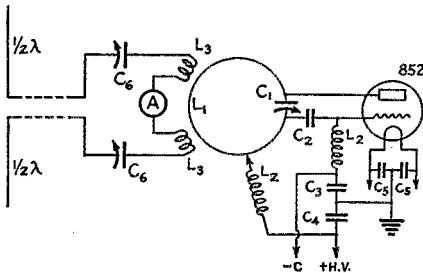

FIG. 2.—THE 852 ULTRA-AUDION OSCILLATOR USED BY W9GFZ

- $L_1$ —1 turn  $\frac{1}{8}$  by 1-inch copper strap, diameter 9 inches.
  - $L_2$ —40 turns No. 36 wire, spaced turns, on  $\frac{1}{2}$ -inch form.
  - $L_3$ —2 turns  $\frac{1}{4}$ -inch copper tubing, diameter 3 inches.
  - $C_1$ —65- $\mu$ fd. variable, high-voltage.
  - $C_2$ —50- $\mu$ fd. fixed condenser.
  - $C_3$ —350- $\mu$ fd. fixed condenser.
  - $C_4$ —400- $\mu$ fd. fixed condenser.
  - $C_5$ —001  $\mu$ fd.
  - $C_6$ —350- $\mu$ fd. variable.
- High-voltage mica condensers should be used at  $C_2$ ,  $C_3$  and  $C_4$ . Positive bias and negative high-voltage returns should be made to filament center-tap.

are tapped on a quarter-wave matching section at the lower end of the antenna. The matching section is also adjusted by a shorting bar, the distance between the feeder taps and the bar being 11 inches. The antenna itself is a vertical wire a full wave in length, with a switch at the center so that only the lower half-wave section can be used when desired.

The input to the final stage is approximately 300 watts from a 900-volt plate supply. The high-Q tank circuit gives good efficiency and is quite easy to adjust for correct feeder matching. The set is keyed in the primary of the high-voltage transformer, with enough filter being used to give a near d.c. note without tails. This gets around the BCL troubles.

For receiving, W4TZ has the ordinary 3-tube t.r.f. job—24 r.f., 24 electron-coupled detector, and 27 audio. It is all a.c. operated, with an 874 tube on the "B" supply to keep the voltage steady.

## W6CAL

THE 10-meter rig at W6CAL is a crystal-controlled outfit starting out with an 802 Tri-tet oscillator and 80-meter crystal. An 841 doubles the 40-meter output of the oscillator to 20 meters, and this in turn is fed into an 800 doubler to 28 mc. The final stage is an Eimac 50T, operated with an input of 100 watts at 1400 volts. Lack of higher plate voltage prevents using more input. This set is built up in a frame,

as shown in the photograph. The final stage is link-coupled to an antenna tuning unit mounted on the wall. The antenna itself is a 7-mc. Zepp. Other types of antennas have been used, including a horizontal 28-mc. Zepp with a reflector, but the 7-mc. Zepp seems to give as good results as any.

Receiving is handled by a simple two-tube using a 57 detector and 56 audio. The set is completely shielded, with filtered leads to power supply and 'phones. By keeping down the stray capacities a fairly high L-C ratio can be used, and the sensitivity for c.w. reception has proved to be quite good. A separate antenna—a 14-mc. current-fed doublet—is used for receiving. The horizontal Zepp with reflector also has been found to give good results for reception.

## W9NY

THE transmitter at W9NY is crystal-controlled using fairly low power. A Tri-tet oscillator with a 7-mc. crystal drives a 58 regenerative doubler (the universal exciter unit, October, 1933, *QST*), 600 volts being used on the plates and 110 volts on the screens of both tubes. The doubler drives a pair of 801's with an input of about 80 watts, link coupling being used between the doubler and final stage. The transmission line to the antenna is clipped right on the amplifier tank. W9NY's antenna is a half-wave vertical wire mounted on a 20-foot wooden pole on the roof of the house. The actual length is 16 feet 6 inches. The transmission line is made of No. 10 wire, transposed on Johnson blocks, the spacing and wire size being such as to give a line impedance of approximately 440 ohms. This terminates at a quarter-wave matching section of the type described in January, 1934, *QST*. The same antenna is used for transmission and reception.

W9NY's receiver is a tuned r.f. job using a 58 r.f. stage, 57 detector with cathode-impedance regeneration, and 59 audio, modelled after the set described on page 17 of *QST* for November, 1933. The noise level at the location is very high, most of it being caused by passing automobiles, but when conditions on the band are good the signals come in with enough strength to ride over the noise.

W9NY is listening and calling on 28 mc. practically every day. On the occasions when the band seems to be "open"—when harmonics from distant commercials come through—a considerable amount of transmitting is done.

## W2TP

THIS station is one of the original members of the 10-meter gang, having been among the first on the band when it was opened in 1928. In the early 10-meter days W2TP had frequent contacts with France and England as well as with stations in this country.

In the fall of 1934 the original self-excited transmitter was dismantled and completely rebuilt for crystal control, using a 59 Tri-tet oscillator with a 7-mc. crystal, doubling in the plate circuit of the oscillator. A 59 regenerative doubler to 28 mc. follows the oscillator, this in turn driving a pair of 10's in push-pull. The final stage uses a 203-A with 200 watts input. Link coupling is used between the 28-mc. doubler and 10's, and also between the 10's and 203-A. The final can be used on 'phone by feeding in modulation from the speech equipment used on the 3.9- and 14-mc. 'phone transmitters at the station.

The antenna system at W2TP was not designed particularly for 28-mc. work but seems to be quite effective. The antenna is 99 feet long and runs from the operating room on the third floor of the house to the top of a 96-foot steel tower. It is fed by a single-wire feeder.

The receiver at W2TP is a single-signal super built like the original in August-September, 1932, *QST*, with 28-mc. coils for r.f. and detector, and using a 14-mc. oscillator coil.

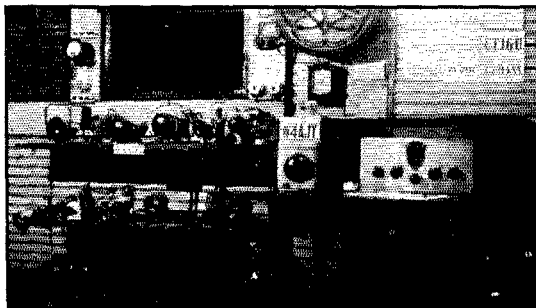

THE 28-MC. EQUIPMENT OF W4AJY

The transmitter is built on two breadboards, the lower containing the exciting stages and the upper the final. The 800 in the final stage is operated as a doubler on 28 mc., the input being about 100 watts.

## W9GFZ

W9GFZ is consistently on 28 mc., having been among those active in the summer of 1933 when the band once before showed signs of coming to life. Many stations throughout the country have been worked during and since that period.

The transmitter at W9GFZ uses an 852 in the ultra-audio circuit, an unusual feature of the set being the single-turn copper-strap tank coil. A diagram of the oscillator is shown in Fig. 2. The 852 is operated at a plate voltage of 2650, and it has been found that an input of 400 watts can be used on 28 mc. with keying. Plate supply is from a bridge rectifier with 866's and a small filter. The oscillator is loosely coupled to the antenna system to minimize frequency variations from swaying of the feed line and antenna. The large box on which the transmitter sits in the photograph contains the bias supply, which will deliver up to 1600 volts, although the actual bias used is 700. Blocked-grid keying is used, and a booster transformer having two secondaries, one in series with the plate transformer primary and the other in series with the filament transformer primary, is used to compensate for line drop during keying.

W9GFZ's receiver is a tuned r.f. set using 6-volt tubes, 6D6 r.f., 6D6 regenerative detector, and 76 amplifier. The detector uses the "electron-coupled" circuit and works well up to 70 mc. Careful construction has reduced stray capacities so that fairly high *L-C* ratios are used. Batteries are used for both plate and filament supply to reduce noise.

Two vertical antennas end-to-end and fed in phase are used for radiating. These are each 16½-foot copper tubes, supported on a wooden mast on top of the house, the top of the uppermost one being 67 feet from the ground. They are fed at the junction by a two-wire tuned line. W9GFZ uses a

200-foot wire about 35 feet high for reception.

## W4AJY

THE crystal-controlled transmitter of W4AJY is shown in another of the photographs. The exciter consists of a 59-Tri-tet oscillator, 46 doubler and 46 buffer. The final stage, on the upper breadboard, uses an 800 as a doubler to 28 mc., since it has

been found that more output can be secured in this way than by running the second 46 as a doubler. Plate input to the final on 28 mc. is about 100 watts.

The antenna at W4AJY is a semi-vertical Hertz having a fundamental frequency of 14 mc. It is fed in the center by a tuned two-wire line, making it two half-waves fed in phase on 28 mc. Feeders are coupled to the transmitter through a matching network of the type described by Collins in a past *QST*. A 7-mc. horizontal antenna also is available, but from all indications is not as satisfactory for 28 mc. as the arrangement described above.

The receiver at W4AJY is a three-tube tuned r.f. job using the circuit of the set described in January, 1933, *QST* and also in the latest *Handbook*.

## W9TJ

WE DO not at this writing have a description of the apparatus used at W9TJ. This station, however, has been located on a farm where a.c. is not available, and hence has been working on low power with storage "B" batteries for plate supply. At the time this is being written the station is being moved into the town of Raymore, Mo., where a more powerful rig working from the regular power lines is being installed. The daily

schedule with ON4AU, which has resulted in several contacts, has been maintained continuously since the first of the year.

#### WHAT TO EXPECT ON 28 MC.

Of course DX like that recorded here is not an everyday achievement on 28 mc. But when we come right down to it, neither is the 14-mc. band reliable day in and day out; it has its high spots and lows, too, as anyone who works the band regularly will agree. But the point about 20 meters is that *there are enough stations situated at all kinds of distances on the band so that a QSO is fairly certain at almost any hour of the day.* That's exactly what we need on 28 mc.—a great many stations in locations all over the world working there regularly. Only then will we be able to get some idea of the distances it is possible to cover and consistency with which signals will come through. An hour or two's listening without hearing anything does not mean, necessarily, that the band is dead. There may have been plenty of stations on—only none of them were located at the right distances for successful communication—maybe everyone was listening only! At present this is a common difficulty, and can be overcome only if enough of the gang will get on "ten."

The chief plaint of the fellows who operate regularly on the band is that too many obviously "good" days go by without a chance of a contact. This is bound to be the case when all activity

is confined to a handful of fellows, most of them with limited time at their disposal, especially in view of the fact that 28 mc. is chiefly a daytime band. As W6VQ says, "Why only a week-end band?" Surely enough hams are at home in daylight hours during the week to get on for an hour or two, at least. One of the best indications of whether or not the band is open is the reception or non-reception of harmonics from commercial stations near the 14-mc. band. When distant commercial harmonics are heard—which is a considerable proportion of the time, incidentally—ham signals would come through. XDA's harmonic on about 29 mc. is heard here in Hartford frequently, indicating that conditions would be excellent for that distance, although until X1AY got busy nothing at all in the way of 28-mc. signals was heard. Fellows in other parts of the country report hearing commercial harmonics regularly.

More listening on the band is not enough. We need transmitting stations, plenty of them. Preferably stations with stable signals, particularly if 'phone is used. The modulated oscillator would appear to be definitely out for 28-mc. DX work, since the frequency modulation in such a rig nearly always makes the signal unreadable on the superhet receivers many of the gang are using.

With the work that's been done already as an inspiration, let's get busy and see if ten meters can be tamed. Who'll get the first WAC on ten?

## New Class-B Tubes With 125-Watt Output Rating

A TUBE which might be called a "revised" version of the RK-18, designed to have improved characteristics for Class-B audio work, has been announced by the Raytheon Production Corporation. The new tube, which will be designated the RK-31, works with zero bias, gives somewhat more output in Class-B than the RK-18, and requires less driving power. It has the same external appearance and terminal arrangement as the RK-18, but has two grids (on the 46 idea) connected together internally. The filament rating is the same as that of the RK-18—7.5 volts, 2 amperes—and the plate rating nominally 1000 volts at 85 milliamperes, the maximum recommended voltage being 1250.

In Class-B modulator service the maximum ratings are as follows:

Plate voltage.....	1250 volts
Grid voltage.....	0 volts
Load resistance, optimum*.....	3250 ohms
Plate dissipation, per tube.....	35 watts

\* For two tubes, multiply by four.

Peak plate current, per tube.....	275 ma.
Average plate current, per tube.....	85 ma.
Power output, two tubes.....	125 watts

The RK-31 can be substituted directly for RK-18 in equipment already designed, the only change required being removal of bias and connecting the center-tap on the grid input transformer directly to filament center-tap.

The tube is also suitable for r.f. service, offering the advantage that it is protected from overload in case of excitation failure in leak-biased circuits. The plate current with zero bias and no excitation is approximately 15 milliamperes per tube at 1000 volts.

### Strays

Appropos indexing the call-book à la W8BKE (page 10, March *QST*), a gouging chisel does the job nicely and leaves no tabs to be torn off when you drop the call-book in disgust.

—W9TEW

# Real Results With a Simple Reflector System

Details of the Antenna Behind the Well-Known Sock of CT2BK

By Henry E. J. Smith,\* CT2BK

A SHORT description of this station and its antenna system may be of interest to some of the many operators of other stations with whom contacts have been made at one time or another.

The transmitter itself is a perfectly straightforward circuit using a 47 oscillator on 3.5 mc. into a 46 doubler and then a 46 final. Plate voltage for the crystal oscillator is obtained from a 280 type rectifier at 300 volts, plate supply for the final also being obtained from similar power pack delivering 350 volts. Grid bias for the 46 doubler and final is also from a small power pack with a voltage divider of only 1500 ohms. Grid bias keying is used on the final and no interference is caused in the owner's own multiwave broadcast receiver (11-tube) or in neighbors' receivers.

When the transmitter is used on 14 mc. the final is run as a doubler and the feeders connected as for 7-mc. operation. On 7 mc. the input

in increments of 15 degrees at a time (Fig. 1B). Several weeks were spent making up averages of reports received. The result of these antenna tests appeared to indicate that a horizontal half-wave Hertz had a sufficiently well-defined field pattern to justify a certain amount of care in the choice of its direction, especially so if one particular zone was of greater interest than another.

It might be of interest that during these tests one fact became more evident than many others. The minima (endwise) of such an antenna system are really quite sharply defined in this particular location. Whether this is merely coincidental is open to conjecture, but in view of subsequent experiments with reflectors it should not be entirely ignored.

A Great Circle route to New York City from this location lies 74 degrees West of North. The same route to England lies just on 45 degrees East of North or almost at right angles to the New York Route (Fig. 1A). This fact is rather interesting when it is correlated with experimental results. The seemingly best position for the horizontal half-wave Hertz antenna here for communication with U.S.A. actually coincided with the antenna wire at right angles to the line of the Great Circle route, which is theoretically correct. Some three months solid tests with the antenna in this direction gave an average (on 7 mc.) of R4-R5 to the U.S. and practically no communications whatsoever on 7 mc. with England.

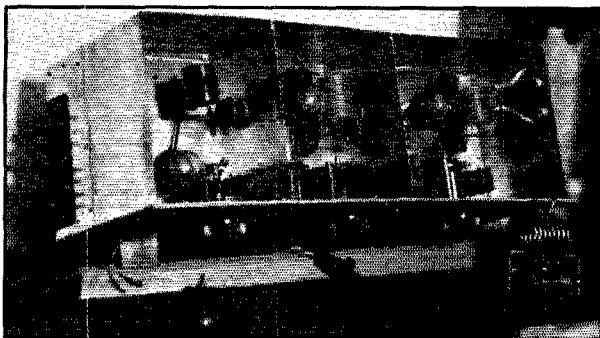

JUST A SHADE OVER 20 WATTS AT CT2BK

to the last stage runs around 18 to 23 watts, depending on the line voltage and on 14 mc. about the same input.

During the course of two years considerable work has been done on antenna systems of various types. The ordinary single-wire fed half-wave Hertz appeared to be equally as good as the Zepp type when care was exercised to get the feeder tapping point correct. Finally, some ten months have been put in on experimenting with a Zepp type 67-foot antenna, 65 feet above the ground. The end nearest the station was kept fixed during the experiments and the "free" end swung around

\* Fanueil Place, New Rochelle, N. Y., exCT2BK.

## WITH A REFLECTOR

Early in February, 1935, it was decided to erect a "reflector" in such a manner as to give still better propagation toward the U.S.A. About a week and half was spent trying out various lengths of reflector distances behind the main antenna, etc. The method of attacking this was similar to that used in regular antenna "pruning" operations—cut and add, making measurements with a shunted Weston thermogalvanometer in the center of the reflector. The correct length (for 7001.5 kc.) proved to be quite critical as shown on following page.

Having decided on 66 feet as the correct length for the reflector wire, further tests were made varying the distance of the two wires, the results



Length of Reflector	Scale Div Deflection
64 feet	55.0
64.5	58.0
65.0	62.0
65.5	84.0*
66.0	92.0
66.5	86.0
67.0	76.0

\* Reflector 33 feet behind antenna.

NOTE.—Both the antenna proper and the reflector are in close proximity to local houses and chimneys (brick).

of this are below and do not appear to be very critical. The reflector is 35 feet above ground.

Distance f o Antenna	Gai'so Reading Degrees
30 feet	72.0
31	76.0
32	85.0
33	92.0
34	87.0
35	80.0
36	74.0

During these tests no attempt was made to make any QOS's. At this stage the reflector was permanently fixed at 33 feet behind the antenna.

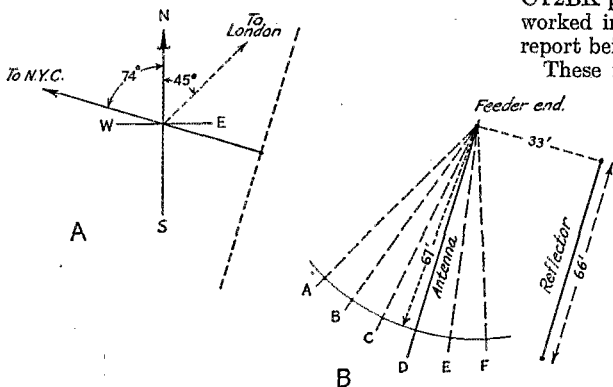

FIG. 1.—SEE TEXT FOR DETAILS

Results of experimental checks and reports are shown below and correspond to Fig. 1B.

A—U.S.A. R2-4	England R3-4	D— " R5	" nil
B— " R3-4	" R3	E— " R4-5	" R3
C— " R3-4	" R3	F— " R3	" R4-5

These are average reports received while determining proper direction of the antenna. The reflector was not in use at the time.

A Type 30 tube, microammeter and necessary batteries for a VT voltmeter rigged on a base-board with a tuned circuit. This was taken in an auto about 3000 feet in front of the antenna out on an open road with no wires close and a 10-foot vertical wooden 2-by 2-inch pole used to support a short antenna.

The bias on the 30 was adjusted and the length of the antenna cut till a half scale reading was obtained on the 0-100 microammeter with the tuned circuit at resonance. No attempt was made to calibrate this VT voltmeter, as only relative

values were of interest. Several readings were taken with the chassis of the car in various positions. The average reading being 65 microamperes circuit tuned to resonance and 11 microamperes untuned (shorted). Then the car was driven around the town to a position just under 3000 feet behind the antenna and a reading at resonance of 15 microamperes obtained. In fact the reading was so small that it was necessary to add more antenna to find the resonant point. As the writer was rather busy for the next few evenings, two more daytime readings were made at the same locations on separate days and did not vary more than 5%.

On the evening of February 23d the first CQ resulted in so many stations calling that the writer wondered what he had fallen into. The first few actual QSO's with W1, 2, 3 and 4's (that had been worked many times previously) showed a marked increase in signal strength in the States. In the course of one week's operation the results proved astonishing. During the previous eighteen months one W6 had been worked, although many had been heard and called. Now, it is quite common to work four or five W6's consecutively, provided the QRM from East Coast stations calling CT2BK permits. On March 6th eight W6's were worked in a string, four W5's and the average report being "QSA5 R6."

These facts are recounted for what they are worth. The results seem more than should be expected from a simple reflector system. Whether the antenna system, or something else, is responsible is conjectural. Three stations in the city of Pittsburgh said "ur the onli European ever heard here." A station in Times Square said "never heard anything like it."

A test also was made on 14 mc., but the reports received from W stations indicated no increase whatsoever. But, after calling CQ DX a few times, several G's were raised and worked at normal strength—and no G answers had been received to "CQ' DX" on 7 mc. since the reflector was added. Is this also incidental?

The writer will shortly be shutting up CT2BK to return to the States and would like to take this opportunity of expressing his thanks for the splendid coöperation he has always received from some 2000 QSO's with W stations. Thanks.

## ~~Strays~~

A catalog clipping sent in by W8HPF advertises a transceiver with "performance limited solely by typographical location." Which, as W8HPF comments, is putting the blame right on the typographical error!

# What the League Is Doing

League Activities, Washington Notes, Board Actions—For Your Information

**Survey** In recent months a great deal of interest has been displayed in questions relating to the nature of A.R.R.L. membership, how much of it is licensed, what class of persons controls A.R.R.L. elections, and so on. The practice in A.R.R.L. is to accept into membership any person either engaged in or only interested in amateur radio, but to confine the right to vote in our affairs to those who at the time of voting possess an amateur license. This is the only workable way that anyone has been able to think of, because licenses expire or get suspended or renewed, or new licenses are issued, beyond the possible knowledge of our headquarters. The only satisfactory arrangement is to say that if a member possesses a license he may vote, and if he has no license he may not vote. Recently some exceedingly tall stories have been started to the effect that only about 15% of our League's membership consists of amateurs and that the rest is hostile to our aims and very possibly had its dues paid by "commercial companies" who would like to do us dirt by swaying our affairs in the wrong direction. The general idea is that, since majority rule must govern and the 85% majority would be opposed to the interests of the true amateur, A.R.R.L. is an anti-amateur society! And that is said even though the 85%, under our present rules, can't vote. Of course not many fellows fell for this line. On the other hand, there admittedly has been a lot of good wholesome curiosity about the matter, and so we decided to make an analysis.

The Federal Communications Commission very kindly gave us their coöperation and permitted us to make a comparison of our membership list against F.C.C. records of licensed amateurs. It took two people two weeks of day and night work to do the job. It was done under the supervision of the amateur section of the F.C.C.'s licensing division. With our membership the highest in our history, we found that 67.76% of our membership in the U. S. and the territories and possessions under F.C.C. was licensed as of the date of making the check; and we uncovered evidence of the recent amateur interest of a considerable percentage of the not-then-licensed members, noting during the check that a great many of them previously possessed licenses or had recently been up for examination.

In any amateur group such as a club meeting or a convention there are always some persons present who do not at the moment possess licenses, being either former amateurs or amateurs-to-be. But they come to such gatherings out of the same

sort of amateur interest as actuates those who are licensed at the moment. The amateur body constantly experiences small changes. While it is proper in A.R.R.L. to deny the ballot to anyone except licensed amateurs, the great bulk of those members unlicensed at any given moment are far from being "hostile commercials" and, rather, are possessed of the same heart-interest as those who hold tickets.

But the League doesn't let them vote even though their hearts are in the right place. The number of our members having a purely legal right to vote because of continuous membership in the League, and regardless of whether they are licensed, is now only a small percent. Failure to renew membership within the thirty-day period of grace has caused a lapse of the legal right to vote and put almost all of these members on the same basis as all recent members, that is, they are entitled to vote only if they are licensed at the time. Only licensed amateurs control A.R.R.L. and all our League's activities are devoted to their advancement and protection.

As the 'phone men put it, "That's the dope on that, old man."

**Racket** Hot upon the heels of the South Pasadena call-clipping racket reported on page 76 of March *QST*, an even more pretentious racketeer launched precisely the same game from New York City under the name of the John T. Manners Company, starting with the Eighth District and working westward. Thanks, fellows, for the several hundred prompt and indignant reports which you dropped in our laps almost simultaneously; they enabled headquarters to take immediate action. The National Better Business Bureau got on the trail at once. We are advised that all of the Manners Company mail has been held up and that prospects are excellent for all of the victims getting back their two bits. The bad-mannered "Mr. Manners" is nowhere to be found.

**License Notes** If you change your address you should notify the F.C.C. even if you hold only an operator license, so that their records may be correct. The case of a station license is even more important because it authorizes operation at only one address except under portable procedure. You may operate as a portable at the new address while the license is being modified. The modification is easy to secure and should be had, because otherwise you are violating regulations.

We again urge all amateurs who have extra old-form licenses for portable operation to send them to the Commission for cancellation. All "fixed" licenses now authorize portable operation without additional authority. The extra license for portable operation is useless, because the F.C.C. has stated: "If the licensee holds two amateur station licenses issued under the old rules, one fixed and one portable, all operation after October 1, 1933, should be under the call of the fixed station license." More than useless, such extra license is a liability. The licensee is responsible for the operation of his station, which is checked up by the monitoring stations, and with misread calls and pirated calls there is always an opportunity for trouble. The existence of such a superfluous license creates a legal responsibility without any single compensating benefit to the amateur. That is why we urge that the extra portables be turned in.

In the occasional cases of severe disciplinary action towards amateurs, the Commission has suspended the operator license for a stated period and revoked the station license. The Commission has recently ruled that in amateur cases, after the period of the disciplinary suspension of the operator license is over, the amateur may apply for a new station license without prejudice.

At the request of the League, arrangements have been made by the F.C.C., through the co-operation of the Navy Department, whereunder the Navy's District Communication Officer at Guam will handle amateur matters there for the F.C.C. in co-operation with the San Francisco Inspector. Thus examinations, and particularly the Class A, will now be available to the amateurs of Guam. Plans are under way to effect a similar arrangement in the case of San Juan, Puerto Rico, and to secure the services of Army officials in Alaska for operator examination purposes—including Class A in both cases. A new F.C.C. office has recently been opened in Honolulu, thus serving the K6's.

By the latest report there were 298,604 motor boats registered in the United States. That's one excellent reason why we don't have mobile amateur operation except on the ultra-high frequencies. Otherwise we'd have a hundred thousand of these motor-boat owners qualifying as amateurs to obtain utilitarian communication, and our bands would be crowded with orders to the butler to come down to the dock with a tray of cocktails, and other important business.

### Ancient History

The impression seems to be around that the A.R.R.L. secretary still receives a commission on memberships and on the net business of *QST*. In the early years of the League that was the arrangement established by the Board of Directors, but it was abolished in middle 1924, about eleven years ago, and in recent years the secretary has

received only a straight salary fixed by the Board of Directors.

### Mexican 'Phones

Many amateurs have protested to headquarters the presence of Mexican 'phone stations in the 7-mega-cycle band. 'Phone operation in this band being against our Board's present ideas of what is proper, the League has requested the Department of State to make representations to the Mexican government to withdraw the authorization for this operation, in the interests of North American uniformity. The attitude of the Mexican administration is not yet known.

### Ten Years

A number of members of the headquarters staff have served the League more than ten years. Amongst the old-timers are Budlong, Hebert, Houghton and Warner, with service running from eleven to sixteen years. In February, Communications Manager Handy reached his tenth anniversary, followed a week later by Miss Ursula M. Chamberlain, *QST*'s assistant advertising manager. Latest member of the ten-year club is Mrs. Julia H. Kirshearn, secretary to the secretary and the assistant secretaries, the w. k. JHK of the "front office's" letters. The headquarters staff now numbers thirty people, plus several extra ones during the winter peak.

### Foreign Traffic

The radio portion of the Madrid treaty is in full effect as between the United States and the following foreign countries: Australia and territories, Austria, Belgium and Belgian Congo and Ruandi Urundi, Bulgaria, Colombia, Czechoslovakia, Denmark, Egypt, Estonia, Ethiopia, Finland, Germany, British India, Italy and its colonies and islands, Japan (and Chosen, Taiwan, Karafuto, Kwantung, and islands under mandate), Morocco except Spanish zone, the Netherlands plus Netherlands Indies, Surinam and Curacao, New Zealand, Persia, Poland, Spain and its territory of Gulf of Guinea, Switzerland, Syria & Lebanon, Vatican City State, Yugoslavia. With these countries we may not handle third-party traffic. The treaty relation also exists with Canada, but the handling of certain types of traffic is permitted by special arrangement as recently reported in *QST*. With all other countries we are free to handle third-party traffic—if we can find a ham on the other end who is not prohibited by his government from handling messages.

### W3ZS

The Vice-President of the League, Charles H. Stewart, W3ZS, has been confined to his room for a couple of months by illness. With time hanging heavy on his hands, he would be pleased to have letters from amateur friends to help him while away the tedium of his confinement. Address: St. David's, Pa.

**Museum** We have started at headquarters a museum of old or historically-famous radio gear, and have built a large cabinet to house the beginnings of a collection which we hope will become very interesting and very valuable to amateur radio. If any of our members has specimens of ancient equipment or pieces of apparatus that did yeoman duty in some record-breaking exploit and are willing to deposit them in the headquarters museum, either as a gift or on loan, we would be very pleased to hear from them. We haven't had time to appoint a curator yet and we haven't published a catalog, but with a little help from you we can assemble something here that will be interesting to all of us and that some day will itself warrant a visit to headquarters. Remember T.O.M.'s rotary gap, "Old Betsy"? . . . Well, not yet, but we have hopes. . . . Has anybody got a coherer rig they'd like to put on exhibition? And an Adams-Morgan loose-coupler?

**Cairo Surveys** It is believed that, in connection with our plans for the Cairo Conference, it would be very helpful to have some amateur surveys of the occupancy by commercial stations of certain bands near ours. We need some statistical data on these wide-open spaces which the plaintive V-wheel makes its haunt. The Communications Department is tackling the job and soon will ask for some volunteer observers. The R.S.G.B. has already undertaken such work in England and it is expected that most of the societies of the I.A.R.U. will give their assistance to the collection of such information as our plans for the Cairo Conference take form.

**Operating News** As our readers have noticed, the operating news in *QST* is now published in four sectionalized issues, central, east, west and south. Thereby a number of desirable features are simultaneously made possible. The space available for each zone is a great deal more than under the old scheme, making it possible to double the size of each C.D. section's report, while presenting in summary the activities of all the other regions of the country. At the same time, the total over-all space is reduced enough to get one or two additional good articles into each *QST*. Naturally all of this costs additional money, and plenty of it, but fortunately the same arrangement makes it possible for us to secure some additional advertising on a sectional basis, and this is sufficient to meet the extra cost. The combination seems to be a fortunate one and when the field reports are adjusted to the new system we believe that all hands will agree that it is well worthwhile.

**Power** A question seems to be going the rounds as to the A.R.R.L. policy towards amateur power. It's easily answered:

our Board of Directors stands for the continuation of the present authorization of one kilowatt, and those are the instructions to the headquarters.

**More Ancient History** We've heard some critics of the League say that amateurs used to possess all the frequencies above 1500 kc. and that if the League had been on the job we would still own all of the high frequencies now. Well, the writers of the 1912 law that put us on "wavelengths not to exceed 200 meters" believed that all the shorter waves were useless. When we commenced to discover their value, we ourselves interpreted our restriction as meaning that we owned all the frequencies above 1500. In just that same way, the American Indian once owned all of North America. As a matter of fact, there was a considerable period of time at about that part in amateur history when the United States amateur was limited to the wavelengths between 150 and 200 meters and was not entitled to operate on any wavelength below 150. Old-timers will remember that the early amateur investigations of 100 meters and the early transatlantic work was done either under experimental X licenses or under special temporary authority. It was from that position that the League, by hard work, achieved substantial assignments to amateurs in the region of 80 meters, 40 and 20—assignments which our own government was perfectly willing to continue for us, which she supported at the 1927 Washington Conference, and which were reduced to their present figures by foreign governments who would not agree.

## A Tribute

AT 7:30 p.m., eastern standard time, over the WJZ Blue Network of the National Broadcasting Company, there is presented a program entitled "Household Musical Memories." On it is featured fireside philosophy and original verse by the poet laureate of America's common people, Edgar A. Guest. Now Mr. Guest, while not a licensed transmitting amateur, is an ardent short-wave listener and we have learned that he has a number of good friends among that stellar crowd of twenty or more amateurs on N.B.C.'s Chicago staff. It is not surprising, then, that at one of his "Household" broadcasts a couple of months ago Mr. Guest dedicated the entire half hour to the radio amateur and wrote a poem in tribute to our activities. A code message—CQ, de EAG and 73 de EAG—was synchronized with the musical background. The program was very well received—the sponsor reports that over one thousand cards were received in acknowledgment from licensed amateurs alone—and everyone concerned was highly elated. Through the kind

(Continued on page 108)



cabinet, behind a screened opening in the panel. As shown in the diagram, the circuit line-up proceeds through one stage of tuned r.f. pre-selection tuned-impedance coupled to the combined oscillator and first detector, a crystal filter of the fixed band-width type, two i.f. stages using transformer coupling with air-condenser tuning, a combined second detector and c.w. beat oscillator, and pentode power output stage.

The tuning system is of the switching type having sectionalized coils and using a six-gang switch, one section being used exclusively for the oscillator padding condensers and the three for the main coils providing shorting of adjacent sections to minimize dead spots. Band spreading, both in calibration and tuning rate, is accomplished by mechanical and electrical methods in combination, an auxiliary gang condenser being used in parallel with the main gang and having its own calibration dial and reduction drive. Approximate band-spread figures<sup>1</sup> for the amateur bands are as follows:

1.75 mc. (in nearly 3 sweeps of band-spread range), calibration spread 1 kc. per scale division, tuning rate 25 kc. per knob rotation; 3.5 mc.

<sup>1</sup> For explanation of the description of band-spread figures, see the note on band spreading elsewhere in this issue.

(in 2.6 sweeps of band-spread range), calibration spread 2 kc. per division, tuning rate 60 kc. per knob rotation; 7 mc., calibration spread 4.5 kc. per division, tuning rate 130 kc. per knob rotation; 14 mc., calibration spread 8 kc. per division, tuning rate 240 kc. per knob rotation.

The crystal filter, which is switched in by a panel control for single-signal reception, is of the fixed band-width type with the phasing condenser variable from the front as an operating adjustment for rejecting an undesired interfering signal. The "transmit-receive" switch, when thrown to the "transmit" position, simultaneously disables the r.f. stage and changes the bias on the i.f. tubes to a sensitivity level suitable for monitoring the station's own transmitter. Additional panel adjustments are the combined power switch and tone control, beat oscillator and wave-change switches, and r.f. gain (volume) control. The beat oscillator frequency and monitor level adjustments are at the rear. The c.w. beat oscillator utilizes the screen-grid section of the 6F7 connected as a triode, the grid and cathode of the triode section being used as the diode second detector (with the triode plate grounded so as to be ineffective). The beat oscillator is capacity coupled to the grid of the second i.f. stage.

## Hammarlund Super-Pro

HAMMARLUND'S new amateur type Super-Pro, scheduled for release in the near future, uses 14 tubes in the receiver circuit proper with 2 more as rectifiers in a separate plate- and bias-voltage power pack. A block diagram of the tube line-up is shown, the complete schematic not being available at the time of this writing. The circuit sequence starts with two stages of

diode type second detector which also furnishes a fourth stage of i.f. A second tube of this type serves exclusively for amplified a.v.c. which is not affected by the output of the electron-coupled beat oscillator and therefore can be used for c.w. as well as for 'phone reception. The diode detector is followed by a resistance-coupled stage of audio voltage amplification, a power driver stage

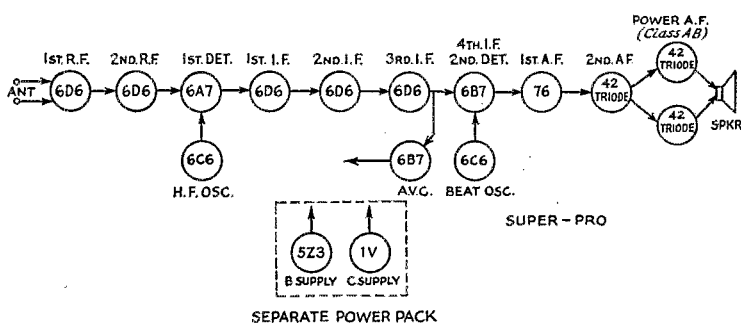

and a push-pull power output stage operating Class AB. Both power stages use pentode tubes connected as triodes.

The tuning system is of the coil-switching type, the switch mechanism being a special slotted-cam operated design providing shorting of all coils except those actually in circuit. Five tuning ranges

tuned r.f. pre-selection, followed by a pentagrid first detector with separate electron-coupled high-frequency oscillator, three stages of 465-kc. i.f. amplification with variable band-width air-condenser tuned transformers, and a pentode-

between 540 kc. and 22 mc. are covered in 2-to-1 steps by the main tuning condenser gang. Band-spread tuning is accomplished by an auxiliary gang which has an individual calibration scale and which is automatically cut in parallel





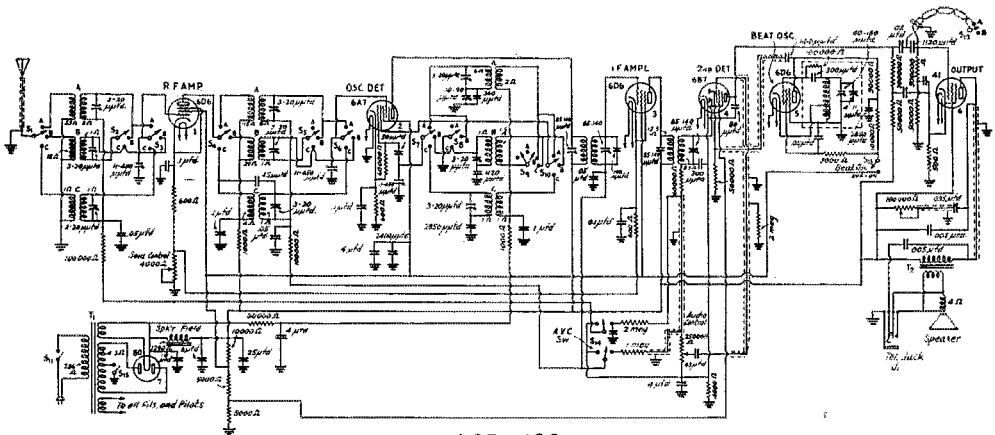

ACR-136

matic overload protection with the a.v.c. switch in the "off" position. The c.w. oscillator, which has a panel control for beat-note adjustment, is capacity-coupled to the detector diode plate and the audio output of the B7 pentode section is

resistance-coupled to the power stage. Headset output is taken from the B7 plate circuit through a jack, and speaker output from the power amplifier plate circuit for which a 7000-ohm load is specified.

### RCA ACR-136

**E**MPLYING five tubes in its receiver circuit proper and an additional rectifier in the self-contained power pack, the ACR-136 line-up is a stage of tuned r.f. amplification, a combined first detector and oscillator, one 460-kc. i.f. stage, a separate electron-coupled c.w. beat oscillator, a combined second detector, a.v.c. rectifier and first audio, and a pentode power output stage. Coil switching selects any one of the main tuning ranges 540 to 1720 kc., 1720 to 5400 kc., and 5400 to 18,000 kc. The last two include the 1.75-, 3.5-, 7- and 14-mc. amateur bands. Coils of the next-lower frequency range are automatically shorted on the higher ranges to prevent dead spots. A visual band indicator operates in conjunction with the switch, letters corresponding with the band-switch positions appearing in sequence through an opening in the illuminated main tuning-scale dial.

A single three-gang condenser is used in the tuning system and is driven through a two-speed reduction gearing giving a ratio of 10-to-1 with the operating knob pushed inward and a ratio of 50-to-1 with the knob pulled outward. The band-spreading method is of the mechanical type. Two concentric dial indicators are used, one being double-ended and indicating on the main 180-degree scales which are calibrated directly in frequencies and in units from 1 to 9, while the other traverses a 360-degree scale calibrated in 100 divisions, the latter being the vernier index. Approximate average calibration-spread figures for the vernier index scale are 1.4 kc. per division on the 1.75-mc. amateur band (2 revolutions of

pointer), 6.7 kc. per division on 3.5 mc., 8.5 kc. per division on 7 mc., and 20 kc. per division on 14 mc. Approximate average tuning rate figures for the amateur bands with the 50-to-1 drive ratio are 47 kc. per knob rotation on 1.75 kc., 222 kc. per knob rotation on 3.5 kc., 300 kc. per knob rotation on 7 mc., and 650 kc. per knob rotation on 14 mc.

Following the i.f. stage, the 6B7 operates as a combined diode second detector, a.v.c. rectifier and pentode first audio amplifier. Audio input to the pentode section is taken from the volume control resistor in the load circuit of one diode plate, and a.v.c. voltage is taken from the same circuit through resistance-capacitance filtering networks, full a.v.c. being applied to the r.f. stage and reduced a.v.c. to the first detector and i.f. stages by tapping in at different points in the diode load resistance circuit, as shown in the diagram. A double-pole switch shorts the grid returns to ground to cut off a.v.c. action for reception with manual gain control, which is provided by the variable resistor in the cathode circuit of the r.f. and i.f. stages. This manual control is also operative with a.v.c.

The second diode plate is capacity-coupled to the plate of the beat oscillator. The operating beat-frequency adjustment is reached by lifting the lid of the receiver case. The plate circuit of the power stage is coupled to the 4-ohm speaker voice coil by a step-down transformer, the speaker being mounted within the case behind a grilled opening in the front panel.



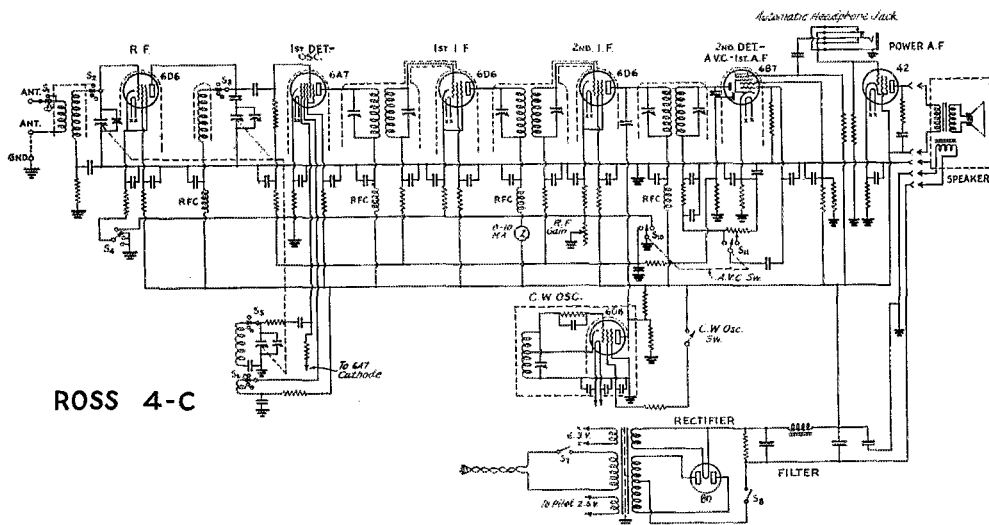

Ross 4-C

**I**MPROVED successor of the earlier "Jupiter" model, the Ross 4-C utilizes a total of 8 tubes, one being the rectifier in the self-contained power pack. As shown in the diagram, the circuit line-up is one stage of tuned r.f. pre-selection, a combination oscillator and first detector using a pentagrid, two 456-kc. i.f. stages, a diode-pentode as combined second detector, a.v.c. rectifier and first audio, an electron-coupled c.w. beat oscillator, and a power pentode output stage. The continuous frequency spectrum 550 to 20,000 kc. is covered in four main steps by the coil-switching tuning system in which separate three-gang condenser units with individual dials are employed for the main ranges and for electrical band-spreading.

Calibration spread for the amateur bands is specified as 8.5 kc. per dial division on 14 mc., 7.3 kc. per division on 7 mc., and 1.6 kc. per division on the 3.9-4.0-mc. 'phone band. The 3.5- to 3.9-mc. c.w. band and the 1.75-mc. band are covered on the main tuning condenser, with proportionately greater band-spreading in slices by the auxiliary control. Tuning rates, with the auxiliary knob tuning nearly 1.7 times for 100 scale divisions, are approximately 500 kc. per knob rotation on 14 mc., 425 kc. per rotation on 7 mc., and 100 kc. per rotation on 3.9 mc.

The c.w. beat oscillator is completely shielded and is coupled to the plate of the second i.f. amplifier, feeding the second detector through the last i.f. transformer. One diode plate of the 6B7 serves for audio detection while the other, capacity coupled to the i.f. input circuit, provides a.v.c. voltage to the first detector and both i.f. stages. A.v.c. is removed for c.w. reception by grounding through one section of the switch indicated in the diagram, the other section of which shifts the audio tap on the detector diode load resistor. Manual gain control by means of the variable cathode resistor is applied to both i.f. stages on the high-frequency tuning ranges and to the first r.f. as well on the broadcast band (switch S4). A d.c. milliammeter in the plate feed circuit of the first i.f. stage serves as a tuning meter and indicator of relative carrier strength.

Headset output is taken from the plate circuit of the pentode section of the 6B7, which operates as the first audio stage, the telephone jack automatically connecting the 'phones between the interstage coupling condenser and ground. The separate speaker unit, enclosed in a matching cabinet, is connected by a standard-type plug and socket to the power pentode plate circuit and also to the power pack for which the speaker field coil serves as the second filter choke.

### Sargent 8-34

**T**HE schematic diagram of the Sargent 8-34 shown is for the "Marine" model which incorporates a tuning range covering frequencies between 200 and 540 kc. (coils "E" and "K") in addition to the normal 540- to 20,000-kc. continuous range covered by the otherwise identical

"Standard" model. Seven tubes are used in the superhet circuit and one in the self-contained power pack, the line-up being first detector and separate electron-coupled h.f. oscillator, two 465-kc. i.f. stages, triode second detector, separate c.w. beat oscillator and pentode power

amplifier. The tuning is in four steps for the 540- to 20,000-ke. "Standard" range and in five for the "Marine" range. Coils of the self-contained assembly are selected by a four-pole gang-switch which has an extra section to short out completely all coils except those actually in circuit, thus preventing "dead-spotting."

tenna-trimmer control is provided for precise alignment of the signal input circuit over each amateur band.

Individual de-coupling of return and supply circuits is employed to insure circuit isolation, along with individual shielding in r.f. and i.f. circuits in addition to the shielding enclosure of

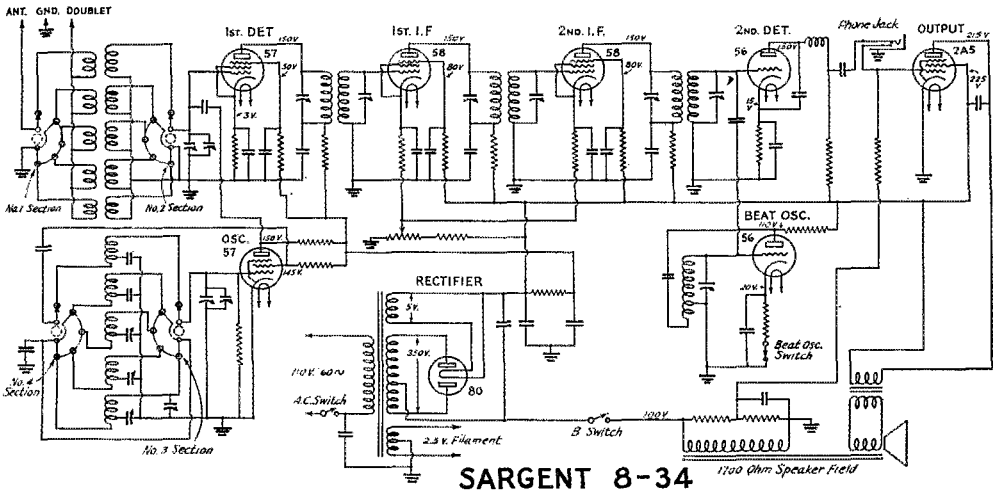

**SARGENT 8-34**

The main tuning dial operates the rotors of the double-gang tuning condenser while the band-spread dial swivels the stators through a small range by operation of a special mechanical link arrangement. Reduction drives are used for both main and band-spread tuning controls, each of which has its own calibration scale. The design is especially intended for amateur-band reception, although figures on the calibration spread and frequency tuning rate are not specified. An an-

the metal case. Speaker output is taken from the power stage by a separate dynamic speaker which is furnished with the a.c. operated models. Headset output is taken from the jack in the plate circuit of the second detector. Models for operation on 110- and 220-volt d.c. supply, as well as for 6-volt and 3-volt battery operation, are also available in corresponding circuit design, permanent-magnet type dynamics being used with the latter.

## The Silver 5C

**M**CMURDO Silver's 5C Single-Signal type receiver has 7 tubes exclusive of the rectifier in the power pack which is on the same chassis. The tuning system is of the coil-switching type with three tuning ranges covering continuously the frequencies between 1500 and 23,000 ke. Band-spread tuning is accomplished by an auxiliary 3-gang condenser on the main unit, the auxiliary coming into action when the main tuning knob is pulled outward. An auxiliary tuning scale indicator of the watch-type dial is also brought into action in the band-spread position of this knob. The calibration spread for the amateur bands is specified as 200 degrees for 1.75 mc., 100 degrees for 3.5 and 7 mc., and 50 degrees for 14 mc. The mechanical ratio of the driving mechanism being 9 to 1, the tuning rates are approximately 60 kc. per knob rotation on 1.75 mc., 200 kc. per knob rotation on 3.5 mc.,

120 kc. per knob rotation on 7 mc., and 320 kc. per knob rotation on 14 mc.

As shown in the diagram, a stage of tuned r.f. pre-selection precedes the frequency converter, which uses a 2A7 as combined h.f. oscillator and first detector. The variable band-width crystal filter unit couples the first detector output to the 465-ke. two-stage air-condenser tuned amplifier, the filter circuit being equipped with a switch to connect the crystal in series, in parallel, or off for straight superhet selectivity. The selectivity figure given is 26-ke. band-width at 10,000 times resonance input without the crystal, and 50-ke. effective band-width at an unspecified input ratio with the crystal. Diode detection, first-stage audio amplification and a.v.c. are accomplished in the 55 second detector, the audio output of which is resistance coupled to the 2A5 power stage. The c.w. beat oscillator is of the electron-

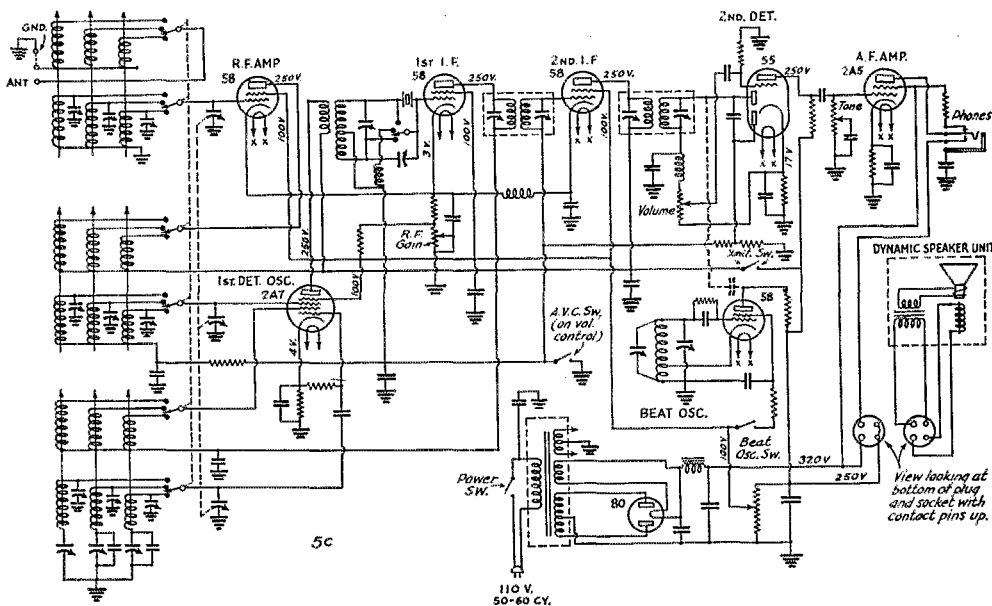

coupled type, capacity-coupled to the detector diode plate. Reduced headphone output is taken from the jack in the 2A5 plate circuit, the speaker being automatically disconnected when the phone plug is inserted.

Panel controls are provided for both audio volume and r.f. gain, operation of the audio control switching in the a.v.c. and the r.f. control

being used to govern output level when the a.v.c. is switched off. Other panel controls include selectivity (on the crystal filter), send-receive switch for disabling the set during transmission, band-change (on the coil switch), tone, primary power and c.w. beat oscillator switches. A matching Jensen dynamic speaker unit is furnished with the receiver.

## About Band-Spread

**B**ACK in the "good old days," when signals were broad and receiver selectivity was inversely proportional, we got into the habit of describing such band-spreading as our tuning systems had simply in terms of how much dial space an amateur band occupied—"spreads the 80-meter band over 60 degrees," or "40 takes up half the dial," became typical forms of description. But do specifications such as these really give a sufficient description of a modern receiver's band-spread? Do they tell us anything at all about how critical a highly selective Single-Signal receiver may be in tuning adjustment? Our experience tells us that the answer to both questions is, "No."

As a matter of fact, simple specification of dial space per band is only a description of *calibration spread*. To get the whole story we must know also how fast we cover the kilocycles with motion of the tuning knob, for it is on the latter that the criticalness of tuning depends. What's the use of having a dial calibration readable to a kilocycle when the manual adjustment is so coarse as

to require three or four swings back and forth to put the tuning hit-or-miss on the peak of a signal? We also must have an idea of the *manual tuning rate*.

Therefore, in describing the band-spreading of amateur receivers it is suggested that the *calibration spread* be given for each amateur band in terms of the average number of kilocycles (or cycles) per dial division; and that the *tuning rate* for each band be given in terms of the average number of kilocycles per tuning knob rotation.

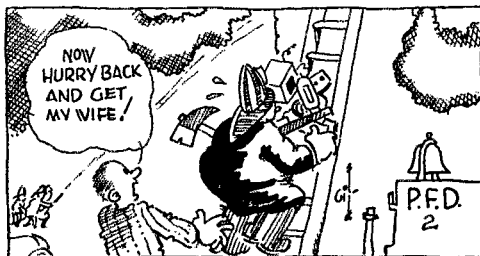

# The V-Doublet Noise-Reducing Receiving Antenna

By H. A. Crossland\*

**R**ESULTS of many experiments and calculations in developing antenna systems for trans-oceanic and trans-continental communication show that the doublet antenna with

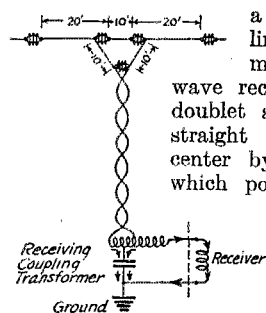

FIG. 1

runs to the receiver. Properly designed, this type of doublet gives ideal efficiency at a frequency determined by its length, but not for a continuous range of frequencies covered by the short-wave bands.

The newly designed "V-doublet" antenna system illustrated in Fig. 1 differs from the elementary doublet which tends to favor certain frequencies and reject others. The antenna is coupled to the low-impedance transmission line by the converging "V." This makes the doublet respond uniformly to a wider range of short-wave signals, and at the same time matches the doublet more properly to the transmission line so that the signal transfer is more uniform over a relatively wide frequency range. The explanation is simple. At the top of the V, where the spacing is wide, the characteristic impedance is high and comparable to that of the doublet; at the bottom where the wires are close together, it is lowered to match the low impedance of the transmission line.

One of the most valuable features of such a system is its ability to exclude interference from outside sources when the doublet is erected out of the field of interference. Fig. 2 illustrates how the signal voltage is induced when a radio wave sweeps across a conductor. In the same way interference radiation induces interference voltage in any conductor within its field. The balanced transmission line of the "V-doublet" pre-

a proper transmission line fills most requirements for efficient short-wave reception. The ordinary doublet antenna consists of a straight wire divided at the center by an insulator, from which point a two-conductor, transposed or twisted transmission line

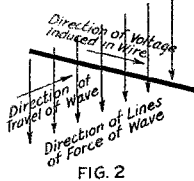

FIG. 2

vents such interference from reaching the receiver, as shown in Fig. 3. Since the direction of travel in each conductor is the same, these voltages are in-phase; while the signal currents conducted from the doublet, having opposite directions in each wire, are out-of-phase. Fig. 4, showing the system with the transmission line terminated in a coil, illustrates how a transposed lead-in can conduct a signal from the doublet to the receiver through interference. Arrows drawn on the line represent the signal, while arrows drawn alongside represent induced interference. The interference currents on the line are in opposition through the coil and the receiver is not affected. The signal current, however, flows through the coil. If it is properly coupled to the

receiver it will reproduce the signal in the loudspeaker.

The receiver-coupling transformer circuit is also illustrated in Fig. 1. The transformer is a balanced-primary auto-transformer which matches the transmission

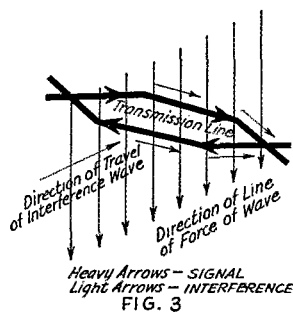

FIG. 3

line to the antenna coil of the receiver and permits in-phase interference to flow to ground through the condenser.

The small capacitance of this condenser makes it relatively ineffective at broadcast frequencies. This permits the system to operate automatically as a conventional "T" antenna system on broadcast signals and as a "V-doublet" on short waves.

The design of the V-doublet antenna lends itself readily to various methods of suspension and is simple to install. Only two points of support are required. Ordinarily the antenna will be erected on the roof of a building or suspended between the roof and nearby tree or pole. If it is inconvenient to erect masts, the doublet can be suspended between two chimneys, or from the eaves

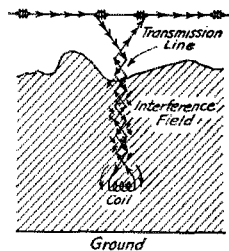

FIG. 4

\* General Electric Co., Bridgeport, Conn.

(Continued on page 110)

# Progress in Ultra-High-Frequency Gear

Some Details of the New Equipment at W1HBD

By Ross A. Hull\*

**G**ATHERING terrific momentum in the last month or so, ultra-high-frequency activity is certainly destined to hit an all-time peak this summer. Flocks of new stations are springing up all over the country, many of them equipped with directive arrays, many of them on frequencies higher than 60 mc., and most of them bent on breaking all existing records.

Hoping to keep up with the parade and plan-

quarters men who run off daily and nightly schedules with Boston stations and simultaneously cook up as much new and improved gear as time permits. The prime purpose of the station is to obtain a continuous record of variations in signal strength over the Boston-Hartford path and for this purpose one directive antenna and the receiver operating a photographic recorder<sup>1</sup> are left intact. With this equipment, hourly recordings of tone signals from W1XW are made throughout the day and night. The remaining gear is used for communication purposes and is torn down and rebuilt often enough to exploit every dizzy idea available.

## A NEW SUPER-REGEN. RECEIVER

The pet gadget at the station is now a receiver employing the new 954 pentode acorn as an r.f. amplifier. The receiver is illustrated on these pages. It is the outcome of experiments with a great many different circuits for both the amplifier and the detector and represents at least one satisfactory method of using the new tube. The receiver is by way of being a rather precision piece of equipment, requiring extreme care in its construction and adjustment. It is by far the most effective receiver ever used at the station, how-

<sup>1</sup>"A Simple Photographic Recorder for the Experimenter," *QST*, March, 1935.

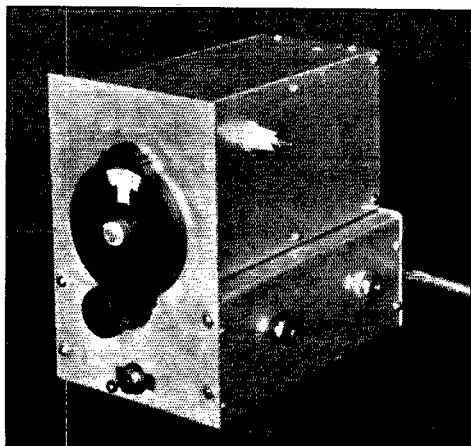

A RECEIVER WHICH PROVIDES GOOD R.F. GAIN ON THE ULTRA-HIGH FREQUENCIES: A GENERAL VIEW OF THE PENTODE ACORN RIG

*Representing a tasty problem for the skilled set builder, this receiver is capable of a high order of performance. The new r.f. amplifier acorn plays the major rôle.*

ning to take full advantage of the summer's work, the gang at W1HBD has done a thorough job of spring cleaning the station. Details of the new equipment probably will be of interest to others planning a similar revision of their gear. W1HBD is, as we have already explained, the new and revamped version of W1AL—the station from which the first Hartford-Boston ultra-high-frequency work was done last year. It is now operated by L. M. Webb and a group of Head-

\* Associate Editor, *QST*.

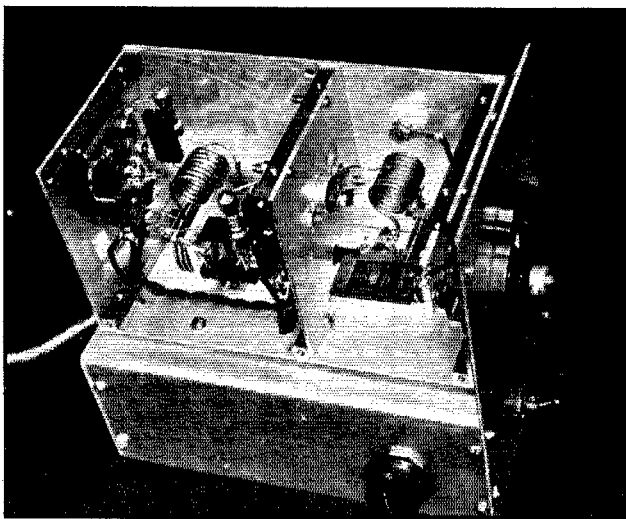

A SIDE VIEW OF THE NEW RECEIVER SHOWING THE ARRANGEMENT INSIDE THE SHIELD BOX



## THE TUBE END OF THE "ORGAN-PIPE" TRANSMITTER

Since this photograph was taken, the grid line has been mounted lower and on the edge of the table in order to permit a reduction in the length of the grid leads. Short tabs of thin copper are used between the plate pipes and the plate terminals to allow a flexible junction.

ever (they include super-regenerators with and without r.f. amplifiers and several superhets).

The receiver was built in two sections—the upper box, containing the r.f. amplifier and detector, being built and adjusted first, the audio stage in the lower section being added later. The top portion consists of an aluminum box divided into two compartments. The 954 is mounted in the detector compartment with the grid end of the tube projecting through the partition. A short piece of tubing squeezed into the hole in the partition serves to improve the shielding at this point. Cardwell Trim-Air condensers are mounted in each compartment and inter-connected with flexible coupling. The coils are mounted directly on the condensers. All r.f. by-pass condensers are returned to a single point on the partition alongside the 954 amplifier tube.

A great deal of careful modification and adjustment was necessary before the 954 provided gain without oscillation. Added difficulties were introduced by the use of a single control for tuning. It is obvious that the adjustment problem could be simplified by the use of two separate tuning controls. The most important adjustments are in the location of the grid and plate taps for the 954 and in lining up the two coils so that satisfactory tracking is obtained. The adjustable antenna condenser is an invaluable aid in this tracking adjustment.

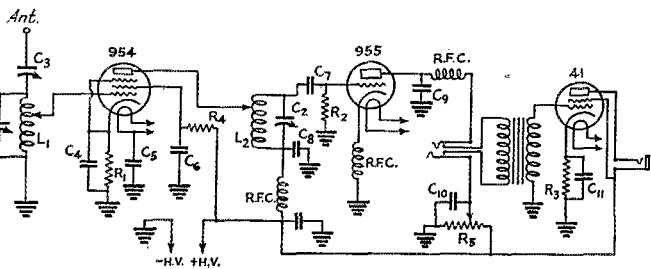
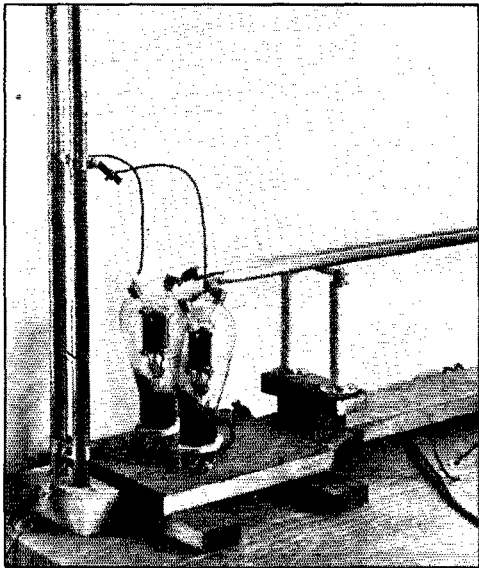

FIG. 1—THE CIRCUIT OF THE NEW RECEIVER

C<sub>1</sub>, C<sub>2</sub>—15- $\mu$ fd. Cardwell Trim-Air condensers. These cover an unnecessarily wide frequency band. Some workers will prefer to remove one or even two of the three rotor plates.

C<sub>3</sub>—35- $\mu$ fd. leaf type trimmer condenser.

C<sub>4</sub>, 5, 6—250- $\mu$ fd. fixed midget condensers.

C<sub>7</sub>—100- $\mu$ fd. fixed midget.

C<sub>8</sub>—250- $\mu$ fd. fixed midget.

C<sub>9</sub>—0.01- $\mu$ fd. fixed midget.

C<sub>10</sub>—5- $\mu$ fd. fixed condenser.

C<sub>11</sub>—2- $\mu$ fd. low voltage electrolytic condenser.

C<sub>12</sub>—0.01- $\mu$ fd. fixed midget (number not marked on diagram).

R<sub>1</sub>—1500-ohm half-watt resistor.

R<sub>2</sub>—1-megohm half-watt resistor.

R<sub>3</sub>—600-ohm 1-watt resistor.

R<sub>4</sub>—100,000-ohm half-watt resistor.

R<sub>5</sub>—100,000 ohm potentiometer.

L<sub>1</sub>, L<sub>2</sub>—Eight turns of No. 14 bare wire  $\frac{1}{2}$ -inch inside diameter. The location of the taps can be determined only by experiment. In the original receiver the grid tap is two turns from the end, the plate tap one turn. Experimental coils for the 112-mc. band had three  $\frac{1}{2}$ -inch diameter turns. In this case the taps were adjusted to within a fraction of a turn.

R.F.C.—25 turns of No. 28 d.s.c. wire on  $\frac{1}{4}$ -inch diameter bakelite rod.

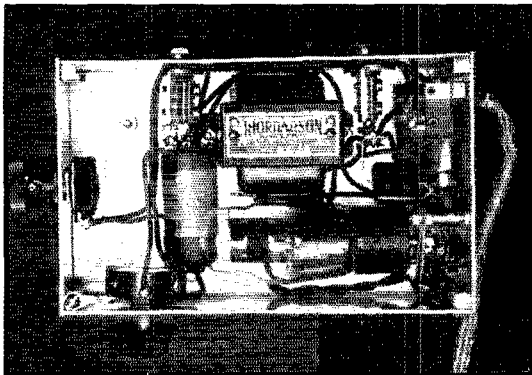

THE UNDER SIDE OF THE PENTODE-ACORN RECEIVER

The audio equipment is tossed in helter-skelter, providing just enough room for the detector voltage control and the output jacks. The location of the potentiometer has proved to be more convenient in actual operation than the conventional one.

Altogether, the receiver is not the type of thing which should be attempted by a worker unfamiliar with the idiosyncrasies of super-regenerative detectors and r.f. amplifiers: It is the sort of equipment which can only be made

to operate satisfactorily by hours of patient and very precise adjustment work.

The behavior of the receiver is a little different from what one would ordinarily expect. It would appear that the "a.v.c. action" of the normal super-regenerative detector somewhat masks the

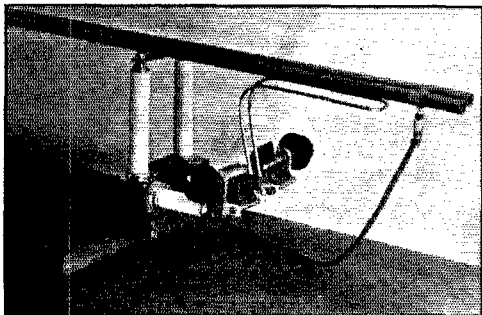

**THE OUTPUT END OF THE 56-MC. TRANSMITTER**

The "hairpin" antenna coupling loop has been found a little more convenient to adjust than the sliding contacts shown in Fig. 2.

gain obtained in the r.f. stage. Many hours of comparison between this receiver and straight super-regenerators have indicated that, while a signal may not be very much louder with the new outfit, the carrier is very much stronger and, as a result, noise suppression is very much more effective. Furthermore, the receiver shows considerable selectivity and has permitted satisfac-

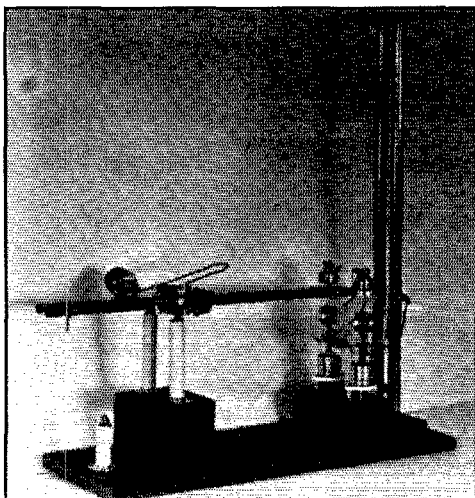

**THE NEW 112-MC. TRANSMITTER AT WIHBD**

Built around a pair of Eimac 50T tubes, this transmitter is similar to the 56-mc. rig except for the use of a choke in each filament lead. The choke consists of ten half-inch diameter turns of No. 14 wire. They are dropped down from the filament terminals alongside the block on which the tubes are mounted. This transmitter is sometimes run with 250 watts input but the tubes don't even blush.

tory communication with stations having signals quite unreadable on the best of our other receivers. It is very obvious that the 954 will play an important part in advanced ultra-high-frequency stations of the immediate future.

**THE NEW TRANSMITTERS**

Since February, the transmitters at WIHBD have been rather thoroughly revamped to include not only the resonant short-line grid circuit but also a linear plate circuit. The result has been a splendid improvement in efficiency and also some slight additional improvement in stability.

The five-meter transmitter now employs the circuit shown in Fig. 2. The modifications include the removal of the filament chokes previously used and the displacement of the coil-condenser plate circuit. The mechanical arrangement is shown in the remaining photographs. From these it will be seen that inductive coupling is used for

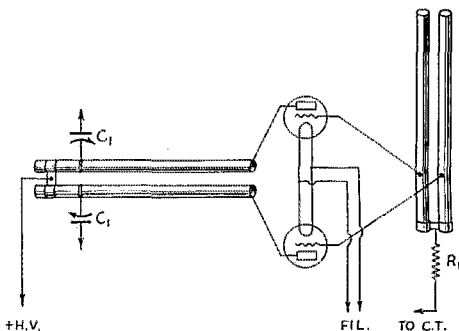

**FIG. 2—THE CIRCUIT USED IN WIHBD'S 56-MC. TRANSMITTER**

$C_1$  indicates the 35- $\mu$ fd. feeder tuning condensers now used in conjunction with the inductive coupling rig shown in the photographs.

$R_1$  is of the order of 15,000 ohms for 800 tubes.

The grid pipes are of  $\frac{3}{4}$ -inch diameter copper tubing, the plate pipes of  $\frac{1}{2}$ -inch tubing.

Needless to say, the grid and plate leads to the pipes are much shorter than this diagram would suggest.

the antenna circuit instead of the arrangement shown in Fig. 2. Experiment with both methods has indicated no particular difference in performance. The inductive scheme proved to be slightly more convenient in adjustment, however.

The 2 $\frac{1}{2}$ -meter transmitter is almost exactly similar except that in this instance the use of a choke in each filament lead was found to be advisable. The new transmitter employs a pair of Eimac 50T tubes. These bottles have been given a terrific beating in daily schedules with W1XW and have shown themselves to be highly suited for the work.

The general procedure followed in tuning up these transmitters is first to adjust the bridge on the grid line so that the distance from the bridge to the open end of the line is exactly one-quarter wavelength at the frequency to be used. The grids

(Continued on page 106)

# DX-Contest Highlights

## Early Reports Indicate Record-Breaking Scores—Over 90 Countries Participated

WHERE were you the morning VS6AH came through on 14 mc.?" "Did you hear PK3ST and OM2RX?" Just typical of questions on the East Coast. The West Coast report Europeans rolling in as never before on both 7 and 14 mc. What DX! What a contest! Scores? All previous records smashed to smithereens—scores before rolled up with limitless time were cracked wide open by operators who carefully picked their times and operated 90 hours or less. Would it be worth while to gamble some precious operating hours to get that extra bonus? After hitting 90 hours to quit or keep going? Harder to work new stations now. What to do? More genuine pleasure was expressed over this contest than any before. We are safe in saying a "swell time was had by all." Mighty few stations worked foreign amateurs on more than three bands. The 3.5 mc. band proved popular for both U. S. coasts. ON4AU, always an outstanding station, heaped more laurels on his station by sending numbers to U. S. on five bands. Ten meters opened up one day long enough to allow W9TJ to pull through ON4AU's number. W9TJ was also the U. S. station to give X1AY his extra credit for 28-mc. work. W1BB contacted foreign stations on 1.7, 3.5, 7, and 14 mc.

As this is being written over 700 reports have been received, which include a few foreign scores. If early reports and remarks provide a correct forecast, the 1935 DX Contest stands out as being the greatest party ever staged in international amateur radio history. Over 90 foreign countries were represented—and 70 of these countries were heard in Hartford, Conn., U. S. A., long famed as the "worst radio location in the world."

The outstanding score to date was run up by W3SI who contacted 234 stations in 55 countries for a score of 36,650 made on 3 bands which is an all time record in DX contests. Outstanding is the station score of W6GRL which is approximately 35,000, made by contact with 50 countries. The West Coast was also favored with several

other scores over 20,000, according to rumors, but scores haven't been received as yet. W2BHZ made 36,600 points. W1SZ scored over 35,000 by contacting 54 countries. Checking scores will take a long time and it will be months before final figures can be presented. So, we must be content with the highlights as we see them at the moment.

X1AY, B. J. Kroger, has the highest foreign score ever made in a DX contest. He contacted 777 stations in 77 hours and 37 stations gave him a number prefixed by 777! The final score of X1AY was 34,326. Says Kroger, "This has been my first experience with modern DX contests as my last participation was as 3APV in the Transatlantics of 1922 when I won 5th prize. There is certainly some difference between then and now." High power? 60 watts to a pair of 10's in p.s.!

CT2BK, popular mid-Atlantic station operated by H. E. J. Smith, put up a beam antenna and had it going a week before the contest to give the West Coast a thrill. Says Smith in part, "With 10 p.m. as Zero Hour on March 8th, here we are, all set for the first and last contest in which this station will participate. The receiver, an incredibly old National SW45, rejuvenated with band-spread coils and doublet antenna is cranked up on the 7-mc. band. Comes 9:50 and the Great Hush descends on the

band, everybody listening, everybody waiting. Right on the dot of 10 p.m. we bang away. Contact! Nrs exchanged and we are off to a flying start. The low frequency end of the 7-mc. band is now a madhouse. Everyone crowding to 7000.1 kc. and closer. 'Hr my nr' 'Hr ur nr'."

ON4AU sent in a radiogram saying that he had contacted all W/VE stations on five bands for a score of over 23,500, which is the highest continental score we have received. Loudly cursed was the W/VE station who called CQ or Test during the contest. 90% of the participants who have any comment to make voice the most vitriolic language against this animal. The amazing part to us seems to be that the cards are

### Reported Scores

Below are listed station scores as reported to us. They have not been checked in any manner and do not indicate final results. It will be several months before the winners are announced.

W1 CMX, 16,224; CUN, 10,224; FH, 28,659; BUX, 16,408; TS, 13,844; RY, 10,036; SZ, 35,588.  
W2 BHZ, 36,650; BSR, 12,578; UK, 31,646; FHL, 12,666; DC, 11,075; HHG, 10,834; CBO, 14,546; GOX, 13,456; GIZ, 10,773; GJK, 18,335; ETM, 14,420; OA, 12,856; GW, 10,450; BWF, 17,881.  
W3 OZ, 13,886; AG, 11,630; CDO, 15,592; EVW, 13,635; BES, 13,430; SI, 40,500.  
W4 CBY, 20,229; AH, 14,986; FT, 20,035.  
W5 EBT, 11,360; JC, 11,500.  
W6 GRL, 35,000; CXW, 25,000; GRX, 16,732.  
W7 BB, 16,940  
W8 DWV, 11,619; CNZ, 22,164; BCT, 10,213; HWE, 10,348; ZY, 20,000.  
W9 TB, 26,530; II, 28,324; ELL, 12,350; PLM, 12,136; PV, 10,016; AEH, 18,880; IU, 16,686; MV, 12,328; IH, 10,102.  
VE 2AX, 15,406.  
X1AX, 20,408; X1AY, 34,326; X1AA, 20,707; X1AM, 15,868; ON4AU, 24,000; CT2BK, 16,170; K6HLP, 21,028; OA4J, 10,108.

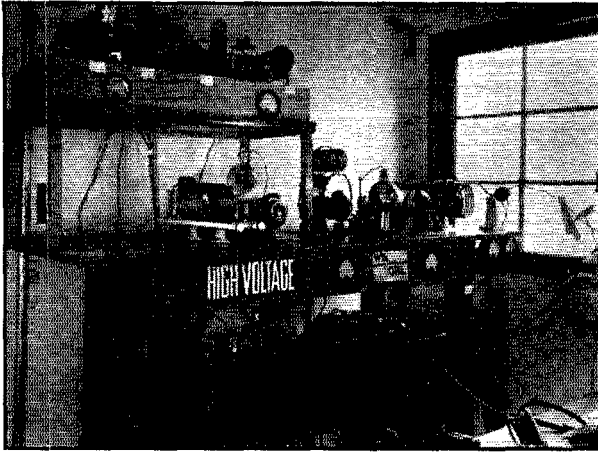

W6GRL, VENTURA, CALIF.

Doctor Stuart's station located right on the shore broke previous West Coast scores by a healthy margin. A pair of 852's in the final with 1-kw. input.

certainly stacked against the W/VE station who does try to attract a foreign station in a DX contest by a CQ. Any foreign station merely calls a CQ himself and picks his reply—why should he take a chance of a contact by answering a W/VE CQ? The scores will certainly bear out the supposition that the only way for W/VE to work DX in a DX contest is by calling specific stations.

We note with interest that the lower the score of the participant the more enthusiasm the individual generates regarding the contest. High scoring stations, almost without exception have not even a word to say about the contest. Perhaps the compilation of several hundred 6-serial numbers for the report robs the contest of any enjoyment that might have been derived.

#### COMMENTS

"Greatest disappointment of the contest was snagging K6KNJ two minutes before the contest ended only to find out he was a portable station operating in Conn. This was followed closely upon learning that W9IJ had scored over 28,000 points."—W9MV. K7ZZK seemed to be active again this year—hope he was in Alaska and not California! VE2AX rolled up the greatest score by several thousand that VE has ever boasted.

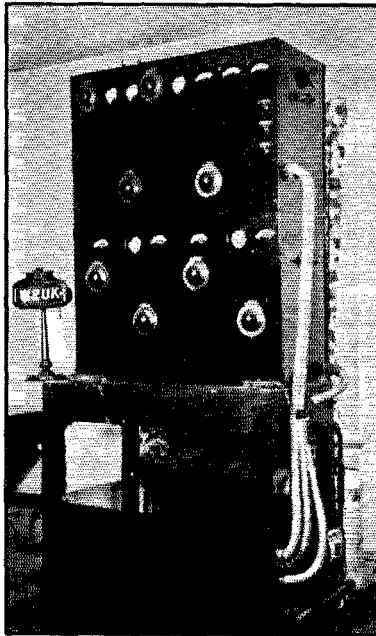

A KILOWATT INPUT AT W2UK  
 Ralph Thomas rolled up a score of 31,646 points with one operator and less than 90 hours.

HC1FG (YL op) seemed to be the most popular station, always R9—day and night, any part of U. S. A. X2C follows closely in popularity. Neither of these stations has given any indication of their scores—which will be outstanding. "Conditions for the most part excellent . . . spent five bucks on juice calling PY1AW—and never did get him! And don't forget, we still had to pull teeth!"—W2ETM. Many dentists were active in the contest, among them was Doctor Stuart, W6GRL with 2 "V" beams, a kilowatt relief operator (W6QD) and station score of 35,000! Regardless of the location every operator seemed to think that a different section of the country was going to have an unfair advantage by the extra band bonus.

"Don't know which gave me the biggest kick—nailing ZC6FF, VS6AH or getting an R7 report from PK3BM."

—W1CUN. Outstanding in contest improvement seems to be early consensus of opinion on 90-hour plan. So far we have seen only two logs which admitted over 90 hours! One chap must have worked every station he called and ceased operation between calls—at that he operated 89½ hours! Another said he operated 79 hours, but the local Radio Club examined his log and said 140!

W3CDO made WAC twice in contest—as did W2DC. W1SZ WAC'd in the final 12 hours of the contest. "How the heck do they expect to get them by calling CQ?"—W1DUK. (Secounded by hundreds.)

Vandekamp (of NY1AB fame) accounted for the bulk of the score of W2HHG. "Van" admits that it's easier to knock 'em off from NY1AB! W4FT was on 14 mc. as well as 7 this year! W8CNZ reports an interesting experiment early in the tests. On several QSO's he cut his kw. input to 150 watts. Results: No change. Ah—saving in the power bill—at the end of the contest; power, 1 kw.! How that extra ¾ kw. helps the ham psychology. VK stations came through on the East Coast morning and evening on both 7 and 14 mc.

"The 90-hour time limit is the bunk—a man can kill himself trying to hold down a job and still get 90 hours in on the contest."—W9AEH.

FF8MQ was in Morocco—same country as CN8. W7BB hangs up a record score for W7. Two different mornings he worked 23 ZL-VK. A boon to those DX stations who used QLM, LM, L or any other indication of the part of band they were going to start tuning. Another to those who signed off and sent a simple “QRZ?” and stood by rather than another CQ. The only lengthy CQ’s heard in the tests were sent by W stations! The roughest notes were signing W and VE calls. And somebody said X2C shouldn’t have been allowed in the tests ‘cause stations calling him created all the QRM! W2DC took a well-earned rest this year and sent in a score having only 55 contacts—but they were in 55 different countries! Schenectady may have a small number of hams but QRM ran high. W2CBO reports 3 500-watt stations (one an over-modulated ‘phone) and a 250-watt station

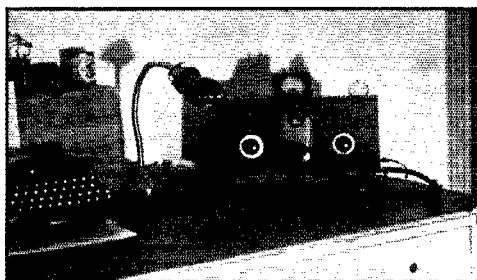

RECEIVING POSITION AT CT2BK  
See Beam Antenna article for further details.

stations use the RST system and for the initial three figures give a fellow’s report. Number 538449 received from DX station would mean you were RST 538 (killing two bird’s with the one rock) and the 449 would indicate the report the DX station received from his previous contact. W4BRG entitles his log, “The War With QRMania.” Stations report two ZS2A’s in the contest—one sending a serial number 111 and the one and only Reid at ZS2A was using 314. ZS2A came on his old frequency the first night to find CT2BK operating there—going was plenty hard—next time we heard ZS2A he was lower in frequency. W3CZO is looking forward to the next contest when he will be signing KA or K6 and then he’ll call CQ and listen to the boys scramble! SUIRO was initiated in his first DX contest.

W8AYD’s first QSO made him WAC! W2BJ looks forward to next year’s contest when he will be stationed at some lighthouse in the Atlantic with a flunkey to grind a generator for him. W8LVV suggests A.R.R.L. lobby for a national holiday during DX contests. W2BST called J2GX three days in a row without success—the fourth he put up a 20-meter half-wave vertical antenna and raised him first call.

“After sitting in a chair twiddlin’ knobs for ten days and nights, I went out yesterday to play tennis. This morning I’m so sore every movement is exquisitely painful! First tournament at Houston April 1st. I should take a portable with me.”—W5VV. “Called LU9DW and QSO’d. He didn’t offer me a number so just to show him I didn’t give him one. Guess he hadn’t heard of the contest and did not want to break the news so late in the contest!”—W9CGY. Charlie Myers, W3SI operated instead of Tom Hall, W3ZJ. All sorts of conjecturing seems to be rampant regarding the power used at HC1FG. “. . . willing to swap 23 QSO’s with Oceania for one in Asia.”—W2GSN. “Glad the contest is over—now I’ll be able to work DX again. Care not if I never sit down again—towards the end I had to stand while operating instead of sitting down!”—W1IBD. “If anyone gets a bonus why not a married man—especially one with children?”—VE2BU.

(Continued on page 122)

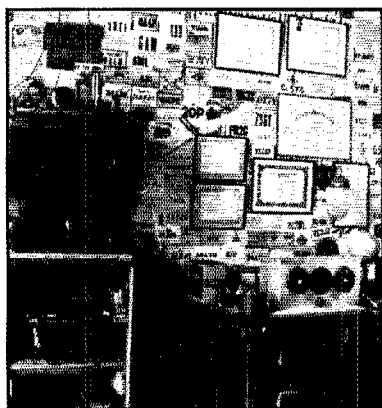

0A4J, OWNED BY WILLIAM GAREY WILSON,  
BARRANCO, PERU

within one block and all trying to work DX on the same band at the same time! . . . oh for the island QRA where automobiles are not allowed! Among single station countries were: FB8C; ON4CJJ; ZE1JB; ZC6FF; VP4JR; VP9R; VP7NB; NX2Z (authentic?); ZD2C; K4AAN and LY1J.

X1AY used two different typewriters and pen and ink in making out his score! Recollections of an old argument on the best number to use in a DX contest when 738 prefaced numbers used by W9PLM and W1SZ. W9ELL contacted 60% of stations heard and 90% of the countries. W1TS (after the contest) was asked “Do you want a kilowatt?” The answer came right back: “No, ten.”

“Will send in some comments when I get caught up on my fishing.”—W9IJ. “We don’t need a time limit—we need a power limit.”—W8DWV. CN8MP will be recalled as CN8YBQ of last contest. CM2OP active again—now 14 years old. W1DLD only operated 8 hours during the contest—doctor’s orders. (W1IQQ, the doctor, was also in the contest!) W8NP suggests that

# New Type Metal-Shell Receiving Tubes Announced for Summer Appearance

**A** NEW line of metal-shell radio receiving tubes which tests indicate to be of greater continued efficiency of operation than the glass-envelope types now in use, developed by General Electric and announced for appearance on the market within the next few months, are not only much smaller and more sturdy but also offer many improved electrical characteristics over the conventional tubes of today. They provide their own shielding, of course, and the metal shell is a better heat conductor and radiator than glass. They are especially advantageous in the field of short-wave reception, which makes them of particular interest to amateurs. The short leads of the tubes permit greater amplification at the higher frequencies and the more effective shielding insures greater stability.

These new tubes, having an entirely different pin arrangement, are not interchangeable with glass tubes in the present type radio receivers and will make their first appearance in the new fall line of General Electric sets.

## A NEW CONSTRUCTION

The metal tubes are cylindrical in form, some in reduced diameter at the top. Others, such as a radio-frequency amplifier, have a terminal at the top extremity. Each lead-in wire passes through a tiny bead of special glass that is fused securely within an alloy eyelet, which in turn is welded to the metal container, thus assuring a long-life vacuum. This alloy, having substantially the same coefficient of expansion as glass, is known as Fernico and is a combination of iron, nickel and cobalt. It was developed expressly for this purpose of a perfect seal on the new tubes.

The inner parts of the tube are first assembled on the steel end plate or header, and then the shell is placed over the assembly and welded to the header at its circumference. In the main, the new tubes are less than half the size of the familiar glass tubes of corresponding rating. The metal shells are, of course, much stronger than glass bulbs and not subject to breakage, while the use of short, stiff supports in the new tubes results in less mechanical vibration of the internal elements. Elimination of the glass "pinch seal," in which leads and supports are concentrated in the bottom of the present glass tubes, allows the leads to enter the header of the new tube at the proper

points for short, direct paths. Also, the new design permits a logical arrangement of base connections and supports between base pins and electrode structure.

The familiar metal shield which is necessary with the glass tube in radio-frequency portions of a circuit is no longer required with the new tube. The metal envelope itself serves as a shield. And, since closer proximity of shield to elements can be realized, the shielding is more effective.

Whereas in certain types of glass enclosed screen-grid tubes the anode is shielded first by an internal structure, next by a coating on the inside of the glass bulb, and finally, when in use, by an external "can," in the new metal tube all these functions are performed by the shell. A further favorable feature of the metal shell engineers believe, is that it aids residual gas cleanup, thus promoting continued efficiency of operation.

The new tubes have one more base pin than comparable glass tubes, since the metal envelope has become the shield, and provision must therefore be made to ground this envelope. In the base of the new tube, all the pins are of the

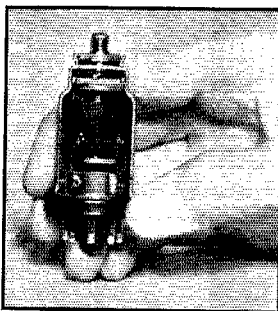

CUT-AWAY VIEW OF A PENTODE-TYPE R.F. AMPLIFIER SHOWING THE INTERNAL CONSTRUCTION

*A hack-saw is the instrument for such an operation.*

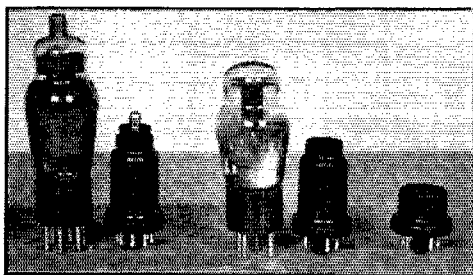

STANDARD METAL-SHELL TUBES COMPARED WITH EQUIVALENT GLASS TYPES

*They are, left to right, a screen-grid r.f. amplifier, a small triode and a duo-diode, the latter an entirely new basic type.*

same diameter, and in the center is a longer insulated keyed pin. By placing this insulated pin in a hole centrally located in the socket, and rotating the tube until the key slips into its groove, the tube is quickly and easily inserted.

The metal construction has been applied both to existing standard types having indirectly heated cathodes, and to newly developed basic types, including a duodiode, and a hexode pentagrid converter for superhets.

# Receiver Selectivity Characteristics

## What They Mean and How to Use Them

By James J. Lamb\*

IN THE practical comparison of receivers, whether for the purpose of proving to a brother ham the goodness of the home-made product or of choosing a manufactured model to grace our personal operating table, there is a family of terms that we bandy about with "the greatest of ease" and, to the uninitiated bystander, with what must seem like deep technical knowledge. Principal of these are "selectivity" and "sensitivity."

But how many of us really do know very much about these terms? Do we consider them as completely independent and separate attributes of a receiver, or as the closely related characteristics they really are? Do we have the complete mental picture of these two in proper relationship to those other members of the receiver characteristic family, "stability" and "fidelity"? And how many of us understand what they all have to do with "signal-noise ratio," "sharp tuning," and the rest of their first, second and third cousins? Well, let's line up some of the information that happens to be available and find out where we stand, taking selectivity as the subject of this article. A considerable portion of the data is from measurements made by a commercial communications laboratory on the original QST S.S. receiver<sup>1</sup> and reported by the author in the I.A.R.U. contribution to the study on receiver selectivity in the 3rd C.C.I.R. at Lisbon last Fall. Other sources that should be identified will be mentioned as we go along.

### SELECTIVITY IN GENERAL

Ideally, of course, a receiver would be responsive only to emissions within the communication band of the desired transmission, the communication band-width being the maximum frequency range occupied by the signal and varying widely with the type of transmission (c.w. telegraph slow speed, c.w. telegraph high speed, radio-telephone, etc.) and also being dependent on the frequency stability of the transmitter. Practically, in commercial and other services where individual channel assignments are wider than the normal communication band necessary for a particular type of transmission, the receiver may be responsive over a considerably wider frequency range and still avoid interference from emissions

of a neighboring frequency; but in services having band assignments with transmissions distributed at random throughout the band, as is the case in amateur service, *the highest receiver selectivity permitted by the fidelity requirements of the communication, and by transmitter and receiver stability, has been demonstrated as immediately desirable.*

While at first consideration the term selectivity might seem almost self-defining, actually being taken for granted as such by many of its users, we find on more thoroughly examining its various interpretations into practice that it is given what appear to be quite different meanings by different people. Not infrequently, for instance, it is taken to mean simply that signals pop in and out with a hair's-breadth movement of the tuning knob, the receiver attached thereto then being qualified as "very selective" because it is "sharp tuning"—when really it is just critical to tune and, more than likely, is not highly selective at all. In fact, some extremely selective receivers are not at all "sharp tuning" in this sense, because they are provided with plenty of step-down in the hand-to-kilocycle ratio for the very purpose of taking such criticalness out of the tuning business. No, there is more to judging the real selectivity of a receiver than this so-called "sharp tuning" test.

It is fundamental to each of the several established definitions of receiver selectivity that *the measure of this receiver characteristic is ability to choose a desired signal while rejecting all others.* Let's put down a couple of these official definitions so that we can keep this basic idea clearly before us. First and most familiarly known is the definition given in the 1933 Standardization Report of the I.R.E.<sup>2</sup> It reads as follows:

*"The selectivity of a radio receiver is the degree to which the radio receiver is capable of differentiating between the desired signal and signals of other carrier frequencies. This characteristic is not expressible by a single numerical value, but requires one or more graphs for its complete expression."*

And then there is the still later definition adopted for international use by the C.C.I.R. This definition, shorter than the I.R.E. version, is even more general in its nature. Recalling that the sub-committee which drafted it (and of which

<sup>2</sup> 1933 Report of the Standards Committee of the I.R.E. A limited number of copies are available from the secretary, Mr. Harold P. Westman, Institute of Radio Engineers, 330 West 42nd Street, New York City, the price being \$1.00 per copy to non-members. This book describes the recommended tests for receivers.

\* Technical Editor, QST.

<sup>1</sup> Described in QST for August and September, 1932. These issues are now out of print. A receiver modeled after the original is described by W9ERU elsewhere in this issue.

I happened to be a member) represented the engineering opinion of at least four countries, this broadness is understandable. It had to be that way to fit the diverse ideas of everyone concerned—and, at the same time, to make good French. Here is the official English translation:

*“Selectivity is the capacity of a receiver to receive a given signal, excluding signals of other frequencies.”*

Comparing the two definitions, it is seen that they are generally similar. But the I.R.E. version specifies differentiating between the desired signal and signals of other carrier frequencies, and the word “degree” implies some evaluation of this capability; while the C.C.I.R. version makes no specification of whether the “signals of other frequencies” should or should not have carriers, and makes no suggestion of how the selectivity should be evaluated. These omissions in the international definition were not the result of over-

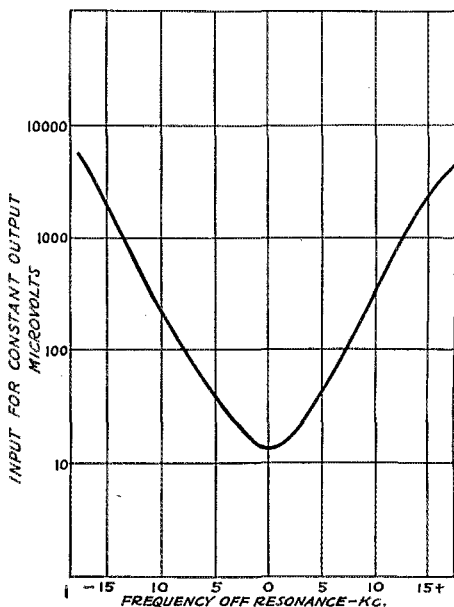

FIG. 1—ILLUSTRATING THE TYPE OF SELECTIVITY CURVE IN WHICH ACTUAL MICROVOLT INPUT FOR CONSTANT STANDARD OUTPUT IS PLOTTED AGAINST FREQUENCY FROM RESONANCE

This curve is for the 525-kc. i.f. amplifier of the 1932 QST Single-Signal superhet without the crystal filter.

sight, however. They were reached after due consideration, the idea being that “signals of other frequencies” might be communication signals without carriers (single-side-band with the carrier suppressed, for instance) or even static and so-called electrical interference. Hence this definition puts selectivity on the basis of choosing the desired signal and rejecting everything else, including noise. The failure to include suggestion of an

evaluation of the selectivity resulted from a consensus of opinion to the effect that, since no generally acceptable method of evaluation had yet been evolved, and since it was no business of a definition to set standards anyway, no such sug-

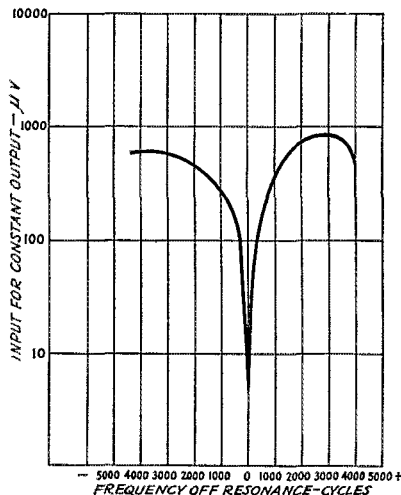

FIG. 2—ANOTHER EXAMPLE OF THE ACTUAL MICROVOLT INPUT TYPE CURVE, THIS BEING FOR THE 525-KC. I.F. 1932 S.S. SUPERHET WITH OPTIMUM (MEDIUM) CRYSTAL FILTER SELECTIVITY

Note that the resonance value of input voltage differs from that of the “straight i.f.” selectivity curve shown in Fig. 1, making the curves difficult to compare by inspection.

gestion belonged in the definition. *Voilà.* The French are great on logic.

But we must have some way to compare the selectivity of different receivers without having to collect a bunch of samples and try them out simultaneously under the same receiving conditions. That might be more to the practical amateur's taste, but hardly feasible for choosing among different types of receivers scattered about the country in Chicago, New York, Los Angeles, Philadelphia, Oakland and Boston. For practical remote comparison we must resort to information in the form of numerical quotations or plotted curves supplied by the producers of the receivers—and hope that they represent measurements made with uniformly standard equipment and methods under sufficiently like conditions to give the data useful meaning.

While test methods and equipment are quite uniformly standardized for broadcast receivers, in this country at least, this has not been so for amateur-type receivers. One reason for this lack in our particular field is that our receivers, with their higher selectivity and higher-frequency tuning range, could not be checked satisfactorily by the usual standard signal generators which were designed primarily for testing less selective



broadcast-band receivers. In addition to this, during the era of regenerative receivers that preceded the present general use of superhets, there wasn't much use of making selectivity measurements because of the unstable nature of the regenerative types and the uncertainty of measurement conditions being duplicated in practical operation. The receivers wouldn't stay put in characteristics long enough to make a selectivity run—and even if they did, the information wouldn't mean much to the user. Suitable signal generators and measurement methods are now being adopted for our much less erratic superhets, however, and more information on their selectivity characteristics will become available. Since too few of us have at hand the necessary laboratory equipment, detailed description of the test methods<sup>3</sup> is not warranted in this article; but we ought to be able to form an opinion of the selectivity of a receiver when we see its graphs and figures.

#### SELECTIVITY CURVES AND FIGURES

The selectivity characteristics of a receiver, whether given in the form of plotted curves or numerically in terms of band-width, are based on signal input voltage required for constant receiver audio-frequency output. The signal frequency range over which the measurements are made at suitable frequency intervals is wide enough so that input voltage ratios of around 1000 to 1 or higher are utilized. When the information is compiled in the form of curves, the usual convention is to plot either actual values or ratios of signal input voltages on a logarithmic ordinate (vertical) scale against frequency off resonance on a linear abscissa (horizontal) scale. In the first-mentioned type the voltages are in actual microvolt (millionth-volt) r.m.s. values for a chosen standard power output. (The I.R.E. recommendation is that this standard be 6 milliwatts for telephone receiver output and 50 milliwatts for loud-speaker output, measured by a meter in a resistance load circuit of value equal to the headset or speaker impedance.)

A curve of the actual microvolt input type is shown in Fig. 1, representing the "straight" i.f. selectivity of the original QST S.S. superhet of

1932, with its home-made air-tuned transformers not perfectly aligned. It should be mentioned, incidentally, that actual selectivity characteristics for the run of receivers are likely to be more or less unbalanced rather than of the beautiful symmetry we find in published literature. The

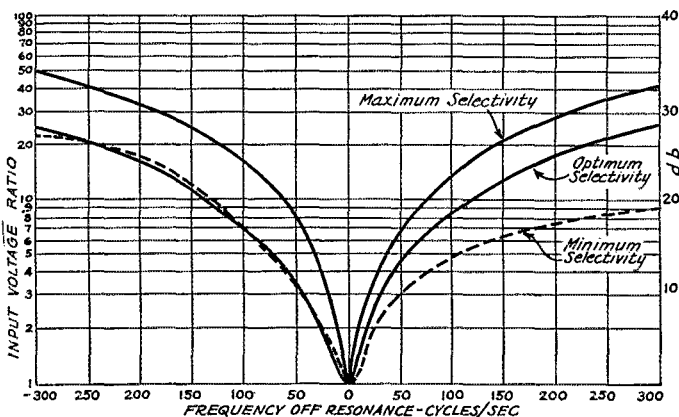

FIG. 3—INPUT VOLTAGE RATIO TYPE CURVES ARE PREFERABLE TO THE ACTUAL MICROVOLT INPUT TYPE FOR COMPARISON PURPOSES

These curves, on an expanded scale for frequencies near resonance, show the variable selectivity obtained with the filter of the 1932 S.S. superhet.

"models" obtained under laboratory conditions (and, perhaps, doctored a bit) simply do not result with ordinary test-bench alignment procedure. Note that this curve is plotted for i.f. amplifier microvolts input *vs.* frequency from resonance in kilocycles. Fig. 2, of the same type, is for the i.f. amplifier with the crystal filter in and adjusted for medium or "optimum" selectivity. Note that its frequency scale is in cycles instead of kilocycles, better to suit the higher order of selectivity.

Now these actual microvolt *vs.* frequency curves have one practical advantage and several disadvantages. The advantage is that they give an idea of the sensitivity while showing selectivity, since the signal input at resonance is indicative of the microvolts required for standard power output—which is the way of describing sensitivity. The sensitivity values of the i.f. amplifier alone, for the two degrees of selectivity shown, are 10.5  $\mu\text{v}$ . for Fig. 1 and 3.5  $\mu\text{v}$ . for Fig. 2—the sensitivity being somewhat higher with the crystal in, as was noted in the 1932 articles describing this receiver and accounted for by an individual peculiarity of this particular set. But for selectivity comparison by inspection, curves of this actual microvolt type are not so convenient. Curves for different receivers or for the same receiver under different conditions, unless they happen to start with resonance at the same value of input voltage on the logarithmic ordinate scale, are difficult to compare. Nor is a single curve so

<sup>3</sup> A simplified selectivity test method that is useful to a limited extent and requires only ordinary equipment was described in the article, "What's Wrong With Our Receivers?", QST for June, 1932. This is the article that introduced the idea of single-signal reception.

readily useful for estimating response to an interfering signal of given relative strength. For these reasons curves of the type shown in Figs. 3, 4 and 5 are to be preferred, the voltage ordinate figures being for ratio of input off resonance to input at resonance for constant standard output. Fig. 3 happens to be an interesting illustration of varia-

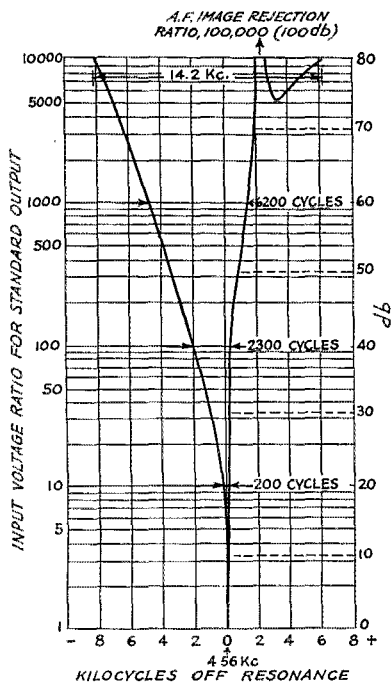

FIG. 4—I.F. SELECTIVITY CURVE FOR A WIDE RANGE OF INPUT VOLTAGE RATIOS WITH BAND WIDTHS INDICATED AT 10, 100, 1000 AND 10,000 TIMES RESONANCE INPUT

The db values corresponding to the input voltage ratios are given on the scale at the right. This curve is for the i.f. amplifier of the HRO receiver at maximum crystal selectivity (minimum band width).

tion in sharpness of resonance of the crystal filter circuit of the 1932 S.S. superhet with operation of the selectivity control, an extremely expanded frequency scale being used. In the range of these curves the signal generator frequency was varied in steps of only 50 cycles. Figs. 4 and 5, representing maximum and minimum crystal filter selectivity from data on a National HRO receiver, illustrate the progress that has been made in the development of crystals and variable band-width filter circuits in the three years since the S.S. receiver represented by the curves of Figs. 2 and 3 was something new.<sup>4</sup>

In addition to variable sharpness of resonance, these curves also show a peculiarity not ordinarily

<sup>4</sup> Improved filter arrangements were described in the article, "Developments in Crystal Filters for S.S. Superhets," QST, November, 1933.

associated with selectivity in that they illustrate the property of anti-selectivity or rejection for a particular frequency, a feature of the S.S. filter circuit provided by the variable phasing control. Since the rejection frequency can be shifted over the range either side of resonance, an almost infinite variety of configurations of different symmetry would be possible. Thus a complete set of characteristic curves describing the selectivity of such a receiver would hardly be feasible. However, a few curves for typical conditions give us what we need for practical purposes. From the curve of Fig. 4, for instance, we learn that a signal 2 kc. above resonance (which would be the audio-frequency image in c.w. reception with the beat oscillator tuned 1 kc. above resonance) would have to have 100,000 times the field strength of the signal on tune in order to give output equal to the desired signal. We see also that a signal of

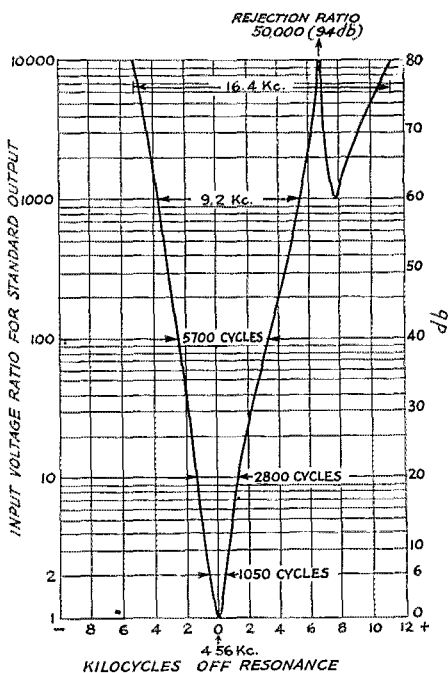

FIG. 5—MINIMUM CRYSTAL SELECTIVITY (MAXIMUM BAND-WIDTH) CURVE FOR THE SAME I.F. FILTER

By comparison with Fig. 4, a band-width range of 14 to 1 at 10 times input is shown. The 94 db notch in the curve at 6.5 kc. above resonance results from setting of the filter's variable phasing control to reject an interfering signal at this particular frequency.

strength equal to the desired signal and 2 kc. below resonance would be "down" 100 times; that is, referring to the db scale on the right, would be attenuated 40 db. From Fig. 5, which represents the greater band-width more suitable for 'phone reception, it appears that an interfering carrier

slightly more than 6 kc. above resonance would be dropped 94 db, while the 1400-cycle sidebands of a 'phone on tune would be reduced to one-tenth and 2500-cycle sidebands to one-hundredth.

As is also indicated in Figs. 4 and 5, selectivity can be described to a useful extent simply in terms of frequency figures for the total width of the selectivity curve at several values of input signal ratio. A single band-width figure might be given for the voltage ratio 1000. But it is preferable, especially for highly selective receivers, also to give band-width values for ratios of 100, 10 and, if possible, for 2 and 10,000. While these figures alone may not give a true picture of the selectivity curve, and certainly will not in the case of an unsymmetrical type such as that shown in Fig. 4, they are of far more value than such limited specifications as "10-kc. selectivity," or "50-cycle selectivity," given without mention of the input voltage ratio with which they should be identified. The input voltage ratio always should be given with the band-width figure.

#### SELECTIVITY WITH CROSS MODULATION—IMAGE RESPONSE

One factor that has not been included in the foregoing discussion is that of cross modulation by an interfering signal causing a reduction in the selectivity shown by the usual curves. Such cross modulation is possible in any vacuum-tube circuit, but with a superhet is most likely to occur in the first detector, particularly when its tuned circuit is coupled to the antenna without benefit of preselection. It is unlikely in earlier stages using variable- $\mu$  tubes.<sup>5</sup> When it does occur, the selectivity of the subsequent i.f. circuits will no longer be as effective as it would appear to be from the normal selectivity curves. C.C.I.R. data show that this effect may become really serious when the interfering signal is of sufficient strength so that at resonance it would put 0.1 volt on the grid of the first detector. The effective cross modulation is independent of the input voltage value of the desired signal, but is approximately proportional to the square of the strength of the interfering signal. Although present designs of superhets generally are such as to minimize this problem for the transmitter powers used by amateurs, especially when there is control of the first detector input, it would do no harm to have cross modulation data for the receivers. This can be obtained by the two-signal selectivity test method described in the I.R.E. Standardization Report referred to previously.

Signal-frequency image response is another factor of importance in the superhet selectivity picture. As with close-up selectivity, this can be described by a curve of voltage ratio of input at image frequency to input at resonance frequency for constant output, plotted against receiver tun-

ing frequency; or by a signal-image voltage ratio for one tuning frequency in each amateur band. A typical curve is shown in Fig. 6, this being for the S.S. superhet having a single stage of pre-selection, the voltage ratios for amateur bands being 13,000 at 2 mc., 1500 at 4 mc., 150 at 7 mc., and 50 at 14 mc.

Image ratio values of this order are considered satisfactory for 2 and 4 mc., passable at 7 mc. and inadequate at 14 mc. Not much better can be expected at the higher frequencies with a single r.f. stage, however, which accounts for the present

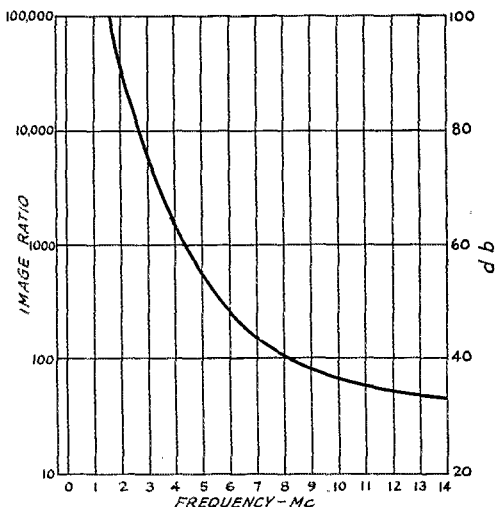

FIG. 6—A CURVE OF THIS TYPE SHOWS THE SIGNAL-FREQUENCY IMAGE RESPONSE OF A SUPERHET THROUGHOUT ITS TUNING RANGE

This one is for the 1932 S.S. superhet having a single r.f. stage ahead of the first detector, the intermediate frequency being 525 kc. Note that the image ratio falls from over 10,000 (80 db) at 2000 kc., to about 50 (34 db) at 14 mc., indicating the need of greater pre-selection at the higher frequencies.

trend toward more pre-selection. Data on amateur receivers should include actual image ratio values for each amateur band.

While there are other incidental aspects of the selectivity question, such as "whistle tests" for interference from harmonics of the c.w. beat oscillator and tests for spurious response peaks in crystal filters, they are more in the nature of checks to eliminate "bugs" in design and are difficult of quantitative specification in connection with the finished product. Hence they hardly warrant detailed treatment here.

The important bearing of selectivity on the other characteristics of our receivers—stability, sensitivity and fidelity—will be discussed from the amateur point of view in a future article.

<sup>5</sup> This was explained in detail in the article, "The Variable: Mu Tetrode," *QST*, May, 1931.

# Acorn-Type Pentode Announced

## Type 954, R.F. Amplifier Companion of 955, Now Available

THE development work on r.f. amplifiers for the ultra-high frequencies has now reached the point where practical tubes are ready for distribution, with the result that a new acorn pentode, designated as the 954, has been announced by the Radiotron Division of RCA Manufacturing Company. The 954 is of the same type of con-

Typical Operation as Class-A Pentode Amplifier

Plate voltage.....	90	250 volts
Screen voltage.....	90	100 volts
Control-grid voltage.....	-3	-3 volts
Suppressor.....	Connected to cathode at socket	
Amplification factor.....	1100	More than 2000
Plate resistance.....	1.0	More than 1.5 megohms
Mutual conductance.....	1100	1400 micromhos
Plate current.....	1.2	2.0 milliamperes
Screen current.....	0.5	0.7 milliamperes

### As a Biased Detector

Plate-supply voltage.....	250 volts max
Screen voltage.....	100 volts
Control-grid voltage.....	-6 volts approx.
Suppressor.....	Connected to cathode at socket
Plate load.....	250,000 ohms or equivalent impedance
Plate current.....	Adjusted to 0.1 ma. with no input signal

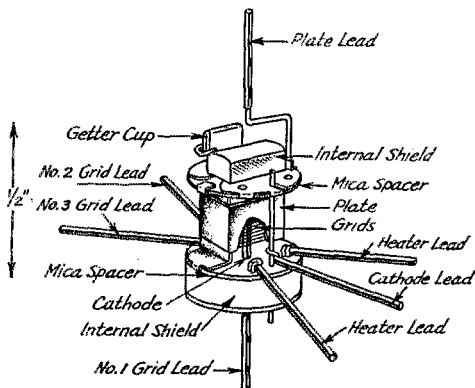

FIG. 1—INTERNAL CONSTRUCTION OF THE 954

struction as the 955 triode and is very similar to the latter tube in external appearance, the chief distinguishing feature being the fact that the 954 has its plate and grid leads brought out the top and bottom. The new tube is a heater-cathode type of pentode designed for wavelengths as short as 0.7 meter, and is capable of gains of three or more in conventional circuits at one meter, with higher gains at longer wavelengths.

Internally, the tube is considerably more complicated than the 955, having in addition to the two extra grids a considerable amount of internal shielding. The enlarged drawing of Fig. 1 shows the element construction. In appearance it is like a greatly reduced version of the 802. Some idea of the minuteness of the elements can be obtained from the fact that the cathode sleeve is about half the length and approximately the same thickness as the common pin.

The tentative ratings and characteristics of the 954 are as follows:

Heater voltage.....	6.3	volts a.c. or d.c.
Heater current.....	0.15	amp.
Direct interelectrode capacitances (pentode connection):		
Control grid to plate (with shield baffle).....	0.007	$\mu$ fd. max.
Input.....	3	$\mu$ fd.
Output.....	3	$\mu$ fd.
D.c. plate voltage.....	250	volts max.
D.c. suppressor voltage.....	100	volts max.
D.c. screen voltage.....	100	volts max.

The tube can be mounted in the same type of socket as that employed for the 955, with the short end projecting through the hole in the socket. Of the five terminals arranged around the circumference of the two heater and the cathode connections, with the cathode in the center. The group of two on the opposite side are the screen and suppressor terminals. The terminal on the short end of the tube is the control grid, while that on the long end is the plate. Connections should never be soldered directly to the tube terminals, since the heat is almost certain to crack the seal.

The heater of the 954 may be operated on either a.c. or d.c., but series operation of heaters is not recommended. If on a.c., the cathode pre-

(Continued on page 88)

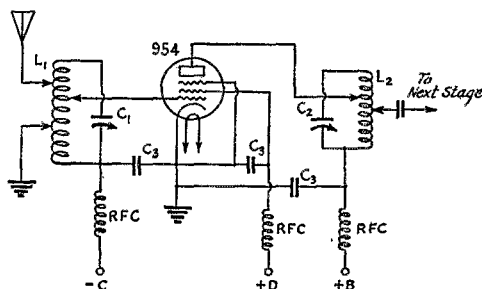

FIG. 2—TYPICAL CIRCUIT DIAGRAM FOR R.F. AMPLIFICATION

$C_1, C_2$ —100 to 500- $\mu$ fd. fixed mica condensers.  
 RFC—15 turns No. 30 wire, outside diameter one-quarter inch.  
 Other circuit constants depend upon wavelength, as follows:

	2.75 to 5.3 meters	1 to 3 meters	0.8 meters
$L_1$ wire.....	10	4	5
and dia.....	No. 16	No. 16	No. 30
$L_2$ length.....	$3/8''$	$3/8''$	$1/2''$
$C_1, C_2$ — $\mu$ fd.....	3 to 25	3 to 25	3 to 4

$L_1$  and  $L_2$  are wound with bare copper wire. Diameters given are outside.

# Matched Impudence

With Apologies to Nobody!

By Prof. Dr. Valadod Turnonanoff\*

SOME seven-hundred odd days<sup>1</sup> ago *QST* presented my thesis<sup>2</sup> on unrelated relativity. Those were the opening days of the new deal all around, and apparently the closing days of pet theories. One correspondent wanted to wager a heavy-side layer-cake that the electromagnetic field had a "Wet Grounds" sign on it when I attempted my exposition. Another chap applied some of my suggestions to his station equipment, and his very first QSO thereafter brought forth a "QRD?" from the grand monitoring station at Grand Island, and with it a cute little pink slip.

In 1865 it was the Monitor and the Merrimac; in 1935 it is the Monitor and the Meter. Continual off-frequency operation, says I in reply, insures a round-trip ticket to that "grand island" of oblivion. And another fellow wanted to know if my theories had any direct bearing on the PST (Punk Signals Tolerated) system. No. But a message-handling incident which occurred shortly

its application to the ultra short-wave field. In this connection I should say that my theory is the cat watching the mouse as he slides down his "spectrum" pole to his trap. Starting at 200 meters the amateur has worked down that "pole" until he is well established at 5 meters, even at  $2\frac{1}{2}$  meters. But, ah! It will be when his arm of experimentation reaches into the *sub-spectrum* (title copyrighted) that I will relate my unrelated relativity theory in ultimate terms. Only two people understand it in its present form, but they can't be reached by second-class mail matter. So, at the proper time, I'll begin where I was left off and end at the beginning. In the meantime, the first amateur to relay a message by radio on a *negative* wavelength, by using a minus-quantity meter, will receive from me absolutely free and postpaid a gadget in hydrometric form proving without question that the shortest distance between two points is *not* a straight line. What a challenge to Amateur Radio! And hasn't it accepted every challenge given to it? If you think it cannot be done, I can only remind you of what a great scientist recently said to a newshawk when asked if he liked to talk about his theories. His reply was, "Yes, but not to you." You prove that which cannot be done, and I shall scientifically verify it!

But on to the present.

The editors of *QST* believe that such a technical person as myself is still qualified to impress upon its readers some of the non-technical phases of publishing a magazine. In the first place, for Heaven's sake when you move from Jaundice, Illinois, to Webfoot, Canal Zone, promptly let *QST* know your new address. The postmaster at Jaundice simply won't forward that brand-new issue of *QST* on to you at Webfoot (even if you are a Democrat) unless additional postage is affixed. You don't want to miss *QST*—particularly an issue which contains my stuff. This request is as sincere as is my technical advice unwarranted. Another thing, when you write a letter please be sure to sign it—and write your address on the letter, too. Your address on an envelope is practically no address at all, because it reaches a well-rounded waste-paper basket as soon as the contents are taken from it. Every well-established business has the loveliest collection of "no action taken" letters, just because so many people believe that mind-readers are made and not born.

And so enters mystery.

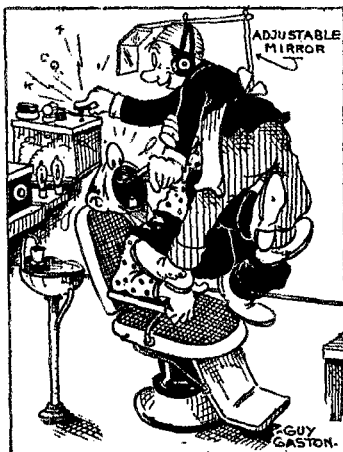

EXCLUSIVE PHOTOGRAPH OF THE PROFESSOR DOCTOR WORKING LATE IN HIS SECRET LABORATORY

after my article appeared comes to mind. The original message read, "Relativity story yours well received." The relayed version read, "Relatives sorry. Your will deceived."

The vast majority of responses wanted to know

\* Late (very late) of the University of Moose-Cow.

<sup>1</sup> Two years to you.

<sup>2</sup> Page 27, the issue doesn't matter.

# A 1935 Version of the Original S.S. Superhet

Constructional Details for the Amateur Who Likes to Build His Own

By Eugene A. Hubbell,\* W9ERU

**I**N THESE days of excellent commercially manufactured amateur receivers for sale at prices just about equalling the parts cost, it may be asked why anyone should want to build his own set. It has always seemed to the writer that a great part of amateur radio's fascination lies in the opportunity for exercise of manual skill, as well as actually operating the completed

volume control, and to the left of this is the beat oscillator switch and beat note control knob. To the right of the main dial and below, from left to right, are the r.f. volume control, a.v.c. adjustment, crystal filter switch, phasing control, and selectivity control.

The panel, finished in black crackle and drilled for rack mounting, is 8 by 19 inches and 3/16 inch thick. The subpanel is of 1/16-inch aluminum, 12 by 17 inches and 2 3/8 inches deep. The shield boxes for the r.f., first detector and oscillator stages are also of 1/16-inch aluminum, measuring 4 by 7 inches, by 4 3/4 inches high. The single box to the left of the main dial is for the high-frequency oscillator, the one to the extreme right for the r.f. stage, and the one in the center for the first detector. The covers for these are hinged from the back of the boxes. The construction is easily recognized as that made familiar by the "rationalized autodyne" of January, 1933, *QST*, also described in the *Handbook*. The cans, sub-panel and panel are held together by drilled and tapped lengths of quarter-inch square brass rod.

In the can immediately behind the r.f. stage is the crystal filter input transformer, which is a standard National 500-kc. i.f. type with the secondary tuning condenser disconnected. To the left of this transformer the crystal is plugged into

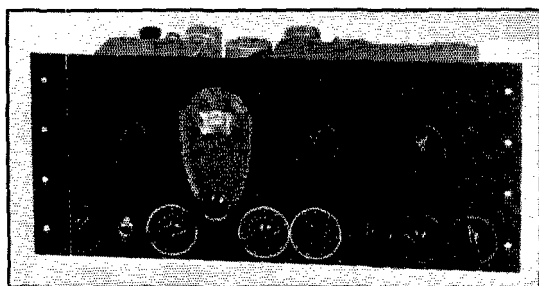

THE EIGHT-TUBE S.S. RECEIVER WITH CRYSTAL FILTER AND AUTOMATIC GAIN CONTROL  
*Constructional details are given in the text.*

station. A commercial transmitter may contact a foreign point with one-hundred percent results, but the credit doesn't go to the man who punches the tape. In the same way, the amateur who buys all his equipment can receive but a small share of credit for the actual operation, compared to the operator of a completely home-built job.

The receiver about to be described was built with this feeling, and while it may not outdo the manufactured article, its performance leaves little to be desired, considering cost and home construction. The panel, as may be seen in the photograph, is outfitted with controls for literally everything in the set. The main tuning dial is located a little to the left of the center. The knob above and to the left is the oscillator padding condenser, to the right and above are the first detector and r.f. stage padding condenser controls. Just to the left of the main dial, and below, is the audio

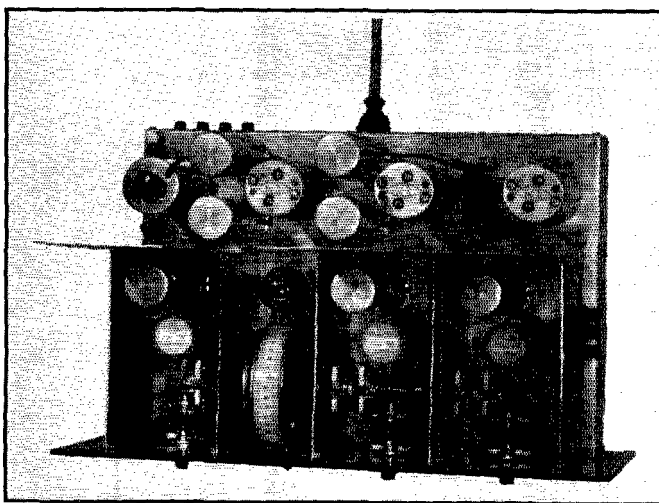

THE TOP VIEW SHOWS THE LAYOUT

\* 227 North 4th St., Rockford, Ill.

two porcelain feed-through insulators, with the connections to the crystal filter switch, phasing condenser and selectivity control brought out below the base. From one of the feed-through insulators a shielded lead runs to the first i.f. tube, still farther to the left and at the back of the chassis. Just in front of this tube is the second i.f.

with the coil specifications is excellent on the amateur bands and satisfactory on any frequency. The high-frequency oscillator is coupled to the first detector *via* a small condenser to the plate winding of the r.f. stage.

The crystal filter is conventional, with series, parallel and off connections of the crystal, controlled with a Yaxley jack-

switch. The split-stator condenser is the variable selectivity control and provides the neutralizing voltage for the phasing control. Some improvement possibly could be made by substituting a large untuned primary on the crystal input transformer for the present tuned circuit. This might increase the maximum selectivity, although it seems ample for all requirements at present.

The intermediate-frequency stages are conventional in circuit arrangement, as is the second detector, which is the self-biased triode type. The only unusual thing about this is the separate power supply leads for use of a.v.c. The varying voltage across a resistor, caused by variations in signal intensity to the second detector, is applied to the grids of the r.f.

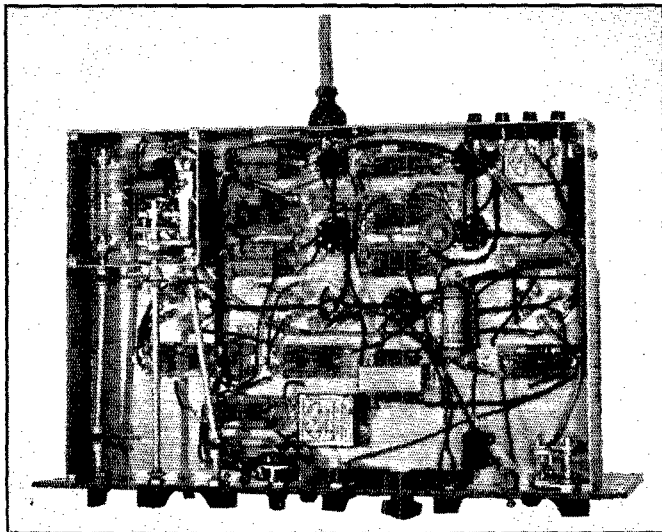

THOROUGH DE-COUPLING IS USED IN THE FEED AND RETURN CIRCUITS UNDERNEATH THE BASE

tube, and between these tubes and the crystal is the i.f. coupling the first and second i.f. stages. To the left again is the third i.f. transformer, and just ahead of it, and behind the dial, is the audio tube. On the extreme left of the chassis, at the rear, is the beat oscillator transformer, the beat oscillator tube being to the right of this and to the rear. And just ahead of this tube is the second detector.

The antenna connections are binding posts on the wall of the r.f. stage shield can, providing input to the r.f. stage primary winding. A separate ground post is provided. The six-conductor power supply cable plugs in the socket on the rear of the subpanel. Audio output terminals include high-impedance output to binding posts on the top of the subpanel at the rear left, and two double tip-jack outlets for headphones and low-impedance voice coil on the back of the subpanel.

#### CIRCUIT FEATURES

The tube line-up is a 58 tuned r.f. stage, 57 first detector, 58 electron-coupled oscillator, two stages of 58 double-tuned i.f., 56 second detector, 58 beat oscillator, and 2A5 audio stage. The tuning system is a combination of padding condenser and tapped coils, this arrangement enabling general coverage with one set of coils and also good band-spread on the amateur bands. Tracking

and one i.f. stage to control the volume automatically. This system was described by J. J. Lamb in Nov. 1933 *QST* in connection with the original S.S. super. If the a.v.c. is not wanted, the second detector need only be connected to the common power supply. The power requirements for this arrangement are 200 volts at about one-half milliamperes, but this must be from a different source than the regular B supply of the receiver.

The beat oscillator circuit is home-made, the one-millihenry coil being wound with a tap for the cathode regeneration scheme. The main tuning condenser is a mica-semi-variable brought out of the top of the can for rough adjustment. Precise adjustment of the beat note is made by a 35- $\mu$ fd. midget connected between cathode and ground, and controlled by the knob on the front panel at the extreme left. The beat oscillator plate is capacity-coupled to the second detector grid, the capacity being cut down until the increase in plate current on the second detector is approximately one-tenth milliamperes when the beat oscillator is switched on.

The audio stage is a conventional resistance-capacity-coupled pentode stage, with a push-pull type 45 output transformer in the plate circuit. This providing a good impedance match with a center-tap to connect through a condenser to a

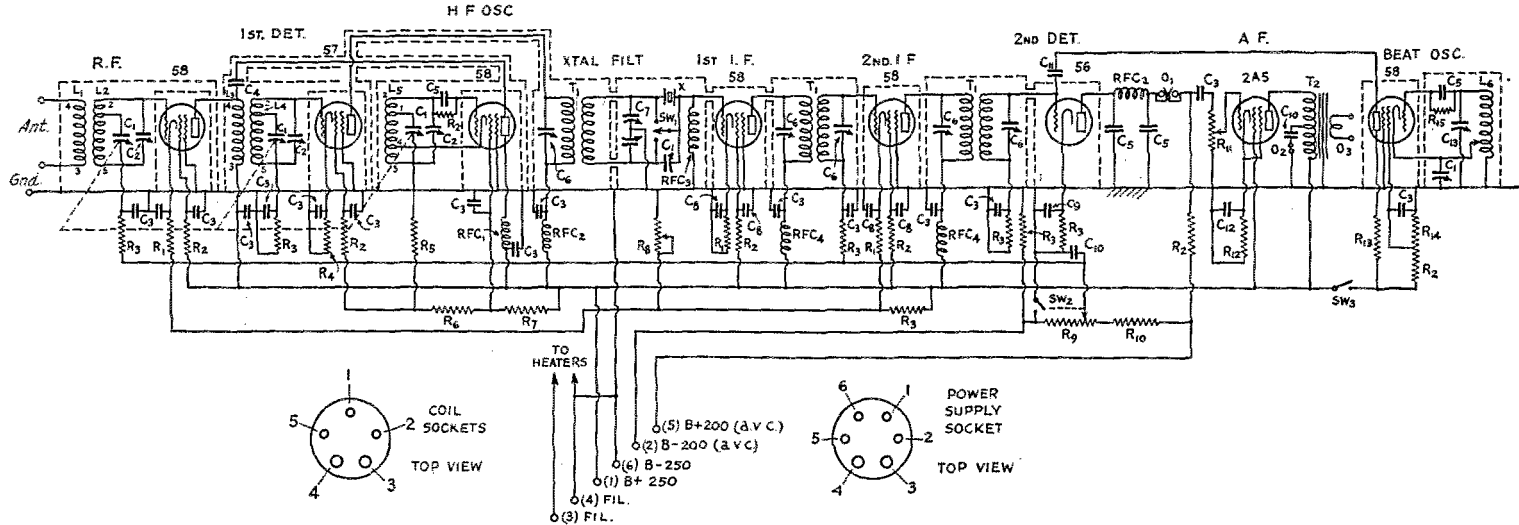

FIG. 1—COMPLETE CIRCUIT OF THE RECEIVER. HIGH-FREQUENCY COIL DATA ARE GIVEN IN THE TABLE

- R<sub>1</sub>—300-ohm 2-watt (3).  
 R<sub>2</sub>—50,000-ohm 2-watt (7).  
 R<sub>3</sub>—100,000-ohm 2-watt (7).  
 R<sub>4</sub>—5000-ohm 2-watt (1).  
 R<sub>5</sub>—3000-ohm 2-watt (1).  
 R<sub>6</sub>—7000-ohm 2-watt (1).  
 R<sub>7</sub>—10,000-ohm 10-watt (1).  
 R<sub>8</sub>—12,000-ohm Electrad (1).  
 R<sub>9</sub>—50,000-ohm Centralab (1).  
 R<sub>10</sub>—500,000-ohm 2-watt (1).  
 R<sub>11</sub>—250,000-ohm Electrad (1).  
 R<sub>12</sub>—400-ohm 10-watt (1).  
 R<sub>13</sub>—30,000-ohm 2-watt (1).  
 R<sub>14</sub>—25,000-ohm 2-watt (1).  
 R<sub>15</sub>—75,000-ohm 2-watt (1).  
 SW<sub>1</sub>—S.p.d.t. (1).  
 SW<sub>2</sub>—S.p.s.t.—Back of R<sub>9</sub> (1).  
 SW<sub>3</sub>—S.p.s.t. snap switch (1).  
 C<sub>1</sub>—35- $\mu$ fd. variable (5).  
 C<sub>2</sub>—100- $\mu$ fd. variable (3).  
 C<sub>3</sub>—006- $\mu$ fd. mica (16).

- C<sub>4</sub>— $\frac{3}{8}$ " x  $\frac{3}{8}$ " surfaces,  $\frac{1}{8}$ " air separation (1).  
 C<sub>5</sub>—250- $\mu$ fd. mica (4).  
 C<sub>6</sub>—100- $\mu$ fd. i.f. trimmers (6).  
 C<sub>7</sub>—140- $\mu$ fd. 2-section variable (1).  
 C<sub>8</sub>—0.05- $\mu$ fd. paper (4).  
 C<sub>9</sub>—0.5- $\mu$ fd. paper (1).  
 C<sub>10</sub>—1- $\mu$ fd. paper (2).  
 C<sub>11</sub>— $\frac{3}{8}$ " x  $\frac{3}{8}$ " surfaces, 1/16" bakelite separation (1).  
 C<sub>12</sub>—10- $\mu$ fd. paper (1).  
 C<sub>13</sub>—100- $\mu$ fd. mica semi-variable (1).  
 RFC<sub>1</sub>—2.5-mh. high-frequency choke (1).  
 RFC<sub>2</sub>—16-mh. universal wound choke (2).  
 RFC<sub>3</sub>—90-mh. low-frequency choke (1).  
 RFC<sub>4</sub>—6-mh. universal wound choke (2).  
 L<sub>6</sub>—1-mh. universal wound coil, tapped  $\frac{1}{3}$  from inside.  
 T<sub>1</sub>—500-kc. i.f. transformer (3).  
 T<sub>2</sub>—P.p. 45 output transformer (1).  
 X—525-kc. crystal (1).  
 O<sub>1</sub>—Phones output.  
 O<sub>2</sub>—Magnetic speaker output.  
 O<sub>3</sub>—Voice coil output.

Band....	1.7 mc.	3.5 mc.	7 mc.	14 mc.
L <sub>1</sub> .....	10 t.	6 t.	5 t.	5 t.
L <sub>2</sub> .....	55½ t.	28½ t.	14 6/10 t.	6½ t.
Tap (1) ..	None	None	9½ t.	3 4/10 t.
L <sub>3</sub> .....	30 t.	20 t.	9 t.	5 t.
L <sub>4</sub> .....	55½ t.	28½ t.	14 6/10 t.	6½ t.
Tap (1) ..	None	None	9½ t.	3 4/10 t.
L <sub>5</sub> .....	43½ t.	25½ t.	13½ t.	6½ t.
Tap (1)	36 4/10 t.	22 t.	8 1/10 t.	3 3/10 t.
Tap (4) ..	15 3/10 t.	8 4/10 t.	4 4/10 t.	2 4/10 t.
Range....	1.6-3 mc.	3-6 mc.	6-12 mc.	12-24 mc.

Coils wound on 1½-inch diameter 5-prong forms (10 ribs). L<sub>1</sub> and L<sub>5</sub> are close-wound at the bottom of the form,  $\frac{1}{8}$ " from L<sub>2</sub> and L<sub>4</sub>, with No. 36 e.c. L<sub>2</sub>, L<sub>4</sub>, L<sub>5</sub> spaced to occupy 2" length for all bands except 14 mc., which is 1½" length. All but 1.7-mc. coils are wound with No. 18 e.c., 1.7-mc. coils being wound with No. 20 e.c.



high impedance speaker, in addition to the low-impedance voice-coil output. An output to headphones is provided by double self-shortening tip-jacks in the plate circuit of the second detector. Audio volume is regulated by a potentiometer in the grid circuit of the 2A5. Another volume con-

square of the percentage of the coil across which it is placed, it was only necessary by simple calculation to find the percentage of the coil across which the 35- $\mu$ fd. tuning condenser should be connected. This was converted into turns and tenths of turns, to which the Hammarlund forms lend themselves very nicely with their ten ribs for reference, and in every case the calculations proved quite successful. On the oscillator coils it was necessary to figure on operation at 500 kc. higher than the other two stages, of course.

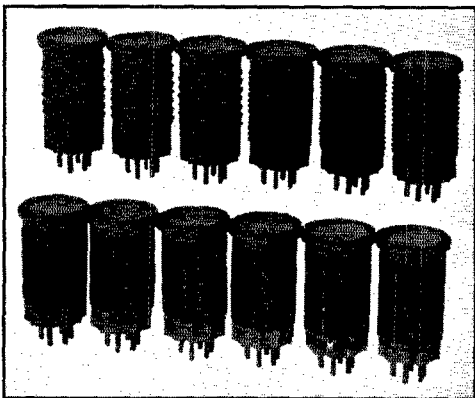

THE RECEIVER'S FULL SET OF PLUG-IN COILS

trol in the cathode circuit of the r.f. stage and the second i.f. prevents overloading the second detector and regulates volume when listening on headphones. It is necessary to apply this control to the r.f. tube to prevent overloading of the first detector by strong local signals. This effect is noticeable only with the strong signals from transmitters in the neighborhood.

The main plate power supply should be capable of 200 to 250 volts at 85 ma., and the filament supply with 2.5-volt tubes should be 9.2 amperes. Six-volt tubes can be substituted with equally good success, 6D6 for 58, 6C6 for 57, 76 for 56, and 42 for 2A5. If the a.v.c. is used, the second high-voltage supply for the second detector can be taken off a dynamic speaker field supply—with proper filtering, of course. Best results are obtained with about 200 volts.

Grid return decoupling resistors are used wherever advisable. The by-pass condensers are 0.006- $\mu$ fd. mica with the exception of those for some of the intermediate frequency circuits, where they are 0.05- $\mu$ fd. paper. Radio-frequency chokes in the plate circuits also help filter out feedback currents that tend to produce oscillation.

The coils are wound on Hammarlund forms with ten ribs. The table gives the exact turns, wire sizes and taps. Celluloid cement was used to hold the enameled wire in place after winding. The coil ranges were all pre-determined with the aid of a "Lightning Calculator," and the taps for band-spreading located by the following process:

A convenient value of padding condenser across the complete coil was assumed, and the necessary amount of capacity needed to tune the amateur band found on the Calculator. Since the tuning range of a condenser decreases as the

#### LINE-UP ADJUSTMENT

The adjustment is similar to that of any of the supers which have been described in *QST*'s pages and in the *Handbook*. The plug-in crystal can be placed in a simple oscillator coupled to the second i.f. grid. No-signal plate current on the second detector should be about two-tenths of a milli-ampere, and coupling should be loose enough to keep this current below three-tenths while all adjustments are being made. After the last i.f. transformer is aligned, the lead coupling the oscillator to the grid should be transferred to the first i.f. tube, and the transformer between this and the second i.f. tube tuned. Then the oscillator can be coupled to the first detector grid and, with the crystal filter switch in the "off" position, the crystal input circuit can be tuned. This includes one adjustment on the transformer and the selectivity control.

With a steady high-frequency signal fed to the antenna input circuit, the high-frequency oscillator padding condenser should be rotated until this signal is picked up, the first detector and radio frequency stages being brought into resonance. With the crystal filter switch in the series position, the main dial can be turned until the signal is brought in at maximum intensity. The beat oscillator should then be turned on and tuned until a beat note of a thousand cycles or so is heard. Without touching any other control, rotate the main tuning control through zero beat and to the same pitch on the other side. Then turn

#### TUBE-SOCKET VOLTAGES (D.C.), MEASURED TO CHASSIS

	Plate	Screen <sup>1</sup>	Cathode <sup>2</sup>
R.f.....	225	115	-3
1st Det.....	225	25	-1.2
Osc.....	225	110	0
I.f.....	225	110	-3.1
2nd Det.....	190		-16
Beat Osc.....	185	20	0
A.F.....	210	225	-12.5

<sup>1</sup> These were measured with 250-v 1-ma. meter.

<sup>2</sup> These were measured with 25-v 1-ma. meter.

the phasing condenser control until this note (which will be quite weak) reaches a minimum. This should complete adjustment of the crystal filter. For best results a little experience will be necessary.

The automatic volume control arrangement

(Continued on page 180)

# The 1934 Sweepstakes

## Results, Fifth National QSO Contest

By E. L. Battey, W1UE\*

**A**LL Records Shattered! The Fifth All-Section Sweepstakes Contest surpassed all expectations!! 970 operators reported scores, a greater national (W & VE) participation than in any previous amateur contest. Scores were of previously unheard magnitude. 35.8% of all scores reported were over 10,000 . . . 22.2% were over 20,000 . . . thirty scores over 60,000 . . . nineteen over 70,000!! Competition was more intense than mere words can explain. The 1934 Sweepstakes was a decided success.

The greatest testimonial any contest can have is the praise of the contestants. Sweepstakes enthusiasts are always strong in their commendation of these annual national QSO contests. A few representative comments of 1934 SS'ers: "It was a dandy contest. I made a lot of new friends and renewed acquaintance with many old ones. But this contest meant more than that to me. It was a severe test for my transmitting equipment."—W9AYO. "The A.R.R.L. Sweepstakes is the biggest event of the year and I enjoy operating then more than any other time."—W9KEH. "This contest made many A-1 operators."—W8HGG. "It's the one high spot of the year in ham radio."—W1BEF. "I am a new ham. This contest certainly opened amateur radio wide open for me and gave me much experience in message handling."—W9SQY. "The amount of experience and knowledge gained in message handling in the SS is worth all of my previous two years of 'hit or miss' operating."—W9IVC. "Haven't had so much fun and as many thrills since my first QSO."—W9PQA. "It's a great game, and activities like the SS keep up the never-ending interest."—W2CBN. "I haven't had so much fun since I was O.R.S. 1LZ in 1922 spark days."—W1ICA. "In the realm of amateur radio I have one greater hobby than rustling an African signal through a background of QRM and QRN, and that is the annual SS contest."—W6ENM. "Foremost in my mind is the pure and simple spirit of cooperation which was apparent on every hand and which tends to maintain the original integrity and honor of the body at large."—W1EZ. "It was the most and best fun yet. New friends, new states, new sections and new QSL cards. For pure unadulterated fun and sheer joy of operating give me the SS every time."—W6JMR. "I got a greater kick out of it than any event I have ever experienced in amateur radio."—W6AZC. "The fine spirit of station operators

\* Assistant Communications Manager.

not engaged in the contest was surprising."—W6FVD. "I never had such a good time in all my ham life."—W7DLN. "I have been licensed for nearly 13 years and have worked from 200 meters on down, but I can truthfully say that I enjoyed the Sweepstakes more than any other experience in amateur radio."—W9CWW. "Here's to bigger and better SS contests and it will be a long time until they are better."—W4APU. "Had more fun than in all time I've been on the air."—W5DFU. "This type of contest certainly gives a fellow a chance to improve his operating and find out what his station can do."—W6FRN. "Thank you for the dandy party."—W3QK. "The SS renews my interest in ham radio."—W8DED. "I obtained more operating experience and knowledge of operating conditions than from many months of ordinary QSOing."—W3DPU.

### SCORING

For the benefit of the non-participant, a word relative to scoring in an SS is in order. The Sweepstakes is open to all amateurs in the 69 sections of the League field organization. The idea is to work as many different stations in as many different sections as possible, exchanging at least one message with each station as proof of "solid" QSO. If a message is sent and acknowledged, "one point" is scored; if a message is exchanged both ways, "two points" are scored. In the case of a 'phone-c.w. QSO an additional point may be added if a message is exchanged both ways (one half point for each message). A power handicap is applied to all points (explained elsewhere). The summation of all points is multiplied by the number of Sections contacted for final score.

### HIGH SCORES

The first-listed contestant in each section in the score list is winner of the certificate award for that section. Congratulations to all victors!

W9HKC, Illinois, and W4BRG, Georgia, ran very close for highest score in all sections. W9HKC is slightly in the lead with 113,679 points! W4BRG came through with 113,360! What scores these gentlemen made!! W9HKC made 377 contacts in 51 sections using inputs of 17.1 watts on 7 mc. and 20.9 watts on 3.5 mc. W4BRG made 443 contacts in 65 sections using inputs ranging from 30 to 45 watts on 3.5, 7 and 14 mc. He says, "I consider one of the most important factors in obtaining a high score in a

competition of this kind to be the use of all three of the most important frequency bands, and the use of the right one at the right time." The highest Canadian scorer was VE5HQ with 52,620 points.

Among the other very high scores we find W5ASG 92,628, W6ENM 89,334, W8HUD 84,294, W9AUH 83,552, W9TJ 82,167, W8FIP 81,600, W9IFE 80,640, W8EUY 79,663, W9IU 79,328, W8FDA 76,284, W9JRK 74,690, W8GUF 73,236, W4AG 71,890, W6BIP (3 oprs.) 71,552, W9GBJ 71,492, W9FM 71,340, W8JTT 70,656.

The dream of the ardent Sweepstakes contestant is to "WAS" (work all sections). W9AUH, well known "King" of QSO contests, set a new record when he worked 68 of the total 69 sections in the 1934 SS!! And if you don't think that's an accomplishment, try it some time! W9AUH snagged all but the Philippines. Congratulations, Moss! The previous section-QSO record was 66. In addition to W9AUH, this was broken by W6BPO, W8DED, W8EUY and W9IU, each working 67 sections. Sixty or more sections were worked by operators at forty-nine stations. W9AQD worked 66; W4AG, W4BRG, W6BXL 65; W5BSG, W6BIP (3 oprs.), W8ANQ, W8JTT 64; W1MK (Hal), W2DPB, VE2EE, W3BES, W5CNK, W6ENM, W8HUD, W8KKG, W9AYO, W9DHN, W9DRN, W9EFK 63; W4APU, W5ASG, W5BZR, W6FMU, W8EYT, W8KWJ 62; W6HEX, W6HJT, W6HRN, W8AQ, W9BQM, W9DMA, W9GBJ, W9IFD, W9TJ 61; W4PL, VE5HQ, W6AZC, W7BSU, W8FIP, W8FQS, W9DCB, W9MIM, W9OLC 60.

#### POWER

For the first time in a Sweepstakes Contest a power factor was introduced in the 1934 competition. Points were multiplied by 3, if the power was 25 watts or less; by 2, if 75 watts or less; and by 1, if over 75 watts. W9AUH was highest scorer in the "over 75 watts group," beating his winning score of 1933 by over 20,000 points! He made more contacts than any other participant—610!! That's endurance. FB! W4BRG and W9HKC led in the "2-multiplier" and "3-multiplier" groups, respectively. Of those operators using both low and medium power (multipliers of 3 and 2), W9JRK had the highest score—74,690. W3DPU led in the group using low and high power (multipliers of 2 and 1) with 35,808 points. W8EUY led the medium and high group—79,663. W4APU had the highest score of those operators using all three multipliers—68,262. Approximately 21.1% of all participants used power not exceeding 25 watts; 46.3% power between 25 and 75 watts; 24.2% over 75 watts. The remaining (8.4%) participants operated in more than one power group.

#### FREQUENCY BANDS USED

7 mc. was the most popular SS band. Approximately 76.3% of all 1934 contestants used the

7-mc. band either full or part time; 63.2% used 3.5 mc.; 35.4% used 14 mc.; 2.9% used 1.75 mc.; 1.9% used 56 mc. Approximately 21.7% used the 7 mc. band only; 18.6% 3.5 mc. only; 1.7% 14 mc. only. 20.5% divided their time between 3.5 and 7 mcs.; 19.4% between 3.5, 7 and 14 mcs.; 11.4% between 7 and 14 mcs.; 1.3% between 3.5 and 14 mcs.

The 56-mc. ultra-high frequency band came in for quite a bit of contest work. W1KH's work on 56 mc. led all others; he made 36 QSO's, among which was one with W1AL, West Hartford, 83 miles air-line, and in a section other than his own. Also, one of W1KH's QSO's was with a plane flying over his shack! W2EYY made 24 QSO's on 56 mc.; W1CRO 19; W2HHF 13; W1BWJ 8; W1CWZ 6. Others using 56 mc. were: W1IAU, W2EYS, W3FJ, W3EBD, W7BRU, W8EFW, W1WV, W1BEF, W3ADE, W1CDX, W8KWD, W9NUF.

#### PHONE WORK

SS participation by phone operators was not so great as in the 1933 contest. There was, however, some noteworthy voice work. 65 of W9GAF's 149 contacts were made on 3.9-mc. phone. 50 of W8DML's 174 QSO's were on 3.9-mc.; his points made by phone alone were 12,064. 8 of W9KBT's 20 contacts were on 3.9 mc. W9ACU, using phone only, on 3.9, 1.75 and 14 mc., made 8262 points (27 sections). W8EMP, phone only on 1.75 mc., scored 2266 points (11 sections). W4AFQ on 14-mc. phone helped a couple of SS'ers add points. W5BTX made his one contact (!) using 1.75-mc. phone, working W5BSG, who was on 7 mc. The following used phone part time on the band indicated: W2BYP, W2HNQ 14 mc.; W8LYS, W9KXD, W2FGG 1.75 mc.; W7CFL, W9IU, W9DEI 3.9 mc.; W8FIP 1.75 and 3.9 mcs.

#### CLUB WINNERS

Special certificate awards were offered to the highest scoring participant in each A.R.R.L.-affiliated club where three or more individual club members took part and submitted scores. Awards are being made to the highest scorer in each of the following clubs; the winner's call is given with the name of each club: W6KRI, Whittier (Calif.) Radio Amateur's Association; W6HEX, Southeast Radio Experimental Association, Bell, Calif.; W6RH, Associated Radio Amateurs of San Francisco; W1NE, Connecticut Brasspounders Association; W1KH, Eastern Massachusetts Amateur Radio Association; W9KEH, Egyptian Radio Club, Nameoki, Illinois; W9REC, Chicago Radio Traffic Association; W9IYA, Southtown Amateur Radio Association, Chicago; W9SOW, Central Illinois Radio Club, Bloomington; W8KLM, Massillon (Ohio) Amateur Radio Club; W8IAW, Cleveland Heights Radio Amateur Club; W8GOD, Radio

Frequency Club, Tiffin, Ohio; W9BQM, Fond du Lac (Wis.) Amateur Radio Club; W2AYJ, Northern Nassau Wireless Association, Long Island; W2ABS, Tri-County Radio Association, Rahway, N. J.; W9JSO, Tri-State Amateur Radio Club, Sioux City, Iowa; W9KPV, Ozark Amateur Radio Association, Joplin, Mo.; W1COI, Hoosac Valley Radio Club, Williams-town, Mass.; W3FJ, Richmond (Va.) Short Wave Club; W4APU, Birmingham (Ala.) Amateur Radio Club; W5BDI, Houston (Tex.) Amateur Radio Club; VE3QD, Hamilton (Ont.) Amateur Radio Club; VE3TD, The Queen City Amateur Radio Club, Toronto; VE3QK, Frontier Radio Association, Windsor, Ontario; VE2DR, Montreal Amateur Radio Club; VE5HR, Victoria (B.C.) Short Wave Club; W3BES, The Frankford Radio Club, Philadelphia; W3ATR, Beacon Radio Amateurs, Philadelphia; W8IOI, Boys Club of St. Marys, Pa.; W8BJO, Southern Tier Transmitting Amateurs, Penn Yan, N. Y.; W8AYD, Elmira (N. Y.) Radio Amateur Association; W3EXB, Cumberland County Amateur Radio Club, So. Jersey; W8ANQ, Rochester (N. Y.) Amateur Radio Association.

#### SS SIDELIGHTS

W4TJ worked W8BWL, who was his first QSO five years ago! W9AWP needs a couple of states to complete his 48; he got 'em in the SS. W4COV worked three S.C.M.s in a row—VE3GT, W4BBT, W9AUH. W4AG recites: "Early to bed and early to rise, made scores reach new highs; But whether you're wise or whether you're not, Ain't the Sweepstakes pretty darn hot?" As an example of how much different scores in 1934 were than in the previous years battle: W8EMW's 1933 score—2310; his 1934 total—31,005! W1BEF again sent a specially designed card to all SS contacts; it has a cartoon of an operator "sweeping the country." Any winner certainly had to sweep fast and furiously! W8HGG "heard all sections." One of the wildest times was the last two or three hours of the contest when everyone was looking for the missing sections. What a madhouse! W1DMD's last QSO in the contest was with W6BPO in Nevada, completing his total of 48 states worked; he had been trying for Nevada for over five years. W2GVZ asked VE3MX his age in one message, and it turned out to be his 31st birthday. W2GGW terms 7 mc. a "hissing inferno"—that's as good as any description of the sound of the bands while filled with "SS SS." Hi. Among the "youngsters" in the contest: CM2OP age 13; W9RQR age 14; W3EPJ age 15. W9AQD had 523 QSO's, W3BES 454, W5CNK 445, W9GGB 365, W4AG 325, W1CLH 305, W2DQH 302. W9KJX learned the value of break-in operation and is now boosting it. W8AXD worked many operators that he had worked in the '33 SS. Those elusive sections! Especially Rhode Island, Vermont, Alaska, Nevada, New Mexico and a few others! W8KWA says, "A general question: Which is more inevitable—death, taxes or W9AUH?" W8EUY found 14 mc. a big help in adding those "hard to get" sections. W4APU had 27 contacts with Illinois, 18 with Ohio, 17 N.Y.C.-L.I., 16 N.N.J., 15 each W.N.Y. and Missouri. W9BWV, the "wind power station" (see March '34 QST), did a swell job with its low power. W9TJ, Raymore, Missouri, is located on a farm and used storage batteries throughout. W7DGY worked New York state for the first time. Who didn't experience those hours when it seemed everyone was working some one except you? W7DLN's average time per QSO—14½ minutes. And there were the lads who called "CQ SS" two or three days after the fray ended—habit! W6IDZ gave W1KH message number 75, his number was 74; the next contact was W5BD, who gave W1KH number 74, his number was 76! W8HSH had been trying to snag Delaware and

Nevada for a year and a half to make the full 48 states; in the SS both these states called him! W8KZO worked Springfield, Missouri, Illinois, Ohio and Massachusetts and lives in Springfield, Ohio. W1KH worked Springfield, Mass.; next contact was Springfield, Ohio. During the contest W9OET's YF thought up a new meaning for QRP—"Quieted by rolling pin." Some W9 gave W8AQ number 113 having a text, "This number is a jinx"; that night W8AQ's antenna blew down and the rope ran through the pulley. His message to the same W9 was "Wish I could work Nebraska"; his next QSO was Nebraska. W9EGQ says his station works on the proverb: "Many are called but few are raised." VE2BU suggests a multiplying factor for married men, and he says, "Make it high." W2BSC, Stevens Institute of Technology, Hoboken, N. J., was manned by nine operators. W9GAF, Beatrice Reiss, enabled many, many to report, "Worked my first YL." Six operators made a good score at W8KYC, Marietta (Ohio) Amateur Radio Society station. An appropriate message for the local competitor: "I'll be glad when you're dead, you rascal you." (Thanks, W9OPN.) Twenty-five stations contacted by V08Y sent messages stating that he was a new country for them. For the period of an SS contest VE2CO figures it would pay to belong to one of these two classes of unfortunates: The idle rich, or, The idle poor! W7BRU made the most "points per hour" on the 14-mc. band. W2BLV and W8DSQ, both members of the Chair Warmers Club, were in on the fun. W3EHW operated both W3OZ and W3WZ; one station is enough for most operators. Hi. W8EXB and W8SJ were rivals; it was a close race; see So. New Jersey scores.

#### "CQ SS"

There's something amiss in my attic,  
I've gone off my noodle I guess,  
For I lie in my bed almost frantic  
Hearing nothing but "CQ SS"

The wall paper looks awfully goofy,  
It gets on my nerves I confess.  
Each time that I peek o'er the blankets  
It's patterned with "CQ SS"

I see it in ads in the street cars,  
On bill-boards, soup-spots on my vest.  
When my wife says, "Attend the furnace"  
I answer "CQ SS"

The next time they're holding a contest  
For a week or a day—even less,  
I hope that I'm up with the angels  
Where I won't hear that "CQ SS"

—The Sky Wire, Montreal.

The above ditty probably doesn't mean quite what it says . . . at least, if it were written by anyone who took part in the SS, we'll wager that he will be right in the next one, head over heels . . . there's something about an SS that gets in your blood, or your hair. Hi. Next SS, if all the promises we've heard are true, we're looking for some operator to work all sections and for at least one score over 150,000! See you there.

#### SCORES

##### Fifth All-Section Sweepstakes Contest, 1934

(Scores are grouped by Divisions and Sections, in the order listed on page 5 of each issue of QST. . . . The operator of the station first-listed in each Section is winner for that Section unless otherwise stated. . . . Asterisks denote stations not entered in contest, reporting to assure that stations they worked get credit. . . . The number of sections worked by each station is given following the score. . . . The "power factor" used in computing points in each score is indicated by letters A, B and C. . . . A indicates power up to and including 25 watts (multiplier of 3), B indicates over 25 watts, up to 75 watts (multiplier of 2), and C indicates over 75 watts (multiplier of 1). . . . More than one letter indicates the use of more than one power rating. . . .)

ATLANTIC DIVISION

E. Pennsylvania

W8FDA 76284-52-A  
 W8BES 55189-63-C  
 W8CFV 41952-67-BC  
 W8AKU 36540-42-ABC  
 W8DFU 35803-48-AC  
 W8EOP 26607-49-BC  
 W8ECI 25938-33-A  
 W8DBX 23880-40-BC  
 W8BKE 22616-44-B  
 W8VRE 20167-43-C  
 W8AIZ 19834-47-C  
 W8EWR 15288-28-A  
 W8EJO 14641-51-C  
 W8ATR 13394-37-B  
 W8ADE 12480-39-C  
 W8BRU\* 12238-31-B  
 W8EKG 11368-29-B  
 W8CHE 11362-46-C  
 W8DYU 10614-29-BC  
 W8DRH 10023-22-A  
 W8DYU 9072-42-C  
 W8BHI 7772-29-B  
 W8AKQ 7500-25-B  
 W8CCK 7020-30-B  
 W8ENX 6944-31-C  
 W8DIF 6758-11-B  
 W8DVO 5355-17-A  
 W8BFL 5088-24-B  
 W8DGS 4444-23-B  
 W8DUR 4108-26-C  
 W8BTP 3683-29-C  
 W8BUK 3585-28-C  
 W8BGD 3060-17-A  
 W8CYC 2380-17-B  
 W8ECA 2262-13-A  
 W8DUI 2250-10-A  
 W8COZ 2079-21-C  
 W8EPI 1738-22-C  
 W8BLN 1302-14-A  
 W8CCD 1288-14-B  
 W8HKB 1056-12-B  
 W8VF 1040-10-A  
 W8DMF 1020-10-A  
 W8CVS 928-16-C  
 W8CFM 700-7-B  
 W8CIG 700-10-B  
 W8DYL 608-8-B  
 W8DQU 540-6-A  
 W8ANZ 520-13-C  
 W8EJH\* 429-13-C  
 W8XK 400-10-B  
 W8MRH 169-6-B  
 W8DZR 64-4-B  
 W8Q3 6-1-A

Md.-Del.-D. C.

W3CWE 26400-44-B  
 W3OZ 12300-30-A  
 W3DML 10296-22-A  
 W3WZ 9100-35-C  
 W3EGN 6480-21-A  
 W3DAZ 4680-30-B  
 W3EIL 2816-22-B  
 W3ABA\* 1908-18-B  
 W3BKZ 1408-16-B  
 W3COK 1360-17-B  
 W3DRE 1154-13-B  
 W3SN 918-18-C  
 W3EPR 253-11-C  
 W3EVP\* 8-2-C

So. New Jersey

W3EXB 24618-33-B  
 W3SJ 24084-36-AB  
 W3NF 20196-51-C  
 W3CBR 14355-45-C  
 W8ELG 10263-34-B  
 W3BZI 7172-22-B  
 W3EWM 5100-20-A

W3DQO 4752-27-B  
 W3AAV 2256-24-C  
 W3DBD 1866-23-C  
 W3DNU 1005-18-C  
 W3ETH 816-8-A  
 W3AIT 50-5-C  
 W3ECE 8-2-C

Western New York

W8EUY 79663-67-BC  
 W8JTT 70656-64-B  
 W8ETH 65888-58-B  
 W8ANQ 46528-64-C  
 W8AQE 43040-40-B  
 W8FQS 40440-60-BC  
 W8EWM 31005-53-C  
 W8FYF 30857-57-ABC  
 W8BJO 27200-40-B  
 W8LDA 26936-37-B  
 W8BEN 26220-57-C  
 W8MAH 23124-41-B  
 W8LFG 21369-34-A  
 W8KMC 20331-27-A  
 W8AIE 14835-43-BC  
 W8LLS 13500-30-B  
 W8AYD 10168-31-B  
 W8FKA 8886-27-A  
 W8JQE 8748-27-B  
 W8LWI 7956-36-C  
 W8FYH 6380-29-BC  
 W8EFC 5712-34-ABC  
 W8JUF 4608-18-B  
 W8KWD 4140-18-B  
 W8FUG 4128-24-C  
 W8KSK 3960-20-A  
 W8GWT 3582-24-B  
 W8KBS 3276-14-A  
 W8LGV 2940-14-A  
 W8CJL 2650-25-C  
 W8AKX 2040-20-B  
 W8GUY 1274-13-C  
 W8LUJ 1058-11-B  
 W8DWB 1040-  
 W8KXA 903-7-A  
 W8LGY 804-12-B  
 W8AWM 124-3-B  
 W8JLW\* 40-4-C

W. Pennsylvania

W8FPI 81600-60-B  
 W8CUT 73256-51-B  
 W8HGG 69264-48-A  
 W8APQ 63759-53-A  
 W8AXD 58550-46-A  
 W8EET 55800-62-B  
 W8KWA 55488-48-B  
 W8KVS 50676-44-B  
 W8KNB 4932-41-A  
 W8JCM 38527-37-A  
 W8JOL 24858-35-B  
 W8DML 24926-55-BC  
 W8FCV 20574-44-ABC  
 W8RY 16243-37-B  
 W8KOB 11322-37-AC  
 W8CHR 8294-29-B  
 W8DYV 5798-23-A  
 W8KBM 5098-26-B  
 W8CUG 4258-28-C  
 W8INE 3148-28-C  
 W8KUZ 2518-17-B  
 W8MHE 2460-15-B  
 W8JAW 1593-9-A  
 W8KXP 1440-16-B  
 W8AAX 1368-24-C  
 W8FUV 1316-14-B  
 W8MII 1292-17-B  
 W8WYF 902-19-B  
 W8JZR 290-10-C

CENTRAL DIVISION

W8HKK 113679-51-A  
 W8FEM 71340-58-A

W9MIM 64920-60-B  
 W9KJY 63200-50-B  
 W9DRN 59970-63-B  
 W9KEH 57310-55-B  
 W9EMN 41856-48-B  
 W9IPT 35830-52-B  
 W9IYA 34944-42-B  
 W9SOW 29640-52-B  
 W9AND 29601-39-A  
 W9CEO 27417-37-A  
 W9LIV 26910-45-B  
 W9FFQ 26620-55-B  
 W9AYO 21357-63-C  
 W9FTH 20962-47-B  
 W9PVM 19106-41-B  
 W9NDB 18768-34-B  
 W9NUF 14760-36-B  
 W9SQY 13448-27-A  
 W9RHE 12276-31-A  
 W9LCO 11696-43-C  
 W9PBU 10508-37-B  
 W9LVD 9960-40-C  
 W9ACU 8262-27-A  
 W9PLL 7560-24-A  
 W9DGT 7200-40-C  
 W9PAR 7000-40-C  
 W9LIZ 6818-29-B  
 W9NBM 6120-34-C  
 W9IVC 5760-30-B  
 W9REC 5451-23-A  
 W9MCC 5100-34-C  
 W9FAU 5050-25-B  
 W9LPK 4619-31-C  
 W9PQA 4494-21-B  
 W9KA 4384-32-C  
 W9DDO 4200-20-A  
 W9KZV 4100-25-B  
 W9RSL 4080-24-B  
 W9KHD 3960-30-C  
 W9KJX 2376-22-B  
 W9STG 2240-16-B  
 W9RKR 1840-23-C  
 W9MUX 1826-22-C  
 W9CKC 1690-13-B  
 W9KQK 1650-10-B  
 W9JSL 1540-22-C  
 W9RBR 1456-14-B  
 W9FTX 1350-15-B  
 W9KXD 1330-11-B  
 W9MWO 1282-17-B  
 W9ANQ 1120-20-C  
 W9PTW 1023-11-A  
 W9SUI 756-12-A  
 W9MFL 720-10-B  
 W9PLX\* 588-14-C  
 W9EYF 468-6-A  
 W9LIZ 414-9-B  
 W9GMT 360-9-B  
 W9LXN 359-11-C  
 W9OLD 210-5-A  
 W9MFO 160-5-B  
 W9AJM 160-5-A  
 W9SBC 128-8-A  
 W9CKA 98-7-C  
 W9AQ\* 80-4-B  
 W9SVY 42-3-B  
 W9WR/APY 6-1-C  
 W9V 3-1-C  
 W9IUF\* 2-1-C

Kentucky

W8AUI 83552-68-C  
 W9GGB 41106-58-C  
 W9PLM 13772-44-C  
 W9OMW 13572-26-A  
 W9HWJ 600-12-B  
 W8HUD 84294-63-A  
 W8CQB 58116-58-B  
 W8GRN 37024-52-B  
 W8DED 31222-67-B  
 W8AIN 31200-40-A  
 W8BGY 30680-40-AB  
 W8HSH 21866-58-C  
 W8IBH 20400-34-B  
 W8SGP 15808-32-B  
 W8IFM 14530-40-BC  
 W8IOR 13496-28-B  
 W8DSQ 13020-28-A  
 W8HSQ 12390-35-B  
 W8ITL 10948-34-B  
 W8DYK 9844-44-C  
 W8FTW 6732-17-B  
 W8SIN 6192-23-A  
 W8DU 4968-27-B  
 W8OWM 4800-27-B  
 W8JCO 4650-25-B  
 W8UCI 4525-35-C  
 W8HBZ 3940-24-B  
 W8GWR 3534-19-A  
 W8EMT 2266-11-B  
 W8KNT 2328-18-B  
 W8MPT 1716-11-A  
 W8LVS 1536-12-AB  
 W8MQU 1078-11-B  
 W8LHH 900-6-A  
 W8LSU 872-8-AB  
 W8CQS 168-6-B  
 W8EKT\* 72-6-C  
 W8AMS 50-5-C

Ohio

W8KJW 61878-62-B  
 W8KFC 53142-51-B  
 W8JDN 46004-53-B  
 W8EFD 38054-53-B  
 W8AQ 37695-61-C  
 W8KZO 35510-53-B  
 W8CGU 33908-49-B  
 W8LJI 31941-30-A  
 W8CMB 30456-47-B  
 W8LAW 27990-45-B  
 W8BYD 23328-26-A  
 W8LZK 22272-32-A  
 W8MAE 19392-32-A  
 W8IEF 17820-33-A  
 W8EWF 13280-39-B  
 W8BYM 10560-44-C  
 W8KQU 10490-40-C  
 W8LJY 10153-24-A  
 W8BSR 10032-33-B  
 W8MCO 9309-29-A  
 W8RLM 9170-31-B  
 W8FKW 9044-38-B  
 W8MCO 8922-22-B  
 W8MLJ 8648-46-C  
 W8AAJ 7149-26-A  
 W8MHM 6420-30-B  
 W8ITR 6156-18-A

6228-36-C  
 6016-32-B  
 4740-20-A  
 3990-33-C  
 3218-17-B  
 1820-14-B  
 1680-24-C  
 1296-12-B  
 1218-21-C  
 930-10-B  
 16-2-B

Michigan

84294-63-A  
 58116-58-B  
 37024-52-B  
 31222-67-B  
 31200-40-A  
 30680-40-AB  
 21866-58-C  
 20400-34-B  
 15808-32-B  
 14530-40-BC  
 13496-28-B  
 13020-28-A  
 12390-35-B  
 10948-34-B  
 9844-44-C  
 6732-17-B  
 6192-23-A  
 4968-27-B  
 4800-27-B  
 4650-25-B  
 4525-35-C  
 3940-24-B  
 3534-19-A  
 2266-11-B  
 2328-18-B  
 1716-11-A  
 1536-12-AB  
 1078-11-B  
 900-6-A  
 872-8-AB  
 168-6-B  
 72-6-C  
 50-5-C

5421-39-C  
 3229-21-A  
 5040-28-B  
 4508-23-B  
 4464-16-A  
 4216-31-BC  
 4104-18-B  
 3136-32-C  
 2618-22-C  
 2448-17-B  
 2352-14-A  
 2349-27-BC  
 2244-17-B  
 2200-20-B  
 2124-18-C  
 2074-17-B  
 1568-16-B  
 1300-13-B  
 1204-14-1B  
 962-13-B  
 810-9-B  
 336-12-C  
 320-10-C  
 132-6-B  
 60-3-B  
 2-1-C

Wisconsin

32412-37-A  
 31842-61-BC  
 29536-52-B  
 28490-45-B  
 19902-31-A  
 19304-39-B  
 18840-35-B  
 14847-42-C  
 11748-44-C  
 7296-32-B  
 4452-21-B  
 4408-17-B  
 3024-18-A  
 2704-26-C  
 2520-30-C  
 2312-17-B  
 1953-21-C  
 1590-15-B  
 1260-15-C  
 1012-11-AB  
 874-19-A  
 864-9-A  
 452-9-A  
 32-2-B

NORTH DAKOTA

W8EYI 44880-55-B  
 W8GRE 27349-49-B  
 W8BTJ 17220-42-B  
 W8DGS 6816-26-B  
 W8LHS 2112-28-C  
 W8PGO 1600-16-B

South Dakota

W8BLZ 17596-53-C  
 W8FOQ 13266-33-A  
 W8CFU 96-4-B

So. Minnesota

W8DMA 50020-61-B  
 W8EFK 30881-63-C  
 W8GNU 8084-43-C  
 W8JEG 7784-28-B  
 W8HZU 3712-32-C  
 W8DEI 3030-30-A  
 W8ADQ 1440-12-A  
 W8DHI 1407-21-C  
 W8DOP 714-17-C

No. Minnesota

W8DNY 27755-43-A  
 W8LJV 11924-44-A

1 Station Score. Les. 848, Elmer 15. 2 Station Score. EFM 1056, CRM 868. 3 Station Score. W3COK 1152, W3CVU 16, 4 W3DXQ operating. 5 Station Score. IVE 9700, Art 744. 6 Station Score. IVE operators. W8LSE, W8IFY, W8IOH, W8IOT, W8KXP. 7 Station Score. Two ops, W8JSL, W9CIEH. 8 Station Score. VB 20706, MEZ 1050. 9 W8XDM 560, W8CND 144. W8IAS 24. 10 Station Score. W8KJG 1760, W8VZ 4512, W8SBR 4002, W8EJA 3298, W8HIE 294, W8CKE 193. 11 Portable in Dayton, Ohio. 12 W8LWQ operating. 13 Station Score. Two operators, W8HZU, W9HGN. 14 Station Score. three operators. 15 Station Score. W2FIS 86121. 16 Station Score. Six operators. W2BVK, W2COU, W2CJD, W2GTU, W2DFO, W2FZS. 17 Station Score. W3BDL 14580, W3BQN 10140, W2BWP 7920, W2DEW 4512, W2EYN 6448, W2CJL 80, W3CPY 48, W2EJ 4, W2AQY 2. 18 Hal Bubb operating. 19 WIFCZ operating. 20 Station Score. W1EOB 34960, W1LTF 504, W1JQ 48. 21 Station Score. W1EFP 21850, W1AK 65. 22 W1VQ operating. 23 Station Score. W6BXL 56058, W6GFP 12, W6GIE 12. 24 Station Score. Three operators. W6LIE, W6JXC, W6VQ. 25 W6SDZ operating. 26 Station Score. W4TTP 22026, W4RP 2 276. 27 Station Score. W8ELI 1920, W8BCQ 110. 28 W5AND operating. 29 W5BSP operating. 30 Portable in Pecon, New Mexico. 31 Station Score. VE1HG 13170, VE1EP 8265, VE1ET 36. 32 Station Score. Sandy 8750, Jack 3400. 33 Station Score. two operators.

W9OWV 9483-29-A  
W9MOV 5832-27-B  
W9BRA 5096-26-B  
W9WLD 4800-30-C  
W9WRT 2562-14-A

DELTA DIVISION

Arkansas  
W8ASG 92628-62-A  
W8BSG 51840-64-AB  
W8CNK 50589-63-C  
W8DHL 20088-36-A  
W8DYU 3648-19-C  
W8MTJ 2940-21-B  
W8ELP 2016-18-B  
W8BTX 6-1-B

Louisiana  
W6BZR 57544-62-B  
W5KC 44712-64-B  
W5DAW 7392-28-A  
W5RLF 2475-15-A  
W5CMQ 648-9-A  
W5EMS\* 72-4-B

Mississippi  
W5DEJ 28968-51-B

Tennessee  
W4PL 54120-60-B  
W4GX 30322-39-B  
W4AYV 16264-38-B  
W4BBT 7074-27-B  
W4ZZ 400-10-B  
W4RAO 306-9-B  
W4BMH 120-4-A

Hudson Division

Eastern New York  
W2PQG 28340-32-A  
W2DDW 24360-28-A  
W2EJN 23192-52-C  
W2HAN 22272-29-A  
W2ESO 22155-35-A  
W2ATM 14742-21-A  
W2GPM 8910-27-B  
W2ACY 8320-32-B  
W2BLU 5842-23-B  
W2BWD 5481-29-C  
W2CXE 4800-20-B  
W2CJM 4148-34-C  
W2AQN 3100-31-C  
W2GGP\* 2618-22-C<sup>13</sup>  
W2BJX 2520-14-B  
W2HCZ 2112-24-C  
W2CBN 1968-16-A  
W2GFM 1512-14-A  
W2GZF 1386-11-A  
W2CTL 1116-12-B  
W2CJT 1100-11-B  
W2DSH\* 2-1-C

N. Y. C. and L. I.  
W2GWE 87759-63-BC<sup>14</sup>  
W2BGO 55572-44-A  
W2DBE 37012-38-B  
W2FDQ 34408-46-C  
W2HNQ 18629-47-C

W2AYJ 17250-50-C  
W2AHC 15810-51-C  
W2RYS 14803-37-C  
W2CKQ 13840-31-B  
W2WVE 12129-38-C  
W2GP 11346-31-B  
W2ALY 11232-26-A  
W2ESK 9315-35-C<sup>15</sup>  
W2GVK 8460-20-A  
W2RKO 7644-26-A  
W2AOD 7425-33-C  
W2FRK 7112-28-B  
W2BCB 5700-30-B  
W2GTO 5548-38-B  
W2GKU 5350-25-B  
W2HJK 4268-22-B  
W2GMP 4050-18-A  
W2HBO 3168-16-B  
W2ECL 2336-16-B  
W2ETT 2328-24-C  
W2HDT 2130-15-B  
W2DUA 2080-26-C  
W2GNX 1836-12-A

W2GEL 1350-10-AB  
W2CHK\* 1120-16-C  
W2AOT 1008-12-B  
W2EVA 1003-17-C  
W2HDN 980-10-B  
W2GVY 560-14-C  
W2ESZ 544-14-C  
W2CUH 520-10-B  
W2EHF 150-2-A  
W2HDF 120-3-B  
W2HDG 54-3-B  
W2AWQ 6-1-B  
W2BWD 2-1-C

No. New Jersey  
W9DPP 55125-63-C  
W2BSC 68112-49-BC<sup>16</sup>  
W2DQH 50738-42-B  
W2BLV 49060-55-B  
W2CUK 47734-58-C  
W2DMY 47136-48-B  
W2FGG 41904-36-B  
W2ABS 41004-51-B  
W2DYO 38704-41-B  
W2CLM 35088-51-B  
W2CFW 31500-45-B  
W2CFW 16828-38-B  
W2CW 18900-42-B  
W2GQX 15232-32-B  
W2EQQ 14528-32-B  
W2LKL 11271-39-C  
W2EYV 11250-30-ABC  
W2DUB 11088-28-B  
W2FQR 10854-27-B  
W2FOA 10080-35-B  
W2GBY 8756-22-B  
W2AGU 8400-30-B  
W2GBD 8050-23-B  
W2ECO 7852-26-B  
W2HMP 7488-26-B  
W2ZHC 7260-20-A  
W2FAV 6498-19-B  
W2HNP 6118-23-B  
W2FOP 5017-29-C  
W2GGW 4698-18-A  
W2GKK 4268-22-B  
W2DCP 4059-23-C  
W2DGE 3876-19-B  
W2EPG 3572-19-B  
W2EOH 3564-33-C  
W2FBS 3016-29-B  
W2CJX 2976-24-B  
W2GKE 2440-20-B  
W2EUV 2289-20-C  
W2GVZ 1716-22-C  
W2BZQ 1239-21-C  
W2GON 1230-10-A  
W2EYZ\* 1176-14-B  
W2FFE 1056-11-A  
W2GHB 693-11-A  
W2EIG 348-6-B  
W2CHZ 224-7-B  
W2GQG 120-5-B  
W2ZAE 99-4-AB  
W2BFP\* 30-4-B  
W2CJF 20-2-B  
W2GTA 6-1-A

New England Division

Connecticut  
W1CLH 54221-57-BC  
W1MK 51093-63-C<sup>17</sup>  
W1BSS 46116-42-AB  
W1GME 32984-38-B  
W1AVV 23408-53-B  
W1BEI 25162-46-B  
W1UUE 21074-41-B  
W1ACV 18900-42-B  
W1BDI 10560-40-BC  
W1LEJ 7999-31-B  
W1NE 7854-34-C  
W1DBU 7524-19-A  
W1CEJ 7344-27-B  
W1DLX 6096-16-A  
W1HYF 3978-17-B  
W1GKM 2112-16-B  
W1APA 1650-15-B  
W1EAO 1650-26-C  
W1BDE 918-17-C  
W1BHM 750-15-C  
W1CTI 65-5-C  
W1GTW 54-3-B

Maine

W1CPS 32912-44-B  
W1DHE 23036-52-C  
W1OR 11692-37-BC  
W1GRJ 11220-34-B  
W1EAF 7776-27-B  
W1CDX 5750-23-B  
W1DHI 3276-18-B  
W1JF 480-10-B  
W1EZR 180-5-A

Midwest Division

Iowa  
W9FDL 26364-58-C  
W9SJO 23184-49-B  
W9FZO 20592-44-B  
W9RQR 20358-39-A  
W9MHV 17458-48-B  
W9AEW 10244-52-C  
W9LEZ 8405-41-C  
W9DIB 6928-26-A  
W9CWD 4520-20-AC  
W9RDK 3820-20-B  
W9ORS 3080-28-C  
W9LSY 1716-13-A  
W9FHC 540-0-B  
W9EHM\* 354-12-C  
W9CCE\* 90-3-A

Kansas  
W9AWP 37800-54-B  
W9CWF 21000-50-B  
W9MFW 17325-33-A  
W9FET 3379-31-C  
W9EHA 2376-18-A

Missouri  
W9JL 82167-61-A  
W9GBJ 71492-61-B  
W9DHN 69426-63-B  
W9OLC 66880-60-B  
W9DCB 53890-60-B  
W9MZF 81360-56-BC  
W9BWX 81255-47-AB  
W9KTV 30600-51-BC  
W9SFO 27300-50-B  
W9KCG 13000-30-A  
W9KOL 18202-41-B  
W9MLR 12720-35-B  
W9OUD 3050-26-B  
W9IGW 7224-28-B  
W9SKB 6072-22-A  
W9RJP 5481-21-AB  
W9LBB 5098-28-AB  
W9DIC 4940-26-B  
W9RME 3672-17-A  
W9LWG 1120-16-B  
W9KIK 648-12-B  
W9RMA 288-6-A  
W9BEU\* 90-5-C

Nebraska  
W9LFE 80640-56-A  
W9DMY 47444-58-B  
W9FTX 44128-56-B  
W9DI 1386-11-AB

New England Division

Connecticut  
W1CLH 54221-57-BC  
W1MK 51093-63-C<sup>17</sup>  
W1BSS 46116-42-AB  
W1GME 32984-38-B  
W1AVV 23408-53-B  
W1BEI 25162-46-B  
W1UUE 21074-41-B  
W1ACV 18900-42-B  
W1BDI 10560-40-BC  
W1LEJ 7999-31-B  
W1NE 7854-34-C  
W1DBU 7524-19-A  
W1CEJ 7344-27-B  
W1DLX 6096-16-A  
W1HYF 3978-17-B  
W1GKM 2112-16-B  
W1APA 1650-15-B  
W1EAO 1650-26-C  
W1BDE 918-17-C  
W1BHM 750-15-C  
W1CTI 65-5-C  
W1GTW 54-3-B

Maine

W1CPS 32912-44-B  
W1DHE 23036-52-C  
W1OR 11692-37-BC  
W1GRJ 11220-34-B  
W1EAF 7776-27-B  
W1CDX 5750-23-B  
W1DHI 3276-18-B  
W1JF 480-10-B  
W1EZR 180-5-A

Massachusetts

W1BIV 52400-50-B  
W1BY 32440-52-B  
W1BEF 25674-39-B  
W1ABG 22168-34-B  
W1BWI 19008-26-AB<sup>18</sup>  
W1DDE 14550-25-A  
W1GCI 11544-39-B  
W1GEN 10820-30-B  
W1CRO 9854-26-AB  
W1KH 9728-32-B  
W1CWZ 9424-38-AC  
W1WV 8176-28-ABC  
W1ESI 7176-23-B  
W1GKA 6528-17-A  
W1HGD 5566-23-B  
W1ECC 4768-32-C  
W1HVP 4380-20-A  
W1DDU 4320-18-A  
W1DDC 3696-21-B  
W1AIO 3424-16-B  
W1ENI 2368-16-B  
W1HCA 2184-21-B  
W1DGE 2080-19-B  
W1HKY 1408-19-C

W1MD 480-10-B  
W1HJP 394-8-B  
W1HIO 256-8-B  
W1BB 100-8-A  
W1ETE\* 72-8-A  
W1CRS 24-8-C  
W1FET 8-2-C

Massachusetts

W1ASY 42896-58-BC  
W1AIA 38272-48-B<sup>19</sup>  
W1COI 36576-48-AB  
W1EBF 22500-50-C<sup>20</sup>  
W1GUO 14320-28-A  
W1FFJ 10608-28-A  
W1IHL 6072-22-A  
W1DCH 6048-21-A  
W1HRV 8792-28-BC  
W1DIE 8344-28-B  
W1FAJ 4320-20-B  
W1LIT 3672-18-B  
W1DWO 3626-16-B  
W1FFK 1344-14-B  
W1AFL 935-17-C  
W1GXL 377-13-C  
W1BPN 360-0-B  
W1AJ\* 4-1-B

New Hampshire

W1DMD 32704-56-C  
W1AVJ 28202-59-BC  
W1CUN 26322-41-B  
W1BLA 14964-29-B  
W1HUD 14352-48-AC  
W1HPX 11426-29-B  
W1APQ 10125-25-A  
W1BAG 8932-29-AB  
W1FGC 3634-26-AB  
W1HJ 4928-22-B  
W1HFO 1190-17-B  
W1GEY 900-11-B  
W1EQG 48-8-B

Rhode Island

W1GBO 6552-28-C  
W1GV 5346-22-A  
W1BEG 4128-24-A  
W1BJA 2130-15-B  
W1GTS 1690-13-B  
W1BBN 290-8-C  
W1BML\* 2-1-C

Vermont

W1ELR 55145-41-AB  
W1EZ 37674-42-A  
W1EFC 19845-35-A  
W1GNF 4050-18-A

Northwestern Division

Alaska  
K7CHP 4380-15-B  
K7DVF 2244-22-C

Idaho

W7BRP 15678-39-B  
W7DBU 8928-32-A

Montana

W7BSU 32940-60-C  
W7EAT 14678-41-B  
W7ES 10240-40-B  
W7ESQ 4760-28-B  
W7EDJ 1776-16-A

Oregon

W7DMS 44368-59-B  
W7COB 23460-46-B<sup>21</sup>  
W7DWB 6664-34-B  
W7UJ 6612-38-BC  
W7EIA 6428-17-A  
W7CTL 1920-15-B  
W7DUE\* 396-9-B

Washington

W7CNM 20868-47-B  
W7DLN 12852-34-B  
W7AKP 10164-33-B  
W7ERO 7560-34-C  
W7CMO 5600-29-B  
W7DGY 5200-20-B  
W7JUS 5014-23-B  
W7WY 1677-13-A

W7EWA 1672-19-C  
W7EAW 1160-11-B  
W7ECX 1100-11-B  
W7BRT 1040-13-B  
W7LD 591-11-A  
W7COB 702-9-A  
W7AFR 120-4-C  
W7BL 32-4-C  
W7BST\* 66-4-C  
W7EJD 2-1-C

Pacific Division

Hawaii  
K6ESV 7560-30-B  
K6MV 2-1-C

Nevada

W6BPO 41071-67-C  
W6JHV 35190-51-A

Los Angeles

W6H2T 55332-58-AB  
W6BXL 51025-65-ABC<sup>22</sup>  
W6CGP 28246-58-C  
W6KRI 16885-47-AC  
W6CVV 14892-51-BC  
W6IOX 13498-56-C  
W6FVD 9240-22-A  
W6LDZ 8280-45-C  
W6KHV 7476-42-C  
W6KTK 7200-25-B  
W6FZL 6318-39-C  
W6KJG 5096-26-B  
W6AIF 4488-34-C  
W6FXL 3024-21-B  
W6GXM 2538-27-C  
W6GIG 2200-20-B  
W6HSO 1872-16-A  
W6BCF 1190-17-B  
W6KRT 672-8-A  
W6FMO 4-1-B  
W6LVS 2-1-C  
W6KVP\* 2-1-C

Santa Clara Valley

W6ELT 34892-61-C  
W6AZC 25620-60-BC

East Bay

W6LRN 29524-61-C  
W6PFU 22336-62-C  
W6AF 1470-21-C  
W6KZF 1353-11-A  
W6LDD 1161-9-A

San Francisco

W6OEM 89334-63-B  
W6BPI 71553-64-BC<sup>23</sup>  
W6JDG 18088-38-B  
W6MR 5850-39-C  
W6JRH 3898-36-B  
W6BU 3850-25-B<sup>24</sup>  
W6IPH 3288-19-B  
W6JAL 3240-15-A  
W6HR 3180-15-B  
W6HJP 3072-16-A  
W6JTS 2556-18-B  
W6JWW 2482-17-B  
W6CAL 2440-20-B  
W6CIS 372-12-C  
W6BYL 300-5-A

Sacramento Valley

W6EUL 30888-54-B  
W6DVE 15540-42-B  
W6GDV 12150-50-C  
W6GUK 8947-43-C  
W6GAC 2520-12-A  
W6GZY 280-7-B

Arizona

W6IQY 20068-58-C

Philippines

KA1HR 2-1-C

San Diego

W6HEX 48678-61-B  
W6BZD 42276-52-A  
W6HVV 12850-50-C  
W6KBD 2520-21-B

(Continued on page 104)

# Push-Pull-Push Oscillator Circuits for 15-Watt Second-Harmonic Output

Tri-tet and Electron-Coupled Arrangements for 59 and Similar Tubes

By J. Stanley Brown,\* W3EHE

SINCE the advent of the 50-watt pentode transmitting tubes, most of us have looked dubiously at our oscillator-buffer-doubler-amplifier rigs, complete with their link coupling and plug-in coils for all stages and bands. One of these new pentodes is comparatively expensive; but its use would enable the operator to throw out most of the clutter in the front end of the set and thereby greatly simplify the whole rig. Even when doubling, one of these tubes (RK-20) will give stable excitation more than adequate for several hundred watts of final amplifier input. Also, since the advent of the above-mentioned tube and as a sequel to the good old 59, several manufacturers have produced well-made 10-watt pentodes expressly for transmitting purposes. These tubes live up to their rating for output at crystal fundamental and in the exciter-transmitter to be described in this article can be relied upon, along with the versatile 59, to deliver very nearly their rated output at second harmonic. While third- and fourth-harmonic output of fair proportion is also possible, for best results some further complication of the circuits is required.

The experimental exciter-transmitter built by Herbert F. Main, W3ERL, from the original sketches and some of the theory following, contained two 59 tubes and gave stable output of 15 watts into a closely coupled, tuned lamp circuit. The input to the two tube plates was 50 mils at 425 volts. The crystal was in the 3500-ke. band and the output was at double frequency, an apparent plate efficiency of about 70% at a load well within the manufacturers rating being realized. Under these conditions this little transmitter was keyed in the cathode circuit to produce the cleanest T9X signal anyone ever heard. A rough check of the r.f. crystal current showed only normal values.

Although the experimentation with this particular circuit is far from complete, it has such universal possibilities as an exciter or low-powered transmitter that it is thought best to tell what is now known about it and to let the A.R.-R.L. membership at it to bring out its full possibilities. Some of the suggested uses are: Keyed oscillator and doubler, crystal controlled; straight

electron-coupled oscillator; suppressor-grid modulated low-powered 'phone; automobile portable, code or 'phone, using the 6.3-volt pentodes such as the new 802. Before getting into detail, all due credit to Jim Lamb, Lieutenant Dow and (I prefer to think) Edwin H. Armstrong.

## ANALYZING THE CIRCUIT

The basic circuit is shown in Fig. 1 for straight push-pull crystal control and push-push for second harmonic output. Fig. 2 indicates the

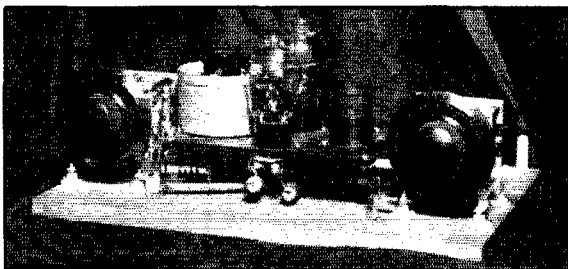

**GOOD FOR 15 WATTS OF SECOND-HARMONIC OUTPUT**  
*Front view of the experimental push-push Tri-tet oscillator built by W3ERL from the author's circuit design. The tub-like shield to the left of the tubes surrounds the L<sub>1</sub>-L<sub>2</sub> combination.*

grid and cathode circuit changes for electron-coupled self-control, which circuit cannot be expected to key very well unless the cathodes, grids and screens are allowed to run as a push-pull triode oscillator and positive plate lead only is broken by the key. Separate power supplies for screen and plate circuit would provide means of keying the ungrounded plate supply negative to the cathode, but this method is mostly a lot of complication. Using one of the new AT-cut crystals there is no reason why two RK-20 tubes could not be used in this same circuit to produce their full rated output at second harmonic.

Analyzing the crystal-controlled doubling circuit, we first lay a rule or straight edge on the diagram so as to cover all the elements individually associated with one of the tubes, as shown in Fig. 3. Then, except for the queer looking grid tank, we have a circuit that begins to look conventional. If the open lead from the crystal is connected to the cathode tap (top) of L<sub>1</sub>, and L<sub>2</sub> is shorted out, we have a Tri-tet with a funny-looking grid circuit that should be cut in two,

\*3039 Macomb St., Apt. 30, Washington, D. C.

horizontally, and then have the cathode r.f. choke removed. The circuit then becomes the original Tri-tet with the crystal direct-coupled.

Go back to the circuit of Fig. 1 and it will be apparent how the original conception of the push-pull/push-push Tri-tet was arrived at. While the rig may not appear to be a Tri-tet because of the inductive coupling between cathode and crystal-grid circuit, the Armstrong regenerative effect gives us a rig, which, when oscillat-

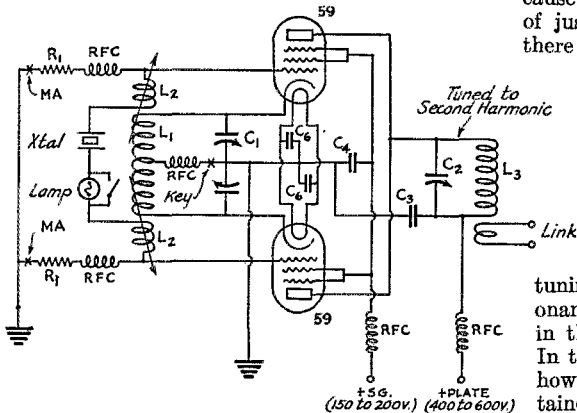

FIG. 1—THE EXPERIMENTAL TRI-TET PUSH-PUSH DOUBLER CIRCUIT

For fundamental output, the plates are connected push-pull.

$L_1$ —Wound on  $1\frac{1}{2}$ -inch form to tune to crystal fundamental at full capacitance of  $C_1$ . For crystal frequency in 1750-kc. band, 45 turns No. 22 d.c.c.; 3500-kc. band, 18 turns No. 16 d.c.c.; 7000-kc. band, 7 turns No. 16 d.c.c. (See Handbook).

$L_2$ —Approximately one-quarter as many turns as  $L_1$ . See text.

$L_3$ —As usual for frequency. See table in transmitting chapter of Handbook.

$C_1$ —125- $\mu$ fd. split-stator condenser (250- $\mu$ fd. per section).

$C_2$ —50- or 100- $\mu$ fd., preferably double-spaced.

$C_3, C_4, C_6$ —0.005- $\mu$ fd. tubular paper type (1000-volt).

$R_1$ —50,000-ohm 2-watt non-inductive resistor.

RFC—High-frequency type r.f. chokes.

ing, we still prefer to associate with the Tri-tet. While we are on the subject of inventors and credit, we should skip to Fig. 2 long enough to recognize Dow and the self-controlled electron-coupled version.

The operation is rather simple of explanation: With all circuits established, screen current begins in both tubes. This current splits in  $L_1$  and flows, in a truly balanced circuit, equally to either cathode. Ordinarily nothing but space current saturation would be the result. However, a certain amount of unbalance is bound to be present and the swing of one grid will differ from that of the other, thereby causing screen and plate current differential and regeneratively induced oscillation to take place with the crystal controlling the frequency.

If the plates are wired push-pull and tuned to crystal fundamental in a circuit built with good

grid-plate circuit isolation, no neutralizing seems to be essential—even when using 59's. The most useful version, however, is in accordance with Fig. 1 in which the plates are parallel connected to a tank circuit tuned to the second harmonic. The output for this arrangement, as pointed out in numerous other articles on doublers, is one complete plate cycle for each half-cycle of grid alternation. The output is very nearly as good as with the fundamental push-pull arrangement, because this circuit is a "natural" doubler instead of just a harmonic amplifier. When doubling there is the equivalence of a buffer stage between

input and output because of the electron coupling hence the lack of any tendency to "pull." Also, the circuit acts exactly like the conventional Tri-tet, becoming very stable when the capacity of  $C_1$  is decreased considerably from the resonant value. If the rig is being keyed, this adjustment should be made with the aid of a monitor. Too much "lead" of cathode tuning causes the dots to miss, while close resonance between the crystal and  $L_1/C_1$  results in the lowest output and the least stability. In the case of the Dow version of the circuit, however, exact resonance should be maintained and  $C_1$  should be about 350  $\mu$ fd. maximum.

#### CIRCUIT VALUES

Coils and condensers are the usual sizes given in *QST* and the *Handbook* for conventional circuits. For crystal operation the maximum capacity of  $C_1$  can be about 125  $\mu$ fd. and that of  $C_2$  about 50- to 100- $\mu$ fd. In the experimental model,  $L_1$  was on a 7-prong coil form with coils  $L_2$  wound on thin tubes telescoping over the main winding. Coils  $L_2$  must be arranged suitably for the initial coupling adjustments and each require about 25 percent of the turns on  $L_1$ . They can be cemented in place after all adjustments. It may be neces-

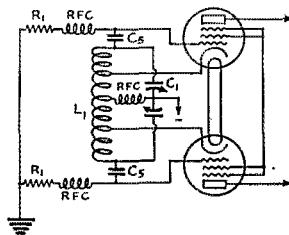

FIG. 2—THE INPUT CIRCUIT RE-ARRANGED FOR SELF-CONTROLLED ELECTRON-COUPLED OPERATION

Values are as in Fig. 1, except condensers  $C_1$  which are 250- $\mu$ fd. mica type.

sary to reverse leads to each  $L_2$  coil to obtain oscillation. All coils are wound in the same direction. Close coupling of  $L_1/L_2$  and low plate volt-



age are advisable while finding the adjustments that produce oscillation. Although some unbalance is theoretically necessary to start oscillation, the grid-cathode circuits should be balanced as well as possible by means of a milliammeter inserted in jacks located in the grid returns at the points in Fig. 1 marked "MA." Also, to avoid

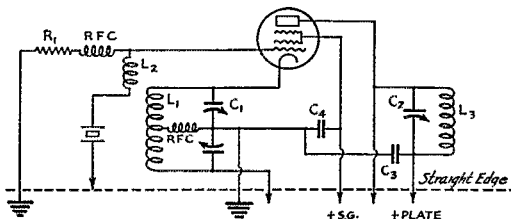

FIG. 3—THE LOWER HALF OF FIG. 1 CUT OFF TO SHOW COMPARISON WITH THE BASIC TRI-TET CIRCUIT

damage to the crystal, a 6-volt dial light is placed in series with it during initial adjustment. This bulb will show dull red at 40 to 50 mils r.f. and full brilliancy at about 150. The bulb used may be calibrated on d.c. with a milliammeter. Unless an AT-cut crystal is used, the crystal r.f. current should be kept somewhat under what appears to be 100 mils. The lamp should be shorted out after all adjustments are made.

In adjusting the coupling to the crystal, the coils  $L_2$  should be backed off as far as is consistent with required output and stable operation during keying. This gives the least crystal current.

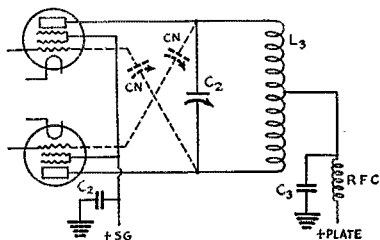

FIG. 4—THE PUSH-PULL PLATE CIRCUIT FOR FUNDAMENTAL-FREQUENCY OUTPUT

Connections for neutralization are shown by the dash lines.

The cathode-screen tank condenser must be split as shown to avoid parasitics, and the plate tank condenser must be single-section for both push-pull fundamental and push-push second harmonic operation. By-passes should be liberal in size. The new high-voltage paper variety has been found to be as satisfactory as the more expensive moulded mica variety. There is some question whether all of the r.f. chokes shown are required. So far the plate circuit has not required one and it is believed that the grid chokes could be removed and grid resistors of the non-induc-

tive variety connected between the ends of  $L_1$  and the respective grids. The screen choke and the choke to the center tap of  $L_1$  should be allowed to remain as shown. Removal of the screen choke will cause loss of output. Removal of the center tap choke will cause loss of excitation and parasitics.

The photographs show views of the original experimental set intended to drive a pair of tens or a 203-A. It has a great deal more output than the tens can stand when biased at 2.5 times cutoff with 600 to 700 volts on their plates. This was with link coupling, which of course helps to realize exciter r.f. output to best advantage. No attempt has been made to realize more than 15 watts of r.f. output from the circuit, but there is every evidence in favor of 20 to 25 watts available with safely higher voltages. Before any attempts are made to obtain the maximum possible stable output, an accurate means of checking the crystal r.f. current should be provided. In the case of 59's there seems to be no advantage in

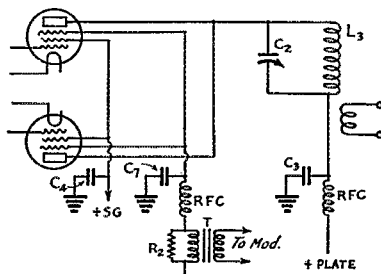

FIG. 5—ARRANGEMENT OF THE CIRCUIT FOR SUPPRESSOR-GRID MODULATION

$C_7$  is a 0.002- $\mu$ fd. mica type by-pass condenser, T the usual 1-to-1 coupling transformer and  $R_2$  a 10,000-ohm 2-watt resistor for modulator loading.

screen voltages higher than 150. For 'phone operation this voltage should be obtained from a tapped bleeder across the plate power supply. For c.w. operation any convenient source of screen voltage will do.

It will be noticed from the photographs that the cathode-screen coil is in an aluminum can. This may be dispensed with if a metal shield is placed between the coil and the tubes. The plate and grid circuits are well isolated. This is especially necessary for output at fundamental when no neutralizing condensers are used.

One point of preliminary operation should be stressed especially. Inasmuch as the coils  $L_1$ - $L_2$  are necessarily cut-and-try affairs, it is logical that initial difficulty will be experienced in getting the rig to oscillate and when it first starts up it is apt to be in so weak a form that no neon lamp ever seen in these parts will give an indication. The thing to do is start up the receiver and use it as a monitor to locate the first feeble peeps. After oscillation is obtained, make the tuning,

coil and coupling adjustments. It is a revelation the way a pure d.c. signal blasts right in out of the supposedly dead circuit. Trim  $L_1$  so that the lowest frequency in the band is at nearly full

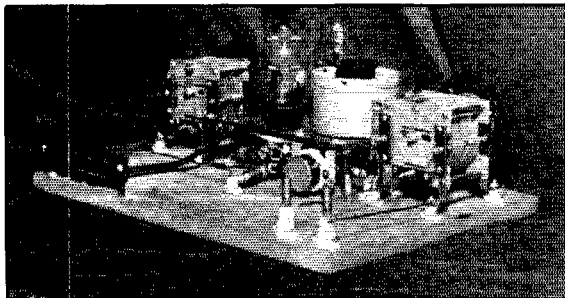

REAR VIEW OF THE UNIT, SHOWING CRYSTAL MOUNTING AND POWER SUPPLY TERMINALS

capacity when resonance is obtained. Adjust the coupling for even flow of current to the grids and to the least coupling that is required for excitation purposes. "Lead" the frequency feedback to

the crystal by means of rotating  $C_1$  towards minimum. Plug the 'phones into the monitor or frequency meter and check for drift with key down and also while keying. Any appreciable drift indicates crystal overload. For the 15-watt output condition there was no drift from a Y- or X-out crystal over a one-hour period, as judged by zero beat in a stable receiver, after an initial warming up period of the receiver. Keying in the cathode is not particularly productive of clicks and any of the conventional simple click filters suffice.

It is intended to do more experimenting with this circuit as soon as time and facilities permit, including tests of a more definite nature on 'phone operation and operation at the various amateur frequencies. So far we are led to believe that good output is available in but two bands for each crystal, but there is reason to believe that a method of good power output as a quadrupler can be developed. The author will be pleased to hear of suggestions that may occur to anyone.

## VK-Contest Results

Announcing Another Contest for October, 1935

By Robert H. Cunningham,\* VK3ML

**WE** GOT the kick of a life time during those thrilling four week-ends in October last! The Centenary Contest will live long in the minds of its many participants. The contest committee were rewarded by words of praise from hams in 50 countries of the world! To know a job well done and successful in the minds of the majority is man's richest reward. We find it hard to express our gratitude to those who helped the Aussies make the Centenary contest a success. Thanks, OMs, and the same to all amateur societies that assisted in announcing our contest.

The ham spirit is hard to down at any time. With the wonderful coöperation that donors<sup>1</sup> gave us, the Centenary contest proved the biggest in history. The number of tubes and meters was enough to stimulate any ham's heart. Aided by a measured map, cross checking logs, and a set of the rules, the committee had a tough job. Several disqualifications were made because of non-adherence to the rules. A number received more points than they originally claimed. Modest

\* Manager Melbourne Centenary Contest Committee.

<sup>1</sup>The Amalgamated Wireless Valve Company Ltd., Philips Lamps Ltd., and Siemens Bros. Ltd.

boys! The battle was between VK3MR and VK3GQ for the first place on the Australian list. VK3MR proved the winner of the contest. VK3HL was outright winner of the handicap section. The Council of the Victorian Division congratulates the winners. VK3MR with 100,320 points won the RCA 852. VK3GQ with 97,218 points was awarded the set of Siemens meters, and VK3JQ with 56,666 points won the RCA 800. VK3HL had the astounding score of 40,181, obtained with 23 watts, representing 1747 points per watt, winning the array of transmitting tubes offered for the handicap section. VKFTH, otherwise Mr. F. T. Hine of Campsie, N. S. W., put up the best effort in the world in the receiving contest. VE5BI's was voted the best station description. Outstanding overseas scores: W6CXW, 7854; PAOAZ, 4908; G2ZQ, 3850; J2GX, 3414; and VE5BI, 2256. W6CXW was closely followed by W9TB, W9FM, and D4BAR. X1AM put an R8 sig into VK with an indoor aerial . . . ZS5U uses 3 watts. VS6AH said it was tip-top. W8FGA says VK3ML and VK7RC were best VKs heard there . . . W5BOW uses an aerial 600 ft. long hi . . . G6HP is the lad who uses an O-V-O

(Continued on page 77)

# With the Affiliated Clubs

## Milwaukee Hamfest

THE Milwaukee Radio Amateurs' Club will hold its annual QSO Party (Hamfest) May 18th in the Elizabethan Room of the Milwaukee Athletic Club. Central Division Director Roberts, W8HC, will be present. All hams cordially invited. Prizes and fun for all. Reservations and details from Oliver E. Zander, W9DIJ, 904 S. 6 Street, Milwaukee, Wis.

## Emergency Equipment

Nine members of the Pike's Peak Amateur Radio Association on March 16th took a battery-operated transmitter and receiver to Camp Colorado, near Woodland Park, Colorado, and tested the Association's emergency equipment. This equipment consists of an 801 in a Hartley for transmitter, and conventional detector and two stages audio, using '01A's, for receiver. Power is obtained from dynamotors run from nine six-volt storage batteries. Setting the gear up in a cabin, and operating under conditions similar to those that would be encountered in case of an actual emergency, many successful contacts were made, from Louisiana to the west coast. The station was operated by W9EHC, W9AMS, W9TFT, W9HDI and W9LJF. The P.P.A.R.A. will have a 56-mc. rig at the summit of Pike's Peak this summer; the 14,109-foot altitude offers great possibilities for some new records.

The Mobile Amateur Radio Club's station, W4CIQ, is equipped with emergency generators. W4CIQ is Net Control Station for the Southern Emergency Net.

## South Jersey Cup Contest

The results of the South Jersey Radio Association's 1934 Cup Award, a contest for the "best station in South Jersey," are as follows: W3BEI, winner; W3ATJ, second; W3ENC, third; W3DYR, special award for best 56-mc. work. Points totalling 100 under each of four headings were the basis for all awards. The factors considered were: (1) Transmitters (quality,

interference, technical design and assembly, range, antenna system, band operation). (2) Receiver (layout, technical design and assembly, ease of operation, efficiency shown by log, modernization of equipment, monitoring facilities). (3) Operator (sending ability, receiving ability, station operation, use of available time to operate consistently). (4) General (neatness and tidiness, contributions to amateur radio, operation facilities, logging methods, operating tactics, frequency check facilities, experiments outside of regular station activity, familiarity with radio laws). These points seem to cover everything and should prove helpful to clubs planning station contests.

## Ludington Amateur Radio Association

Amateur radio in Ludington, Mich., took quite a step forward in August, 1932, when the Pere Marquette Railroad decided to move its radio station to another part of the city. This left a small building vacant as well as a 175-foot steel tower, for which there was no further use.

A group of enthusiastic hams immediately hit upon the idea of forming a club. Permission was granted to use the building and tower for a station. The Ludington Amateur Radio Association then came into being, and in the fall W8HXT went on the air as the club station. To-day activity is high, with portable contest work, local QSO parties, and other allied interests keeping up interest. All meetings are held in the club meeting

room in the First National Bank and Trust Company building; the railroad's building is used only for the club station. The tower is the envy of all visiting hams! Present officers: W8JWH, president; W8LLL, vice-president; W8IFQ, secretary-treasurer; W8JTK, activities manager.

## Low-Power Trophy Contests

The Northern Nassau Wireless Association is holding a series of low-power contests. A silver

*(Continued on page 58)*



OFFICERS, "THE WIVES OF RADIO AMATEURS CLUBS" OF DALLAS AND SAN ANTONIO, TEXAS

Left to right: Mrs. J. B. Rives (W5JC), Mrs. Bren Queureau (W5BJ), Mrs. L. D. Wall (W5ZAE), Mrs. W. I. Abbott (YF of the R.I., Dallas), Mrs. Frank M. Corlett (W5ZC). Other officers are: Mrs. J. D. Vance (W5DCS), Mrs. Gerald Morgan (W5ABQ) and Mrs. Alfred E. Crabtree. The members of these clubs are interested in hearing from other Wives' Clubs throughout the country; address the Dallas secretary, Mrs. Crabtree, 2812 So. Britton, Dallas, Texas.

for the

# EXPERIMENTER



## Portable 75-Meter 'Phone

**T**HE circuit diagram of a portable 75-meter 'phone transmitter which has been used with considerable success by Ben C. Brown, W6BZF, is shown in Fig. 1. Four two-volt tubes are used; the r.f. part of the set consists of a 30 crystal oscillator driving a 19 amplifier with the two sets of tube elements arranged in

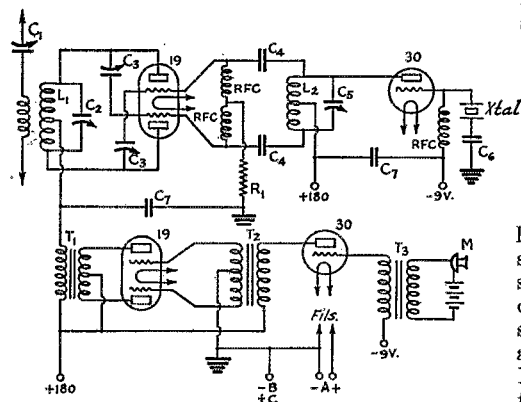

FIG. 1—BATTERY-OPERATED PORTABLE 75-METER 'PHONE

L<sub>1</sub>—32 turns No. 20 s.c.c. wire on receiving coil form; antenna coils 5 turns each.

L<sub>2</sub>—28 turns same, L<sub>1</sub> and L<sub>2</sub> both tapped at center.

C<sub>1</sub>—500- $\mu$ fd. variable.

C<sub>2</sub>—100- $\mu$ fd. midget variable.

C<sub>3</sub>—Neutralizing condensers; low-capacity trimmer or padding condensers.

C<sub>4</sub>—100- $\mu$ fd. fixed mica condensers.

C<sub>5</sub>—100- $\mu$ fd. midget variable.

C<sub>6</sub>—150- $\mu$ fd. fixed.

C<sub>7</sub>—0.01- $\mu$ fd. fixed.

R<sub>1</sub>—20,000 ohms.

T<sub>1</sub>—Class-B output transformer to couple Type 19 tube to load of approximately 6000 ohms (such as Collins 740 Z).

T<sub>2</sub>—Class-B input transformer to couple a Type 30 driver to Type 19 Class-B amplifier (such as Collins 750 X).

T<sub>3</sub>—Single-button microphone transformer.

M—Single-button microphone.

RFC—Short-wave type chokes.

push-pull, and the audio portion has a 30 speech amplifier driving a 19 Class-B amplifier. The input to the r.f. tube is about five watts.

W6BZF's rig is built into an ordinary monitor box, which shows that the outfit can be quite compact. It can be operated either from batteries or from a "B" eliminator having an output of 180 volts or less. Tuning adjustments would be the

same as with any other oscillator-amplifier and Class-B audio outfits. The neutralizing condensers, C<sub>3</sub>, are trimmers of the type used for padding receiving circuits, and should have fairly low capacity (the Hammarlund type EC-35, for example). Midget condensers are used to tune the oscillator and amplifier plate circuits, a standard-size receiving condenser being used for the antenna circuit because of the greater capacity needed. With five watts input the amplifier should be adjusted to draw 28 milliamperes at a plate voltage of 180, representing a modulator load impedance of about 6400 ohms. The Class-B output transformer should be one designed for a load of this order, although the exact value is not critical since the plate input to the r.f. amplifier can be adjusted readily to suit the particular transformer used.

As an interesting commentary on the high-vs.-low-power question, W6BZF writes that on several occasions he has asked other stations to stand by for the portable after having raised them on his 500-watt 'phone, the average difference in signal strength between the two being reported as about two points on the R scale. Reports of R7 to R9 have been obtained with the little set from stations up to 250 miles away in late afternoon.

## Speeding Up Rough Grinding

The following kink, one which assists in cutting down quartz crystals with rapidity and economy, may be of interest to amateurs who do not have complete metallurgical equipment. In rough grinding, the usual home method is to grind on glass with a course abrasive. Since ordinary window glass is not satisfactory, the more expensive plate glass must be used, and after a little use must be discarded because of the concave surface left by grinding.

It is possible to make a rapid job of cutting down a thick crystal to the approximate finished thickness by grinding it on a sheet of Wetordry Trimitite paper. A half or quarter sheet of grit 150-C taped down on all edges to a flat surface forms a rough but level base on which to grind. The actual grinding is done with water in the usual way, adding a little 280 mineral (silicon carbide) to the surface when cutting slows up. Thus the sandpaper replaces the plate glass for most of the work. The finishing touches should be

done with 400 mineral on the plate glass to insure perfect flatness.

The sandpaper also serves as an excellent abrasive for rounding off corners or smoothing the edges.

—T. J. Miller, W9OYC

## Antenna Directivity

The following letter from W. W. Smith, WHIO, describes his experiments along the line of obtaining antenna directivity. Undoubtedly it will be of interest to fellows who want to do some work of this type and have the necessary space:

"I have erected and tuned a matched-impedance Zeppelin antenna similar to the one described by L. L. Hardin in February *QST*. It is unnecessary, however, to cut the flat top and insert a meter or lamp for tuning. I used a low-resistance

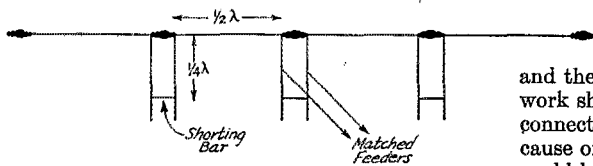

FIG. 2—A DIRECTIVE ANTENNA CONSISTING OF FOUR HALF-WAVE ANTENNAS FED IN PHASE

Quarter-wave phase-transposing sections are used between the individual antennas, the correct length being found by adjustment of the shorting bar. An antenna of this type radiates best in the direction at right angles to the line of the antennas.

lamp bulb in the center of the shorting bar, a scheme which gives good results since the shorting bar is at a current antinode when properly adjusted. On high power a small shunt could be placed around the meter or lamp bulb. After the adjustments are completed the shorting bar with the lamp in it can be replaced with a solid wire soldered to the feeders.

"After using the half-wave Zeppelin for a while I began to wonder how I could improve it. I then decided to add another half-wave section on the dead ended feeder and operate both flat tops in phase. This made the antenna slightly directional and improved reports from stations at right angles to the flat top. After using it this way for a while I wanted more directional effect, so made up another quarter-wave feeder with shorting bar and another half-wave flat top and added that to one end of the antenna. This narrowed the beam of radiation to about a 45-degree arc at right angles to the flat top, and we started getting R9 plus reports with only 50 watts input to a pair of 46's. The second quarter wave feeder is tuned with a shorting bar with lamp bulb in series with it, the bar being slid up and down until the point of maximum brilliancy is found just the same as on the first feeder.

"To date I have operated four half waves in

phase for a flat top, and it gives better results than any beam idea I have tried. Some day I am going to make a reflector just like the antenna and place it a quarter wave behind the flat top for still more gain. This will make it a one-direction radiator of a shape more suitable for my location than a 'V' type antenna."

## Antenna Filter for Reception

Judging by the letter from Edward W. Meyer, of St. Louis, Mo., quoted below, the antenna filter network described by Collins in February, 1934, *QST*, is equally effective for reception as transmission, especially when an antenna of random length is used. Mr. Meyer writes as follows concerning his experiences with the filter:

"Having two 0.0005 General Radio receiving condensers, I rigged an apparatus as described (in February *QST*) and tried the network out for reception. I was agreeably surprised at the results obtained, and the vast difference that the use of this network showed as compared with a direct antenna connection. The volume became greater and, because of the increased signal strength, reception could be accomplished at a lower noise level.

"I am using an indoor antenna 18 feet long, and my tests were made on the 40-meter band. The adjustment of the network is not critical, because in setting the adjustment in the middle of the band, reception was considerably improved for the whole band, indicating that once adjustment is made, it need not be changed for a particular band for reception within reasonable limits. Jumping from the 40-meter amateur band to the 49-meter broadcast band, readjustments were necessary to obtain the maximum results from the use of the network, but here again the adjustment was not critical and did not have to be touched to receive broadcasts which were then on the air. I made no tests on other bands but am sure that the results obtained could be repeated on other bands."

It is quite possible that a network of this type would be particularly beneficial with superhet receivers, especially those not equipped with preselectors, not only in increasing signal strength but also in reducing image response.

## Rectifier Switching for Voltage Changing

Having several plate voltages available is desirable not only from the standpoint of being able to change power to suit QRM conditions, but also for economical reasons, since the difference between one or two hundred watts and a kilowatt quickly shows up on the power bill. The switching arrangement shown in Fig. 3, used by J. O. Ellison, W8COW, is quite flexible in this respect.

Two porcelain-base knife switches are required, one a d.p.d.t., and the other a t.p.d.t. By manipulation of the switches either center-tap or bridge rectification can be used, and the voltage taps on the transformer changed as well.

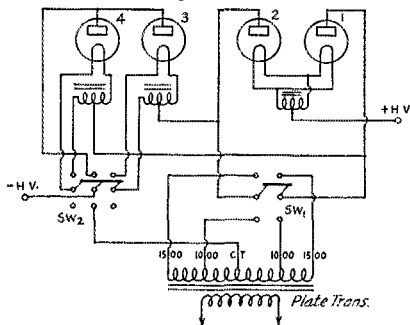

FIG. 3 — RECTIFIER SWITCHING CIRCUIT FOR VOLTAGE CHANGING

When both switches are in the upper position, the filament circuits of rectifiers 3 and 4 are closed and the four tubes are connected in bridge; the 1500-volt taps on the transformer are connected in the circuit so that the output is 3000 volts r.a.c. With  $Sw_1$  down, the output is 2000 volts r.a.c., using the same bridge rectifier. With both  $Sw_2$  and  $Sw_1$  down, the filament circuits of tubes 3 and 4 are opened and tubes 1 and 2 are connected in the center-tap circuit. The output is 1000 volts r.a.c. If  $Sw_1$  is now put in the upper position, the output voltage is 1500. The plate transformer must, of course, be capable of handling the power taken from the highest-voltage connection.

### A Cure for Receiver Hum

For some time a tunable hum has been present in my receiver in the vicinity of the 14-mc. band. Neither a three-section filter consisting of 90 henrys and 48  $\mu$ d. nor an r.f. filter in the power supply leads had any effect. The remedy was simply a small by-pass condenser connected across half the center-tapping resistor which is across the heaters, as shown in Fig. 4.

With this condenser installed, every trace of tunable hum disappeared, and d.c. notes, which previously had been "fuzzy" in the 14-mc. band, became just as clean-cut as in any other band.

The receiver is a three-tube affair, using one stage of tuned r.f. detector, and one audio. At present, the tubes used are two Type 36's and a 38, but the hum was just the same when two 24's and a 27 were used.

—Curtis C. Springer, W9EMR

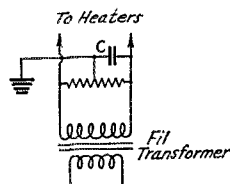

FIG. 4

### Suggestions Wanted

A problem which is seldom mentioned but nevertheless often is only too real is that of getting good grounds for both r.f. and audio equipment when the station is located on a floor some distance above the ground itself. We quote below a letter from Roderick D. MacDonald, VE2FO, which pretty well sums up the problem:

"... General outlines regarding shielding and de-coupling devices have been described (in *QST* and the *Handbook*), but consider for a moment the situation in which I find myself. It is typical of dozens of hams I have worked.

"The station is located on the third floor of a three-story house. The output varies from 100 to 500 watts depending on line-up used at any given time. On 80 meters all is lovely, but the moment a shift to 20 meters is made the fun begins. All manner of feedback occurs and standing waves on the house plumbing can be detected. Chokes in the line where it enters the set have been installed, neutralizing checked, and various antenna coupling schemes resorted to without result. Several discussions with the Marconi Company only resulted in the suggestion I move the rig to the basement or tune or trap the plumbing system, both of which are impractical.

"Now a ground system with standing waves on it is about the most undesirable thing to hook a speech amplifier to. At least twenty amateurs I have contacted are up against the same trouble and the chief difficulty seems to occur between the third and fifth story.

"Several things (most of them unscientific) have been tried. (1) The common negative lead from the final amplifier to the ground connection was removed and a series tuned circuit inserted. (2) A tuned circuit was installed between the cold water system and the heating system at the second floor level. (3) Ditto between lighting system and cold water at second floor. (4) Tuned chokes in power supply leads. (5) Small capacities hooked to the mike and s.a. can; i.e., a 20-by-30-inch plate laid on the floor with four feet of wire connecting it to mike head or s.a. can. This latter arrangement was quite effective and seemed to provide enough capacity to offset the feedback.

"The one puzzling thing was that individually each one worked for short periods of time, but a change in weather conditions seemed to alter conditions and other combinations had to be resorted to."

No doubt hundreds of other amateurs have had the same sort of experience; many of them, perhaps, have reached solutions which were satisfactory in their own particular cases at least. Suggestions for making a supposed ground act like a real ground will be welcomed. If enough information accumulates it may be possible to develop a technique for handling situations of this type.

(Continued on page 110)



# Amateur Radio STATIONS



## W7EAN, Seattle, Wash.

**W**7EAN is one of those stations which we think of as being typical of the effective low-power amateur station, both in apparatus and appearance. It is owned by Walter Johnson, 4533 Bagley Ave., Seattle, who in the short time he has been on the air—since November, 1933—has been doing some consistent operating, with the result that a considerable amount of DX has been worked.

The transmitter, at the right in the photograph, is a crystal rig having a 47 oscillator, 46 doubler and a pair of 46's in parallel in the final. It is much

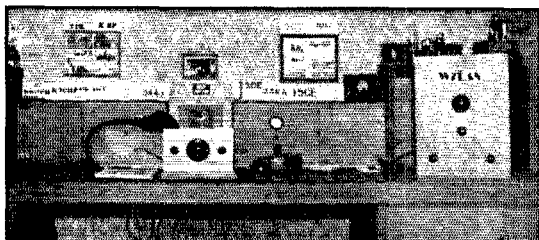

W7EAN

the same as the one described in February, 1932, *QST*, and in the *Handbook*, and is operated on a frequency of 7096 kc. The input to the final stage is about 80 watts. W7EAN's antenna is a 7-mc. Zepp having a 66½-foot flat-top and 40-foot feeders.

The receiver, which occupies the center of the operating table, is a detector-and-two-step outfit using 6-volt tubes, the detector being a 77 and the audio tubes a 37 and 38 respectively. A loud-speaker is mounted in a small baffle to the left of the receiver behind the lamp. The whole layout is quite neatly arranged, with a noticeable absence of haywire.

In the year and a half that W7EAN has been on the air some 15 countries have been worked, including W, VE, K6, K7, X, J, XU, PK, OM, ZL, MX, VS, KA, VK and OA, all on 7 mc.; R9 reports having been received many times from the Orient. The station's signals also have been reported several times from Europe on the same frequency, although to date no European contacts have been made.

## W8BIH, Elmira, N. Y.

**A**LTHOUGH the OM at W8BIH, George M. Tomlinson, is far from being a newcomer to amateur radio, having been in the game since the early days, the station pictured here is of quite recent vintage, having been put into operation only in November of last year. It represents the latest of a long series of transmitters and receivers which have now passed into memory. W8BIH is located at 78 Carrollton Ave., Elmira, N. Y.

The cabinet at the left contains the transmitter—again a rig using 46's—which is a combined 160-meter 'phone and 80-meter c.w. outfit. The r.f. line-up includes a 160-meter 47 crystal oscillator, 46 buffer-doubler, and a pair of 46's in parallel. The input to the last stage is about 60 watts. This part of the set is built on a metal chassis and occupies the upper half of the transmitter cabinet. Jacks are provided in all grid and plate circuits for current measurements and for grid keying.

The lower half of the cabinet contains the modulator and power supplies. The speech end of the set consists of a 57 first speech amplifier resistance-coupled to a 46, which drives a pair of the same tubes in Class B.

The microphone is a Universal double-button model X. One heavy-duty power supply handles the buffer, Class-C amplifier and the Class-B tubes, while a smaller supply takes care of the oscillator and two speech amplifiers.

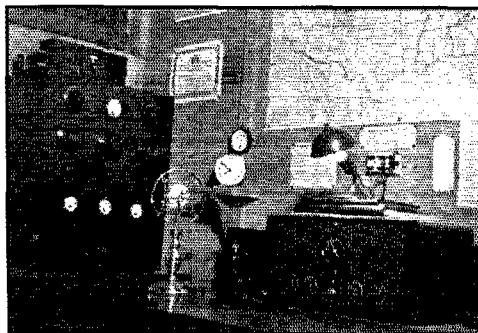

W8BIH

The receiver, on the operating table, is a 7-tube superhet built up from an All-Star kit. To

its left is a small regenerative set used as a stand-by receiver. An electron-coupled frequency-meter monitor sits at the right of the receiver, but does not show in the photograph.

On 160-meter 'phone all Canadian districts except the fifth and all U. S. districts except the fifth, sixth and seventh have been worked in the few months the set has been on the air. It gets out well on 80-meter c.w., too, W8BIH's signals having been reported from Germany on this frequency.

Tomlinson writes that he likes this rig much better than the old loose-coupler, galena detector and Ford coil, and also that the present-day catalogs are much better than Duck's!

### VE3VD, Toronto, Ont.

VE3VD, owned by Erich Bartmann, 1609 Queen W., Toronto, dates back to November, 1933. The transmitter is the popular push-pull TNT 45 outfit, built in this case for vertical mounting on the wall above the operating table, where it is easily accessible yet does not occupy table space. It is operated exclusively on 7 and 14 mc., the output being about 15 watts. For power supply, a transformer giving 400 volts under load, with 83 rectifier and the usual filter, is used. The antenna is a 66-foot Zepp with 33-foot feeders.

The receiver at VE3VD is a home-built job having a 35 untuned r.f. stage, 24 detector and 27 audio. The monitor, to the right of the receiver in the photograph, uses a Type 30 tube. The 'phone cord goes to the control box mounted along the right-hand side of the table and is connected to a switch so that the phones can be shifted from monitor to receiver. The other switches control the transmitter filaments and plates.

DX with the low-power set includes, to date, VO, TI, X, CM, K5, VP, F, HC, and all W and VE districts. VE3VD's signals also have been reported from New Zealand.

Plans are now under way for the construction of a superhet receiver and a crystal-controlled transmitter.

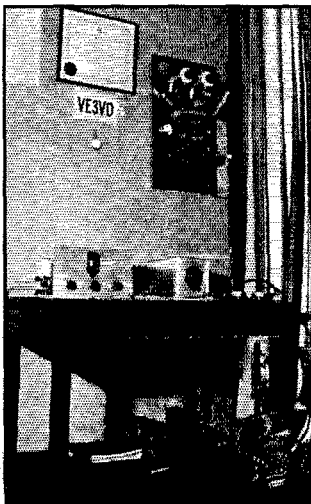

VE3VD

### W2HBK, New York City

OF EVEN shorter ham experience is W2HBK, Howard Critchell, 170 E. 79th St., New York City, since W2HBK was put on the air for the first time in 1934. Also a nice-looking layout,

this rig is of further interest because the station is located in the d.c. district of the city, where ordinary power supplies cannot be used.

The transmitter, built into a small frame at the right, is a simple two-stage affair having a 47 crystal oscillator and 46 amplifier. Plate power is supplied by a 500-volt motor-generator set, enclosed in the box on the floor below the transmitter. Filament supply [for the transmitting tubes is obtained from the [110-volt d.c. line



W2HBK

through a dropping resistor. The plate input to the 46 usually is about 35 watts. The antenna has a 66-foot flat-top, fed at the center by twisted-pair feeders.

The apparatus on the operating table includes an SW-3, battery operated, Vibroplex and straight keys, Gross monitor, and a frequency meter, the latter being alongside the transmitter. From an operating standpoint everything essential is right at hand.

### Strays

Post offices continue to have trouble with QSL cards addressed simply "W—, Blankville," which, properly speaking, is no address at all. The latest SOS comes from the Long Beach post office via W6AM. Improperly addressed cards arrive there at the rate of about a dozen a day, and

even though the office has been furnished with a call book, the personnel doesn't have the time to dig out the QRA's which the senders of the cards should have looked up in the first place. Same goes for other towns and cities of any size.

Before sending a card, get the complete address from the call book. If it's not in the book, send the card to the QSL manager for the call area involved. Complete list given in every QST.



# • I. A. R. U. NEWS •

Devoted to the interests and activities of the

## INTERNATIONAL AMATEUR RADIO UNION

President: H. P. MAXIM

Vice-President: C. H. STEWART

Secretary: K. B. WARNER

Headquarters Society: THE AMERICAN RADIO RELAY LEAGUE, West Hartford, Conn.

### MEMBER SOCIETIES

American Radio Relay League  
Associazione Radiotecnica Italiana  
Canadian Section, A. R. R. U.  
Československí Amatérský Vysílač  
Deutscher Amateur Sende-und-Empfangs  
Dienst  
Experimenterende Danske Radioamatører  
Irish Radio Transmitters Society  
無線技術士会  
Liga Colombiana de Radio Aficionados

Liga Mexicana de Radio Experimentadores  
Nederlandsche Vereeniging voor Internationaal Radioamateurisme  
Nederlandsch-Indische Vereeniging Voor Internationaal Radioamateurisme  
New Zealand Association of Radio Transmitters  
Norsk Radio Relæ Liga  
Polski Związek Krotkofalowcow  
Radio Society of Great Britain

Rede dos Emissores Portugueses  
Reseau Belge  
Reseau des Emetteurs Français  
South African Radio Relay League  
Suomen Radioamatööriitto r.y.  
Sveriges Sandareamatörer  
Unión de Radioemissores Españolas  
Union Schweiz Kurzwellen Amateure  
Wireless Institute of Australia

### Conducted by Clinton B. DeSoto

#### Malta:

From H. G. Cunningham, ZB1A-G5CI, comes the following information concerning amateur radio in this rather unusual spot:

"At the present time there are six licensed transmitters, but only four of these are active, the owners of the other two tickets being in England at the present. ZB1E is the more active of the crowd (if we can call it a crowd!) and is doing the duty of Empire Link station at present.

"The actual ticket is 10/- per year and is similar in conditions to the English; the main points in which they differ are as follows:

"1. Malta stations are not allowed to transmit

"The B.E.R.U. representative is Mr. L. Grech, ZB1C, 44 Sda S. Benedetto Kiroop, Malta (succeeding Mr. Cunningham, who held the post for the past eighteen months.—C. B. D.).

"One WBE certificate is on record here, and that was obtained by Mr. S. Rance, now BERS201-exYI2DS, with the call VP3X before licenses were being issued by the government."

#### General:

Here is a QSL address for SU and ZC cards: F. H. Pettitt, Catholic Club, Mustapha Barracks, Alexandria, Egypt . . . . H. G. Powditch, G5VL, reports no difficulty in hearing

4-mc. W 'phones these days, W1, 2, 3, 4, 8 and even 9 coming in very well in a single hour . . . . He suggests that W's listen in the British 'phone band, 3520-3730, for QSO's . . . . A few frequencies: G5VL, 3719; F8VP, 3528; PAOASD, 3770 ke . . . . Al Santmier, Jr., W8AKX, passes on a request from VQ4CRP in Kenya (Nairobi) on 14325 ke. for VE5 contacts . . . . He has worked all W and VE1, 2, 3, 4 districts . . . . Australia, South Africa and Japan on the U. S. East Coast within three hours of a late afternoon? . . . . It can't be done,



EA4AV, ESTEBAN MUNOZ DIAZ, AVENIDA DE PABLO IGLESIAS 38, MADRID, SPAIN

type A3 ('phone) at present, but it is hoped that this rule will be cancelled before very long.

"2. We are not allowed on the 3.5-mc. band; this also we hope to overcome before very long.

"3. Auto-transmission is not allowed.

but Arthur M. Braaten, W2BSR, did it with VK4GK, ZS6AL, and J2HG . . . . W8JTT reports VK2EO coming through as late as 10 a.m. recently . . . . All of which signifies some very nice 14 mc. working and, perchance,

the beginning of an excellent spring DX season . . . . . The call of F3SMI in Martinique has been changed to F3MTD, we are told by W1GDY . . . . . G6NF is concerned by indications that someone is bootlegging his call, apparently on the U. S. East Coast . . . . . Through W1FVO, he is soliciting the aid of U. S. amateurs in running down the offender . . . . . Reports can be sent to the A.R.R.L. Communications Dept. . . . . ON4AU continues his excellent work on 28 mc., reporting contacts with W9TJ and being reported heard by L. E. Winton, in Campbellstown, 50 miles from Sydney, Australia . . . . . Latest WAC-on-'phone is R. Bartholemew, K4SA, Garrochales, Puerto Rico . . . . .

## A Short History of the Réseau Belge

By Jacques Mahieu, ON4AU

ALTHOUGH there existed in Belgium before the war several amateurs who were interested in radio transmission and who actually worked with c.w. and even with 'phone, it was not until June, 1922, that any organization of the amateurs was thought of. The idea of a Belgian radio club devoted to amateur transmission is due to R. Deloor (P2, now ON4SA) and J. Mussche (ON4BJ), who were then members of a BCL club called "La Fédération Belge des Cercles d'Etudes Radio-Electriques."

On August 12th, the "Réseau des Deux" was founded in Brussels, having for its president R. Deloor; for its secretary, M. Ocreman, and for its traffic manager, M. Haumont (B7). The members were: W2, I2, O2, B2, E22, 4ALS, 1CF, 4ZZ and U3.

The actual *Réseau Belge* was founded in September, 1923. R. Deloor was still president, and the next year, 1924, he proved his worth as an amateur by accomplishing the first QSO between Belgium and the United States.

At the International Amateur Congress held in Paris in April, 1925, and presided over by the late General Ferrié, the *Réseau Belge* was represented by Messrs. Deloor, Ocreman and Haccourt. It was at this Congress that the International Amateur Radio Union was founded.

Each week the members of the *Réseau Belge* met and discussed their hobby, and all the new records and technical developments. It was at one of these meetings that Robert Deloor (P2) introduced us to the "bug" (April 27, 1927).

In June, 1926, the first number of "QSO," our official organ, was published.

In 1926, Paul de Neck (U3) succeeded P2 as president, the other members of the committee remaining the same as before. That same year the Belgian amateur was first officially recognized by the authorities; the first laws relating to amateur transmission were passed, and the now

familiar two-letter calls (4AA to 4ZZ) were introduced for licensed stations.

In February, 1927, M. Haumont, the traffic manager, resigned and was replaced by G. Neelemans (O8).

In April, 1927, the *Réseau Belge* was officially recognized as a section of the I.A.R.U.

In June, a petition was sent to the Ligue Maritime Belge asking them to install a short wave transmitter on board the training ship "L'Avenir." The petition failed, and it was only through the initiative of two members, Messrs. Neelemans (4FT) and Regnier (4WW), that the desired result was obtained in August, 1928. The complete installation was built by M. Velghe (4OI) and "L'Avenir" was in daily communication with the home country via 4FT, 4WW, 4GN and 4AU.

By July, 1927, the *Réseau Belge* had 270 members and in August of the same year the first WAC certificate was awarded to the late Louis Era (4BC).

The first 'phone WAC certificate in the world was awarded to our president, Paul de Neck



ON4AU AND F8EX AT "LE MANOIR," PERUEWELZ

(ON4UU), in January, 1930, a year in which the R.B. showed great activity. The Antwerp section, in particular R. Kerse (ON4GW), vice-president, and R. Verstrepen (ON4AA), district manager, put in a bit of hard work in organizing during the Exhibition there an International Congress at which eleven branches of the I.A.R.U. were represented. A transmitter was installed at the Exhibition which created great interest amongst the visitors.

Besides the first 'phone WAC, the R.B. has many interesting exploits to its credit. In 1922, J. Mussche (4BJ) accomplished the first QSO on 8.5 meters between Brussels and Antwerp; the same year, 4BJ went down to 3.2 meters and was the first ON to try out this wavelength.

In May, 1927, the first two-way contact be-

(Continued on page 128)



w4aj w5wg w6ann w6bky w6bxl w6bxy w6cal w6cfx w6cfs  
w6cnu w6crl w6fzy w6glj w6grx w6hko w6hxx w6hut w6idf  
w6lgy w6lly w6lly w6lhr w6kpl w6kvv w6llf w6lvq w7ayq w8bst  
w8cte w8dvy w8dvw w8eth w8hdh w8hhr w8mma w9ela w9lg  
w9ny w9sic hjo kxjl kxz kwv wdg wgt wqp wqs wat yyr

**W7BPJ, Walter Dyke, Forest Grove, Oregon**

(14-mc. band, July, 1934-Mar. 18, 1935)

fm8bg oc3fl ocler on4my om1x on4bx on4su on4mx on4hm  
on4rx oc4cl ok2hm ok2ad ok2sl ok2le ok2rm oz8d f8te f8wk  
f8vk f8eo f8rq f8ex f8tq f8zf f8wb d4dbr d4dgt d4eda d4bar  
d4bml d4bnn d4bfn d4bfl g6lk g6qx g6qe g6cl g5ml g6ag g5bj  
g2bm g2qo g5ml g2rq g6hp g6by g2od g6wy g6zp g2td g5by  
g6be g6aj g2dv g2wq g6ul g2lo g6im g6rv g2uh g5vs g6vp g5yh  
g2op g6azf e1sf e1sb l1kkm p9f1x b9dys papzk papll p9dce  
p9grn p9suv v9d v9dy v9dcl z9pl z9saa z9zj z9ljj z9zco ea4av  
ea2ad ea3eg ea4ao ea3bv hb9j u3vb fb8c

**J. W. Wenglar, 1414 Beaver Rd., Ambridge, Pa.**

(7-mc. band)

ka1es kajds kaifs kalhr kalor kalus kalxs om1xs pk1bo vs6al  
vs6aq vs7gl

(14-mc. band)

j2hg j2hj k7dvt ulbl

**W3AYS, C. B. Smack, 5500 Groveland Ave., Baltimore, Md.**

(7-mc. band)

l5ce j2gw fqlzj vs6aq om2rx kailg

**SPL-423, Zbigniew Rybka, Krasnik, woj. Lubelskie, Poland**

(3500-kc. band, Dec. 1934)

wlhud w2eys w3oqs w3dxd w8clm w8gkb

**G6ZU, R. H. Jackson, 54, Prince's St., Stockport, Cheshire, England**

(14-mc. band)

w6adp w6bvx w6byu w6bpl w6cxw w6fzl w6grx w6hjt w6llf  
w6lrx w7ayq cx1cg ex1bu lufel lu9bv p1law py1d1 py2bk py2cd  
ve4du zc6ff zelfz zelij zslau zshl zslp ztlr zt6x y12fk

**K7CCL, Wil Lane, and K7GH, Rod Mc Ardle, Tanana Crossing, Alaska**

(Heard Feb. 23th-Mar. 14th)

(7-mc. band)

w5zg w5avg w5aaz ve4mj w4uc w5ewd

(14-mc. band)

wialh fne aax led lz geh aep ebf w2eea brq ddy afu fe gah fvt  
awf gbc byp fmm w3cct exb w4bbr ah ber mr cqr zh w8ega enz  
ane eax w6zy kyy kzh hqj hqx kvx bfg fr lzk jlw dqe dvx lke  
ecw deo hrb eci w6co sho rkr pk jmb rxi lk cdm fh kma fcc  
hwt tky gra jgf lfu bmx avs prf fco tdu sch arr drn jro ka ts  
ftv apw (Fone) ftk ve2al ee dv dg ve3gh

**G6YL, Miss B. Dunn, Felton, Northumberland, Eng.**

(7,000-kc. band)

k5aw lu6ax v8ac vs7ra zu6p xzn2b xzn2c ea8ae

(14,000-kc. band)

w4cyn w4zh w5asx w5brq w6ahz w6aux w6bpl w6bpb w6bpo  
w6byu w6bpl w6caw w6cxq w6fzl w6lzy w6grx w6hjt w6lly  
w6hzu w6lbe w6llf w6qd w6vw w6zdz pk3bm pk3ic ont4j  
oz7eak v8ac ve8kz ve8no ve8oa xoh3gn vq2m vq8a vssab vu2bl  
vu2ed vu2fp vu2jp vu2lj vu2lz zd2c zelfz zelij zeln zeljo  
zlhly zl3aj zl3bs zl3dw zl3gm zshl zslc zssa zsal zila ztlr  
zt6a zt6j zt6m zt6s zu6e xzn2b xzn2c

**W1AJZ, Rienzi B. Parker, Harwichport, Cape Cod, Mass.**

(14-mc. c.w.)

em5ex cx1lf lulpl lu5bc lu7ef lu8dj lu8af oa4j py2bu py2mm  
py4ac ve8eu ve8ko vk2eo vk3bw vk5kw vp2at vp4ta vp5pz xlay

(14-mc. 'phone)

co2hy co2kc co2ra co2se co2sv co2wz co6om g5ml g5vl helfg  
hh5pa hl7g la1g lu6ap tl3wd v6bhn vp3bg xlg xlw xlah ynlpp

**W2ICE-W8ACY, B. L. Kelley, 66 Warren Ave., Harbor Heights, Mamaroneck, N. Y.**

(14-mc. band)

fb8ce fc4cl j2lk l5ce j7cl ly1l pk2dx pk3bm pk3ic pk3st pk3yl  
sv1b sv3a ulah ulbc ul8a ul8v ul8h vk2eo vk2vl vk3lx vk3ml  
vk3xq vk3yp vk4ap vk5fm vk5wk vk5yk vq4cl vq4erp vq8a  
vs6aq vu2lj zc6ff zd2c zelij z2lk z2nr zssa zssa zsb6 zt6k

**W9GDB, B. H. Hansen, Milford, Kansas**

(7-mc. band)

ka1ss ka9wx om1tb vq6ak vu2kp vu8ky ku6f

**VE4LK, S. Fulton, Calgary, Alberta, Can.**

(14-mc. band)

ce5ad cm2an cm2ge cm2lj d4bnn ea4ao ea4av f3le f8ex f8fc  
f8pz f8lx f8tq f8wb g2bg g2tm g5kg g5ml g5wr g6gn g6nj g6vp  
g6tk f8lx k5aa k6hlp k6coq k6aja k6lhw k7dvt helfg ly1j  
on4aa oa4j pa0xt py1dl py1ll py1by lulcf lu5dd lu4dq j2hg  
j2gx j3cg j5ce on4hm on4ix on4mx on4or on4su on4uf on4yr  
vp4tc vp4tf vp4tg vp5pz vp2at vu2am vk4kx vk4mr vk5wr  
z1lar z2pc xlay xzc xzba z2am

**W5WG, W. E. Owen, Ruston, La.**

(23-mc. band, Mar. 30th, 6-7 p.m., C.S.T.)

w6vq w6aky w6bnu w6cal w6cfs w6dio w6hcf w6lhr w6lhm  
w6kgo w6kwa w6kzl xlay z13aj

**W8KPB, N. Jacoby, and W8KOL, William Minor, Cleveland Heights, Ohio**

(Heard during DX contest)

(7- and 10-mc. bands)

om2pl om2aa om2ld om2rx om1tl j2kv j4ea j2gx vk6mn vk6mo  
vk6sa vk6ko k6akp k6cck k6esu k6hlp k6hnu k6hnl k6lhw  
k6jpd k6kef k6kpl k6sa k6u k6hr f3mtd luleh lu1ch lu2lc  
lu3dx lu4dq lu5vl lu5ca lu6er lu9bv ce5el ce7aa on4aa oa4j  
py1aw py1du py2bu py2cd helfg (y1 and ow) hczno cx1cb  
cx1cg cx1om cx1cx cx1gt xzn2b xzn2c zd2c fb8c on4ej on4el  
ze1lj sulch vq4er vq4ero fm8bg fm4ab fm4af ea8af ea8ah ea8al  
zsa2 ztlh ztlr zt5r zu6p zszc ea1av ea3an ea3cg ea3ca ea4ao  
ea4ap ea4av ea5bs ea7bo ea7bx f8am f8eb f8ex f8eo f8fc  
f8pz f8vp f8tq f8zl p9dce p9f1x p9suv p9dbr d4bdr d4bfn d4bnn  
cl1aa cl1z cl5f cl8b g5fjk g6fw ok2bc g2ks g2zm g5ml g6nj  
la1g ct2bk ny2ab hplv vp5pz vp5ab vp5bf vp2bx vp2ff vp7bn  
vp9r v9d v9dy v9zj x1aa x1am xlay xzc xzn x3g cm2fa cm2op  
cm6gt cm8af hnlp hl7g (Best vk's hrd, vk2da vk2ns vk3gq  
vk3kx vk4bb vk7re (Best z1's) z1gx z1gzs z13an z14al

**W9CFB, Gerald Tipton, Moulton, Iowa**

(14-mc. band)

op1eg j2xj j2hj j2km j5cm vq4erp yalot zn2bx zd2c

**W1CUN, H. M. Stevenson, Bethlehem, N. H.**

(7- and 14-mc. bands)

j2cm j5ce j4cl j2hg j2hj j2gx j2gw vs6aq vs6ah vu2bl vu2lz  
zc6ff zklj pk2dx pk2gw pk3bm pk3st vk4sk vk4cl fb8c vq3bl  
vq4ero vq4cl vq4erp om2rx ze1lj ze1j ze1jo ze1jn vq8a zd2c  
ff8mq u3cy ulan

(28-mc. band)

w6cal w6lhr

**Latest from VK-ZL**

The following Calls Heard on ten meters were received from VK-ZL by W8ZY on April 9th.

Heard at VK3KX

W9NY W6VU W4TZ W2TP J2HJ J2IS

Heard at ZL2GQ

W1SZ W2TP W4MR W4AJY W4AJX W4TZ  
W6VQ W6BNU W9NY W9FFQ X1AY J2HJ  
J2IS

Heard at VK2NS

W1SZ X1AY W6VQ (R9 hours at a time!)

Reported heard in VK by VK2NS

W1SZ W2TP W4AJX W4AJY W4TZ W6CAL  
W6VQ W6BIO W6AKY W6BNU W6CUL  
W6CIS W6ALD W6AITY W6IDF W6BLS  
W6RH W9NY W9FFQ X1AY J2HJ J2IS  
CE4AN ON4AU

**Strays**

Speaking of calls, B. G. Ryland, Headquarters Company, 30th Infantry, must have some sort of record for the number he's signed. Now W6BEW, his former calls include W6ZZBT, W6GKG, "RD" at K6DV, WJZ, FU2, AG2, CR9, KF7, RH6, 2B6, 3NU, 4NQ, BK4, plus six other "sines" on land wires!



# OPERATING NEWS



Conducted by the Communications Department

F. E. Handy, Communications Manager

E. L. Battey, Asst. Communications Manager

OVER two thousand amateurs have returned the frequency registration coupon which appeared in March QST (page 67). This is a number equal to 10.3% of the membership of the A.R.R. L. in the U. S. A. and Canada—five times as good a return as on the similar return of a questionnaire less prominently presented two years ago. In addition this is written on April 3rd with another month of receipts of coupons to swell the total.

Analysis of all the results as of this date shows that 9.7% of the registrants use radiotelephony alone, 45.7% use telegraphy alone, and that 44.6% have stations using both forms of transmission. Considering this latter group only, 17 1/4% are more-than-50% users of 'phone, while 27.2% are more-than-50% users of telegraph. Complete analysis of the first 6% of the return received on or before March 21st has been completed, and while analysis of the whole cross-section may change the picture in minor details, the registration by bands and other ratios will probably continue to run of about the same proportions. These are as follows:

Bands	Telegraph	'Phone	Bands	Telegraph	'Phone
160	1.58%	7.08%	10	.337%	.35%
80	33.22%	9.26%	5	.20%	3.96%
40	27.73%	....	2 1/2	.01%	.07%
20	10.91%	5.28%	1 1/4	.003%	.01%
				73.99%	26.01%

In addition to the frequency registration in which all amateurs were asked to register their division of operating time between bands, certain questions were printed to give all hams an opportunity to tell Directors their opinion on certain proposals that were being raised for changes of 'phone-telegraph frequency allocations within the present amateur bands. The number voting "opposed" and "in favor" varies from day to day, but the percentage response will doubtless not change very much from the first complete national analysis (made on approximately 6% return). Since a number have asked about the "trends," a brief advance summary is given here for general information. All replies received to date have been forwarded to the Director representing each individual, so each point raised may be studied in advance of the May meeting. Questionnaire trends are as follows:

In favor of moving the 14,150-14,250-kc. 'phone band.....	79.2%
Opposed.....	20.8%
Now.....	44.1%
With Canada.....	55.9%
Move it to the 14,000-kc. end.....	43%
Move it to the 14,400-kc. end.....	57%
In favor of more 3.5-mc. 'phone frequencies.....	41%
Opposed.....	59%
In favor of opening part of the 7-mc. band to 'phone.....	32%
Opposed.....	68%

—F. E. H.

## Canadian Regulations Revised

The Radio Administration (Department of Marine) at Ottawa has just announced revised regulations for Cana-

dian radio amateurs, these effective from April 1, 1935.

Radiotelegraph bands for continuous wave work remain the full width permitted the amateurs of any country by the international treaty. General telephony and I.C.W. are permitted only on 28-30-mc., 56-60-mc., and 400-401-mc. bands. Special endorsements "for telephone" are granted subject to meeting certain equipment conditions. Telephone work will then be authorized, by endorsement for the bands 1775-2000 kc., 3500-3550 kc., 3850-4000 kc., and 14,100-14,300 kc. In the three last named bands telephone endorsements will be granted only to amateurs having held licenses and operating actively for at least two years. The equipment conditions which apply for 'phone work in these four bands are as follows:

(a) The station shall be equipped with a reliable frequency meter.

(b) The transmitter shall be of a type which is preferably crystal controlled, or which has a stability and constancy comparable to that of a crystal controlled oscillator.

(c) The modulation system shall be so designed and operated as to ensure intelligible speech. Modulation *must not in any case* exceed 100 per cent and must not disturb the frequency stability of the transmitter.

The main changes in Canada's amateur regulations from those previously in effect in that country, are the loss of 1715-1775 kc. 'phone authorization, and in its place an additional 3850-3900 kc. Canadian band for operators with the endorsement for 'phone obtained from one of the five Divisional Radio Offices.

All Canadian amateurs are now authorized to operate one portable station in 28-30-mc., 56-60-mc., or 400-401-mc. bands, in a passenger automobile owned by the licensee, or at a temporary location, for communication with any other licensed amateur station, including equipment at the home address, provided that (a) When in use the portable equipment shall be designated by the call signal assigned in the station license followed by the word "portable," and (b) the portable equipment shall be available for inspection at the licensed address of the station whenever required by departmental Radio Inspectors.

## The VE QSO Contest—March 9th—19th

By S. B. Trainer, Jr., VE3GT

THE March VE contest sponsored by the Canadian Tire Corp'n Ltd., "went over with a bang" in the opinion of all who took part. More VE's were heard during the contest period than any of the old-timers ever heard. VE5HQ, winner of the VE/W contest last fall, again took undisputed possession of first place among the C.W. gang by working 160 different VE's, including three VE1's, for a total of 5400 points. Input to his final stage never exceeded 47 watts, and all bands were used. In all he heard 250 different VE's and had QSO's with 50 different VE cities or towns. VE3NO and VE3ABW each worked 120 VE's. VE3TD, VE4GE, VE4IG, and VE5FG all worked over 100 VE's. VE1FL worked VE5AC on 3.5 mc. which is one of the longest recorded Trans-Canada 3.5 mc. QSO's. VE4IG figured he worked 103,810 miles in his QSO's.

The leading 'phone station was VE3FP, who worked the amazing total of 93 VE's for 1250 points. Our YL op, VE3YL, took second place with 1020 points, while using only 45 watts input. VE3FP worked 7 VE1's, 6 VE4's, and one VE5

all on 1.75 mc. VE2CA working 14 mc. only had 20 QSO's, and begs that the C.W. men look for 14 mc. VE 'phones in the next contest of this nature, as he heard scores who were not listening for 'phones.

The usual amount of equipment was blown up, antennas came down, monitors wouldn't work, and so on. VE2IY worked 46 VE's for 1185 points with only 12 watts input, while VE3PO "snuk" into the prize group with only 10 watts. About 90% used less than 50 watts input, which shows well how low power will get out. Every one shall be looking for another contest next year. The scores follow. All C.W. scores listed down to and including VE3PO's are "prize winners."

C.W. SCORES			
VE5HQ	5400	VE3WV	787
VE1HG	3060	VE4G	778
VE4E	2856	VE3RN	750
VE1BH	2205	VE3AAG	735
VE3IB	1740	VE3BO	730
VE3CD	1710	VE3JC	720
VE1FN	1600	VE3ACL	705
VE3NO	1552	VE2FE	700
VE5FG	1470	VE3YO	700
VE5HR	1455	VE4TO	690
VE4SH	1433	VE3PO	675
VE3LV	1410	VE1EV	660
VE3ABW	1403	VE2BU	650
VE1ER	1360	VE4OB	630
VE1GL	1275	VE2GZ	605
VE3HF	1260	VE3LI	600
VE1FL	1230	VE3UF	575
VE3TD	1215	VE4EO	520
VE4LB	1185	VE4NH	510
VE2IY	1185	VE3DD	505
VE3DJ	1178	VE2EE	460
VE3GT	1170	VE3JL	450
VE4IG	1165	VE4SF	405
VE3DU	1163	VE4CE	502
VE3QK	1125	VE3LJ	400
VE3JF	1118	VE3WA	370
VE1FW	1080	VE3AD	360
VE4LK	1080	VE3VZ	345
VE3OR	1065	VE2LL	300
VE3PC	1057	VE3ACM	300
VE4KU	1000		
VE2DR	970		
VE2FG	945		
VE3TE	938		
VE4AC	930		
VE3BC	870		
VE3NB	865		
VE4HJ	810		
VE4KA	810		
VE3SZ	805		
VE2LJ	795		
VE3NL	795		

**'PHONE SCORES**

VE3FP	1250
VE3YL	1020
VE3JH	750
VE3PM	676
VE3NX	630
VE3NC	470
VE3C	240
VE3JB	240
VE2CU	172
VE3AZ	120

## Receiving Ability

By Roy A. Jenkins, W6CBY \*

The following contribution by Mr. Roy A. Jenkins, wins C.D. article contest prize for this month. Your articles on any phase of amateur communication activity are likewise solicited and may win you a bound Handbook, six logs, or equivalent credit applied toward other A.R.R.L. supplies. Let us have your article, and mark it "for the C.D. Contest," please. —F. E. H.

DOZENS of articles have been written in the last two years concerning improved operating practice, all of which pleaded for better sending and elimination of superfluous signals; and while the rules laid down therein are beneficial to amateur radio, there is another side of the question that is without a doubt more important than good sending—speed and accuracy in receiving. To be able to copy accurately at 30 or 35 words per minute should be the ambition of every operator. It really makes the game more enjoyable since it helps to overcome our own shortcomings (lack of good wording due to low speed) as well as those of the other operator (poor sending).

One operator copying fifteen words per minute, and that being his top speed, is getting part of the transmission and guessing at the rest. Another operator, copying this same speed, but able to copy thirty, is setting it down solid and

\* 665 West Grant Avenue, Escondido, Calif.

has plenty of time to reflect on the subject matter besides. The first mentioned operator has his mind concentrated on each single letter as it is sent and has no time to think about letters he has missed or break down letters that the sending operator has jammed together into one long combination of dots and dashes. The latter is receiving every letter perfectly, and though the letters may run together, or are sent in a jerky manner, he can reason the words out because he has time to think over each word as it comes in. We are unable to change the manner in which the other operator is sending, so it is necessary for us to make our receiving ability so good as to have time to use a little logic in deciphering his characters. How may this practice be obtained?

Above and below the 7 and 14 mc. bands are numerous commercial stations which are sending messages at speeds to suit every need. Abbreviated ham language is not satisfactory for gaining code speed and accuracy. That leaves us only the commercials. Using their tape transmissions we can get the most perfect code practice available. WGG is the most excellent station on the air for the operator trying to copy 20 w.p.m. This station sends stock quotations followed by press<sup>1</sup> at this speed. The stocks are especially good for those needing number practice; the press, being fully punctuated, proves that our punctuation marks have a useful purpose other than sounding keen in place of double dashes. NAA transmits weather every night and it is usually sent at 18 w.p.m. from tapes. Nearly all RCA and MRT stations are at various times sending regular commercial traffic which is composed largely of ten-letter code groups which are without equal in attaining absolute accuracy in copying. Code groups and unfamiliar languages take the guesswork out of copying—the bugaboo of traffic-handling or other real communication work by amateurs.

It must be borne in mind that most of the above-mentioned broadcasts are private business and come under the "secrecy" regulation and should be treated as such. This means that while there is no law against receiving such traffic, it is prohibitive to divulge the contents of any specifically addressed messages, amateur or commercial. Free items, such as sent by NAA and KUP can be passed around to impress friends but not those copied from WGG, WFB, XDB, etc.

For honest-to-goodness code practice we should stick with any transmission for at least two hours if it lasts that long and not be content to stop when the novelty wears off or when the speed starts breaking us down. By the time that we have tired of copying our subconscious mind is translating the dots and dashes and we do not feel that terrific mental strain that is the cause of our guessing at certain letters. After learning to copy subconsciously we find it possible to copy page after page of press and not be aware of a single sentence in it. It is better to not be conscious of what is copied because when we try to follow the sense of the message we often become confused over a seeming disparity in words and then actually miss a word or two. We should keep our mind on the word being copied and then dismiss it entirely and take up the next one instead of trying to memorize the whole sentence to see if it sounds right. Another very bad habit is that of guessing at the suffixes of words and it should be cured at once.

Every QSO becomes a greater joy if we can receive it solid, and the accurate operator is the one whom we all like to contact for we do not have that tedious repetition that soon wears down any man, be he beginner or old-timer. Finally, being able to copy rapidly and accurately will eliminate a lot of this fancy bug-rattling which is so prevalent in our bands to-day, for it is no fun to exert ourselves trying to impress a fellow-ham who can get it solid and never miss answering all our questions despite our "rotten sending."

<sup>1</sup> KUP's schedules are also recommended as excellent for code practice: PRESS, daily except Sundays and holidays, 1:00 a.m. P.S.T. on 6440 kc.; STOCKS, daily except Sundays and holidays, 4:00 a.m. P.S.T. on 6440 and 8350 kc.; PRESS, daily except Sundays and holidays, 7:00 a.m. P.S.T. on 6440 and 8350 kc.; WEATHER, daily including Sundays and holidays, 8:48 a.m. P.S.T. 6440 and 8350 kc.; FINANCIAL SURVEY, daily except Saturdays, Sundays and holidays, 4:30 p.m. P.S.T. 11,340 kc.; PRESS, daily except Sundays and holidays, 7:00 p.m. 6440 kc.; WEATHER, daily including Sundays and holidays, 8:00 p.m. P.S.T. 6440 kc. For schedules of other stations see page 295, latest Radio Amateur Call Book Magazine.

# A.A.R.S. ZAG Contest

By Roy C. Coderman, W3ZD/WLMD\*

THE second ZAG contest of the A.A.R.S. for 1935 was conducted during the period 6:00 p.m. March 2nd to 12:00 midnight March 4th. To those not familiar with the Army Amateur Radio System it may be well to explain that a ZAG contest is a communication "spree." Every active member of the A.A.R.S. tried to work every other member. From the QRM observed during the period of the contest it seemed that the entire personnel of the A.A.R.S. was on the air at one time. These contests are held several times each year; They, like the O.R.S. parties held by the A.R.R.L., have come to be very enjoyable to those who enter them. New friends are made, old friendships are renewed. The weak spots in the old transmitter are brought to light under the continuous operation practiced by the participants.

The scoring: One point for contact; two points for the exchange of a cipher message; three points for the exchange of a third party message in English; four points for delivery of message within 100 miles of receiving station. Distance Points: One point for contact over 500 miles, two points—over 1000 miles, and three points—over 1500 miles. Besides the direct scoring, there were handicaps as follows: Power—Final point score multiplier: (1) Under 15 watts—2.3. (2) 15-40 watts—2.0. (3) 40-75 watts—1.8. (4) 75-150 watts—1.5. (5) 150-250 watts—1.3. (6) 250-500 watts—1.1. (7) Over 500 watts—1.0. Time—Final point score multiplier: (1) All scoring in one day—1.0. (2) All scoring in two days—1.5. (3) All scoring in three days—2.0.

As soon as the contest was announced, the challenges between corps areas began. Each was out to win. The scores show how they backed up their boasting. The competition between corps areas was on three basis, so that the final position attained would give all an even break.

Percent of Active Stations Participating (1)	Average Individual Score per Station (2)	Highest Individual Score (3)
III..... 93.0	III..... 1304	II..... 7228.8 (W2DBQ-WLNB)
V..... 85.1	IX..... 1051.89	III..... 6521.2 (W3EOP)
VII..... 83.22	IX..... 793.0	VI..... 4360.0 (W4HRC)
VIII..... 66.07	IV..... 673.0	IV..... 4305.0 (W4AEP)
VI..... 66.0	VII..... 531.07	IX..... 3776.0 (W6FIL-WLVC)
II..... 62.9	VI..... 411.2	VIII..... 2985.0 (W5EES)
IX..... 61.03	V..... 400.3	VII..... 2590.0 (W5DHU)
IV..... 51.6	I..... 375.8	V..... 2544.0 (W3SRN)
I..... 44.2	VIII..... 374.1	I..... 1827.0 (W1OR)

The position standing for the contest based upon the above: 1st Place: III Corps Area, 2nd Place: II Corps Area, 3rd Place: VI-IX Corps Areas (Tie), 4th Place: VII Corps Area, 5th Place: IV Corps Area, 6th Place: V Corps Area, 7th Place: VIII Corps Area, 8th Place: I Corps Area.

For attaining the highest individual score, a silver cup suitably engraved will be awarded to W2DBQ-WLNB, Richard E. Nebel, Brooklyn, N. Y. W2DBQ is the S.N.C.S. of the Southern New York State Net. A certificate or letter of commendation is being furnished each of the other members making highest individual scores in their respective corps areas. The Chief Signal Officer congratulated the Third Corps Area and W2DBQ for their fine efforts as evidenced by their scores. He also commended all corps areas and members of the A.A.R.S. for their excellent scores.

From the comments made by the contestants and transmitted with their scores the usual experiences of such contests were very much in evidence. A few of them: "Blew up final amplifier, finished with a single 45." "Some contest! Never lost so much sleep." "My first ZAG contest. Didn't know there were so many FB operators in A.A.R.S." "Lost two rectifier tubes and one crystal." "Business interfered with my pleasure." "Let's have another one soon." "Wish I had a rock-crusher like W3SN."

## The Break-In Club

W2CFS reports the "Break-In Club" on 3585 kc. The purpose of this club is to develop each operator's ability to

\* Chief Radio Aide, A.A.R.S.

use break-in effectively, intelligently and with a maximum of efficiency. The club meets nightly from midnight to about 2:30 a.m. and includes the following members: W2CFS, W2DUP, W2GYY, W2CCZ, W2CLM, W2GGW, W9RMC, W7BVE, W6LIE, W6LBM, W6WT, W6JIT and W5JC. All these operators can "take it" from 25 to 50 words per minute. All hams working on 3585 kc. are invited to join this "break-in" club. It is growing rapidly in popularity.

## WLMK Assigned to A.R.R.L. (W1MK)

EFFECTIVE April first, your A.R.R.L. station, W1MK, received a special authorization from the Signal Corps, permitting the equipment to be used on 3497.5 and 6990 kc. under the designation WLMK, for work with A.A.R.S. stations.

This authorization does not mean that W1MK contemplates extensive operation on these frequencies, or is under obligation to enter into extensive drill work. W1MK remains free to devote all its time to work with and for League members, and free to collaborate fully with amateurs, N.C.R. members, and A.A.R.S., as any normal or emergency situation shall require in order to be of the greatest service in such situation.

The authorization from the Chief Signal Officer is primarily to better prepare W1MK for any possible emergency communication in case of disaster of any kind, by making it possible for your station to work on the special Army Net frequency, free from the usual amateur interference. It empowers the station to transmit and receive such traffic of an official nature as necessary to any such situation, and invites as full participation in general A.A.R.S. work as the usual operating program of the station will permit. Installation of crystals for transmitter control on these special frequencies is contemplated in the near future.

The affiliation of the Signal Corps and the Transmitting Radio Amateurs which was worked out in 1925 had some of

the following purposes in mind: (1) The setting up of additional channels of communication throughout the U.S.A. for use in time of emergency such that the land lines, both telephone and telegraph are seriously damaged or destroyed by flood, fire, tornado, earthquake, ice or other causes. (2) The providing of a means of establishing contact with a considerable number of radio operators, enabling them to know about Signal Corps activities, and to exchange views on experimental work. (3) The providing of a reservoir of radio operators trained in army methods of procedure and in the basic principles of the army's methods of using radio in the field.

It is particularly in furtherance of this first purpose or object that the assignment of WLMK has been made.

All amateurs can readily understand how important it is that in addition to experimenting with communication equipment, each individual station should be capable of organized participation in communications emergencies, and each operator highly qualified to function effectively at each opportunity. Also one should keep in mind the thought that the fullest degree of amateur interest and cooperation is due the A.A.R.S. and the N.C.R. as well, due to their friendly interest and support in our battles for frequency-privileges, as well as on patriotic grounds. A.R.R.L. Headquarters will at all times refer any amateur inquiry in either the Army Amateur Radio System or the Naval Communication Reserve to the proper authority to enable him to get lined up for cooperative communication work, if interested.

## DX Notes

### Trans-Ocean Work on 1.75 and 3.5 mcs.

**D**X contests always bring about interesting and unusual feats in international communication work. Among this year's highlights we find that W1BB, Winthrop, Mass., worked both ON4AU and G5BY on "160 meters" (c.w.); this was on March 9th, 12:47 a.m. and 1:20 a.m. E.S.T. respectively. On the same date W8HMJ heard G5AB calling W1BB. From W6ICW, Oakland, California comes the news that he was QSO J2GX on the 3500-ke. band at 2:00 a.m. P.S.T., March 17th! Contest numbers were successfully exchanged. This work speaks for itself!

VE1BV reports a daily 14-mc. schedule with ZC6FF, 11:30 a.m. A.S.T. ZC6FF is on about 14010-ke., n.d.c. note, and wants contacts with W stations. On RPT work with VE1BV, ZC6FF cut power to a 45 volt B battery, oscillator drawing 7 mills . . . his signals were QSA3 R2 . . . VE1BV had four QSO's with India during March, three with VU2BL, one with VU2CD, about 8:15 a.m. A.S.T. . . W1CGY and WITS on March 30th snagged VE5NO, Resolution Island, Baffinland. This in itself may not appear unusual, but—VE5NO's transmitter uses an '01A with 127 volts at 12 mills! And his signal is reported R7-8, with an antenna only 15 feet above the ground. He is located at a government direction finding station . . . VP4TF, ex-VP4FH, wants the gang to know that he is off the air for a short time. He desires to send a QSL to all stations he has worked, but has lost record of those already sent. If you worked him, and have not received a card, which is FB and very much worth having, drop a line to your QSL manager; if no card for you is there, request same from VP4TF direct. QRA: F. A. Herbert, 29 Reid Lane, Belmont, Trinidad, B.W.I. . . W6CUH, unable to participate in this year's DX contest, did put in some time listening with excellent results: The first day of the tests he heard 175 foreigners in 31 countries between 7:30 a.m. and midnight! At 7:00 p.m. on the same date he made HAC (Heard All Continents) in 5 minutes, 10 seconds, only to lower the time to 3 minutes, 40 seconds at 7:15 p.m.—this sounds like a real record!! The stations heard were J2GX and ZL2GQ on 14-mc., and ZS2A, CT2BK, HC1FG and W8ZY on 7 mc. . . W1CGY reports PK3ST, R4, April 1st, 6:45-8 a.m. E.S.T. on 14, 150 kc. VS6AQ is still coming thru on the East Coast on 14,250 kc. between 7-8 a.m.

The South Bay DX Gang: A live-wire organization of DX hounds is the South Bay (Calif.) Amateur Association, more commonly known as the "South Bay DX Gang." The members are W6QD and W6CUH, Manhattan Beach, W6HXU and W6DLN, Los Angeles, W6GRL, Ventura, W6VB, Santa Monica, W6DIO, Ocean Park and W6EGH and W6ACL, Redondo Beach. They are bonded together by their mutual interest in DX. There are no regular meetings, although they congregate occasionally for a "blow-out". The S.B.A.A. always shows up "in a body" at quarterly section banquets and conventions. The members even have QSL cards which are alike. The calls will be recognized by all real DX men.

More re the Thursday Morning Club: W5EBU and W5DVK are the only 1.75-mc. members of this club of 'phone operators whose interest is DX. Other members use 3.9 mc. Both W5DVK and W5EBU on 1.75 mc. have worked K6LQL (3.9 mc.). W5DVK on 1.75 mc. has worked YWC, Venezuela experimental station (7 mc.). On March 14th W5MS on 3.9 mc. worked ZL2BE, who was on 7 mc.

### Minnesota/Wisconsin Emergency

A terrific sleet and snow storm on March 4th and 5th completely cut off wire communication from Superior, Wis., and Duluth, Minn. Radio amateurs were on the job! W9ASQ, Superior, put up an emergency antenna in his attic (his regular antenna was grounded by the storm) and raised W9GYH, W9GBN and finally W9AN, St. Croix Falls, Wis. W9AN, located at the Hydro Power Station, had a direct telephone line to Minneapolis. W9ASQ and W9AN handled Western Union traffic and power company messages from Minneapolis to Duluth and Superior.

S.C.M. W9DEI tells the story of the work of other ama-

teurs in this emergency: "At about 10:15 a.m., March 5th, I heard an appeal from a broadcast station that communication was out from Duluth and vicinity and that amateurs should try to make contact. I went on the air immediately (3.5-mc. c.w.). At 11:45 W9JSN answered a QST I sent out asking all stations to listen for the storm area. At noon I heard W9IDJ, Two Harbors, Minn., call QRR; I answered him and he came back asking if I could get some wire orders through to Duluth. I made a schedule with W9IDJ for each hour, on the half hour. A schedule was later made with W9EFK, Minneapolis, to move the traffic from W9IDJ. At 3:00 p.m. W9IDJ called me and asked if I could get a very urgent message through to Minneapolis. After giving an OK I called W9EFK, who had picked up W9IDJ and copied the message direct. W9EFK then got an answer and relayed it back to me. When I called W9IDJ he had copied it from W9EFK. Hence W9IDJ was in direct communication with Minneapolis. I turned W9IDJ over to W9EFK after six hours of work with the storm area. At 11:25 p.m. I contacted W9KRH, Duluth, who said wire and telegraph lines were again functioning. At midnight I contacted W9HDP of Superior who reported everything OK."

W9KRH, Duluth, maintained schedules with W9HCC, Minneapolis, furnishing the local press with news flashes. W9IDJ cleared traffic through W9HZ, Duluth, W9NRH, Duluth, and W9GYH, Eveleth, in addition to W9DEI. W9SQA was assistant operator at W9IDJ. All traffic from the C.C.C. camp at Two Harbors was handled by W9IDJ. W9MYX and W9LIP, St. Paul, assisted in transmitting A.P. bulletins to papers in Duluth and Superior.

W4CPS, Memphis, Tenn., sends the following dope: On March 5th at 11:15 a.m., W9PQI, St. Louis, was pounding out vigorously, "QRR Duluth. All ham stations try to communicate with Duluth, Minn., and Superior, Wis. Western Union wants contact. Any station contacting, please report to W9HPP, Chicago, who is standing by on 7225 kc." W4CPS later heard W9LEX, St. Paul, QSO W9GRH, Duluth, and transmit a message about the storm. W4CPS then worked W9HPP and passed along the dope on W9LEX' frequency. W9LEX was first in St. Paul to contact Duluth. Others assisting in the emergency work were W9CD, W9FNC and W9DWU. W9HPP was handling W.U. traffic, W9CD telephone company data.

## Don't Miss—

The Third Annual A.R.R.L. Field Day Contest  
June 8 and 9, 1935

Only portable stations, actually operated in the field (away from permanent base or home address) are eligible to submit field-day scores. Any amateur frequency can be used, 'phone or telegraph. Scores may be multiplied by 2 if either receiver or transmitter is independent of commercial power supply, by 3 if both transmitter and receiver are supplied from an independent local source rather than from public mains.

In addition, if the power input to the final stage is:  
(a) Up to and including 20 watts multiply score by 3.  
(b) Over 20, and up to 60 watts multiply score by 2.  
(c) Over 60 watts multiply score by 1. This is all based on a count of one point for each different station worked in the contest period.

Get your PORTABLE rig, capable of operation on emergency power, ready now. Could you operate effectively in a real communications emergency? Prove it in the June Field Day.

## O. B. S.

The following is a supplement to the list of A.R.R.L. Official Broadcasting Stations in October QST (page 49): W2HCP, W3AVR, W3BET, W4ABS, W4DIO, W8IOH, W9NGZ, W9NUM, W9PDE, W9RHM.



## Briefs

### The Eight-Foot Rod Club

The Eight-Foot Rod Club is a group of about fifteen 56-mc. stations in the vicinity of Philadelphia, operating between 1:00 a.m. and 3:00 a.m. each Saturday. The gang stands by every half hour to listen for DX signals. All 56-mc. operators are invited to join in with this club at their weekly get-togethers.

W9GTG heard the world's longest CQer when he heard a W5 call CQ 2568 times without signing!! That sure must be a record. HI.

### License Exams at Baltimore

Examinations for Class "A" and "B" amateur operator licenses will be conducted at the Baltimore office of the F.C.C. at 7:00 p.m., April 30th. Persons desiring to take the examination should secure the necessary application from the Inspector in Charge, Fort McHenry, Baltimore, Md., and complete it, together with the jurat before a Notary Public, prior to appearance on the scheduled date and time of examination. Applications will be accepted until 8:00 p.m.

We've heard of B.C.L.'s getting "ugly," but W1FNP's experience beats all—a B.C.L. wrecked his 50-foot mast with dynamite!

W3AZT is a fireman and has his 56-mc. rig located in the fire house (in Philadelphia). While QSO W3AGI one day, W3AGI said: "Come quick, our house is on fire." W3AZT took the matter as a joke at first, but finally after much persuasion he changed his mind, and with the rest of the company responded to the call. They found W3AGI's cellar ablaze. Instead of an SOS, this was an SOC: "Save our cellar"!

### Purdue University Hamfest

The Third Annual Purdue University Hamfest and Amateur Round-up is scheduled for May 4th and 5th at LaFayette, Ind. These annual affairs have made a name for themselves, and anyone who has ever attended one will surely not want to miss this! All amateurs invited. B. H. Short, instructor in electrical engineering at the university, promises you a good time.

W2HIT, W2UX, W2AJB and W1BY BT2 have been definitely established as key stations in the New York 56-mc. message-delivery net. Outlets to all parts of the country are maintained via W2GFB and W2HAN, who keep schedules with stations on organized traffic routes on 3.5 mc.

The Norsk Radio Relae Liga (Norway) proposes the signal QSLN for use in indicating: "This station does not want QSL cards and will not send one except on special request."

28-mc. schedule announced by W9LLX-W9LLX, Chicago, will be on 28-mc. phone each Sunday starting at 11:00 a.m. C.S.T. His frequency is 28,200 kcs., crystal-controlled.

### Metropolitan New York 56-mc. Net

All amateurs willing to cooperate in a 56-mc. message-delivery net for the New York City metropolitan area should communicate with Herb Gordon, W1BY BT2, Route Manager, 56-mc., Eastern New York, or W2FQA, Glen Cove, N. Y. Those amateurs having a telephone are particularly desired. Also, since messages will be coming from all over the country, amateurs who use both 56-mc. and one or more of the regular low-frequency bands can tie into the plans very nicely. These fellows could feed the net whatever traffic they collect on the

## BRASS POUNDERS' LEAGUE

(Feb. 16th-Mar. 15th)

Call	Org.	Del.	Rel.	Total
W9LH	24	73	1784	1881
W3BND	284	153	1143	1580
W6MCO	89	106	1329	1524
W9FLG	76	115	1328	1519
W2BCX	58	109	1138	1305
W3OK	147	117	997	1261
W5CEZ	159	192	880	1231
W8GUF	182	157	824	1163
W8RYD	157	245	752	1154
W0KTY	100	309	844	1144
W9ESA	42	130	950	1122
W3ADM	70	59	980	1109
W9KPA	19	16	1020	1055
W8JTT	80	53	914	1047
W9FLA	194	182	586	962
W2DQH	74	47	804	925
W8AXN	52	20	794	866
W8ADY	114	37	686	837
W1MK	57	101	670	828
W3AKB	57	128	802	817
W9LEZ	93	114	609	816
W1N	101	164	544	809
OMITB	323	112	362	797
W8DVC	42	16	714	772
W9ICN	9	13	732	754
W9FAM	27	20	702	749
W3WI	31	57	592	739
W1GME	33	61	622	716
W7WY	20	56	633	709
W9PVZ	31	61	582	674
W8KGO	16	37	610	663
W2GNK	75	163	414	652
W9MZD	21	17	614	652
W9OQV	—	—	625	625
W8FTW	22	30	571	623
W9IQI	120	109	386	615
W3EDA	126	135	340	601
W3BWT	112	83	388	583
W8CQ	75	57	380	512
W8CUG	103	78	396	577
W3ANT	37	211	268	566
W8RN	97	136	312	545
W6LHK	67	112	366	545
W2BCO	377	99	66	542
W8FQU	371	123	40	534
W9FWW	17	99	418	534
W8JQE	98	130	252	530
W8EFK	362	30	133	530
W3EOP	237	163	126	526
OM2RX	122	37	309	519
W3BYA	121	87	313	516
W8KMC	91	308	114	513
W6GQC	57	56	396	509
W3ABA	11	418	74	503
W9AIJ	67	117	319	503
W9DI	75	66	389	501
W7KL	20	110	370	500

### MORE-THAN-ONE-OPERATOR STATIONS

W3SN	852	1561	461	2894
W6ZG	506	899	194	1599
W3EOY	422	217	602	1241
KA1ER	453	486	144	1083
W5OW	126	333	456	965
W8NIG	957	2	—	959
W3CXL	69	82	741	892
W9JRK	43	40	681	764

These stations "make" the B.P.L. with totals of 500 or over. Many "rate" extra credit for one hundred or more deliveries. The following one-operator stations make the B.P.L. for delivering 100 or more messages; the number of deliveries is as follows: Deliveries count!

W6CCK, 232	W4AEP, 126	W5OPP, 103
W2DBQ, 215	W5BFA, 123	W6EBK, 103
KAILG, 164	W5EES, 114	W8CDK, 103
W6CKZ, 144	W1DPS, 112	W8DFU, 103
W6FQJ, 136	W4BOU, 111	W7DUE, 102
W6RJ, 134	W5DEJ, 111	W9KCG, 102
W3ZI, 132	W23CHK, 109	W8BCK, 100
W7BB, 129	W9OKA, 107	W6BVL, 100
W8KKG, 127	W9DIC, 106	More-than-one
W6LXP, 127	W1FRQ, 105	W6BK, 104
	W9SGP, 104	

### A.A.R.S. STATIONS

Call	Org.	Del.	Rel.	Total
WLMG (W2BZZ)	10	9	1266	1285
WLVS (W6ETL)	106	211	744	1061
WLNF (W2BCX)	35	62	510	607

### MORE-THAN-ONE-OPERATOR STATIONS

WLM (W3CXL)	259	255	1948	2462
WLJ (W5OW)	176	108	1048	1330
WLMA (W8YA)	42	8	591	641
WLW (W6ZG)	124	252	140	516

A total of 500 or more, or just 100 or more deliveries will put you in line for a place in the B.P.L.

low-frequency bands destined for New York City. Among the 56-mc. operators who have already signified an interest in the enterprise are W2BZB, W2AMJ, W2CKO, W2HND, W2AJB, W2JZ, W2GHV, W2GPB, W2EKC, W2DFU, W2HIT, W2BZG, W2BUG and W2HLN. W1BY is also attempting to line up a route from Washington to Boston, all 56-mc. If you will cooperate in either the net or the route mentioned, please get in touch immediately with W1BY, 39 Kress Ave., New Rochelle, N. Y., or with W2FQA, 129 Elm Ave., Glen Cove, N. Y.

## W1MK

Addressed telegraph transmissions to amateurs are sent simultaneously on two frequencies, by automatic, from the Headquarters station, W1MK, on the following schedule:

Days	Times E.S.T.	Speeds (w.p.m.)	Frequencies
Sunday	8:30 p.m.	13	3825-7150 kcs.
Sunday	Midnight	22	3825-7150 kcs.
Monday	8:30 p.m.	22	3575-7150 kcs.
Monday	10:30 p.m.	13	3575-7150 kcs.
Tuesday	8:30 p.m.	13	3575-7150 kcs.
Thursday	8:30 p.m.	13	3825-7150 kcs.
Thursday	Midnight	22	3825-7150 kcs.
Friday	8:30 p.m.	22	3575-7150 kcs.
Friday	10:30 p.m.	13	3575-7150 kcs.

Official Relay Station schedules are at present kept with W3BWT, W3CXL, W6AM, W3JTT, W8GUF, W9AUF, W9FO, C8SYB, NY1AA. The additional time is divided between 7- and 3.5-mc. bands for "general" contact with any ham who may call. Operators try to "chew the rag" with just as many hams as time permits, as well as QSP whenever possible. QRG service is also available.

## W1INF

The station of the A.R.R.L. Headquarters Operators' Club transmits the Official Broadcasts, addressed to all amateurs, by radiotelephone, at 12.00 noon, Eastern Standard Time, daily except Sunday. These transmissions are made on a frequency of 3984 kc. during the weeks starting April 7th, April 21st, May 5th, and May 19th . . . and on a frequency of 14,198 kcs. at 12.00 noon E.S.T. during the weeks starting April 14th, April 28th, May 12th, and May 26th. Immediately following these transmissions W1INF looks for any replies or calls in the 75- or 20-meter 'phone bands. When possible additional 5 p.m. transmissions are made, and rag-chewing schedules outside regular office hours are kept by individual staff-club-members.

Headquarters operators and their personal "sines": Harold A. Bubb, "HAL," Chief Operator W1MK; F. E. Handy, "FH," W1BDI; E. L. Battey, "EV," W1UE; A. A. Hebert, "AH," W1ES; C. C. Rodimon, "ROD," W1SZ; F. C. Beekley, "BEEK," W1GS; C. B. DeSoto, "DC," W1CBD; K. B. Warner, "KEN," W1EH; George Grammer, "HG," W1DF; Don Mix, "DON," W1TS.

## 1.75 mc.

B. W. F. Mainprise, G5MP, temporarily located at Tenerife, Canary Isles, is making listening observations on the 1.75-mc. band. He listens nightly between 2100 and 0100 E.S.T., and will continue to do so throughout March. Among the "W" stations (c.w.) he has logged are W3CGK, W9FWJ, W8GZW, W8CIA, W8KFC, W2GCE, W9TQI, W9HCH, W1AFD, W8UV, W1AZW, W2SYS (?), W8ASI, W9AMO, W8KVU, W1EFN, W2FMD, W1SLV (?), W8CNC, W1MK. These were logged during December and early January. Mr. Mainprise also believes he heard W3UZ and W8CHL on 'phone but, not being sure of the calls, is awaiting confirmation. He uses a one-tube receiver and says that strength of "W" signals averages R3 to 4.

W8ASI, Buckhannon, W. Va., is on the look-out for

1.75-mc. trans-Atlantic calls each night from 7:00 p.m. to 3:00 a.m. E.S.T.

S.C.M. W4BCZ writes as follows: "On Nov. 18th W4CPG was heard QSA4 R5 in Japan on 160-mx 'phone . . . and has the card to prove it!"

## More DX

W1QV has worked D4CAF on 14, 7 and 3.5 mcs. . . WANTED: some definite dope on the elusive VU2CP . . . he has been worked by W3ANE, W1HE, W1LZ, W1ZI, W1GF and others (about 14,125 kc.), but no confirmation has been received by any of these stations . . . the lads wonder if it is the authentic VU2CP they are working . . . W4FT has worked 63 countries . . . Bob Wilson, W1YU/KHMZA, reports meeting several of the Hong Kong gang while in China . . . he says the VS boys smoulder until the annual DX Contest rolls around . . . take care of 'em this year, fellows . . . Bob also met G2TM, G2BM, G2ZQ, D4BUF, D4CCF, D4BPF, Y17NN and others on his jaunt.

W8CNC, Warren, Ohio, has worked all continents except Asia on 3.5 mc, with 200 watts since December 10th . . . On May 6, 1933, W9IQV worked VK2OJ on 3.5 mc. using a pair of '45's push-pull . . . Has any one any information on a station signing VS6FVD on 3.5 mc.? W9IQV would be interested . . . Add to the long list of c.w. stations working across the Atlantic on 3.5 mc.: W8DHU, W8GWY, W1AFB.

W1DBM has had another successful season of trans-Atlantic QSO's on 1.75 mc. . . he worked G2II on February 10th and was heard on the same date by G5WU and BRS1089 . . . reports ranged from R6 to R9! . . . British stations are limited to ten watts input on 1.75-mc.!! . . . it's a wonder any of them get across and it certainly speaks well for the efficiency of their outfits . . .

## INVITATION

Non-O.R.S. who have active stations and handle messages accurately, and move them speedily and reliably are cordially invited to apply to the proper S.C.M. for appointment. Non-O.P.S. working voice stations, avoiding over-modulation, and living up to the Amateur's Code of fraternalism and cooperation are similarly invited to inquire regarding the 'phone appointment. Traffic interest is *not* required of O.P.S. Activity reports are *welcomed* from all. The proper Section Manager who has full authority in making these field organization appointments (see address, page 5 this QST) will be glad to see that application forms are sent you, and arrangements with Route Managers or Phone Activities Managers made to get proper endorsement-recommendation on each application.

S.C.M.s solicit activity reports from all amateurs, whether holding special appointments or not. But if you have a really good station, why not qualify for O.R.S. or O.P.S. appointment? These stations are widely known for their excellence. You will enjoy QSO's with skilled operators.

A.R.R.L. organization has two basic appointments. The Official Relay Station appointment for the telegraphing amateur interested in handling traffic and in maintaining a high degree of operating proficiency and activity . . . the Official Phone Station appointment especially for voice operated stations, for every ham who normally uses his mike more than his key, who takes pride in maintaining a superior type 'phone station, with the highest standards of apparatus adjustment, with a really good signal, and high operating ideals.

## Standard Practices

Here are several useful, if too often overlooked detailed practices, attention to which will make operating snappier and amateur work more enjoyable for all concerned.

(1) For fills. Do you use ?AA ?AB ?WA ?WB etc.?

If not, sit down and learn 'em now with other handy miscellaneous abbreviations. Get 'em into use on your skeds right now, or when you resume.

(2) Abbreviations vs. Accuracy. Abbreviations over the air are fine, but too many are creeping into message texts these days and resulting in garbled traffic—so let's nail these crippled messages where they start. Make accuracy come first; kill the abbreviations *in texts*.

(3) Brevity helps Speed. Brevity in drafting messages, not to sacrifice of clearness will help speed up service. Brevity in CQ's likewise helps to reduce the time in raising stations. Learn to break a call frequently to listen for replies.

(4) "QSD!" Spacing characters and words *properly* will improve readability of sending. Avoid unnecessary flourishes and "swing."

(5) Speed of Transmission. This should be adapted to (a) transmission conditions, and (b) the abilities of the receiving operator. The signal strength report of the operators of the stations you work, and any Q-code instructions as to speed, with your own observations (lacking such definite advices), must determine the rate of sending adopted.

(6) Don't waste time "in explanation" when routine "fills" will save time. Ask fills and give repeats courteously as a *matter of routine*. Don't judge the other fellow's receiving conditions by your own. Work to put over the message or the thought in *matter-of-fact* routine. Don't waste time for both by long discussions and excuses when the time should be spent on the job in hand, *not* in wasted apology and recriminations. *Avoid* wasted time.

(7) Courtesy with Speed. QSG when conditions permit, and remember to be decent enough to pause between messages (after AR and "h" to show more is coming) long enough to enable a change to a new blank, and entry of station and time rec'd on each message. (We have worked two or three good traffic men whose chief fault was this lack of thought for the receiving operator.)

(8) Accept responsibility for promptly forwarding or delivering messages when you accept them. Operating, after all, is to a great degree merely the exercise of good common sense. Proficiency develops with practice. It's up to us to dig out our own failings. The necessity for using common sense practices is well recognized. To keep our personal operating above average, and make snappy QSOs which are a pleasure for those we contact as well as ourselves (as well as an example to other amateurs) is just a matter of a reasonable amount of study—plus a small effort to put the ideas outlined for ourselves into practice.

All consistent records in traffic and general activity (contest winners know) are made by those fellows who study out ways of making *best use* of every minute spent at the key. Increased operating efficiency develops increased *results* from station operation—increased joy in the knowledge and fact of being in this glorious amateur game. More dx, a "real" file of good traffic, increased pleasure in conversational or rag-chewing work, all these things follow the application of common sense operating procedure to amateur work, and, best of all, these gains can be made without spending any money for new parts, increased power, elaborate equipment, etc. All that is required may be a study of present results, and some "applied intelligence" directed toward common sense betterments.

The numbered points (above) have been chosen from an analysis of too-common operating faults, that may be cited as "examples." (1) Too many do not know the meanings of ?AA ?WA ?AB ?WB QSZ QRS QRQ QSQ etc. (3) Too long CQs (often without proper interposition of one's call signal at frequent intervals for identification), tire out hams anxious to send replies and QSO, resulting in lost contacts, wasted time and needless QRM. Some fail to comb the band carefully after QRZ or a short CQ before making another

call. (5) Stations answering calls fail in giving useful operating reports and instructions before their "K", when an R-S-T 239 QSZ" should bring the following transmission through *words twice at not over 15 w.p.m.* Likewise, "R-S-T 559 QRS 12" would show conditions perfect but slow speed *single* sending desired to suit a slower operator. (New operators: Please note that there is *no stigma*, but *high* operating efficiency, in requesting a satisfactory operating speed where necessary to understandable communication.) Too many fail to send single on getting a strength-5 R-S-T report or a QSA5 report indicating 100% copy!!

In the old days we absorbed a lot of incentive for using snappy procedure from the 600-meter traffic we listened to before getting going on amateur frequencies. Today, hams get on the air more quickly. Those of us who help beginners should suggest at least some study of operating methods individually and in club groups, to remedy the confusion and difficulty and unintelligent first attempts of new operators at making QSOs.

Just one parting thought, with the several suggestions for improving personal operating efficiency. Let's all study our operating work for possible improvement. Then apply any obvious improvements in our practice. Useful standardized practices should be added to our ham vocabularies, new terms adopted, where they handle recurrent amateur communication situations with increased operating effectiveness. Let us give and receive suggestions for the betterment of amateur radio operating freely, tactfully, constructively, all to the end that amateur communicating may be made more effective, more enjoyable, more fun, in all its different phases.

## That's What Little Hams are Made Of

I  
I want to tell you a story,  
A story I have heard;  
You may think it all a fable,  
But it's gospel, every word.

II  
The Good Lord took a blacksmith  
And a tinker and a bo  
Who used to hold a trick job—  
(Train dispatching, don't you know.)

III  
A 'phone lineman and a "central,"  
An "electric" engineer,  
A radio announcer and a  
Man who couldn't hear.

IV  
And he mixed 'em all together  
With a grain of salt or two  
And set 'em in the shadows  
And let the mixture brew.

V  
Then he ran it through a filter,  
And screened it through a grid;  
He seasoned it with pepper,  
And lifted off the lid.

VI  
He moulded it and twisted it,  
And shaped it here and there;  
Then took it out and looked at it,  
And set it on a chair.

VII  
He put some earphones on his head  
And shot it full of juice;  
But when it didn't seem to care,  
The Lord said, "What's the use?"

VIII  
"Here I've tried to make a genius,  
But it won't work worth a d—,  
So I'll just let it go at that . . ."  
And he called the thing a "Ham."  
—From "The Ham Reporter" (Dec. issue)

Add to W9FO's radio crew: W3AZF, Quick; W3DIS, Hartley; W6FUD, Watts; W5EGJ, Key; W4NP and W1BLQ, Speed; W8FNE, Schock (shock); W9OJC, Payne (pain). These are submitted by W3DYX.

## HUDSON DIVISION

**E**ASTERN NEW YORK—SCM, Robert E. Haight, W2LU—EGF reports T.L. "L" perking FB. LU is alternate for EGF on T.L. BLU wants schedules east and west. BJA hopes every C.W. man writes his Director. GPB is active in 56-mc. net with a.c. osc. BJB and HVS attended Hudson Div. meeting. 11BY-2, RM. for 56-mc. band, operates traffic net: HAN, BZB, AJB, BJR, UX, HIT, GPB, APU, FTV, FHJ, and 3FDV. FQG is rebuilding. GOW, O.P.S., is doing FB traffic work, and DX. CC reports 900th QSO with VK5HG; 100% C.W. DDW is QRX for M.H. A.R.C. to replace crystal. HCP sends Candler System Code Practice three times weekly. HIT hits 'em on 56 mc. UL is back from FB trip to Florida. HCM reports via Special Delivery. GNI needs Asia for W.A.C. With all members of E.N.Y., GNI express sympathy to the parents of late W2HMX. AVS was in 'phone contest with VO. BYP went out to win DX contest. SZ operates 56-mc. 'phone, 14-, 7- and 3.5-mc. C.W. by fast changes. CDC is on 3.9-mc. 'phone. HNU is going remote control. CVT is on 7 mc. COY works real DX on 3.5 mc. CGT builds new transmitter and receiver. BYV is back on 3.9 mc. after one year off. CBN was sick with measles. CJS is on 7 and 3.5 mc. QY schedules CIF at Florida. DQT plays hockey and works 3.9-mc. 'phone. HTN is on 3.9-mc. 'phone with 250 watts input. HJN is coming back on 1.75-mc. 'phone. HTH joins A.R.R.L. ICE, new ham, worked 20 foreigners in week. ESO is selling out. EGQ is rebuilding. HLB reports for Albany. HTN had 830 go west. FDI is active on 56 mc. HYK, HYN, HYO, HYQ, HYS, HZD and HZG are new hams. HCJ has trouble with BCL's. FBA got Class A ticket. CYW is back on the air. HLB uses 59 Tri-tet on 3.5 mc. with 841. DEL is active on N.C.R. drills. CGO was in DX contest. GRY-FGE has new rig with 211 final. HVR is on 1.75 mc. HBD, GZZ, HVR, GYH and HCE desire interested 28-mc. hams get in touch with them.

Traffic: W2EGF 441 LU 407 BLU 228 BJA 129 GPB 58 BJB 53 11BY-2 45 FUG 37 GOW 33 CC 20 BZB 15 DDW 14 HCP 13 HIT 8 UL 18 HCM 5 UX-GNI 3 BJR-FHJ 4 HAN-AJB-AVS 2 SZ-APU-FTV 1 HTH 6 BZZ 126 (WLMG 1285) GTW 17. W3FDV 2.

**NEW YORK CITY AND LONG ISLAND**—SCM, E. L. Baunach, W2AZV—The following are out for O.R.S.: BDR, DPQ, EYS, GWD, HWS, HXT and DCF is out for O.P.S. We are still desirous of having more O.R.S. and O.P.S. in the Section; all those interested should get in touch with the S.C.M. HNH, HQK and HSV are having B.C.L. trouble. GYV is working on 56 mc. ERE reports for the Lenox S.W. Club, FPU, that they are attempting a bowling schedule with 8GUL in Cleveland. EQU was seriously injured when hit by a bar rag. ARG is getting nowhere fast with the YL's. HJJ is busy on 56 mc. BRB is arranging a series of tests on 400 mc. HKO is off the air due to a burned-out plate transformer. KI is now able to work break-in with crystal control. B.C.L.'s have cut IAW's antenna. HUN is on with a '10 and is the former 2ATZ. BSR, DOG and UK worked full time in the DX contest. AZV is working nights and pounds brass in the day time. HMJ sends in his first report. HNJ has formed a new club called the B-C radio amateurs; anyone interested should get in touch with him. During the past few weeks LG has been trying to work England on 1750-ke. C.W. with his low-power rig. HBO has joined the A.A.R.S. HJK is installing 8LUQ's twisted feeder system described in Jan. QST. BGO has to cut schedules because he can't dig enough traffic to keep them going. DBQ is QRL publishing an A.A.R.S. bulletin called the "Washline." CHK worked EA4AO on 3.5 mc. DXO won the N.N.W.A. flea power contest with 1032 points. BTF worked seven countries in four days in the DX contest. GDF finds that the rig perked FB in the DX contest. CSO has 400 watts input to a '52. PF is designing a new 56-mc. transmitter. AHC is QRL with the Hudson Division Convention. FF can be heard on 14,242-ke. 'phone. BNJ has been trying to recruit hams in the N.C.R. DJP has new rig using '10's in parallel. AYJ got 861 perking. BYL is rebuilding rig in sections so will always have rig on the air. EAR worked first two ZL's since being in the game. DUP worked G6RB and D4BPJ on 3.5 mc. with new rig using '24, '46, '10. ATB is rebuilding for 1 kw. GMI is now on 7

mc. GNO is secretary of CWL. GHN is having sweet time making his 7-mc. rig behave. HXC can't get his sigs into N.Y.C. HWV is going in for traffic with flea power rig. GEI's 225-watt rig is working plenty of DX on 7 mc. After AGC got an antenna up he was in bed week with the grippie. CDJ reports that ESK is increasing power.

Traffic: W2BGO 542 EYS 260 DBQ 493 (WLNB 104) CHK 389 (WLNM 78) DXO 87 DCF 47 BTF 51 GDF 36 CSO 27 PF-AHC 27 AVZ 26 FF 19 BNJ 15 ELK 13 (WLNJ 2) DJP 13 AYJ 12 BPJ 11 FPU-BYL-EAR-WK 8 ADW-DUP-HWV-BIK-GWO-QS 6 FIP-HJK-HBO 5 CIT-LG-HNJ-HMJ 4 EDZ-ERH 2 GYV-AGC 1.

**NORTHERN NEW JERSEY**—SCM, Charles J. Hammersen, W2FOP—BCX's buffer stage blew up from handling so much traffic. DQH is net control station for A.A.R.S. for the Section. GNK has been appointed to Trunk Line "C," handling all north and south traffic. 3ETX was forced to give up all schedules on account of work. 2BJK had rig set up in Boy Scout exposition in Newark. GGE can pull a one-inch spark from final tank using pair of ten's. DCP is rebuilding as usual. GGW is new N.C.R. recruit. GFW worked NY2AB on 3.5 mc. HHY keeps four daily traffic schedules. DLF made some fine contacts in DX contest. GWJ reports two more hams in Irvington, IBO and IDU. ECO is working DX on 3.5 mc. HZC finds 7-mc. zepp won't work for him on 80. CTT, working from Rutgers with call DYM, intends putting up 260-ft. ant. HRN worked KO1F and can't locate country with that prefix. BXM keeps daily schedule with 3FDV on 56 mc. HED has receiver which refuses to oscillate in the center of the 7-mc. band. DYP worked Alaska on 3.5 mc. HFZ received first-class 'phone ticket. GNW is working tests with Pratt Institute on 56 mc. BJK is looking for someone to make experiments on 2½ and 1¼ meters with him. AHN is having considerable success with direction finding equipment. With a pair of 45's on 3.5 mc. HHY worked HC1FG. EPR is studying for commercial ticket. CAY has worked nine countries on 3.5 mc. HTX has new Go-Devil. ABS was second op. at BXU during DX contest. BTZ using 50-watt rig in final. DVN is active in N.C.R. HFO has new 50-watt rig. CW is getting new Patterson receiver. O.R.S. and O.P.S. appointments are behind the quota set for the Section. FOP, S.C.M. would like all qualified ops. who are interested in either of the appointments to get in touch with him for getting the necessary material for application.

Traffic: W2BCX 1305 (WLNF 607) DQH 925 GNK 652 BJK 300 GGE 173 DCP 150 GGW 76 GFW 70 HHY 64 FOP 43 CJX 18 DLF 14 GWJ 13 ECO 11 HZC 7 CTT 5 HRN-BXM 2 HED 1. W5ETX 319.

## ROANOKE DIVISION

**N**ORTH CAROLINA—SCM, H. S. Carter, W4OG—The SCM wishes to thank the gang for electing him to the job, and asks that every ham in the Section show their loyalty by reporting any activity on the 15th of each month. Raleigh: The Floating Club was well entertained at the March Meeting by the Raleigh Gang. EG is rebuilding his 7-mc. rig, but worked some DX in the contest on 14 mc. ANU has a pair of 50-watters on his 'phone rig. JB is busy with the Naval Reserve. HV and BTC are in the Reserve. DW says the reason he didn't work any DX in the contest was that the foreigners thought he was a local and just wouldn't answer him. Charlotte: CXK is busy with traffic since being appointed O.R.S. BLN has some good traffic schedules. ALD has Class A ticket. BFB is on 14- and 3.9-mc. 'phone. CLB and BX visited CWH, who is a shut-in down in Georgia. BXF is busy with N.C.R. work. CSO handles traffic along with N.C.R. work. DIS is a new station, but an old-timer in the game. DCX is active on 1.75-mc. 'phone. BXB has a 56-mc. rig about ready to go. BWV, ZE, AEN and BHS are all active. Winston-Salem: NC, AHF, CYA, CXF, RA, COK and OG entered the DX contest. IY is having receiver trouble. DKI is a new ham; he also joined the club. CFR has moved and is rebuilding with crystal control. BWC is building. CGY has returned to the air after a long lay-off. IF is doing good work on 14-mc. 'phone. ABT has a new AC'R receiver. NC is busy with plans to win the Field Day Contest in June. The 1.75-mc. 'Phone Net is

very active with BYA as the head; he reports twenty stations in the net now. AI, an old-timer, has returned to the air and is a member of the net. BV, CDQ and DCX handled traffic on the net. AGF is busy with A.A.R.S. and is alternate Control Station for the State. BHR has some FB traffic schedules. BRT devotes most of his time to traffic handling and has some good schedules. Charlotte has been given an official appointment as the Convention City for October, so plan to attend.

Traffic: W4DW 159 BC 105 CXC 72 AGF 43 BRT 38 BLN 33 ALD 19 CSO 25 BHR 18 BX 14 CDQ 11 BYA 10 AI 5 BV-CLB 2 BFB-OG-COK 3 DCX-CXF 1.

VIRGINIA—SCM, Neil E. Henry, W3BRY—EMA is experimenting with two types of Tri-tet. CYK is on both C.W. and 'phone. BRE has gone crystal control. EEN handles lots of N.C.R. traffic. FBR is new 'phone in Lynchburg. EGD has new power supply. DVP has new '03A in final. BRY is rebuilding. BSB was active in DX contest. EHL has new bug. EDG has been QRL school. FJ reports from Port Monmouth. N. J. ELA had big time in ZAG contest. CPN discarded '52 for pair of '46's. FBL schedules 8NEY weekly. CHE applies for O.R.S. EAP is remodeling BC set to make s.s. super. GY has new Tri-tet perking great. WM has thoughts of swimming. hi. EOO has new Bug. EPH likes new style "Ham." EZL is working on portable rig. ANT really believes in traffic! B.P.L. APU was active in ZAG contest. AVR is new O.P.S. FB. EBD has new P.P. '10 amp. ECQ shot '66. GE is active in A.A.R.S. again. AZU is trying 56 mc. UVA worked five continents in one day. ALP has new 50-ft. skyhooks. EPW says daytime A.A.R.S. Net going swell. EZJ worked F8 and CM2. AAJ is trying to learn how to work without sleep. Hi. BYA makes B.P.L. DAM is working DX on 14 mc. APF has new Jr. opr. Next meeting of Va. Floating Club will be at Norfolk in June. All O.R.S. and O.P.S. should check dates on their certificates and send in for renewal if needed. AAF and EBK took part in DX contest. OGR's rig went haywire in middle of contest. ECR has sweet sig on 3790 kc. ELB tried 1.75-mc. 'phone, but likes C.W. best. AHC says two new hams are all set to go at Staunton. AIJ got Mod. trouble fixed. AMB and DBV report. ASK is sitting tight awaiting PR-12. ENO has new '03A. EVO has 212-D final. EVV has BCL grief. EXW is on 7225 kc. FBW is rag-chewing on 3675 kc. FE is back with P.P. '10 TNT. FFD and FGR (ex2CAW) are new stations at Charlottesville. FHS is new station at Richmond. MQ is experimenting with Acorn tube on 56 mc. BAN is furnishing QRG service to Calif., C. Z., Quebec and Portugal! BIG is having hard time getting O.P.S. Net going. BIW has new 65-ft. masts. BRA is building portable. BTR is even more QRL than SCM, hi; works 84 hours a week. BZ gets out to the shack now and then. BZE, CNY, COO, CYM, DWE and DZW are rebuilding. DNW sends FB poem for "Va. Ham." 2HGJ is operating portable at Richmond.

Traffic: W3EMA 7 CYK 9 BRE-FBR-DVP-EDG-FBL-AV-R-EZJ-DAM 1 EEN 59 EGD 59 BRY 30 BSB-EOO-UVA-APF-BFW 2 EHL 64 FJ 57 ELA 58 CPN 5 CHE 25 EAP 5 GY 6 WM 8 CA 11 BJX 282 (WLQF 12) DCU 182 EPH 66 EZL 10 ANT 566 APU 52 EBD 89 ECQ 169 GE 44 AZU 4 ALF 64 EPW 101 BEB 19 AAJ-BSY 4 BYA 516.

WEST VIRGINIA—SCM, C. S. Hoffman, Jr., W8HD—KKG won a crystal for highest score in State during January O.R.S. contest. CVX has new RK20 P.A. MZD worked FMS, JRL is working ZS, ZT, ZU. BOK has new Collins rig. GDF has new Jr. opr. Congratulations! KGT has parasites crawling in new rig. AMX is on 'phone and C.W. JM worked HI7G on 14-mc. 'phone. Harrison County has 17 pre-selector! ELK was heard by OHBNX on 3.5 mc. ELO, LTD and DMF were heard in Mexico on 3700 kc. NKZ is new Logan ham, an ex-K6. MCR is adding an '03A P.A. The W.V.A. A.A.R.S. Net needs stations in Parkersburg, Morgantown and Martinsburg. Interested hams are requested to get in touch with OK, HD, ELJ, KKG, KHB, MSI and LGB are off temporarily. MSI rebuilding; while ELJ tested his new set, used the lamp from dummy antenna as elimination for their work bench! GDF is changing to Class B modulation. NAU uses 30 watts input, new rig. GBF uses two '52s in P.A. HD/WLHF acted as Corps Area N.C.S. for a week. JWJ applies for O.P.S. MBB was

heard in Porto Rico on 1.75-mc. 'phone. LTD visited 3EZT. EYV is disgusted with 'phone QRM. KWL was heard in Germany, with 45 watts input. KEC took West Point entrance exams. MOP visited LTC. NBH is new Williamson ham. ELJ visited LTC and LTD. MCL visited CDE and 9TEK.

Traffic: W8KKG 256 MCR 39 OK 75 HD 68 (WLHF 84) JWJ-DFC-KEC 1 AKQ 10 LJX 51 LTD 54 HWT 106 CMJ 13 LTC 8 MCL 5.

#### ATLANTIC DIVISION

EASTERN PENNSYLVANIA—SCM, Jack Wagenseller, W3GS—The B.P.L. list this month beats even last month's lineup with EOY, ADM, AKB, 8FLA, 30K, EDA and EOP all making the grade. EOY won A.A.R.S. third Corp Area ZAG contest. AZJ and 8AZT report for first time. 3AZJ and EBP are out for O.R.S. appointments. EPJ is rebuilding some thought towards 1.75-mc. 'phone. 8CVS says one spot Navy Drill very FB. 3AKB's report is biggest she ever had. AQN and 8FLA are QRL Army schedules. 8EU was away on trip showing movies. 8ASW finds 15 watts to be just as good as 100 watts. 3FED is a 28-mc. specialist and will devote a lot of time to it this summer. BYS has a 1.75-mc. traffic schedule to N.Y.C. ECD is back on 56 mc. OK, EDA and 8LYH report via radio. CL's YL QRM is getting to be a serious matter. VR is now O.R.S. 8LRI discovered that when 211's blush too hard they go west. 3FEP has new rig to work on 14, 7 and 3.5 mc. with 125 watts. GS is experimenting with 56-mc. supers. 8BFF has been off the air rebuilding. 3MG tells us that there are over fifteen stations on 56 mc. in Harrisburg now. ABQ finally built his breadboard rig into a rack. The Lansdowne Club is going to have a hamfest at the Hotel Lorraine in the early part of June. The Delmont Ultra High Frequency Club is erecting a 24-element beam antenna to work on 56 mc. This will be aimed at Hartford in an attempt to work up that way on 56 mc. AGI sent in a fire alarm via 56 mc. EWR at Girard College runs 25 watts into a '10 final on 3554 kc. C.W. and 3903-kc. 'phone. FGA, new Phila. ham, operates c.c. 'phone on 1817-kc. with pair of tens in final.

Traffic: W3AZJ 78 EOY 1241 EBP 126 ADM 1109 AKB 817 EPJ 172 EZ 359 ADE 224 AQN 93 FED 39 BYS 75 ECD 378 BZP 125 OK 1261 (WLQA 225) EDA 601 CL 92 VR 32 EOP 526 GS 6. W8AZT 6 CVS 26 IWT 18 FLA 963 EU 4 ASW 24 LYH 474 LRI 8 W3EWR 65.

MARYLAND-DELAWARE-DISTRICT OF COLUMBIA—SCM, Edgar L. Hudson, W3BAK—3CXL, 3CQS, 3SN, R.M.'s 3BWT, Chief R. M. Opr. "HC" of CXL is leaving for three months' vacation on the West Coast. Calif. State net, A.A.R.S., complains that SN busts up their drill every night on 3.5 mc. BWT worked England, Holland and Switzerland on 3.5 mc. ABA uses his spare time feeding chickens. CDG has '52 running at 400 watts input. DML wants early morning schedules. ASO wants traffic for Washington and South. BAK is rebuilding again. CQS had two weeks' naval cruise on U.S.S. *Herbert*. EYX is building 56-mc. rig. DPA has new crystal transmitter and new F7 receiver. CDQ, BWT, ASO and BAK attended Wilmington, Del. Hamfest. BHE had another '10 go west, also filter condenser. The Wilmington, Del., banquet and hamfest on March 2nd was a brilliant success. Five hundred attended.

Traffic: W3CXL 892 (WLM 2462) SN 2394 BND 1580 BWT 593 ABA 503 CIZ 456 BKZ 197 CDG 144 DML 130 ASO 126 EDS 35 BAK 29 CQS 15 EYZ 5 DPA 4.

SOUTHERN NEW JERSEY—Acting SCM, Carroll D. Kentner, W3ZX—The South Jersey Radio Ass'n made its annual awards for the best South Jersey stations at a big meeting March 21st. BEL carried away the silver loving cup. ATJ received second award, ENC third award, and DYR a special award for the best ultra-high frequency station. The Club will move to an excellent new meeting place; the Bird-wood Club in Haddonfield. NF schedules his brother once a week at 8YA. ENB reports QST break-in system FB, and wants O.R.S. DNU sends in nice total, and reports FEX a new ham. The Atlantic City gang are migrating down to 2½ meters. BO, an old timer, sends in his first report for many a moon, and is anticipating a shiny new O.R.S. ticket. CQR has been recommended for O.R.S. DQO says his low total is due to his activity in the DX contest. FBM is a new reporter

who is anxious to get into the message handling game. AYZ is back on 'phone again after being off a week due to slight mishap. ZI copped second prize in the "ZAG" Contest by working 28 states on the 3.5-mc. band in one evening. COT is as proud of his new O.P.S. ticket as he is of his new 14-mc. 'phone. AN is fumigating his "sender" after last month's quarantine. IS has applied for O.P.S. A EJ handles consistent traffic with three schedules per week. AVJ says the Atlantic City Radio Club house burned down March 1st. Their hamfest will be held May 25. CLW is back on the air. Somebody is pirating DK1's call. APV and ZX are candidates for S.C.M. VE sends in nice total. ZX on 3880 kc. is looking for contacts with all active stations in this Section; particularly on Monday evenings.

Traffic: W3VE 151 APV 132 AEJ 13 ZI 276 AYZ 4 AVJ 10 CYI 6 DQO 14 CQR 12 BO 23 DNU 128 ENB 47 ZX 7 BEI 31 NF 5.

WESTERN NEW YORK—SCM, Don Farrell, W8DSP —JTT, RM is doing very fine traffic work. JQE is a new O.R.S. with plenty of traffic. KMC has fine schedules and is using low power. DSS, R.M., is doing fine traffic work. CDK is alternate on Trunk "G". DBX has several good schedules. AQE is very busy with A.A.R.S. work. LMI is new man with plenty of traffic. MQX did some nice QRR work. GWY is working DX on 3.5 mc. GZM has left the Western Union. BJO, R.M. is on the air again weekends. MBY is on with several schedules. FTB wants traffic for Western New York. LUO is alternate on trunk "G". FYF has A.A.R.S. call WLNL. BHW just bought a new home. BR has a new c.c. job on 3525 kc. LUQ, 'phone, was married on March 28th. BQJ was busy with DX contest. AWM has a new a.c. receiver. GBS is very busy with 56-mc. work. CJJ had great time in DX contest. EBR is doing lot of 56-mc. mobile work. LIJ is rebuilding. AKX worked YI-VQ, VK and ZL during month. KXA is having trouble with line voltage. BLP wants O.R.S. again after long time. FMX just finished rebuilding rig. AXE sends report by radio. JJJ is doing a lot of work on 56 mc. The Mohawk Valley Brass Pounders are going strong; they have a new rack and panel job at the club house and have put up a doublet antenna for the FBXA. LGR has a new McMurdo 5C super. LGV has heard six countries on the 3.5-mc. band. LGY is on 1.75 'phone. The Mohawk Valley Amateur Radio Club is cooperating with the Boy Scouts in their exhibition work. AFM says he is too busy to get on the air. IYL is going on 28-mc. 'phone with a new 30-watt rig. HWR is still working on new transmitter and receiver. DWJ will be back at Brantingham soon for the summer. AYD made W.A.C. during the DX Contest. LUJ is having trouble with his 1.75-mc. 'phone. FHM is on 14 mc. Ten members of the Rome club attended the hamfest at Utica. GWP is teaching the YL the code. DRM has moved from Camden to Rome. EXT is running a gas station. The gang at Rome and Oneida is trying to hook up on 56 mc. The 56-mc. gang at Syracuse are doing a lot of mobile work every Sunday afternoon. FOY and DSP are building 224 mc. transmitters and receivers. The Rochester gang are active on 56 mc. and have several beam antennas in operation. GAR is at Mitchell Field Radio School. LLN has 830's in his final now. NGG is on at Brainardville with a battery job. All the gang working on 56 mc. or higher frequencies please get in touch with the S.C.M. regarding the arranging of a field day sometime during the summer. MNW of Rochester sends his first report; he has been on 3.5 mc. and is rebuilding for 7 mc.

Traffic: W8JTT 1047 JQE 530 KMC 513 DSS 433 CDK 280 DBX 166 AQE 164 LMI 113 MQX 78 GWY 54 GZM 47 BJO 36 MBY 41 FTB 27 LUO 27 FYF 36 CPJ 20 BHW 18 BR 16 LUQ-AWM 13 BQJ 10 GBS 9-CJJ 9 EBR-LIJ-AXK 5 KXA-BLP 3 FNX 2 AXE 2A.

WESTERN PENNSYLVANIA—SCM, C. H. Grosarth, W8CUG—GUF still tops the list and makes himself a nice score in the A.A.R.S. contest. ADY says the A.A.R.S. sure swells the totals. CUG handled KWA's schedules for two weeks. YA is back with A.R.R.L. schedules and needs a good one south. KWA has returned from the south and is at it again. IUY has a fine c.c. rig working. JZR turns in a nice total. MHE joins the O.R.S. gang and sends a nice newsy letter. Welcome, OM. MOT has a nice new rack for the rig. KSG keeps busy with A.A.R.S. schedules. LIG re-

ceived his O.R.S. appointment and reports NEQ a new ham in Warren. INE is active as usual. CMP has been getting the summer transmitter ready. LOQ is working on 56 mc., but is QRL school. CQA is busy building a new receiver. ABS wants to get an O.P.S. net started in the section. KXP works INE A.A.R.S. schedules at noon. IOH wants to work a W5 to get all districts. IOI is going to try some 7-mc. work. FIP won second prize in the Sylvania QSL contest. Nice work, Fred. MTD has a new All Star super and a nice rig on 7 mc. NDE uses two 830's in the final. HAP is building '52's class B. IBX has joined the A.R.R.L. BBV says BLQ is doing some nice 56-mc. work and LDM and EFB are building transceivers for the 56-mc. net. UK had a lot of fun in the A.A.R.S. ZAG contest. KNB worked G5YG on 3.5 mc. with 20 watts! KOB wants a good schedule west and south on 7 or 3.5 mc. AXD's schedules bring him a very nice total. JZZ needs some good schedules. MIH says FPD will be back from the world cruise soon. JCE is in line for O.R.S. and A.A.R.S. IZD is busy rebuilding. LAY is using P.P. rig on 3.5 mc. MST is very interested in 56-mc. work. GUX has a nice new radio room. IYQ keeps schedules with the home town. IRY is going in for P.A. work. HDY says the Collins system is FB. ASV is trying for DX on 7 mc. DYV is just too busy. MHO and MKO are after DX on 7 mc. MJF gave up 7 mc. to chat on 3.5 mc. MSV KBQ and KBC are getting out nicely on 3.5 mc. MII got his new Elmac 50-T too late to get it on for the DX contest. MIB is planning a new 1.75-mc. outfit. MIY is building the rig up in rack and panel style.

Traffic: W8GUF 1163 ADY 837 CUG 577 YA 409 (WLMA 641) KWA 289 IUY 165 JZR 110 MHE 100 MOT 66 KSG 50 LIG 44 INE 40 CMP 25 LOQ 19 CQA 11 ABS 9 KXP 9 IOH 8 IOI 6 UK 217 KNB 171 KOB 81 AXD 197 JZZ 115 MIH 53 MII 2.

#### NEW ENGLAND DIVISION

CONNECTICUT—SCM, Frederick Ellis, Jr., W1CTI—Number of reporting stations and traffic shows a healthy increase over last month. MK tops the list; Hal says CMSYB schedule on 3.5 mc. is working well. GME wants to know when the next Conn. QSO Party will be held. One is being planned. Watch for announcement. DOW sends in some good dope for "Contact." YU's traffic was handled during Electrical Exhibition. CVL cured a case of B.C.L. QRM by using a relay keying in cathode of 56 crystal osc. DBU made 2429 points in DX contest and applied for O.R.S. AMG says lots of Navy business this month. AMZ is boosting the C.W. end of the much-talked-of 'phone-C.W. question. BDI says Headquarters 'phone rig 1NF gets out well on 14 mc. HYF is looking for early a.m. schedules with O.R.S. APZ worked D4UAO and D4BPJ on 3.5 mc. March 10th at 10:30 p.m. FSH is using a borrowed crystal on 3680 kc. GKM is doing some 56-mc. work with a transceiver. ES had 18 teeth out and is feeling much better now. IDJ has four operators. HPI has four frequencies available on switch on his new 250-watt output rig; he is Consulting Engineer for W1XHC on 30,100 kc. BNB says new amateur IEP is coming along fast. IKE is getting ready to rebuild. BFS saved his keying finger nearly off on a cord wood saw table, but manages to use the bug with remaining four fingers. IIS applies for O.R.S. EAO blew a tube in DX contest, and reports a lot of off-frequency work. New O.R.S.: HTS, DLX, CTB. Welcome, OM's.

Traffic: W1MK 828 GME 716 UE 353 (WLGQ 27) DOW 340 YU 280 CVL 149 (WLG1 65) DBU 104 AMG 92 AMZ 69 BDI 44 HYF 43 APZ 39 FSH 30 GKM 21 NE 13 ES 12 CJD 8 DEP 6 IDJ-HPI-BNB-CTI 4 IKE-DLX 3 CTB 2 BFS-IIS-EAO 1.

MAINE—SCM, John W. Singleton, W1CDX—OR worked France on 3.5 mc. EF worked G and PA on 3.9-mc. 'phone. DEX QSO'd Portland on 56 mc. HSE would like a Boston schedule. BNC renewed O.R.S. ticket. DHH worked 16 W9's in one day. BWR is back on the air for good. IEH is planning to have a portable 3.5-mc. rig. IDN is hard at work getting ready for 56-mc. mobile work this summer. CDX moved to 73 Allen Street, Wilton. ITA is new ham in Hallowell. BZS has 1st class 'phone and 2nd class telegraph tickets now. APX has trouble with B.C.L. QRM. EZR discontinued all schedules. EEY has new 56-mc. transceiver

ready for summer. GOJ is new O.R.S. PD is new O.P.S.

Traffic: W1OR 184 EF 112 DHX 42 HSE 35 BNC 28 CRP 13 DHH 11 BWR 6 IEH 22 IDN 19 CDX 44.

**EASTERN MASSACHUSETTS—SCM, Joseph A. Mullen, WIASI—**ASI has turned his attention to N.C.R. ABG says traffic slow-spring slump ahead. KH and WV have new HRO's. EVJ worked his first So. Am. station. BMW has new rig using '59 osc. and pair of 2A5's. DFS is alternating on T.L. "C" for FRO. RE is doing a bit on 7 mc. BZO is starting up the traffic ladder again. FRO makes B.P.L. for first time. FB, Alice! GCL reports plenty DX on 3.5 mc. Second op at FPO has Comm. 2nd Ticket. IGN, YL op, is on 3750 and 3775 kc. daily. BFR finds DX FB on 3.5 mc. BEF is now in wholesale ham business in Lowell. HKY is keeping schedules with DCW and IGN. JL is keeping a few schedules. FNZ reports ISM new station in No. Abington. DBM reports from Reno from his portable station. BVL is just back from trip to Porto Rico. VA's equipment does not approve of Jack's change in QRA. Eastern Mass. needs 13 more O.P.S. and 28 more O.R.S. to fill its quota. Can YOU qualify for one of these appointments? Write the S.C.M. ZK is all installed in his new QRA. AKN has completed his cellar studio. CGM is starting work on his subterra firma static parlor. It will have "Janik Air Conditioning." BIO is now peddling ham parts for Jappe Co., in Boston. MD is working towards an O.R.S. appointment. HVR sends a very FB report; he is A.A.R.S. and is handling traffic on 3580 kc. SW is active on 7, 3.5 and 56 mc. WE worked a VK5 for his W.A.C. BB worked G5BY and ON4AU on 1.75 mc. during DX contest!

Traffic: W1ASI 14 ABG 42 KH 52 WV 74 EVJ 95 DFS 188 RE 2 BZO 89 FRO 243 GCL 31 FPO 5 1GN 71 BFR 58 BEF 31 HKY 74 JL 27 FNZ 2 MD 6 SW 9 HVR 62.

**WESTERN MASSACHUSETTS—SCM, Percy C. Noble, WIBVR—**DVW, Chief R.M., sure is doing his stuff, running around 35 schedules per week plus A.A.R.S.! GZL has been appointed P.A.M. and will write an O.P.S. section for monthly Bull'. BVR is making his West. Mass. A.R.R.L. Bulletin a monthly affair; he worked HB9J on 3.5 mc. ARH is getting to be a real traffic hound. DIE schedules the Chief R.M., along with many others. BNL is building Speech Input and Modulator à la March QST. HNP is doing fine as a new O.R.S. ZB made 85 QSO's in 37 countries in DX contest. DDK reports that Wore. Radio Assn. is busy with Wouff Hong Skit. CTK is QRL now with employment, and has cancelled schedules. IJR is the new Trustee for the Hoosac Valley Radio Club (IPTS). DUZ attended Mid-West Hamfest at Chicago. ADF has been heard in the Canary Islands on 1785 kc. BJS has made a break on 28 mc. GJJ is starting an extensive rebuilding operation. GYI has new transmitter. Old-timer AJD is getting started in traffic again. GUO has cancelled all schedules due to studies. APL is still having trouble with his transmitter. BAP is still burning up 57.5 mc. BWY has changed time of broadcasting O.B. to 8 p.m. Thursdays. COI worked D4BAR and HB9Y on 3.5 mc. FFK gets RS in Switzerland on 3.5 mc. New ORS: DWO, HNP, and HRV. The West. Mass. O.R.S. Channel has been shifted from 3700 kc. to 3732.5 kc.; we did not want to interfere with the W. Va. Net which, it seems, has been operating on 3700 kc. for nearly three years.

Traffic: W1DVW 326 GZL 104 BVR 97 (WLG 273) ARH 85 DIE 62 BNL 61 HNP 23 ZB 26 DDK 17 CTK 14 IJR-IJW 10 DUZ 9 ADF 8 AWW 7 BJS-GJJ 5 GYI 4 AJD 3 GUO 2 EOB 178.

**NEW HAMPSHIRE—Acting SCM, Robert V. Byron, W1AVJ—**"CU in Manchester on May 18th" is the slogan now, as we are to hold the 2nd Annual N. H. Hamfest at the Hotel Carpenter on that date. The price is \$1.50 including everything. It will be bigger and better than last year, so we hope to "CU in Manchester on May 18th." ET is still doing fine work timing skiing with 56 mc. rigs; also ET now has 1.75-mc. 'phone going. UN is very busy with weather reports from Mt. Washington and snow reports for Boston. GEY plans to be on more. EAL and GDE are new O.R.S., and we welcome them. IJB, IP and FFZ are handling some traffic. GMM, HTO and AEF have applied for O.R.S. BXU has all-band transmitter from 56 to 3.5 mc. with very few change controls. DUK and EPC are busy with DX. AVL, DMD and AVJ contacted Europe in DX contest on

3.5 mc. QRM in Concord sounded like boiler factory during DX contest; no sudden deaths reported as yet. FCI reports new club in No. Conway with 10 members. FCI, GOC, GOB, IDY, IOC and DMD are doing lot of 56-mc. work. APK is getting 56-mc. rig ready for mountain work in summer. HJI is working DX on 7 mc. ANS is going strong on 1.75 mc. IDY is putting 860 in final stage. GMM sends first report and is handling traffic. AUY says round table is working very fine. FFL (WLG B) has his hands full with A.A.R.S. and sends in his usual fine traffic total; he would like to get someone in Keene and Rochester in A.A.R.S. Net. Anyone interested, drop him a line. ERQ handled fine bunch of traffic as usual. GHT reports for Nashua and says AGO has very fine rack and panel 'phone rig. HQE is working DX on 3.5 mc. IGI is active on 56 mc. HOU, HOV and GKE are on 14 and 7 mc. Once again, "CU in Manchester on May 18th" from 2 p.m. until midnight. Plenty of prizes and fun.

Traffic: W1ERQ 306 FFL 189 (WLG B 85) UN 136 DMD 81 GDE 69 GHT 61 FCI 51 FFZ 42 GEY-IJB 20 ET 15 IP 11 HJI 5 GMM 4.

**VERMONT—SCM, Harry Page, W1ATF—**'Phone activity increases in spite of P.A.M. EFC blowing a lot of his equipment. R.M. BJP was drafted as P.A.M. to fill the gap and—Lookee—he "hi-tails it" to EFC's shack, 125 miles away, to hold an official pow-wow. Coöperation! AVP may call on you any day. He is new O.P.S. with '52s in P.P. and a new RME9D receiver. (Bill is the friendliest cuss you ever met, but he must classify his traffic score!) New radio club in St. Johnsbury elected BNS president. GAE is playing ham checkers with GGT, who is convalescing from scarlet fever. GNF is giving 28 mc. a whirl. BD has had to expand his crystal-grinding facilities. He advertises through A.A.R.S. with cryptanalytic cross-word puzzles. HI! DQK holds steady on 1901 or 1912 kc. Who says hamfest in Vermont this summer? Well, see BJP and/or EFC.

Traffic: W1BJP 45 BD 12 (WLG A 22) GGT 33 ATF 27 GAE 22 DQK 10 GNF 4 EFC 2.

#### NORTHWESTERN DIVISION

**IDAHO—SCM, Nellie Hart, W7NH—**EMT is grinding I crystals and renews old ham acquaintances. BAA is busy with A.A.R.S. CHT is fishing for DX. DBP is QRL, but finds time for DX. NH is awaiting new 50T tubes. AAJ has photos to swap. AOT is on 3.9-mc. 'phone. CAP is having B.C.L. troubles. AVP is awaiting receiver and blew himself for new coupe. ACD is on 14- and 3.9-mc. 'phone with new ribbon mike; Jr. YL op arrived. Congrats! ATN is building high voltage power supply. EFR is new O.R.S. CFX is on 14-mc. 'phone. EFL is building portable for National Guard camp. DEB is building portable. DSU is QRL radio service. FYU is new ham in Twin Falls. AVZ gets out FB with new portable. JW is awaiting PR-12. KG has new R-136 receiver. BYW worked W.A.C. during DX contest. BLT is back with us again. How about a little coöperation from the O.R.S., R.M.s. and the rest of the gang? Please send in your reports. Thanks!

Traffic: W7EMT 26 BAA 21 CHT-DBP 10 NH 351.

**MONTANA—SCM, O. W. Viers, W7AAT—**BSU has job at Valier and is new O.R.S. BVE received a heard card from G6RB reporting his 3510-kc. sigs. FB, Skrivy! EWR, EWD and EXS are new stations in Great Falls. CRH schedules DRD, also has A.A.R.S. schedules. AFS made W.A.C. CEG has safety devices in transmitter. ASQ had the mumps! AOD has nice list of schedules. CRU has ordered new super. BVI tries matched impedance antenna. AQN is working on ultra-high frequencies. CRE is on in Missoula. CNE's frequency meter has big output as transmitter. AOD is after DX hot and heavy. ERY of Broadus just returned from the Canal Zone and will be in commission soon. (This report received via radio when ERY contacted the S.C.M. from 6FAE.) BDS is turning to c.c. CPY and BYE were knocking 'em dead in DX contest. ESI, one of the new Billings stations, is breaking into the traffic game. FB, DHW is still going strong, as is EPM. EQC is building new All Star 7-tube super. AAT is still going full blast on trunk line. EVP is rebuilding. COX is still getting out FB.

Traffic: W7BVE 142 AAT/COX 97 CRH 91 AOD 55 BDS 30 ASQ 11 ESI 5 EQC 4.

**OREGON—SCM, Frank L. Black, W7AMF—**KL heads



traffic list and makes B.P.L. this month. EYY is new ham at Seaside. DDG is operating portable at Corvallis. EIA is putting in crystal by request of monitor station. AHZ is moving into ham shack on wheels. From the time of our reports this month, the DX contest is responsible for a very small traffic total, too much QRM. Salem has several new 56-mc. rigs on the air this month. Oregon State Convention will be held at Corvallis on April 13th and 14th. Please, fellows, mail your activities reports so they will reach the S.C.M. before the 20th of the month. We need a few more O.R.S. to fill Oregon's quota. Make application to either the Route Manager or the S.C.M.

Traffic: W7KL 500 DUE 435 UJ 177 CRK 93 BWD 167 HD 77 CXK 75 WR 70 AYN 68 BRH 50 BDU 49 EBQ 38 WL 34 EFP 31 DP 18 DNP-DDG 7 AMF 5 DAV 6 BGF 4 CEB 3 AEZ 1 AWI (WLVO 11).

WASHINGTON—SCM, Stanley J. Belliveau, W7AYO—BB schedules KAICS, ZS2X, CT2BK, OM2RX and K6MV. AZI got picked up for one-arm driving. DTV has 1-kw. input. BBK is new O.P.S. AEA is doing FB on Trunk Line "E." RT has new Ford V-8 sedan. CGO is at Grand Coulee Dam. EKA worked ZL, VK, OM2, J, CE; 20 watts input. BUX is now on 3.9-mc. 'phone. AVM is building ribbon mike. Reporters with no traffic: AUP, CWN, EFJ, ETC, DRK, BG, CRY, ANI. Thanks, OM.

Traffic: W7WY 709 BB 313 CQI 245 APS 171 AYO 163 AZI 99 DTV 87 ALH 65 DET 65 DRY 50 BBK 44 AEA 43 RT 42 DGY 39 CND-CGO 32 DRD 31 DDO 28 CSK 27 BLX 24 EA 22 AHQ-DPU 19 EPT 17 EXE-DZX 16 EOR 13 AQ 11 AIT-BBY EKA-DRR 10 BUX 7 DLN-DMN-BGS 6 AW-AVM-CDC-DSO-AXS 5 CAC 4 ECM-BRT-IG-EFZ-ETP 3 APR-DSY-BAK 2 ETX-RL-ETO-ECX-UE-DJ-LD 1.

#### DELTA DIVISION

ARKANSAS—SCM, H. E. Vette, W5ABI—BMI is still head traffic handler. DRY worked DX: FM, EA, VK, K and ZL. IQ is constructing transmitter for the Little Rock Radio Club. MU operates KUOA; he has 250-ft. feeders for his ham receiver, lead-covered. WH has good traffic total. ABI is planning a more powerful rig. ABL is ironing bugs out of transmitter. CPV is on low power; has QSA1 R1 mustache. ASD reports traffic low due to power trouble. DTI wants another hamfest soon. CGT spends week-ends in Russellville. DYT and DRZ are on 1.75-mc. 'phone. DZE is trying for Class "A." DRW has new SW3. EIP has an 830 in final, 100 watts. VK is on 56 mc. most of the time. BDW says his 800 kicks out with a bang. EIJ is constructing 1.75-mc. 'phone rig. EWV is new station in Carlisle. CVO visited hams in Tulsa, Okla. DHU is keeping England (Ark.) on the map. EQG is new station in Rogers, and is A.A.R.S. DHV and DYT have portable rig in Hot Springs. DXN is on 7-mc. C.W. LD is on 28- and 56-mc. 'phone. DYG is new station in Russellville. BIZ's name is Sparks, and he hails from the Lone Star State. EOR, Little

Rock's YL, was elected Secretary-Treasurer of the Radio Club. Thanks for the nice reports, fellows. Since the last report we have held the first hamfest Arkansas has had; those who attended will tell you that we had a wonderful time. Attendance was 81. A radio club has been formed in Little Rock, with ABI pres., VK vice-pres., and EOR secy-treas. Meeting dates will be announced later.

Traffic: W5BBI 344 DRY 251 IQ 170 MU 218 WH DYT ABI 126 ABL 22 CPV 21 ASD 20 DTI 10 CGT 144 DYT 8 DZE 6 DRW 25 EIP 3 DHU 357.

LOUISIANA—SCM, W. J. Wilkinson, Jr., W5DWV—AFW is back after long lay-off. BPL is keeping schedules. HR is on 14-mc. 'phone. CVW is new fellow at Barksdale. BZR has nickname of "Nasty Man." AOK is busy with 56- and 1.75-mc. 'phone. DAQ is active in N.O. Nets. DKR is doing 56-mc. work. BPN wants traffic. BI is active. EDY is working DX. CXQ got bad news from F.C.C. LA is getting out FB. CWX is active on 7 mc. GR teaches at Gulf Radio School. DXK is new Activities Manager of N.O.R.C. EVA just received ticket. JW is working "J's" FB. DWC's transmitter went haywire. DES likes 'phone and C.W. CJO is the "all around ham." ACA is still at sea. DMF and EDZ are active in N.O. AEH is busy with police radio. CMQ has new rig. AQC is waiting for license. EEZ is building nice rig. EBB had the measles. AKW went on seismograph party. CFF and CFG are brothers. BYQ is fixing up receiver. BYY has swell rig started. AYZ is QRL work. ERV gets out FB. EAL, CYC and ASH QRM B.C.L.'s. It won't be long now before the Third Annual Louisiana State Convention. Watch this column for exact dates. Everyone report on the 16th. DAQ reports a Mississippi Flood Emergency Net organized, with Key Station in New Orleans; 5KC has been of great help.

Traffic: W5AFW 20 BPL 7 HR 18 CVW 29 EMS 92 BZR 12 OAZ 22 DAQ 82 DKR 60 BPN 18 DAQ 8.

MISSISSIPPI—SCM, J. H. Weems, Jr., W5CWQ—DEJ makes B.P.L. on deliveries. CUU's new 'phone works FB. CO was heard in England on 1.75-mc. 'phone. ARJ is on the air with ANI's rig. CLD is busy with A.A.R.S. work. North Mississippi hams seem to be all going on 1.75-mc. 'phone. CJB has new 50-wattier. DGV works DX.

Traffic: W5DEJ 300 CWQ 155.

UTAH-WYOMING—SCM, Arty W. Clark, W6GQC—Asst. SCM Wyoming, T. J. Rigby, W7COH—Wyoming: TAXG has a new preselector for his receiver. HX has rig all fixed over. Sheridan: TEUF, an old ham with new call, is now engineer at KWYO. DCO bought AAH's bug. CSE swapped with AAH for a 50-wattier and 1500-volt transformer. CCC is busting up things on 1.75-mc. 'phone. ARK visited California. CRP has new 801. CPL has Class "B" modulator. EKR is on 7 mc. now and then. AAH of Gillette was visited by CSE and DCO. AMU is going strong as Asst. S.N.C.S. DIE, Rock Springs, is handling Trunk Line "E." COH was off air for two weeks due to illness. CLG is busy with Boy Scout Class in absence of COH.

## National Highlights

DX Contest participation held the center of the stage in amateur operating activities during the month now being reported. From every indication it was the greatest "international QSO party" ever held. Some interesting notes on the affair appear elsewhere in this issue.

The Ham Program from WILL, University of Illinois, continues each Saturday at 10:00 a.m. C.S.T. The Central Illinois Radio Club of Bloomington invites all amateurs to listen in to its half-hour program over local broadcasting station WJBC, 1200-ke., every Friday at 11:00 p.m. C.S.T. 56-mc. activity is starting to show its head in Kentucky. An Ohio "Grab Bag Party" (QSO Party for all A.R.R.L. appointees) is held the first Sunday of each month from 6:00 a.m. until midnight. Route Manager W8HCS now has the Ohio Traffic Net in good working order. The Detroit Hamfest of March 24th under the auspices of the Motor City Radio Club was a decided success; about 650 were in attendance! W8NLC, Detroit Amateur Radio Association station, handled over 1500 messages from the Detroit and Michigan Exposition in eight days.

W7LD, Washington Route Manager, is working on plans for a spot-frequency state net. W7BB, Seattle, offers good service on schedules with KAICS, ZS2X, OM2RX and K6MV. The Oregon State Convention at Corvallis will be history when this appears in print. The Virginia section bulletin, the "Virginia Ham," is now edited by W3BRY, the new S.C.M. The next meeting of the Virginia "floating club" will be at Norfolk in June. There are now twenty stations in the North Carolina 1.75-mc. 'phone net, which is very active with W4BYA, P.A.M., at the helm.

Speaking of unique names for section bulletins, the Illinois bulletin is called "Ill-Noise"! Members of the Alabama "Grapevine Net" (1.75-mc. 'phone) hold a round-table QSO every Sunday afternoon; the netters include W4ADL, W4DDN, W4D1D, W4DCI, W4BJL, W4CYV, W4DGN, W4DGS, W4DFE, W4ARJ, W4CCP and W4BSL. CM8YB is now Assistant S.C.M. for Cuba, Porto Rico and Virgin Islands; amateurs in those territories should report to him in the future. The Florida chapter, "Meters of the Morning," issues an attractive certificate to its mem-



bers; this group of 'phone operators keep things humming "down south." W4DIO, Key West, the most southern O.R.S., is now a terminal station on truck line "C".

Army Amateur and 56-mc. work hold the attention of operating amateurs in the San Francisco section. An amateur radio club is now going along in excellent shape on the isle of Guam. The Philippine Island report came via radio KAIHR to W6TM, Williams, California, and by mail from there. Amateurs in Southern California are looking forward to the Ham Fiesta and Banquet to be held in the San Diego World's Fair grounds July 20th and 21st. W6USA, the Fair station, will go on the air about May 29th. Affiliated clubs in the Los Angeles section have a monthly traffic competition, under the guidance of S.C.M. W6BPU. The Northern California A.A.R.S. Net took honors in the ZAG Contest of March 2nd, 3rd and 4th. W6FII was highest man in the entire 9th Corps Area. The following are members of the 7294-kc. "good fellowship" net organized by W6ZX: W6AZ, W6DVS, W6CBX, W6ZQ, W6CI, W6CMQ, W6BLP, W6GXM, W7E1K, W9ISG, W3COZ, W7EK. Any station operating on or near 7294-kc. is invited to join in with this gang on their rag chew sessions 7:00 p.m. P.S.T. daily and 9:30 a.m. P.S.T. on Sundays.

Amateurs in the vicinity of Duluth, Minnesota and Superior, Wisconsin had an opportunity to be of "public service" on March 5th when a severe sleet storm carried away the wires of telephone and telegraph companies. They responded with true amateur spirit and did a splendid job. Further details will appear in "Briefs." W9BNN, Heron Lake, Minnesota has reported to his S.C.M. 55 months without a miss! R. L. Rode, W9QMI, is the new S.C.M. of the Northern Minnesota section. When caught in the rain—W9DRG, South Dakota, worked Illinois using an umbrella for skywire. What next? W9OEL, W9KBE and W9DGS, all in North Dakota, assisted in the sleet storm emergency work. Three major activities seem to occupy the attention of Colorado hams at the present time: N.C.R., A.A.R.S. and 56-mc. work. W9ESL, well known Kansas 'phone operator and Phone Activities Manager for that state, is now located in Colorado; he is interested in getting in touch with his old friends everywhere. A Ham Picnic is being planned for July 4th in Moberly, Missouri. The Northeastern Iowa Ham Club held open house at Luther College; some fifty hams were entertained with technical talks by college instructors.

The Western New York S.C.M. is working up plans for a field day for some time during the summer. W8ABS, P.A.M. W. Pa., is organizing an O.P.S. net; a 56-mc. net is already shaping up. The South Jersey Radio Association made its annual award to the "best station in South Jersey." W3BEI won the first prize—a silver loving cup. W3ATJ was second, W3ENC third. W3DYR won the special award for the best ultra-high frequency stations. The Wilmington, Delaware banquet and hamfest on March 2d was a brilliant success; 500 attended. On March 14th the "Haywire Net" (3.9-mc. 'phone operators) celebrated its one-hundredth session. On that date the membership numbered thirty. The Delmont Ultra-High Frequency Club is erecting a 24-element beam antenna in an effort to work Hartford, Conn., on 56 mc. It will be erected on one of the highest spots in the suburbs of Philadelphia. When complete operation will be maintained continuously for a period of 48 hours over one week-end. The beam should pass approximately over New York City, Hartford and Boston.

Arkansas' first Hamfest was held in the Y.M.C.A. building, Little Rock, on February 24th, with an attendance of eighty-four. Some hitch-hiked from extreme corners of the state. Good technical talks were made. Much equipment was given as prizes. A Mississippi Flood Emergency Net has been organized up the Delta as far as Memphis with the key station in New Orleans. Much 1.75-mc. 'phone interest is reported in Mississippi. "The Radiator," published by the Nashville Amateur Radio Club, is growing with every issue. The Chattanooga Amateur Radio Club is conducting a code practice program; W4BTT is in charge. W5AOP, the Acting S.C.M. New Mexico, is stirring up interest in operating enterprises. Oklahoma State Convention is scheduled for Ponca City, June 8th-9th. Oklahoma again exceeded her previous record for traffic volume and number of stations

reporting. W5EEW, Dallas, Texas, advises that Allied Youth, a young peoples organization, wants to get in touch with some of the hams in its ranks for continental traffic and communication with Alaska. The ranks of 1.75-mc. 'phone operators in the fifth district were saddened recently by the passing of Johnny Flynn, W5DXS, one of the most well known and best liked operators on the band. As a tribute, the 1.75-mc. band was practically soundless on the evening of his death.

WIIBY, portable, Route Manager for 56-mc., Eastern New York section, has organized a 56-mc. traffic delivery net, covering metropolitan New York in a most effective manner. Connections with nationwide traffic lanes feed the net messages for delivery. A Northern New Jersey section QSO contest is scheduled for the last week-end in April and the first in May. (Details, page 62, April QST.) The Western Massachusetts O.R.S. channel has been changed to 3732.5 kc. in order to avoid QRM to the West Virginia 3700-kc. net. Eastern Massachusetts has two very active YL operators—W1FRO and W1IGN; W1FRO made the B.P.L. this month. S.C.M. W1ASI is working for a strong O.P.S. and O.R.S. organization. The New England Division Radiophone Association holds meetings on the air every Sunday morning, 7:30 a.m. on the 1.75-mc. band, 9:00 a.m. on the 3.9-mc. band. About twenty members have a round table QSO at these meetings. W1AUY is control station on 3.9-mc., W1FRQ on 1.75-mc. A.A.R.S. interest is very high in Vermont; 'phone activity is increasing. The Second Annual New Hampshire Hamfest will take place at the Hotel Carpenter, Manchester, May 18th. The Outing Club, Dartmouth College, each year takes 56-mc. gear on its annual trek and sends back accounts of its experiences via WIUN for publication in the college paper. WIET, Dartmouth Radio Association, provided 56-mc. timing for the National Downhill Ski Championships. A Connecticut QSO Party is being planned for some time in May.

## CANADA MARITIME DIVISION

MARITIME—SCM, A. M. Crowell, VE1DQ—EX was active in DX contest on 14 mc. GL worked nine countries on 3.5 mc. GH works duplex 1.75-mc. 'phone and piles up DX on 3.5-mc. C.W. GN expects to move his 1.75-mc. 'phone to 3.9 mc. this summer. GM has new rig for 7 mc. and 14 mc.; he expects to try some DX now. VO1W schedules VO2Z Sundays. VO1N is new local man at St. John's. VO1H has new R.C.A. receiver. VO1P, VO2Z, VO4K, VO4Y are quite active. VE1EP won second prize in VE contest. FN won pair of 866's in "ditto." ET has slight B.C.L. trouble to offset by DX on 14 mc. DQ was quite active on 14 mc. in DX tests. DR is heard at work in the A.M.'s on 14 mc. GR's 1.75-mc. fone has been heard in England. DD: Welcome back on 14 mc., old-timer. AW has the 3.9-mc. 'phone running well. AQ is quite active on 1.75-mc. 'phone and 14-mc. C.W. BC has been doing lots of duplex 'phone work on 3.9 mc. AG has been keeping schedules with Halifax, getting information from relatives in hospital. BV has been working Asians regularly and arranging tests. FB has cards for St. John hams; send in stamped envelope. HH reports for IA, HX, EY and BZ. HX is changing receiver from d.c. to a.c. BZ is working on flea power 3.5-mc. 'phone and C.W. rig for portable work. EY schedules FL daily. FT worked thirteen new countries in the DX contest.

Traffic: VE1EX 15 GL 12 FT 5 IA 6 HH 7.

## ONTARIO DIVISION

ONTARIO—SCM, S. B. Trainer, Jr., VE3GT—PL is getting 56-mc. outfit going. VE9AL's 14-mc. rig is working well with vertical antenna. 3JT handled some traffic against Doc's orders. KI is working on frequency standard equipment for use of the gang. RO burned out another power transformer. GW is moving to North Bay. ACS is installing crystal. NX is going to try 14-mc. 'phone. ACG is new station in Wingham. TM reports Trunk Line "M" going well. AEE denounces bootlegging of calls. AR is trying to figure how two can live as cheaply as one. BX, HA and AW run CFB; OK runs CFJ. GN is at Rat Rapids. GX thinks the ACR-136 is swell; he is operating for O.F.B. at Woman

Lake along with BO. TO is on 7 mc. ER was heard by a "G" on 3.5 mc. ZA has become a poet. ZR applied for O.P.S. RQ is looking for schedules. AD appears to have gotten hitched. XZ works all over with 1 watt on 1.75-mc. 'phone. GG is acting as mediary for love matches over the air and is running T.L. "I." MX reports considerable 56-mc. activity in Ottawa District. XW is getting ready for 1.75 mc. EM and BC have been DXing. IB led the VE3's in VE contest. FB! TF worked FM8BG on 3.5-mc. C.W. RK has his antenna up again. ADW is new ham in Moose Creek. JE is DXing on 14 mc. ACM hopes to be O.R.S. soon. ACL and ADR get out FB. QN and RM are having spring troubles with "love bugs." SZ is going to try 'phone. QC is putting new rig on. ABW was visited by VE2IE. SG is back on schedules. ABD is duplexing 1.75-56-mc. 'phone. WV is operating all bands, 'phone and C.W. QK was at a wedding. Champagne!!! Many VE3's were surprised to win a prize in VE contest. Any VE3's who do not receive XTAL, please drop a card to the S.C.M. Many stations throughout the Section are on 56 mc., or can be, and would like to make Saturday and Sunday afternoons the time for this activity.

Traffic: VE3PL 1 JT 12 KI 1 GW 29 NX 2 TM 116 ER 8 RQ 3 GG 39 IB 19 TF 9 LC 25 DU 89 WK 60 SG 1 GT 62 QK 410. VE9AL 30.

#### QUEBEC DIVISION

QUEBEC—Stan Comach, VE2EE—Another International DX contest has faded into history and again 2AX comes out on top in Quebec with the fine score of over 15,000, having contacted 41 countries and again making his W.A.C. Stations taking part included GZ, DR, BU, BD, HG, CX, AP and EE. EC is making a rack job. FQ had his final torn down to iron out a bug. HF is up to his ears in a sniggle-sniggle. HK is rebuilding in relay racks for his new QRA. Traffic is moving along steadily. HK, still on top, has a keen competitor in II, one of the Sherbrooke boys. DR is very consistent. BU handed an important message from Cuba when all telegraphic communication was suspended on account of general disorders. The Tri-colour Network comprising HT, AB, EC, AC, and CZ is carrying on business at the old stand and doing their usual good work. DD is heard quite often, as is GH, the old "hayseed" station. Nice work, Ted. HG has received his W.A.C. parchment! That new transmitter at DG sounds swell and is another feather in the cap of FQ. That 14-mc. 'phone is beautiful, HM; it's a credit to our Division. Our old friend CM has new rig perking on 14 mc. IE will have that new receiver before this goes to print. DQ is doing quite well among the "G's," but contemplates returning to the old home town. Understand CA has a new rig perking. Your S.C.M. has been indisposed for four weeks; he hopes to be with the gang when this appears in print. Because it is a secret, I won't tell you that AP has at last received his new H.R.O. receiver; it's a pip; CH didn't exactly enter the DX contest, but he hunted around and captured four new countries.

Traffic: VE2HK 203 EE 26 CG 18 BU 53 DR 54 BB 15 AC 12 II 103 HT 29 AB-EC 14 DD 15 AP 7.

#### VANALTA DIVISION

ALBERTA—SCM, J. Smalley, Jr., VE4GD—BZ led all traffic men this month with an FB total due to the Trunk Line clicking in good shape. LX, who usually is near the top, was QRL moving to the farm. QK is a new O.R.S. and turned in a good total. NH has loomed on the traffic horizon. AF leads the Lethbridge gang. The Edmonton gang has gone ultra-high with several of the gang on 56 mc. and with EA and HM planning to try 125 mc. Alberta was well represented in the DX contest this year both in the north and south of the province. AX and CY are having quite a 'phone-C.W. controversy amongst themselves. GD is back on the air with 3.9-mc. 'phone. PH says he heard 32 countries in two days during the DX contest. GE will soon be first O.R.S. of Drumheller. EO enters every contest going. FB. OF sticks to 1.75-mc. 'phone. OG has a pair of 211's perking. TQ has gone bugs on Television. BV has his 800 perking at last. LE and LM work through one station to cut down 'phone QRM with BCL's. WS is another YL ham. The third member of the Oakes family, AR, has received his

ticket. GE took third prize in the VE contest. FB, OM, EC is back on the air after his illness. The 3.9-mc. 'phone gang grows every week. Another dozen tickets taken out in Calgary for the new fiscal year. WM is a new ham in Edmonton. WS is the latest addition to Alberta YL's. She is HW's sister. LK did well in the DX contest and hooked up with India. The Alta. Radio Experimenters Association hold dinner meetings, with a good programme, every first Friday in the month at the Hotel York. Visiting hams will receive a hot welcome.

Traffic: VE4BZ 116 QK 29 NH 25 AF 20 EO 6 LG 1. BRITISH COLUMBIA—SCM, R. K. Town, VE5AC—FG worked VP4JR for his 21st country. EU says his low power and DX won't click. HI. HQ won Canadian QSO Contest. LU is commercial oping now. NQ is station of the High School of Commerce. JA is holding lots of schedules. EC is big DX man on 14 mc. EZ is V.S.W.C. station, now 450 watts input. JL got his final stage neutralized at last. HP is back on with full power on all bands. HC is using Goyder lock on 7 and 14 mc. MT is ether busting with '45's TNT. KP is heard on 3.5 mc. occasionally. AL schedules VE4LX daily. Trunk Line "I" keeps AC busy with traffic. NB is leaving for the prairies. DZ hears DX but doesn't work any. IM resigns O.R.S. on account work. HR is contacting N.W.T. gang. OA is working ZL's and Europe regularly. Let's hear from the N.W.T. gang. CO is only ham in Golden, B. C. BY is a busy 'phone man.

Traffic: VE5FG 29 EU 1 HQ 7 LU 2 NQ 3 JA 16 EC 2 EZ 14 JL 6 HP 15 HC 4 MT-KP 2 AL 3 AC 66 NB 16 DZ 10 FM 72.

#### PRAIRIE DIVISION

MANITOBA—SCM, A. J. R. Simpson, VE4BG—Your new S.C.M. sends his best regards to all the gang in Manitoba. Just want to remind you that your report must be mailed to me not later than the 16th of the month in order to be included in the monthly report for QST. The QRA is No. 71 Thelmo Mansions, Winnipeg, Man. Activity in traffic is on the increase and AG holds the lead as the Trunk Line station. KX is to be heard again after being QRL while getting married. LH has sold out. MY is increasing power with a T250 in the final. The St. James gang are putting on a ham exhibit shortly. Most activity the last of the month was on 14 mc., 'phone and C.W. being pretty evenly divided. IU has worked an F8. The M.W.E.A. beginners' class is going in full swing; there will be a lot of new operators in this Section soon.

Traffic: VE4AG 207 IP 18 SF-BG 5. SASKATCHEWAN—SCM, Wilfred Skaife, VE4EL—SY has trouble with doubler stage. RE worked a W2 on 3.5 mc.; he has trouble with e.c. osc. and got a new bug. IV works Vancouver on 3.9-mc. 'phone and has now gone there for three months. OM, FW, and IG are working 28 mc. FW staged surprise hamfest for the club at his home. When everybody said Pass, they adjourned to the shack and had a real pow-wow on radio matters till the wee sma' hours. All went over big. FB, Archie, that's the stuff. LI is trying 7 mc. RB works all districts on 3.5 mc. QZ uses P.P. '10's. PE is getting new filter. RJ has junior op. MA tried 14-mc. 'phone, but—TN got rid of B.C.L. trouble. UD has key click trouble. KJ made 86 QSO's last month with 5 watts input on 1.75-mc. 'phone; he enjoyed a nine-party round table 'phone QSO; average distance 435 miles; everybody heard and worked twice round; some party, boys. QJ gets x.p.d.c. reports with Ford coil power supply, and thinks this the best bet for country stations; he has lots of QSO's with '01A. AY has new National SW3 and worked his first W6. UL is building Freqmeter-Monitor and is holding schedule with TX. QS worked his first VE1 and 2. How about Watrous (Manitou Lake), the centre of the Province, for a hamfest this year? It has been suggested for June 29th to July 1st inclusive. Tent life for those who want it. Swimming, boating, roller skating, dancing and golf to fill in between business sessions and 56- and 28-mc. 'phone trials. Saskatoon, Regina, Moose Jaw and Swift Current Committees to run it. Write in and say what you think about it, for and against.

Traffic: VE4CM 228 FW 26 EL 10 UL 8 AY 3 QJ 4 LI 3 MB 1 KA 4 IV 1.



# CORRESPONDENCE

The Publishers of *QST* assume no responsibility for statements made herein by correspondents

## 'Phone Harmonics

Albany, N. Y.

Editor, *QST*:

In the past I have assisted the League in moving commercials off the amateur bands; but now I am going to reverse the process.

We subscribe to a news service, for broadcasting, and thus we have several receiving schedules a day from commercial stations on both coasts, some of which are in the neighborhood of 37 meters. We frequently are bothered with serious interference from amateur harmonics, doubtless the second harmonics of 80 meter 'phones, many of which fall outside the amateur 40-meter band. These are not local harmonics, but are from stations at considerable distances, usually outside the amateur district in which we are located. Some of them are getting more DX on their second harmonics than they could expect to get on the fundamentals. They are often strong, clear, readable signals.

Since these harmonics are entirely illegal, if we can't get the cooperation of the 80-meter 'phone men in eliminating them, I am quite sure we can get the cooperation of the Commission. This service is costing us money, and we cannot afford to have it messed up.

—Alan F. Burgess, W8CWH  
Adirondack Broadcasting Co.

P. O. Box 21, Bulyea, Sask., Canada

Editor, *QST*:

. . . There is an O.P.S. located fifteen miles from here, and while I was listening on the 80-meter band I heard this man calling CQ.

After he got through, I heard another station 175 miles away calling him on 80 meters, and naturally he got no response because the O.P.S. is on 160.

I gave the distant man a call, and when I hooked him I told him that the 'phone station in question was on 160 and it was no use to call him using c.w., because he cannot read code. . . .

I was QSO with a station in Prince Albert a few minutes ago and he asked me if I could hear a bad harmonic from a broadcasting station, right in our band. I said I could hardly hear anything else, and that I had written the station two days

ago but it was worse than ever now, so he said he would write them also. If that does not do any good we will have to complain to the Radio Inspector. The broadcast station is fifty miles from here and one hundred and eighty miles from Prince Albert, and if he is interfering up there you can imagine what it is like here. . . .

—H. Brown, VE4BX

EDITOR'S NOTE.—See comment on this subject, page 78, March *QST*.

## The Manners Racket

Fargo, N. Dak.

The John T. Manners Co.  
509 Fifth Avenue  
New York City

Dear Sir:

Thank you very much for your very interesting card. I am sorry that I cannot oblige with the 25¢ requested, as I am already too deeply in debt to another concern for payments due on the Brooklyn Bridge, Grant's Tomb, and the top twenty floors of the Chrysler Building, which I purchased last year from a like concern.

Believe me, I'm sorry, too, as I've always been a publicity hound and love to see my name in print, especially in a magazine having the wide circulation of the one you mention. But, I've "made" the pages of that periodical four times a year for the years 1930-34 inclusive, and even to a glory seeker like myself it has become a bit monotonous.

The last time I heard of your—shall we call it "business"?—you were operating from the West Coast. Perhaps I have a competitor in mind. What a shame that your business methods are not patentable, so that you might protect yourself from petty swindlers!

Your success inspires me. I have always contended that there is a future in this land of ours for a really bright individual. Think of the possibilities when you enlarge your activities to include not only call book clipping, but telephone and city directories. Think of it . . . and rejoice that you live in the "Land of Opportunity."

As a profitable sideline, may I suggest the carving of stone monuments, statues, and the like? With the practice you will have had chiseling

some forty thousand amateur radio operators, you should be terrific as a sculptor.

So, Mr. "Manners," I give you no quarter. Neither would I if I could get close enough to you.

—Don Holaday, W9DOY

**EDITOR'S NOTE.**—This East Coast version of the West Coast racket publicized with the aid of W4ARU in March *QST*, reported to us by several hundred cooperative amateurs, has been promptly nipped in the bud. Interested readers are referred to a more detailed account of the affair elsewhere in this issue.

---

## Good Old Days

431 Lincoln Way, San Francisco, Calif.

Editor, *QST*:

Just a few words of congratulation on the March issue of *QST*. From the standpoint of quality and quantity, our magazine rates so far above the dozens of commercial competitors that comparison is ridiculous. But in this issue, *QST* surpasses even itself.

Your editorial provoked our sincere admiration and considerable favorable comment among our old-timers and beginners alike. Yes, the "good old days" are gone forever . . . Heaven be praised! We have something infinitely better in their place.

—Art Holmes, W6JAL

---

## On Secretary Warner's Trip

Chicago, Ill.

. . . Since your talk here last Thursday there has been an abrupt change of sentiment in Chicago, and where before there was a tendency to criticize and belittle the work of the headquarters staff there is now a sympathetic understanding of the difficulties which you face and a strong sentiment for 100% support and encouragement. . . .

—Cyrus T. Read, W9AA

. . . Mr. Warner gave them something to think about. He gave them a talk straight from the shoulder, simple, direct, plain facts, presented in a straightforward manner that was sincere and convincing. It went over big. To paraphrase: "They came to scoff and stayed to worship". . .

—W. D. Ferrell, W9CGV

. . . A number of the fellows who thought A.R.R.L. was off on the wrong track remarked that they had learned things which put them solidly behind the League's efforts. We'll back the League. It does for the amateur what no one else can do, and that should be a matter of prime importance to every amateur.

—Charles W. Roth, W9DOU

Cleveland, Ohio

. . . He certainly gave us something to think about. . . . He convinced us that he is capable, conscientious, sincere, intelligent and sympathetic of the amateur's needs, and an able representative in matters pertaining to legislation and protection in connection with government regulation of the amateur's rights and privileges.

—Roland V. Courtad, W8FFK

. . . Mr. Warner is the exact opposite of what certain magazines have stated him to be.

—Paul M. Cornell, W8EFW

Des Moines, Iowa

. . . Your last two letters have convinced us that you fellows back there aren't half as bad as we might have expected. . . .

—Frank J. Sadilek, W9APM

Louisville, Ky.

The visit . . . has resulted in setting at rest all of the rumors which were going the rounds. I feel, therefore, that A.R.R.L. and its policies is better understood by the Kentuckians who were able to attend the meeting. I feel sure that in the future they will not be so ready to believe rumors which reach us from other sections knocking A.R.R.L. policies.

—J. B. Wathen, W9BAZ

. . . Warner has given me a better understanding of things in general than I have ever conceived, and I am for him. . . .

—G. W. Mossbarger, W9AUH

Minneapolis, Minn.

. . . I might tell you that the net results of your trip here to the Twin Cities is that you left the opinion with the majority of those attending the meeting that you evaded giving satisfactory answers to the majority of questions asked you. Also, they felt that your attempt to blame everything on the Board is not justified when it is known that you and the Executive Committee have dominated the Board meetings. . . .

—Eex L. Munger, W9LIP

. . . Warner's visit here in Minnesota was welcomed. It is my firm belief that most of the fellows felt sorry for him because of the terrible razzing he got. Mr. Warner made two grave mistakes: first, he should never have consented to answer questions after his speech. Second, he placed all the blame on the Directors, when it was proved at the meeting by OUR director that some of the headquarters staff and several directors tried to threaten him to keep him quiet. Any headquarters member who tries to unduly influence a director should be fired. . . .

—F. C. Kramer, W9DEI

**EDITOR'S NOTE.**—The statement attributed to Director Jabs would be untrue if he made it, which he did not. Ask YOUR director.

St. Louis, Mo.

At the meeting of the O.B.P. Amateur Radio Club on March 12th, the following resolution was adopted:

*Resolved*, That the Secretary of the O.B.P. Amateur Radio Club be authorized to convey to the American Radio Relay League our feeling of friendship and confidence in the Headquarters staff.

—F. E. Norwine, Jr., W9EFC

---

## Long Live QSL!

Jacksonville, Fla.

Editor, *QST*:

It's hard to believe the letter I see  
On page 76 of March *QST*.  
Can it be that a ham has fallen so low  
As to want QSLing forever to go?  
I just can't conceive of a ham so obsessed  
That to him QSLing is only a mess.  
Just think what would happen if it came to pass  
That QSL cards were abolished en masse.  
Why, nine hams out of ten would quit in despair,  
And the tenth couldn't live with just his kind on the air,  
Then there's the gang way over the seas,  
Most everyone signs with "QSL pse."  
And don't you remember the first DX you worked,  
And some that you told said, "Buddy, you're nerds!"  
Then several weeks later—it seemed like a year—  
That good old card came and you gave a loud cheer.  
You showed it with pride to all whom you met,  
Especially the ones that had said, "You're all wet."  
But let's not be hasty and blackball this 9,  
'Twould be a drab world without some of his kind:  
So bear it and grin and say "Wot tha hell—  
My pride and my joy is a good QSL!"

—Jacksonville Radio Club

(Continued on page 84)

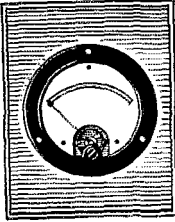

TO MOST AMATEURS, electric meters or instruments present only one problem, that of balancing the budget. Toward the solution of this problem we can offer little help, unfortunately, but we do think some of the suggestions below may be helpful in making the most of available meters.

We shall start with two warnings. The first is this: beware of steel meter panels. Iron, being magnetic, will shunt the permanent magnet in D.C., Thermo, and Rectifier A.C. instruments, causing the meter to read low. This error is larger than one might imagine. Before writing this page, we tested a number of instruments of different makes in a standard steel relay rack panel. With the meter in the worst position, the error was from 10% to 20%, depending upon make. In the position where they are normally used, the error is, fortunately, about one-half as much.

Sometimes it is expedient to remove a meter from its case, to repair resistors, change scales, and so forth. This is not an operation that we recommend, as the meter is very apt to be "sticky" afterward. Apparently, the principal reason for this "stickiness" is almost invisible dust which drags against the moving system. It is very difficult to guard against this as magnetic particles are attracted to the air gap and non-magnetic dust is attracted to the scale and coil by the electrostatic charge which is often present. If you must take your meters apart, do it only in a place where the air is clean, and lay a clean sheet of paper over the table surface that you are working on.

Many transmitters are designed to use a single meter for all measurements, by the use of jacks with a plug on the meter leads. This single instrument is usually a milliammeter of high enough range to carry the maximum current anywhere in the transmitter, probably 200 MA or more. However, this range is much too high for many purposes. For instance, a low range of perhaps 20 MA is highly desirable as an indicator of grid current when neutralizing or checking excitation. A multi-range instrument could be used, but it is expensive and can easily be damaged if the wrong range is inadvertently used. We have a suggestion. For the meter, use a 50-millivolt one-mil instrument. In each circuit where it is desired to measure current, wire in a shunt of the proper range connected to an open circuit jack suitably marked to show instrument range and circuit position. These shunts are quite inexpensive and are easily obtainable. In use, it is thus merely necessary to plug in the meter and the proper range is automatically cut in. Best of all, the meter is also available for voltage measurements, in which case multiplier resistors are used instead of shunts, of course. If a "universal" rectifier instrument is used, even A.C. filament voltages can be measured. It is obvious that the system is flexible, but it also happens to be quite inexpensive. One precaution should be observed when using shunts in this way. The leads and contacts between the meter and its shunt must be of low resistance, as this affects the accuracy of the meter. One-fourth of an ohm, or less, is satisfactory and not difficult to obtain.

JAMES MILLEN



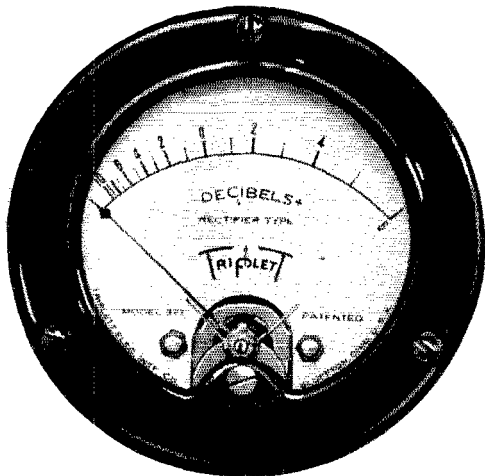

No. 321

## THE **TRIPLET** DECIBEL METER Measures Sound and Noise Levels

**P**OWER Level Indicators are used to measure sound or noise levels in the amplifying systems of Public Address, Theater, Broadcasting Studio, etc. The Model 321 Decibel Meter enables the operator to make immediate adjustments and keep the system free from distortion.

Furnished in two ways — either standard dampened or highly dampened, according to the particular need. Highly dampened meters are generally used in Theaters, Broadcasting Studios and Public Address Systems. Standard dampened meters may be used for Broadcasting Station equipment and special requirements.

The standard range furnished reads up 6 and down 10 decibels, zero decibels at 1.73 volts, 500 ohm line, 6 milliwatts. Other ranges to order only. Meter furnished in Bakelite case.

SEE YOUR JOBBER

**The Triplet Electrical Instrument Co.**  
148 Main Street, Bluffton, Ohio

**MAIL TODAY FOR DETAILS**

**TRIPLET ELECTRICAL INSTRUMENT CO.**  
148 Main Street, Bluffton, Ohio

Gentlemen: Please send me more information about Triplet Instruments. I am particularly interested in the Model 321 Decibel Meter.

Name.....

Street.....

Town.....State.....

53 E. 7th St., Holland, Mich.

Editor, *QST*:

I have been reading *QST* for ten years now and never have I missed an article. On page 76 of March *QST* I found the most ridiculous, unfounded, foolish, and what have you, article regarding the nuisance of sending QSL cards.

Any amateur who writes such a statement should be put out of the ranks of the American amateurs forever. *QST*'s correspondence editor should be severely criticized for printing an article that is absolutely detrimental to amateur radio, besides being unfounded and untrue.

Every ham gets a thrill out of receiving QSL cards from any distance. Of course, providing the card is neatly printed, no trashy stuff. Amateur radio would lose one of its major thrills if the QSL card were done away with. As long as there is amateur radio there will be QSL cards.

Hereafter I suggest that the correspondence editor of *QST* does not print articles that are unfounded and detrimental to amateur radio. I suggest he read the article before printing. Read it thoroughly—not haphazardly.

The more and the better the QSL cards, the more thrill for each amateur. QSL cards are proof of contact and courtesy and a friendship reminder. The editor of *QST* wrote these words in 1922 in December *QST*: "Sending a card is rendering a fellow amateur a service and it may mean a record for him."

—Rus Sakkers, W8DED

**EDITOR'S NOTE.**—Frank Clark, W6DHS; Chester Voorhees, W2EWM; David A. Kunibolm, W1HOZ; Rodman D. Lord, W3BIK; Joseph C. Villandrie, W1IMY; J. Horton Bowen, W1IHB; Gerard Moline, W9RAK; D. B. Middleton, W4BLP; Paul Niles, W9KXX; Norwood V. Bradshaw, W2ELN; Bruce Henke, W6JFJ; P. A. Taylor, VE4LO; W. E. Maddox, W5DGV, and others are of similar mind regarding the sending of QSL cards.

## Doubling Up

914 Holcomb Ave., Clairton, Pa.

Editor, *QST*:

A remedy for the QRM on our 'phone bands is the issuance of station licenses to groups of operators when 'phone operation is desired.

Other than lessening the QRM by taking some stations off the air it will better the quality of the station because of the "pooling" of time, money, experience and equipment of the two owners and/or operators.

As I see it, time and money are great drawbacks to experimentation—one can't keep a 'phone rig on the air and still have time to try other ideas—so the requirement that any 'phone station have two or more owners or operators would be of great help, both in improving the stations and opening opportunities for advancement of radio in general.

—P. L. Ketter, W8CFO

## To Mr. Meeker

Harlingen, Texas

Editor, *QST*:

I object to the printing of such letters as that written by Richard E. Meeker and printed in the March *QST*. He is not an amateur in the true spirit and in all probability has read *QST* "since it was a few sheets of paper" merely to get technical information and knowledge that he could not possibly get out of any other magazine.

I suppose that Philco or some similar set manufacturer taught Hartley, Reinartz, and scads of others how to do the things that they did. I would like to have some one show me where these manufacturers he mentions have ever fed the amateurs.

If he reads the code at all he should practice up a bit so that he can get more than the common and familiar signal reports that are exchanged at the beginning of all or most all

(Continued on page 86)

# A. C. RELAYS

Made by

## Allen-Bradley

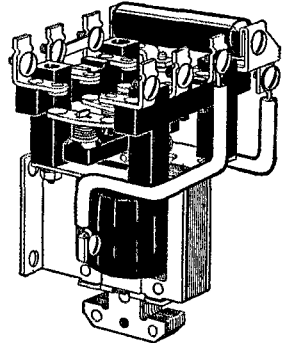
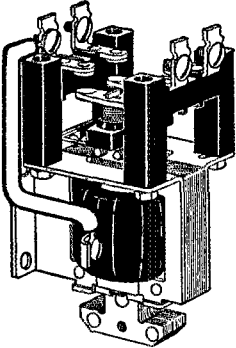

These A. C. solenoid relays are ideal for remote control of transmitters, for control of crystal ovens, and for any general remote control application except for keying. THESE RELAYS WILL NOT OPERATE IN KEYING SERVICE. Silver-to-silver double break contacts are used throughout.

The maximum contact rating is 10 amperes at 220 volts. The relay coils are wound for 115 volts 60 cycle alternating current. Relays for other voltages can be supplied on special order. Use coupon below when ordering.

Type No.	Poles	Nor- mally	Circuit Diagram	Price		Type No.	Poles	Nor- mally	Circuit Diagram	Price	
				Open	In Cab.					Open	In Cab.
A107	1	Open		\$3.50	\$4.50	A177	1	Closed		\$7.50	\$8.50
A117	1	Closed		4.50	5.50	A207	2	Open		4.00	5.00
A127	1	Open and Closed		5.00	6.00	A217	2	Closed		6.00	7.00
A137	1	Open		4.00	5.00	A227	2	Open and Closed		7.00	8.00
A147	1	Closed		5.00	6.00	A237	2	Open		4.50	5.50
A157	1	Open and Closed		5.50	6.50	A247	2	Closed		6.50	7.50
A167	1	Open		6.50	7.50	<p><b>Radiostat</b>—A stepless graphite compression rheostat for primary of 550 watt filament or plate supply transformer. Range 4 to 150 ohms. <b>Price \$6.50</b></p>					

### ORDER BLANK—MAIL WITH REMITTANCE TO

Allen-Bradley Co., 108 W. Greenfield Ave., Milwaukee, Wis.

Enclosed find money order for \$..... for which please send me, shipping charges prepaid, the following items:

..... for..... Volts..... Cycles

Name.....

Address.....

# SPEED UP YOUR CODE

## GET your COMMERCIAL TICKET.

And when you are sitting in the examination room of the Supervisor of Radio, remember, "More than half of the holders of EXTRA FIRST GRADE commercial tickets are CANDLER graduates."



CANDLER is the "Maker of Champions": Ted McElroy, the world's fastest radio telegrapher; little Jean Hudson, the 9-year-old girl who holds the Class "E" championship, etc., etc. MOST of the champs are CANDLER graduates.

Want to learn to punch a mill-high speed? Want to learn to copy as much as a sentence behind? Want to be a COMMERCIAL OPERATOR so you can make money with radio? No system of printed sheets can teach you. Write CANDLER today.

# CANDLER HIGH SPEED

**FREE** copy of "BOOK of FACTS for RADIO OPERATORS." Send the coupon or write today.



**Candler System Co.**  
6343 S. Kedsie Ave., Dept. Q4  
Chicago, Ill., U. S. A.

Send me FREE copy of "BOOK of FACTS for RADIO OPERATORS." No obligation.

Name .....

Address .....

.....

QSO's. Let him add up the total number of messages handled by amateurs in a year or even a month. Why doesn't he read about some of the emergency work done by us? These are only two of the hundreds of things that amateurs accomplish.

How can this man have the audacity to use the word "OUR" in speaking of the amateur bands, in the last paragraph of his letter?

I've read QST ever since it was a few sheets too and I've never read anything that "riled me up" more than his letter. . . .

If this letter is not published I would like you to forward it to him so that he can let me know how my modulation is.

—J. W. Brannin, W5DCI, ex-W5OK

Hurd Pond, Millinocket, Maine

Editor, QST:

Please do not print any more letters in QST such as Richard E. Meeker's letter in March issue.

I realize you like to print both sides of any controversy, but letters like his reflect on amateur radio and QST.

—George D. Preston, W1UH

## Clean House

Adamstown, Md.

Editor, QST:

The purpose of this letter is to register a most vigorous opposition to the proposed increase in frequency allocations to 'phone stations on the 80-meter band. It is apparent that the 'phones have been actively endeavouring to secure additional territory on this band at the expense of the c.w. stations.

Now, I'm not one of the die-hard 'phone opponents. I have been in this ham game since the days of the old crashing rotaries. I have passed through most of the various phases of the thing and so have a tolerant attitude toward every man's individual uses of ham radio.

My opposition to this move is not based on a desire to retain for my own uses the frequencies in question. I am more concerned with the justice of the 'phone complaints. You know, when the new 'phone regulations went into effect a while ago, we all thought that there would be an immediate and very decided improvement in that part of the band. And there was. But it didn't last long. Soon the quality of the 'phones was just as bad as it had been before.

It is generally conceded by those who are in a position to know that most of the 'phone men's trouble is brought on by the equipment they use or the manner in which they use it. Overmodulation, side bands, etc. Why, I even heard one 80-meter 'phone boasting that he always overmodulated over 150% and most of the time close to 175%! Do you wonder that he needs more room? And he is not the exception.

Why not pass some laws regulating the modulation percentage? Or apply some corrective measures to side band emission? Should we who operate trunk line skeds or A.A.R.S. nets and do something really worthwhile, give over a large percentage of our territory to 'phone operation which does no national service and seems to consist mainly of "Well, that's the dope on that" and like platitudes?

Let the 'phones clean house first and if that doesn't work then let them holler.

—H. E. Eaton, W3ABA-WLQE

## Correction

614 N. W. 25th St., Oklahoma City, Okla.

Editor, QST:

The publication of the article entitled "International 'Phone Ethics" has brought about considerable misunderstanding among the amateurs who have read it. Since the publication of this article, page 70, December QST, I have received correspondence, telephone calls, and personal calls from amateurs who are concerned with the condition which prevails in the 7-mc. band. . . .

I have no axe to grind and I do not desire to assume the responsibilities of an advisor to any communication govern-

(Continued on page 88)



### FILAMENT TRANSFORMERS FOR BRIDGE RECTIFIERS

Using 83 tubes 5 v-5 v-5 at 3 amps. C.T.  
 — 3000 v insulation.....\$2.25  
 For 866 tubes 2 1/2 v-2 1/2 v-2 1/2 v C.T.  
 — 10,000 volt insulation.....\$4.50

### GROSS CASED POWER TRANSFORMERS

650 v ea. side C.T. 350 ma. fila. 2-7 1/2 v C.T. and 1-5 v will give 500 v with choke input using 83 or 5Z3 tubes. You can run your entire R.F. and class B off this trans.....\$5.50  
 750 v ea. side C.T. 300 ma. fila. 2-7 1/2 v C.T. and 1-5 v.....\$5.65  
 750-1000 v ea. side of C.T. 300 watts.....\$6.65  
 850-1350-1500 v ea. side of C.T. 400 watts.....\$8.75  
 (the ideal job to give 750-1000-1250 v D.C. with choke input)  
 850-1350-1500 v ea. side of C.T. 550 ma.....\$12.50  
 1500-2000 v ea. side of C.T. 800 watts.....\$11.70

### EXTRA SPECIAL MOUNTED, UNCASED TRANSFORMERS

500-750-1000 volt each side of C.T. 300 watts.....\$5.50  
 400-800 volts each side of C.T. 160 ma.....\$3.40

### MOUNTED CENTER TAPPED FILAMENT TRANSFORMERS

2 1/2 v 8 a — 2 1/2 v 3 a — 5 v 3 a.....\$1.29  
 2 1/2 v 4 a — 7 1/2 v 2 1/2 a — 7 1/2 v 2 1/2 a.....\$1.29  
 2 1/2 v 4 a — 5 v 3 a — 7 1/2 v 2 1/2 a.....\$1.29  
 5 v 3 a — 7 1/2 v 2 1/2 a — 7 1/2 v 2 1/2 a.....1.29  
 2 1/2 v 6 a — CT (midget)......75  
 5 v 3 a — CT (midget)......75  
 6.3 v 1.5 a — CT (midget)......70  
 7 1/2 v 3 a — CT (midget)......90

### CASED FILTER CONDENSERS

**OIL IMMERSED** silver cased filter condensers with stand off insulators.  
 Cap. D.C. Working Voltage Price  
 2 mfd. 1000.....\$1.45  
 1 mfd. 1500.....1.25  
 1 mfd. 2000.....1.65  
 1 mfd. 2500.....2.95

**FILAMENT TRANSFORMERS shielded in metal cases, center tapped secondaries**  
 2.5 Volt 10 amperes for 866's.....\$2.25  
 10 to 12 Volts at 8 amperes.....2.25

Special 10-12 Volt 7.5 ampere filament transformer, extra special.....\$1.10

**Cased Combination Filament Transformers**  
 2 1/2 V. C.T. 10 amps. for 866's.  
 10 V. C.T. 7 amps. for '50's or '52's.  
 10,000 Volt Insulation.....\$3.25

### GENERAL ELECTRIC PYRANOLS

We have been appointed distributors of this famous commercial line of capacitors now for the first time available to the amateur.

	1000 V.	1500 V.	2000 V.
	D.C.	D.C.	D.C.
1 mfd.....	\$1.78	\$2.23	\$3.12
2 mfd.....	2.67	3.71	4.75
4 mfd.....	4.16	5.35	6.53

### Nickel Silver Name Plates

Black background with silver letters and border. Size 1/2" x 1 1/4". Following markings:  
 Gain Speech Doubler  
 Buffer Modulator Class-B  
 Amplifier Class C Filaments  
 Stand-By Plates Grid  
 Oscillator Neutralizer Crystal  
 Microphone Antenna Plate  
 10c each 6 for 50c

### RELAY RACKS

Constructed of very heavy gauge steel (about 1/8" thick). Finished thruout in black Shrivel Lacquer — Complete with all panels. Panels 1/8" thick. Made in two sizes.  
 Type R7: — with 7 panels. 8 1/2" x 19". Overall size 21 1/2" wide, 66" high. Price.....\$14.75  
 Type R4: — with 4 panels 8 1/2" x 19". Overall size 21 1/2" wide, 39" high. Price.....\$10.45

### EIMAC UNSURPASSED TRANSMITTING TUBES!

Performance — Ruggedness — Power — Price  
 50-T Output 75 to 250 watts... \$13.50  
 150-T Output 150 to 450 watts... 24.50

### CASED FILAMENT TRANSFORMERS FOR EIMAC TUBES

Cased 5 volts CT 12 Amps.....\$2.95  
 Cased 5 volts CT 20 Amps..... 5.95

### OHMITE COIL CHANGING SWITCH FOR TRANSMITTERS

Single Gang.....\$1.80

### GROSS CASED INPUT SWINGING CHOKES

5/25 H, 200 MA, D.C. Res. 140 Ohms.....\$2.50  
 5/25 H, 300 MA, D.C. Res. 105 Ohms.....\$3.75  
 5/25 H, 500 MA, D.C. Res. 70 Ohms.....\$6.50

### GROSSCASED SMOOTHING CHOKES

12 H, 200 MA, D.C. Res. 140 Ohms... \$2.50  
 12 H, 300 MA, D.C. Res. 105 Ohms... \$3.75  
 12 H, 500 MA, D.C. Res. 70 Ohms... \$6.50

### OUTSTANDING!!

#### Gross Crystal Holder

WHITE CERAMIC commercial type crystal holder — priced at less than ordinary holders. Adjustable pressure, dust proof, no tools required to open. Takes crystal to 1 1/4" square. Plugs standard 1/2" spacing. Most efficient job yet. \$1.00

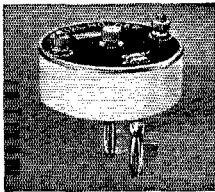

### EXTRA SPECIAL!!

MAC-KEY Semi-Automatic and Straight Key.....\$7.95

### THORDARSON CASED TRANSFORMER

600 volts each side of C.T. 200 MA 2 1/2 V. 10 amps. C.T., 5 V. 3 amps. 7 1/2 V. 3 amps. C.T. \$2.45  
**THORD. CHOKE 12 H 250 MA... \$1.95**

### The "EAGLE" Three-Tube Short-Wave Receiver

"Band Spread" over any portion of the tuning range — only finest material used thruout. Employs one '32 R.F., one '32 detector and one '33 Pentode Audio — 15 to 200 meters — four coils, supplied. The "EAGLE" is economical — two dry cells will operate the filaments. See March or April 1933 QST for full description of this most excellent value in short-wave receivers.

"Eagle" completely wired and tested.. \$11.95 Three tubes tested in your receiver... \$3.00

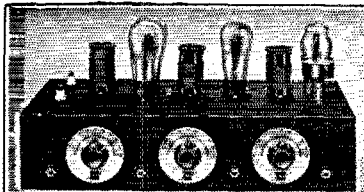
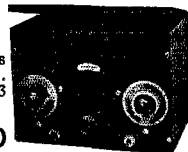

### GROSS C C TRANSMITTER—OUTPUT 25-30 WATTS

The "CW-25" transmitter kit due to its low cost makes it possible for anyone to own a modern crystal controlled station. A schematic hook-up and parts layout sheet as well as tuning instructions are furnished, thus enabling the most inexperienced operator to wire and put the set on the air, for real results. The "CW-25" is supplied with a shrivel finished sturdy metal chassis under which all parts are mounted, making the wiring and components dust-proof. A plug-in crystal holder is furnished with the kit. Only one milliammeter is required for tuning the transmitter and each stage is provided with a jack for this purpose. The "CW-25" uses one '47 as crystal oscillator, one '46 as buffer or doubler and two '46's in the amplifier stage, set of three coils supplied with kit for 20, 40, 80 or 160 band. Additional coils 75c each. \$13.95

Complete kit, less tubes and crystal.....

20% DEPOSIT WITH ALL C. O. D. ORDERS REMIT BY M. O. INCLUDE POSTAGE Cable Address: GROSSINC

**GROSS RADIO, INC., 51 VESEY STREET, NEW YORK CITY**

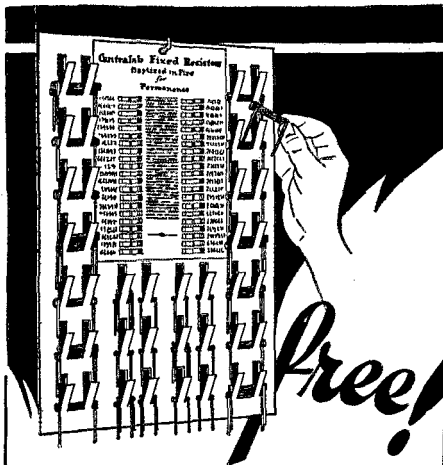

# Free!

## Centralab HANDY FIXED RESISTOR RACK

Say goodbye to lost resistors . . . throw away the cans and bottles that formerly held 'em. Hang this CENTRALAB Rack on your wall and KNOW at a glance just where they are . . . and what values you have on hand . . . yours ABSOLUTELY FREE with a SPECIAL DEAL, consisting of 20-1½ watt 316 type and 20-½ watt 310 type CENTRALAB RESISTORS.

The RACK of heavy sheet metal will give years of service.

R.M.A. Color chart is in full colors.

Write for descriptive information today.

## Centralab

Division of Globe Union Mfg. Co.

MILWAUKEE, WIS.

**Centralab**                      *Mail This Today*  
900 E. Keefe Ave., Milwaukee, Wis.

Please send me information about your special deal which includes a FREE HANDY FIXED RESISTOR RACK.

Name .....

Address .....

City ..... State .....

My Jobber Is .....

QST 5-35

ing body, therefore, I shall not express myself on conditions which exist in radio communication either in the United States or elsewhere. . . .

—Richard C. Webb, W5AAQ

**Editor's Note.**—Mr. Webb's concern over the fact that the call W5AAQ was used to identify the writer of the letter in question, when actually he himself was the licensee of W5AAQ, is understandable. QST makes correction and retraction, and apologizes to OM Webb.

(Continued on page 116)

## Acorn-Type Pentode Announced

(Continued from page 42)

erably is connected to the center-top of the heater circuit. In circuits where the cathode is not directly connected to the heater (when grid bias is secured through the use of a cathode resistor, for example) the potential difference between heater and cathode should be kept as low as possible. If a resistor of relatively high value between heater and cathode is necessitated by the circuit design, such a resistor must be thoroughly by-passed to ground, otherwise the hum may be excessive.

Screen voltage may be obtained from a series dropping resistor, if the tube is cathode-biased, or from a voltage divider across the plate supply. If "B" battery supply is used, the screen may be fed from a tap on the battery.

### PRACTICAL APPLICATIONS

The most obvious field for the 954 is as an ultra-high frequency r.f. amplifier. Typical operating conditions have already been given for this type of service. Because of the small dimensions of the tube and the magnitude of the frequencies involved, the physical treatment in this application differs considerably from the conventional. Careful shielding between stages is a necessity if the amplifier is to function properly. The method of shielding recommended by the manufacturers is to mount the socket, or insulating ring carrying the connection clips, on a metal partition or baffle having a hole so that the grid end of the tube can project through, the hole being drilled so that its edge is in close proximity to the internal shield in the control-grid end of the tube. The shielding effect can be increased by putting a small collar or ring on the baffle hole so that somewhat more of the tube structure is enclosed.

Effective grounding of auxiliary grids and cathode for r.f. potentials is essential. A recommended method of by-passing is that of using leads to the connection clips made of flat ribbon instead of wire, the ribbons being insulated from the shield plate by sheet mica spacers. The ribbons and plate thus form by-pass condensers with negligible lead length. Plate and grid return circuits should be grounded to a common point, preferably right at the cathode ground, to avoid r.f. interaction through common return circuits. We have learned the importance of this feature at ordinary frequencies; it is just that many times as important at 300 megacycles, where a lead an inch long is equivalent to one 30 inches long at 10 mc. In some circuits chokes in the supply leads may improve the operation.

(Continued on page 90)

---

---

---

# 1935 Supplies for 1935 Stations

## ... THE LOG BOOK

Designed to comply with the detailed regulations of Federal Communications Commission regarding logkeeping, providing for the recording of every item of required information. To this end places are provided on the inside cover and at the page heads to log basic information which may stand for long periods of time, and the actual logging of transmissions is reduced to a very simple operation. Columns are provided for recording signal reports by the R-S-T method, both as to your observation of the station contacted and as to the other fellow's report of your signals. The QSA- and R- scales are given with suggestions for logging by that method if desired. The new page heading makes the log as useful for mobile or portable operation as it is for fixed. 38 ruled pages in book form.

40c each      3 for \$1.00

## ... THE RADIOGRAM BLANKS

The radiogram blank has been revamped to allow for that much needed room for the body of the message and to facilitate copying of messages.  $7\frac{1}{2} \times 8\frac{1}{2}$  sheet padded 100 sheets to the pad. It will reflect credit on your station when you deliver a message on this form.

35c each      3 for \$1.00

## ... THE MESSAGE FILE

The F. C. C. requires amateurs to keep messages handled for a period of one year. The message file has been designed to facilitate compliance with that regulation. An expanding file of thirteen compartments (one for each month and one for extra papers), it provides for more messages per month than the average station will handle. On the face of the FILE, space is provided for a complete and accurate record of traffic handled. It will accommodate a year's traffic. For a practical and convenient solution of the regulation, you can't beat it.

40c each      3 for \$1.00

**AMERICAN RADIO RELAY LEAGUE**  
**WEST HARTFORD, CONNECTICUT**

---

---

---

# CONCENTRIC GRID 56 MEGACYCLE OSCILLATOR

Completely built ready to operate. Uses any type of triode — 210, 245, 800, etc. Signals from a Concentric Grid transmitter can be received on a superhet.

COMPLETELY BUILT  
LESS TUBE

## \$12.45

SPECIFY TUBE  
YOU INTEND TO USE



We have just completed a real new idea in 2½-5-10 meter superhets. Will completely revolutionize the 5 m etc. bands. All AC operated — very selective, band spread, dynamic speaker, a really extraordinary value with tubes. . . . . **\$33.50**

*If you can't come, write for the dope*

## TRANSMITTER SERVICE OUR SPECIALTY

*Repairs and reconstruction at very reasonable prices*

For the High power gang — We can furnish a CW Xmitter for 20-40-80 m operation. A 1 KW Job that can deliver an honest 1100 W. to the ant. Complete with tubes f.o.b., Newark. . . . . **\$450**

## R.F. REACTORS

are the MODERN and PERFECT r.f. chokes

Type	RFR-1	RFR-2	RFR-3
Suggested Operating Band — mc. . . . .	1.7 to 4	3.5 to 14.4	7.0 to 30
Inductance Value — $\mu$ h. . . . .	170	70	30
DC Ohms. . . . .	5.5	3.5	1.5
DC Current-amps. . . . .	2	2	2
Price. . . . .	\$1.05	\$ .90	\$ .75



## K & R 550V. 200 MA. POWER SUPPLY

2½V. @ 10A. — 7½V. @ 5A.  
TWO-SECTION FILTER  
Uses 83 rectifier

EXCELLENT  
REGULATION **\$15.00**

**KALTMAN & ROMANDER**  
62 Court Street Newark, N. J.

A typical r.f. amplifier circuit is shown in Fig. 2. The taps on the grid and plate coils are used to avoid excessive loading of the tuned circuits. It may not be necessary to tap the plate connection down on  $L_2$ , since the extremely high plate resistance of the tube has comparatively little effect on the circuit impedance. Impedance coupling between the plate circuit and the following grid is recommended. Needless to say, the condensers, both variable and by-pass, should be

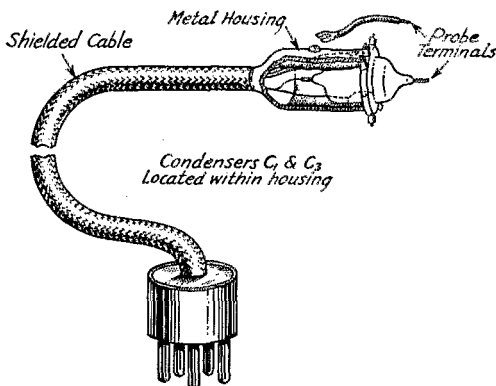

FIG. 3—A PROBE-TYPE VACUUM-TUBE VOLTMETER USING THE TYPE 954 TUBE

of high quality and of the type designed for ultra-high frequency work.

Other applications of the tube include a.f. amplification, detection, and as a vacuum-tube voltmeter. For audio work, the plate-supply voltage should be 250, the screen voltage 500 volts; and the control-grid bias 2.1 volts negative. The suppressor should be connected to the cathode. A plate-load resistor of 250,000 ohms

(Continued on page 98)

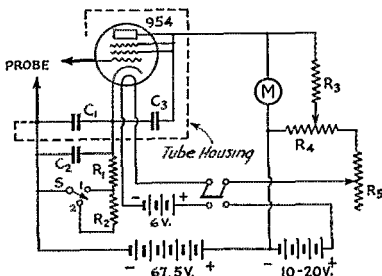

FIG. 4—CIRCUIT DIAGRAM OF THE PROBE VACUUM-TUBE VOLTMETER

The tube is used with triode connections.  
 $C_1$ —500- $\mu$ fd. mica condenser.  
 $C_2$ —16- $\mu$ fd. condenser for calibration with and measurement of low frequencies.  
 $C_3$ —500- $\mu$ fd. mica condenser.  
 $R_1$ —2000 ohms, wire-wound.  
 $R_2$ —50,000 ohms, wire-wound.  
 $R_3$ —10,000 ohms, wire-wound.  
 $R_4$ —40,000-ohm potentiometer for coarse adjustment in balancing out plate current.  
 $R_5$ —2000-ohm variable resistor.  
 $M$ —Microammeter, approximately 50 ohms resistance.  
 With switch S on position 1, range is 2 volts r.m.s.; on position 2, 14 volts r.m.s.  
 Lead A is connected to grounded housing and cable shield; all other leads from tube housing run through cable to apparatus shown.  
 Condensers  $C_1$  and  $C_3$  are inside the housing.

## BYRD ANTARCTIC EXPEDITION II

Boston, Mass.  
9 Brimmer St.  
20 June 1934

Burgess Battery Company  
Freeport  
Illinois

Gentlemen:

You will be interested to know that on returning to Little America, after a four year's absence, we found our telephone system still working—thanks to Burgess batteries. It was a pleasant surprise that this equipment of the first Byrd Antarctic Expedition was still functioning.

Burgess dry cell batteries are being used on the present expedition in many ways; such as lighting, radio and instrument operation.

Sincerely yours,

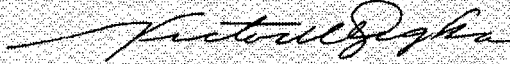

Victor Czegka

“after a four year's absence,  
we found our telephone system still working”

*thanks To Burgess Batteries*

This letter from Victor Czegka, of the Byrd Antarctic Expedition II, brought us news of a dramatic example of the dependability and long life of BURGESS Batteries. During four years in sub-zero Little America, the patented BURGESS Chrome Formula held their power in readiness. And, when a member of the Second Byrd Expedition picked up a phone, they responded immediately! That same Chrome Formula “holds” the power in your BURGESS Batteries when they are not in use. And, consequently, your Batteries give you the long, dependable service which has made them the favorites of Explorers and Radio Amateurs the world over. Explorers and Amateurs know what others soon learn—that it is wise to look for the BURGESS Black and White Stripes when buying batteries. BURGESS BATTERY COMPANY, Freeport, Ill.

# BURGESS

Say You Saw It in QST — It Identifies You and Helps QST

# ... "a very pleasant QSO"



No. 6 Microphone  
\$3.95

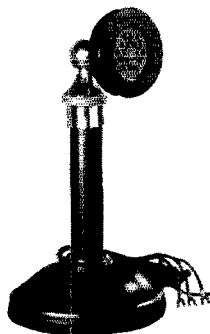

No. 5 Microphone \$12.00

With the new Stromberg-Carlson Microphones, you can be sure that this part of your equipment will be contributing its share.

It is a single button carbon type of an entirely new design with higher efficiency than any other type designed for good frequency response. Enables reduction of audio gain for an equivalent degree of modulation or of output volume. Extra sensitivity eliminates the necessity of "hugging the mike." Carbon hiss is practically inaudible at the recommended working voltages of 1 to 4 volts D.C. Operates efficiently in any position.

Available in two styles. No. 6 — a hand microphone with suspension loop and short two-wire cord for 100 ohm or 75 ohm circuits. No. 5 — on a desk stand with knuckle joint and non-skid base, a three-wire cord and balancing resistor for input transformers designed for 200 ohm double button mikes.

### Fill in COUPON and mail to

Stromberg-Carlson Telephone Mfg. Co.  
100 Carlson Rd., Rochester, N. Y.

I enclose cash  Amount \$..... Send C.O.D.   
...No. 6 Microphone (s) ...No. 5 Microphone (s)

Name.....

Street.....

City.....State.....

## Stromberg-Carlson

will be satisfactory. The voltage amplification is about 100, an output of 40 to 50 volts r.m.s. being obtainable without distortion.

Operating conditions as a biased detector have already been given. The bias may be secured from a cathode resistor, values between 20,000 and 40,000 ohms being suitable.

One interesting use of the tube is in voltage measurements where long leads and capacity effects have to be avoided, as in r.f. measurements. Since the tube is so small it can "get into" places which would be inaccessible to the ordinary tube voltmeter. As a result, measurements can be made at r.f. with a minimum effect on the constants of the circuit under measurement. A novel arrangement of this sort is pictured in Fig. 3, where the tube is mounted in a metal housing at the end of a connection cable. The grid terminal of the tube itself is used as a probe, together with a short length of wire connected to the housing. The circuit diagram of a voltmeter of this type is given in Fig. 4.

### With the Affiliated Clubs

(Continued from page 57)

cup trophy is offered by the president, W2AYJ, to the winners; this trophy must be won three times before it may be kept permanently. The rules of the series of six contests will be of interest: The transmitter must use a single '01A tube in self-excited or crystal-controlled circuit. There are no limitations as to voltage or current used. Any and all bands may be used. Stations worked in the W5, W6, W7 and VE4 and VE5 districts count two points each; each contact with all other W and VE districts counts one point. The QSO points are multiplied by the number of A.R.R.L. sections worked. Each foreign station worked (outside of the U. S. and Canada) adds ten points to the score. Fifty extra credits are added to the score for each band on which one or more QSO's are made.

### Visit the Clubs

At A.R.R.L. headquarters there are recorded the addresses of the several hundred amateur radio clubs affiliated with the League, their places and times of meetings. Clubs are splendid places to get acquainted with other amateurs and to participate in interesting discussions on amateur radio. Why not drop in at your local club and "meet the gang"? Address the Communications Manager (enclosing 3¢ stamp, please) for data on affiliated clubs in your vicinity.

### Miscellany

On March 11th the Cape Cod Radio Club, Hyannis, Mass., witnessed a demonstration of copying by T. R. McElroy, code champion . . . perfect copy for plain language text was 77 words per minute! . . . The affiliated clubs of Eastern Pennsylvania held a joint meeting on March 5th. . . . A weekly radio class is being held at

(Continued on page 102)

# BUY IT AT LEEDS!!!

For ten years America's largest communications companies, broadcast networks, radio laboratories and thousands of amateurs in 62 countries, have found that the "BUY IT AT LEEDS" habit pays

LEEDS cased oil impregnated condensers solve the filter problem at reasonable prices; 2 mfd. capacity only.

*D.C. Working Voltage*

1,000 volts.....	\$1.75
1,500 volts.....	2.50
2,000 volts.....	2.95

We carry a complete stock of GORDON name plates; with mounting screws each **10c**

NA-ALD Black crystalline Lacquer for those that want to finish their own metal or wooden panels. 2 oz. can... 21c Pint can... 75c

The LEEDS isolantite based 210 with thoriated filament and small molybdenum plate is F.B. for 56 mc and 112 mc work. Each..... **\$1.75**

## AT LAST!

Muller Pee-Wee clips, all copper for lowest R.F. losses each **7c**

## HEAD PHONES

TRIMM 2,000 ohm phones.. \$1.88  
TRIMM 4,000 ohm phones.. 2.25  
TRIMM featherweight phones \$5.88

FROST 2,000 ohm phones... 1.45  
FROST 3,000 ohm phones... 1.65  
FROST DX specials..... 2.65  
20,000 ohm impedance

Western Electric type P-11 phones **\$3.95**

LEICHTNER Flint Glass by pass blocking and coupling condensers. Type D-3 Working voltage 5,000 volts

50 mmf } 100 mmf } 250 mmf }	<b>60c</b> Type G-2	.001.....	\$1.10
500mmf....		75c	.002..... 1.35

PIEZO Astatic crystal microphones; type D-104. **\$13.23**

KESTER rosincore solder; 3 oz. can..... 18c  
pound spool..... 56c

By the way O.M.—did you see LEEDS low prices on Crystals? See our ad in the April issue for description and prices

## Leading the 1935 Trend to Convenient Coil Switching Transmitters

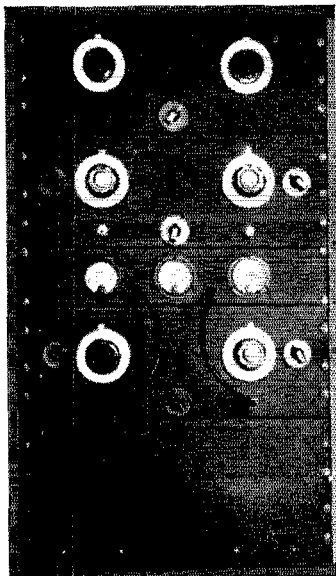

### LEEDS TYPE 4-B TRANSMITTER

1.7 mc 3.5 mc 7.0 mc 14 mc  
No plug in coils. Complete front of panel control.

LEEDS Navy type all brass keys with navy knob..... **\$1.15**  
with plain knob..... .95

### THEY ARE GOING FAST!

LEEDS Graphite Anode **\$8.45**  
203-A's.....



*The Home of RADIO*  
**LEADS THE FIELD**

World Wide Service to Amateurs

45 Vesey Street  
New York City

Cable Address, "RADLEEDS"

## COMPARE!!

LEEDS wet processed glazed porcelain antenna insulators 1" diameter.

7" long .....	25c
12" long .....	35c
20" long .....	50c
Airplane type strain insulators	
4c each. 10 for 35c	

## NATIONAL

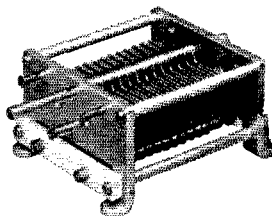

### T M C CONDENSERS

double spaced, polished plates, isolantite insulation.

50 mmf.....	\$2.40
100 mmf.....	2.55
150 mmf.....	2.75
300 mmf.....	3.30

## JUST A FEW MORE LEFT

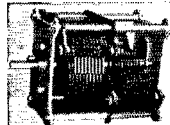

### General Radio

S.L.F. split stator condenser; 175 mmf per section; ideal for antenna net-

works and medium power stages..... **\$1.25**

We carry a complete stock of General Radio Amateur Accessories.

200 watt Vitreous Resistors complete with variable slider and mounting brackets.

5,000 ohms .....	\$1.00
10,000 ohms .....	1.10
15,000 ohms .....	1.15
20,000 ohms .....	1.20
25,000 ohms .....	1.25
35,000 ohms .....	1.30
50,000 ohms .....	1.40
60,000 ohms .....	1.45
80,000 ohms .....	1.55
100,000 ohms .....	1.60
extra sliders, each	9c

LEEDS 866's are doing their stuff steadily in hundreds of power supplies. Reasonably and steadily priced. Each... **\$1.50**

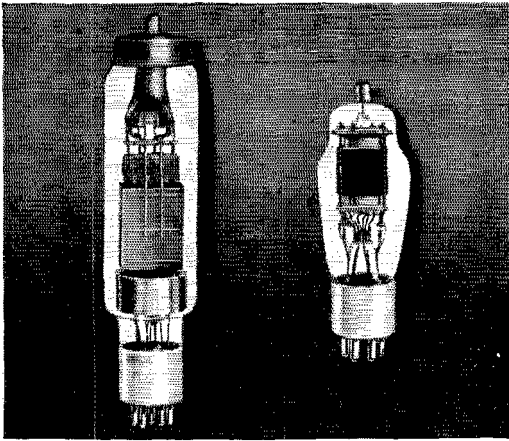

# RK-20 RK-23

**SUPPRESSOR GRID MODULATION and the RK-20** are linked inseparably in amateur radio. The performance of the RK-20 in this application is appreciated by thousands of amateurs.

Yet the original advantage of low excitation requirement still holds true with other familiar methods such as control grid bias, screen grid or simultaneous plate and screen grid modulation of the RK-20.

The RK-23 and RK-25 provide the same flexibility with a minimum of excitation. For the low power station they offer the best in internal shielding, and low losses through the use of an Isolantite base.

## RAYTHEON PRODUCTION CORPORATION

30 E. 42 St. 55 Chapel St. 445 Lake Shore Dr. 555 Howard St.  
New York Newton, Mass. Chicago San Francisco

**RAYTHEON PRODUCTION CORP.,**  
Dept. J5, 30 E. 42nd St., New York, N. Y.  
Please send 1935 Tube Chart

Name \_\_\_\_\_

Address \_\_\_\_\_

City \_\_\_\_\_



## Standard Frequency Transmission

Date	Schedule	Station	Date	Schedule	Station
May 3	B	W9XAN	June 5	C	W9XAN
	B	W6XK	June 7	B	W9XAN
May 8	C	W9XAN		A	W6XK
May 10	B	W9XAN	June 12	BB	W9XAN
	A	W6XK	June 14	BB	W6XK
May 15	BB	W9XAN		A	W9XAN
May 17	BB	W6XK	June 15	BX	W6XK
	A	W9XAN	June 16	C	W6XK
May 18	BX	W6XK	June 21	A	W6XK
May 19	C	W6XK	June 28	B	W9XAN
May 24	A	W6XK		B	W6XK
May 31	B	W9XAN			
	B	W6XK			

### STANDARD FREQUENCY SCHEDULES

Time (p.m.)	Sched. and Freq. (kc.)		Time (p.m.)	Sched. and Freq. (kc.)	
	A	B		BB	C
8:00	3500	7000	4:00	7000	14,000
8:08	3600	7100	4:08	7100	14,100
8:16	3700	7200	4:16	7200	14,200
8:24	3800	7300	4:24	7300	14,300
8:32	3900		4:32		14,400
8:40	4000				

Time (a.m.)	Sched. & Freq. (kc.)	
	BX	
6:00	7000	
6:08	7100	
6:16	7200	
6:24	7300	

The time specified in the schedules is *local standard time at the transmitting station*. W9XAN uses Central Standard Time, and W6XK, Pacific Standard Time.

### TRANSMITTING PROCEDURE

The time allotted to each transmission is 8 minutes divided as follows:

- 2 minutes—*QST QST QST de* (station call letters).
  - 3 minutes—Characteristic letter of station followed by call letters and statement of frequency. The characteristic letter of W9XAN is "O"; and that of W6XK is "M."
  - 1 minute—Statement of frequency in kilocycles and announcement of next frequency.
  - 2 minutes—Time allowed to change to next frequency.
- W9XAN: Elgin Observatory, Elgin National Watch Company, Elgin, Ill., Frank D. Urie in charge.  
W6XK: Don Lee Broadcasting System, Los Angeles, Calif., Harold Peery in charge.

## Schedules for WWV

**E**ACH Tuesday and Friday (except legal holidays), the National Bureau of Standards station WWV will transmit on three frequencies as follows: noon to 1:00 p.m., E.S.T., 15,000 kc.; 1:15 to 2:15 p.m., 10,000 kc.; 2:30 to 3:30 p.m., 5000 kc. These emissions are accurate to better than 1 part in five million at all times and are readily useful for calibrating amateur-band frequency meters by harmonics from an auxiliary 100-kc. oscillator, as described in previous *QST* articles (June and October, 1933; February, 1934).

## New All-Metal Crystal Holder

**I**N POWER oscillators the quartz crystal usually attains a temperature considerably higher than its surroundings, even when kept in a constant-temperature box, because of the heat gen-

(Continued on page 96)



# "OFF-BREED"



**A** WESTERN AMATEUR breezed in (via the mails) not long ago. In the salty vernacular of the range he expressed a subtle distinction which, to him and in the minds of many other discriminating users, aptly characterizes less desirable condensers as considered apart from CARDWELLS. Said he:

"I am planning on taking all the *\*off-breed* condensers out of my transmitter and putting in CARDWELLS, then send you a good picture of a real transmitter . . . . Also am planning on 1 kw fone and cw job . . . ."

Remember that while "OFF-BREED" condensers may satisfy to a degree, you're SURE of the utmost in efficiency, quality and dependability with CARDWELLS! Send for literature.

*\*The italics are ours.*

CARDWELL "TRIM-AIR" "MIDGET" CONDENSERS

CARDWELL "STANDARD" MODELS FOR RECEIVERS and MEDIUM POWER TRANSMITTERS

CARDWELL MIDWAY "FEATHERWEIGHT" CONDENSERS, RECEIVING and TRANSMITTING

CARDWELL 16-B TRANSMITTING CONDENSERS FOR LARGER TRANSMITTERS

CARDWELL HIGH VOLTAGE CONDENSERS FOR COMMERCIAL RADIO-TELEGRAPH and BROADCASTING STATIONS

CARDWELL S-2244 OIL DIELECTRIC FIXED CONDENSERS FOR HIGH FREQUENCY FURNACES and TUBE BOMBARDERS

**THE ALLEN D. CARDWELL MFG. CORP'N.**  
83 PROSPECT STREET, BROOKLYN, N. Y.

**"THE STANDARD of COMPARISON"**



**NEW  
JOHNSON  
"Hi-Q"**

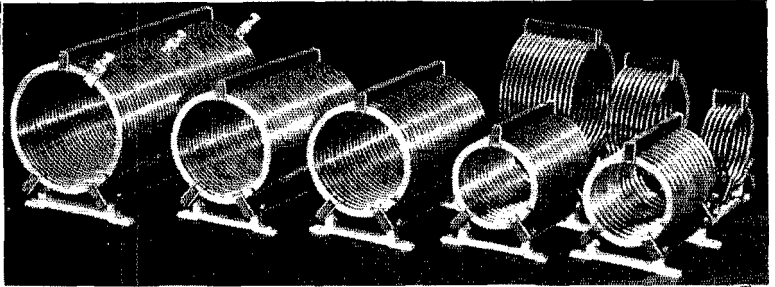

**TRANSMITTING INDUCTORS**

Here's the answer to the inductor problem in your 1935 transmitter . . . Scientifically designed, accurately-constructed transmitting inductors, ready to connect in your circuit! They enable you to attain peak efficiency and provide new convenience in adjustment of tuning and loading. *And they're ideal for the new Band-Switching circuits!* *Bulletin 350* gives circuit data and complete details—write for it today. (Transmitting Condensers to match are described in *Bulletin 200*.)

- **PEAK EFFICIENCY.** Carefully-chosen shape-factors, generous conductor size and minimum dielectric in coil field insure peak efficiency. Models for high-C or low-C, single-ended or push-pull operation in all amateur bands.
- **EXTREME FLEXIBILITY.** Easily, quickly adjusted to the exact value required by means of special low-resistance clips. Ideal for the new Band-Switching circuits!
- **EXCEPTIONALLY RUGGED and COMPACT.** Edge-wise copper construction combines high mechanical strength with minimum inductor size.

Available from your regular **JOHNSON Distributor**  
(or see QST "Where To Buy It" section)

**E. F. JOHNSON COMPANY**  
Manufacturers of Radio Transmitting Equipment  
WASECA, MINNESOTA      « »      U. S. A.

*... Click!*  
**INSTANT Q S Y**  
(Frequency Change)  
with the New Transmitting

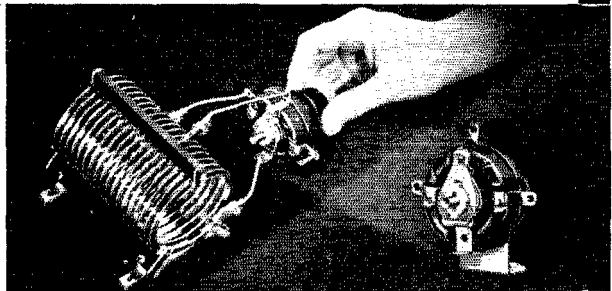

**OHMITE BAND-SWITCH \***

Are you anchored to one band because it's a big job to change coils and re-tune? Do you lose valuable operating time in drawn-out readjustments every time you **Q S Y** from band to band? *Bulletin 104* tells how you can instantly shift *your* transmitter from band to band the 1935 way — with the new OHMITE Band-Switches. Write for your copy today.

\* Patents Pending

- **LOW LOSSES.** Low-resistance, self-aligning contact shoe. Ceramic insulation throughout. Low inter-contact capacity.
- **HIGH CURRENT-CARRYING CAPACITY.** Ample contact surfaces and correct design insure efficient operation up to 1 kw.
- **UNIVERSAL in APPLICATION.** Adaptable to single-ended or push-pull tank circuits, impedance-matching networks and antenna circuits. Two or more switches may easily be ganged for "single-control" band switching.

**OHMITE MANUFACTURING CO.**  
631 NO. ALBANY AVE.      CHICAGO, U.S.A.

# HAVE YOU A LOG BOOK

## for Your Portable Operation?

The present log meets all requirements. You will find it better to have a separate log for your portable work.

40¢ Each  
Three for \$1

THE AMERICAN RADIO  
RELAY LEAGUE  
WEST HARTFORD, CONNECTICUT



### New BIRNBACH Transmitter ANTENNA LEAD-IN INSULATOR

CONFORMS to Federal regulations. Each cone, 2 3/4" high, made of low-absorption, highly vitrified glazed porcelain, with 1/4-20 brass, nickel-plated nuts, washers, wingnuts and threaded rod. Cork washers for watertight mounting. Two sizes available: — 10" rod for 4" wall, 90c list; 15" rod for 9" wall, \$1.00 list.

BIRNBACH RADIO CO., Inc.  
145 HUDSON STREET NEW YORK CITY

Write Dept. Q-5  
for Complete  
Data

## A.R.R.L. QSL Bureau

FOR the convenience of its members, the League maintains a QSL-card forwarding system which operates through volunteer "District QSL Managers" in each of the nine U. S. and five Canadian districts. In order to secure such foreign cards as may be received for you, send your district manager a standard No. 8 stamped envelope. If you have reason to expect a considerable number of cards, put on an extra stamp so that it has a total of six cents postage. Your own name and address go in the customary place on the face, and *your station call should be printed prominently in the upper-left-hand corner*. When you receive cards, you should immediately furnish your QSL manager with another such envelope to replace the used one. List of managers follows:

- W1—Allen W. Jones, W1NW, 1626 Commonwealth Ave., Boston, Mass.
- W2—H. W. Yuhnel, W2SN, Lake Ave., Helmetta, N. J.
- W3—R. E. Macomber, W3CZE, 418 10th St., N. W., Washington, D. C.
- W4—B. W. Benning, W4CBY, 520 Whiteford Ave., Atlanta, Ga.
- W5—E. H. Treadway, W5DKR, 2749 Myrtle St., New Orleans, La.
- W6—C. E. Spitz, W6FZQ, Box 1804, Phoenix, Ariz.
- W7—L. Q. Kelly, W7BPC, 4919 So. Prospect St., Tacoma, Wash.
- W8—F. W. Allen, W8GER, 324 Richmond Ave., Dayton, Ohio
- W9—George Dammann, W9JO, 319 Sherman Ave., Evanston, Ill.

- VE1—J. E. Roue, VE1FB, 84 Spring Garden Rd., Halifax, N. S.
- VE2—W. H. Oke, VE2AH, 5184 Mountain Sights Ave., N. D. G., Montreal, P. Q.
- VE3—Bert Knowles, VE3QB, Lanark, Ont.
- VE4—Dr. J. J. Dobry, VE4DR, Killam, Alberta.
- VE5—E. H. Cooper, VE5EC, 2024 Carnarvon St., Victoria, B. C.

## New Microphones

WITHIN the past month or so four manufacturers have announced new microphone models which would appear to have considerable interest for amateurs. These include an improved single-button carbon type, a new high-quality crystal microphone, a dynamic type, and a miniature ribbon microphone.

The carbon microphone, a product of the Stromberg-Carlson Telephone Manufacturing Company, of Rochester, N. Y., is of a new design employing a thin, light aluminum-alloy diaphragm of conical shape with annular corrugations forming a "W" crimp near its periphery. The diaphragm is pierced by a breather hole to equalize front and back pressures, and the frame is designed to minimize cavity resonance. A

(Continued on page 100)

# ANNOUNCING— THE A. R. R. L. LIGHTNING RADIO CALCULATOR

A valuable device for radio amateur, radio engineer and radio experimenter. Saves hours of time and prevents expensive errors. Solves in a moment radio problems of frequency, wavelength, inductance, capacity, coil size and wire size.

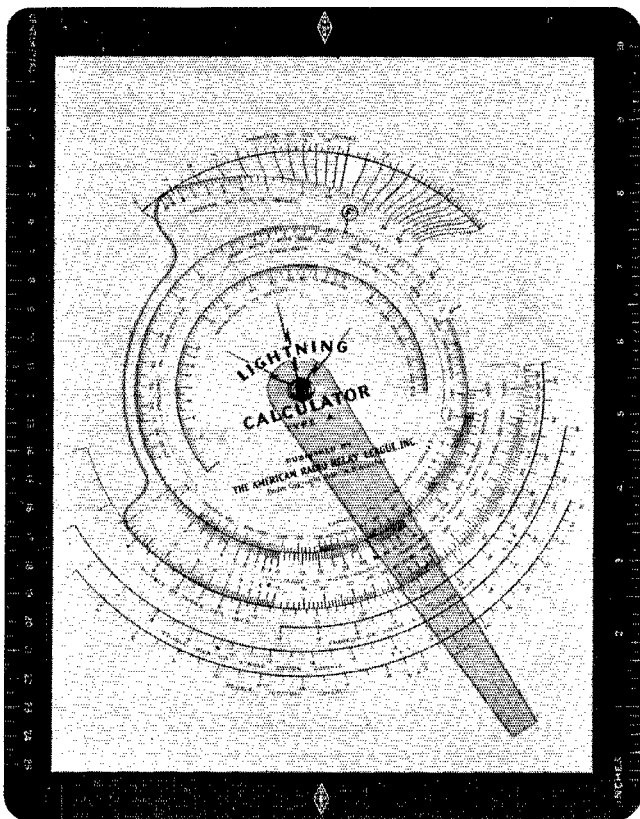

Printed in four colors on durable card. Published by the American Radio Relay League because we believe that it, like the Handbook, meets a definite need and will be worth many times its cost to thousands of amateurs, engineers and experimenters.

**\$1.00** Postpaid  
anywhere

**AMERICAN RADIO RELAY LEAGUE, INC.**

*West Hartford, Connecticut*



# "E. H. Rietzke SPEAKING!"



Mr. E. H. Rietzke, President of CREI, and originator of the first thorough course in Practical Radio Engineering.

## RADIO is on the UPTURN ... are YOU?

Radio sales . . . radio production . . . radio broadcasting . . . are all on the upswing . . . business is good. Of course, that doesn't guarantee you a job or an advancement . . . UNLESS YOU ARE ACTUALLY TRAINED FOR BETTER THINGS. The foremost engineers will tell you that TECHNICAL TRAINING is essential . . . and the progress of CREI graduates certainly proves that!

Think Now . . . Write Now . . . About the Complete CREI One-Year Course in PRACTICAL RADIO ENGINEERING . . . Fall class now forming, begins September 23rd.

### 3 CONVENIENT PLANS OF STUDY —

CREI training covers every Branch of Radio Engineering in our Residence Course . . . the original Home Study Course . . . or the combination of Residence and Home Study Instruction.

WRITE FOR FREE 44-PAGE ILLUSTRATED BOOKLET

CAPITOL  
ENGINEERING



RADIO  
INSTITUTE

14th and Park Road, N. W.

Washington, D. C.

Dept. Q-5

## Immediate Delivery

from Receiver Headquarters

RME-9D (13 to 550) . . . . .	\$112.50
Complete with Tubes, Speaker, Speaker Cabinet, etc. . . . .	127.50
PATTERSON PR12 (8-550) (Available soon) . . . . .	83.70
With crystal, complete . . . . .	89.70
Also available in chassis and console models	
SARGENT 8-34 (15 to 550) Complete . . . . .	54.50
MARINE MODEL 8-34 (15 to 1500) Complete . . . . .	62.50
SUPER SKYRIDER (13 to 240) Complete . . . . .	59.95
With crystal, complete . . . . .	68.95
Also available with broadcast or 10-meter band	
RCA-ACR-136 (15 to 550) Complete . . . . .	69.50
McMURDO-SILVER 5C (13 to 200) Complete . . . . .	74.70
With crystal, complete . . . . .	83.70

Send for descriptive folders on any of the above receivers

**SHIPPED PREPAID** If Full Purchase Price Accompanies Your Order  
(RME-9D and RCA-ACR-136 excepted)

# MARINE RADIO C O M P A N Y

W2GOT-W2GRQ

163-18 JAMAICA AVE. JAMAICA, NEW YORK  
Formerly

L. I. MARINE & ELECTRIC COMPANY  
Same Ownership—Same Management—New Name Only

Telephones:

JAmAica 6-2925 Night (long distance) LAurelton 8-4000  
Cable Address "ELEC MARINE, NEWYORK"

special grade of carbon is used, the granules being enclosed in a lava cup impervious to moisture under normal operating conditions and sealed by an auxiliary (internal) diaphragm of cellulose acetate. To allow for rotation or orientation in any position and to prevent packing or damage by shocks, the carbon cup is only partially filled with granules and is so designed that the electrodes are covered to a uniform depth and pressure no matter what the position of the microphone. The carbon employed is quite tolerant as to operating current, and will perform satisfactorily with battery voltages from a fraction of a volt up to 12 volts. At the working voltages recommended—1 to 4 volts d.c.—carbon hiss is claimed to be practically inaudible.

The new Stromberg-Carlson microphone is designed primarily for good reproduction of speech, but has also proved to have wide-enough frequency response for music pickups in outside work. The sensitivity is said to be considerably higher than that of any other type designed for good frequency response. It is available in both hand and desk mountings. The latter is provided with a three-wire cord with balancing resistor so that it can be used with input transformers designed for 200-ohm double-button microphones. The hand model has a two-wire cord and is intended for use on 75- or 100-ohm circuits.

A new wide-frequency-response crystal microphone, known as the "Dia-Cell," has been introduced by the Turner Company, Cedar Rapids, Iowa. These microphones employ a number of Dia-Cell units connected in series-parallel, the effective diaphragm area of each unit being approximately one-quarter the size of a postage stamp. Together with the small diaphragm and an improved method of mounting and driving, a flat frequency response from 30 to 7000 cycles, with a rising characteristic of about 5 db. from 7000 to 10,000 cycles, has been obtained. Because of the small diaphragm area, resonant peaks are forced into the inaudible frequency range.

The Dia-Cell microphones are available in several models, using three, four, six or eight Dia-Cell Units. The four-cell model is recommended for general work, those with the larger number of cells being suited especially to work with long lines to offset the line capacity. The output level varies from -75db. for the three-cell model to -70 db. for the eight-cell model. Frequency response is practically the same for all models.

A new dynamic microphone, for which the advantages of extreme ruggedness, low background noise, and higher sensitivity than has heretofore been obtainable in previous dynamic types are claimed, has been marketed by the Radio Receptor Company, New York City. The model "6C," designed for public-address and amateur work, has a response within plus or minus 2 db. over a frequency range of 40 to 7500 cycles. The sensitivity to normal speech at a distance of three feet is -59 db. The microphone impedance at 1000 cycles is 30 ohms. The low

(Continued on page 108)

# 10 points of OSCILLATOR difference

## — OF VITAL INTEREST TO YOU!

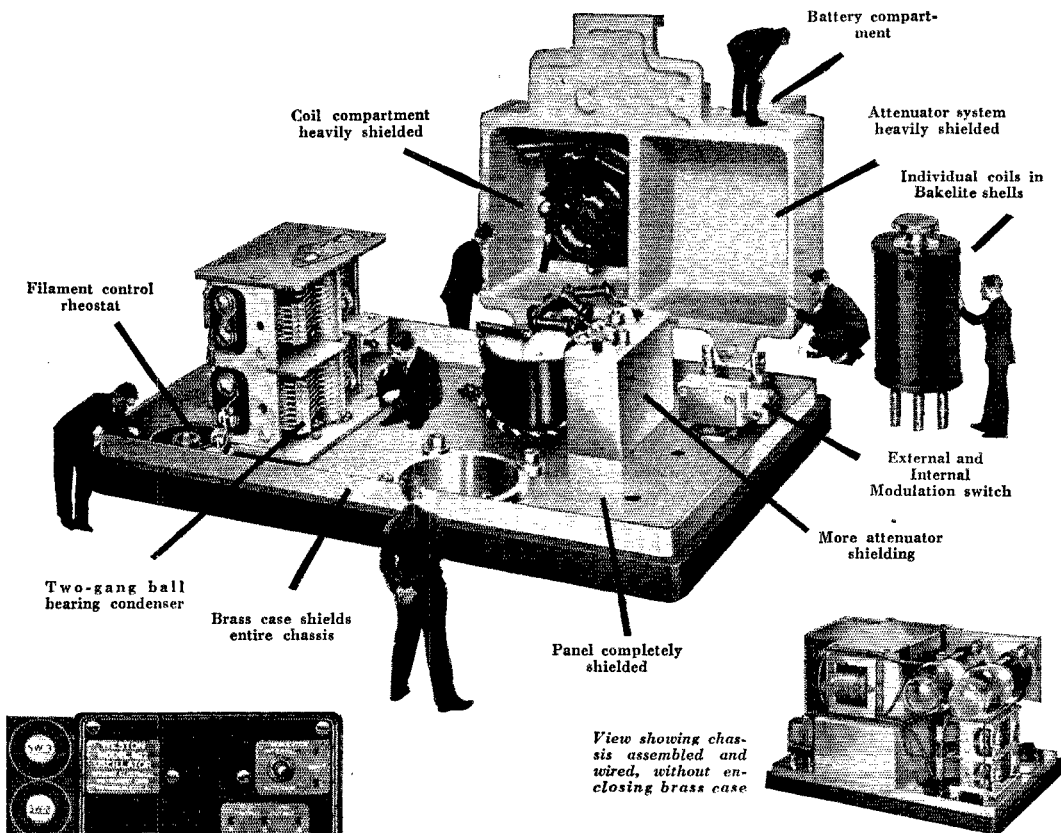

Compare this Weston Model 692 All-Wave Oscillator . . . in all details of design and construction . . . part for part . . . with any the market affords. Note particularly that each part in Model 692 has been carefully designed for its special purpose. You'll agree that here is an oscillator you can safely stake your reputation on . . . that will enable you to do accurate servicing on all modern receivers. See Model 692 at your jobber's, or write for descriptive bulletin . . . Weston Electrical Instrument Corporation, 602 Frelinghuysen Avenue, Newark, New Jersey.

**THE WESTON ALL-WAVE  
OSCILLATOR**



# WESTON Radio Instruments

Say You Saw It in *QST* — It Identifies You and Helps *QST*

# TRIADYNE



**6B5**

**T**RIAD offers a basically improved audio tube with unlimited possibilities for the Amateur. An entirely new patented audio system of dynamic coupling, which is a function of the tube itself, provides high audio power with high fidelity without the necessity of any driver stages.

The 6B5 in the Hi-E arrangement which has been described in these columns will produce 20 watts audio at less than 5% distortion. At the present time, there are no audio tubes in the low price class that can duplicate this performance.

Complete technical bulletins are available to supplement feature articles carried by current publications.

6B5 Triadynes are available for immediate delivery — List Price \$2.25 — Your local jobber should have them in stock — If not, write for name of nearest jobber.

# TRIAD

**MANUFACTURING CO., INC.**  
PAWTUCKET, RHODE ISLAND

impedance makes the microphone suitable for operation at considerable distance from the speech amplifier, line lengths up to 1000 feet being practical. No operating current is required.

A miniature velocity microphone, its size about the same as that of a match box, has just been announced by the Amperite Corporation, New York City. Its weight is eight ounces, including the output transformer, which is mounted inside the microphone case. It can be hung from a ribbon around the neck in monocle fashion, or can be hand held. Output impedances of either 50 or 200 ohms are obtainable, the unit being capable of working into a cable up to 2000 feet in length. The response level is -68 db. on open line, the frequency range being 60 to 7500 cycles, although no data is given on the shape of the response curve. The new midget velocity is known as the Amperite "7-Point Junior."

## With the Affiliated Clubs

*(Continued from page 98)*

Long Junior High, Dallas, Texas, with L. N. Nelson, ex-W9XAC, supervising. . . . New officers, Associated Radio Amateurs of San Francisco: W6BAY, president; W6IPH, vice-president; W6BVL, secretary-treasurer. . . . The Mobile Amateur Radio Club, with a portable transmitter at Dauphin Island, furnished the only means of communication to 800 people during the Alabama Deep Sea Rodeo; this was the only means of communication between the island and the mainland. Twenty-four-hour service was rendered for five days and many important messages were handled. . . . Dr. J. M. B. Hard, X1G, visited the Houston (Tex.) Amateur Radio Club during his tour of the States. . . . W4BZL, L. F. Sexton, is new president of the Richmond Short-Wave Club. W3AAJ, for many years president, resigned, but was retained as vice-president. . . . The South Town Amateur Radio Association, Chicago, reports the conclusion of a successful membership drive. Membership was increased over 75%. Attendance at meetings now averages over 100. The S.T.A.R.A. sends notices of all meetings to approximately 600 licensed amateurs, using the call book for QRA's. . . . The Alberta Radio Experimenters Association, Calgary, organized in 1924, is sponsoring a monthly dinner for all licensed and ex-licensed amateurs. These dinners, known as "Alberta QSO Parties," are simply get-togethers for good fellowship's sake, and arguments, etc., are taboo. . . . The Providence (R. I.) Radio Association issues a monthly bulletin to its members, the "PRA-LOG"; it's a great "pepper-upper." . . . W1HRC is editor. . . . The Bloomfield (N. J.) Radio Club is planning a "Boiled Owl Party." W2JC, the club station, is on practically every night and the litchstring is always out. New officers: W2AOG, president; W2TP, vice-president; W2AQG, secretary; L. Zelliff, treasurer. . .

—E. L. B.

# Coto

## High Fidelity\* Transformers

FOR THE NEW 6B5 AND 801 TUBES

Type	Purpose	List Price
CI-402	2-6 B5's to 203A Class B Grids	\$ 8.00
CI-404	2-6 B5's to 5000 Ohm Class C Load	8.00
CI-405	2-801's Class B to 5000 Ohm Load	8.00
CI-406	2-6 B5's to 242A-211 Class B Grids	8.00
CI-403	Class B Output, 203A's-242A's to 2500-10,000 Ohm Load	28.00

\* Completely shielded in high permeability casting. Signal Frequency response flat from 50 to 9000 cycles.

### MIDGET R. F. CHOKES

Universal Wound on Isolantite with Four TAPERED Pies — Three Types

Type	List Price
CI-11 2.5 mh 125 ma. . . . .	\$.60
CI-12 2.2 mh 250 ma. . . . .	.75
CI-13 U.H.F. choke. . . . .	.40



Write for bulletin describing other Coto products. If your jobber cannot supply you, order direct and include his name.

List Prices are subject to 40% discount

**Coto-Coil Company**  
229 Chapman Street  
PROVIDENCE, RHODE ISLAND



# THE A.R.R.L. DIAMOND

## LICENSE MANUAL

### A TWO BAGGER

A study of the questions and answers in the LICENSE MANUAL will so thoroughly prepare you for the exam that you need have no qualms about your ability to pass. The text of the regulations governing amateur radio are also to be found in this book. 25c postpaid.

### A TRIPLE

The HANDBOOK is what its name implies. It contains just the dope that you will want for the construction of gear and the intelligent operation of a station. You will find it worth while to read over the chapters on electrical and radio fundamentals before applying for a license. It's a big book for \$1.

## HANDBOOK

### A SINGLE

HOW TO BECOME A RADIO AMATEUR will get you started right with its clear and concise and easily understandable explanation of amateur radio, dope on learning the code, constructional details for an efficient station, and how to operate it. 25c postpaid.

## HOW TO BECOME

### A HOME RUN

For complete and full enjoyment of your hobby you will want to be a member of the A.R.R.L. With its other privileges, membership includes subscription to the monthly organ, QST, which you will find chock-full of new developments, constructional articles and operating notes.

Membership in the League is \$2.50 per year

You will find HINTS & KINKS ready to deliver the goods when you are trying to make some of the gear in the "junk box" fill a need of the moment; or when you are wondering if an idea will work. Price 50c postpaid.

## HINTS & KINKS

*Pinch Hitter*

## QST

THE AMERICAN RADIO RELAY LEAGUE  
WEST HARTFORD, CONNECTICUT

# EIMAC

**DO YOU WANT A KILOWATT?**

(See April QST page 8)

**COST.** \$49.50 worth of EIMAC 150Ts operating within rating at 2500 volts is ideal for 1 KW input.

**INDUCTANCES.** The low C construction of the 150T (Cgp 3.5 uufds.) allows use of really efficient tank circuits.

**PARASITICS** are practically unknown among EIMAC users due to short, direct leads and low interelectrode capacities.

**DRIVER REQUIREMENTS.** 35 watts of grid power to two EIMAC 150Ts allows over 750 watts of CW *OUTPUT* on 14 MC with 1 KW input.

**BIAS.** Twice cut-off bias is plenty.

**NEUTRALIZING.** The low capacities and direct leads possible with EIMAC tubes allows perfect neutralization at all frequencies without special circuit treatment.

150T—\$24.50

50T—\$13.50

AT YOUR DEALER

—“COMPARE AND REFLECT”—

**EITEL-MCCULLOUGH, INC.**

SAN BRUNO, CALIF.

## Scores

(Continued from page 58)

W6GNT 1920-16-B  
W6RQU 504- 9-B

*San Joaquin Valley*  
W6DQR 34048-56-B  
W6CLP 8084-43-C  
W6FYM 2520-15-A  
W6BNE 1728-12-B  
W6LQX 600- 8-A  
W6KU 440-10-B

### ROANOKE DIVISION

*North Carolina*  
W4TP 22302-59-BC\*  
W4MR 9810-45-C  
W4TJ 9180-45-BC  
W4CEN 6878-38-C  
W4BRT 5130-27-B

*Virginia*  
W3FJ 24024-56-BC  
W3AZU 15260-35-B  
W3UVA 11840-37-B  
W3CHE 9114-49-C  
W3DVO 6050-25-B  
W3EDG 3780-20-A  
W3BZE 3600-20-A  
W3EYN 3534-19-A  
W3EHL 2556-16-B\*  
W3EBD 1632-16-AB  
W3CFL 1176-12-B  
W3AAJ 306- 9-C

*West Virginia*  
W8IKG 37989-63-BC  
W8LSJ 3150-15-A

### ROCKY MOUNTAIN DIVISION

*Colorado*  
W9IFD 68137-61-AB  
W9SMN 15768-36-A  
W9NIT 7192-29-B  
W9PMF 432- 8-B  
W9NLN 180- 6-A

*Utah-Wyoming*  
W7CY 34908-57-B  
W6FRN 24660-45-B  
W6JVB 8019-27-A  
W6EXL 4900-25-B  
W6HVU 2970-15-A  
W7COH 252- 7-B

### SOUTHEASTERN DIVISION

*Alabama*  
W4AG 71890-65-BC  
W4APU 68262-62-ABC  
W4BOU 47908-58-BC  
W4DS 25756-47-BC  
W4CJG 23848-44-B  
W4AJY 16330-46-C  
W4BHJ 1743-21-C  
W4ARF 252- 7-B  
W4CYW 56- 2-B

### Eastern Florida

W4BGG 28600-50-B  
W4COV 28116-33-A  
W4AGP 22032-36-A  
W4CBZ 2604-21-B

### Western Florida

W4MS 32820-49-B  
W4BSJ 31252-52-C  
W4AGS 28992-48-AB

### Ga.-S. C.-Cuba.-etc.

W4BRG 11360-65-B  
K4KD 8360-21-B  
W4BDT 1650-15-B  
CM2OP 1216-19-C  
W4CIR\* 54- 3-A  
W4AFQ\* 12- 2-C

### WEST GULF DIVISION

### Northern Texas

W5CPT 36000-50-A  
W5CPB 35100-45-A  
W5CKL 25228-53-B  
W5EHM 22960-56-C  
W5AZB 15480-45-B

W5DFU 6960-30-B  
W5EBW 1620-15-A  
W5BCW\* 1045-19-C  
W5EKK 780-10-A  
W5DAF 528-11-B

### Oklahoma

W5CUX 39050-55-B  
W5AQE 38772-54-B  
W5BDX 30576-49-B  
W5CJZ 23374-58-C  
W5CEZ 6804-36-C  
W5YJ 275-11-C\*

### Southern Texas

W5BDI 37850-50-AB  
W5BD 1728-34-A  
W5EEK 10440-86-B  
W5ABH 3694-42-C\*  
W5SY 7980-45-B  
W5CLZ 5811-38-C  
W5DBN 4056-28-B  
W5DWN 1700-25-C  
W5VV 1608-24-C  
W5DSH 1462-17-B  
W5ENK 24- 2-B  
W5CLP 21- 1-A  
W5ECP\* 1- 1-C

### New Mexico

W5ELL 12096-32-A  
W5CVB 11470-37-B  
W4CA 2508-19-A\*  
W5DZY\* 12- 2-B

### CANADA

### Maritime

VE1EX 16302-33-B  
VE1HG 26788-37-AB\*  
Y08Y 11772-27-B  
VE1DO 6732-22-B  
VE1FT 8500-26-B  
VE1GE 6240-20-A  
Y08HK 3614-26-C  
VE1FL\* 484-11-B

### Ontario

VE1LL 41838-57-B  
VE3GT 37908-54-B  
VE3QD 27724-58-BC  
VE3DU 25929-43-A  
VE3DJ 14280-34-B\*  
VE3QK 14013-27-A  
VE3WY 10092-29-B  
VE3TD 8178-29-B  
VE3WK 6150-25-A  
VE3IW 4944-24-B  
VE3QU 3111-17-A  
VE3BZ 2448-17-B  
VE3ZE 2145-18-A  
VE3OT 2080-13-B  
VE3VZ 1815-11-A  
VE3ZV 1749-11-A  
VE3MV 858-11-A  
VE3ABO 399- 7-A  
VE3NS 324- 9-B  
VE3QJ 150- 5-A  
VE3CQ 112- 4-B  
VE3J\* 3- 2-C

### Quebec

VE2DR 46330-41-B  
VE2EE 33705-62-C  
VE2FG 18315-45-C  
VE2AF 14152-29-B  
VE2EN 11544-28-A  
VE2CO 11480-28-AB  
VE2HF 4416-23-B  
VE2HA 4158-27-C  
VE2BU 3960-33-C  
VE2KC 2288-18-B  
VE2GX\* 5- 1-C

### Alberta

VE4AX 4200-25-B  
VE4LG 3432-22-A  
VE4PH 3264-17-A  
VE4GE 2176-16-B

### British Columbia

VE5HQ 52820-60-B  
VE5FG 28322-49-B

(Continued on page 106)

## A NEW HIGH IN MICROPHONE VALUE

### The Turner Dia-Cell Microphone

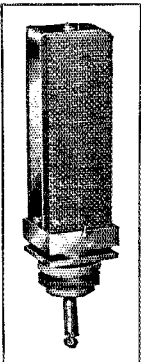

Here is a new high fidelity microphone of the multiple crystal type designed for the most exacting broadcast requirements. Licensed under Brush Patents. Unusually flat frequency response from 30 to 10,000 cycles. As no energizing current is required, background noise is eliminated. Not affected by temperature or weather conditions. Ideal for outdoor use involving rough handling. Various models and mounting stands are available at prices surprisingly low.

Write for descriptive circular or see your jobber for complete details

**THE TURNER COMPANY**  
CEDAR RAPIDS IOWA, U. S. A.

# IT'S SWEEPING THE KILOCYCLES!

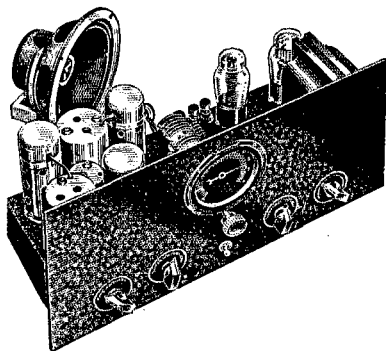

All Wave 30 MC to 540 KC continuous band spread. Beat oscillator for C.W. reception. Excellent sensitivity and selectivity. Uses 1 — 6A-7; 1 — 6F-7; 1 — 77; 1 — 42 and 80 rectifier. Resistance coupled audio insures faithful reproduction with dynamic speaker. Humless built in 110 v. — 60 cycle power supply. Optional S.S. reception.

Good News Travels Fast. LEEDS announcement in the April issue of *QST* on the low cost single signal reception was no exception. LEEDS single signal version of the ALL STAR JR. super het is already proving its worth in many amateur stations. Just ask the man who owns one.

The standard "ALL STAR" kit is sponsored by 11 leading radio manufacturers to fill the demand for low cost, all wave, band spread reception. The complete kit, including all parts, drilled chassis, panel, and complete instructions can be assembled and wired in 5 hours with screw driver, pliers and soldering iron at the amazingly low cost of..... **\$27.97**

6" Dynamic Speaker .....\$2.50  
Matched Kit Sylvania Tubes.....\$2.87

**BRASS POUNDERS** We supply the additional parts and instructions necessary for conversion of the All Star Jr. receiver to single signal reception at.....\$2.25

As a finishing touch **LEEDS** black crystalline finished metal cabinet.....\$3.85

**LAZY HAMS** — The "ALL STAR JUNIOR" completely wired and tested \$5.00 extra.

A postcard request brings the 4 page "ALL STAR" new bulletin to you. Remember — ALL STAR JR. "SINGLE SIGNAL" is exclusively LEEDS.



World Wide Service to Amateurs  
45 Vesey Street  
New York City  
Cable Address, "RADLEEDS"

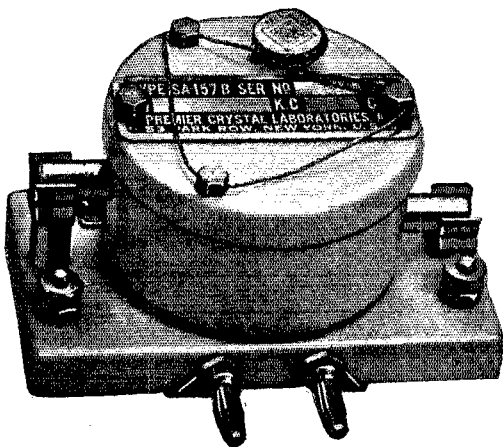

## A NEW RECORD IN FREQUENCY STABILITY!

PREMIER AT cut Crystals mounted in our Type 157 Precision Adjustable Air Gap Holders are being used by several of the largest Broadcasting Stations to insure absolute zero beat on their assigned frequency.

It may only require a slight change in your present equipment to put you on zero beat. Send us full particulars of your monitor and frequency control equipment. You will find us pleased to assist in solving your problems.

To be sure you are using a PREMIER Crystal—look for the seal. Our Crystals are sold only in a serial numbered Holder bearing a PREMIER lead seal. Send for Bulletin No. 103 which fully describes our complete line of Isolantite low-loss Holders.



**PREMIER CRYSTAL LABORATORIES, INC.**  
**53 PARK ROW, NEW YORK, N. Y.**



*Specializes in*  
**Quality**

**Binding Posts  
Tip Jacks  
Male Plugs  
Female Plugs  
Low-Loss Sockets  
A-C Switches  
Tap Switches  
Terminal Strips  
Short Wave Switches**

Write for Latest Bulletin

**HUGH H. EBY Inc.**  
2066 Hunting Park Ave.  
PHILADELPHIA, PENNA.

# WARD LEONARD



## MIDGET REMOTE CONTROL RELAYS

Send for your free copy of circular 507E.

**WARD LEONARD ELECTRIC CO.**

41 South Street, Mount Vernon, N. Y.

Please send me a free copy of your latest bulletin on Midget Remote Control Relays.

Name .....  
Street .....  
City and State .....  
Call Signal ..... Q

VE5EU	17316-39-B	VE4KX	8640-45-C
VE5HR	14520-44-B	VE4DZ	624-13-C
VE5JC	4257-33-C*		
VE5KB	3360-21-B	<i>Saskatchewan</i>	
VE5HS	1240-20-C	VE4KA	33920-53-B
VE5EC	1036-14-B	VE4CV	16544-44-B
VE5MD	495-9-B	VE4OC	13440-32-A
VE5MR	390-5-A	VE4MN	8335-31-A
		VE4LI	1170-15-B
<i>Manitoba</i>		VE4UN	360-6-A
VE4SF	13366-41-B	VE4QZ	357-7-A

### Progress in U.H.F. Gear

(Continued from page 38)

are then tapped on at about one-third the distance up from the bridge. The plate-circuit bridge is then set so that the active length of the line is less than one-quarter wave and, upon applying the plate voltage, the plate-circuit bridge is pushed back and forth until minimum plate current is obtained. At this stage, the grid taps are moved in small steps down toward the bridge to the lowest point which still provides the desired plate current and smooth oscillation. If the utmost stability is to be expected, the adjustment of the grid line should be made while listening with a monitor.

It is obvious that we still have a great deal to learn about the operation of this type of oscillator. We make no claim that the transmitters represent the ultimate development. They are simply experimental units which have shown considerable frequency stability and which have given us a higher order of efficiency than we ever had before.

Experimenters playing with the single-tube circuit shown on page 15 of February *QST* will find it worthwhile to connect the grid return lead not to the bottom of the resonant line but to the outer conductor at a point opposite the grid tap. For reasons yet to be disclosed, this would seem to reduce the loading effect of the tube on the line. In both the single and double-tube circuits, the grid line should be exactly one-quarter wave-length long. The length of the plate line will depend, of course, upon the type of tubes used and the length of the leads from the ends of the pipes to the plates. It is obviously possible to use a concentric line in the plate circuit in the case of a single-tube oscillator. Some difficulty will be had, though, in providing an appropriate bridge for the closed end of the line and some means of coupling to the antenna circuit.

The spacing of the conductors in the resonant line is according to the following ratio:

$$\frac{b}{a} = \text{something between 3 and 4 for both concentric and open-type lines.}$$

When  $b$  = inner radius of outer conductor in concentric line, or the spacing between the pipe centers in open lines.  
 $a$  = outer radius of inner conductor in a concentric line, or the pipe radius in an open line.

We are still highly enthusiastic over the way in which these circuits operate. It is obvious that Dr. Terman made an invaluable contribution to the ultra-high frequency game by proposing<sup>2</sup> this type of frequency control.

<sup>2</sup> "Resonant Lines in Radio Circuits," by F. E. Terman, *Electrical Engineering* (A.I.E.E.), July, 1934.

# EVEREADY

## RADIO BATTERY SPECIFICATIONS

Catalog Number	Voltage	Terminals	Taps	Dimensions			Weight lbs.	List Price
				L	W	H		
485	45	Spring	22.5	8 $\frac{1}{2}$	3 $\frac{1}{16}$	8	9.5	\$1.95
486	45	Spring	22.5	8	4 $\frac{1}{16}$	8	14.25	2.50
872	45	Spring	22.5	7 $\frac{15}{16}$	3 $\frac{1}{16}$	8	9.	1.65
870	45	Spring	22.5	7 $\frac{31}{64}$	4 $\frac{1}{16}$	8	13.75	2.10
572	45	Spring	22.5	7 $\frac{15}{16}$	3 $\frac{1}{16}$	8	9.	1.25
570	45	Spring	22.5	7 $\frac{31}{64}$	4 $\frac{1}{16}$	8	13.75	1.70
768	22.5	Spring	-3,4,5,16.5	4 $\frac{3}{8}$	2 $\frac{1}{2}$	3 $\frac{3}{8}$	1.55	.90
771	4.5	Spring	-1.5,3	4	1 $\frac{3}{8}$	3 $\frac{1}{16}$	.45	.30
771 T	4.5	Screw	-1.5,3	4	1 $\frac{3}{8}$	3 $\frac{1}{16}$	.45	.30
762	45	Ins. Screw	22.5	4 $\frac{1}{8}$	2 $\frac{9}{16}$	6 $\frac{1}{16}$	3.12	1.20
763	22.5	Screw	-	3 $\frac{15}{16}$	2 $\frac{1}{16}$	2 $\frac{3}{8}$	.8	.75
764	22.5	Spring	3 $\frac{3}{8}$	3 $\frac{3}{8}$	2 $\frac{1}{16}$	6 $\frac{3}{16}$	2.12	.75
766	22.5	Spring	18	6 $\frac{11}{16}$	4 $\frac{1}{16}$	3 $\frac{3}{4}$	4.6	1.50
779	22.5	Spring	4 $\frac{1}{16}$	4 $\frac{1}{16}$	3 $\frac{1}{16}$	7 $\frac{1}{16}$	4.75	1.50
781	4.5	Screw	2 $\frac{1}{16}$	2 $\frac{1}{16}$	$\frac{3}{4}$		.28	.40
781 T	4.5	Screw	-1.5,3	2 $\frac{1}{16}$	$\frac{3}{4}$	3 $\frac{1}{4}$	.28	.40
773	7.5	Screw	-1.5,3,4,5,6	4 $\frac{1}{16}$	$\frac{3}{16}$	3 $\frac{1}{4}$	.57	.65
783	15	Spring	-3,10,5,13,5	4 $\frac{1}{4}$	1 $\frac{3}{4}$	3 $\frac{1}{16}$	1.4	1.25
769	135	Ins. Screw	{ -1.5,3,4,5,9 + 22.5,45,67,5	9 $\frac{1}{2}$	2 $\frac{13}{16}$	7 $\frac{1}{16}$	10.8	7.25
A-600	2.5	Ins. Screw		13 $\frac{1}{2}$	6 $\frac{3}{4}$	11	25.	8.50
X-124	3	Ins. Screw		10 $\frac{1}{4}$	10 $\frac{1}{4}$	7 $\frac{1}{4}$	18.25	7.50
X-125	3	Ins. Screw		11 $\frac{1}{16}$	4 $\frac{1}{4}$	6 $\frac{1}{2}$	42.	3.20

### NATIONAL CARBON COMPANY, INC.

GENERAL OFFICES: NEW YORK, N. Y. • BRANCHES: CHICAGO, SAN FRANCISCO

Unit of Union Carbide  and Carbon Corporation

## \*\*\*\*\* THE RADIO SHACK \*\*\*\*\*

### INTERNATIONAL PLATE TRANSFORMERS

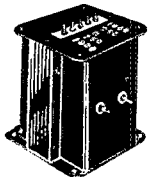

Outstanding for quality. 750 and 1000 volts each side of c.t. at 300 mills. Case finished completely in steel, crackle finish.

Model 2000.....\$5.95  
Model 3000 — Same in appearance, 750-1000-1500 each side of c.t., 300 mills. ....\$8.95  
We know of nothing that equals the value received in these two items

MAY marks the end of our first advertising year in your QST. Briefly we thank you for your splendid support—We want you to know that in your dealings with us quality — service — fair prices and an iron clad warranty are yours. . . . This policy will never be minimized—rather it will be increased. Drop in to see us when you get to town. The latch string is always out!

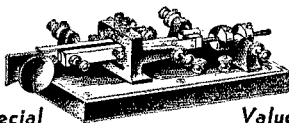

Special Value

JR. EDITION OF THE KENCO SEMI-AUTOMATIC KEY  
An unusual value in a semi-automatic key — construction is excellent. The chrome model of this product \$3.95 sold for \$9.00.

### PYRANOL

2 mfd. 2000 volt trans. condensers \$2.90

Impregnated and filled with Pyranol. We rate these at 2000 volts working and we know of cases where they are in use at a 50-75% overload. Made by one of the world's largest manufacturers of electrical apparatus.

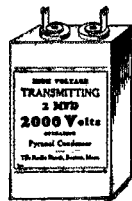

### Baldwin type C-phones

Triad 866. A real heavy duty tube, and guaranteed. \$1.60

EIMAC 150T. \$24.50  
EIMAC 50T. \$13.50

Triad 841. \$2.25

Plate transformers 750-0-750V-300MA. 7.5V-7.5V at 3A 5V-3A. \$6.95

750-1000 each side 300M. Weight 17 lbs. \$7.50

1000-1500V each side 175 MA. \$8.00

Triplett meters 3 $\frac{1}{4}$ " bakelite case 0-5 to 500M \$3.75  
0-15 a.c. volts 3.75

Triad 210.....\$1.00  
281.....1.00  
46......50  
59......63

The Mac-Key. \$7.95

30H-300 Mill. choke 90 ohms d.c. Resist. \$5.00

Mail orders filled. Please send M.O. Foreign customers. Payment must be made here. Cannot ship C.O.D.

### Thordarson Plate Transformer

600-0-600 200M 5V-3A-2.5V 12A 7.5V 3A. \$2.75

As distributors we can supply from stock — The RCA-ACR-36 ham receiver. \$69.50

The Super Sky Rider Immediate delivery. \$59.95

## THE RADIO SHACK

46 BRATTLE STREET BOSTON, MASS.

### Browning 35 in stock.

10 volt 6.5 amp. cased. \$2.10  
Peak Pre-Selector. \$19.86

RAYTHEON RK-18.....\$10.95  
RK-20.....15.00  
RK-23.....5.95

Dunco Keying Relay. \$2.00

Ohmite 200W bleeders from 0-100,000 ohms. Var. \$1.50

Turner Crystal Microphone \$13.50

Haigis 5M transceiver. \$13.50  
Sickles 5M kit. \$1.20

Audio trans. with mike winding. \$1.20

Output to march. \$9.90

4 PDT switch \$4.45

RCA Hand Mike. \$1.20

VT 203A Graphite. \$9.00

Raytheon 250 \$7.75

866 filament trans. 2.5V-12A. \$1.25

RCA 800. \$10.00  
RCA 955. 3.75  
RCA 802. 3.90

Gammatron type 354. \$24.50

# NEW TRANSCEIVER

FOR 2½ OR 5 METERS

A completely redesigned unit with a new, stable circuit permitting increased efficiency and extremely small size at a new low price. Although almost of camera size, it is a big performer and capable of putting better than .1 ampere into a quarter wave antenna on 5 meters with 135 volts of B. Employs standard 30 and 33 tubes and incorporates a volume control, new transfer switch and 3 way jack for handset. Ideal for ultra-portable work where size and weight are important factors. TRANSCEIVER LESS TUBES.....\$14.95

MODERN, EFFICIENT  
STATION OR FIELD EQUIPMENT  
FOR ALL AMATEUR FREQUENCIES

Write for full details

ON

- HF-4 UHF receiver with power supply and built-in speaker.
- RTM 4 watt transmitter-receiver unit for fixed frequency use between 30 and 60 Mcs.
- RTF 10 watt companion unit for 110 volt operation.
- FT-30 Radiophone transmitter for 4 Amateur bands.
- TRITET exciter unit for five band operation.
- RK-20 Amplifier, an ideal companion unit delivering 120 watts CW, 35 watts phone.

**HARVEY RADIO LABORATORIES**

12 Boylston Street

Brookline, Mass.

UNSURPASSED  
VALUES

**OIL FILLED**  
**2 Mfd. 2000 Volts**  
**Condenser**  
**Net \$2.40**

Rectangular can, 4½" high with stand off insulators, and mounting brackets  
**FULLY GUARANTEED**

*N. E. Distributors for Hammarlund National, RCA products, Thordarson and most National lines.*

**H. JAPPE COMPANY**

46 CORNHILL  
Worcester, Mass.

BOSTON, MASS.  
Dover, N. H.

W1BIO  
W1DAU

W1LA  
W1DOD

W1DJU  
W1ALN

## A Tribute

(Continued from page 20)

offices of Paul J. Moore, W9MV, and Willard O. Conrad, W9WC, we are able to reproduce the poem for even more general approval:

There's something about them you've got to admire.

They work for the love of the task, not for hire. Every one of them's blessed with the heart of a boy!

What's a job to the drudge unto them is a joy. While we to our regular schedules are keeping, The amateurs do without eating or sleeping.

They worry their wives—since so short is a day— They don't get to bed when they should, but they stay

Sending calls on the air; catching calls from afar—

And I think as I hear them how patient they are! How much better we'd work here if only we knew it

In that amateur spirit of wanting to do it!

Professionals weary sometimes and they shirk. Since they're paid to perform they look on it as work.

They begin with reluctance; they're glad when they're through—

And they measure in money whatever they do; But the amateur never begrudges a minute; He goes to the job for the joy that is in it.

So here's to the amateurs—brave hearted throng—

Though short be their waves, may their lives all be long;

May the wisdom they gain and the joys which they reap

Make up for the nights when they go without sleep;

And may we—in their spirit and deep understanding

Of work and its joy—keep our amateur standing!  
©1934, E. A. Guest

## Strays

Hear about the would-be ham who figured he wouldn't be able to use 204-A's as modulators because they're not supposed to be any good at high frequencies and his voice was pretty high pitched?

—W9OKZ

## Crackle Finish

Hams are always inquiring about paints to put that crackle finish on home-made gear. F. B. Hodgdon, of Framingham, Mass., writes that the Patterson Sargent Company, makers of "BPS" paints and varnishes, have a crackle finish paint which is just the thing for panels. It is known as "No. 6286 Special Frost Finish Black Enamel." Your hardware or paint store probably can get it for you.

# THERE IS A DIFFERENCE IN CRYSTALS!

## ACCURATE CALIBRATION

Biley Crystals sold only in holder in which they are calibrated accurate to .001% or better. Unconditionally guaranteed 0.03% accurate in your set.

## GUARANTEED OPERATION

Over 30 inspection tests guarantee high power output and satisfactory operation in your transmitter.

## STANDARD PLUGS

Holder plugs into any standard 5 prong tube socket. G. R. plugs at slight additional cost.

## SPECIAL HOLDER

One piece low loss molded bakelite holder specially designed to give foolproof protection without loss of operating efficiency.

## LESS DRIFT

Electrodes of special alloy heat treated. Cover serves as upper electrode; radiates heat allowing greater loads with less frequency drift.

BC3 mounted 40, 80, 160 meter crystals from \$3.95 up. Get new catalog from our distributor.

# BILEY ELECTRIC CO., ERIE, PA.

# Why You Will Want G-E Instruments

**BECAUSE** their sturdy construction and large clearances mean extra-long life for the instrument.

**BECAUSE** their neat, well-balanced appearance will add to the attractiveness of your transmitter.

**BECAUSE** you can be assured of high quality and dependable operation.

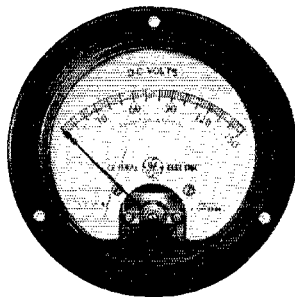

**A**SK to see these new G-E instruments at your jobber's or radio dealer's. We will gladly send you a copy of our bulletin, **SMALL PANEL INSTRUMENTS, GEA-1239B**, on request. Radio Department, General Electric, Schenectady, N. Y.

430-54

# GENERAL ELECTRIC

**FACTS**  
 You should know about  
 Condensers

**WE PROVE IT!**

**FREE!** You owe it to yourself to write today for a copy of this **BOOKLET**

Just what does the Power Factor rating really mean in the condensers you buy?

... What is the truth and the whole truth about leakage claims — capacity and voltage ratings?

As serviceman or amateur, how can you be SURE you are getting the most filtering, the best performance for the least money?

These and many other bothersome condenser questions are clearly explained in our new free booklet illustrated above. It will show you that we not only claim Sprague Condensers are best — but explain exactly how we PROVE it! Write for a copy. SPRAGUE PRODUCTS CO., North Adams, Mass.

**SPRAGUE  
 CONDENSERS**

Made Right  Priced Right

**EXCLUSIVELY  
 FOR AMATEURS**

*Midwest Is Truly the  
 Amateur's Headquarters*

Midwest caters exclusively to the amateur. Only by concentration on amateur equipment can Midwest offer the prompt, accurate and complete service for which it is famous.

**88 Complete Lines**

The Complete lines of 88 famous radio parts manufacturers—in fact, all worthwhile lines—are kept in stock ready for instant shipment.

**Big Free Catalog**

Write for your copy of Midwest's free catalog—the largest, most complete short-wave equipment catalog in the world.

**MIDWEST  
 RADIO MART**

520 S. State St., Chicago, Ill.

## The V-Doublet Antenna

(Continued from page 29)

of a building. Where sufficient ground space is not available to provide the normal span of 51 feet, the doublet may be shortened, with a slight sacrifice of efficiency in the region of the 49-meter band only. The directional effect of the doublet is advantageous where a source of interference is unavoidably near. Least interference is intercepted by the doublet when the horizontal wire points toward the source of interference.

If desired, the transmission line can be extended as far as 500 feet from the receiver. This permits wide latitude in choosing a noise-free location for the doublet. At least 100 feet of line should be used to maintain correct electrical matching. Excess line of the first 100-foot section can be coiled at the end nearest the receiver and after the initial 100 feet, the line may be spliced or cut as desired.

## Experimenters' Section

(Continued from page 60)

### An Antenna Mast Without Guy Wires

How many times have you wished you could erect an antenna mast without a maze of guy wires to keep it up? Many times we want to run the antenna right up to the pole, especially when the back yard is small and every inch is needed. This often results in the guy wires acting as reflectors.

Here is the solution: Two "2 by 4's" bolted together with "U" bolts as shown in Fig. 5, making a "T"-shaped section. Up to a length of forty feet (or possibly more) this pole will require no guy wires, if set in cement. A 60-foot pole may require several guy wires about 20 feet up the pole.

The "2 by 4's" are alternated so no two splices come together. In order to do this it is only neces-

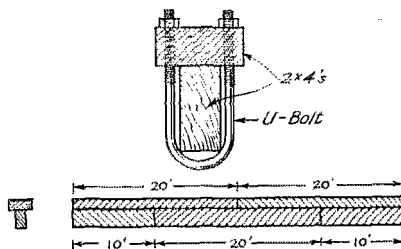

FIG. 5

sary to start out making the pole with one 10-foot and one 20-foot 2" by 4" and use 20-foot pieces thereafter to the required length, then finish off the last one-half piece with another 10-foot length.

The "U" bolts should be placed closely enough so that the pole is rigid and will not bend either way. If you do not go in for permanent construction, the "2 by 4's" simply might be spiked to-

(Continued on page 118)



# Del-Rad presents the Super SKY-RIDER

NOW AVAILABLE ON DEFERRED PAYMENTS

FROM exacting laboratories, with standards of vital precision, Science and keen Craftsmanship bring you the Super SKY-RIDER—the incomparable Amateurs' Short Wave Receiver. Here are just a few of the challenging features: ● Four Short Wave Bands ● 5 Band Selector Switch ● Full 7 Inch Band-spread ● Pre-Selection ● Crystal Filter ● Frequency Meter and Monitor ● An Oscillator That Does Not Creep ● Air-Tuned I.F.'s: Temperature-proof.

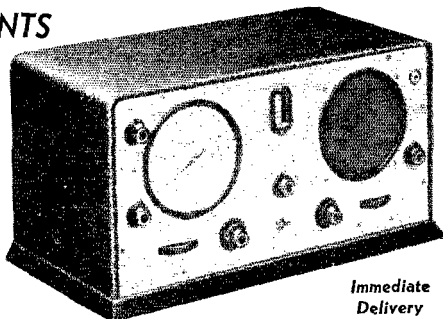

Immediate Delivery

Model	Cash Price	Time Price	Down Payment	Monthly 5 months
S4	\$59.95	\$66.00	\$21.00	\$9.00
SX4 (with xtal)	68.95	76.00	26.00	10.00
S5 (with BC band)	69.95	77.00	27.00	10.00
SX5 (with tal & BC band)	78.95	87.00	32.00	11.00
S6 (with 10 meter band)	69.95	77.00	27.00	10.00
SX6 (with xtal & 10 m. band)	78.95	87.00	32.00	11.00

WRITE US FOR 16-PAGE DESCRIPTIVE BOOKLET

## DELAWARE RADIO SALES COMPANY

405 Delaware Ave.

ATTN W3DQ

Wilmington, Delaware

### GENTRY CRYSTALS

X-CUT  
1715 — 4000 Kc ± 5 Kc..... \$2.00; Exact Kc..... \$3.00  
7000 — 7300 Kc ± 25 Kc..... \$3.00; ± 5 Kc..... \$3.75

A-CUT  
1715 — 4000 Kc ± 5 Kc..... \$5.00; Exact Kc..... \$7.50

Bulletin on Request

**GENTRY LABORATORIES**

803 W. Maple Ave.

Independence, Mo.

### GULF RADIO SCHOOL

Radiotelegraphy

Radiotelephony

Radio Servicing

SECOND PORT } 1007 Carondelet Street  
U. S. A. } NEW ORLEANS, LA.

Established
1906

**PURATONE**  
Products  
for  
Scientific  
Noise Reduction

Write for Cat. 235-R  
for All Service Needs

Antenna Coupler

Receiver Coupler

Power Line Filter

Test-O-Lite

L. S. BRACH Mfg. Corp. NEWARK, N. J.

### Latest Development

Non-inductive, wax impregnated, and conservatively rated, the New Midget Type Y Paper Condensers are particularly suited for use in compact and portable transmitters. Housed in seamless metal containers with bakelite bushings insulating the solder lugs. Flash tested at twice rated voltage. D.C. insulation resistance, 1000 megohms per microfarad. Manufacturers of Carborite Insulated Resistors



**CONTINENTAL CARBON Inc.**

13924 Lorain Ave., Cleveland, O.

### High Voltage — Low Priced

Code	Capacity in Mfd's.	D.C. Working Voltage	Dimensions in Inches	List Price
YA101	0.1	1000	13/16" x 2" x 3/4"	\$1.00
YA1025	0.25	1000	13/16" x 2" x 3/4"	1.15
YA105	0.5	1000	1 1/8" x 2" x 2"	1.25
YA11	1.0	1000	1 1/8" x 2" x 2"	1.75
YA12	2.0	1000	3" x 2" x 2"	2.80
YA14	4.0	1000	3" x 2" x 2"	4.50
YAE1	1.0	1500	3" x 2" x 2"	2.50
YAE2	2.0	1500	3" x 2" x 2"	4.50



# Where to buy it

A directory of suppliers who carry in stock the products of these dependable manufacturers.

**BURGESS BATTERY COMPANY**  
*"Chrome" protected*  
**RADIO BATTERIES**  
 Look for the Black and White Stripes  
 FREEPORT, ILLINOIS

- ALBANY, N. Y. 356 Broadway  
 Uncle Dave's Radio Shack
- BOSTON, MASS. 46 Brattle Street  
 Radio Shack
- MONTREAL, CANADA 285 Craig Street, West  
 Canadian Electrical Supply Co., Ltd.
- NEWARK, N. J. 219 Central Ave.  
 Wholesale Radio Service Company
- NEW YORK, N. Y. 44 West 18th Street  
 American Sales Company
- NEW YORK, N. Y. 100 Sixth Avenue  
 Wholesale Radio Service Company
- READING, PENN. 404 Walnut Street  
 George D. Barbey Company
- SPRINGFIELD, MASS. 349 Worthington St.  
 T. F. Cushing

**Super SKYRIDER**  
  
 the hallicrafters

- ALBANY, N. Y. 356 Broadway  
 Ft. Orange Radio Distributing Corp.
- BOSTON, MASS. 46 Brattle Street  
 Radio Shack
- HARTFORD, CONN. 227 Asylum Street  
 Radio Inspection Service Co.
- PROVIDENCE, R. I. 32 Broadway  
 W. H. Edwards & Co.
- WILMINGTON, DEL. 405 Delaware Ave.  
 Delaware Radio Sales Co.

**E.F. JOHNSON COMPANY**  
 MANUFACTURERS OF  
**RADIO**  
 TRANSMITTING EQUIPMENT  
 WASECA, MINN.  
 U.S.A.

- MONTREAL, CANADA 285 Craig Street, West  
 Canadian Electrical Supply Co., Ltd.
- NEWARK, N. J. 219 Central Ave.  
 Wholesale Radio Service Company

- NEW YORK, N. Y. 100 Sixth Avenue  
 Wholesale Radio Service Company
- NEW YORK, N. Y. 142 Liberty Street  
 Harrison Radio Company
- PITTSBURGH, PENN. 603 Grant Street  
 Cameradio Company
- READING, PENN. 404 Walnut Street  
 George D. Barbey Company

**NATIONAL**  

**RADIO PRODUCTS**
  
 NATIONAL COMPANY, INC., MALDEN, MASS.

- ALBANY, N. Y. 356 Broadway  
 Uncle Dave's Radio Shack
- ALLENTOWN, PENN. 1024 Hamilton Street  
 Radio Electric Service Company
- BALTIMORE, MD. 303 W. Baltimore St.  
 Radio Electric Service Company
- BOSTON, MASS. 10 Boylston Street  
 Tremont Electrical Supply Co.
- BOSTON, MASS. 46 Cornhill  
 H. Jappe Company
- BOSTON, MASS. 46 Brattle Street  
 Radio Shack
- BUFFALO, N. Y. 216 E. Genesee Street  
 Dymac Radio
- HARTFORD, CONN. 203 Ann Street  
 Hatry & Young
- MANCHESTER, N. H. 1008 Elm Street  
 Radio Service Laboratories
- MONTREAL, CANADA 211 St. Sacrament St.  
 Canadian Marconi Company
- MONTREAL, CANADA 285 Craig Street, West  
 Canadian Electrical Supply Co., Ltd.
- NEWARK, N. J. 219 Central Avenue  
 Wholesale Radio Service Company
- NEW HAVEN, CONN. 86 Meadow Street  
 Hatry & Young
- NEW YORK, N. Y. 100 Sixth Avenue  
 Wholesale Radio Service Co.
- NEW YORK, N. Y. 227 Fulton Street  
 Sun Radio Company
- NORFOLK, VIRGINIA Newport & 35th Streets  
 Newport Radio Service Company
- PHILADELPHIA, PENN. 10 S. 10th Street  
 Eugene G. Wile

# Where to buy it

A directory of suppliers who carry in stock the products of these dependable manufacturers.

PHILADELPHIA, PENN.	N. E. Corner 7th & Arch Sts. Radio Electric Service Company	NEWARK, N. J.	219 Central Avenue Wholesale Radio Service Co.
PHILADELPHIA, PENN.	512 Market Street M & H Sporting Goods Company	NEW HAVEN, CONN.	86 Meadow Street Hatry & Young
PHILADELPHIA, PENN.	438 Market Street Herbach & Rademan, Inc.	NEW YORK, N. Y.	25 Park Place Federated Purchaser, Inc.
PITTSBURGH, PENN.	603 Grant Street Cameradio Company	NEW YORK, N. Y.	44 West 18th Street American Sales Company
PROVIDENCE, R. I.	32 Broadway W. H. Edwards & Company	NEW YORK, N. Y.	16 West 22nd Street Royal-Eastern Electrical Supply Co.
RICHMOND, VIRGINIA	27th & Marshall Streets Hudson Radio Supply Company	NEW YORK, N. Y.	30 Irving Place Sanford Samuel Corp.
SPRINGFIELD, MASS.	349 Worthington Street T. F. Cushing	NEW YORK, N. Y.	100 Sixth Avenue Wholesale Radio Service Co.
SYRACUSE, N. Y.	265 Erie Blvd., West Roy C. Stage	NEW YORK, N. Y.	142 Liberty Street Harrison Radio Company
SCHENECTADY, N. Y.	710 Broadway M. Schwartz & Son	PHILADELPHIA, PENN.	10 S. 10th Street Eugene G. Wile
SPRINGFIELD, MASS.	397 Dwight Street Springfield Radio Company	PITTSBURGH, PENN.	603 Grant Street Cameradio Company
WASHINGTON, D. C.	1328 New York Ave., N. W. National Electrical Supply Company	PROVIDENCE, R. I.	32 Broadway W. H. Edwards & Company
WILMINGTON, DELAWARE	405 Delaware Avenue Delaware Radio Sales Company	PROVIDENCE, R. I.	89 Broadway Kraus & Company



ALBANY, N. Y.	31 Hudson Avenue Havens Electric Company, Inc.
BINGHAMTON, N. Y.	188 State Street Southern Tier Electrical Supply Co., Inc.
BOSTON, MASS.	10 Boylston Street Tremont Electrical Supply Company
BOSTON, MASS.	46 Cornhill H. Jappe Company
BOSTON, MASS.	46 Brattle Street Radio Shack
BUFFALO, N. Y.	155 Genesee Street Radio Equipment Corp.
CHARLESTON, W. VA.	Virginian Electric, Inc.
HARTFORD, CONN.	203 Ann Street Hatry & Young

READING, PENN.	8th & Elm Streets Bright & Company
SPRINGFIELD, MASS.	349 Worthington Street T. F. Cushing
SYRACUSE, N. Y.	265 Erie Blvd., West Roy C. Stage
WILMINGTON, DELAWARE	405 Delaware Avenue Delaware Radio Sales Company



ALBANY, N. Y.	1039 Broadway Capital City Distributing Corp.
BOSTON, MASS.	88 Pearl Street Eastern Radio Company
BOSTON, MASS.	46 Cornhill H. Jappe Company
BOSTON, MASS.	46 Brattle Street Radio Shack



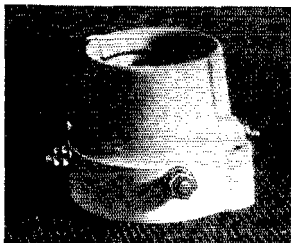

### 50-WATT SOCKET

● In this quality product, the usual metal shell has been avoided, thus eliminating the usual source of arc-over. The insulation is a one-piece low-loss Steatite shell. The contacts are heavy and of the side-wipe type for low contact resistance. Fifty-Watt Socket. Type XC-50, List price \$3.50.

In stock at authorized distributors, usual discounts applying.

**NATIONAL COMPANY, INC.**  
MALDEN, MASS.

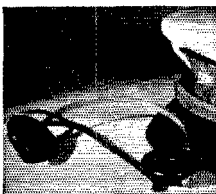

### FEATHERWEIGHT HEADPHONES

write

### TRIMM

Radio Mfg. Co., Dept. Q5  
1528 Armitage Ave., Chicago

## The New Shure Model 70E\* CRYSTAL MICROPHONE with REMOTE PREAMPLIFIER

A convenient Desk-Type Crystal Microphone, complete with remote two-stage preamplifier . . . high quality reproduction, wide utility, beautiful appearance in keeping with deluxe equipment. List Price, as illustrated, fifty-six fifty.

\* One of a complete series of Carbon, Condenser and Crystal Microphones manufactured by "Microphone Headquarters." Ask your Jobber, or see QST "Where To Buy It" Section.

Licensed under Brush Patents

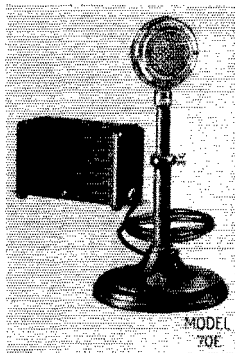

MODEL 70E

### SHURE BROTHERS COMPANY

Manufacturers of Microphone Headquarters Telephone  
Engineers 141-1421  
215 WEST HURON ST. CHICAGO, ILLINOIS

## Correspondence Dept.

(Continued from page 88)

### Carribbean 7-mc. 'Phone

Akron, Ohio

Editor, QST:

Throughout the world, those countries which have large numbers of hams choose to restrict the 7-mc. band to c.w. Most hams in those countries which do not restrict the band follow this rule also. However, in the past few months, increasing numbers of Carribean Sea stations have opened up on 'phone—and on 7 mc. QRM on this band has already reached alarming proportions. 'Phone—unchecked and unlimited—will be the last straw.

One example of poor ham spirit. An HI7 in Santo Domingo in QSO with a W-75 meter 'phone says, "I get out much better on forty than I do on eighty." R9 plus in this area, and blotting out most of the low-frequency end of the band on all but S.S. receivers.

This club is about evenly divided in membership between 'phone and c.w. hams. In the hope that we may discourage these violations, both factions have united in resolving to QSO no station, foreign or local, which is violating hamdom's code of ethics unless the specific purpose of the QSO is to request the violator to remedy the defect.

This is all that we can do. We are asking other ham clubs to do likewise, for alone we can have no effect.

—The Buckeye Shortwave Radio Association

### Dual Identity

Washington, D. C.

Editor, QST:

. . . Would the gentleman who is using my call be so kind as to . . . go down and get one of his own, as it is kind of embarrassing to come on the air at the same time and start CQ'ing a few kilocycles apart from my own frequency. . . .

—Barron P. Freeburger, W5DK

### Cleaning Up 'Phone

2348 Tipperary Road, Kalamazoo, Mich.

Editor, QST:

Let's not recommend to the F.C.C. that amateur radio-phon stations be given more space in any of the present amateur bands. At least not until the majority of 'phone men have learned how to use their present space to their own benefit and to the benefit of amateur radio.

In making the above request I want you to know that it is not prompted in any spirit of antagonism toward 'phone operation, although I am not a 'phone man. I am, as a matter of fact, constantly considering the addition of 'phone equipment to my station. But, when I tune into the 'phone portion of the band and listen, I become quickly discouraged. Why? Not because the interference is heavy, and not particularly because of the excessive space occupied in the band by the numerous over-modulated and poorly controlled signals—but simply because of the character of the QSO's that take place.

I grant that there are many interesting, useful contacts that take place between men whose stations (and they themselves) are a distinct credit to amateur radio. BUT, many contacts seem to be a combination of pointless conversations that in the worst phase degenerate into a palaver that is close to sickening to listen to.

One of the quickest ways in which amateur radio can be killed is to cheapen and degrade it in the eyes of and through the ears of non-amateur listeners—and they are becoming overwhelmingly plentiful. One of the quickest ways for us to allow the commercial interests to start action that will eventually deprive us of what space we now have is to furnish evidence that we amateurs are not useful in any way, and that we constitute a nuisance in the form of undesirable and sometimes offensive broadcasting. AND WE HAVE

(Continued on page 118)

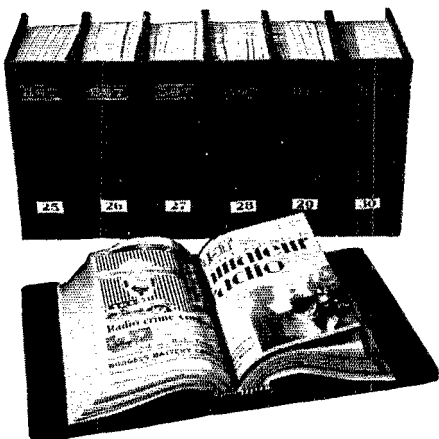

● NOTE ●

The illustration shows each binder with a yearly mark. This marking is not stamped on the binder. Simply cut the year label from a calendar, or paste on a piece of paper, marking it in your own handwriting.

TO

- ▶ enhance the appearance of your station
- ▶ facilitate your reference work
- ▶ preserve the records of the advancement of the radio art

YOU NEED

QST

# Binders

One for this year's issues and one for each of the accumulated year's issues that you have. It will accommodate twelve issues of QST and a yearly index. The QST Binder is covered in deep maroon cloth. It is cleverly designed to take each issue as received and hold it firmly without mutilation. It permits the removal of any desired issue without disturbing the rest of the file.

(Not available outside of the United States and Possessions, and Canada)

A GOOD INVESTMENT AT

**\$1.50** POSTPAID

**AMERICAN RADIO RELAY LEAGUE, WEST HARTFORD, CONN.**



Acquire the CODE — with **SPEED**

*Instructograph* Automatic Code Teacher can help you to become an expert Radio or Morse operator. No experience is necessary. Book of Instructions explains each step just as an instructor would do. You can buy or rent *Instructograph*. Terms are very reasonable. Extra tapes sold separately, if desired. Write NOW for full details.

**INSTRUCTOGRAPH CO., Dept. Q5**  
912 Lakeside Place Chicago, Ill.  
*Representatives for Canada*  
Radio College of Canada, Ltd., 863 Bay St., Toronto

**JACOBS ADJUSTABLE SEPARATOR**



U. S. Patent No. 1,950,173 — March 6, 1934. Others Pending.

Made of porcelain they provide the means whereby 2 wire R. F. feedlines of any separation from 1" up to and including 3" (used in conjunction with Hertz antenna systems) may be rapidly and efficiently constructed. \$2.00 for a set of 6.

**CHARLES F. JACOBS (WZEM), 270 Lafayette St., New York, N. Y.**

## IN STOCK

National HRO \$139.80, RME9D \$112.50, Silver 5C complete prepaid \$74.70. Super SKYRIDER complete prepaid \$59.95. All Collins transmitters at lowest prices.

Trade in your receiver or transmitter

**POSITIVELY IN STOCK:** Eimac 50Ts \$13.50, 150Ts \$24.50; Mac-Keys \$7.95 prepaid; Astatic D-104 and Turner type G crystal mikes \$13.25; Peak preselectors and Peak Telephony monitors \$19.80 prepaid; K cut power crystals \$1.50 prepaid; All Star receiver kits. Lowest prices all Dwyer condensers, Thordarson transformer, Cornell-Dubilier condensers, Sylvania and Taylor transmitting tubes, Triplett meters, Cardwell condensers, Johnson products, Hammarlund and National parts, Bliley crystals, others.

Your used apparatus accepted in trade on any new apparatus and all types of RCA and W.E. transmitting tubes, meters, receivers, and other used apparatus cheap. You need send but 10% deposit with order. Write for bulletins and any information.

**Henry Radio Shop** 211-215 No. Main St. BUTLER, MISSOURI

Radio  
Engineering  
Complete in  
Telegraphy-  
Telephony

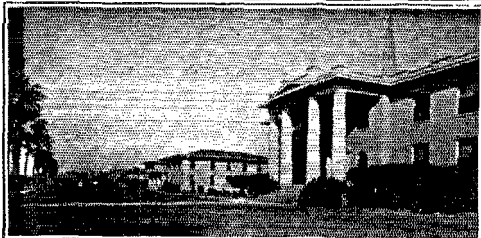

Studio Technique  
and Transmitter  
Operating Expe-  
rience Guaranteed

KPAC

500-Watt 1260 Kilocycles

In 3 to 7 months we train you to secure Commercial Telegraph Second-class, and Radiotelephone First-class government licenses. Course consists of Wireless Code, Radiophone, Microphone-Studio Technique, Service, Police, and Aeronautical Radio. We are authorized to teach RCA texts. At completion of course you receive practical studio technique experience in our commercial broadcast studios located in administration building, and experience as an operator on K-P-A-C (500-Watt Commercial transmitter located on the campus and owned and operated by the college), and WPA, 4000-Watt Commercial Wireless Station. If interested, write for Bulletin K.

**PORT ARTHUR COLLEGE**

Port Arthur (world-known port) Texas

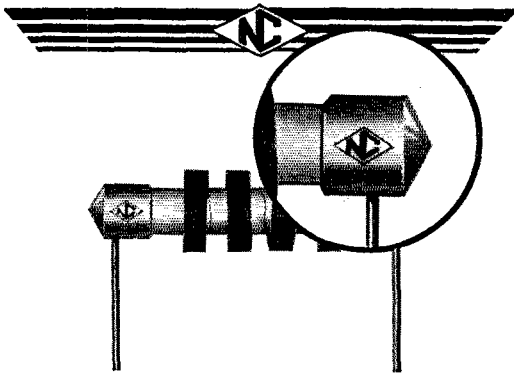

Appearance is much easier  
to imitate than performance

PATENTED

NATIONAL COMPANY, Inc.  
MALDEN, MASS.



"The Crystal Specialists Since 1925"

**PIEZO-ELECTRIC CRYSTALS**

Guaranteed Accurate to BETTER than .01%

**SCIENTIFIC RADIO SERVICE**

UNIVERSITY PARK, HYATTSVILLE, MD.

**FASTEST WAY TO LEARN CODE**

Easy, Fascinating;  
**LEARN by EAR**  
to be a Good Op!

The New MASTER TELEPLEX Code Teaching Machine is exactly what thousands are looking for. No experience needed. Ideal for beginners—steps up w.p.m. for all ops. Only instrument ever produced which records your sending in visible dots and dashes on copper tapes—then sends back your own key work. You actually HEAR the dots and dashes, any speed you want. You learn code the way you'll be using it—by SOUND! Complete Code Course included, no extra charge. Used by U. S. Army, Navy, R.C.A., A. T. & T. Co., and others. Low cost, easy terms, **Money-Back Guarantee**. Send now for booklet Q-29, no obligation. Postcard will do.



**TELEPLEX COMPANY**

76 CORTLANDT ST.

NEW YORK, N. Y.

**MADE ALARMING STRIDES IN THIS DIRECTION IN THE PAST YEAR!**

C.w. telegraph contacts have many, many faults. But at least the now frequent "listening public" cannot understand them.

It is hard to write a letter of this type and not give the impression that the writer is a bitter anti-'phone amateur. But I assure you again, such is not the case.

Many 100% 'phone men recognize the danger to amateur radio that I have tried to call attention to in this letter. As a typical illustration, I was talking recently with a ham much my junior, but who has a sincere interest in amateur radio, both in the operating and technical sides, and who has been operating almost exclusively on 20-meter 'phone. When I suggested that, after pounding brass for almost fifteen years as a ham I was considering dividing my time between c.w. telegraph and some 'phone operation, he doubtfully shook his head. "I'm afraid you wouldn't like it very much," he said. "Frequently I listen to other 'phone contacts and many times I ask myself, 'Am I one of those?'"

What amateur, of reasonably mature years, has not been automatically placed in the embarrassing position of being classed with those who so thoughtlessly talk with abandon through the medium of amateur radiophone? In the minds of those non-amateurs who have "all-wave" broadcast sets amateur radio is completely judged by the type of conversations they listen to—and it isn't code. What do we care? We should care—plenty! That is if we need the support of Congressmen and Senators in the advancement of our hobby with additional frequencies, or perhaps in the preservation of our present meager space.

The 'phone men need more space, but they don't deserve it—not until the influence of those good 'phone operators is reflected in the 'phone contacts of the offending 'phone operators in the nature of sensible QSO's.

—C. V. Patterson, W3GUC

## The Answer

123 Waverly Place, New York, N. Y.

Editor, QST:

Your editorial in the March issue had such a worthwhile tone that I take the liberty of breaking into "correspondence" print for the first time during my twelve years as a reader.

Coöperation, in these parlous times, is a pretty important thing. I daresay that, insofar as the BCL vs. amateur feud is concerned, the honors are about even, and this simply because there exists an unfortunate minority among us whose theory is that the man who takes his enjoyment from broadcast programs is a scourge, and therefore a fit subject for maltreatment, if not annihilation. Yes, I've met professed members of our fraternity who have seemed out to cut their own throats with a "to heck with BCL's" attitude. Yet we know there are many of the latter who have sought legislation destructive to amateur radio as we know it. . . .

Hence, in the best Bronx, "So what?" The answer, to my mind, lies in factual coöperation among the fraternity. You can hunt your DX avidly, or put all your effort into traffic, or pester your brethren with endless CQing—the individual flair is and should be undisturbed, but it's gospel you cannot expect to do a thing but a tremendous amount of harm to the game if you allow yourself to be blinded by petty differences among yourselves, and fail to see that by thus weakening the united front, you permit breaches that will allow commercialism to enter and destroy, and by showing dissension among yourselves provide the very material that certain destructive interests will seize upon and turn against you.

I think we all worry too much about the problem of the moment, the personal thing, and fail to enlarge our vision enough so that we may look to the really important things, the well-being of this grand game of ours, and the maintenance of a high status as a group.

'Way back in the days when Adams-Morgan made a swell job known as the Paragon RA-10, and Paul Godley was loading his tent for a hegira to the English coast, I heard some pretty sound words from a prominent amateur. Their sense was this—that when he was hopelessly QRM'd he endeavored to find out how his receiving equipment could be

(Continued on page 120)



# For All Amateur Bands

## IN LOW POWER STAGES AND OSCILLATORS

Many thousands of amateurs have purchased the Type 677 Coil Forms. For low power oscillators, buffer and amplifier stages and outputs up to 50 watts they are entirely adequate and are much cheaper than the extra low-loss forms intended for high-power use.

They may be used with or without the plug-in features. Many circuits do not require interchangeable inductances in the pre-output stages.

### SPECIFICATIONS

	Type 677-Y	Type 677-U
Length.....	4 $\frac{1}{8}$ inches	4 $\frac{1}{2}$ inches
Diameter.....	3 $\frac{1}{8}$ inches	2 $\frac{1}{2}$ inches
Threads.....	30	21
Amateur Bands.....	160 and 80 m	80, 40 and 20 m
Wire Size.....	12 B & S	10 B & S
Price (Form only)	\$0.75	\$0.50

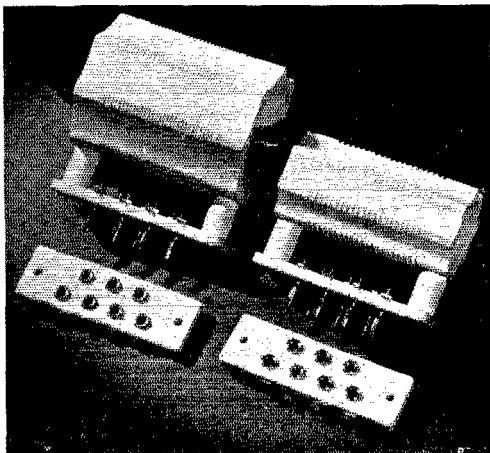

Type 677-Y

Type 677-U

Type 677-P-1 Spacers (2 required) \$0.30 per pair  
Type 678-P Plug Base (with 7 plugs) \$0.70  
Type 678-J Jack Base (with 7 jacks) \$0.65

Order direct from this advertisement, including cash with order, and we prepay forwarding charges anywhere in U. S. and Canada

GENERAL RADIO COMPANY, 30 STATE ST., CAMBRIDGE A, MASS.

"Quicker  
than a  
Short circuit"

## LITTELFUSES

- INSTRUMENT LITTELFUSES, for meters,  $\frac{1}{2}$ 00 amp. up.
- HI-VOLT. LITTELFUSES for transmitters, etc., 1,000, 5,000 & 10,000 volt ranges.  $\frac{1}{8}$  amp. up.
- NEON VOLTAGE FUSES & Indicators (TATTELITES) 100, 250, 500, 1,000 & 2,000 volt ratings.
- AIRCRAFT FUSES, AUTO FUSES, FUSE MOUNTINGS, etc. Get new Cat. No. 6.

Littelfuse Labs., 4509 Ravenswood Ave., Chicago, Ill.

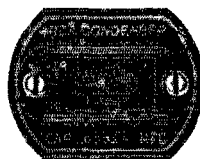

## SANGAMO ACCURATE CONDENSERS

A quality product for the amateur who wants the best results. Available in 1000, 2500, and 5000 volt construction

Write for catalog sheet

**SANGAMO ELECTRIC CO.**  
SPRINGFIELD, ILLINOIS

## LEARN RADIO

New Classes Now Forming! Send for 40-page catalog, explains fully. 190 licensed graduates placed in past 3 years in broadcasting, shipping, police radio, aviation, etc. We teach all branches. Oldest, largest and best equipped school in New England. Equipped with Western Electric sound and broadcasting equipment and RCA marine transmitter. Course prepares for United States Government telegraph or telephone license.

MASS. RADIO SCHOOL, 18 Boylston Street, BOSTON

## . . . complete ultra-high frequency transmitter and receiver in a single cabinet (7 $\frac{1}{2}$ x 15 x 8")

Model TR 53-6A6 employs push-pull unity coupled oscillator, class B modulator and class A driver; and standard 3 tube receiver with dynamic speaker.

TWIN TRIODE tubes used exclusively in transmitter; type 53 for AC and the 6A6 for mobile use. Carrier power 10 watts; complete modulation.

An efficient, practical unit for DUPLEX OPERATION at either MOBILE OR FIXED STATIONS. Just plug in 6.3 or 2.5 volt tubes and DC or AC operated power units.

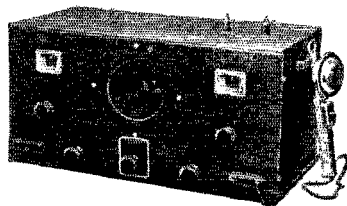

Price \$39.75, less tubes. 110 volt AC Power Supply with cables and plugs — complete \$25. 6 volt to 250 volt 175 m.a. Dynamotor with cables and plugs — complete \$34.00.

**RADIO TRANSCIEVER LABORATORIES**  
86-27 115th STREET RICHMOND HILL, N. Y.

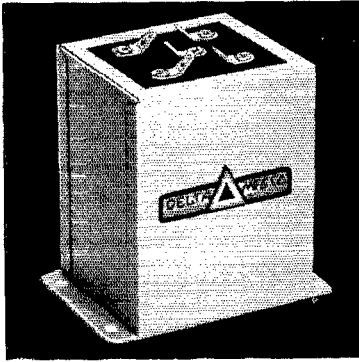

# ACME-DELTA COUPLING TRANSFORMERS

R.K. 20      R.K. 18      R.C.A. 800      SYLVANIA 830-B

Input Transformer	Out of	Into	List Price	Output Transformer	Into	List Price
AD 75	9-2A3	RK-18	\$7.50	AD-76	Class C, RF	\$15.50
AD 77	"	800	7.50	AD-76	Class C, RF	15.50
AD 78	"	830-B	7.50	AD-79	Class C, RF	30.50
AD 92	To couple one 45 to R.K. 20 suppr. grid.					7.50

Good power supplies are required with Class B audio. Write for catalog Bulletin Q48-13.



**RAYTHEON MANUFACTURING CO.**  
ELECTRICAL EQUIPMENT DIVISION  
190 Willow Street, Waltham, Massachusetts  
Successor to Delta Manufacturing Co.

## RADIO ENGINEERING

RCA Institutes offers an intensive course of high standard embracing all phases of Radio, Practical training with modern equipment at New York and Chicago schools. Also specialized courses and Home Study Courses under "No obligation" plan.  
Illustrated Catalog on request.

**RCA INSTITUTES, INC.** Dept. ST-35  
75 Varotk St., New York      1154 Merchandise Mart, Chicago  
Recognized Standard in Radio Instruction Since 1909

## PRECISION CRYSTALS



Crystal Holder—\$1.00

'X' and 'AT' cut crystals one inch square carefully ground for frequency stability and maximum output. Be sure of your transmitter frequency — use PRECISION CRYSTALS. Guaranteed to be the highest quality obtainable.

'X' cut PRECISION Crystals carefully ground for maximum power supplied to your specified frequency accurate to 0.1% and calibrated to within 0.03% are priced as follows: 1750 and 3500 kc. bands—\$3.00 each. 7000 kc. band—\$3.50. Add \$1.00 to above prices if plugin, dustproof holder is desired. Jacks to plug holder into — \$1.50 pair.

The 'AT' cut crystal recently developed has a temperature coefficient of practically zero and will handle more power than ordinary crystals. 'AT' cut crystals ground to your specified frequency accurate to 0.1% and calibrated to within 0.03% are priced as follows: 1750 and 3500 kc. bands — \$6.00 each. Crystal holder — \$1.00. Jacks for holder \$1.50 pair.

Crystals and ovens for commercial use quoted on at your request. When ordering our product you are assured of the finest obtainable. Now in our sixth year of business.

**PRECISION PIEZO SERVICE**  
427 Asia Street      Baton Rouge, La.

improved to correct the situation, and not how the interfering station could be barred from the air.

We've come a long way since that time, but the fundamental soundness of that doctrine, obviously one of cooperation, has remained in my mind. That particular amateur is still one whose accomplishments are something for most of us to gauge our own progress by—but the game is still as fascinating as ever to him, he is one who puts traffic where it belongs, and one with whom an hour or so of rag-chewing is a rare pleasure. And the answer to his enviable position lies in that willingness to cooperate with his fellows, and is a lesson to the least of us. . . .

—Alden Smith, W1AOC-W2GIF

## Slices

2313 East 60th St., Kansas City, Mo.

Editor, QST:

Noting recent publication of figures showing the number of licensed amateurs had increased from 17,000 to 47,000 in the last five years, the time was never riper for us to make a determined effort to obtain more frequencies. These 30,000 new members of our fraternity should be provided bands in which to operate.

Radio has been my hobby for 20 years and I am more interested in it now than at any other time, but I hate to see such a useful and instructive pastime ruined by the overcrowded condition of our bands, even with the most up-to-date receiver.

Instead of widening our present territories, I suggest a generous slice of frequencies around 60, 30 and 15 meters. This would open some new fields for the amateur which should prove very interesting. Restricted 'phone operation should be allowed on all bands.

—N. W. Cook, W9EYM

## 1935 Version of S. S. Superhet

(Continued from page 47)

has been briefly described above. The potentiometer  $R_2$  provides for bucking out excess negative bias developed across the fixed resistor  $R_3$  in the negative lead of the separate power supply to the second detector. The proper adjustment of this potentiometer can be checked by the plate current of the radio frequency stage, which should be just the same as with the a.v.c. off, providing no signals are coming through. About a half-rotation of the bucking control is sufficient. In connection with the a.v.c., special mention of the switch turning it off must be made. To avoid another panel control, a Centralab volume control with detachable switch was used, and the switch disassembled. The small bakelite or fiber cam carrying the contact arrangement was turned over and the switch thus reversed. This switch when reassembled should make contact in the normal "off" position and should be open at all other positions.

Fixed resistors are mounted in pairs on little insulating boards supported above the surface on pillars slipped over machine screws. These screws form a convenient ground point for the by-pass condensers associated with the resistors. Stranded hook-up wire is used and no attempt made to make the wiring look pretty. All connections are available for testing, however.

Total cost of a receiver of this type, excepting tubes and power supply, should not exceed \$60.

(Continued on page 122)



# A.R.R.L. EMBLEM

—*insignia of the radio amateur*

wear proudly wherever he went. There was need for such a device. The post-war boom of amateur radio brought thousands of new amateurs on the air, many of whom were neighbors but did not know each other. In the July, 1920, issue the design was announced — the familiar diamond that greets you at the top of this page — adopted by the Board of Directors at its annual meeting. It met with universal acceptance and use. For fourteen years it has been the unchallenged emblem of amateur radio, found wherever amateurs gathered, a symbol of the traditional greatness of that thing which we call Amateur Spirit — treasured, revered, idealized.

In the January, 1920, issue of *QST* there appeared an editorial requesting suggestions for the design of an A.R.R.L. emblem — a device whereby every amateur could know his brother amateur when they met, an insignia he could

## Do You Wear the A.R.R.L. EMBLEM?

*THE LEAGUE EMBLEM, in heavy rolled gold and black enamel, is available in either pin or button type*

There are three special colors for Communications Department appointees. . . .

- Red background for the SCM
- Blue background for the ORS
- Green background for the RM and PAM

**\$1.00**  
POSTPAID

*Red and green available in pin type only, blue may be had in either pin or button style. All Emblems priced the same*

**\$1.00**  
POSTPAID

### American Radio Relay League, West Hartford, Connecticut

#### BARGAIN BARGAIN BARGAIN

NEW THORDARSON POWER TRANS. PLATE & FIL. 1200 volts C. T. 200 mills—2½ volts 10½ amps. —7½ volts 3 amps.—5 volts 3 amps.

Just the trans. for 801's or 210's class B. NET cost \$3.00. SENT C. O. D. to any part of U. S. A.

**W. H. EDWARDS & CO.**

32 Broadway Providence, R. I.  
*Distributors for Thordarson Trans.*

#### WHEN BETTER AERIALS ARE MADE LYNCH WILL MAKE THEM . . .

AND OTHERS WILL TRY TO COPY THEM

*Write for Free Bulletin on LYNCH  
PATENTED and GUARANTEED  
Noise-Reducing Antennas for Home, Auto Use.*

**ARTHUR H. LYNCH, INC., 227 Fulton St., N. Y.  
PIONEER OF NOISE-REDUCING AERIALS**

## THE *Crystal* CONTROLLED 7-TUBE SHORT WAVE RECEIVER

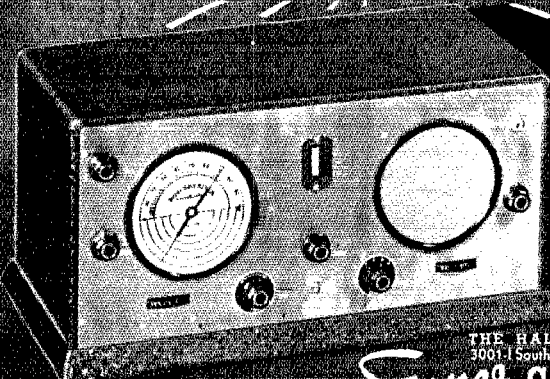

Designed expressly for amateur communication. The CRYSTAL FILTER CIRCUIT, controlled by a variable knob on the front of the set, gives one signal selectivity—without affecting sensitivity! PLUS the drastic reduction of man-made static.  
Write for details.

THE HALLCRAFTERS, INC.  
3001 Southport Ave., Chicago, U.S.A.

### THE *Super* SKY-RIDER

Say You Saw It in *QST* — It Identifies You and Helps *QST*

# HIPOWER

## CRYSTALS

Stability—Dependability—Accuracy

### TYPE M HOLDER

**\$1.00**

Molded Bakelite, plugs in to tube socket.

FREE plug-in mounting



"A" cuts, "X" cuts and "Y" cut crystals at prices every amateur can afford.

WHY pay more, you CANNOT buy as good for less.

If your dealer cannot supply you order direct.

TYPE	FREQUENCY	Supplied within 10 K.C. or choice of dealer's stock	SPECIAL Within 1 K.C.
Y	3500-1700 K.C. Bands	\$1.35	\$2.35
X	3500-1700 K.C. Bands	\$2.35	\$3.35
A	3500-1700 K.C. Bands	\$3.90	\$4.90
AH	7000 K.C. Band Only	\$4.25	\$6.25

Exact frequency of each crystal marked on package

It will pay you to patronize dealers who carry HIPOWER crystals. They are anxious to serve you with QUALITY merchandise at the RIGHT PRICES.

### HIPOWER CRYSTAL CO.

3607 N. Luna Ave., Chicago, Ill. Phone: Avenue 5170

YOU cannot buy a better crystal than HIPOWER at ANY price.

### THE EO-1 LOW-LOSS 72 OHM TWISTED-PAIR RF TRANSMISSION LINE

Is being successfully used as an efficient feeder system for matched impedance half-wave doublet TRANSMITTING ANTENNAS. For this purpose, the EO-1 Line is connected directly to the center of the antenna.

The uniform separation and low RF resistance of the conductors (No. 12 solid bare copper) and the extremely low-loss special radio compound insulation (dielectric constant 2.7) make the EO-1 Line entirely suitable for untuned transmission line purposes in the more complicated systems of the type employing the resonant quarter-wave matching transformer section with the shorting bar. Antennas of this type may be several wavelengths long, resulting in low angle radiation and high efficiency.

For prices, refer to advertisement in April issue of QST.

See your Jobber or order direct. Write for information.

RUSSELL A. GRAY

(Amateur radio)  
W8AAC

HOMER, NEW YORK

## new! KELLOGG TRANSCIVER HANDSET



A better all-around Transceiver Handset! Highly efficient single-button Kellogg microphone, super-sensitive Kellogg receiver. Easy to hold. Fits the face. ● Microphone has greater sensitivity and "flatter" response curve than the usual "mike" of this type. Precision built, as are all Kellogg products. Gold plated diaphragm. Especially processed carbon. ● Receiver is the product of 35 years experience building telephone apparatus. Bi-polar magnet of cobalt steel. Cadmium plated diaphragm. Small, compact, easy on the ear. ● Simply and ruggedly constructed and light weight. Cast aluminum triangular handle. Baked black enamel finish. Has 6-foot, 4-conductor, 18-strand tinsel cord of telephone quality. ● You will be proud to own this unit. Better yet, it's not expensive. Code No. 38-A, 70 ohm receiver, list price \$10.00. Code No. 38-B, 2000 ohm receiver, list price \$11.00.

**KELLOGG SWITCHBOARD & SUPPLY CO.**  
1068 W. Adams St. CHICAGO, ILLINOIS

122

Say You Saw It in QST — It Identifies You and Helps QST

All complete with speaker and two power supplies, \$75 should foot the bill. While no claim of exceptional performance is made, the use of this receiver has put some fun back into ham radio for the writer, when the use of anything less selective had made receiving a torture rather than a pleasure. It is possible to pull through DX on the crowded 7-mc. band in the evening, and during the recent International tests several new countries were heard. Anything less than a high-power local just doesn't interfere at all, and with a well-shielded antenna lead and fully neutralized transmitter, break-in can be worked quite close to the transmitter frequency. The writer will be pleased to answer questions concerning the receiver if a self-addressed stamped envelope is included with the query.

### I. A. R. U. News

(Continued from page 64)

tween Belgium and Hawaii was made by 4WW, while the first Europe-Hawaii contact on 'phone was established in April of last year on ON4AU. He was closely followed by ON4BZ, in May.

In the A.R.R.L.'s first International DX Tests, ON4AU was placed first among the Belgian competitors with 118 points. He was classed second for the whole world in the following year's contest.

Other recent exploits of R.B. members are too well known to necessitate repetition here. An idea of the R.B.'s activity can be gained from the fact that since February 30, 1930, 42 WAC certificates have been awarded to Belgian amateurs, among which are 5 for 'phone work.

In conclusion, we invite all amateurs to visit our stand at the 1935 International Exhibition to be held in Brussels, and to participate in our big International Convention next August.

### DX Contest Highlights

(Continued from page 36)

"Boy, is my wife glad that's over!"—W1AER. Dick Bartholomew at K4SA used both 'phone and e.w., operated about 30 hours and had a score of 8800. "Found that calling a fellow blind paid dividends." W6JMR.—"Give us a chance to work DX same as you have done for the W/VE gang."—VO4Y. W1WV snagged G5BY on 3.5 mc. for this TBTOC. One chap mentioned this was his third contest but the first one in which he had had a contact!

Outstanding DX stations who were named by scores of W-VE amateurs include: HC1FG, EA4AO, F8FC, X2C, CT2BK, VK2DA, ZL4AI, J2HN, ON4AU, EA8AF, VK2NS, VK2EL, K4KD, LU2FC, K6HLP, EA4AV, D4BAR, ZT1R and VS6AH.

—C. C. R.

# HAM-ADS

(1) Advertising shall pertain to radio and shall be of nature of interest to radio amateurs or experimenters in their pursuit of the art.

(2) No display of any character will be accepted, nor can any special typographical arrangement, such as all or part in capital letters be used, which would tend to make one advertisement stand out from the others.

(3) The Ham-Ad rate is 15¢ per word, except as noted in paragraph (6) below.

(4) Remittance in full must accompany copy. No cash or contract discount or agency commission will be allowed.

(5) Closing date for Ham-Ads is the 25th of the second month preceding publication date.

(6) A special rate of 7¢ per word will apply to advertising which, in our judgment, is obviously non-commercial in nature and is placed and signed by a member of the American Radio Relay League. Thus, advertising of bona fide surplus equipment owned, used and for sale by an individual or apparatus offered for exchange or advertising inquiring for special equipment, if by a member of the American Radio Relay League takes the 7¢ rate. An attempt to deal in apparatus in quantity for profit, even if by an individual, is commercial and takes the 15¢ rate. Provisions of paragraphs (1), (2), (4) and (5) apply to all advertising in this column regardless of which rate may apply.

Having made no investigation of the advertisers in the classified columns, the publishers of *QST* are unable to vouch for their integrity or for the grade or character of the products advertised.

**QUARTZ**—Direct importers from Brazil of best quality pure quartz suitable for making piezo-electric crystals. Diamond Drill Carbon Co., 719 World Bldg., New York.

**REPAIRS:** Microphones, meters, broadcasting equipment, electronic devices, instruments. Prompt repair service. Low prices. Estimates on request. Sound Engineering Corp., 2200 Kinzie, Chicago.

**RADIO** engineering, broadcasting, aviation and police radio, servicing, marine and Morse telegraphy taught thoroughly. All expenses low. Catalog free. Dodge's Institute, Byrd St., Valparaiso, Ind.

**GENERAL** Electric 24/750 volt 200 mill dynamotors, \$25. 12 volt input delivers 375. Two machines 1500 volts, \$40. 500 cycle 500 watts aircraft 110-220 volts \$7.50. Westinghouse 6-15 volts 500 watts, \$10. 27 1/2/350 volts, \$10. List. Henry Kienzle, 501 East 84th St., New York.

**HAM** equipment bought, sold or traded. Distributors of all nationally known ham apparatus. Write for catalogue. Walter Ashe Radio Co., St. Louis, Mo.

**1000W** General Electric transformers, 1100-2200-4400 each side center on 110. Solid hams right years. \$13.50. Dawson, 5740 Woodrow, Detroit.

**TRADE**—xtals for meters, tubes and what-not. W4KP, Tarrant, Ala.

**QSLs, SWLs, 75¢** per hundred, two colors, samples on request. W5ECM, 319 Rosetta, Little Rock, Ark.

**6 ASSORTED** 75 watt Ohmite resistors, \$1. Postpaid. RCA849s, \$25; 04As, \$20, guaranteed. Cardwell, Stancor, Taylor, Cornell-Dubilier parts in stock. Van Sickle, W9KJF, 34 W. Ohio St., Indianapolis, Ind.

**PATTERSON** PR-12, \$87.90 prepaid, Sargent, Skyriider, McMurdo Silver, RME9-D, Cardwell, Sangamo, Biley, Raytheon, Sylvania, Eimac, Signal, Speed-X, others. Used receivers. Vinson Radio Co., W5VK, 2123 Broadway, Little Rock, Arkansas.

**50 watters, \$7.50; 203A** and 854s, new. Amateur Service, Fairview, N. J.

**FOR sale**—150 watt xtal transmitter and Universal Pilot receiver, \$175. Paul Hampton, W9JAP, Box 126, Jamesport, Mo.

**TRADE "A"** cut crystals for parts, meters, tubes. Make offer. W9ARE.

**TRADE** good used 211D for two hundred fifty microfarad both sections, split strator, transmitting condensers. K7EGC, Elm, Alaska.

**QSLs.** Free samples. Printer, Corwith, Iowa.

**SWAP**—York upright "BB" bass for good receiver. W5ERU, Erick, Okls.

**SELLING** station! Complete 100 watt output tri-tet excited transmitter, receiver, power supplies. Ready to go. All fitted into writing desk. Complete description available. W9ALT, P. O. Box 701, Lincoln, Neb.

**CALLBOOKS, \$1.25.** W8DED.

**QSLs! SWLs! No cheap, trashy stuff! Samples.** (Stamp.) W8DED, Holland, Mich.

**CRYSTALS!** Biley (World's Finest) with holder, \$3.95. W8DED.

**QSL** cards, two color, cartoons, message blanks, stationery, snappy service. Write for free samples to-day. W1BEF, 16 Stockbridge Ave., Lowell, Mass.

**QSLs, SWLs, free samples.** Waggoner, 458 S. 5th St., Louisville, Ky.

**FOR sale:** Esco 110/220V a.c. to 1000V 500 mil. d.c. motor-generator, in good condition, f.o.b. \$30. or swap for analyzer. J. G. Rountree, Beville, Tex.

**300 watt input rack transmitter.** Collins units, Weston meters, RCA tubes, "47" crystal, "46," "10," "03A." Year and half intermittent service. First class running condition. Photograph. \$185. Thompson, 1301 Findlay Ave., New York City.

**SELL** 3 and 5 tube regenerative receivers complete. Alex Gallinson, 45 Paulson Ave., Passaic, N. J.

**QSLs, phone cards, C.W. cards.** W9CMJ, Chamberlain, S. D.

**SELL** 133 copies *QST*, 10 years complete 1922-31 inclusive as lot or by year. Others from 1917-19-20-21. Also 13 years Proceedings I.R.E. August 1923-February 1935. Like new. Sell miscellaneous transmitting and receiver parts, tubes, meters. Bargains in this sell out. W8CLV.

**SELL** Gross Eagle. Abramowitz, 445 E. 5th, Brooklyn, N. Y.

**CALLBOOKS**—new Spring 1935 Radio Amateur Call Book, new Prefixes, hundreds of new DX QRAs, many new pages of late W and VE calls, is yours for \$1.25, or four issues (one year) for \$4.00 (in foreign countries \$1.35 and \$4.35, Postpaid). W9FO-610 S. Dearborn, Chicago.

**QSLs.** Samples? W2SN, H. W. Yahnel, Helmetta, N. J.

**WANTED**—to buy used Collins or Gross fine transmitter. Will pay cash. W8NDZ, Box 841, Beckley, W. Va.

**TRANSFORMERS**—1200 watt 1200-2200-3200 each side, \$23. Frank Greben, W9CES, 2012 S. Peoria St., Chicago, Ill.

**CRYSTALS**—160-80 meters, within three kc., \$1.50. Guaranteed strong oscillators. Volmer Radio Lab., 5126-35th St., San Diego, Calif.

**SELLING** out complete Hartley transmitter and receiver. All high grade equipment. Also Martin Vibroplex and Omnigraph, wavemeter. Last 6 years of *QST*. Best reasonable offer. Write for information. M. R. Purlee, Seymour, Indiana.

**CRYSTALS:** zero cut. Your approximate frequency, 80 or 160 meters, \$1.85 postpaid. Selected for less than 1/2 cycle drift per million, per °C, \$3.25. Plug-in holders, fits G.R. or tube socket mountings, 75¢. Fisher Laboratory, 4522 Norwood St., San Diego, Calif. "Pioneers of low priced crystals."

**CRYSTALS**—guaranteed oscillators, approximate frequency 80, 160 bands, \$1. 450-500-ke. \$2. Blanks, from quality quartz, 50¢. W9FES, 4433 N. Kilbourn, Chicago.

**QSLs** by Maleco. Finest in country. Free samples. Maleco, 1512 Eastern Parkway, Brooklyn, N. Y.

**METERS, tubes, transformers, etc.** 30 watt class B modulator, \$15. 500 watt commercial type transmitter. Send for bargain list. W3KA, 4819 9th St., N. W., Washington, D. C.

**QSLs.** samples. 2143 Indiana Ave., Columbus, Ohio.

**CRYSTALS:** unconditionally guaranteed, 160-80 meters within 10-ke. Cuts—Y, \$1; X, \$1.50; A, \$2; 40 meters, within 25-ke. Y, \$2; X, \$3; A, \$4. Wright Laboratory, 5859 Glenwood, Chicago, Ill.

**FOR sale**—Hammarlund Pro and Silver Marshall all wave receivers. Sampson three stage two fifty amplifier. Glenn Watt, Chanute, Kans.

**RCA UX852** new, original cartons, only a few, \$15. Unconditionally guaranteed. Also RCA UV204As used less than 50 hours, \$20. Some used slightly more. \$15. Satisfaction or money refunded. Cash or deposit. D. C. Akers W2FL, 181 Greenwood Ave., East Orange, N. J.

**CLASS B** transformers—Universal for two or four 46's, 210's, 800's, RK18's, etc., \$7.75 pair postpaid. 70 watts audio from 46's, 100 watts for 10's. Write for details. W8UD, Douglas, Michigan.

**CRYSTAL** holders: Machined Formica, genuine "GR" plugs. Special non-warping alloy electrodes. Holds 1 1/2" crystal. \$1.00. Crystals 1715-4000, 1", "X", within three kilocycles, \$1.95. Catalog. Ham Crystals, 1104 Lincoln Place, Brooklyn, N. Y.

**SURPLUS** cheap. Big list. Stamp appreciated. 500 Walnut, Fall River, Mass.

**QUALITY QSLs.** T. Vachovetz, Elmsford, N. Y.

**SWAP** hand press for pair 46 class Bs, or what? W8GVN, Nunica, Mich.

**CHICAGO** hams! X cut crystals 80 meters within 3-ke. \$2.35. W9CUK.

"A" cut crystals, 1" square, approximate frequency in 160 or 80 meter band, \$1. Guaranteed W8EBV, 1397 Sixth St., Muskegon, Mich.

CRYSTALS, guaranteed, 160-80 meter, less than 1", X or Y, plus or minus ten kilocycles, \$1.35. Plus or minus two kilocycles, 1", \$2.25. Rough-cut blanks, 60¢; oscillating 85¢; odds and ends, five for \$1. Speedy service. William Threm, W8FN, 4021 Davis Ave., Cheviot, Ohio.

SELL SW5 complete, tubes, power supply, speaker and 9 sets coils. First \$22.50 takes it. W3CDG.

VIBROPLEXES, rebuilt, \$5-\$7. New, large base bugs, \$9. Lydeard, 28 Circuit, Roxbury, Mass.

ALUMAKEY—semi-automatic \$5. Details, W2CPQ, 245 Martine, White Plains, N. Y.

QSLs! W6FZQ/W6HEU. Box 1804, Phoenix, Ariz.

RECEIVERS—new and used sold and traded in, as Hammarlund, National, Postal, International, etc. Schwarz Radio Service, Dumont, N. J.

CRACKLE enamel, 75¢ half pint. Crystals from \$1.35. Radio Specialties, 433 Monroe, Brooklyn, New York.

NEW Haven vicinity hams. Short wave headquarters. Exchange Department. Congress Radio, 207 Congress.

X or Y crystals, \$1.50. AT, \$4. Superior holders, \$1. Faberadio, Sandwich, Ill.

FREE bulletin guaranteed, reconditioned Weston meters. Convert 301 meters, 0-1 milliampere, \$3. Want burned out Westons. Reasonable repair work. W2EDW.

WANTED: Western Electric amplifier 69B or other models. Write lowest price. Schwarz, 535 Fifth Ave., New York City.

WILL pay two dollars per copy for the following issues of QST for the year 1916. January, February, March, April, June, July. Clement Stewart, Pacific Beach, California.

TRADE Sundstrand adding machine, 23 jewel watch. Teleplexes wanted. Ryan Radio Company, Hannibal, Mo.

WANTED equipment used with 1-kw. spark transmitter. W9BTF.

NEON call letters show when operating your transmitter. \$1. per letter. Cash with order. Immediate service. Radio Research Labs., 186 Front St., Marietta, Ohio.

CRYSTALS: inch square, power ground. X-cut 80-160 meters within 5 kilocycles \$2.00; exact frequency \$2.50; 40 meters 25 kilocycles \$3.00; 5 kilocycles \$3.75. Dustproof holders G. R. or socket mounting \$1.00. Gentry Laboratories, 803 W. Maple, Independence, Mo.

QSLs? None better. Samples? W8DDS, 2156 West 80th St., Cleveland.

OMNIGRAPHS, code learners become expert easily, quickly. Dials exchanged free. Reduced prices, \$2.50 to \$25. Terms. Catalog. Omnigraph Mfg. Co., 810 E. 39th St., Q, Brooklyn, New York.

KILOWATT fone-cw transmitter at W8AKU for sale. Write for details. Brown, 420 Pacific, Pittsburgh, Penna.

FOR maximum performance—million dollar appearance. The answer is relay racks. Break-proof antenna wire. Heavy duty power equipment. Edison B batteries for isolated stations. Rectifier Engineering Service, 4837 Rockwood Rd., Cleveland, Ohio.

HICKOK all wave oscillator, \$38, Hickok Statiktester, \$95, case, \$7, multiplexes, 5, Hammarlund Pro, \$60. Balabanow, Box 3, Roseville, Newark, N. J.

QST—February Resonant Line Transmitters 2.5 & 5 meter oscillators \$10.00; Pushpull \$12.50: Five meter receivers \$12.50: Transceivers \$12.95: We build to order Transmitters, receivers. Precision Radio Laboratories, 109 East 94th Street, Brooklyn, N. Y.

QSLs, SWLs, W6DOU, Hayward, Calif.

METERS repaired reasonably. W9BMA.

WANTED—radio dealers for world's most compact and beautiful radios. Outstanding for profits and performance. Unusual sales plans. W9CKU, Kadette Distributor, Heron Lake, Minn.

MG 250 watt 250 mil 1000 volt direct coupled 110, 60 cycle motor—bronze bearings. Perfect condition. W2US.

**PANELS - BAKELITE - RUBBER - ALUMINUM**

All Sizes Cut to Order BAKELITE TUBING & RODS

Drilling, Engraving & Special Work

ALUMINUM CANS—Stock sizes. Special sizes, made to order.

ALUMINUM CHASSIS—Threaded brass studs for 6/32 screws. Length from 1/4" to 6"—price 5c to 30c.

Insulating bushings Couplings in brass

for all size shafts or Bakelite—15c

Bakelite Tubing Threaded to Specifications. Transmitting frames and racks

**UNITED RADIO MFG. CO.** Est. 1923 191 Greenwich St., New York

# RESISTORS



... AEROVOX Engineered

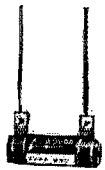

Yes, AEROVOX makes resistors, too. Fit companions for AEROVOX condensers — same painstaking research, thorough engineering, careful workmanship, mass production price. A complete line for transmitting and receiving needs:

- Wire-wound vitreous-enamel units — 5 to 200 watts.
- Adjustable wire-wound vitreous-enamel units — 10 to 200 watts.
- Carbon, lavite, grid leak, flat strip, mountings, etc.
- Also special terminals and mountings on special order.

**FREE DATA:** New 1935 catalog covers condenser and resistor lines. Also free copy monthly Research Worker.

# AEROVOX

CORPORATION

73 Washington St. \* \* Brooklyn, N. Y.

# QRM?

## THEN EQUIP WITH ASTATIC FOR A CLEAR SIGNAL

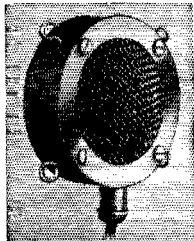

With excellent response and clean, clear voice this rugged, handsomely finished D-104 Astatic crystal microphone will cut through that troublesome QRM. For better performance equip your transmitter with this guaranteed instrument.

# ASTATIC

CRYSTAL MICROPHONES  
LICENSED UNDER BRUSH DEVELOPMENT CO. PATS.

ASTATIC MICROPHONE LABORATORY, INC.  
YOUNGSTOWN, OHIO

"Pioneer Manufacturers of Crystal Products"

# Your Nearest Dealer Is Your Best Friend

Your nearest dealer is entitled to your patronage. You can trust him. He is equipped with a knowledge and understanding of amateur radio. He is your logical and safe source of advice and counsel on what equipment you should buy. His stock is complete. He can supply your needs without delay. His prices are fair and consistent with the high quality of the goods he carries. He is responsible to you and interested in you.

Patronize the dealer nearest you — You can have confidence in him

<p><b>ALLENTOWN, PENNSYLVANIA</b> Radio Electric Service Co. 1024 Hamilton Street Complete stocks transmitting equipment</p>	<p><b>NEWARK, NEW JERSEY</b> Kaltman &amp; Romander 62 Court Street Drop in for an over-counter QSO</p>
<p><b>BALTIMORE, MARYLAND</b> Radio Electric Service Co. 303 W. Baltimore Street Everything for the amateur</p>	<p><b>PHILADELPHIA, PENNSYLVANIA</b> Consolidated Radio Corp. 612 Arch Street Ham receivers, Transmitting tubes, Collins transmitters, etc.</p>
<p><b>BOSTON, MASSACHUSETTS</b> Nutter &amp; Cross, Inc. 99A Milk Street All OMs, OWs, and YLs welcome — W1HRF</p>	<p><b>PHILADELPHIA, PENNSYLVANIA</b> Radio Electric Service Co., Inc. N. E. Cor. Seventh &amp; Arch Sts. All nationally-advertised lines in stock</p>
<p><b>BROCKTON, MASSACHUSETTS</b> Ware Radio Supply Co. 913 Centre Street Hammarlund, Triplett, Ohmite, Raytheon, Bliley, Browning Kits</p>	<p><b>PHILADELPHIA, PENNSYLVANIA</b>  Eugene G. Wile 10 S. Tenth Street  Complete Stock of Quality Merchandise</p>
<p><b>BUFFALO, NEW YORK</b> Dymac Radio 216 E. Genesee St. — Tel. Cl. 2080 Complete Stock Amateur Parts — Standard Discounts — W8AWK</p>	<p><b>PITTSBURGH, PENNSYLVANIA</b> Cameradio Company 601-3 Grant Street "Ham" Headquarters for Pennsylvania-Ohio-W. Virginia</p>
<p><b>BUFFALO, NEW YORK</b> Kronson Service Company 143 East Genesee Street Western New York's largest wholesale distributors — W8EHF</p>	<p><b>PROVIDENCE, RHODE ISLAND</b> Kraus &amp; Company 89 Broadway Everything for the amateur and serviceman</p>
<p><b>ERIE, PENNSYLVANIA</b> Jordan Radio Laboratory 2512 Peach Street Amateur, service parts, including Bliley, National, Raytheon. W8CXG</p>	<p><b>SAN ANTONIO, TEXAS</b> Straus-Frank Company Distributors for nationally advertised amateur products RCA-DeForest transmitting tubes</p>
<p><b>HARTFORD, CONNECTICUT</b> Radio Inspection Service Company 227 Asylum Street What do you need? We have it</p>	<p><b>SPRINGFIELD, MASSACHUSETTS</b> T. F. Cushing 349 Worthington Street An amateur, endeavoring to sell good parts</p>
<p><b>JACKSONVILLE, FLORIDA</b> Glover Weiss Co. Radio Headquarters for Southeast Distributors: RCA Victor, Stromberg-Carlson, Standard Ham Lines</p>	<p><b>SYRACUSE, NEW YORK</b> Roy C. Stage, W8IGF Complete stock of standard Ham &amp; BCL parts Standard Discounts. Free technical service</p>
<p><b>MANCHESTER, NEW HAMPSHIRE</b> Radio Service Lab. of N. H. 1008 Elm Street — Tel. 218-W Branches — Portland, Me. and Barre, Vt.</p>	<p><b>WASHINGTON, D. C.</b> George's Radio Co. 816 F Street, N.W. Washington's largest distributor of radio parts</p>
<p><b>MONTREAL, CANADA</b> Canadian Elec. Supply Co., Ltd. 285 Craig St., W. Quality parts and equipment for discriminating buyers</p>	
<p><b>NASHVILLE, TENNESSEE</b> Braid Electric Co. Ham Supplies — Replacement Parts RCA, National, Hammarlund, and other leaders</p>	

# You Are Protected When You Buy From QST Advertisers

“Advertising for QST is accepted only from firms who, in the publisher’s opinion, are of established integrity and whose products secure the approval of the technical staff of the American Radio Relay League.”

Quoted from QST’s advertising rate card.

Every conceivable need of a radio amateur can be supplied by the advertisers in QST. And you will know the product has the approval of the League’s technical staff.

## For Your Convenience QST’S INDEX TO ADVERTISERS IN THIS ISSUE

Aerovox Corporation	124
Allen-Bradley Company	85
Astatic Microphone Co.	124
A.R.R.L. Application Blank	96
Binder	117
Emblem	121
Handbook	4
Lightning Calculator	99
Log Book	98
Publications	103
Supplies	89
Barr Laboratories	123
Birnbach Radio Company	98
Billey Electric Company	109
Brach Mfg. Company, L. S.	111
Burgess Battery Company	91
Candler System Company	86
Capitol Radio Engineering Institute	100
Cardwell Mfg. Corp., Allen D.	95
Central Radio Labs.	88
Cohen’s Sons, I. S.	121
Collins Radio Company	Cov. 2
Continental Carbon Company	111
Cornell-Dubilier Corp.	112
Coto Coil Company	102
Delaware Radio Sales Co.	111
Eby, Inc., Hugh H.	106
Edwards & Co., W. H.	121
Eitel-McCullough, Inc.	104
General Electric Co.	109
General Radio Company	119
Gentry Laboratories	111
Gray, Russell A.	122
Gross Radio, Inc.	87
Gulf Radio School	111
Hallcrafters, Inc., The	121
Hammalund Mfg. Co.	1
Harvey Radio Labs.	108
Henry Radio Shop	112
Hipower Crystal Co.	122
Instructograph Company	117
Jacobs, Chas. F.	117
Jappe Company, H.	108
Johnson Company, E. F.	97
Kaltman and Romander	90
Kellogg Switchboard & Supply Co.	122
Leads	93, 105
Littelfuse Laboratories	119
Lynch, Inc., Arthur H.	121
Marine Radio Company	2, 100
Massachusetts Radio School	119
Midwest Radio Mart	110
National Carbon Company	107
National Company	83, 116, 118, Cov. 3
Offenbach Electric Co.	113
Ohmite Manufacturing Co.	97
Port Arthur College	117
Precision Piezo Service	120
Premier Crystal Laboratory	105
Radio Receptor Corp.	112
Radio Shack	107
Radio Supply Company	117
Radio Transceiver Labs.	119
Raytheon Mfg. Company	120
Raytheon Production Corp.	94
RCA Institutes, Inc.	120
RCA Radiotron Company	Cov. 4
Sangamo Electric Co.	119
Scientific Radio Service	118
Shuler Supply Company	113
Shure Brothers Company	116
Sprague Products Company	110
Stromberg Carlson Telephone Mfg. Co.	92
Teleplex Company	118
Triad Manufacturing Company	102
Trimm Radio Mfg. Company	116
Triplet Electrical Instrument Co.	84
Turner Company	104
United Radio Mfg. Company	124
Ward Leonard Electric Co.	106
Weston Electrical Instrument Corp.	101
Yazley Manufacturing Co.	127



# "100% YAXLEY" Means Better Service

...and as every Service Man knows  
...a better source of supply

Yaxley distributors who standardize 100% on Yaxley parts assure you of a high class of service that can only be built on a dependable source of supply and that means better profits. Not only are they able to supply your needs immediately, but they make your job easier by providing you with a product for which a wide acceptance has long been established by an extensive and sustained program of national advertising.

Start today to capitalize upon these advantages by mailing the coupon for your free copies of the Yaxley catalogs Y-201, Y-202 and Y-203, illustrated at the left. They contain complete information and prices on the entire Yaxley line of replacement parts.

**YAXLEY MANUFACTURING COMPANY, INC.**

Division of P. R. Mallory & Company, Incorporated  
INDIANAPOLIS, INDIANA

Call Address: Pelmallo

## DON'T MISS THIS SPECIAL OFFER

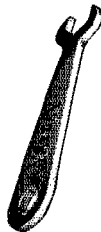

This Kit of 6 Yaxley Volume Controls will service more than 2500 set models. The handy Wrench (left) is free with each kit. Also send for your free copy of the most complete Replacement Manual (right) for service men ever published.

YAXLEY MANUFACTURING CO., INC.  
Indianapolis, Indiana

Gentlemen:

Please send me free copies of Catalogs Y-201, Y-202, Y-203.

I enclose \$3.60 (which is 40% less than the regular list price of individual controls) for kit of 6 Volume Controls, which entitles me to FREE Wrench.

I enclose 6 carton tops for FREE Wrench.

Please send me free copy of Replacement Manual.

Name.....

Address.....

My Jobber's Name is.....

# BARR

• DB 3 •

## Class B Modulated Transceiver

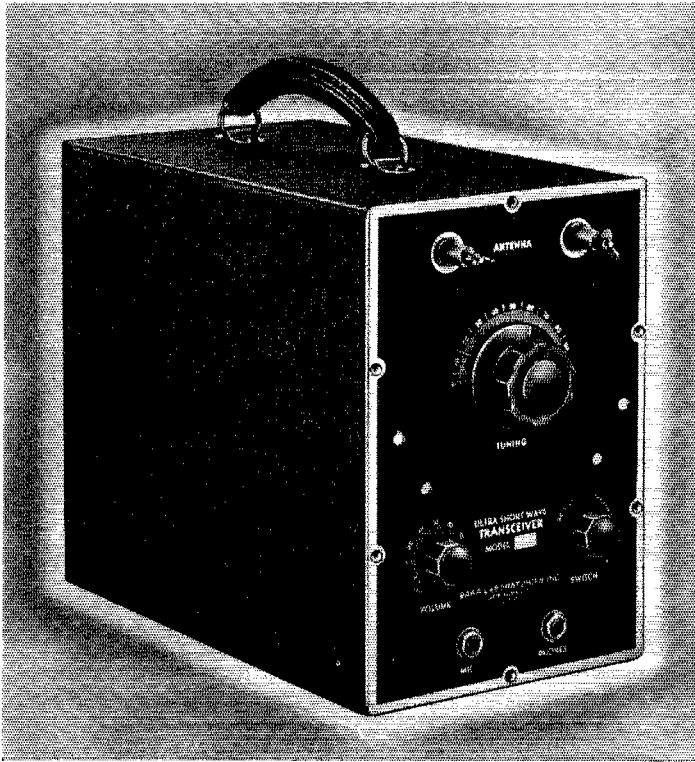

### AN OUTSTANDING VALUE

less tubes and batteries **\$27<sup>00</sup>** List Price 40% discount to amateurs

The DB 3 utilizes a Class B Audio amplifier and modulator giving an output of 2.1 watts, which is many times greater than that of ordinary transceivers.

#### SPECIFICATIONS

**CASE:** Size 11" long x 9½" high x 6½" wide, black wrinkle finish metal, heavy leather handle. All batteries are self-contained in case. Removable side panel for easy access to the batteries and tubes.

**PANEL:** Beautifully finished in black enamel with silver scales and lettering.

**CONTROLS, ETC.:** Two ceramic insulators are supplied for antenna, special large easy tuning knob, volume control on and off switch which acts as such in the receive position, and

as a gain control in the transmit position, transmit and receive switch, microphone and headphone jacks.

**FREQUENCY:** Will cover 56mc to 60mc (amateur 5 meter band).

**BATTERY REQUIREMENTS:** Three 45-Volt B Batteries like Burgess 5308, two No. 6 dry cells, and one 7½ Volt C battery.

**TUBES USED:** One type 30 — one type 19 — one type 49.

**SHIPPING WEIGHT:** 12 pounds.

*Order from your nearest distributor — if not yet stocked we will temporarily fill orders direct*

*BULLETIN ON REQUEST*

## BARR LABORATORIES

1476 BROADWAY

+ + + + +

NEW YORK

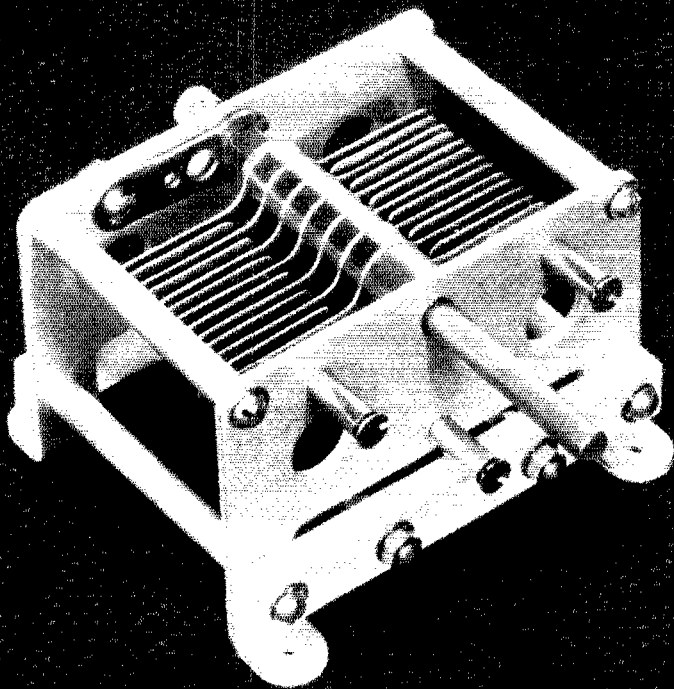

 **ROUNDED AND POLISHED.** *Rounded and polished plates are unusual in an inexpensive condenser. The National TMC has them, however, along with low-loss Steatite-Isolantite insulation.*

 **ACCURATE.** *Accuracy is another important detail. The permanently accurate fitting of the TMC is one reason why it exceeds its voltage rating so generously.*

 **QUIET.** *Quietness means more than reliable rotor contacts; it means a quiet frame and non-microphonic plates.*

 **NINE LIVES.** *And to make the many virtues of this condenser proof against adverse conditions, it is built into a sturdy, rigid corrosion-resistant frame. See it at your dealer's. You will find much to admire in both its construction and its prices.*

NATIONAL



COMPANY

# NOW



## RCA RECEIVING

## TUBES COST

## LESS THAN EVER BEFORE

During the past year we have used this space primarily to tell you about improvements and new developments in RCA deForest tubes. However, the constant research in the RCA Radiotron Laboratories has brought forth many improvements in RCA receiving tubes. In recent years RCA has contributed greatly to the art of tube design and manufacture. Such developments as the use of the dome bulb to secure a more rugged structure, introduction of copper side-rods and heat radiators for grids to reduce grid emission, improved heater and cathode designs to increase efficiency and reduce hum, and the use of many specially processed materials to provide better performance characteristics have been pioneered and instituted by RCA. Today RCA tubes are better than ever before. They offer you the best assurance of quality, uniformity and satisfactory operation.

During the past year RCA has also pioneered large reductions in receiving tube prices, passing on to the consumer the savings of an improved manufacturing technique. Recent drastic reductions in RCA receiving tube prices now mean that you can obtain these tubes at less cost than ever before. See your supplier immediately for new low prices.



## AMATEUR RADIO SECTION

RCA RADIOTRON DIVISION, RCA MANUFACTURING CO., INC., CAMDEN, N. J.