

# QST

devoted entirely to

# amateur radio

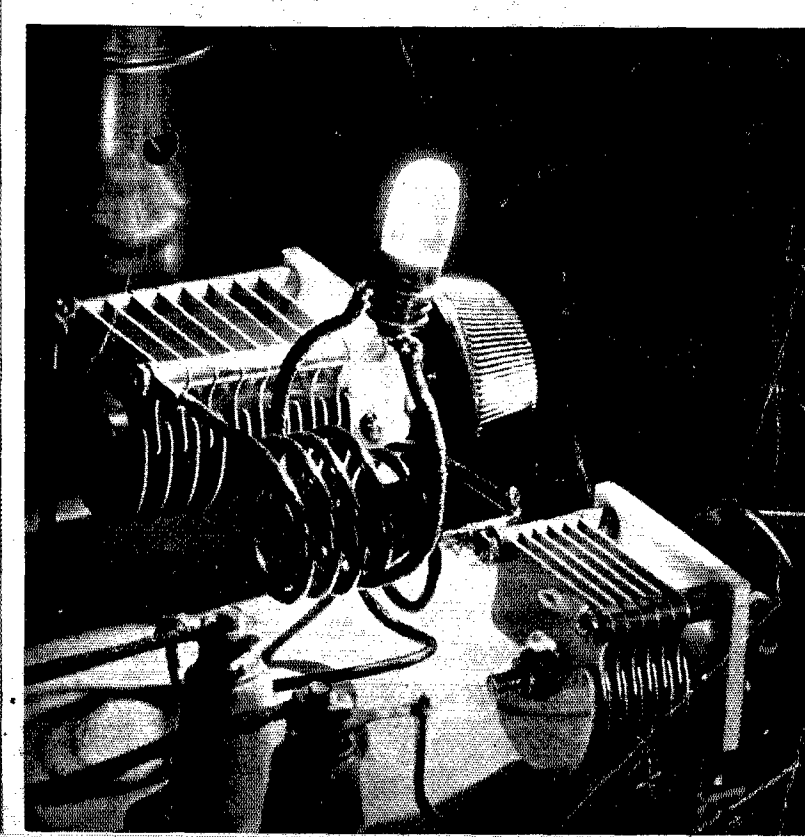

July  
1934  
25 cents

# SPECIAL OFFER

A Year's Membership in QST

A Year's Subscription to QST

The Radio Amateur's Handbook

\$3.00

3

1950-1951

DURING  
**JULY**  
AND  
**AUGUST**  
ONLY

WED.

THUR.

WED.

Take advantage, NOW, of this exceptional opportunity

QST has been the radio amateur's "bible" for nineteen years. It is the world's leading authority on technical changes and communication. It is indispensable to radio amateurs and experimenters.

## THE AMERICAN RADIO RELAY LEAGUE

1800 K STREET, N.W., WASHINGTON, D.C. 20006

The Radio Amateur's Handbook is the standard guide-book to check-out and receive a license. It is the most comprehensive and up-to-date book of its kind. It is the most accumulated and authoritative source of information on radio.

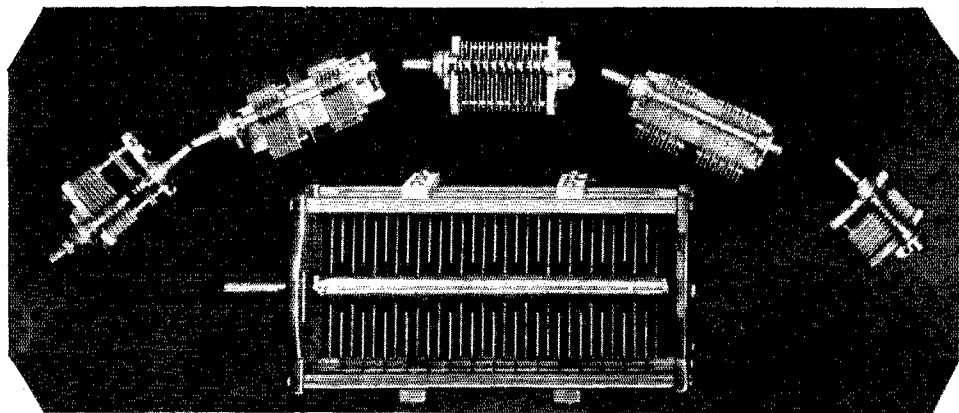

# "HAMMARLUND"

SOMETIMES, even the most careful amateur is tempted to "economize" on his equipment — and often to his sorrow. For experience has definitely proved that results in radio cannot be superior to the parts used in construction.

Since the early pioneer days, "HAMMARLUND" has meant QUALITY! But it has never meant high price.

Bear that in mind when next you need condensers, coils, transformers, chokes, shields and sockets.

At the right are illustrated two exceptional new Hammarlund Chokes. A midget R.F. Choke, wound on Isolantite core. Inductance 2.1 mh. D. C. resistance 35 ohms. Distributed capacity 1 mmf. And a heavy duty Transmitter Choke which has more than 500,000 ohms of impedance at the 20, 40, 80 and 160 meter amateur bands. Isolantite core. Inductance 2.5 mh. D. C. resistance 8 ohms. Distributed capacity less than 1.5 mmf.

means

*Quality!*

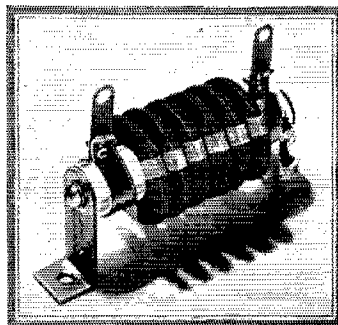

*Mail Coupon for Details*



HAMMARLUND MANUFACTURING CO.  
424-438 W. 133rd St., New York

—Check here for General Catalog "34" of condensers and other precision radio equipment. —Check here for booklet describing the famous COMET "PRO" 8 to 550 meter Superheterodyne Receiver.

Name .....

Address .....

..... Q-7

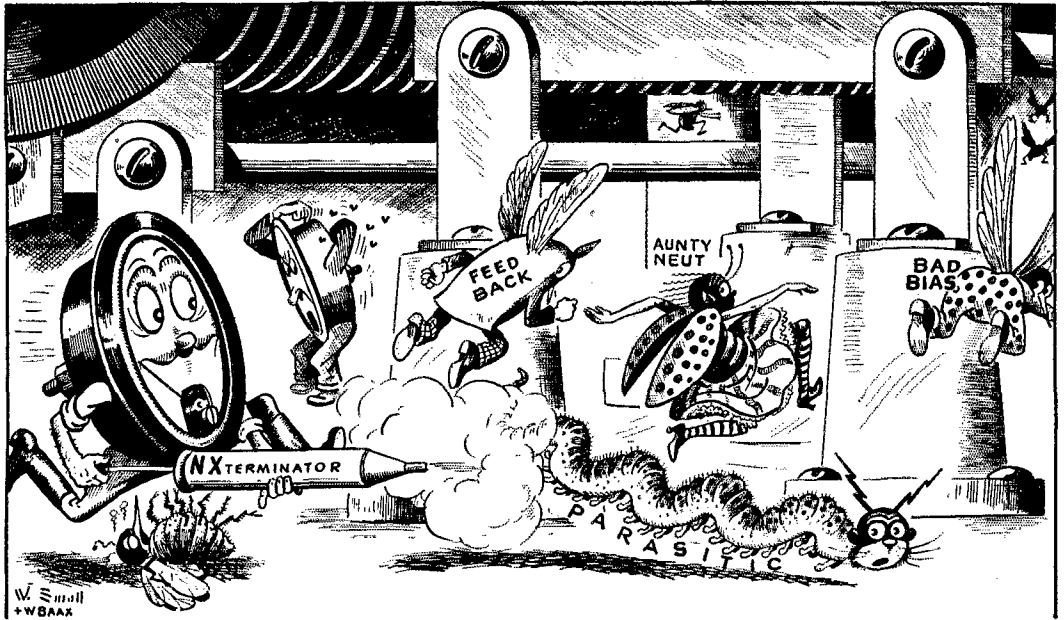

# It takes GOOD INSTRUMENTS to Chase the Bugs Out!!

**W**HEN your last stage won't shut up with the key open; when parasitics heat your coils but leave the ether unruffled; when you can't load the buffer with link coupling; when the single-wire feeder blossoms out with standing waves; when you run into any of the ills that keep you from going WAC . . . you need *good* instruments . . . and you can't begin to tell where your trouble lies without them.

It isn't enough to buy an instrument of the proper size and rating. There are as many ways of making an instrument as there are of hooking up an oscillator. The main parts of an instrument are few, but to make them properly, and to assemble them to give high accuracy . . . and to retain it . . . requires skilled engineering and painstaking manufacture.

# Westinghouse

Quality workmanship  
guarantees every Westinghouse product



Since 1888, Westinghouse engineers have been designing instruments, and they have put their whole bag of tricks in the MX and NX line . . . certainly as high a grade of instruments in their size as was ever offered.

A new folder, F. 8338, takes an NX instrument all apart—shows how it operates and why. Every individual piece that makes up the instrument is illustrated and its purpose and method of manufacture are given. In addition, the usual forms of construction are described. You'll find complete and precise information in this new folder.

## SEND FOR INFORMATION

Westinghouse Electric & Manufacturing Company  
Dept. 132, Room 2-N East Pittsburgh, Pa.  
Gentlemen: Please send the booklets checked below:  
F. 8338—What's Behind the Dial  
Catalog 43-340—Types MX and NX Instruments  
Catalog 43-341—Type NX Universal Rectox Instruments  
Catalog 43-342—Type NX Multi-Range R. F. Ammeter

Name .....

Address .....

City ..... T 85059

State ..... Call..... QST 7-34

# QST

Published monthly, as its official organ, by the American Radio Relay League, Inc., at West Hartford, Conn., U. S. A.; Official Organ of the International Amateur Radio Union

devoted entirely to

## AMATEUR RADIO

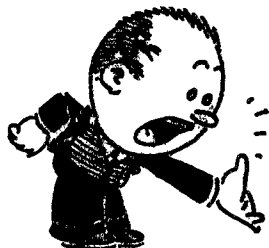

Editorials . . . . .	7
Massachusetts State Convention (Announcement) . . . . .	8
Iowa State Convention (Report) . . . . .	8
28-Mc. Tests . . . . .	8
Automatic DX Relay Work for the Ham . D. A. Griffin, W2AOE	9
First Boston-New York 56-Mc. Relay . T. F. Cushing, W1HMO	14
A Vacuum-Tube Type Modulation Meter E. and C. Seiler, W8PK	15
What the League Is Doing . . . . .	18
Progress on 28 Mc. . . . .	21
A Modern Transportable Station . . . Harvel Baker, W7ALH	23
A Relay Rack for Two Dollars . J. M. Carstarphen, Jr., WACCH	25
Typical Technical Questions Answered . . . . .	26
Hamdom . . . . .	28
Ham Radio in Japan . . . . . W. S. Upson	29
The Incandescent Lamp As a Resistor . . . F. Hamburger, Jr., W3AAM	31
A 14-Mc. Rotary Beam Antenna . . John P. Shanklin, W3CIJ	32
Amateur Radio Stations . W6ITH, W9FAY, W2ESK, W8WT	35
For the Experimenter:	
PLATE MODULATION WITH TAPPED CHOKE — TRANSFORMER-LESS A. C. — OPERATED MICROPHONE AMPLIFIER — THE TWISTED-PAIR-FEEDER TRANSMITTING ANTENNA FOR RECEIVING — ON TRANSMITTER "C" BIAS SUPPLIES — THE ABSORPTION CONDENSER MICROPHONE — MAGNETS FOR THE VELOCITY MICROPHONE . . . . .	37
I. A. R. U. News . . . . .	40
Communications Department . . . . .	42
Correspondence . . . . .	56
Silent Keys . . . . .	66
Hamads . . . . .	74
QST's Index of Advertisers . . . . .	78

JULY  
1934

VOLUME XVIII  
NUMBER 7

Kenneth B. Warner (Secretary, A.R.R.L.), *Editor-in-Chief and Business Manager*; Ross A. Hull, *Associate Editor*; James J. Lamb, *Technical Editor*; George Grammer, *Assistant Technical Editor*; Clark C. Rodimon, *Managing Editor*; David H. Houghton, *Circulation Manager*; F. Cheyney Beekley, *Advertising Manager*; Ursula M. Chamberlain, *Assistant Advertising Manager*.

*Editorial and Advertising Offices*  
38 La Salle Road, West Hartford, Conn.

Subscription rate in United States and Possessions and Canada, \$2.50 per year, postpaid; in all other countries, \$3.00 per year, postpaid. Single copies, 25 cents. Foreign remittances should be by international postal or express money order or bank draft negotiable in the U. S. and for an equivalent amount in U. S. funds.

Entered as second-class matter May 29, 1919, at the post office at Hartford, Connecticut, under the Act of March 3, 1879. Acceptance for mailing at special rate of postage provided for in section 1103, Act of October 3, 1917, authorized September 9, 1922. Additional entry at Concord, N. H., authorized February 21, 1929, under the Act of February 28, 1925.

Copyright 1934 by the American Radio Relay League, Inc.  
Title registered at United States Patent Office.

*It Is the Radio Amateur's  
Number One Piece of Equip-  
ment—order your copy today*

*the eleventh edition*

## **RADIO AMATEUR'S HANDBOOK**

The new eleventh edition of the Radio Amateur's Handbook is a complete revision and enlargement from the previous edition. It is the standard of the world as the textbook of Amateur Radio. Its 260 pages and 224 illustrations are a complete education in the technique and practices which have been developed through the years—right up to now.

THE MOST COMPLETE  
BOOK ON AMATEUR  
RADIO EVER PRINTED

*Price*

**\$1**

*postpaid anywhere*

(in buckram binding, \$2)

THE AMERICAN RADIO RELAY LEAGUE, INC.  
West Hartford, Connecticut

## Section Communications Managers of the A.R.R.L. Communications Department

All appointments in the League's field organization are made by the proper S.C.M., elected by members in each Section listed. Mail your S.C.M. (on the 16th of each month) a postal covering your radio activities for the previous 30 days. Tell him your DX, plans for experimenting, results in 'phone and traffic. He is interested, whether you are an A.R.R.L. member or get your QST at the newsstands; he wants a report from every active ham. If interested and qualified for O.R.S., O.P.S. or other appointments he can tell you about them, too.

Eastern Pennsylvania	W3GS	<b>ATLANTIC DIVISION</b> Jack Wagenseller	24 South Fairview Ave.	Highland Park, Upper Darby
Maryland-Delaware-District of Columbia	W3BAK W3OL	Edgar L. Hudson Gedney Rigor	412 2nd Ave. 213 Hickok Ave.	Laurel, Delaware Haddon Heights
Southern New Jersey	W8DSP	Don Farrell	R. F. D. 3, Elcher Rd.	Syracuse
Western New York	W8CUG	C. H. Grossarth		Emsworth, Bellevue, Pa.
Western Pennsylvania				
Illinois	W0WR	<b>CENTRAL DIVISION</b> Fred J. Hinds	6618 West 34th St.	Berwyn
Indiana	W9TE	Arthur L. Braun	911 Reiser St.	Indianapolis
Kentucky	W90X	Carl L. Pfumm	P. O. Box 359	Louisville
Michigan	W8DYH	Kenneth F. Conroy	7538 E. Robinwood Ave.	Detroit
Ohio	W8BAH	Harry A. Tummounds	2073 West 85th St.	Cleveland
Wisconsin	W9FSH	Harold H. Kurth	2550 N. 8th St.	Milwaukee
North Dakota	W9JVP	<b>DAKOTA DIVISION</b> Fred J. Wells	1022 11th St., S.	Fargo
South Dakota	W9PFI	Mike G. Strahon	601 S. Grange Ave.	Sioux Falls
Northern Minnesota	W9TIE	Robert C. Harshberger	1200 Fauquier St.	St. Paul
Southern Minnesota	W9DEI	Francis C. Kramer	W. Bluff St.	St. Charles
Arkansas	W5ABI	<b>DELTA DIVISION</b> H. E. Velte	2918 West 15th St.	Little Rock
Louisiana	W5DDW	W. J. Willkinson, Jr.	1624 Allen Ave.	Shreveport
Mississippi*	W5VI	W. P. Allen	P. O. Box 66	Jackson
Tennessee	W4AFM	F. F. Purdy	P. O. Box 173	Kingsport
Eastern New York	W2LU	<b>HUDSON DIVISION</b> Robert E. Haight	1080 Helderberg Ave.	Schenectady
N. Y. C. & Long Island	W2AZV	E. L. Baumach	7823 10th Ave.	Brooklyn
Northern New Jersey*	W2BPY	Robert Maloney	315 Watson Ave.	Perth Amboy
Iowa*	W9CWG	<b>MIDWEST DIVISION</b> E. F. Alberts	210 Exchange St.	Keokuk
Kansas	W9FLG	O. J. Spetter	305 Western Ave.	Topeka
Missouri	W9EYG-JPT	C. R. Cannady	300 Sixth St.	Monett
Nebraska	W9FAM	Samuel C. Wallace	Green St.	Clarks
Connecticut	W1CTI	<b>NEW ENGLAND DIVISION</b> Frederick Ellis, Jr.	19 Merrill Rd.	Norwalk
Maine	W1CDX	John W. Singleton	10 High Street	Wilton
Eastern Massachusetts	W1AST	Joseph A. Mullen	16 Mercer Ave.	Ashmont
Western Massachusetts	W1ASY-WIRB	Earl G. Hewinson	33 Cortland St.	Springfield
New Hampshire	W1APK	Basil Cutting		Pembroke
Rhode Island	W1QR	Albert J. King	66 Lisbon St.	Providence
Vermont	W1ATF	Harry Page	R. 1	Hinesburg
Alaska	K7PO	<b>NORTHWESTERN DIVISION</b> Richard J. Fox	Box 301	Ketchikan
Idaho	W7AVP	Don D. Oberbillig	P. O. Box 1271	Boise
Montana	W7AAT	G. W. Viers		Red Lodge
Oregon	W7ABZ	Raymond W. Cummins	4835 N. Amherst St.	Portland
Washington	W7AYO	Stanley J. Belliveau	Route 7, Box 387	Yakima
Hawaii	K6EWQ	<b>PACIFIC DIVISION</b> Atlas O. Adams	21st Infantry Brigade	Schofield Barracks
Nevada	W6EAD	Keston L. Ramsay	1151 Buena Vista Ave.	Reno
Los Angeles*	W6BPU	Howell C. Brown	120 N. El Molino Ave.	Pasadena
Santa Clara Valley*	W6DBB	Barton A. Wood	R. 1, Box 722	Campbell
East Bay	W6ZX	P. W. Dann	1821 Chestnut St.	Berkeley
San Francisco	W6CAL	Bryon Goodman	141 Alton Ave.	San Francisco
Sacramento Valley	W6LVE	Geo. L. Woodington	716 Redwood Ave.	North Sacramento
Arizona	W6BIF-W6QC	Ernest Mendoza	1434 East Madison St.	Phoenix
Philippines	KA1XA	Newton E. Thompson	P. O. Box 593	Manila, P. I.
San Diego	W6EOP	Harry A. Ambler	4101 Hamilton St.	San Diego
San Joaquin Valley	W6DZN	G. H. Lavender	Route 6, Box 425	Stockton
North Carolina	W4AVT	<b>ROANOKE DIVISION</b> G. H. Wright, Jr.	2817 Montrose Ave.	Wendell
Virginia	W3AAJ	R. N. Eubank	100 20th St.	Richmond
West Virginia	W8HD	C. S. Hoffmann, Jr.		Warwood, Wheeling
Colorado	W9BTO	<b>ROCKY MOUNTAIN DIVISION</b> T. R. Becker	1176 Gaylord St.	Denver
Utah-Wyoming	W6GGC-IDM	Arty W. Clark	260 So. 9th West	Salt Lake City, Utah
Alabama	W4KP	<b>SOUTHEASTERN DIVISION</b> L. D. Elwell	1066 Waverly St.	Tarrant
Eastern Florida	W4NN	Ray Atkinson	4524 College St.	Jacksonville
Western Florida	W4MS	Edward J. Collins	1517 East Brainerd St.	Pensacola
Georgia-So. Carolina-Cuba- Isle-of-Pines-Porto Rico- Virgin Islands	W4UT	George A. Love	50 Muscogee Ave.	Atlanta
Northern Texas	W5AUL	<b>WEST GULF DIVISION</b> Glen E. Talbutt	1133 Amarillo St.	Ablene
Oklahoma	W5CEZ	Carter L. Simpson	2010 So. 4th St.	Ponca City
Southern Texas	W5BHO	David H. Calk	6726 Ave. Q	Houston
New Mexico	W5DUI	Dan W. De Lay	407 South Girard St.	Albuquerque
Maritime	VE1DQ	<b>MARITIME DIVISION</b> A. M. Crowell	69 Dublin St.	Halifax, N. S.
Ontario	VE3GT	<b>ONTARIO DIVISION</b> S. B. Trainer, Jr.	4 Shorncliffe Ave.	Toronto
Quebec	VE2GA	<b>QUEBEC DIVISION</b> J. A. Robertson	245 Edison Ave.	St. Lambert, P. Q.
Alberta	VE4GD	<b>VANALTA DIVISION</b> J. Smalley, Jr.	611 1st Ave., N. W.	Calgary
British Columbia	VE5AC	R. K. Town	1754 Graveley St.	Vancouver
Manitoba	VE4GC	<b>PRAIRIE DIVISION</b> Reg. Strong	711 Ashburn St.	Winnipeg
Saskatchewan	VE4EL	Wilfred Skafte	2040 McTavish St.	Regina

\* Officials appointed to act until the membership of the Section choose permanent S.C.M.'s by nomination and election.

# The American Radio Relay League



**T**HE AMERICAN RADIO RELAY LEAGUE, INC., is a non-commercial association of radio amateurs, bonded for the promotion of interest in amateur radio communication and experimentation, for the relaying of messages by radio, for the advancement of the radio art and of the public welfare, for the representation of the radio amateur in legislative matters, and for the maintenance of fraternalism and a high standard of conduct.

It is an incorporated association without capital stock, chartered under the laws of Connecticut. Its affairs are governed by a Board of Directors, elected every two years by the general membership. The officers are elected or appointed by the Directors. The League is non-commercial and no one commercially engaged in the manufacture, sale or rental of radio apparatus is eligible to membership on its board.

"Of, by and for the amateur," it numbers within its ranks practically every worth-while amateur in the world and has a history of glorious achievement as the standard-bearer in amateur affairs.

Inquiries regarding membership are solicited. A bona fide interest in amateur radio is the only essential qualification; ownership of a transmitting station and knowledge of the code are not prerequisite. Correspondence should be addressed to the Secretary.

## DIRECTORS

<i>President</i>	
HIRAM PERCY MAXIM	..... W1AW Box 216, Hartford, Conn.
<i>Vice-President</i>	
CHARLES H. STEWART	..... W3ZS St. David's, Pa.
<i>Canadian General Manager</i>	
ALEX. REID	..... VE2BE 169 Logan Ave., St. Lambert, P. Q.
<i>Atlantic Division</i>	
EUGENE C. WOODRUFF	..... W8CMP 234 W. Fairmount Ave., State College, Pa.
<i>Central Division</i>	
LOREN G. WINDOM	..... W8GZ-W8ZG 1375 Franklin Ave., Columbus, Ohio
<i>Dakota Division</i>	
CARL L. JABS	..... W9BVH 1822 James St., St. Paul, Minn.
<i>Delta Division</i>	
M. M. HILL	..... W5EB P. O. Box 274, Natchitoches, La.
<i>Hudson Division</i>	
BERNARD J. FULD	..... W2BEG 280 Broadway, New York City
<i>Midwest Division</i>	
H. W. KERR	..... W9DZW-W9GP Little Sioux, Iowa
<i>New England Division</i>	
G. W. BAILEY	..... W1KH 74 Webster Road, Weston, Mass.
<i>Northwestern Division</i>	
RALPH J. GIBBONS	..... W7KV-W7BIX 3134 N. E. 25th Ave., Portland, Ore.
<i>Pacific Division</i>	
S. G. CULVER	..... W6AN 2962 Russell St., Berkeley, Calif.
<i>Roanoke Division</i>	
H. L. CAVENESS	..... W4DW State College Station, Raleigh, N. C.
<i>Rocky Mountain Division</i>	
RUSSELL J. ANDREWS	..... W9AAB 1867 So. Lafayette St., Denver, Colo.
<i>Southeastern Division</i>	
J. C. HAGLER, JR.	..... W4SS 3424 McDowell St., Augusta, Ga.
<i>West Gulf Division</i>	
FRANK M. CORLETT	..... W5ZC 2515 Catherine St., Dallas, Tex.

## OFFICERS

<i>President</i>	..... HIRAM PERCY MAXIM, W1AW Hartford, Connecticut
<i>Vice-President</i>	..... CHARLES H. STEWART, W3ZS St. David's, Pennsylvania
<i>Secretary</i>	..... KENNETH B. WARNER, W1EH West Hartford, Connecticut
<i>Treasurer</i>	..... ARTHUR A. HEBERT, W1ES West Hartford, Connecticut
<i>Communications Mgr.</i>	... F. EDWARD HANDY, W1BDI West Hartford, Connecticut
◆	
<i>General Counsel</i>	..... PAUL M. SEGAL, W3EEA 1010 Shoreham Building, Washington, D. C.

Address all general correspondence to the executive headquarters at West Hartford, Connecticut





# THE EDITOR'S MILL

THE amateur regulations require that the code examination for a Class-C license be given by a licensed operator of appropriate grade and that the written part of the examination be filled out in the presence of a witness. Generally it is convenient amongst amateurs to combine the functions of code examiner and witness in the person of a licensed amateur operator of Class B or higher. On the application form, statements must be sworn to before a notary that the applicant actually passed the code test and that he answered the written questions without assistance of any kind.

We heard recently of the case of an amateur operator who acted as witness for eight acquaintances who were taking the examination. On some of the questions, all eight turned in identical answers. Fortunately for the causes of law and order and poetic justice, the answers were uniformly wrong and all the candidates failed the examination. But under such circumstances it should not seem like too much preaching for *QST* to moralize on this theme a moment.

You should not perjure yourself to get your friends through the examination. The oath should mean something. It is foolish to run the risk of losing your own amateur privilege. You should help to keep amateur radio a clean game. Regardless of friendship, it is better for amateur radio that those who are unqualified be kept out—until they do qualify.

EVERY amateur probably noticed that the A.R.R.L. Board of Directors at its recent meeting ordered that work commence at once on plans to increase the frequency allocations of amateurs at the next world-wide conference—to be held in Cairo in 1937. It is time to get busy, for we shall have lengthy and careful planning to do, both at home and abroad. It will be a tough job, for we shall be confronted by all of the hostility of commercials and foreign governments. Yet there is room available for our pressing needs: if the commercials made a quarter as advantageous use of their space as we do ours, there would be room to spare for everyone. We repeat the public notice that we have already served—for the whole world might as well know it now as later—that the amateur has to have more space in the spectrum, particularly in the region of 7 megacycles.

PERIODICALLY some of us get concerned over the possibility that the growth in the number of radio amateurs is bringing so many new and unskillful operators onto the air that it is getting too tough for the rest of us. We can think up splendid ideas for good operating practice, for cooperative methods that accomplish this or that, for new apparatus that by improved performance makes another accomplishment possible despite QRM. The seasoned amateur can readily adopt these suggestions and is generally prepared to do so. But then it is pointed out that the success of most of these projects depends upon their widespread adoption and that they are of little avail if our bands are crowded with the activities of men young in amateur radio, not yet skilled in operation, not yet possessed of a fine sense of cooperation and amateur ethics, and possessing only beginners' equipment.

The answer frequently proposed is that beginners without previous experience be restricted to a certain portion of the amateur spectrum during a probationary period of, say, a year. During that time they would learn what it is all about, they would acquire skill and, more important, a realization of our interdependence when we work in common bands. Then when they entered the regular amateur bands everyone would be much happier and the general tone of amateur radio would be that of a superior social structure in which the opportunity for the sway of intelligence and cooperation would create greatly improved conditions. In several countries just such a rule applies, at the request of the local amateurs.

We would like to get some discussion in *QST* on this suggestion. What do you think about it, OM? Do you believe any restrictions should be placed upon inexperienced beginners? If so, for how long, where, what?

TIME was when amateur radio in summer was as dead as a burnt-out '10. In the long-wave days, and particularly before the advent of continuous waves, King Static held undisputed sway from May until September. The September issues of *QST* used to be called Fall reopening numbers and contained stirring appeals to rebuild stations and get ready for a new winter season's activity.

How different it is to-day! High frequencies make us nearly independent of atmospheric conditions and the "summer slump" in amateur

radio is a thing of the dead past. This is particularly advantageous to the fellow in school. Winter with him is the time he can least afford to devote to radio. One of last year's new amateurs recently expressed it thus to us: "I haven't been able to do much with my set this winter, since study takes up most of my evenings, but it won't be long until summer, now, and then—oh boy!—I'll bet I'm operating it every night."

Few things so well illustrate our progress of the past ten years as the attainment of year-around

ability to communicate. What we old timers would have given to be able to talk twenty miles through mid-summer QRN!

If we still have a seasonal manifestation in amateur radio it is in ultra-high-frequency operation with portables. It is admittedly too tough to climb mountains or grain elevators during raging blizzards unless there is an emergency on. Five-meter DX work is still distinctly a summer activity. But—well, this is summer, isn't it?

K. B. W.

## Massachusetts State Convention

(New England Division)

July 28th at Provincetown, Mass.

A MAMMOTH program is being sponsored by the Provincetown Radio Club for July 28th during the Naval Fleet visit at Provincetown, Mass. Besides the convention routine there will be inspection of 35 ships in the harbor, ultra-high-frequency work from Pilgrim Monument, navy band concert, baseball games, boat races, etc. The town officials are giving their full cooperation to the radio club, and it will be open house during the day. There will be special transportation rates by rail or water for that day. The fee including dinner is \$1.75 at door; \$1.50 reserved; groups of 5 reserved \$1.25. Further information and reservation may be made to T. L. Chase, Sec'y, Provincetown Radio Club, Provincetown, Mass.

## The Iowa State Convention

(Midwest Division)

APRIL 20th-21st will be considered history making dates in the annals of Iowa Conventions, the Des Moines Radio Amateurs Association of Des Moines getting much satisfaction by outdoing all previous conventions in the Midwest Division. With the largest registered attendance ever recorded and a program replete with interesting lectures, the delegates soon realized they were to get their money's worth.

With the welcoming address of Hon. Clyde L. Herring, governor of Iowa, Chairman Sadilek immediately opened the convention for the lectures. H. F. Gulliver (W9HMI) discussed the various steps in converting sodium potassium tartrate crystals into microphones and demonstrated several types. John Lewis, research engineer, Parrot Film Co., talked on speech scrambling equipment; Dr. E. B. Kurtz, of Iowa State University, on Television and some of its problems. Arthur Collins of Collins Radio Co., an old-time amateur, spoke on speech equipment followed by Boyd Phelps on receiving and transmit-

ting antennas with further demonstration of ultra-high-frequency equipment.

The Naval Reserve was well represented by Lt. (j.g.) C. H. Morgan and Mr. R. H. Miller of the General Electric Co. entertained the guests at the banquet with motion picture demonstration.

The exhibitors' display proved an attraction well worth the efforts of those who participated. The Friday night open forum was the high light of the convention where League policies were thoroughly discussed. One of the stunts at the banquet was an address by Mr. H. P. Maxim, president of the A.R.R.L., over long distance from his home in Hartford. "Andy" Woolfries, announcer at WOI, proved himself an ideal toastmaster. The big "swap fest" and "auction" trips to points of interest in the city, prize contests and the distribution of the many worthwhile prizes made the delegates feel they had made no mistake in attending the convention. The thanks of the convention goes to the convention committee consisting of F. J. Sadilek, chairman, E. A. Pedersen, F. P. Williams, E. F. Brown, L. S. Gordon and J. M. Dean, for their hard work in staging this successful convention.

—F. J. S.—A. A. "H."

## 28-Mc. Tests

THE Metropolitan Amateur Radio Association of Melrose, Mass., is sponsoring a 28-mc. test to be held on the last two Sundays in July and the first Sunday in August.

Points will be earned by the following table:

- 1 point for each station heard
- 2 points for each W or VE station worked
- 3 points for any foreign station worked

If 'phone was used for contacts the "contact" points may be doubled. Multiply the resulting score by the total number of W and VE districts worked. Certificates will be awarded winning stations reporting in each W and VE district, or foreign country. A special certificate will be awarded the station making the highest score.

Any clubs with members interested in this work should get in touch with the secretary of the Melrose club. Reports may also be sent A.R.R.L.

# Automatic DX Relay Work for the Ham

Details of the Necessary Equipment and Technique: Some Proposed Lay-Outs for International Round-Table Nets and Globe-Circling Relays

By D. A. Griffin, W2AOE\*

ONCE upon a time—all amateurs were on 200 meters, more or less. Everyone knew everyone else, traffic handling and DX (that would be laughable to brag about today) were the only interests. In those days the primary worry was whether or not the signal would be picked up even a few miles away. Continued effort to increase the transmitter range was unquestionably a powerful incentive to “keep at it.” Then came the development of tube transmitters, short waves, and multi-stage receivers. The present picture is unquestionably far better than that of the “good old days,” so far as equipment is concerned. At the same time it is futile to deny that there is need for further progress and advancement of technique.

Little Willie's experiences tell the story. Following the *Handbook's* instructions, he builds a rig, works 70 countries, collects a WAC certificate, and then writes to Headquarters to find out what he can do next. Willie is like Alexander the Great, sighing for more worlds to conquer. In plain English, he is stumped, and cannot find a worthwhile outlet for his efforts. There are thousands in Willie's predicament on the air. Just listen in on 'phone or c.w. and you will hear great numbers of them. They are the boys that say “Ur sigs QSA 5 R7 wx fair QRU-SK,” and then proceed to repeat the performance over and over again.

It would be foolish to say that further technical progress is impossible. We are undoubtedly going to have better transmitters and receivers as time goes on. The question is what next, after everyone's signal is R9 everywhere. Contact between

two stations, even though at opposite ends of the earth, has lost its thrill for many. Fortunately, an entirely new and revolutionary type communication awaits our development. The writer feels privileged in presenting to the fraternity the material to follow. It is the work of a small group of amateurs chiefly in the Hudson Division covering a two-year period. It is time-tried and tested and should certainly revolutionize our conception of amateur radio as a communications medium and provide us with a galaxy of new thrills and records to establish.

First, let's light up the old corn-cob, or what have you, and sit back and permit our imaginations to have free rein for a moment or two.

Can you imagine W1MK's official broadcast being transmitted simultaneously by stations in all our 48 states, with the tape-machine at Hartford controlling all of the stations' transmissions? Wouldn't you like to control a transmitter 200 miles away and have that station return to you a reply from one still further away that you cannot hear, doing it automatically? Wouldn't it be a thrill to send out a signal on 14 mc. and hear it coming back to you via a 'round-the-world relay on 7-mc. meters in one-seventh of a second? How about an all-continent QSO, with any one of the six transmitters controlling the other five? All of these dreams and countless

other combinations for both telegraph and telephone can be realized. Several already have been proven possible by actual test. The rest await the construction of properly located stations on a worldwide basis.

How this can be accomplished is the obvious



THE ONE KILOWATT TRANSMITTER AT W2AG  
—ONE OF THE PARTICIPANTS IN THE AUTO-  
MATIC RELAY WORK DESCRIBED

\* This transmitter may be keyed locally or by W2CUZ on 56-mc. i.c.w. two miles away. W2AG operates on 14, 7 and 3.5 mc.

\* Leeds, 45 Vesey Street, New York City.

question, and the answer is simple—the use of 56 mc. for remote control. While ultra-high-frequency communication is fascinating in itself, the range is decidedly limited. However, it can be utilized for remote-control work in a very simple fashion, to produce the startling results outlined above. The first two stations to set up a satisfactory circuit of this sort were, I believe, W2TP and W2JN. With W2TP operating on 14-mc.

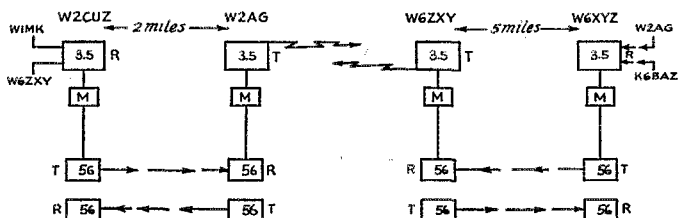

FIG. 1

'phone and W2JN on 56 mc., twelve miles away, Atwater sounded as if he were in "Musty's" operating room, as many listeners can attest. Other experimenters include W2LI, W2LV, W2BCO, on 3.5 and 7 mc., together with several 9's and 6's whose calls are unknown to the writer.

The purpose of this article is to describe the necessary apparatus and procedure so that a greater number of stations will participate. As soon as the ball starts rolling, interest will unquestionably increase rapidly. New thrills in operating that make present-day stuff look child-like are waiting for us.

Let us first take a simple one-band relay for an example. W2CUZ has a complete 56-mc. station, but no 3.5-mc. transmitter. W2AG is equipped for both 56 and 3.5-mc. work. W2AG picks up the A2 56-mc. signal of W2CUZ and feeds it into a rectifier tube which operates a small relay. This relay in turn operates the keying relay of W2AG's 3.5-mc. transmitter. W2CUZ can now call CQ and work on 3.5 mc. a 1-kw. transmitter two miles away. Can he work break-in? And how! No rectifier hash, no ear-breaking crash when W2AG's frequency of 3620 kc. is approached with the 3.5-mc. receiver. It is a perfect circuit that is truly commercial in operation. W2CUZ and W2AG can both listen on 3.5 mc. for an answer to a call and if W2CUZ doesn't hear one and W2AG does, he can readily shoot the signal to W2CUZ via his own 56-mc. transmitter, as they

Operators engaged in re-broadcast work of this nature should remember that the regulations require the signing of the station call at least every 15 minutes and at the end of each transmission. Practical experience in automatic relaying will doubtless disclose some procedure which will enable all stations participating to break away and sign their own calls at pre-arranged periods or on receipt of some special signal.—Editor

easily work duplex on 56-mc. The 56-mc. circuit serves both as a keying circuit and as a telephone line at the same time. Just imagine similar set-ups in operation all over the country. What a time they can have setting up all sorts of combinations!

Let's look into a little more complicated circuit. Suppose W1MK is sending out the regular weekly broadcast. W2CUZ, with an S.S. superhet on 3.5 mc. can easily pick up a perfect signal from W1MK and send the audio beat-note to W2AG over the 56-mc. channel. Just as in the case of W2CUZ's own ICW, W1MK will then key W2AG's 3.5-mc. transmitter automatically. Of course, it is just as easy to retransmit the signal on other bands.

Now assume that we have a similar two-station combination on the west coast with W6XYZ on 56 mc. controlling W6ZXY on 3.5 mc. W6XYZ can pick up W2CUZ through W2AG and feed the signal into his 56-mc. transmitter, which controls W6ZXY on 3.5 mc. Now W2CUZ will have control of both W2AG and W6XYZ. What a CQ that ought to make! On the other hand, W6XYZ can pick up a station in Hawaii, for example, and send it to W2CUZ

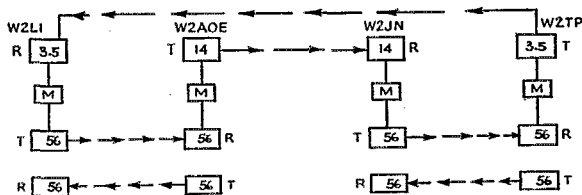

TWO-BAND QSO

FIG. 2

through W6ZXY when Hawaii is inaudible on the east coast. But enough, before you and the writer both go off the deep end. . . .

This same procedure is used by W2TP and W2JN for 'phone work. Obviously, no relays are necessary, but the requirements, so far as the 56-mc. channel is concerned, are much more rigid than they are for telegraph. An R9 signal with excellent quality is absolutely essential for good

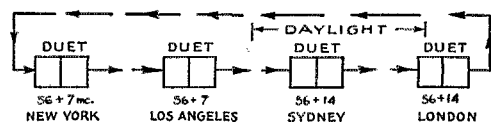

SUGGESTED SET-UP FOR ROUND-THE-WORLD RELAY WHO WILL BE THE FIRST?

FIG. 3

The "duets" indicated comprise two ham stations, each fitted with 7 or 14-mc. equipment in addition to 56-mc. gear and mixer apparatus.

retransmission. Weak signals of mediocre quality will not do, as the quality becomes progressively worse as the signal is put through a receiver and another series of audio stages in the low-frequency transmitter. Here again, good operating practice is necessary, and again the duplex 56-mc. circuit provides "land-line service" to make it possible. The 14-mc. carrier at W2TP is cut off at the end of each transmission. "Carrier, please," says Atwater in Montclair, and "Musty" throws the switch in Leonia when the DX station stands by. The stuff is there, fellows, 'round-the-world relays and all. Let us see what is necessary to secure these results and then go to it.

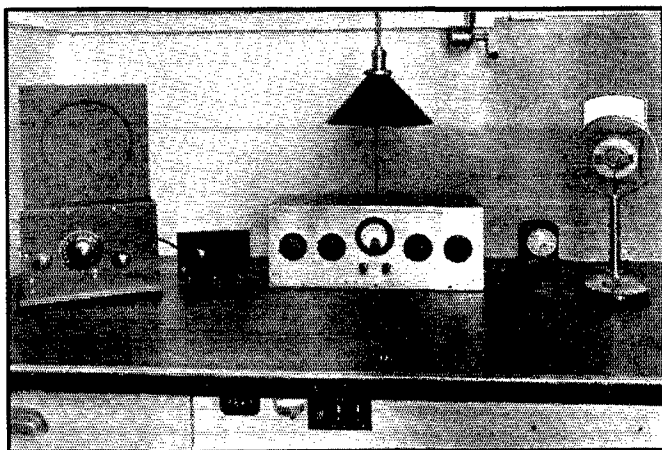

THE 56-MC. CONTROL PANEL AT W2CUZ

On the left is the 56-mc. receiver. Immediately to the right is a simple mixer. Pre-amplifier, tone generator, faders etc. are in the aluminum box. The key controls W2AG in the set-up of Fig. 1. The microphone provides the "talk-back" as described in the text.

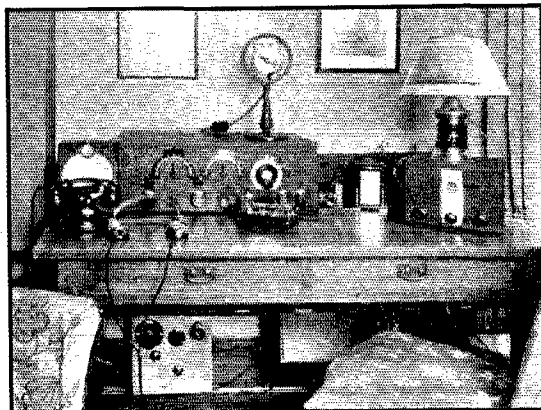

THE OPERATING TABLE AT W2AG

The low-frequency receiver is at the left, 56-mc. receiver at the right. The mixer is located on the lower shelf.

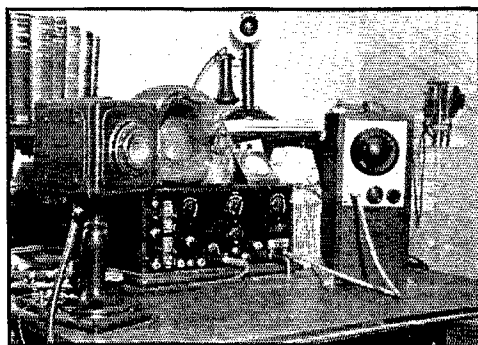

W2JN, showing the mixer, transmitter remote-control keys and 56-mc. receiver. W2JN on 56 mc. is regularly retransmitted by W2TP on 14 mc.

The first requirement is a complete installation of 56-mc. gear in your own and your "partner's" stations. A multitude of five-meter circuits have already been described in *QST*, and further enlargement on this subject is unnecessary. As pointed out above, loud signals that will completely suppress the rush of super-regeneration in the 56-mc. receiver are essential for 'phone work. It is advisable to err on the side of too much power rather than too little. Naturally, the c.w. man does not have to install a microphone. However, it will speed up operation immensely if the circuit between the two local stations can be used as a telephone line as well as for keying purposes. If both stations are listening to the distant station, errors in copy can be cross-checked and the proper "fill" secured.

Many amateurs can secure help from local 56-mc. enthusiasts in getting started with the least amount of trouble. They will undoubtedly be glad to help, as it will enable the 56-mc. bug to work DX stations using his 56-mc. ICW signal. Another advantage not pointed out previously is the fact that if the 56-mc. station is located at a fair distance it can be used as a remote receiving point if local QRM is breaking things up. This is a distinct advantage if the high-powered ether buster around the corner opens up on your pet band. You can laugh at the QRM because it will not exist five or ten miles away at the receiving point. And is it a pleasure? Just try it.

It certainly would be advisable to get acquainted with straight 56-mc. transmission and reception for a few days before going into the heart of the system—the mixer circuits. Of course, the low-frequency transmitter will put a harmonic

into the 56-mc. band that will block the "rush" in the same manner as an incoming signal. It is evident that the other fellow's 56-mc. transmitter cannot be located at that frequency, but must be set at a frequency that is free from harmonic trouble on the receiver. Your own 56-mc. transmitter must then be set on a frequency far enough from your partner's so that duplex work is possible. At the same time, the frequency you select for your 56-mc. transmitter must be at a "harmonic free point" on his receiver if he is also using a low-frequency transmitter. With a powerful low-frequency transmitter located in the same room, the 56-mc. receiver may be entirely blocked. Care in the placement of the receiver and its antenna in relation to the transmitter will help to correct this trouble if it is encountered. At the start, a number of minor difficulties will probably be encountered. These can be readily overcome with a little practice.

Now for the mixer and relay circuits. The various photographs show these units in various types of construction. While the design and appearance varies considerably, as the photographs indicate, basically they are very similar so far as the circuit is concerned. The writer takes the liberty of describing his own unit because it is home-grown and therefore a familiar article. It will do all the necessary tricks and then some. Less complicated outfits can be easily constructed to do the job, but naturally the flexibility is somewhat limited. The mixer is necessary because the loud-speaker to microphone method of retransmission has proved, to say the least, unsatisfactory. Feed-back difficulties are always encountered, together with other annoying noises. The degree of control in securing the correct amount of signal is also limited.

Referring to the diagram, we find a pre-amplifier stage for use with a double-button microphone. This is unnecessary if a single-button microphone is used. It is included in this case because the output level of the double-button microphone is down considerably. This stage is placed before the volume control or fader system so that the microphone level will approach that of the detector tubes in the receiver, at the point of volume control. Jack  $J_1$  is used for the microphone and  $J_2$  to measure its current. Jacks  $J_3$  and  $J_4$  are connected to the two plate-to-line transformers. Only one of these tube-to-line circuits is necessary, but two of them make it possible to fade in two receivers together

with the talk back circuit at the same time. It is essential that jacks be placed in the detector plate circuit of both the 56-mc. and the low-frequency receivers, so that either may be connected at will to the mixer by means of patch cords. The patch cords are made of short two-wire cable with a 'phone plug at each end.

Multiple jacks in the detector circuits are advantageous. A split pair of 'phones (one 'phone from each receiver) can then be plugged in to both sets so that the 56-mc. signal will be heard in one ear and the low-frequency signal in the other. At the same time, it is possible to retransmit the signals via the mixer.

To return to the diagram once more, we note that the three output windings of the transformers  $T_2$ ,  $T_3$ ,  $T_4$ , are in series, each working into its own volume control. Potentiometers are shown for the sake of convenience. They will work satisfactorily and are cheaper than the "T pads" which might be employed by those who desire the last word in efficiency and quality. The potentiometers connect to the 500-ohm transformer, or can, if economy is necessary, connect directly to output jack  $J_9$ . The 500-ohm line from this point connects to the 500-ohm winding of the input transformer to the main speech amplifier. This amplifier is used to modulate the 56-mc. transmitter only, where telegraph is to be employed. Where both 56-mc. and low-frequency

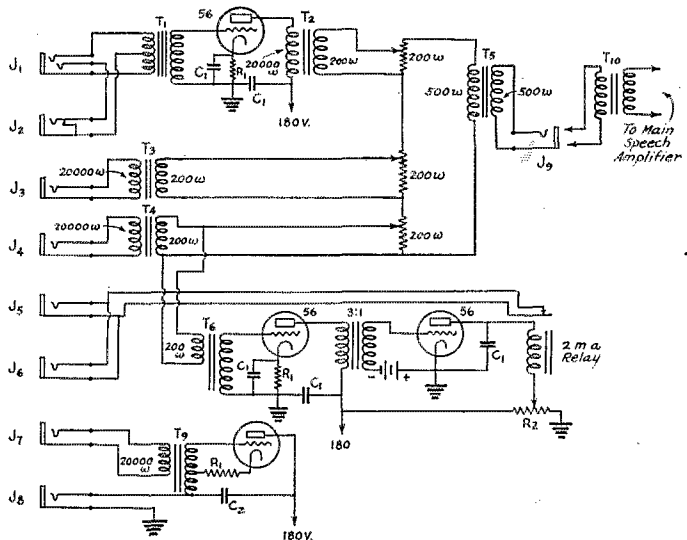

FIG. 4—COMPLETE CIRCUIT OF W2AOE'S MIXER

- $T_1$ —Double-button mike-to-grid transformer.
- $T_2$ ,  $T_3$ ,  $T_4$ —Tube-to-200-ohm line transformers.
- $T_5$ —One-to-one 500-ohm transformer.
- $T_6$ ,  $T_{10}$ —500-ohm-to-grid transformer.
- $T_9$ —Push-pull input transformer.
- $C_1$ —2  $\mu$ fd. fixed condensers.
- $C_2$ —0.1  $\mu$ fd. fixed condensers.
- $R_1$ —2500 ohm, 1-watt resistors.
- $R_2$ —10,000-ohm potentiometer.
- 1 or 2 ma. relay.

'phone is used, it will be necessary to provide means for shifting its output so that either transmitter may be modulated.

The next step is the keying or relay circuit. If an ICW signal or the beat note of a c.w. signal is fed from either receiver into  $J_4$ , and the fader control is open, the signal will be amplified by the 56 audio stage and the voltage will be impressed on the grid of the second 56 tube. This second stage is used as a rectifier and its adjustment is important. Fixed battery bias is essential as we are interested in securing the greatest plate current change for a given change in grid voltage. Automatic bias tends to hold the plate current at a fixed level and, for this reason, is unsatisfactory. With a fixed bias of  $7\frac{1}{2}$  volts, the plate voltage on the rectifier tube is adjusted so that the plate current flowing is just below that necessary to

operate the relay. The transmitter can then be keyed locally.

Last, but not least, is the audio oscillator or howler tube. This tube is connected in a simple

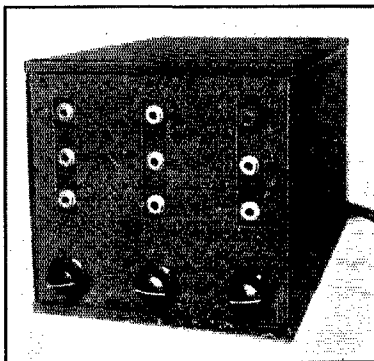

EXTERNAL VIEW OF THE MIXER AT W2AOE

*Each of the nine jacks is necessary in order that all the stunts described in the text may be easily accomplished. The faders are conveniently located at the bottom of the panel.*

circuit furnished with output and keying jacks. For ICW, the key is plugged into  $J_8$ . A patch cord connects  $J_7$  to  $J_3$  or  $J_4$  so that the audio oscillator output is fed into the amplifier, the volume being controlled by the fader. Thus tone modulation can be fed into the 56-mc. transmitter at any desired level.

The mixer, then, can be looked upon as a distributing system with a number of different functions. All controls are on one convenient panel. The manipulation of a patch cord or two and the proper setting of the faders make extremely rapid changes possible. A tone generator, a

remote keying circuit, local voice transmission, and retransmission of both voice and telegraph simultaneously can all be obtained with a twist of the wrist. Proper operation of the unit can naturally be acquired only by practice.

In conclusion, it might be well to point out that a general adoption of the relay system described above will require coöperation between local amateurs to a degree unnecessary heretofore. To date, most amateur accomplishments have been individualistic in nature. It is obvious that a high order of coöperation will give us increased flexibility and greater enjoyment as is the case with other coöperative efforts. Such coöperation and an increased amount of inter-band QSO's will do much to restore contact between amateurs with different interests and different viewpoints working on our widely separated bands.

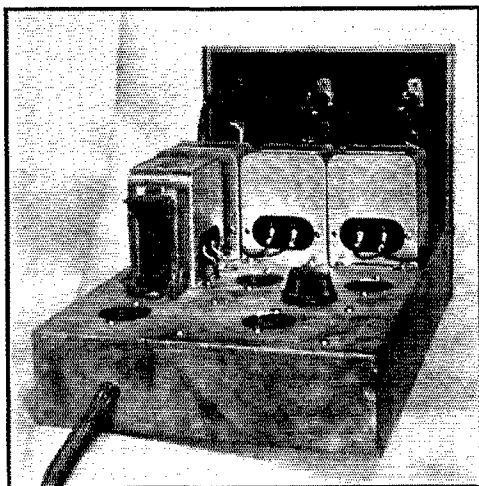

AN INSIDE VIEW OF THE BOX OF TRICKS

*The jacks, mounted on a bakelite panel, are shown just back of the tube-to-line and pre-amplifier transformers. The keying relay is mounted vertically in the left foreground.*

Then any signal impressed on the grid of the tube will close the relay. A large by-pass condenser is necessary across the relay winding, as the winding will otherwise offer an impedance to the signal which will cause "chatter."

Jacks  $J_5$  and  $J_6$  are multiple across the relay contact. A line from the transmitter keying relay may be plugged into the other jack so that the incoming keying pulses may be shut off by a turn

## Strays

With reference to the use of a home-made grid choke in the 830 amplifier described in May QST, W4AKJ writes that he has cured similar cases of parasitic oscillation by putting another choke in series with the grid choke, thereby detuning the low-frequency circuit. Any sort of choke seems to work, provided there is enough inductance to avoid resonance between grid and plate circuits.

Suggested "Q" sig for those QSO's in which you have to quit suddenly to get to work on time — QQQ. Meaning — "Must QRT immediately, will explain in next QSO or on QSL." W4MS is the author.

# First Boston-New York 56-Mc. Relay

By T. F. Cushing, WIHMO\*

ON Sunday May 13, 1934, due to the good organization work of D. B. Whittemore, W2CUZ, the long talked of Five-Meter Relay between Boston and New York City took place. Such a relay had been the dream of 56-mc. men for the past two years. Two previous attempts

cerned. The next hop was from Mount Wilbraham (WIHMO) to Mount Wachusetts where W1AHX was located with his portable outfit, and able to contact Boston stations with ease. Messages were sent each way over the route and made excellent time. A queer condition prevailed between Mount Wilbraham and Mount Wachusetts. W1AHX at Mount Wachusetts could hear WIHMO at Mount Wilbraham very nicely, but WIHMO at Mount Wilbraham could not hear W1AHX, while W1DE located on High Ridge, some 20 miles northwest of WIHMO, with an elevation slightly better, was able to receive W1AHX, but could not contact him. Consequently, messages going west were obliged to travel farther than those going east. W1DE saved the day and the relay by being on the job and acting as receiving station for WIHMO.

An interesting report was turned in by W1HDQ who was located for the day on Mount Ascutney,

near Windsor, Vt. He was able to hear, and understand fully both W2CTF and WIHMO, and the airline distance was well over 125 miles.

The time elapsed in the relaying of the messages was less than one hour — from 2:21 to 3:12 p.m. EDST, May 13th. Portable, W2CTF, was located 85 miles from Mount Wilbraham, using  $8\frac{1}{2}$  watts input from a 165 v. dynamotor, on his 112 A's. He was 90 miles airline from  
(Continued on page 72)

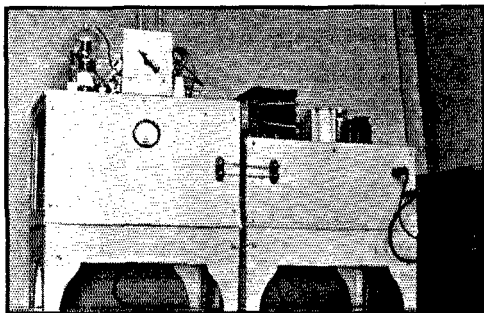

THE MODULATOR UNIT AND R.F. AMPLIFIER

One 46 drives a pair of 46's and 825 tubes with 800 volts on the plates.

had been made which failed.

W2GEC was on the New York City end, with W2AG located up the river at Yonkers for the first hop. It fell to the lot of W2CTF to make a long trek of 125 miles up state to the Catskill Mountains (Haines Falls, N. Y.) for a portable location from which they hoped to make the contact direct to Wilbraham Mountain, about ten miles east of Springfield, where WIHMO (formerly W1AWW) has had a permanent location doing five-meter work exclusively and continuously for the past two and one-half years.

Shortly after 10:00 a.m. WIHMO called W2CTF in the Catskills — and W2CTF came back! What a thrill! Stations in the First and Second licensing areas were QSO over one of the longest hops of the route. After the usual greetings, W2CTF put the signals of WIHMO through to W2AG at Yonkers, who in turn put them through to W2GEC at New York City. This double re-transmission of WIHMO to W2GEC with a total distance of around 200 miles is an indication of what may become every-day occurrences, and incidentally hangs up a record for the present time as far as WIHMO is con-

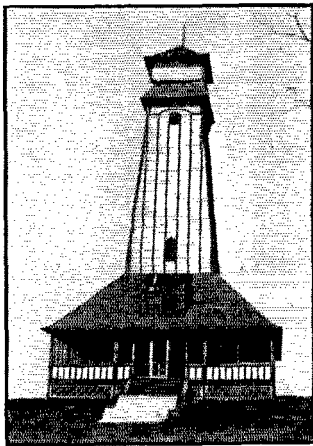

THE 80-FOOT TOWER AT WIHMO

The station is on the second floor, elevation 900 feet, antenna at the top.

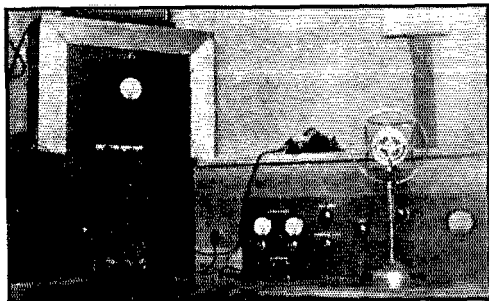

THE OPERATING POSITION AND CONTROLS  
Jacks and patch cords make it possible to connect any receiver to any transmitter at WIHMO.

\* 349 Worthington St., Springfield, Mass.



# A Vacuum-Tube Type Modulation Meter

By E. and C. Seiler, W8PK\*

**T**HE ideal tool to check percentage modulation and find out whether or not a radio frequency modulated wave is distorted is the cathode ray oscilloscope. The apparatus to be described, which is of the vacuum-tube voltmeter type and resembles the General Radio modulation meter, is the next best tool with which to check percentage modulation. This apparatus may be constructed by consulting the old junk pile and referring to the wiring diagram of Fig. 2.

## PRINCIPLE OF OPERATION

If a symmetrically modulated radio-frequency wave is introduced into the full wave rectifier of Fig. 2, the average amplitude for complete, partial, or no modulation remains constant. Therefore, the rectified voltage across the 2500-ohm load resistance of the full wave rectifier, if measured with a high-resistance direct current meter, would always be the average voltage, equal to  $E_1$  of Fig. 1-A—the reason being that the average amplitude of the carrier is constant under the conditions of complete, partial, or no modulation.

If a voltage  $E_2$  were now connected in parallel with  $E_1$  and made equal to  $E_1$ , and the direct current voltmeter connected into the circuit as shown in Fig. 1-B, the meter would read zero. If in place of the direct current voltmeter we now connect a unidirectional *peak* voltmeter this meter will still register zero on no modulation. However, if modulation is applied, the instantaneous voltage across the 2500-ohm resistance will vary over one cycle from the value  $E_1$  to  $(E_1 + E_x)$ , then to  $(E_1 - E_x)$ , as indicated in Fig. 1-A. During the positive part of the modulation cycle the *peak* voltage, which will be measured by the unidirectional peak voltmeter, will be equal to the algebraic sum of the battery voltage  $E_2$  and the peak voltage  $(E_1 + E_x)$ . Since  $E_2$  was made equal to  $E_1$ , we have  $(E_1 + E_x) - E_2 = E_x$ . Similarly, during the negative part of the cycle the peak voltage across the resistance is  $(E_1 - E_x)$ ; and if the connections to the unidirectional peak voltmeter are reversed the voltage measured by the unidirectional peak voltmeter will again be  $E_x$ , since in this case (adding algebraically) we have  $(E_1 - E_x) - E_2 = -E_x$ . In other words, the meter can measure the actual positive or negative peaks of modulation.

\* Box 114, E. Bloomfield, N. Y.

## CONSTRUCTION AND OPERATION

$L_1$  and  $L_2$  are r.f. chokes wound on a spool as shown in Fig. 3. In winding these chokes use No. 22 cotton-covered wire and wind the layers on smoothly placing a strip of waxed paper between each layer. Wind on enough layers so that the spool is within one-eighth inch of being full. RFC is a choke of 600 turns of No. 28 silk-covered or enameled wire wound on a spool having the same dimensions. This choke can be scramble wound.

In laying out the equipment divide the box into two compartments. Line the inside of the box with tin or copper. Referring to Fig. 2, place all the equipment shown to the left of the dotted line in one compartment and the remaining equipment in the second compartment. The purpose of this arrangement is to isolate the r.f. from the rectified r.f. circuits.

After the equipment is assembled and wired it is ready for test. Connect 110 volts a.c. to the transformer, 90 volts d.c. to the 5000-ohm potentiometer binding posts, and the microammeter across the meter binding posts.

Turn the single-pole switch so that the half-wave rectifier is shorted out of the circuit. The

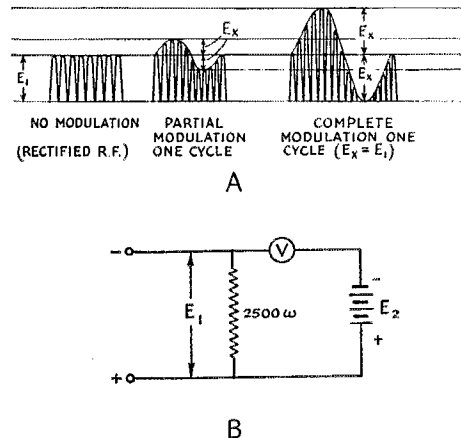

FIG. 1—ILLUSTRATING THE PRINCIPLE OF OPERATION

potentiometer arm should be turned so that it is in the extreme position, towards the positive side of bias battery, so that there is no voltage across the condenser  $C_b$ . The next step is to determine in which position of the d.p.d.t. switch the meter will indicate "Up" modulation. To find this out, turn

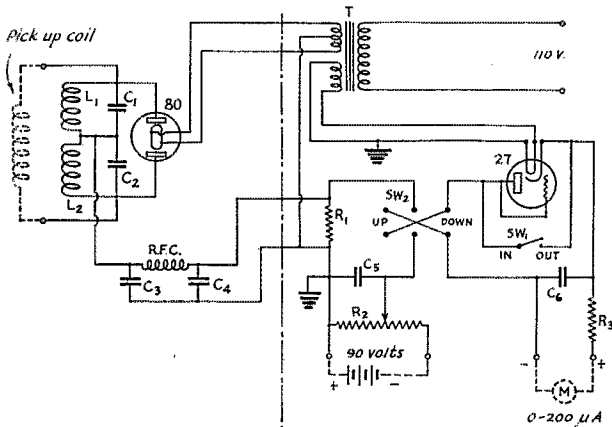

FIG. 2—CIRCUIT OF THE MODULATION METER

- $L_1$  and  $L_2$ —See text.
- $C_1$  and  $C_2$ —0.001  $\mu\text{fd}$ .
- $C_3$  and  $C_4$ —250  $\mu\text{fd}$ .
- $C_5$ —4  $\mu\text{fd}$ .
- $C_6$ —1  $\mu\text{fd}$ . (low leakage).
- $R_1$ —2500-ohm resistor, 10-watt size or larger.
- $R_2$ —5000-ohm potentiometer, five-watt size or larger.
- $R_3$ —500,000-ohm. Use five good 1-watt size 100,000-ohm resistors, in series.
- $SW_1$ —Single-pole single-throw key or toggle switch.
- $SW_2$ —Double-pole double-throw key or toggle switch.
- RFC—600 turns wound on spool. See text.
- M—0-200 microammeter (Weston Type 301).
- T—Filament transformer, 5-volt and  $2\frac{1}{2}$  volt secondaries.

the potentiometer arm towards the negative terminal so that the microammeter needle shows a deflection. If this deflection is on the scale the d.p.d.t. switch is in position to measure "Up" modulation. If the needle kicks off scale, however, the d.p.d.t. switch is in position to read "Down" modulation.

Knowing which position is for "Up" and which for "Down" measurements, set the d.p.d.t. switch in the "Up" position and turn the potentiometer arm towards extreme positive position as before. Connect the pick up coil to the r.f. terminals and, with the rectifier switch still in the "Out" position, couple the pick up coil to the tank of the final stage—or whatever stage you wish to check—and adjust the coupling so that the meter reads exactly 100 microamperes. Suggested coupling arrangements are shown in Fig. 6. Next introduce just enough bias voltage, by turning the potentiometer arm towards the negative side, to make the needle return to zero. Now you are ready to measure up or down modulation by merely cutting the half-wave rectifier into service, which is done by putting the s.p. switch at the "In" position. Now apply tone to the modulating system and read the "Up" and "Down" deflections by flipping the d.p.d.t. switch. The meter deflections read directly in percent, since the combination of half-wave rectifier, 1- $\mu\text{fd}$ . condenser and microammeter is a unidirectional peak voltmeter. The micrometer at 100 scale divisions indicates that the voltage

being measured is 50 volts (0.0001 a. x 500,000 ohms = 50 volts). The r.f. power to operate this device is in the neighborhood of 0.5 watt.

To determine whether or not the 'phone is over-modulating, turn the "In-Out" switch to the "Out" position. Next turn the potentiometer to the extreme positive position mentioned before and adjust the coupling so that meter indicates 100 scale divisions. Modulate the transmitter, and if the meter needle remains stationary there is no carrier shift. If the meter needle moves to 110 there is a 10% shift. Likewise, if the meter needle moves to 150 there is a 50% shift.

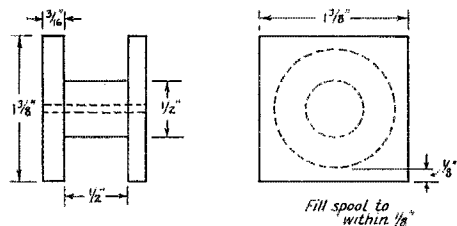

FIG. 3—DETAIL OF COIL SPOOL

This meter may be used, in conjunction with a volume indicator or vacuum-tube voltmeter and an audio oscillator, for determining the modulation characteristic of any transmitter. By varying the input voltage at 1000 cycles to the speech equipment in steps of 2db, the "Up" and "Down" percentages may be read and a curve plotted on semi-logarithmic paper of db input vs. % modulation. For excellent transmission this curve should be a straight line. A typical modulation characteristic is shown in Fig. 4.

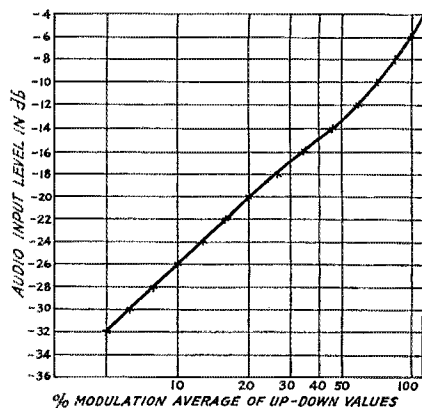

FIG. 4—A TYPICAL PLOT OF THE TRANSMITTER MODULATION CHARACTERISTIC

If the audio oscillator is of the variable type, a complete overall audio-frequency characteristic can be obtained by applying a series of tones to the audio equipment at a constant voltage, as indicated by a v.t. voltmeter or v.i., and measuring the percent "Up" and "Down" modulation. Using 1000 cycles as the reference, proceed as follows to obtain a db vs. frequency curve such as shown in Fig. 5:

1. Obtain data shown in first four columns of Table I.

2. Convert the average "Up-Down" percent values in the fourth column to "db difference from 1000 cycles," either by direct calculation as shown in the sample problem or by consulting a table of db values corresponding to ratios of voltages as calculated from values in fourth column.

3. If the values in the fourth column are less than the reference values, the sign preceding the values in the db column will be negative. If the values in the fourth column are greater than the reference values the sign preceding the values in the db column will be positive.

4. Plot a curve from values in the first and fifth columns.

If the resultant curve is flat from 250 to 3000 cycles the quality will be good for voice. If it is flat from 100 to 5000 cycles the quality will be as good as that of a great many broadcast stations. If it is flat from 30 to 10,000 cycles the quality will be excellent for voice or music.

If the frequency characteristic curve is nearly flat from 30 to 10,000 cycles and if the modulation characteristic is a straight line, the transmitter may be considered truly modern.

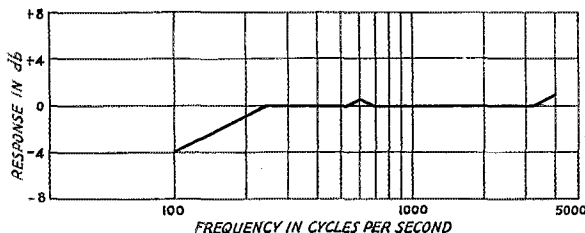

FIG. 5—A TYPICAL TRANSMITTER FREQUENCY CHARACTERISTIC

FURTHER SUGGESTIONS AND PROOF OF PERFORMANCE

A better working model of this meter may be made by using two of the new Type 25Z5 rectifiers, one as a straight full-wave rectifier in place of the 80 and the second as a half-wave rectifier, both plates tied together, in place of the 27.

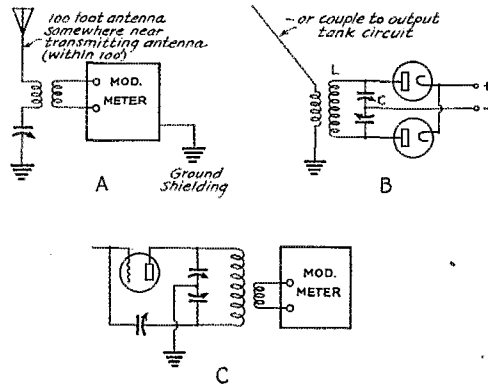

FIG. 6—METHODS OF COUPLING THE MODULATION METER TO THE TRANSMITTER

The system shown in A is suitable for transmitters of 100-watt or greater output. The pick-up antenna system should be tuned to resonance with the carrier frequency by proper choice of antenna coil and condenser.

The input system of B eliminates the necessity of L<sub>1</sub>L<sub>2</sub> and C<sub>1</sub>C<sub>2</sub> of Fig. 1. If LC, tuned to the carrier frequency, has particularly sharp resonance it may "cut" the higher-frequency sidebands somewhat.

System C is the most generally useful, especially with small transmitters. The input of the modulation meter is simply coupled to the output tank circuit of the transmitter.

not do because the operation of this peak meter depends upon the charging of the condenser to a value equal to the peak voltage, then discharging through a high resistance which in this case is 500,000 ohms. If a condenser has appreciable leakage the discharge will divide between the leakage resistance and the 500,000-ohm resistance, and a false reading will obtain since the microammeter would then read only the discharging current through one path.

Bear in mind also that a low-value resistance, say 100,000 ohms, cannot be used because this would tend to knock the peaks down in the same manner that a bleeder resistance knocks the peak voltage down on any rectifier system.

In making measurements, the "Up" readings may differ appreciably from the "Down" readings. This may be due to a lopsided input wave shape. To check for lopsided wave shape of the modulating signal, reverse the leads from the audio oscillator and compare "Up" and "Down" readings with those taken before and after reversal. Record also the readings on the v.i. before and after reversal. Analysis of these data will indicate whether or not the audio signal is distorted. If the wave shape is sym-

(Continued on page 20)

# What the League Is Doing

League Activities, Washington Notes, Board Actions—For Your Information

WE BROKE a few records around here to get you fellows the minutes of the Board meeting in the June *QST*. *QST* was already on the press when the Board met, and the only place we had a chance of meeting it with the story of the Board meeting was in the bindery. Working day and night the first few days after the meeting, we got our story ready, Roddy drove it to the printer's in New Hampshire, the printer set it up overnight, printed it the next day as an extra "form," and it was just in time to get bound into the issue a week after the Board went home.

## Financial Statement

The League had an excellent first quarter in 1934. Members will be pleased to see this evidence of the sound financial condition of their organization. By instructions of the Board, the operating statement is here published for your information:

### STATEMENT OF REVENUE AND EXPENSES FOR THE THREE MONTHS ENDED MARCH 31, 1934

REVENUE		
Advertising sales, <i>QST</i> .....	\$12,895.52	
Newsdealer sales, <i>QST</i> .....	12,475.01	
Handbook sales.....	15,149.83	
Booklet sales.....	3,423.23	
Membership dues.....	14,129.05	
Membership supplies sales.....	2,674.40	
Interest earned.....	700.84	
Cash discounts earned.....	252.20	
Bad debts recovered.....	151.14	
		\$61,851.22
<i>Deduct:</i>		
Returns and allowances.....	\$ 2,941.32	
Exchange and collection charges..	15.19	
Cash discounts on sales.....	316.04	
Increase of provision for newsstand returns of <i>QST</i> .....	273.87	3,546.42
Net Revenue.....		\$58,304.80
EXPENSES		
Publication expenses, <i>QST</i> .....	\$11,670.48	
Publication expenses, Handbook..	8,519.07	
Publication expenses, Booklets...	1,023.31	
Membership supplies expenses.....	1,440.71	
Salaries.....	16,757.52	
<i>QST</i> forwarding expenses.....	617.74	
Telephone and telegraph.....	530.72	
Postage.....	1,527.89	
Office supplies and general expenses.....	3,008.56	
Rent, light and heat.....	826.97	
Traveling expenses.....	1,022.18	
Depreciation of fixed assets.....	230.82	
Communications Dept. field expenses.....	222.99	
Headquarters station expenses...	66.91	
Federal tax on checks drawn.....	6.44	
Total Expenses.....		47,472.31
Net Gain from Operations....		\$10,832.49

## New Privileges

The several requests that the Board of Directors made of the Federal Radio Commission have been transmitted to Washington by A.R.R.L. headquarters. At this writing there has been insufficient time to secure action on any of them, but we can report that they are all under consideration and that there is excellent likelihood of their adoption. The Commission seems favorably inclined towards the proposal to permit the use of the "N" prefix by members of the N.C.R. We may hope to possess very soon not only the right to engage in ultra-high-frequency work on frequencies above 112 mc. but also to be permitted mobile operation on 56 mc. and above. Maybe you don't believe that will be fun! Yessir, if this proposal is approved we shall have the right to put 5-meter 'phones in our automobiles and chew the rag with the fellows in each town we drive through. Log-keeping is going to be simplified and rationalized. The Commission is sympathetic towards our need to have Class-A (phone) examinations held in additional cities visited by the inspectors in the normal course of their duties (over and above the 34 regular examining points). The trouble has been lack of money; the Commission has operated this year on about half of its average previous budget. We believe that some way will be found to provide additional Class-A examinations soon.

## Rumors

Current rumors needing spiking:  
 1. That A.R.R.L. and R.C.A. have a deal on with F.R.C. to permit 5-meter operation without licenses. The law requires both a station and an operator license. The A.R.R.L. Board of Directors is unanimously on record not only as wanting licenses but as demanding knowledge of the code before securing a license to operate on any amateur frequency. See minutes in June *QST*, page VII.  
 2. That A.R.R.L. has requested F.R.C. to require 'phone stations to limit their emissions to a width of 3000 cycles. No such request was made or is under consideration. The Board instructed *QST* to endeavor to cook up dope on low-pass filters to limit 'phone modulation frequencies to about 3000 cycles. The idea is that if 'phone stations would do this, interference in the 'phone sub-bands would be greatly reduced without affecting the intelligibility of communications. But no regulation is being sought. See minutes, page V.

## Legislation

As we write, it is generally believed in Washington that before Congress adjourns it will adopt new legislation creating a Federal Communications Commission, and that that new commission will actually be in existence by early July. The new commission would have jurisdiction over telephone and telegraph and cable, as well as radio. It would take over intact the existing F.R.C. organization except the present commissioners themselves, and would continue radio administration under the existing regulations. Unified control of communications is a prime aim of the administration, but no threat to amateur radio is visible in the proposed arrangement at this time.

## Madrid Ratification

The Madrid Telecommunications Convention is now being made effective in the United States. Perhaps the process by which this is done is of interest. On May 1st the Senate gave its consent to ratification. About May 18th the President signed a document constituting ratification by the United States. But the ratification is not effective until it is deposited in the archives of the Spanish government. A certified copy of the ratification by the President, with appropriate instructions, was transmitted to the American embassy at Madrid. When that certified copy is actually deposited with the Spanish government, the convention becomes binding upon the United States. The embassy, therefore, will cable to Washington when the deposit is made, whereupon the President will proclaim the effectiveness of the treaty. It is expected that this will take place about June 10th, before this issue of *QST* appears. The convention of course applies only internationally and only with other countries that have also ratified it.

## Retransmission

Get down your copy of the F.R.C. Rules and Regulations and note the following amendment to our Rule 371 which the Commission made on May 9th: "371. Amateur stations shall not be used for broadcasting any form of entertainment, nor for the simultaneous retransmission by automatic means of programs or signals emanating from any class of station other than amateur." This amendment really came about because it was discovered that some amateur 'phone stations were retransmitting the programs of broadcasting stations; and although other stations may not so rebroadcast, there was a loophole in our regulations that did not forbid it. Note that this change has no effect upon the retransmission of other amateur signals. Automatic relaying is a coming thing in amateur radio, particularly in the ultra-high frequencies—see the articles in this issue.

## Portable Operation

How long may a portable station be operated at one location? The rules forbid notifying portable operation for periods of longer than thirty days in advance, but how many successive notices for one location will be accepted? The inspectors have been instructed to accept without question notices of portable operation at the same address covering a period up to three successive months. If they receive further notice for operation at the same address, the Commission then investigates to determine why modification has not been applied for, as there is generally something irregular in such cases. Many amateurs who attend college have wondered how they could operate a portable station there over as long a period as the school year, and why they could not get a second station license. Their proper procedure is to apply for modification of their home station license to relocate the station at the school address, operating it there during the nine months of the school year. Then during the summer vacation they may operate as a portable, even including fixed operation at their home address for a period up to three months. Separate station licenses are not necessary for a station at school.

## "Special Arrangements"

Last year the League asked the Department of State to endeavor to conclude arrangements with a number of countries to permit the handling of the so-called "unimportant" third-party messages by amateur radio. Progress is slowly being made. Canada has agreed to a renewal of the existing arrangement, and diplomatic notes to that effect are now in process of being exchanged. The Mexican government would "view with great satisfaction" the conclusion of such an agreement with the United States, but the same is prohibited by the present Mexican laws; the authorities are therefore considering amending the laws to make possible the acceptance of the U. S. proposal. The Irish Free State has "tabled the motion." China has refused. Great Britain has not been heard from, but our sister society there, the Radio Society of Great Britain, has recommended to the government that it decline, since the R.S.G.B. has no interest in message traffic and doesn't see why we have! Negotiations with Cuba were delayed during the recent civil trouble there but have now gone forward. The Union of South Africa is not favorably inclined and cannot see that such privilege would be of any real benefit to the amateur. Other countries with whom the arrangement is under negotiation are Argentina, Australia, Bermuda, Brazil, British India, Chile, New Zealand, Peru, Spain and Straits Settlements. Amateur societies in all these countries have been requested by A.R.R.L. to assist in the endeavor.

## Interpretations

The Commission has recently ruled that if an amateur changes the location of his fixed station and applies for modification of the license to the new address, he may at once engage in portable operation at the new address, under the procedure governing portable operation, for a period of sixty days, unless the license sooner expires. However, he may not operate as a fixed amateur station at the new location until the modified license has been received from the Commission—he must notify the inspector of his portable operation in installments of not over thirty days at a time, sign the portable symbol, etc. . . . A Class-C licensee moving into one of the 125-mile circles will not be required to take the Class-B operator examination as a precedent to obtaining a modified station license.

## Alternate Directors

When will elections be held for alternate director? It is provided in the amendment adopted by the Board at its annual meeting that "an alternate director shall be elected at the same time as the director is elected." There will, therefore, be elections for seven alternate directors this coming autumn, and in the remaining divisions at the 1935 elections. The elections this year are in the Central, Hudson, New England, Northwestern, Roanoke, Rocky Mountain and West Gulf divisions. It is time to start thinking about alternate directors in those divisions.

## Reprinted By-Laws

The Constitution & By-Laws of A.R.R.L. have been reprinted to show all amendments to date, particularly including those made at the last meeting of the Board. A copy is available to any member upon request. It wouldn't hurt to be a little more familiar with the constitution of your organization. Half the things you hear about aren't even possible under our rules.

Herbert L. Pettey is secretary of the Federal Radio Commission. He catches more hx than any other radio person except the secretary of the League. Many an amateur complains that he got a notice from Mr. Pettey saying so and so, and he wants to know "who this bird is." It is the rule in commissions such as F.R.C. that all of the official letters are signed by the secretary, regardless of who wrote them. In other words, that signature is really the style under which the Commission does business, and when you get a letter signed Pettey it doesn't mean that Mr. Pettey has a personal grudge against you, or that he personally knows anything about the matter—it is simply an official communication from that august body which is the Commission.

More next month.

## A Vacuum-Tube Type Modulation Meter

(Continued from page 17)

metrical at the audio input but not at the modulation meter, the audio- or radio-frequency amplifiers may be at fault.

A meter using the 80 and 27 tubes was compared with a Type 49-A RCA—Victor cathode-ray modulation indicator. With one operator at the 49-A and another at the modulation meter, simultaneous readings were recorded. These readings checked within ten percent.

If the modulation meter is to be used to monitor the transmitter under operation with voice modulation, keep in mind that the needle of the microammeter cannot follow the voice peaks. A comparison of the modulation meter was made with the 49-A cathode ray meter while viewing voice. When 100% peaks were being registered on the 49-A, the needle on the modulation meter would only flick to around 75%, although on music the needle rides to a higher value for the reason that the peaks are more sustained than with voice modulation.

TABLE I

Freq. in Cycles per Second	Percent Modulation		% Average	db Diff. from 1000 cycles
	Up	Down		
1000	48	52	50	0
100	30	32	31	-4.1
200	44	46	45	-0.9
500	50	50	50	0
4000	54	56	55	+0.9

Sample problem:

$$\text{db difference} = 20 \log_{10} \frac{V_1}{V_2}$$

$$\text{db} = 20 \log_{10} \frac{50}{31} = 4.1$$

$$\text{Ratio} \frac{50}{31} = 1.6$$

From db tables this corresponds to 4.1 db.

## Strays

Who has the longest transmitting antenna? Here's one claim for the title—W3AAF has one 540 feet long. Any bigger ones?

Inquiries occasionally come in about the code-practice phonograph records which some years ago were quite popular for self-instruction in receiving. The RCA—Victor Company advises that these are still available. The complete set consists of six ten-inch double-face records, an instruction booklet and a special container. They may be procured through any Victor record dealer.

# Progress on 28 Mc.

## More Activity Needed—First Transatlantic Report in Years

**W**ORK on the "10-meter" band has been going on apace for the past six weeks, building up more stations and better contacts until latter May and mid-June finds the band "ripe" as far as everyday, general contacts are concerned. Each year with the coming of warm weather and attendant DX and local work on the 14-mc. band has awakened that tireless group of experimenters who ply their QSO's on 28 mc. This band has been one of our most eccentric stamping grounds but, during the past five years, summer months have always brought forth contacts on this band.

Last summer the Experimenters' Section of *QST* compiled reports and a weekly bulletin was sent to active amateurs operating on ten meters, styled the *Temegang*. In this way all interested knew of conditions at different localities much quicker than monthly bulletins or *QST* could reach them. Week-end tests were also sponsored.

Perhaps the most accurate way to see conditions as they stand at the moment is to note reports of stations who are active and what they have reported in the past month.

W1CKF in Middle Haddam, Conn., has spent many hours on 28 mc., using both 'phone and c.w., as reported in *QST*. Nothing special was done in way of contacts until middle May. Since that time weekly reports have been received, each more enthusiastic than the former. Since the first of June VE4, VE5 and W4, 6, 7, 8 and 9 districts have been heard. Contacts have been made with W4 and W9. W1CCX reports W4MR, W4BFH, W4AJO and several W1's in an hour's listening on June 3d. W1ZB heard W4BFH, W4AJY, W4AJX and worked W4MR on the same day. W1CUN of Bethlehem, N. H. (in White Mountains), has done much work on 28 mc. Since May 27th QSO's have been had with W9GFZ, W2DAR, W3AUX, W4MR, W8DJJ, W8IXS, W9BRX, W9FFQ, W9NY, W9BQM and VE4OB. Other stations heard include W2TP, W3BBB, W4AJX, W8DVX, W9DII and the two police 'phones around 9 meters, W4XK and W4XR. W1CUN's outfit consists of a pair of '45's as a TNT oscillator and 'phone has been used with another '45 as a modulator!

Recent reports have not been received from the 2d and 3d districts, but from the above it will be noted that there are stations active in these districts.

The only report from the 4th comes from W4TZ who has contacted the west coast by a QSO with W6GM on May 27th. Other QSO's have been had with W2JN, W2TP, W2BHD, W4AJX, W9GFZ and W9DZX. Hunter says

that he hears Central American stations every day, and believes that active stations in South America would break through just as well. Here

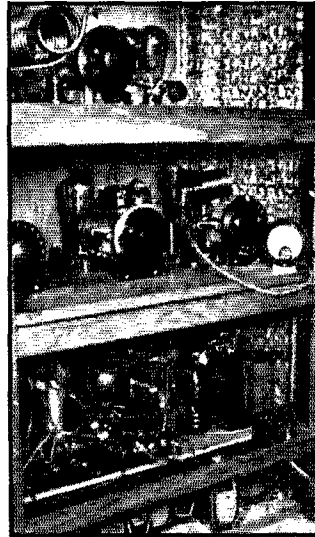

G2OA, OWNED BY JIM DAVIES OF CHESHIRE, ENGLAND

Past seasons have found this station among the active stations on 28 mc. The final stage has an input of 60 watts.

are some harmonics copied on 28 mc. at W4TZ: W1ZD, W1BES, W1DHE, W1HP, W1HTA, W1LZ, W2TP, W2BAZ, W2CXU, W2CDA, W2UK, W2GOX, W2AMP, W2EYZ, W3BPH, W3ANS, W3BBB, W3COP, W3CJN, W5ABL, W5NW, W5AQS, W5CDH, W6QD, W8BTK, W8HYZ, W8CRA, W8CCW, W8ZY, W8DHC, W8DPO, W9ROL, LU4DQ, K5AF, NY2AB, HC1JW, HC1FG, HC5ZA, VE2FQ and VP5PZ.

W5BD reported QSO W6CAL during March and heard W6MHG and W6MX. No recent reports have been received from this station.

W9GFZ reports hearing many stations in the past two weeks, including W3CIC, W7VY, W5AFV, W5BG, W8ILA, W8EFP, W3ANH, W3BPH, W2CGX, W9RHK, W1DNL, W3CJN and W8CTE. The stations worked include W4TZ, W1CUN, W3AUX, W2CRT, and W2TP. W9ELQ reports hearing W1CKF and says that W9ELQ will be on every Sunday morning. A note quoted in part from W9DZX says, "For the past week 28 mc. sure has been FB here. Have heard W2TP, W9EKU, W9NY, W3AXU, W9PVC, W4TZ and numerous harmonics from 14. Have heard other 28-mc. stations, but failed to get the

calls. I've been keeping a sked with W4TZ for the past four nights, and we have been QSO as late as 9:30 p.m. EST with sigs R4 or better at each end. . . . All's wrong with '28' now is lack of stations there. Wish the gang would get going there."

That last sentiment seems to be echoed in every report we have seen. Apparently the band has opened up a month earlier this year than last and with a great deal more enthusiasm.

W9NY of Milwaukee, Wisc., reports hearing W8HEQ, W9AUH, W9HUI, W9PTU, W9BPL, W3CPX, W2CVR, W2AND, W1DOX, W2CDA, W2CTO, W1CUN, W8DVS and W3BBB. W2TP, W2CRT and W3AUX have been worked.

Mr. R. B. Marberry of 604 S. Busey Ave., Urbana, Ill., reports hearing the following stations during May on 28 mc.: W8CPO, W2EUG, W2EYZ, W3BBB, W8YA, W3CKT, W1RY, W4TZ, W1HM, W2CZO, W2DMO, W2DMS, W2AMP, W2ECU, W8DHC, W2AIW, W3COP, W8LXS, W8CXF, W2GOX, W8IZW, W3MD, W9NY, W3LX, W9GXI, W9NUG, W2TP, W3CCU and W3AJP.

X1AY, B. J. Kroger of old 3APV fame in '24 writes from Ixtacehuatl, Mexico, that he's back on the air on 28 mc. He mentions some times he will transmit on Sundays: 11:15 to 11:30 a.m.,

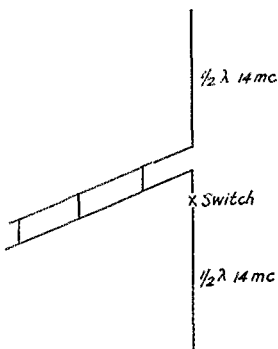

THE ANTENNA USED BY W4TZ

This antenna has been used very effectively on 28, 14 and 7 mc., with series tuning in all cases as the feeders happen to be about 130 feet long. The bottom leg of the antenna is only used when operating on 7 mc.

11:45 to noon, 12:15 to 12:30 p.m. and 12:45 to 1 p.m. Listening will be done between transmitting schedules and times given are CST.

VE3YY reports hearing W9LL, W8RT, W4MR and W2AOL.

Topping these reports comes a note from OK1AW saying that contacts were had with G2FN, PA0APX, F8OZ, ON4GN, G5OJ and G5FV on May 22d. A daily schedule is kept after 1700 GT and Saturdays between 1230 and 1330 GT. The frequency used is 28190 kc. On June 1st a radiogram was relayed from OK1AW via W1GCX which said that W2ZJ was heard by

OK1AW at 6:15 p.m. on June 1st. This is the first transatlantic reception on 28 mc. that we have heard of in two years! The summer is still young.

Week-ends seem to be the popular times for contact as well as the two hours before darkness every evening. Practically all of the stations mentioned have used less than 50 watts. Receivers used are in most cases of the simpler variety. Report all activity to ARRL Hq. for inclusion in bulletins and mention in QST.

—C. C. R.

## Strays

The turns of transmitting coils wound with No. 14 or larger wire can be spaced quite easily by using a section from one of the old inside spring antennas, if one which fits tightly on the coil form is available. It will slide along as the regular winding is put on, will hold tight enough to give good spacing, and will unscrew or pull off easily after the coil is completed. The spacing coil should have about the same number of turns as the coil to be wound.

—W3AAJ

Sponge earphone cushions are just the thing for the fellow who wears glasses. If regular cushions are unobtainable, rubber sponges with holes in them will make a good substitute.

—W3EDG

A new "solution" for shining up copper tubing is suggested by W8LLI. It consists of a cup of vinegar with three tablespoonfuls of salt. Rub the tubing with the mixture, rinse, and dry; W8LLI guarantees that a fine lustre will result.

On April 9th, W6DCP, K6JJP, K6EWQ and K7CHP got together for a four-way DX round-table QSO which lasted an hour and ten minutes. The distance around the triangle is approximately 10,000 miles. FB, OM's!

We learn that a certain third district station recently spent a "profitable" afternoon attempting to get a transmitter going on 10 meters. A Type 10 lasted but a few minutes, followed immediately by a pair of 81's. Thinking a larger tube would stand the gaff, a 203-A was put in the circuit along with the spare pair of 81's. With the first punch of the key the 203-A smacked against the plate and the second pair of 81's went west! At least one W3 is going to stick to the lower frequencies!

At the Hudson Division Convention W2AKF and W2AIS drew a great deal of attention by their demonstration of the Ultra-Midget (described in June QST). It was difficult to convince most of the fellows that the power supply was not hidden under the table!

—W2CPG



# A Modern Transportable Station

A Design in Which Compactness and Light Weight Are Attained Without Sacrifice in Performance

By Harvel Baker, W7ALH\*

EVERY fellow has his own ideas about the design and construction of portable stations. Some persons aim toward extreme compactness at a sacrifice of power and operating convenience. Many portable stations that possess a reasonable amount of power output are equipped with battery receivers that employ antiquated circuits. This type station, which is usually in addition to a better-equipped home station, has its uses, of course, but the disadvantages are far too numerous.

Of course there is the opposite extreme—"portable" stations in two or three separate units, the whole making a clumsy affair that is really neither portable nor practical. The station described here was designed to be entirely practical—for the average ham of average means. It is not elaborate

and may be operated on any of the four most-used amateur bands. The entire outfit weighs less than 40 pounds and may be carried as

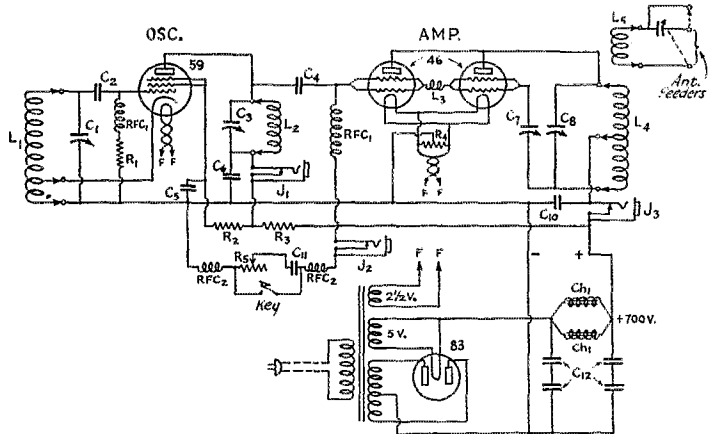
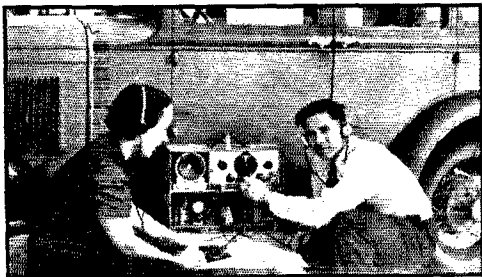

FIG. 1—CIRCUIT OF THE TRANSMITTER AND POWER SUPPLY UNITS. ALTHOUGH THE ELECTRON-COUPLED OSCILLATOR CONNECTION IS SHOWN, THE OSCILLATOR IS ALSO ADAPTED TO TRI-TET CRYSTAL CONTROL AS SHOWN IN NOV., 1933, QST

- L<sub>1</sub>, L<sub>2</sub>, L<sub>4</sub> and L<sub>5</sub> are as specified for the Universal Exciter Unit, Nov., 1933, QST. L<sub>5</sub> is wound to suit the antenna system used.
- L<sub>3</sub>—Parasitic suppressor choke, 20 turns of 1/4-inch diameter.
- C<sub>1</sub>—500-µfd. receiving type variable.
- C<sub>2</sub>—250-µfd. mica grid condenser.
- C<sub>3</sub>—100-µfd. midget variable.
- C<sub>4</sub>—100-µfd. mica coupling condenser.
- C<sub>5</sub> and C<sub>6</sub>—0.005-µfd. mica r.f. by-pass condensers.
- C<sub>7</sub>—50-µfd. midget neutralizing condenser.
- C<sub>8</sub>—100-µfd. variable (500-µfd. split and double spaced).
- C<sub>9</sub>—350-µfd. variable.
- C<sub>10</sub>—0.006-µfd. mica by-pass (1000-volt or higher).
- C<sub>11</sub>—1-µfd. click-filter condenser.
- C<sub>12</sub>—8-µfd. 450-volt electrolytics.
- R<sub>1</sub>—50,000-ohm 2-watt.
- R<sub>2</sub>—40,000-ohm 2-watt.
- R<sub>3</sub>—12,000-ohm 10-watt wire-wound.
- R<sub>4</sub>—20-ohm center-tapped.
- R<sub>5</sub>—0-1000-ohm variable click-filter resistor.
- J<sub>1</sub> and J<sub>2</sub>—Plate-current jacks.
- J<sub>3</sub>—Amplifier grid-current jack.
- Jacks used with a 0-150 d.c. milliammeter equipped with plug and cord, plug sleeve connected to positive meter terminal.
- RFC<sub>1</sub>—2.5-mh. r.f. chokes.
- RFC<sub>2</sub>—60-mh. broadcast-band type r.f. chokes (click filter).
- T—Power transformer, plate winding 450 volts each side of center tap, 150 ma.; filament windings, 2.5 volts at 5.5 amp. and 5 volts at 3 amp.
- CH<sub>1</sub>—30-henry receiver power-pack type chokes (see text).



W7AYO, S.C.M. of Washington, and his sister do some open-air brass-pounding with the author's portable. A.C. operated, the outfit is especially suitable for hotel, tourist-camp, and similar locations where a.c. supply is generally available.

rate, yet has all the essential features of a good, low-powered modern station.

The entire equipment is a.c. operated. The receiver uses a tuned radio-frequency stage and gives ample output for speaker operation. The transmitter is capable of 30 watts output on 3.5

\* Farm Bureau News, Oak Harbor, Wash.

easily as an ordinary suitcase. It gives creditable performance in practically any location where 110 volts a.c. is available, and may be set up and ready to go on the air within a few minutes. The station is inexpensive, uses the latest circuits and tubes. While it is a portable, it is plenty good for the home station as well.

In designing the station, compactness, light weight, economy, operating convenience, high-quality signals and sufficient output for all ordinary purposes were considered. The idea of a battery receiver was at once discarded as a much more efficient circuit with plenty of output is possible with the new a.c. tubes. The circuit selected employs a 58 tuned r.f., a 58 detector and a 56 audio impedance coupled to the detector. The receiver closely follows the one described in January, 1933, *QST*, and in the current *Handbook*, to which the reader is referred for the actual circuit details.

The second unit—the receiver power pack and speaker—fits in the carrying case to the left of the receiver. A midget power transformer with

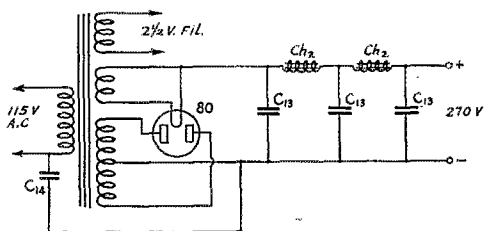

**FIG. 2—CIRCUIT OF THE RECEIVER POWER PACK**  
*C<sub>13</sub>*—8- $\mu$ fd. electrolytic filter condensers.  
*C<sub>14</sub>*—0.006- $\mu$ fd. mica condenser.  
*T<sub>2</sub>*—Midget type power transformer, plate winding 250 volts each side center, 2.5- and 5-volt filament windings.  
*CH<sub>2</sub>*—Receiver-type 30-henry chokes.

280 rectifier, two 30-henry chokes and three 8 $\mu$ fd. electrolytic condensers make up the power pack. The addition of two small by-pass condensers makes this arrangement entirely hum-free on all wavelengths as low as 16 meters, and gives enough voltage so the tubes may work at their fullest efficiency. Strong speaker signals may be obtained on the midget magnetic speaker which fits directly in front of the power pack. Band-spread is of course employed with the receiver and plug-in coils for continuous coverage from 16 to 350 meters are carried behind the receiver panel.

The transmitter unit presented more of a problem. In view of economy and efficiency with the latest circuit, the transmitter was designed to use either an electron-coupled or crystal-control tri-tet oscillator with a Type 59 tube, capacity coupled to a pair of 46's operated in parallel with the split-stator final tuning condenser as described in January, 1934, *QST*. Type 46 tubes are low-priced, give reasonable output on low voltage and make a simple keying arrangement possible.

The stability when the electron-coupled arrangement is used is comparable to that with crystal control. There was apparently no loss in efficiency in crowding the transmitter parts together.

Power for the transmitter is furnished by a standard 450-volt power transformer with filament windings for both the transmitter and the Type 83 rectifier. Using condenser input, fairly good

regulation is obtained with an output of 525 volts at 100 ma. The cost of the power pack, using new parts throughout, was less than five dollars. The filter uses four electrolytic condensers, two connected in series before the choke and two in series after the choke. The choke is a double 30-henry receiver type with the sections connected in parallel. Pure d.c. signals are obtained with this power pack.

In placement of parts, the transmitter with its power pack are put in the lower two compartments and the receiver with its power pack fill the upper two. The power packs are placed in opposite ends, so their weight tends to balance the carrying case.

The carrying case is made of three-ply veneer and is braced throughout with small iron angles. This gives a light yet strong carrying case that will stand many a bump. Dimensions of the different units are: Receiver, 12 inches long by 6 inches high by 6 $\frac{1}{2}$  inches deep (overall); receiver power pack, 6 inches long by 6 $\frac{1}{4}$  inches high by 6 $\frac{1}{2}$  inches deep; transmitter, 12 inches long by 6 inches high by 7 inches deep; transmitter power pack, 6 inches long by 7 inches deep by 6 $\frac{1}{2}$  inches high. The overall inside dimensions of the carrying case are 18 $\frac{1}{2}$  inches long by 7 inches deep by 13 $\frac{1}{2}$  inches high. The weight of the complete station, ready to carry, is 38 pounds—not much weight considering the contents.

By having the station built in small convenient units, the component parts may be slipped out of

(Continued on page 50)

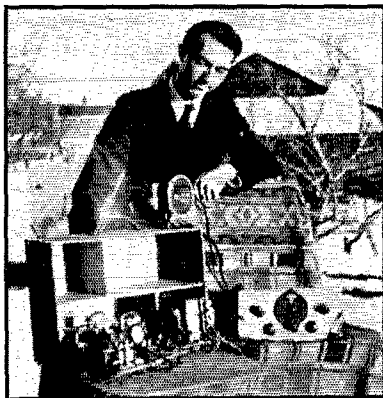

Illustrating the sectional-type assembly and how the units may be slipped out of the carrying case. The receiver power pack and speaker unit is the one atop the case. The transmitter is at the left, with its power pack to its right. The receiver, an electrical duplicate of the January, 1933, *QST* "Autodyne," is at the extreme right.

# A Relay Rack for Two Dollars

By J. M. Carstarphen, Jr., W4CCH\*

**T**HE advantages of the relay rack for transmitter construction are universally acknowledged, but from the amateur's standpoint the manufactured article has two serious drawbacks—cost and weight. It is not difficult, however, to build a light-weight rack which offers the benefits of ready access to ap-

and twisted at one end for fastening to the wooden uprights. Fig. 2 shows the construction quite clearly. The brackets, if not too long, will support an r.f. unit easily with no additional bracing. The brackets holding the power-supply shelves had best be given additional support by an extra brace of the type also shown in Fig. 2. In making the shelf brackets, those intended for the right-hand side of the rack (from the front) should be twisted to the right; those for the left-hand side should be twisted in the other direction. This brings the supporting surface to the inside so that a shelf cut to fit between the uprights (approximately 18 inches) will have plenty of surface to rest upon.

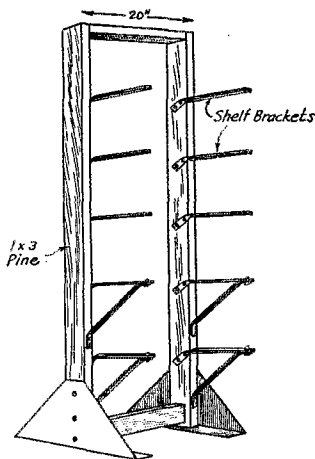

FIG. 1—ESSENTIALS OF THE INEXPENSIVE RELAY RACK

Strap-iron brackets are firmly secured to wooden uprights. The feet are cut from sheet metal.

paratus and economy of floor space occupied by the transmitter. The cost, too, can be low—the rack described here costs but two dollars, within a few cents, including such outside labor as had to be performed on the metal parts.

The general construction of the rack is shown in Fig. 1. The uprights and top and bottom crosspieces are made of 1- by 3-inch clear pine. In picking out the wood it is advisable to go to the lumber yard yourself and make sure that the pieces are straight. The uprights can be made any height suitable for the transmitter to be placed on the rack; in my case the rack is 4 feet 2 inches high. The total width is 20 inches, leaving an 18-inch space between the insides of the uprights, and permitting the use of a 19-inch panel.

Special brackets support the baseboards holding the various r.f. and power-supply units. These brackets are made of strap iron, wide enough to give solid support to the baseboards,



BREADBOARD TRANSMITTER UNITS REST ON THE BRACKETS PROJECTING FROM THE UPRIGHTS

This is a view of the rack with the panel removed. Every piece of apparatus is easily accessible from the rear and sides.

proximately 70 pounds. The important dimensions are given in Fig. 2. The bent-under portion which rests on the floor is about 3 inches wide.

The strap-iron brackets can be turned out in short order by your local blacksmith. He has the facilities for heating the iron and making the twists—and, incidentally, it's a good idea to have him drill the holes as well, because the iron is

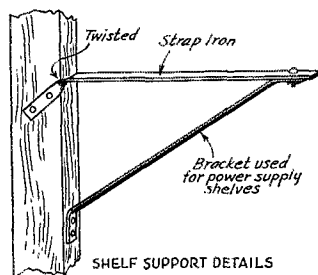

FIG. 2—SHELF-SUPPORT AND MOUNTING-FEET DETAILS

\*1000 St. Patrick St., Tarboro, N. C.

(Continued on page 70)

# Typical Technical Questions Answered

## Circuit Values for License Manual 'Phone—1750-kc. Coils and Modulator for 100-Watt Three-Tube Transmitter—High-Frequency Band Coils for "Low Cost" 1750-kc. 'Phone-C.W. Set

**W**E HAVE received numerous requests for a list of suitable circuit values for the diagram of the complete 'phone transmitter shown in *The Radio Amateur's License Manual* and reproduced in Fig. 1. For those who wish to construct such a 'phone transmitter the following circuit values are suggested:

### OSCILLATOR

Grid leak—5000 ohms 2-watt.  
Screen voltage dropping resistor—50,000-ohm 5-watt.  
Plate tuning condenser—250- $\mu$ fd. receiving type.  
Oscillator-buffer coupling condenser—100- $\mu$ fd., mica receiving type.  
Plate voltage dropping resistor—3000-ohm 5-watt.

### BUFFER AMPLIFIER

Grid leak—5000-ohm 5-watt.  
Neutralizing condenser—25- $\mu$ fd. double-spaced.  
Plate tank condenser—100- $\mu$ fd. total (200- $\mu$ fd. per section).  
Buffer-Final Amplifier coupling condensers—100- $\mu$ fd. each, mica receiving.

### FINAL AMPLIFIER

Neutralizing condensers—25- $\mu$ fd. double-spaced.  
Grid leak—5000-ohm 5-watt.  
Plate tank condenser—100- $\mu$ fd. total (200- $\mu$ fd. per section).  
Plate by-pass condenser—0.001- $\mu$ fd. mica receiving.

### 27 SPEECH AMPLIFIER

Microphone transformer—single-button type.  
Gain control—500,000-ohm potentiometer.  
Cathode resistor—4000-ohm 1-watt.  
Cathode by-pass condenser—4- $\mu$ fd.  
Plate circuit by-pass condenser—2- $\mu$ fd.  
Speech amplifier-driver coupling transformer—1-to-2 ratio (step-up) interstage, push-pull secondary.

### CLASS-A DRIVER

Grid suppressor resistors—100-ohm 1-watt.  
Cathode resistor—550-ohm 2-watt.  
Cathode by-pass condenser—4- $\mu$ fd.

### CLASS-B MODULATOR

Class-B input transformer—Thordarson T-5100, Kenyon BMI, Collins 719 or equivalent.

Class-B output transformer—Thordarson T-6425, Kenyon BMO, Collins 780 or equivalent.

### POWER SUPPLY

Input choke—Swinging type, rated at 10 to 12 hys. at 250 ma.  
Smoothing choke—20-hy. 250-ma.  
Filter condensers—Each 4- $\mu$ fd. 1000-volt.  
Bleeder resistance—25,000-ohm (tapped every 2500 ohms) 50-watt.  
Plate transformer—400 ma., 600 to 700 volts each side of center tap.  
Filament transformer—Rectifier, 2½-volt 10-amp.; F<sub>1</sub>, 7½-volt 8-amp.; F<sub>2</sub>, 2½-volt 7½-amp.

### GENERAL

All r.f. chokes—Receiving type Hammarlund, National Type 100 or equivalent.  
All grid circuit by-pass condensers—0.001- $\mu$ fd. mica receiving.  
All plate circuit by-pass condensers except final amplifier—0.002- $\mu$ fd. mica receiving.  
Final amp. plate by-pass condenser—0.001- $\mu$ fd. 5000-volt mica.  
All filament by-pass condensers—0.001- $\mu$ fd. receiving.

### COIL SPECIFICATIONS

For the 1800- and 3900-kc. 'phone bands, the oscillator tank coils may consist of 25, and 10 turns, respectively, of No. 14 d.c.c. wire 2½ inches diameter. These coils should be tapped at approximately one-third of the total number of turns from the plate ends. For 14-mc. operation a 7-mc. crystal must be used and the frequency doubled in the buffer stage. The 7-mc. oscillator coil may consist of 5 turns of No. 14 d.c.c. wire 2 inches in diameter or 4 turns 2½ inches in diameter. For the 1750-kc. 'phone band, the buffer tank coil should consist of 53 turns of No. 14 d.c.c. wire 2½ inches in diameter; for the 3900-kc. 'phone band, 29 turns of No. 12 wire 2½ inches diameter, turns spaced the diameter of the wire; and for the 14-mc. 'phone band, 5 turns of No. 12 wire 2 inches in diameter, turns spaced the diameter of the wire.

For the output amplifier tank coil, 53 turns No. 14 d.c.c. wire 2½ inches in diameter or 50 turns No. 10 d.c.c. wire 3 inches in diameter may be used for the 1800-kc. 'phone band; 24 turns of ¼ inch copper tubing 4 inches in diameter with ½ inch spacing between turns, or 29 turns of

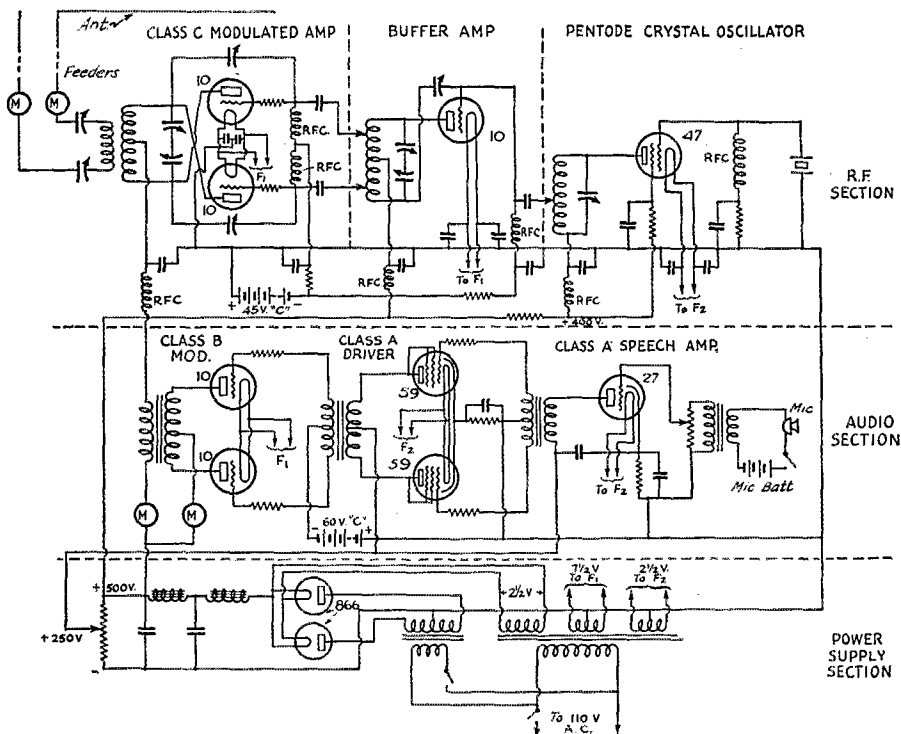

FIG. 1—DIAGRAM OF 'PHONE TRANSMITTER SHOWN IN THE RADIO AMATEUR'S LICENSE MANUAL

No. 12 wire  $2\frac{1}{2}$  inches in diameter, turns spaced the diameter of the wire, for the 3900-kc. 'phone band; and 5 turns  $\frac{1}{4}$  inch copper tubing 3 inches in diameter with  $\frac{1}{8}$  inch spacing between turns, or 5 turns No. 12 wire 2 inches in diameter, turns spaced the diameter of the wire, for the 14-mc. 'phone band.

The antenna tuning condensers should have a maximum capacity of 250 to 500  $\mu$ fd. The dimensions of the antenna coupling coils will, of course, depend upon the type and size of antenna used.

\* \* \*

Many also are interested in 1750-kc. operation of the 100-watt 3-tube transmitters described in *QST* for November, 1931 and February, 1934, and also in recent editions of the *Handbook*. For either version, an oscillator tank coil consisting of 25 turns No. 14 d.c. wire  $2\frac{1}{2}$  inches in diameter, or 35 turns 2 inches in diameter, should be satisfactory. Also, in either case the buffer tank coil may consist of 55 turns No. 14 d.c.c. wire 2 inches in diameter tapped at approximately 20 turns from the lower end of the coil, or 40 turns  $2\frac{1}{2}$  inches in diameter tapped at 15 turns from the lower end. For the older version of this transmitter, which uses a 250- $\mu$ fd. single stator condenser in the output amplifier tank circuit, the

1750-kc. coil may consist of 20 turns of  $\frac{1}{4}$ -inch copper tubing 6 inches in diameter; or if this is deemed too cumbersome, a coil consisting of 45 turns of No. 12 wire  $2\frac{1}{2}$  inches in diameter, with turns spaced the diameter of the wire, will be satisfactory. Either of these coils should be tapped at approximately one-third to one-half the total number of turns from the lower end. A copper tubing output tank coil for the 1750-kc. band for the improved version of this transmitter, the description of which appeared in *QST* for February, would be entirely too bulky to handle conveniently. One made of 50 turns of No. 12 wire 3 inches in diameter should be satisfactory.

For those who are looking for a proper modulator for these transmitters, the one described in *QST* for January and in the *Handbook* on page 124 should be just the thing.

\* \* \*

Many of those who built the "Low-Cost 1750-Kc. 'Phone-C.W. Transmitter" described in *QST* for July and August, 1932 (which issues are now out of print), desire coil specifications for 'phone or c.w. operation in other bands. Suitable coil dimensions for operation in the other bands are as follows:

(Continued on page 68)

# H A M D O M



**M**ANY amateurs have achieved prominence in professional radio, but few as spectacularly as Elizabeth M. Zandonini, W3CDQ, radio aide at the Bureau of Standards in Washington. Her first interest in radio was during her third year at high school; during the summer months of 1917 she attended the National Radio Institute and secured her commercial ticket. Later, she



taught at the school, and during 1919-20 was radio instructor (Women's Radio Corps) at Camp Meade and Fort McHenry. In 1921 she joined the Bureau of Standards. Her work there is to assist in maintaining the primary frequency standard, prepare the I.R.E. Proceedings reference lists, translate technical articles and letters (an

accomplished linguist, she is fluent in Spanish, German, French and Italian), and handle many miscellaneous public contact jobs. On a trip abroad in 1926 and again in 1928 she cemented many friendships made over the air. Yes, EMZ's a real ham, and she's no more proud of that than we are!

**C**LYDE DE VINNA began pounding brass on the railroad when he was 14 — a good many years ago — and he's still pounding it in places far away and near. His early ham experience was about 1908; then the U. S. Navy with spark gaps and Leyden jars from 1909 to 1913; eventually the Benwood rotary and United Wireless "coffins" until the neighbors objected and he closed the station. Years later, on a motion picture trip to Tahiti, he struck up a friendship with F3OCB ("BAM" in the old days) and discovered that with a couple of insignificant bottles he was chewing the fat with hams all over the world. The bug bit again—hard—and W6OJ came into being. It's been active, either in Hollywood or following De Vinna on one of his motion picture expeditions, ever since. He's chief cinematographer for M-G-M, as you probably know—among his



triumphs are "White Shadows of the South Seas," "Trader Horn," and "Eskimo." Where he will head next, he doesn't know, but wherever it may be the little old portable will follow as a boon companion, as ever.

**I**N 1906, he used a nickle-and-dime coherer-decoherer to warn a friendly druggist of approaching storms. In 1920 work began in earnest with a 1 kw. Acme and Dubilier condensers at Camp Pike, Little Rock, Ark. That was when Captain Norman Lee Baldwin started to earn his reputation in Hamdom. In the winter of '20-21, as 5YH, he acted as west coast link station with Johnny Clayton, and participated in the early transcons. He went to China in '21; in February, 1924, he heard the first west coast stations in Peking. Back from China, in 1925, to the signal school at Fort Monmouth, and from there to the Michigan National Guard—nu8DKX. In 1929 he went back to Fort Monmouth to take over the Army Amateur Radio System. It stands today as a monument to his efforts. He built the system up from 38 stations in 1929 to over a thousand, when Capt. Black took over last year. He leaves soon for a new tour of duty in the Philippines—GL, BN, and CUL.



**F**RANK M. CORLETT, W5ZC, director of the West Gulf Division, is the senior member of the A.R.R.L. Board of Directors. He was first elected in 1917, and is the only director the West Gulf Division has ever had. His amateur career started back before the first radio law.

From 1913 to 1925 he was president of the Dallas Radio Club, of which he was one of the founders. He served the A.R.R.L. as division manager from 1920 to 1926, in addition to the directorship. To add to the family laurels, Mrs. Corlett, having lived patiently with a ham husband since 1921,

(Continued on page 38)

# Ham Radio in Japan

## The Description of a Typical Station, J2HZ

By W. S. Upson\*

A JAPANESE amateur station is, perhaps, one of the very hardest to describe, since the home, the conditions surrounding the station, and the materials themselves are different to any we come in contact with on this side of the Pacific. However, at the request of several of the Yokohama Amateurs, I'll try to describe Mr. Oshima's set and the description is likely to run into other things than radio.

Japan is, perhaps, the most mountainous country in the world and Yokohama is one of the hilliest cities in the world—as anyone who has walked into the outlying sections can tell you. Any amateur knows that this brings about a condition very unfavorable to radio transmission and reception. To most of us, obstacles of this nature would be overcome by the use of brute force. In Japan, though, all hams are limited to an input of ten watts and brute force is “out” from the start. Oshima is located in one of the most hilly portions of Yokohama. From his home can be seen nearly the whole of Yokohama and part of the great Tokio Bay. His home is nearly on the top of a hill with an opening between two hills, which seems to give his signals a straight sweep out to sea and beyond to our United States.

Now, try to picture a Japanese home. Nearly all Japanese homes are solidly built of wood. Not the squared beams and finished T and G of our homes but the solid branches of trees for beams. Finished wood is used, however, for door and window sashes. Doors and windows all slide in grooves and are constructed like our own windows except that paper is used for panes rather than glass. Usually three sides of a room are constructed of these sliding doors or windows. Thus, in warm weather, the house can be opened, permitting whatever breeze there is to sweep through it. Even the poorest Japanese homes have a garden and all homes are surrounded by a fence or hedge with a gate. All homes have a little alcove in which the

shoes are removed before the house is entered. The floors are all highly polished by the feet or stockings of the inmates and are made, usually, of a dark hard wood similar to Philippine mahogany.

One enters Oshima's outer gate of unpainted wood, and passes through to the “shoe-off place.” His mother, a very tiny, sweet little lady, kneels just inside the entrance door to welcome the guests as they enter. The guests bow to the floor and follow Oshima to his radio-room in the back of the house. Now, many of the Japanese homes do not have chairs of any kind. A Japanese man or woman is far more comfortable sitting on a cushion on the floor than on a chair. Oshima's radio-room is fitted out with operating table and chairs, however, and looks like any other ham shack except for the sliding paper window. Before one has a chance to look at a set or the equipment Oshima's mother enters with a tray of cakes and the customary tea for the visitors.

Now for the sets. The receiver is the conventional tuned radio-frequency set, using one stage of tuned radio frequency, detector and two audio stages. It is mounted in an aluminum case that would make a professional green with envy. It is highly polished and needs but a glance to show the care and workmanship that has gone into the set. How would you like to sit in your shack at two or three in the afternoon and hear signals from England, the United States, the Philippines, not to mention China and Guam. That is what I heard on the afternoon of the last visit with Mr. Oshima. Not only that, but with a short, snappy, fast call on the bug, he landed W6CXW in Long Beach and

was given a signal report of R7 QSA5. How do you like those apples? And by the way, it happened on the forty-meter band. One thing to be remembered is that there is very little QRM in comparison to what we find in our country. As a matter of fact, Japanese amateurs complain more of interference from the Philippines than from

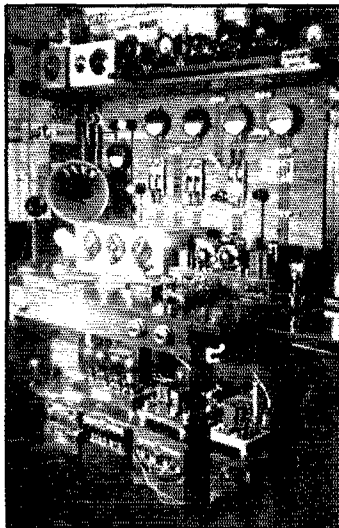

THIS MODERN JAPANESE STATION SIGNS J2HZ, EX J1FF

\* Radio Operator, S. S. Frank H. Buck, Associated Oil Co., Associated, Cal.

their own stations. This because all Japanese stations are *pure d.c.* The receiver is no different from thousands of others you have seen except—each part shows the care and patience of the builder. No part was installed until it was tested and experiments proved it to be worthy. Even after installation in the set, each part was tested and proved again and again until the set reached its maximum efficiency. That is the reason for Japanese DX as far as reception is concerned.

The transmitter is a fit running mate for the receiver. It consists of crystal stage, buffer, intermediate stage and the output stage. Japanese tubes are used throughout, of course. I wish that you could see that crystal stage. Precision is the keynote. One gathers the impression that the finest of micrometers and calipers were used in its construction. You all know more about the circuit than I do so I'll not go into that. The transmitter proper is placed on a shelf over the receiver and all switches are mounted on the table at the right hand of the operator. The leads from switches to set are run up the wall in parallel lines and are, of course, mounted on insulators, which are polished, giving the lines the finished appearance of the rest of the equipment. Each unit is separate and can be put in or out at the operator's will. The last stage is a Japanese fifty-watt tube but input is carefully limited to the ten watts permitted by law.

Oshima's DX seems to be unlimited. I wonder how many of you remember a cover that appeared on *QST*, way back about 1922 or possibly before? It showed an American amateur with QSL cards from all the world, some on the walls, some on the floor, while he stands with a handful just received. Oshima's shack reminds one of that picture. Finland, South Africa, England, Germany, France, Poland, Sweden, Chican, the Philippines, Guam, America, both North and South, Cuba, Porto Rico and others make up the list. And here is the joke. He is not a DX hound in any sense of the word. He much prefers to chew the rag and is a member of the Rag-Chewers Club as well as being a WAC.

The antenna would probably be heartily laughed at in the States but it seems to do the work. It is a single wire and a very light wire at that. Hi-pressure antennas do not seem to be very popular in Japan. The simple antenna and ground are used in ninety-nine percent of the stations and seem to function perfectly.

It is a shame that I am unable to give you a more technical layout of Mr. Oshima's installa-

tion. But, if you wish more information, I am sure that he will be glad to give you any you desire. The photograph will give you an idea of the appearance of the station and of the man

himself. Mr. Oshima is a student of engineering and economics at the University of Tokio. He speaks good English, as do most of the amateurs of Japan. His home, like his station, is a gem in a perfect setting. He is very anxious to visit our country and hopes to do so after completing his course at the University. He is alert, intelligent, happy and carefree and, as I can testify, surely enjoys a good time. It seems to me that he is a typical Japanese amateur of to-day. One look at Oshima's QSL card will convince you of the hearty good will displayed by Japanese hamdom. Considerable pain

and exactness, coupled with humor, seems to permeate the J's.

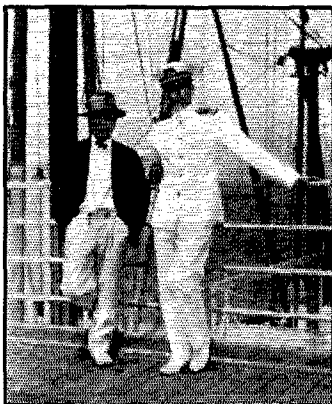

J2HY AND THE AUTHOR

## A Modern Transportable Station

(Continued from page 24)

the case for inspection or trouble-shooting; just the receiver or just the transmitter portion may be carried along; or the parts may be taken out and arranged on the operating table to suit one's taste. The units are made as adaptable as possible so that other power packs may be used with the receiver or vice versa, and other power may be substituted for the transmitter power pack if necessary.

Anyone who has tuned transmitters using neutralized final stages will encounter little difficulty in tuning this transmitter. The only meter normally used is a small milliammeter in the grid circuit of the final stage. The grid current furnishes a sensitive indication of neutralization, and runs around 20 ma. when the transmitter is operating properly.

Many types of antennas have been tried with the portable station, the one found most useful for portable use being an arrangement using a 65-foot antenna with a 32½-foot "counterpoise." Although this is not as effective as a larger antenna, it gives satisfactory results on both 80 and 40 meters. Parallel tuning is used on 80 meters, where the antenna system is tuned as though it were a pair of Zepp feeders. A neon bulb on the counterpoise, where the voltage is sufficiently high to give an indication, helps materially in tuning up and checking the output. When the proper amount of coupling is found between the antenna coil and tank coil, the antenna tuning

(Continued on page 68)



# The Incandescent Lamp as a Resistor

F. Hamburger, Jr., W3AMM\*

**I**NCANDESCENT lamps are exceedingly useful in all types of electrical experiments. They are not only useful because they may be used as pilot lamps to indicate when power is on or off, but they fill an ever-present need in the form of resistors for many purposes.

In order that they may be used intelligently as resistors, we must bear in mind the fact that the material of which the lamp filament is made, either tungsten or carbon, has a marked variation of resistance with change in temperature. This fact is well known and has been made use of since the tungsten and carbon filaments behave quite differently with temperature changes.<sup>1</sup> We shall concern ourselves here only with the tungsten-filament lamps, since these are more readily available than the carbon filament lamps. The accompanying curve, Fig. 1, gives the temperature-resistance variation in terms of the voltage drop across the lamp and the current flowing through it. These curves are extremely helpful in selecting the proper size lamp for a given purpose.

The curves given are for a standard<sup>2</sup> make of tungsten gas-filled lamp with a voltage rating of 120 volts and must be used in connection with this type of lamp. The performance of lamps of other voltages or of other than standard quality will deviate appreciably from the curves here given.

Several examples of the method of using these curves may be helpful:

**EXAMPLE No. 1.** — Let us assume that we have a 120-volt supply and that we desire to supply a circuit with 0.65 ampere at 50 volts. Obviously we need a resistor which will drop the voltage 70 volts at 0.65 ampere. On the curve we move up the vertical 0.65 ampere line to the curve which most nearly crosses this line at 70 volts. In this case we see that it is the curve for a 100-watt lamp crossing the given current at 67.5 volts, which will be sufficiently accurate for most purposes. If more accurate control is needed, we note the following:

At 70 volts a 75-watt lamp takes 0.475 ampere, a 15-watt lamp takes 0.088 ampere, thus we can connect a 75-watt lamp in parallel with two 15-watt lamps and we will have a voltage drop of 70 volts with a current of 0.475 plus twice 0.088 or 0.651 ampere.

**EXAMPLE No. 2.** — A circuit requires 1 ampere at 18 volts. If this is to be supplied from a 120-volt line, a voltage drop of 102 volts at 1 ampere is needed. At 102 volts we note that a 150-watt lamp takes 1.157 amperes and hence is not satisfactory. A 100-watt lamp however takes 0.77 ampere at 102 volts and a 15-watt lamp takes 0.11 ampere at 102 volts, hence one 100-watt lamp in

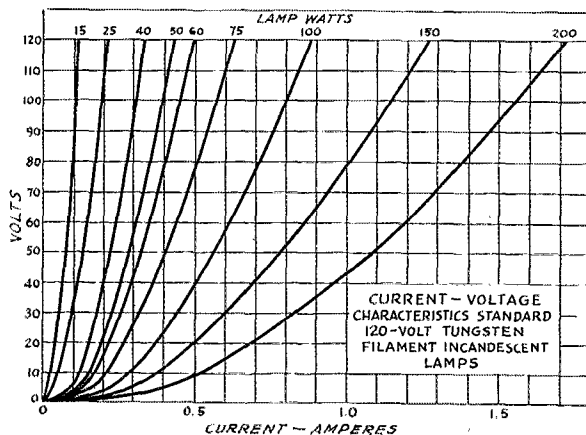

FIG. 1—CURRENT-VOLTAGE RELATIONS OF TUNGSTEN LAMPS OF STANDARD MANUFACTURE

parallel with two 15-watt lamps will take 0.77 plus twice 0.11 or 0.99 ampere and will be satisfactory.

**EXAMPLE No. 3.** — A circuit requires 0.11 ampere at 45 volts. On a 120-volt circuit the voltage must therefore be dropped 75 volts. No single lamp quite satisfies this requirement, but we note that at 0.11 ampere a 25 watt lamp has a voltage drop of 38 volts. Therefore, two 25-watt lamps in series will meet the requirement, giving a voltage drop of 76 volts at 0.11 ampere.

These examples should indicate the general method of selecting lamps as resistors for particular problems. Needless to say, the lamps should serve in a great many instances and should be particularly helpful to the electrical experimenter.

\* Instructor, School of Engineering, Johns Hopkins University, Baltimore, Maryland.

<sup>1</sup> See Redgrave, "The Light-Bulb Resistor," *QST*, March, 1934.

<sup>2</sup> The term "standard" refers to the better-known makes of lamps that are marked in small sizes for twenty cents — the cheaper or ten-cent lamps now available deviate from the curves given.

# A 14-Mc. Rotary Beam Antenna for Transmitting and Receiving

An Effective Way of Increasing Transmitted and Received Signal Strength

By John P. Shanklin, W3CIJ\*

**A**LTHOUGH the general idea of directional antennas for both transmitting and receiving has attracted the interest of most of us at one time or another, the very nature of a fixed type directional system, concentrating its

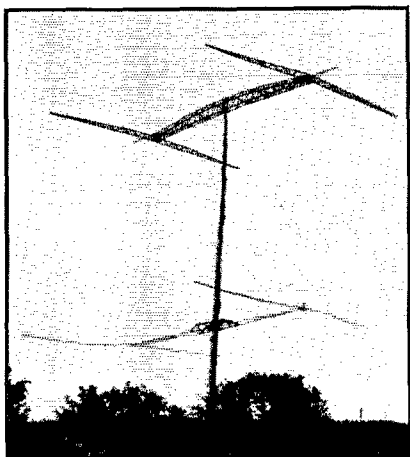

W3CIJ'S ROTARY 14-MC. BEAM ANTENNA MAKES A STRIKING APPEARANCE ON ITS PRIVATE HILL 650 FEET FROM HIS SHACK

energy along one path toward a limited group of possible receivers, runs contrary to the amateur's natural desire to communicate with anybody in almost any direction. The fixed type of directional antenna system is, therefore, of limited use in amateur work. While it may be of great advantage for communication in the particular direction toward which it points, it is a decided handicap to communication in every other direction.

What we want, then, for our work is a directive system that can be pointed in any direction. The only alternative to this would be a number of separate systems, one for each direction in which we might have occasion to work—which, of course, is completely "out" for most of us. But the antenna system of adjustable directivity is not. In fact, the rotary 14-mc. directional antenna system that has been in use at W3CIJ for some time has shown the idea to be entirely

\* Marion, Va.

practicable and, by the excellent results it has given with a 50-watt 'phone-c.w. rig, has demonstrated that such a system is more than worth the expense and work required to construct it and get it into operation.

For instance, on three typical nights when, with a good non-directional antenna, only occasional VK's were heard and these were mostly unreadable, using the beam for both transmitting and receiving seven out of eight VK's heard were worked. Five reported the 'phone readable and one QSO was entirely on 'phone. With the beam swung around to point on Europe, several good 'phone QSO's have been had with stations there, and the ease with which they have been worked has given me the idea of going after a 'phone W.A.C. as soon as time permits.

The many requests for descriptions of the system that have been received from fellows contacted while using it show that it has widespread interest among hams.

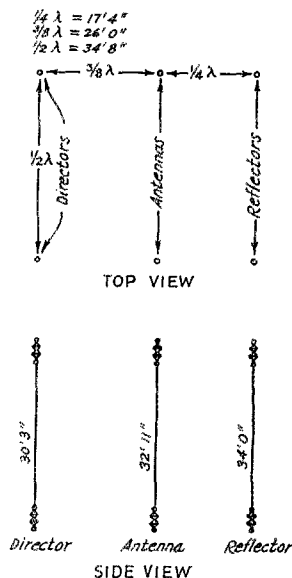

FIG. 1—SPACING AND LENGTH OF THE ELEMENTS OF THE BEAM

Note that the reflector wires are slightly longer than the antennas while the directors are slightly shorter. The percentage values are given in the text.

## DESIGN AND CONSTRUCTION

As shown by the accompanying diagrams, there are six essential elements. First there is a pair of half-wave radiators, separated a half-wave and excited in phase. These are backed up by a pair of reflectors spaced a quarter-wave behind the antennas and a half-wave from each other. Finally, there is a pair of directors in front, the latter being spaced three-eighths-wave from the radiators and one-half-wave from each other.<sup>1</sup> The direction of transmission is, of course, along a line at right angles to the plane of the radiators and from the reflectors toward the directors. The dimensional arrangement of these elements is shown in the upper part of Fig. 1. The spacings between the elements are shown in wavelength fractions and in actual dimensions for a frequency of 14,200 kc. (wave-length, 21.13 meters), the center of the 14-mc. amateur band.

The lower portion of Fig. 1, the side view, shows the lengths of the respective elements for this frequency. These were calculated on the following basis: Antenna (radiator), 95 per cent of a half-wave in length; reflectors, 98 per cent of a half-wave in length; and directors, 87 per cent of a half-wave in length. The "tuning" was done entirely with a yard-stick when the beam was put up. The experimental check with instruments, made after the power was turned on, showed that nothing needed to be changed.

Fig. 2 shows the method of feeding the antennas, the feeders being connected to the lower ends of the radiators in Zepp fashion. Transposition of the feed line half way between the two radiators, as shown, is necessary to excite the

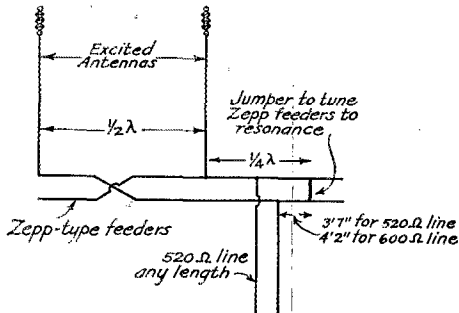

FIG. 2—HOW IMPEDANCE MATCHING IS PROVIDED AT THE ANTENNA TERMINAL OF THE TRANSMISSION LINE

The coupling idea is the same as that used in the familiar Y-fed doublet-type system.

<sup>1</sup> For a discussion of the action of wave reflectors and directors in this type of antenna system, see, "Beam Transmission of Ultra-Short Waves," by H. Yagi, *Proc. I.R.E.*, June, 1928. A similar combination was used in the 28-mc. tests at W1CCZ, described in *QST*, October, 1928, and January, 1929.—Editor.

two antennas in phase. As is also shown in this figure, the feeders are extended a quarter-wave from one of the antennas, this quarter-wave section being shorted at its outer end. This extension is used as a folded half-wave antenna

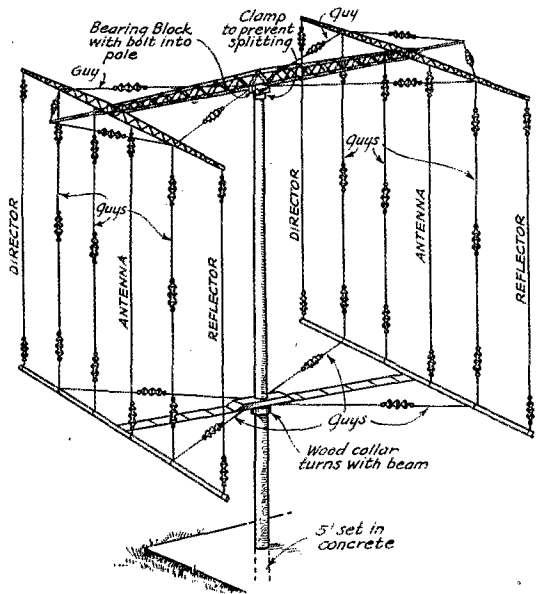

FIG. 3—A PERSPECTIVE DRAWING OF THE COMPLETE ASSEMBLY

The wood pole carrying the beam is 50 feet in height.

serving as a linear-impedance matching transformer to which the transmission line is coupled, as illustrated. It acts very much the same as a doublet-type antenna using the "Y" feed method—except that the quarter-wave section does not radiate. The transmission line used has a characteristic impedance of 520 ohms (No. 12 wire spaced 3 inches or No. 10 wire spaced 4 inches). When tapped on 3 feet 7 inches from the jumper, the whole system puts the same load on the transmitter as a 520-ohm resistance dummy load. With a 600-ohm line (No. 12 wire spaced 6 inches or No. 10 wire spaced 10 inches) the transmission line would be tapped on 4 feet 2 inches from the jumper. The 520-ohm line used here is 650 feet long.

Fig. 3 and the photograph show the complete assembly of the beam, while Fig. 4 illustrates the construction of the main girder and the end supports which carry the elements. The transmission line connections, although not shown in Fig. 3, are as previously described in connection with Fig. 1.

A good husky wooden pole of about 50-foot height carries the whole load. This is set in concrete, to insure its remaining rigidly vertical. Pine flooring and plaster lath are the materials

from which the main girder and end supports are made, the cost of the wood being about \$15 and the whole works weighing only about 300 pounds. The tongue and groove were removed from the 1-inch by 3-inch pieces of flooring to make the 3-inch pieces, and those serving as the 1-inch by 2-inch pieces were cut down further to the latter dimension. This type of construction has been

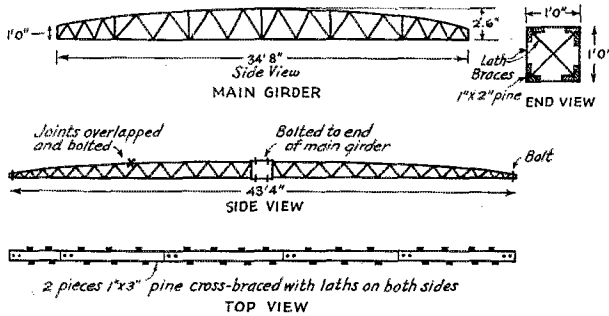

FIG. 4—DETAILS OF THE MAIN GIRDER AND END SUPPORTS THAT CARRY THE BEAM ELEMENTS

3-inch pine flooring and ordinary plaster lath are the materials used.

found satisfactory, although undoubtedly variations from it would serve as well. With the woodwork painted black, using roof and bridge paint, the structure has a striking appearance perched on its 60-foot hill.

With the bearing block on top and the collar at the bottom properly fitted, the beam is readily turned in any direction in a few minutes by means of a couple of rope stays. Once set at the desired position, pointed to dump the signals into the part of the world of interest at the moment, the ropes are pegged down to keep the beam from turning with the wind. To keep the feeders from becoming tangled up when the beam is turned, the line from the shack is anchored to

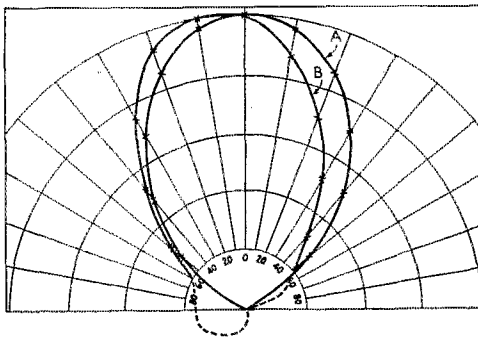

FIG. 5—THE THEORETICAL AND EXPERIMENTAL FIELD PATTERNS ARE IN GOOD AGREEMENT

The theoretical power gain as compared to a non-directional half-wave antenna is approximately 6 db, representing a power gain ratio of 4. Which is one way of making 50 watts behave like several hundred.

the pole below the lower bearing point and flexible jumpers of sufficient length are connected between the line terminals and the quarter-wave coupling section of the beam. A pulley and weight arrangement keeps the line running to the shack taut under varying conditions of weather and temperature. Although rotating the antenna through 180° puts some kinks in the jumpers, operation does not seem to be affected to any noticeable extent.

The other end of the transmission line is coupled either to the transmitter or receiver. The coupling to the transmitter is as conventionally used for any two-wire line (See the *Handbook*). For coupling to the FBXA receiver, a one-to-one transformer is used with 8 turns on each winding, both on the same 1-inch diameter form. The turns are spaced slightly, but the two coils are coupled together closely for best results, small-size wire being used to mini-

mize capacity coupling to the line. Since the antenna is directional for receiving along the same line that it is directive for transmission, the system works both ways on the same QSO with equal effectiveness. The results in reception are balm to interference-harassed ears, both QRM and QRN being considerably minimized by the directivity. Off-beam signals leak through, but are weakened 3 to 5 points on the R scale. The beam action seems to be equally good over the whole 14-mc. band.

#### PERFORMANCE, MEASURED AND PRACTICAL

Fig. 5 shows the calculated horizontal field pattern (A) and the measured field pattern (B) of the beam. The intensity meter used in getting the experimental curve consisted of a Type 33 tube used as a diode rectifier, with both grids and the plate tied together, a 0-1 millimeter connected in the output circuit giving the indications. Before taking the measurements it was calibrated on 60-cycle a.c. In taking the measurements the intensity meter was set up 10 wave lengths from the beam and the beam was then revolved through 180°, measurements being taken at a sufficient number of settings. The dotted portion of curve "B" is approximate, the reading being too small in this region to be determined accurately.

Theoretically the beam should boost the signal approximately 6 db over a non-directional antenna or, in other words, should give a power increase of 4 times—which means that the 50 watts here is effectively made equal to some several hundred watts with a nondirectional antenna. My calculations give the maximum concentration of radiation in the vertical plane to be between 20° and 40° above the horizontal, with

(Continued on page 68)

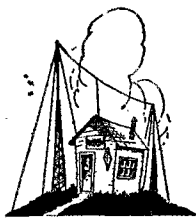

# Amateur Radio STATIONS

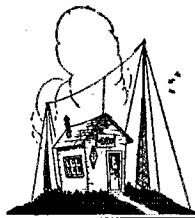

## W6ITH, Berkeley, California

**D.** REGINALD TIBBETTS, owner of W6ITH, is chief engineer of the San Francisco-Oakland Bay Bridge Construction Radio-telephone System. This net of stations is being used for communication on frequencies on both sides of the 56-mc. band during the three-year construction period. Naturally, since Tibbetts works so much near 5 meters, he has a good five- and ten-meter outfit in addition to the larger transmitter for 3.9- and 1.8-mc. 'phone.

The photo shows the larger transmitter as well as the "five and ten" mounted in the relay rack. This relay rack holds four receivers covering all wavelengths from two to eleven meters, monitoring speakers, patching panel and several power supplies besides the "five and ten" transmitter. The speech amplifier for the other transmitter is also mounted in the ultra-h.f. rack.

The large transmitter has a 47-crystal oscillator, 841 buffer-doubler, 800 amplifier and a pair of 203-A's in the final modulated amplifier. The speech end starts with a Western Electric moving-coil microphone, a 77 and a 76 in the pre-amplifier, a 56 into a 53 into a pair of 2A3's in the speech amplifier, and a pair of 203-A's in Class B in the modulator.

The operating desk across the room is not shown, but on it is a Patterson PR-10 Receiver and the transmitter controls. All switching is done by means of push-buttons. Voice relays are used for fast break-in operation.

Although "ITH" is well along in the sixth district calls, Tibbetts operated 6PD back in 1926 and has held W6XT for some time.

## W9FAV, Oshkosh, Wisconsin

**E**RWIN RASMUSSEN, of 52 Eveline Street, Oshkosh, who owns W9FAV, writes that Oshkosh is a peculiar city as far as ham radio is

concerned. Of the three active hams in the town, the youngest in point of service has been going for 13 years, and one fellow who expects to get on the air soon started in the game in 1909! W9FAV is therefore no newcomer, although his present call was obtained in 1930. He broke in back in 1917, ordering some parts from the once-famous Wm. B. Duck catalog. With radio activity stopped during the war, it was 1920 before a whole station was put on the air, using the call 9BCH. 9BCH was one of the first 200-meter stations to be reported by 6ZAC in Hawaii and was also heard by WNP.

The outfit now in use is shown in the accompanying photograph. The transmitter consists of a 47-crystal oscillator, 10 doubler and 203-A final amplifier, following one of the popular QST circuits. Input usually runs 300 watts on 3.5 mc., 350 watts on 7 mc. and 250 watts on 14 mc., the 203-A being used as a doubler on the latter band. The antenna is an 80-meter Zepp, with a switching arrangement which cuts it in half for operation on 40 and 20. The receiver is a tuned r.f. job similar to the one described in January, 1933, QST, and an electron-coupled frequency meter, not visible in the

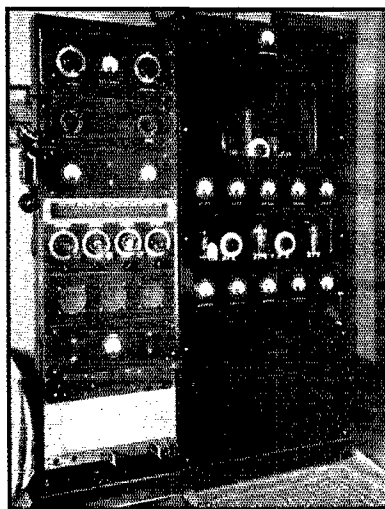

W6ITH

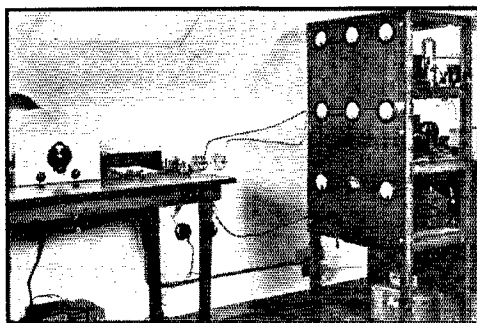

W9FAV

photo, uses a circuit given in the same issue. A 100-kc. electron-coupled oscillator, checked against WWV, is used for calibrating.

Up to the present time forty countries in all continents have been worked. Rasmussen has held O.R.S. appointments at various times and also was city manager under the old system.



W2ESK

### W2ESK, New York City

W2ESK, the station of the Harlem Radio Club, is located in the 135th Street Branch Y.M.C.A., New York. The accompanying view shows the operating table and one of the transmitting units. A second transmitter, for 160-meter 'phone, is also owned by the club, but unfortunately could not be included in the photograph.

The rack at the right contains two separate crystal-controlled transmitters, one for 3.5 mc. and the other for 7 mc. The 3.5-mc. set uses a 47 oscillator, 46 buffer and 10 amplifier, and works into a half-wave antenna which is fed through twisted-pair feeders 100 feet long. The 7-mc. out-



W8WT

fit consists of a 47 oscillator, 46 doubler, 46 buffer, and a 10 amplifier. A separate half-wave antenna is used for this transmitter, also fed through twisted pair feeders. Power supplies for both these transmitters are contained in the rack.

The 1.75-mc. 'phone transmitter uses a 45 Hartley oscillator, a pair of 46's in parallel as buffers; and a pair of 10's in push-pull in the final stage. Speech equipment includes two voltage-amplifier stages using 27's, a driver stage with a 46, and two 46's in the Class-B modulator. The antenna for this transmitter is 246 feet long, fed at the center with twisted-pair feeders 200 feet long. The unusual length of the feeders is accounted for by the fact that this particular antenna is fastened to the highest point on the tower on top of the 16-story Y.M.C.A. building.

In addition to these sets, the club also has a portable designed for operation in the 7- and 14-mc. bands, using a pair of 30's in parallel with 180 volts on the plates. In the same carrying case is a receiver using a 32 detector and 33 amplifier.

The apparatus on the operating table includes an SW-3 receiver, transmitter control panel, keys, microphone, and loud speaker.

The club recently held a highly successful amateur radio exhibition at the Y.M.C.A., and has handled a considerable number of messages for people in the vicinity. Courses in code and radio are conducted by the club at the Y.M.C.A.

### W8WT, Detroit, Michigan

THE year 1931 marked the entry of Lester Jeffrey, 5435 Bewick Avenue, Detroit, into the ranks of transmitting amateurs, under the call W8WT. A period of experimenting with various sorts of transmitters has resulted in the rack-and-panel rig shown in the photograph, a crystal-controlled job operating on 7 mc.

The r.f. part of the transmitter is in the upper region of the rack, and consists of a 47 oscillator, 46 doubler, and a pair of 46's in push-pull in the last stage. The power supplies are located in the lower part of the rack. The frequency used for the most part is 7008 kc. W8WT's antenna is a half-wave Hertz with 45-foot feeders.

The receiver is a home-made tuned r.f. job using 24 r.f., 24 detector, and 27 audio. The small box to the left of the receiver contains a monitor with a 99 tube.

### Hamdom

(Continued from page 28)

in 1931 started the Wives and Mothers of Radio Amateurs Club, of which she is still president. Frank is automatic chief of the Western Union telegraph offices in Dallas—good training for any official of the American Radio Relay League.



## Plate Modulation With Tapped Choke

An interesting suggestion in connection with Heising modulation is offered in the following letter from D. T. Broadhead, W8CXI, of Jamestown, N. Y. It may prove of value to 'phone men using Class-A modulators, especially when confronted with Class-C amplifier plate-voltage problems such as W8CXI describes.

"I have worked out a modification of the conventional Heising modulation circuit which I

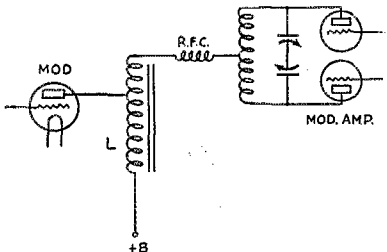

FIG. 1—THE CHOKE, L, IS TAPPED TO WORK AS AN AUTO-TRANSFORMER SO THAT BOTH MODULATOR AND MODULATED AMPLIFIER CAN OPERATE AT THE SAME D.C. PLATE VOLTAGE

believe will be helpful to many who are using this system.

"The idea is simply to convert or build a choke to act as an auto transformer by taking out a tap for the modulator plate at a point 30% to 50% down from the end of the coil, as shown in Fig. 1. The proper location of the tap (in turns from the plate-supply end of the choke) may be found as follows: Tap turns =

$$\frac{\text{Modulator plate swing volts (peak)}}{\text{total plate voltage}} \times \text{total turns}$$

total turns.

"The modulator plate swing can be found from the load line plotted on the familiar plate-current plate-voltage curves for the tube in use, using the formula:

$$\text{Plate swing volts} = \frac{E_{\max} - E_{\min}}{2}$$

"If the maximum undistorted output of the modulator at the operating voltage and current have been ascertained, then the plate current to the final r.f. amplifier is simply:

$$\frac{\text{Watts (audio)} \times 2}{\text{plate voltage}}$$

"Several advantages result from the use of this method. It eliminates nuisance of the dropping resistor, which wastes from 35% to 50% of the d.c. power supplied to the modulated amplifier; the drain on the high voltage plate supply is reduced; and finally, it permits the operation of high-voltage low-current tubes such as the 852 at full voltage.

"The modulator here is an 851, which at 2500 volts and 240 ma. has an output of 165 watts audio power. The plate swing is 1375 volts, hardly enough to operate a pair of 852's at good efficiency, and requiring a plate current of 240 ma., using the dropping resistor method. Now with 2300 volts audio swing the 852's may be operated at full voltage and only require about 140 mls for the same carrier. The total plate current requirement has been reduced from 480 to 380 ma., making the use of an 866 bridge rectifier practical.

"It is usually preferable to allow the carrier power to be a little more than twice the audio output, then if the gain is held below the point where the modulator kicks up there is little danger of overmodulation, provided the r.f. amplifier is properly excited."

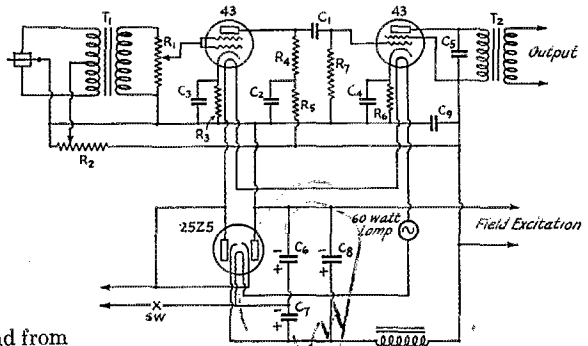

FIG. 2—MICROPHONE AMPLIFIER AND TRANSFORMERLESS VOLTAGE-DOUBLING POWER SUPPLY

- C<sub>1</sub>—0.02 μfd.
- C<sub>2</sub>—0.25 μfd.
- C<sub>3</sub>, C<sub>4</sub>—20-μfd. electrolytic.
- C<sub>5</sub>—0.01 μfd.
- C<sub>6</sub>, C<sub>7</sub>—8-μfd. electrolytic.
- C<sub>8</sub>, C<sub>9</sub>—12-μfd. electrolytic.
- R<sub>1</sub>—200,000-ohm potentiometer.
- R<sub>2</sub>—20,000-ohm potentiometer (see text).
- R<sub>3</sub>—500 ohms.
- R<sub>4</sub>—150,000 ohms.
- R<sub>5</sub>—50,000 ohms.
- R<sub>6</sub>—500 ohms.
- R<sub>7</sub>—500,000 ohms.
- T<sub>1</sub>—Microphone transformer.
- T<sub>2</sub>—Output transformer (see text).
- L—15-henry choke.
- SW—S.P.S.T. switch.

## Transformerless A.C.-Operated Microphone Amplifier

The speech-amplifier circuit of Fig. 2 is contributed by K. E. Schonert, W9HQD, engineer at WEBQ, Harrisburg, Ill. It is used for remote pickup work, where a compact and humless microphone amplifier is especially desirable.

Inspection of Fig. 2 will show that plate power is obtained from the 110-volt line through a 25Z5 rectifier used in the voltage-doubling circuit. The tubes used in the audio amplifier are 43's, the first having its control grid and screen connected together to give the effect of a high- $\mu$  triode, the second being used as an ordinary pentode amplifier. Resistance coupling is used between the two stages. The double-button carbon microphone gets its current from the rectifier-filter through the potentiometer  $R_2$ . This potentiometer, incidentally, should be capable of carrying the current for the two microphone buttons, which will run between 15 and 50 milliamperes per button, depending upon the manufacturer. A fairly low current would seem to be desirable from the standpoint of load on the rectifier tube.

The output transformer design will depend upon the service for which the amplifier is intended. It may be a tube-to-line transformer for remote work, or may be a speaker output transformer if the amplifier is intended for use as a small public-address outfit. Speaker field connections can be taken off as indicated in the latter case, a high-resistance field winding being required. If the amplifier is to be used in the station and further speech stages are contemplated, the output transformer characteristics will depend upon the input requirements of the following stage.

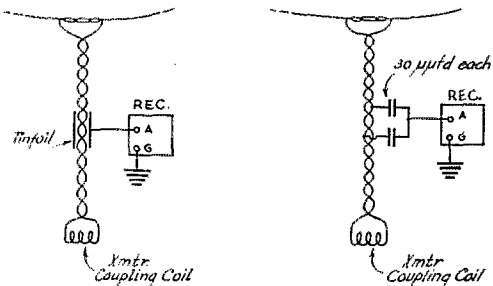

FIG. 3—USING THE TWISTED-PAIR-FEEDER TRANSMITTING ANTENNA FOR SIMULTANEOUS TRANSMISSION AND RECEPTION

### The Twisted-Pair-Feeder Transmitting Antenna for Receiving

The following might be of interest to those amateurs who use a low-impedance twisted-pair line for the transmitting antenna, and who would like to use this antenna for reception without the customary changeover switch or relay.

A piece of tinfoil or leadfoil about six inches

long is wrapped around the lead-in, as shown in Fig. 3, and the antenna post of the receiver connected to it. The ground post of the receiver is connected to ground. The antenna now works as a "T" type for receiving because of the relatively

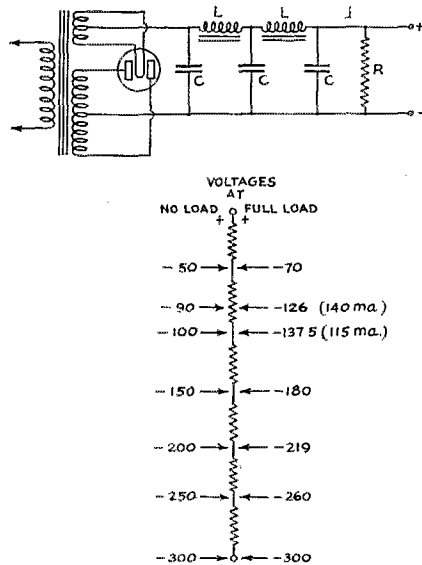

FIG. 4—ESSENTIALS OF W8VJ'S "C" BIAS SUPPLY, SHOWING THE VOLTAGE VARIATION FROM NO LOAD TO FULL LOAD WITH TWO AMPLIFIER STAGES DRAWING GRID CURRENT

Filter values are not critical. Each choke should be capable of carrying 100 milliamperes and should have an inductance of about 15 henrys. The condenser may comprise the three sections of a triple-section electrolytic or may consist of three separate electrolytic condensers of 8  $\mu$ fd. each. W8VJ's bleeder is made up of six 500-ohm units, each tapped at 100, 300 and 400 ohms, an arrangement which gives plenty of output voltages.

high capacity between the lead-in wires but is unaffected for transmitting. The receiver antenna coupling coil or condenser, together with this coupling device, comprises a balanced high-impedance circuit bridging the low-impedance feeder, and does not absorb a measurable amount of power.

Two equal small capacities of about 30  $\mu$ fd. could be used, but most hams probably will want to use tinfoil or leadfoil because it costs nothing.

—M. W. Rife, W9JWV

### On Transmitter "C" Bias Supplies

In connection with using "B" eliminators for biasing r.f. amplifiers which draw grid current, the following letter from I. L. Brown, W8VJ-W8IDE, of Clifton Springs, N. Y., offers a scheme for overcoming to a large extent the voltage variation which occurs when several stages are biased from the same source:



"After reading the article on bias in March *QST*, I have the following suggestions to make. In experimenting with bias supplies I found, as stated in the article, that with an ordinary eliminator I might as well have a plain resistor—I had a sweet time getting the proper voltages to the various stages.

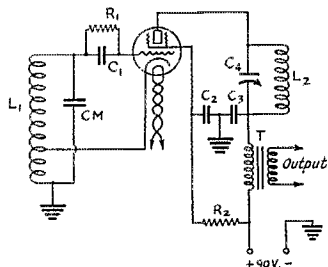

FIG. 5—THE CONDENSER MICROPHONE VARIES THE OSCILLATOR FREQUENCY, CAUSING AUDIO-FREQUENCY VARIATIONS IN PLATE CURRENT

An oscillator frequency outside an amateur band should be chosen to avoid heterodyning. W6BJE uses 6000 kc. The inductance of the coils  $L_1$  and  $L_2$  will depend upon the frequency chosen.

CM—Condenser microphone head.

$C_1$ —250  $\mu\text{fd}$ .

$C_2$ —0.001  $\mu\text{fd}$ .

$C_3$ —100  $\mu\text{fd}$ .

$C_4$ —50- $\mu\text{fd}$ . midjet variable.

$R_1$ —50,000 ohms.

$R_2$ —10,000 ohms.

T—Tube-to-line output transformer, input impedance 18,000 ohms.

"As I wanted to 'burn' the transformer anyway why not go at it right? I dug up a 160-watt power transformer of three-hundred volts, a couple of hefty chokes and a three-anode electrolytic filter condenser. A single 80 served as a rectifier, though it has long ago been replaced by an 83. The bleeder resistor? There, fellers, is the catch—three thousand ohms. Figure it out for yourself—the darned thing passes a hundred mils.

"But how sweet that made the bias proposition! With my 203-A's in push-pull taking 25 mils in the grids the bias remained quite stable. The single 211 driving them gets 15 mils and the 47 doubler, although it will operate successfully at 180, is given the full 300 volts to keep it from burning up when out of resonance. As a result the grid current to this tube is negligible.

"Consulting the table in Fig. 4 you will see that there is so little change in the voltage that it does not seriously affect the operation, and it works very well for a multistage transmitter.

"Here is the one point I want to especially bring out. When the 'B' batteries begin to get old and the bias has to be raised to keep the tubes at cut-off, and then when the set has been run an hour you find the output down to fifty percent because the bias has built up; then, by crackie, I'm here to tell you I wouldn't put anything other than my rectified bias on my multistage transmitter. Even when the batteries are new and

a heap of grid current is passing the voltage will be found to be above rating when the key is pressed; i.e. the regulation is none too good."

### The Absorption Condenser Microphone

A modified version of the absorption condenser microphone,<sup>1</sup> in which the inherent stability of the electron-coupled oscillator is utilized, is shown in Fig. 5. This circuit was adopted in an effort to eliminate the critical tuning and unstable operation of most types of absorption circuits, and meets the requirements admirably.

Little need be said about the circuit components. The condenser microphone capacity  $CM$  is in the control grid circuit, while the plate circuit is tuned slightly off resonance. When a sound wave strikes the microphone diaphragm the fluctuating capacity of  $CM$  causes the radio frequency of the control circuit to vary at the applied audio frequency, and this in turn produces corresponding audio frequency variations of the plate current by reason of the fluctuating resonance point. The output equals or exceeds that of a double-button microphone.

Either an a.c. or d.c. filament type tube may be used, and well-filtered r.a.c. is thoroughly satisfactory as the plate supply. A frequency in the vicinity of 6000 kc. is used to avoid heterodyning with transmitter frequencies or incoming signals. I am unable to say how nearly linear the plate-current curve is, but the quality obtainable sounds excellent, while the ease and stability of operation is a relief after experiencing the annoyances associated with other types.

—Cecil Lynch, W6BJE

<sup>1</sup> Experimenters' Section, July, 1932, *QST*.

## Strays

### QRR

Pity the ham  
From eve 'til dawn  
Calling CQ  
With the juice not on!

— W9IYA

### Epitaph for an SWL

Here lies our pride, old Joe DX,  
Whose fame we knew so well,  
Who always rose at peep of dawn  
And worked VU, VK, ZL. . . .

His tales, we were supposed to think,  
Were really for belief;  
But oh! to hear the line he slung  
Did always cause us grief.

— W2EJF

# ● I. A. R. U. NEWS ●

Devoted to the interests and activities of the  
**INTERNATIONAL AMATEUR RADIO UNION**

President: H. P. MAXIM

Vice-President: C. H. STEWART

Secretary: K. B. WARNER

Headquarters Society: THE AMERICAN RADIO RELAY LEAGUE, West Hartford, Conn.

## MEMBER SOCIETIES

American Radio Relay League  
Associazione Radiotecnica Italiana  
Canadian Section, A. R. R. L.  
Ceskoslovenski Amatérni Vysilaci  
Deutscher Amateur-Sende-und-Empfangs-Dienst  
Experimenterende Danske Radioamatorer  
Irish Radio Transmitters Society  
Liga Mexicana de Radio Experimentadores

Nederlandsche Vereeniging voor Internationaal Radioamateurisme  
Nederlandsch-Indische Vereeniging Voor Internationaal Radioamateurisme  
New Zealand Association of Radio Transmitters  
Norsk Radio Relæ Liga  
Polski Związek Krotkofalowcow  
Radio Society of Great Britain  
Rede dos Emissores Portugueses

Reseau Belge  
Reseau des Emetteurs Français  
South African Radio Relay League  
Suomen Radioamatööriilitto r.y.  
Sveriges Sandareamatorer  
Unión de Radioemisores Españoles  
Union Schweiz Kurzwellen Amateur  
Wireless Institute of Australia

## Conducted by Clinton B. DeSoto

### 28 MC.:

With the 14-mc. band doing some surprising DX flippops in May, it is not surprising that reports of 28-mc. work are encouraging. It seems to be axiomatic that good conditions on 14 mc. mean good conditions on 28 mc., and a cessation of magnetic activity during middle May produced some pleasing results for the boys who were on the job on both bands. In the United States, W9GFZ worked W2GOQ, May 20th, with QSA4-5 reports. W9GJS worked W2DTB and W1CKF. W1CKF heard six C.W. stations on the 20th, and five 'phones—a banner day. A W7 on C.W. and a W8 in Cincinnati were among the haul. Several other reports of unusual reception on this band have been received, including harmonics from several DX stations. Commercial stations in South America and Europe around 25 mc. have been banging through loudly here at all times of the day and night.

In short, there's renewed interest in the 28-mc. region, and plenty of reason for it. In addition to the stations mentioned in the foregoing, WKUN, W2JN, W2TP, W4AEJ, W4BIK, W4BQI, W4AT and W4TZ are active and searching for DX contacts from 8 to 10 or 11 p.m. E.S.T. every night. Others scour the band during daylight hours over the week-ends. A group in Springfield, Mass., are regularly on

with fairly powerful 'phone rigs—write W1ZB for schedules. G2OA and OK1AW are still faithfully active. Take a whirl on the band one of these nights. You're likely to be surprised.

If you haven't the time for consistent listening, pick a time when the 14-mc. band is hot. When signals come through on that band until midnight with good strength, as they have been lately, 28 mc. can be counted upon to throw good signals some surprising distances around this old world.

### QSL:

A new QSL address for Hungary, sponsored by the National Union of the Hungarian Shortwave Amateurs: VIII, Matyas-ter 6, Budapest, Hungary.

The new address of the *Polski Związek Krotkofalowcow* is Warszawa, Nowy Swiat 21, Poland.

The QSL address of the Japanese Amateur Radio League is now P. O. Box 377, Tokyo, Japan.

The new address of the C.B.S.K.W. (Central Bureau of the Society of the Friends of Radio) is Moscow, Karuninskaa pl. 2/5, U.S.S.R. This is the QSL bureau for all Russian and Siberian stations.

R. Bruce, VK5BJ, has resigned as the W.I.A.'s QSL Officer for Australia, and the position is now occupied by George Luxon, VK5RX. Cards can be sent either to 8 Brook St., West Mitcham,



THE IDENTITIES OF HERMANN WOLTMANN, D4BET, AND OTTO ANTON KLOTZ, D4BAO, ARE SELF-EXPLANATORY

On the right is Ango Taig, ex-D4PSO, Chinese student at the Berlin Technische Hochschule.

South Australia, or Box 284D, G.P.O., Adelaide.

The U.S.K.A. has a new address for Swiss QSL cards, at the home of the QSL Bureau manager, HJ39AC: Neu Allschwil nr Basle, Switzerland.

#### Contest:

A unique international language contest in which 1000 francs are being offered as prizes is being sponsored by D. Jaime Mas, EA6AB, author of "Radio Vademeecum," and originator of the QXX code system. The contest consists of translating a passage written in this code. Six prizes are being offered for the best translations, respectively of 500, 250, 100, and three of 50 francs each. The text and the rules of the contest follow:

"YC DSTNZ FRM ISL FDHII IN DNG SPWK AT DWN. CPTN DCDHI RQT HLPO FRM ANTR NVGO BY FLGS AL BY TILGRO. LTNXI NBD? Y. 2 AMTRS LTNQIS RQT SCCRO FRM YC. 1 RCVQI STTN YC: LTTD N. LNGT W. 2Z AMTR EMBKQII RPDY IN ANTR LTTL YC THT RNTQI. TMPT MKQI T LTTL YC ALMT SNK; BT ALLS SVQQIS: CPTN, HLPUS, ANMLS; BT YC LQII AFT SHRT TM.

"TRMHA TRNLO: NW ANTRS WRKXIS: 1Z LCTXIS, THN DCDXIS. HPHA WN SMT. NTFXXA WTN FWS DYS? Y. NTFXXE VY RPDY AFT DY FQ FR CL. AL NTFXXI FRY BLVQA ENCN DFCTS BT NW SYHA THT T CH HI DLGZ, FCLZ. BLVHA THT EMPLXXI MC BY MNY AMTRS IN CMMTOS, CRDS, LTTTS. HPHA THT ATR INCRXI VCBL IN BNFO ALL AMTRS. END.

#### "Rules governing the contest:

1. Papers may be presented either typewritten or in ink, but in the latter case must be very clearly written.
2. The translation of the text may be carried out in Spanish, French or English.
3. The closing date for this competition will be August 31, 1934, but competitors are requested to send in their solutions early so that the judges may proceed with the classification in order to be able to publish results as soon after the closing date as possible.
4. The translations should be submitted on plain sheets of paper, octavo size (14 x 20 cm. or 5½ x 7¾"), and these should not bear any indication as to the name or address of the sender, but merely a "nom-de-plume" or other pseudonym. The competitor's name and address should be written on a separate sheet of paper and enclosed in a sealed envelope bearing the same "nom-de-plume" or pseudonym on the outside.

5. Competitors are requested to reply to the following questions:

- (a) Now that you have studied the rules governing the QXX code, what is your opinion of same?

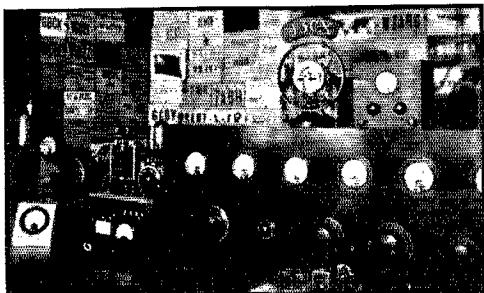

J3CX, THE STATION OF M. KOHNO, KITO AINO MACHI HICHUO, KYOTO

A 4-stage c.c. transmitter ending in a 211D, modulated by another 211-D with two-stage speech amplifier.

- (b) Are you in favor of the use of this code when the usual abbreviations are insufficient to express our thoughts?
6. The prizes above mentioned will be awarded to the six translations which, in the opinion of the judges, are considered the best. The judges' decision will be final.
7. Any unforeseen difficulty which may arise will be settled by the judges.
8. The judges will be: Mr. John D. Steell, ex-wireless operator of the British Royal Air Force; M. Andre Planes-Py, author of several works on radio, and operator of radio station F8EI and Sr. D. Juan Catala, Spanish National school master and operator of radio station EA6AI.
9. The results of the contest will be published in the technical press for the information of all interested.
10. Solutions should be sent addressed to the Secretary, International Radio Contest, Calle Jose Villalonga, n.º1, Palma de Mallorca, Spain."

#### Next Month:

We will present a review of the amateur regulations in more than a dozen of the principal nations of the world. This compilation will be of unusual value and interest to all internationally-minded amateurs.

### **Strays**

The budding 2-fer-a-nickel radio store on our block has put on the market a piece of radio apparatus that will revolutionize the radio game because it is—"a new and unique variocoupler in which the stator rotates and the rotor remains stationary."

—QST, July, 1933

# THE COMMUNICATIONS DEPARTMENT



F. E. Handy, Communications Manager  
E. L. Battey, Assistant Communications Manager



## High-Speed Operation

By E. A. Hubbell, W9ERU\*

MUCH has been said in *QST* columns relative to accuracy in operation, and no one will argue that this requirement is not paramount in radio transmission. A word or two on speed may be in order, also. In 1930-31, I scheduled "GL" (George Kimmel, W3CXL-WLM Washington), in my opinion one of the best ops and certainly one of the fastest. "GL" could copy on the mill some 50 w.p.m., and no one could send a readable code on a bug at this speed long enough to lose George. To improve our schedule Kimmel undertook to raise my speed, by the simple process of sending faster than I could copy (which didn't take much) until I broke for too many repeats. If I could get one message all OK, the next was sure to follow at a faster clip, until I missed too much, whereupon "GL" calmed down a bit. Some six months or so of six day a week schedule keeping, and I could hang onto 30 words a minute with fair accuracy. Of course, "GL" could copy anything I could turn out that resembled Continental, and for over 18 months our schedule was certainly a pleasure to both parties.

Kimmel and myself had plans for an operators' club similar to the present "Al Operators' Club" sponsored by A.R.R.L. but confined to good operators of *high speed*, with the primary object to increase the code speed in general use by amateurs. QRM would be greatly lessened and operation made more enjoyable if the average code speed could be raised, say, 50 or 100%. That doesn't mean that all of us must become "Chain-Lightning Hills." If we could raise the usual 15 w.p.m. to 20 or 25 w.p.m. more QSOs of the same number of words might result, in less actual time on the air.

Increase in speed comes from a studied attempt to improve it. Turn loose a raw radio school graduate capable of taking twenty-five per from an omnigraph (yes, they can do it) on the 3500-ke. band. He will fold up like a potato peel on a hot stove! Give this same operator six months experience as a ham *handling traffic, as well as general rag chewing*, and watch him tear off the speed stuff, tho. Pick yourself some station usually too fast to copy comfortably, and strike up a sked to handle traffic, and explain to the other op what you are about, and ten to one he will be more than glad to help you out. Don't make the error of attempting to guess your way to higher speed. Copy what is sent. Also for this, copy commercial epher transmissions. Don't be misled by advertising claims on trick methods of learning the code. Outside of extremely fast work, code speed is mostly a matter of hard work and hours of practice.

A typewriter or mill will simplify things greatly, especially for anyone with a good knowledge of the touch system. With only a few hours of code reception on a typewriter, and that nearly a year before, I copied my way into the 40 w.p.m. class at the Chicago contests last summer,

\*O.R.S., 227 N. 4th St., Rockford, Ill.

and thirty-five words per minute was ridiculously easy. But copying longhand is impossible for me above 30 w.p.m.

Given high speed accurate sending, with high speed accurate copying, and intelligent use of operating procedure, and amateur operation will run much closer to our ultimate aim, 100% QSOs with any and every station on this globe!

## Alaskan Mountain Climbers

W1CVF BT 7 will be used by operator David Putnam while in Alaska with the "Mount Chhillon Expedition." This party, composed of Harvard and Dartmouth College men, will attempt to climb Mount Chhillon. Some geology work will also be done, and not the least of the aims of the trip is to try some 56-mc. work in the mountainous country around the base of the peak. A base camp will be maintained. A 56-mc. transceiver will be installed there and two units will accompany the climbing party. The attempt will be made to maintain communication between the base and the climbers daily. A transmitter working on the 7- and 3.5-mc. bands will also be in operation at the base camp. This set-up will be used primarily to relay traffic to and from the party. Amateurs within range are requested to keep an ear open for W1CVF BT 7 and assist in moving traffic whenever possible. Operations should be under way when this issue leaves the press. Portable call W1CVF BT 7 will be used for all work.

A second expedition, the "Mount Foraker Expedition, Alaska, 1934," is leaving Cambridge, Mass., June 17th to attempt the ascent of Mount Foraker, sister peak to Mount McKinley and second highest peak in the Alaskan range. This party will take along a small transmitter working in the 3.5-mc. band. Call letters are not yet known.

## Bol-Inca Expedition

Complete details on the Bol-Inca Expedition to Bolivia will be found on page 54, June *QST*. Gordon Barbour, ex-W1ASR/ex-W3DH, is radio operator and uses the call CP1GB in the amateur bands. W8KPB, Cleveland, Ohio, reports that CP1GB was heard on about 7008 kcs. on May 13th, QSA5 R7, chirpy d.c. W8FFK, also of Cleveland, was QSO CP1GB at 1:00 a.m. May 14th. CP1GB uses a pair of 50 watters push-pull. He wishes to QSO as many U. S. amateurs as possible, and is especially desirous of making reliable schedules for traffic routing. CP1GB is now using 7300 kcs.

## Pioneer Memorial Flight

A flight to honor the pioneers of aviation, the Wright brothers, is scheduled to start from the Miami (Fla.) municipal airport about July 1st. A Bellanca plane will be used for the flight, which will visit 31 foreign countries. Radio equipment operating on 8280 kcs. will be used. Cooperation of radio amateurs has been requested. Starting about July

1st. please be on the lookout for this plane on 8280 kcs. Call letters are not yet known, but this information and further details will be sent from WIMK on regular Official Broadcast schedules just as soon as available.

## O.R.S. QSO Party Scores — April, 1934

From all reports the April get together resulted in a profitable period of real operating for all Official Relay Station appointees. Such opportunities for A.R.R.L.-O.R.S. come quarterly and attendance of the 1000 or more key stations is always excellent. Opportunity for testing station performance is combined with exchange of traffic, making of new friendships and "skeds" and enjoyment in work with skilled operators.

W9AUH (KY.) worked 122 stations in 43 different A.R.R.L. Sections, hearing 43 O.R.S. in addition to those worked. His score (23,263 points) led the country by a small margin. W9IU (ILL.) made 22,632 points with 118 O.R.S. QSOs in 41 Sections, and 70 other O.R.S. heard! Third highest honors go to WIDMD (New Hampshire) who earned 11,890 points (82 QSOs in 29 Sections and 72 others heard.) The usual list of ten highest scorers follows:

W9AUH 23,263	W1OR 10,530
W9IU 22,632	W4APU 10,112
WIDMD 11,890	W9EMN 9,900
W9KJY 11,439	W9JRK 9,380
W4NC (W4OG opr.) 11,190	W2ENZ 8,475

## O.P.S. QSO Party Scores

Official Phone Station appointees likewise reported that over three times the interest and participation shown in the initial first activity was evident in the April 21/22 period of operation. This resulted in scores several times as great and in fullest enjoyment and success of both 80- and 160-meter band operation by A.R.R.L.-O.P.S.

Three Virginia O.P.S. hold the honors for their Section by taking the first three places, but many other Sections won honors by placing stations in the "high ten," scores as follows:

W3GY (Va.) 765 (13 QSOs in 9 Sec., 10 Hrd.)	W2DC (E.N.Y. 322 8 wk. in 7 Sec., 3 Hrd.)
W3BIG (Va.) 680 (12, 10, 4)	W9IXN (Ky.) 306 (9, 6, 3)
W3CNY (Va.) 510 (15, 6, 5)	W9ACU (ILL.) 287 (7, 7, 3)
W8CJG (Ohio) 483 (13, 7, 2)	W2CAZ (E.N.Y.) 258 (7, 6, 4)
W8AHF (W.Va.) 330 (9, 6, 5)	W8GDC (Ohio) 235 (7, 5, 6)

The Neosho Valley Amateur Radio Club (Emporia, Kansas) each month awards an A.R.R.L. membership to the individual member who has performed an outstanding service to the club. Through contacts and special publicity cordial relations with BCLs are maintained. Feature stories on amateur radio have been prepared and run in the Emporia Gazette. Also the club is starting a series of advertisements (two each week for six weeks) of an educational nature along the lines of "explaining and solving" interference difficulties. Secretary Trimble, W9MFT-MPW can furnish details.

## 1.75-Mc. Code Practice

W2FHY, Ocean Gate, N. J., announces a change in schedule of sending code practice. Transmissions are now on 1871-kcs. as follows: Tuesday 8 p.m., Thursday 4 to 5 p.m., Saturday 11 a.m. to 12 noon. All times are EDST. Four stations of the Utica (N. Y.) Amateur Radio Club transmit code lessons between 1800-1900 kcs. from 10 to 11 p.m. on Mon., Tues., Wed., Fri.

## O.B.S.

The following is a supplement to the list of A.R.R.L. Official Broadcasting Stations in September QST (page 44): W1BZO, W2BZZ, W5CRS, W6FYW, W6ITH, W7AGQ, W8EWP, W8WE.

## 14-mc. DX Work

Did you ever sally forth into the 20-meter regions for a Sunday afternoon of DX, and run into trouble due to 'phone QRM on your signals? Hq. has received occasional complaints from 14-mc. 'phone operators of c.w. interference—and from c.w. telegraph DX men of 'phone QRM. The remedy? *When you work c.w. DX please tune carefully into either the 14,000-14,150-kc. or the 14,250-14,400-kc. parts of the band.*

Avoid the ham 'phone allocation 14,150-14,250 kcs and your c.w. DX will not be subject to complaints of 'phone QRM.

14-mc. c.w. operators—don't just "tune to the center" of the band (which creates QRM for others, and insures your own signal of getting similar QRM from 'phones). Check operation carefully with a frequency meter, or listen on your super-het and determine 'phone band limits. Adjust your set to the high and low frequency 14-mc. band edges, and you will get optimum DX results.

C.W. operators using 3500-3900-kc. or 1715-1800-kc. territory will also get best results in two-way work with other c.w. stations if they steer clear of 3900-4000 and 1800-2000-kc. territory, where 'phone operations part of the time are of sufficient magnitude to make interference to telegraph operation very heavy.

## Announcement, A.R.R.L. O.R.S. and O.P.S. July Activities

**O.R.S.:** The next 1934 QSO Contest will be held July 21st-22nd. Only O.R.S. may take part in these "doings" and complete details with the full report on our last activities will reach all O.R.S. appointees with the regular A.R.R.L. bulletin in mid-July. But mark your calendar and plan to be on hand those dates. Along with credit for starting a message to another O.R.S. will be a period set aside to try two-way work between O.P.S. and O.R.S.

**O.P.S.:** 48 new and additional Official 'Phone Station appointments have been made recently, with only four cancellations in the same period. Additional applications are still under consideration by S.C.Ms, appointments being made when the station signal and operating standards have met the test applied by the 'Phone Activities Manager.

Every O.P.S. is invited to try to work every other O.P.S. in the July Party. A portion of the time has been set aside to try some 'phone-c.w. QSOs with O.R.S. who have their quarterly activities at the same time and suitable scoring credits will be given for such work. Full details will be included in the July 'phone bulletin from A.R.R.L. Headquarters. Mark your calendar (July 21st-22nd) and be on hand for some good operating. Test station equipment, make new O.P.S. friendships, further high standards in constructive voice operation. Watch the scores mount too, due to the larger number of O.P.S. now active!

To the roster of O.P.S. (page 47, April QST) add: W1AVG W1BDN W1BVP W1DMI W1DOF W1ERQ W1ZK W2AMB W2BRI W2CAZ W2DC W2GWH W3AKZ W5ATB W5AYB W5DPX W6BZF W6DEF W6ITH W7AAJ W7CCR W7DNP W7BGF W7DDG W7BOG W8ABX W8AOM W8DDW W8DZO W8EYV W8FYC W8HBN W8IY W8KIP W9ACU W9AVB W9COW W9CWD W9DLC W9EQX W9ESL W9GQH W9HQH W9IKQ W9KEF VEIAG VE4GR VE4HM. Delete: W5ON W6IT W6TT W9JHY.

**To Prospective O.R.S. or O.P.S.:** A.R.R.L. field organization appointments are made by A.R.R.L. Section Communications Managers. There are basically two types of appointments — one primarily for c.w. telegraph stations — one especially for voice operated, or 'phone amateur stations.

Official Relay Station appointment is for every radio telegraphing ham interested in traffic relaying and operating organization activities. Non-O.R.S. who have active stations handling messages in responsible fashion are invited to make application for appointment to the proper S.C.M. (See address page 5 this QST.) He will see that proper forms are supplied and tests arranged with the Route Manager to pass on your application.

Official 'Phone Station appointment is for every qualified ham who normally uses his "mike" more than his key, and takes a pride in owning a superior type station, and high standards of signal and operation. O.P.S. operators are pledged to use circuit precautions avoiding overmodulation, and to live up to the Amateur's Code of fraternalism and cooperation. Traffic handling reports while by no means a requirement of this appointment are welcomed from voice-operated stations as well as news of their other activities. Qualified 'phone hams are all invited to apply to the S.C.M. for O.P.S. appointment.

The following contribution by Mr. M. R. Gutman, W2VL, wins the C.D. article contest prize for this month. Your articles on any phase of amateur communication activity are likewise solicited and may win you a bound Handbook or three logs, or equivalent credit applied toward other A.R.R.L. supplies. Let us have your article, and mark it "for the C.D. Contest," please.—F. E. H.

## Practical Use of U.H.F.

By M. R. Gutman—W2VL \*

ULTRA HIGH FREQUENCIES have passed the novelty stage. We can now stop to consider just what we can use them for and how well they are suited for our purpose. An example of how the 56-mc. band is used for traffic at W2VL may help to illustrate its possibilities.

W9SH in Chicago, Ill., called W2VL on 7 mc., and asked W2VL to take a message to Brooklyn and get an answer back by telephone. Since Brooklyn is a toll call from Lynbrook, L. I., and the operator had no telephone available, the message could not be delivered by telephone. However, in the New York area the 56-mc. band is usually active. It was certain that some Brooklyn station would be on the air. W9SH was asked to QRX, and a shift was made to 56 mc. where a "CQ Brooklyn" brought W2GHV into the picture. He took the message and got an answer back in about two minutes. This was passed on to W9SH in Chicago. Until 56 mc. came into use, messages of this type were very difficult to deliver because of skip, etc.

Due to the lower power that will work on the higher frequencies, excellent portable transmitters can be built without much cost. These can be used in times of emergencies because the antenna systems on 56 and 28 mc. are extremely simple. The writer strongly recommends that nets be formed on the high frequencies using portable low power apparatus. In times of emergency these will function without trouble.

In the Long Island area 56 mc. has been used by the various clubs on the Island to keep in contact. Arrangements have been made for inter-club hamfests and other affairs solely on this band. Now all of the radio clubs on the Island have active 56-mc. outfits.

It is the writer's opinion that 28 mc. will be even better for local 'phone work than 56 mc. The super-regenerative receiver at W2VL has been put on 28 mc. by merely doubling the diameter of the coils and using the same number of turns. Duplex modulated oscillators similar to 56-mc. design are used. Since the present position of the sun spots seems to successfully prevent DX on these two bands at the present time, let's make them work overtime on local functions. Our apparatus and knowledge will increase and may lead to greater DX on these bands.

\* 17 Devon Street, Lynbrook, L. I., N. Y.

## A.R.R.L. Traffic Routes

We are listing here only routes and schedules which are reliable and in operation as this issue goes to press. Other reliable routes appeared on page 52, June QST. Make use of these traffic chains and trunk lines.

**West Coast 3708-kc. Channel:** The following California stations, operating on 3708 kcs., are in daily contact (12:30/1:00 a.m. Pacific time):—W6RH (San Francisco), W6FBW (San Jose), W6HHM (Oakland), W6JGA (Los Angeles), W6CJZ (Altadena), W6DZR (San Fernando). Each station works "BK in" and clears traffic without delay.

**West Coast 3690-kc. Channel:** From 6:00 to 7:30 a.m. Pacific time on Monday, Wednesday and Friday, W6RH, San Francisco, contacts the following California cities on 3690 kcs.—Fort Bragg (W6JDG), Fresno (W6JIC), Dinuba (W6KPI), San Jose (W6IIZ), Paso Robles (W6FYW), W7DBR, Bandon, Oregon, is also scheduled. Trans-Pacific traffic is routed via W6FYW.

**W6GXM offers Trans-Pacific service:** W6GXM, Los Angeles, will QSP traffic for KA, K6 and OM, via regular and reliable schedules with K6AUQ (Ft. Kamehameha), K6EWQ (Schofield Barracks) and KAINA (Olongapo). He covers the 7-mc. band at 3:00 a.m. PST, daily, for calls from anyone who has traffic of a rush nature for either California or Trans-Pacific points. Traffic may also be mailed to W6GXM for QSP, or may be routed through any reliable stations that connect with him. W8JTT, Fredonia, N. Y., maintains daily schedules with W6GXM.

**W6ETL gives reliable Trans-Pacific service:** W6ETL, Los Angeles, has long been one of the best clearing points for Trans-Pacific traffic. At present he has daily schedules with K6EWQ, KA1HR and OM2AA. He also schedules W6BMC (Bard, Calif.), who clears eastern traffic through W9ESA (Denver) to W9KG (Kansas City), who maintains a distributing system around central-U. S. and to the east coast.

**W7QI's schedule line-up:** W7QI, Seattle, Wash., is well fixed to handle traffic for almost any point. His schedules include K6EWQ, KA1CM, K7CAN (Tyee, Alaska), W6FRN (Salt Lake City), W8IQS (Flint, Mich.), and W9GJQ (Aurora, Colo.), all daily. W7QI connects by land 'phone with W7APS (Seattle), who has a 3.5-mc. hook-up of local cities, and who connects through W7WY (Vancouver, Wash.) to Oregon, Calif., etc.

**Coast to coast trunk line:** WIUE (Hartford, Conn.)-W8JTT (Fredonia, N. Y.)-W6GXM (Los Angeles). Also via W8JTT-W9HPG (Chicago)/W9LEZ (Davenport, Iowa)/W9GJQ (Aurora, Colo.) to Oakland, San Francisco, Los Angeles, etc.

**Seattle, Wash. to Hartford, Conn., trunk:** W7QI (Seattle)-W8IQS (Flint, Mich.)-W1MK (Hartford). Also, W7QI-W6FRN (S.L.C., Utah)-W9GJQ (Colo.)-W8JTT (Fredonia, N. Y.)-WIUE (Hartford), and W9GJQ-W9HPG (Chicago)-W8JTT-WIUE.

**K6EWQ's schedules:** Of interest to those wishing to know how to route traffic for Hawaii will be this list of schedules maintained by K6EWQ, Schofield Barracks—W3CXL (Washington, D. C.), W5OW (Ft. Sam Houston, Texas), W6AZU (Long Beach, Cal.), W6ETL (Los Angeles), W6GXM (Los Angeles), W6ZG (San Francisco), W7QI (Seattle, Wash.), KA1HR (P. I.), and OM2AA (Guam), all daily.

**W6BHF collects 1.7-mc. 'phone traffic:** W6BHF, San Diego, stands by on 1.7-mc. 'phone daily, except Sunday, from noon to 12:30 p.m. Pacific time for outgoing traffic. W6BHF moves all traffic thus collected via schedule with W6FQU, who is tied into the A.R.R.L. national trunk line system.

**West Virginia Net:** The following stations are members of the now famous "one spot" W. Va. Net, operating daily, except Sunday, at 6:30 p.m. EST and at 11:30 a.m. EST on Sunday. All are crystal-controlled on 3700 kcs.:—W8EIK, W8HD, W8ELJ, W8EZR, W8BDD, W8GB, W8KKG, W8HUK, W8KDP, W8DMF. All these are O.R.S. and A.A.R.S. New members of this net are W8LJX and W8MAO. Incoming and outgoing traffic moves rapidly and reliably via outside schedules maintained by members of the net.

Information will be appreciated on any reliable traffic

routes or nets now in operation, which have not appeared in *QST*. Send in the dope at once with complete data on stations involved, frequencies used, times, days, etc.

## W9USA

W9USA went on the air at the Radio Amateur Exhibit, World's Fair, Chicago, on May 19th. The first station worked was W1FNW, Springfield, Mass., on 7 mc.

The W9USA transmitter in the Court of the Hall of Science went into operation May 26th. A special QSL card is being prepared for the Court station, which will be in charge of W9AIO.

All amateurs are cordially invited to visit W9USA while in Chicago. However, *no amateur radio operator may operate any W9USA transmitter without his operator's license being on his person! This is important!* If you wish to operate W9USA, be sure to bring your license or the pleasure will not be yours.

## WCNW Offers Code Practice

Broadcast station WCNW, Brooklyn, N. Y., is transmitting code lessons at 4:15 p.m. E.D.S.T. daily except Saturday and Sunday, on a frequency of 1500 kcs.

## KTAT Short Wave Club

Radio KTAT, key station for the Southwest Network, Fort Worth, Texas, conducts a quarter-hour program each Saturday at 4:30 p.m. C.S.T. for the benefit of radio amateurs and other short-wave enthusiasts. A.R.R.L. bulletins and other items of interest are presented as well as basic technical talks by members of KTAT's technical department. Membership in the "Club" is obtained by sending a card of confirmation to KTAT. A membership certificate is issued at no cost. Code practice is also featured on these programs.

A radiogram received via G5QY and W1BKJ advises that Mr. F. Wiseman of Newcastle, England, has many phonograph recordings of U. S., Canadian, Porto Rican and Colombian amateur 'phone stations on the 14- and 3.9-mc. bands. He will furnish recordings of interested stations, if they will send postage to cover mailing (about 25c). He will also record any DX 'phone stations under the same conditions, if they will get in touch with him and arrange schedules. Mr. Wiseman may be reached in care of G5QY, H. C. D. Hornsby, 7 Lansdowne Terrace, Gosforth, Newcastle on Tyne, England.

## Coming Meetings

*Elmira (N.Y.) Hamfest*, July 1st, auspices Elmira Radio Amateur Association. Details from Grant E. Meeker, Sec'y, 624 Reynolds St., Elmira, N. Y.

*Second Annual Hamfest of Hannibal Amateur Radio Club*, July 22nd at new club house, 1800 Booker St., Hannibal, Missouri.

*Central Illinois Radio Club Hamfest*, August 5th, Pavillion Municipal Park, Bloomington, Illinois.

56-mc. amateurs, attention!! Stand by on July 14th and 15th for 56-mc. stations on Mount Hood, Mount McLoughlin, Three Sisters Mountain, Council Crest and Saddle Mountain, all in Oregon and above 6000 feet in altitude.

On November 30, '33, W1EJ, Providence, and W1AMD and W1AAD, Pawtucket, R. I., were QSO W2GKL, Commander Hawks, on 56 mc. At the time of contact W2GKL was enroute from New York to Boston, and as W1AAD puts it, "The Sky Chief wasn't exactly wasting time going places." The reports were R9 all around.

## BRASS POUNDERS' LEAGUE

Call	Ortg.	Del.	Rel.	Total
W2EKM	154	163	1697	2014
W6GXM	154	331	1304	1789
W9KJY	86	140	1406	1632
W2DIU	259	358	942	1559
W3CJQ	112	65	112	1285
W9KG	121	484	622	1259
W9ESA	34	155	1011	1200
W6FTL	112	209	864	1185
W6BMC	92	107	975	1174
W9JWI	329	56	760	1145
W2BCX	137	121	846	1104
W6BMT	157	203	622	982
W7AYV	103	152	732	977
W8ZG	10	43	868	921
W8GUF	101	125	654	880
W5CEZ	147	159	550	856
W9LEZ	71	102	662	835
W7CZY	48	121	691	800
W7LD	251	59	482	792
W3ADM	91	204	486	781
W3BWT	147	132	441	720
W9TLH	57	108	548	713
W9DOU	75	150	478	703
W1VS	66	93	549	699
W9ABE	198	229	250	677
W1CRA	44	69	562	675
W9BKX	121	150	372	643
W7DBR	76	106	446	628
W2AYJ	47	114	432	593
W5MKN	92	189	308	589
W8HFG	71	129	375	575
W8DVC	12	25	538	575
W8DSS	47	39	480	566
KA1CM	308	73	180	561
W9IOL	123	106	330	559
KA1NA	245	44	270	559
W8GUC	75	75	400	550
W9MLH	405	34	106	545
W9OQC	269	130	137	536
W1ERQ	107	49	380	536
W6HZT	62	236	236	534
W3BYS	324	66	124	514
W2EGF	48	27	433	528
W8CIO	82	77	362	521
W8HCS	36	21	464	521
W9MZO	43	6	472	521
W7AYO	182	106	230	518
W6SJT	73	73	369	515
W3AKB	38	129	338	505
W7HD	33	42	430	505
W9HKC	19	18	466	503
W1BVR	15	81	405	501

### MORE-THAN-ONE-OPERATOR STATIONS

W3CXL	265	513	3311	4089
K6FWQ	613	533	1954	3100
W6ZG	546	653	696	1895
KA1ER	588	259	885	1732
W5OW	178	174	853	1205
W1MK	61	86	423	570

These stations "make" the B.P.L. with totals of 500 or over. Many "rate" extra credit for one hundred or more deliveries. The following one-operator stations make the B.P.L. for delivering 100 or more messages; the number of deliveries is as follows: Deliveries count!

W6AZU, 278	W2DQG, 122	W9AII, 107
W6GHD, 239	W6NFC-FN, 119	W9DJU, 107
W2BGS, 145	W9MIN, 116	W5ZM, 107
W6EPA, 143	W7BHE, 116	W8EYF, 105
W9BWJ, 142	W9IYA, 113	W6GYX, 105
W2ENZ, 141	W6RJ, 112	W9FJV, 104
W5AJF, 138	W3CL, 112	W7BWD, 104
W6ETJ, 131	W6HIR, 111	W7CFM, 104
W6DQN, 123	W2CHK, 110	W1BTG, 103
W9IQI, 123	W9NNZ, 110	W6HCT, 102
W7CRH, 123	W6JAL, 109	V22HK, 101
W5BXM, 123	W8BON, 108	W9FYP, 101

A total of 500 or more, or just 100 or more deliveries will put you in line for a place in the B.P.L. Make more schedules with reliable stations. Take steps to handle the traffic that will qualify you for B.P.L. membership also.

## Give Complete Address!

In messages and letters requiring a reply be sure to give your complete address! Call letters only are not enough. The person you are writing may not have an up-to-date call book with your correct address. It is especially important for amateurs to give their complete addresses when writing manufacturers and publishers, many of whom do not possess call books. In station-to-station message exchanges complete addresses in the signature may not be necessary—but, of course, the old rule about "complete addresses" of addressees must always be followed to alleviate necessity for SVC messages requesting "Pse GBA!"

## Improving Local Radio Conditions

By W9AIO, W9BVY, W9BYA, W9EQG, W9FKC, W9KB and W9MDO

**F**ORTY-FIVE thousand amateurs can't be wrong—but plenty are. With the prevalent congestion on all bands, reception in the Chicago area, due to improperly adjusted transmitters, has been chaotic. Personal complaints to the offending stations brought little improvement, and frequently engendered antagonism. Many stations continued to offend, knowingly or otherwise, because of a lack of willingness of other amateurs to complain.

These intolerable conditions, with lack of cooperation, prompted the formation of a group whose purpose it was to clean up the situation. This group, a committee appointed by the South Town Amateur Radio Association, was composed of men whose unselfish interest in amateur radio was unquestioned. Its first move was to publicize offenders. To remove personalities, complaint slips were circulated among the members. These signed complaints, upon return to the committee, were openly read at subsequent meetings omitting the name of the complainant. In addition, the committee sent a letter to the offender a draft of which accompanies this article.

A good percentage of the local offenders went to work and favorable results were immediate. It is felt that the efforts of similar cooperative groups will avert the necessity for a general house cleaning from Washington and help amateurs to mend improper conditions before they get into difficulties with the F.R.C. or receive F.R.C. monitoring station discrepancy reports. The motto of our committee is, "Not fewer, but better signals!"

The comments of representatives of the F.R.C. on the enforcement of amateur regulations may be of interest. One official said, in substance: "Policing the air is an immense task and requires much time but there can be no doubt about final results. Eventual monitoring station check up on all amateur signals, as some are now being checked, will result in the inevitable downfall of those who continue to disregard the regulations." Another endorsed the plan of the South Town Amateur Radio Association, adding, "In order that those amateurs complying with . . . regulations may not be penalized as a body for the errors of comparatively few, it is believed that when these few . . . fail to rectify errors after courteous notification, they should be reported to the Commission. . . ."

### SOUTH TOWN AMATEUR RADIO ASSOCIATION,

Committee on Violations.

Memorandum of Violation.

Station Call . . . . . Time . . . . . Date . . . . . Frequency  
(Band) . . . . . Calling . . . . . Working . . . . . Cause for  
Complaint . . . . .

Signature and Call

This form must be signed and complete data given. Name of person making report will be held strictly confidential. Form can be mailed or given to W9—, W9—, etc.

### SOUTH TOWN AMATEUR RADIO ASSOCIATION

COMMITTEE ON VIOLATION

Chicago, Illinois

Dear O.M.:

Our attention has been called by a fellow amateur to the faulty operation of your station. The committee has reason to believe that this is a matter of utmost importance, not only to you as an individual, but to all amateurs. We are including below a copy of this complaint:

Station Call . . . . . Time . . . . . Date . . . . . Frequency  
(Band) . . . . . Calling . . . . . Working . . . . . Cause for  
Complaint . . . . .

We know that no amateur station is wilfully operated illegally. For our self-preservation as amateurs we suggest that you remedy the existing condition. Should you have difficulty, any member of the committee will be glad to help you.

Sincerely and 73,

—Committee

Committee—W9AIO, W9BVY, W9BYA, W9EQG, W9FKC, W9KB and W9MDO.

## Briefs

In May, 1934, W6CUH and W6QD celebrated the first anniversary of combining their stations. Looking back over the log for the year they found over 1800 DX contacts in 62 countries—including 51 times WAC, seven of them in less than 24 hours—and 238 African QSOs—yet their goal has been DX *ray chewing*, rather than the mere DX itself!

When W3BWT is mentioned the first thing which comes to mind is "reliable traffic work." In two hours and fifteen minutes of schedules he recently handled 75 messages—his record!

On January 12th the following stations participated in a seven-way QSO: W1EBM, W1BLV, W1DEQ, W1ERQ, W1FCR, W2BII and W2ENZ. The QSO was in progress from 1:00 to 3:30 p.m. on 3.5 mc. c.w.

On February 9th the Western Union Telegraph Co. at Elkins, West Virginia experienced wire failures; traffic was routed via amateur radio to Columbus, Ohio, where it was turned back to the W. U. . . . service was provided by W8IKN, a member of the A.A.R.S., contacting the Army radio station at Columbus and arranging for a schedule with the Fifth Corps Area N.C.S., WLH-W8ZG. Sixteen messages were handled between these stations during the several hours interruption of the land wire service.

S. N. D. Lorenzo, Radio Operator on the S.S. *Pan Bolivar*, WDEK, tells of the exasperated commercial operator, who, having long suffered trying to copy something reputed to be "Morse code," asked the Lid, "What's the idea of using a snowshoe on your left foot when you've got the key screwed to the ceiling!?"

*K after CQ:* Attention is called again to the fact that while AR is appropriate at the end of messages and calls to stations (where contact has not yet been effected), that CQ's should conclude with K (not AR).

## Results 1750-Kc. Tests

The trans-Atlantic tests on 1750 kc. held each weekend from the first of the year were brought to a close on March 18th. These tests, primarily between British and W/VE amateurs, were arranged by G5UM, Manager 1.7 mc. RSGB Contact Bureau, and W1DBM. The results of the complete series of tests have just been received from G5UM via W1DBM. Several successful contacts were made as follows: W1DBM and G5WU had four QSO's on Feb. 3rd, 4th, March 3rd and 17th. W1CHV had two QSO's with G5WU on March 3rd and 17th. W1BR and G5WU clicked on March 17th. W1DBM was heard at least once by each of the following: G5RX, G5FI, G6YJ, G2BK, G5UM, G6FJ, G2YI and BR8727. BR8727 also heard the following 'phones: W1WF, W3CBU, W2BIC, W3ERU and W3CIG (some doubt about the calls). G5WU heard W1CCI, W1ATE, W1AGB (?), W2DVY, W8BFN (twice), W1GEY and W1MV. G5FI heard W1ATE, W1AGB (?), W2DVY, W8BFN and 'phone W2CB7. G5UM heard W1CBZ (twice) and W8BFN. G6YJ heard W1CEV (?). BR8727 heard W1AXA. G5WU received a report from VELA0, G5FI, G5WU, G6YJ, G2YI and G5RX, who cooperated in the tests, are members of the RSGB official 1.7-mc. experimental group 10A. Other British amateurs cooperating were G6FF, G6WQ and G6QC. No British amateur is permitted to use more than 10 watts input owing to possible interference with Mobile Marine Services which share the 1.7-mc. band in Europe. In view of this fact G5WU's work in making seven QSOs with the United States on 1.7 mc. is a decided achievement! And to the U. S. hams who got across, very FB! Here's to more 1.7-mc. trans-Atlantic work in the winter of 1934-35!



... It isn't that we hold anything against the changing times—Heaven forbid!—but it's just that some of the changes seem so stupid. For example: Three amateurs of '22 used to tune in a commercial press station and see how long they could copy before they broke. At the end of five minutes they would stop and count the letters, thereby ascertaining the speed. In one instance we know of, it was 35 w.p.m. on paper. Of course, copying in their heads they could do 40 or better. That, you understand, was just the routine of learning to be a good ham. In other words, code ability went along with DX and theory like "ham" goes with "and." How many of us who even go so far as to sport WAC certificates can copy 30—even in the head? We can't. But then again, maybe code isn't essential any more, because as soon as somebody adores the R.I.'s good nature to the extent of getting a ham tag on a very questionable 8 w.p.m., he immediately goes on 'phone and spends the rest of his amateur career telling wiser heads how to improve their modulation. . . .

—Lud Smith, W6BJM  
(From "QSA5," Marin Radio Amateurs)

W9PGS' first QSO on 14 mc. (with W8IHW) was also W8IHW's first 14-mc. QSO!

#### ATLANTIC DIVISION

**EASTERN PENNSYLVANIA**—SCM, Jack Wagen-seller, W3GS—RMs 3MC and 3ALX. 3BYS-534, 3AKB-505, 3CL-442 and 3ADM-781 make BPL. 3DGM-188 reports via radio. 3BWP-2 is rebuilding 3.5-mc. rig. 3MC-389 is QRL YLs. 3BYS-534 reported for QV-10 and CTB-57. 3ABT originated 286 at open house day at U. of P. 3AKB-505, our YL-ORS, got Class A ticket. 3EOP-6, 3ENX-13 and 3DMF-12 report for first time. 3EOH-13 is recuperating from sickness. 3FLA-180 was at Allentown Hamfest. 3CT-442 scheduled from 3GX while on active NCR duty. 3BCM is getting over auto accident. Painters took feeders of 3DYX-3 while painting house. 3AKG-83 has 841 perking FB. 3DIG-43 says gang is organizing Susquehanna Valley Radio Club. 3ASW-8 wants help in locating 9IST. 3EIM-1 built c.c. rig. 3BNK originated 2, both for ZL. 3EAV-14 is in new net running from 1HWP to 4BGU. 3LRI-11 would like to be on top of that mountain instead of at the bottom. 3VD-78 got his yearly case of spring fever. 3LUI-35 is first licensed C.C.C. amateur station. 3AQN-243 is well supplied with traffic from 8GUF. 3GS-21 is now on 56, 14 and 3.5 mc. 3BEX, Frankford Radio Club, is on 3.5 mc. The York Road Radio Club held first annual banquet June 5th. 3DQU is looking for 3.5-mc. traffic. 3CZW has Class B 3.9-mc. 'phone. W3EZ-370, CB-112.

**MARYLAND-DELAWARE-DISTRICT OF COLUMBIA**—SCM, E. L. Hudson, W3BAK. 3CXL, 3CQS, RMs; 3BWT, Chief RM. 3DWF is operating WVVG of C.C.C. radio net at Little Orleans, Md. He is looking for a reliable traffic schedule in Baltimore. The following BPL: 3CXL-4089 (2 ops), 3BWT-720 and 3BND-318. Putting up new antenna: 3DRE-6, BGI-30. Building receiver: 3EIL, BAK-15. Working 56 mc.: 3DIM, DRX. Working 28 mc.: 3BHE, BFX. Building Tri-Tet: 3CDG-74. 3EKJ at Howard University is operated by 3DIM, DRX and "Lanky." 3CVT is radio engineer with the Waltham Watch Co., and operator at 1XL and 1AY. KAPPA SIGMA Upsilon RADIO FRATERNITY of Washington affiliates with A.R.R.L. W3EHW-76, ASO-54, DML-44, CTD-32, CIZ-29, CWE-11, EIV-28.

**SOUTHERN NEW JERSEY**—SCM, Gedney M. Rigor, W3QL—New ORS: 3EDP and NF-18, who has moved to S.N.J. 3ARV-8, Ex-HM, is on air full blast. 3BDH-34 is going c.c. 3APV-123 reports new hams 3EQI, EPP. The Atlantic City Club has new SW3. 3BEI-13 has new crystal 100-cc. bar. Sammy Kale of 3VE-173 fame can't wear a hat on account of a new Jr. opr coming to his shack. 3AEF-11 keeps regular schedules. 3EBC-1 has new PRIO. 3ZI-220 reports the D.V.R.A. very active in Trenton. 3CFB-56 wants schedule in South Jersey at 7:30 a.m. year round. 2FQV is operating WVQV C.C.C. Co. 1249th Marion, Va., on 4305 kc., from 8 to 5 p.m.

EST, and W2FQV/3 operates on 3805 kc. from 7 to 10 p.m. Anyone desiring schedules, write immediately to Chas. Earle, Opr. This is important; someone please take the schedules with W2FQV/3. S.J.R.A. had 86 present at last meeting. Visitors welcome each third Thursday of the month. W3CWL-116, DPE-8, DH-131, BYR-QL-KW-4, AVJ-6, DSC-107.

**WESTERN NEW YORK**—SCM, Don Farrell, W8DSP—8GWZ-2 handled traffic with 5KAA. 8DPS was QSO a "J" on 14 mc. 8GWP is selling out. M.V.B.P. visited the Fort Stanwix Radio Club, and 8DT gave a very good talk on "Doublets." 8ON-15, station of the Jamestown Club, has been moved to its old location at 117½ Front St. 8CDK's transmitter is being used and CDK is Chief Op. New calls in Jamestown: 8HTT, LTN. 8JTP-238 wants O.R.S. 8CHA is at C.C.C. camp at Quaker Bridge. 8CYT made W.A.C. 8EBR-5 was at ORS Party. 8LOW is Ex-2GFL. 8DWJ spent his usual six months in Florida. 8HEC is back after a year's absence. 8LUO is on at Cobleskill. 8BJO is working shift work nights. 8EMW-95 is rebuilding. 8AKX-1 is working DX in great shape. 8EUY-37 applied for W.A.C. 8GZM-15 is moving back to Oneida. 8FYC-49 keeps several schedules on 1.7-mc. 'phone. 8IY-149 uses an 851 as linear. 8FYF-238 reports the Utica A.A.R.S. Net going FB. 8AYD-74 changed rig from inductive back to capacity coupled. 8EWP-6 copies the OBS from 1MK and retransmits same every Friday night. 8KBS-20 reports from Elmira. 8KMC-354 keeps thirty schedules per week. 8KXA is trying to get bugs out of receiver power pack. 3FDY is operating at Fort Slocum. 8FUG-44 has a new job. The S.T.T.A. are holding a one week's "QSO Contest" among members. 8BQJ-25 worked VK5HG. 8DZF-4 has new rack and panel job. 8AXE-2 is increasing power. 8EDA recently lost his mother. Our sympathies to him and relatives. 8JTT-157 was on a two weeks' trip around Virginia. 8LGR-31 is building 'Tri-Tet. New calls: 8LYW, LUF, LVZ, KYM, LWD. 8IMR has Tri-Tet crystal job. 8JQE-53 wants schedules with Buffalo and Jamestown. 8LUJ-5 sends first report. 8BHK-20 had a fine time at ORS Party. 8FTB-12 was heard by G2BZA on 3.5 mc. 8DSS-566, R.M. is high traffic man for the month. 8AWX-241 is taking up flying. 8GFS-48 joined A.A.R.S. 8IDJ-130 is rebuilding with '04A in final. The Rochester gang is doing lot of work on 56 mc. 8BGN is putting 56-mc. rig in his car. 8DSP is building rack and panel job with 830 final. 8AOW bought a gas station and gone in business for himself. 8FMH gets fine reports on 3.5 mc. with a 14-mc. half-wave antenna. W8DBX-149, DHU-65, GWY-39, GPT-24, JJJ-12, GWT-11, FMX-5, AEK-98, BWY-117.

**WESTERN PENNSYLVANIA**—SCM, C. H. Gros-sarth, W8CUG—8GUF-980 found time to work all continents except Asia during DX Contest. 8KWA-262 suggests that we try a Sunday morning Section QSO Party. What say, gang? 8KD-121 is back in ORS ranks. 8ABS-26 is looking for OPS applications. 8JZZ-10 is lining up a bunch of schedules. 8GBC-9 has been playing traveling salesman. 8AAQ announces arrival of a 9-pound Jr. Op. Through 8FKU-8 we learn that the Quaker State Radio Club has enlisted most of their members in the U.S.N.R. 8KQQ-4 is putting '04A in final. 8KOB-10 has been building new rig. 8FTM worked the elusive continent. 8EWE has R9 reports from all continents except Asia. 8PX has worked 7 districts on 1.75-mc. 'phone. 8GJM-3 tells us that 8IRK is back on 7 mc. 8DKL-3 works plenty of 14-mc. DX. 8AYA-1 uses break-in on 'phone. 8KSG has 1.75-mc. rig going. 8KRG has started a superhet. 8AVY and CUG-26 attended FB meeting of Keystone Radio Club. How do you fellows feel about the Sunday morning QSO Party suggested by 8KWA? Drop me a postal, and if there are enough to make it worth while we will start them. W8YA-251, AXD-26, CMP-16, CQA-11, CKO-15.

#### CENTRAL DIVISION

**ILLINOIS**—SCM, Fred J. Hinds, W9WR-W9APY—RMs, 9AND and 9ERU. Ex-K7HV is now 9RQZ. 9HPG-575 is A.A.R.S. 9EAL and RLP are both rushing

same YL! Pair of '45s at 90VY-1. 9CIA-46 handles DX traffic. 9COW says no OPS heard on 14 mc. in OPS party. New c.c. rig at 9PBQ-15. 9RCQ-3 is lucky at winning Convention prizes. Six of 9HQH-58 messages were handled on 'phone. 1.7-mc. 'phone soon at 90XA. 9PVG has new Gross c.c. rig. 9PQM-5 has given up 'phone and gone to CW forever. 9MKK-188 says A.A.R.S. keeps his score up. 70 hams attended Podunk Shack Hamfest. 9 PNE-3 works fine DX. 9CZL is the only ham in town. 9BRX will soon be OPS. 9KJY-1632 steps up onto the top of the traffic pile again. 9MIN-373 is now A.A.R.S. Junior op arrived safely at 9LIV. Housecleaning at 9FTX-3. 9AVB-6 says, "Let's have more Dances in Chicago for hams." 9KRZ-6 has gone to 3.5 mc. for traffic. 9KOQ-20 says A.A.R.S. is good practice. 9CKC-104 wants more radio shows so he can make BPL on deliveries. 9FXE is on trip to west coast. Five-stage c.c. rig at 9AFN-9. 9IYA-216 and IVF are Alternate S.N.C. A.A.R.S. 9MJJE received Class "A" license. New rack and panel at 9ACU. 9LNI-7 is working on flea-power rig with c.c. 9BDO-137 says two more YLs joined the A.A.R.S. 9LIV and OIU changed their junior ops initials to H.A.M. 9BYZ says only locals on 28 mc. 9PTW-2 sends first report. W9ILH-713, DOU-703, MLH-545, HKC-503, HUM-280, NN-240, MDL-201, IEP-174, CGV-135, ORT-115, NIU-58, KOR-46, HUX-43, KEH-41, DJG-34, EMN-33, ICN-30, FYZ-28, FO-25, CUH-21, MMB-15, MAJ-13, CNH-GKH-SG-12, PHX-8, CEO-7, DGT-1, WR-1.

INDIANA—SCM, A. L. Braun, W9TE—9HZH has an SW3. 9KLG has 825 in final. 9JHY-27 is giving CW a whirl. 9PQL is looking for few sevens. 9AUT-23 is looking for DX. 9HUO-53 wants O.O. 9DPL raised N. Y. for LX. 9EPT got a job in Ky. 9KDD is planning on new rig. 9QG-1 raised ZL and VK. 9MFW joined up CCC. 9PSB is on 3.5 mc. 9CTT-35 is handling traffic again. 9FQ will be on soon. 9EJB-13 is back on 3.5 mc. 9MQQ-3 has a 2nd harmonic hertz. 9LSZ-20 has a pair of '66s. 9BTR uses low power. 9AKJ-3 is on 7 mc. 9HML-27 wants a few good schedules. 9EGQ-69 has a home-made bug. 9TE-9 is trying to get good DX ant. W9EUV-5, DET-43, HUF-17, DJU-281, JRK-186, AXH-6, MBL-1, YB-36.

KENTUCKY—SCM, Carl L. Pflumm, W9OX—9BWJ-301 takes traffic honors. 9HAX-118 is going c.c. 9OMW-122 continues good work. Ky. traffic net-work will function on 3810 kc. All stations desiring to participate will obtain crystals accordingly. 9CDA-117 wants a rake-off on his crystal. 9CNE-92 is building extra transmitter. 9BAZ-88 is laying foundation for 1KW outfit! 9MWR-53 hankers for ORS. 9AUEH-48 has his troubles. 9OFFE-42 is visiting hams at large. 9EDQ-42 continues traffic schedules through hot weather. Page 9HBQ-34 when you want a message put through quick. 9IXN-31, 9JYO-16 schedule is moving traffic south in good shape. 9ARU-23 cleared up his "fuzzy" 'phone. 9BAN-18 is looking for a good op. 9EQO-19 pinch-hits on JYO's schedules. 9BJA-16 is back after a year's absence. 9FGK-8 is gardening. 9HCO-5 works G6IF on 14-mc. 'phone. 9EDV-5 is awaiting Ky. Hamfest. 9L BX-4 is cleaning up on P.A. systems. Ex-9BXX of spark fame will soon be with us again. Uncle steps 9ZZQ's call! 9EYW-2 is monkeying with 56 mc. 9IPG-1 raises new stick. 9FZV-1 monitors Ky. party from WPDE. 9EOM divides time on 'phone-c.w. 9CIS parks on 7 mc. 9PLM-5 will have ½ KW rig on air by July. 9IFM goes in for Ky. parties. 9RBN is opening up with pair 276's on Ohio River camp. Out-town business breaks up 9ERH's operating. 9CIM-8 is moving AGAIN. 9GLH says Class B on 1.7-mc. 'phone is berries. 9FQQ-37 is dickering for WES42A. 9NWR-10, PAZ-2, KOX-5, NBD, ACD-27 report. W9OX-155, AYH-3, ELL-21.

MICHIGAN—SCM, Kenneth F. Conroy, W8DYH—Info from Radio Inspector, Frank M. Kratokvil, 8BA, states that 19th district office will be located Tenth Floor, New Federal Bldg., Detroit, Mich., Room 1025. The Hamfest at Grand Rapids was a Wow—175 attending. D.A.R.A. Annual Spring Hamfest brought out over 450 hams. MICHIGAN NINES: 9PDE, U.P. RM, got job in Munising. 9LUU has c.c. ready. 9GUF is interested in CCC radio. 9LLD-1 reports all quiet on northern front.

9RIT-3 tells us all hams want to schedule 9PCU-85. 9HSQ-4 is studying for Comm' ticket. 9LGU attended D.A.R.A. Hamfest and walked off with prize of 5 months' tuition at Port Arthur, Texas. 9OOQ-6 buried the hatchet --and not in the SCM's skull either. Hi. 9KDE-6 reports RBS new in Hancock and JCN still in Detroit. 9IOV-8 hooked ZL2FR. 9EQV-9 reports QRM so had in Dollar Bay that each ham uses separate band! 9CWR-16 wants to know how we'd like to go fishin' in that man's country? All Ironwood Amateurs are c.c. now: 9EMB, ADV, HNJ, CUC, LPI and CWR. 9NEZ-12 nominates HK for A-1 Op Club. 9AAM-11 helps keep WX schedule with copper country. 9OVX-10 schedules OXL-36 tri-weekly. 9DDK-31 uses link coupling. 9OZM's-32 rig wouldn't work in shack, so took it into parlor and now works FB. 9CWD-48, U.P. 'Phone RM, plans weekly roll calls for 'phone net. 9CE-60 schedules 9ADY-202, PDE and CWD. MICHIGAN EIGHTS: 8DVE-575 BPLs for second time. 8GUC-550 seconds with BPL. 8QT-347 is going strong. 8FTW-313, Detroit RM, raves about GUC's net. 8EGI-162 will soon be at 8HCC. 8KOX-135 reports BXJ working on S.S. receiver. 8LAL-37 needs fire bell in place alarm clock for Sunday a.m. schedules. 8CPY-63 will lay a clear breast re: the Ludington softies. Next month. 8IPX-47 reports for first time. 8GDR-46 says, "We're gonna start a separate Section! Youze guys didn't even mention us in the Bull." SIUP reports Wayne University on 7 mc. and 1967 work. SCM reports U. of D. on with 8LGA on 1.75 mc. 8EBQ says, "The beer—I mean the Grand Rapids Hamfest was FB." 8CUX has a 263-ft. zepp for high angle radiation. 8MV will handle schedule with 8HFB (8AIU at camp). 8CFU plans a visit to one of those famous (?) Marquette YLs. 8ECB signs WADU on lakes. 8CST and 8FDC (Sgt. Steadley, Consulting Engineer) are now at WEXL. 8EA quit radio for four hours, then May issue of QST came and he's at it again! 8DIV-3 runs that hot Pontiac Club "Bull-Ton." 8CSL-3 finds things rosey—works in a greenhouse. 8KZ-6, East Mich. 'Phone RM, is lining up 'phones in his territory. 8DPE-8 and KOX are organizing the CCC into a net. Anyone with parts to loan or donate to this cause, write to SCM. 8IFE-18 put P.P. '08A on rack, and thing looks bow-legged. 8GSP-17 wants another ORS party soon. 8JKO-14 plans a club for Port Huron. 8GRN-11 hooked J2GX for WAC! 8LNA-11 was bartender at G.R. Hamfest. 8DNM-24 reports Shelby gang all QYL! 8CVF is out for OBS and OPS and some 8JO Forest fire work. 8BTP won prize for drinking most beer at G.R. Hamfest. 8GHP-35 expects to have small c.c. rig on air soon. 8JLA will operate at 8JO a lot this summer. 8JO-45 wants to hear from gang with portable for forest fire work. 8LAI has weekly schedule with his brother, 1GOB. New officers Gratiot County Amateur Radio Association: Pres., 8BDH; Vice-Pres., 8EEY; Secy.-Treas., 8KIQ; Pub. Mgr., 8LLW. W8DWB-176, KNP-111, FDX-44, BMG-42, IOR-40, IKO-36, KYS-33, DED-32, DZ-31, DCQ-26, HBZ-25, ARR-18, KMT-17, EHD-15, GQB-HL-14, FX-13, JCS-9, AW-8, HFU-JNK-6, DYH-5, AIJ-AYO-HSE-4, IFQ-JTV-3, DSQ-GQS-HA-ICM-JIU-2, BTK-IXM-1.

OHIO—SCM, Harry A. Tummonds, W8BAH—Election results. Total of 49 ballots mailed for election of Chief Ohio RM. 31 votes cast as follows: 8VP (6), 8FGV, 8BH, UW (3 votes each), 8BKM, HC (2 votes each), 8BON EJ, GOD, DVL, GZ, EBY, DVE, EEZ, GSO, GDC, HMH, CUL (1 vote each). 8VP declared elected and takes office immediately. 8ZG-921 leads state! Dist. No. 1: New calls in Lakewood Radio Club: 8HSX, LXP, LXA, LXG, UY. Cleveland Attorney receives call 8MAN. 8FGC, GME and KZL report. 8FGJ-1 is on 1.7-mc. 'phone. Welcome back, 8DSS-3. 8FLB is laid up with bad leg. 8BMX-16 is working in Ashtabula. 8EBY-17 will graduate. 8GUL-20 works nights. Collins antenna at 8BAC-26. 8FVL-27 new QRA: 4669 Liberty Rd., South Euclid. 8KFK-111 likes to rag chew. 8HGE-132 wants schedule for Put-In Bay, Ohio. 8KJK-137 was in A.A.R.S. Contest. Five schedules at 8EPP-166. RM 8BON-205 gets his commercial license. 8DVL-244 made 1437 points in A.A.R.S. Contest. 8RN-368 is on KFLN, Great Lakes.

Cleveland Heights Radio Club meets every Wednesday at 8FFK-422. 8CIO-521 works A.A.R.S. schedules. Dist. No. 8: 8DQC and HMS-7 want ORS. New antenna coupler at 8BKE-24. RM 8FV-27 reports by message. Dist. No. 4: 8WE renews ORS. 8PO-11 announces all-Ohio Portable tests and contest. A.A.R.S. at 8HMH-14. 8IET-106 is new reporter. RM 8UW-248 says we need state ORS Net. Dist. No. 2: RM-8EEZ, 8UX sold transmitter. 8EJ-41 reports Navy Net office. Dist. No. 5: 8BOF joins League. 8BMK-2 will graduate. 8KLP-5 has a job! RM 8FGV-15 works plenty DX. 8AMF-25 schedules NP and GNO. 8LGL-88 wants dope on early morning schedules. Dist. No. 3: 8APC-RM. 8JMB is new reporter. 8AEW-9 likes traffic work. Dist. No. 7: RM 8WVP is operating on about 3535 kc. Dist. No. 6: 8JTW wants ORS. 8AEL joins Ohio State Police Patrol. 8GDC-3 suggests 8BMU for OPS. 8EQO-3, ARW-7, EQC-3 and DZO send good reports. RM 8GSO-73 says Lancaster and Columbus gang starts 56-mc. tests. 8JGZ graduates with high honors. FB report from 8JFZ-29. Officers of Toledo Radio Club: 8GJS, Pres.; 8ESN, Vice-Pres.; 8ATN, Secy.; Sage Rowe, Treas. Ralph Kachenmister, Sgt. at Arms. 8BAH-34 will be on 1.7-mc. 'phone soon. 8VP is organizing State Net for all Route Managers. 8PO is arranging portable tests for the state. "Coöperation" is the Ohio word to lead us to the top. Let's go, gang. 8W8ISK-125, LCY-101, BDY-68, JMV-60, ICC-41, ESN-18, AQ-16, ELB-7, CMY-2.

WISCONSIN—SCM, Harold H. Kurth, W9FES—9ESK—320 is still leading state. 9ATO-148 deserves congrats for fine traffic work. 9KJR-36 has been after DX. 9IQW-33 is learning to use mill for traffic. 9GVL-31 handled traffic from HCJW and K5AZ. 9OKS-30 ordered an AGSX receiver. 9JCH-21 has crystal in super now. 9DNU-9 and ETM-59 want schedules. 9OTL-7 improved output with Collins antenna system. 9JDP-5 visited Milwaukee hams. 9GWK-2 and HGG are going camping. Officers of Rock River Radio Club: Pres., 9JVW; Vice-Pres., 9ADK; Secy., 9APU. Milwaukee Radio Amateurs Club QSO Party was a big success. New officers, M.R.A.C.: 9REH, Pres.; 9KWV, Vice-Pres.; 9FSS, Secy.; 9ANA, Treas. W9NSM-31, LFK-20, OXP-16, KPO-9, PTE-8.

#### DAKOTA DIVISION

NORTH DAKOTA—SCM, Fred J. Wells, W9JVP—New Margo stations: 9LYX, EHK and RPJ. 9KBE-13 is the new RM for eastern N. D. 9LHS-6 '03A works FB. 9RPJ uses Tri-Tet. 9EJC-265 will rebuild with 800 in buffer. 9EJJ is going c.c. 9AFM is returning to air. 9KZL-50 gets out with .06 watts. 9MGR and PQW are on the road. 9FSF-47 seems to be king pin in A.A.R.S. 9LBI is trying 56 mc. SCM has new freq.-meter and monitor. 9DGS-102 is on 1.7-mc. 'phone. 9PAI-149 also has 'phone on air. Minn-Dak Radio Club is up and coming. 9RQX is new Hope ham. 9OEL handled traffic from 9BPM celebrating Engineers' Day at Univ. The Fargo Amateur Radio Club's second Bi-Annual Hamfest, May 6th, had an attendance of 155. Visits to ham stations, business meeting and banquet with prize drawings were featured. All present were enthusiastic in declaring this Hamfest a success. W9PGO-105, JAR-65, JVP-18, MZE-44, EFN-6, PDC-110, OEL-59, PJT-2.

SOUTH DAKOTA—SCM, Mike Strahon, W9PFI—Many outside hams were at Sioux Falls picnic—9ALO-32 brought portable. W9BLZ-10, AJP-4, PFI-24.

NORTHERN MINNESOTA—SCM, Robert C. Harshberger, W9JIE—9LAY is on 7 mc. 9IDJ is control station for Northern Minn. C.C.C. Camps. 9RAL-1 and RBZ report via 56 mc. 9BBL, EKX, HRB, PKO are on 56 mc. 9DJW is back after year's illness. 9HDN is on 3505 kc. 9OOU-5 uses vest pocket Hartley at camp. 9IGZ was at Fargo Hamfest. 9JCD is at Ft. Snelling. 9PWW is new Alexandria station. 9FEP is in Kensington. 9OOO-43 is heading for 14 mc. 9OMI-4 is radiating house paint. 9PUB-3 is increasing power. 9PUZ and FTJ are A.A.R.S. W9LIP-19, HNS-4, LFO-234, JIE-104, IPN-35.

SOUTHERN MINNESOTA—SCM, Francis C. Kramer, W9DEI—9BKK, RM. 9BKX-643 makes BPL

7th consecutive month! 9BKK-103 and CKU operate from same QRA. 9AFR-83 uses P.P. '10s final. A breeze took away 9BNN's-76 sky wire. 9BN-57 is a reliable Twin-City traffic station. 9DEI-51 has pair of 845s Class A mod. "73" is 9FCS's-36 telephone Nr. 9FDL-34 is new ORS. 9RAU-23 plans trip to Hollywood! "Grid mod. cuts down output too much," says 9BHZ-19. 9AQH-16 moved to the lake, and will have 9HCC going full blast. 9DH-10 is op at 9BN. 9RAB-4 will take portable to his work in Colo. 9OAK-2 joined A.A.R.S. 9GLE-2 asks, "Is a fisherman a fisherman when he catches no fish?" 9RKG-1, and PLD are new reporters. 9EGG-1 had to have a relief driver on way home from Fairmont. 9MOW applies for OPS. We need several more such applications, fellows. 9RBW had 4 flats on way from SMRA meeting. 9JQA is using "Collins" coupler. 9ELA worked Japan long way around. 9IDF has MOPA. 9ANU was farming 'till the farm blew away. 9AGO was host to 13 S. E. Minn. and La Crosse amateurs. 9AIR reports work on "Old Man River" is enjoyable. All Boy Scouts interested in organizing a Scout Net, send me your names. The S.M.R.A. held annual meeting in Fairmont, May 6th. Over 90 attended. 9OEV won grand prize. W9MOV-38, KDI-3.

#### DELTA DIVISION

ARKANSAS—SCM, Henry E. Velte, W5ABI—5BMI-982 made the BPL two ways. 5DYL uses P.P. '45s. 5BXM-242 made BPL on deliveries. 5CR completed 40-watt suitcase 'phone rig. 5CCW was gone to California. 5ASD is putting YM, U. of A. Station, on the air. 5BSG sent news on his part of state. 5CZG-5 worked T2LR. 5DVI has FBXA. 5DUS is Ex-9BKA. 5DUV uses '10 final. 5DRY-1, CEO and DWL are rebuilding. 5CVO-11 is interested in U.S.N.R. 5DRW and DFY are going in for Tri-Tet. 5DRR-31 was heard in Germany on 3.5 mc. 5SI has low-power 'phone. 5DGO, CPV and DGD have c.c. 5DSW-3 has fun with speed boat. 5DTT-44 is QRL service work. Ex-CM8xc lives in Arkadelphia. 5DYX-9 installed 50-watter. 5BDB is on 14-mc. 'phone. The Four States Amateur Club plans field days for this summer. 5AXP and ABU are on 7 mc. 5ANZ has new receiver. 4AJJ (port.) is located at Texarkana. 5DVR-73 has four schedules daily. 5ABL has been sick. We miss your signals, OM. 5BED is editing a sheet called the "Arkansas Bull." 5ABI is assistant editor. Copies will be sent only to those who report to the SCM on the 16th of each month. New Ark. stations: 5EEJ, DUU, EAR. 5DYT, a member of Scout Amateur Radio Net, is building 1.7-mc. 'phone. W5DJE-DHG-4, DFZ-3.

LOUISIANA—SCM, W. J. Wilkinson, Jr., W5DWW—5AOZ is trying to get 14-mc. rig working. 5CJO reports. 5DIQ is in Algiers. La. 5DMF-10 building Tri-Tet. 5ST is active in N.O. affairs. 5ACV is receiving DX cards. 5AJJ is in N.O. 5DKR is new South La. R.M. 5EDZ is new in N.O. 5DYR is call of N.O.R.C. 5BPN will soon have three ops. 5AEH has fine rig. QRN ran 5CTR off 1.7-mc. 'phone 5AXU-6 joined A.A.R.S. and CGN. 5BPL-3 is back. 5BZR-275 (RM) worked seven countries in 2 hours. 5CQF-ZV had 5DLD-3 and PG as visitors. 5AYZ took trip to N.Y.C. 5DPM is rebuilding. 5AGM tried 56 mc. The Louisiana State Convention, September 1st-2nd, Shreveport, La. Write Shreveport Amateur Radio Club, Box 1076, Shreveport, La., for further information. 5DVP has been QRL Army Air Mail work. 5NM is op on S.S. Santa Marta. 5CEN is building rig in rack. 5CRE rebuilt. W5BID-32, BYY-25, CQF-19.

#### HUDSON DIVISION

EASTERN NEW YORK—SCM, Robert E. Haight, W2LU—2EGF-528, new RM, conquers BPL! 2BZZ totals 411, 10 days period!! 2BLU-402, new OBS, scores high. 2BJX-266 is new ORS. 2BJA-143, Chief RM, is oiling up for fall. Welcome, 2GTC-51, to ORS ranks. 2FQG-40 reports traffic first time. 2EQC-16 sports FT37A. 2CLL-16, GPB-12, BLL-2, GRV, CBN-4 are doing their part for ENY traffic. 2CFU-11 and UL-14 report 9AAB, Dir. R.M. Div., paid them visit. 2ACY-1 in 29 days

QSO'd 43 countries. 2CC-14 schedules DX. 2GNI-15 uses 3796 and 3860 kc. 2FPH visits GNI. 2BSH-7 is gardening in spare moments. 2ATM-4 gets active duty with NCR. 1EFM-6 has new Silver 5B super. 2KW-15 is fixing things for 3.9-mc. 'phone. 2GWY-16 and GXE are new reporters. 2HES is new station at Poughkeepsie. 2CJS-2 revamps for 7-mc. DX. 2DTB and ACD are on 14 mc. 2ENY, ENG, FAM are heard at Troy. 2DYC-6 tries for Class A. 2FXC-7 goes to 14 mc. 2CSM rebuilds receiver. 2FSD: Congrats on that new YL op. 2EMK joins CCC at Iona Island. 2GFD reports for Kingston boys, 2BNR and CZL. 2CWO is on 56 mc. 2AMM works heavy 14-mc. DX. 2CAZ-8, DC, CBO attended Springfield Hamfest. 2AZH is proud Daddy, Frank Jr. 2AQN is on 14 and 7 mc. Remember the ENY Bulletin. It's yours for reporting to your SCM. 2LU-390, DSH-16, ETH-9, GTW-7, QY-3, EQD-60, CJP-2.

**NEW YORK CITY AND LONG ISLAND—SCM,** Ed. L. Baunach, W2AZV—2GDF-5 and DJP-106 are out for ORS. 2CAC says crystal filters work FB. 2FBE worked a "G." 2BAS-4 was heard by V5YAK. 2BBS is on 14 mc. 2FSW pounds brass on S.S. *Cucotta*. 2GDQ and EBT-3 inspected RCA Rocky Point transmitter thru courtesy of FFT. 2AXN-2 and CEH sport new poles. 2EYQ-234 says speed bug got him. 2FDQ is installing '04A. 2EGA-32 landed job in N. J. 2FPB's new QRA is Roosevelt, L. I. 2BTF-4 got a message off to K6EWQ for a friend. 2GOV entertains the gang on 1.7 mc. 2GOW-4 is on 7204 kc. 2DBA-3 is on 3.5 and 1.7 mc. 2BGO-252 is looking for stations for A.A.R.S. in the BRONX. 20Q-65 handled entire correspondence between a couple in Savannah and Mineola. 2FIP's-22 56-mc. choke went west. 2GEI and FF do plenty of experimenting. 2EVA-12 reports new ham, GZK. 2DTM sends first report. When not printing the newspaper 2GLJ-9 is heard pounding brass. 56-mc. bug has 2CK. 2AZV's-36 new transmitter size is 2 by nothing. 2DUP-11 hears VE4's on 3.5 mc. 2LG-10 has receiver trouble. 2CCD-17 has several 1KW tubes standing idle. 2CSO-17 worked his first YL. 2AA-8, ADW-12 and GZ-12 held first N.C.R. meeting at Hempstead, L. I. 2LB-17 can be heard from Louisville, Ky. W2AYJ-593, BGS-479, CHK-475, DBQ-334, EYS-143, AEN-14, DRG-DWW-11, BKP-BYL-9, CIT-BPJ-8, CYA-8, ASG-4, CBE-3, CPY-AGC-2, AYI-GOV-1, AOB-4, EAF-3, LR-BIK-6, PF-5, AOO-AQQ-1.

**NORTHERN NEW JERSEY—Acting SCM,** Robert Maloney, W2BPPY-Ed, W2DIU-1559, is leaving for St. Louis on July 21st. He will certainly be missed! Good luck, Ed. 2EKM-2014 finishes writing out one of the country's best single man reports, to scrub floors for the OW. 2BCX-1104 continues his fine heavy traffic work. 2BNZ-272 is doing twenty mile marathon swim at local "Y" pool. 2FOP-45 is on 3.5 mc. 2CTT-33 won five out of seven door prizes at the TCARA. 2CJX-28 hands in his report on a Form 1, vintage 1922! 2DPA-22 gets the ZLs. 2CIZ-10 is tutoring his boss's son into ham radio. 2CLM-4 worked PK3BY, Java. 2BXM-1 enjoyed the last ORS party. 2DPC's-22 new QRA is 410 Bloomfield Ave., still in Verona. 2EIC-10 reports strong U.S.N.R. activity. 2BAI-9 put in two weeks' active duty with NCR. 2GLB-8 uses 59 Tri-Tet and 10 amp. 2GCV-2 will use link coupling all through. 2ETQ-1 is working oodles of 7-mc. DX. 2FLT is applying for ORS. Reports for 2JC-422, HFO-3 and GGW-174 come via BKM. A Silent Key, 2BHR, George C. McClintock of Rahway—an old-timer of the finest. W2BPPY-1, AFK-233, LK-114, GVZ-2.

#### MIDWEST DIVISION

**IOWA—Acting SCM,** E. F. Alberts, W9CWG—W9HPA-RM, W9ABE-RM. 9LEZ-835 illustrates what a good line of schedules will do! 9ABE-677 runs a good second. 9LXX-257 is holding daily schedules with lots of traffic. 9HPA-71 has a new car. 9CWW-69 is Acting SCM to take on the duties of FFD-10, who is swamped. 9GWT-17 holds schedules with his cousin, W6. 9JDY-6 got new rig on. 9DIB-4 is on 3.5 mc. 9NVF has lots of fun with DX. 9IDEA comments on "ulterior motives" and circulations. W9FYC-52.

**KANSAS—SCM,** O. J. Spetter, W9FLG—9KG and 9IOL C. W. RMs. 9ESL Phone RM. 9KG-1259, IOL-559 and OQC-536 make BPL on totals and IQI-421 on deliveries. 9LGV-1 is building Universal testing meter. 9PRI is new Lenora ham. 9BUY-10 is building low-power rig. 9ATN has '52 final. 9HLD worked a K6. 9PKD-44 worked 4PL with '59 osc. 9PB-85 reports U.S.N.R. had Federal inspection, May 1st. 9OFR-210 is after DX. 9ESL has 50-watter. Twenty-five hams from Elgin, Tyro, Independence, Parsons, Bartlet and Caney met with FB DX Club at Coffeyville, May 1st. Good program, prizes and eats enjoyed by all. W9BYM-311, NJS-261, HSN-260, IEL-203, EFE-180, NI-LTG-37, FRC-3.

**MISSOURI—SCM,** C. R. Cannady, W9EYG-JPT—9JWI-1145 is trying to get to top of BPL. 9MZD-521 wants more interest in State Net. 9RPC-1 is dad of MZD. 9ALI-431 says JBV and JZB QRL school. 9NNZ-378 got DX fever. 9GTK-138 is building c.e. rig. 9KVN-112 built 56-mc. outfit. 9AQX-80 is active in U.S.N.R. 9LBA-80 is on 14 mc. 9RMH and RLX are new hams in Joplin. 9CRM-30 gets good results since c.e. working. 9JAP-16 is working with C.C.C. camp for traffic. 9HNM-12 is just over mumps! 9KEI-12 wants traffic schedules. 9LLN-6 puts 21IE in final. 9EYM-4 sends first traffic report. 9DLC-1 has trouble with S.S. receiver. 9KIK-1 uses '10s parallel. 9NNF has 6 watts input on 3.9-mc. 'phone. 9NBE has '10s final. 9NBV uses s.s. super. 9GSO is getting parts for c.e. rig. 9HVP is about ready with c.e. 9GUO and PBZ are rebuilding. 9NKS gets c.e. rig on 7 mc. 9HVN uses e.e. rig. 9ILI is winding big transformer. 9GHI gets first VK. 9DUD is gaining fame with daily rag. 9PYD has new zepp. 9HWF makes St. Louis receivers tremble. 9ZK works them all on 3.9-mc. 'phone. 9HLP-HWP are going strong. 9KHV wants W7 QSO. 9MLR blew filter. 9LGC is now c.e. 9IAC has 300-watt job about finished. 9MND works Europe and S. A. 9CGA goes 14-mc. 'phone. 9KBV schedules VK. 9IAL goes back to Minneapolis. 9NIS put up 1.7-mc. doublet. 9CHE is trying 56 mc. 9BLU is building highpower c.e. job. Following QRL: 9MO, HEL, FWQ, LTH, CCZ, HUG, ASV, DIC, FAB. Excellent progress is being made towards completion of an FB program for Missouri's 1934 Fourth Annual Convention at Kansas City the first part of August. Plan now to be there. W9CJR-309, FJV-201, ENF-177, PHV-DIC-70, HUG-55, BMA-45, ASV-42, LEQ-DPJ-30, KCG-EYG-17, OEK-16, JFT-12, GBJ-IXO-8, AUC-LBB-6, LWG-6, PWV-NPQ-2, EL-1.

**NEBRASKA—SCM,** S. C. Wallace, W9FAM—9FYP-341 is an OPS. 9OPP-85 has good schedules. 9FWW-15 has good schedule with Omaha. 9BQR-15 is hitting on all six 9DGL-14 has new rig. 9PDE-3 and FGS-151 have c.e. W9JED-71, DMY-69, DI-4, FAM-12, MGV-163, DLK-20, DHO-3.

#### NEW ENGLAND DIVISION

**CONNECTICUT—SCM,** Fred A. Ells, Jr., W1CTI—"Hal" is doing great work at 1MK-570. 1AMG-485 missed BPL by a hair. 1FIO-392 is busy selling fish. 1DOW-131 runs away with CBA traffic banner for third time! The gang from WICC, assisted by IIM, operated portable 1DIO-87 at Bridgeport Industrial Exhibition from May 4th to 12th. The following ran the rig: 1DIO, NN, FHL, ASC, BJC and ANN. 1GC-84 has five schedules. 1DBU-77 schedules LA3C. 1APZ-42 sends in best total in a long time. 1HPI-38 is QRL full-time WTIC on 1040 kc. 1GGX-21 keeps busy selling G.E. equipment. 1QV-14 applies for OPS. Bulkeley High School Radio Club elected officers: 1HJV, Secy.; 1GKM, re-elected President. 1EFW-1 says 56 mc. is going strong. 1FEF, West Peak, contacted 2XER at Bear Mountain. W1UE-169, CJD-104, BDI-101, DGG-56, CTT-51, GME-35, GUC-32, GKM-17, GTW-15, ES-11, EAO-8, GGM-BMP-4, HYF-2.

**MAINE—SCM;** John W. Singleton, W1CDX—1BTG-438 leads the traffic list. 1CRP-66 got a job at last. 1EFA-64 has new '66s. 1ERB-52 keeps Augusta on the map. 1GBM-38 is rebuilding. 1IAD is new Skowhegan

ham. 1DHH-41 is increasing power 1BLI-13 is looking for schedules. 1BTA-12 is on 7 and 14 mc. 1FJP-12 works all bands. 1OKZ-6 is moving to Brunswick. 1BNX-6 gets out fine with 1/2 watt input! 1EEY has new c.c. rig. 1CDX-28 schedules LA3C. 1APX is home again. There are now about fifteen 56-mc. stations in and near Portland. 1FA, EWN, CHF, TE, BNG, CRP, AHY, PP and DVP are the most active. 1XR at Mt. Washington has been contacted by many of these stations. There is also 56-mc. activity in Kennebunk, Biddeford, Old Orchard, Kittery and Livermore Falls. The Kennebunk gang are putting over one of their famous hamfests on June 30th. Don't miss it—good food, good speakers and good prizes. Subscription, \$1.50; place, Narragansett Hotel, Kennebunk, 6:00 p.m. EDST. W1CHF-103, OR-65, GKC-64, AQL-9, EZR-4, HUX-1, EF-109.

EASTERN MASSACHUSETTS—SCM, Joseph A. Mullen, W1ASI—1DFE reports collision in gas buggy with heavy damage to starboard side. 1ABG-50 is QRL on 56 mc. 1KH-84 is actually losing weight due to heavy ham activity. 1AGA-36 was QSA 5 R9 at G2BVV on 14-mc. 'phone. 1RE-16 keeps plenty of schedules for county net work. 1VS-699 reports "nothing exciting" (note the traffic total!) 1BZO-145 and CH are looking for jobs. 1FRO-140 handles S. Middlesex in great shape. 1CRA-675 went to 9th district for vacation. 1CNA is on at N. Bedford with portable. 1ZC-13 had appendix removed. 1VT did a swell job for ham radio at Home Beautiful Exhibit. 1HOM is flying around with 56-mc. rig in his ship. 1DDM and ELL went out and rounded up the absentees at a Kiwanis meeting with a 56-mc. rig, and had them give their excuses via radio to the gathering assembled at the hotel. 1FPO-13 keeps schedules with Worcester County. 1DJK is now President of the C.C.R.C. at Cape Cod. 1AXM is handling the Big Time at Provincetown when the fleet gets in. 1DOF-39 reports 30 miles DX with his transceiver. 1HTV and FYT-16 got commercials. 1CRO-20 is building new shack. 1BFR-16 worked PAQASD on 3.5 mc. 1ZK was made RM for 'Phone Activities on May 1st. O.P.S., please note. 1ALP is working on 56 mc. and was heard at Mt. Washington on the second night on. The SCM acquired a YF on June 16th! 1CGM is on 14 mc. with quarter kw. rig. 1AKN is doing a bit of experimenting on 56 mc. 1ACH is still 56-mc.-minded. W1EVJ-97, BMW-48, AZF-35, EHJ-29, ASI-A10-7, GCL-6.

WESTERN MASSACHUSETTS—SCM, Earl G. Hewinson, W1ASY-RB—1BVR-501 makes BPL again. 1EOB-68 and ASY-23 joined A.A.R.S. 1BAX-30 has antenna troubles. 1GUO-14 is building new outfit. 1COI-13 is busy crystal grinding. 1DUZ-12 keeps 56-mc. schedules daily. 1GHU-9, RM, is doing a good job on Worcester County Net. 1FTS-6 reports 50% of its members attending Convention got prizes! 1BVP is working on 56 mc. on N. Y., N. H., & Hartford R. R. W1DUS-1 is doing FB work as OBS. 1HHR was laid up with measles. 1APL is going to do some 56 megacycling at QRA. W1FNY-225, DCH-87, DVV-84, AWW-55, BKQ-44, ARH-11, AJO-DDK-4.

NEW HAMPSHIRE—SCM, Basil Cutting, W1APK—FLASH—N. H. has gone 56 mc. About half of the state climbs the White Mts. each Sunday afternoon. Look for QSOs on 56 mc. each Sunday p.m. 1ERQ-536 tried 1.7-mc. 'phone, but BCLs did not enjoy the QRM. 1AUY-2 went to N. E. Convention. 1DMD-32 worked BPI on Mt. Washington on 56 mc. 1HOU-10 is new ORS. 1FFZ has some new equipment. The following are the N. H. 56-mc. gang: 1DMD, UN, BII, APK, EAW, CCM, AVJ, BPI, GKB, HOV, HPX, GEY, AFD, BHI, FGC, HQB, AUY, BST, The St. Paul's School Radio Club, the Dartmouth Radio Club, and the Twin State Radio Club. The SCM will be out on prominent mountains this summer each Sunday p.m. (weather permitting) with 56-mc. gear. 1CFG of WFEA had ORS transferred to N. H. from Maine. W1FCI-71, IP-4.

RHODE ISLAND—SCM, Albert J. King, W1QR—1CAB-26 worked PAQASD on 3.5 mc. 1GV-116 joined A.A.R.S. 1HRC-80 handed third party message to N. Y. C. and received reply in half hour. FB. 1GTN-10

is in the chicken business. The PRA is planning a banquet. 1CPV-61 is still the old reliable in PAWT. W1BJA-17, QR-15.

VERMONT—SM, Harry Page, W1ATF—1AZV-4 was a Vermont winner at N. E. Convention. 1AAK and GAE-9 are new ORS. 1BD-35 is grinding Army crystals. 1EFC-1 and GAE are scraping acquaintance with "Q" stations. 1CCF-147 is QRL engineering at U.V.M. 1BJP works on day and night "shifts" in power company. 1GGT-38 pounds a wicked key every Sunday a.m. in A.A.R.S. Drill. W1DQK-117, ATF-43, GNF-4.

#### NORTHWESTERN DIVISION

ALASKA—SCM, Richard J. Fox, K7PQ—7DEV-1 has a new station license. 7EZ uses Collins 30 to drive pair of '52s. 9JBG visited 7BNW-16. 7BND is attending school at Auburn, Wash. 7BQE is new Cape Decision ham. 7FF is QRL cannery. 7EBR-52 is proud operator of hundred-watt commercial 'phone and c.w. station. 7ANQ-73 returned from vacation trip. 7AIB returned from trip to states. 7VH-39 has FB7 receiver. 7CKK is on again. 7AAC came on for first time in over a year and handled 130 messages! 7CSZ has c.c. job working FB. 7PQ worked 1MK on 3.5 mc. K7DJA-19, EGC-31, CHP-48, PQ-77, BOE-60.

IDAHO—SCM, Don Oberbillig, W7AVP—Two New Mullan stations: 7EKX, EKV. 7CAP-10 uses 3606 kcs. 7CHT-10 rebuilt. 7DMT-97 is active in A.A.R.S. 7BAA-98 likes A.A.R.S. contests. 7NH-9 reports new schedules. 7CFX is on 14-mc. 'phone. 7BLT has new brunette in Missouri. 7AVZ is fishing for DX. 7AAJ-4 reports for Pocatello. 7DAY has MOPA. 7AOT is on 3.9-mc. 'phone. 7EGU is building Tri-Tet. 7BYW visits SCM. 7DSL-14 handled traffic from Spokane Sportsmen's Show. 7DBP-4 is QRL Lumber yard. 7DDU is active at Wilder. 7DWI and DCG are on 3.5 mc. 7BCU is moving to 14-mc. 'phone. 7BMF-27 is on with new rig. 7GL, BZJ are enthused about Jenny Lake Hamfest in August. 7ACP, KI, AHS are experimenting on 56 mc. 7CKO is to have five-band operation. 7BAR is QRL refrigerators. 7DCM is lining up schedules to Boise. 7GU has new operator's license. 7EEZ has new job. 7CJK is on 1.7-mc. 'phone. Gem State Amateur Radio Club contemplates hamfest in Sept. 7CGR has new YL junior op. Nampa hams were hosts to GSARC at meeting. 7CMD goes in for midget transmitters. 7CZO is QRL garage business. 7CSP plans to attend Seattle Convention. 7DAW, AVP, BKF, DUE, ACP plan to go to Moose, Wyo. 7DEQ examines EAY for Class "C." 7BRU has neat portable receiver. 7ATN is chasing "bugs" at experimental farm. 7BDX lost antenna via lightning. (W7CHT-9 March-April.)

MONTANA—SCM, O. W. Viers, W7AAT—7CRH-318 takes traffic honors. 7ASQ-161 lost his tonsils. 7CCR-148 schedules daily. 7BYE-15 reports for Roundup. 7BDS-38 is in Bakery now. 7EDJ works YLs on 7 mc. 7CPY-7 is DXing. 7BYE visited 9USA and XER. 7AOD-38 on 3536 kc. 7AAT/COX-58 are organizing transcon net. W7AFS-168, CEG-43.

OREGON—SCM, Ray Cummins, W7ABZ—7BLN-99 and BWD-170 entertained Coos Bay Club with a picnic. 7CMK is putting in a '52. 7DVX-1 and ABZ-11 are on 1.7-mc. 'phone. 7AZJ is filling secretary's shoes. 7DIU-1 reports that DDZ took trip to the altar. 7AMF-21 visits AEZ-24. 7MF-103 and DP-16 are getting ready for 56-mc. tests. 7BKD burns up all filament transformers. 7BDN is building club transmitter. 7BZS graduates from high school. 7CTL-9 is active on 3.9-mc. 'phone. 7AYV-977, DBR-628, HD-505, BWD-170, and CFM-162 make BPL. 7DBE moves to Calif. for summer. 7BAX-45 works lots of DX. 7BKC is on 14-mc. 'phone. 7CHB-9 handles worthwhile traffic. 7BUF-2 has daylight 'phone QSO with K6YAL on 3.9 mc. 7DAY joins A.A.R.S. 7HD, QY, and AKY leave for brass-pounding duties in Alaska. 7CIK-25 reports lots of rebuilding going on in Southern Oregon Club. 7AGZ has fine 1.7-mc. 'phone. 7SY-216 sends mighty fine traffic total. 7ABZ has a PR10. Don't forget 56-mc. field days, July 14th and 15th. CU from the top of Mt. Hood on those dates.

W7WR-141, BUB-82, ANX-81, BKL-46, BMN-19, ABD-18, AXO-10, BQK-6, AGZ-EBQ-CMK-5, AIG-4, DMK-4, DKT-3, DHZ-EJY-EKB-EKD-EGV-BMM-2, CTR-ALM-1. W8SBI.

WASHINGTON—SCM, Stanley J. Belliveau, W7AYO—7CZY-800 leads the Section and BPLs for Nth time. 7DJJ-22 reports by radio. 7AWF-208 made nice score in ORS Party. 7BBK-42 wants schedules. 7AZI drives a truck. CRM 7WY-300 comes back strong! 7DLN-10 has new rig. 7ECM-1 is joining Sea Scouts. 7DET-8 broke state high jump record by nearly four inches. Congrats, Bill. 7QI-305 schedules KA, K6 and K7. 7BRC-13 reports first time in ages. 7CQK helps keep Cheney on traffic map. 7ECA-42 is organizing traffic net on 1.7-mc. 'phone. 7DRD-28 is new ORS. 7DPU-65 has 11-tube Philco All-Wave. 7EAN-21 works VK, J, KA, with pair of '46s. 7AVM-10 blew flock of condensers. 7AGE-47 is rebuilding. 7ALH was visitor at SCM's shack. 7DGY-10 threw a big party on some of VE5 gang. 7EKC-5 is new reporter. 7DGN-100 has new Dodge. 7BAD-183 credits his big score to A.A.R.S. 7IG-148 visited Tacoma Club. 7APS-136 keeps several good schedules. 7DRY-295 almost made BPL on Del. 7BHH-221 and AYO-518 make BPL. OO 7ABU-76 says notes are getting better. 7LD-792 almost beat Larry out of first place. 7CAM-15 applies for OPS. 7RT-2 is moving to Wenatchee. 7AUP-3 clicked his J and KA. Active in ZAG Contest: 7AWJ-82, CXC-33, CQI-5, DNL-5. 7AUC-16 gets out of C.C.C. July 5th. The Spokane gang put on a swell hamfest June 9th and 10th. Don't forget big Northwest convention at Seattle, middle of August! W7DRK-36, BCS-10, IC-8, AQ-6, AIT-CSK-5, DZH-RL-BYB-4, BUX-3, DWF-2, QW-NZ-1.

#### PACIFIC DIVISION

HAWAII—SCM, A. O. Adams, K6EWQ—The OARC is going strong. 6EWQ-3100, new SCM, would appreciate full cooperation. 6AGI, GQF, and JRN are on 1.7-mc. 'phone. 6JPT-403 and FAB-41 are awaiting new ticket. 6AJA is visiting coast, to be followed by CQZ-30. 6ENE is going to work at KHK. 6FUL has been working on transmitter for yacht *Hawaii*. 6KFB uses low power. 6GZI schedules IDK and EWQ. K6GUA-257, KCK-152, GZI-131, COG-14, CIB-10, EGE-7, EDH-5.

NEVADA—SCM, Keston L. Ramsey, W6EAD—6AJP-78 is fixing quarters for Reno NCR unit. 6GYX-148 rebuilt transmitter. 6HGL-199 made good score in ORS Contest. 6BYR is rebuilding 'phone using relay rack. 6BIC QSO'd Japan. 6GGO-20 is installing an '03A. 6FUO has new super-bet. W6AAX-33, UO-27, GIC-2.

LOS ANGELES—Acting SCM, Howell C. Brown, W6BPU—Fine report this month, gang! Thanks for your help. Six make BPL: 6GXM-1789, ETL-1185, HZT-534, AZU-402, NF/CFN-402, ETJ-348. 6ETM got married. Congrats. 6BGF-2 received QSL card from VK after waiting two years! Clubs—Six Federation Clubs report traffic for members, and Long Beach takes Section Club Banner from Bell, which loses for first time! Whittier plans low-power contest. QRL-6BKY-1, DZI, GXW-2: business. 6EUV-16, FGT-46, FXL, IZF: school. 6EK-44: beauty shop. Rebuilding: 6ALR-9, AZU, BKY: 14-mc. 'phone. 6BXR, COF, IKW, CVV-3, HEM: c.c., 6HLF-7, JAG, JZE, JTF, KBB; MOPA, 6SJ: 3.9-mc. 'phone. Portables: 6CYS-20 at Riverside, BZF-147, IAR: c.c. DX. 6DOK worked VK5 on 14 mc. at 11:30 p.m. PST. 6FYT made WAC in 48 minutes. 6ERT-14 worked PK3JJ at 7:30 p.m. on 14-mc. 'phone. 6JWL-15, HZT work trans-pacific. 6IVU, KAO, brothers, work plenty. Experimenting: 6CV-10: Tri-Tet. New equipment: 6GEX-9 temp. control, IDZ: c.c., EAK: 1kw., KEI-9: condenser mike. U. S. N. R.: 6HID-100, CGE-33, HHJ-22, IJV-19. A.A.R.S.: 6DZR-232, IWO. New ORS: 6KBY-17, IK-8, ERT. New QRA: 7AHJ-88 and AJX-72 at 3079 Walnut, Riverside. 6CAH is building house. 6BVZ and AIF have been ill, but both better now. FB. 6BFL-7 has BC troubles. 6ERT took OPS test where he has to show procedure of calling W3ZX and worked him next night!! Report but no traffic—6ANN, AXQ, BVZ, CAE, CLY, COF, DCJ, DZI, FXL, GFG, GVI, IZF, JOJ, JTF, MA, TH, WJT. New hams: 6KQO Burbank, KRO

Ventura, Ex-4JP now 6KNU, KRI-2. Board turns down new Southwest Division, but we are going to keep on trying. W6CUU-396, EDW-259, GNM-250, EBK-242, AKW-183, EGJ-180, GMA-170, BPU-155, IOX-127, AUB-112, DJS-98, DWP-95, AIF-91, FYW-89, HEW-88, DEP-83, DNA-80, JSZ-75, AM-73, RZ-70, JJI-68, HEM-59, DJC-ALD-57, GTE-56, JQS-53, HJW-IDK-52, JZV-47, IIA-46, BPP-44, EAR-42, FLC-41, HDV-40, IRD-39, JEB-33, EQW-CPM-32, FYT-LN-28, ZBJ-DOK-22, IDZ-21, GSR-16, IFC-15, AAK-13, BVD-11, FUS-ELU-10, ITK-CEM-ERM-HQS-CWZ-9, HHG-8, DGH-TN-IWE-IVT-GWO-7, AEM-FXI-IGO-JXW-HQV-6, ALR-IWC-JBP-IBS-5, FJK-LC-JSZ-AYQ-DUX-DUC-4, ON-GHI-BPM-IRX-GIG-JXZ-3, VO-JUS-BMN-AAE-DYQ-EOF-DYH-JZS-PD-JEV-JSK-HCF-FMO-CKR-FEX-2, JNE-JWV-FQG-ILV-KCG-AGF-AMY-KMO-GOY-HZM-HFU-JGL-1.

SANTA CLARA VALLEY—Acting SCM, Barton Wood, W6DBB—6YG-123 schedules FBW-113 daily. 6FBW clears traffic to all points. 6YX-25 is getting new rig working. 6DBB-9 is building portable 1.7-mc. 'phone. 6YL-8 continues to bring in R9 reports. 6BSO-2 looks forward (?) to final exams. Doubler stage has 6JUQ-1 worried. 6JYW has TPTG rig. 6AUC moved to Pacific Grove. 6FUM worked a J7. 6BCF's station is being built up. 6DRU is back after year in C.C.C. 6HJF has rebuilding fever. 6HZW gave the blonde the slip. W6CUZ-65, AOF-4.

EAST BAY—SCM, P. W. Dann, W6ZXX—On April 28th the Tri-Section Hamfest was held in Oakland. Over four hundred were present! Our friend from HQ, Budlong, was there, and we were all very glad to meet him. The SCM wants to commend the committee on its fine cooperation, especially Ed Sargent and Stewart Ayers, 6GEA, who put in so much time. The Hammond Memorial Bug this year goes to 6GHD-239. 6RJ-396, 1933 holder, was again high for the year, but one is allowed to hold this Trophy but one time. Congrats, George. 6ITH is new OPS and OBS. 6KNO-19 sends first report. 6RJ's Army call was changed to WLVB. 6GHD has held schedule with AC2RT for over a year. 6RF-114 suspended schedules in Naval Reserve. FAC says s.s. receiver makes summer operating a pleasure. 6EJA-73 schedules KAIJR Mon., Wed. and Fri. at 4:30 a.m. 6AHI-56 (Ex-TG) has a one-half KW rig. 6YM-27 (FLP) has new Pro receiver. 6DHS-24 won three prizes at Hamfest. 6FS-14 put up new Zepp. 6CIZ-7 says conditions on air in regards to violations are improving. 6HRN reports R-9 sigs from VK's and ZL's. 6FJD and AIJ are at C.C.C. camp. 6FKQ and FJQ are fixing up their rigs. 6IEW is coming on 1.7-mc. 'phone. 6HRG QSO'd VO8G. 6KRX is new Oakland ham. 6HRT has new c.c. rig. 6ATJ is busy with Naval Reserve. 6ZX-100 has new FBXA.

SAN FRANCISCO—SCM, Byron Goodman, W6CAL—6ZG-1895 leads the Section, and BPLs, as do RM 6JAL-343 and HIR-163. 6NK-96, JN1-23, and KJ-5 are busy in U.S.N.R. 6RH-87 has nine schedules. 6JPA-55 visited JDG. 6DDO-28 has worked all districts on 3.5 mc. 6AZK-21 and GIS-13 have power leak trouble. 6BIP-21 is WAC twelve times this year. 6HZP-15 worked a VK7. 6PFU-11 schedules 6AM. 6EWX-7 works east coast on 3.9-mc. 'phone. 6HSA-7 worked a K6 with '45. The '45s at 6JBZ-6 are still perking after a thousand QSOs. 6KNH-5 works 3.5 mc. exclusively. Tri-tets and 6BIM-5 disagree. 6DZQ-4 is organizing phone men of the Section. 6IPH-4 got his first K7. 6HJP-3 has QRP c.c. rig on 7 mc. 6JVV-3 is building relays and chokes. 6HTQ-2 has a '10 with "high anticipation." 6JWD-2 is after traffic. 6KCC-1 is after DX. 6CAL-1 worked his 35th country. 6JDG-80 worked KA1CM on '46 final! W6JMR-28, FVJ-2, GWH-1.

SACRAMENTO VALLEY—SCM, George L. Woodington, W6DVE—6AHN's portable is under way. 6ZS is with us. 6KQJ is new No. Sacramento ham. 6BVK-14 is back from Woodleaf. 6GAC opened a grocery store. 6FOD has receiver troubles. 6CKV is back home. 6HVM plans high power. 6KPY worked all districts and ZL this winter. 6FND is rebuilding. 6JOR is in for repairs. 6DFT-1 is c.c. now. The Susanville gang is now 100% c.c.! 6IMV is proud father of a fine baby girl. Congrats, OM. 6IQH, AYZ, and GDJ visited GVM. 6IZE and GVM use low power. 6GR is on 28-mc. 'phone. 6KCA worked a K6. 6JPI has trouble with E.C. osc. 6FRP-1, and CCB have condenser mikes. 6ESZ

has 1.7-mc. 'phone. 6IMJ is building monitor. 6ADS is trying for Airport berth. 6DON is with KFBK. 6GDJ is building 1.7-mc. 'phone. 6GZY joined A.A.R.S. W6CGJ-165, EWB-82, DVE-15, EFM-11.

**PHILIPPINES**—SCM, N. E. Thompson, KA1XA—P.A.R.A. meeting was held at INA, Olongapo, June. 3rd Annual meeting and hamfests at JIR, June 24th. KA1HR-1732, CM-561, NA-559, LG-233, CS-190, EE-171, JR-131, RC-140, FS-122, AN-73, XA-60, TS-30. KA4HW-52, GR-31.

**SAN DIEGO**—SCM, Harry Ambler, W6EOP—RMs 6FQU, 6QA. Phone: 6IBK. 6BMC-1174 leaves old location for cooler weather. 6DQN-488 BPLs on deliveries. 6EFK-215 schedules his old Army buddy, 6KMX. 6FQU-200 handled 71 goodwill messages from San Diego schools. 6BHF-62 is arranging schedule with Y.M.C.A. camp. 6KFM will be chief op at Y.M.C.A. camp. 6CNK-27 schedules KA1FM. 6IBK-16 has crystal d.c.-a.c. portable. 6KBD-2 is new reporter. 6AXN-2 has new transmitter. 6FKT attended last meeting of San Diego Radio Club. 6BOW, GWY and GNP are on 'phone. 6DNS is with KFSD. 6GTD sends 73 from S.F. 6VQ, EZQ and HY were in hospital. 6KJU was killed in auto crash. 6GOG and LD are building 'phones. 6AJM has new 14-mc. 'phone. 6JEZ visited SCM. W6GTM-15, EOP-14.

**SAN JOAQUIN VALLEY**—SCM, G. H. Lavender, W6DZN—6FFU-39 and AOZ-11 are on 56 mc. 6GXL got last stage perking. 6AGV-84 is going after traffic total. 6FYM-51 holds good traffic schedules. 6IKG-13 has new antenna system. 6EXH is busy with chicks. 6DXL is new Pres. S.A.R.C. 6HIP has new Tri-Tet.

#### ROANOKE DIVISION

**NORTH CAROLINA**—SCM, G. H. Wright, Jr., W4AVT—4AEL-5 worked HC2CV. 4AAK worked F8, PY, and G5. 4AMC worked L4, D4, G2, 5 and 6, K5, VE5 and number of EA's. 4ZH-2 worked J2GX. 4OG-1, IY-1, and CFR-1 are active in DX work. Building new rigs: 4TP-12 (14-mc. rig); 4AEH-24 (work on club 1.7-mc. 'phone); 4AAK (new 'phone). New rigs: 4BYD-1 and ZE. New station: 4CVQ. New receiver: 4CLB. QRL: 4BHR-7, work; CJP-43 and IF, moving; BLN, station repairs; CCF, school; AHH, vacation to Bermuda. 4VB-14 is experimenting on 1.7-mc. 'phone. FB traffic reports from 4BTC-390, BST-91, BRT-109, ABT-146, and CUB-55. New RM: 4BK8-8 in Wilmington, succeeding 4BC. 4PA is building new shack. 4MR-1 tried Collins antenna. 4BYA-5 is working up a 56-mc. 'phone net in Winston-Salem. 4BLU-9 is having trouble with his OM's prize pecans growing limbs into his antenna feeders. Subscribe to the Tar Heel Ham, a publication second only to QST in this Section. W4BRK-BX-17, AVT-15, DQ-9, AH-4, BPL-BXF-RA-2, AOA-25.

**VIRGINIA**—SCM, R. N. Eubank, W3AAJ—3AAJ-2 handled important traffic. 1.7-mc. 'phones: 3DZW-4, AHC-13, BEB-38. 3.9-mc. 'phones: 3AHQ-55, GY-15, ASK-2, BPI, AVL, BIG-3, CZJ-8, CNY-4, AVR, CIJ, 14 mc. 'phones: 3CIJ. Traffic stations: 3FJ-162, BAD-128, DCU-105, DQB-26, BWA-36, BRY-35, ECQ-99, ELJ-11, DFS-51, NT-83, GZ-29, CMJ-107, APU-3, BYA-42, BDQ-12. DXers: 3DNR, WM-1, DEH, AAJ, BTR, EAP, ELB-6, DFS, EGD, CWS, AGY, ADD-7, BAN-2, DWP-4. Experimenters: 3FJ, DNR-37, DQB, AAJ, BPI, ENQ, EBM, EEN-24, JIG, COO-2, AII, CNY, BZE. Good schedules: 3FJ, BAD, DCU, AHQ, ALF-35, EBD-10, CYM-5, NE-4, ELA-3, AHC, BRY, BWA, CKM, COO, EBK-5, ECQ, ELJ, EEN, CMJ, APU, BYA, CIJ. New calls: 3ENO-5, ENQ, ENR, ELB, EOX. New transmitters: 3EBD, CPN-5, ENO, BPI, EBM, BTR, BZA-18, EBK, ELB, CSY-18, JG-1, AVR. New receivers: 3DNR, CPN, ENO, BPI, ELB, CUU. New antenna: 3DNR, DQB, ENO, EMX, ELB. 3ECT had an operation. 3BYA lost his mother. Our sympathies, OM. Rebuilding: 3DZW, BIW-1, ZU, CVU, DEH, CWS, DWP, CZJ, BRA. Roanoke Divn Convention! Roanoke: Oct. 5th-6th. GET READY! Norfolk Hamfest in August includes swim Va. Beach. On 56 mc.: Richmond Scout Crew—3FJ, GE, AAJ, ZU, CVU, CGR, EAP, DAM,

EGD, BRA. Nets: 3FJ's 3.5-mc. A.A.R.S. Net, Mondays, 6-9 p.m., Va. OPS Net by 3GY Sundays, 9:45 a.m.—3AHC 1.7-mc. Net, Sundays, 1:30 p.m.—3BRY Lunchburg A.A.R.S. Net. 3DCU is at C.C.C., Bassets. 3CKM is at C.C.C., Natural Bridge. 3CSI is at C.C.C., Clifton Forge. 3DFS is back in Staunton. 3CUV is at Portsmouth (Deep Creek). 3DWE is back at Harrisonburg. 3BGE is at C.C.C., Clinchport. Murr of 3BAI is at Bolling Field, D. C. 3BWA is new RM. 3ALF wants ORS. 3GY's OPS gang leads U. S. 3EHL uses '47 only. 3CPN joined A.A.R.S. 3WM, EAI, CPN visited Richmond and D. C. 3AAJ visited A.R.R.L. HQ and N. E. Convention with YF. 3BTR has new Jr Ops. Congrants. 3PO uses Class B. 3CFV-4 blew rig. 3EQC ant. came down twice. 3ELJ added an '03A. 3MQ-1 is swell speaker. 3GE has new YL op. Congrants. 3CSY is back in Hampton. 3BGS is QRL sick family. 3CMJ blew filter conds. W3EHL-9, CA-7, DWB-5, AAF-4, CJR-2.

**WEST VIRGINIA**—SCM, C. S. Hoffmann, Jr., W3HD—The Hamfest held by Ohio Valley A.R.C. was attended by 75; officers for coming year: 8ELO, Pres.; 8CDV, Vice-Pres.; 8DPO, Secy.-Treas. 8HWT and JLX joined A.A.R.S. 8DNN left to operate Gulf steamer. 8AAO is on summer U.S.N.R. cruise. 8KKG visited A.A.R.S. gang in Southern cities of State. 8EIK (WLHG)-417 again acted as Corps Area NCS, when 8ZG (WLH) went to A.R.R.L. Board Meeting. 8CMJ is installing new receiver. 8EHL is building c.c. job with '52s final. 8EYV-3 is new OPS. 8BLE visited Clarksburg hams. 8DWZ will build 1.75-mc. 'phone. 8KEC-3 got appointment to Annapolis Military Academy. 8TI is selling big set. 8EWM-19 handled important traffic with 4RO, for patient in Hospital. 8KWU-32 desires traffic schedules. 8EYV attends W. & J. College. 8CAL is fishing. 8HBQ worked J3EH. 8AHF-18 made 485 points in OPS Contest. 8AKQ's mother died. W8BDD-163, KDQ-68, HD-65, ELJ-42, KSF-2, KWL-1.

#### ROCKY MOUNTAIN DIVISION

**UTAH-WYOMING**—SCM, Arty W. Clark, W6GQC—Lt. L. K. Grenlie, W3CXF, chief radio op on Byrd's Arctic and first Antarctic expeditions, addressed Utah Amateur Radio Club. W7AMU-48 is running for sheriff. 7CSE-167 reports good activity around Sheridan Amateur Radio Club. 7ERK is new station. 6FYR-41 is QRL job in Weso, Nev. 6GQR-31 has luck with "worn-out" 211-E's. 6ITW-2 works VK's and K's. 7ARK is back from Calif. 7DCL kept schedules with Calif. for ARK. 7CLG works portable rig. YF ill at 7COH-142. We wish her speedy recovery, OM. 6DGR-1 will take cruise on destroyer in NCR. 7BJS has good results with 3.9-mc. 'phone. 6KOP is rigging up a station. 6DPJ-455 got job in Moose, Wyo., and will QSO from 7DXV. 6BSE-44 built portable for summer N.G. camp. 6FRN-18 and KDI-63 keep FB schedules. 7NY and CJR are rebuilding. 7AXX has new call, EJT. 7CYN is QRL new aircraft. Mrs. 7AEC is licensed with call ELU. 7CCC has new Silver 5B. 7CPL has new crystal. 6KRL, KRS: new stations in S.L.C. 7CRP is experimenting with Tri-Tet. 7DCO and CSE graduate from high school. W6GQC-301, GPJ-94, AFN-13, GQM-6, W7COO-2.

**COLORADO**—SCM, T. R. Becker, W9BTO—9GJQ-1295 and 9ESA-1200 are our big traffic handlers. 9BYX and APR have PR10s. 9HRI has been in hospital due to automobile accident. 9AUJ works at KFEL. 9FYG is on 7 mc. 9CJJ is on 14- and 3.9-mc. 'phone. 9LYE is building 'phone. 9BYK has new speech amplifier. 9AAB returned from Directors' Meeting. 9EMU will be on soon with '03As Class "B." 9JB has job with Denver Police Dept. 9HQT is on in afternoons. 9GBQ has been bitten by 'phone bug. 9EKQ keeps Littleton on map. 9CBU returned from Cleveland. 9BVZ is on 3.9-mc. 'phone. 9EYN is working for KOA. 9GCM-62 has new YL junior op. 9JNZ took exam by mail. 9BRZ is hunting bugs in MOPA. 9GNK-148 is QRL U.S.N.R. 9PQB is an old-timer in Durango. 9CDE-55 keeps regular A.A.R.S. schedules. 9FXQ and EHC-46 are dismantling 'phone rigs. 9PWU-5 is active in Arvada. New Denver hams: 9PVY, PVZ, RDB, and HRF. 9NRK moved to Illinois. 9JRV worked two K6s. 9YL, HIR, and GGN are

on 'phone. 9PGS-5 is building MOPA. 9GLI-77 passed Radiotelephone First. 9MLU-10 passed Radiotelephone Second. 9LQU passed Radiotelephone Third with code endorsement. The R.F.A.R.C. is building 56-mc. transmitters. The Pueblo crowd have a real club, known as the San Isabel Radio Club. 9NLD has FB 1.7-mc. 'phone. 9NQV has a bunch of 50-watt bottles to build 500-watt outfit in May QST. 9PMF is JCQ's private Secty. Hi. 9NLN has new antenna. 9PMS is going to Radio School. 9OTM works lots of DX. 9LEK has FB c.c. rig. 6ERC is now at Grand Junction. 9RX is busy at KFXJ. 9MXJ moved to Loma. W9JCQ-2.

#### SOUTHEASTERN DIVISION

**ALABAMA**—SCM, L. D. Elwell, W4KP—4CIU applied for ORS. 4DS-186, Chief RM, has reports coming in several times each month via the air. 4APU-68, RM for northern section, has several schedules lined up. 4CWB is new reporter. 4GL-72, Mobile RM, sends dope from his section: 4COU, CPC and CBI are ops for Police Station WPGW. 4CRF is building three-stage c.c. job. 4GP had two 800's go bad. 4CQV keeps 14 mc. hot. 4BLL is QRL Mobile Club transmitter. 4FB has a Comet Pro. 4BOU-184 reports that Tuscaloosa gang made more than one third of the total score in last A.A.R.S. Contest. 4BJA-247 has been taking some of BOU's schedules. 4CCP reports the Gorgas gang are busy. 4CCN moved to Lay Dam. New hams: 4CVW, BLX. 4AJY-3 made high score in Alabama QSO Party. 4BIT-6 was in the contest. 4BCV is active on 'phone. 4APJ (with CCC) will move to Livingston. 4BZG-8 has high-power 'phone. W4CJG-107, DD-19.

**EASTERN FLORIDA**—SCM, Ray Atkinson, W4NN—4AKJ-74 is Tampa's star traffic man. 4BOT and BN are rebuilding c.c. rigs. 4BNR-10 is trying to work all K6's and K7's. 4AJX-2 and TZ-26 have been busy with schedules with Byrd Expedition. 4CRN is adding pair of '03As. 4AII while in England QSOed Tampa from G2OA, G2WQ, G6TT and G6GV. RM 4WS-35 reports A.A.R.S. and Knights of the Kilocycles schedules are static-proof. 4ASR-11 is building s.s. receiver. 4BUM has gone to Iowa for the summer to do hotel work. 4AS went on active duty in the Navy. 4BWZ is building new receiver. Warning: Don't forget to get your emergency equipment ready for the coming storm season! Please drop the SCM a card as soon as your emergency rig is ready for action. 4NN-97 and AGB-6 have completed portable c.c. job. 4AZB reports lots of fake calls. 4AKH and DE are on 14 mc. 4MF was seen riding the merry go round at the State Fair. 4CCA-4 visited the SCM. W4ALP-17.

**WESTERN FLORIDA**—SCM, Eddie Collins, W4MS—RM's 4ACB and 4AUU. 4CBD-10 is home again. 4BPA visited the SCM. 4BGA buried an 866. 4AUW-22 sports some FB QSL cards. 4MS-18 received a VK QSL exactly one year to the day after the QSO. 4VR-6 is stepping out in great style. 4QK is going c.c. 4QU and SZ are busy with U.S.N.R. 4CV is on a ship. Ex-W4MX stands watches at WCOA. 4BGB and AUV are on 3.5 mc. 4CUR is new at Millville. 4CLP keeps things going in Perry. 4AXP-4 is building 7-mc. rig. 4QR-48 has Tri-Tet. 4BSJ raised three VK's on three CQ's. 4KB-55 keeps regular A.A.R.S. schedule every a.m. on 3.9-mc. 'phone. 4CMJ has 56-mc. Transceiver. 4ACB-14 is getting ready for PNG summer camp. 4CRN has crystal Comet Pro. 4CUV is QK's brother. 4BPI is at U. of F. 4COG had his photo on the first page of the JARL NEWS along with MS' tower. 4CTZ has FB three-stage rig. 4CUR's '45 is going FB. W4BSJ-30, CDE-15.

**GEORGIA-SOUTH CAROLINA-CUBA-ISLE OF PINES-PORTO RICO-VIRGIN ISLANDS**—SCM, George A. Love, W4UT—Following South Carolina report received from Assistant SCM, Bannie Stewart, W4CE. 4ANK-187 was the outstanding ham for South Carolina this past month. 4CO has a 56-mc. transceiver. 4BQM-15 wants schedule with ham in Potstow, Pa. 4CHD-2 is on daily from Greenville, S. C. 4WA is on 1.7-mc. 'phone. 4CIR went up for commercial ticket. 4BZX has big time on 1.7 mc. 4CQQ is now on 3.9-mc.

'phone. 4AFQ-2 works portable in Charleston, S. C. 4OW-1 is back after long absence. 4BAT is active on 7 mc. 4CE-27 will be active in Dillon, S. C., this summer. The Columbia Club had the Director in to their meeting, recently, and heard about the Hartford Meeting; the club will meet during the summer.

K5AF-274 is known to Army Amateurs as WZAL.

#### WEST GULF DIVISION

**NORTHERN TEXAS**—SCM, Glen E. Talbutt, W5AUL—5BII, C.R.M.; 5SP, P.A.M.; RM's 5ARS, 5BKH. 5ZD-251 is in the traffic game with both feet. Write 5BII-312 for schedules. 5BCW has new 60-ft. masts. 5CPT-66 is a windmill fixer. 5CPB-162 reports EEF and EES new Clarendon hams. 5AW-150 likes to explore bottles, all kinds. 5BKH-86 joins Abilene Club. 5DAA-11 says Terrell gang still working on Clubhouse. 5NW-3 is campaigning for Director. "YF" 5DUR is on air daily about 10 a.m. 5AJ is c.c. on 7 mc. 5DM has new c.c. panel job. 5ABW and COK have new Tri-Tets. 5DAF has MOPA. 5CRP is in Kingsville. 5ARV-16 has new Frigidaire. 5ARS-146 may soon have that "N" call. 5CXS has been ill; glad you're better, Billie. 5BZT and CMS are rebuilding. 5BAY has new portable. 5AUJ is on 14 mc. 5QA, DST, BNS, CYU, DYU, DKF, AZB, BXY, BST are active in Abilene Club. 5SP-14 wants more OPS. 5AUL has new job and new QRA; see page 5. 5CPH is now a fireman. 5AOD is on air at Lubbock with 6DGT as partner. 5CHJ-41, CIJ-10, DXA-1.

**OKLAHOMA**—SCM, Carter L. Simpson, W5CEZ—New traffic reporting stations for the year: 5BTZ-140, YJ-30, RU-26, AMT-11, CRS-4, and CON-2. 5DTC-25 is new ORS. 5DDW-8 and COA apply for ORS. 5CEZ-856 and AJF-286 make BPL. 5BDE is dropping 1.7-mc. 'phone during summer QRN. 5BAT and ALI are on 14-mc. 'phone. 5CCB is kicking a pair of '52s with '04A's in Class B. 5ABK, ASF, AJF, CEY and CRS take exams in Oklahoma City. 5JP works all continents. 5BLF has new SW3. 5BRD has been pinch-hitting for CAI. 5RF-81 is making preparations for N.C.R. cruise. 5AA has had transmitter trouble. 5BJE is on 7 mc. 5CGH says 7-mc. DX is good. 5AJF won first place in A.A.R.S. April ZAG Contest, with CEZ coming in second. The Ponca City Key Clickers sent a bulletin to all Oklahoma A.R.R.L. members. They would like to hear from those getting it. What is your reaction? Your SCM is anxious to see new Okla. hams get started right. The Radio Laws of the United States state that the use of the people's air shall be in public interest. The best means of justification of use of the air is through traffic handling. Learn to handle traffic! Originate good traffic, move it quickly and efficiently and then report to your SCM on the 16th of each month. 5BQZ-159, ASQ-102, BAR-80, DQV-71, BWN-64, BJG-57, CNC-42, BCS-30, BDX-11, CYV-10.

**SOUTHERN TEXAS**—SCM, D. H. Calk, W5BHO—The Gulf Coast Storm Net has issued a call for new members. Anyone living along the Gulf Coast who wishes to join should communicate with 5BTK, Chairman, or the Galveston Amateur Radio Club. 5DIG, the Galveston Amateur Radio Club, has been rebuilt. 5CDD has '45s in final. 5DSI is rebuilding to c.c. 5CQF and BZO are on 7 mc. 5ABH is rebuilding receiver. 5BB-29 will be visiting in Maine for the next three or four months. 5VV is in Washington, D. C., playing golf. 5GZ and CT moved transmitter out to KA's new shack. 5OV and KA were used at the "Power Show" at the U. of Tex. 5DGG uses '03A in final. 5BSH and KA work at same Radio Store. 5BFA-302 reports handling traffic for West Texas Chamber of Commerce Convention. 5MN-589 reports that when total gets over 500 it's almost too much for one man station. 5BJ-81 wants reliable schedules with El Paso. 5PF uses MOPA with PP '45s in both stages. 5CVW-22 wants summer schedules to handle west-bound traffic from 9USA. 5BVG has five transmitters on as many bands. 5DPX-2 is on 1.7-mc. 'phone and 7-mc. c.w. 5ADZ-15 worked all continents. 5AXO requests traffic schedules for the summer. 5BRC moved to Jacksonville. 5BVX is building 1.7-mc. 'phone. 5DXS has



FB 1.7-mc. 'phone. 5BEX is new call. 5TG reports 14-mc. 'phone FB. 5ON, BVX, AXH, DSP, AFV, ANW, BKW, BEO are regularly on 56 mc. 5CTC is rebuilding 14-mc. 'phone. 5OW-1205, BEF-66, BHO-7.

NEW MEXICO—SCM, Dan W. De Lay, W5DUI—5DSN build 56-mc. rig. SCM has new Jr. op. 5AAX-4 and family took vacation in Calif. 5DVX moved to Colorado. 5ZM-280, DLG-38, BNT-14, DUI-13, DZY-AAX-AOP-4, AOE-2.

## CANADA

### MARITIME DIVISION

NOVA SCOTIA—SCM, A. M. Crowell, VE1DQ—1GL-47 piles up nice total on 3750 kc. 1EX-7 lined up local gang to work "SU" on Sunday a.m. 1AG-2 has been ill with flu. 1FW changed to 14 mc. and hooked D4BAR. 1CY and DS are taking E.E. course at U. of N. B. 1EA-3 is rebuilt for all bands. 1FE has FB note. 1GF is on 3.5 mc. 1FG on 14 mc. handled a reply to trans-Canada test message of SCM. 1EP hears "J" 's well. 1EI is selling out. 1DE-45 is going to try 3.9-mc. 'phone. 1EF finds impedance matching system for antenna very good. 1DQ is piling up W6 QSOs on 14-mc. 'phone. 1EK gets out well on 7 mc. 1FN got R7 from LUIEP. VOSW is stepping out on 14 mc. with pair of 'O1As; he would like a VE QSO. VOSHK is new ham on 14, 7 and 3.5 mc. VE1CA-5, FB-4, FN-23.

### ONTARIO DIVISION

ONTARIO—SCM, S. B. Trainer, Jr., VE3GT—3JT-515 makes BPL and leads Section. 3DW-12 enjoys RMNites. 3NJ and QL are on again. 3JP, VP, VG, and DJ are QRL school. 3SZ visited JV and worked five countries in 30 minutes. 3MB-33 along with SA and XL visited RK. 3AZ has been testing receivers in planes and 9AL-31 has been yodelling to him. 3VD-6 saved his rig when his apartment burned. The Simcoe Amateur Radio League has been formed, 3DM Pres., 3QM-24 Secy.-Treas. 3GH hooked J2GX for WAC. 3YL naturally QRL YL. 3QI is QRL gas station. 3TA-3, EA, and QO are going c.c. 3QK has job in Windsor. Ontario's O.O., 3GI, is checking poor notes and off-frequency operation. 3JN moved further north to Timmins. 3ZA, TA, and SM-4 send newsy reports. 3LJ moved to Kapuskasing. 3HW-11 reports little DX. 3HY is installing radio for OFB. 3HA, HN, GX, DD, ex.-Ly, CX, ET are out with OFB in the big woods, already reporting forest fires. 3QN, RM, RN, YO, XW, and XL are new additions to VE3. Canadian Division Convention is planned for Toronto, Oct. 5th and 6th, followed by a big VE/W Contest the next weekend. The Toronto Centennial Radio Council will look after Centennial traffic throughout the summer. 3SG-22 is Chairman, 3JT Secy.-Treas., 3GT-351 Communications Manager, and 3GR-2 Publicity Manager. 3FZ and PT are on 7 mc. 3JI-65, RK-54, LI-4, and MX-37 continue active in Ottawa. 3GO-112 keeps noon schedules. 3LZ-76 broke his traffic record. 3NB is heard on 3585 kc. 3WK-64 plugs along. 3WX-192 finds the gang solid behind the A.R.E.L. If any W/VE stations hear Toronto station sending "CQ TFC," please give them a call. Much Centennial traffic is expected. 3RK, NO-40, WX, GT, JT and QK enjoyed the last ORS party. 3UY is on 28 mc. VE3XO-43, DJ-22, QB-17, RT-8, NB-2.

### QUEBEC DIVISION

QUEBEC—SCM, Joe Robertson, VE2GA—Thanks for your support, gang. Please help me by sending in your reports regularly. 2AP is busy with "SKYWIRE." 2HK-345 makes BPL for second month in succession. 2BE attended Directors' Annual Meeting at Hartford. 2AX will be married by time this is in print. 2CF's engagement is announced. Congrats to both. 2BT worked first Irishman on March 17th. Hi! 2EE-12 and GO-2 are going strong at new QRA's. Neighbors moved and took 2HO's antenna by mistake? 2CQ has gone c.c. 2DG-27 is great help to SCM. Newsy letter from 2AO, and old-timer. 2BG-23 has cleaned up shack. 2EL is experimenting with 56 mc.

2CO-11 has new mast and antenna. 2EK applies for OPS. 2CG-14 is new ORS. 2HP has Tri-Tet working FB. 2HQ puts out a powerful signal. VE2DR-25, BU-26, CA-3, GA-5.

### VANALTA DIVISION

ALBERTA—SCM, J. Smalley, Jr., VE4GD—4QX-26, AF-32, and KG-30 are new ORS. 4LX-31 gets nice total. The gang at Rockyford had a young hamfest and worked the SCM via 4LA's 3.9-mc. 'phone. Those heard from: 4DQ, LA, LX, KN, LE, LM, IN, IB, HB. Calgary Keaklix has over 50 subscribers. 4GM is rehasing his heap. 4GP can QSO anything but VE's. 4JP-1 is on 7 and 14 mc. 4NB is settled down in Kingman. 4EO-5 is QRL moving. 4LG and RU are new calls. 4BW will have a Collins in the fall. 4HM-2 worked some Aussies on 14 mc. 4IZ QSO'd a "D" in the German tongue. 4EA has an 800. 4HQ likes 14-mc. 'phone. 4FI hooked K6 and X1 on 14-mc. 'phone. 4GD-31 worked K6 on 3.9-mc. 'phone. 4CY is resurrected. 4NH and AX like P.P. jobs. 4LK-16 has two ops. 4AW has c.c. rig. 4JK is frequent visitor at FG. Ex.-4AG is now 4GH. 4BZ-79 sends his usual fine total.

BRITISH COLUMBIA—SCM, R. K. Town, VE5AC—5HW and CK are B.C.'s main victims of YLitis. 5IM-153 is head traffic man. 5GI-87 and JA-70 do good traffic work. 5FG-21 mixes traffic and DX. DXers: 5CD, HC-11, IJ, EU-15. 5KL-2 uses low power. 5JC-16 works VOSG on 7 mc. Plans for bigger and better equipment at 5GS, JI, EP, IO, IM, JL-13. VE2DS is visitor from Montreal. 5JK-14 reports a W6 visitor. 5IZ is hunting bugs in his MOPA. 5JE-10 is surveying at UBC. 5CH-7 is going to survey Fraser Canyon. 5EJ and GR are on 3.5 mc. 5CL is on again. 5BC-6 is oldest VE5 ham! Congrats, Granddaddy. New hams: 5DT, DL, EA, EN, ES, GH. Active on 3.5-mc. 'phone: 5JB, JF, ER, BK, BY. Commercial operating claims 5DF. 5EL-15 plans to attend Spokane Hamfest. 5GG finds power leak in his filter condensers. Hi. VE5EP-42, AI-7, HP-66, AC-96, IO-9, GT-11, BK-4, IC-18, FE-11, AG-12.

### PRAIRIE DIVISION

MANITOBA—SCM, Reg. Strong, VE4GC—St. James has formed a Radio Amateurs Club. 4LB schedules DK and GR. 4BG is rebuilding. 4DJ works 7-mc. DX. 4DY is putting in 250-watt 'phone. 4FT is experimenting with 50-watters. 4GQ and KX have good results on 14-mc. 'phone. 4HZ has a Tri-Tet. 4IU is chasing DX. 4LL has FB modulation. 4NF left 1.75 mc. for 14 mc. 4NM and DF use tens on 7 mc. 4NW, LH and RO work many VK's. 4NZ uses c.c. 4PR is new station in Brandon. 4QD has restricted operating hours. 4ER put up 3.5-mc. antenna. 4QN works 3.5 mc. 4TV, TJ and SS are newcomers. 4AC, LN, NK are active at Brandon. 4IT has FB receiver. D.R.P. Coates gave an interesting talk on spark days at the M.W.E.A. VE4MV-65, DU-55, DZ-41, AG-39, MY-36, LH-30.

SASKATCHEWAN—SCM, W. Skaife, VE4EL—Coast to coast schedule: VE2FQ to VE4BF, VE4GR-58 to VE5AC. FB! 4GJ has nice layout. 4GN has a new rig (I think it's a Ford A. Hi). 4KV says May QST a "Pippin." 4BR gets c.c. reports. 4PP would appreciate some local QSOs. The P.P. 10s of 4CV certainly push through. Your SCM appreciates all letters received. 4NK is working away from home. 4QK-4 reports lots of QSOs during daytime. 4RG is working at P.A. 4PL is with North Forestry station. 4AV-1 is on every Sunday. 4ES plans new rig. 4QK, QM and BX are doing nicely. 4ND likes handling traffic. 4OC is on the job. 4EH likes 'phone QSOs. 4GA is the liveliest of our bunch. 4EU visited Regina. 4EL-16 had visits from EU, CV, FY, EB, OO, and IG. 4AT is back on the air. 4EU will be at home to all visiting hams this summer. 4RB worked his first W6 and W9 on 3.5 mc., 4QZ his first W6 and VE5. 4RI is going on 1.7-mc. 'phone with supp. grid. mod. 4PW uses P.P. 45s. 4MB is trying 7 mc. 4MA uses supp. grid. mod. 4LI has S.S. receiver. 4JB is new ham. 4HS gets FB PDC note with Ford coil power supply. VE4MH-42, KB-8, KJ-4.

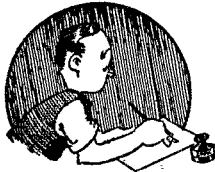

# CORRESPONDENCE

The Publishers of *QST* assume no responsibility for statements made herein by correspondents

## Call Thieves

Beverly Hills, Calif.

Editor, *QST*:

In these days of ever-increasing numbers of amateur stations, there is a menace to the rights and privileges of an amateur operator that seems to be increasing in like proportion—the prevalent practice of “pirating” of amateur station calls. I was thus put on the “spot” recently, and anyone who has had his license similarly jeopardized knows exactly how I feel.

Unfortunately, there is a “laissez faire” attitude or else the feeling among amateurs that it would not be sporting to turn in such an offender. That both such attitudes are wrong is plainly shown by the fact that this matter of “pirating” vitally concerns us all.

When one call becomes too hot to use longer, the pirate merely chooses another call that sounds good or that he thinks isn’t being worked overtime and continues merrily to CQ and wobble from one band to another. He doesn’t care what call he takes, what his signals sound like, or what his frequency is. And that call he chooses, dear friend, might just as well be yours.

Personally, I fail to see any difference between stealing someone’s call, thereby placing the owner’s license in danger of cancellation, and forging a check to someone else’s name. I had just as soon turn in one as the other.

It behooves us to stick together. When we hear of some pirating going on, follow it up, turn the culprit in and put him on the same spot that he otherwise would have us on.

—*J. E. Ruggles, W6IH*

doublet type was so simple to put up that was really the best thing to do!!!), cover them with umbrellas so the insulators won’t leak, put plenty of grease on them so the sigs will have an easy time sliding off, install an air-conditioning plant to supply the apparatus with dry, cool air (no more defunct audio transformers), pipe in 1000-cycle juice (who likes 60 or less?), silver plate the coils and condensers, replace the r.f. chokes with resistors . . . and plenty of other things anyone can think of.

To be consistent only an oscillator must be used. Any m.o.p.a. would be out of the question for over-all efficiency. But then who cares about over-all efficiency? All the average efficiency bug wants is to put 999 watts into the antenna with 1 kw. input (to the last stage). Of course, you may have to use a water-cooled tube as a driver, but that’s only an incident. And the poor, mishandled 852. Why doesn’t some kind soul pick on the old faithful 199 (UV)? With the base removed, a highly efficient circuit, and a fire hose directed point blank at the tip, someone should be able to obtain at least  $\frac{1}{4}$  kw. of certified r.f.!

. . . And Zepp feeders like we ole timers used? Omyomy. The sigs wouldn’t leave the front porch with such a hopeless antique system. We should give ourselves up unless we use a super impedance matched triplet with zippers at each end, or else man-made (to say nothing about Phords) static will pollute the sigs and bring in bum r.a.c. reports. Somehow, I feel like tuning up the ole spark set, adding a few turns to the OT and pouring some fresh oil in the condenser. . . .

—*W2BRB*

P. S. Don’t take yourselves too seriously!

## Efficiency Plus

Editor, *QST*:

If we were to believe all the efficiency-minded authors of late with their new antennas, feeders, circuits, tubes and gadgets, each giving 20% or 30% increased efficiency, we should have reached at least 200% or 300% by now! And all the DX (really the basic reason for all this fuss) that has been done to date must have been handicapped by an efficiency of surely not over—10%.

How’s to move the shack to a new location about 100 yards offshore, erect at least one antenna for each band (recently read that a

## Harmonics

4101 Illinois Ave., N. W., Washington, D. C.  
Editor, *QST*:

. . . Because of recent transmitter rebuilding I have had plenty of time in which to listen to commercials, especially in the 36- and 46-meter mobile bands. Several times I had heard some very “uncommercial” fists and notes, but paid very little attention to them. . . . One night I heard a fist that sounded familiar, so I started investigating. I found this ham to have about fifteen harmonics between 35 and 50 meters, but still this did not cause me any great worry as he

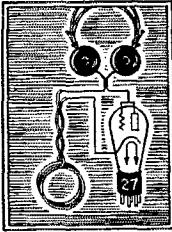

Generally it is the easy things we do not like to do. We will put all kinds of time, effort, and money into the construction of a high grade phone transmitter and then balk at the construction and use of a simple monitor. Certainly anyone listening on the 75 meter phone band at present will find ample proof of the need for their more general use. If some of the stations operating in this band at present would listen to their own signals, they would do some reamping in a hurry.

The overall characteristic of the audio channel in our own transmitter is nothing to brag about, but we really do think that it is sufficiently above the average to warrant us saying a word or two in favor of monitoring. At present the best phone amateurs are striving to avoid over-modulation and to improve the general efficiency of the RF end of their transmitters by the use of an oscilloscope or other suitable equipment. I think we owe much to Jim Lamb for this general house-cleaning.

An oscilloscope, as ordinarily used, however, is not an indicator of the quality of modulation. Neither is a loud speaker hooked across the input to the modulator stage. An effective "audio quality" monitor is neither expensive nor complicated. As most of you fellows already know, a three- or four-turn untuned pickup coil, an audio rectifier, and a pair of phones is all that is required. The rectifier can be a copper-oxide unit of the instrument type, or a 27 tube used as a diode detector. The circuit is not critical, and the best equipment to use is whatever you find in the junk-box.

If you are using a linear for the final stage, don't couple the monitor to the modulated stage, but couple it very loosely to the final tank circuit, just the same as you would if the final stage were the more conventional Class C.

What about it, some of you fellows? How about listening to your own signals for a few minutes tonight? Maybe you will find something to be proud of, and then again maybe not. There really are plenty of both kinds on the air right now.

One thing more. A number of amateurs have written to us asking if we made neutralizing condensers for use with the RCA-800 and RK-18. At the time some of their letters were received we had no such condenser, because, frankly, we did not think anybody would want to buy one. It is the kind of thing that any amateur can make out of scrap parts. However, we have since designed a neutralizing condenser for this service. After seeing it you may decide to build one like it yourself. Maybe you will buy it to save yourself the trouble. We hope so. But take a look at it. Your dealer will be glad to show it to you.

JAMES MILLEN



**THESE** are the transceivers that were the sensation of the recent Hudson Division convention

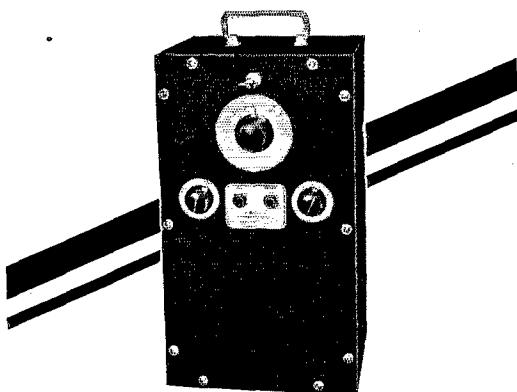

**REALLY PORTABLE TRANSCEIVERS**  
with battery space in same case

This feature will be appreciated by anyone doing serious 5 meter work in the field.

**SOLD AT PRICES YOU WOULD LIKE TO PAY BUT NOT BUILT DOWN TO THOSE PRICES**

NATICO transceivers can be supplied in three models, all of which have the same outward appearance.

**Type TR-1: Battery Model \$10.95**  
(less tubes and batteries)

This NATICO 5 meter transceiver is strictly portable, allowing two way communication even when being carried. This is accomplished by the fact that the two dry cells and 90 to 135 volt B battery are self contained in the one case.  
TUBES REQUIRED: One 30 and One 33

**Type TR-2: Mobile Model \$11.95**  
(less tubes, battery or eliminator)

Specially designed for automobile use or wherever a 6 volt battery is available. The case has sufficient space to hold the 135 to 180 volts of B battery or a 6 volt B Eliminator which eliminates the necessity of all B batteries.  
TUBES REQUIRED: One 76 and One 41

**Type TR-3: A.C. Model \$16.95**  
(including power supply, less tubes)

Here you have a portable A.C. transceiver which includes power supply in the same case (size only 6 1/2" x 7 3/4" x 12 3/4"). It can be operated anywhere that 110 volt A.C. is available.  
TUBES REQUIRED: One 76, One 41 and One 80.

**ACCESSORIES:**

Matched Tub- Kits for --

TR-1 .....	\$ 1.95
TR-2 .....	1.75
TR-3 .....	2.15
6 VOLT B Eliminator for TR-2 .....	11.50
Hygrade very high gain hand mike with battery switch, special .....	5.50

*Natico's Exclusive Distributors:*

**GROSS RADIO INC.**  
51 VESEY ST. NEW YORK CITY

was only two blocks away. After listening a little further I logged twenty-eight harmonics of W9—. Not so hot. After two weeks. . . I have heard harmonics of all W and VE districts, some being much louder than the fundamental signal and all louder than R7. This includes many 75-meter 'phones. And the strangest part is that they seem to group in the mobile bands. The hottest one, though, occurred one night when WCC told a ship to QSY as W8—'s harmonic was so strong he could not get him through it!

When things get that bad it is time something is done. Certainly these harmonics are reducing the strength of the desired signal, so why put up with them? Why not get to work and clear up those extra signals and save yourself from a run-in with the commercials — and at the same time give your sigs that little extra "sock" so you can work those elusive J's and AC's?

— Walter C. Kimball, W3CWE

**7000 Kc. or 7000-7300 Kc.?**

1762 No. Vermont Ave., Hollywood, Calif.

Dear Eddie:

My subject of complaint is conditions on the 7-mc. band.

. . . All amateurs want more territory in this band, but the majority of us use but half of it — the low-frequency end.

Most hams seem to think everyone tunes from low-frequency to high, "so-o-o" they all pile up at the low end in hopes that they will be heard first. This condition has become so bad that to have a decent QSO with any one at that end is almost impossible. An s.s. receiver would help — But!

My transmitter is on 7250, and in several months I have been QRM'd but three or four times. I seem to be all by myself down there. The 7300 end just peters out, while the 7000 end is plenty sharp.

Why cry for more when we don't use what we have?

— V. K. Hatfield, W6BXR

**Oh, How They Wiggle!**

2904 No. Robinson St., Oklahoma City, Okla.  
Editor, QST:

You may not believe it. I didn't and still don't! However put this in your pipe and smoke it:

Recently built a tri-tet at W5APG — usual 59 oscillator, 59 doubler-buffer and 10 amplifier. Nothing wrong about that. But the foolish tri-tet insisted on oscillating without any plate supply. This is quite common in long-wave receiving sets, but I have never seen a high-freq. oscillator perk up so freely. Am quite sure most any kind of rock for a crystal would give results.

However, that is not the worst of it. Page Ripley, quick! One evening I had been playing



### Hoyt Antenna Meter

Hot wire antenna meters, 2 1/4" mounting hole, flange 3" diameter, supplied in 1 1/2, 3 and 5 ampere ranges. Why work without antenna meters when you can buy them at this special price?.....\$2.95

### Hoyt Milliammeters and Voltmeters

Perfectly damped meters at a price. These are not to be confused with the usual inexpensive meters. 2" mounting hole, flange 2 1/4" diameter, supplied in the following sizes: 10 ma. 25 ma. 50 ma. 100 ma. 150 ma. 250 ma. 300 ma. 4 V. AC, 10 V. AC, 15 V. AC, 10 V. DC. Price each \$1.30, 3 for \$3.60.

### NEW !!

### Gross Crystal Holder

WHITE CERAMIC commercial type crystal holder — priced at less than ordinary holders. Adjustable pressure, dust proof, no tools required to open. Takes crystal to 1 1/8" square. Plugs standard 3/8" spacing. \$1.00 Most efficient job yet....

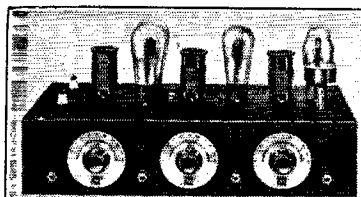
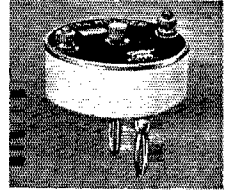

### GROSS C C TRANSMITTER — OUTPUT 25-30 WATTS

The "CW-25" transmitter kit due to its low cost makes it possible for anyone to own a modern crystal controlled station. A schematic hook-up and parts layout sheet as well as tuning instructions are furnished, thus enabling the most inexperienced operator to wire and put the set on the air, for real results. The "CW-25" is supplied with a shrivel finished sturdy metal chassis under which all parts are mounted, making the wiring and components dustproof. A plug-in crystal holder is furnished with the kit. Only one milliammeter is required for tuning the transmitter and each stage is provided with a jack for this purpose. The "CW-25" uses one '47 as crystal oscillator, one '46 as buffer or doubler

and two '46's in the amplifier stage, set of three coils supplied with kit for 20, 40, 80 or 160 band. **\$13.95**  
Additional coils 75c each. Complete kit, less tubes and crystal.....

### The "EAGLE" Three-Tube Short Wave Receiver

"Band Spread" over any portion of the tuning range — only finest material used thruout. Employs one '32 R.F., one '32 detector and one '33 Pentode Audio — 15 to 200 meters — four coils supplied. The "EAGLE" is economical — two dry cells will operate the filaments. See March or April 1933 QST for full description of this most excellent value in short wave receivers.

"Eagle" completely wired and tested. **\$11.95** Three tubes tested in your receiver. **\$3.00**

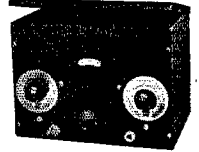

### Ward Leonard Vitreous Resistors

8 1/2" long with variable sliders — will carry 200 watts.	
1000 ohms.....	.99
2500 ohms.....	1.05
5000 ohms.....	1.05
10000 ohms.....	1.11
15000 ohms.....	1.20
25000 ohms.....	1.29
35000 ohms.....	1.35
50000 ohms.....	1.44
60000 ohms.....	1.49
80000 ohms.....	1.59
100000 ohms.....	1.65

### CARDWELL and HAMMARLUND

Complete stock for immediate delivery

### RAYTHEON RK-20

The New RF Pentode Power Amplifier Tube.....\$15.00  
(see page 14 June QST)

### SPECIAL TUBES!!

CARBON PLATE 203-A.....\$8.75

### EXTRA SPECIAL!!

866 tubes that carry our full guarantee — ISOLANTITE top — Heavy duty rectifiers.....\$1.45

### GUARANTEED TUBES

Gross 210 Thoriated filament.....	\$1.59
59's.....	.98
888 or 871 Isolantite top.....	.95
83's, 47's, 46's.....	.70
81's.....	.80
3/4, 1/2 and 1 watt Neon Bulbs.....	.35

### MIDGET DOUBLE SPACED NEUTRALIZING CONDENSERS

35 mmf. — a real buy.....\$ .59  
Pilot J-23 100 mmf. condensers.....\$ .55

CLASS B TRANSF. — 19 TUBES per PR.....\$3.00

### AUDIO TRANSFORMERS

with Microphone Windings for (5 meters).....\$1.10

### CASED CONDENSERS

6 MFD 700 VOLT.....\$ .59

### GROSS SPECIAL TRANSFORMER

600 volts each side of C.T. 200 MA  
2 1/2 V. 10 amps., 5 V. 3 amps.,  
7 1/2 V. 3 amps.....\$3.39

### Cased Combination Filament Transformer

2 1/2 V. C.T. 10 amps for 866's  
10 V. C.T. 7 amps for '50's or '52's  
10000 volts insulation.....\$3.24

### GROSS CASED POWER TRANSFORMERS

650 v ea. side C.T. 350 ma fila. 2-7 1/2 v C.T. and 1-5 v will give 500 v with choke Input using 83 or 5Z3 tubes. You can run your entire R.F. and class B off this trans.....\$5.50  
750 v ea. side C.T. 300 ma fila. 2-7 1/2 v C.T. and 1-5 v.....\$5.75  
750-1000 v ea. side of C.T. 300 watts, \$6.65

850-1350-1500 v ea. side of C.T. 400 watts.....\$8.70  
(the ideal job to give 750-1000-1250 v D.C. with choke input)

850-1350-1500 v ea. side of C.T. 550 ma.....\$12.50  
1500-2000 v ea. side of C.T. 800 watts \$11.70

### Mounted Center Tapped Filament Transformers

2 1/2 v 8 a — 2 1/2 v 3 a — 5 v 3 a.....	\$1.29
2 1/2 v 4 a — 7 1/2 v 2 1/2 a — 7 1/2 v 2 1/2 a.....	\$1.29
2 1/2 v 4 a — 5 v 3 a — 7 1/2 v 2 1/2 a.....	1.29
5 v 3 a — 7 1/2 v 2 1/2 a — 7 1/2 v 2 1/2 a.....	1.29
2 1/2 v 6 a — CT (midget).....	.74
5 v 3 a — CT (midget).....	.74
6.3 v 1.5 a — CT (midget).....	.69
7 1/2 v 3 a — CT (midget).....	.89

### Filament Transformers shielded in metal cases, center tapped secondaries

2.5 Volt 10 amperes for 866's.....\$2.25  
10 to 12 Volts at 8 amperes.....2.25  
Special 10-12 Volt 7.5 ampere filament transformer, extra special.....\$1.10

### FILAMENT TRANSFORMER FOR BRIDGE RECTIFIER

using 83 tubes 5 v-5 v-5 v at 3 amps C.T. — 3000 v insulation.....\$2.25

### GROSS CASED CLASS "B" TRANSFORMERS

Heavy Duty — for use with 10's, 46's or 4-46's in push-pull par. per pr.....\$7.50  
For 2-46's only, per pr.....4.65  
GROSS uncased Class B transformers for '46's or '53's special per pair.....\$3.85

### Universal Antenna Coupling System Inductances

Wound on threaded double X natural bakelite tubing, can easily be tapped, with clip supplied, ea.....\$1.75  
(Use one coil for single-wire feed and two coil for two-wire systems)

### Universal Antenna Tuning Unit

Complete kit of parts for outputs up to 50 watts.....\$13.95

### Low C 40-80-160 Meter Amplifier Coils

(See transmitter by GRAMMER page 46 May QST) Plug-in, wound on threaded Natural bakelite tubing, will tune with 50 or 75 mmf. condenser any size, each.....\$2.00

### Johnson Airplane Strain Insulators

White or black 3/4" and 1" Stand offs, doz.....\$ .50  
White or Brown Berhvie Ins., doz.....\$ .45  
Isolantite spreaders 3" long, 10 for.....\$ .35

### HIGH QUALITY CASED COND.

2 mfd 2000 V. working.....\$3.95  
2 mfd 1000 V. working.....2.10

THORD. 15 H 250 MA choke.....\$2.95

GROSS 30 H 200 MA cased choke.....1.94

Cased 30 H 125 MA choke......95

### Hard Drawn Tinned Copper Antenna Wire

No. 12 (any length) per 100 ft.....\$ .55  
No. 14 (any length) per 100 ft.....\$ .35

20% deposit with all C.O.D. orders. Remit by M.O. Include postage

**GROSS RADIO, INC.**

**51 VESEY STREET**

**NEW YORK CITY**

# Need a Transformer? —choose from over 130



## Transmitting Types

including

Plate Transformers  
Chokes  
Class B Audios  
Class A Audios  
Class C Modulation

Filament Transformers  
Input Audios  
Line Coupling Audios  
Mixer Transformers  
Output Transformers

Get complete data on these new  
Transformers

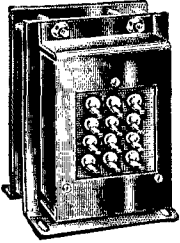

T-6416 — New multiple winding filament transformer. Has 10 V. 3¼ A., 10 V., 6½ A., 7½ V. 1¼ A., and 2½ V. at 5 A. windings. Primary tapped for 105, 110, and 115 volts. 1600 V. insulation. List \$11.50, net \$6.90.

T-6406 — Is a 380 m.a. input choke for use in 1 k.w. power supplies. 19 h. at no D.C. and 10.4 h. at rated current. 5000 V. insulation. Weight 16 lbs. List \$12.00, net \$7.20.

T-6315 — 280 m.a. input choke for use in NEW 800 TUBE plate supplies. 19 h. at no D.C. and 12.35 h. at rated current. 5000 V. insulation. Weight 10 lbs. List \$8.50, net \$5.10.

T-6285 — Provides 1 k.w. input for 851's or 849's. Actual D.C. rating out of filter 3000 V. at 380 m.a. New "air-cooled" construction. Weight 70 lbs. List \$65.00, net \$39.00.

T-6411 — Designed specially to supply plates of NEW 800 TUBES. D. C. rating 1250 or 1000 V. at 280 m.a. May also be used with 203's, 211's, 845's, RK18 and similar types. Weight 30 lbs. List \$23.00, net \$13.80.

T-6423 Class B audio output transformer for NEW TYPE 800, RK18, and 830B type tubes. Carries full plate current of Class C stage. Weight 17 lbs. List \$16.00, net \$9.60.

Get the new  
Transmitter  
GUIDE

# THORDARSON

ELEC. MFG. CO.

Dept. B, 500 W. Huron St., Chicago, U. S. A.

Please send new free THORDARSON Transmitting Equipment Catalog or find 10c enclosed for which I am to receive in addition a new THORDARSON Transmitting and Power Amplifier Guide.

Name .....

Address .....

around with the rig for quite a time and everything was well warmed up. . . . I was QSO some station that heterodyned with my own signal, with the result that Mr. Tri-tet oscillating without plate juice was rather annoying to copy through. So we proceeded to cut off the filament supply to the whole transmitter, including the 59 oscillator. The heterodyne was still there! In disgust I copied through it for about five minutes and then finally reached over and touched the crystal holder. The signals ceased. . . . Being wholly skeptical I fired up the rig again and put her through the paces with the same result. Believe it or not — Perpetual Motion! I am quite sure that the heater of a 59 cannot possibly remain warm enough for emission for the period of time the heater current was cut off. Have not been able to repeat the performance to date, but recent experiments have been perfunctory, and the rig has not been warmed up like it was at the time. . . .

Whether you believe it or not . . . (I will make affidavit to the phenomenon) a moral can be drawn from my tale (or is it a moral?). Any little crystal in a tri-tet oscillator is quite a wriggly critter!

— K. M. Ehret, W5APG

## Wired Wireless?

858 Alma Avenue, Oakland, Calif.

Editor, QST:

Here is an idea for local communication when one tires of QRM. Wired-wireless fitted for the ham.

Simply substitute the 110-volt lines for the antenna as shown on diagram and tell your friends about it. With low power, you can work all over a local area and have QRM-less contacts. Since you are not on the air but merely using lines you don't need calls,\* frequency stability, high power or superhet receivers. But don't let any of the energy get on the air. That can be worked by using low power.

I haven't tried this scheme yet but intend to when I get time. I have several friends building up

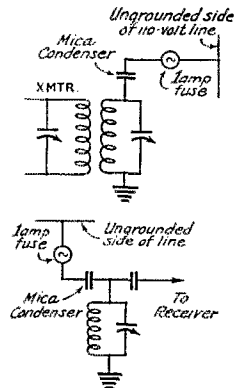

## HALF THE WORK IN BUILDING Any Transmitter or Receiver IS SAVED IF

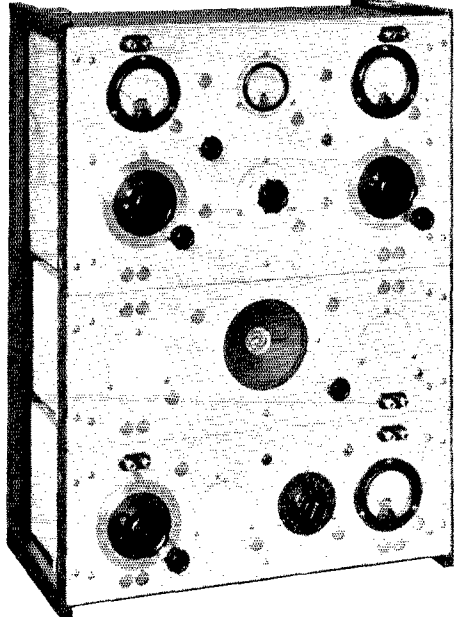

**S**OMEONE else does all the cutting, laying out, drilling and finishing the panel for you. General Radio's new unit panels are supplied completely finished ready to use. House your experimental set in decent surroundings — make the breadboard layout look and work like a finished job.

Completely interchangeable, all parts in the G-R Unit Panel may be used over and over again — and a single panel will accommodate anything from a one-tube blooper to a ten-tube super.

All panels complete with mounting plates, blank hole fillers, spacers and other gadgets to make the work even easier for you.

Prices? You'll be pleasantly surprised. For example, a 7 x 19 inch panel for \$4.00 — a 12 x 19 inch panel for \$6.00.

For complete information, dimensions, layout, and description of other G-R Unit Panel parts and prices write for **Bulletins 934-935 Q6**.

★ ★ ★ ★ ★ ★ ★ ★  
**GENERAL RADIO**

**COMPANY** 30 State Street  
Cambridge A, Mass.

### Are You "Stuck" ? LEARN CODE QUICKLY AND EASILY and become a Skilled Amateur or Radio Operator . . . AT HOME

Watson, WIBGL, op Bear of Oakland, Byrd Expedition, says: "Candler training enabled me to pass rigid competitive tests for this position."

Many Instructors and ops in U. S. Army, Navy and Aviation are Candler trained.

The FASTEST and most SKILLED Amateurs and Commercial ops during the past 22 years were Candler trained. 9 year old girl wins championship in Class "E" 2 months after beginning our Code Course for Beginners.

If you're wise you'll get your SPEED where the champions got theirs and prepare for that Amateur or Commercial Ticket the CANDLER SCIENTIFIC WAY. It's EASY and INTERESTING.

CANDLER STUDENTS NEVER FLUNK. Tell us what ticket you're preparing for and we'll show you how easy it is to get.

SEND FOR BOOK OF FACTS for Radio Ops, Amateurs and Beginners. Your questions answered promptly. No obligation.

#### Candler System Code Guild

An organization of CANDLER trained ops sending practice programs daily from their stations all over the U. S.

Become a CSCG Member. We furnish Schedules listing all CSCG stations, time on the air, speed 8 to 45 wpm.

You can bring in CSCG Practice Programs with your S.W. Receiver. This is REAL practice that costs you nothing. There is no substitute for it. CANDLER trained ops will help you develop your code technique.



**CANDLER SYSTEM CO.**  
Dept. Q-7 6343 S. Kedzie Avenue, Chicago



## TRANSCEIVERS

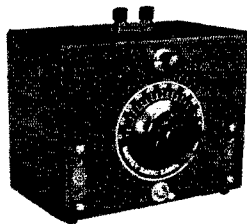

6-Volt.....\$17.95  
Tubes..... 1.68  
2-Volt.....\$18.75  
Tubes..... 2.04  
Pickard type  
antenna..... \$2.25  
5-10 meter phone transmitters are now available, operating from either 6 volts DC or 110 volts AC and ranging in output from 3-8 watts. Built standard or to your own specifications.

## RK-20 POWER AMPLIFIER



50 watts  
CW

15 watts  
phone

A new Power Amplifier built to follow the Harvey Tritet or similar exciter unit and employing the new RK-20 tube designed for suppressor grid modulation. Requires less than one watt audio power for 100% modulation. Complete with tested RK-20 tube and coils for one band but less modulator.....\$59.50

All prices are net F.O.B. Brookline and are subject to change without notice. Write for literature on the above apparatus.

**HARVEY RADIO LABORATORIES**  
12 Boylston Street  
Brookline, Mass.

# RCA FULL RANGE TEST OSCILLATOR

Type TMV-97-B **\$ 29.50**

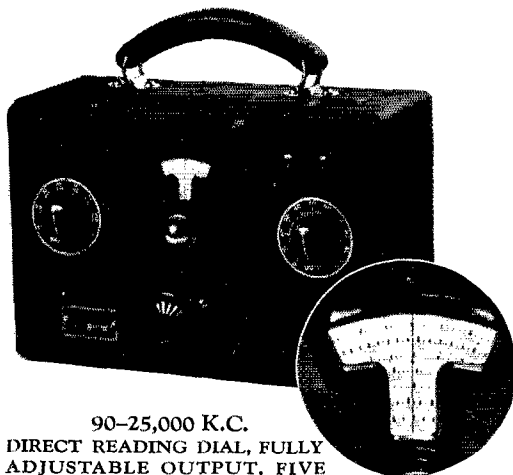

90-25,000 K.C.  
DIRECT READING DIAL, FULLY  
ADJUSTABLE OUTPUT, FIVE  
POUNDS WITH BATTERIES

## Specifications

**CIRCUIT** — A tuned grid, plate modulated circuit is used which gives good stability over a wide range of voltage and climatic conditions. The output is modulated approximately 50% at 400 cycles.

**ACCESSORY ADAPTOR** eliminates modulation. Oscillator may then be used as heterodyning oscillator for S-W superheterodyne receivers or to adapt standard broadcast receivers for amateur use.

**RCA RADIO TUBES** — TWO RCA-30s are used, one as an R.F. oscillator and one as an A.F. modulator.

**BATTERIES** — One 22½ volt "B" and one 4½ volt "C." Batteries not supplied.

**SIZE** — Height 8½ inches (including raised handle), Width 9¾ inches, Depth 4½ inches.

**WEIGHT** — 5 lbs. including batteries.

**FREQUENCY RANGE** — 90 KC to 25,000 KC by eight overlapping steps.

**OUTPUT** — Adjustable to any level.

**CALIBRATION** — The dial is calibrated directly in frequency which is accurate to 3%. Individual calibration may be obtained for \$5 additional.

**CASE** — The entire oscillator is enclosed in a black wrinkle-finished aluminum case.

\* \* \*

## RCA WORLD WIDE ANTENNA SYSTEM

Specially designed for all-wave receivers. Double doublet antenna gives greatly increased signal strength. Scientific transmission line and impedance matching transformer reduce noise to a minimum. Recommend it to your broadcast listener friends. List price \$7, plus installation.

Order from your distributor or write

**RCA Parts Division**

**RCA VICTOR CO., INC.**  
CAMDEN, N. J.

oscillators using c.w., i.c.w. and 'phone using tubes such as '01-A's, 71-A's and 12's. However, I think I will tune the circuit to 160 meters for start, then if I can, go to 20. The idea is to limit the emitted waves on the air, if any, to an amateur band.

—Henry Ben Plant, W6DKZ

\* **EDITOR'S NOTE.**—Schemes of this sort offer an opportunity for some interesting experimentation, but caution must be used in applying them. If there is any radiation from the power lines the transmitter is capable of causing interference to other services and therefore must be licensed and the transmissions confined to an amateur band. There is also the question of whether or not the use of power or other lines for these purposes is legally possible; in many localities only approved appliances can be connected to the power lines.

14 Wallace Avenue, Bellmore, N. Y.  
Editor, *QST*:

As an aid to beginners studying the code I propose the use of two very low-power low-frequency oscillators (say 100-300 kc.) coupled via the lighting circuit. The use of two such oscillators in place of the common buzzer and key at each end has obvious advantages. First, an actual c.w. signal is used, necessitating the use of all the adjustments to be made in actual com-

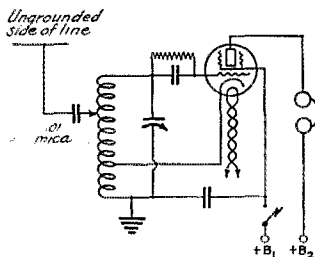

munication later on, second, no wires are needed between the two set-ups or stations, third, the beginners are introduced to problems of interference (in the form of line disturbances), frequency stability and other difficulties often met with in the actual operation of a c.w. station. Some useful experience may also be had in the construction of these units.

The disadvantages of this system are: first, interference to other services. Because of the low frequency used radiation is almost nil. The only chance for interference would be to a broadcast receiver on the premises, which could easily be eliminated by the proper choice of frequency. Chances of this interference getting beyond the boundaries of a house are almost nil. This constitutes the second disadvantage, namely the limited range of such a system. The range depends a great deal upon the lighting lines and connections to the main feeders on the block. Not much investigation has been made along these lines, but in rural districts the signal should reach several hundred feet if not a few blocks. In cities the range might be only a house or two.

—Ed Glaser, W2BRB



# "Have 5 Bliley Crystals . . . giving very satisfactory results"

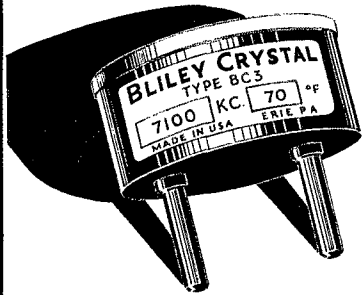

Type BC3 mounted crystals in the 1.7, 3.5, and 7.0 Mc bands having a precision of .03% supplied within 25Kcs or any frequency from distributor's stock, \$4.95—to exact specified Kc at slight additional cost. Bliley Crystals are sold by all progressive distributors of amateur equipment. If our distributor doesn't have your choice in stock, he can get it for you quickly; order from him.

"Perfect," "Most Satisfactory," "Sure Can Take It," "Giving Excellent Service," "Naturally Turn to Bliley for Crystals," are but a few of the many expressions of praise for Bliley 40-Meter Mounted Crystals received from amateurs all over the world.

Because 40-meter crystals must be finished with greater care and precision, these testimonials are tributes to Bliley skill and craftsmanship.

More and more amateurs are turning to Bliley 40-Meter Mounted Crystals for high power output. And remember, when you choose Bliley your transmitter is locked on the exact selected frequency. Bliley Piezo-Electric Co., 208 Union Station Bldg., Erie, Pa.

See Our Display at the 1934 World's Fair Radio Amateur Exhibit



*"E. H. Rietzke SPEAKING!"*



Mr. E. H. Rietzke, President of CREI, former chief instructor at Naval Research Laboratory, and today an outstanding figure in the radio profession.

## "If You Do Get 'A Break' . . . Are You Qualified for It?"

The radio situation is brighter today than in many years . . . opportunities are opening for ambitious, well trained radiomen. If YOU had a chance to step into a big job today . . . could you make "a go" of it?

Technical training is more important than ever. Success depends on adequate training, and there is no reason why you should sacrifice your Radio future when CREI makes it so easy to obtain this needed training! Let us explain!

Write for Our New Complimentary 40-Page Booklet

With pictures and full details of our courses and laboratories.

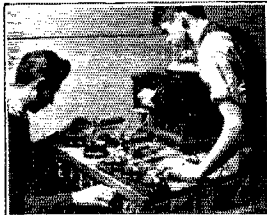

Students preparing to study the wave form of modulated transmitter output. The Oscillograph is one of the most important pieces of equipment in the CREI laboratories.

CAPITOL RADIO ENGINEERING INSTITUTE

14th and Park Road, Washington, D. C.

Dept. QS-7

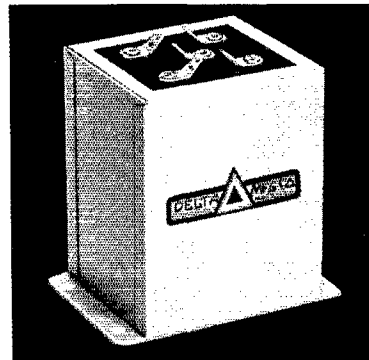

## ACME-DELTA COUPLING TRANSFORMERS

R.K. 20      R.K. 18      R.C.A. 800      SYLVANIA 830-B

Input Transformer	Out of	Into	List Price	Output Transformer	Into	List Price
AD 75	2-2A3	RK-18	\$7.50	AD-76	Class C <sub>v</sub> RF	\$15.50
AD 77	"	800	7.50	AD-76	Class C <sub>v</sub> RF	15.50
AD 78	"	830-B	7.50	AD-79	Class C <sub>v</sub> RF	30.50
AD 92	To couple one 45 to R.K. 20 suppr. grid.					7.50

Good power supplies are required with Class B audio. Write for catalog Bulletin DL48-13.

F. S. Dellenbaugh, Jr.

Pres. & Chief Engr.



G. E. M. Bertram

Treas. & Gen. Mgr.

UNIT OF RAYTHEON MANUFACTURING COMPANY

Say You Saw It in QST — It Identifies You and Helps QST



Nothin' wrong with this boy.

If you ask us he's a tough hombre . . . he ought to be . . . for he was Baptized with Fire at 2700 degrees and he's vibration proof, heat proof and moisture proof.

On that next replacement job try a CENTRALAB FIXED RESISTOR and note the difference. Good business too . . . for the customer won't be coming back with a squawk.

At your jobber . . .

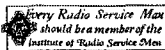

**Central Radio  
Laboratories**

MILWAUKEE, WIS.

**Centralab  
RESISTORS**

## What Is an A-1 Operator?

The *A-1 Operator Club* was organized by A.R.R.L. in May 1933 to promote and encourage a high calibre of operating in the amateur bands.

In choosing operators for the "A-1 Operator Club" the following points are considered by members. (1) General keying. Well formed characters and good spacing will be considered before "speed." Similarly, good voice operating technique, clearness, brevity, cooperation with other operators, careful choice of words, etc., may be used as criteria in nominating 'phone operators. (Special extra credit may be given for use of standard word-lists in identifying calls and unusual expressions.) (2) Procedure. Use of correct procedure is a natural qualification. This applies to both general operating and message handling. (Procedure as recommended by A.R.R.L. is a good standard.) Long CQs, unnecessary testing, long calls without signing, too much repetition when not requested, and all other such poor practice, are grounds for disqualification. (3) Copying ability. This to be judged by proficiency in copying through QRM, QRN and other difficulties, and accuracy of copy, as well as by ability to copy at fast speeds. (4) Judgment and courtesy. The "CUL 73" type operator can never make the grade. An operator should be courteous and willing to consider the other fellow's viewpoint. He should QRS or QSZ, without "crabbing" when requested. He should embrace every opportunity to assist beginners, and to help them along through some of the more trying experiences of operating. He should never knowingly QRM another station, but should cooperate as much as possible with stations working on his frequency. He should not decry "lid" operating, but should assist the newer operators and offer friendly, courteous advice as to how they might improve their operation. The matter of "good notes," "sharp" signals, lack of frequency "wabbulation," good quality (phone), use of sound technical arrangement and proper adjustment, while not directly points of *operating* ability, are certainly concerned directly *with courtesy and judgment* and as such these things must be weighed under (4).

To A-1 Operators:—In considering candidates for nomination to the "club" it is suggested that each of the four qualifications outlined above be carefully considered, each counting a possible 25 points (of 100 total). No operator nominated shall have a rating of less than 20 of any one qualification.

Regarding *disqualification*. After an operator has been nominated if exception shall be taken, or complaint made of faults in his operating work, copy of such complaint shall be sent to him in order that he may profit from constructive suggestions, or explain the circumstances. In the event of a sufficient number of objections to a nomination or lacking a satisfactory explanation, the call may be added to a "disqualified" list or record at Headquarters.

HOW'S YOUR SUPPLY OF --

## MEMBER'S STATIONERY



Write your radio letters on League stationery — it identifies you. Lithographed on 8½ x 11 heavy bond paper. Postpaid. 100 sheets, 50c; 250 sheets, \$1.00; 500 sheets, \$1.75.

## MESSAGE DELIVERY CARDS

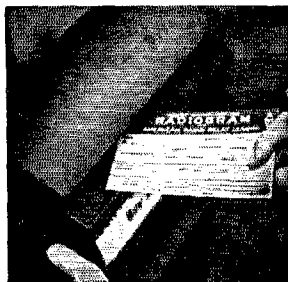

Neatest, simplest way to deliver a message to a near-by town. On U.S. stamped postals 2c each. On plain cards (for Canada, etc.) 1c each postpaid.

THE AMERICAN RADIO RELAY LEAGUE — WEST HARTFORD, CONN.



## NEW GAMMATRON TRANSMITTING TUBE

Many distinctive new advantages, plus PIONEER DEPENDABILITY. 100 watts plate dissipation. Write for prices and free circular.

**HEINTZ AND KAUFMAN LTD.**

Radio Engrs. and Mfrs. since 1919

311 California St., SAN FRANCISCO, CAL.

### CORNELL-DUBILIER

#### NEW TYPE TDF

These condensers now equipped with glazed porcelain insulators. Highly efficient, due to new impregnation and selected paper.

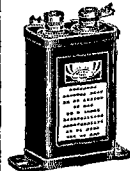

Type	Capacity	Volts	List	Net
TDF-6010	1 Mfd	600	\$1.75	\$1.03
TDF-6020	2 Mfd	600	2.75	1.62
TDF-6040	4 Mfd	600	4.50	2.65
TDF-10010	1 Mfd	1000	2.50	1.47
TDF-10020	2 Mfd	1000	4.50	2.65
TDF-15010	1 Mfd	1500	3.75	2.21
TDF-15020	2 Mfd	1500	6.25	3.68
TDF-20010	1 Mfd	2000	5.25	3.09
TDF-20020	2 Mfd	2000	8.00	4.70

Write for free catalog

**CAMERADIO**

603 GRANT ST.  
PITTSBURGH -- PA.

## RADIO ENGINEERING

RCA Institutes offers a combined course of high standard embracing all phases of Radio. Practical training with modern equipment at New York and Chicago schools. Also specialized courses and Home Study Courses under "No obligation" plan. Illustrated catalog on request.

**RCA INSTITUTES, INC. Dept. ST-34**  
75 Varick St., New York. 1154 Merchandise Mart, Chicago  
Recognized Standard in Radio Instruction Since 1909



## Learn CODE

in HALF the Usual Time!

It's Easy to Do at Home with

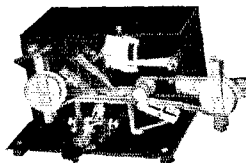

### The NEW MASTER Teleplex CODE TEACHING MACHINE

As a child, you understood spoken English long before you could read or write. You learned by *Hearing*. CODE is the same way! Why make it hard for yourself, trying to learn with old-fashioned methods? HEAR as you learn, and learn in half the time, with The New Master Teleplex. This world-famous instrument records your sending *visibly* — then sends back to you through headphones! The *natural* method; beginners learn faster, ops speed up their work amazingly. Used by U. S. Army and Navy, R. C. A., A. T. & T., and others. We give you Complete Course, lend you instrument, instruct you personally — all under MONEY-BACK GUARANTEE. Low cost, easy terms. Write now for folder QST 19 — no obligation.

**TELEPLEX COMPANY**

76 Cortlandt Street

New York, N. Y.

## THE IMPROVED CATHODE-RAY OSCILLOSCOPE

Linear sweep model for broadcast stations and advanced amateurs, physics labs., etc.

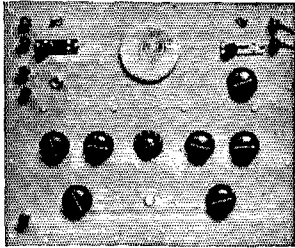

This instrument embodies all features ordinarily contained in only the highest priced Cathode Ray equipment

● Controlled linear sweep 0-150,000 C.P.S. ● Controlled external sweep. ● Freq. locking device for sweep frequency. ● Picture centering adjustments. ● Wide range focus adjustments. ● Complete component shielding. ● Unit is self contained and includes batteries and 110V-60 cycle power supply. ● Tubes RCA 906-385-234-281-280. ● The current model of the oscilloscope is adaptable for standard relay-track mounting at no extra charge.

COMPLETELY EQUIPPED READY TO USE

**F.O.B. Newark—\$85.00**

Conforming with our policy of the best apparatus for the least money, we are now able to supply a tailor-made 50-wattor with newest type construction Graphite Anode — Your choice of 211, 203-A or 845.....\$8.75

TUBES — Depression Type — to fit the depression pocketbook. These tubes are first class products and carry our absolute guarantee for 90 days.			
281.....	\$ .90	866 HD.....	\$1.50
281 Mercury.....	1.35	203A.....	8.75
210 — 15W.....	1.15	211.....	8.75

### FILTER CONDENSER SPECIAL

Dubilier 902 — 6 mfd-700V.....\$ .45

The revolutionary HAIGIS DUPLEX 5-METER TRANSCEIVER.....\$17.40

We now carry in stock a full line of threaded bakelite tubing

FILAMENT TRANSFORMER — 2 windings — 2½V @ 3A — 7½V @ 3 Amp.....\$1.45

PLATE TRANSFORMER — two 7½ and two 2½ volt fil. windings — 750-750-160 mils.....\$3.50

DUPLEX POWER SUPPLY  
1100 v. 250 ma. and 550 v. 250 ma.

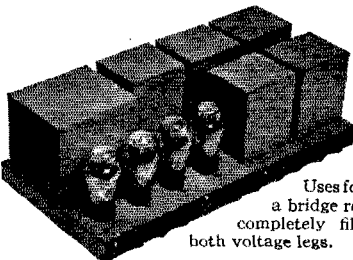

Uses four 83's in a bridge rectifier — completely filtered in both voltage legs.

**\$35.00**

These units can be had on special order in any size mounting or form

We are specializing in transmitter construction to customers' orders and specification. Write for quotation on your favorite transmitter.

Special code classes for beginners. No charge. Telephone for appointment.

**KALTMAN & ROMANDER**  
62 Court St. Newark, N. J.

## Silent Keys

It is with deep regret that we record the passing of these amateurs:

Edward Blake III, W1GEC, Waban, Mass.

William J. Butler, W1DYX, Brockton, Mass.

J. M. Crump, W4ZN, Winston-Salem, N. C.

W. H. Dinger, W4AEQ, Miami Shores, Fla.

Edward W. Gnakow, W9LSA, Genoa, Ill.  
Donald V. Hogan, W6DET, Berkeley, Calif.

R. W. Mintrom, ZL3AW, Christchurch, N. Z.

Lt. Durward O. Lowry, "Dud" at W8KY, Selfridge Field, Mich.

Harvey T. Moore, W1EZT, Alstead, N. H.

Frank C. Niczky, W2FTR, Jamaica, L. I.

J. L. Stauf, OA1B, Negritos, Peru

C. A. Rose, W9NYU, Oak Park, Ill.

Raymond C. Sellers, W9DZM, Sycamore, Ill.

Frank D. Smith, W3TM, Norfolk, Va.  
Kenneth V. White, W1BOF, Rockland, Me.

Edward Wolverton, ex-W9DQV, Grand Junction, Colo.

## In Memoriam:

Wallace Purinton Jr., W9CZT, Danville, Ill. Born July 17, 1911—Died July 18, 1933

*Far through the still, cold blackness of the night,*

*Ten times an hundred miles of vale and peak,  
I heard his voice—the voice of those who speak*

*With hand on clicking key, and put to flight  
Traveling near and far with speed of light*

*Dim eerie whispers. Now my friend I seek  
On ether lanes no more—in accents meek*

*I ask a blessing on his soul tonight.  
I never saw his face in life, nor heard*

*His voice, nor felt his hand clasped tight in mine;*

*Fate kept us far apart, yet friends may laugh  
At space, even at death; free as a bird*

*He seeks whate'er he will, held by no line—  
"My Unseen Friend"—God bless this cenotaph!*

—Duane Magill, W9DQD,  
Grand Junction, Colo.

## Strays

In taking a civil service examination recently, W2DLK had this question popped at him: "Who licenses amateur radio operators?" No trouble about answering that one!

# HINTS AND KINKS FOR THE RADIO AMATEUR

(No. 10 in the A.R.R.L. series entitled *The Radio Amateur's Library*)

Amateurs are noted for their ingenuity in rather than buy new equipment. This overcoming by clever means the minor book is a compilation of hundreds of and major obstacles they meet in their pursuit of their chosen hobby. An amateur must be resourceful and a good tinkerer. He must be able to make a small amount of money do a great deal for him. He must frequently be able to utilize the contents of the junk box

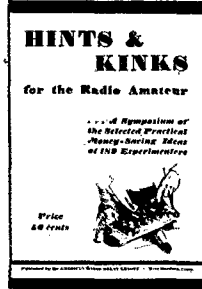

good ideas which amateurs have found helpful. It will return its cost many times in money savings—and it will save hours of time. Why try to figure these things out for yourself? You might just as well profit by the experience of others. Order your copy today.

PRICE  
CENTS

80 pages in attractive paper covers. **50** (no stamps, please), postpaid anywhere

AMERICAN RADIO RELAY LEAGUE, INC., WEST HARTFORD, CONN.

## PYRANOL FILLED TRANSMITTING CONDENSERS 2000 VOLTS 2. MFD

- PYRANOL IMPREGNATED
- LOW COST
- HIGH EFFICIENCY
- NON-INFLAMMABLE
- HIGH DIELECTRIC STRENGTH AND CONSTANT

**\$2.50**

A unit of this type can be operated continuously at voltages and ambient temperatures which are destructive to condensers using ordinary impregnators.

"Believe us these are fine business!"

BALDWIN TYPE C. PHONES.....\$2.50

Mail orders filled—Send Postage—Prompt Service

### THE RADIO SHACK

46 BRATTLE ST. BOSTON, MASS.

## LEARN RADIO

New Classes Now Forming! Send for 40-page catalog, explains fully. 180 licensed graduates placed in past 2½ years in broadcasting, shipping, police radio, aviation, etc. We teach all branches. Oldest, largest and best equipped school in New England. Equipped with Western Electric sound and broadcasting equipment and RCA marine transmitter. Course prepares for United States Government telegraph or telephone license.

MASS. RADIO SCHOOL, 18 Boylston Street, BOSTON

## NO ADJECTIVES!

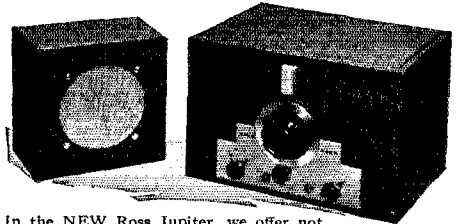

In the NEW Ross Jupiter, we offer not mere claims, but actual performance that will surprise you. Designed *exclusively* for amateur use. Try one in your own shack. If it is not all you expect—and more—you can return it in 5 days. **\$69.50** (less tubes)

**A. H. ROSS & CO.** Glenwick Ave. and Waverly Rd. GLENSIDE, Penna.

Kindly send folder and details of your test-for-yourself plan on the NEW Ross Jupiter Amateur 4-Band Receiver.

Name.....

Street.....

City.....State.....

## THE NEW WING TRANSCIVER

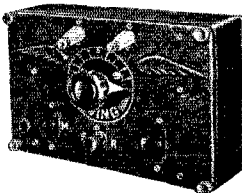

An improved 5-meter transceiver with higher output and higher efficiency. Antenna coil mounted on porcelain stand-offs which are brought through to front of case. New type insulation strip for coils with connections for either A.C. or D.C. operation. Insulating coupling on knob to eliminate hand capacity. New dial plate. Full-size Lynch resistors. Unit construction, all parts mounted on front panel which can be removed by unscrewing four thumb screws. We invite your comparison of details both electrically and mechanically with any other transceiver and believe you will be sold with the "Wing."

**\$16.50 less tubes**

### CHAUNCEY WING'S SONS

GREENFIELD, MASS.

Say You Saw It in *QST* — It Identifies You and Helps *QST*

# NEW ULTRA-HIGH FREQUENCY PORTABLE COMBINATION TRANSMITTER-RECEIVER

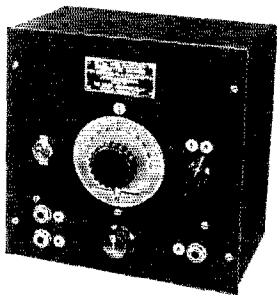

NEW  
HIGHLY EFFICIENT  
CIRCUIT  
Many New Built-in  
Features

Tone Telegraph and  
Voice — Sidetone in  
Phones on Transmis-  
sion — Rheostat, On-  
Off Switch, Real  
Jacks — Complete  
Instruction Book —  
Uses One Type 30  
and One Type 33 —  
Size 7 1/4" square, 5"  
deep, Weight 7 lbs.  
— Black Wrinkle  
Finish.

PRICE  
**\$17.40 NET**

At Your Nearest  
Dealer or Our Factory

We as engineers of long experience in the ultra-high frequency field take this opportunity to express our appreciation for the instant approval and acceptance of our efforts in producing a unit of this type for amateur use. We have produced a highly efficient transmitter which becomes a very sensitive receiver by simple transfer of circuits. No further noticeable gain in range can be obtained using any of the smaller type tubes. For instance if it were possible to double the power only a barely noticeable gain of 3 db. in the received signal would result. It is customary to increase transmitter power by multiples of 10 to obtain material gain and such equipment could hardly be considered portable. Knowing this we have added additional features which add reliability and ease of operation.

As a guide to those of you interested in the capabilities we present the following facts:

1. In free space at high altitude for an airplane the power limitation limits the range for reliable communication to the order of 60 miles by actual test.
2. Communication from the ground to a plane flying at 1500 feet is usually reliable up to 25 miles if the equipment is properly installed.
3. You can maintain two-way communication from an automobile to a fixed station with an antenna elevated 40 or 50 feet within a radius of 5 to 6 miles over reasonably flat country and for 10 or 15 miles from elevated points.
4. Two-way communication can be maintained over water from a 40 or 50 foot elevation on shore to a boat with the antenna a few feet above the water for upwards of 20 miles.
5. You can communicate between two fixed stations whose antennae are elevated 40 or 50 feet over reasonably flat terrain for 6 to 15 miles.
6. From hill-top to hill-top with the line of sight grazing intervening hills 25 mile ranges are reliable.
7. If you live in country where elevation changes of thousands of feet occur ranges of 50 miles may be possible across intervening valleys.

This is a portable unit, use it as such, or for home station use until you can afford more suitable permanent equipment.

Watch our advertisement or your dealer's window which will feature such equipment in the near future.

Non-radiating receivers — stable transmitters — and antennae equipment which takes the guess-work out of tuning.

**The HAIGIS LABORATORIES, INC.**  
MAPLE SHADE, N. J.

*Pioneers in the Ultra-High Frequency Field*

## A Modern Transportable Station

*(Continued from page 80)*

condenser may be turned through resonance without causing oscillation in the final stage. Other antenna systems tried with the transmitter were a 132-foot radiator with Zepp feeders and a Marconi system.

The portable had a chance to prove its mettle shortly after it was built when it was taken on a trip of 200 miles during one of the worst flood seasons in Washington since 1917. The portable received no small amount of bumps and jars, made part of the journey lying on its back in a baggage rack and near the end of the trip had to be carried over a swollen river via a half-washed-out railroad trestle. But the station was ready to go upon reaching the destination and regular schedules were worked.

## A Rotary Beam Antenna

*(Continued from page 84)*

considerable radiation as low as 10°. However, since the antenna is on a sharp 60-foot knoll the concentration of radiation at low angles is probably somewhat greater.

As an illustration of direct comparison of the beam and an ordinary non-directional antenna in actual communication, one evening W5AOT was contacted while the beam was aimed at Europe, nearly in the opposite direction. Switching over to a non-directional antenna he reported the signals *R8* while they were only *R3* to *R4* from the back of the beam. Several days later, in a subsequent QSO, with the beam pointed west, he gave reports of *R9*-plus on the beam and only *R3* to *R4* on the same non-directional antenna as had been used in the previous test. The later QSO was made under poor 14-mc. conditions, providing a striking example of the gain of the beam over the ordinary type antenna under such conditions as are commonly experienced on this band.

All that now remains is to make the rotation of the beam more convenient. Some day I'm going to install ropes and pulleys down the hill at the shack—and turn the beam with a crank, right from the operating position.

## Typical Technical Questions Answered

*(Continued from page 87)*

### 3500-KC. BAND

$L_1$ —10 turns tapped at 3 turns from the grid end for filament and 5 turns from the plate end for excitation.

$L_2$ —14 turns tapped at 9th turn from plate end for neutralization and 5th turn for excitation.

$L_3$ —14 turns tapped at the center.

### 7000-KC. BAND

$L_1$ —5 turns tapped at the 2nd turn from the grid end for filament and at one turn from the plate end for excitation.

# A.R.R.L. EMBLEM



—insignia of the radio amateur

**I**n the January, 1920, issue of *QST* there appeared an editorial requesting suggestion for the design of an A.R.R.L. emblem—a device whereby every amateur could know his brother amateur when they met, an insignia he could wear proudly wherever he went. There was need for such a device. The post-war boom of amateur radio brought thousands of new amateurs on the air, many of whom were neighbors but did not know each other. In the July, 1920, issue the design was announced—the familiar diamond that greets you at the top of this page—adopted by the Board of Directors at its annual meeting. It met with universal acceptance and use. For fourteen years it has been the unchallenged emblem of amateur radio, found wherever amateurs gathered, a symbol of the traditional greatness of that thing which we call Amateur Spirit—treasured, revered, idealized.

Red and green available in pin type only, blue may be had in either pin or button style. All Emblems priced the same

**\$1**

POSTPAID

## DO YOU WEAR THE A.R.R.L. EMBLEM?

THE LEAGUE EMBLEM, IN HEAVY ROLLED GOLD AND BLACK ENAMEL, IS AVAILABLE IN EITHER PIN OR BUTTON TYPE

There are three special colors for Communications Department appointees. . . .

- ▶ Red background for the SCM
- ▶ Blue background for the ORS
- ▶ Green background for the RM

## AMERICAN RADIO RELAY LEAGUE, WEST HARTFORD, CONNECTICUT

For Your 'Phone

### SHURE MODEL 40D CONDENSER MICROPHONE

A high quality Broadcast-type Bullet Condenser Microphone, complete with tubes, suspension adapter and cable.

Only

**\$60**

LIST

Subject to usual discount

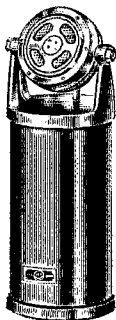

Ask your parts distributor

**SHURE BROTHERS COMPANY**  
Microphone Headquarters  
215 W. HURON ST., CHICAGO

## LOW RANGE FUSES

- *Littelfuses for Instruments:* Amps.: 1/100, 1132, 1/16—20c ea. 1/8, 1/4, 3/8, 1/2—15c ea. 1, 2—10c ea. For milliammeters, ham rectifiers, etc. Use 1/8 for radio B circuits. *High Voltage*
- *Littelfuses:* 1000, 5000, 10,000 volt ranges in 1/16, 1/8, 1/4, 3/8, 1/2, 3/4, 1, 1 1/4, 2 amps. Renewable. Price 35c to \$1.25 ea. NOW—\$100 PROTECTION GUARANTY. Get New Cat. #5.
- **LITTELFUSE LABS.** 4509 Ravenswood Ave., Chicago

"Quicker than a Short circuit"

## LITTELFUSES

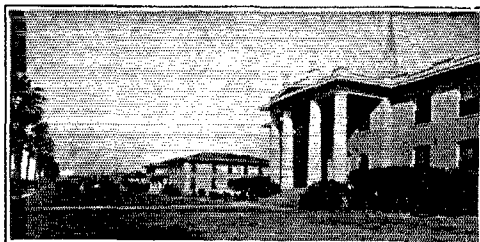

In 3 to 7 months we train you to secure government license. Course consists of Wireless Code, Radiophone, Microphone-Studio Technique, Television, Service, Police, and Aeronautical Radio. We are authorized to teach RCA Institutes, Inc., texts. Return coupon for details.

Name.....  
Street or Box.....  
City and State.....

## PORT ARTHUR COLLEGE

PORT ARTHUR, TEXAS



## SANGAMO ACCURATE CONDENSERS

Available in 5000 volt construction for use in short wave transmitters

Write for catalog sheet

**SANGAMO ELECTRIC CO.**  
SPRINGFIELD, ILLINOIS

# To OUR READERS *who are not* A.R.R.L. Members

YOU should become a member of the League! That you are interested in amateur radio is shown by your reading of *QST*. From it you have gained a knowledge of the nature of the League and what it does, and you have read its purposes as set forth on the page opposite the editorial page of this issue. We should like to have you become a full-fledged member and add your strength to ours in the things we are undertaking for Amateur Radio. You will have *QST* delivered at your door each month. A convenient application form is printed below — clip it out and mail it today.

*A bona fide interest in amateur radio is the only essential qualification for membership*

AMERICAN RADIO RELAY LEAGUE  
West Hartford, Conn., U. S. A.

I hereby apply for membership in the American Radio Relay League, and enclose \$2.50 (\$3.00 outside of the United States and its Possessions, and Canada) in payment of one year's dues, \$1.25 of which is for a subscription to *QST* for the same period. Please begin my subscription with the.....issue. Mail my Certificate of Membership and send *QST* to the following name and address.

.....  
.....  
.....

Do you know a friend who is also interested in Amateur Radio, whose name you might give us so we may send him a sample copy of *QST*?

.....

*Thanks*

L<sub>2</sub>—10 turns, tapped at the 7th turn from the plate end for neutralizing and at the 4th turn for excitation.

L<sub>3</sub>—10 turns tapped at the center.

### 14-MC. BAND

L<sub>1</sub>—4 turns No. 12 wire 1½ inches in diameter, turns spaced the diameter of the wire, tapped at one turn from the grid end for filament and ½ turn from plate end for excitation.

L<sub>2</sub>—4 turns, tapped at the center for neutralizing and at one turn from the plate end for excitation.

L<sub>3</sub>—4 turns, tapped at the center.

All coils except 14-mc. oscillator coil should be wound with No. 12 wire, 2½ inches in diameter, turns spaced the diameter of the wire.

If ¾-inch copper tubing is used for the output tank coils, the dimensions should be as follows:

3500 kc.—15 turns, 3 inches diameter.

7000 kc.—6 turns, 2½ inches diameter.

14 mc.—3 turns, 2 inches diameter.

—D. H. M.

## A Relay Rack for Two Dollars

(Continued from page 25)

plenty hard after being heated, and is hard to handle without an electric drill. This job, including the cost of the material, came to ninety-five cents. The mounting feet were cut out of regular stock and bent by a tinner, working from a paper pattern so that he had no difficulty in making both the same size. This item amounted to fifty cents. The 1 x 3's came to forty-five cents, and a few cents more covered the necessary wood screws. If you like, the rack can be given a coat of black enamel to improve its appearance.

The photograph shows a view of the rack with the baseboards in place, but without a panel. Careful inspection will show the copper strips which run up the inner sides of the rack to serve as a common ground connection for all units. The shelf brackets are bonded to these strips. In addition, a 110-volt fuse block is fastened to the lower wooden crosspiece, and the a.c. line runs from it up one side of the rack in the rear, with sockets under the various shelves for convenient connections to transformers.

Various inexpensive materials can be used for panels. Mine is made of Presdwood, a wood-pulp board which can be obtained from most dealers and works nicely, and can be made moisture proof by putting on several coats of Duco or similar clear varnish. A sheet of this material measuring 4 by 6 feet can be bought for two or three dollars, one sheet making panels for two good-sized racks. Get together with another ham and split the cost.

A rack of this sort is ideal for the ham who finds pleasure in making changes in circuits and trying out new ideas. The messiness of separate breadboards scattered around the room on tables is avoided, while at the same time there is none of the reaching around corners so bothersome with "four-poster" frames of the same dimensions.



## HOW'S YOUR SUPPLY OF—

### LOG BOOKS



Bound with heavy paper covers.  $8\frac{1}{2} \times 10\frac{3}{4}$ . Contains 39 log pages, and same number of blank pages for miscellaneous notes. Also list of Q sigs, message number sheet and sheet of cross-section paper. 40c each or 3 for \$1.00. Postpaid.

### MESSAGE BLANKS

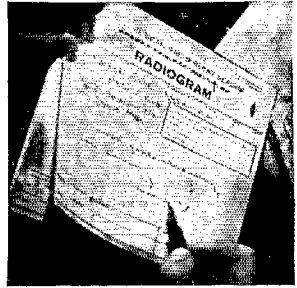

Most convenient form. Designed by the Communications Department of the A.R.R.L. Well printed on good bond paper. Size  $8\frac{1}{2} \times 7\frac{1}{4}$ . Put up in pads of 100 sheets. One pad postpaid for 35c or 3 pads for \$1.00.

THE AMERICAN RADIO RELAY LEAGUE—WEST HARTFORD, CONN.

## GULF RADIO SCHOOL

Radiotelegraphy Radiotelephony  
Radio Servicing

SECOND PORT } 1007 Carondelet Street  
U. S. A. } NEW ORLEANS, LA.

### PANELS—BAKELITE—RUBBER—ALUMINUM

All Sizes Cut to Order  
Drilling, Engraving & Special Work  
ALUMINUM CANS—Stock sizes. Special sizes, made to order.  
ALUMINUM CHASSIS—Threaded brass studs for 6/32 screws. Length from  $\frac{3}{4}$ " to 6"—price 5c to 30c.

Insulating bushings for all size shafts  
Couplings in brass or bakelite—15c  
Bakelite Tubing Threaded to Specifications.  
**UNITED RADIO MFG. CO.** Est. 1923 191 Greenwich St., New York

## HATS!

CAST ALUMINUM AND BRONZE

FOR HIGH Q  
56-60 MEGACYCLE  
TRANSMITTERS

See May QST

AVAILABLE FOR IMMEDIATE DELIVERY

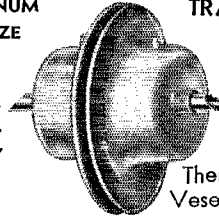

Send for List of Sizes and Prices or See Them at Leeds, 45 Vesey St., N.Y. City

**CHAUNCEY WING'S SONS**  
GREENFIELD, MASS.



A Holder with each crystal purchased

## A Good Crystal

— is the best investment you can make for your transmitter

PRECISION CRYSTALS are manufactured for those who want the best. For the past five years these crystals have been recognized as a quality product. By painstaking care in their manufacture — always striving to turn out the best — a crystal we could be proud of — we have earned a reputation which is our best advertisement.

PRECISION CRYSTALS are X cut, one inch square, from the finest grade of Brazilian quartz, and scientifically ground for maximum power output. Only after they have undergone a most rigid test and check up to the requirements of an A-1 crystal are they sent out to you with our guarantee of the finest obtainable.

If you want greater power from your oscillator, better efficiency and a more steady frequency use PRECISION CRYSTALS. You can depend on them.

Temperature controlled ovens and crystals for commercial use quoted on at your request.

Not a dissatisfied customer in five years.

## PRECISION PIEZO SERVICE

427 ASIA STREET

BATON ROUGE, LOUISIANA

Prices of crystals ground to your specified frequency in the amateur bands accurate to 0.1%. Calibration accuracy 0.03%.

1750 & 3500 kc. bands..... \$4.50 each  
7000 kc. band ..... 5.50  
Bakelite, plugin holder ..... 1.50

(Holder with each crystal purchased)

Jacks to plug holder into ..... .15 pair

# CONVERTIBLE VOLUME CONTROL

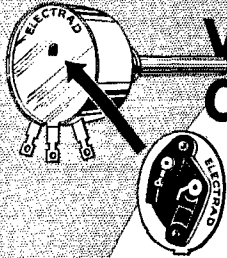

*Ideal for  
Replacement  
in All Sets*

RADIO experimenters and service men praise the quality and convenience of this unique Electrad Volume Control. Rugged and dependable. Interchangeable end cover permits addition of a power-switch assembly without disconnecting leads. Long ALUMINUM shaft is easy to cut. Only five types will service 799 standard receiver models.

Write Dept.  
Q-7 for  
FREE Catalog  
and Vest-  
Pocket Vol-  
ume Control  
Guide

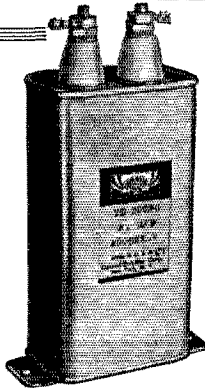

... and it has  
Got Places!

Brand new, only just announced, this money-saving, space-saving unit has won many friends. It's a real "ham" job — special high-voltage breakdown oil impregnation; large glazed porcelain insulators; handsome silver-finished case.

## NEW Type TD OIL X-mitting Condensers

Type No.	Cap. Mfd.	Size (H-W-D)	List Price	Your Cost*
Working Voltage 600 V D.C., (440 Rect. A.C.)				
TD-6010	1 2½x1	13/16x1 1/16	\$1.75	\$1.05
TD-6020	2 2½x1	13/16x1 1/16	2.75	1.65
TD-6040	4 4 x1	13/16x1 1/16	4.50	2.70
Working Voltage 1000 V D.C., (750 Rect. A.C.)				
TD-10010	1 2½x1	13/16x1 1/16	2.50	\$1.50
TD-10020	2 4 x1	13/16x1 1/16	4.50	2.70
TD-10040	4 4½x2½	x 1½	7.00	4.20
Working Voltage 1500 V D.C., (1000 Rect. A.C.)				
TD-15010	1 2½x1	13/16x1 1/16	3.75	\$2.25
TD-15020	2 4½x1	13/16x1 1/16	6.25	3.75
TD-15040	4 4½x2½	x 1½	11.00	6.60
Working Voltage 2000 V D.C., (1500 Rect. A.C.)				
TD-20010	1 4½x1	13/16x1 1/16	5.25	3.15
TD-20020	2 4½x2½	x 1½	8.00	4.80

\*Available from your supplier anywhere in the U. S. at 2% cash discount.

NOW AVAILABLE — "Ham" Catalog No. 126 — Write for it  
**CORNELL-DUBILIER CORPORATION**  
 JOBBERS' DIVISION  
 4373 Bronx Blvd. New York City



## First Boston-New York 56-Mc. Relay

(Continued from page 14)

W2AG. The message from Boston (North Wal-  
tham, W1DEK) covered 268 miles in six jumps,  
W1DEK-W1AHX-W1DE-W1HMO-W2CTF/2-  
W2AG-W2GEC. The dispatch for Boston trav-  
elled the same route and W1AHX sent it to  
W1SL via W1COX in Lowell.

The Third 56-mc. Field Day of New England  
and Hudson Division groups interested in this  
band was held on Sunday, May 27th, and was the  
occasion of another successful relay. The route:  
W1BPI (Mt. Washington, N. H.) — W1HDQ  
(Mt. Monadnock, Jaffrey, N. H.) — W1DE  
(High Ridge, Whateley, Mass.) — W1HMO (Mt.  
Wilbraham, Mass.) — W1HNZ (Mt. Everett,  
Mass.) — W2XER (Catskill Mts., N. Y.) —  
W2AG (Yonkers, N. Y.) and W2GEC (N. Y. C.).

Also it is believed that W1HDQ (with W1FME  
assisting) worked the most stations and DX in  
the field on this occasion; 25 of the 45 stations  
called were worked in 8½ hours of continuous  
operating. W1FEF Meriden, Conn. at 95 miles,  
and W1BPI at Mt. Washington, N. H., 110  
miles, were the most distant. Others worked were:  
W1HMO, W1DEK, W1BWJ, W1FEM, W1CFE,  
W1AKS, W1DBE, W1DE, W1GJZ, W1BQK,  
W1GCV, W1ELP, W1BEF, W1AFF, W1ZJ,  
W1ACH, W1HOY, W1BHH, W1DMD, W1FX,  
W1BPI, W1FEF, W2FUU/1, W2HBU/1. Three  
antennas were used at W1HDQ, a vertical "Pick-  
ard" for both transmission and reception, a  
horizontal "Pickard," and a four-foot loop for  
reception, each of these bringing in a different  
group of stations. A pair of 12A's with 19 modula-  
tor and 31 driver were used.

These successful relays on 56-mc. are in their  
way likely to be as epoch marking as was the  
W1AW-W9AWM-W6ZAC relay of years ago.  
With sufficient 56-mc. activity there is nothing  
to prevent planning of relays between Boston,  
New York, and Chicago — and eventually per-  
haps a transcon. This ought to be an interesting  
summer of 56-mc. work and progress.

**GUARANTEED - 1ST QUALITY**

*New Low Price*

**TYPE 83  
RECTIFIER TUBES**

**AMATEURS!... SERVICE MEN!...**  
Here's **REAL VALUE** in a Full Wave  
**Mercury Vapor Rectifier!**

- Will handle plate voltage for any small oscillator or amplifier up to a 210.
- Low price permits use of 2 tubes with plates in parallel connected in full wave permitting up to 500 M.A. output current.
- Use in a bridge to provide heavy current, at much higher voltage.

Don't delay! — Send your Order Today!  
**57A 283**—Type 83 Genuine Silvertone Mercury Vapor Tube. Prepaid, Each... **\$0.63**  
 Special Price for Two... **\$1.17**  
 Special Price for Four... **\$2.26**  
 Send your order to our Chicago, Ill. or Philadelphia, Pa. mail order house, whichever is nearest you.

**SEARS, ROEBUCK and CO.**

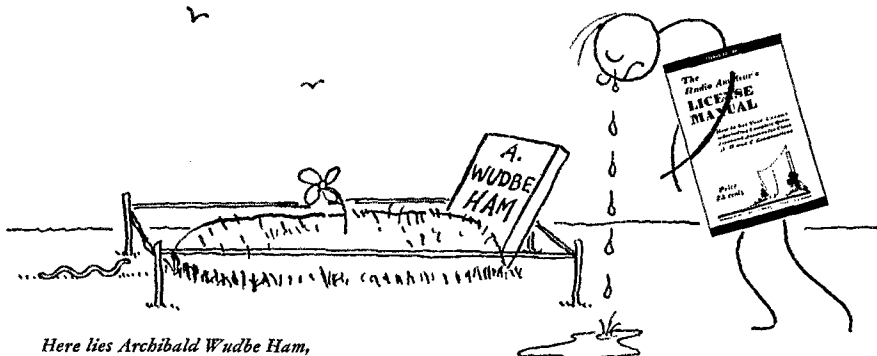

Here lies Archibald Wudbe Ham,  
Who met his sad fate in the license exam.  
The guy with the weeps at the right of the picket  
If consulted by Arch would've got him his ticket.

## THE RADIO AMATEUR'S LICENSE MANUAL

25c, postpaid, no stamps, please

A necessity for the beginner — equally indispensable for the already licensed amateur. Going after your first ham "ticket"? You need the manual for its instructions on where to apply, how to go about it in the right way — and, most important of all, for the nearly 200 typical license exam questions and answers. Already got a license? The manual is still necessary — for its dope on renewal and modifica-

tion procedure, the Class A exam (with questions and answers), portable procedure, etc. All the dope on every phase of amateur licensing procedure, and, of course, the complete text of the new regulations and pertinent extracts from the basic radio law. Get a copy of "The Radio Amateur's License Manual" and be sure to get your ticket.

(No. 9 in the series entitled *The Radio Amateur's Library*)

THE AMERICAN RADIO RELAY LEAGUE, WEST HARTFORD, CONN.



**THE INSTRUCTOGRAPH**  
(Code Teacher)

The Scientific, easy and quick way to learn the code. Send a post card today for literature. Machines, tapes and complete instructions for sale or rent. Terms as low as \$2.00 per month. Rental may be applied on purchase price if desired. Rent for a month. If the Instructograph meets every requirement, buy it. If not, send it back.

INSTRUCTOGRAPH CO., 912 Lakeside Place, Chicago,

**BIRNBACH**

Highest grade, highly-glazed porcelain with nickel-plated brass hardware. All standard types, including FEED-THRU models for panel mounting (plain or jacks). Write for Bulletin Q-7.

*Standoffs*



BIRNBACH RADIO CO., Inc.  
145 Hudson St. New York City

**STILL**

**Another Reason Why**



THE TRIMM FEATHER-WEIGHT phones are accepted as best on the market. All Featherweight double headsets are now equipped with a specially developed moisture proof cord, giving unparalleled durability and service.

DX more efficiently with Trimm Featherweight phones.

Buy from your local dealer

**TRIMM RADIO MFG. CO.**  
1528 Armitage Avenue Chicago, Illinois

**SCHWARTZ OFFERS**

National Cathode Ray Oscilloscope, less tubes. \$17.70  
RCA-de Forest Cathode-ray tubes: types 906 @ \$18; 905 @ \$40; 904 @ \$50.  
Haigis type AM Transmitter-Receiver, portable \$17.40  
Trimm featherweight phones. . . . . \$5.88  
RK-18 @ \$10.95; RCA-de Forest 800 @ \$10; Sylvania 830 @ \$8.75.  
I.C.A. one-tube short wave receiver kit, complete with cabinet, tube and batteries. . . . . \$6.65  
Atlas wire wound tubular resistors, 10 watt, 5 to 25 M ohms, each 15c; 20 watt, each 20c.

We stock a complete line of: Centralab, Electrad, Stancor, Aerovox, Acme-Delta, Triplett meters, Weston, Universal mikes, RCA-de Forest, Yaxley, IRC resistors, Hammarlund, Thordarson, Cardwell and many other lines. Write for quotations. 20% with order, balance C.O.D. Postage extra. Remit by M.O.

**M. SCHWARTZ & SON**  
710-12 Broadway Schenectady, N. Y.

**BUILD YOUR OWN!**

with the new SHURE MODEL 40K  
**CONDENSER MICROPHONE KIT**  
with **FACTORY-ASSEMBLED HEAD**

Includes regular Model 40 Broadcast-type Condenser Microphone Head, fully factory-assembled and tested, and all essential parts for the construction of a high-quality two-stage head amplifier. List price \$42 (subject to usual discount). Ask your jobber.



**SHURE BROTHERS COMPANY**  
Microphone Headquarters  
215 WEST HURON STREET CHICAGO

# HAM-ADS

(1) Advertising shall pertain to radio and shall be of nature of interest to radio amateurs or experimenters in their pursuit of the art.

(2) No display of any character will be accepted, nor can any special typographical arrangement, such as all or part capital letters be used which would tend to make one advertisement stand out from the others.

(3) The Ham-Ad rate is 15c per word, except as noted in paragraph (6) below.

(4) Remittance in full must accompany copy. No cash or contract discount or agency commission will be allowed.

(5) Closing date for Ham-Ads is the 25th of the second month preceding publication date.

(6) A special rate of 7c per word will apply to advertising which, in our judgment, is obviously non-commercial in nature and is placed and signed by a member of the American Radio Relay League. Thus, advertising of bona fide surplus equipment owned, used and for sale by an individual or apparatus offered for exchange or advertising inquiring for special equipment, if by a member of the American Radio Relay League takes the 7c rate. An attempt to deal in apparatus in quantity for profit, even if by an individual, is commercial and takes the 15c rate. Provisions of paragraphs (1), (2), (4) and (5) apply to all advertising in this column regardless of which rate may apply.

Having made no investigation of the advertisers in the classified columns, the publishers of *QST* are unable to vouch for their integrity or for the grade or character of the products advertised.

**MICROPHONE** and meter repairs. Low prices. Quick service. Sound Engineering Corp., 416 N. Leavitt St., Chicago, Ill.

**RADIO** engineering, broadcasting, aviation and police radio, servicing, marine and Morse telegraphy taught thoroughly. All expenses low. Catalog free. Dodge's Institute, Byrd St., Valparaiso, Ind.

**QUARTZ**—Direct importers from Brazil of best quality pure quartz suitable for making piezo-electric crystals. Diamond Drill Carbon Co., 719 World Bldg., New York.

**BARGAIN** dollar sale: overstock 872s, one at \$17.50, two for \$18.50. Guaranteed. 410 So. Marengo, Alhambra, Calif.

**QSLs, SWLs.** W6DOU, Hayward, Calif.

**CRYSTALS**, guaranteed 80, 160 meters, your approximate frequency, \$1.10. Blanks 50¢. W9FHS. 4433 N. Kilbourn, Chicago.

**AMATEURS**, data, circuits, bulletins, 50¢. 75¢ beyond Rockies. Resume, 10¢. Kladaglabs, Established 1921, Kent, Ohio.

**WILL** trade pair 872s, one 860, 4 condensers 2.5 mid each 2200 volts, for a job along coast of California or Oregon. Write W9HUU, Wendell Snyder, 1216 W. Mulberry, Kokomo, Ind.

**CRYSTALS:** x cut, 1" within 2 kc., \$2. Crystal and Biley BC2 holder, \$3.25. W8DLM, Rochester, Mich.

**QST** June ultra midjet transmitter, \$10.95; kit \$8.50; receiver, \$10.75. Write for information. We build to order. Precision Radio Labs., 109 E. 94 St., Brooklyn, N. Y.

**SWAP** FB7, 160 meter coils for twenties. W9NYD.

**UNIVERSAL** double-button "X" mikes \$3.95 net. Keying Relays, 3 volts, ¼ amp., contacts for 4 amps. 85¢ net. Dry-cells decent life on C.W. Mike-transformer \$1.18, for above. Hatry and Young, Hartford.

**TRANSMITTING** tubes repaired. New tube guarantee. New filaments 203A \$8.00, 852 \$11.00, 204A \$30.00, postage not included. Tubes returned C.O.D. Will quote on any type tube. If the glass is cracked or broken, tube can be rebuilt for following additional charges: 203A \$5.50, 852 \$1.50, 204A \$3.00. New half wave mercury vapor rectifiers 10,000 volt peak inverse. 1½ amp forward current 2½ volt 6 amp filament, 1000 hour guarantee, \$2.75 postpaid. Universal Engineering Company, 1331 Fifth Ave., Pittsburgh, Pa.

**INSURE** 100% QSOs, R9 signals. *QST* designed power equipment, relay racks, panels, Edison B headquarters. See May display, June hamad. Rectifier Engineering Service.

**NEW** opportunity for amateurs, experimenters. We buy, exchange, sell or trade equipment of standard make. Write us for trade in allowance on receivers or supplies before buying. Our stock largest in middle west National, Hammarlund, Bliley, Beede, Westinghouse, etc. Walter Ashe Radio Co., 1100 Pine St., St. Louis, Mo.

**QSTs**, complete from Number One. I.R.E. 1928 to 1934. All perfect. Send for list of others. W1GY, Worcester, Mass.

**TRADE**—Keefe slide trombone. Cost \$40 secondhand. Want radio apparatus, any kind. W6AHI, Berkeley, Calif.

**IN** stock—shipped prepaid: Patterson PR-10s, \$70.25, preselectors \$18; Comet Pros \$88.20. The following not prepaid: FB7As \$34.20, FBXAs \$47.70, SW3s \$17.70, preselectors \$11.40. RME9D \$112.50. Trade in your receiver. Lowest prices Taylor, Thordarson, National, Hammarlund, Cardwell, Sprague, Triplett, Johnson, Trim, Billey, others. Teleplexes rented. Write: Henry's Radio Shop, Butler, Mo.

**SELL**, trade: RCA211s, 852s, 860s, 204As, 861s, 851s; WE212Ds; Vibroplexes; receivers, dynamotors; MGs; meters, etc. W9ARA, Butler, Mo.

**203A** fifty watters, \$9.75 each. New, first quality and fully guaranteed. Also 211s and 845s. VTE Labs., Ridgefield, N. J. 50 Watters, \$7.50; 203As and 854s, new. Amateur Service, Fairview, N. J.

**WANT** xtal 160 meter phone transmitter. Trade. W2CIZ.

**1000** hour transformer—866s, \$1.49; 825s, \$4.95. Transformers. Howard Radio, 314 Pine Ave., Chicago.

**QSLs!** Bright! Attractive! Investigate! W6FZQ, Box 1804, Phoenix, Ariz.

**QSLs**, 75¢ a 100, two colors. W9DGH, 1816 5th Ave., N., Minneapolis, Minn.

**GUARANTEED** xtals \$1. W9EGK.

**LIFETIME** microphones, America's outstanding values. Model 6 double button. List \$10. Special "Ham" price, \$2.95. Complete catalog free. W8ESN, 1827 Cone, Toledo.

**SWAP**, complete electrical, radio and business courses for station equipment. Make offer. W9LV8.

**TRADE** 2-212Ds for receiver or transmitting equipment. What have you? W9RGY, High School, East Peoria, Ill.

**PATTERSON'S** latest receiving equipment. Send for dope. Lyon-Wyatt, Wichita, Kans.

**PATTERSON** PR-10 Pre-Selector complete, two 58's \$17.84. Hagis, the finest Transmitter-Receiver, \$17.40. Descriptive literature. VTE fifty watters, guaranteed \$9.65. New! Raytheon RK-20 \$15.00. Franklin Transformers. See June Hamad other equipment and tubes. Free monthly bulletin "Amateur Transmitter" L. I. Marine & Electric (W2GOT-W2GRQ) 163-18 Jamaica Avenue, Jamaica, N. Y.

**TRADE**—sell. New, used, speech amplifiers, transmitters, receivers, accessories, RCA course, Teleplex. Buy movie, radio equipment. List. W2CR, 3219 Kingsbridge Ave., New York City.

**CRYSTALS**, guaranteed. 160-80 meter, ¾ to 1", X or Y, within 10 kc., \$1.35. 1", within 2 kc. \$2.25, oscillating blanks 75¢, blanks from the saw 50¢, grinding instructions 25¢, plug-in holders, \$1. Wm. Threm, W8FN, 4021 Davis Ave., Cheviot, Ohio.

**CRYSTALS**. 160-80 meter. Trade for tubes, meters, transformers. Bill Threm, W8FN, 4021 Davis Ave., Cheviot, Ohio.

**TRADE** 12/350 dynamotor for carbon-plate 203-A or other medium power equipment. W9HNW, Anamoose, N. Dak.

**QSLs** and **SWLs**. 200 for \$1. Cards with personality plus. Write for samples. Crystals, Lifetime mikes, Sooooooooo. W8ESN, 1827 Cone, Toledo, Ohio.

**QSLs** by Malco. None better. Get free samples. Malco, 1512 Eastern Parkway, Brooklyn, N. Y.

**1000** watt transformer, 2000-2500-3000 each side c.t., \$11. 500 watt transformer 1100 and 1500 each side, \$7. Filament transformer 2½ volt 10 amp. and 10 volt 4 amp. \$3.50. W3CGA.

**150** watt 110 volt 60 cycle a.c. generator. 6 volt field, \$15 or 7 Harold Long, 912 Indiana Ave., LaPorte, Ind.

**FB7s**, Teleplexes, Omnigraphs, receivers, meters, Vibroplexes, converters, bought, sold, traded. Ryan Radio Co., Hannibal, Mo.

**CLASS B** transformers—Universal for two or four 46s, 210s, 300s, RK18s, etc., \$7.75 pair, 70 watts of audio from 46s. Write for details and complete transformer catalog. I pay the postage. W8UD, Douglas, Michigan.

**CRYSTALS:** Guaranteed excellent oscillators, 160 or 80 meters, your approximate frequency \$1.35 postpaid. Crystal Maker's blanks 1" 65¢—dozen \$6.00. Irregular shapes 25¢. Improved dust-proof Bakelite holders, non-exposed 1½" silvered electrodes, plugs into G.R. or tube socket mountings, any position, 75¢—dozen \$5.40. Fisher Laboratory, 4522 Norwood, San Diego, Calif., formerly El Paso, Texas.

**WESTINGHOUSE** motor generator 1000 volt, 250 mil in good condition, \$25. W9EFC.

**FOR** sale 50 watt 20 meter fone, class B modulator power supply r.f. equipment, self-contained and complete, \$70. 1300-0-1300 300 mil transformer, \$10. Robert Laurenson, Miffin Ave., Wilkinsburg, Pa.

**SELL** transmitter, Hartley single 210, 500 volt power supply, tubes, antenna. All for \$15 cash. W3DWN.

**QSLs**. See our samples before you order. 2143 Indiana Ave., Columbus, Ohio.

**SELL**—FBXA—one month old, with crystal, tubes, National Preselector and Power Supply, 20 and 80 meter coils. Over \$100.00 value. First \$60.00 takes it. W3AN—Dr. Wm. A. Smith, Merchantville, N. J.

**CALLBOOKS**—new summer 1934 Radio Amateur Call Book, hundreds of new DX hams, many pages of late W and VE calls, is yours for \$1.10. Four issues for \$3.65 (in foreign countries \$1.20 and \$3.90). W9FO-610 S. Dearborn, Chicago.

**CRYSTALS**: \$1.35 Hipower oscillators 3500-1700 KC. Bands, close to your specified frequency. 7000 KC. \$4.25. Plug-in holders with mounting, \$1.00. Blanks 65¢. Immediate delivery. Send for complete price list and bulletin. Crystals for Broadcast stations. Prices on request. Hipower Crystal Co., 3607 N. Luna Ave. You cannot buy a better crystal than Hipower at any price.

**SELL** latest Comet Crystal Pro, with tubes, Pro speaker, 6 sets coils (all). New. Perfect performance. Make offer. All inquiries answered. Harold Grant, 1808 E. Cornell St., Springfield, Ill.

**CANADIANS**—sell or swap SW3, 20-40-160 coils. What offers? VE3TS, Sarnia, Ontario.

**QSLs**, two color. Samples. Printer, Corwith, Iowa.

**FOR sale**—latest model FB7A complete with power supply, tubes, 20 and 80 meter bandspread coils, \$45. Philco converter with tubes and power supply, \$12. W4PW, Guilford College, N. C.

**WANTED**—burnt-out xmitting tubes. Cash or swap. Write. W1CJR, Ware, Mass.

**QSLs! QSLs! QSLs!** Finest stock, inks and designs. Service! Stamp for samples. W8DED, Holland, Mich.

**QSL cards**, two color, cartoons, message blanks, stationery, snappy service. Write for free samples to-day. W1BEF, 16 Stockbridge Ave., Lowell, Mass.

**SELL** complete station. Three band operation. Push-pull xmitr, power supply, coils, two bands. Cardwell T-199, Jewell, Sangamo, 50 midgets, parts. Reasonable. Write. W9RFW, 219 E. Oak St., Kewanee, Ill.

**WANTED**: FB7, tubes, regular coils, \$35. Harry Novak, Memphis, Tenn.

**SELL**: latest model FB7A with air-tuned intermediates. National Pre-selector, bandspread coils for 20, 40, 80, 160 and BC, new RCA tubes—no pack. Best offer takes it. W9ADS.

**SWAP** xylophone, trap drum for FB7, similar superhet, or what? W9HFW.

**PILOT** d.c. super-wasp with tubes. Good condition, \$7. Ruland's, Natick, Mass.

**WANTED**—single or multiple coil winder. Give details. Ruland's, Natick, Mass.

**KENNEDY** Universal 150—20000 meters with amplifier and tubes. Good condition, \$20. Ruland's, Natick, Mass.

**SURPLUS**: a.c. and d.c. receivers, miscellaneous parts, sell cheap or trade. W1ZB.

## CQ-AMATEURS of the West

Just off the Press, send for your copy

### 1934 CATALOG

All Nationally advertised parts  
for Transmitting and Receiving  
Lowest Prices

### RADIO SUPPLY CO.

H. A. DEMAREST, President

912-14 So. Broadway Los Angeles, Calif.  
(W6FBI, located in Building)

## Radio Operating Radio Servicing—



Prepare for the new Government Radio Operating license examinations; Radio Operator, Marine and Broadcasting. Also Radio Amateur Telegraph and Telephone. Resident courses.

Write for Booklet

**NEW YORK YMCA SCHOOLS**  
4 West 63rd Street, New York City

Say You Saw It in QST — It Identifies You and Helps QST

## QST

# Oscillating Crystals

"SUPERIOR BY COMPARISON"

All "Scientific Radio Service Crystals" are accurately ground to an accuracy better than .03% on equipment tested regularly by the U. S. Bureau of Standards standard frequency signals.

### BROADCAST and COMMERCIAL BANDS

Mounted in our Standard Holder and ground to our usual high degree of accuracy \$35.00 each. Mounted in our NEW Insolantite Monel Metal Crystal Holder \$45.00 (adjustable air gap). Prices for other Frequency Bands quoted upon application.

### AMATEUR BAND

Ground to within FIVE Kilo-cycles of your specified frequency in either 80 or 160 meter bands \$15.00 each. Accurate calibration with each crystal.

Free! Send for New Illustrated Folder—Free!

PROMPT SHIPMENTS ASSURED

## Scientific Radio Service



"The Crystal Specialists" Since 1925

124 Jackson Ave., University Park  
Hyattsville, Maryland Dept. Q-7

No Amateur Can Afford to Miss a  
Single Issue of This Publication!

The Aerovox  
Research Worker

50c

Per Year—  
(12 issues)



THIS engineering bulletin is replete with genuine information . . . usable facts and figures . . . something you can really apply . . . It's the medium through which first-hand, authoritative, practical data on condensers and resistors, circuits and practices, are made available to radio engineers, laboratory workers, experimenters, amateurs, service men and others. No puff stuff . . . No publicity . . . No generalities . . . No fillers . . . No wasted space . . . Just a solid mass of condensed, concise, carefully selected and thoroughly edited data . . . the cream of the crop of advanced radio information!

Send for a Free Sample Copy or Mail This  
Coupon with 50c for a One Year Subscription

AEROVOX CORPORATION (QST 734)

73 Washington Street, Brooklyn, N. Y., U. S. A.

Gentlemen:

Kindly enter my name on the RESEARCH WORKER mailing list for one year beginning with the next issue for which I am enclosing \$ . . . . . 50c per year in U. S. A., 60c in Canada and Foreign Countries.

Send me a FREE Sample Copy of the RESEARCH WORKER.

Send me the latest 1934 Catalog of Aerovox Products.

Name . . . . . (PLEASE PRINT)

Address . . . . . City . . . . . State . . . . .

Kindly check classification of your connection in Radio:  
Manufacturer  Engineer  Dealer  Jobber  Serviceman  Amateur  Student  Broadcast Station  Research Lab.

# Your Nearest Dealer

Your nearest dealer is entitled to your patronage. You can trust him. He is equipped with a knowledge and understanding of amateur radio. He is your logical and safe source of advice and counsel on what equipment

Patronize the dealer nearest you—

<p><b>ALLENTOWN, PENNSYLVANIA</b> Radio Electric Service Co. 1024 Hamilton Street Complete stocks transmitting equipment</p>	<p><b>CLEVELAND, OHIO</b> Northern Ohio Laboratories 2073 West 85 Street Wholesale Distr. for National, Hammarlund, Thordarson, Cardwell</p>
<p><b>BALTIMORE, MARYLAND</b> Radio Electric Service Co. 303 W. Baltimore Street Everything for the amateur</p>	<p><b>CLEVELAND, OHIO</b> Radio Servicemen's Supply Co. 206 Prospect Street Wholesale Distributors catering to Amateurs, Dealers, Servicemen</p>
<p><b>BOSTON, MASSACHUSETTS</b> Nutter &amp; Cross, Inc. 99A Milk Street All OMs, OWs, and YLs welcome — W1HRF</p>	<p><b>DENVER, COLORADO</b> Inter-State Radio &amp; Supply Co. 1639 Tremont Place Amateur Radio Headquarters in the Rocky Mountain Region</p>
<p><b>BROCKTON, MASSACHUSETTS</b> Ware Radio Supply Company 913 Centre Street Everything in parts. Comet Pro in stock with crystal filter</p>	<p><b>DETROIT, MICHIGAN</b> Radio Equipment Sales Co. 14036 Woodward Avenue, Highland Park A complete stock of amateur, shortwave and service parts</p>
<p><b>BUFFALO, NEW YORK</b> Dymac Radio 359 Capen Blvd. — Tel. Univ. 9380 Complete Stock Amateur Parts — Standard Discounts — W8AWK</p>	<p><b>DETROIT, MICHIGAN</b> Radio Specialties Company 171 E. Jefferson Avenue Ham Supplies — National &amp; Hammarlund Sets and Parts</p>
<p><b>BUFFALO, NEW YORK</b> Kronson Service Company 143 East Genesee Street Western New York's largest wholesale distributors — W8EHF</p>	<p><b>ERIE, PENNSYLVANIA</b> Jordan Radio Laboratory 1019 East Fifth Street Amateur, service parts, including Bliley, National, Raytheon. W8CXG</p>
<p><b>CHARLOTTE, MICHIGAN</b> General Engineering Corporation Everything for the Transmitting Station</p>	<p><b>HARTFORD, CONNECTICUT</b> Radio Inspection Service Company 227 Asylum Street Yes, we'll take your old set in trade</p>
<p><b>CHICAGO, ILLINOIS</b> Chicago Radio Apparatus Company 415 South Dearborn Street Dependable Radio Equipment. Established 1921. All Standard Lines</p>	<p><b>HOUSTON, TEXAS</b> Straus-Frank Company Distributors for nationally advertised amateur products RCA-DeForest transmitting tubes</p>
<p><b>CHICAGO, ILLINOIS</b> Mid-West Radio Mart 520 S. State Street All standard lines carried in stock</p>	<p><b>KANSAS CITY, MISSOURI</b> Burstein-Applebee Company 1012-14 McGee Street "Specialists" in supplies for the Amateur and Serviceman</p>
<p><b>CHICAGO, ILLINOIS</b> Newark Electric Company 226 W. Madison Street Chicago's oldest radio parts store — established 1921 John T. Wallace, Technical Adviser</p>	<p><b>KANSAS CITY, MISSOURI</b> Radio Laboratories 1515 Grand Avenue Amateur Headquarters — Complete Stock — Quality Parts</p>
<p><b>CHICAGO, ILLINOIS</b> Newark Electric Company 226 W. Madison Street Chicago's oldest radio parts store — established 1921 John T. Wallace, Technical Adviser</p>	<p><b>LOS ANGELES, CALIFORNIA</b> Radio Manufacturers Supply Co., Inc. 1000 S. Broadway Amateur Headquarters of the Pacific Coast</p> <p><b>MANCHESTER, NEW HAMPSHIRE</b> Radio Service Lab. of N. H. 1008 Elm Street — Tel. 218-W Branches — Portland, Me. and Barre, Vt.</p>

*This advertisement is paid for by the firms listed above. Qualified dealers*



# You Are Protected When You Buy From QST Advertisers

“Advertising for QST is accepted only from firms who, in the publisher’s opinion, are of established integrity and whose products secure the approval of the technical staff of the American Radio Relay League.”

Quoted from QST’s advertising rate card.

Every conceivable need of a radio amateur can be supplied by the advertisers in QST. And you will know the product has the approval of the League’s technical staff.

For Your Convenience

## QST’S INDEX OF ADVERTISERS IN THIS ISSUE

Aerovox Corporation.....	75
A.R.R.L. Application Blank.....	70
Emblem.....	69
Handbook.....	4
Hints and Kinks.....	67
License Manual.....	73
Special Offer.....	Cov. 2
Supplies.....	65, 71
Birnbach Electric Co.....	73
Billey Piezo-Electric Co.....	63
Cameradio Company.....	65
Candler System Co.....	61
Capitol Radio Eng. Inst.....	63
Cardwell Mfg. Corp., Allen D.....	79
Central Radio Labs.....	64
Collins Radio Company.....	80
Cornell-Dubilier Corp.....	72
Delta Mfg. Company.....	63
Electrad, Inc.....	72
General Radio Company.....	61
Gross Radio Company.....	58, 59
Gulf Radio School.....	71
Haigs Labs.....	68
Hammarlund Mfg. Co.....	1
Harvey Radio Labs.....	61
Heintz & Kaufman, Ltd.....	65
Instructograph Company.....	73
Kaltman and Romander.....	66
Littelfuse Labs.....	69
Mass. Radio School.....	67
National Company.....	57, Cov. 3
New York V.M.C.A. Schools.....	75
Port Arthur College.....	69
Precision Piezo Service.....	71
RCA Institutes, Inc.....	65
RCA Radiotron Company, Inc.....	Cov. 4
RCA Victor Company, Inc.....	62
Radio Shack.....	67
Radio Supply Co.....	75
Ross & Co., A. H.....	67
Sangamo Electric Co.....	69
Schwartz & Son, Maurice.....	73
Scientific Radio Service.....	75
Sears, Roebuck and Co.....	72
Shure Brothers Co.....	69, 73
Teleplex Company.....	65
Thordarson Elec. & Mfg. Co.....	60
Trimm Radio Mfg. Co.....	73
United Radio Mfg. Co.....	71
Westinghouse Elec. & Mfg. Co.....	2
Wing’s Sons, Chauncey.....	67, 71





**T**HE Clean Cut Performance of the thoroughbred hunter is taken for granted by the horseman. So is the Clean Cut Performance, Durability and Precision of Cardwell Condensers taken for granted by those *who know* that The Cardwell Condenser represents the ultimate in engineering accomplishment.

There is a Cardwell for every tube and purpose. Let us tell you how Cardwells can increase the efficiency of your own equipment.

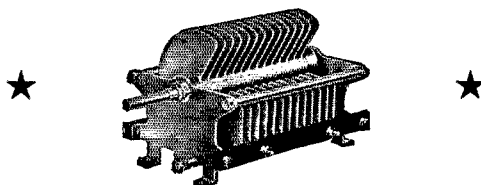

CARDWELL "STANDARD" MODELS FOR RECEIVERS  
and MEDIUM POWER TRANSMITTERS

CARDWELL MIDWAY "FEATHERWEIGHT" CONDENSERS,  
RECEIVING and TRANSMITTING

CARDWELL 16-B TRANSMITTING CONDENSERS  
FOR LARGER TRANSMITTERS

CARDWELL HIGH VOLTAGE CONDENSERS  
FOR COMMERCIAL RADIO-TELEGRAPH and  
BROADCASTING STATIONS

CARDWELL S-2244 OIL DIELECTRIC FIXED CONDENSERS  
FOR HIGH FREQUENCY FURNACES  
and TUBE BOMBARDERS

---

The ALLEN D. CARDWELL MFG. CORP'N.  
83 Prospect Street, Brooklyn, N. Y.

---

**"THE STANDARD OF COMPARISON"**

---

Say You Saw It in QST — It Identifies You and Helps QST

# IT'S A HIT!

The Collins 30FXB is the new model embodying the latest refinements and developments of the past six months. This transmitter meets all the requirements of a modern installation — plenty of power, high fidelity, and multiband operation without neutralization adjustment. Installation is simplicity itself — merely connect antenna, power, key and microphone, and you are "on the air."



## COMPLETELY SELF-CONTAINED

### TECHNICAL DATA

**POWER OUTPUT** — 100 watts nominal rating (203A).

**FREQUENCY RANGE** — 1500 to 15,000 kc. (standard). New isolantite coil forms are used.

**FREQUENCY CONTROL** — Crystal oscillator with isolation of oscillator from amplifier by a buffer stage.

**POWER SUPPLIES** — 1000 and 1250 volts at 400 MA DC for modulators and power amplifier. 400 volts DC for crystal and buffer.

**MODULATOR** — Two 830B or 203A tubes are used in Class B.

**FIXED NEUTRALIZATION** — All neutralization adjustments in the 30FXB Transmitter are fixed at the factory so that the user does not have to do any balancing of the various circuits. Shifting from one band to another is merely a matter of changing the plug-in coils and setting the dials to the calibrated position.

**SPEECH AMPLIFIER** — The 7C Speech Amplifier designed primarily for use with a crystal microphone is furnished as an integral part of the 30FXB Transmitter.

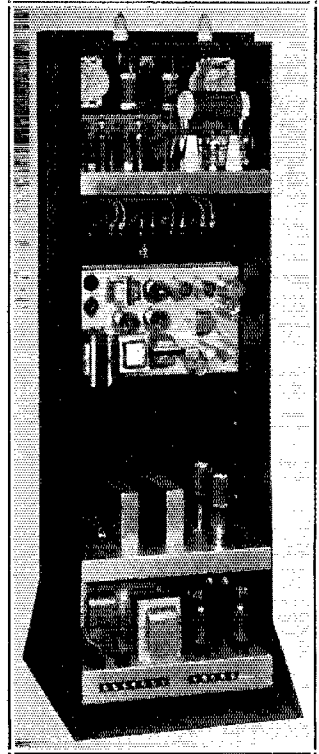

Thus, no external apparatus, except the microphone and telegraph key, is required and the installation is neat, self-contained and compact.

**ANTENNA TUNING** — The 2C pi Section Antenna Matching Network is furnished as standard equipment. This provision makes it possible to connect the 30FXB to any available antenna and to accomplish efficient energy transfer with proper attenuation of harmonics.

**DIMENSIONS** — 60" high, 20½" wide, 20" deep.

**SURPRISINGLY LOW PRICED. WRITE FOR FULL INFORMATION**

## COLLINS RADIO COMPANY

CEDAR RAPIDS  IOWA, U. S. A.

NEW YORK OFFICE—136 LIBERTY STREET, N. Y. C.

# 56 M.C. GEAR

The best materials are none too good for 56 m.c. operation, for the available power is low, and losses are necessarily high. National has developed special products for this difficult service and we feel that the advantages derived from their use will more than justify the small investment required.

The widely used Pickard Antenna, for example, requires the use of an efficient R.F. transformer for coupling the feeders to the antenna. The TRP coupling unit (1) was designed for this express purpose. The feeders should be spaced well away from the vertical radiator, and convenience as well as efficiency indicate the use of AA-1 Victron Transposition Blocks (6) or the smaller Steatite AA-2 Block (5). Steatite Dielectrics are recommended for supporting the system, in preference to the felt hat illustrated on the cover of June QST.

For portable use, the transmitting

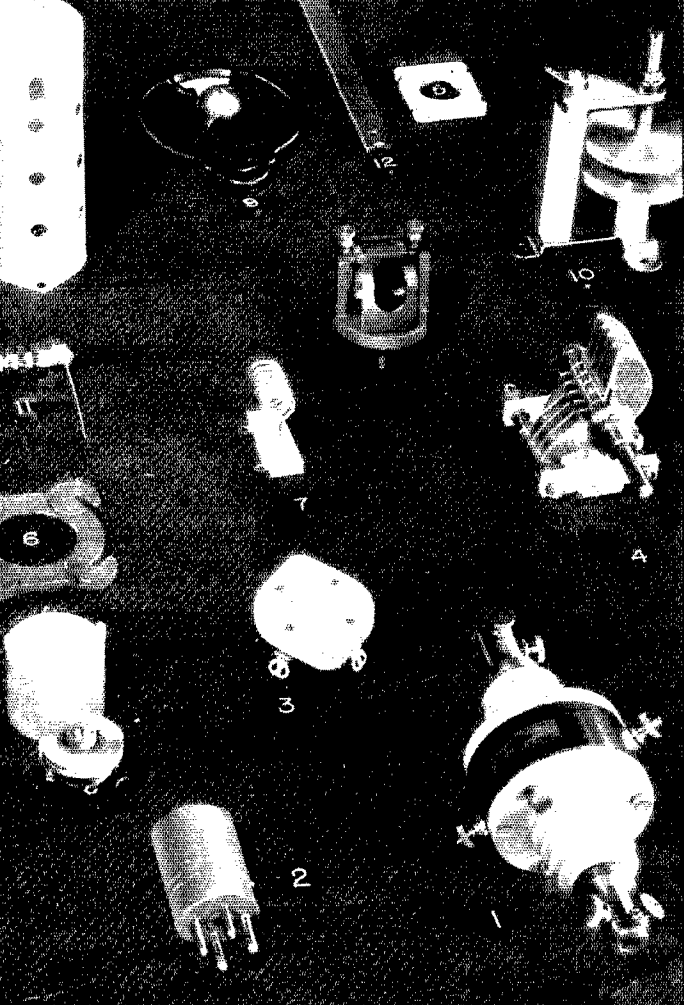

equipment may well be of the transceiver type (see below), but a permanent installation should employ a more pretentious crystal control rig. The SEU Condensers (4), originally designed for the National 5-meter Superhet, have proved very suitable for oscillator, doubler or final stages. Their companion unit, the XR-1 Coil Form (2) adds plug-in flexibility with the high efficiency of R-39 insulation. For single band operation the Steatite-mounted XR-9 Inductor (7) is compact and inexpensive, and may be adjusted by varying turn-spacing. Chokes are important at any frequency, but at 56 m.c. nothing less than an R-100 (11) is practical.

The National Line of 56 m.c. gear is complete, even to midget dials (9) and interruption-frequency oscillator coils (8) for super-regenerators. Look them over at your dealer's.

**NATIONAL COMPANY**  
MALDEN MASS.

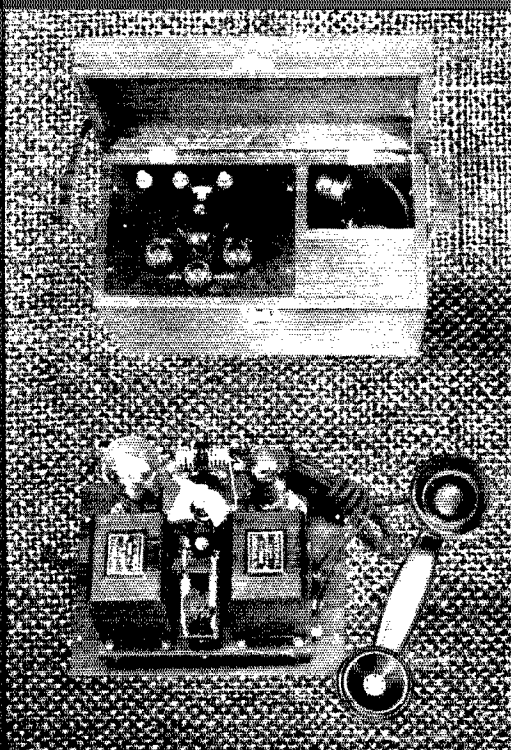

# YOU STILL CALL THEM "50 WATTS" BUT SEE WHAT THEY WILL DO

**RCA-203A/503A** is a three-electrode transmitting tube designed for use as oscillator, r-f power amplifier, or Class B modulator. It is capable of giving high power output with relatively low plate voltages. As a class C r-f power amplifier, the RCA-203A/503A is capable of 130 watts output under maximum rated conditions of operation.

**RCA-211/511** is a three-electrode, general purpose transmitting tube. It may be used as oscillator, r-f amplifier, or Class B modulator. Capable of high output with relatively low plate voltages, the RCA-211/511 as a plate modulated r-f power amplifier (Class C) will provide approximately 100 watts under typical conditions of operation.

**RCA-845/545** is a three-electrode tube for use as modulator or an a-f power amplifier. The RCA-845/545 is not recommended for r-f applications. As an a-f power amplifier and modulator (Class A), the RCA-845/545 is capable of 24 watts undistorted power output.

Constantly improved over the years, the RCA-203A/503A, 211/511 and 845/545 have graphite anodes and a rugged mechanical structure. Ever popular with the amateur, they represent a vast improvement over the original designs. The net price is \$17.50 for the RCA-203A/503A and RCA-211/511, \$20.00 for the RCA-845/545 at your RCA deForest Distributor.

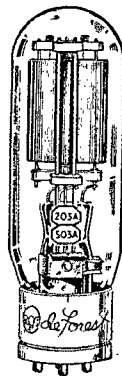

For information on these or any other RCA tube type, write to:



*de Forest* AMATEUR RADIO DIVISION  
**RCA RADIOTRON COMPANY, INC.**  
CAMDEN, NEW JERSEY