

QST 

devoted entirely to

**amateur
radio**

august
1932
25 cents

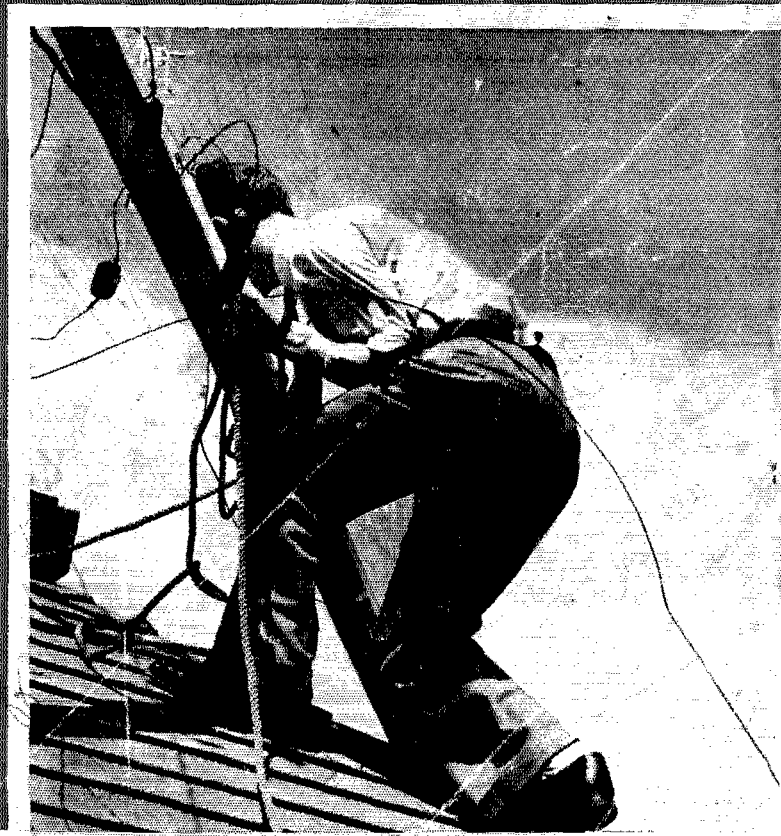

EVEN IF YOU AREN'T A TRANSMITTING AMATEUR

YOU NEED THE RADIO AMATEUR'S HANDBOOK

From cover to cover (242 pages, 231 illustrations, 187,654 words) the Handbook is packed full of information of value to anyone with a technical interest in any branch of radio

PRICE ONE DOLLAR — POSTPAID ANYWHERE

THE AMERICAN RADIO RELAY LEAGUE
WEST HARTFORD CONNECTICUT, U. S. A.

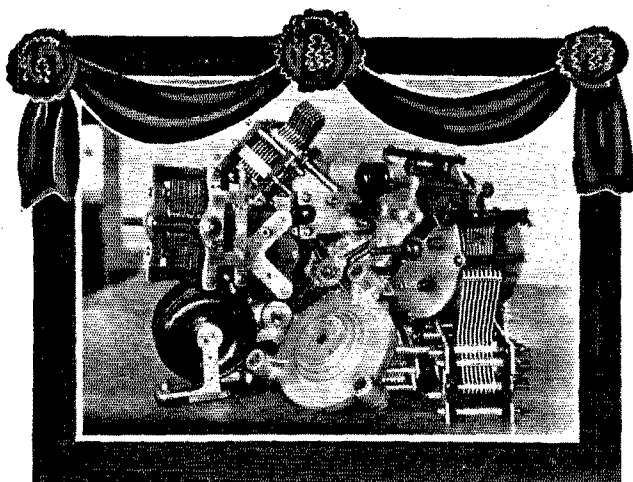

Innovations

"I believe that CARDWELL condensers are about the best thing a fellow can get for high-frequency work, regardless of the new innovations that certain laboratories are putting out."

A pearl of wisdom, worthy of your notice, from a letter written to us recently by a highly competent Amateur.

Pause a moment to contemplate the picture, figures of another day. They were "The Acmes of Perfection," "The Ultimates" of their time. Who mourns their passing?

Innovations—novelties, the making of meaningless changes in something of established worth, eye-catchers, gadgets—are not for CARDWELL unless a genuine advantage can be shown to exist.

The good CARDWELL, "The Standard of Comparison" for more than a decade, is fundamentally right; sturdy, strong and reliable. It will hold down the job for a lifetime. Every feature of its design is time-tested and all materials used are the best for their respective purposes. The CARDWELL condenser represents an ideal compromise, which is the essence of good engineering.

That is why, literally from Pole to Pole—in Equatorial jungles, in the air, on the seven seas—CARDWELL condensers have demonstrated their electrical and mechanical superiority under the most adverse conditions.

You can trust the time-tried CARDWELL!

Send for literature.

The supplier who tries to discourage you, or attempts to substitute, or refuses to supply CARDWELLS, has not your interest at heart. He can get CARDWELLS for you if service means as much to him as a little more profit. Get what you want—insist on CARDWELLS. Order direct from us if your dealer will not supply, or let us tell you where you may buy.

**"THE
STANDARD
OF
COMPARISON"**

**THE ALLEN D. CARDWELL MFG. CORP.
83 PROSPECT STREET • BROOKLYN, NEW YORK**

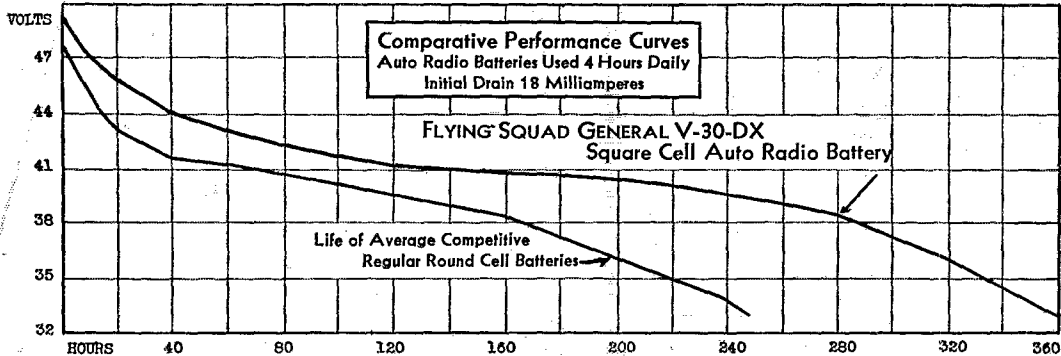

110 Hours of Better Battery Current Free

Hey, 5 Meter Hams! Here's a steam box that's smaller on the outside and bigger on the inside than any other 45 volt "B."

Hook her in your rig and get more life, more DX and the lowest cost for clear, steady plate supply. Square cells instead of round. Less space, more juice. No tar, all Battery.

Direct from the factory at the lowest price ever quoted for a fine engineering job. Designed and used by our own Ham department for copying the "J's," Aussies and Zedders, and gets 'em.

V-30-DX is a regular size 45 volt square cell battery for super performance, priced at \$2.25. See special offer below.

V-30-X is a super heavy duty police type for fixed receivers, public address equipment, 5 meter transmitters and other uses. Priced at \$3.75. See special offer below.

V-30-AA is a midget 45 volt battery for monitors, portables and experimental work.

Small enough for your coat pocket. Weighs 22 ounces. Priced at \$1.50.

P-2-KX is 3 volts for "A" circuit. Weighs 1½ pounds. Priced at 60 cents.

P-2-X is 3 volts for "A" circuit. Weighs 13 ounces. Priced at 35 cents.

These are all newly designed batteries made especially for amateur radio operators and sold direct at factory prices.

Special Introductory Offer:

GENERAL DRY BATTERIES, INC.
 W8GYR, 7100kc.
 13000 Athens Avenue, Cleveland, Ohio
 General Dry Batteries of Canada, Limited
 Toronto, Ontario

General Dry Batteries, Inc., 13000 Athens Ave., Cleveland, Ohio. Ham Department, W8GYR. Enclosed find (postal order, money order, check) for \$..... for which please send me postpaid in the United States:

- V-30-DX "B" Batteries at \$2.25 each
 - V-30-X "B" Batteries at \$3.75 each
 - V-30-AA Midget "B" Batteries at \$1.50 each
 - P-2-KX Midget "A" Batteries at 60c each
 - P-2-X Midget "A" Batteries at 35c each
- ONE Battery FREE with an order for TWO of either of the above. All the above NET

PRINT NAME AND ADDRESS PLAINLY IN MARGIN

QST

Published monthly, as its official organ, by the American Radio Relay League, Inc., at West Hartford, Conn., U. S. A.; Official Organ of the International Amateur Radio Union

devoted entirely to AMATEUR RADIO

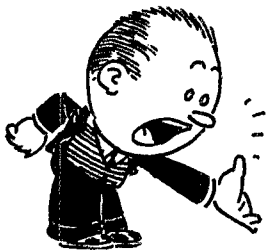

Editorials	7
President Hoover Lauds the Radio Amateur	8
Short-Wave Receiver Selectivity to Match Present Conditions <i>James J. Lamb</i>	9
Building a Low-Cost 1750-Kc. Phone-C.W. Transmitter — Part II <i>George Grammer</i>	21
Central Division Convention (Announcement)	26
W6USA — Amateur Radio at the Olympics <i>W. A. Lippman, Jr., W6SN</i>	27
During the Eclipse	28
The World's Largest List of Calls Heard!	28
Pacific Division Convention (Announcement)	28
A High-Output Amplifier for the Battery Receiver <i>Clinton B. DeSoto</i>	29
An Efficient Battery-Powered Transmitter <i>L. S. Fox, W2AHB</i>	34
Strays	36
Making Practical Use of Grid-Bias Modulation <i>Reuben A. Isberg, W9YAA</i>	37
Results — International Goodwill Tests	41
Amateur Radio Stations <i>W8AXJ, W9AA, W1PH</i>	47
Experimenters' Section CHECKING THE FREQUENCY METER FROM WWV — PHOTRONIC CELL FOR TEMPERATURE CONTROL — GROUNDS — RECEIVER "B" SUPPLY WITHOUT PLATE TRANSFORMER — DIRECT- COUPLED R. F. AMPLIFIER	49
I. A. R. U. News	53
Calls Heard	57
Communications Department	58
Correspondence Department	74
Northwestern Division Convention	90
Hamads and QRAs	91
QST's Index of Advertisers	94

AUGUST
1932

VOLUME XVI
NUMBER 8

Kenneth B. Warner (Secretary, A.R.R.L.), *Editor-in-Chief and Business Manager*; Ross A. Hull, *Associate Editor*; James J. Lamb, *Technical Editor*; George Grammer, *Assistant Technical Editor*; Clark C. Rodimon, *Managing Editor*; David H. Houghton, *Circulation Manager*; F. Cheyney Beekley, *Advertising Manager*; Ursula M. Chamberlain, *Assistant Advertising Manager*.

Editorial and Advertising Offices
38 La Salle Road, West Hartford, Conn.

Subscription rate in United States and Possessions and Canada, \$2.50 per year, postpaid; all other countries, \$3.00 per year, postpaid. Single copies, 25 cents. Foreign remittances should be by international postal or express money order or bank draft negotiable in the U. S. and for an equivalent amount in U. S. funds.

Entered as second-class matter May 29, 1919, at the post office at Hartford, Connecticut, under the Act of March 3, 1879. Acceptance for mailing at special rate of postage provided for in section 1103, Act of October 3, 1917, authorized September 9, 1922. Additional entry at Concord, N. H., authorized February 21, 1929, under the Act of February 28, 1925.

Copyright 1932 by the American Radio Relay League, Inc.
Title registered at United States Patent Office.

The New Tapped Bradleyometer

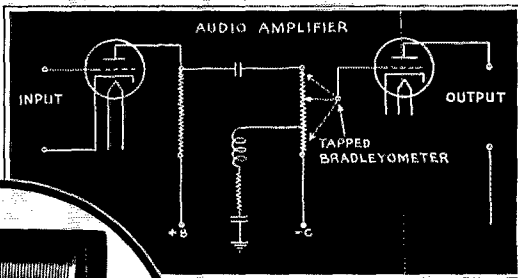
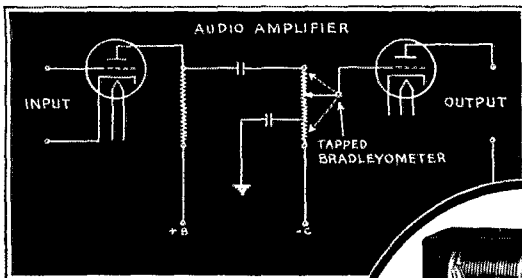

A tap on the resistance element is brought out to a fourth terminal. The network necessary to provide tone correction is usually connected between this tap and the grounded or low potential end of the Bradleyometer. (See above diagrams.)

A single-pole line switch approved by the Underwriters' Laboratories and the Hydro Electric Power Commission of Ontario with a rating of 2 amperes, 125 volts, can be provided within the Bradleyometer and is operated by the regular control knob.

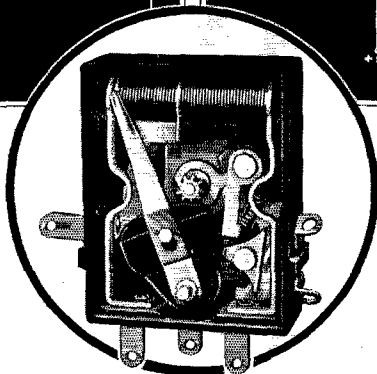

for Automatic Tone Correction with Volume Control

The sound pressure representing the threshold of audibility varies greatly with the frequency and is a great deal higher at low and high frequencies than in the middle register. Therefore, the volume control unit must vary the frequency characteristics of the audio amplifier so that the apparent quality



of reproduction remains the same for all volume control settings. The new tapped Bradleyometer achieves this result in any one of several audio frequency networks and automatically accomplishes tone correction with volume changes. Write for complete data on the new tapped Bradleyometer.

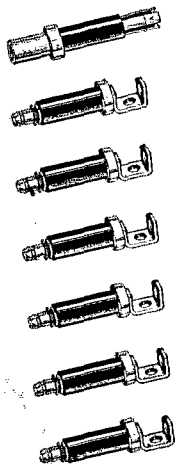

Bradley Suppressors are special solid molded resistors, used by prominent car manufacturers to provide individual resistors for each spark plug and for the common cable to the distributor on radio-equipped cars.

They increase the resistance of the high tension ignition system and minimize the disturbing oscillations in the ignition circuit which interfere with the radio receiver in the car. When used with suitable by-pass condensers in other parts of the circuit, shielded ignition cables are unnecessary. Write for data, today.



Bradleyunit Resistors are made in five sizes, with or without leads, and are R. M. A. color coded for resistance value identification. These solid molded resistors are accurately calibrated and have great mechanical strength.

Bradleyunit Resistors are used by the world's largest radio manufacturers, because their resistance value is stable under varying conditions of load, temperature, and moisture. Don't risk the reputation of your receiver with poor resistors. Get an Allen-Bradley quotation on your next order.

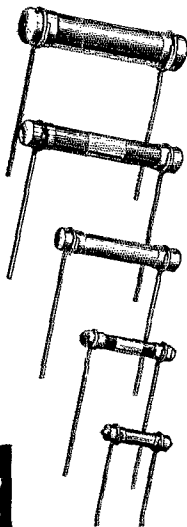

Allen-Bradley Co., 108 W. Greenfield Ave., Milwaukee, Wis.

ALLEN-BRADLEY RESISTORS
Produced by the makers of Allen-Bradley Control Apparatus

Section Communications Managers of THE COMMUNICATIONS DEPARTMENT, A. R. R. L.

Eastern Pennsylvania Maryland-Delaware-District of Columbia Southern New Jersey Western New York Western Pennsylvania	W3GS W3NY W3SM W8DSP W8CUG	ATLANTIC DIVISION Jack Wagenseller Harry Ginsberg Robert Adams, 3rd Don Farrell C. H. Grossarth	210 Main St. 2305 N. Pulaski St. 1302 Keswick Ave. 213 Hickok Ave. R. F. D. 3, Eicher Rd.	Pennsburg Baltimore, Md. Haddon Heights Syracuse Erwinorth, Bellevue, Pa.
Illinois Indiana Kentucky Michigan Ohio Wisconsin	W9APY W9BKJ W9BAZ W8DMS W8BAH W9FSS	CENTRAL DIVISION Fred J. Hinds George Graue J. B. Wathen, III R. J. Stephenson Harry A. Tummonds Harold H. Kurth	3337 Oak Park Blvd. 824 Home Ave. Mockingbird Valley 216 Florence Ave. 2073 West 83th St. 2550 No. 8th St.	Berwyn Fort Wayne Louisville Highland Park Cleveland Milwaukee
North Dakota South Dakota Northern Minnesota Southern Minnesota	W9DGS W9DNS W9DQJ W9AIR	DAKOTA DIVISION Wm. Langer Howard Cashman Palmer Andersen Herman Radloff	402 First Ave., S. 121 N. Spring Ave. Route 1, Box 270 R. 2, Box 15	Jamestown Stoux Falls Duluth Sleepy Eye
Arkansas Louisiana Mississippi Tennessee	W5ABI W5WF W5AZV W4SP	DELTA DIVISION H. E. Velte F. M. Watts, Jr. William G. Bodker James B. Witt	4017 West 10th St. 1716 Park Ave. 208 W. Elm St. 732 N. Fifth Ave.	Little Rock Shreveport Jackson Knoxville
Eastern New York N. Y. C. & Long Island* Northern New Jersey	W2LU W2AZV W2WR	HUDSON DIVISION Robert E. Haight Edward L. Baunach A. G. Wester, Jr.	1080 Helderberg Ave. 7823 10th Ave. 50 Princeton St.	Schenectady Brooklyn Maplewood
Iowa Kansas Missouri Nebraska	W9FFD W9CET W9EYG-HCP W9FAM	MIDWEST DIVISION George D. Hansen J. H. Amis C. R. Cannady Samuel C. Wallace	Box 27 915 Lincoln Ave. 300 Sixth St. Green St.	Salix Topeka Monett Clarks
Connecticut Maine Eastern Massachusetts Western Massachusetts New Hampshire Rhode Island Vermont	W1CTI W1CDX W1ASI W1ASY W1ATJ W1AWE W1BD	NEW ENGLAND DIVISION Frederick Ellis, Jr. John W. Singleton Joseph A. Mullen Earl G. Hewinson V. W. Hodge N. H. Miller Roy Gale	19 Merrill Rd. 16 Mercier St. 33 Cortland St. 227 Main St. 25 Phillips St. 41 Beacon St.	Norwalk Wilton Ashmont Springfield Claremont Providence Barre
Alaska Idaho Montana Oregon Washington	K7PO W7AKZ W7AAT-7QT W7ALO W7RT	NORTHWESTERN DIVISION Richard J. Fox Oscar E. Johnson O. W. Siers Dr. Dolph L. Craig John P. Gruble	Box 301 422 Antone St. 701 First National Bank Bldg. 1921 Atlantic St.	Ketchikan Sandpoint Red Lodge Salem Seattle
Hawaii Nevada Los Angeles Santa Clara Valley East Bay San Francisco Sacramento Valley Arizona Philippines San Diego San Joaquin Valley	K6COG W6EAD W6HT W6AMM W6ZM W6WB W6AXM W6BJF K1A1SL W6EOP W6BVV	PACIFIC DIVISION C. D. Slaten Keston L. Ramsay H. E. Nahmens Bruce Stone S. C. Houston C. F. Bane Paul S. Farrelle Ernest Mendoza I. S. Lizer Harry A. Ambler E. J. Beall	Pearl City 1151 Buena Vista Ave. Box 903 R. 1, Box 311 2523 23rd Ave. 262 Castro St. 1326 P St. 1434 East Madison St. Care Manila Bulletin 4101 Hamilton St. Box 246	Oahu Reno Long Beach San Jose Oakland San Francisco Sacramento Phoenix Manila, P. I. San Diego Newman
North Carolina Virginia West Virginia	W4DW W3AAJ W8HD	ROANOKE DIVISION H. L. Caveness R. N. Eubank C. S. Hoffman, Jr.	State College 2817 Montrose Ave. 126 Washington Ave.	Raleigh Richmond Wheeling
Colorado* Utah-Wyoming	W9BJN W6DFJ	ROCKY MOUNTAIN DIVISION Artie Davis C. R. Miller	2459 South Sherman St. 134 E. 2nd North St.	Denver Provo, Utah
Alabama Eastern Florida Western Florida Georgia-So. Carolina-Cuba- Isle-of-Pines-Porto Rico- Virgin Islands	W4KP W4NN W4MS W4PM	SOUTHEASTERN DIVISION L. B. Elwell Ray Atkinson Edward J. Collins Chas. W. Davis	1066 Waverly St. 329 East First St. 1517 Brainard St. 668 Cooleage Ave., N. E.	Tarrant Jacksonville Pensacola Atlanta
Northern Texas Oklahoma Southern Texas New Mexico	W5RJ W5VQ W3ZC W5AUW	WEST GULF DIVISION Roy Lee Taylor Emil Gisel H. C. Sherrod Jerry Quinn	1614 St. Louis Ave. 1st Baulton Co. 2609 Ave. 094 524 West Coat Ave.	Ft. Worth Fort Sill Galveston Albuquerque
Maritime	VE1DQ	MARITIME DIVISION A. M. Crowell	69 Dublin St.	Halifax, N. S.
Ontario	VE3HB	ONTARIO DIVISION H. W. Bishop	49 Eastman Ave.	London
Quebec	VE2AC	QUEBEC DIVISION Alphy Blais	Box 221	Thetford Mines
Alberta British Columbia	VE4HM VESAL	VANALTA DIVISION C. H. Harris J. K. Cavalsky	10806 125th St. 4868 Blenheim St.	Edmonton Vancouver
Manitoba Saskatchewan	VE4BO VE4EL	PRAIRIE DIVISION John L. Green Wilfred Skafte	115 Furby St. 2040 McTavish St.	Winnipeg Regina

* Officials appointed to act until the membership of the Section choose permanent SCM's by nomination and election.

The American Radio Relay League

DIRECTORS

<i>President</i>	
HIRAM PERCY MAXIM W1AW Drawer 2102, Hartford, Conn.
<i>Vice-President</i>	
CHARLES H. STEWART W3ZS St. David's, Pa.
<i>Canadian General Manager</i>	
ALEX. REID VE2BE 169 Logan Ave., St. Lambert, P. Q.
<i>Atlantic Division</i>	
EUGENE C. WOODRUFF W8CMP 234 W. Fairmount Ave., State College, Pa.
<i>Central Division</i>	
LOREN G. WINDOM W8GZ-W8ZG 1375 Franklin Ave., Columbus, Ohio
<i>Dakota Division</i>	
LAWRENCE E. LINDSMITH W9GKO 1055-85th Ave. W., Duluth, Minn.
<i>Delta Division</i>	
M. M. HILL W5EB P.O. Box 274, Natchitoches, La.
<i>Hudson Division</i>	
A. LAFAYETTE WALSH W2BW 220 West 42d St., New York City
<i>Midwest Division</i>	
H. W. KERR W9DZW-W9GP Little Sioux, Iowa
<i>New England Division</i>	
G. W. BAILEY W1KH 74 Webster Road, Weston, Mass.
<i>Northwestern Division</i>	
K. W. WEINGARTEN W7BG 3219 No. 24th St., Tacoma, Wash.
<i>Pacific Division</i>	
CLAIR FOSTER W6HM Carmel, Calif.
<i>Roadside Division</i>	
W. TREDWAY GRAVELY W3BZ Box 245, Dauville, Va.
<i>Rocky Mountain Division</i>	
RUSSELL J. ANDREWS W9AAB 169 So. Ogden St., Denver, Colo.
<i>Southeastern Division</i>	
J. C. HAGLER, JR. W4SS 2424 McDowell St., Augusta, Ga.
<i>West Gulf Division</i>	
FRANK M. CORLETT W5ZC 2515 Catherine St., Dallas, Tex.

• THE AMERICAN RADIO RELAY LEAGUE, INC., is a non-commercial association of radio amateurs, bonded for the promotion of interest in amateur radio communication and experimentation, for the relaying of messages by radio, for the advancement of the radio art and of the public welfare, for the representation of the radio amateur in legislative matters, and for the maintenance of fraternalism and a high standard of conduct.

***** It is an incorporated association without capital stock, chartered under the laws of Connecticut. Its affairs are governed by a Board of Directors, elected every two years by the general membership. The officers are elected or appointed by the Directors. The League is non-commercial and no one commercially engaged in the manufacture, sale or rental of radio apparatus is eligible to membership on its board.

***** "Of, by and for the amateur," it numbers within its ranks practically every worth-while amateur in the world and has a history of glorious achievement as the standard-bearer in amateur affairs.

***** Inquiries regarding membership are solicited. A bona fide interest in amateur radio is the only essential qualification; ownership of a transmitting station and knowledge of the code are not prerequisites. Correspondence should be addressed to the Secretary.

OFFICERS

<i>President</i> HIRAM PERCY MAXIM, W1AW Hartford, Connecticut
<i>Vice-President</i> CHARLES H. STEWART, W3ZS St. David's, Pennsylvania
<i>Secretary</i> KENNETH B. WARNER, W1EH West Hartford, Connecticut
<i>Treasurer</i> ARTHUR A. HEBERT, W1ES West Hartford, Connecticut
<i>Communications Mgr.</i> F. EDWARD HANDY, W1BDI West Hartford, Connecticut
<i>General Counsel</i> PAUL M. SEGAL, W3EEA 1010 Shoreham Building, Washington, D. C.

Address all general correspondence to the executive headquarters at West Hartford, Connecticut



EDITORIALS



FAR be it from us to suggest the conversion of amateur radio into a body of talebearers and informers. There is one possible case, however, which we think calls for a handsome job of informing — far, fast and furiously.

Call Thievery

Simple self-preservation seems to require it. We have in mind the moronic business of bootlegging calls, of which there has recently been a mild epidemic amongst the feather-brained contingent of our fraternity. One trouble is that some fellows, on learning the identity of the dumbwit who has been illegally making use of their call, do not feel it is particularly necessary to report full details to the Supervisor — apparently in the belief that even if trouble comes up later the call-bootlegger will be the only one held responsible. Wrong, OM — and there's some sort of a legal name for it. We heard just the other day of a chap whose call had been borrowed without his "permission" and who told the borrower that he shouldn't do that and that he didn't like it — but let it go at that. The "borrower" got caught operating outside the bands and now they're both in trouble.

Call-stealing is illegal, reprehensible, demoralizing, moronic. You cannot "permit" another to use your call. If you know of another using your call, you should report him to the Supervisor in the same direct manner that you'd report any other kind of a thief to the police.

THERE seems to be some misunderstanding about what the regulations permit in the way of tone-modulated telegraphy. Perhaps it's a good idea to go over the subject here.

Modulated Telegraphy

We start out by stating that our regulations contemplate that ultimately the only amateur signal shall be a pure d.c. one. "Adequately filtered direct-current power supply" is spoken of, and all the amateur bands are open to pure d.c. c.w. telegraphy, which is what is meant by the "type A-1 emission" spoken of.

There is another kind of c.w. telegraphy called "type A-2 emission," which is c.w. modulated at an audible frequency. When stations in the marine service use intentional modulation, so their signals may be received on crystal detectors or on old-fashioned non-oscillating regenerative receivers, that is type A-2 emission. In that form it is not permitted amateurs. However, a signal with any supply modulation on it — is of type A-2; and so we find the amateur regula-

tions stating that in addition to pure d.c., amateurs may also use "type A-2 emission to the extent hereinafter provided (see paragraph 382)." The right to employ modulated telegraphy is therefore found to be restricted to the terms of paragraph 382. Let us see what it says.

We find that it calls for either (1) adequately filtered direct-current power supply or (2) arrangements that produce equivalent effects to minimize frequency modulation and prevent the emission of broad signals. Either one, but one or the other. Inventive ingenuity is not stifled; a ham doesn't have to use d.c. if he is clever enough to devise an alternative arrangement that produces a signal just as sharp as d.c. In general terms, however, the burden of proof is upon him, except in one case. The regulations specify one case, for the guidance of Supervisors, that is okeh: "For example," they state, "the use of unrectified alternating-current power supply for the amplifier stages of oscillator-amplifier transmitters, so arranged that variations in plate voltage of this supply can not affect the frequency of the oscillator, will be considered satisfactory." This arrangement concerns the amplifier stages only and presupposes the use of pure d.c. on the oscillator itself and on the practically-essential buffer stage.

This exception to the use of pure d.c. was not designed to humor in us the desire for intentional tone-modulation or anything approaching i.c.w. On the contrary it may be said that modulated telegraphy is permitted only to the extent that it is the accidental result of an "economy program." It happens that we were present when this regulation was first phrased some years ago and we know what was contemplated. Rectifiers and filters for the higher powers costing a great deal of money, we insisted that strictly from the economic viewpoint it was desirable to permit the continuance of "straight a.c.," temporarily at least, if the transmitter was an oscillator-buffer-amplifier or was otherwise so constructed and adjusted that it would cause only amplitude modulation and not frequency modulation or "wobulation." The regulation was designed to save us money by letting us use the 60-cycle or 50-cycle or 25-cycle juice if we had a transmitter that would stand it without gumming up the ether, without obliging us to put out *muchos pesetas* for high-voltage condensers and chokes.

What the regulations do *not* contemplate is the deliberate application of modulation to broaden the signal, give it a characteristic tone, etc. Our

standard is the p.d.c. signal and we deviate from it only to the extent stated. The use of gadgets to put intentional tone-modulation on a good pure signal is not permitted. The regulations do not specify the frequency of the a.c. that may be used under the special cases, but it is to be said that ordinary commercial a.c. is contemplated. The thought is that, in the proper sort of sending set, there will be little or no wobulation but only side-bands close in to the carrier — removed by only 60 cycles, say — which is fair enough. The use of 900-cycle alternators, etc., when there is d.c. or even 60-cycle juice available, is, in our opinion, greatly to be discouraged.

We speak above of the amateur bands up to 14,400 kc. We haven't room in those bands for broad signals. The pure signal, too, is far and away the best performer. However, on the frequencies higher than 28,000 kc., particularly in the "5-meter" band, there is a different story. Our best results there, at this stage of the art, are with super-regenerative receivers, which require a modulated signal for effective work with simple transmitters. That is why we have asked the Commission to modify our regulations to permit intentional tone-modulation on frequencies above 28,000 kc. But ND on our DX and traffic bands!

•By the terms of an amendment recently made to the Radio Act, operator licenses in future will be issued only to citizens of the United States. We understand that existing operator licenses held by aliens will be permitted to continue for their stated terms but that they won't be renewed.

This change originated as a measure to help the unemployment situation — confining commercial

radio jobs to U. S. citizens — which is, it seems, good national policy. Representations of A.R.R.L. that it was not necessary to apply the policy to amateur radio, where there are no jobs at stake, were without avail. We regret that we must lose from the air the comradeship of some good lads, true enough amateurs, but not citizens. That, it seems, is to be the policy of our country.

We just heard a hot fast one, and it's supposed to be true, too. In a certain New England movie theatre, one of the typical films of the day was being shown. It was a nice soupy love story and the audience sat on the edge of its chairs, sticky hand in sticky hand, as the action moved rapidly to the grand climax. In a thrilling bit of dialog, the beautiful heroine was about to give all; the fatal moment impended. Then, R9 through the theatre, and right from the midst of the love-nest scene, rang the raucous tones of a typical *genus americanus hamus phonus*, intoning the following, to wit: "Hello, CQ! Hello, hello. Double-you one blub-blub-blub calling CQ. Hello, CQ! . . ." It drowned out the heroine completely, it shattered the illusion, it spoiled the show.

Talkie technicians summonsed by a frantic management found the trouble the next day. Something had gone squiffy with the bias on the loud-speaker amplifiers and they were acting as rectifiers of a signal picked up by the wiring from a ham station a block or so away. Interference on receiving apparatus of modern design? Not on your life! We call it the rebroadcasting of an amateur station for entertainment purposes without his consent, in violation of paragraph so-and-so of the regs!

K. B. W.

President Hoover Lauds the Radio Amateur

From a letter read by Dr. Julius Klein before the Atlantic Division Convention at Washington, June 18th

Please convey to my friends of the Atlantic Division of the American Radio Relay League my cordial greetings and good wishes on this occasion of their annual gathering. As you know, I have for many years been keenly interested in their constant efforts in productive experimentation in this highly important field. Their keenly intelligent curiosity and ambition has been a major factor in the truly miraculous development of radio during the past decade. Improvements of high significance have thus been evolved and the radio art in its broader aspects owes much to their inquiring spirit and tireless zeal. They have contributed materially to the widening of our horizons, the broadening of our vision, by thus promoting and strengthening the community of interest and better understanding throughout the country. Yours faithfully,

HERBERT HOOVER

Short-Wave Receiver Selectivity to Match Present Conditions

Constructional and Operating Features of the Single-Signal Superhet

By James J. Lamb, Technical Editor

PERHAPS those of *QST*'s readers who had the perseverance to wade through the previous article on things wrong with our high-frequency receivers, and on receiver selectivity generally,¹ will begin this, its sequel, with justifiable foreboding. They may be apprehensive, just a bit suspicious that such a more or less involved discussion must needs beget a fearfully monstrous machine to put those abstractions to work. Chuck that illusion right at the start. The rig that does the business is nowhere near as entangling as the principles on which it is based. The burden of this piece is a practical "how-to-do-it," with some "why" and a little "how-not-to-do-it" thrown in for insurance. The aim here is to show how one job of receiver construction has succeeded in overcoming the basic defects of the receivers we have been using, to give the essentials of its building and adjustment, and to suggest such diversifications and modifications for future development as experience with this example have shown to be possible or advisable. The fact that, as far as we know, this receiver is the first model of its type, containing a first-time combination of several unusual features, makes inevitable a process of evolution. Undoubtedly it will have successors little resembling (and perhaps disowning) their parent. Let that be so. For the present it is satisfaction enough that a way has been found to make a sizeable dent in the particularly acute QRM afflicting us in these piping days of amateur radio, what with some 30,000 of us at it now and more joining up every day, and more than double the effective width of our bands at the same time.

Many of these thousands are putting clean, steady signals on the air. Transmitter development has not been dormant. But the receivers aren't able to do them justice. Actually, most of the receivers in use to-day are essentially of the

same breed as the autodynes of fifteen years ago, differing basically from the original "detector and one-step" only in the stage of r.f. that has been added to the front end and, sometimes, the audio filter that has been tacked on behind. Except for their occasional post-detector audio selectivity for c.w., such ability as they have for discriminating between signals could be duplicated

by any well-constructed and carefully operated job of the low-loss era, the "two-circuit" (modern "pre-selection") tuners of that earlier day just about breaking even in point of selectivity with the 1932 tuned r.f. jobs. (They had to be that good. Ever get tangled in a little spark QRM?) Two sets of audio beat notes for every carrier, unstable oscillating detectors that block on strong signals, the rotten signal getting through with undeserved preferment to steady d.c., background

racket, QRN — all as of yore.

The root of these faults in performance, as was pointed out in the June article, is shortage of effective r.f. selectivity in combination with lack of stability, oscillator stability in particular. The gross result of these deficiencies is that our bands sound as if there were at least twice as many c.w. signals as there really are. When the receiver is tuned across the bedlam, each signal pops up on either side of zero beat. And when we tune in a signal on the "north" side of its zero beat, likely as not we find ourselves afflicted with an interfering beat-note from the "south" side of another (complex to visualize but easy to recognize). Hence, the first step toward multiplying ham-band utility by two and toward single-signal c.w. selectivity: Make each signal give but one set of audio beat notes, all on the one side of zero beat; get rid of the audio-frequency image. Then the next step: Narrow down the response on that one side until it becomes but a few-cycle slice out of any c.w. band. The first step can be realized to a considerable degree

The method of reception disclosed in this article establishes a new standard in amateur receiver performance, bringing it to par with crystal-controlled transmission. The receiver described is capable of thoroughly useful selectivity that not only greatly increases the effective width of our bands but also places the deserved high premium on the good steady signal, and warts for warts, puts the unsteady signal in the background where it belongs. Adoption of this kind of receiver by the advanced amateurs for whom it has been designed will do much to discourage the rotten note.

— EDITOR.

¹ Lamb, "What's Wrong With Our C. W. Receivers?", *QST*, June, 1932.

with no more selectivity than that possessed by superhets of standard design *in combination with the off-set tuning scheme suggested in the previous article.* The second is realized by augmenting this selectivity with a sharp filter. Of course there must also be stability, flexibility in control and kindred features not common to other receivers of our acquaintance.

THE ESSENTIAL ELEMENTS

It has been intimated that the receiver must be a superhet and, unless the future brings forth developments to change the situation, that is so.

This is not really undesirable, however. Despite prevalent impressions to the contrary, for ordinary service a high-frequency receiver of the superheterodyne type, when given the consideration that it deserves, can be made less noisy, more sensitive and far more selective than any tuned radio-frequency receiver of equivalent cost. When extraordinary service is demanded, as it must be for r.f. selectivity measurable in hundreds of cycles, superhet reception becomes the only recourse. Imagine the number

of tuned circuits, tubes and plug-in coils that would be necessary for just one band in a t.r.f. set that would give the selectivity obtainable with a two-stage i.f. superhet — to say nothing of the ganging nightmare, inevitable instability and cost. Where high selectivity is the quest, then, *it must be obtained in an r.f. amplifier whose tuning can be peaked and remain fixed.* That's the i.f. amplifier of a superhet. To make such a fixed-tune amplifier useful over a wide signal-frequency range, there has to be a frequency conversion. Every signal must be changed to the intermediate frequency. That's taken care of by the high-frequency oscillator and first detector of the superhet. In the first detector the incoming signal is beat against (heterodyned by) the output of the oscillator so that the difference between their two frequencies is the frequency to which our fixed intermediate amplifier is tuned and into which amplifier the detector output is fed. The frequency of the local oscillator may be either intermediate-frequency higher or i.f. lower than the signal frequency. It is in this that the superhet differs from other kinds of receivers.

The complete chain of events is more vividly shown in the picture of Fig. 1, an attempt to portray graphically the treatment a c.w. signal would receive between antenna and output of an ideally ultra-selective superhet. Of course all the links are not absolutely essential to every receiver. The stars mark the ones that constitute the bare minimum. The picture is largely self-explanatory, with the possible exception of the pre-selection and high-frequency image elimination of "B." Because many high-frequency superhet designs seem to ignore this feature — and suffer image trouble as a consequence — it merits explanation.

Since the intermediate-frequency is the difference between the oscillator and signal frequencies, and since the oscillator may be either i.f. higher or i.f. lower than the signal frequency, *it is possible to get the same intermediate frequency from two different signal frequencies at the same time.* An illustration: The i.f. amplifier's resonance frequency is 525 kc. The ham signal being received is on 7100 kc. The oscillator is tuned 525 kc. higher or to 7625 kc., beating with the signal

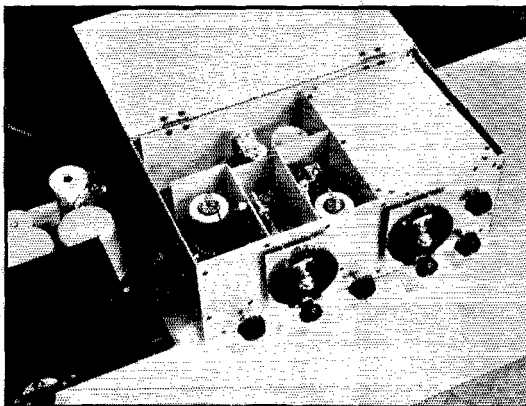

HIGH-FREQUENCY CIRCUITS AND THE I.F. FILTER ARE CONTAINED IN ONE UNIT, SHOWN HERE COUPLED TO A TUNED R.F. BROADCAST RECEIVER (LEFT) DOING DUTY AS THE I.F. AMPLIFIER

The aluminum cabinet is 17 $\frac{3}{4}$ inches wide by 9 $\frac{3}{4}$ inches deep by 7 inches high, inside dimensions. The closed compartment at the right contains the high-frequency oscillator.

to give the intermediate frequency. The antenna is coupled right into the first detector, with but one tuned circuit between it and outdoors. Parked on 8150 kc. and banging away at his A, B, C's is a high-power commercial — and his signals rattle the 'phones "R9 plus." How come? The oscillator frequency is exactly 525 kc. lower than his frequency and there isn't enough selectivity ahead of the first detector to keep his signal from getting in along with the ham signal to which the receiver is supposed to be tuned. That's radio-frequency image interference.² The cure? Put enough selectivity ahead of the first detector to keep the r.f. image response down below the danger line. Add a pre-selector. For convenience in coupling and to give a little additional gain, this pre-selector can be simply a tuned r.f. stage. This element makes other improvements, too. It improves the signal-noise ratio by keeping out background and

² Not to be confused with this is the pseudo-image interference caused by two incoming signals that heterodyne each other to produce intermediate frequency, even with the oscillator switched off. It also is eliminated by pre-selection.

static of the lower r.f. kind that might be passed readily to the i.f. amplifier if it once got to the detector; it prevents radiation of the high-frequency oscillator output via the antenna; with c.w. reception it keeps stray output of the i.f. beating oscillator from getting into the i.f. amplifier through the first detector; and, of course, it adds its bit to receiver sensitivity and all-around selectivity. Which brings us to the block diagram of Fig. 2 and the lineup of the actual receiver.

As shown by the division of the diagram into two sections, the receiver is built in two units. The one at the right, whose constructional details are given in this article, contains the high-frequency circuits and the i.f. filter. The intermediate-frequency and audio unit at the left may use a h.c. receiver chassis as a foundation, as noted, or may be a specially built unit such as will be described in a subsequent article. These two units mount one above the other in the same relay rack that holds the Class B audio amplifier-modulator described in December, 1931 *QST*, and other permanent laboratory equipment. Both superhet units go behind one common panel and for that reason the illustrations of this article show the controls temporarily mounted. The circled letters tie in with the links of Fig. 1, correlating the receiver elements with the processing described in that figure. The operating controls of the receiver are shown connected by the dash-lines to the elements with which they are associated. A mental picture of the complete receiver in this form will aid considerably in following the detailed description of the elements that go to make it up and will clarify the operating procedure.

THE HIGH-FREQUENCY CIRCUITS

The three receiver elements that have to deal with high frequency (as contrasted to intermediate and audio frequencies) are the r.f. pre-selector stage, the first detector and the h.f. oscillator. The r.f. stage and first detector input circuits are tuned to the incoming signal frequency and the oscillator to a frequency that is higher or lower than the signal by an amount equal to the intermediate frequency. Designing the tuned circuits for the r.f. and first detector stages is therefore identically the same as for the r.f. and detector of an ordinary receiver. In fact the coils and tuning condensers can be borrowed intact, as they have been in this case. Referring to the circuit diagram of Fig. 3, and the notated top and bottom views, the arrangement of the pre-r.f. and first detector stages is recognizable as little different from that of the r.f. and regenerative-de-

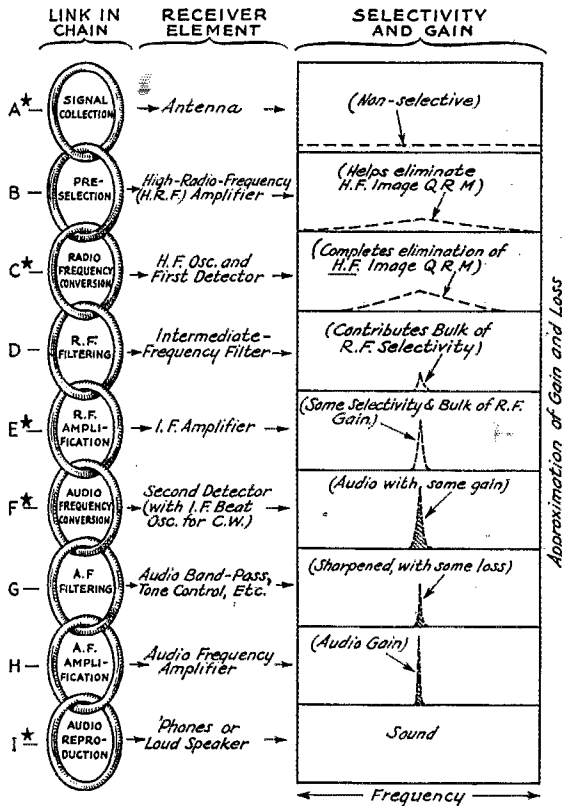

FIG. 1 — THE PROCESSING CHAIN OF SUPER-HETERODYNE RECEPTION

detector stages of the National SW3 chassis³ which serves as their foundation. Tube sockets, coils, tuning condensers, are in their original positions. A few circuit changes, provision for r.f. gain control, resistor-capacitance circuit isolation, substitution of six-prong sockets and tube shields for the 58's,⁴ the addition of some helpful shielding, constitute the differences.

The 3/32-inch thick panel fronting the whole of the unit is 17 3/4 inches wide by 7 inches high. Machine screws fasten the 9 1/2-inch by 9-inch r.f.-detector base-plate to it 2 inches from the bottom and 5/8-inch in from its left edge. The base-plate has a 1/2-inch turned-down edge all

³ Millen, "A Combination A.C. and D.C. Amateur-Band Receiver," *QST*, Sept., 1931.

⁴ Characteristics on page 35, June *QST*, and socket connections on page 30, July *QST*.

around which serves for its fastening to the panel and to the left side of the oscillator compartment, against which it butts. Inter-stage shielding is provided by the semi-baffles which measure 6 inches back from the panel, 4½ high and 3¼ inches wide. These are also of 3/32-inch thick aluminum and are fastened to the base-

Since band-spread coils of the type used require seven terminals (the tuning condenser is connected across only part of the secondary), each has its individual grid lead with a clip for connection to the tube. To accommodate coils of the non-band-spread type, the grid leads indicated by the dotted lines in Fig. 3, and shown

fastened to the dummy plugs in the photograph, are brought out from the coil-socket terminals that connect to the condenser stators. When not in use they are kept out of mischief by the small pieces of bakelite rod conveniently mounted on the inner sides of the compartment shields. The special six-terminal coil sockets are mounted on 1½-inch square platforms, each elevated ⅞-inch above the base-plate on four U-shaped strips of brass. Leads from these sockets are taken to their terminations by the most direct routes. The antenna con-

nections are made to a pair of G.R. jacks mounted on a small strip of bakelite at the left-front on the upper deck, in preference to bringing them in beneath and from the back. Neither terminal grounds on the shielding, permitting doublet antenna connection. The idea is that the antenna is supposed to have coupling to the grid of the pre-r.f. stage only — and precautions that prevent other couplings are in order.

Coil specifications for the amateur bands are given in Table I, the coils for both r.f. and first detector being identical. If coils for a National SW3, SW5 or SW58 happen to be available they can be used, although it is recommended that the grid leak and condenser of the detector coils be either shorted or removed and a jumper substituted. Plate detection, not grid detection, is wanted in this stage. The small adjustable compression type condensers (CT), integral with the detector coils, are handy for spotting the bands in the middle range of the dial scale.

In order to reduce unwanted coupling through grid-return circuits and, at the same time, to adapt the circuit to automatic gain control (as used for 'phone in the complete receiver), the blocking condensers C_5 and C_6 are connected between the lower ends of the grid coils and the grounded rotors of the tuning condensers. Isolating resistors R_1 and R_4 provide the desired filtering, their common connection being brought out to the terminal marked "—C." For manual gain control, this terminal is grounded, as

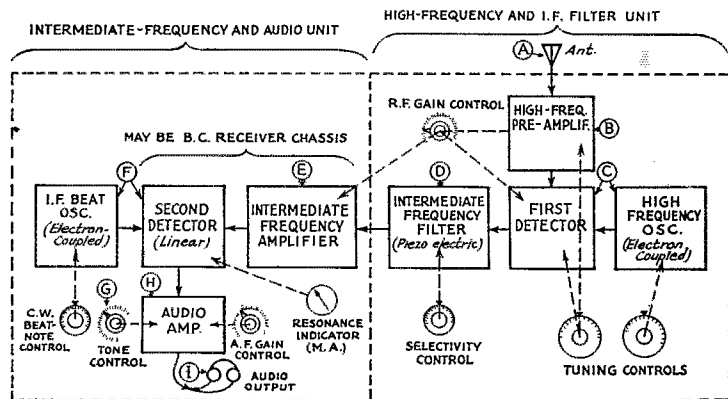

FIG. 2 — BLOCK DIAGRAM OF THE ESSENTIAL ELEMENTS OF THE SINGLE-SIGNAL SUPERHET SHOWING HOW THEY ARE RELATED AND CONTROLLED

The circled letters tie in with the chain of Fig. 1.

plate and panel but not at the top or sides. This may seem like a half-way measure, but it was deemed advisable to use this semi-baffle type of shielding rather than to risk common couplings through the imperfectly grounded top and probably noisy contacts at the sides. The effectiveness of the shielding, freedom from contact noise and lack of instability have proven the idea to be justifiable. The rear end of the tuning condenser alley is blocked off by the 3½-inch high by 4-inch wide aluminum baffle-plate which is fastened at the bottom only. It should be noted that ¼-inch square brass pieces, drilled and tapped for 6-32 screws, are used for fastening these above-deck shields and are used generally in the assembly of the unit. This type of construction is not only more sturdy than that resulting when screws and nuts are used but is also a time-saver where frequent assembly and dis-assembly are inevitable in the fitting process.

Not to be overlooked is the 8¼- by 2-inch baffle running front to back on the underside, isolating the pre-r.f. and first detector circuits down there. It is also fastened by the tapped brass-rod method. This shielding, together with the r.f. filtering in the grid and plate circuits, is unquestionably responsible in considerable measure for the notably noise-free performance of the receiver. It demonstrates as erroneous the belief that r.f. amplification ahead of the first detector in a high-frequency superhet must make the thing noisy.

indicated, and connected to the moving contact of the variable resistor R_{11} . The other terminal of this resistor connects to the cathodes through the resistors R_2 and R_5 , which cathode resistors provide optimum bias for maximum sensitivity with the gain control in the full-on position.

The value of 5000 ohms specified for the first-detector cathode resistor has been found more satisfactory than other values tried. This size resistor, in combination with the low screen-grid voltage (22 volts or a little less) seems to provide greatest first-detector sensitivity.⁵ The resistor R_{10} in the gain-control circuit is simply a bleeder to give complete cut-off of sensitivity by maintaining a minimum flow of current through the gain-control circuit. Connections to this circuit are shown in dotted lines because it is external to the high-frequency unit, being actually contained in the i.f. unit (or b.c. receiver chassis used as such).

Screen-grid resistors R_2 and R_5 serve both for filtering and for providing good screen-grid voltage regulation, compensating for the tendency for the screen-to-cathode voltage to change when the control-grid bias is varied by gain-control resistor R_{11} . Although these resistors and those in the grid return circuits might be omitted, their presence contributes worthy improvements in

⁵ Cf. Chinn, "A High-Frequency Converter," *QST*, June, 1931.

receiver operation. The same applies to the high-frequency chokes RFC_1 .

In mounting these resistors and chokes, especially the terminals that connect to supply leads, small scraps of 1/16-inch bakelite or fiber with soldering lugs riveted to them are placed as may be convenient and fastened by machine screws with thick washers to space them from the base-plate. The same gadgets are used for heater supply and other external connections that are usually awkward to make. A batch of them can be made up in a few minutes with no more than bakelite or fiber scrap and some brass or copper rivets for materials.

In contrast to usual practice in high-frequency superhets, inductive coupling between the oscillator output and grid circuit of the first detector is utilized successfully in this receiver. This is made completely satisfactory by the

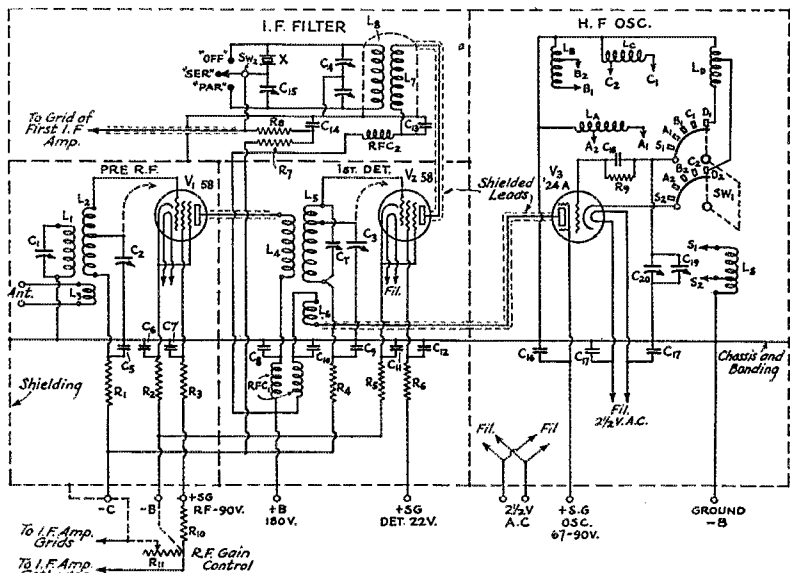

FIG. 3—THE CIRCUIT DIAGRAM OF THE HIGH-FREQUENCY AND I. F. FILTER UNIT

L_1, L_2, L_3 —Normal primary, secondary and antenna windings of National band-spread coils for r.f. stage. See Table I.

L_4, L_5, L_6 —Same as above for detector stage. See Table I.

L_7, L_8 —I. f. filter input transformer. See text for details.

$L_9, L_{10}, L_{11}, L_{12}, L_{13}$ —Oscillator coils. See Table II.

C_1 —Antenna trimmer condenser, 50- μ fd. midget.

C_2, C_3 —Ganged 100- μ fd. variable condensers. (Two National Type ST-100 with insulating coupling, or two-gang National Type 2 SE-100 or Hammarlund MCD-140 M).

C_4 —2 to 35- μ fd. adjustable condenser, one in each detector coil form. (Hammarlund EC-35).

C_5 —Double-section filter tuning condenser (selectivity control), 140- μ fd. per section. (Hammarlund MCD-140 M).

C_6 to C_{17} , inclusive—0.01- μ fd. mica bypass condensers.

C_{18} —250- μ fd. mica grid condenser.

C_{19} —Oscillator padding condenser, 200- μ fd. midget. (Hammarlund MC-200 M).

C_{20} —Oscillator tuning condenser, 3- μ fd. min., 20- μ fd. max. Midget type with fitted front and rear bearings. (Hammarlund MC-20 M Special).

R_1, R_4, R_7 —Grid circuit isolating resistors, 250,000-ohm 1-watt.

R_2 —Pre-r.f. cathode resistor, 300-ohm 1-watt.

R_3 —Pre-r.f. screen-grid resistor, 5000-ohm 1-watt.

R_5 —Detector cathode resistor, 5000-ohm 1-watt.

R_6 —Detector screen-grid resistor, 50,000-ohm 1-watt.

R_8 —Grid coupling resistor for first I.f. stage, 1-megohm.

R_9 —Oscillator grid leak, 100,000-ohm 1-watt metallized type.

R_{10} —Bleeder resistor for gain control circuit, 100,000-ohm 1-watt.

R_{11} —Variable gain-control resistor, 2000-ohm tapered type.

SW_1 —Oscillator coil switch, two-circuit five-position. Mounted on National coil-switching panel.

SW_2 —Filter switch, single-pole double-throw miniature knife type or single-circuit three-position rotary type.

RFC_1 —High-frequency r.f. chokes (National Type 100).

RFC_2 —Intermediate-frequency choke (Hammarlund shielded Type SPC).

All circuit "grounds" to chassis are bonded by No. 18 copper wire soldered to each terminal.

peculiar stability of the electron-coupled oscillator — its relative imperviousness to frequency change with variations in its load circuit tuning. The whys and wherefores of this have been covered in a previous article⁶ and need not be repeated here. The coupling is provided by L_6 , the normal tickler winding of the plug-in detector coil, connected for series plate feed to the oscillator. The shielded lead between the oscillator plate and coupling coil is very short, as shown in the top view, running through the side of the oscillator compartment directly from oscillator plate to coil-socket terminal. This lead (and other shielded leads throughout the receiver) is a piece of Belden shielded cable such as that used for ignition systems, etc. It should have low capacity between conductor and shield, and the shield should make positive connection with the chassis.

THE HIGH-FREQUENCY OSCILLATOR

As we have said before, and it will bear repeating, the ability of this receiver to make practical use of its high selectivity is completely dependent

TABLE I
PRE-R.F. AND DETECTOR COILS

	Band			
	1750-kc.	3500-kc.	7000-kc.	14-mc.
L_1 and L_4^* Turns Size wire	40 34 d.s.c.	22 30 d.s.c.	16 34 d.s.c.	8 34 d.s.c.
L_2 and L_3 Turns Length Size wire Tap, turns from ground end.	64 1 $\frac{1}{16}$ " 30 enam. No tap†	35 1 $\frac{7}{16}$ " 22 enam. 16 $\frac{3}{4}$	21 1 $\frac{1}{16}$ " 22 enam. 5 $\frac{3}{4}$	10 1 $\frac{1}{2}$ " 22 enam. 2 $\frac{1}{4}$
L_5 and L_6^\ddagger Turns Size wire	6 34 d.s.c.	4 34 d.s.c.	4 34 d.s.c.	3 34 d.s.c.

* Wound between turns of L_2 and L_3 , starting from bottom.

† Wound in slot at bottom of form.

‡ Tuning condenser across whole coil.

§ Six-prong coil forms, 1 $\frac{1}{4}$ -inch diameter. For further details, see pages 13 and 14, *QST*, Sept., 1931.

⁶ Lamb, "Stabilizing Superheterodyne Performance," *QST*, April, 1932.

on the stability of the received signal and of the high-frequency oscillator. Selectivity and stability, stability and selectivity — they are as closely identified with each other as ham and eggs. Therefore every reasonable means to the end of making the oscillator stability duplicate that

of the best ham signals is worth pursuing. The circuit, rugged parts, sturdy mechanical construction, all are to be sought out and applied as rigorously as we know how. No claim is made that the ultimate has been attained in this particular job. But its performance marks it as a considerable advance in the right direction.

The circuit is the electron-coupled type adapted for indirectly heated tubes as described in April *QST*. The first trial of this

circuit in a hamband superhet immediately demonstrated that it was head and shoulders above every other that had been used in our experiments *insofar as electrical stability was concerned*. The frequency would stay put remarkably with usual voltage variations and with tuning of the coupled load circuit. But its own tuning had to be precisely adjustable and had to be unaffected by mechanical instability. Therefore, coil mounting, condenser bearings, mechanical coupling between dial and condenser, and even the dial itself — all these mechanical things became responsible for stability rather than the purely electrical properties of the circuit. Even temperature effects that could be tolerantly ignored in most receivers began to assume importance. Hence the leaning to mechanical considerations in this oscillator. The schematic diagram and specifications for parts used are given in Fig. 3, while the mechanical construction is illustrated in the plan view.

The oscillator compartment is completely enclosed and is built of 3/32-inch aluminum sheet. Its inside dimensions are 5 $\frac{3}{4}$ inches high by 7 inches wide by 9 $\frac{1}{4}$ inches deep. The overall height of the sheet forming the sides is 6 $\frac{3}{4}$ inches so that there is a sub-base space of 1-inch depth. The two sides and back are formed by bending a single piece, although three separate pieces could be used just as well. The panel serves as the front. The convenient $\frac{1}{4}$ -inch square brass rod, drilled and tapped for 6-32 machine screws, is used for fastening at the corners and for supporting the base-plate and

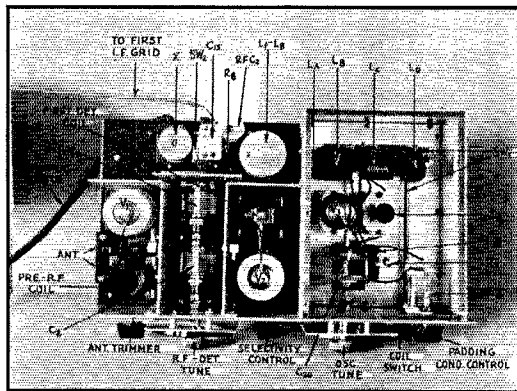

THE TOP PLAN, SHOWING THE ABOVE-DECK ARRANGEMENT IN DETAIL

Adequate shielding contributes to stability and freedom from noise.

the cover which measures $7\frac{3}{8}$ by $9\frac{1}{8}$ inches. The lower edge of the sub-base compartment is cut away sufficiently along its right and rear sides to leave a small gap between it and the bottom of the outer case, but the left edge is fastened to the bottom, having a piece of drilled and tapped $\frac{1}{4}$ -inch square brass rod for fastening. The bottom view of the chassis shows this.

Within the compartment, the tuning condenser C_{20} is mounted on a small bakelite platform supported from the floor by four legs made of the quarter-inch brass rod, fastened to the platform and bottom by 6-32 machine screws threaded into the drilled and tapped ends of the legs. A flexible coupling is used between the condenser shaft and dial drive. The grid leak and condenser are carried on this same mounting by a small brass angle. The UY-type tube socket and UX-type coil socket are supported from the bottom by the spacing bushings that come with the Hammarlund Isolantite sockets, through which run the fastening screws. The National coil and switch panel is held in place rigidly by screws through the bottom and left side, into the 6-32 inserts provided in the R39 panel. The front-panel bearing for the quarter-inch round switch shaft was obtained from a midget condenser that had served its time. Alternatively, the removable threaded sleeve from a telephone jack that is made that way can be used. The hole just fits a quarter-inch shaft. The shaft itself is 8 inches long. The 200- μ fd. variable padding condenser C_{19} is mounted on the panel to the right of the tuning condenser, its occasional adjustment permitting less rigorous mechanical treatment than that required by its smaller partner. The oscillator tuning dial should be carefully considered for its mechanical properties. It should have a knob-to-shaft ratio of at least 20 to 1; be independent of the condenser shaft for mechanical support; be free of back-lash; and, preferably, have a flexible driving member between the knob and condenser shaft. It need not have a precisely calibrated scale. The precision Type N National dial, for instance, is not as well suited to this job as the older Type B that was finally adopted. So much for mechanical details — now for those of the circuit.

OSCILLATOR SWITCHING AND BAND SPREADING

Although coil switching was rejected as impracticable for the pre-r.f. and first detector circuits, because of the large number of terminals involved and the limited flexibility it would impose, coil switching has been adopted wholeheartedly for the oscillator. Whereas some three or four coil terminals would have to be switched simultaneously in each of the r.f. and detector stages, only two are involved in the electron-coupled oscillator — the grid and cathode; and whereas only one frequency range could be covered with each pair of coils in the other

stages, at least four and even six or more ranges can be obtained from each oscillator coil. By using oscillator output either higher or lower than the incoming frequency and by using oscillator harmonics in addition to the fundamental, the four ham-band coils specified (one band-spreading two ranges) serve for at least 20 frequency ranges. With some duplication, these ranges include commercial point-to-point, the short-wave broadcasting channels, expedition frequencies, etc., even though the circuit is designed primarily to give complete band-spread on each of the amateur bands 1750-, 3500-, 7000- and 14,000-kc. In fact it goes even further. To make the spread of the 500-kc. wide 3500-kc. band conform to the "kilocycle" spread of the rest, the exclusively c.w. portion, 3500 to 3900 kc., has been given a whole range for itself — and the 3900- to 4000-kc. 'phone band has been given another! What's more, we have used the umpteenth harmonics in operating this receiver on 56 mc.

One method of band-spread tuning has been shown for the r.f. and first-detector circuits, in which the tuning condenser is connected to an extra tap, across part of the inductance. This high- L is advisable in circuits where selectivity and amplification of weak signals are at stake, because there is a voltage step-up to the grid of the tube. But in the case of the oscillator, where convenience is desirable, efficiency is secondary and stability is all-important, another type of band-spread tuning is in order. One that we like has been adopted for this job. A tuning condenser of small capacity range, in parallel with a larger adjustable padding condenser and in cooperation with the right inductance, spreads each band over all but a small margin at either end of the scale. This works out especially well because the tuned circuit becomes increasingly high C as the frequency becomes greater, thereby improving the proportionate stability. The tuning condenser has a minimum capacity of 3 μ fd. and a maximum of 20 μ fd., a range of 17 μ fd., while the padding condenser in parallel has a maximum capacity of 200 μ fd. In attempting to reduce the oscillator band-switching to a single operation, the scheme of equipping each coil with its own adjustable mica-type padding condenser was first tried. This was satisfactory for frequencies up to about 7000 kc., but on the higher ranges the creeping caused by the normally inconsequential temperature coefficient of these condensers condemned them to rejection in favor of the air-dielectric type. The bulk and greater cost of the air type (midgets) dictated that a single condenser would have to do for all ranges, adding an operation to the band-switching but improving the stability and flexibility more than enough to make up for the inconvenience.

The coil design hangs on the frequency of the intermediate amplifier, because the oscillator

output must be intermediate frequency higher or lower than the incoming signal frequency. While the choice of intermediate frequency may be sometimes a matter of individual preference, where the amateur bands are the primary consideration there are factors that narrow it down to a limited range. The i.f. must be low enough to permit reception at the lowest ham-band frequency, 1715 kc., and still not so low as to make it difficult for the pre-selector to prevent image interference at the higher amateur frequencies where the tuned input circuit becomes less effective. Experience suggests that something between 1600 and 450 kc. would meet these requirements. But the gain of the i.f. amplifier would be greater at the lower frequency. Therefore the lower frequency is to be favored. To keep out of the broadcast band and to avoid inter-

150 kc. for the 7000-kc. band and 200 kc. for the 14,000-kc. band. The specifications for the coils, including the ranges covered by the oscillation generation circuits, are given in Table II. It should be noted that the 3500-kc. band coils are designed so that the oscillator output is 525 kc. *lower* than the signal-frequency (referred to as "low-beat") and that the oscillator output is 525 kc. *higher* than the signal frequency ("high-beat") for the other bands. This was done to make the "B" and "C" coils more useful for covering other ranges.

As a diversion from our usual ham procedure, these coils were not designed by the cut-and-try method but the complete specifications were worked out in advance, using a "Lightning Calculator."⁷ Every one hit its range right on the nose the first trial — greatly relieving the

TABLE II

Band-Spreading Oscillator Coils for 525-kc. Intermediate Frequency									
Coil	Signal Band, kc.	Osc. Range, kc.	Osc. Output used	Inductance, μ h	No. Turns	Length of Coil	Size Wire (B. & S.)	Cathode tap, turns from Ground End	Approx. Padding Capacity (C_{10})
L _A	1715-2000	2240-2525	Fund. (High-beat)	65	64	1½"	28 d.s.c.	20	62 μ fd.
L _B	3500-3900	2975-3375	Fund. (Low-beat)	45	48	¾"	28 d.s.c.	15	49 μ fd.
L _C	3900-4000	3375-3475	Fund. (Low-beat)	12	27	1"	20 d.s.c.	9	173 μ fd.
	7000-7300	3763-3913	2nd Harm. (High-beat)	12	27	1"	20 d.s.c.	9	136 μ fd.
L _D	14,000-14,300	7263-7463	2nd Harm. (High-beat)	2½	12*	1"	18 enam.	4	181 μ fd.
L _S	Available For Any Special Range That May Be Desired								

* Spaced diameter of wire. All other coils close-wound.

All forms 1-inch diameter. These coil specifications are suitable for any i.f. between 500 and 550 kc. with oscillator tuning capacity range of 17 μ fd. or more. Other oscillator ranges between 20,000 and 1400 kc. are available by suitable adjustment of C_{10} , and harmonics may be used for still higher ranges.

ference from possible amateur-frequency harmonics of the i.f. heterodyne oscillator that is to be used for c.w., an intermediate frequency between 500 and 550 kc. was finally decided upon for this receiver. The oscillator coils were designed accordingly.

The LC combinations are worked out so that the oscillator fundamental output frequency is used for the 1750- and 3500-kc. bands, and so that second-harmonic output is used for the 7000- and 14,000-kc. bands. This use of the second harmonic for the higher-frequency ranges was found necessary to eliminate the last vestige of reaction of first detector tuning on oscillator frequency. The second harmonic gives completely satisfactory heterodyning and the fundamental component does not cause harmful detector overloading. When designing for second-harmonic output, the frequency range covered by the LC circuit is half that of the output range,

tedium of the "how-many-turns" business. If they are made up exactly as specified and if the two variable condensers have the capacity ranges given, no juggling of windings should be necessary. To make the cathode taps without interrupting the winding process, a small tab of varnished cambric is slipped under the proper turn, with ends up in the form of a loop, as that turn is put on. When the coil is completed, the insulation is scraped off and the tap soldered without danger of injury to the insulation of adjacent turns. Finally, each coil is given a coating of clear Duco or airplane dope. Coils A, B, C and D are mounted with machine screws in the "cradles" molded for them on the panel (which, by the way, is the same as that used in the National NC5 converter), while coil S takes the plug-in position. The grid taps are soldered to the switch points on the front and the cathode taps to the cor-

⁷ See page 76, June QST.

responding points on the back. The extra grounding switch arm on the front is removed to allow use of all five switch positions, shorting of one coil to prevent interlocking being unnecessary in this tuning system.

When the oscillator construction is completed, it can be tested by connecting temporary supply leads, with a small milliammeter in the positive screen circuit. At each switch position, the screen current should kick upward sharply when the control grid of the tube is touched. With the cover of the oscillator compartment off, the signal picked up on a regenerative receiver should be clean and steady. If there is a main carrier with a family of chirps on either side it indicates what the Britishers call "squegging" — too much feedback or too much grid-leak resistance. If the leak is not more than 100,000 ohms, the screen voltage is too high and should be reduced.

This completes the high-frequency circuits and brings us to the filter.

THE I.F. FILTER

Before deciding on the type of high-selectivity intermediate-frequency filter circuit for the receiver, several possible forms were investigated. The first was the straight multi-section type, consisting of a flock of coils and tuning condensers. This was immediately rejected because of its complexity in construction and adjustment, and because of the high losses that would necessitate additional amplification. The next was a single circuit with regeneration. Trial of this brought discouragement in the form of instability. It would give noticeable selectivity as between weak or moderate signals but immediately broadened out and became ineffectual on strong signals, where it was most needed. It was also tricky in adjustment and spilled over into oscillation on the slightest provocation. The next form to suggest itself was the electro-mechanical filter, the quartz crystal. Its "stiffness," its equivalence to a very large inductance in series with a very small capacity and a resistance, makes its L/CR very large — pointing to extremely sharp resonance and high efficiency. Its stability is so well known as to need no comment.

Dr. Cady first suggested the use of the quartz resonator as a sharp electric wave filter⁵ over ten years ago and recently its use as such has been greatly accelerated. We recall that the series resonator as a filter in a receiving circuit was tried

several years ago by Paul Zottu in Dr. Cady's laboratory at Wesleyan University. A wide variety of applications has been made by the Bell Telephone Laboratories, Radio Corporation of America and others. A quartz filter is also used

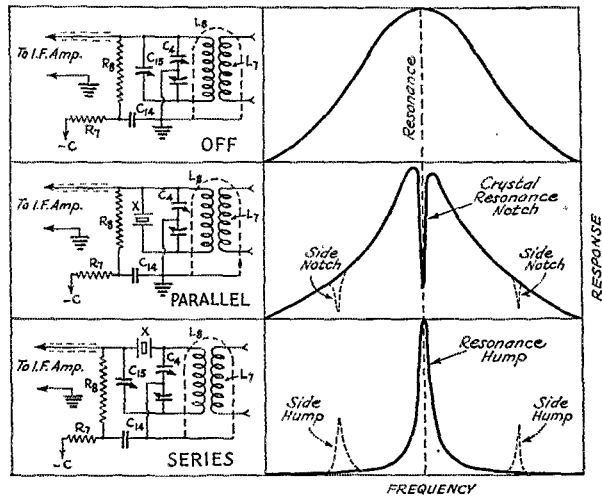

FIG. 4—THE SELECTIVITY CHARACTERISTIC OBTAINED WITH FILTER SWITCHING

In the "Off" position the circuit performs as a transformer with tuned secondary, making the receiver a "straight" superhet. In the parallel position the crystal has the same characteristic that it would have in the usual oscillator circuit, putting a sharp peak on the curve at a frequency slightly off its main resonance frequency and acting as a rejector for a signal right on its resonance frequency. This connection is useful for both phone and c.w., taking out heterodyne interference when the interfering carrier is shifted into the notch. In the "Series" position maximum selectivity for c.w. reception is obtained, the circuit performing as a very sharp acceptor for one frequency and a rejector for other frequencies. The side notches with the parallel connection and the side humps with the series connection are caused by the secondary resonance peaks characteristic of the quartz crystal. Their slight effect can be nullified for c.w. reception by a low-pass audio filter cutting off at about 1000 cycles.

in the Stenode broadcast receiver, recently given considerable publicity in England and this country, its use therein being to secure high r.f. selectivity for modulated signals (particularly broadcasting), prior to linear detection and subsequent restoration of the audio component relationship by a compensating circuit of progressive high-frequency response — to make up for the progressive side-band attenuation or high-note loss inevitable with high r.f. selectivity. Whether or not this method of reception for modulated signals is sufficiently effective under amateur 'phone conditions has not been definitely determined. Using the crystal as a parallel resonator, to be described immediately, has given more satisfactory results up to the present.

For c.w. reception of steady signals, the sharp r.f. filtering provided by the quartz crystal as a series resonator is completely practicable. That audio-frequency amplitude modulation is ironed out makes things all the better. Our c.w. signals are supposed to be pure r.f. carriers of a single

⁵ Cady, "The Piezo-Electric Resonator," *Proc. I. R. E.*, April, 1922.

frequency and they may remain so until the second detector is reached. There should be no audio-frequency modulation and there are no side bands involved until the carrier has been heterodyned in the process of detection. For reception of the less steady signals, awaiting the day when all get into the top bracket, provision is made to broaden the response with a tuning adjustment which may well be called the selectivity control. When a still less steady signal is encountered, one that is too unstable for the series-resonator type filter at its broadest, or when 'phone reception is desired, a flip of the filter switch either puts the crystal in as a *parallel* resonator or cuts it out altogether. Therefore there are three distinct ranges of selectivity available, sufficient to meet any requirement, with a selectivity control to regulate the degree of each. The circuit and specifications of the filter circuit are included in Fig. 3 while the analysis of the filter operation is given in Fig. 4. The receiver may be built without the quartz crystal, of course, providing its owner with a top-notch straight superhet. But ultimate inclusion of the crystal should be contemplated.

Contrary to expectations, the carrier sensitivity of the receiver is in no wise reduced by the series quartz filter. In fact, for steady c.w. carriers the signal at the second detector is actually greater with the "Series" connection than with the "Off" connection (as shown by the increment in second detector plate current), probably because the low-decrement quartz filter tends to encourage regeneration and gain in the first i.f. stage. Moreover, the apparent sensitivity for steady c.w. signals is much greater with the series filter because of the large improvement it makes in the signal/background ratio. Unsteady signals are treated much less cordially, as would be expected, and are relegated to the background in direct proportion to their instability. For instance: "Xtal d.c." that is ordinarily QSA3 becomes QSA5; wobbly "r.a.c." that is ordinarily QSA5 can be made QSA3 or so — and the crystal signal can be copied right through it.

The filter input circuit is simply a conventional

r.f. transformer with its secondary tunable by the double-section midget condenser C_4 , maximum capacity of each section 140 $\mu\text{fd.}$, 70 $\mu\text{fd.}$ for the two sections in series. This is the selectivity control. The transformer is contained in the shield can behind the first detector compartment. The tuning condenser is directly underneath, with its Isolantite base bolted to the side of the oscillator compartment and its shaft coupled by a flexible unit to the $\frac{1}{4}$ -inch brass rod running out to the selectivity control knob on the panel. The plug-in crystal holder and filter switch are mounted on the small bakelite panel to the left of the transformer. The adjustable phasing condenser C_{15} is fastened to a bakelite extension at the top. The shielded choke, RFC_{21} , is between the transformer and small panel, at the

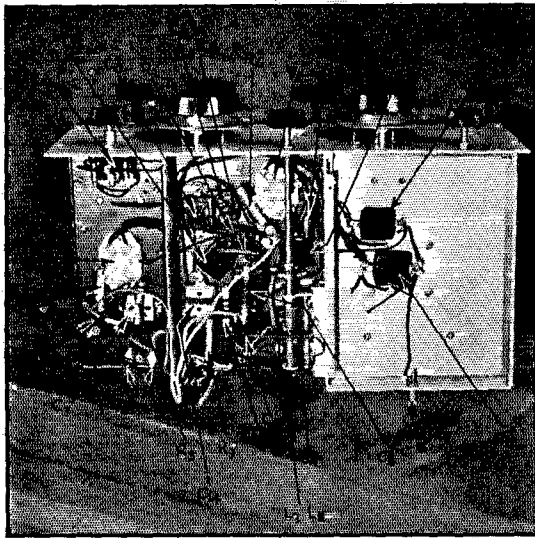

RESISTORS AND BY-PASS CONDENSERS PREDOMINATE IN THE SUB-BASE REGION, DOING THEIR PART TO MAKE THE RECEIVER STABLE AND "QUIET"

rear edge. The insulated terminals of this choke extend through the base. For greater convenience in operation, it is suggested that a single-circuit three-position rotary type switch with panel control be substituted for the s.p.d.t. miniature knife switch shown.

The transformer shown has primary and secondary windings of the "Diamond Weave" type (made by the F. W. Sickles Co.)⁹ with close coupling between the two coils. A home-made transformer of the straight solenoid type, used in the preliminary development model that preceded this receiver, is somewhat more bulky but works satisfactorily. For the benefit of those who may wish to roll their own, the latter transformer has the following specifications:

Primary:

- Diameter of form, 1 inch (bakelite tube).
- Length of coil, 2 inches.
- Size wire, No. 34 d.s.c.
- No. of turns, 195.
- Approximate inductance, 400 microhenries.

Secondary:

- Diameter of form, 2 inches (bakelite tube).
- Length of coil, 2 inches.

⁹ 300 Main St., Springfield, Mass. Alternatively, the 465-ke. i.f. transformers made for s.w. superhets (Hammarlund, Silver-Marshall, etc.) could be used with the adjusting condensers removed.

Size of wire, No. 34 d.s.c.

No. of turns, 195.

Approximate inductance, 1.3 millihenries.

For No. 32 d.s.c. wire, the primary and secondary each should be wound with 220 turns (length of coil $2\frac{5}{8}$ inches), other specifications remaining the same. The primary is mounted inside the secondary and concentric with it. The diameter of the primary could be larger (say $1\frac{1}{2}$ inches, inductance 800 microhenries), other specifications remaining the same. With the circuit as shown, this transformer will tune from 500 to 800 kc. approximately. Since it would require an individual coil shield of about 4-inch diameter, shielding the whole filter circuit in a box would be preferable.

Experience with a number of quartz crystals (both X- and Y-cut) ground for use as oscillators at broadcast-band frequencies has shown that the crystal filter presents no special problem. Both X- and Y-cuts seem to have a pair of secondary humps, one either side of the major peak, as suggested in Fig. 4. The amplitude of these side humps is considerably less than the main peak, however, and their importance is reduced still further by the selectivity of the succeeding stages. It should be noted that these humps are not in harmonic relationship to the crystal's major frequency but are the result of other modes of vibration determined by the dimensions and shape of the plates. Even crystals that work at only one frequency in the conventional oscillator show these humps when they are used as resonators. The response of the crystal, and hence the efficiency of the filter, is considerably better with an air-gap between the quartz plate and top electrode. Therefore an air-gap mounting should be used. The size of the gap is not critical. A spacing washer (bakelite with a hole in it to accommodate the crystal), slightly thicker than the crystal and placed between the top and bottom electrodes, will do nicely. The gap need not be adjustable. The mounting shown in the photograph is one of several of the G.R. air-gap type that were picked up, broadcast-band crystals included, in a second-hand store.

The phasing condenser C_{15} is used with the series resonator to balance out the residual audio-frequency image for c.w. reception, as will be explained in the following paragraphs.

TUNING UP

It is not necessary, nor would it be advisable, to kick off operating tests with this high-frequency unit coupled into an i.f. unit whose acquaintance was yet to be cultivated. The better plan is first to line up the high-frequency and filter unit with a good t.r.f. broadcast-receiver of known perform-

ance doing i.f. duty, thus isolating preliminary adjustments to the new piece of apparatus. The shielded output lead (length not more than 2 feet) from the filter unit is connected directly to the control grid of the first stage in the b.c. receiver, having a grid clip for that purpose, and the ground post of the h.f. unit is connected to the ground terminal of the b.c. set. The unit's

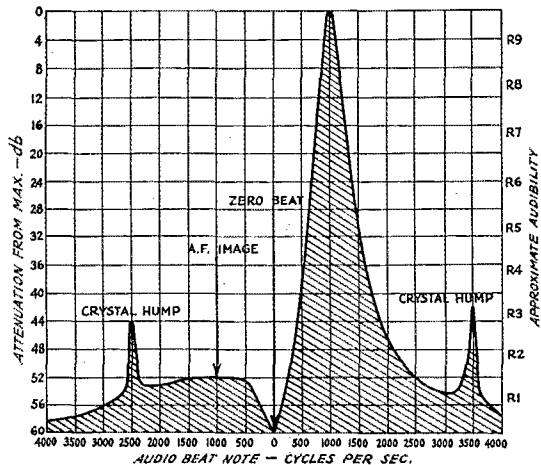

FIG. 5 — THE PICTURE OF SINGLE-SIGNAL C.W. SELECTIVITY

Actual audio response curve of the receiver for a 1000-cycle beat note. This represents the cumulative selectivity of all the tuned circuits, including the i.f. filter in the "Series" connection and two tuned-primary tuned-secondary i.f. transformers. No audio-frequency filtering was used in running the curve. The crystal (and i.f. amplifier) resonance frequency is 528 kc. Even with this order of selectivity high-speed keying is reproduced cleanly. Still higher selectivity can be obtained but puts tails on the signals.

power supply can be a $2\frac{1}{2}$ -volt filament transformer and either a "B" eliminator tapped to give the usual voltages or a 180-volt block of "B" batteries. The usual antenna and ground are connected to the unit's antenna terminals. After the oscillator has been given its preliminary test, as outlined previously, the routine procedure is as follows:

1. Tune the b.c. receiver to about 550 kc., being careful not to land on the carrier of a local station. Set its volume control at maximum.

2. Set the filter tuning condenser (selectivity control) at about two-thirds capacity. With a small screwdriver (one made of quarter-inch wood dowel or bakelite rod preferred), adjust the phasing condenser (C_{15}) to near minimum capacity — about 8 turns of the screw from maximum. The filter switch should be in the "off" position, shorting the crystal terminals. The crystal is not necessary for these tests or for straight super-het operation afterwards, incidentally.

3. Insert the 3500-kc. band coils in the pre-r.f. and detector stages and set the ganged tuning at about mid-scale.

4. Set the oscillator tuning condenser C_{20} , at midscale and the coil switch at position "C." Starting at maximum capacity, carefully turn the padding condenser C_{19} towards minimum, listening for ham 'phones. When the band is located, leave this condenser set and go back to the r.f.-detector tuning, adjusting the ganged condensers, antenna trimmer and detector-coil trimmer for maximum response. There are two settings of the oscillator padding condenser at which the 'phones should be heard, one near maximum and one at about mid-scale. The near-maximum position should be used to give the low-beat for the 3900- to 4000-kc. 'phone band. More precise calibration of the oscillator settings and adjustment of the r.f.-detector tuning can be made with a heterodyne frequency meter or other calibrated oscillator, a milliammeter connected in the plate-feed circuit of the second detector serving as a resonance indicator. Things are simplified if the b.c. set has a.v.c. and a tuning meter. If the receiver happens to be a superhet and a series of "burps" is experienced with tuning of the high-frequency oscillator, suspect harmonics from the b.c. set. Modern broadcast jobs are supposed to be free from such but some models still have them.

Failure to get results with this procedure must mean that there is a defective part or that a mistake has occurred in the construction. As with any new piece of equipment, maximum performance follows continued playing with the adjustments, each detail contributing to the whole.

C.W. RECEPTION — OFF-SET ADJUSTMENT

The i.f. beating oscillator arrangement shown on page 16 of June *QST* should be rigged up to modulate the second detector for beat-note reception. It should be completely shielded as shown in the diagram on that page and it should be tunable to the low-frequency end of the broadcast band, assuming that a t.r.f. set is to be used as the i.f. unit. A milliammeter should be connected in the "plus B" lead to the second detector. With the i.f. beating oscillator shut off, fire up the heterodyne frequency meter or other low-powered local oscillator that is to serve as the signal generator and tune it in on the receiver. Adjust the tuning and the selectivity control for maximum deflection of the plate milliammeter, adjusting the antenna trimmer and r.f. gain control so that the second detector is not overloaded. Several peaks of maximum current would mean that the i.f. circuits are out of gang, necessitating adjustment of the b.c. receiver's r.f. trimmers. This is easily done, using the detector plate meter as a resonance indicator. After setting the high-frequency tuning for peak signal at the second detector we are ready for the off-set adjustment that is the first step towards single-signal reception. Results are certain if the following instructions are followed closely.

1. Tune the first oscillator so that the detector plate current just begins to fall off. Tune towards *minimum* capacity (higher frequency) if a low-beat oscillator range is being used; towards *maximum* capacity (lower frequency) if a high-beat range is being used. The idea is to put the frequency of the signal going through the i.f. amplifier on the *low* side of i.f. resonance.

2. Turn on the i.f. beat oscillator and tune it into audio beat with the i.f. signal, approaching from the low-frequency (maximum condenser capacity side). Adjust for a note of 1000 cycles or so.

3. Tune the high-frequency oscillator back and forth "through zero beat," simultaneously adjusting the selectivity control for maximum difference between "signal" and "image" response.

4. Repeat the procedure several times to get the swing of it and for most satisfactory adjustment. If the i.f. amplifier has any sort of steep-sided resonance curve, a very effective signal to audio-frequency image ratio can be realized. The i.f. amplifier to be described in next month's article has such selectivity.

ADDING THE QUARTZ FILTER

If the frequency of the crystal is known, set the b.c. receiver to it. If not, rig up a temporary oscillator with the crystal and use it as a signal generator to tune up. Then put the crystal in the filter circuit with the switch set on "Series." Repeat the previously described adjustment for maximum signal at the second detector, but omit the off-set tuning. Everything is "on the nose" with the sharp filter. Be particularly precise in adjusting the h.f. oscillator and selectivity control because the peak of resonance will be very sharp. Again turn on the i.f. beat oscillator and adjust it for a suitable beat note, as before. Then tune the high-frequency oscillator "through zero beat," so that the weaker note on the other side is about the same pitch as that on the peak. Then adjust the phasing condenser, C_{15} , using a wood or bakelite screwdriver, to the point where there is a sharp *minimum response to the image signal*. Go through this procedure several times to get the "feel" of it. This gives real single-signal selectivity for c.w. The final result should sound like the curve of Fig. 5 looks. Picking the right peak of the crystal may be confusing at first, but landing on the best one is not difficult after a little experience.

Experience with the system also will reveal what can be done using the parallel resonator connection for both 'phone and c.w. reception. The wide range of selectivity obtainable by adjustment of the selectivity control, with the switch in any of its three positions, is a revelation in receiver operation. This feature is to ham-band traffic conditions what free-wheeling, automatic clutch and all the trimmings are to modern

(Continued on page 30)

Building a Low-Cost 1750-kc. 'Phone-C.W. Transmitter

Part II—The Radio-Frequency Portion*

By George Grammer, Assistant Technical Editor

IN ADDITION to generating a steady "carrier" the radio-frequency end of a 'phone transmitter must be capable of taking the audio-frequency power from the modulator and adding it to the carrier in such a way that the signal, when detected, will sound just like the modulator output would have sounded if fed to a loud-speaker instead of to the transmitter. Besides this, present-day radio conditions demand that the 'phone station cause a minimum of interference — the signal must be "sharp" — which in turn means that the frequency of the carrier must not change when modulation is taking place. The radio-frequency portion of a good 'phone transmitter therefore automatically becomes an excellent c.w. transmitter because of the extremely steady signal required.

Since the frequency of almost any self-excited oscillator will change when its plate voltage is varied — an effect which is termed frequency modulation — it is obvious that good practice will not permit modulating an oscillator directly, and it is necessary to apply the modulation at some point where a change in voltage cannot cause a change in frequency. It is especially desirable that a transmitter operating in the 1750-kc. band have a minimum of frequency modulation, because frequency modulation has a bad habit of causing spurious radiations which can cause interference in the broadcast band just "next door."

Frequency modulation can be prevented by making the job of the oscillator chiefly that of frequency control. To accomplish this it is good practice to use at least two stages of radio-frequency amplification following the oscillator, the intermediate stage acting in the capacity of a "buffer" in further isolating

the oscillator from the modulated stage, and serving also to provide the necessary excitation for that stage. For these reasons a buffer amplifier is incorporated in the transmitter described here.

DETAILS OF CONSTRUCTION

The oscillator, buffer amplifier and final amplifier are built as separate units, each having its own panel, as shown in the photographs. The panels each measure 5 by 14 inches, and may be made of bakelite, hard rubber, dry wood or other good insulating material. The wooden frame which holds them is made of 1" x 2" stock and is quite simple in construction. The oscillator is on the lower panel, buffer amplifier next above, and the final amplifier on top.

In the circuit diagram of Fig. 1 the dashed vertical lines divide off the components mounted on each panel. The oscillator portion is at the extreme right. A Type 46 tube with the outer grid connected to the plate is used in a series feed Hartley circuit. Looking at the rear view of the panel, the tube socket is at the left, tuning condenser C_1 in the center, and the oscillator inductance L_1 at the right, mounted rigidly on C_1 by means of small pieces of brass strip. The grid leak R_2 is directly beside the tube socket at the left; the filament center-tap resistor R_1 is just below, and the grid condenser C_2 between the socket and C_1 . The tube is mounted in a horizontal position. The two by-pass condensers, C_3 and the radio-frequency choke in the plate circuit are mounted on the lower edge of the panel near the oscillator inductance.

The second panel, the buffer amplifier, contains the parts shown in the central section of Fig. 1. To minimize inductive coupling between the output circuit of this stage and the oscillator,

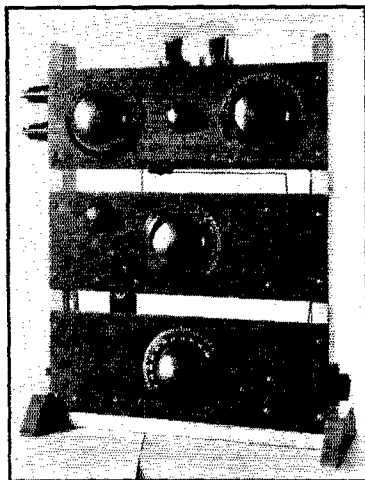

A FRONT VIEW OF THE TRANSMITTER

This unit, with one of the power supplies described in July QST, constitutes a complete c.w. transmitter of the oscillator-amplifier type for the 1750-kc. band. With a second power supply and the modulator described last month, it becomes an effective 'phone set of moderate power.

*Part I of this article appeared in July QST.

the positions of the coils and tubes have been reversed and the axes of the coils placed at right angles. The buffer tank inductance L_2 is mounted vertically at the left of the panel in the rear view, supported from the panel by machine screws running through pieces of small-diameter brass tubing as stand-offs. Tuning condenser C_2 oc-

sawing an old sub-panel bracket in two. On the under side of the shelf are the grid coupling condenser C_3 , mounted at the right on a small brass angle, the grid choke and the grid leak, R_2 . The neutralizing condenser C_6 is on the panel just above the shelf which holds the tubes. The amplifier tuning condenser C_3 is at the left of the panel in the rear view, while the antenna condenser C_4 occupies the corresponding position on the right. The tank inductance L_3 is supported horizontally behind the tube-shelf by brackets made from stiff brass strip, one of which is anchored under the plate binding post of one of the tube sockets while the other is bolted to the frame of C_3 . Plate by-pass condenser C_7 is behind L_3 , between C_3 and the shelf which holds the tube sockets. Below it, mounted on the panel, is the r.f. choke in the plate circuit.

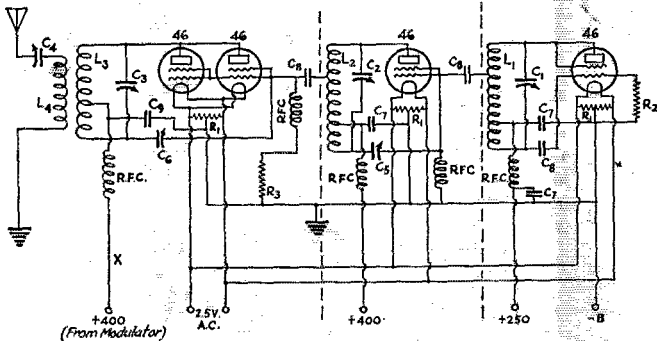

FIG. 1 — WIRING DIAGRAM OF THE RADIO-FREQUENCY END

- C_1 — 500- μ fd. variable condenser.
 - C_2, C_3, C_4 — 250- μ fd. variable condensers.
 - C_5 — 100- μ fd. midget condenser.
 - C_6 — 50- μ fd. midget condenser.
 - C_7 — 005- μ fd. fixed condensers.
 - C_8 — 250- μ fd. fixed condensers.
 - C_9 — 001- μ fd. fixed condenser.
 - R_1 — 20-ohm center-tapped resistor.
 - R_2 — 50,000-ohm, 1-watt resistor.
 - R_3 — 1000-ohm, 2-watt resistor.
 - RFC — Radio-frequency chokes, Silver-Marshall Type 275 or equivalent.
 - L_1 — 17 turns of No. 12 enamelled wire, spaced to occupy $2\frac{1}{2}$ inches on $2\frac{1}{2}$ -inch diameter form, tapped at 5th turn from grid end. Buffer excitation tap at 10th turn from plate end.
 - L_2 — Plate portion: 30 turns No. 18 enamelled, spaced to occupy $1\frac{1}{2}$ inches on $2\frac{1}{2}$ -inch diameter form, tapped at 23rd turn from plate end for excitation to following stage. Neutralizing portion: 12 turns same spaced to occupy $\frac{3}{4}$ -inch on same form, $\frac{1}{2}$ -inch away from plate portion.
 - L_3 — 38 turns of No. 14 enamelled wire, spaced to occupy $3\frac{1}{2}$ inches on $2\frac{1}{2}$ -inch diameter form, tapped at center.
 - L_4 — 30 turns of No. 18 enamelled wire on $1\frac{1}{2}$ -inch diameter form; no spacing between turns.
- Key or keying relay may be placed at X for c.w. transmission.

cupies the center portion of the panel, with the tube socket to the right. Neutralizing condenser C_6 is mounted just above the tube socket. The plate by-pass condenser C_7 and r.f. choke take up the space between C_2 and the tube socket. The buffer tube also is mounted horizontally. The coupling condenser C_3 is mounted in a vertical position below the tube socket by a small piece of brass strip. The grid choke is in the lower right hand corner of the panel. The socket connections of the buffer tube differ from those used with the oscillator because the two grids in this case are connected together, allowing the tube to operate without grid bias.

The final amplifier is supported by the uppermost panel of the three. Yet a different mechanical arrangement is used here, again for the purpose of preventing inter-action between stages. The two tubes, which are operated in parallel (the two grids are tied together in each tube), are mounted on a small shelf which is held horizontally from the panel by small brackets made by

nut is tightened to hold it firmly in place. The filaments of all four tubes in the transmitter are wired in parallel. Each stage has its own filament center-tap resistor, more for the purpose of serving as a return for r.f. than as a d.c. return. The filament leads, negative plate supply lead and the positive plate voltage leads for the oscillator and buffer amplifier are all brought down to a 5-prong tube socket mounted on the lower side of the frame at the left in the rear view. It is, therefore, an easy matter to plug in a cable (which may be a home-made affair consisting of a 5-wire cable and an old 5-prong tube base) to get voltages, and the power can be taken off quickly when adjustments are being made. The filament leads in the cable should be extra heavy so there will be little loss of voltage in the cable. The four tubes take approximately seven amperes, which makes necessary the use of heavy leads. The plate supply lead for the final amplifier is brought out separately to a Fahnestock clip on the frame near the final amplifier panel.

MEASURING PLATE CURRENTS

A milliammeter is practically indispensable in the adjustment of a multi-stage transmitter, and is an absolute necessity if a 'phone transmitter is to be adjusted with any degree of assurance. The least expensive way to meter all circuits is to use a single milliammeter of suitable range and put a jack in each circuit to be measured. The meter then can be connected to an ordinary 'phone plug and shifted from one circuit to the other very quickly.

The milliammeter panel shown in one of the photographs in July *QST* is arranged for this purpose. The meter is a 0-200 d.c. milliammeter of the miniature type. Five single closed-circuit jacks are mounted around it on the panel, a jack being provided for each of the three r.f. circuits, one for the Class B modulator, and the last for

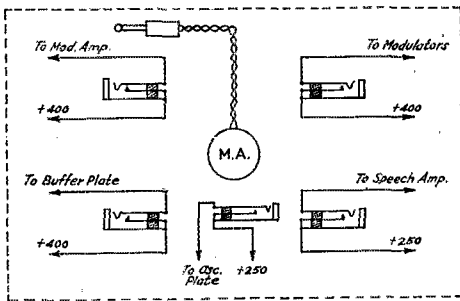

FIG. 2 — METER PANEL CONNECTIONS

Five single closed-circuit jacks are required. The frame of the jack should be connected to the lower contact spring so the circuit to the plates of the tubes will be closed when the meter plug is removed. In some makes of jacks this connection is already made.

the speech amplifier. The connections are as shown in Figs. 2 and 3. If more than one milliammeter is available the extra ones may be placed permanently in circuits where it may be desirable to have them, such, for instance, as in the modulator or final amplifier plate circuits.

ADJUSTMENTS

The most practical way of adjusting a multi-stage transmitter is to take one stage at a time and clear up any troubles that may appear before tackling the next. There should be few difficulties, however, if the specifications are followed closely and the wiring is carefully checked. To test the oscillator, remove the buffer tube from its socket and touch a neon lamp to the stationary plates of C_1 or the plate end of L_1 . A glow will indicate that the tube is oscillating. The milliammeter plug should be inserted in the jack which reads oscillator plate current, with the reading in the neighborhood of 10 milliamperes. Now replace the buffer amplifier tube in its socket (but with its plate voltage off) and the oscillator plate current should rise to about 15 milliamperes.

It is important to be certain that the oscillator

is working inside the 1715- to 2000-kc. band. If the transmitter is to be used for telephony the frequency must be between the limits of 1875 and 2000 kc. A frequency meter or calibrated monitor must be used, therefore, if trouble is to be avoided. The use of these instruments is fully covered in the chapter on "Frequency Meters and Monitors," in *The Radio Amateur's Handbook*.

Because of slight variations in tube and condenser capacities, it is impossible to give exact frequencies for any oscillator dial settings even though the specifications in Fig. 1 are followed exactly. The band should lie approximately between 70 and 90 on the oscillator dial, however, with 1875 kc. at about 75. The band should be found between 25 and 35 on the buffer dial, and between 45 and 60 on the last stage.

With the oscillator running properly on a frequency inside the band, touch the neon bulb to the plate end of L_2 and turn C_2 until the bulb glows. (The tubes in the final amplifier should be out of their sockets.) With C_2 at the setting which gives maximum glow, turn the neutralizing condenser C_5 until the bulb goes out. Return C_2 to make sure that turning the neutralizing condenser has not affected its setting, making a final adjustment to C_5 if necessary, and the buffer is neutralized. It may happen that the r.f. voltage reaching the buffer tank circuit from the oscillator is not great enough to ignite a neon lamp, since the oscillator plate voltage is intentionally low. If this should be the case the easiest way to neutralize is to listen to the signal in a monitor (which should be done continuously anyhow, from the time the oscillator is first tuned up) and find the setting of C_5 which gives the least reaction of the buffer tank condenser tuning on the oscillator frequency. It should be possible to run C_2 through resonance without causing a perceptible change in the oscillator frequency.

When neutralization is complete the tuning condenser C_2 should be adjusted to resonance—or as nearly so as can be judged from the setting at which the neon glow appeared before neutralization—and the plate voltage applied. The setting of C_2 which gives minimum plate current is the right one. This plate current will be 5 to 10 milliamperes; after the tubes are replaced in the final amplifier it will rise to about 15 ma.

The process of adjusting the final amplifier is much the same as that of adjusting the buffer. First, disconnect the antenna and ground, hold the neon bulb on the plate end of L_3 or on the stator plates of C_3 , tune C_2 for maximum glow and then neutralize by adjusting C_5 until it is impossible to get any indication of r.f. in the amplifier tank circuit at any setting of C_3 . The plate voltage should be off while neutralizing, of course. After neutralizing is complete, apply the plate voltage and adjust C_3 for minimum plate current, which, with the antenna disconnected, should be around 10 milliamperes.

THE ANTENNA

With adjustments completed this far, it is time to give some consideration to the antenna. The arrangement which a large number of amateurs are likely to use on the 1750-kc. band is the regular antenna-ground system. Space limitations do not permit the use of half-wave Hertzian antennas by most city dwellers, since the length of such an antenna is in the neighborhood of 250 feet, while Zepp feeders also become rather lengthy. If a good water-pipe ground is handy, the Marconi antenna will give quite good results. The total length of such an antenna is preferably in the vicinity of 150 feet, including the lead-in and the ground lead. An antenna of this length will be worked somewhat below its fundamental wavelength, which permits the use of a series condenser for tuning and improves, rather than detracts from, the radiating ability of the antenna. If space is available, a second wire of the same length as the antenna may be used to replace the ground connection. This so-called "counterpoise" may be run in any direction that is convenient, but should not be too close to the antenna. A separation of at least 60 feet is desirable if the two wires are parallel.

Assuming that the antenna-ground system is to be used, and that the whole system measures approximately 150 feet in length, the coupling coil, L_4 , will be about as indicated in the specifications under the circuit diagram, Fig. 1. Other antenna arrangements may make it necessary to modify L_4 , in which case the right size had best be determined by experiment. At the first trial the coupling should be loose; that is, the two coils, L_3 and L_4 , should be well separated. With C_3 set at the point which gives minimum plate current, turn C_4 until the plate milliammeter shows a definite rise as the antenna circuit is tuned through resonance. Some form of resonance indicator in the antenna circuit, such as a 0-1 hot-wire or thermocouple ammeter or a small flashlight bulb, also will be helpful. Now tighten up the coupling, retune the antenna circuit for maximum antenna current, and readjust C_2 for minimum plate current. This minimum point actually will represent a higher reading as the coupling is increased, but C_2 always should be set at the point where the plate current is minimum,

even though the minimum is comparatively high. The process of tightening coupling, with simultaneous readjustments to C_4 and C_3 , should be carried on until the minimum plate current is in the vicinity of 100 milliamperes. The antenna current should show a constant increase, too, if it is being metered. Probably it will be necessary to shunt a few inches of wire around a flashlight bulb resonance indicator to prevent burning it out when the coupling is tightest.

For 'phone work the plate current to the final amplifier always should be kept at 100 milliamperes at the power supply voltages recommended. Maintaining the modulated-amplifier plate current at this figure insures having the right load conditions for the modulator.

COMBINING MODULATOR AND R.F.

With the modulator and r.f. end separately adjusted and working properly, the two may be combined to complete the 'phone transmitter. Fig. 3 indicates, without going into detailed circuit diagrams, how the five units are connected to each other. One power supply furnishes all filament and plate voltages for the r.f. part of the transmitter, and the other handles the modulator unit. The negative terminals of the two plate supplies should be tied together and grounded; this is the only connection between the

two power units. All five of the high-voltage leads run through their respective jacks on the meter panel so the current in each of the audio and r.f. stages can be measured at will.

The plate current for the modulated amplifier is passed through the secondary of the Class B output transformer of the modulator unit. The audio power from the modulator is therefore put directly into the plate circuit of the modulated amplifier by transformer coupling. Parenthetically,

the load which the final r.f. amplifier presents to the Class B modulator is just about the right value to permit the use of a Class B output transformer designed for use with Type '10's, but used with 46's. The plate resistances of the two types of tubes are sufficiently different to make the same transformer ratio work well when the final r.f. amplifier plate current is adjusted to 100 milliamperes, as described above. With the National Class B transformers used in the modulator

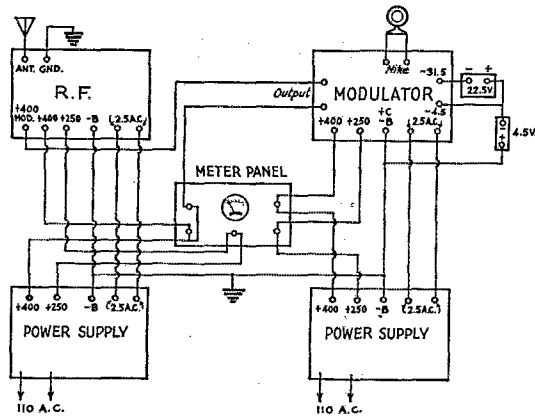

FIG. 3—BLOCK DIAGRAM SHOWING HOW THE FIVE UNITS ARE CONNECTED TOGETHER

The terminal legends in each of the blocks correspond with the external connections shown on the individual circuit diagrams.

described last month, the terminals marked "output" in Fig. 1 on page 10 of July *QST* should be connected to terminals 1 and 4 on the secondary of the output transformer.

The microphone and bias batteries are connected to the terminals provided for that purpose on the modulator unit, as indicated in Fig. 3. These voltages are not especially critical; optimum values are the ones shown on the modulator diagram in last *QST*, but a single 4.5-volt or 6-volt battery and a 22.5-volt battery connected as shown in Fig. 3 will work just about as well, even though the total bias on the grid of the speech amplifier is somewhat lower than the recommended 31.5 volts.

When the various units have been connected together as shown in Fig. 3, the r.f. part of the outfit should be tuned up and the antenna coupling and tuning adjusted to make the modulated r.f. amplifier draw approximately 100 milliamperes, as described above. Summarizing, then, the current to each of the stages should be about as follows:

Oscillator — 15 milliamperes

Buffer Amplifier — 15 ma.

Final Amplifier — 100 ma.

Speech Amplifier — 20 ma.

Modulator (Class B) — 10 to 20 ma. without speech; 100 ma. maximum with speech.

The gain control on the modulator should be set so that the plate current on the modulator "kicks" up to 100 milliamperes or so, for normal speech. The sensitivity of the microphone plays a large part in this; the average single-button microphone has sufficient output to cause the Class B stage plate current to rise to the required value without making it necessary for the operator to talk with undue loudness.

None of the plate current values given above are especially critical, although any differences from those given should preferably be toward the low side to avoid overloading the power supplies. The plate current to the final amplifier should not vary more than 10% with full modulation. The plate current to the Class B modulator stage will vary in accordance with the strength of the voice, and the milliammeter therefore can be left plugged in on that stage, after adjustments have been completed, to serve as a convenient volume-level indicator. The antenna current will rise about 20% to 25% above the unmodulated value with a steady audio signal which drives the modulated plate current to 100 ma.

MONITORING

A monitor is an extremely valuable adjunct to any transmitter, and is especially helpful with 'phone transmitters. It can be used to check the frequency, either by being calibrated itself or used in conjunction with a calibrated receiver or frequency meter; the voice quality can be checked with its aid; and frequency modulation can be detected, if present.

To check for frequency modulation, tune in the signal with the monitor in an oscillating state and adjust for a beat note of fairly low frequency. Have some one else talk into the microphone and run up the gain until the modulator plate current kicks up to 100 milliamperes on the peaks. Listen closely to the beat note in the monitor as the transmitter is modulated. If frequency modula-

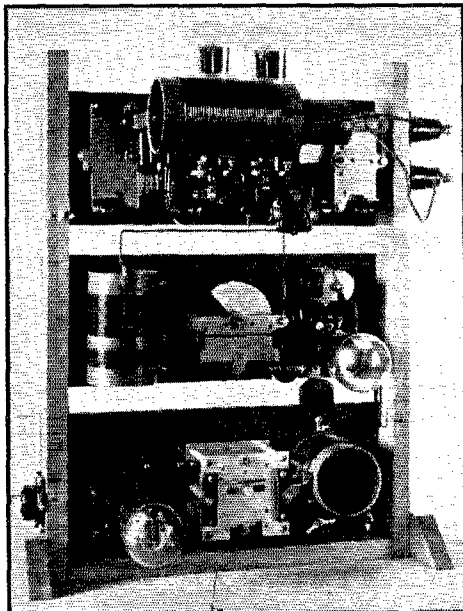

FROM THE REAR

This photograph shows how the parts are arranged on each of the three panels. The oscillator is at the bottom, buffer amplifier in the center, and the final amplifier at the top. A complete description is given in the text.

tion is present the beat note will change as the other person talks, making the beat take on a mushy character. If frequency modulation is negligible, however, the beat note will remain unchanged and the voice will sound as though it is independent of the carrier. This may be checked with several different values of beat frequencies if desired.

A second check is to tune the monitor, still oscillating, exactly to zero beat with the carrier and then listen to the voice. If the voice is just as clear as when the monitor is non-oscillating, frequency modulation is negligible. This test, however, is not a very certain one unless the signal in the monitor is quite weak; if the signal is strong the zero beat area is too wide to be of much use.

Should appreciable frequency modulation prove to be present, the indication is that the final amplifier is reacting on the oscillator to cause a frequency change, probably as the result of stray coupling. Reaction of this sort usually can be prevented by carefully isolating all stages with

chokes and by-pass condensers in the power-supply leads. In some cases, if the various stages are too close to each other, shielding of the oscillator or buffer may be necessary. Make sure also that none of the audio voltage from the modulator is getting back to the plate circuits of the oscillator and buffer in addition to being fed to the plate of the modulated amplifier where it belongs. A condenser of 2 μfd . or larger (rated at least 500 volts) connected between ground and the side of the Class B output transformer secondary which goes to the jack on the meter panel should help keep the audio voltage in the proper paths.

To approach the carrier stability characteristic of crystal control it is necessary to protect the self-excited oscillator from vibration, which can wreck the stability even of the most carefully-built oscillator. Consequently the r.f. part of the transmitter should be placed somewhere in the operating room where jars from people walking in the house, trucks passing by, etc., are least likely to affect it. Probably it will be a good idea to place the whole frame on a piece of thick felt, such as is used for putting under rugs, or on one of those rubber kneeling pads sold by most 50-cent stores. The monitor will show up any faults of this nature, and is equally useful in indicating whether or not the remedies applied have done any good.

FOR C.W.

The r.f. part of the transmitter can be used for c.w. by inserting the key or keying relay at the point marked "X" in Fig. 1. Because the filament and plate supplies are common to all three stages it is necessary to put the key in the positive high-voltage lead, which makes a keying relay desirable in the interest of avoiding an accidental shock. The key might also break the return circuit to the grid leak, R_3 , in the final amplifier, although this method sometimes allows enough leakage grid current to flow to cause a back-wave to go out on the air. One of the blocked-grid keying systems described in *The Handbook* and recent issues of *QST* could be used to overcome this, however.

A single power supply will take care of the entire transmitter for c.w., but the fact that the final amplifier, which takes the greatest plate current, is keyed makes it desirable to have a separate plate supply for the oscillator. Because the regulation of the power supply is not perfect the voltage is bound to fluctuate as the amplifier is keyed, which in turn may cause a frequency change with keying which some operators find annoying. This so-called "back-wave" is not heard on the air unless there is some leakage through the final amplifier because of incomplete neutralization or stray coupling to the antenna, and therefore does not adversely affect the quality of the signal heard by other stations.

Even though a separate oscillator plate supply is used this effect is likely to remain if the buffer plate voltage fluctuates during keying. Because of the high amplification factor of the 46 the grid resistance varies to a rather large extent with plate voltage changes, and since the grid resistance of the buffer tube constitutes the load on the oscillator, this variable load will affect the oscillator frequency.

The procedure used in adjusting the transmitter for c.w. is exactly the same as that described previously. There is no need, however, to have the final amplifier plate current set at 100 milliamperes. The plate current may be increased to any reasonable value so long as the antenna current continues to rise at the same time. To prolong tube life probably it is a good plan not to exceed 60 milliamperes per tube, however. On the other hand, the input to the last stage may be reduced, if desired, below the 100 ma. required for 'phone work.

HOW FAR CAN I SEND?

Much as we'd like to be able to answer this popular question, no definite reply can be given. So much depends upon the radiation efficiency of the antenna system, atmospheric conditions and other highly variable quantities that time and trial alone can give the answer. Given a fair location and antenna, together with an occasional "break" on QRM and QRN, there should be no difficulty in working several hundred miles at night on 'phone—considerably more on c.w. That better work than this can be done we haven't the slightest doubt. Settling questions like that is part of the fun of amateur radio.

Central Division Convention

Cleveland, Ohio, Sept. 2d and 3d

IF hard work means success, the convention to be held at the Hotel Carter and Euclid Beach, Cleveland, Ohio, Sept. 2d and 3d, should be a grand affair, and to make it a huge success every amateur in the Central Division should make an effort to attend this convention which is being sponsored by the Cleveland Amateur Traffic Association, and is extending to all a very cordial invitation. A Royal Order of the Wouff Hong initiation is to be given during the convention. The events are to be carried out at Euclid Beach and the Hotel Carter, the latter being the convention headquarters. There will be contests of all description; baseball games, races, smoke ring blowing contest, etc. Radio Division will have inspectors to give examination. All delegates are assured plenty of entertainment and instructive addresses besides. Registration \$3.00 only. Let's hear from you, gang. Just write to H. A. Tummonds, Convention Manager, 2073 West 85th St., Cleveland, Ohio.

W6USA—Amateur Radio at the Olympics

By W. A. Lippman, Jr., W6SN*

IF ALL the copy concerning the Olympic Games printed during the past years were laid end to end it might be a good thing, for then everyone who read it would know the whole story. Unfortunately, this cannot be done here. The games themselves are an age-old tale. But in describing the birth and growth of W6USA our chief concern is with Olympic Village.

Beginning in Southwest Los Angeles, the Baldwin Hills stretch west ten miles to the ocean. Two miles wide and 300 feet above the surrounding country, these flat-topped grass hills have never been subdivided — no houses, no streets, just a few oil wells and Loyola College out near the ocean end. On the eastern end of this mesa the Olympic Village has been built. Covering a square mile, it is a complete city. Row on row of two-room bungalows (550 in all), rambling white stucco administration buildings, several large dining halls, recreation buildings, post-office and even a fire department. W6USA is in this village.

Early in May of this year the Olympic Games Committee communicated to Mr. Norman L. Madsen, W6FGQ, their desire to offer the Los Angeles amateurs space for a station. They felt that radio amateurs should have a place beside the rest in this world-wide amateur event. Mr. Madsen, not being in a position to shoulder the entire load, came to the writer, who had cooperated with him and others in sending several thousand invitations to La Fiesta de Los Angeles last fall. Mr. Charles A. Cheatham, W6CUU, was enlisted and several listening surveys were made in and around the Village. Results far exceeded any wildest dreams of an ideal location — no noise, less fading and static, and we heard signals that simply hadn't existed for us before. Who could resist?

After several bull sessions we went into action. The power company put up two 50-foot telephone poles and a separate 220-volt supply, center-tapped. The Village engineer installed a telephone and the necessary carpentry work within the cottage. Through the very kind efforts of Senator Hiram W. Johnson and Senator Samuel M. Shortridge (both of California), Mr. Paul Bestor, Federal Farm Loan Commissioner, and Mr. Bernard H. Linden, Supervisor of the Sixth Radio District, we were granted the call W6USA for three months, June, July and August, 1932. The Wireless Shop and the Radio Supply Company of Los Angeles donated several pieces of extremely necessary equipment.

Desiring to work both 7 and 14 mc. and not

being able to make our 204-A perk right on 14 mc., it was decided to use a separate amplifier for that band. The 7-mc. outfit is a conventional four-stage one, consisting of a 210 oscillator on 3502 kc., 203-A doubler, 203-A buffer and 204-A final, taking approximately 1-kw. input. The 14-mc. amplifier uses two 852's in push-pull drawing 800 watts; this set is merely switched into the circuit in place of the 204-A. Three power supplies are used, one feeding doubler and buffer, and keying is effected in the center tap of this unit. The antenna, as shown by the accompanying photograph, is a single wire fed Hertz made of No. 10 enameled wire. A d.c. Super-Wasp with bands well spread out is used for all receiving work.

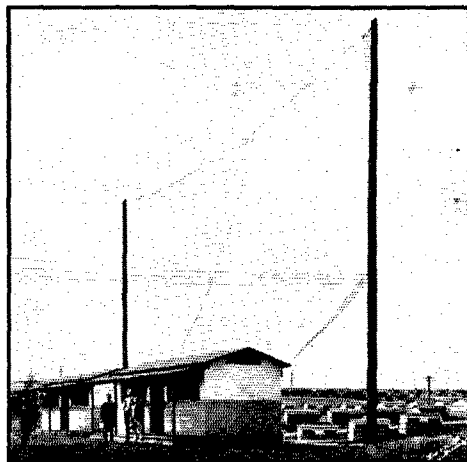

W6USA AT OLYMPIC VILLAGE
Cheatham, W6CUU is showing two members of the Japanese team the "works."

While some experiments are being made at the station, the main objective is traffic. After the four-man team from India arrives June 14th, other teams will pour into the Village. Japan sends 210, Great Britain 125, France 75, Italy 60, Canada 400, Australia 50, South Africa 12, and so on down the line. These men will be a long way from home and friends and unable to pay the prohibitive cable and wireless charges for sending reassuring words home. What better way than amateur radio? A.R.R.L. Headquarters has letters from many foreign clubs expressing regret that their governments will not allow handling of traffic of any sort. However, we are working with those others that do not prohibit it.

Mr. Harold B. Churchill, W2ZC, is acting as booster station for all European bound traffic.

*224 S. Rodeo Drive, Beverly Hills, Calif.

Several months were spent in lining up schedules over the Atlantic, and establishing listening posts in Europe and Northern Africa. Señor Carlos Cordovez of HC1FG is the main point for South American traffic. VK2OC handles Australia and New Zealand, VE2CA near Montreal holds down Eastern Canada. OM1TB and OM2TG are central points for Asia, Japan, India and South Africa. All these stations are centralized distribution points — other schedules with less consistent countries are kept, though less regularly, to ease the load on the main links.

At the present writing we have been on the air but one week and have worked five continents consistently. Our heaviest work will come during the interim between this time and the time that this article appears in print. On August 14th the games end and our work will be over, and we hope to have much that is good to our credit. The personnel of the station is as follows: C. A. Cheatham, W6CUU; F. C. Martin, W6AAN; Don Shugg, W6ETJ; C. D. Perrine, Jr., W6CUH, N. L. Madsen, W6FGQ, and the writer. Others will be added as our 24-hour watch fills up with schedules. Broadcasts will be made of messages addressed to remote corners of the world, and we earnestly request that any man who can boost a message along will copy it down and do so.

Mr. H. O. Davis, Managing Director of the Olympic Games, and a staunch friend of the radio amateur, has made all this possible. A fine personality and a tremendously capable leader of such a project, we are deeply grateful to him for this opportunity to put amateur radio before the public eye. To the many individuals and organizations who have contributed their time, interest and materials we extend our sincerest thanks, and hope that the things accomplished will justify it all. Letters and cards will be answered promptly, and our QSL cards are well worthy of that spot just above the operating table!

During the Eclipse —

Here's Action for 5-Meter Stations

FOR the special benefit of those located along a narrow path stretching across the north-eastern corner of the United States and into Canada, the moon is to eclipse the sun on the afternoon of Wednesday, August 31st. The occasion will be an ideal one for the observation of any unusual quirks in the performance of radio signals and plans are under way for the coöperation of amateurs with various scientific bodies undertaking measurements of the Kenelley-Heaviside layer height and other experimental work.

Five-meter enthusiasts are particularly asked to keep their ears cocked for an expedition planning to operate on snow-capped Mt. Washington in the White Mountain Range, New Hampshire. Amateurs throughout New England

will have an unparalleled opportunity to work some DX on this band for Mt. Washington towers over anything in the Eastern States with its summit at 6200 feet. *Contact Mt. Washington, you mountaineers!*

The equipment available to this expedition includes the Autogyro of Mr. John M. Wells, W1ZD, from which DX 56-mc. working probably will be attempted in addition to routine contact with the expedition ground station. No calls have as yet been assigned to the stations. They will make themselves known on the air, however.

Reports of unusual contacts or signals heard on any band during the eclipse period should be sent to Headquarters.

The World's Largest List of Calls Heard!

We are gradually emerging from the cyclone of reports which were received after the last International Contest which was staged during March of this year. This month we are presenting the foreign stations heard in United States and Canada. Next month we will publish the U. S. and Canadian amateurs heard in foreign countries.

The number of stations in this list is stupendous. Some 80 foreign countries were active in this contest and stations in all corners of the world sent in lists of American and Canadian stations heard. Over 5000 different stations will find their calls listed. The method of presentation is unique in that each country not only shows every station heard, and on which band, but how many different stations in that particular country heard any one call. We consider this a Calls Heard List Supreme — no active station will want to miss the September issue of *QST*.

Pacific Division Convention

Long Beach, Calif., Sept. 3d and 4th

ON to the Hotel Breakers, Ye Hams. Look at the date above and take due note thereof. Saturday and Sunday, the 3d and 4th of September, will be two gala days, and it will all be under the auspices of the Associated Radio Amateurs of Long Beach. A cordial invitation is extended to every radio amateur to visit us. Pass the word around and let Hal E. Nahmens, Convention Manager, know about it. His address is Box 903, Long Beach, Calif.

A High-Output Amplifier for the Battery Receiver

Improved Performance from Battery Sets—An Application for the New Class B Audio Tube

By Clinton B. DeSoto*

IT IS generally conceded, we believe, that the modern battery receiver can be, and at present is, made fully as effective as its more wasteful a.c. brother except for its audio system. The neck of the one bottle is the part that is the smaller; the bottles themselves are of about the same size. If we desire to increase the power capability of our modern battery set, then, we find that the biggest need for improvement lies in the audio section.

As usual, past experience suggests a convenient means of doing this. In building a power audio amplifier for use in connection with a modern battery receiver we took this into consideration, and the result was an amplifier-adaptor which could be used practically without alteration on any existing d.c. receiver, using any of the present types of tubes, with little more difficulty than the insertion of a cable plug and the changing over of speaker terminals.

The performance under such a wide range of operating conditions remains consistently satisfactory. The amplifier performs its job of power converting in an equally satisfactory manner, permitting from 1 to 5 watts of audio power to be taken from the ordinary battery receiver with, usually, less battery drain than under the original arrangement.

As shown in the illustrations, the amplifier is small in size, and will fit into any small cavity in the cabinet of an existing receiver, lying snugly in back of the chassis or mounted in a vacant space near the top. It is built on a small aluminum chassis 4 x 11 x 1¼ inches, formed by bending down the edges of a sheet of aluminum

of proper size. The construction and wiring are both simple and straightforward.

The circuit is the conventional Class B, as shown in Fig. 1. Two major modifications have been employed to make possible the extreme adaptability suggested in a foregoing paragraph. On the output end, the secondary of the output transformer is wound to match the impedance of most present-day permanent magnet dynamic speakers, 1½ ohms. Almost all standard dynamic speakers, both of the permanent magnet field and electromagnetic field types, work satisfactorily, the principal differences being a slight reduction in high note response with speakers of more than 10 or 15 ohms impedance, and reduced power output. Inasmuch as such speakers are more or less uncommon in connection with battery receivers, it is not anticipated that these difficulties

will prove serious. If it becomes desirable to operate an electrodynamic speaker at high output levels, however, the insertion of an ordinary output transformer with its primary coupled to the amplifier's magnetic speaker terminals is suggested.

Coupling to magnetic speakers is accomplished directly off the primary, through two series condensers. While the impedance match with the general run of magnetic speakers is far from optimum, entirely satisfactory reproduction and essentially full

output have been obtained with the types tried in the Hq. lab. For really superior reproduction with magnetic speakers, two or even three speakers should be connected in series, so that they will reinforce each other and provide a more suitable output load. Surprisingly authentic reproduction can be had by this arrange-

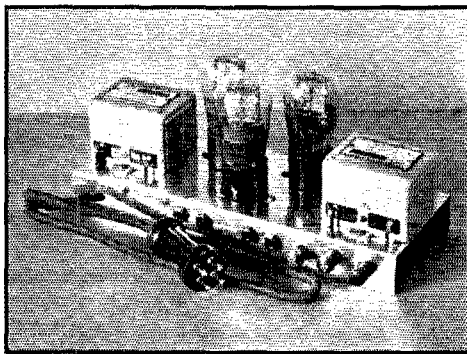

THE CLASS B AMPLIFIER WITH THE NEW TYPE 49 TWO-VOLT TUBES AND SILVER-MARSHALL TRANSFORMERS

A sheet of aluminum with the edges turned down forms the chassis; power is derived through the socket plug from the receiver with which the amplifier is used.

*W1CBD-W9ZZF. Assistant to the Secretary, A.R.R.L.

ment with speakers of even ordinary quality.

The use of the two principal types of speakers is accomplished simply by plugging into the proper pair of tip jacks. These jacks are of the insulated variety coming one red and one black in each pair. The red members of the two pairs were used for dynamic speaker coupling, and the black for the magnetic, to facilitate identification.

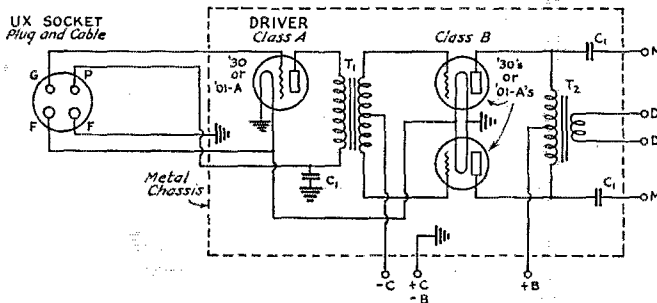

FIG. 1—THE WIRING IS SIMPLE AND STRAIGHT-FORWARD FROM THE STANDARD UX SOCKET PLUG TO THE SPEAKER TERMINAL PAIRS

T_1 —Silver-Marshall type 10189 Class B input transformer.
 T_2 —Silver-Marshall type 10183 Class B output transformer.
 C —1- μ d. 250-volt condensers.
 DD —Dynamic speaker output, 1-15 ohms.
 MM —Magnetic speaker output, 2000-20,000 ohms.

PLUG-IN INPUT CIRCUIT

The second major modification is in the input circuit. A UX socket plug is carried on the end of a short four-wire cable, and is intended to plug into the audio stage socket of any existing battery receiver, replacing the tube in that socket. This automatically connects the grid circuit of the driver tube in the amplifier to the output circuit of the receiver, and at the same time supplies all potentials to this tube as well as filament supply to the Class B tubes.

The grid circuit of the replaced receiver audio stage is thus continued through to the driver tube grid in straight-forward fashion, and correct biasing of this tube is automatically accomplished, since it is assumed that the tube used as the driver will be of the same type as that removed from the receiver. Plate supply voltage is taken through the succeeding receiver transformer primary, being satisfactorily by-passed inside the amplifier. If the tube replaced in the receiver is the output tube and direct speaker coupling has been employed, it will be necessary to shunt the empty speaker terminals on the set so as to close this circuit.

The Class B stage plate voltage and grid bias connections are brought out separately, since it is likely that suitable potentials will not be available in the receiver. If the driver stage is being operated at 135 to 180 volts, however, another connection may be made as indicated by the dotted line, and the external "B+" terminal omitted.

We come now to the choice of tubes to be used.

Battery sets to-day, exclusive of the automobile type, operate with tubes requiring two different filament potentials. The 2-volt type is unquestionably predominant, and is probably employed without exception in the receivers being manufactured at the present time. Using the amplifier with a receiver employing these tubes, we may logically choose the type '30 for all positions, since it is the smallest and most economical available, and yet is capable of producing a watt or so of undistorted power output.

This one watt of U.P.O., obtainable from the '30's with 180 volts on their plates, can be secured without difficulty with almost any standard loud-speaker. Of course, there are very few speakers, even of the large dynamic type, that can satisfactorily handle the full watt on anything except transient peaks. The output of a normal detector preceded by suitable r.f. amplification will give sufficient input on any fairly strong

local signal to make such outputs possible; comfortable signal level of the order at which a home receiver is normally operated can be obtained on almost any station, with a fairly sensitive receiver. This is referring particularly to the broadcast band; operation from an amateur receiver is fully as satisfactory, although on any set having fairly low r.f. amplification it is desirable to have an intermediate audio stage if maximum output is to be obtained on the weaker signals.

The foregoing, while applying particularly to the 2-volt receiver, is also applicable to those using the older 5-volt filament tubes. Those wishing to "convert" an existing receiver of this type can do so very easily by using the amplifier as described and substituting type '01A's for the '30's. The driver tube may again be the tube replaced in the audio stage of the receiver. This will automatically set its operating conditions correctly, whether it be '01A, '12A, or '71A.

The 180-volt supply, while desirable, is not a necessity — 135 volts on the plates of the Class B tubes will permit considerably greater output than with a '33 pentode or a '71A at the higher voltage, and reduce the d.c. input surprisingly. This facilitates elimination of the extra "B" connection, too, and makes it necessary only to hook in a "C" battery, plug in the socket and the speaker, and the amplifier is ready for use.

Following is a table of the correct grid bias voltages to be used with each normal value of plate voltage in this amplifier, for both the driver and Class B stages. All bias voltages are obtainable from the standard 22.5 volt "B-C"

battery, and the values should be carefully adhered to.

Tube	Driver		Class B	
	Plate Voltage	Grid Bias	Plate Voltage	Grid Bias
'30	90	-4.5	135	-12
	135	-6	157.5	-13.5
			180	-16.5
'01A	90	-4.5	135	-12
	135	-9	157.5	-16.5
	180	-13.5	180	-18

(When other types of tubes are used as drivers it is anticipated that they will have been removed from the receiver, and their operating conditions will therefore automatically be correct.)

The bias values given for Class B and driver operation are for use when the negative side of the filament is grounded. If the socket wiring of the receiver being converted is such as to cause the positive filament side to be grounded, and the receiver will not function properly with these connections reversed, additional bias equivalent to the filament voltage should be added.

It is perhaps needless to mention that this amplifier can be made to function with sets using the 6-volt auto type tubes operated on 6-volt storage battery filament supply. With a five-prong socket for the driver tube, either a '37 triode or a '38 pentode can be used as the driver, depending on the output arrangement of the receiver. The '37 is by far the simplest to arrange, and will supply plenty of power for all normal Class B levels. The circuit is given in Fig. 2, the series filament resistor in the Class B stage

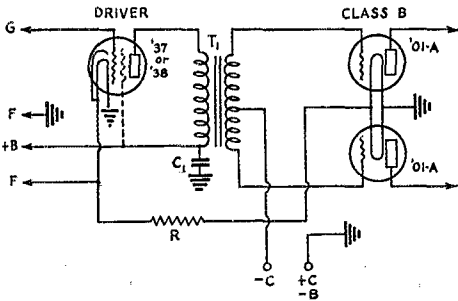

FIG. 2 — FOR USE WITH 6.3-VOLT TUBE RECEIVERS

Either the triode '37 or pentode '38 may be used as the driver tube, with type '01A's retained for the Class B stage. The 2-ohm fixed resistor "R" drops the filament voltage to the proper 5 volts.

being necessary to drop the filament voltage to 5 volts.

No tone control has been incorporated in the amplifier, since it was anticipated that most receivers with which it would be used would already

have such a control. If, however, there is none, and some means of controllable distortion is deemed desirable, a .01- μ fd. fixed condenser and a 100,000-ohm variable resistor in series may be shunted across the driver tube grid circuit as shown in Fig. 3.

A few figures on comparative efficiencies may be of interest. The overall d.c.a.c. conversion efficiency, including filament consumption, of the

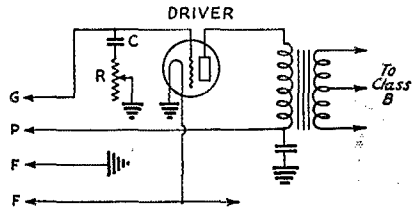

FIG. 3 — TONE CONTROL MAY BE ADDED TO THE AMPLIFIER, IF THE RECEIVER WITH WHICH IT IS USED DOES NOT HAVE THIS FEATURE

The .01 fixed condenser C in series with the 100,000-ohm variable resistor R, shunted across the grid circuit of the driver tube, give plenty of control range.

Type '33 pentode (Class A) under normal conditions is about 15%. The Class B converter, on the other hand, gives an overall efficiency of better than 30% when '30's are used in it, giving appreciably more output with 25% less d.c. input. Much the same is true with the 5-volt types; although the efficiency so far as d.c. plate dissipation is concerned of two '71A's in push-pull approaches that of the '01A's in Class B, the U.P.O. of the latter is five times as great, and the d.c. input for equivalent output is very much lower. The quality in all these cases can be regarded as about the same, with the Class A pentode application perhaps somewhat inferior.

The utility of the amplifier is, of course, not limited to existing battery receivers. A UX socket mounted on a small board with its connections brought out to Fahnestock clips or binding posts will permit use of the adapter with any sort of input — a.e. radio, microphone, or phonograph. Many interesting possibilities are opened up by use as a portable phonograph amplifier of satisfactory power and sensitivity, and in connection with small public address installations where a.e. supply is either cumbersome or difficult to secure.

THE TYPE 49 CLASS B TUBE

As described above, there is almost no applicable situation in which this amplifier cannot be used. That does not mean there is no room left for improvement, however; and the biggest avenue for improvement has been opened up by the recent announcement by Eveready Raytheon, makers of the air-cell, of the new 49 tube designed for such amplifiers as this.

The type 49, like the 46 (described in May *QST*), is a zero-bias tube having two grids. It

has a 2-volt filament, operating at .12 ampere, making its use in conjunction with the air-cell receiver possible. Several definite advantages over the type '30 for such work as this present themselves from a consideration of the tube characteristics: First, the zero bias requirement simplifies circuit and battery arrangements; second; the theoretical power output maximum is three times that of the '30 (although the filament emission is nominally only twice as great, the tube geometry difference is such that the 49 delivers its power with only 75% the resistance of the '30); third, this maximum power output can be reached with considerably less input voltage, the practical advantage of this being that approximately twice as much power can be obtained from the 49's as from the '30's, with the same driver tube.

The no-signal battery drain is about the same in each case, and the efficiency of the output stage is approximately the same for the same power output. The 49's, therefore, give better driver-voltage sensitivity, and in addition offer a means of securing from two to three times the maximum U.P.O. of the '30's.

The present rating and characteristics of the 49 are as follows:

Filament voltage	2.0 volts
Filament current	0.12 ampere
<i>As a Class A Amplifier</i>	
Plate and outer grid voltage	135 volts (Max.)
Control grid voltage (inner grid)	-20 volts
Plate current	5.7 milliamperes
Plate resistance	4000 ohms
Amplification factor	4.5
Mutual conductance	1125 micromhos
Undistorted power output	170 milliwatts
<i>As a Class B Amplifier</i>	
Plate voltage	180 volts (Max.)
Control grid voltage (both grids)	0 volts
Plate current at zero signal level (both tubes)	4 milliamperes
Optimum load resistance (per tube)	3000 ohms
Optimum load resistance (plate to plate)	12,000 ohms
Power output (both tubes)	3.5 watts
Peak plate current (per tube)	50 milliamperes

It can be seen from the above that, properly driven, we can anticipate about three watts output from the converter when using the 49's.

For this power, a third 49 is essential in the driver socket; the '30 will prove inadequate. The grid bias for the driver should be -20 volts, or the -19½ volts obtainable from a "C" battery. A 49 ordinarily can be used to replace a '31, but the extra couple of volts bias used with the '31 is enough to impair the output of the 49.

The principal constructional change involved

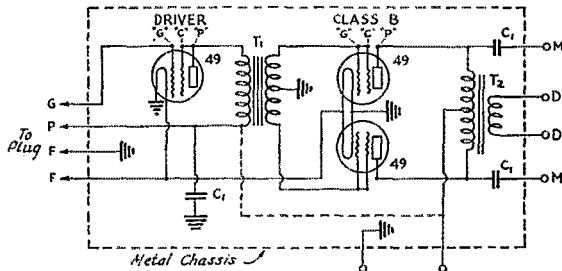

FIG. 4—SUBSTITUTION OF 5-PRONG SOCKETS IS THE MAJOR CHANGE TO BE MADE IN USING THE NEW TYPE 49 CLASS B TUBES

No bias is required on the Class B tubes, but precautions should be taken to insure about 20 volts bias being applied to the driver tube through the receiver circuits. The dotted connection again indicates that the external "B+" connection may also be omitted if the driver tube plate voltage, supplied through the receiver, is sufficiently high to operate the Class B stage satisfactorily. This makes the amplifier completely plug-in.

in the substitution of these tubes lies in the necessity for 5-prong sockets throughout. The slightly altered wiring diagram appears in Fig. 3. In this case, no provision need be made for "C" bias terminals on the converter, since the 49's in Class B operate without bias.

INCONSISTENCIES VERSUS PERFORMANCE

While figures have been given to indicate the comparative efficiency of this amplifier against other standard types, it must be admitted that the unit, viewed in conjunction with its associated devices, looks like a more or less inefficient example of its breed. With the probability of using four or five quite different types of tubes, and as many more varieties of speakers, it is impossible to arrange any really accurate

comparative efficiency of this amplifier against other standard types, it must be admitted that the unit, viewed in conjunction with its associated devices, looks like a more or less inefficient example of its breed. With the probability of using four or five quite different types of tubes, and as many more varieties of speakers, it is impossible to arrange any really accurate

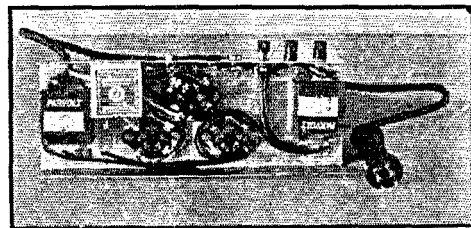

WIRING, SOCKETS, AND BY-PASS CONDENSERS ARE ABOUT ALL THERE IS UNDER THE SUB-PANEL

Caution: Special care should be taken to make certain that the grid and cathode terminals are connected together on the Class B (lower) sockets, and the plate and cathode on the driver tube socket.

impedance relationships. Forced to the use of the same transformers for all these applications, we are faced with possible distortion, reflection, power losses, and other inconsistencies of sufficient magnitude to appall the conscientious designer of electrical equipment. What, for instance, could be more unapt than shunting a 4000-ohm

(perhaps) magnetic speaker across a circuit supposed to be terminated by a 16,000-ohm load — or hooking a 3500-ohm 71A onto a 15,000-ohm transformer primary?

Yet, despite all these inconsistencies, we are able to get respectable tone quality and to approach the calculated power outputs. Tests of the frequency characteristic of the amplifier show no audibly observable falling off in response even at the very limits of the audio frequency generating equipment, which had a range of from 100 to 6000 cycles. Insofar as power output limitations as a result of these inconsistencies is concerned, while the possible U.P.O. may be considerably lessened from the maximum values given if widely varying tube and speaker arrangements are employed, we have yet to encounter a situation where a good deal more than "house volume" was not obtainable from any fairly efficient loudspeaker when using any of the types of tubes mentioned. This has held true even when working directly into the grid circuit of the driver tube with the fairly low voltage output of a low-impedance phonograph pick-up.

The performance of this converter leads us to recall a few years back, when a.c.-operated receivers led to the economical production of large voice powers. Yet here we have a case where superior tonal quality and reproduction, with the absence of background noise, result from the use of batteries and battery tubes. It would seem possible, from these results, to get better value for one's money, dollar for dollar, by using batteries in this way than by using a.c. And there isn't any hum.

An Inexpensive Time-Delay Switch

THE diagram shows a method of making a time-delay switch utilizing a home-made thermostat made from strips of hard rubber and

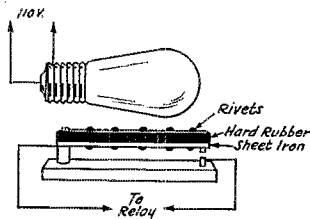

sheet iron riveted together. The difference in the expansion coefficients of the two materials causes the riveted strip to bend when heated, thus closing the contacts, which may close the circuit to a relay or may be used to operate the controlled circuit directly if circumstances permit. The heat for operating the thermostat is furnished by an ordinary electric lamp. This stunt is suggested by Lester F. Boss, W1AXM.

The amount of delay can be varied by changing the spacing of the contacts, and also will depend upon the size of the lamp used as the heater. The whole thing should preferably be enclosed in a box to make the most of the heat available.

Drilling Glass Bowls

AFTER having spent countless hours using every imaginable means of drilling holes through glass, the following described method was tried and found to be the quickest and easiest ever used, with far less danger of breakage. Material necessary is a small can of valve grinding

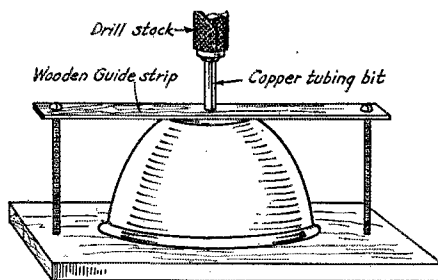

compound, medium; a piece of copper tubing the size depending upon the size of hole desired; and a hand drill. If a speed drill is available the speed and ease of drilling will be increased just that much more.

In drilling a hole through a glass bowl first lay the bowl bottom up on the bench or other flat surface and place three or four small brads around the edge to hold it firm. Next fasten a thin strip of wood over the bottom of the bowl to serve as a centering device for the hole to be drilled. First drill a hole the size of the copper bit through the center of the wooden guide and another small hole at each end to take a nail or long wood screw to fasten the guide. The drawing should make this clear.

The bit, which is made from a piece of copper tubing, should be about two inches long. Fill it with the valve-grinding compound, and also fill the center hole in the wooden guide. In a short while a groove will be ground into the glass deep enough to hold the bit in place without the use of the wooden guide. Now remove the guide and keep adding valve grinding compound, at the location of the hole, until the drilling is completed.

— George Maki, K7HV

Strays

W9FBC thinks that moonlight nights are better for YL's than for DX.

For the Ham Who Has No A.C.

An Efficient Battery-Powered Transmitter

By L. S. Fox, W2AHB*

TWO years ago the radio industry announced two new developments: First, a comparatively inexpensive "A" battery giving a thousand hours of service without requiring any attention beyond a few drops of water from time to time in each of its two cells—the air cell battery;¹ second, a series of tubes of unusual economy of both "A" and "B" current—the two-volt tube.

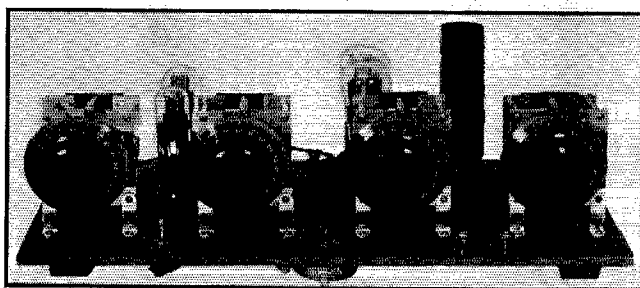

FRONT VIEW OF THE EFFICIENT LOW-POWER BATTERY-OPERATED TRANSMITTER

This transmitter is powered by an air-cell "A" battery and three 45-volt heavy duty "B" batteries, and is intended for use where electric power is unavailable. While the power is not high (the output is about 6 watts), it is unusually efficient. For instance, a single type '10 self-

The grid coil L_1 is wound on a National R-39 coil form, center tapped. The plate coil L_2 is wound on the same type of coil form with taps as indicated in the coil table. Two Type '33 pentodes are used in the neutralized push-pull amplifier. L_2 forms an auto-transformer for coupling the oscillator and amplifier so as to obtain a high-C oscillator plate tank and also enough step-up of r.f. voltage to swing the pentode grids for maximum excitation.²

Amplifier grid bias is obtained from a small 22½-volt "C" battery. When the "B" battery voltage has dropped to 120 volts, the grid bias should be changed to 16½ volts. The "B" batteries can then be used down to 100 volts.

The illustrations show the layout above the baseboard. In the rear view the antenna tank condenser C_4 is at the extreme left. Next are the amplifier plate coil L_3 and antenna tank coil L_4 wound on the same bakelite tube

5 inches long and with inside diameter to fit a tube base which is cemented inside one end. To the right of this are the Type '33 amplifier tubes connected to L_2 through blocking condensers C_5 and C_6 . Just above these the neutralizing condensers C_7 and C_8 are made by attaching 4-inch lengths of

VIEWED FROM THE REAR
—PUSH-PULL OSCILLATOR AT THE RIGHT,
PUSH-PULL PENTODE AMPLIFIER AND OUTPUT AT
THE LEFT

The twisted leads between the amplifier and plug-in coils to their right make up the neutralizing capacities.

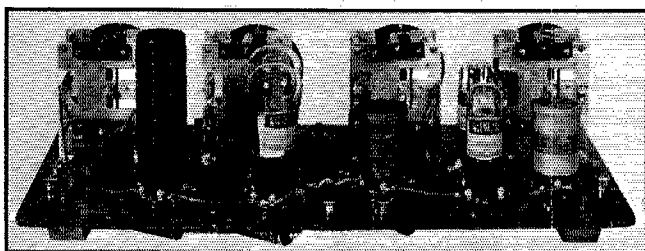

excited oscillator and '80 rectifier use up about five watts for each watt of output, while this transmitter uses only about 2½ watts for each watt of output.

Fig. 1 shows the circuit, with two Type '30 tubes used in the push-pull t.p.t.g. oscillator.

* Sales Engineering Department, National Carbon Co., 10 East 40th Street, New York City.

¹ Fox, "Filament Supply for 2-volt Tubes," *QST*, September, 1931.

rubber-covered hook-up wire to each grid and plate socket terminal. Each grid wire is twisted with the plate wire of the opposite tube. When sufficient capacity for neutralization has been obtained in this way, the remaining wire is cut off. Make sure that the open ends do not make contact as this will short circuit the "B" and "C" batteries.

² Hull, "A Medium-Powered Oscillator-Amplifier Transmitter," *QST*, March, 1931.

In front of the amplifier tubes is the amplifier plate tank condenser C_3 and next to this the oscillator plate tank condenser C_2 and coil L_2 . To the right of the Type '30 oscillators is the grid tuning condenser C_1 and coil L_1 .

Coils for the 7000- and 14,000-ke. bands should be single spaced, all others close wound. All coils are wound with No. 20 enameled wire. The number of turns in L_4 and coupling to L_2 will vary with different antenna

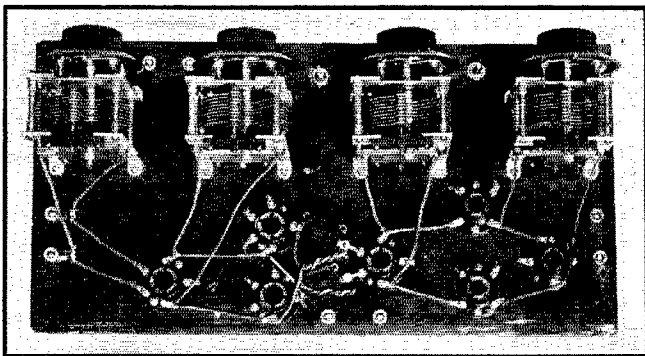

THE PLAN VIEW SHOWS THE RADIO-FREQUENCY WIRING. NOTHING COULD BE SIMPLER

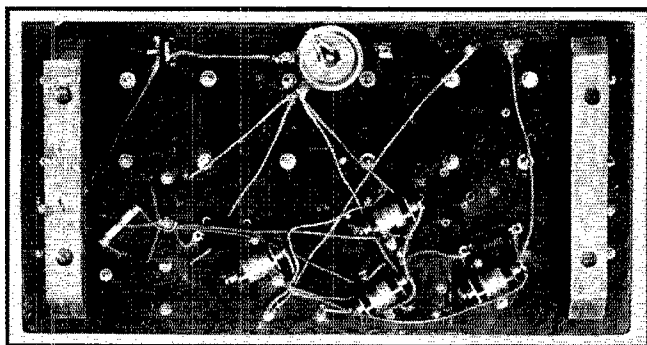

SHOWING WHAT'S BE- NEATH, WITH THE BASE- BOARD TIPPED UP ON ITS REAR EDGE

The oscillator grid leak is at the left with the r.f. chokes and by-pass condensers to its right.

systems and experiment will be necessary for best results. For permanency give all coils a light coat of thin lacquer or collodion.

Underneath the baseboard are the grid leak R_1 , r.f. chokes, by-pass condensers C_9 , C_{10} ,

rheostat R_2 , switch SW , and all except radio-frequency wiring. In wiring the filament circuits run a separate pair of wires from each socket to "plus A" and rheostat R_2 . This will insure equal voltage on each filament.

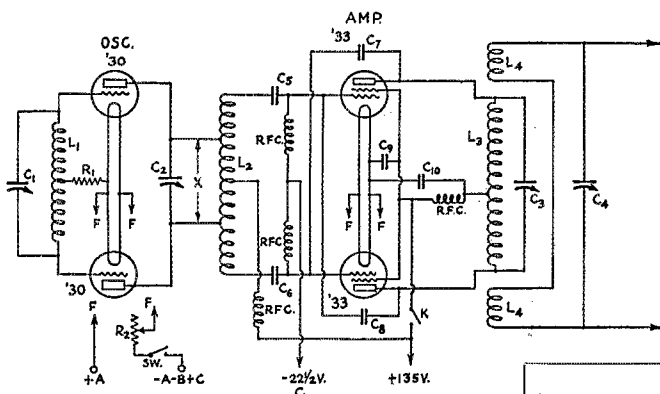

CIRCUIT OF THE PUSH-PULL BATTERY- OPERATED TRANSMITTER

- L_1, L_2, L_3, L_4 — See coil table.
- C_1, C_2, C_3, C_4 — 350- μ fd. variable condensers.
- C_5, C_6, C_9, C_{10} — 200- μ fd. fixed condensers.
- C_7, C_8 — See text.
- R_1 — 10,000-ohm carbon type resistor.
- R_2 — 1- or 2-ohm rheostat.
- RFC— National Type 90 radio-frequency choke.
- K— Telegraph Key.
- SW— Switch.

With a new air-cell battery, set the rheostat to give 2.2 volts at the tube sockets with all tubes in. Higher voltage will seriously shorten tube life. As adjustment of the rheostat will seldom be necessary, a hack-saw slot cut in the end of the shaft will serve for this purpose. Keep the connections to the battery as short as possible and use No. 14 wire or larger. The transmitter provides a full load for the battery and no additional current should be

(Continued on page 40)

Coil Specifications

Band	L_1 Turns	L_2 Turns	X Turns	L_3 Turns	L_4 Turns
1715-ke.	26	40	26	40	12
3500-ke.	14	30	14	30	10
7000-ke.	8	18	8	18	9
14,000-ke.	4	10	4	10	7



STRAYS



We note in a recent issue of "DX," the official organ of the Hong Kong Amateur Radio Transmitting Society that one of the VS experimenters in tuning up his 5-meter rig and further testing afield employed the services of his coolie to purr-r-r into the mike while master "checked his modulation."

After hours of sitting in the "lab" reeling off everything from tube characteristics to reading *QST* backwards into a mike to accomplish the same purpose we envy our VS brother. Incidentally, we believe that Editor Merriam of "DX" deserves a slap on the back for being one of the few people who writes in a pleasing style "of, by and for amateur radio."

Which stirs us to comment on the genuine pleasure we at Hq. get out of scouring the pages of foreign ham leaflets and magazines, some mimeographed and sent to a mere handful, others more elaborately printed than *QST*, but all catering to the same breed of ham.

No doubt many League members got the same kick we did on the night of June 18th when our loudspeaker boomed forth the announcement that the ballroom of the Mayflower Hotel, Washington, scene of the Atlantic Division Convention was going to furnish us with the next program. We had the pleasure of hearing Dr. Klein of the Dept. of Commerce, League General Counsel Paul Segal and Toastmaster Doc Woodruff's introductions. A solid half hour of praise and advice for the amateur came over the Columbia network.

Amateur radio is officially twenty years old this month. It was the Act of August 13, 1912 that first recognized stations operated by individuals, for purposes other than commercial communication or experimentation, as a part of the new field of radio to which it brought the first legislative control. Among the numerous regulations laid down in that Act was the memorable Regulation Fifteenth which dealt with amateur stations and provided: "No private or commercial station not engaged in the transaction of *bona fide* commercial business by radio communication or experimentation in connection with the development and manufacture of radio apparatus for commercial purposes shall use a transmitting wavelength exceeding two hundred meters, or a transformer input exceeding one kilowatt, except by special authority of the Secretary of Commerce contained in the license

of the station. . . ."

Recently, *The Chicago Times* published a list of weird 9th district calls in their "Strange As It Seems" department. Stranger to us was the fact that the artist had included each and every member of the Barnyard Club without being aware of such an organization!

Radioed via W1ZZ we are informed of the arrival of another son at ZL2AC who has been named Francis Barry O'Meara. (Note the initials — FB OM, and we check!)

Jack Paddon of W2ZZAT tells of the first three foreign contacts at W2AAR being EAR96, a Cuban and HC1FG — which is nothing startling but when they made out the QSL cards they noted the three names as Senor Cordova, Senor Cordova and Senor Cordovez!

We announce the appointment of F. Cheyney Beekley as our advertising manager, succeeding G. Donald Meserve. "Beek" is no stranger in our organization, until middle 1929 having been both managing editor and advertising manager of *QST*. After three years in the cold commercial world, he returns to the fold. As announced last month, we have closed our New York office and the advertising department is now located at West Hartford with the rest of us.

While the H. A. M.'s are settling their disputes W. A. Cline of Philadelphia comes forward and claims to be "Kingfish of the WAC." Are there any W. A. C.'s who are WAC's? Our records fail to disclose any. Next best would be a H. A. M. who is a WAC.

New Radiv regs for operator renewals provide renewal without reexamination if the applicant can show frequent use of code during the expiring term. The regs say that it will be "ample proof" to submit an affidavit indicating at least three amateurs with whom applicant has communicated by code within the last three months of the license term. Here is an interesting and useful quirk. It does not require communication by radio; code knowledge is what they want; buzzer is OK. If you have been off the air the last three months of your operator-license period and can't appear before the RI in person, call in three buddies before the license appears and get them to test you by buzzer and sign an affidavit on your code speed.

Making Practical Use of Grid-Bias Modulation

Applying It to Amateur 'Phone Transmitters

By Reuben A. Isberg, W9YAA*

FOR the past ten years grid-bias modulation has been in a dormant state. This is attributed to the fact that the early grid-bias modulated radio stations were very unsuccessful. The broadcast stations built at that time used modulated oscillators and plate modulation was generally used because it allowed a higher percentage of modulation and greater carrier output. The grid-bias modulated oscillators would tend to stop oscillating when the audio frequency variations in grid voltage caused the grid to be excessively negative and it was necessary to make very careful adjustments of the amount of the grid bias, or the value of the grid leak, and the power input before even a fair percentage of modulation could be obtained.

During the past ten years the practice of modulating an oscillator has changed to that of modulating a Class C radio-frequency amplifier. Then if the modulated stage is not capable of delivering the desired carrier power output, a Class B linear r.f. amplifier is added.¹ The knowledge of the operation of the Class B linear amplifier is the foundation for the design and operation of a grid-bias modulated transmitter. The modulated stage of a grid-bias modulated transmitter is a Class B amplifier with its radio-frequency excitation reduced. It is modulated by varying the grid bias with the output of an audio amplifier.

About a year ago the Western Electric Company announced a new grid-bias modulated transmitter having a carrier power of 100 watts and requiring an audio input level of but "plus ten" decibels (.6 watt) to modulate the transmitter 100 percent. The transmitter and power supply are all contained in the same cabinet, the only external connections necessary being the antenna and ground leads, the power leads and the speech input circuit. The output stage of the transmitter uses two 500-watt tubes in push-pull,

and it is operated as a modified Class B amplifier. The transmitter is modulated by coupling the speech input equipment to the grid circuit of the output stage by means of a transformer.

The big disadvantage of grid-bias modulation is that its efficiency is very low. The Federal Radio Commission rates a grid-bias modulated amplifier 22 percent efficient when the percentage of modulation is from 86 to 100 percent, and 27 percent efficient when the percentage of modulation is from 75 to 85 percent.² These figures may be contrasted with the F.R.C. ratings of the Class B linear amplifier used after a modulated stage of a low level transmitter. When the modulated stage is 100 percent modulated, the Class B amplifier is 33 percent efficient. When the percentage of modulation is from 75 to 85 percent, the efficiency is 40 percent. The above ratings indicate that for higher percentages of modulation the radio-frequency excitation to the Class B amplifier must be reduced whether it is used as a linear amplifier or as a grid-bias modulated stage.

The F.R.C. also rates the output power of a Class B linear amplifier as one-fourth the tube capacity of that stage. In other words a tube rated at 500 watts as a Class C amplifier is capable of furnishing a carrier output power of but 125 watts when it is operated as a Class B linear amplifier. The same five-hundred-watt tube is rated at only fifty watts output when operated as a grid bias modulated stage. *This means that the tube capacity for a grid-bias modulated stage should be ten times the desired carrier output.* Hence the Western Electric 12-A transmitter uses two 500-watt tubes in push-pull for a 100-watt carrier. The amplifier which is to be grid-bias modulated should have its grid bias set at such a value that the tubes are drawing some plate current without excitation. The radio-frequency excitation must be kept at a low value, being adjusted for the de-

Recent commercial revival of the long-dormant system of grid-bias modulation has aroused considerable amateur interest. This authoritative article, in thoroughly practical fashion, shows how grid-bias modulation should be used. It also points out the limitations of the system and demonstrates where it is impracticable in comparison with the more popular plate modulation system. The data for a typical amateur transmitter using two Type '03-A tubes in the grid-bias modulated stage and having a rating of 20 watts carrier at 100% modulation will be useful in adapting the system to transmitters of other tube line-ups. Close attention to the information given will prove profitable to every amateur interested in radiotelephony. — EDITOR.

* 514 Sixth St., Greeley, Colo.

¹ For definition and explanation see Grammer, "The A, B and C of Amplifier Classifications," *QST*, June, 1932.

² This and subsequent F.R.C. ratings are from *Rules and Regulations of the Federal Radio Commission*, obtainable from the Government Printing Office, Washington, D. C., price 45 cents. (Stamps or checks not accepted.)

sired percentage of modulation as will be shown later.

At 100 percent modulation, the carrier power output of the transmitter is equal to .22 times the product of the plate voltage and the plate current. If the percentage of modulation is from 75 to 85

wire. This coil was placed in the center of the oscillator tank coil.

Since we did not believe that there was enough radio-frequency voltage in the buffer tank circuit, we also inductively coupled the grid-bias modulated stage. The coupling coil was wound on a

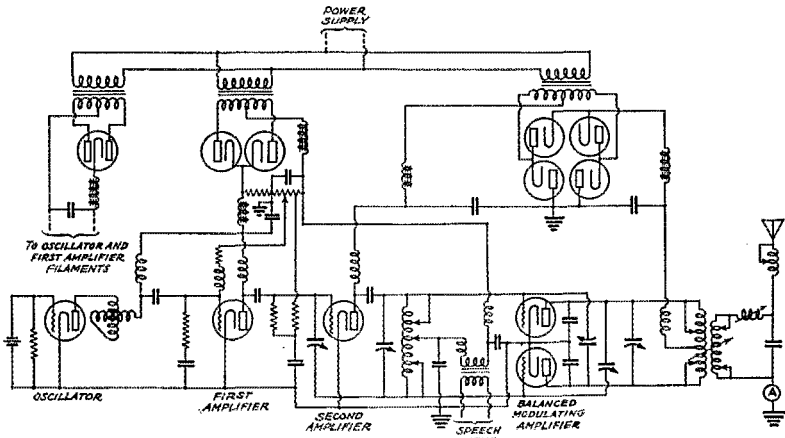

FIG. 1—SCHEMATIC DIAGRAM OF THE 100-WATT WESTERN-ELECTRIC TRANSMITTER USING GRID-BIAS MODULATION

The modulated 100-watt output stage contains two 500-watt tubes. The audio power required is approximately 60 milliwatts for 100% modulation.

percent, the output is equal to .27 times the product of the plate voltage and the plate current. The efficiency of the amplifier increases as the excitation is increased and the modulation capability decreases as the efficiency is increased. The power output also is increased by increasing the amount of the excitation.

A PRACTICAL HAM TRANSMITTER

Mr. Howard Swanson, Mr. Carl Nesbitt and I selected grid-bias modulation for a special laboratory study in physics at Colorado State Teachers' college last winter. We built the transmitter shown schematically in Fig. 2, using a Type '10 crystal-controlled oscillator, an 865 buffer stage, and two 203-A's in push-pull for the grid-bias modulated stage.

The oscillator and buffer were operated in the conventional manner as described in *The Radio Amateur's Handbook*. The oscillator had a plate voltage of about 300 volts and the buffer 500 volts with 40 ma. plate current. The screen-grid voltage adjustment on the 865 seems to be a very important factor, the recommended value of 125 volts seeming to work best. The 865 is a rather hard tube to excite, and it needs relatively large excitation before it will deliver its normal output. For this reason we inductively coupled the 865 to the oscillator instead of directly coupling it to the tank of the oscillator as is done in general practice. The coupling coil was wound on a 3/4-inch dowel with 100 turns of number 28 d.s.c.

3/4-inch dowel with 200 turns of d.s.c. wire. The coil was center-tapped and taps were made every ten turns in order to allow an adjustment of the radio-frequency excitation for the modulated stage. The coil was placed in the center of the buffer tank coil and the grid bias for the push-pull amplifier was fed into the center of the coupling coil as shown in the center of the buffer tank coil and the grids of the tubes were connected to the taps at the ends of the coil as shown in

Fig. 2. The ground return to the tank of the buffer stage was not made at the end of the tank coil, but at the center of the coil. This places the voltages at the ends of the coil 180 degrees out of phase with each other.

The grid bias for the modulated amplifier is run through a high impedance audio choke and then through the secondary of the modulation transformer before it reaches the coupling coil in the grid circuit of the amplifier. A .001- μ f. by-pass condenser is connected between the center of the coupling coil and ground. In contrast to this arrangement the grid-bias modulated stage of the Western Electric 12-A transmitter (Fig. 1) is directly coupled to the tank of the amplifier preceding it. The grid bias for this stage flows in at the center of this tank coil and the grids of the push-pull amplifier are connected at the ends of the tank coil. The ground return for the tank of the exciting stage is made at the center of the tank coil, through a condenser from the center of the coil and ground.

The push-pull r.f. amplifier is tuned and neutralized in the same manner that is described in *The Radio Amateur's Handbook*. The grid-bias adjustment for grid-bias modulation should allow a small amount of plate current to flow when there is no excitation. The bias for the 203-A tubes used in our transmitter was -35 volts when the plate voltage was 1000 volts. The plate current for both tubes at that bias was 20 milliamperes.

AUDIO SYSTEM

The main advantage of grid-bias modulation is that very small audio power will fully modulate a fairly high-powered transmitter. The Western Electric Company states that an input level of "plus ten" decibels will fully modulate their 100-watt transmitter. This is equivalent to .6 watt of audio power. An ordinary three-stage amplifier capable of delivering an undistorted audio output of .6 watt should be large enough to modulate this transmitter. It is advisable, however, to build the output stage of the audio amplifier large enough so that the varying load on the secondary of the modulation transformer will not cause appreciable distortion. A speech amplifier using two stages of transformer- or impedance-coupled audio amplification with Type '27 tubes, followed by an output stage using a pair of '45 tubes in push-pull and feeding into the modulation transformer, will give very good results. This amplifier will modulate a 100-watt transmitter and it can be used on the lower powers very successfully.

The modulation transformer that we used in our experiment was a regular output transformer having a secondary coil of the impedance to match a magnetic loud speaker. Although the results were very satisfactory, it is better practice to use a transformer having a secondary that will match the dynamic grid impedance of the tubes being modulated. The input transformer designed for the Class B modulator³ and described in the December, 1931 issue of *QST* should be just the thing. It is designed for two Type '45 tubes in push-pull and when it is used with grid-bias modulation the whole secondary coil should be used in series with the grid bias for the modulated stage.

The audio-frequency choke that is placed between the modulation transformer and the bias supply should have a large amount of inductance. We found that a choke of about 75 henries worked very well. The by-pass condenser C_1 shown in the transmitter diagram, connected between the transformer side of the choke and ground, was

found not to be of a critical value. A .1- μ fd. condenser will be suitable.

TUNING UP

A grid meter in the bias circuit of the modulated amplifier is very helpful in adjusting the

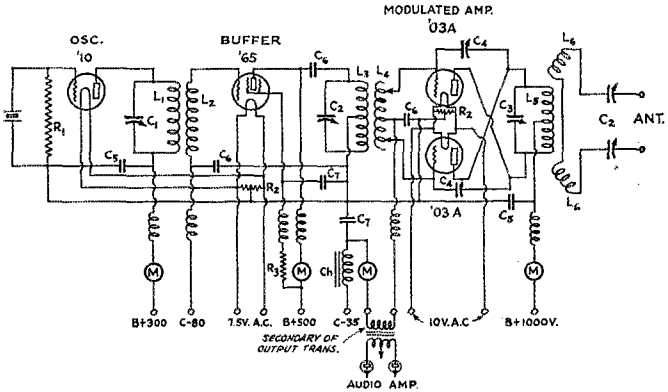

FIG. 2 — EXPERIMENTAL TRANSMITTER USED AT W9YAA

The Rated Carrier Power is 20 Watts, 100% grid-bias modulated.

- R_1 — 10,000 ohms.
- R_2 — 50 ohms, center tapped.
- R_3 — 25,000 ohms.
- L_1 — 20 turns No. 18 wire on 2-inch diameter tubing.
- L_2 — 100 turns No. 28 d.s.c. wire on $\frac{3}{4}$ -inch dowel.
- L_3, L_5 — 15 turns $\frac{3}{16}$ " copper tubing $2\frac{3}{8}$ " diameter.
- L_4 — 200 turns No. 28 d.s.c. wire tapped at the center and at every tenth turn; wound on $\frac{3}{4}$ -inch dowel.
- L_6 — 6 turns $\frac{3}{16}$ -inch copper tubing, $2\frac{3}{8}$ -inch diameter.
- C_1 — 250- μ fd. receiving type condenser.
- C_2 — 350- μ fd. receiving type condenser of good quality.
- C_3 — 350- μ fd. Cardwell transmitting condenser.
- C_4 — Type 410-B Cardwell neutralizing condensers.
- C_5 — .002- μ fd. high-voltage plate by-pass condensers.
- C_6 — 500- μ fd. high-voltage condensers.
- C_7 — 1- μ fd. by-pass condenser.
- CH — Secondary of 5-to-1 audio transformer or a 75-henry audio choke.
- RFC — Wound on slotted $\frac{1}{2}$ -inch diameter wood dowels with 300 turns No. 34 d.s.c. wire. Each choke has five slots and 60 turns are wound in each slot. The transmitter was designed for operation in the 3900- to 4000-kc. 'phone band.

transmitter for proper modulation. The gain control should be set at the point where the grid meter will just begin to kick when the microphone is spoken into. In actual operation it would be better to set the gain just back of the point where the grid meter shows current because of the danger of distortion. A modulometer is a very handy thing to have around when one is adjusting the transmitter for a desired percentage of modulation.⁴ In the absence of a modulometer, a 40- or 50-watt light bulb can be used for a load in a dummy antenna, and the percentage of modulation can be determined fairly accurately by the increase in brilliancy of the light.

If the desired percentage of modulation is 100 percent, the transmitter should be adjusted for the carrier power which will allow it to be modulated 100 percent. With the modulometer

³ "High-Power Performance from the Small 'Phone Transmitter." See also Chapter VIII, *The Radio Amateur's Handbook*, 9th edition.

⁴ Construction and use of the modulometer are described in Chapter VIII of the *Handbook*.

or by observing the increase in brilliancy of the light bulb in the dummy antenna, the percentage of modulation can be determined when a prolonged "O-o-o-h" is sounded into the microphone. The gain should be advanced to the point where the gridmeter pointer *just moves upward*. If the percentage of modulation is not quite 100 percent, the radio-frequency excitation will have to be reduced, by reducing the coupling to the preceding stage. The check on modulation should be repeated until the modulometer or the light bulb indicates that the transmitter is capable of 100-percent modulation. The output power of two 203-A's grid-bias modulated from 86 to 100 percent, is about 20 watts. When the same transmitter is capable of from 75 to 85 percent modulation, the output power (carrier) is about 27 watts. When the transmitter is capable of about 60 to 75 percent modulation, the carrier power is approximately 33 watts.

A number of hams who have tried this system of grid-bias modulation seem to be having very good results.

I should like to point out that the system of grid-bias modulation works equally as well with a single-ended transmitter as it does with a push-pull job. In case some of you have a high-power tube that you can't modulate decently because of the lack of modulator equipment, operate it as a grid-bias modulated stage, and get the kick of operating a good 'phone station. Many of the 'phone hams who are getting poor results with an outfit on high power with a low percentage of modulation might change the transmitter to grid-bias modulation at a high percentage of modulation and lower carrier power—and get good quality and better results.

It is hard to expect very much from a transmitter using grid-modulated Type '10 tubes because the output is so low. The output of two type '10's in a push-pull grid-bias modulated transmitter is 1.5 watts if the tubes are operated with the plate voltage recommended by the manufacturers for a normal output of 15 watts for the pair. The average '10 will deliver about 15 or 20 watts maximum when the plate voltage is increased to about 750 volts, however, and a pair of them operated at 750 volts in the grid-bias modulation system will give a carrier output of about five watts at approximately 100 percent modulation. But one must be very careful not to put too much plate voltage on the tubes because the radio-frequency voltages on modulation peaks will be quite high and might cause sparking inside the tubes.

In conclusion, I wish to state that grid-bias modulation is not really practicable unless one has a large amount of tube capacity in the modulated stage. Most of the amateurs who have high-power tubes can afford to build a power type plate modulator that will modulate the tube at maximum rated output. However, if one does not

have a modulator capable of completely modulating the high-powered tube's maximum output, a system of 100 percent grid-bias modulation would be more satisfactory — even though the carrier power must be materially reduced.

For the Ham Who Has No A.C.

(Continued from page 35)

drawn for any other purpose, as the battery will be overloaded and ruined. The receiver of the type described in *QST* for May, 1932 makes an excellent companion for this transmitter.³ It is recommended that separate batteries be used for the receiver, rather than attempt to switch one set from transmitter to receiver.

Three factors guided the design of this transmitter, economy of upkeep, efficiency and economy of cost. The total cost of parts required will be about \$25.00. In fact, with judicious shopping the cost of the complete transmitter, batteries and tubes included, can be kept under \$40.00.

Curing Parallax

USERS of the National Type B vernier dial should welcome this stunt for eliminating the parallax caused by the fact that the celluloid window on which the indicator line is engraved is some distance from the dial scale. The window furnished with the dial should be removed and a



Regular Window

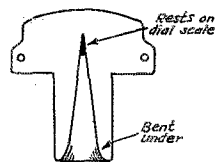

Rests on dial scale

Bent under

new one, cut from stiff celluloid as shown in the diagram, substituted. This has an "extension" which is tapered to a point and bent under, the point riding on the dial scale. For good visibility a little black ink should be put on the point. Be careful of the rivet when removing the old window.

The scratching noise in the receiver sometimes encountered when this type of dial is used on a metal panel is caused by the brass disc of the dial rubbing against the panel, and can be cured by cutting out a disc of celluloid and gluing it to the back of the dial.

— Harry Hurley, W6CKS

³ Grammer, "A Compact Receiver."

Results—International Goodwill Tests

Part I*

FOR several weeks we have been receiving inquiries from many of the hundreds of amateurs who participated in the A.R.R.L. International Goodwill Tests of February and March. We have asked them to "have patience," to "bear with us until the long task of compiling the list of 'calls heard' could be completed," and to "watch *QST* for the final results." We are now prepared to present the tabulations of stations heard during the test periods, and to show you on which continents and in which countries your signals were logged. The operators at the thousands of stations listed surely must agree with us that "it was well worth waiting for!"

Due to the unexpectedly large number of stations reported heard the complete list of calls heard on each continent, tabulated by test periods and frequency bands, reaches unprecedented proportions. For that reason the list of stations heard is being split up, and the *QST* report will be presented in sections. Part I, which appears this month, contains a list of all "DX stations heard in the United States and Canada" throughout the two test periods, February 20th-26th and March 10th-16th. This list is tabulated by frequency bands to show the stations of each continent logged in each separate United States' and Canadian government inspection district. In order to save "magazine space" the "international prefix" of each country is given rather than the complete name of the country. One asterisk after a call indicates that that station was reported from "five to ten" different sources. Two asterisks indicate from "ten to fifteen" reports, three asterisks indicate from "fifteen to twenty" reports, and so on. If no asterisk at all appears after the call, it indicates one, two, three or four reports were received.

Throughout the test periods "W" and "VE" amateurs logged stations in approximately 70 different countries in every corner of the world. The list of calls tells its own story, and shows to some extent in which United States and Canadian districts signals are received best from each foreign country. Much valuable data were received from "VE" and "W" amateurs as to the best time to receive signals from each continent. It is hoped that these data can later be chronicled in a *QST* article covering the subject of "how and when to work DX."

General conditions were quite favorable throughout the February 20th-26th period. Many splendid lists of "stations heard" were compiled, several reaching "call book" proportions. The list which follows shows just what

stations were heard in each locality in the United States and Canada, but it will be interesting to review several cases of reception which might be termed "unusual." In the eastern portion of the United States reception from Asiatic points was rather "sketchy." W1AFU logged VS7AP, Ceylon, on 14 mc. at 11:47 a.m. E.S.T. W1BDF heard Y16KR, Iraq, on 14 mc. between 10 a.m. and noon E.S.T. Y16WG was logged by W1AVJ, also on 14 mc. Japan was logged in the east more frequently than any other Asiatic country. J1CT was heard on 7 mc. by W2ANX, W3NM, W3ABA, W4VW, W4AUB; W4FV, W8DWV and W8FIV. Other "Js" logged on 7 mc. in the eastern part of the United States are J1DV (heard by W2ASS, W4FV and W4WE), J1AV (heard by W4UC), J5CF (heard by W8ANN), and J5CO (heard by W4IF). On 14 mc. J1DO was logged by W3FQ and W8ERZ at about 4:00 p.m. E.S.T. W8DHU on 14 mc. logged VS7AP, VS7GT and Y16KR. VS7AP was also heard by W8DMJ. KA1HR was heard on 7 mc. by VE2AC at 8:30 a.m. E.S.T. W3ABA logged both KA1HR and KA1JR on 7 mc. ET2IM, Abyssinia, a rare country, was heard by W4IF on 7 mc. at 4:11 p.m. E.S.T. SU1CH, Egypt, was reported heard on 7 mc. by W2ASS and W3BCF. W2ASS' reception of SU1CH was at 7:45 p.m. E.S.T. W3CCF logged YA1C, Afghanistan, on 7 mc. New Zealand amateurs are rarely heard in eastern and central U.S.A. on 14 mc., but during the tests ZL3AS was heard on that band by W8APQ and W9DBN. W9DBN's reception was at 5:10 p.m. C.S.T. G5BY and LU8DJ were logged using 'phone on 14 mc. W1AK is one who reports G5BY's 'phone. W3CCF reports LU8DJ. One of the very few fortunate enough to log DX on the 3.5-mc. band is W8BBN, who heard PA0QQ's 3500-kc. signals at 1:25 a.m. E.S.T. Noteworthy reception of Asiatic stations in the U. S. Ninth District is as follows: On 7 mc. J1CT was logged by W9DQD, W9CTW and W9HJU. W9SF heard VS2AT (Malaya) and AC7ZW (China) on 7 mc. at about 4:00 a.m. C.S.T. W9GFZ, receiving on 14 mc., reported VS7GT, J1EC and UH7M (Hedjas). 7-mc. reception of European stations in the U. S. Sixth and Seventh districts, which is quite unusual, is reported as follows: G5BY heard by W6CVZ, and EAR185 heard by W7AMK. Signals from India crept into the receivers of W6AUM and W7BAC, who respectively heard VU2LW and VU3OH. ET4VIA, Ethiopia, a country not heard every day, was logged on 7 mc. at about 9:00 a.m. P.S.T. by W6AKD.

Outstanding stations reported for the February

* The first of two parts. Part II will appear next month.

20th-26th period and the approximate number of times each was reported are as follows: (7 mc.) VK3VP VK3ZX 100; PY1FF 90; EAR96 85; VK2OC 65; EAR224 K5AC 45; VK3ZW 35; VK3ES 30; KA1HR ZL4AP HC1FG K5AA X1AA 25; EAR185 CM2WD VK3LQ J1CT 20; ZL2CI ZL1AR VK3WZ K5AB J1DM J1EE 15. (14 mc.) EAR96 65; CT1AA 55; G5BY 40; G5VL OA4J 30; G5ML EAR185 EAR224 K5AA 25; G5YH F3MTA 20; G2BM HC1FG 15.

Reception during the March 10th-16th period, though not as good as during the first period, was good enough to permit amateurs in some 60-odd countries to be logged in the United States and Canada. Certain "unusual" reception was reported as follows: AU1DE, Siberia, was pulled in at W1MK on 14 mc. at 7:12 a.m. E.S.T. W3CCF logged YA1C, Afghanistan, and J1DM on 7 mc. W3APN logged KA1CO and J1CE on 7 mc. On 14 mc. W8ACY logged J1DO and J1EC; W8CRA logged J1DO, J1DP and J1DD between 6 and 7 p.m. E.S.T.; W8ERZ logged J1DP at 5:05 p.m. E.S.T. VS6AG, Hongkong eased into W8DHU's receiver via 7 mc. Australia is heard but seldom in the U. S. First District so W1CJD's reception of VK3TM on that band is worth mentioning. 3500-kc. DX reports were "few and far between" because of the heavy QRM on that band. W3AAJ was one of the few to pull through any DX on 3.5 mc. He reports hearing G5QB. K6BAL was logged in the U. S. Third District, K6VG in the Fifth District, and K6BAZ in the Sixth and Seventh districts on 3.5 mc. G5BY's 14 mc. 'phone was reported by W1BEO and W3CCF. W3CCF also heard LUSDJ on 14 mc. 'phone. Perhaps the most outstanding bit of Asiatic reception in the mid-western section of the U. S. is W9GHI's list of Japanese stations heard on 7 mc.: J1CT, J1DV, J1DW, J1EE, J1ER, J2DP, J3DK and J3SW. Other Ninth District Asiatic reception is J1EC on 14 mc. by W9GDH, J7CF on 7 mc. by W9CNO, J1CT and J3DP on 7 mc. by W9DQD, J6RG (worked) on 14 mc. by W9BXK, and AC8AG on 7 mc. by W9BNT. 7000 kc. European reception in the U. S. Sixth District was as follows: EAR98 by W6SO, D4AU and EAR185 by W6YO, and EAR96 by W6CQF (11:20 p.m. M.S.T.). W6SO received the signals of VU3JF, India, on 7 mc.

Outstanding stations reported for the March 10th-16th period and the approximate number of times each was reported are as follows: (7 mc.) VK3ZX 70; VK3ES 65; ZL3CC 45; X1AA 35; VK2OC K6CQZ 30; VK3HL VK3TM 25; VK3VP EAR96 J1DM VK5GR VK3WZ K6AJA 20; J1CT VK5HG VK5PK J1DV 15. (14 mc.) EAR96 CT1AA 20; PY2AJ 15; G5BY EAR185 EAR224 F8TV PA0XF PY2BN PY2BQ 10.

In summarizing the comments of United States and Canadian amateurs who sent in reports on

DX heard we find that there was a sad lack of cooperation on the part of many "W" amateurs in observing the "quiet periods" set aside as periods when "W" and "VE" amateurs should listen for DX. A "black list" printed in *QST* of the poor sports who transmitted during the "listening periods" was contemplated and has been strongly urged from all quarters. Due to the great length of the list of "violators" we unfortunately cannot find space for such a list at this time. It is expected, however, that the calls of persistent and flagrant "listening period pirates" in the United States and Canada will be deleted from the list of "W" and "VE" stations heard, which will appear in September *QST*. Had every amateur done *more listening* and less sending (*in the quiet periods*), and had half the participants who hoped to be heard sent in even modest "heard" lists, the list of stations which follows in this and next month's *QST* would have reached even greater proportions.

We dare not estimate the number and types of "automatic sending machines" used during the Tests. We can say, however, that they ranged in "elegance" from a commercial type tape perforator to a slotted cardboard disk rotated on a phonograph turntable with "Test de W1XXX," etc. W1BEO used such a rig as the latter run by a 1/2 h.p. motor — to key a Type '10 set! W3ZX recorded a signal on a wax record and used the amplified record and a "repeat" mechanism (with suitable relays) to key his transmitter. Three records were worn out in 23 hours of sending. W8CNM was the only participant who told us the exact degree he was on the air. He says, "The signals 'Test de W8CNM' were sent 12,000 times from here, which makes a total of 132,000 characters sent during the DX Test." Not being a hound for higher mathematics, we'll let you tell us how many characters were sent by the sum total of all "testers!"

The list of amateur stations heard in the United States and Canada follows. Remember the September issue of *QST* will contain the list of "W" and "VE" amateurs heard, showing on what bands and in what countries your signals were logged. We can't guarantee that every reader's call will be in the list, but it's a "whale of a list" so watch for it!

— E. L. B.

First Period — February 20-26

3500-kc. band

LOGGED IN U. S. EIGHTH DISTRICT (W8)
EUROPE: PA QQ NORTH AMERICA: VO SZ

7000-kc. band

LOGGED IN U. S. FIRST DISTRICT (W1)
AFRICA: CNS MA MD MI MK NZ FM8 CP CB* CSP EG*
IH WZ SU 1CH ZU 6W EUROPE: CT1 AA AE AV AY AZ*
BX BY CO GD GT2 AE AF AN AR AW D4 AAR GQJ EAR
10 18 21 37 38 46 96*** 116 121 123 125 166 167 176 177 182
185** 196 200 224*** 226 227* EI IR F8 BS EX PM PZ* RJ
SK TC TX VP XF G2 BM VQ G5 BY* G6 WT HB 9U I IIM

LOGGED IN U. S. FIFTH DISTRICT (W5)

AFRICA: ZU 6W ASIA: JI CT DV EK J3 DI EUROPE: EAR 96 NORTH AMERICA: HH 7C K ACE J3 A AC... ARB BMY QZ HQ X IAA 28B OCEANIA: JR RA KG... ARB BMY QZ HQ X IAA 28B OCEANIA: JR RA KG...

LOGGED IN U. S. SIXTH DISTRICT (W6)

AFRICA: ZS 2A 5U ASIA: AC3 MA AC6 AA ZS AC8 AG CC... AG CC VG XZ AC9 DT AU IK JI CB CF CN CT** DH** DJ... DM**** DN** DO DP DQ DV D** DY EA EC EE** EF EK** EL...

DR DY FG FQ FY GQ GR GZ HA HE HG HL HM* HQ HZ*... JE JH JI JN JO JZ LK LC LJ LM LS LX* NR NS OC**... OJ RA** SA SB SD SK SM VC VS XB XF XG XH XU ZK...

LOGGED IN CANADIAN THIRD DISTRICT (VE3)

EUROPE: EAR 96 224 LA 20 NORTH AMERICA: GM2 CF... CR FC GR JM LC NA OP RH RG VM WV WW GM5 FC... OF BY GM7 SH GM8 AZ YB HH 7C HI 8X KA AB AC...

LOGGED IN CANADIAN FOURTH DISTRICT (VE4)

OCEANIA: K6 CQZ VK3 ES JK ZX ZL 1CF 1CR 2GR 3CC

LOGGED IN CANADIAN FIFTH DISTRICT (VE5)

OCEANIA: K6 ACW AJA CQZ VK2 BQ BU HM OJ VK3... CO EK ES HL JK TA ZX VK4 JU VK5 HG HZ PK WR... ZL2 BX GR ZL3 CC CU GR

14,000-ke. band

LOGGED IN U. S. FIRST DISTRICT (W1)

AFRICA: CN8 MI MJ* MJB FMS EG* IH ASIA: AU IDE... EUROPE: CT1 AA** AV AZ BG BX BY CE GD GT2 AD D4... BIT GGG UAO EAR 10 16 98** 124 149 185* 186 224** E1 B8...

LOGGED IN U. S. SECOND DISTRICT (W2)

AFRICA: CN 8MJ FM8 CR EG* EUROPE: CT1 AA AV BG... BX CB D 4UAO EAR 16 98* 185* 224** E1 SH F8 EX FG... HD TH UO VJ YB ZC BM DZ IG IM OQ GS AW BY* CV VT...

LOGGED IN U. S. THIRD DISTRICT (W3)

AFRICA: CN 8MJ FM 8EG ZS 6Y EUROPE: CT1 AA* AV... AZ BG BX CE GM EAR 96 185* 224** E1 D2 B8 F8 EX... OJ PZ RJ SX T** G2 BM* DZ FN IG OA EI OQ PD WQ XD G5...

LOGGED IN U. S. FOURTH DISTRICT (W4)

AFRICA: CN 8MJ EUROPE: CT1 AA BG BX HY EAR 96... 185 224 F8 EX OD T VJ WB G2 BM DZ G5 BY ML 8Y VL... G6 VP ON 4BZ NORTH AMERICA: CM 2JT 2RA 8AZ F3...

LOGGED IN U. S. FIFTH DISTRICT (W5)

AFRICA: FM 8EG ASIA: JI DO EC EUROPE: CT1 AA AV... EAR 22 96 185 224 G5 BL BY VL VP G6 VP NORTH... AMERICA: F3 MTA K5 AA VP2 PA SOUTH AMERICA: CE...

LOGGED IN U. S. SIXTH DISTRICT (W6)

ASIA: JI DH DM DO* DP* DV DY EC EK EL V53 AC V56... AE AG AH AN EUROPE: EAR 85 96 G5 BY JK G6 RG VP

LOGGED IN U. S. SEVENTH DISTRICT (W7)

ASIA: JI CT DH DM EE EG ER FE ZJ CD CF J3 CL CR... CS DJ DL DO J5 EB J6 JC J7 CF NORTH AMERICA: GM... 2GR 28G 8YD HH 7C K ACE J3 A AC... ARB BMY QZ HQ X IAA 28B OCEANIA: JR RA KG...

LOGGED IN U. S. EIGHTH DISTRICT (W8)

AFRICA: ZU 6A ASIA: V56 AG EUROPE: CT1 GD EAR... 96 185 224 F8 EX OD T VJ WB G2 BM DZ G5 BY ML 8Y VL... G6 VP ON 4BZ NORTH AMERICA: CM 2JT 2RA 8AZ F3... MTA K4 RK 8A AC NY 1AB T2 FG RC TA TAO W08...

LOGGED IN U. S. NINTH DISTRICT (W9)

AFRICA: ZT 6K ZU 6W ASIA: CAG 8AG JI CT DV DW EE... BR J2 DP J3 DK DP SW J7 CF VS IAD EUROPE: EAR... 96 224 LA 18X NORTH AMERICA: GM2 AG CR CW FC... FN GA GR GU IG JM LC MG NA OG OP* OR RA RZ SB...

PA QF NORTH AMERICA: GM 2RA 5RY 8AZ HH 7C K5
 AA AB AC K7 EZ MN NY LAB TJ 2FG X1 AA AX N 9A
 OCEANIA: KA AJV AID AJA CAB DM SOUTH AMERICA:
 CE 1AI* 1LC 3CH 7AA* CX1 AF AN HC 1FG 2GM LUI CA
 LU2 CA LUS DH LA LU4 DA LU7 EF LUS DJ DJC LU9
 DT OA4 J S U* PY1 BA FF PY2 AJ* AK AR AZ BN* BO
 BQ PY3 AJ

LOGGED IN U. S. SEVENTH DISTRICT (W7)

ASIA: J1 AA DO DP* DY EC* EL J2 CE EUROPE: EI 2D
 F8 EZ YI WB G2 BG G3 BY RV VV VL G6 RG ON 4R PA
 LL WX NORTH AMERICA: CM2 FC XR CM8 YB K5 AA
 AIN K7 AWN BNV NY1 AA AS XI AA D N X 9A OCEANIA:
 K6 AIU BAZ BEI VP1 JA SOUTH AMERICA: CE 1DCE 2AI
 7AA HC 1FG LU 1CA 3FA OA4 J Z PY1 AF AG BA PY2 AG
 AJ* AK* BN* BQ PY3 AJ

LOGGED IN U. S. EIGHTH DISTRICT (W8)

AFRICA: CN8 MI MJ* FM SCR ASIA: J1 DD DO DP EC
 EUROPE: CT1 AA** AV* AZ BG BX* BY D 4BIT EAR 24
 96** 185** 224* 244 EIS B D F8 EX* GW HR MB PZ TV
 VJ WE G2 AO DZ IG OQ UX YD G5 AW BH BJ BY* CV FV
 LA ML VL YH G6 GS VP WY* YX ON4 AU BZ GN PA LD
 LL MS QI WD XF NORTH AMERICA: CM2 JM JT* MG
 TD SG WY CM6 BX AZ F3 MTA 1H 7C RC K4 RK RL
 R5 A* AC NY1 AA AB* RX 1AA T12 FG* RC TA TAO*
 T13 XA V08 AE AN AW LC WG X1 AA* AF AX* D N X 3A
 9A OCEANIA: KA 1HR K6 ARB ERH PK 4AO VPI JA* PA
 SOUTH AMERICA: CE 1AE 1AI* 7AA* CX 1AF 2BM*
 7AB* HC 1AF 2FM 2JM HJ IAK LU 1CA 2CA* 2DY LU3
 DE DH LU4 DQ LUS DJC DW OA4 J U* Z PY1 AF BA* CA
 CE WS PY2 AG AJ* AK AZ BK BN* BO* BQ* BR WA
 PY3 AJ

LOGGED IN U. S. NINTH DISTRICT (W9)

AFRICA: CN 8MJ FM 8DA ASIA: J 1EC RG EUROPE: CT1
 AA AT BX GU D 4BIT EAR 96* 185* 224* EI 8B F8 EX HR
 EZ TV VJ G2 BI BY DE IG NM OQ G5 BJ BQ BY* CV DJ
 VJ LA LY ML OQ VJ 1H YB VL YH G6 GS LI LL QB ER
 RG VP WY* YC YR ON4 AU BZ FL JB JJ PA2 LL XD XF
 NORTH AMERICA: CM2 JM JT LC MG RA XR CM8 AZ
 F3 MTA K4 RK K5 AA* AB AC K7 BNV NY1 AA AB RX
 1AA T12 FG RC TAO V08 AW LC MG WG X1 A AA* AX*
 D N X 9A OCEANIA: K6 AIU BEI VP1 JA ZL 2CU SOUTH
 AMERICA: CE 1AA 1AI* 4AI 7AA* CX 1AF* 1FB 2BM*
 3BM 7AB HC 1FM 2JM* 2OM HJ IAK* LUI BA CA* LU2
 AG AM CA* DY LUS DH LA LU4 DA LUS FA LU7 EF LUS
 DJ DJC DO LUS DT OA4 C J* U* V Z* OA5 P PY1 BA* CA
 CE FF PY2 AD AG AJ** AK* AZ BF BK BN** BO* BQ**
 BR BS BU BZ PY3 AD AJ* SK PY6 DT ZP 6AB

LOGGED IN CANADIAN THIRD DISTRICT (VE3)

AFRICA: CN 2MJ FM EUROPE: CT1 AA BX EAR 96 185 224
 EI 8B F8 EX G2 IG G5 BJ BY ML VL G6 GY PA XF NORTH
 AMERICA: CM2 JM JT RA VV CM8 AZ F3 MTA K4 RK
 K5 AA AC NY 1AB RX 1AA T12 FG TAO V08 AW LC VP2
 PA OCEANIA: VPI JA SOUTH AMERICA: CE 1AI HC
 2JM HJ IAK LU 1BA 2CA OA4 U Z PY2 AJ BN BQ PY3 SK

LOGGED IN CANADIAN FOURTH DISTRICT (VE4)

SOUTH AMERICA: LU 1CA

LOGGED IN CANADIAN FIFTH DISTRICT (VE5)

ASIA: J1 DO DP EC SOUTH AMERICA: CE 1AI PY 2AJ

New Crystal Oven

A FEW years ago plain crystal control seemed to be the last word in transmitter frequency stability. But since crystals have come into general use we've gotten into the habit of think-

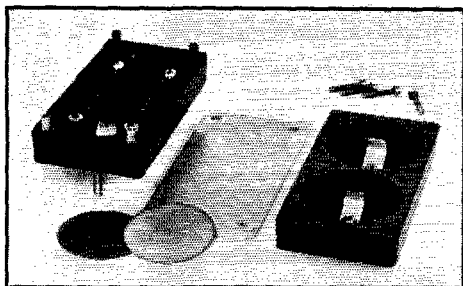

ing of stability in terms of cycles instead of kilocycles, and simultaneously have begun to pay some attention to the effect of temperature on the frequency of oscillation of a crystal; nowadays the

amateur who wants the best there is gives thought to devices for controlling crystal temperature.

The photographs show an ingenious crystal oven which has been marketed recently, and which, we think, is the first really practical de-

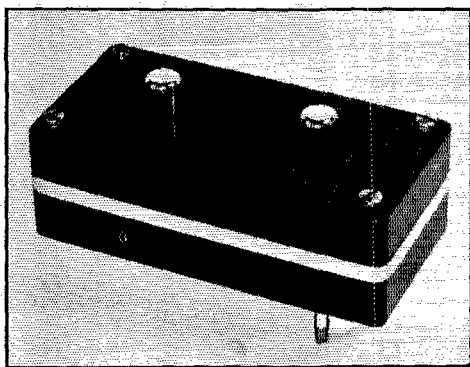

vice of this kind made for ham use. Most ovens heretofore marketed or built by amateurs have been a great deal more elaborate than the amateur requirements demand. The new oven will maintain the crystal temperature within one degree centigrade with ordinary variations in room temperature — plenty good enough for amateur transmitters — and is just about the size of two ordinary crystal holders placed side by side. Instead of using a heat-insulated chamber to enclose the crystal, a heavy copper plate, which serves as the bottom plate for the crystal holder, is maintained at the desired temperature by supplying heat to it at the same rate as heat is lost by radiation. Heat distribution over the entire plate is uniform because of the high thermal conductivity of copper and the thickness of the plate.

The photograph shows an exploded view of the oven. The molded parts are made of Durez, which resists heat. The molded bottom piece at the left contains the heater elements and the thermostat. The top piece, at the right, has compartments for two crystals. The two discs in the foreground are the top plates for the crystal holders; these are made of monel metal. It is claimed that brush discharge around the crystal is minimized by the use of monel metal and copper in the holder. Connections to the heater are made by means of two plugs on the bottom plate of the holders. Connection to the top plates is made by slipping a grid-grip over the studs on the top of the case. This makes shifting from one crystal to the other an easy matter.

The heater operates with an applied voltage of 10 to 12 volts, and about 20 minutes is required to bring the oven to a stable temperature. The thermostat is adjustable and may be set at temperatures between 35 and 50 degrees C. The crystal oven is manufactured by Western Wireless Ltd., 95 Minna Street, San Francisco, Cal.

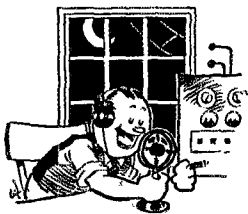

Amateur Radio STATIONS



W8AXJ, Beaver Falls, Pa.

THE accompanying photograph is a view of the equipment owned by William Wetzel, Beaver Falls, Pa., signing W8AXJ.

The transmitter employs the push-pull t.p.t.g. circuit, essentially the same as that described in

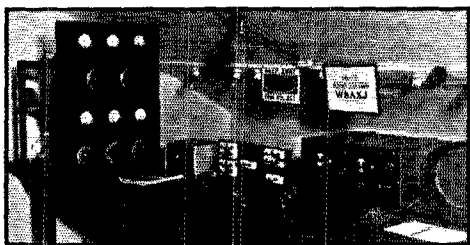

W8AXJ

The transmitter is a push-pull 210 outfit, occupying the left end of the table. The super-het receiver is at the right.

both the June and September 1930, issues of *QST*, except that it is built rack-and-panel style. A pair of 210's are used as oscillators with 750 volts on the plate. The entire transmitter is wired with copper tubing, and condensers and meters are mounted on a 21"×28" bakelite panel. Operation is chiefly on 7250 kc.

A 750-volt Thordarson transformer furnishes the plate power, and a separate 7.5-volt transformer lights the filaments of the 210's. A third transformer handles the filaments of the 866 rectifiers. The filter consists of two 4- μ f. condensers, an 18-henry and a 30-henry choke. A 50,000-ohm bleeder resistor is used across the output of the rectifier. Voltages are regulated by Bradleystats in the primaries of all transformers. These are located on the switch board. A large Weston precision type meter which cannot be seen in the photograph is located just back of the main panel.

The receiver is mounted in a copper cabinet, and is built along the lines of the one described in March, 1929, *QST*, with alterations to suit the builder's fancy. 'Phone stations from 23 foreign countries have been heard using this receiver.

The monitor, built in an aluminum cabinet, is very substantially made so it will retain its frequency calibration, which is regularly checked from W1XP's Standard Frequency Transmissions.

The antenna is a 65½-foot Zepp with 34-foot feeders. All U. S. districts have been worked, and W8AXJ's signals also have been heard in Australia and New Zealand.

W9AA, Chicago, Ill.

CYRUS T. READ, owner of W9AA, became interested in amateur radio in 1915 and received an amateur operator's license in 1916. At the close of the war when amateur operation was again permitted 9AA was the first station on the air in Chicago and has been on more or less regularly ever since. The original 9AA transmitter consisted of a borrowed 5000-volt transformer, Mason-jar condensers, a Mesco rotary gap and an enormous oscillation transformer. Since that time there have been transmitters too numerous

to mention: everything from a 1-kw. spark to 300-watt c.w. i.c.w. and 'phone.

The present transmitter was designed for reliability, compactness and convenience. It consists of a 245 crystal controlled oscillator, a pair of 210 doublers and an extra large 20-watt 210 as final amplifier. Operation is usually in the 7000-kc. band, and normal input to the last stage is around 150 watts with output running as high as 120 watts.

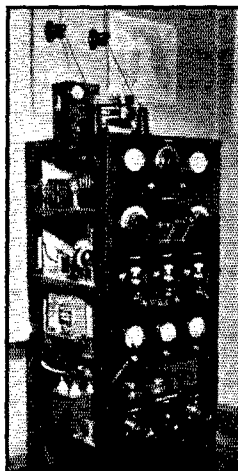

W9AA'S TRANSMITTER

A crystal-controlled set complete with power supplies and bias batteries all contained in the one frame.

Power supply consists of a 250-watt transformer, a pair of 866's and a filter of 4 μ f. capacity with a 3-henry choke on the input to the filter. Power for the oscillator is furnished by a 280 power pack, and dropping resistors are used to feed the doubler stages. "C" bias is furnished by batteries for all tubes except the oscillator, which has resistor bias.

In the photograph the bottom panel contains main power switch, power rheostats and pilot

lights. Above this panel is a wire grill through which the 866's can be observed. The next panel has the a.c. voltmeter for reading filament voltages and two milliammeters with suitable jacks so they may be plugged into any part of the circuit desired. The third panel contains the tuning controls for the oscillator and doublers and the plug-in crystal mounting. The fourth panel has antenna tuning condensers and a switch to change from series to parallel tuning, and the top panel

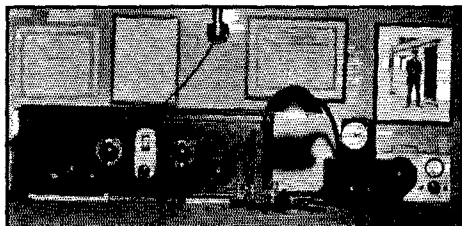

OPERATING POSITION AT W9AA

The receiver is a tuned r.f. affair with a.c. tubes. The small cabinet on which the clock sits is the remote-control box for the transmitter.

contains the final stage tuning condenser and the antenna ammeters. The shelves behind the panel contain in order from the bottom; power supply and filter, "C" bias and relay batteries, oscillator and doubler stages, and final amplifier and antenna coupling apparatus.

The picture of the operating table shows the receiver, the remote control box and the calibrated monitor. The receiver is a four-tube affair using type 235 tuned r.f. and detector stages, 227 resistance-coupled first audio and a 238 pentode output stage.

The r.f. and detector tuning condensers are ganged together on the main tuning control and auxiliary tank capacities are also mounted on the panel. In practice it is unnecessary to move these auxiliary controls once the band has been set. The 238 pentode is used because of the indirectly heated cathode, which makes it possible to keep the heater current entirely separate from the rest of the wiring. Batteries are used for plate supply.

Except for turning on the main power supply the transmitter is controlled entirely from the control box at the right of the receiver. One switch turns off the receiver and turns on the transmitter with a suitable lag between filament and plate supply.

The antenna is a 40-meter Zepp about 20 feet above the roof of the three-story building. The station is located in a room at the rear of the third floor and the feed wires are about 30 feet long.

The main activity at W9AA has always been ragchewing, as Mr. Read's work as a musician for the Columbia Broadcasting System has such irregular hours that the keeping of schedules for traffic handling is impossible.

W1PH, Brookline, Mass.

W1PH is the station of Edward E. Hayward, Jr., at 57 Pleasant Street, Brookline, Mass. Two transmitters are used, the upper one at the left in the photograph of the station working on 14,000 kc. and the one below it on the table on the 7000-kc. band. Both transmitters are self-excited Hartley oscillators, a 203-A being used in the 20-meter transmitter and an 852 on 40. The input to the former is about 150 watts, while the 852 runs at about 200 watts input.

The receiver is a revamped battery-model Super-Wasp with one stage of tuned r.f., detector and two stages of audio. Plate supply is from "B" batteries. At the right hand end of the receiver is the calibrated band-spreading condenser.

The antenna for 14,000 kc. is a half-wave Zepp, fed by 49-foot feeders, series tuned. The flat-top is 45 feet above ground. A 100-foot wire is stretched directly under the flat top 10 feet above ground and is used as a reflector. In testing this reflector with distant stations it was found that the signal strength was considerably greater when the reflector was used under the antenna. The 40-meter transmitting antenna is a third harmonic split Hertz, also series tuned. The receiving antenna is one of the half portions of the split Hertz.

The power supply is not shown in the photo but consists of a 1500-volt transformer with 866



W1PH

A 50-watter on 20 meters and an 852 on 40 comprise the transmitting equipment. The receiver is a Super-Wasp with some alterations to adapt it for ham use.

rectifier tubes, well filtered. The same power supply is used for both transmitters. Two switches enable the operator to change from one transmitter to the other in a second.

Strays

Ever wonder how much electrons are worth? The December *Electric Journal* says that at five cents per kilowatt-hour you can buy 230,000 million, million, million electrons for a nickel. But a pound of them would cost \$80,000.



Checking the Frequency Meter from WWV Signals

IN past issues of *QST* various writers have recommended the use of a "trimmer" condenser of extremely small capacity across the main tuning condenser in a frequency meter, monitor or calibrated receiver for the purpose of permitting the operator to compensate for slight day-to-day changes in circuit constants caused mainly by changes in room temperature or humidity. Such a trimmer also is useful in the period during which the oscillator tube in a heterodyne frequency meter is warming up, if a signal of known frequency is available for checking.

A letter from C. H. Vincent, W8RD, who is a strong roofer for the trimmer idea, outlines his method of using the 5000-kc. transmissions from WWV every Tuesday between 2:00 and 4:00 p.m. and 10:00 p.m. and midnight, E.S.T. Here it is:

"In case you consider this worthy of noting in *QST* for the benefit of the newer operators, I will briefly outline the method used in checking against the 5000-kc. signal sent out by the Bureau of Standards.

"First: A d.c. receiver using two-volt tubes and having very little creep is first tuned to zero beat with the 5000-kc. signal.

"Second: A 2500-kc. inductance is then placed in the monitor, which is tuned to zero beat with the No. 1 receiver.

"Third: A second receiver which in this case happens to be a.c. operated, is tuned to 7500 kc., or to zero beat with the third harmonic of the monitor.

"Fourth: The second harmonic of the dynatron frequency meter, which operates on the 3500-kc. band, is then tuned to zero beat with the No. 2 receiver and the trimmer condenser on the frequency meter so adjusted that the vernier dial of the meter reads the same as the master curve, which in this case is drawn on 18 by 24-inch cross sectional paper providing two kilocycles for each division.

"All this sounds very complicated but it is surprisingly easy, and the whole operation does not ordinarily require more than five minutes to obtain several accurate readings."

The extra receiver used by W8RD is convenient for checking back to make sure none of the settings have changed after the trimmer on the frequency meter has been set, but is not strictly

necessary if the work is done carefully. The 5000-kc. signal can be picked up on the regular receiver and the procedure followed through as described above, plugging in a coil for 7500 kc. in the receiver for the third step. Even the monitor can be eliminated if the frequency meter covers the 1750-kc. band with a little leeway on the low-frequency side, although it is a necessity if the frequency meter is on 3500 kc., as it is in W8RD's case. If the frequency meter will tune to 1666 kc. its third harmonic can be set to zero beat with the 5000-kc. signal; the receiver should then be tuned to the sixth harmonic of the frequency meter, or 10,000 kc.; leaving this setting, the frequency meter is tuned to 2000 kc. and its fifth harmonic brought to zero beat with the receiver. The trimmer may then be adjusted to bring the 2000-kc. point to coincide with the calibration chart.

Many other combinations of harmonics can be worked out to give numerous points inside the amateur bands, so that a frequency meter can be fully calibrated as well as simply checked as described above. The WWV signals are especially useful for checking a previous calibration from Standard Frequency Transmissions, however, since only one point is required and nearly everyone can find it convenient to use the rather lengthy transmissions each week.

Photronic Cell for Temperature Control

Here is an interesting application for the Weston Photronic Cell in controlling the heat in a crystal oven. The cell with its associated equip-

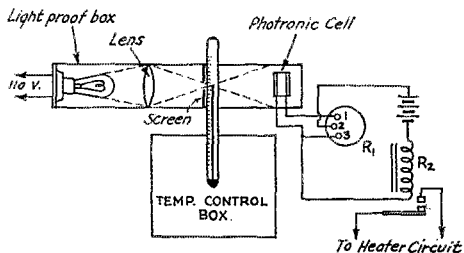

FIG. 1—USING THE PHOTRONIC CELL AS A LIGHT-OPERATED THERMOSTAT

ment replaces the thermostat and it is claimed that with proper adjustment the control will be a great deal more accurate than that obtained with the usual bi-metallic thermostat.

Details of the arrangement are shown in Fig. 1. The thermometer itself becomes the controlling element, with a beam of light passing through it so that the light to the cell is cut off as the mercury column passes the mark at which the oven temperature is to be maintained. A light-proof box similar to that shown in the diagram has a hole cut in it through which the thermometer can be passed, the photronic cell being placed on one side and a lamp and lens on the other. On the lamp side of the thermometer there is a screen which completely cuts off the light to the cell side except for a pinhole in the center. The position of the lens is adjusted so that a fine beam of light is focussed through the pinhole, behind which is the mercury column of the thermometer.

If the mercury column is below the pinhole the light passes through and falls on the cell. The current set up in the cell by the action of the light operates the miniature relay, R_1 , which in turn closes the circuit to relay R_2 , through a battery of about 12 volts. Relay R_2 is the power-type relay furnished with the photronic cell kit. This in turn closes the circuit to the heater elements in the temperature-control box, and the temperature inside the box rises. When the mercury column of the thermometer passes the pinhole the light is cut off, with the result that both relays open and the heat is turned off.

The temperature setting on the thermometer is made by sliding the thermometer up or down inside the box. The lamp should be a small one — the 10-watt size should do nicely. The tem-

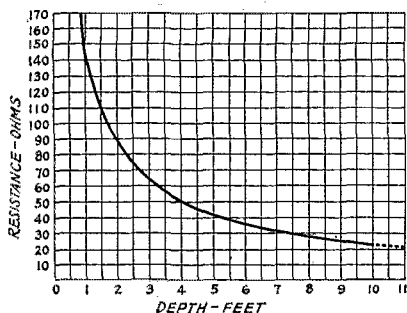

FIG. 2—CALCULATED EFFECT OF DEPTH ON THE RESISTANCE OF A GROUND CONNECTION

perature at which the device operates can be varied within quite wide limits simply by moving the thermometer. The oven itself can be made to any design the builder may like.

Grounds

Although the ground connection is not given nearly as much attention in these days of Hertz antennas as it was when spark transmitters were in vogue, the increasing use of the 1750-kc. band again brings up the question of the "good" ground, because not all of us have room to put up

Hertz antennas for that band and therefore are forced to use a Marconi-type antenna. The following information extracted from a bulletin published by the Copperweld Steel Company

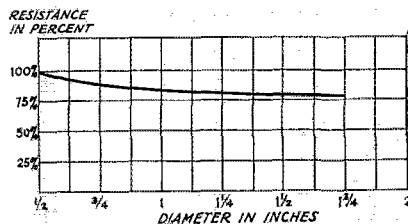

FIG. 3—EFFECT OF DIAMETER OF DRIVEN GROUND ROD ON GROUND RESISTANCE

should prove to be useful in such cases, particularly if there is any reason to suspect that the w.k. water-pipe is not working out so well.

There are four principal factors affecting the resistance of a ground connection. These are the length of the ground rod, the diameter of the rod, number of rods used, and the character of the soil.

Taking the rod itself first, its length should be such that it will reach below the permanent moisture level of the soil. Of course the depth of the moisture level will vary with different localities, but experience indicates that to fulfill this requirement the rod should be at least 8 feet long. Fig. 2 is a curve, taken from Bureau of Standards Technical Paper No. 108, showing the calculated effect of the length of the ground rod on the resistance of the ground connection for one type of soil. In practice it is

FIG. 4—THIS GRAPH SHOWS HOW THE RESISTANCE OF A GROUND DECREASES AS THE NUMBER OF GROUND RODS IS INCREASED

likely that a greater decrease in resistance than the curve indicates will be obtained at the lower depths, because there is usually more permanent moisture at the lower depths than near the surface. A deep ground is also likely to maintain a more constant resistance under all sorts of weather conditions for the same reason.

Rather surprisingly, the diameter of the ground rod has comparatively little effect on the resistance. There is little advantage in using a rod of greater diameter than one inch, as Fig. 3 shows quite clearly. Even smaller rods will be quite satisfactory; in fact, some authorities recommend that the rod be only large and strong enough to be driven into the soil without bending or splitting. But if the use of a rod of large diameter is unnecessary, there is an advantage in employing

a number of ground rods connected in multiple, provided the rods are spaced sufficiently far apart. Fig. 4 shows the decrease in the resistance of the ground connection with an increasing number of rods with three different separations. Taking the resistance of the ground connection as being 100% with a single rod, it is evident that 2 rods separated by 4 feet will show only 65% as much resistance, while with 4 rods and the same separation the resistance will be down

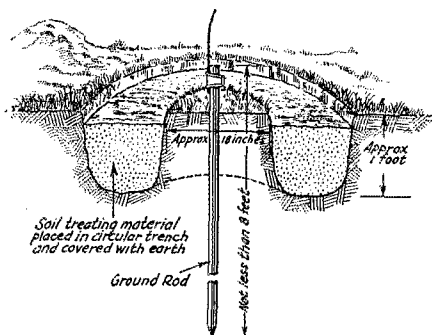

FIG. 5 — TRENCH METHOD OF SOIL TREATMENT
Probably the most effective scheme of utilizing chemicals to lower soil resistance.

to about 37%. The benefits to be obtained by using a number of rods are markedly less if the separation is smaller than 4 feet, while the decrease in resistance is slow beyond that separation. We may therefore conclude that rods in multiple should be not less than 4 feet apart and that a greater separation is slightly more desirable.

The effect of the soil on the ground resistance depends upon the type of soil and cannot very well be predicted. The resistance of the connection can be measured if suitable instruments are available, but few amateurs are so equipped. Naturally-moist soil probably has the least resistance. The resistance of any ground connection can be reduced by soil treatment, although treatment usually gives comparatively better results in high-resistance soil. For example, a ground connection which shows a resistance of 30 ohms in low-resistance soil may be improved 50% by treatment; on the other hand, the same treatment may reduce a resistance of the order of 1000 ohms by 90%.

Fig. 5 shows the method which has proved to be most effective in treating soil to reduce resistance. A shallow trench is dug around the ground rod about 18 inches from it and the treating material poured in, after which the trench is covered with earth. The chemicals used chiefly are magnesium sulphate, common rock salt and

copper sulphate. The salt crystals should be placed in the trench—the salt should not be dissolved in water before being used—after which the trench may be flooded with water. Normal rainfall will furnish enough water for carrying the crystals in solution into the earth. The solution seeps downward through the soil around the electrode, thus taking the most effective position for reducing the resistance. Fifty pounds of crystals placed at the top of the soil in this fashion will have an effective life of two to three years for the first treatment. Subsequent treatments show longer life than this.

The resistance measurements which form the basis for this discussion were made with direct current, and it should be realized that the r.f. resistance of the ground may be quite different from the d.c. resistance. It seems logical to suppose, however, that the benefits obtained by these methods would be applicable to radio frequency.

Receiver "B" Supply Without Plate Transformer

Fig. 6 is the diagram of a "B" eliminator which requires no plate transformer and will at the same time deliver about 250 volts for a receiver or low-power oscillator. A transformer with two separate filament windings or two filament transformers will be necessary, however, although even these can be eliminated if Raytheon rectifiers are used. The v.t. rectifiers may be '80's with their plates tied together or any of the receiving tubes with grid and plate tied together.

The circuit is arranged for voltage doubling, with a filter which is quite ordinary in other respects. Three resistors comprise the voltage divider, the taps being placed to take off the

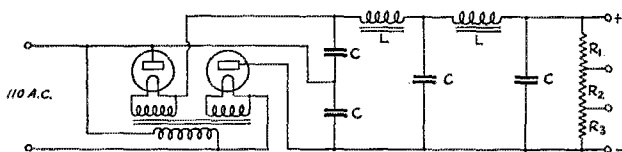

FIG. 6 — "B" SUBSTITUTE WITHOUT HIGH VOLTAGE TRANSFORMER

C — 8- μ fd. electrolytic filter condenser.
L — 30-henry choke.

R₁ — 20,000-ohm, 2-watt resistor.
R₂ — 7,500-ohm, 2-watt resistor.
R₃ — 10,000-ohm, 2-watt resistor.

correct voltage for the screen grid of the detector and the screen-grid of an r.f. amplifier.

One caution: a direct ground cannot be used on the receiver. To do so would short-circuit one rectifier tube or put the 110 volts directly across one filter condenser, depending upon which side of the a.c. line is grounded. The receiver ground should be made through a large condenser (paper type) of 1 μ fd. or so.

Direct-Coupled R.F. Amplifier

The circuit of Fig. 7, used by H. A. Erickson, W9EVI, of Ishpeming, Mich., is unusual in that direct coupling is used between the buffer and final amplifier somewhat in the style of the Loftin-White audio system.

The oscillator is a high-*C* Hartley with a Type '45 tube, shunt fed. It is coupled to the buffer, another '45, with series grid feed. Separate filament supplies for each of these tubes permit the

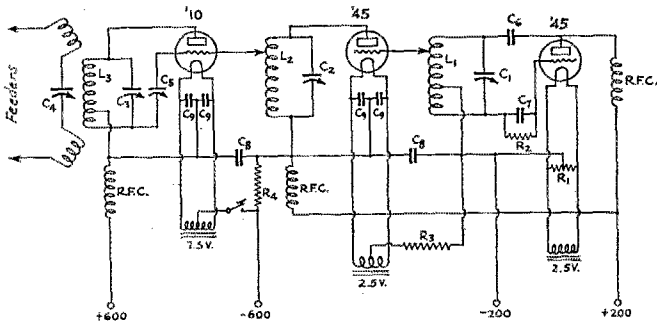

FIG. 7 — R.F. AMPLIFIER WITH DIRECT COUPLING

- | | |
|--|---|
| C_1 — .001- μ fd. variable. | R_2 — 50,000 ohms. |
| C_2, C_3, C_4 — 350- μ fd. variable. | R_3 — 1000 ohms. |
| C_5 — 100- μ fd. variable. | R_4 — 15,000 ohms. |
| C_6 — .002- μ fd. fixed. | L_1 — 7 turns No. 8 wire on 3-inch dia. |
| C_7 — 250- μ fd. fixed. | L_2 — 12 turns same. |
| C_8, C_9 — .002- μ fd. fixed. | L_3 — 14 turns copper tubing, 3-inch dia. |
| R_1 — 20-ohm c. t. resistor. | |

The coil specifications are for 3500-kc.

use of resistor R_4 to provide grid bias for the buffer tube. The oscillator works permanently on the 3500-kc. band, the buffer tank coil being changed for either 3500- or 7000-kc. work. A 200-volt power supply handles both these tubes.

As Fig. 7 shows, the grid of the final amplifier, a Type '10, is coupled directly to the plate tank coil of the buffer, which places the buffer plate voltage right on the amplifier grid. The bias on the grid of the amplifier is not positive, however, because the filament is supplied from a separate source and the 600-volt power supply which furnishes plate current for the amplifier is well insulated from the negative side of the 200-volt supply. Thus there is series feed on both the buffer plate and the amplifier grid. The remaining points about the circuit should require little comment.

Tuning and operation should be about the same as with other circuits. W9EVI tried using a 45-volt battery as bias on the final amplifier, in addition to the 15,000-ohm grid leak, but found that the latter alone gave about the same results. Inputs as high as 50 watts have been used on the amplifier, with good r.f. output to the antenna. The signal from the rig is nearly always reported "crystal d.c."

Although not shown in W9EVI's diagram, it is

probable that the buffer tube will require neutralization when operating on 3500 kc.

Strays

If small copper tubing has a tendency to flatten when wound on iron pipe, the flattening can be prevented by filling the tubing with fine dry sand or grit before winding. It is an easy matter to shake the sand out of the coil after it is wound.

— W4WO

While trying to get a really symmetrical layout of parts in a low-power push-pull oscillator, VE3ZB hit upon the stunt of interchanging the grid and plate leads in the base of one of the tubes. In this particular case the tubes were '45's, and the crossed leads were insulated from each other by spaghetti tubing. This allows the sockets to be mounted with the filament terminals facing and avoids crossing the wiring.



CLASS B AUDIO INVADES THE SUPER-POWER FIELD

Here is the 44-k.v.a. (conservative rating) audio-frequency transformer being used experimentally at KDKA in a Class B modulator that works on the final r.f. power amplifier of a 50-kw. "plus" transmitter. It was designed by ex-ham John A. Hutcheson, now with Westinghouse at Chicopee Falls, Mass., former holder of several "9" calls out North Dakota way as well as of a "W1" — and threatening to resume ham activities as soon as the new "YF" can be persuaded.

• I. A. R. U. NEWS •

Devoted to the interests and activities of the

INTERNATIONAL AMATEUR RADIO UNION

President: H. P. MAXIM

Vice-President: C. H. STEWART

Secretary: K. B. WARNER

Headquarters Society:

THE AMERICAN RADIO RELAY LEAGUE, West Hartford, Conn.

MEMBER SOCIETIES

American Radio Relay League
Asociacion E. A. R.
Associazione Radiotecnica Italiana
Canadian Section, A.R.R.L.
Deutscher Amateur Sende-und-Empfangs
Dienst
Experimenterende Danske Radioamatorer

Lwowski Klub Krotkofalowcow
Nederlandsche Vereeniging voor In-
ternational Radioamateurisme
New Zealand Association of Radio
Transmitters
Norsk Radio Relé Liga
Radio Society of Great Britain
Rede dos Emissores Portugueses

Reseau Belge
Reseau Emetteurs Français
South African Radio Relay League
Suomen Radioamatööriili to r.y.
Sveriges Sandareamatorer
Union Schweiz Kurzwellen Amateure
Wireless Institute of Australia
Wireless Society of Ireland

Conducted by Clinton B. DeSoto

THE I. A. R. U. has selected its delegation to Madrid. The names of the delegates, three in number, can now be made known, as promised in these columns last month.

Heading the delegation will be Kenneth B. Warner, the Union's secretary and leader of the A.R.R.L. representation as well. The representative of the R.S.G.B., at this writing scheduled to be Arthur E. Watts, G6UN, and the president of the Spanish section, Mr. Miguel Moya, will be the other delegates.

While the delegation proper has been selected by vote by the Union member-societies, they will undoubtedly be assisted by amateurs of other countries who are now planning to be in Madrid for the conference.

Plans for the amateur campaign are now being made insofar as possible by correspondence between our representation, to be solidified when personal contact becomes possible upon the for-gathering of the amateur delegation in Madrid around the first of September.

Other decisions of importance have been reached by the Union as a result of its recent vote. The Suomen Radioamatööriili to r.y. (S.R.A.L.), national amateur society of Finland, has been elected to Union membership, as will be seen by the inclusion of its name upon the roster at the head of this department. The twentieth member of the Union, the S.R.A.L. joins our ranks at a time pregnant with significance to the entire world of amateur radio, and the adding of its strength to our organization will be welcomed not only by the other member-societies of the Union, but by amateurs everywhere.

An amendment to the constitution of the Union is the remaining recent significant action voted by the members. This amendment provides for the submission of annual reports on their activities and the progress of amateur radio in their countries by the member-societies. Not only will this action improve the stock of information maintained by Union headquarters concerning the conditions affecting amateur radio in the various principal nations of the world, but the interchange of this information between countries via the medium of the I. A. R. U. Calendar will aid in bringing better international understanding and greater society amity than even that desirable state which has existed in the past. Publication of the first group of these reports will be eagerly awaited by amateurs of all countries.

Changes in the U. S. postal rates which went into effect July 6th make it necessary to modify to a certain extent the table appearing on page 42 of the June issue of QST. The changes are minor, being simply the substitution of the new 3-cent rate for the 2-cent rate in every case where the latter figure appears under the "Letter Oz." heading. No other alterations have as yet been made; foreign and post card rates remain the same as they have been.

Accompanying the noted Prof. Piccard, Belgian physicist, on his second balloon ascent into the stratosphere to be attempted this summer, will be the young Belgian scientist and radio amateur, Max Cosyns, B9. The original balloon flight, made last summer, in which Prof. Piccard reached

a height greater than ever before attained by man, will be remembered by all readers of the daily press.

The present ascent is of particular interest to the radio fraternity in that radio equipment is

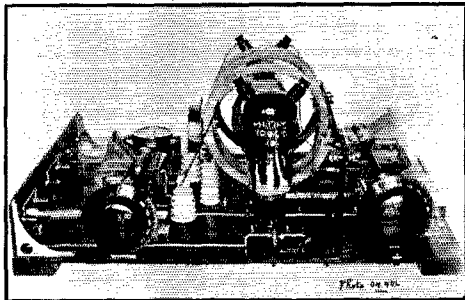

THE TRANSMITTER WHICH WILL ACCOMPANY MAX COSYNS ON HIS FLIGHT INTO THE STRATOSPHERE, IT IS HOPED HIGHER THAN HAS EVER BEFORE BEEN REACHED BY MAN

Using a pair of Philips TC 04/10 tubes operated at 500 volts, the nominal input rating is 50 watts.

to be taken aboard the metal-shelled balloon, and test contacts will be made during a considerable part of the ascent. It is hoped that amateurs not only in Europe but throughout the world will maintain a watch for these signals when the attempt is made, reports Paul de Neck, ON4UU.

No date has been set as yet for the attempt, nor are the transmitting frequencies known, but this information will be broadcast as widely as possible throughout the world when it is available. The headquarters of the various national societies will be informed so as to have the details available for distribution to their members; special announcements will be transmitted from ON4UU on 7 mc. at 1800 and 1830 G. C. T.; in the United States special W1MK and O.B.S. broadcasts will herald the event. Consultation of the daily newspapers will undoubtedly provide information as to the time of the take-off, if not of the radio circumstances.

The Transmitting Amateurs of France and the R.E.F.

By J. Lefebvre, President-Fondateur

(This concludes the narrative account of French amateur radio begun in the July issue of QST, and represents a complete résumé of the modern, or high frequency, period of the radio development in France. — C. B. D.)

ON the night of November 25-26, 1923, Mr. Deloy (8AB), having arranged a schedule with an American amateur, sent out his first signals on the wavelength of 100 meters, and was immediately heard across the ocean. Two days later 8AB succeeded in establishing the longest distance two-way radio communication on short waves with this same American (Fred Schnell, 1MO).

This contact was maintained for a fortnight at the request of military authorities, whose interest had been aroused by these tests, and it proved, conclusively, the utility of the hitherto insignificant short waves.

On Dec. 16th Mr. P. Louis, 8BF, established two-way communication with another American amateur working with a power of only 80 watts on a wavelength of 108 meters. This was due, in part, to the cooperation of Mr. Deloy, who had requested his American friend to be on the alert for the signals of 8BF.

The fourth series of transatlantic tests was held in December, and the transmitting was done entirely by the Europeans. Practically all chose to transmit on the usual longer wavelengths, that is, in the neighborhood of 200 meters. Messrs. Deloy and Louis, however, transmitted in the 100-meter band and achieved such remarkable results that many others followed their example and were equally successful. It was the unusual interest manifested in these tests that brought about the development of the short waves.

While technicians concentrated their efforts on this new branch of radio science, amateur radio was gaining in great strides in France and the number of privately owned stations increased daily.

In April, 1924, Mr. P. Louis succeeded in establishing the first contact between France and America on telephony, using the same power of 80 watts and the wavelength of 108 meters. During July and August broadcasts made on a wave length of 44 meters, at the request of military authorities, were received all over Europe and in America in code, and telephony as far as Syria.

In October, 1924, Mr. Louis established the first two-way communication between an amateur in France and one in New Zealand (Mr. Bell, 24AA), through the courtesy of Mr. Menars, whose excellent reception at Pau made it possible to receive the signals of Mr. Bell and relay them to 8BF, who had not the time to build an adequate receiver.

At the beginning of 1925 Mr. Lefebvre, 8GL, proposed a move that was dear to the heart of every French amateur. He suggested, and founded, in France, an association of amateur transmitters. A pamphlet, prepared by Mr. Lefebvre and eight other amateurs, was sent on March 26, 1925, to the press and to all persons interested in short waves. This invitation on the part of the "8's" was a general call to all French amateurs to join the association. Many enthusiastic and encouraging replies were received.

The Easter Congress of 1925 met at Paris and agreed to lay the foundation of the International Society of Amateurs. Permission was granted to the "8's" to group themselves into a society and they were encouraged to make the acquaintance of their foreign friends. During the congressional

session at which amateur delegates representing numerous countries met at the various assemblies and furthered friendships that had been made by radio the International Amateur Radio Union was virtually formed. The enthusiastic support of all present made the Union possible. The "8" members present were sufficient in number to form the French section of the International Amateur Radio Union and this move was proposed after the status had been voted upon, toward the close of the meeting.

The following officers were immediately elected:

President, Mr. Lefebvre, 8GL

Vice-President, Mr. LeBlanc, 8DE

Secretary-Treasurer, Mr. Audureau, 8CA

The French section was the second group (after the A.R.R.L.) to enter the Union.

The first General Assembly of the French Society was held at Paris on May 30, 1925. The purposes of the Association were outlined as follows: Union of all amateur transmitters and persons interested in the development of short waves. Protection of their interests. Adequate representation of French amateurs at home and abroad, and the offer of every possible means of help in developing the science of amateur radio both in France and in her colonies.

The committee was composed of recognized amateurs, elected by members of the Association who had no connection whatever with the press or commercial radio. They received no remuneration from the Society. After making known the status of these individuals the Association, through its President, became affiliated with the public services (Interministerial Commission of T.S.F.) and proceeded to a vote on its rules and regulations. The Association took the name "Reseau des Emetteurs Français" (Society of French amateurs) and adopted "Le Journal des 8" as its official organ. The R.E.F. was officially recognized by the Police Commissioner of the Seine district on May 30, 1925.

At the General Assembly of July 19, 1926, the President announced that a membership fee of one dollar would be imposed upon each individual. He also declared that the Union would be composed of a number of societies from various countries. This suggestion was met with universal approval and contributed largely to the advancement of the "R.E.F."

In October, 1926, Mr. Levassar, 8JN, Communications Manager, organized routes for the maintenance of traffic with distant countries, conditions permitting. Levassar organized contacts with New Zealand, Indo-China, Saigon, China and California. Reyt, 8FD, Hoffmann, 8KF and Ternynck, 8FC, took charge of contacts with Hawaii, Shanghai, Hongkong, United States, Philippines and Saigon. This group, under the guidance of 8JN, contributed in no small manner to the development of amateur communication in France.

In January, 1927, at the suggestion of Mr. Larcher, France was divided into districts. Metropolitan France, the colonies and protectorates each constituted a section, at the head of which was a representative appointed by the Board of Directors.

Up to this time service on QSL cards was rendered among French members by Mr. Veucelin. Now the Society, in league with Mr. Veucelin, extended this service to foreign amateurs. This service has always been rendered by Mr. Larcher, 8BU, and is appreciated by the members for its real value to them.

At this time the amateurs were authorized to use bands below 200 meters, with some restric-



CTICB, OWNED BY ANISIO SOARES, IS LOCATED AT 26 R. NOVA DOS ARCOS, PORTO, PORTUGAL

The transmitter employs the Colpitts circuit, 50 watts input, and works on 7 and 14 mc. W8DYU is the best DX on 'phone.

tions. The power was not allowed to exceed 100 watts.

On the 12th and 13th of April, 1927, Mr. Levassar, 8JN, organized transmitting and receiving tests in the mines of Charbon de Bruay (in the North), and on May 15th Mr. Ternynck began a study of underground transmission in the stone quarries of St. Gobain (Aisne). The tests were highly successful.

In accordance with the desires of the I.R.C. (at Washington) in 1927 the amateur wave bands were changed. In a spirit of perfect coöperation we accepted the wavelengths allotted to the amateurs and their work.

A tax of 200 francs was levied on each amateur transmitting station, and suggestions were made to the Board of Directors of the P.T.T. for a reorganization of present conditions.

On July 23, 1928, the hydroplane *Le Fregate* attempted a transatlantic flight, but was forced down in the Azores. All messages were received by members of the society and relayed to their proper destinations.

In October, 1928, the society was requested to get word through to the party of the *Gen. Laperriere*, an airplane that had set out for Madagascar

and was forced down, by accident, in the center of Africa. Practically all of the messages were received in spite of the difficulties encountered in reception. The remarkable results obtained during this emergency (with the assistance of Mr. Levassar, 8JN) brought to the realization of the authorities and the general public the great usefulness of amateurs and furthered interest in their work.

These same amateurs made another important contribution to the science of short-wave broadcasting during the tests undertaken by the National Meteorological Office. The Navy received the collaboration of amateurs in following the manoeuvres of the cruiser, *Jules Michlet*, in Japanese waters. Communication was constant in spite of the limited apparatus on board.

On the 1st and 2nd of June the Society held its first convention in Paris. In September and October the R.E.F. took part in the International Exposition of T.S.F. and arranged a public demonstration at the "Magic City" of amateur work and the reception of American broadcasting stations.

In November, 1929, at the suggestion of Mr. Veuclin "Le Journal des 8" ceased to be the official organ and in its stead the first official bulletin of the R.E.F. was issued to all Association members. It appeared bi-monthly, and contained 2, 4 or 8 pages devoted exclusively to information regarding the Society. Despite its modest beginning it soon became the only contact point between members of the Association.

In December, 1929, the airplane, *Fajhu*, piloted by a departed fellow-member, Mr. LeBrix, took off from France in the direction of Indo-China. An accident put an end to his flight. Almost all messages sent out were received directly by members or were relayed to them by other stations on the alert for signals. In spite of the many difficulties encountered in receiving, admirable contact was maintained between the ground and the plane in flight. Any number of tests were made by members of the R.E.F.

Mr. Tousson made an investigation of the 10-meter band and established the first DX contact, on this wavelength, with Mr. Auschitsky, SCT.

On May 30-31 and June 1, 1930, the Second Convention of the French amateurs was held at Paris. Mr. Lucat, 8LU, was appointed Treasurer at this assembly. In September, 1930, Mr. Bastide, 8JD, founded the "Emergency Unit" for the purpose of uniting many French stations in various sections and training them in the methods of handling traffic quickly and efficiently so that they could be called upon in case of necessity. The "Emergency Unit" has never ceased to function regularly and has, in many instances, rendered invaluable service.

The Society's official organ, "R.E.F.," was improved considerably in November, 1930. A col-

umn, "Radio R.E.F.," was introduced which recounted the activities of the foreign as well as the French amateurs.

The Association took part in the Colonial Exposition at Paris and presented an excellent argument in favor of the development of amateur radio and its usefulness in the colonies. The "Grand Prix" rewarded their efforts.

The General Assembly of 1931 proposed an important change in the statutes of the Association. The Government of the Society was put into the hands of a Board of Directors comprising 18 persons named by members. Each district had at its head the delegates elected by the members in that district.

Conditions regulating amateur transmissions in force in France are as follows:

License Fees:

- Up to 50 watts — 100-francs per year.
- From 50 watts to 100 watts — 150-francs per year.
- From 100 watts to 1 kilowatt — 200-francs per year.
- Above 1 kilowatt — each kilowatt or a fraction of kilowatt — 200-francs per year.

The above tax is levied on all amateur stations working exclusively in the handling of amateur traffic and having no connection whatever with work of a commercial nature.

A limited power of 100 watts was permitted on the bands allotted to the amateurs at the Washington Conference, as follows:

5	-	5.35 meters
10	-	10.70 "
20.8-	21.4	"
41	-	42.8 "
75	-	85 "
150	-	175 "

French amateurs have been making real efforts to improve their apparatus technically. On the advice of the Technical Information Service of R.E.F. amateurs have begun to use stabilized quartz crystal oscillators more frequently which, with the use of monitors, improved modulation in radio, better antennae telephony, careful frequency observance, all helped to build up this new amateur technique.

The Society, in league with other European groups, has instituted regular broadcasts to distant countries.

In February, 1932, the Association mourned the death of General Ferrie, Honorary President of the Society, who had always shown a most active interest in our work.

In April the Secretary recorded the 1700th membership subscription. The growth of our R.E.F. has been steadfast and sure, and in our new strength we hope to maintain the traditions of amateur service in France and throughout the world upon which we, and with us the I. A. R. U., were founded.

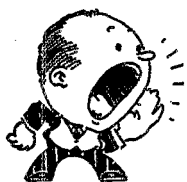

CALLS HEARD

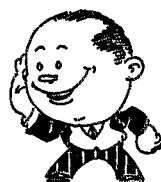

KAINA, D. C. Redgrave, Olohago, P. I.

ac2rt ac3ma ac6aa ac6zz ac8ar ac8al ac8em ac8go ac8hr
 ac8js ac8na ac8sd ac8vg ac8we ac8zt ac8zw ac9dt ac9gh
 ac9js ac9zh aulcz au3ea au3et au8kal cf12 ear10 ear74
 ear96 ear116 ear224 ear226 eu2nx gl3ct haf9af hb9q jlet
 j1dh j1dm j1dm j1dr j1ee j1ek j1ep j1eq j2eb j2ty j3de
 j3dh j3di j3dm j3pk j5cc j5ce j5ef j6ca k6alm k6bmy k6gf
 k6vz ob2sk om1tb om1ms om2dm om2rc om2tg on4rm
 pk1ac pk1bu pk1ef pk1jr pk3bm vk28q vk3pr vk4er vk4da
 vk4ja vuleh vk2br vk2bq vk2gn vk2or vk2dm vk2dw
 vk2fq vk2gl vk2gr vk2kg vk2hg vk2hl vk2hq vk2hw
 vk2hx vk2jz vk2lv vk2lx vk2mw vk2nr vk2ns vk2oc
 vk2ok vk2ou vk2oz vk2ps vk2pv vk2pz vk2rk vk2sg
 vk2tm vk2wz vk2xu vk2yz vk2zn vk2zw vk3aj vk3cx
 vk3dt vk3dw vk3ek vk3fm vk3fq vk3gr vk3gw vk3jf
 vk3ka vk3kr vk3lp vk3lq vk3lz vk3ml vk3mr vk3or vk3ou
 vk3pf vk3pr vk3qk vk3rg vk3rl vk3tm vk3uk vk3wk
 vk3wl vk3wm vk3wx vk3wy vk3wz vk3xf vk3xi vk3zb
 vk4ba vk4eb vk4ju vk4pr vk4xn vk5aj vk5am vk5av
 vk5aw vk5ax vk5bo vk5do vk5dx vk5gw vk5hg vk5ju
 vk5lo vk5lg vk5mb vk5mk vk5ml vk5mx vk5my vk5pk
 vk5qr vk5rh vk5ux vk5yk vk6ag vk6bn vk6bo vk6dh
 vk6fl vk6fm vk6fz vk6gf vk6hl vk6jk vk6jt vk6lj vk6lx
 vk6mn vk6nj vk6or vk6ow vk6rl vk6rm vk6rw vk6sa
 vk6vi vk6xf vk7ef vk7eh vk7ge vq3msu vs1ad vs1vr
 vs2af vs3ac vs3vr vs6ad vs6ab vs6af vs6ag vs6ah vs6al
 vs6an vs6ao vs7ar vs7gj vs7gt vs7ks vs7nx vu2bg vu2ca
 vu2kh w4ft w6ac w6acv w6adx w6af w6afh w6afz w6agf
 w6ahz w6akb w6alu w6am w6amm w6an w6aoa w6aor
 w6apd w6atv w6avj w6awo w6awy w6ban w6bbz w6bec
 w6bdd w6bjz w6bpc w6brv w6bsf w6bsj w6bt w6buo
 w6bzi w6by w6byj w6cal w6caz w6ceo w6cew w6cmq
 w6cab w6cuh w6cul w6cvi w6cvm w6cox w6cyy w6czz
 w6dep w6dep w6dfo w6dio w6djp w6dkw w6dll w6dxm
 w6daz w6daz w6edo w6egh w6eij w6eje w6em w6eme
 w6exq w6eyo w6fef w6fgq w6hm w6ktg w6li w6maw
 w6mv w6qu w6qw w6ro w6ry w6rz w6sa w6sn w6so
 w6tm w6u w6vb w6vo w6w w6wo w6wx xz1yj z1lar
 z12be z12bh z12bo z12cj z12fi z12go z12ha z12jk z13aq
 z13bn z13ct z14ai z14z z52a z52f z52j z55m z55u

VK6KZ, R. A. A., Barracks, Albany, West Australia

From March 19th to April 13th, 5.30-7.30 a.m. E.S.T.

7000-ke. band

w2cjm w2doy w2box w3la w3bgl w3ajx w3chu w3md
 w3zk w4ax w4bcb w4tn w4abi w5bjh w5aqk w6so w6etr
 w6eel w6bq w6erm w6bnd w6had w6age w6ocq w6ano
 w6amo w6dgn w6bny w6cww w6hs w6btu w6do w6jl
 om2tb om2tm om2tg kalhr kalcm k6alm k6avi k6ad
 z12eb z13pk z13ct z14bb

WSEZ, Thomas Hale, 1814 E. Colvin St., Syracuse, N. Y.

7000-ke. band

w6acl w6aah w6ahz w6aor w6apd w6arz w6atj w6ayi w6bax
 w6bbz w6bgn w6bif w6bjz w6bjf w6bkr w6bnn w6bqp
 w6bsz w6buo w6bur w6by w6cae w6caz w6cda w6cfl w6cnd
 w6coe w6col w6coq w6cvi w6cxj w6cww w6czk w6dak w6dc
 w6dde w6dep w6der w6deu w6dew w6dfo w6doh w6dou w6dow
 w6dqj w6dsz w6du w6dvw w6dwa w6dlw w6ech w6efr
 w6egh w6ego w6ehy w6eij w6ele w6eni w6erz w6ear w6eub
 w6eun w6ewk w6exq w6eyc w6elu w6fff w6fen w6flc w6gn

w6io w6lo w6kn w6qu w6wp w6zsz w7aby w7aco w7aho
 w7aea w7brm w7btz w7bvm w7ib w7pk w7vt k4ajp k4rk
 k4wr k5aa k5ab k5ac k6gi k6bmy k6cqs k6etf j7boy
 em2ay em2fc em2fn em2gu em2jm em2na em2op em2sv
 cm2wd cm5fl ear38 ear96 ear201 ear209 ear224 ear227
 helfg he2ea hb7c h8x hilly j1dm ti3la vk2ba vk3zw vk3rs
 vk3bj xlajd xblia x1aa x1m x1n x1u x2h x5c z1lcc z1lck
 z12ab z12be z12ci z12do z12fa z12ga z12gw z12hz z12kx
 z12ws z13ao z13cc z13cu z14ai z14au z14db z14ip zult

DEO1G5, ex-D4HL, Kurt Jling, RCVR: 1-V-P, Leipzig N 25, Kieler Str. 4

w1ajl w1arb w1axa w1axx w1azl w1bnj w1cmx w1cpt w1fs
 w1iwe w1ls w1mi w1vp w1wa w1yu w2adp w2ajx w2akk
 w2aog w2arb w2awz w2bro w2bjo w2bks w2btw w2bug
 w2cjh w2cgb w2cjr w2cis w2cpx w2crb w2djo w2mj w2mt
 w2rs w2tp-w3adm w3ajd w3anh w3bhv w3buf w3cfd w3cm
 w3jx w3la w4eg w4ei w4hz w5eg w6vvt w6dk w6wo w8bl
 w8cjr w8cp w8dd w8erf w8ga w8sf w9adm em2vm
 em5fg em5ry em8by emyb ce2ab cx1bu cx1pl hc1yr hc2ea
 hh7c k4aop k4ry lu3de lu4kc pylcm pylff pylay py3aj
 f3tp ve1bi ve1bt valdg ve2b ve3he ve5fx vo8lc vo8mc
 vo8zn ys1ml yv3lo

W1BIS, J. A. Baker, 120 Myrtle St., Claremont, N. H.

14,000-ke. band

ce1ai ce3ag ct1ay ct1bg ct1cb d4jpc d4poj ear96 ear121
 ear185 ear224 f8cla f8gi f8tv fm8cr g2bm g2by g2dh g2dw
 g2fn g2gf g2nu g2oa g2oc g2os g2pz g5bv g5bz g5ju
 g5la g5ml g5qa g5rb g5r g5sy g5vb g5vp g5wk g5wn g5xn
 g6bm g6jg g6py g6rb g6vw g6xn g5qx haf3vr helfg h1jak
 hk1s k5aa k5ab lu2ca lu4nde nylaa nylab oa4ag oa4v oa4z
 ok2op ok2va on4fe on4gn on4nc pa0ms pa0xf py1dy py2az
 py2bk py2bm py2bn py2bq rx1aa sm1zh ti2ags ti2db ti2rc
 ti2tao vp2ja vp2mr x3a x10a yv3lo

W6EQV-W6FSM, Frank D. Craig, 2528 Piedmont Ave., Berkeley, Calif.

au1nek ce3ag cm2fn em8yb helfg hb7c jlet j1dm j1dn j1do
 j1dv j1ee j1ei j1eo j1ep j1er j2ce j3ct j3cr j3de j3dp j3du
 j6ce j6cg j7cf k6as k4aan k5aa k5ab k5ad k6ain k6aiu k6aja
 k6alm k6arb k6auq k6avi k6baz k6bmy k6boe k6cab k6cbj
 k6cib k6cqs k6dv k6ebr k6fab k6pmm k7atd k7atf k7bmc
 k7bnd k7ff kalcm kalcu kalgc kalhr kaljr kallg kalna
 kalpr kalto ka3aa lulba nylaa om1tb om2tg pktlv ti3la
 ti3za vk2az vk2br vk2fr vk2go vk2hg vk2hl vk2ia vk2nr
 vk2oc vk2oj vk2ou vk2pr vk2px vk2zw vk3bj vk3bv
 vk3es vk3ek vk3gp vk3je vk3lq vk3pr vk3rg vk3rj vk3rs
 vk3tm vk3tz vk3vp vk3vl vk3vw vk3xi vk3zb vk3zm
 vk3zw vk3zx vk4ag vk4eb vk4gk vk5hg vk5mb vk6mu
 vk6wi vk7jw vs2ah vs6ag vs6ah vs6an x1aa x1u x9a x26a
 x28t x29a x29b ylnic z1lar z1bg z1lck z1len z1ler z1lep
 z1lq z12ab z12be z12ci z12cj z12ga z12gk z12gh z12gq
 z12gw z12je z13aw z13ax z13az z13cc z13cl z13ct z13cx
 z13gw z14ai z14am z14ao z14ap z14ba z14bb z14bt z14ck

W3WN, Edward J. Daugherty, P. O. Box 242, Frederick, Md.

7-mc. band

w6adk w6and w6bjf w6cww w6dcj w6dep w6tm w7bfn
 ve2dq ve3kj ve3mr ve4he k6ph k6rl k6avi lu9ax cm2amm
 cm2gr cm2ga cm2wd cm5fl cm6cp ear28 ear86 ear96
 ear227 x1aa klax x1dx vk2hq vk3hl

THE COMMUNICATIONS DEPARTMENT



F. E. Handy, Communications Manager
E. L. Battey, Assistant Communications Manager

"10% Station, 90% Operator"

By Harry Ginsberg, W3NY*

A WISE OM said once that most "lids" were "lids" not because of "cussedness," but because they just didn't know the right way to send, and because no one was there to tell them that way. This is all too true.

A chap near my frequency called me one night for six minutes. Boy, I thought the steam gage would burst that night. I told this chap plenty and followed this up with a letter, telling him how he might judge the length of his calls, as well as his CQs. His reply showed clearly the truth of the above. The operator didn't know how long to call or send CQ; no one had ever explained it to him. My method, as will be disclosed below, and based on my own experience, has always resulted in more "QSOs per hour," better QSOs, and less cost for power and equipment per QSO.

There is no reason for any CQing to last longer than one minute. My general calls, usually repeated four times, are made up as follows, "CQ CQ CQ CQ de W --- . W --- ." and the call signal is also sent four times on the last round. Besides giving a greater percentage of contacts for each "CQ," a limitation of CQs will make available for more valuable material, space usually devoted in QST to printing those wails and growls against the long CQer.

When sending a directional "CQ," be sure the direction goes between the last "CQ" and de of each round. Confusion often arises when "CQs" are sent *after* the direction, and just before "de," for anyone happening on this call on its last transmission will think it a general "CQ" and answer regardless of his direction.

In answering a CQ, the length of the call will depend somewhat on the difference between your frequency and the frequency of the station called, since operators habitually start listening near their own frequency. A monitor or frequency meter will help in judging how long it will be necessary to call. To eliminate all unnecessary calling and raise stations as quickly as possible, "break" or pause briefly (after a "sine") and listen for the answer to your call. You will thus receive a reply as soon as you have been heard. When evident that no answer is forthcoming, the call may be continued — or if you hear the station called answering some other station, you should stand-by until the station is free again, to listen for your calls.

It is the proper procedure to "cover" the band after each "QSO," to look for any station that may be calling you. To inform him that you will do so, at the end of your "QSO," send "QRZ?" once or twice, adding 3900 or 3500 (7300 or 7000), so he can judge how long he should call you. This will save you many a "CQ," give you more "QSOs," and give the other fellow a chance. Let's all pull together, fellows, in order that we may all get the most enjoyment out of our Amateur Radio.

* SCM Maryland — Delaware — District of Columbia Section A.R.R.L., 2305 North Pulaski St., Baltimore, Md.

PRIZE ARTICLE

The following contribution by Mr. Rus Sackers, W8DED, wins the C.D. article contest prize for this month and we believe all DX-minded hams will appreciate the suggestions for working DX. Contributions by Mr. Abbott, VK2YK, and Mr. Krim, W1BKD, are presented in addition, and receive honorable mention.

Your articles on any phase of amateur communication activity are likewise solicited. Each month the prize winner has his choice of three selections of prizes. See page 45, June, 1932, QST, for more complete details of the article contest. Send yours to-day. — F. E. H.

How to Work DX

By Rus Sackers, W8DED*

UNLESS a fellow can work a bunch of DX he usually thinks his transmitter is not perking. In many cases he has the transmitter working but he hasn't the receiver to hear the DX. This he usually blames to the conditions which in most cases is not the fault at all.

The good DX man can work it in most any place. Unless a fellow goes at DX correctly he will find his percentage of contacts rather low. The first essential in DX work is a good receiver, one with high selectivity, good band-spread and a low noise level. Secondly his transmitter must have a high quality, stable signal. The station must have a good antenna system. Many high powered sets never reach out due to the fact that the antenna is not tuned correctly, or is not in the open to permit proper radiation. DX work to-day is more of an achievement than ever. The steady increasing numbers of new hams make QRM very bad. The DX hound must learn to read weak signals through stronger signals.

The 14-mc. band is the best bet for DX. Skip distance makes local QRM less and hence makes DX more enjoyable besides more possible. 14 mc. is used for DX into Europe, Africa, South America and Asia. The 7-mc. band is best for early morning work with Australia and New Zealand.**

A fellow may have to try perhaps a dozen times until finally he finds conditions right and DX comes his way. Usually you can tell if DX conditions are right by listening to the other fellows. If they are calling DX then you should

* 53 East 7th St., Holland, Mich.

** See table of best times for DX on different frequency bands for different continents — for month of February, compiled at Schenectady, N. Y.

hear DX too. If no one is calling any DX, conditions for the time and frequency are probably poor. The number calling foreign stations is so great that perhaps the loudest American station calling gets the QSO or else the first one heard. This makes DX harder to work.

A foreign signal may have a peculiar hollow tone and the keying sound different than the usual style. Many American amateurs believe they can work DX by calling "CQ DX." This system invariably proves unsuccessful and is a waste of time as a rule. Practically all DX is gained by listening for the foreign station to CQ. Never get discouraged by not being successful in contacting DX. Some days it just can't be done, due to the fact that conditions are bad on the other end. Think of all the other fellows calling the foreign stations. Keep trying. You will be rewarded. If the foreigner seems to always get someone else your best bet is to keep listening until he sends his "sk" and then give him a buzz. It works!

Continents	BEST TIME FOR DX (E.S.T.)		
	14 mc.	7 mc.	3.5 mc.
Oceania	6-8 a.m.; 3-6 p.m.	Midnight-5 a.m. (or 3 to 5 a.m.)	Mid. (or 2 A.) to 5 a.m.
Asia	11 p.m. a.m.; 7-9 a.m.	3-5 a.m.	3-5 a.m.
So. America	1-5 a.m.; 2-4 p.m.	5 p.m. to 3 a.m.	5 p.m. to 1 a.m.
Europe	1-4 a.m.; 2-4 p.m.	5-11 p.m. (1)	5 p.m.-10 (1) p.m.
Africa	11 p.m. a.m.; 2-4 p.m.	5-10 p.m.	6-8 p.m.

The World's Loneliest Radio

By Roy E. Abbott, VK2YK*

LOCATED in the Coral Sea, about 400 miles east of Townsville, Queensland, is a small coral island about 500 yards long and 150 yards wide. This is Willis Island, the home of the world's loneliest radio station. On this island for a year at a stretch live two radio operators whose duty it is to observe the readings of weather instruments and transmit them to the mainland. By this means the weather bureau is able to forecast cyclone warnings, and weather forecasts at least 24 hours before they would otherwise be able to do so.

The station has been in operation about ten years. For the last couple of years the monotony has been relieved by the installation of an amateur radio station with the call sign of VK4SK. For six months the operators see no other human besides themselves and the only company is that of the terns, noddies and gannets which come to nest in thousands. (The birds return for the egg laying at the same time each year, within a day or two of the same date, year after year.) Amateur radio enables the operators to obtain news of their friends and relatives and it is the pleasing duty of VK2YK to handle such news, weekly. The transmitter at VK4SK is a T.P.T.G. using about 100 watts to a DET 1 tube. The power supply consists of a petrol driven generator and the QRI is a typical 500 cycle note as used by short wave marine stations. Work is done on the 3.5-, 7- and 14-mc. bands and American listeners would do well to watch for this station on 7 mc. each Wednesday at 7:15 p.m. Sydney time and on 14 mc. at 1:45 p.m. on the first and third Sunday of each month, throughout the year.

The island is surrounded by a coral reef, is 22 feet above sea level and has a shark proof bathing enclosure constructed by the operators. Spare time is spent studying, working amateur stations, playing golf with sticks and tennis balls and in swimming. As the temperature averages about 80° the latter is very popular and Willis Island fashions generally consist of shorts and singlets with perhaps a beard if the wearer prefers it to shaving.

How would you like to pound brass at a ham station like this? No local QRM or background! Look for VK4SK and work the world's loneliest amateur station.

* Park St., Dorrigo, New South Wales, Australia.

Balance Your Activities

By Norman B. Krim, W2AJP-W1BKD*

TOO many of our younger members are completely dominated by amateur radio; the ham game is not a hobby but a passion with many new brasspounders of high school age. When a hobby or even an education grows to the stage of totally mastering one's actions it no longer is desirable.

I remember vividly the many early mornings I crawled out of bed to the key to work DX with a heavily padded key. I can happily recall the days I remained home from school under one pretext or another just to work old W2AJP. Yet, I look back with horror at those hundreds of hours I spent at the key sacrificing all intellectual endeavors — for what — a high degree of operating proficiency and a filled log book! With perfect honesty to myself I derived but one material benefit aside from recreation. It was a healthy interest for radio in its engineering field. On the other hand, I feel that the hundreds of contacts were useless in this respect.

It is with this personal experience that I should like to warn the younger men. Don't lose sight of the whole scheme of society when you are bitten by this thing called the radio bug. As soon as you find yourself slipping in health or educational endeavor due to a perverted interest in what is a normal hobby to most hams — then have the foresight to break away until you once more regain equilibrium. If you hear "nk" at W1MX give him a buzz and we will compare our like experiences.

* 523 Newberry St., Boston, Mass.

BRASS POUNDERS' LEAGUE

Call	Orig.	Del.	Rel.	Total
W3CXL	207	384	1324	1895
KA1HR	349	260	536	1145
W7BB	381	411	370	1112
W9IU	85	57	394	1036
OMITB	287	129	276	692
W1VS	44	73	552	674
W3ADQ	330	335	2	667
W6PQ	357	133	176	666
W8DDS	31	167	336	534
W3OU	302	225	—	527
W3BWT	119	121	284	524
W6BTL	33	121	368	522
W1MK	86	181	247	514
W3NN	225	277	—	502
W6DQ	50	111	280	441
W6CDU	87	209	136	423
W6NFCFN	244	109	62	415
W6ADP	40	104	252	396
W8CKQ	150	104	6	260
W6AMM	124	131	4	259
W9GPB	47	103	86	236
W6YAU	35	120	10	165

Month of May 16-June 15. Note the stations responsible for above one hundred deliveries. Deliveries count!

A total of 500 or more *done* *file* messages handled and counted in accordance with A. B. P. L. practice, or just 100 or more deliveries will put you in line for a place in the B. P. L. Why not make more schedules with the reliable stations you hear and take steps to handle the traffic that will qualify you for B. P. L. membership also?

Official Broadcasting Stations

(CHANGES AND ADDITIONS)

Local Standard Time

W1APK	3800 kc. Daily 7:00 p.m.
W6BNA	3875 kc. Nightly except Sat. and Sun., 7:30 p.m. Also Sat. and Sun. when convenient.
W6CVZ	14124 kc. Daily except Sat. and Sun., 4:30 p.m.
W6EMK	14100 kc. Most any day between 7:00 and 8:00 p.m. and between 10:00 and 12:00 p.m.; Sun., between 10:00 and 12:00 a.m.
W8DBY	7080 kc. (c.c.) Daily except Tues., 7:00 p.m.
	7094 kc. (c.c.) Tues., 6:30 p.m.
W8EVC	Sun., 6:30 p.m.

W9AFQ 3915 kc. (Phone) Tues., Sat., 6:00 p.m.; Thurs., Sun., 6:00 a.m.
7150 kc. (CW) Tues., Thurs., 6:30 p.m.; Sat., 10:00 p.m.; Sun., 12:00 noon.

Traffic Briefs

A number of amateurs have asked the difference in use of QSV and QSY. We believe that this is indicated by examination of the exact wording of the definitions involved:

QSV? Must I shift to kc. for the rest of our communications, and continue after sending several V's?
QSY? Shift to kc. for the rest etc.
QSY? Must I send on kc. without changing the type of wave?
QSY? Send on kc. without changing the type of wave.

It should be noted that QSV specifies the use of the test signal, V, to help in the reestablishment of communication, also that this abbreviation does not specify whether or not a change in the type of emission, such as might be concerned by use of types* A1, A2, or A3 is involved. It is logical to assume that this should be the signal for amateur use when changing frequency into the phone band at the same time a shift from c.w. to 'phone is being made.

QSY, on the other hand, specifies definitely that which ever type* of emission is being used will continue in use with the specified change of frequency. Also since the use of V's is not specified it may be assumed that the transmission will continue without testing.

Whenever the contact is poor, frequency is to be changed, and it is desired that V's be sent, QSV is the signal to be used in accordance with the definition. For a slight change in frequency where no test to reestablish contact is necessary and the type of emission remains the same after as before the change in frequency, use QSY.

W3BAK's 7-year-old daughter, Jeanne Hudson, now in the second grade at school, can copy traffic solid at 12 w.p.m.; and words at 20 w.p.m. if double spacing is used between words. SCM Ginsberg (W3NY) witnessed Jeanne in the act of copying and says, "It's almost a revelation to see this child copy words she knows nothing of, not missing any letters, and spacing properly. OM W3BAK is an old Morse op; guess it's hereditary!"

THE ATLANTIS

The research ship *Atlantis* of the Woods Hole Oceanographic Institution (Woods Hole, Mass.) sailed last February for deep sea observations to collect data in line with the purposes of the Institution. The course, Woods Hole to Chesapeake Bay, to Bermuda, to Trinidad, to the Amazon River and to Para, Brazil, and return. Lester F. Boss, W1AXM, made arrangements whereby messages and news could be sent to it by amateur radio on prearranged schedule. The *Atlantis* carries no transmitting equipment. W1DBM, W1DFS, W1BR and W1MK all cooperated in transmitting messages to various members of the crew on schedule.

Lt. Commander Wm. Justice Lee, U.S.N.R., comments on 1750 kc.: "We agree with you it would be very desirable to make more use of the 1750-kc. band. In the bulletin issued by this office we will make mention of the desirability of using this frequency, particularly for local communication. It appears desirable that this band should be more fully occupied by amateur stations."

B. C. L.: "Say, I can hear every word you say on my radio. I'm listening to the football game."

W6Y: "So? Does it interfere a lot with your reception?"

B. C. L.: "No, I just came over to see if my listening-in would interfere with your operation over here."

Curtain!

* A1 — C.W. telegraphy.

A2 — Modulated c.w. telegraph.

A3 — Speech or music.

The thrill of a radio operator's lifetime, and one which comparatively few have experienced, came to W2DJA, a new ham, not long ago when he intercepted an SOS call on the 7-mc. band. He had just completed his receiver and was listening for receiving practice when he heard a station sending a string of SOS's . . . and then "de MVREX . . . off Sable Island, engines disabled, drifting southeast . . ." Immediately W2DJA reported what he had received to the government radio at Mitchell Flying Field. W2DJA says, "It was an exciting moment for me; and even before I had my license!"

WIBFS of Mystic, Conn., receives local W1CNC with neither headphones nor loud speaker — he gets CNC's signals through the output transformer of his receiver. 'Tis bad for the earphone manufacturers!

An important message from friends in Porto Rico relative to the serious illness of her husband was sent via K4RK-W2RD to Mrs. J. Lacayo, wife of the Venezuelan Vice Consul to the U. S. A. W2RD 'phoned the radiogram and had a reply within five minutes. A few days following, report of Mr. Lacayo's unfortunate death was sent by amateur radio via W2CNIH-K4RK, the time beating commercial cable route by over eight hours.

"This is the coffin of Johnny Jones,
What is left of him is in it.
He tested his input with his hands
— There is one born every minute."

— The Calgary Keaklix

With his wife confined to a hospital in Jamestown, 200 miles away, W9DM, Bathgate, N. Dak., needed some means of regular communication with her. How to do it? Amateur radio, of course! He arranged a daily schedule with W9EIG at Jamestown and was kept in constant touch with his YF. Bathgate does not have telegraph service on Sundays, so when a lil' YL operator was born Sunday morning amateur radio brought W9DM the news the same day, at 1:00 p.m. W9DM says he now has a good talking point for his endeavors to convert his YF to the ranks of the brasspounders.

W3ADI "takes a pass" at traffic handlers as follows: "Another thing I would like to 'kid' you traffic handlers about is the way in which you pass around the local messages until you find a 'sucker' who will spend the nickel for a 'phone call or three cents for a stamp. The other day I listened to fourteen 'message handlers' swap a local message all around the town. When I could stand it no longer I took the message and mailed it. Checking up on the men who handled it I found that six of them were within a mile and a half of the addressee, and I was completely across town." There is certainly a "moral" in W3ADI's remarks. Isn't it just this? — "Don't accept a message for your city or locality unless you intend to deliver it. The delivery is the final and most important part of message handling. Don't pass the buck. Deliver whenever you have the opportunity."

Commander G. M. Dyott, well known explorer, has written a book entitled "Manhunting in the Jungle." In this story there are several passages which every radio amateur should read and consider seriously. At one time Dyott's expedition was endeavoring to escape from a tribe of savages. The time arrived in their flight when the Commander decided they must abandon the heavy radio equipment. And so, with the savages following, no one knew how closely behind, the men set up their transmitter and endeavored to QSO the United States. After hours of listening with tropic static crashing in his ears, the radio operator heard a "four" in South Carolina, whom he called and raised. The explorers sent their position and told of the threatening danger. Then the ham came back with "OK OM. Glad to QSO. Hope cuagn." What a disappointment this was to these men fleeing from possible death! Luckily, after losing three days, another amateur who could copy the code was worked and the urgent traffic of the expedition forwarded. After reading this account you should stop and contemplate. Can you serve as any amateur should be able to? Could you give proper

assistance when in a similar position as that "four" mentioned above? Prepare yourselves for anything that may arise in the pursuit of your hobby, amateur radio. Make operators of yourselves and insure ham radio a place on the air forever.

The Nevada Amateur Radio Association has started a technical library for the use of members and others interested in radio. Books, periodicals and technical data have been compiled and are being segregated into files. It is expected that within a short time the N.A.R.A. will have one of the best technical libraries in the state of Nevada.

Referring to page 48, February QST, where we reported W1AUY had worked G2AY on 1750 kc., W1AUY writes as follows: "About my QSO with G2AY, I believe someone was having a little fun (if you could call it that). The reason is that I have received no QSL or other confirmation from G2AY. I do not know his QRA or I would have QSL'ed first. The QSO was in conjunction with W2FR, who told me G2AY was calling me; also W2FR did most of the copying. W1DBE and one S.W.L. also reported to me that they heard both sides of the QSO. I hope that G2AY has not suffered from a 'call snicher.' If I do get a card or letter from G2AY, I'll be very glad to report same."

Speaking of multi-relays, on the evening of December 22nd during the hours 6 to 7:30 and 9:30 to 12 (four hours) W8GZ handled 223 separate messages. About half of them were important Philippine Island traffic, part routine stuff and part Christmas greetings (GZ says darn the latter). Can you tie that record?

According to W6AXM the recent song hit, "On the Beach With You," should be dedicated to graduates of some of the commercial radio schools!

W5ACC gave a message to W6CLE addressed to his brother, who is in the Naval service and was thought to be stationed in Guam. W6CLE passed it along, and in a few days W5ACC received a radiogram answer from Yokohama, Japan. Apparently the Navy Department had been kind enough to take the message at Guam and transmit it to the addressee, who had been transferred to Japan.

W9CWD, Loretto, Mich., worked W8DNO, Pittsburgh, on 1/2 mc. while using only 1/2 watt input to an '01A. W8DNO gave him a very good report. This was at 3:00 p.m. The possibilities of 1/2 mc. as a low-power band are certainly many.

R. G. Russell, ex-KA1DJ, is now located at Mather Field, Calif., and is signing W6APJ. He is looking for reliable traffic schedules on 7 and 14 mc. Note, you traffic hounds.

The Army Amateurs will appreciate this one: W9GTK says a new ham has heard "ZLAA" being called quite a lot, and wonders if it is a station in New Zealand!

ELECTION NOTICES

To all A.R.R.L. Members residing in the Sections listed below: (The list gives the Sections, closing date for receipt of nominating petitions for Section Manager, the name of the present incumbent and the date of expiration of his term of office.) This notice supersedes previous notices.

In cases where no valid nominating petitions have been received from A.R.R.L. members residing in the different Sections in response to our previous notices, the closing dates for receipt of nominating petitions are set ahead to the dates given herewith. In the absence of nominating petitions from Members of a Section, the present incumbent continues to hold his official position and carry on the work of the Section subject, of course, to the filing of proper nominating petitions and the holding of an election by ballot or as may be necessary. Petitions must be in Hartford on or before noon of the dates specified.

Due to a resignation in the Oregon Section nominating petitions are hereby solicited for the office of Section Communications Manager in this section and the closing date for receipt of nominations at A.R.R.L. Headquarters is herewith specified as noon, August 15, 1932.

Section	Closing Date	Present SCM	Present Term of Office Ends
Kansas	July 15, 1932	John Amis	July 28, 1932
Nevada	Aug. 15, 1932	Keston L. Ramsey	May 15, 1932
South Dakota	Aug. 15, 1932	Howard Cashman	July 12, 1932
North Carolina	Aug. 15, 1932	H. L. Caveness	July 15, 1932
Oregon	Aug. 15, 1932	Dr. David L. Craig (resigned)
Kentucky	Sept. 1, 1932	J. B. Wadlen, III	Sept. 8, 1932
Idaho	Sept. 15, 1932	Oscar E. Johnson	Oct. 2, 1932
Sau Joaquin Valley	Oct. 14, 1932	E. J. Beall	Oct. 15, 1932
Colorado	Nov. 1, 1932	Ed. C. Stockman	Nov. 5, 1932
Arkansas	Nov. 1, 1932	Henry E. Vette	Nov. 15, 1932
Maritime*	Nov. 1, 1932	A. M. Crowell	Nov. 15, 1932
Rhode Island	Nov. 15, 1932	N. H. Miller	Dec. 1, 1932
San Francisco	Dec. 15, 1932	Clayton F. Bane	Dec. 20, 1932

To all A.R.R.L. Members residing in the Sections listed:

1. You are hereby notified that an election for an A.R.R.L. Section Communications Manager, for the next two-year term of office is about to be held in each of these Sections in accordance with the provisions of By-laws, 5, 6, 7, and 8.

2. The elections will take place in the different Sections immediately after the closing date for receipt of nominating petitions as given in opposition to the different Sections. The ballots mailed from Headquarters will list the names of all eligible candidates nominated for the position by A.R.R.L. members residing in the Sections concerned. Ballots will be mailed to members as of the closing date specified above, for receipt of nominating petitions.

3. Nominating petitions from the Sections named are hereby solicited. Five or more A.R.R.L. members residing in any Section have the privilege of nominating any member of the League as candidate for Section Manager. The following form for nomination is suggested:

Communications Manager, A.R.R.L. (Place and date)
 38 La Salle Road, West Hartford, Conn.
 We, the undersigned members of the A.R.R.L. residing in the Section of the Division hereby nominate as candidate for Section Communications Manager for this Section for the next two-year term of office.

(Five or more signatures of A.R.R.L. members are required.)

The candidates and five or more signers must be League members in good standing or the petition will be thrown out as invalid. The complete name, address, and station call of the candidate should be included. All such petitions must be filed at the headquarters office of the League in West Hartford, Conn., by noon of the closing date given for receipt of nominating petitions. There is no limit of the number of petitions that may be filed, but no member shall sign more than one such petition.

Members are urged to take initiative immediately, filing petitions for the officials for each Section listed above. This is your opportunity to put the man of your choice in office to carry on the work of the organization in your Section.

— F. E. Handy, Communications Manager

ELECTION RESULTS

Valid petitions nominating a single candidate as Section Manager were filed in a number of Sections on or before the closing dates that had been announced for receipt of such petitions. As provided by our Constitution and By-Laws, when but one candidate is named in one or more valid nominating petitions this candidate shall be declared elected. Accordingly election certificates have been mailed to the following officials, the term of office starting on the date given.

Saskatchewan	Wilfred Skaife, VE4EL	June 15, 1932
Santa Clara Valley	Bruce Stone, W6AMM	July 1, 1932
Nebraska	S. C. Wallace, W9FAM	July 1, 1932
Missouri	C. R. Cannady, W9EYG-HCP	July 1, 1932
Wisconsin	Harold H. Kurth, W9FSF	July 1, 1932
Western Massachusetts	Earl G. Hewinson, WIASY	July 1, 1932
New Hampshire	V. W. Hodge, W1ATJ	July 1, 1932
Illinois	Fred J. Hinds, W9APY	July 1, 1932
Western Pennsylvania	C. H. Grossarth, W8CUG	July 1, 1932

In the Northern Texas Section of the West Gulf Division Mr. Roy Lee Taylor, W5RJ and Mr. E. J. Halling, W5HY were nominated. Mr. Taylor received 71 votes and Mr. Halling 36 votes. Mr. Taylor's term of office began May 10, 1932.

In the North Dakota Section of the Dakota Division Mr. Wm. Langer, W9DGS and Mr. C. J. Webster, W9IK were nominated. Mr. Langer received 37 votes and Mr. Webster 9 votes. Mr. Langer's term of office began May 10, 1932.

In the Oklahoma Section of the West Gulf Division Mr. Emil Gisel, W5VQ and Mr. Norman B. Drake, W5ASQ were nominated. Mr. Gisel received 42 votes and Mr. Drake 33 votes. Mr. Gisel's term of office began May 10, 1932.

*In Canadian Sections nominating petitions for Section Managers must be addressed to Canadian General Manager, Alex Reid, 109 Logan Ave., St. Lambert, Quebec. To be valid such petitions must be filed with him on or before the closing dates named.

Report Your Traffic

Whether one or a hundred messages are handled, whether your work is mainly of experimenting, DX, traffic, or 'phone interest, whether you are an A.R.R.L. member or just buy *QST* at the newsstands, your SCM (see address page 5 each *QST*) welcomes and invites your report. Mail it on the 16th of each month for the preceding 30-days work! Let him know your plans for amateur work and what you are doing.

Traffic Briefs

W9AEF: "Do you know which country can hear the most DX?"

Second Ham: "No, which one?"

W9AEF: "Spain, because they are all 'EARs'."

W6FXM answered a CQ from KA1CM, who had an urgent 50 word message for Los Angeles. The message was received, delivered by 'phone, and a 30 word reply transmitted within a total elapsed time of 27 minutes. Mail would have required 59 days for the round trip!

In a DX contest conducted by "Red Espanola," Spanish amateur society, from January 15th to January 31, 1932, first prize for the "out of Spain" group was won by W4AJX of Tampa, Florida. This prize was a gold medal. The following "Ws" won diplomas for their respective districts: W1YU, W2AMR, W3ZD, W4AJX, W5ATF, W8EGY and W9GFZ. The first prize for Spanish stations, a silver cup, was won by EAR96.

The "Sunset Route" for traffic handling is being organized by W6AF, Oakland, California. At the latest report the following stations were lined up: W6EDZ (Santa Barbara, Calif.), W6AE, W6CNB (San Diego), W6CQF (Tucson, Ariz.), W5BNJ (El Paso, Texas) and W5MN (San Antonio, Texas). When complete the "Sunset" will extend to the east coast through the southern states.

W8CSE tells of a nice bit of "high speed" message handling. While pounding brass at W8FEJ in Cortland, N. Y., W2DUG was raised. QSO disclosed that W2DUG had a message for Cortland. As soon as the message was received W8FEJ called the addressee, delivered the message and obtained a reply. This was all done by the time W2DUG had "signed," and when W8CSE (who was operating W8FEJ) went back the receipt of W2DUG's message was acknowledged, and the reply immediately transmitted. W8CSE figures that the only way to beat this speed in relaying is to send the reply before the message! Hi.

W6USA

Direct schedules lined up with different points for the QSP of traffic are: Alaska K7UT, India VU1AN, South Africa ZS5U, South America HC1FG OA4I, Philippines KA1HR, KA1CO, Guam OM1TB, New Zealand ZL2AC, Australia VK3RJ VK2OC, Eastern Canada VE2CA, Europe via W2CZ EAR96 D4UAZ, etc., Canal Zone NY1AA, Eastern U.S.A. via W1MK. These schedules are semi-weekly for the most part. The following daily schedules are kept for domestic QSP: W2ACM, W2CGB, W3BBB, W4ABY, W5CJH, four 6's, W7BB, W9CVQ, W9TJ — also W8CFR, W9D0U and W8AXV are arranging semi-weekly schedules. First messages filed were those by M. C. Dhawan (India) and Juan Carlos Zabala (Argentina). The line-up of schedules is being increased as traffic arrangements are perfected. Some clearing point, with 24-hour operation! Is fun in traffic handling over for the season? Not on your life! See dope on this station elsewhere in this issue. Work 'em and QSP. W6USA, 7004 and 14,008 kc., 1000 watts.

Relative Traffic Standings

Messages Per Station (25%)	Stations Reporting Traffic (25%)	Gain or Loss (Traffic Reports) (25%)	Traffic Total (25%)	Standing Based on Average of All Four Ratings %	Leading Section in Division
Delt. 90.3	Gen. 238	S. E. - 1	Pac. 14187	Pacific 91.1*	Los Angeles
Atl. 79.6	Pac. 211	Pac. - 2	Gen. 9967	Northwestern 76.9*	Washington
N. W. 67.9	N. E. 120	W. G. - 5	Atl. 9394	Atlantic 73.3	Md.-Del.-D. C.
Pac. 67.2	Atl. 118	N. W. - 9	N. E. 6473	New England 73.3	Maine
N. E. 53.9	N. W. 75	Can. - 11	N. W. 5093	Central 62.5	Illinois
Hud. 49.3	Mid. 70	R. Mt. - 11	Hud. 2665	West Gulf 57.2	Northern Texas
Dak. 45.7	Roa. 70	N. E. - 13	Mid. 2368	Midwest 51.9	Missouri
Gen. 41.8	W. G. 54	Mid. - 11	W. G. 2231	Hudson 46.5	N. Y. C.-L. I.
W. G. 41.3	Hud. 54	Dak. - 16	Dak. 2198	Dakota 42.9	Southern Minnesota
Mid. 33.8	S. E. 53	Atl. - 17	Roa. 1660	Delta 39.3*	Arkansas
Roa. 23.7	Dak. 48	Delt. - 23	Can. 1046	Southeastern 39.3	Western Florida
Can. 22.7	Can. 46	Roa. - 32	Delt. 723	Roa. 35.7	Virginia
R. Mt. 16.7	R. Mt. 16	Hud. - 32	S. E. 663	Canada 35.7	Maritime
S. E. 12.5	Delt. 8	Can. - 64	R. Mt. 268	Rocky Mt. 25.7	Utah-Wyoming

THE TEN HIGHEST SECTIONS

S. C. M.

P. I. 263	Los Ang. 107	Mo. +12	Los Ang. 5347	Los Angeles 67.5	Nahmens, W6HT
M.-D.-D. C. 187.9	Mich. 74	Maine +7	M.-D.-D. C. 3753	Inde. W9APY 47.5	Hinds, W9APY
Alaska 98.5	Ill. 64	Ore. +5	Ohio 3027	Md.-Del.-D.C. 45	Ginsberg, W3NY
S. E. 98.4	Ohio 38	San Diego +4	Wash. 2692	Philippines 40	Liner, KA1SL
Ark. 96.	W. N. Y. 38	Los Ang. +2	P. I. 2630	Ohio 37.5	Tummonds, W8BAH
Sac. V. 91.5	Va. 36	Ill. +2	Ill. 2533	Michigan 32.5	Stephenson, W8DMS
No. Dak. 84.5	Wash. 35	Alaska +2	Mich. 2372	Alaska 32.5	Fox, K7PO
Kansas 84.7	E. Va. 35	Pa. +2	Wash. 2360	Washington 32.5	Grubie, W7RT
E. Pa. 84.2	Wisc. 31	S. Clara +2	Conn. 2262	Missouri 25.5	Cannady, W9EYG-HCP
E. Bay 81.5	Mo. 29	W. Fla. +2	Maine 1728	Maine 25	Singleton, W1CDX

LOS ANGELES again carries the Banner. We warned the other sections last month to "watch L. A." and we repeat that admonition this month! When L. A. starts she "goes places"! This month she leads two of the four "rating columns," "Stations Reporting Traffic" and "Traffic Total," "Messages Per Station" and "Gain or Loss in Traffic Reports" are led by the Philippines and Missouri respectively. Attention is called to the fact that Los Angeles has over 100 stations reporting traffic. FB.

During the traffic reporting month May 16th-June 15th, 1181 stations originated 14203; delivered 11799; relayed 32934; total 58936. (82.8% del.) (49.9 m.p.s.)

* No report was received this month from the Hawaiian, Idaho, Louisiana and Tennessee Sections.

Invitation

All live amateurs: *If you do not already do so, send your reports (DX, traffic, 'phone, r.c.c., experimenting, etc.) to your S.C.M. (address given on page 5) on the 16th of each month for the preceding thirty days' work. Get your report in QST. Make and keep your Section a leader by regular reporting!*

W1CV-GU writes: "My experience in the relaying of messages has been rather unique. While the pursuit of a professional training has left me no time to run up an impressive total, I have had the pleasure of relaying many fine messages and retrospection affords me many pleasant memories of them. A boy on a tanker in the Gulf of Mexico in communication by radio — telephone with his mother who was dying in a local hospital — the plaintiff fading carrier triumphing over the crash of tropical static — that message to Coventry, England, in two days — the one to San Diego by way of Hillsboro, Miss., in six hours — mothers in Toronto, in New York City and in Cleveland talking with their sons at local college dormitories by radio and local 'phone — the schedule with my good friend in Rutherford, N. J., every Saturday noon for nearly two years. . . . All of these shall live in my memory as among the more pleasant experiences afforded in the operation of my amateur radio station." This is but one of the hundreds of comments on the "pleasures and fun in traffic handling" received regularly at A.R.R.L. HQs. Get in on this message handling work, OMs.

Bettering W9GIG's "miles per watt" record of 675 m.p.w. mentioned on page 49, April QST, VK3HL comes forward with the following dope: On January 19th VK3HM was QSO ZL3DI and ZL4BS with an input of .54 watt! A Type '01A was used with 90 volts at 6 mills. The distance of each contact was 1560 miles or 2338 miles per watt. Both contacts took place on the 3.5 mc. band. ZL3DI reported VK3HM's signals QSA5 R5 and ZL4BS QSA4 R5.

Amateur radio was used to assist Boy Scouts in the relaying of a special message to Governor Winant of New Hampshire inviting him to attend the 62nd Commencement exercises of the University of N. H. Portable W1JB operating on 3600 kc. was set up at Epsom, N. H., at 5:45 p.m. June 8th. In about fifteen minutes a Boy Scout brought the message from the President of the University via bicycle for transmission. The message was sent from W1JB to W1APK in Pembroke, N. H., and from there was forwarded via motorcycle the remaining 7 miles to its destination, Governor Winant's home in Concord.

The Johnson Davis Bill prohibiting the issuance of radio operators licenses to aliens has been signed by President Hoover. Its purpose is to give United States citizens the commercial radio operators jobs which are now held by wireless men from other countries. We understand that existing amateur and commercial operators licenses issued to non-citizens will not be renewed when they expire but that no action to cancel existing licenses before expiration will be taken.

Four messages from OM2TG traveled via W6ETL — W1ANC — W2AUS, and were delivered in New York and Philadelphia the same date as originated (June 8). Some speed!

W8HLP, portable of W8CKG, was in operation June 4 to 12 inclusive (3900-ko. 'phone) at the Columbus (Ohio) Electrical Exposition. The booth-station was under the auspices of the Columbus Amateur Radio Association. Traffic was relayed from W8HLP to local stations for further handling. A.R.R.L. Route Manager, W8BBH, and other

active Columbus amateurs were on the job clearing traffic from Columbus during the exposition period.

In these days of depression wouldn't it be wonderful if each of the CQs we have heard were a penny in our bank account!

DIVISIONAL REPORTS

ATLANTIC DIVISION

SOUTHERN NEW JERSEY — SCM, Robert Adams, 3rd, W3SM — W3BWC and W3CEU are working for their ORS. W3BQN will be appointed after his QSO with the SCM. W3ZI spent two weeks at Camp with the Signal Corps. W3BYW and W3BZY are new "hams" in Trenton. W3AEJ kept four schedules daily. W3ARV and W3ARN sent in nice totals. W3BPT is quite active on 3.5 mc. W3QL has a new junior op. W3SM attended the Atlantic Division Convention in Washington with W3AKI, W3ACD, W3BQC, W3BEI and W3ASG.

Traffic: W3BWC 56, W3QL 10, W3ARN 254, W3ADL 16, W3ZI 9, W3BEI 11, W3BQN 14, W3BPT 23, W3RV 172, W3AEJ 12, W3ASG 22, W3SM 281.

WESTERN PENNSYLVANIA — SCM, R. M. Lloyd, W8CFR — W8YA is high again this month. W8ELZ, W8CUG, and W8AJE placed first, second, and third respectively in W8YA's Western Pennsylvania Rag-chew Contest; each received a crystal. W8DLG has a new portable call, W8HLL. W8CUG has been playing with 56-mc. receivers. W8CQA reports the club in Warren is putting a station at the airport. W8DZP will spend the summer visiting. W8EDG was in Pittsburgh during the month. W8DML expects to spend a lot of his time on the air. W8GBC sends in his first report; W8DYL operates from this station at times. W8FKU worked Costa Rica. Most of W8AZG's traffic was handled with Porto Rico. W8ELZ's work keeps him off the air a lot of times. Summer months, warm breezes, and suntanned YLs keep a lot of good ops off the air — W8AJE not excepted. W8DLV reports the Westmoreland County Amateur Radio Association expects to run some 56-mc. tests. W8DRO announces a bug at his shack. W8DVZ sends his report from the Atlantic Division Convention. W8CMP is rebuilding! W8DKL reports for W8FGL and W8FSZ. W8FAD tells us W8GNE, W8FBE, and W8FGO are out for DX. W8CEO and W8GI held an all-night checker marathon. W8CRK is using W8PT's crystal. W8AAQ stopped to see the SCM. W8CFE is working on a new 1.75-mc. transmitter. W8EEC is back on the air. W8CFR, this being his last report as SCM, sincerely wishes to express his thanks for the cooperation and good will of the gang during his term. I am quite certain the new SCM, C. H. Grossarth, W8CUG, RFD No. 3, Eicher Road, Emsworth, Pittsburgh, Pa., will prove to be a most capable official. He will stop at nothing to boost our Western Pennsylvania Section. Help him, won't you, gang?

Traffic: W8YA 234, W8DLG 105, W8CUG 96, W8CQA 78, W8DZP 76, W8EDG 49, W8DML 39, W8GBC 38, W8FKU 36, W8AZG 33, W8ELZ 27, W8AJE 26, W8DLV 26, W8DRO 14, W8DVZ 13, W8CMP 12, W8DKL 8, W8FAD 5, W8CEO 4, W8CRK 3.

EASTERN PENNSYLVANIA — SCM, Jack Wagenseller, W3GS-W3BF — W3OU and W3NN lead the Section. W3MC has his 56 mc. rig working. W3OK was heard in Holland and Chile on 3.5 mc. W3AKB won new tubes for her transmitter, W8EOK is a new ham. W3QV remembered to report. W8AFV is now in AARS. W8CFF wants his ORS appointment held until fall. W3AQN is all settled in new QRA. An ORS appointment is under way for W3BPX. W3BRH is playing with crystal. W3MG was up to see the Syracuse gang. The Chester Radio Club, W3BKQ, continues its fine work. W3AOR has completed a new crystal rig. W8FLA had trouble with MOPA. W3BES reports again. W3BCD is redecorating his shack. W3CEI and W3BYS report for first time. W3AAD has crystal perking. W8VD says not much doing until fall. W3BUH'S station license renewal blanks went to the Dead Letter Office. W8EU wants several late evening schedules. W3AXA uses an '01A. W3BTP says it's too hot to be on air. W8EUL is rebuilding. W3BEY is at Camp.

Traffic: W3OU 527, W3NN 502, W3MC 264, W3OK 235, W3AKB 125, W8EOK 94, W3QV 78, W8AFV 76, W8CFF 63, W3AQN 51, W3BPX 36, W3BRH 38, W3MG 28, W3BKQ 23, W3AOR 23, W8FLA 22, W3BES 19, W3BCD 14, W3CEI 8, W3AAD 7, W8VD 5, W3BUH 5, W8EU 3, W3AXA 3, W3BYS 3, W3BTP 1, W8EUL 1, W3BEY 106.

MARYLAND-DELAWARE-DISTRICT OF COLUMBIA — SCM, Harry Ginsberg, W3NY — Robert Hensell, W3A00, and Edgar Hudson, W3BAK, RMs; Eppa Darne, W3BWT, Chief RM. The Atlantic Division Convention is now a thing of the past, and what a past! The D.C. gang certainly put it across R9, and I extend the hearty thanks of our Section for furnishing everyone such an FB time. Too much credit cannot be given those who stand highest in deliveries. The first three are W3CXL 364 deliveries, 19.2% of his traffic total; W3BWT 121 and 23.1%; and W3NY 69 and 24.4%. These non-ORS reported: W3HT, W3BND, W3CJS, W3BTE, W3IZ, W3CER, W3ADO, W3JK, W3BRS, W3WN, W3BHE, W3AHA, W3AVD. Congrats to W3CDG, our newest ORS. The Frederick Amateur Radio Association is building a rig on top of Mt. Pleasant. The Westminster Amateur Radio Club have applied for station license. District of Columbia: W3CXL leads as usual W3BWT continues to make the BPL two ways. We regret W3ASO's loss of Ed Day, his first operator. W3NR finds 3.5 mc. FB. W3CDQ and W3IL are almost swamped with Convention details. Maryland: W3NY breaks his own record and leads Md. Hi! W3HT is building 250-watt crystal rig. W3A00 feels traffic depression. W3SN is fighting QRM from telephone exchange. W3BND took 30 days leave so he wouldn't miss the Convention. W3CJS will be on with 50 watter soon. W3BTE does his bit to help the Section. W3BGI expects a new sky wire soon. W3IZ promises 250 watt crystal rig by Sept. W3ADO is getting personal portable W3ZZAB. W3LA made third place in late ORS contest. Congrats. W3JK reports two new C.W. hams. W3AHA is rebuilding our local WCBM. W3DGD and W3APS run extensive 56-mc. tests every Wednesday night. W3ZK is building 56-mc. equipment. W3BHE is having trouble with his rig. W3BRS will have his 50-watt rig going shortly. W3WN is going on 3900-ke. 'phone soon. W3AVD finds it hard without his license. W3BKC gets unlimited 'phone certification. Delaware: W3BAK always maintains schedules to QSP into the Eastern Shore Md. and Delaware. W3CER is new ham in Newark. W3ALQ wants long suspension of ORS.

Traffic: W3CXL 1895, W3BWT 524, W3ASO 284, W3NY 282, W3HT 202, W3A00 201, W3SN 141, W3BND 47, W3BAK 38, W3CJS 37, W3BTE 23, W3BGI 20, W3CDG 17, W3NR 11, W3IZ 10, W3CER 8, W3ADO 6, W3CDQ 5, W3LA 5, W3JK 2.

WESTERN NEW YORK — SCM, Don Farrell, W8DSP — W8DSS is high traffic man. W8AED visited the gang at Rome. W8QL is still playing with 56 mc. W8DBX has moved to Lawyersville. W8FFL has applied for portable license. W8BFF is arranging the 56-mc. apparatus to be used at the National Glide Meet to be held in Elmira July 11th to 24th. W8AWX is a new ORS. W8AOW has been working duplex 'phone with portable W8CO. W8AOW would like Central New York Clubs to send him items of interest for his articles in the Sunday paper. W8DEU is on a vacation. W8FOL says his traffic has been good. W8FDY is QRL. W8EWT expects to be working in Buffalo soon. W8DEQ reports conditions very bad. W8ECF admits spending too much time on DX. W8CSW reports activity on 56 mc. W8FTB is teaching two of his school chums the code. W8DGR keeps a schedule with W8EBC. W8CJJ is busy with 56-mc. tests for the Glider Meet. W8DSP has been rebuilding. W8AGS reports hot weather too much for him. W8BLP says 14 mc. very erratic. W8BHK reports new officers for S.T.T.A. — Pres., W8AKC; Vice-Pres., W8DEQ; Secy.-Treas., W8CYQ. W8BLH thinks conditions are improving on 7000 kc. W8BFG is busy building 56-mc. transmitter and receiver. W8AFM has his 14 mc. transmitter on the air. W8ECM is experimenting on 56 mc. W8DXF is rebuilding to crystal control. W8DES is off the air during the summer months. Don't forget the Atlantic Division (Western New York Section Convention) to be held in Syracuse at Hotel Onondaga on Sept. 10th-11th.

Mrs. W8DSP will spend her time during the convention with the OWs and YLs from out of town. W8GWZ and W8DT visited the SCM on May 29th. W8DT is President of the Mohawk Valley Brass Pounders. The Elmira Club has elected new officers: President, W8BFF; Vice-President, W8EKL; Secretary, Doo Meeker. W8CJJ has good southern schedules. W8ACQ is back from radio school. W8DCX is rebuilding. W8DZC has changed his QRA. W8BTE is on 3.5 mc. W8ERZ moved all his junk to the attic. W8BOM is back from VE2CP. W8GQ is QRL photography. W8DWJ is building a new crystal 'phone. W8JE has a real 1932 signal. W8CSE spends 100% of his time at amateur radio. W8GWT reports for the first time. W8DMJ is spending his vacation in Washington. W8EWC has a card from EAR96 who reports his 3.5 mc. signals FB in Spain. W8FME will be using a portable W8ZZAD in Vermont this summer. W8GWM is a new man reporting. W8AKX has a new screen grid receiver. W8JV is using his new MOFA. W8EJC reports from Cattaraugus.

Traffic: W8DSS 201, W8AED 130, W8QL 96, W8DBX 91, W8FFL 65, W8AOW 57, W8BFF 52, W8AWX 51, W8DHU 45, W8FOL 39, W8FDY 33, W8EWT 27, W8DEQ 26, W8ECF 22, W8CSW 21, W8FTB 19, W8DGR 19, W8CJJ 14, W8DSP 10, W8AGS 8, W8BLP 7, W8BHK 6, W8BLH 6, W8BFG 5, W8JE 124, W8ERZ 117, W8BOM 84, W8EMW 27, W8DMJ 19, W8CSE 10, W8JV 10, W8GWT 9, W8AKX 8, W8EJC 5, W8GWM 4, W8EWC 3, W8FME 2, W8GQ 2.

CENTRAL DIVISION

INDIANA — SCM, George H. Graue, W9BKJ — W9FUT again is the star traffic station. W9JFA is a new station in So. Bend. W9AIP hopes to have a 250 watt crystal rig. W9FYB is QRL work. W9BXT has a MOFA well under way. W9JQ, W9JQX, W9JJK, W9JRR, W9JTU and W9IGN are new stations in Ft. Wayne. W9CKB's '10s went haywire. W9CHA has been appointed RM for southern Indiana. W9HHI has visions of a job. W9HPQ is preparing to put a 50-watt job on the air. W9HTX has a new '52. W9EFA is trying to get a 'phone on the air. W9ARK is going to try 56-mc. 'phone. W9JIY is a new station in Indianapolis. W9FJN works out FB. W9EGE is rebuilding. W9BZF is on 3.5-mc. 'phone. W9GFS is building 1750-ke. 'phone. W9HUO is planning new crystal rig. W9FXM is QRL golf. W9EWQ and W8BZN are holding regular schedules on 56 mc. W9HSF has applied for ORS. W9FKI is preparing list of prehistoric sigs. W9HDB uses a dynamotor. W9EEO is having trouble with MOFA. W9HBG has moved back to Ill. W9AKJ has dynatron working. W9GGJ expects to handle loads of traffic. W9EXL has daily schedule on 56 mc. with W9BCP.

Traffic: W9FUT 324, W9EXL 56, W9GGJ 45, W9DHJ 17, W9AKJ 14, W9BKJ 14, W9FKI 13, W9FXM 9, W9HSF 8, W9GYB 7, W9HUO 4, W9CHA 2, W9AIP 1.

KENTUCKY — SCM, J. B. Wathen, III, W9BAZ — W9BWJ was QSO 43 phones in CW-Phone Contest. Traffic totals show increase at W9JL. W9EDQ is now at Revelo. Summer conditions don't keep W9DKD from getting good totals. W9OX is firmly convinced he needs a new antenna. The new transmitter at W9BAZ is doing fine. W9CEK couldn't sleep with bullets zipping through the walls, so is changing houses. The new crystal job at W9CIM isn't perking just right yet. W9HAX has his new transmitter in a fine cabinet now. "14 mc. Improving," says W9AUH. Sure glad to have W9CIS reporting once again. W9LXL expects to be one of the Lexington Police Radio operators. W9GJZ says "W9BPB is on with 500 watts." W9ERH joined the Natl. Guard. W9HNV seems to be the only really active station in Ashland. W9JMR changed from TNT to Hartley. W9CDA is planning a crystal job. W9IFM wants schedules. W9CML is building a 'phone. Richmond sports two stations active on 3.5 mc. — W9DPW and W9DGN. Will those KY. stations active on 1750 kc. drop a line to W9CHL? W9CNE has a 56 mc. receiver. W9ETT and W9LEH visited in Louisville. W9HTR has a National SW3. W9EDJ is planning a push-pull transmitter. W9AMQ complains that someone is using his call. W9AEN is rebuilding transmitter. W9FZV is having trouble swapping licenses with the K. I. Henderson almost has a "ham" orchestra — W9DLU banjo, W9HIN, banjo, W9DDH piano and W9BAN sax. W9CEE has

turned his talents to boat building. W9BEW is planning 75-watt crystal job. W9ACS is now CRM in USNR. W9BBO changed QRA again. J. H. Martin of Paducah expects to have his call shortly. W9ABV found but again lost the 14-mc. band. As W9BAZ' term of office as SCM ends Sept., and he is not "choosing to run in 1932," better get your nomination petitions into Headquarters without delay.

Traffic: W9BWJ 186, W9JL 128, W9EDQ 76, W9DKD 73, W9OX 65, W9BAZ 62, W9CEK 35, W9CIM 34, W9HAX 16, W9AUH 13, W9CIS 11, W9IXL 7, W9GJZ 6, W9ERH 5, W9HNV 5, W9JMR 4, W9CDA 3, W9IFM 2.

OHIO — SCM, Harry A. Tummonds, W8BAH — District No. 1 RM W8DVL. W8EFW says that Heights Radio Club will meet at W8GQU throughout the summer. W8GUL now has a '10. W8GME is having fun with '26 in TNT. The ORS letter which you received in early June was the work of W8DDS, W8EBY is QRL examinations. W8CIY sends 73. W8CIO is busy getting out Central Division Convention tickets. W8AGL will be at Camp Perry. West Tech Radio Club, W8CQF, disbanded for summer. W8RNL is still on KFMK. W8EEW is on 56 mc. W8ZZAQ will soon be on road with W8BYD as operator. W8UC has nice total. W8BMX reported late direct to HQs. W8CZT has a new National receiver. More and more output at W8EXA. W8BNC has been testing portable W8ZZK. Welcome to new ORS, W8ENJ. W8EBT is announcer on WJAY ham programme every Wednesday evening. District No. 2: RM W8BKM. W8BKM is CRM USNR. District No. 3: A nice total from W8BTT. W8APC holds morning schedules with W8PP. We welcome first report from W8EXD. District No. 4: RM W8EEQ. "Will have 100 watt crystal rig on air soon," reports W8GXQ. W8HT and W8UW report by radio. W8ATV is operating on 3524 kc. W8PO schedules W8EEQ, W8BAH, W8ALQ, W8DBX and W8CQA. W8EEQ leads his District. District No. 5: RM W8DFR. The Buckeye Short Wave Radio Assn. will give a '52 to the first member who earns a WAC certificate. W8DVE and W8BSR report. "Here is a hot report," says W8EXL. District No. 6: RM W8BBH. Nice report from W8ARW. W8CNM is now at Nelsonville with ONG. W8FJN reports nice total for W8GZ. W8BBH handled Electrical Exposition Traffic. District No. 7: RM W8VP. A real report from W8CKQ. New crystal rig at W8ANS, 3825 kc. W8CKX is back on 3507 kc. W8VP schedules W8DDS and W2CBY. District No. 8: RM W8CGS. W8ENH is selling out. Nice report from W8FA. All set for old time totals at W8CGS. District No. 9: Report from Wellston, Ohio. No call? Schedules being arranged at W8DUV. "See the gang at Central Division at Cleveland," reports W8EQB. W8ANG, Warren, Ohio, was married on May 16th. GL, OM. W8BAH was at Great Lakes, Ill. for two weeks at NAJ on U. S. N. R. duty. Suggest Ohio hams listen in for Ham Programme over WJAY every Wednesday, 8:30 p.m. See you at Central Division Convention, Cleveland, Ohio, Sept. 2nd and 3rd. W8BAH has a lot of QSL cards for Cleveland hams forwarded here for better addresses. Stop in and get yours at once.

Traffic: W8DDS 534, W8BBH 443, W8EEQ 416, W8PO 272, W8CKQ 260, W8VP 207, W8GZ 146, W8BAH 112, W8ALQ 71, W8BKM 130, W8BMX 61, W8UW 54, W8ENJ 45, W8BYD 38, W8EBT 30, W8ATV 26, W8CGS 23, W8BNC 18, W8EQB 15, W8CNM 15, W8CKX 13, W8EXA 12, W8ARW 12, W8HT 9, W8DUV 8, W8APC 7, W8BTT 7, W8GME 7, W8ZZAQ 7, W8UC 7, W8CZT 6, W8ANS 6, W8FA 2, W8GXQ 2, W8EXI 2, W8GUL 2, W8EFW 1, W8ENH 1.

ILLINOIS — SCM, F. J. Hinds, W9APY — RM, E. A. Hubbell, W9ERU. W9APY was the only call on the SCM ballot so is to be your SCM for the next two years. Thanks to you all for reelection. PY2BF visited W9IYA, W9EFQ, W9PK and W9EQG. W9IYA and W9IVF are brothers. W9ANQ is on again. W9BBR is on with a new MOPA. W9BJH is looking for a good '10. W9CNQ has a dandy 1.75 mc. 'phone. W9CUH is planning a new 500 watt crystal. Receiver trouble at W9EPU. W9EGY is plugging away on 3500 CW. W9GYK is building a new speech amplifier. W9HPJ has a Second Commercial. W9EYI holds U.S.N.R. schedules. Let's all pack up and go to Hamfest in Waukegan August 20th — write W9ANQ for dope. W9DBO is trying to win the crystal in the tests. W9IEP is

putting in '45. W9AAR is rebuilding receiver. W9HQH and W9LW are doing fine traffic work. W9IJA used to be 9MC who sent bulletins to the McMillan Expedition. W9FGN will push traffic hard this summer. W9ILH is a newcomer in traffic. W9CFV moved to new QRA. W9JO's antenna came down. W9BON and W9FKG applied for a portable 56 mc. license. W9FFQ and W9DSS QSO'd on 56 mc. for two and a half hours for a record. Rockford hams want 56-mc. schedules with outside points — write W9DSS or W9ERU. W9ENH is building a new '52 crystal outfit. W9FGV is a new ORS. W9RO has been on sick list. Crystal troubles at both W9HUX and W9CGV. Traffic hard to get at W9HNC. W9PK blew the filter. W9CLM has fine new '45 PP. New Zepp at W9DPD. W9EPN is rebuilding the shack. The '66s went out at W9GDI. Panama traffic wanted by W9FFQ for his K5AE schedule. W9CUX blew the '81s. W9HOS is using a '46 as crystal oscillator. W9IUF's dog burned her nose on the tank coil. Newcomers in our ranks are W9JCW, W9JBH, W9JFV, W9JJY, W9JJK, W9JQN, W9JSP, W9INZ, and W9JKU. New club formed by W9CKM in Oregon and Mt. Morris to push traffic. W9BTT, W9ERU and W9CRT are rebuilding. W9BRX is experimenting with grid modulation. W9CZL says 7000 much better. Illinois 56-mc. boys are as follows: W9AAV, W9AFF, W9AGV, W9BON, W9BRY, W9CGW, W9CNO, W9DDE, W9DEU, W9DSS, W9DZG, W9ERU, W9ETU, W9FFQ, W9FKG, W9GIG, W9GVU and W9UZ. W9NN is doing his stuff from his W8CWR outfit in Dayton, Ohio. W9FO has been commissioned Ensign C-V (S) in the U.S.N.R. W9IBA is doing fine traffic work. W9HZB is using a '10 outfit. W9AAK is rebuilding whole station. W9CEO is now out of the hospital. W9ATS is working with public address systems. W9QI and W9FXE are touring Illinois. W9ACE is rebuilding receiver. The '10 is going strong at W9HPK. W9AFN is learning golf from W9LW. W9ACU is working 'phone for a while. W9BVV was heard in England. W9BSR has an '03-A in final amplifier. Traffic was reported by W9DOU, W9DGK, W9AVB, W9BPU and W9GFW. The amateurs of Oregon and Mt. Morris, Ill., have formed the "Ogle County Radio Traffic Association," with the following officers: W9OQ, President; W9AND, Vice-President; W9CKM, Secretary and Treasurer; W9GFY, Publicity Manager. A traffic network is being organized, as well as a 56 mc. network. Anyone interested should drop a card to W9CKM.

Traffic: W9IU 1036, W9BTT 194, W9VS 183, W9CGV 155, W9ALA 100, W9APY 73, W9ERU 73, W9FGN 62, W9HQH 47, W9FFQ 45, W9CZL 40, W9HOS 34, W9GVX 27, W9CRT 24, W9LW 24, W9KA 18, W9DBO 17, W9ACE 16, W9CUH 15, W9ENH 14, W9IBA 13, W9DJD 12, W9FO 11, W9FGV 10, W9HPK 10, W9FGD 9, W9LXF 9, W9BYZ 8, W9IEP 8, W9JO 8, W9ACU 7, W9FRA 7, W9NN 7, W9BSR 6, W9BTU 6, W9DPD 6, W9EMN 6, W9AAR 5, W9DZG 5, W9FTX 5, W9HNC 5, W9AFN 4, W9PK 4, W9FCW 3, W9IUF 3, W9IVF 3, W9IYA 3, W9AAK 2, W9BR 2, W9BON 2, W9BVV 2, W9CLM 2, W9FXE 2, W9GDI 2, W9HUX 2, W9ILH 2, W9BRX 1, W9WR 1, W9GFU 11, W9EPU 2, W9AVB 17, W9DGK 6, W9DOU 83, W9GAI 14.

MICHIGAN — SCM, Ralph J. Stephenson, W8DMS-W8GTH — Some traffic men have deserted us on 3.5-mc. for 1.7-mc. 'phone, forming the Wolverine 'Phone Club, in and around Detroit. W8PQ is QRL at WXYZ. W8FX said a while ago "BPL or get married." He must be married by now. W8COW takes in both National Conventions at Chicago. W8DA is studying for commercial ticket. W9EXT will be pitching hay for the rest of the summer. W8BMG is off 'till fall. W9VL is QRL work. W8DYH is still looking for that job. W8GP reports DX 4½ miles on 56 mc. W9HK is rebuilding. W8LU, W8CAT, W8DEH and W8JD all leave for Nat. Guard Camp July 5th. W8ZN has a k.w. on 7 mc. W8ARR is leaving for Naval cruise. W8FLQ sends in first report. W8FTV's crystal has several frequencies. W8GUC reports "CR" on Navy cruise and "CV" away on business. W8CFM reports new club in Muskegon, with W8CJ, President; W8CGH, Secretary, and W8CFM, Treasurer. W9IHM is trying to organize club in Escanaba. W8BTK has been farming. W9DAB expects to be on more since school is out. W8GQS shifted to 7 mc. W9HSQ is rebuilding for fall traffic. W8EVC landed a job so his time is

limited now. W8JO-JC wants Lansing and Central Mich. traffic. W8EBQ manufactured his own bug and tape code machine. W8JX changed QRA. W8PP is still leading the traffic list. W8BUH is looking for "Thumb" traffic. W8CEU had a one round bout with lightning. W8FTW beat both W8WR and W8DEH playing checkers via radio. W8DHA is QRL work. W9CWR finds too many outside cool spots to stay in the shack. W9DPQ says, "YLS and traffic do not mix." W8DED is saving his pep for fall. W8AKN is on 56 mc. Our friend, J. E. Brown, who has been acting supervisor of radio for 8th District has been transferred to the New York office. Mr. Emory H. Lee from New York is now the 8th District supervisor. Mr. S. W. Edwards, the old supervisor, has resigned. W8AIU is at camp for boys at Honor, operating call W8HFS. W8AUT is busy on the farm. W8EGI will operate W8HCC during summer. W8QT is rewinding power transformer. W8BG is building police transmitter at Saginaw. Now's the time to overhaul and prepare to keep Michigan at the top all next season.

Traffic: W8PP 367, W9HK 236, W8FX 172, W8FTV 95, W8EVC 94, W8BMG 78, W9DAB 75, W9FSK 74, W9EGF 64, W8JX 62, W9CE 61, W8CPH 59, W8ECN 58, W8AZQ 56, W8DMS 51, W8BJG 47, W8EHD 42, W8FTW 39, W8QT 38, W8DA 36, W8GBB 32, W9IHM 31, W9IJB 30, W8EVJ 28, W8DM 24, W8DYH 23, W8ARR 23, W8ZN 22, W9CGP 22, W8EGI 20, W8AKN 20, W9CQB 19, W9GUC 18, W8AYO 18, W9CWR 15, W8GDT 14, W8DED 14, W8JO 14, W8WR 12, W9EXT 12, W8DZ 12, W9NW 10, W9HIS 9, W9BBP 9, W9DPQ 7, W8QM 7, W8CST 7, W8BIU 6, W9CEX 6, W8EZM 6, W8GTN 6, W9GQF 6, W8DOS 5, W8ALL 5, W9EEM 5, W8BUH 5, W8NR 4, W8ABH 4, W8COW 4, W8AJL 4, W8GP 3, W8AIJ 3, W8AUT 3, W8FWT 3, W8CSX 3, W8GQS 3, W8DHA 2, W8EYH 2, W8FWG 2, W8CFM 2, W8BIK 1, W8MV 1, W8CAT 1, W9HSQ 1.

WISCONSIN — SCM, C. N. Crapo, W9VD — This is W9VD's last report. Mail next report to the new SCM, Harold H. Kurth, W9FSS, 2550 N. 8th St., Milwaukee. W9VD is resigning because he thinks he thinks he deserves a vacation — he has been SCM since July 1926! A long time. Thanks to all for the splendid support, and may you continue to work in similar fashion with the new SCM. W9LA-ZZN is now in Milwaukee. W9SO is being rebuilt for fall. W9ZY is clearing up some of the bad power leaks. W9FDI has cancelled all schedules for the summer. W9FLX is on 7 mc. W9BUP is getting new 'phone license. W9HTZ is busy with dance orchestra. W9DKA works 1.75-mc. 'phone. W9FAF has four schedules. W9FAW is operating W9HHD at Camp Williams. W9JAZ has a '10 working into a Zepp. W9CZZ is another Stanley ham. W9GVL is thinking of going to 56 mc. W9HSV has schedules with W8CPH and W9GTK. W9HMS schedules W9JCH. W9ISD is new station at Shiocton. W9JCH is new station at Appleton. W9RH will be off for the summer. W9ATO will change frequency. W9AUX says three new hams are waiting for tickets in Sheboygan. W9AVG is keeping regular schedules. W9IQW is building new transmitter. W9DXI is working low power 'phone and CW. W9DNU is building MOPA. W9BIB works W9EYH and W9AVG. W9AQU is working his 3.5 mc. antenna on 7 mc. W9CFP reports new hams at Racine: W9JFE, W9JFY, W9IZW, W9JGW, W9JJG and W9IZM. W9EAR blew his buffer plate supply. W9ESZ is not keeping schedules. W9ISD reports from New London. W9CJU is not doing much at present. W9ABM says license renewals have arrived. W9EYH will be on little during summer. W9FSQ is an engineer at WKBH. W9ESF is off the air until Sept. or Oct. W9AZN wants to trade crystal. The Chippewa Falls boys held a picnic on first of June with a good attendance. On June 5th the gang from Elroy and Mauston held a picnic at the Dells and some of the Milwaukee boys attended. The Lacrosse Club picnic was held on June 4th and they had a fine evening for it. The Milwaukee Radio Amateurs Club will hold their annual picnic on August 28th at Waukesha Beach. See W9FSS, General Chairman, for details. The next meeting of the Milwaukee Radio Amateurs' Club will be held on Sept. 15th in the Trustees Room of the Milwaukee Public Museum at 3:00 p.m. All amateurs are invited. The Northern Wisconsin Radio Club held its annual picnic on June 5th at Lake Hallie. About 75 attended, including W9FGX and W9FCT of

Wausau. Portable W9HFY was put on the air and two stations worked. An all-round good time was enjoyed by all.

Traffic: W9FSS 187, W9LA-ZZN 133, W9SO 128, W9ZY-AZN 44, W9HTZ 29, W9DKA 46, W9FAF 23, W9HHD 20, W9GVL 19, W9HSV 18, W9FDI 17, W9HMS 12, W9RH 12, W9BUP 11, W9ATO 11, W9AUX 10, W9AVG 8, W9FLX 8, W9IQW 6, W9DXI 4, W9DNU 3, W9FAW 2, W9BIB 2, W9AQU 2, W9CFP 2, W9EAR 2, W9ESZ 2, W9ISD 2, W9CJU 1, W9VD 21, W9EYH 27.

DAKOTA DIVISION

SOUTH DAKOTA — SCM, Howard T. Cashman, W9DNS — W9CFU is rebuilding for crystal. W9BAE has unlimited 'phone permit. XW9HAF is quitting the game. W9GYG was at Fort Snelling for two weeks. W9FLM is moving. W9GEE is on 14 and 7 mc. W9GNT has moved to East Pierre. John Berg, now W9IRS, is on 7 mc. W9GRJ is making some changes. W9FYR is rebuilding. W9IQZ moved to 7 mc. W9DKL is busy fixing us up a nice convention. W9HTZ is leaving for the west coast.

Traffic: W9FKL 6, W9ALO 9, W9BLZ 6, W9HSH 4. NORTH DAKOTA — SCM, Wm. A. Langer, W9DGS-W9IFW — W9BPM leads state with over 300 originated on Engineers Day. W9EKR and W9DIW are on the air in Grand Forks. W9HJC says W9AFM is awaiting license modification. W9BVF is going east for higher education. W9CRL and W9DYA participated in the A.A. Contest. W9EYQ was active in the 'Phone-CW and Consistent DX contests. W9EOZ has rebuilt W9HRP and with W9CBM is pioneering 56 mc. work in N. Dak. W9DHQ gets on the air over week ends. W9DM burned up transformer immediately after installing '66s. W9GNS has been active with Portable W9JQG at the National Guard camp near Devil's Lake. The SCM is using portable call W9LFW pending license modification. Note new QRA on page 5, this issue.

Traffic: W9BPM 318, W9DGS 150, W9HJC 89, W9BVF 66, W9CRL 22, W9EVQ 18, W9HRP 8, W9DYA 5.

NORTHERN MINNESOTA — SCM, Palmer Andersen, W9DOQ — W9BAR, W9BBL, and others are in Northwoods. W9IJS, a newcomer, puts us to shame by leading this month's traffic total. He reports W7AXB working in Willmar. W9FNQ is busy with Naval Reserve. W9BCT says too hot for brass pounding. W9HRB is busy with YL. W9HNS and W9HDN are working lots of DX. W9HDN recently worked an elusive Asian, "JIDO." W9IAA is pushing a nice signal. Your SCM has been using 'phone to work c.w. boys up on 3.5 mc. W9GYH recently hitch-hiked sixty miles to get to take his amateur exam. W9HCW has 1.75, 3.5 and 56 mc. rigs. W9BAR is new ORS. W9AEL is rebuilding to crystal. W9HZ says commercial traffic slow at marine station. W9CGN is going down on 14 mc. W9HIE reports by radio. A Northern-Southern Minnesota picnic is being planned by the Arrowhead gang for some Sunday in near future.

Traffic: W9DOQ 35, W9HIE 9, W9BAR 25, W9HZ 12, W9GYH 2, W9CCN 3, W9AEL 6, W9IAA 7, W9IJS 37, W9HNS 4.

SOUTHERN MINNESOTA — SCM, H. Radloff, W9AIR — W9EPJ is pounding ivory with a road show. W9BKK obtained his Amateur First class license. W9BN still receives reports on International Test transmissions. W9BNN is QRL line construction. W9JBA was host to the gang for a 56-mc. PARTY. W9AFR is plunging in traffic. W9FBV-W9IXQ coming a close second. W9EPD works 10 power DX with his monitor. W9CFP is installing a dynatron. W9CTB QSW 14 mc. W9DH uses '47s in new marine design transmitter. W9HRH reports ex5RR located at WLB. W9FUI, W9FJK, W9HXV and W9HOP are on operating staff of W9CZS at Camp Ripley. W9FCS completed new MOPA. W9CSJ is a World War Veteran. W9HFF is QRL radiating house paint. W9FFY is enjoying vacation pounding brass. W9FNK keeps an onboard motor oscillating. W9CKU had his new Chevy especially equipped for hamfesting. W9DGE reports visit by W9EQJ. W9COS reports Naval training a bit strenuous. W9GUX is gumshoeing for someone who appreciated his call. We mourn the passing of W9EJR. W9DKT is a new call at Fairmont. W9IKO has a commercial ticket. W9IJD is on 7 mc. W9DHP left on a trip to Europe. W9GVM employs a non-directional Zepp. W9FCC has moved. W9JFH is on 14 mc.

W9IUD is new call in Minneapolis. W9GNU is proud papa to a baby YL. W9HXR is constructing 1.7-mc. 'phone. W9DWU is none other than Lee Herron, winner of Minn. State Open Golf Championship! Minneapolis Radio Club is holding regular meetings throughout the summer. W9FMB visited W9IRH. W9HEX constructed a condenser mike. W9YC will be inactive until fall. W9BNF removed to Washington, D. C., where he will op at W3LA. W9FPY and W9IRT carry on for Luverne. W9EAT experiments with 56 mc. W9TF toots a sax. W9FLE and W9EEB toured the Black Hills. W9DEI will spend the summer in research work. W9EGG modulates a '10 with a WE 211E. W9EYL had W3EI as visitor. The big ones get away from W9GLE. H. W9ELZ is closed for summer encampment. W9BHB insists on copying his International with a sounder! W9EVG built a successful AC receiver. W9DRG reports W9JDJ a new one in Owatonna. W9EYS experiments with super-regeneration. W9FAJ is trying 3.5 mc. CW. W9BKK is designing an all push-pull rig. W9CYX is going hot at Pipestone. With this report a new requirement for ORS applicants will go into effect. Hereafter all ORS applicants will be required to make a test QSO with the RMs before having appointment approved.

Traffic: W9EPJ 318, W9BKK 241, W9BN 136, W9BNN 159, W9JBA 100, W9AFR 81, W9AIR 78, W9LXQ-W9FBV 44, W9EPD 30, W9CPP 22, W9CTB 20, W9DH 16, W9HRH 14, W9BKK 17, W9CZS 13, W9FCS 12, W9CKU 10, W9CSJ 11, W9DRG 12, W9HFF 9, W9FFY 5, W9FNK 3, W9COS 2, W9DGE 2, W9GUX 1, W9EVG 1.

DELTA DIVISION

ARKANSAS — SCM, Henry E. Velte, W5ABI — W5BMI hands in a nice report. W5JK is building an MOPA. W5CCY hands in a report. W5BDR will soon have a type '52. W5BRI has built a new radio shack. W5BED is touring the Southern States. W5BDW is ready to shove off on 7 mc. W5FB was heard by a ZL on 3.5 mc. W5QI is a new station in Hazen. W5AQD is getting out well. W5EG is a new station. W5CFE is a new station in Ft. Smith. W5CBK is getting out nicely. W5AYJ has worked all Districts. W5BMV has been on the air for the last year. W5BRW has moved from Paris to Ft. Smith. W5SR sends code lessons for the Boy Scouts. W5CGW is using a pair of '45s in P.P. W5BBS is responsible for the nice report sent in from Ft. Smith. W5IQ is kept busy operating at KLRA. W5BLG works for the Post Office. W5PX has nice crystal rig. W5ABI lost his antenna in a wind storm.

Traffic: W5BRI 410, W5ABI 154, W5BDR 39, W5BRI 20, W5JK 19, W5CCY 17, W5BED 13.

MISSISSIPPI — SCM, William G. Bodker, W5AZV — W5ANX will operate his all-district portable W5ZZAB at Fort Knox, Ky., this summer. W5VJ and W5AZV are experimenting on 56 mc. W5BXZ is attending Port Arthur College.

Traffic: W5ANX 51.

HUDSON DIVISION

EASTERN NEW YORK — SCM, R. E. Haight, W2LU. — RM, W2BJA reports with FB letter on traffic situation in his section. W2DUG did FB work on W2LU's receiver. W2UL helped erect antenna for W2ECU. W2BVR took a trip through New England. W2ACD was rebuilding. W2ATM is attending C.M.T.C. at Camp Dix, N. J. W2KW has some Class B 'phone transformers and any power transformer needed. W2BLL is QRL exams. W2ANV joins the boys in the V.C.R. W2ECG is new call in Albany reported by W2CJS. W2DQT is keeping White Plains on the air. W2ACY keeps three bands QRL. W2COQ will be at Center Harbor, N. H., for summer. W2DVC was heard on 56 mc. W2UQ is new ham in Schenectady. W2BJP is taking it easy. W2BZZ reports new ham, W2EDY. W2CFG is experimenting 100%. W2BMX is back from W8SG. W2CGO and W2DEL are kept busy at WGY, while W2SJ is honeymooning. W2BSH enjoyed vacation at Lake George. W2CJP is QRL at his profession. W2DWK, exW2BKW, desires 56 mc. schedules. W2LU enjoyed QSO with W2QJ. The Crystal Radio Club (W2DMC) had a "barrel" of fun at their outing on the Hudson. Among those present were W2DXJ, W2AUX, W2ECC, W2AAA, W2CSC, W2BGH, W2DON, W2DFU, W2CTE and W2EBX (Ask 'em about the barrel).

Traffic: W2BJA 182, W2LU 148, W2UL 79, W2BVR 34, W2ACD 34, W2ATM 32, W2KW 19, W2BLL 18, W2ANV 18, W2CJS 10, W2DQT 9, W2ACY 6, W2COQ 6, W2BJP 3, W2DUG 2.

NEW YORK CITY AND LONG ISLAND — Acting SCM, E. L. Baunach, W2AZV — New ORS this month are W2AHO, W2ASG, W2DOG and W2VL. Manhattan: W2AOU reports for the Manhattan Radio Club. W2CBW and W2BIS traveled to Staten Island and tried 56 mc. W2BHL is getting out FB. W2ANQ tried 7 mc. W2AWT moved to his summer QRA, the "roof." W2AOY is now operating W2BDD. W2DIV is getting out. W2SC now works on 3504 kc. Bronx: W2QM is getting ready with his new crystal job. W2ALX is back on 7 mc. W2BGO finds traffic dead. W2CYX is rebuilding. W2APV just came back from Jamaica, B. W. I. W2CBB is too busy to be on the air. W2CWP is breaking in new ops. Brooklyn: This is not a "calls heard" list but some of the boys on 56 mc.: W2A0B, W2BVT, W2ASG, W2HY, W2RZ, W2BRB, W2TI, W2AAZ, W2AZV, W2BYY and W2BNY. W2BEV is one ORS looking for schedules. W2PF is now at Camp Dix. W2DBQ is off for the summer. W2FS, the DX cop, is QRL W2EE. W2ASG says 3.5 mc. is punk now. W2CUD wants to sail with the U.S.N.R. W2AEN is busy sending foreign QSL cards to the DX hounds in the 2nd District. News comes that we have a new YL in these parts, W2NI. W2TI will soon be heard on 'phone. W2BO is also trying 'phone. W2AAZ took the parts from his 56 mc. receiver to build his portable 3.5-mc. transmitter. W2AQN will be operating his portable, W2ZZCQ, in the Catskills this summer. W2BEG is home again after one of his flying trips from Washington. W2BRB is making neon tubes oscillate. W2EET, a newcomer, makes his first report. W2BAS persuaded his MOPA to perk. W2DHI makes a first report. W2DNQ has a beautiful outfit and has W5ACA as a second op. W2NO is fooling with crystals. W2AZV now has his CC job perking nicely on 3570 kc. Queens: W2ADQ will take traffic for West Coast and Pacific Islands. W2DPU says DX is lacking. W2AUS keeps his Army schedules. W2AIQ is off the air until Sept. 15th. W2DQK has become AC receiver minded. W2EDW and W2EDU are two new men. Long Island: W2BFG is working on a new transmitter. W2DOG exchanged visits with W2CQA. W2CHK is getting them off for China. W2CFH reports new hams on the island. W2ML had her CQ heard in Indo-China. W2BST received 65 foreign cards. W2GDT and W2CNK have YLitis. W2BVL, the Nassau Radio Club, will soon be on the air. W2TC is trying 3.9 mc. 'phone. W2ECE believes in low power. W2AWQ just got back from the west coast. W2OT takes a summer rest. W2HP is too QRL to be on. Staten Island: W2AHO says that W2EAV is an old timer from the first district. Ex9UB is now W2UB. W2WP just missed the BPL this month.

Traffic: Manhattan — W2BHL 6, W2ANQ 15, W2AWT 13, W2AOY 4, W2SC 110. Bronx — W2BGO 25, W2QM 43, W2CWP 22, W2CYX 38. Brooklyn — W2ASG 7, W2BAS 20, W2AZV 8, W2PF 72, W2BEV 13, W2DBQ 28, W2NO 84. Queens — W2ADQ 667, W2DQK 13, W2AIQ 87, W2DPU 13, W2AUS 84. Long Island — W2DOG 16, W2CHK 56. Staten Island — W2AHO 53, W2WP 188.

NORTHERN NEW JERSEY — SCM, A. G. Wester, Jr., W2WR — Your SCM wishes to thank all ORS and reporters for their fine support in his eight years of office and asks that they carry on with the new SCM. W2TP will be Jersey's candidate for the Division Directorship. W2AOS has been operating stations in the third district. W2CJX now works on 3.5 mc. W2CNL declares war on rotten notes. W2BPY has put traffic aside for rag chewing. W2AGO reports 8 amateurs graduating from High School. W2CEX reports after a few silent months. W2CIM has located his transmitter in the cellar. The Newark Amateur Radio Association holds meetings via radio on the 160-meter band. The Bloomfield Radio Club has its new prize winning transmitter on the air for traffic. W2CIZ is remodeling. W2DPB will be off until Sept. W2DQJ is trying to get a steady job with his commercial ticket. W2DCK was heard by W2WR on 5 meter 'phone. W2ALD took the U.S.N. Volunteer Reserves to visit Brooklyn Navy Yard. W2BJZ has been on 5 meters and wants work. W2BDD never misses a summer at Allenhurst and will use portable W2EEX. W2ADP was

proud to work Asia. W2CBY had the highest traffic total this month.

Traffic: W2AOS 35, W2CJX 12, W2CNL 11, W2BPY 24, W2AGO 78, W2CEX 16, W2AMT 17, W2CIZ 20, W2DPB 7, W2DQQ 26, W2DCK 8, W2ALD 7, W2BJZ 1, W2CBY 118.

MIDWEST DIVISION

IOWA — SCM, George D. Hansen, W9FFD — W9BPG, RM; W9EIV, RM. W9CWG is playing around with a new transmitter. W9IO went to 14 mc. W9FFD vacations a little. W9HMM is still at it. W9DMX has aspirations toward ORS. W9EIV finally got the license. W9ABE says traffic is light. W9CYL has the crystal perking. W9FYC says all schedules off. W9ACL says activity has slackened. W9GWT reports new receiver. W9EOE is building new rig. W9AFQ is working with AC receivers. W9BWF reports QRL receivers. W9ABH reports. W9GPL has been moving. W9IQE requests report cards. W9ERY moved to farm. W9BPG is still playing baseball. W9FTB says he is leaving us. W9HOH is a new reporter. The TSARC gang at SC reports a picnic at W9GP's place. The Boys at Keokuk and eastern Iowa have a big picnic coming soon. How about it clubs?

Traffic: W9CWG 73, W9IO 52, W9FFD 30, W9HMM 27, W9DMX 23, W9EIV 21, W9ABE 17, W9CYL 10, W9FYC 9, W9ACL 8, W9GWT 7, W9EOE 5, W9AFQ 5, W9BWF 4, W9ABH 1, W9GPL 1.

NEBRASKA — SCM, S. C. Wallace, W9FAM — The SCM appreciates the honor of reflection tendered by the gang. Many thanks for your hearty support these last two years. W9DMY heads the list this time. W9EYE turns in good total. W9DI gets at it on week-ends. W9DGL says no one has any traffic. W9BBS has been fishing. W9FUW cancelled all schedules for summer. W9EWO is building new crystal rig for the rush this fall. W9BQR reports. W9FWW joined USNR. W9DFR helped with Omaha air races in cooperation with KOLL broadcast. W9HTU says new ham started up there. W9CSW wants to help a well Nebraska's traffic total. W9DDS reports FB total. W9FAM is busy rebuilding 1.75 kc. transmitter.

Traffic: W9DMY 91, W9EYE 68, W9DI 4, W9DGL 4, W9BBS 4, W9FUW 2, W9EWO 2, W9BQR 1, W9HTU 4, W9CSW 9, W9DDS 16.

MISSOURI — SCM, C. R. Cannady, W9EYG-HCP — St. Louis: W9GTK visited W9GBC at Hannibal. W9CCZ is QRL YL. W9LLI operates on 7 and 14 mc. W9HVP has new 50 watter. W9GSO is on 7 mc. W9FTA sends in nice report. W9BMU, W9ASC, W9FYW, W9AMR reported by W9FTA. W9HVK is off air. W9HUZ was in DX contest with W9HVJ. W9BCD will soon be back on. W9HWE is contemplating high power. W9FSR is planning to get back in the game. W9FCH QSY to 14 mc. W9HVJ sends in blanket report. W9FCH's address is wanted! Who has it? W9HVN and W9HEL, and think of it: "HVN" and "HEL" both in St. Louis. W9GDU says St. Louis is picking up. W9IJW and W9LJO were previously reported by error as W9EJD and W9EJW. State News: W9FHF says QRM bad. W9AOG is back from Fayette. W9AHY says YF is "Radio-Minded." W9BYN says OW parked baby crib where 500 watter should be — hence silence. W9RR-ZZZ says activity decreasing. W9BGS is inactive for present. W9DHN is working on 14 mc. outfit. W9HNM sends small blanket report. W9IXD is moving to Fayette to go to college. W9JTH is a new ham at Marcelline. W9AIJ is trying a new super. W9CUT is on with 50 watter. W9ASV and W9CLQ took exams for Extra Firsts and Unlimited 'phone. W9TJ, new RM, turns in very FB report. W9HVW is on 7 mc. W9INT is a new ham at Pleasant Hill. W9ARA has two FB ops back from school itching to go. W9AEK is QRL golf. W9IUR is new station at Liberty. W9DVD is back from Harvard. W9CXU is working in bank at K. C. Ex-W9GDD is planning come back. Ex-W9DGI was disappointed in BC field. W9GAU is on 7 mc. between tricks at KGPE. W9FPI plans entering Gulf Radio School. W9BKO is on 7 mc. with 1000 watter. W9FVM-W9CON is back from Arkansas University. W9EHS and W9LXO joined A.A.R.S. W9FYU had BCL trouble. W9HDM is reported QRL. W9CJR is on with new crystal rig. W9IGP and W9HUG joined A.A.R.S. W9EYG-HCP is back from Missouri School of Mines.

Traffic: W9TJ 294, W9FPI 53, W9GAU 29, W9AHY 18, W9AOG 15, W9EYG 13, W9HUZ 11, W9GTK 10, W9AIJ 10, W9HNM 8, W9HVN 7, W9GDU 5, W9BKO 5, W9EHS 5, W9FVM 4, W9HVW 4, W9HWE 4, W9HCP 3, W9HVJ 2, W9FHF 2, W9DHN 2, W9INT 2, W9LXO 2, W9FYU 2, W9CON 1, W9NP 165, W9RR 7, W9CFL 3, W9ZZ 1.

KANSAS — SCM, J. H. Amis, W9CET — W9GPB leads the Section. W9FLG is on 7000 kc. for the summer. W9NI and W9HWW are getting ready for K.N.G. Camp at Ft. Riley. W9FRC is keeping three schedules. W9CUF reports school is out. W9CET is out of town most of the time. W9IEW is arranging to handle traffic for the R.O.T.C. Camp at Ft. Leavenworth. W9DVQ reports little activity. W9KG reports a good total. W9BGL is experimenting. W9GCL is building a 56-mc. transmitter. W9JVC is a new ham. W9CXW has moved his transmitter to the shop. W9GXY is looking forward to the Convention in September. W9EDU is a first reporter. W9DEB just returned from U.S.N.R. cruise. W9IDM is a new station at Wathena. W9HSN has been on a vacation. Save your cash for the best Midwest Convention ever staged, at Topeka, in September.

Traffic: W9FLG 224, W9GPB 236, W9HWW 44, W9NI 87, W9FRC 125, W9CUF 160, W9IEW 38, W9DVQ 54, W9BGL 5, W9GCL 10, W9GVO 10, W9EDV 16, W9HSN 70, W9KG 104.

NEW ENGLAND DIVISION

VERMONT — SCM, Roy L. Gale, W1BD — We welcome the following new stations this month: W1EDR, Essex Jct.; W1EFC, Lewiston; W1EGU, Barre; W1EIV, Fifteen-Mile Falls; W1EJF, Lyndonville; W1ELR, White River Jct.; W1EIS and W1EEB, Windsor. The gang will be glad to know about W1CGX's fine recovery from a recent operation. W1DAJ calibrated his monitor-frequency meter. W1BJP is very QRL. W1CGV and W1BZD received ORS certificates. Dead "B" batteries caused W1ATF's traffic to drop. W1BHR needs new tubes. W1CBE gets out well from the new shack. W1BNS does a lot of rebuilding. W1EFC uses his receiver also as a transmitter. W1DEX has improved his note. W1CGV has a portable with call W1EQU. W1OI gets out well. W1AXN is experimenting with Ford-coil power supply. W1CBW has his station at Joe's Pond for the summer. W1BD is camping at W1ATF's place while attending summer school. Many of the gang are asking for a Vt.-N. H. Convention this autumn. Please let the SCM know your reactions to this idea.

Traffic: W1BD 46, W1BZD 38, W1ATF 35, W1CGV 33, W1BJP 31, W1BNS 28, W1AXN 5, W1DEX 2, W1EFC 2. NEW HAMPSHIRE — SCM, V. W. Hodge, W1ATJ — Thank you for the reflection, gang. With your help we can make this Section one of the best. Traffic is beginning to drop according to W1IP. W1AU has a new 50-watt crystal outfit for CW. W1CCM has moved downstairs. W1APK handled the Boy Scout message to the Governor. W1YB has closed for the summer. W1DMI is back on 3.5 mc. W1ELJ is part time op at W1DMI. W1CGP is taking a portable with him to camp. W1BAC and W1BPI have accepted jobs with the Appalachian Mt. Club. W1DNC has shut down until September. W1CGJ is looking for work. W1AVG has finished his new rig. W1BXU reports a new ham, W1EAW. W1CVK is now portable. W1AXL has changed his whole station, including a new shack.

Traffic: W1P 289, W1DNC 63, W1AXL 28, W1APK 26, W1BXU 8, W1CVK 3, W1CGJ 2.

EASTERN MASSACHUSETTS — SCM, Joseph A. Mullen, W1ASI — W1ABG has gone in for saving postage stamps. W1KH has been bitten by the 56-mc. bug. W1ASI is hibernating till the fall. W1WV requested to be placed on the inactive list. W1AGA is building a new MOPA. W1BNJ is moving into a new shack. W1BZQ is playing with 56 mc. W1ATX and W1BER are building new receivers. W1CQN is looking forward to big things. W1ME reports his '52 working FB. W1BGW is doing some experimenting. W1CFI lost his ORS. W1VS makes the BPL! W1NC resigned his TL appointment. OM depression silenced the transmitter at W1ABF. W1BIBY is a new ORS. W1DVD is on active duty at N.W.N. W1CGB reports W1EMN on the air in Melrose. W1BO reports tossing traffic with a Dutchman for his folks now traveling in Europe. W1BEF is originating lots of traffic. W1DUR reports as the first from Winchester.

The latest addition to our list of clubs is the Middlesex Amateur Radio Society who list among their officers WICKR, Steward, and WIASL, president.

Traffic: WIVS 674, WIABG 138, WIBEF 89, W1NC 76, WIASI 75, W1DVD 68, W1KH 81, WIAGA 56, W1CGB 41, W1BYY 24, W1BZQ 23, W1BNJ 16, W1M1 13, W1CQN 9, W1BGW 8, W1BO 8, W1ATX 7, W1BFR 5.

RHODE ISLAND — SCM, N. H. Miller, WIAWE — WIAWE spent 15 days' duty at Navy compass station in Newport. W1CAB is building a new receiver. W1EX blew his 50 watter. The members of the Providence Radio Association are still full of 56 mc. dope. W1MO is doing big 14 mc. DX business. W1BUX is on most every day from 7 to 8 a.m. W1GR is getting out quite well with his 14-mc. 'phone. W1BTP, Pawtucket High School station, lost its President (WIASZ) through its graduation. W1AQ is building big crystal transmitter. W1CPV will soon have his ORS. WIASZ has two licenses now. W1AOP is going strong in Pawtucket as are W1DCE, W1ELU, and W1BGA. W1BOY slowed down for the season. W1BZI-W1ZS-W1II in Chapaquet is busy with his OBS-OO job. W1DW puts out a nice sock on 14 mc.

Traffic: WIASZ 42, W1BTP 28, WIAWE 4, W1BUX 2, W1AQ 2.

MAINE — SCM, John W. Singleton, W1CDX — W1CFG leads the section this month and wins the wall sign presented the section leader each month by W1BWB. W1BOF is a close second. W1CDX has been visiting ham shacks. W1BEU is busy with the Waterville Radio Club. W1BUO wants to play "salvo" with the SCM. W1BEZ is having a lot of fun with his 'phone. W1APR and W1BTC have good totals. W1BOZ has a new P.P. transmitter. W1DIJ sends in his second report. W1AQW is selling out. W1MT reports a new ham in Sanford, W1EMR. W1EF is very QRL business. W1EEY, W1CHF, W1BGZ and W1DHH send in their first reports. W1CPT is working lots of DX. W1DPR says transmitter on the bum. W1APX took the SCM and his YL over the Arnold Trail into Quebec. W1AGL sends us some dope on the local boys. W1AWN has a 'phone permit. W1BWI sold out. W1ANU has a new fifty. W1APU says 1750 kc. not so good. W1AXJ says lot spring fever. W1BTG gives us a report. W1BWS and W1BLR report traffic. W1AKT says, "W1APX lost the traffic contest due to key clicks and BCLs and his YL due to the traffic contest — but still has his key clicks. Hi."

Traffic: W1CFG 269, W1BOF 261, W1CDX 238, W1ATO 184, W1BEU 102, W1BUO 97, W1BEZ 84, W1APR 61, W1BOZ 56, W1BTC 42, W1DIJ 42, W1AQW 35, W1MT 32, W1ABQ 29, W1EF 28, W1DHH 22, W1CPT 20, W1DPR 12, W1BGZ 12, W1EEY 8, W1CHF 7, W1AGL 6, W1APX 4, W1AXJ 4, W1BTG 2, W1BLR 42, W1BWS 29.

CONNECTICUT — SCM, Fred A. Ellis, Jr., W1CTI — W1MK leads off with a BPL total. RM W1CJD is concluding his schedules to take a well earned vacation. "EV" at W1BDI says the Hartford gang is plenty active. W1BNP was QSO WSQ 150 miles off Boston. W1EJT is a new ham in East Hartford. W1APJ will soon have crystal going on 3572 kc. W1CTI handled a little traffic. W1AMG shut down to put in a new rig. W1CIG sends in last report until school opens in fall. W1AJB suggests an early morning Conn. traffic net for the summer months. How about 6 a.m. EST, gang? W1APW dropped in on the SCM. W1BFS-W1EJZ plans to put in a station at the Lawn Bazaar in Mystic about the first of August. W1ANC-W1ZZAA worked 15 VKs, 1 ZL and 3 K6s on 7 mc. W1BEO went to Boston and got his ticket. W1BYW applies for ORS. W1BNB says traffic slow. Visitors at W1CBA included W1BHM, W1DGG, W1HQ and W1CJD. RM W1BHM lost his 8 year old fifty watter. W1ES is off the air due to change in location. W1ASP was in New York City on active duty with Naval Communications Reserve. W1EFI says same old story, "QRU pse QSL 73 CUAGN." W1TD is hard at work on his new transmitter. W1DOW schedules W1ATK. W1COA reports W1EMV a new ham in New Haven. W1AVB is taking a portable receiver with him on a trip to Virginia. W1DIO was busy building 56-mc. 'phones for W1IM, W1BM and W1EEE. W1EMV has been issued to Jack Lenox, State Deputy, Commission of Aviation, Al Dubin, Air Marine Inspector, also operates W1EMV. The

following report traffic: W1BAX, W1CLG, W1BQS, W1KV. W1DGG, W1FL, W1AZK, W1APZ, W1BGJ and W1ATW. OO W1EAO has moved to new QTH in Hartford. W1CNC worked PY9HC on 14 mc. W1EFW reports a new ham club, YMCA Radio Club of Southington. W1BNP is winner of W1CJD's free QSL cartoon offered to the Connecticut station handling the greatest total of messages for the month ending June 15th. PB, OM! W1ARB has a snappy new QSL drawn by W1CJD.

Traffic: W1MK 514, W1CJD 469, W1BDI 243, W1BNP 172, W1APJ 117, W1CTI 65, W1AMG 64, W1BAX 63, W1CIG 60, W1AJB 48, W1CLG 42, W1APW 37, W1BFS 33, W1BQS 33, W1ANC 29, W1KV 21, W1BEO 18, W1BYW 18, W1DGG 17, W1BNB 17, W1CBA 16, W1FL 13, W1BHM 11, W1AZK 7, W1ES 5, W1APZ 5, W1ASP 4, W1EFI 4, W1TD 4, W1DOW 4, W1BGJ 3, W1COA 2, W1AFB 77, W1ATW 18, W1EJT 9.

WESTERN MASSACHUSETTS — SCM, Leo R. Peloquin, W1JV — W1ASY, 33 Cortland St., Springfield, has been elected SCM for Western Mass. He is to be congratulated for his fine work as Route Manager for the past two years and for his election as SCM. In the future all reports and correspondence regarding section matters should be addressed to Mr. Hewinson. W1AJD leads the Section in traffic this month. W1CJK and W1BPT are two ORS prospects. W1AQM sports a portable call W1CVJ which operates each Sunday on 56 mc. atop Mount Wau-chusetts. W1OF with his portable call W1AWW spends his spare time at Wilbraham Mountain, also on 56 mc. W1BYW reports the usual summer schedule at the Springfield Club. W1AFI reports a new ham in Webster, W1ENB. W1APL has new QRA. W1AUQ has cancelled all schedules. W1DJQ is a new ham in Baldwinsville. W1BZA reports BCL trouble. W1DCH is looking for schedules. W1BKQ has several new blue ticket operators. W1BNL is rebuilding to crystal. W1BXF requests his name be placed on inactive list. As this is his last SCM report, W1JV sends his 73 to the gang, thanking all for their support during his term of office. W1ASY deserves the cooperation of those who like a hard worker. We are sure he will chalk up a brilliant record during his term as SCM.

Traffic: W1AJD 56, W1AQM 42, W1APP 39, W1BNP 35, W1OF 35, W1BWW 33, W1ASY 29, W1AFI 16, W1BVR 16, W1ATK 15, W1APL 10, W1AUQ 10, W1ARH 8, W1DJQ 7, W1BZA 6, W1DCH 8, W1BKQ 5, W1BNL 4, W1EFM 3.

NORTHWESTERN DIVISION

MONTANA — SCM, O.W. Viers, W7AAT — W7FL and W7AHF tied for star traffic station this month. W7AOD has some nice schedules. W7AQN worked a K6. W7CHW is a new Missoula station. W7BVI sold out. W7BGC was on the sick list. W7BBS has been on his vacation. W7AHF is putting in a '47 Pentode for crystal oscillator. W7ASQ is holding schedules on 3500 kc. W7FL works both 7 and 3.5 mc. W7CT is rebuilding to crystal control. W7BST and W7BSS are on CW. W7BNL is working on 7 mc. W7AMA is putting in crystal. W7CBS is a new station. W7BDP is building a portable. W7BKB is on 1.75 and 3.5 mc. W7BDZ has YLitis. W7BYR has an MOPA. W7BDJ has applied for ORS. W7BKM says warm days and the YL have him down. W7BNU is disgusted with crystal control. W7BYE is a new station in Roundup. W7AAT is increasing power.

Traffic: W7AAT 2, W7FL 126, W7ASQ 21, W7AHF 126, W7BGC 11, W7AOD 13, W7BYR 5, W7BKM 5.

OREGON — SCM, Dr. Dolph L. Craig, W7ALO — W8AEM leads in traffic this month. W7WL had FB 'phone-CWQS O with a VE1 and a VK2. W7AJX has a new crystal rig. W7BCZ and WL applied for portables. W7IF worked NZ. W7AVT sold out. W7APE has been under the weather. Several new hams are awaiting tickets at Coos Bay according to W7BLN. W7AGX, 7AMQ, 7BEC and 7VVS are leading 56 mc. activity in Portland. W7AJM hooked two VEs in one day. W7CCU is new ham in Portland. W7WV gets out FB. W7ALA edits "The Amplifier," a ham magazine with a regular monthly circulation of 500 copies, sent without charge upon request to all licensed 7th district hams. W7VS got the coveted police radio job. W7BZO is Portland's only YL operator. The Portland gang are laying

elaborate plans to handle Legion traffic during the National Convention to be held there in September. W7WR reports Navy Net inactive until September. W7CBA will be in Seaside this summer. W7AYV uses tube keying. W7UK has a 56-mc. rig going. W7BOG likes traffic. W7AUL reports DX picking up. W7AXJ sends in his first report. W7HD says power leak QRM bothers plenty. W7ED got his WAC certificate. W7ACH is ready for traffic. W7AEM likes 1.75 mc. W7ALM has heard some good DX. W7ALO is rebuilding to crystal. W7AMF says lots of 'phone QRM.

Traffic: W7AEM 198, W7BMR 131, W7ALO 121, W7WR 104, W7AYV 72, W7AUL 57, W7UK 54, W7SY 29, W7BOG 29, W7ED 24, W7BOO 16, W7AMF 32, W7AXJ 11, W7WL 9, W7PE 7, W7BUF 4, W7IF 4, W7BLN 4, W7BKG 1, W7HD 2.

ALASKA — SCM, Richard J. Fox, K7PQ — K7FF and K7BLI report everything sour so far as traffic is concerned. K7BLI added a 100-watt push-pull amplifier. K7BPD is rebuilding. K7AUW at College, Alaska, is shut down during the summer. K7BQP is a new comer at Fairbanks. K7PQ lost a lot of sleep during the DX contest. K7TF reports breaking through QRM to the east coast. K7AOC is ruining ears all over the U. S. with his FB 'phone. K7BMY is Alaska's second ORS. K7HZ is reported to be handling much traffic for Bristol Bay points.

Traffic: K7FF 303, K7BND 232, K7PQ 145, K7ANQ 142, K7BLI 102, K7BMY 80, K7AAC 60, K7BLI 43, K7TF 40, K7ARL 21, K7BQV 11, K7AHI 4.

WASHINGTON — SCM, John P. Gruble, W7RT — Much credit should go to our star traffic station, W7BB of Seattle. Ed Stevens has done excellent work with this section, and is to be complimented on maintaining the numerous DX traffic schedules, including such points as Guam, Philippines, Alaska, and others. W7BC is the call used by W7BB when on vacation, from which station regular schedules are maintained. Now how about giving Ed a little competition? W7BHH is to operate from Bainbridge Island during the summer months. Building a dynatron meter keeps W7RL busy. W7OI is off the air due to station reconstruction. W7AVI just returned from college. W7ADS schedules W7ID and W7IC. W7AIT desires additional reliable schedules. W7SL keeps a sure-fire schedule with K7AOC and W7US on 'phone. New frequency at W7HS is 7284 kc. Centralia is represented by W7AJS. W7LD worked J and several VKs on 14 mc. W7WY's traffic is increasing. Our RM, W7QL, is always pleased to aid in lining up schedules. Spokane is aided by reports from W7BRG and W7AFC. W7BCV reports for W7BBD and other Walla Walla stations. W7KZ would appreciate hearing from the gang. His QRA is now Box 14, Chico, Calif. OBS W7AVM handled an important message for Shanghai. W7BNI reports from Oakland, Calif. W7TX's brother departed for Alaska. W7AYO says the coming Yakima Convention will be FB. W7ALE is studying for commercial. W7EM and W7BJV are the sole members of the South-side Radio Club at Ocoosa. W7KO is right on the job as Official Observer. W7TX reports the traffic of W7BSX and W7BLH. W7AYO reports for the Yakima gang. He and W7AUC graduated from High School. W7CGZ is the newest ham in town. W7BUW worked several VKs. W7AGV is at National Guard camp. W7BUX is busy with convention plans. W7BCS tries to play the sax. W7ANF blew a pair of 212Ds. W7BKI and W7BUQ are easing along. W7AUE is going to California. W7BBD received broadcast license. W7BLX is now W7KV. W7ZZM is the portable call of W7BDD. W7GT is on 3910-kc. 'phone. W7CGN does nicely in DX and traffic. W7BTX schedules K7ANQ and W7AHI. W7APV of Tacoma passed away June 12th. Nice card received from W7AXI-W7BUC. Ex-SARC was a recent visitor at W7RT. W7BLH is reported to be handling much traffic. A 50-watt crystal is working at W7AGP. W7AZI wonders where all the locals are. Club News: The Amateur Radio Club of Seattle announces new meeting place at the YMCA, at 8 p. m. each Tuesday. The Vancouver Amateur Radio Club meets each Friday at 107 West 8th. The Seattle Inter-Scholastic Radio League has been dissolved until the fall school term. Meet the fellows you've worked over the air at the coming Northwest Division Convention at Yakima. Date is September 30th, and a very nominal fee will be charged. This is an event you'll enjoy, and remember for a

long time. Let's have 100% cooperation. C U at Yakima. Traffic: W7BB 1112, W7BCV 268, W7BHH 202, W7TX 120, W7WY 105, W7AIT 81, W7HS 50, W7BTX 41, W7SL 40, W7QI 39, W7CGN 25, W7OI 20, W7RT 20, W7GN 18, W7APS 17, W7BRG 16, W7ADS 11, W7AJS 11, W7AIE 10, W7AFC 10, W7BNI 9, W7AHQ 8, W7AVM 8, W7LD 7, W8BBD 6, W7GT 4, W7AZI 3, W7KO 3, W7RL 2, W7BSX 119, W7BLH 264, W7AYO 28, W7AUC 1, W7BUW 13, W7BUX 1.

PACIFIC DIVISION

SAN JOAQUIN VALLEY — SCM, E. J. Beall, W6BYV — W6DQV made a cruise on the U.S.S. *Oklahoma*. W6FRH has been having filter trouble. W6BCH has a 50 crystal on 3.5 mc. W6BRJ services radios. W6FFU, W6AME and W6BRV are doing good 56-mc. work. W6EPQ is complaining about the cattle knocking down his stick. W6BIP turned in the Fresno gang's report. W6CGM is a new ORS and OBS. W6DXB turned in a nice traffic report. W6AOA reports two new hams in Bakersfield, W6GEG and GEL. W6AOB will be off due to an automobile accident. W6FKV finds time to ham between jobs. W6EJU is in hospital. W6KE has a mean wallop. W6SF is the only ham reporting from Stockton. W6AV reports from Lodi. W6EBH is now on with '52 crystal MOPA. Ten of the members from Lodi Club attended a lecture by Ellis Manning of the Research Lab of the G. E. Co. W6AK and W6AV ganged up on the A.A.R.S. ZAG contest and scored 520 points. W6ETY turned in his first report. W6BWK is on 14 mc. W6CYY has hooked 3 continents on 14 mc. W6DQR uses a '10 TNT. W6ENA moved to San Jose for his vacation. W6FFP gets all his DX on a clothesline. W6GGN is a new Ham. W6CVT keeps Army schedules. W6BLB has YLitis. W6EPQ is on vacation. W6FFY has crystal on 3.5 mc. The Valley Radio Club in Fresno is coming along FB. W6DWE of Clovis has crystal on 3.5 mc. W6CLB is building a set to fit his new '60.

Traffic: W6DQV 22, W6FFU 35, W6AME 69, W6EPQ 41, W6BIP 8, W6BWK 7, W6ETY 29, W6DXB 13, W6AOA 118, W6SF 24, W6CGM 69, W6AV 69, W6BYV 110.

EAST BAY — SCM, S. C. Houston, W6ZM — CRM Ken Ross, W6ATJ. OAKLAND: W6ATJ leads Oakland as usual. W6RJ keeps his total high with trunk line schedules. W6AF turns in a high total. W6PZ left for Boston June 18th as operator on the famous Old Coast Guard Cutter *Bear*, which will be used by Commander Byrd for his next trip to Little America. W6BIS keeps regular schedules. W6CDA says his schedule with OM2TG is regular as a Telechron. W6ZM is still trying to get the crystal rig going. W6CDP turned in a report. W6DUB blew some filter. W6CYC reports a few. W6DKZ is building a new super. BERKELEY: W6CTX leads the section this month. W6DWI has a weekly schedule with OAAU, the Magnetic Observatory in Peru. W6EDR comes on again with a few. CONTRA COSTA COUNTY: W6EJA says W6BIG doesn't get on much, but when he is on all he does is CQ San Diego as his YL is there for the summer. NAPA COUNTY: RM John Claussen, Jr., W6AUT — Ex-W6CUM will be on again soon. W6BYS is building a receiver. W6CZN says the bridge is finally finished. W6FII is still plugging along. W6AUT finally has his crystal rig going at last. W6CAN has been on 56 mc. W6EDO says QRN and Power Leak QRM bad. W6EUL is QRL work. SOLANO COUNTY: W6BPC has a regular schedule with OMITG. W6DLT says that W6FII was a visitor a short time ago; also that the gang up that way have a new club that meets Sunday once a month. SONOMA COUNTY: W6AOH was spending all his time looking for work.

Traffic: W6CTX 206, W6ATJ 182, W6RJ 166, W6AF 152, W6PZ 149, W6BIS 137, W6CDA 118, W6BPC 115, W6ZM 107, W6DWI 94, W6CDP 45, W6DUB 29, W6FII 12, W6DLT 10, W6CAN 10, W6CYC 9, W6EJA 4, W6EDR 3, W6AOH 1.

SACRAMENTO VALLEY — SCM, Paul S. Farrelle, W6AXM — RM. B. F. Herzog, W6AIM. W6AIM is star traffic man. W6FEJ joined the A.A.R.S. W6FPH is pounding away on 7 mc. W6FFY is a new call at Yuba City. W6BSQ is still QRL National Guard. W6CUM, W6FBS and W6CRN are using 1750-kc. 'phone. W6DGS has moved to new location. W6GBB is a newcomer. W6BHM has a 50-watt crystal rig. W6CAW and W6AHN are on again.

W6CMA cannot find anyone with traffic. W6EJC and W6EAG are YLing. W6BLX is taking flying lessons. W6AXT graduated from college. W6EOU is on 14 mc. W6EJM found a "job!!" W6FMX has his crystal '52 almost ready to go. W6GCM is a new call at Marysville. W6DKW is QRL his U.S.N.R. Unit. W6AUO works at Tel. Co. W6BYB is collecting parts for a new high power rig. W6FRP is in line for ORS. W6DVE has a very FB schedule. W6AID and W6ELC are the 56-mc. sharks. W6APJ has been in the hospital. W6DON bought the YL an engagement ring. W6EMK is getting ready for National Guard Camp. W6GR was heard on 7 mc. W6GF is busy as Radio Service Manager. W6GX is blasting away on 7 mc. W6EFM is looking for DX. W6CFB is still working on 7 mc. W6BKB is enjoying married life. W6AXM is changing to crystal. W6ECN manages to get on the air. W6BHE has been rebuilding. W6ADS is in a sanitarium with T. B. W6LO is still with us. W6CTH is on 3.5 mc. W6AAC let his license expire. W6TM is busy with Trans-Pacific schedules. W6EWB is playing with flea power. Don't forget to report your traffic totals on the 16th of each and every month. W6GDJ is a newcomer in Sacramento.

Traffic: W6AIM 317, W6DVE 16, W6FRP 9, W6EJM 22. SANTA CLARA VALLEY—SCM, F. J. Quement. W6NX—Well, gang, yours truly makes a bow this month and winds up over ten years' continuous activity as your SCM with this final report! Many thanks to all of you who sent in nominating petitions on my behalf, but I find myself without sufficient time to do justice to the job. I thank you one and all for the wonderful support given me and I know that you will give the same cooperation to Bruce Stone, W6AMM, my successor. W6AMM continues to work daily with PL. W6FBW is second high this month. W6YG closed the term with 213. W6NJ is moving into new U.S.N.R. Armory. W6HM is back with his daily Transpacific schedules. W6DSZ is getting into the traffic game again. W6DNY says the Watsonville gang is going 1750 kc. 'phone. W6FMT is sister of W6DSE. W6CEO's Transpacific schedule blew up when KAICO went on vacation. W6FBU will be away from Stanford until Oct. W6DRW is ready for t.r.f. W6DCP has moved to Santa Cruz. W6ALW has 250 watter. W6BMW rebuilt his transmitter.

Traffic: W6AMM 259, W6FBW 220, W6YB 213, W6NJ 96, W6HM 87, W6DSZ 26, W6DNY 23, W6FMT 18, W6CEO 14, W6FBU 10, W6DSE 5, W6BRW 5, W6DCP 5, W6NX 12.

SAN FRANCISCO—SCM, Clayton F. Bane, W6WB—W6PQ as main Net Control station, A.A.R.S., has been doing some mighty splendid work. W6NK reports they won the U.S.N.R. competition for 1931-1932. W6EKC is scheduling 'em hot and furious. W6BNA took portable on his vacation. W6MV is making frantic efforts to get on 14 mc. W6ADK straightened out his trouble with the Coast Guard. W6CAL is known to have been working. W6BVL is doing big things. W6DZZ can now be heard pulverizing 14 mc. W6CZK's stick is at half-mast. W6FFE was active in the DX contest. W6IU put in a 7 mc. crystal with pentode. W6CBN is back on. W6WN has gone and done it. Yep, married! W6DTA expects to be off the air for some time. W6OS is finding out why soupers are sometimes known by other names. W6PW has the answer to the pentode doubling situation.

Traffic: W6PQ 666, W6NK 181, W6EKC 232, W6BNA 154, W6MV 71, W6ADK 52, W6BVL 23, W6DZZ 18, W6CZK 24, W6FFE 9, W6IU 11, W6CBN 8, W6WB 6, W6DTA 4, W6OS 17.

PHILIPPINES—SCM, I. S. Limer, KA1SL—KA1SP is acting chief radio instructor in local radio institution. KA1LG plans QSO soon. KA1NA is doing lots of experimenting. KA1JR is building high power crystal. KA1CM is again active. KA1HR is still going strong. KA1CO is experimenting with antennas. KA3AA takes two persons to operate; Fred pounds brass while the wife throws the switches. OM2TG has good line schedules. OM1TB uses both 14 mc. and 7 mc. KA1SL designed new way of operating while in bed with malaria by using lots of wire and services of a patient mother.

Traffic: KA1HR 1145, OM1TB 692, OM2TG 320, KA1LG 150, KA1SL 106, KA1NA 73, KA1JR 68, KA1CM 38, KA1CO 23, KA1SP 15.

ARIZONA—SCM, Ernest Mendoza, W6BJF—W6CDU has moved W6ALU out to his country home for the summer. W6EFC is consistently on 7000 kc. W6BJF swapped his complete 100-watt PP TNT transmitter, 15-tube receiver, and wavemeter (all AC) to W6DPS for a Harley-Davidson motorbike. W6CQF worked 21 VKs, 3 ZLs, and Guam since the DX tests began. W6CVW is a new ORS. W5ZZB is experimenting on 56 mc. W6CAP and W6CUR are attempting to make hams out of Boy Scouts. W6DJH has a portable 3900 kc. 'phone under call, W6ZZAF. W6FZQ, old W2API, likes the 2-volt tubes in his new receiver. W6CGL is busy at Dept. of Commerce Airways station. W6CDY is busily engaged installing BC station in Yuma. W6BYD is building up a 1.75 mc. portable 'phone. A new ham is W6GFK. W6COI is on 7000 with a MOPA. W6BFA hasn't been on much lately. W6EL keeps daily 'phone schedule with W6DJH. W6FGG has a new National receiver. Ex-W6CFE is soon to be on air from Scotland, according to W6CQE. W6DPS is up in northern Arizona for his vacation. W6DKF (portable W6GDI) was up in the hills as Boy Scout Sub-Camp Director. W6FIP reports a new ham in Yuma, W6FWD. Ex-W6DQW, W8LQ, is contemplating building a portable transmitter at his sanitarium in northern Michigan. W9AM—W9WW—W4ZZE and his party motored through Phoenix enroute to Long Beach, Calif. W7BBB motored through Phoenix enroute to El Paso. W6AWD is making preparations for a more elaborate heap this fall. W6DKU is waiting for a plate transformer. Ex-W6BZO is rebuilding for fall activity. W6DOW and W6EFC have both joined the A.A.R.S. W6FKX no sooner buys some radio apparatus than he sells it to another ham. W6DRE, W6GZ, and W6AND are on 14 mc. W6DSA, portable, is up near Flagstaff for the summer. W6EBP is QRL politics. W6EKP and W6DOW are building portable CW jobs for vacation trips. W6FNM is on 7000 kc. W6FIL has gone to lower California on vacation. W6DVJ is showing some activity on 7000 kc. W6CTI, old W6EAA, is announcing at KTAR, as is W6DHA. W6DIE gets fine results from 6 volt heater receiving tubes.

Traffic: W6CDU 423, W6EFC 98, W6BJF 89, W6ALU 87, W6CQF 86, W6CVW 16, W5ZZB 13, W6CAP 12, W6DJH 8, W6FZQ 3, W6CGL 3, W6BYD 1, W6COI 1.

LOS ANGELES—SCM, Hal E. Nahmens, W6HT—DON'T FAIL to read the last sentence of this report! 107 stations report traffic, a gain of two over last month. Five men make the BPL: W6ETL, W6DQ, W6NF—CFN, W6ADP and W6YAU. LOS ANGELES COUNTY: Nightly schedules with OM2TG and OM1TB put W6ETL way out in front. Second report from W6DQ finds him in second place! W6ADP is on air eight hours per day. W6ETJ is putting in lot of time at W6USA. W6ERM reported direct to HQs. W6DER reports via radio. W6BPU reports the Section net practically complete. Portable W6FBK was in operation at the annual L.B.J.C. and W.W.H.S. Spanish Fiesta. W6AIX, W6FDQ, W6FDE, W6EZZL, W6DFB, W6DQG, W6DJC, W6DOJ and Art Herrald all helped to dispatch the traffic garnered. W6BZF has portable W6GDU. W6EKZ is now 600 watts crystal controlled. W6CVZ has daily schedule with W4ATS. W6EBK is preparing for commercial exam. W6ACL dropped schedule with K6AUQ kept nightly for last five months. W6EV, a ham since 1912, sends in first report! W6AKW is revamping his new rig. W6FEX moved to Maywood. W6OJ is now signing K7UT on 7290 kc. W6UJ predicts plenty of QRM on 56 mc. W6AHQ is new reporter. W6ADH has won ORS appointment. W6CCF craves traffic! W6EXX has left for a year's stay in Japan. W6FGT installed crystal. W6CVF handles mostly DFW traffic. Total shown for W6USA is for one day's operation! W6DKM promises bigger total next month. New antenna at W6HT. Route your ZL and VK. traffic through W6FT. W6BLS is building new receiver. W6TE worked Panama for his 32nd country. W6EUV reports final exams over. W6WO worked 21 Ja. W6DZR is doing good work on 3.5 mc. W6FUS lived up to his call when a ham tried to make away with one of his transformers. Most of W6CUU's junk is out at W6USA. W6EQD has portable W6GBS. W6RME has K6 schedule. W6AM is installing high power Wireless Shop condensers. W7DSP reports that W6FGL, W6FRF and W6FPR are new hams

in Glendale. W6MA was QSO W6ZZA operated from W9UZ's shack in Chicago. W6EYJ worked OA for his 15th country. W6BEE is on 56 mc. W6TN is showing 1500 volts on his fifty. W6BVI voices Section's sentiments when he says, "Dope Sheet FB — keep it up!" W6CXW worked F8PZ for WAC and 40th country. W6DPB has 56 mc. outfit completed. W6FJT QSO'ed his first VK on 14 mc. W6FGQ is struggling to eliminate key thumps. W6BER has his portable W6DCL at Hermosa. W6DWP had QSO using just crystal oscillator and no antenna. W6BVZ is playing checkers over the air with W6FJW. YLs and a new "Rockne" keep W6FEW off the air. W6FDM is sporting a new Pontiac. New rig at W6DFO is 100 watt c.c. push-pull. W6COF wants traffic. W6AFU now has 50-watt rig. W6CGP is getting out well. W6BUP and W6EHO have joined the 56-mc. ranks. W6AIF is building crystal rig. W6DNA is still on sick list. W6AKD is too busy to pound brass. W6ANN has copped that B.S. degree. W6ERL, W6BGF and W6FXL all have more time now that school is out. W6DLL, W6BEE and W6EDW take traffic for San Pedro on Section net. W6VH and W6LY are back on air. W6EXQ worked his 40th country. W6EVE passed the new 'phone exam. W6CTT gives code instruction on 1935 kc., Monday, Wednesday and Friday at 7:30-8:30 p.m. W6CUH rang up over 169,000 miles in DX QSO contest. W6AGF reports new junior op. W6EK says if she could only grab off just one lil' W3 she'd have all districts. W6BHP is heading for 56 mc. Vacation and dead batts kept W6DZI off air. RIVERSIDE COUNTY: W6NF-CFN leads the country as usual. All traffic at W6DZC is U.S.N.R. Activity gaining at W6DLV. W6EFY moved to 3857 Oakwood Place. W6DZF has finally returned to the air. SANTA BARBARA COUNTY: W6YAU received visit from the SCM. W6BZF has new portable, W6GDU. W6EDZ is building MOPA. W6FFF was busy moving. W6EZK is using two 7 mc. single wire fed Hertz' on 3.5 mc. W6EMY has daily schedule with L.A. W6ZBJ is spending month at Boys' Camp. W6ENJ is first man to report from the U.S.N.R. unit at Santa Barbara. W6DJS is President of S.B.R.C. W6FFC, W6DYQ and W6AWY report. SAN BERNARDINO COUNTY: W6FYT leads the county. W6ATL was in operation at the Chaffee Junior Fair. W6CVV blew his '66s. W6BIK is working for ORS. W6FNG has good report. W6FTV is building new crystal rig. W6DGL is trying to eliminate klix from BCL sets. W6DXC promises to handle lots of traffic. VENTURA COUNTY: W6CVK sends in dope on the gang. W6FET has sworn off YLs. W6BCO puts out smooth signals. (Works for Oil Company.) W6ERU went fishing and caught the flu. W6DJZ his home from college. W6BHO, W6DJZ's OM, puts out a juicy 'phone signal on 1750 kc. When W6FBU returned from Stanford, he brought the "pater" a surprise — one new wife! W6CVK also took the fatal step. Fillmore is as dead as an anchovy in a tin can since W6ACF and W6CQA let licenses expire. SAN LUIS OBISPO COUNTY: W6ALQ graduated from High School. W6DWW is pushing a '52 with a '10. W6AJL is active in U.S.N.R. Spend your vacation at Long Beach and attend the 13th Annual Pacific Division A.R.R.L. Convention at the Breakers Hotel Sept. 3rd and 4th! Mail me your reservation NOW!

Traffic: W6ETL 522, W6DQ 441, W6NF 415, W6ADP 396, W6ETJ 303, W6DER 215, W6DJC 185, W6BPU 175, W6FBK 172, W6YAU 165, W6BZF 150, W6EKZ 134, W6CVZ 130, W6EBK 110, W6DEP 90, W6EDZ 78, W6FYT 64, W6ACL 55, W6EV 54, W6AIX 54, W6EZX 53, W6AKW 53, W6FEX 49, W6OJ 45, W6ATL 45, W6CVV 45, W6UJ 44, W6EMY 43, W6AHQ 42, W6ADH 42, W6AWY 40, W6CCF 40, W6EXX 40, W6FGT 39, W6ETM 38, W6CVF 37, W6USA 36, W6DKM 35, W6DYQ 31, W6BYD 31, W6HT 31, W6BIK 29, W6FT 25, W6BLS 24, W6ZBJ 22, W6CZT 22, W6TE 22, W6EUV 21, W6DZC 20, W6FDE 20, W6FNG 18, W6DLV 14, W6ENJ 13, W6FTV 13, W6WO 13, W6DZR 12, W6CUU 11, W6EQD 11, W6EFY 10, W6BME 10, W6AM 10, W6AFU 9, W6CZZ 9, W6DJS 8, W6DKT 8, W6CGP 8, W6AIF 8, W6AKD 8, W6ANN 8, W6EGJ 8, W6YBB 8, W6ERL 8, W6EHO 7, W6DLI 7, W6AYF 6, W6LY 6, W6VH 6, W6EXQ 6, W6EVE 6, W6CCT 5, W6CUH 5, W6AGF 5, W6CUJ 5, W6BGF 5, W6EK 4, W6BHP 4, W6FFC 4, W6DWP 4, W6BCK 4, W6MA 4, W6EYJ 3, W6BEE 3, W6EDS 3, W6TN 3,

W6BVI 3, W6CXW 3, W6DPB 3, W6DGL 2, W6FJT 2, W6FZK 2, W6FGQ 2, W6BVC 1, W6BER 1, W6DEL 1, W6DWF 1, W6FXL 1, W6ERM 23.

SAN DIEGO — SCM, Harry Ambler, W6EOP — W6CNB leads the section this month. His brother, W6BHF is second. FB OMs. Both plan to apply for ORS. W6BHF handled traffic from an ice-bound schooner in the Bering Sea. W6CNB is the western terminus of a new route east to San Antonio, Tex. W6AXN says 20 meters is FB for traffic. W6CNQ visited the SCM and is applying for ORS. W6AXV is back with a ¼ KW and skeds OM1TB. W6FQU, also W6EOH (3.5 mc. xtal), each expect to take out an ORS ticket soon. W6BAM says conditions were poor for traffic. W6CTP worked HH and VK. W6CTR is on 1750 kc. 'phone. W6EOP and W6BOW have five meter rigs working duplex. W6EFF is moving to Chula Vista and will soon be on. W6BAS took a 23-day vacation. W6AYK says "QRL BCL business." W6QY has his shack all fixed up now. W6EAB and W6DDJ have gone to 7 mc. for the summer. W6EFD sticks with 'phone in spite of the static. W6KD and W6DDJ are taking portables to the mountains. W6DAZ and W6BEY have been working on W6DAZ's summer cottage in the mountains. Several new hams are coming on the air in the valley. W6QA is moving and re-building. W6QA, Route Manager for the San Diego Section in the valley, says the coming winter will see lots of activity. The valley (below sea level) is very hot in summer but next winter the gang will make up for lost time. W6EOP, the SCM, expects to attend a meeting of the club at El Centro in the near future.

Traffic: W6CNB 129, W6BHF 120, W6AXN 27, W6AXV 19, W6FQU 17, W6EOH 5, W6EOP 4, W6BAM 4, W6CTP 2, W6BCF 1, W6AKY 4, W6BOW 7.

NEVADA — SCM, Keston L. Ramsey, W6EAD — W6AJP, W6FMS, W6FKY, and W6UO have a four-way QSO every day at noon and at 6 p.m. W6FMS has ordered an '04A. W6BYR, W6EGA and W6EEF are rebuilding. W6EAD built a low pass filter for his receiver. W6UO held a hamfest for the members of the Army Amateurs.

Traffic: W6AJP 26, W6UO 17, W6AAX 6, W6EAD 6.

ROANOKE DIVISION

WEST VIRGINIA — SCM, C. S. Hoffmann, Jr., W6SHD — W6ELO and W6CSF are in Norfolk for U.S.N.R. work. W6BWK is having trouble getting a good note. W6BKJ is experimenting with Zepps. W6FFO says it's harvest time, so QRL! W6AKZ and W6GEG are rebuilding. W6OK is moving to new location. W6EJZ is on trip to California. W6TI is operating W6HEI at home, and has portable W6ZZAN. New crystal signals in Wheeling are W6BJB and W6FAA. W6GEG has portable W6ZZAF. W6AIC, W6AKQ and W6ATT are Morse operators. W6GB promises there will be several crystal notes in Moundsville. W6HD is getting good reports with his new crystal set. The RL promises to visit Huntington and Wheeling soon to conduct examinations.

Traffic: W6GB 164, W6ELO 14, W6BWK 12, W6BOW 5, W6BKJ 2, W6FFO 2, W6CKE 3, W6HEI 1, W6SHD 2, W6CZ 1, W6AZD 8, W6CLQ 4, W6GEG 5, W6EL 10.

VIRGINIA — SCM, R. N. Eubank, W3AAJ — RM, S. T. Terry, Jr., W3AGH, W3AGH made 1015 points in Virginia Contest for 1st prize. W3WO won 2nd prize. W3BJE wants Virginia schedules. W3BGS is on 3690 kc. W3NE is on evenings at 7 p.m. W3AVR is QRL exams. W3BTR now has 7-lb. YL. W3BRY made 370 points in Virginia Contest. W3RL has new 'phone license. W3BSB is still with us. W3BXP is new station at Ferrum. W3CKM is new station at V.P.L. W3AZU reports traffic. W3CAH blew buffer power supply. W3ACN is Ensign Commanding U.S.N.R. at Lynchburg. W3AEJ is commercial operator. W3NT is active on 56 and 7 mc. W3BAN sends wonderful O.O. list. W3ZZZ, portable of W3EJ, is flying plane in Third District. W3BUR is Secy.-Treas. of New Roanoke Radio Club. W3CA is Vice-President of same. E3BDZ is President. W3AGY was visited by W2BYL. W3APU spends 75% of time on traffic. W3APT handled messages to Senators. W3BXN is new station at Quantico. W3AJA asks about O.B.S. W3FE will have crystal going soon. W3BZE reports traffic first month. W3BTC has new receiver. W3AAJ spent week with Washington gang and Convention. W3BWA is

building new receiver. W3BBE reports every month. W3GY reports monthly. W3BVE is active. W3CLV is new station in Ashland; portable W3CNI. W3BE is on with call W3CIT. Following stations and scores in last Virginia Contest. Congrats, all: W3CLV 334, W3BAI 340, W3AGH 1015, W3BBA 3, W3WO 750, W3BAG 545, W3AAJ 575, W3CIE 390, W3BRY 370, W3RL 120, Jones, Ashland 108. W3BAG is moving to Doswell. W3BZ has 56 mc. rig. W3AHQ's QRA is 200 Orchard St., Strasburg. W3BFQ is getting plenty power from '64 tube. W3GE is off due to moving shack. W3AKZ-W3BDZ were in Washington. W3BPR is using MOPA. W3AZI moved around corner. W3BIB visited SCM. W3HJ moved to Penna. W3RS finished school at Manassas. W3ASK is on CW 100% now. W3CFY is quitting grand old game. W3FJ won GR Monitor at Washington. All Virginia hams thank Washington Club for one grand time. W3AU now has call at his place of business, too. W3ZY is selling out. W3AYB is new station at Bassett. W3BYA is new station at Clifton Forge. W3BZE-W3BFS-W3CLD-W3BZD and W3CKZ all new stations in Richmond. W3EW is OT Bradley back on after ten years. W3CCU is now in N. C. W3BBX is on at times. W3BBA has new crystal rig. W3ANM has also gone crystal. W3CEB is operating on ship. W3ALL is back on. W3ZU reports. W3YD has FB crystal rig. WCBWT wants a Virginia schedule for lots of traffic. W3ATY will get lots traffic from West Point Cadets at Ft. Monroe for summer. All Virginia stations licensed in last three months are urged to send dope to SCM for listing here and in Virginia bulletin.

Traffic: W3AGH 250, W3WO 127, W3CAH 97, W3NT 88, W3AAJ 43, W3AVR 22, W3BJE 21, W3BSB 19, W3BTR 18, W3NE 17, W3BZE 5, W3BUR 9, W3BXN 7, W3AEI 7, W3AZU 7, W3APT 6, W3APU 4, W3AGY 1, W3BAN 5, W3ACN 5, W3RL 5, W3FE 4, W3BRY 2, W3BGS 2, W3AJA 2, W3CKM 1, W3BFQ 2, W3GE 1, W3EJ 76, W3AHQ 40, W3AKN 23, W3AKZ 17, W3BAG 6, W3BPR 4, W3BFQ 2, W3ZU 4.

NORTH CAROLINA — SCM, H. L. Caveness, W4DW — A good delegation from Winston-Salem, headed by W4ABT and W4OG, attended the ham convention in Washington. Others attending were: W4OC, W4AVT, W4EG and W4DW. We heartily congratulate the Washington Club on putting over such a successful convention. W4AVT says the N. C. Net is shaping up. Control stations are W4AVT, W4TR, W4ABT, W4JR, and W4TO. W4AGO is trying to find room for a 3.5-mc. antenna. Carpenters repairing W4AGD's house tore down his antennas. W4TR recently QSO'd 72 stations in one day. W2DBV and his mother spent a week with W4TR. W4AAE is QRL with YLs. W4TJ took another spill with his motorcycle. W4IF expects to be a student at State College this fall. W4MR has an '03A on now. W4BKG is a new ham in Turkey. W4BIS, W4BMW and W4BNL are new hams in Raleigh. W4AGF is working on 7 mc. until fall. W4ALK says that W4ALT is QRL YLs. W4TP is building a new shack. W4ADK is lining up some schedules. W4VB has received an average of one QSL card a day since he received his ham license. W4ZH and W4AOE are still on the air. W4ED is experimenting with 1.75-mc. 'phone. W4AEH has been rebuilding. W4NP is anxious for a schedule on 7 mc. with Baltimore. W4BP says that he and W4BJU are on a 1.75-mc. 'phone. W4AGH is a comparatively new ham in Lumberton. W4MI and W4BC have hopes of entering State College. W3CHK, Ex-W4NJ, is working at Chimney Rock this summer. Ex-W4OU is chief operator, and W4ANI is second operator at WWNC. W4RE had two weeks active duty training with the Naval Communication Reserve at Charleston, S. C. W4BOH will be one of the operators at W4ATC next school year. W4ANU has a crystal rig on 3.5 mc. W4EG is rebuilding. W4GZ is one the air in Charlotte this summer. W4CP is spending the summer at Rocky Mount. W4WX is a student in State College summer school.

Traffic: W4TR 252, W4AOE 27, W4ZH 25, W4GZ 25, W4AVT 21, W4ANU 18, W4DW 18, W4AGF 14, W4NP 14, W4VB 9, W4IF 9, W4AGD 8, W4AAE 8, W4RE 7, W4MR 6, W4TP 5, W4AEH 4, W4BD 3, W4ADK 3, W4ALK 2.

ROCKY MOUNTAIN DIVISION

COLORADO — Acting SCM, Artie Davis, W9BJN — Our SCM, W9ESA, is still on the sick list but is improving nicely. The Colorado Experimenters Association gave a hamfest at Sedalia in honor of our Director, who told us all about what took place at the Directors' meeting at Headquarters. W9BQO and W9CBW are keeping up the Navy Net interest. W9EAM, W9EKQ and W9GB are keeping the Army Net work going. W9CJJ, Colorado 'Phone, is on 14 and 3.5 mc. W9FRP, W9AUJ, W9BY, W9BTO, W9CBU, W9HPY, W9FCK and W9BPH are active. W9CKO reports for the northern part of the state. W9IFD has a new steel tower. W9CRK will be on soon. W9HWR is on 1.75 and 14 mc. W9YL-W9HIR is on 3.9-mc. 'phone. W9FYL has a new call — W9IUH. W9IFQ is a new ham. W9FG has Africa to work and a WAC is his. W9FNR says W9FJH (Ex-2AYS) is new in Boulder. W9FFU-W9FYK and W9HKN are active. W9BOO is perking on 3.5 mc. W9FQJ operates W9YAA and has portable W9ALC. W9EDM has QRM from school work. W9PO has a portable, W9ETM. W9IES put Sterling on the map. W9AAB is building a real portable. W9DQD is pounding plenty of brass. W9CDE never fails to be on. W9DNP is building. W9ZE, our R. I. is on with a portable.

Traffic: W9FYU 20, W9EAM 7, W9JCQ 7, W9EHC 3, W9DQD 19, W9CDE 1, W9FCK 8, W9BJN 3, W9GNK 59. **UTAH-WYOMING** — SCM, C. R. Miller, W6DPJ-W6ZZZ — W6DEU, W6BSE, W6APM, W6AVW and W6DPJ spent several days fishing and pounding brass at W6ZZZ up in the mountains. W6EXL finished his portable outfit. W6FEB has a mercury vapor rectifier. W6DEU experimented with several transmitters. W7CDH is a new station in Yellowstone Park. W6FAE and W6AVW are now in the A. A. Net. Nothing new at W6DAM. W6DPO is rebuilding again. W6BTX is in California again.

Traffic: W6DPJ 87, W6DAM 17, W6BSE 11, W6APM 10, W6DPO 8, W6FEB 5, W6EXL 3.

SOUTHEASTERN DIVISION

ALABAMA — SCM, L. D. Elwell, W4KP — Over 40 of the Birmingham hams are out for a "Hunt the hidden transmitter" contest. W4EA is QRL BC repairs. W4BBA changed his QRA. A new MOFA is perking at W4APU. A flock of rectifiers went west at W4AP. W4AJY leaves for Georgia Tech. with the call W4BAB. W4AYK, W4AXU and W4GN paid a visit to the SCM. The past SCM is easing back on the air with crystal control. W4ALA is keeping three schedules per week to W4BBO. W4BFM is observing "Quiet Hours." W4BEI is trying to make his Type Ten perk on 14 mc. Ex5BWT is on with the call W4ZZM. The newcomer at Wilsonville is W4BIV. W4BAU spends his time on 3.9-mc. 'phone. A new receiver is in the making at W4BAL. W4ADJ is a new prospect for OHS. An R9 report is prized by W4DD. W4HO is doing a trick at a local BC station. W4ADL is building an airplane transmitter for 56 mc. tests. W4BFP is off for the C.M.T.C. W4AHU plans a cellar for combating the summer heat. Hi. DX has a hold on W4AGI. W4VC bought the neighbor a new electric fan. Hi. The SCM is vacationing on 7 mc.

Traffic: W4ALA 14, W4KP 9, W4AP 5, W4AJX 5, W4AYK 4, W4ADJ 4, W4BAI 4, W4AHP 1.

WESTERN FLORIDA — SCM, Eddie Collins, W4MS-W4ZZP — RM, S. M. Douglas, W4ACB-W4PCN. W4FV-W4ZZR leaves us for Annapolis for a post graduate course at the Academy. W4ATN leaves for the West Coast where he will be W6IM again. W3ADO is applying for a W4 call. W4BNE is a new one in Pensy. W4BGA gets out FB. W4AXF likes the OM's transmitter better than her 7½ watter. Hi. W4ALJ-W4CV got a portable call, W4ZZAE. W4AQY has worked all districts. W4AOO got a nice report from a W5 on 1750-ka. 'phone. W4BGF and W4AXP are going FB on 3500 kc. W4ASG is very silent. W4BKD pounds them out. W4BOW is a new ham in Marianna. W4AUW uses an indoor 14000-ka. antenna. W4AUV is experimenting. W4BMJ and W4BWL are trying spark oil for power supply. The Hamfest at W4KB's was a great success. W4AGS-W4PCK has a FB MOPA. W4ADV let his call expire so will operate from W4AWJ. W4QK still has power trouble. W4QU has moved to 7000 kc. W4ASV-W4ZZW is getting out FB. W4BKQ has filter trouble. We

are glad to see W4ALJ using PDC. W4VR is held up only by the company he ordered his grid leak from. W4UW-W5NO reports a FB trip on a sea going tug. W4ARV has been busy. W4ART-W4BGB is on occasionally. W4BIV is in Milton. W4BEW only needs a tube. W4ACB-W4PCN is completely rebuilding. W4QR-W4PEL has an FB portable. W4ART has been busy with work. W4ML says his jaws are tired from saying "Hello CQ." Hi. W4AUA attends the USNR drills regularly with the help of W4ACB. W4QR keep W4SC clicking right along. W4MX made the trip to N. O. to see the — YL. W4SZ is busy at W. U. W4HQ-W4PBW. NDD is installing a transmitter on a fishing smack for Naval Reserve work. W4MS-W4ZZP is all set in his new shack. W4AQ-W4PDS reports a prospective ham. W4BGA does likewise.

Traffic: W4ATN 10, W4QU 11, W4ALJ 5, W4ASV 15, W4AQY 4, W4AXP 3, W4AUW 12, W4AUV 6, W4QR 16, W4ACB 18, W4AGS 22, W4KB 15, W4BGA 14, W4UW 3, W4BFD 2, W4BKD 2, W4AFT 1, W4FV 45, W4MS 16, W4ARV 4, W4ART 3, W4ML 1, W4BJF 2.

EASTERN FLORIDA — SCM, Ray Atkinson, W4NN — W4UX has gone to sea. W4AEM has been active. W4BNA, JAROC Club Station, is on the air regularly. W4UJ has new 250 watt job. W4ZV made application for ORS. W4VP reports plenty rain. W4YJ is L. A. Roddy in Tampa. W4AGB built a new transmitter. W4NN is inactive. W4BMN is a new ham in Miami. W4PCZ took a portable to Tenn. W4AKW keeps schedules daily with W4AUL. The Knights of the Kilocytes carry on with their regular Sunday morning meetings. W4HY still handles traffic. W4AKV sends in a list of DX heard. W4AZB is mourning a burnt out power transformer. W4MF built a public address outfit. W4DTS has moved to Michigan. W4DW says DX "ain't so hot." W4AKH is in another DX contest. W4BGR has a good total.

Traffic: W4AEM 31, W4BGR 21, W4AGB 13, W4BMN 9, W4VP 8, W4UJ 8, W4AZB 4, W4HY 4, W4DE 3, W4AKV 3, W4MF 3, W4AKW 2, W4AKH 1.

GEORGIA-SOUTH CAROLINA-CUBA-ISLE OF PINES-PORTO RICO-VIRGIN ISLANDS — SCM, Chas. W. Davis, W4PM — Thanks for reports and felicitations, gang. W4SM leads in traffic with W4BLQ close second. CM2WW is now on 7200 with crystal. CM2JM is getting out on 14-mc. 'phone. CM2XR is also on 14 mc. 'phone. How about key clicks, CM2DO? Don't cut such an r.a.o. hole. CM2MM. CM2SH is going to Ga. Tech. W4AAY is now RM. Contact him, gang. The following took part in 56 mc. tests: W4KU, W4SI, W4IB, W4KA, W4XB, W4MO, W4UD, W4BEY, W4PCL (on Stone Mt.), W4PAV (on Kennesaw Mt.), W4PAG (Biltmore Hotel, Atlanta). How about relaying all local traffic by 56-mc. 'phone, gang? About 50 members of the Atlanta Club were present on Stone Mountain and had great time.

Traffic: W4BLQ 76, W4AM 83, W4BET 11, CM8AZ 36, CM8YB 41, W4SS 5, W4AAY 7, CM2WW 8, W4AZT 10.

WEST GULF DIVISION

NEW MEXICO — SCM, Jerry Quinn, W5AUW — W5AOP sends in another good report. W5BVC handled his share. W5MP passed his amateur exam. W5AOD has been QRL business. W5BUY reports a new transmitter. W5AUW is putting in crystal. W9GNK, W5BUY, W5CGJ and W5AVE were visitors at the SCM's shack. Ex-W5BPJ got his pink ticket. W5AGP has connected with AARS. W5ZM has applied for an ORS. W5AVE is using crystal on 7 mc. A new one at Chamita is W5CGJ. W5AAX worked China. W5AOE ordered a crystal. W5AXV will be on with a '10. W5ASR spent a week at Tulsa.

Traffic: W5AUW 195, W5ZZQ 103, W5AOP 41, W5BVC 24, W5ZM 20, W5AAX 14, W5AOD 10, W5MP 10, W5AOE 10, W5ASR 5.

OKLAHOMA — SCM, Emil Gisel, W5VQ — W5BMU heads the list this month. W5BEZ is active on 7 mc. W5BLF is off the air for a while. W5ALI has a DB mike now. W5AUA is thinking of high power. W5BHQ is working on 7190 kc. W5AMS visited W5VQ. W5CIZ is a new man in Ponca City. W5JW is a new ham in Lawton. W5ABK is getting better results on 7 mc. The Key Clickers Club is still experimenting with 56 mc. W5ANB and W5BLW

recently visited W5PP and W5AJO. W5AND is experimenting with MOPA. W5BTZ is having antenna trouble. W5RU is active on 1.75-mc. 'phone. The Muskogee Amateur Club is up and at 'em. W5ATB has a fine 'phone. W5BQA finally got his crystal working. W5BOE is awaiting renewal of license. W5CHX is new station at Sasakeva with two '10s in TPTG.

Traffic: W5BMU 145, W5OJ 42, W5ASW 5, W5AUA 3, W5ASQ 2, W5AND 1, W5BHQ 17.

SOUTHERN TEXAS — SCM, H. C. Sherrod, W5ZG — Austin: W5CT has opened up the portable W5CCZ for the summer and is on the air at Lometa, Caswell, second op at W5VV, has gone to Maine for the summer and is signing W1AYJ. W5VV is still playing tennis. Livingston: W5CET is a newcomer. At last! A report from Beaumont. The donor is W5CDM, Ex-W4ACC. W5BTE is on a six months' vacation in California. W5BCG is awaiting cool weather. W5AFG is building new equipment. W5OL is a new ham. W5SM has a new receiver. Brownsville: W5CKS is a new man. The Brownsville amateurs have organized with W5CGO, President; W5CKS, Vice-President; and W5PR, Secretary and Treasurer. College Station: W5BWB is now using a 211 crystal controlled on 7052 kc. San Antonio: W5PF has been QSO NY and RX. A new man in the Alamo City interested in traffic handling is W5OR. W5MN is on consistently. W5BWM is gloating over the acquisition of a brand new '03A. W5NU is another newcomer. W5BUV reports for the San Antonio Radio Club. During July and August the SARC will take a vacation and will resume regular meetings the first Friday in September. W5CAS has changed his QRA. The following are on regularly: W5CS, W5RV, W5BVG and W5OW. W5BQH has the crystal note going good. W5OR is on consistently. El Paso: The following are on quite consistently: W5AEC, W5AEP, W5AFN and W5AOT. W5AFS sends 73 to the gang. The hot weather has W5AUL. W5EAD has gone to San Antonio. W5BCD lost his station license. W5BNJ, W5BQU, and W5CAW all passed the examination. W5DE is peddling pop to parched people. W5ES has moved to 1207 Arizona St. W5NT is going to Mexico for a visit. W5GI is handling some traffic. Kerrville: W5BKE is on 7020 crystal controlled. W5BSF is on vacation. W5BKK passed Unlimited Broadcast. Bay City: W5ABH reports little activity. Serrill is now W5CHM. Douber is applying for a license. Houston: W5AFV is on 7 mc. CW and 14 mc. 'phone. W5BDI is on 5 mc. W5CEC is using a '45. W5BTD is also working on 56 mc. W5BTD successfully copied the Akron, NZRLB, on 12615 kilocycles. W5BHO is working the Army Net every Monday night. W5ON is on 3.9 mc. 'phone. W5BKW is off the air. W5QW is still building. W5AMX is working CW in the Army Net. W5AZR is selling out. W5BRC is busy testing with W5YH, with the assistance of W5ON. Shortly there will be a new amateur in San Antonio. We of Galveston are indeed sorry to see the departure of Captain C. E. Hart, W5CDH, for the Alamo City. The SCM will appreciate any courtesy shown Captain Hart by San Antonio amateurs. Kindly send all reports to W5ZG at the address shown on page 5, this issue.

Traffic: W5BWB 1, W5PF 12, W5MN 27, W5BWM 1, W5NU 9, W5CS 15, W5BVG 21, W5BUV 16, W5AEP 8, W5AFN 1, W5AOT 12, W5BNJ 75, W5BQU 71, W5CAW 15, W5NT 15, W5GI 4, W5BKE 12, W5AFV 2, W5BTD 4.

NORTHERN TEXAS — SCM, Roy Lee Taylor, W5RJ — W5BII is now our main Route Manager as W5AUL has given it up for the present. W5BKH is paving the road to the BPL. W5BCW is after an ORS. W5AYX is doing his share as are W5ARS, W5BJX and W5CJE. The WPARC wants more of the gang to listen to KGKO amateur broadcasts each Saturday at 3 p.m. CST. W5SU worked a K5. W5AUL is busy at his job. W5CIJ is a new ham at Olney. W5JA is doing nice work. W5AAO reports 20 men in his second district A.A.R.S. net. W5BYF reports. W5AJG has been on the sick list. W5IT wants to know of anyone sending code practice. W5ANU sends in a list of good and Prehistoric signals. W5CHJ-CHK will be on shortly. W5BZT is in the Army Net now. W5AMF of Hereford is a new member of our Section. W5AID has portable W5ZV now. W5SH is putting in Tourmaline 14-mc. 'phone. W5QY and W5BYN are at Worth Ranch. W5CAM says W5AXT is installing a '52. W5AZC visited hams in Mississippi. W5AUB of Tupelo,

Miss., will be in and around Ft. Worth for vacation and wants to meet the gang. W5WP got his hand into 11,000 volts while on duty at WBAP and burnt part of his fingers off. W5ARK says it's too hot. W5AGQ will be on soon. W5AVF is on with new crystal rig. W5AUL, W5CDG, W5BFX, W5SP, W5ANU, W5BZT, W5AVF and W5BAH visited the SCM the past month. Visitors are always welcome at W5RJ. The Sixth Annual West Gulf Division Convention will be held at the Blackstone Hotel, Ft. Worth, Oct. 7th and 8th. For further information write Roy L. Taylor, Convention Chairman, W5RJ, 1614 St. Louis Ave., Ft. Worth, Texas. "Sparks" will be carried on and will be printed instead of a mimeographed affair. The first issue will be out August 10th or thereabouts. For more dope on "Sparks" write W5CDG, W5AUL, or W5RJ.

Traffic: W5BII 243, W5BCW 215, W5BKH 196, W5AYX 267, W5ARS 4, W5BJX 28, W5CJE 2, W5SU 5, W5AUL 41, W5CII 33, W5JA 87, W5BYF 18, W5AAO 30, W5AJG 20, W5IT 48, W5ANU 12, W5AMF 4, W5AID 10.

CANADA

MARITIME DIVISION

NOVA SCOTIA — SCM, A. M. Crowell, VE1DQ — VE1AE leads the traffic list this month. VE1BV piles up 110. VE1DI and VE1DH have combined their resources. New man at River Hebert — Call VE1CL. VE1ER keeps schedules with Massachusetts. VE1CW has rebuilt. VE1AX has left for New York. VE1DQ just got back from Columbus, Ohio. VE1BM reports for Cape Breton. VE1AL is getting his receiver overhauled. VE1AH is new man in Sydney. VE1AV has been giving 7 mc. a try. VE1BN is all set to go with the new high power 'phone. VE1DW reports via 14 mc. VE1DM worked Brazil with his 14-mc. 'phone. VE1DR is rebuilding to crystal. VE1DL is working DX on 14 mc. VE1DW is getting out well. VE1CK worked his first PY on 14 mc. VE1CN is getting good reports. NEW BRUNSWICK — RM, W. A. Kelso, VE1AE — VE1BQ, VE1BA and VE1AK are on regularly with 3.5-mc. 'phone. VE1AU is on 14 mc. VE1DC has a 3510 crystal and doubles to 14 mc. VE1DY is a commercial op. at Keswick, N. B. VE1CL sends in nice report. VE1DC, 'DP and 'CY recently visited VE1AE.

Traffic: VE1AE 145, VE1BV 110, VE1DI 26, VE1ER 26, VE1CY 11, VE1AX 9, VE1DM 5, VE1DQ 4, VE1DW 1.

ONTARIO DIVISION

ONTARIO — SCM, H. W. Bishop, VE3HB, VE3GT is operating VE9DG for the Ontario Forestry Branch. VE3LI is a newcomer. VE3AD is playing Sax at Crystal Beach. VE3PN is QRL studies. VE3HN handled a rush message for the OFB. VE3GX and VE3RA are operating stations for the OFB. VE3DX is a new addition from Ft. William. VE3GB and VE3HN have been experimenting. VE9AL is going to operate a portable under VE3AL at Stony Lake. VE3IH is in camp with five hams and one BCL. VE3DM and VE3HM paid a visit to VE3IH. VE3AU can't locate his reporting cards, VK card, monitor or monitor since the big flood when the Apartment roof sprang a leak. VE3GK is on 14 mc. VE3AQ is trying 56 mc. VE3LN is a new ham in Weston. VE3IB is a crippled war veteran. VE3DE is a new ham in Niagara Falls. VE3IG has increased power. VE3DB is QRL golf. VE3HB is scheduling W1CV. VE3DG is a new ORS. The W.A.O.O. are going to conduct a 56-mc. test, VE9AL taking VE3AZ in his plane until their signals can no longer be heard. VE3GL, VE3FR, VE3TT, VE3IX and VE3IB are applicants for ORS. We all sympathize with VE3GA in the loss of his father, the Rev. J. F. Sutcliffe. VE3LW and VE3FD are conducting experiments on 56 mc. VE3CM is still pounding away. VE3HZ is QRL exams. VE3SA reports for VE3JW, and says VE3LI, VE3RK and VE3SA are known as the "Terrible Triode."

Traffic: VE3HN 31, VE3GK 35, VE9AL 21, VE3GT 20, VE3HB 17, VE3AQ 15, VE3IH 8, VE3AU 7, VE3AD 3, VE3JW 1, VE3SA 1.

QUEBEC DIVISION

QUEBEC — SCM, Alphy L. Blais, VE2AC — VE2CU is off with a forestry expedition. VE2AP is preparing an outfit to be used during the eclipse. VE2BB keeps a few schedules. VE2AG and VE2AQ are heard consistently. VE2CX started on a 56-mc. outfit. VE2CO is testing out his new outfit. This is the last report from the present SCM who is forced by doctor's orders to resign his post. I want to thank the amateurs of this Division for the support and the help they have given me while I acted as SCM. I am proud of this Section and I know that the next SCM will find it, as I did, the greatest Section of them all.

Traffic: VE2BB 41, VE2CA 2, VE2CL 4, VE2CX 22.

VANALTA DIVISION

ALBERTA — SCM, C. H. Harris, VE4HM — VE4GY wins the cup in miles per watt contest. VE4HA is on week ends. VE4IZ is using MOPA. VE4EO reports for first time. VE4FJ now has his license. VE4FR is QRL gardening. VE4GT is pleased with reports from his new outfit. VE4BV is rebuilding. VE4EA works France. VE4HM's first contact on 'phone is responsible for report from Calgary gang via VE4HQ. VE4GD was heard in Honolulu on 3.5-mc. 'phone. VE4CY is rebuilding Class B modulation. VE4GP left for Lake Athabasca. VE4JI changed QRA. VE4JK moved to Edmonton. VE4JX is on 7 and 14 mc. VE4IT is on 3.5 CW. VE4HQ is pounding through on 3.5 mc. 'phone. VE4DX is going to rebuild. VE4DT keeps up the traffic total.

Traffic: VE4HM 25, VE4EO 5, VE4FJ 2, VE4IZ 2, VE4DT 59.

BRITISH COLUMBIA — SCM, J. K. Cavalsky, VE5AL — The SCM paid a visit to VE5DM and VE5CT. VE5AC has a Victoria schedule. VE5FF is moving. VE5BC says his schedules to the east went west. VE5AG has changed his location. VE5FG reports traffic scarce. VE5BR was a visitor in Vancouver. VE5HP is still going strong. VE5HR can't get a good note on the high frequency bands.

Traffic: VE5HP 88, VE5FG 16, VE5AC 34, VE5AG 36, VE5BC 12, VE5AL 10, VE5FF 10, VE5BR 5, VE5HR 6.

PRAIRIE DIVISION

MANITOBA — SCM, J. L. Green, VE4BQ — Two new stations appear in Brandon — VE4IF and VE4RS. VE4AC will soon be active. VE4DK is building crystal rig for 14 mc. VE4DJ hooked VK5BR, 5GK, 5ML, 5DR and ZL2GK. VE4FU rebuilt. VE4CI is on again. VE4FU and VE4BQ visited VE4CP. VE4CS pushes fine signal. VE4GC is now on 14-mc. 'phone. VE4FT has been QRL. VE4BQ hooked F8PZ, F8WB, PY2BK and RX1AA. VE4GQ will be on with 100-watt job. VE4AK is arranging a Winnipeg schedule. VE4JB uses 7 mc. VE4EF has MOPA. VE4AG says he can't "get out." VE4IC left for Beauharnois, Que. A successful banquet was held in the St. Regis Hotel, about 30 local ops being present.

Traffic: VE4DK 9, VE4DJ 8, VE4FU 18.

SASKATCHEWAN — SCM, W. J. Pickering, VE4FC — A very successful hamfest has been put over by the Swift Current gang; over 40 in attendance. VE4IH won the 50-watt (Thermos) tube. VE4BB turns in the best traffic report, followed by VE4GR. VE4EL finds 3.5 mc. crowded. VE4HX has forgotten his grudge against the WX. The Saskatoon QSL contest came to an end with only two left in the race, VE4GR and HX. VE4BF has been getting out well. VE4GR worked a JI. VE4GJ is on the air in Saskatoon.

Traffic: VE4BB 64, VE4GR 40, VE4EL 16, VE4HX 12, VE4JV 4.

Traffic Briefs

We understand that W4ACB tried beating his receiver with his monitor and broke them both.

W3OK reports that SCM Jack Wagenseller, W3GS, took unto himself a wife on June fourth. Congrats, OM.



CORRESPONDENCE

The Publishers of QST assume no responsibility for statements made herein by correspondents

Effects of the Aurora Borealis

West Hazleton, Pa.

Editor, *QST*:

Were you listening on the night of May 29th? If you were you certainly must have noticed the unusual conditions existing at that time. By careful observation here we have secured data on the effects of the Aurora Borealis, known more familiarly as the "Northern Lights." The observations were made on the 40-meter band, and the display was one of the brightest seen from this location in years.

During daylight until 5:10 p.m. E.S.T., the conditions were normal. Normal conditions here are when ninth and fourth district stations come in regularly through the eighth and first district stations. The second and third districts are not heard at all during normal conditions.

At 5:10 p.m. the signals were suddenly diminished in volume from an average of R_7 to R_6 . But this didn't mean much alone. However, at about 5:25 p.m. it was impossible to receive stations on this side of the Mississippi River. The fifth and sixth districts were rolling in very well. This period lasted until 7:50 p.m.

Around 8:00 p.m. the signals increased in volume, but only the second and third district stations were coming in. Regardless of what power most hams were using there was an average R_6 signal all over the band. A QSO with two Philadelphia stations reported "Your sigs are stronger here than the local stations, QSA5 R_6 plus." Ham after ham worked in the second and third districts gave the same reports. This period lasted until 11:47 p.m. when the signals became weaker and only the western and southern stations were rolling in. While QSO'ing a three the conditions changed so that his R_6 sig was R_4 . Truly a remarkable thing to happen at less than a second's notice.

From 8:00 p.m. until about 11:30 p.m. is when the display of Northern Lights was brightest and also it was during this period that it was possible to receive only the second and third districts. This was very unusual since second and third district stations rarely are heard here at those times. Reports on conditions on other bands will be appreciated if sent to WSEPY, West Hazleton, Pa.

—Paul Skitzki, WSEPY-WGCP

Splendid Relaying

Wogack Road 33 Flat No. 1,
Ex-Russian Concession,
Tientsin, China

Editor, *QST*:

On the 15th of February I received an anxious letter from my uncle who is in Australia. He had no news from us since May, 1931, as evidently my father's two letters never reached him. Now, a letter from Tientsin to Australia takes approximately two months, and you never can be sure that it will reach its destination. If you register the letter you can be sure of its safely reaching the addressee, but in just double the time.

My father, therefore, did not know what to do, whereupon I suggested I would try amateur radio and if it failed then we could always send a commercial cablegram. This was accepted and we set up a message which I mailed to Dr. Malcolm, AC3MA of Chefoo, he being the nearest active ham station from Tientsin.

This ham received my message a week later, on the 22nd, and immediately fired it away at KA1HR, Fort McKinley, P. I. This OM in turn pounded it off at ZL2CJ, Wellington, New Zealand, who at once turned to his transmitter and sent on the message to VK5PK, South Australia, who in turn mailed my message to my uncle next morning, the 23rd of February, and it was received three days later. Thus this message had crossed the ocean and the enormous distance from Chefoo, North China, to Georgetown, South Australia, in less than a single night! This no doubt constitutes a record of some kind!

Now everybody in Tientsin thinks amateur radio to be a great achievement. And I, as well as my whole family, wish to take this opportunity to thank all the participating stations publicly for this wonderful service, made possible through their kindness and through their splendid teamwork in QSP'ing my QTC.

With 73's and loud Hurrah to the amateur cause, I am sincerely yours,

—Baron P. D. N. von Hoyningen-Huene

P.D.C. vs. R.A.C.

34 Walnut St., Gloversville, N. Y.

Editor, *QST*:

About those r.a.c. and a.c. notes. This station has been used for a little experiment covering a

THE TRIMMINGS

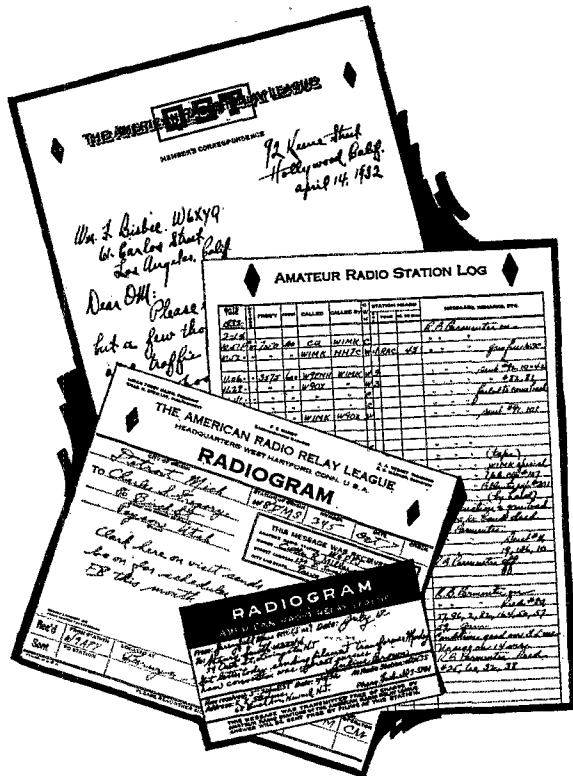

Here are the TRIMMINGS you need to be a real, full-fledged, blown-in-the-bottle AMATEUR

OFFICIAL A.R.R.L. MESSAGE BLANKS

The proper and most convenient form. Designed by the A.R.R.L. Communications Department to make speedy and accurate handling easy. A great aid to good operating practices which reflect credit on your station. Bond paper, size $8\frac{1}{2} \times 7\frac{1}{4}$. Put up in pads of 100 sheets. One pad 35c or three pads for \$1.00. Postpaid.

OFFICIAL A.R.R.L. LOG BOOK

A well-kept log is an essential part of a well-run station. This book, with 39 pages for operating records and 39 blank pages for miscellaneous notes, forms a complete history of your station — your most valuable radio record. Contains list of Q signals, etc. Size $8\frac{1}{2} \times 10\frac{1}{4}$, bond paper, bound in heavy paper covers. One book 40c or three books for \$1.00. Postpaid.

MEMBER'S CORRESPONDENCE STATIONERY

Write your radio letters on this A.R.R.L. stationery. It identifies you. Used by most old-timers and prominent amateurs. Excellently lithographed on $8\frac{1}{2} \times 11$ bond paper. Now using heavier 20-lb. stock instead of 16-lb. as heretofore. 100 sheets — 50c; 250 sheets — \$1.00; 500 sheets — \$1.75. Postpaid.

MESSAGE DELIVERY CARDS

Neatest, simplest way to deliver a message by mail. Good looking and easy to use. Saves writing an explanation of method in which message was handled. On U. S. stamped postals, 2c each; on plain cards (for Canada, etc.) 1c each. Postpaid.

THE AMERICAN RADIO RELAY LEAGUE

WEST HARTFORD, CONNECTICUT

Jewell Radio Company

**POWER AMPLIFIERS
PACKS SUPPLIES A SPECIALTY**

Exclusive Eastern Distributors for
PURADYNE PRODUCTS

Reg. U. S. Pat. Office

Buy the Best!! It Pays!!

After years of experience in making transformers, choke coils, condensers of the highest quality and the most careful workmanship; PURADYNE has developed a new line by incorporating features learned by studying the needs of the laboratory, the radio amateur, the radio transmitting station, and the commercial application of the vacuum tubes.

The PURADYNE Power Transformers are designed for continuous operation at full load. The insulation test at a potential of 10,000 volts insures satisfactory operation under all possible conditions.

No.	Out Put Voltage	Filament Voltages	Watts	Price
80	2500-0-2500 1500-0-1500	—	850	\$12.50
50	1000-0-1000 1000-0-1000 1500-0-1500	—	500	9.00
40	1000-0-1000	—	400	7.50
10	750-0-750	7 1/2V. c.t.-7 1/2V. c.t.	325	5.00
10A	600-0-600	7 1/2V. c.t.-7 1/2V. c.t.	200	4.00

Shielded with stand-off insulators:
No. 80.....\$14.00 No. 10.....\$9.00
No. 50.....10.50 No. 10.....6.00

PURADYNE filament transformers, 10,000V. insulation in metal cases with stand-off insulators: All guaranteed for six months against any defects.

ALL CENTERTAPPED:

2 1/2V. — 12 amps for 866's.....	\$3.50
2-2 1/2V. c.t. 10 amps each winding, for four 866's.....	4.50
5V. — 20 amps for 872's.....	6.00
7 1/2V. — 7 amps for 210s, 250s, 281s.....	3.50
7 1/2V. c.t. at 6 amps each.....	4.50
10V. — 1 1/2 amp for 203As, 211, 852s, 860s, 845s.....	4.00
12V. — 10 amps for 204As, 212Ds.....	4.50
14V. — 12 amps.....	5.50

PURADYNE microphone transformers, single button \$1.75 double button \$3.50. Mike stands, table model \$2.00, floor model.....

PURADYNE 30 Henry 125 mil. choke 260 ohms d.c. resistance..... 1.00

PURADYNE 250 mil. choke 30 Henrys 110 ohms d.c. resistance in metal case with stand-off insulators..... 3.00

PURADYNE 30 Henry 250 mil. double chokes..... 5.00

PURADYNE 500 mil. choke 30 Henrys 110 ohms d.c. resistance in metal case with stand-off insulators..... 7.50

PURADYNE guaranteed transmitting filter condensers, metal cased with stand-off insulators. All condensers rated at a continuous working voltage:

Capacity	1000V.	1500V.	2000V.	3000V.	4000V.
1 Mfd.	\$1.25	\$2.00	\$3.00	\$6.00	\$10.00
2 Mfd.	2.00	3.00	5.00	11.00	18.00
3 Mfd.	2.50	4.25	6.50	18.00	27.00
4 Mfd.	3.25	5.50	9.00	22.00	36.00

PURADYNE 200 Watt center tapped transmitting grid-leaks in metal cases with stand-off insulators:

5,000 Ohms.....	\$1.75	20,000 Ohms.....	\$2.50
10,000 Ohms.....	2.00	30,000 Ohms.....	2.75
15,000 Ohms.....	2.25	50,000 Ohms.....	3.75

PURADYNE Portable Microphone and Pre-amplifier for Public Address Systems and Transmitting Phone Work. All compactly installed in neat metal case..... \$9.50

NOTE: JEWELL carries the most complete line of power amplifiers and PA Systems in the city. Send for literature. PURADYNE heavy duty 50 watt sockets, porcelain base, metal shell, double contacts. Very Special..... 1.00

PURADYNE Mercury Vapor AAA Heavy Duty 866 Rectifying Tubes..... 3.50

SUPER SPECIALS!

SANGAMO 5000V. Condensers .002.....	.75
MURDOCK 15,000V. Condensers .002.....	1.50
AMERTRAN 250 P.P. POWER TRANSFORMERS 700-0-700 Volts 7 1/2V. c.t., 7 1/2V. c.t., 225 MILS. 325 WATTS.....	4.75
WEBSTER double button microphone listed at \$50. Our price.....	\$7.50
300-0-300 Trans. with 5V. winding, socket mounted on top of trans. for 880 tube.....	1.00
THORADARSON Fil. Trans. 1 1/2V., 2 1/2V., 5V.....	1.25
W. E. Shielded three wire microphone cable per foot.....	.06
MERSON electrolytic Condensers, metal cases, 8 Mfd. 450 Volts.....	.45
MAGNOX double button carbon microphone.....	.75
AMERTRAN T. 250 RESISTORS 41,000 OHMS.....	1.25
Voltage Dividers, 18,000 ohms for 245 P.P.'s Taps.....	.35
W. E. 21AA — 1 Mfd. Condenser.....	.25

Write for Catalogue. It is free.
We Can Supply Anything — At Jewell's Prices — Ask For It.
Include postage with all orders and 20% deposit against C.O.D. Shipments

Jewell Radio Company

New Address: 110 Chambers St., N. Y. City
Phone Barclay 7-8937 Dept. S

period of three months. During this time W8BDK was operated 50% of the time with a pure d.c. note and 50% of the time with r.a.c. The transmitter is a 50-watt TNT using a 203-A with 1000 volts on the plate. The power supply uses a pair of 866's, a double 18-henry 250-mil. choke and 12 mikes of filter condensers. While operating with r.a.c. the filter condensers and one section of the choke were removed.

While using pure d.c. 40% of the CQ's and 42% of the calls were answered, with an average report of QSA6 R₆ p.d.c. On the other hand, using r.a.c. 72% of the CQ's and 70% of the calls were answered with average QSA4 R₆ r.a.c. or a.c. reports.

The above shows that while the r.a.c. note brought a higher percentage of QSO's the d.c. note had a better audibility percentage.

It seems that most of the gang answers CQ's and calls that are the easiest to find and keep in tune on the receiver dial. I'll admit (and think most of the gang will, too) that an r.a.c. note draws attention a lot quicker than a d.c. one when you're listening for an answer to a CQ or call.

Now, gang is it fair to the fellow who invests his jack in equipment to get that d.c. note? I don't think so. There isn't much incentive for a ham putting in a d.c. power supply knowing that he will have a better QSO percentage with r.a.c.

Why not take a little longer going across the dials and tune in a few of those little squeaks that only cover about a fifth of a division but are really an R₆ sig when you get them tuned in, and give them a break?

What say, Mr. Editor, can't we get the gang to tune their receivers more carefully and not grab off the first loud buzzsaw they hear answering their call or CQ? It might discourage the fellows who like to splash their r.a.c. or a.c. notes over several dial divisions.

—L. W. Mattison, W8BDK

About "Raising Technical Standards"

Route No. 1, Box 30, Norwalk, Calif.
Editor, QST:

I've regusted! I'm referring to Rufus P. Turner's letter as published in June QST.

Perhaps I had better toot my own horn a little, just in case I'm not clearly understood. I happen to hold the highest class op's license any amateur can obtain. Does that make me a good op? Buloney! You know it doesn't.

Since the F.R.C. made the new ruling on 'phone, I contemplate taking the exam for unlimited 'phone operation, and what's more, I know I shall pass. Will that exam make me a better 'phone op? Nurts!

To illustrate my point: A certain amateur in Pasadena, California, used to have one of the best 'phone stations I have ever had the pleasure of listening to. And from what I can gather from the gang, he knew his stuff. He's using c.w. today. Why? Oh, he flunked the exam for U.P.O.

TRY THIS CONDENSER AT 5 METERS

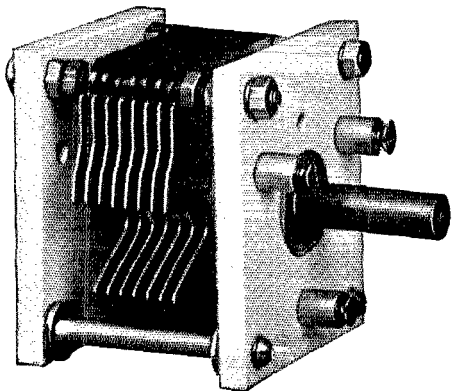

TYPE 568-D, 175 μf maximum,
SLC Plates

TYPE 568-K, 50 μf maximum
SLF Plates

Work at 5 meters requires a condenser designed for 5-meter operation. Such features as soldered brass plates, isolantite end plates, and the removable bakelite insulated shaft are important features of the General Radio Type 568 Variable Air Condensers.

They are made in two sizes, one with straight-line capacitance and the other with straight-line frequency plates.

GENERAL RADIO COMPANY CAMBRIDGE A, MASSACHUSETTS

Pacific Coast Warehouse: 274 BRANNAN STREET, SAN FRANCISCO

QST HAS BACK-COPY VALUE

In the ham-ad section of March QST \$12.00 was offered for a back copy. The offer was for the very first issue of QST (and how rare it is!) but all back copies are valuable. Moral: You should have a binder for each twelve issues — and the yearly index. You'll like the new binder, too.

A Dupont fabrikoid material of waterproof and oilproof imitation leather in a rich wine color, which matches the color of your present binders. Instead of metal wires, it has well-designed strong metal strips to conveniently place your copies in the binder — 13 such strips, too — 12 for the yearly supply of QST and one for your QST index. It doesn't cost any more either.

Holds 12 issues of QST and index

\$1.50 each, postpaid

AMERICAN RADIO RELAY LEAGUE

38 LaSalle Road, Hartford, Conn.



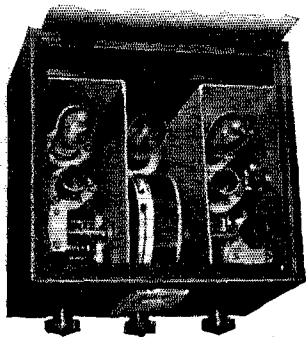

FOR FIVE-METER WORK

New Ultra H.F. Converter

The NATIONAL HFC

This new Converter has been designed to give **RESULTS** on the Five-Meter Band. When used with a broadcast receiver having even moderately good characteristics, it will provide a degree of sensitivity unequalled by any other type of Ultra H.F. Receiver. The detector circuit has a high gain instead of the usual signal loss of from ten to twenty times, a result of newly developed circuits of great sensitivity and efficiency. As another consequence of the new circuit, tube-hiss has been largely eliminated.

When using the standard plug-in coils furnished for 56-60 mc., the band is spread over 100 dial divisions. Special coils are available for the 20- and 80- meter amateur phone bands.

Uses standard A.C. tubes; — 2-224's and 1-227. Power supply is taken from a small filament transformer and three 45-volt B batteries (not furnished with Converter). Constructed throughout from the new NATIONAL Ultra H.F. Parts.

Send for new catalogue No. 200 which contains full description of this and other 56 mc. Band for Amateur Equipment, using coupon below.

NATIONAL 56 M ULTRA H.F. CONVERTER

NATIONAL COMPANY, INC.
61 Sherman Street
Malden, Massachusetts

Gentlemen:

Please send me your catalogue No. 200

Please send me a copy of your Ultra Short Wave Manual for which I enclose \$.50.

Name

Address

Q-8-32

80 Wir bitten darum, sich auf QST zu berufen — Sie weisen sich dadurch aus und unterstützen dadurch gleichzeitig QST

Now listen closely, brother. I can name, at the present time, at least seven sixth-district 'phone stations legitimately operating in the 3900- to 4000-kc. band that should have their licenses revoked.

Now that that's out of my system, I can blow up on another very unimportant subject, viz., Hi power vs. Lo power.

Nell's bells! Can't you fellows find something more important to argue about? Who cares what power the other guy uses? Did any of you fellows ever play football? If so, did you break down and cry because your opponent was bigger than you were? Naw! You used your wits and overcame his brute strength.

Amateur radio is my hobby. I play at it. When I cease to be amused and start to make work of it, you fellows will find me playing polo or some other game less strenuous than ham radio.

—Earl V. Fouch, W6CZO-W6DWB

Useless QRM

Danville, Ky.

Editor, QST:

I believe something should be done about the QRM situation now prevailing on the 40- and 80-meter bands. During the daytime the 80-meter band is fairly quiet, but with nightfall the band becomes thick and alive with seemingly thousands of stations. Fortunately, the majority of these stations have good signals.

It used to be that the ham shack visitor could be satisfied with hearing someone's fine crystal sig and, at least, go away with the idea that the ham is progressing. Now, all the layman can hear is a mass of stations all sitting on the same frequency, and immediately he forms his opinion of the congested operation of the amateur.

Of course, the ham who toils all day long has only the dark hours to operate and for those individuals who know how to have a friendly chat and handle traffic there is an apology. However, for those hams with the "tax fer call — ur sigs qsa etc. cuagn" stuff there is no excuse, and such stations should see the greediness of such abuse of the ether.

I do not think there will be much progress for better conditions on these bands until the great mass of CQ-hounds and rubber stamp QSO's are done away with. If every one would abide by the "Amateur's Code" better conditions would result.

I hope this message of criticism will be taken and heeded in the proper amateur spirit and something in the way of an amateur reformation brought about.

—W. C. Alcock, W9CDA

Tuning at Night

Decker, Ind.

Editor, QST:

I have been a consistent reader of QST for seven years and have never registered a protest

Your A.R.R.L. EMBLEM



The League Emblem comes in four different forms. Its use by Members is endorsed and encouraged by the League. Every Member should be proud to display the insignia of his organization in every possible way.

THE PERSONAL EMBLEM. A handsome creation in extra-heavy rolled gold and black enamel, 1/2" high, supplied in lapel button or pin-back style. The personal emblem has come to be known as the sign of a good amateur. It identifies you — in the radio store, at the radio club, on the street, traveling — you can spot an amateur by it. Wear your emblem, OM, and take your proper place in the radio fraternity. Either style emblem, \$1.00, postpaid.

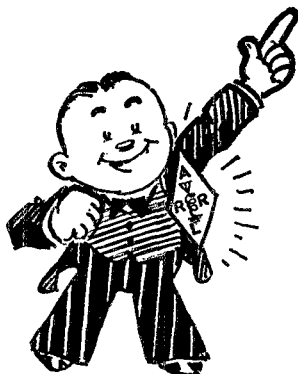

THE AUTOMOBILE EMBLEM. 5 x 2 1/2", heavily enameled in yellow and black on sheet metal, holes top and bottom, 50c each, postpaid.

THE EMBLEM CUT. A mounted printing electrolyte, the same size as the personal emblem, for use by Members on amateur printed matter, letterheads, cards, etc. \$1.00 each, postpaid.

THE "JUMBO" EMBLEM. How about the shack wall or that 100-footer? Think of the attention this big yellow-and-black enamel metal emblem will get! 19 x 8 3/4", same style as Automobile Emblem. \$1.25 each, postpaid.

The American Radio Relay League
West Hartford, Conn.

CRYSTALS \$3.95

3500-4000 K.C. 1" sq. X or Y cut
1715-2000 K.C. band.....\$3.95
7000-7300 K.C. band..... 8.75
All crystals one-tenth of 1% hr spec. freq. Write for other prices. Satisfaction or your money back.

EMPIRE STATE RADIO LABORATORIES
LYON BLOCK ALBANY, N. Y.

LOW RANGE FUSES

- **Littelfuses for Instruments:** Amps.: 1/100, 1/32, 1/16 — 20c ea. 1/8, 1/4, 3/8, 1/2 — 15c ea. 1, 2 — 10c ea. For milliammeters, ham rectifiers, etc. Use 1/8 for radio B circuits. **High Voltage Littelfuses:** 1000, 3000, 10,000 volt ranges in 1/16, 1/8, 1/4, 3/8, 1/2, 3/4, 1, 1 1/2, 2 amps. Renewable. Price 35c to \$1.25 ea. Write for instructive bulletin 4-A.

● **LITTELFUSE LABS.** 1772 Wilson Ave., Chicago

"Quicker than a Short circuit!"

LITTELFUSES

Odeon High-Grade Filament Transformer for 866 Tubes. Cased, 10,000-volt insulation... \$3.75
Two H.D. 866 Tubes, with Trans..... 9.95
Two Reg. 866 Tubes, with Trans..... 8.45
Pentode Adapters. Each..... .35
W.E. Microphone Buttons. Each..... .35

SPECIAL
RCA-VICTOR
Hand Microphone
\$1.85

The best buy on Filter Condensers: **ODEON—RCA** — surge proof quality. Conservatively rated at 1000 D.C. working volts. Compact in size and made in accordance with RMA specifications. Furnished in fibre boxes, wax dipped.

Capacity	1000 Volts	10% Off
1 MFD	\$.39	in Dozen Lots
2 MFD	.59	
4 MFD	.95	

ODEON
CARBON RESISTORS
1 Watt. All sizes
Per dozen..... **\$1.40**

SPRAGUE
ELECTROLYTIC
CONDENSERS
8 MFD 500 VOLTS
Each **55c**

TRF SCREEN GRID
ANTENNA or RF COILS
Each **39c**

ODEON'S "LITTLE GIANT"
The New 888
Constantly gaining favor. Giving excellent service. Half-wave Mercury Vapor Rectifier.
Fil. Volts 2.5 Fil. Amps. 2.0 Each..... **\$2.00**
INVERSE } Plate Volts 7500 Plate Amps. 300 Mills
PEAK }
Special Dealer Quantity Discount

ODEON'S QUALITY
866 TUBES
KEEP GOING OVER
The regular 866 Tube, guaranteed 90 days..... **\$2.45**
The heavy duty 866, guaranteed 6 months..... **\$3.95**
Compare these tubes

R F CHOKES
40 and 85 Mils.
Per dozen..... **\$1.20**

HIGH-GRADE
281 } RCA
210 } LICENSED
250 } TUBES
Guaranteed Each **\$1.45**

CROSLY AUDIO
TRANSFORMERS Each **49c**
Victor Power Transformers
6-226 2-245 Each... **\$1.95**
2-227 1-280

Metal Radio Cabinets. 10 x 8 x 20. Each... 60c
Midget Metal Base. 2 3/4 x 14 x 6 1/2. Each... 45c

GENERAL ELECTRIC
30-Henry 150 Mil. Chokes
\$1.25

ODEON SET ANALYZER and TUBE TESTER
Measures capacity and resistance.
New and complete..... **\$125.00**

Include 20% deposit with C.O.D. orders. Postage or express extra. All Foreign orders must remit in full, plus delivery charges.

We cannot accept orders for less than \$2.00

ODEON MFG. CO. 30 CLINTON STREET
NEWARK, N. J., U.S.A.

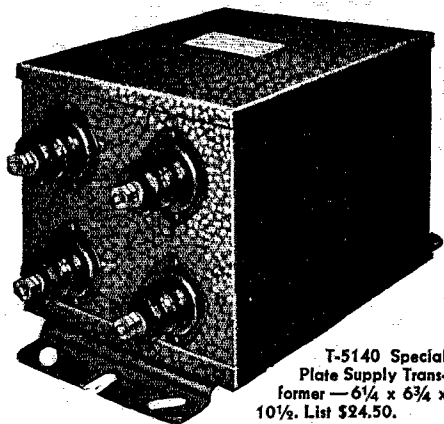

T-5140 Special
Plate Supply Trans-
former — $6\frac{1}{4}$ x $6\frac{3}{4}$ x
10 $\frac{1}{2}$. List \$24.50.

DO YOU REALIZE

THE IMPORTANCE OF
ADEQUATE POWER SUPPLY



For Class B operation **THORDARSON** has developed a special and entirely new transformer No. T-5140 (illustrated above) for use with 210's. This unit has practically a linear output characteristic, an exclusive feature. And since the power output is greatly limited by the regulation of the power supply you need this unit for satisfactory results. And to improve the quality of your transmission **THORDARSON** offers T-5100 and T-5101 special coupling transformers to make a perfect hook-up.

Consistent coast-to-coast records with 210 tubes have been made with **THORDARSON** apparatus. Let our engineers work with you. No obligation. Thordarson Electric Manufacturing Company, 500 West Huron Street, Chicago, Illinois.

THORDARSON

TRANSFORMER
SPECIALISTS
SINCE 1895...

yet, but in trying to work through this heavy QRM on 80 I have begun to think it is time to say something. I enjoy reading the letters on operating and have gotten pretty sore over some of them, but so far I have restrained myself. However, here goes.

Why, oh why, does a fellow have to pick the busiest part of the day, or rather night, to do his tuning? Some fellows wait until everybody is trying to work through the QRM and then start their tuning. Almost everybody has had plenty of good QSO's wrecked from some thoughtless fellow tuning. A fellow can work though pretty heavy QRM and get along pretty good, but let some fellow come in with a squeally wavering sig right on top and things go on the bum right away. If I have any tuning to do I wait until the air is quiet or fairly quiet so as to cause a minimum of QRM. Why not do your tuning before the busy time — say from midnight to four p.m.? If this is done you will cause very little interference and plenty of fellows will bless you. Why not respect the other fellows rights? He has as much right to the air as you have. It is the same way with the 'phone as with c.w. That whistling to test is certainly fierce. Build yourself a dummy antenna and stop the QRM.

—Edwin L. Robb, W9DGC-W9IBV

Low-Power DX

Washingtonville, Ohio

Editor, *QST*:

Most of the fellows feel that we must use high power in order to work DX consistently. I was of that opinion myself until lately.

A couple of months ago some one broke into my home and stole everything on my transmitter of any value, including a 204-A, a pair of 852's, a pair of 866's, four meters, a couple of crystals, 'phones and a score of African and Asian QSL cards, so I am reduced to using one 210 tube in the final stage with an input of 21 to 40 watts.

This power works almost as good for DX as my old sets using up to 250 watts input. I was able to WAC in two nights in January on 7 mc., with an R_2 from ZU6W for the worst report and an R_6 from ZL4BA for the best. Using 21 watts I have worked ZL's every night for a month, some contacts as early as 12:30 a.m. E.S.T. — all this on 7 mc.

I think if more of the fellows would only get decent notes and didn't try to get the last ounce out of their rigs, they would be able to do all I'm doing with the low power.

—George Morrow, W8BKP

Ten Meters and Calls Heard

211 18th Ave., Sterling, Ill.

Editor, *QST*:

I have several things or ideas that I would like to present, the first being the 10-meter question. I have been on 10 meters since April, 1930, and

NEVER BEFORE, SUCH VALUE!

COMPLETE POWER SUPPLY PARTS for 5- to 30-WATT TRANSMITTER

WILL deliver 150 M.A. at 550 volts of pure D.C. plate supply completely filtered with full wave rectification, including filament current for one or two 210 or 510 tubes.

Economical means to equip your multi-stage transmitter with individual power supply for each stage.

Brand new with simple wiring instructions. Also ready to operate as a high grade wired audio power amplifier, with dynamic speaker. Complete unit built by KOLSTER.

All parts are of excellent design and conservatively rated. Mounted on a rugged steel chassis 11 x 19". Ample space is available for a complete Push-pull R.F. circuit when the speaker and audio transformers have been removed.

HERE ARE THE PARTS YOU RECEIVE WHICH CONSTITUTE THE COMPLETE ASSEMBLY

- 1 — KOLSTER Power Trans. 1150 V. C.T. and Fil. for two 281's and extra winding for two 210's C.T.
- 1 — DUBILIER Condenser Block, total capacity 11½ mfd.
- 1 — KOLSTER 18 Henry Filter Choke
- 1 — WARD LEONARD Voltage Divider and Bleeder Resistor
- 5 — EBY Binding Posts
- 1 — 11 x 19 inch Steel Chassis
- 1 — KOLSTER Interstage Audio Transformer, plate to grid
- 1 — KOLSTER Output to Speaker Matching Transformer
- 1 — KOLSTER 10" Heavy Duty Auditorium type Dynamic Speaker

Have you received our FREE Big 136-page Wholesale Radio Catalogue? It's full of amateur items at low prices. Send for your copy today

Model K5

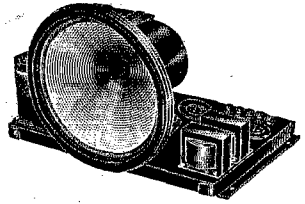

\$5.95

COMPLETE

American Sales Company 44 WEST 18TH STREET NEW YORK CITY

The oldest Amateur Supply House, since 1919

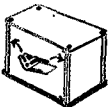

ALUMINUM BOX SHIELDS

Genuine "ALCOA" stock, Silverdip finish
 5 x 9 x 6 \$1.75 Photograph Needle test prods.
 5 x 5 x 5 Shield . . . \$1.00
 7 x 7 x 9 Frequency meter shield . . . \$2.50

Always sharp pointed using Phonograph needles to puncture insulation, corrosion, etc. \$1.00 a pair.

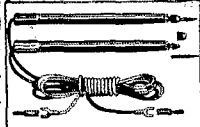

We specialize in radio parts exclusively.
 BLAN, The Radio Man, Inc.
 Dept. Q7 89 Cortlandt St., N. Y. C.

Now ARCTURUS Offers Five Improved Tubes

Keeping up with radio developments, Arcturus now offers the new 6.3-volt tubes—Types 41, 42 and 44—and the following new 2.5-volt tubes:

- TYPE 82 — Full-wave mercury-vapor rectifier.
- TYPE 58 — Variable-mu r. f. pentode.

- TYPE 46 — Class "B" power amplifier.
- TYPE 57 — Screen-grid detector-amplifier.
- TYPE 56 — Detector, amplifier and oscillator.

Technical data sheets sent on request.

Arcturus Radio Tube Co.
 Newark, N. J.

ARCTURUS

The BLUE Tube with the LIFE-LIKE TONE

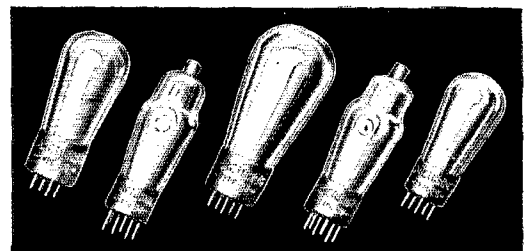

NEW CORNELL CATALOG READY



It describes the new Cornell line of PAPER DIELECTRIC CAPACITORS for radio, television and ignition, and RESISTORS for radio and television. The data and information in this catalog are of interest to all radio men. Write for your free copy today.

Ask for Catalog A
 CORNELL ELECTRIC MFG. CO., Inc.
 Long Island City New York



Crystals

Precision ground, powerful oscillators

Unconditionally Guaranteed

80 and 160 meter bands, "X" or "Y" cut, stated calibrations guaranteed accurate to 1/10th of 1% or better—adjusted to within:—

- 5 Kc. of frequency specified \$7.50
- ¼ of 1% of frequency specified 6.50
- 1% of frequency specified 5.50
- 40 meter band within 1% of frequency specified . . . \$10.00
- 1-inch oscillating blanks \$3.00
- Unfinished blanks 2.00
- 100 Kc. Standard Freq. Bar, including mounting . . . \$12.50

TOURMALINE CRYSTAL and BLANKS
 Frequencies up to 15 Mgs. Quotations on request
 BROADCAST CRYSTALS, highest accuracy—write for prices
PREMIER CRYSTALS LABORATORIES, INC.
 74 Cortlandt Street New York City

UNCLE DAVE

TUBES

UX 250's, each 65c; 15 watt 210's, each.....	\$1.20
Type 82-M, each \$2.25; 280-M tubes, each.....	1.00
281-M, each \$2.25; 871's, each.....	1.75
CG-1162, new, 3 for \$1.00; UX-200A, new, each.....	.75
UX-240, RCA, new, 3 for \$2.00, or, each.....	.75
Mercury Vapor, 866 heavy duty, each.....	1.79
W-211E tubes, each \$3.89; Rectobulb R-3, each	5.90
R-81 rectobulbs \$3.40; Extra heavy duty MV-866	
tubes, 1000 hours unconditional guarantee,	
each.....	3.35

METERS

Readrite milliammeters, 0-10, 0-25, 0-50, 0-100,	
0-150, 0-200, 0-300, 0-400, each.....	.65
Readrite AC voltmeters 0-10, 0-15 volts AC, each	1.50
C. E. 0-500 mills, used \$1.50, new.....	2.75
Weston 0-50 mills \$3.75; Roller-Smith 0-4 amps	
RF.....	2.89
Hovt 0-10 volts AC panel meter, each, new.....	1.15
Arco standoff insulators, per dozen.....	.75
30-watt sockets 75c; 75-watt sockets.....	1.35
204A sockets, \$1.95; 212D sockets.....	3.50
Shielded single button Jefferson mike xformers.....	1.95
Double button \$2.95; Universal single button	
baby mikes, each.....	1.75

ARSCO PRODUCTS

Calibrated monitors with batteries, tubes, etc....	9.35
Calibrated wavemeters.....	6.25
80 or 160 meter xtals, guar. with adj. bakelite	
holder, complete \$4.50; 40-meter xtals.....	3.50
Your present phone xtals exchanged for new	
bands.....	2.00
Your pet xtal ground to any higher frequency.....	2.00
Finished, oscillating blanks, guar. \$2.00, un-	
finished blanks \$1.20, guaranteed.....	
Bakelite dustproof adj. xtal holder 89c; same but	
plug-in type \$1.15; Commercial precision	
plug-in xtal holder beautiful job (G.R. plugs).....	1.49
Arco filament transformers, 2 1/2 volt 10 amp; 5	
volt 10 amp; 7 1/2 volt 7 amp; 10 volt 6 1/2 amp;	
11 volt 6 1/2 amp; 12 volt 3 1/2 amp; each type	
Power xformers, all fully mtd, aluminum en-	
cased, bakelite posts, 750 volts each side center,	
2-1/2 volt C.T., fl. windings, each \$6.50;	
1000-1500 volts each side C.T., 375 watts \$8.00;	
1500-2000 volts each side C.T., 350 watts	
\$11.00; 1500-2500 volts each side C.T., 850	
watts.....	14.20

Arco xmitting condensers — 1 year uncond. guar.			
1500 volt	2000 volt	3000 volt	3500 volt
1 mfd. \$1.75	1 mfd. \$3.50	1 mfd. \$7.25	1 mfd. \$8.00
2 mfd. 3.00	2 mfd. 6.00	2 mfd. 10.50	2 mfd. 12.00
4 mfd. 4.50	4 mfd. 10.00	4 mfd. 18.75	4 mfd. 22.00

Very sturdily built, finest material, all cont. working DC voltage.

600 volt			500 volt			1000 volt					
1 mfd.	\$2.20	1 mfd.	\$3.30	1 mfd.	\$4.45	2 mfd.25	2 mfd.40	2 mfd.70
3.5 mfd.35	3.5 mfd.50	3.5 mfd.70	4 mfd.40	4 mfd.60	4 mfd.	1.00

Above are unmounted but sealed in paraffin, guar. 90 days.

Silver Marshall Round the World 4.....	\$17.50
National 4 tube Thrill Box.....	17.50
Arco 3-meter receivers \$17.95; in kit form.....	12.00
Arco 8-meter transmitters \$8.95; in kit form.....	5.00
Heavy duty 2 1/2 volt 10 amp sl. trans. for 866.....	1.69
Teleplex with three rolls of tape \$13.00. 5-dial	
omnigraph.....	6.50
Signal Corps Army bugs, each.....	8.75
Genuine Acme solid enameled aerial wire	
100 ft. 10 gauge 95c; 200 feet.....	1.65
100 ft. 12 gauge 65c; 200 feet.....	1.25
100 ft. 14 gauge 50c; 200 feet.....	.90

INCLUDE POSTAGE WITH ALL ORDERS AND 20% DEPOSIT AGAINST C. O. D. SHIPMENTS

OPEN EVENINGS Write for Free Ham Sheet

Visit Uncle Dave's New Radio Shack When in Town Good Time Assured, hi!

What have you for sale or trade?

WE CARRY EVERYTHING FOR THE HAM IN STOCK. MORE FOREIGN TRADE SOLICITED

We also carry a tremendous stock of used parts, etc. Write in on special requirements and we shall be pleased to take care of you.

Uncle Dave's Radio Shack

Long Distance Phone 4-5746

356 Broadway Albany, New York

up to date have heard about a half dozen stations. Now during the week ends that I do listen down there I always say to myself, "When will somebody be on for sure." In the past *QST* has been filled with 10-meter pep articles trying to get the boys to go down there. It certainly has been a tiresome task fishing around at no fixed time hoping that somebody would be on.

Why not set something definite as to the time down there? My idea is to have all the "W" stations test starting exactly on the hour and have the rest of the world listen at that time. Then at the one quarter or one half hour have the "W" hams listen and the rest of the world start their ten meter rigs going. In this way we would have something definite to go by. The "W's" could be split up into east and west, and a lot of other combinations of listening and transmitting teams could be worked out. I really believe that this is the logical thing to try as you know as well as I do that 10 meters is still a mystery and that there are very few QSO's being held down there. I for one would certainly go down there a lot more if such a plan would be tried.

The next thing on the list is the "Calls Heard" argument. I certainly do approve of the Calls Heard section. It is one of the old features and always a very interesting one at that. However, there is one thing that does get me hot under the collar. That is when some ham, say in Chicago for instance, takes a sheet and copies a page of calls heard of which half the list contains W8 and W9, sends it to HQ and they go right ahead and waste half a page of good *QST* in printing the useless list. There really is nothing to that. The "Calls Heard" section should be for DX only. It's OK that the W hams send in their lists, but for heaven's sake throw out all the locals heard.

— Robert A. Lundstrom, W9FUR

A Queer Superhet

90 W. Main St., Ripley, N. Y.

Editor, *QST*:

Having never written to *QST* before, this should be started by stating that "I would like to get something off my chest," I suppose. However, I would like to relate an experience of peculiar circumstances.

A new ham here had just completed the construction of a single-control TNT low-power transmitter and power supply. These were placed on a table about five feet from a modern broadcast receiver, which was running. The filament and plate connections were made, but no antenna was connected to the transmitter for the preliminary test. The cord to the power supply was plugged into the same receptacle as that furnishing the BCL set with a.c.

The broadcast receiver was tuned to a nearby station until the key circuit on the transmitter was closed, when instantly the voice of W8IH at LeRoy came forth from the speaker. Upon tuning over the dial it was found that the small transmitter comprised a very fair converter with good

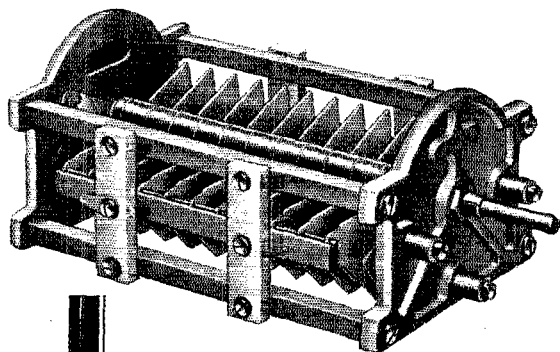

The NEW HAMMARLUND Transmitting CONDENSER

THIS new Hammarlund model is without an equal among stock transmitting condensers.

Heavy polished aluminum plates, with rounded edges; 10 percent wider spacing than others; lowest-loss Isolantite insulation; rigid cast aluminum alloy frame; perfect-fitting bearings; smooth, self-cleaning rotor contact.

A strong, good-looking, low-priced precision instrument worthy of any laboratory, professional or amateur use.

*All Sizes
Low Prices*

•
Write Dept. Q-8
for Descriptive
Literature •

Hammarlund Mfg. Co., 424 W. 33rd St., N. Y. C.

For Better Radio
Hammarlund
PRECISION
PRODUCTS

REAL BARGAINS!

G. E. Oil Tank Filter Condensers

All metal cased and rated at
DC WORKING VOLTAGES

4 Mfd., 1250 Volt.....	\$2.25
Two 30 Mfd., 1000 Volt sections. Series connection gives 15 Mfd. at 2000 Volts. 10" x 5" x 10 1/4". 22 lbs....	\$8.95
Same capacities but 1250 Volt. 46 lbs.....	\$10.95
Three 5 Mfd., 2000 Volt sections. 22 lbs.....	\$9.75
Same but 2500 Volt. 15" x 3" x 13 1/2". 35 lbs.....	\$11.75
Heavy Duty 20 Henry, 400 Milliampere POWER CHOKE. FB for choke input to filter. 3000 Volt insulation. 70 Ohms. Open Frame mounting. 8 1/4 lbs. Special.....	\$2.85
Uncased 15 Henry, 125 MA chokes.....	.55c

RCA licensed TUBES

These tubes stand up! If they didn't, we could not sell them with an **Unconditional Guarantee for Three Months!** Every tube is tested and dated before shipment.

112-A.....	50c	227.....	35c	280.....	45c
201-A.....	40c	233.....	80c	281-M.....	\$2.25
226.....	40c	238.....	85c	199.....	65c
232.....	80c	250.....	95c	224.....	50c
237.....	70c	866.....	\$1.65	231.....	65c
247.....	75c	171-A.....	45c	236.....	80c
871.....	\$1.55	222.....	\$1.10	245.....	45c
120.....	60c	230.....	65c	281.....	\$1.10
210.....	\$1.10	235.....	55c	280-M.....	\$1.25
		240.....	90c		

ALL OTHERS IN STOCK

20% deposit required with all orders

VISIT OUR NEW SALES ROOMS WHEN IN TOWN

HARRISON RADIO CO.

142 Liberty Street Dept. T-8 New York City

SPECIAL OFFER



to experienced

RADIOMEN

who want
to know

"... What's

PADLOCKING

those extra dollars"

One thing is certain, when experience has carried you part of the way — *higher technical knowledge is necessary for further advancement.* We can help men who are in a rut — men who know enough to realize that a **BETTER UNDERSTANDING** of Radio and Television Engineering is the only safeguard to success.

----- FREE SPECIAL OFFER -----

CAPITOL RADIO ENGINEERING INSTITUTE
14th and Park Rd., N. W., Washington, D. C.

Please send Radio and Television Engineering examination with answers so I can test my ability and see what is covered by your advanced training.

Name.....

Address.....

City and State.....

QST-8



SPECIALS

10 YEARS OF DESIGNING AND BUILDING SHORT WAVE APPARATUS PLACES REL AS THE LEADING MANUFACTURER OF HIGH GRADE AMATEUR EQUIPMENT. BUY TRIED AND TESTED PARTS THAT CARRY A GUARANTEE OF DISTINCTIVE REPUTATION.

5-METER RECEIVER

A real receiver that works. Rigidly constructed and housed in a businesslike cabinet. See "ad" June 1932 QST for details. You must have a good receiver for 5-meter work, any old contraption won't do. Ask for the "296." Price Net \$20.50.

5-METER TRANSMITTER

Complete transmitter. Includes both oscillator and modulator circuits. Finest parts, including Weston meter. A fit companion for the "296" receiver. Small, compact and mounted in metal case. See June QST for full data. "297" is the catalogue number of this job. Price Net \$27.75.

5-METER OUTDOOR OSCILLATOR

For DX 5-meter work use REL "300" Unit. Can be mounted at high elevations. Push-pull circuit. Uses any UX base type tubes. Housed in small cast aluminum weatherproof box. Fitted with 8-ft. aluminum tube antenna. Price Net \$31.75. Suitable modulator unit for indoor mounting and designed to control the "300." Uses 47 type tubes, known as the "301." Price Net \$25.50.

COMMERCIAL 5-METER UNIT

Compact 5-meter transmitter and receiver designed for duplex radio telephone communication. Ideal for portable, mobile or aircraft use. Fully described May QST, page 30. Catalogue No. 289. Write for further data and prices.

E. C. FREQUENCY METER

The last word in frequency meters. Surpasses the dynatron. See July QST. Every amateur station will have one. Can be purchased: completely built and calibrated; built but uncalibrated, or in kit form. It's a commercial item that can't be built from scraps and tin cans. Prices within the range of the "Ham" pocket. Ask for the "291."

IF YOUR DEALER CANNOT SUPPLY,
SEND YOUR ORDER DIRECT

RADIO ENGINEERING LABS., INC.
LONG ISLAND CITY, N. Y., U. S. A.

selectivity over the 3500-kc. fone band. The transmitter was in no way coupled to the broadcast receiver except through the 110-volt a.c. mains and possibly through inductive coupling, although the receiver is well shielded.

Perhaps you have had a similar experience, but I am passing it along as "just another one of those things."

— R. W. Collins, W8EUY

Appreciation

71 East 119th St., New York, N. Y.

Editor, QST:

I wish to take this opportunity to congratulate you and your staff on the remarkable work you have done in connection with the Standard Frequency Transmissions. They have been of incalculable benefit to many of my friends and myself and are the means, I believe, of saving the amateur from misgivings. I also believe that the amateur puts himself at a disadvantage by not employing these signals as a means of keeping within the limits of his bands as they are sent especially for his benefit.

— George Berenbaum, W2CFX

A Good Suggestion

Jamestown, N. Y.

Editor, QST:

It certainly would give me a great kick to take a peek at the dead letter office and get an average on the number of QSL's that go there every month.

The point is this — a good many ham's calls are not in the book or they're incorrectly listed, and when there's a lot of QRM and QRN it's pretty hard to be sure you have the street and number correct.

Here in Jamestown (a town of 45,000) one of the fourteen hams made out a list of the QRA's of everybody in town and gave it to the Post Office. When a ham asks your QRA all you have to tell him is radio W8APK Jamestown, N. Y., and the chances for mistake have been reduced.

I think if every ham club or group made out a similar list and kept it up-to-date, there would be fewer QSL's going to the Dead Letter Office.

— Edson Snow, W8APK

Real Relay Service

Sumay, Guam, M. I.

Editor, QST:

I would like to commend to you and the members of the American Radio Relay League, a model relay station.

The station I refer to is W6DMJ, of Carmel, California. I have for the past forty-five days had a three-hour daily schedule with them and have experienced no difficulty in moving traffic with the maximum speed and accuracy, under adverse conditions.

They have the best of operators, as good a note

FOR YOUR FRIEND

Who Wants to be an Amateur—And Who Asks You to Explain What It's All About

Of course you can take the time to tell him. But why not save yourself a lot of trouble and at the same time make your friend happy by suggesting that he get a copy of the new second edition of the League's special beginner's booklet — "How To Become A Radio Amateur?" In its 32 pages it briefly tells the story of amateur radio, how to learn the code and build a simple station. A single transmitter, receiver, power supply and antenna are described with clear illustrations and easily-followed building instructions — and there's concise dope on getting licenses and operating properly, too. An inexpensive introduction to ham radio, and preliminary to the *Handbook*. The price is 25c postpaid.

AMERICAN RADIO RELAY LEAGUE, West Hartford, Conn.

EVEREADY Layerbilt "B" BATTERIES

FOR LESS THAN \$20

CRYSTAL CONTROLLED TRANSMITTER AND POWER SUPPLY
All R.C.A. tubes, crystal ground 1/10 of 1% your specified frequency, milliammeter, metal cabinet, vernier dial, assembled and wired.

Write for full sensational details

EMPIRE STATE RADIO LABORATORIES
LYON BLOCK ALBANY, NEW YORK

UNIVERSAL BULLET TYPE MICROPHONES

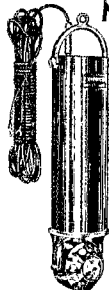

Carbon Granule Type with
Hiss Eliminating Filter

A new Universal Product designed to give the public address man the ultimate in appearance and proved UNIVERSAL performance at very reasonable cost. Elegant design. Rugged construction. Special adjustment screw for adjusting microphone to varying acoustic conditions. Hiss level far below background noises encountered. Finished in highly polished Aluminum Chrome Plate.

Available in Models BB, KK and LL

Universal Microphone Co., Ltd.

424 Warren Lane
Inglewood, Calif., U. S. A.

Married Men appreciate

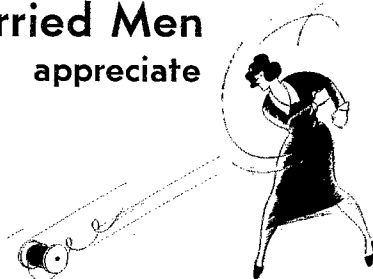

WARD LEONARD MIDGET REMOTE CONTROL RELAYS

You only have in sight the receiving box and sending key. All the unsightly stuff is in the attic or cellar, so women folks won't object. Circular now ready. Send for your FREE copy.

WARD LEONARD ELECTRIC CO.
41 South Street, Mount Vernon, N. Y.

Please send me a free copy of your latest bulletin on Midget Remote Control Relays.

Name

Street

City and State

Call Signal

QST Oscillating Crystals

"SUPERIOR BY COMPARISON"

Does the frequency of your monitor comply with the new regulations of being within the plus or minus 50-cycle limits? If not, we are at your service to adjust your monitor to within those limits. **SHIP YOUR MONITOR TO US** for either adjustment or grinding a new crystal if necessary. Our charge for this service is right, and will require but SEVEN to TEN days to perform this work. **ASK ANY BROADCAST ENGINEER** what HE thinks of our service.

CRYSTALS / CRYSTALS / CRYSTALS

Prices for grinding POWER CRYSTALS in the various frequency bands are as follows:

FREQUENCY RANGE

100 to 1500 Kc.....	\$40.00
1501 to 3000 Kc.....	\$45.00
3001 to 4000 Kc.....	\$50.00
4001 to 6000 Kc.....	\$60.00

Above prices include holder of our Standard design. If crystal is wanted unmounted deduct \$5.00 from the above prices. Deliveries can be made within two days after receipt of order. In ordering please specify type tube, plate voltage and operating temperature. *Special prices will be quoted in quantities of ten or more.*

POWER CRYSTALS FOR AMATEUR USE

The prices below are for grinding a crystal to a frequency selected by us unmounted (if wanted mounted add \$5.00 to the price list) with a calibration accurate to BETTER than a tenth of one per cent. Immediate shipments can be made and all crystals guaranteed.

1715 to 2000 Kc. band.....	\$12.00 each
3500 to 4000 Kc. band.....	\$15.00 each

LOW FREQUENCY STANDARD CRYSTALS

We have stock available for crystals as low as 13 Kc. Prices upon receipt of specifications.

SCIENTIFIC RADIO SERVICE

124 Jackson Ave., University Park
Hyattsville, Md. "Crystal specialists since 1925"

HANDBOOK
ELPS
AMS
EAVENLY !

DINKY
DOLLAR—!
DON'T
ELAY !

A.R.R.L.
38 LaSalle Rd.
West Hartford, Conn.

Rush Ninth Edition Handbook!

.....
(Name)

.....
(Street or Box)

.....
(City and State)

as can be had, but best of all they deliver by mail and service each and every message received, which puts them into an outstanding class of amateurs, who will long be remembered by the American people of Guam.

Guam is just a speck in the middle of the Pacific, with mail service of once every three months.

The people of Guam wish to thank W6DMJ and its excellent staff, through QST, for the wonderful service they have rendered in delivering messages for the past forty-five days. OM1TB and the people of Guam sincerely hope this schedule will last for many more months.

If all amateur stations were like W6DMJ, what an organization we would have.

— H. A. Pickering, OM1TB

The Regulations

1222 E. Poplar St., Stockton, Calif.

Editor, QST:

After reading the letter from M. W. Weeks in March QST, one might be very much confused regarding the use of unrectified a.c. for plate supply. From the tone of his letter one would judge that pure d.c. was the only type permissible, but such is not quite the case.

Quoting from QST for January, 1932, page 37, the F.R.C. Regulations state in Section 382, "Licensees of amateur stations shall use adequately filtered d.c. power supply for the transmitting equipment or arrangements that produce equivalent effects to minimize frequency modulation and prevent the emission of broad signals. For example, the use of unrectified alternating current power supply for the amplifier stages of oscillator-amplifier transmitters, so arranged that variations in plate voltage of this supply can not affect the frequency of the oscillator, will be considered satisfactory."

In the light of this regulation and the approval that has been given for the use of alternating current plate supply under certain conditions, I feel that the letter referred to is too strong and gives a wrong impression. That the question of interference is a vital one cannot be denied, but a whole lot of it can be eliminated by complying with Section 26 of the Radio Law of 1927.

It might be pointed out that a violation and conviction of that section costs \$500, and amateurs are not exempt from observing it fully and to the letter.

— Taubner G. Hamma, Ex-W6BBE-W6BMP

~~W~~ Strays

W9HCM, Winston Bull, wants to become a member of the 9th District Barnyard Club. Well, you members in good standing, is a name as good as call letters for full membership?

TI3LA and W3LA agreed to exchange a ten-dollar bill as a QSL after a nice QSO on 7 mc.

A COMPLETE LINE OF STANDARD AND "HARD TO GET" PARTS

"JERRY'S PLACE"

25 WARREN STREET, N. Y. C. TELEPHONE BARCLAY 7-6698



Announcing Hoyt Antenna Meters!!!

Hot wire antenna meters 1½ and 3 amperes ranges. Why do without antenna meters when you can buy them at Jerry's who knows what the "Ham" wants. Special low price.....\$2.95 each

Hoyt perfectly damped meters at a price. These are not to be confused with the usual meter "bargains." 2" mounting hole, flange 2¾" diameter, supplied in the following sizes: 10 m.a., 50 m.a., 100 m.a., 150 m.a., 250 m.a., 300 m.a., 10 volt A.C., 15 volt A.C. 10 volt D.C. Price each, \$1.60; three for.....\$4.50

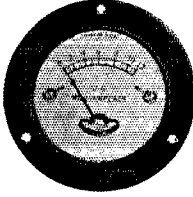

See Our July QST Ad

Jerry has been requested by many of his out-of-town friends to continue his July sale thru August to give them an opportunity to take advantage of the many bargains offered, when they come in to town. Jerry sells only reliable merchandise and the prices are low.

Bound Volume XV of QST

WE have a limited number of copies of Bound Volume XV of QST. Vol. XV comprises the entire 1931 series of QST. This volume is made up of two books or sections, each containing six issues of QST. It is handsomely bound in red cloth and with gold imprint.

The complete volume is priced at \$5.00, post-paid.

QST

West Hartford, Connecticut

AMATEURS

West of Rocky Mountains

We can supply all parts for the new circuits

Send for your Catalog of Nationally Advertised Transmitting and Receiving Parts at LOWEST PRICES

Amateurs' Headquarters of the West

RADIO SUPPLY CO.

H. A. Demarest, President
912-914 So. Broadway Los Angeles, California
(W6FBI located in Building)

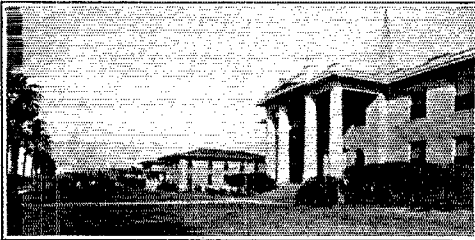

In 3 to 7 months we train you to secure commercial license. Course consists of Wireless Code, Radio-Phone, Microphone-Audio Technique, Television and Aeronautical Radio. If further details desired, write

PORT ARTHUR COLLEGE

PORT ARTHUR, TEXAS

Laboratory and Kit Equipment for Service Men



Shallcross Resistors have many uses in Multi-Range Meter circuits and modern set analyzers. Our Bulletin 150-C contains many valuable charts and wire diagrams completely describing their use.

Send now 4¢ in stamps for your copy of this valuable booklet. Resistors required for linear electronic voltmeters (Page 18, May QST) carried in stock.



DEPENDABLE — PERMANENT — EFFICIENT



Improve your present equipment with a

BUD SPEAKER

1156 Dorr Street

BUD LOUD SPEAKERS positively eliminate distortion under pressure, overheating, unbalanced tone, background noises, etc. **BUD'S** new and exclusive diaphragm and voice coil assembly assures permanent, dependable performance, regardless of atmospheric conditions. Priced as low as ordinary speakers, **BUD** represents the world's greatest speaker value! Accept our Free Five Day Trial Offer — be convinced.

BUD ALUMINUM TRUMPET HORNS are clear, bell-like, astonishingly realistic in tone — light in weight, absolutely unaffected by weather conditions. Ideal for in and outdoor P.A. installations. Write for details.

BUD SPEAKER COMPANY

Toledo, Ohio, U. S. A.

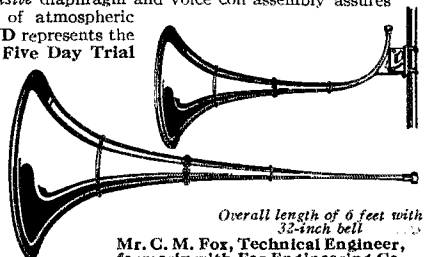

Overall length of 6 feet with 32-inch bell

Mr. C. M. Fox, Technical Engineer, formerly with Fox Engineering Co.



FREE
The new 50c CENTRALAB VOLUME CONTROL GUIDE, with additional data is just off the press. It is yours without cost with your order of only five (5) Centralab Replacement Volume Controls.

C e n t r a l a b

Central Radio Laboratories
Milwaukee, Wis.

GULF RADIO SCHOOL

COURSES IN
RADIO OPERATING
AND
RADIO SERVICING

Second Port, U. S. A.

844 Howard Avenue NEW ORLEANS, LA.

**The HAND
That
Encircles
The WORLD**

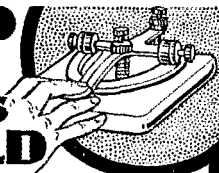

YOU CAN MAKE BIG MONEY

There's romance and fortune in radio and telegraphy. Become an expert operator. LEARN IN YOUR OWN HOME — easily, quickly with TELEPLEX — the Master Teacher.

Entirely new code course in 12 rolls of tape. During last ten years, TELEPLEX has trained more operators than all other methods combined.

Write for folder Q-8

TELEPLEX CO.

76 Cortlandt St. New York

Teleplex



But here's the big question — who's going to QSL first?

With pleadings, Ted and Felix Klingel of W8AUU insist that they are *not* "Laura," "Josephine," or "YL," not to mention being over thirteen years old. The error that has crept in is from the photo we published in April *QST* which was taken at W8AUU because W8EKM-W8BTS was a bit "haywire" at the moment.

Beginners should go to Worcester, Mass., for their code practice. Here's a note from the local daily: "The Radio Club is to start a series of code classes for beginners who wish to obtain operators' licenses tomorrow afternoon." Some speed.

A clipping from a New York paper informs us that W2WV "sent an indignant letter today to authorities in Washington, protesting against the activities of broadcasting stations which have interfered with his communications with other hams."

Short-Wave Receiver Selectivity to Match Conditions

(Continued from page 20)

motoring. One can pull the really steady signal through otherwise impossible mazes of a.c. hash, separate good signals of equal strength when they are as close together as 500 cycles, drag 14-mc. c.w. out of automobile QRM that puts any other receiver out of the running — and even go in and get a d.c. signal that is between the carrier and a 1000-cycle side band of a 500-cycle supply crystal rig. All these things, and more, have been done with this receiver, both with a selective t.r.f. broadcast receiver as the intermediate unit and with the completely modern companion unit that will be described next month.

Northwestern Division Convention

Yakima, Wash., Sept. 3d and 4th

THE stage is all set for one of the best conventions in this division, and the Yakima Amateur Radio Club sponsoring the affair extends a cordial invitation to all radio amateurs in the Northwestern and neighboring divisions. Saturday and Sunday, Sept. 3d and 4th, respectively, are the dates that should be put down in your calendar. All meetings are to be held in the Chamber of Commerce rooms, and the big banquet at the Commercial Hotel. While there will be business meetings, a 5-meter 'phone contest, technical talks, etc., the committee announces that entertainment will be the keynote, with visits to interesting points. There will also be an initiation of the Royal Order of the Wouff Hong. Jim Lamb, Technical Editor, *QST*, will be with us. Registration \$4.00. Address all inquiries to John H. McAulay, President Yakima Amateur Radio Club, 304 North 16th Ave., Yakima, Wash.

THE Amateur's Bookshelf

GOOD TEXTBOOKS and operating manuals should be on every amateur's bookshelf. We have reviewed practically all the books in which the amateur would be interested, and have arranged to handle through the QST Book Department at A.R.R.L. Headquarters those volumes which we believe to be the best of their kind. Take pride in a small but good radio library; buy a few good books and get into the habit of reading them.

- Principles of Radio**, by Keith Henney. This book is chock-full of meat for the experimenter. The subjects treated range from the fundamentals of electricity to the most modern concepts of modulation and detection. 477 pp., 306 illustrations. **\$3.50**
- Elements of Radio Communication**, by Prof. J. H. Morecroft. This is a new book by the author of the "Principles" listed below. It is about half the size of the larger work, and the subject is treated in more elementary fashion. Simple algebra is sufficient. An excellent book for the "first-year" student. 269 pp., 170 illustrations. **\$3.00**
- Principles of Radio Communication**, by Prof. J. H. Morecroft. An elaborate general textbook, and one of the recognized standards on theory for the engineering student. A working knowledge of mathematics is desirable for the reader who expects to get the greatest benefit from this work. 1001 pp., 5¾ x 9. **\$7.50**
- Radio Engineering Principles**, by Lauer and Brown. While not as voluminous as "Morecroft" this excellent general textbook on radio principles is the favorite of many students. A moderate knowledge of mathematics is desirable. 300 pp., 5¾ x 9. **\$3.50**
- Experimental Radio**, by Prof. R. R. Ramsey. Revised Edition. A splendid book for the experimenter. This is a laboratory manual, describing 128 excellent experiments designed to bring out the principles of radio theory, instruments and measurements. 150 illustrations, 229 pp., 5¾ x 7. **\$2.75**
- Radio Theory and Operating**, by Mary Texanna Loomis. Although giving a moderate amount of theory, it is essentially a practical handbook for commercial and broadcast operators, and as such ranks among the foremost publications of this sort. Used as a textbook by many radio schools. A good book for any amateur. 1000 pp., 800 illustrations. **\$4.25**
- The Radio Manual**, by George E. Sterling. Another excellent practical handbook, especially valuable to the commercial and broadcast operator, and covering the principles, methods and apparatus of all phases of radio activity. Over 900 pp. **\$6.00**
- Radio Telegraphy and Telephony**, by Duncan and Drew. Still another work along the lines of a general practical handbook. In size it is approximately the same as the two listed just previously, and the subject matter generally follows along the same lines. A good book in this class. 950 pp., 468 illustrations. **\$7.50**
- Practical Radio Telegraphy**, by Nilson and Hornung. Written particularly for the student training for a commercial license, and covering theory and apparatus. A practical handbook. 380 pp., 223 illustrations. **\$3.00**
- Radio Data Charts**, by R. T. Beatty. A series of graphic charts for solving, without the use of mathematics, most of the problems involved in receiver design. 82 pp., 8¾ x 11. **\$1.50**
- Thermionic Vacuum Tube**, by H. J. Van der Bijl. For many years this has stood out above all other works as a theoretical textbook and treatise on the vacuum tube and vacuum tube circuits. A knowledge of higher mathematics is required. Not a book for the beginner, but for the laboratorian and engineering student it is without a peer. **\$5.00**
- Radio Operating Questions and Answers**, by Nilson and Hornung. Revised Edition. This is intended as a companion volume to "Practical Radio Telegraphy" by the same authors. In conjunction with that work it should leave the commercial license applicant well prepared for his examinations. There is a chapter on amateur license questions and answers, too. 267 pp., 5¾ x 8. **\$2.00**
- How to Pass U. S. Government Radio License Examinations**, by Duncan and Drew. Intended as a companion volume to "Radio Telegraphy and Telephony" by the same authors, as a guide to the applicant for commercial licenses. It is not a text in itself. The chapter arrangement follows that of the sections of the commercial theoretical examination, each being made up of typical examination questions and their answers. 169 pp., 92 illustrations. **\$2.00**
- Theory of Radio Communication**, by Lt. John T. Filgate, S.C., U. S. Army. An excellent book on the theory of receivers, transmitters and associated equipment for those familiar with elementary electricity and magnetism. 250 pp., 180 illustrations. **\$2.00**
- Radio Traffic Manual and Operating Regulations**, by Duncan and Drew. A book for students, amateurs or radio operators who contemplate entering the commercial field; it will enable you to learn quickly and easily all the government and commercial traffic rules and operating regulations. 181 pp. **\$2.00**
- ABC of Television**, by Raymond F. Yates. A practical treatment of television with particularly complete chapters on photo-electric cells, amplifiers and scanning methods. 205 pp., 78 illustrations. **\$3.00**
- Manual of Radio Telegraphy and Telephony**, by Commander (now Admiral) S. S. Robison, U.S.N. Published by the Naval Institute. Covers both the theoretical and practical fields. 895 pp., 6¼ x 9. **\$4.00**
- Radio Frequency Electrical Measurements**, by H. A. Brown. A thoroughly practical book for the experienced amateur, the experimenter or engineer who has knowledge of the elementary principles of radio communication and of alternating currents. **\$4.00**

Prices include postage

Read 'em and learn!

AMERICAN RADIO RELAY LEAGUE, INC.
West Hartford, Connecticut

HAM-ADS

(1) Advertising shall pertain to radio and shall be of nature of interest to radio amateurs or experimenters in their pursuit of the art.

(2) No display of any character will be accepted, nor can any special typographical arrangement, such as all or part capital letters be used which would tend to make one advertisement stand out from the others.

(3) The Ham-Ad rate is 15¢ per word, except as noted in paragraph (6) below.

(4) Remittance in full must accompany copy. No cash or contract discount or agency commission will be allowed.

(5) Closing date for Ham-Ads is the 25th of the second month preceding publication date.

(6) A special rate of 7¢ per word will apply to advertising which, in our judgment, is obviously non-commercial in nature and is placed and signed by a member of the American Radio Relay League. Thus, advertising of bona fide surplus equipment owned, used and for sale by an individual or apparatus offered for exchange or advertising inquiring for special equipment, if by a member of the American Radio Relay League takes the 7¢ rate. An attempt to deal in apparatus in quantity for profit, even if by an individual, is commercial and takes the 15¢ rate. Provisions of paragraph (1), (2), (4) and (5) apply to all advertising in this column regardless of which rate may apply.

PLATE power for your set, the very heart of its performance, for quietness, DX ability, lifelong permanence, absolute dependability, lowest ultimate cost, no other plate source even approached, the achievement of an Edison steel alkaline storage B battery. Built painstakingly; every joint pure nickel, upset electrically welded. Gaining Edison Electrolyte. Our list describes complete batteries, construction parts, enameled aerial wire, silicon steel. Available immediately; filament and plate transformers for the new 873-866 rectifiers, complete plate power units. Rectifier Engineering Service, 4837 Rockwood Road, Cleveland, Ohio.

THE finest in marine, broadcast and amateur apparatus. Construction to order. Bulletins, quotations on request. Enslar Radio Laboratory, 1527 Grandview St., S. E. Warren, Ohio.

GENERAL ELECTRIC 24/1500 volt dynamotors \$37.50; 24/750 volt 150 watt \$27.50 in lots of six \$20. each. Shafts for external drive \$3.00 additional. Westinghouse 27½/350 volt \$7.50; 6-15 volt 400 watt \$10. 500 cycle 500 watt with DC exciters Special \$7.50 new. Crocker-Wheeler 24/1500 volt 450 watts \$37.50. All ball bearing machines. Henry Kienzle, 501 East 84th Street, New York.

TRANSMITTERS—we build them—March QST 245 transmitters with power supply, \$11. QST 210 transmitters with power supply, \$14. Rack jobs \$2. extra. Other bargains. Ernest Ruland, 40 E. Central St., Natick, Mass.

QSL cards. Send 15 cents for samples, new ideas. Good printing. Exchange, P. O. Box 607, El Monte, Calif.

QSLs, samples for stamp. W9GQH, Java, S. D.

COMPLETE DX xmitter with aluminum panel and meters, \$20. W9FQC, Knoxville, Iowa.

QSL cards, message blanks, stationery, snappy service. Samples free. Write today. WIBEF, 16 Stockbridge Ave., Lowell, Mass. WILL sell or trade complete Pilot a.c. super-wasp minus power-pack, \$15. Also station parts. List free. Henry Grady, 42-20 Kissena Blvd., Flushing, L. I.

WANTED—Fox or Racoon units open diaphragms or good amplifiers. Give best price or will trade ham stuff. Cook, 1140 Richter Rd., Columbus, Ohio.

TRADE: dynatron QST February 1931 for 852. Photo. W8FDD.

QSL cards printed by W8DED can't be beat. They are the best! Free samples? W8DED, Holland, Mich.

WANTED MG set 110V a.c. to 1000V d.c. about 250 watts. Cash. Give particulars. W6UC.

WANT anything in receiver or transmitting line, or what else have you? VE3GG Hydro, Ontario.

RECEIVER, \$7.50. W1AVE.

PPTNT transmitter with two 247s, 500 volt power supply, \$25. W9FLI, Wagner, S. Dak.

CRYSTALS, Brazilian Quartz, X or Y cut, COD, finished crystals, 1715 KC to 4000 KC \$3.50 — unfinished blanks \$1.00 — finished oscillating blanks \$2.00 — all guaranteed and about one inch square. — Grinding compound, coarse or fine 25¢ per box, enough to grind 6 or 8 crystals. — Odds and ends in unfinished blanks 50¢ each — RF chokes, three slot 50 MA 20¢, form 10¢. Five slot 250 MA, 30¢ form 15¢. Write for special dozen lot prices. William Threm W8FN, 68 East McMicken Ave., Cincinnati, Ohio.

NEW Vibroplexes ¼ base \$12. Rebuilds \$9, guaranteed. Lydeard, 28 Circuit, Roxbury, Mass.

CODE machines, tapes and complete instruction — both codes — for rent very reasonable. Rental to apply on purchase of new equipment if desired. Special rates to amateurs. Extra tapes for all machines. Instructograph, 912 Lakeside Place, Chicago.

FILAMENT transformers, cased, mounted, for any use or rating. Cheap. W9DKF, Peoria, Ill.

WANTED—Will pay cash for any antique radio receiving or transmitting set if well built. I am especially interested in loose couplers and the old audion that had 5 wire tubes and 2 filaments and also panel to go with the tubes. Anything that is old and that you want to sell send me a description and price and how old it is. Frank Ries, Box 112, Beverly Hills, Calif.

SELL complete station, \$30. Penney, 35 Eutaw St., East Boston, Mass.

QSLs, 90¢ a 100. Two coils. W9DGH, 1816 5th Ave., N., Minneapolis, Minn.

CONSTRUCTION of radio and sound equipment to your specifications. Write for estimates. Mabbott and Chapman, Stevensville, Montana.

PUSH-pull 245 xmtsr as per Handbook with dx record. Sell \$12 with all coils. W9DKF, Peoria, Ill.

SELL transmitter, \$5, receiver, \$10. Parts, tubes, or trade for superwasp. E. L. Felder, Tylertown, Miss.

CRYSTALS x or y cut, 80-160 meters, \$4.40, meter \$9. W6DCV.

SELLING out surplus ham equipment for the low and high power fone or cw station, tubes, transformers, condensers, receivers, transmitters, everything. Write for list. W9DKF, Peoria, Ill.

WANTED: Receivers, transmitting tubes, meters. Trade, sell: fifty-watters, crystals 3507, 3543, 3642.5, 7019. Guaranteed \$5.00. W9ANY, 3327 College Avenue, Kansas City, Mo.

CRYSTALS: \$2.50 c.o.d. Guaranteed. W9ANY.

OMNIGRAPHS, Teleplexes, Vibroplexes, receivers, meters. Bought, sold, exchanged. W9CNS, Hannibal, Mo.

GUARANTEED microphone repairs—Any make or model—24 hour service. Stretched diaphragm double button repairs \$7.50. Others \$3.00. Single button repairs \$1.50. Write for 1932 catalog with diagrams. Universal Microphone Co. Ltd., Ingleswood, Calif.

CRYSTALS: \$4.65. Good oscillators. Oscillating blanks, \$1.50. Elwood Shepard, 6018 Stewart Ave., Cincinnati, Ohio.

SPECIAL transmitting and receiving equipment custombuilt to your requirements, using your parts if desired. Careful engineering; adequate shop facilities; good workmanship; reasonable prices. Let me quote on your job. Holmes C. Miller, Radio Engineer, Box 105, Palo Alto, California.

CONDENSER microphone excellent response, \$15. Arthur J. Hurt, 550 Clayton St., Denver, Colo

REAL "ham" magazine,—"R9," \$1.00 yearly (Canada \$1.75). Box 666, Hollywood.

SELL—Two RCA 204A's \$35 each; three RCA 852s \$15 each; Leach breakin relay Type 83, \$15; Jewell d.c. voltmeter 2500 volts with resistor Pattern 88, \$20; General Radio type 558 frequency meter, \$5 no grades. W5UX.

CRYSTALS—0.1 of 1% calibration, all bands, \$3.50 each. Plug-in dust proof holders, \$1.50 tourmaline crystals, prices reasonable. Joe DuPre, Beachwood, N. J.

RCA 852s, two brand new guaranteed \$15. each. Mercury arc \$7.50, Samson 16 Pam, \$25. W4WM, 679 Grady Pl., Atlanta, Ga.

QSLs—nicest cards ever printed. W8AKY.

SELL Weston 0-30 voltmeter, xmtsr with meters, key and buzzer, b.c. set. Monitor complete, \$5. W9DLC, Spruce, Mo.

"4MOST" has established system in QSLing—get the dope from Drawer E, Camden, New York.

CRYSTALS: Your approximate frequency 80 or 160 meters, \$1.25. Guaranteed. Plug-in Holders 75¢. Fisher Laboratory, El Paso, Texas.

203As brand new, Westinghouse or GE \$12.00. Class B transformers pair 210-\$7.00 for 203As-\$10.00. 10,000V heavy duty 866s-\$3.00. 10 amp. c.t. fl. transformers for 866s-\$2.50. New RCA 210s-\$3.00; RCA 250s-\$2.25. .002-5000V Sangamos .45 ea. Weston type 301 milliammeters \$3.75 (some new, all new cond., most all ranges). Perfect RCA 204As-\$35.00; 204s-\$20.00; 851s-\$75.00; 852s & 880s; 212Ds \$30.00. Beginners Candler course \$25.00 (used). New Weston RF meters \$5.25. Stamp for list. Edwin C. Ewing, Jr., 1057 Pratt Blvd., Chicago, Ill.

QSLs, two color, 65¢ a hundred, two hundred \$1. Samples, Foster Press, 1040 Prospect Ave., Appleton, Wis.

SELL a nationally known 6 tube receiver, two complete transmitters, monitor, wavemeter, all power supplies built in. Moving in a direct current district. Act quickly. Price \$70. W2CRN, 730 Courtlandt Ave., Bronx, N. Y. C.

BEGINNERS new 2 tube a.c. or d.c. shortwave receiver, \$7.75. W9DKF, Peoria, Ill.

RCA 852s, brand new, \$17; 203A, 211, 845, \$12, 210s, 20 watter, \$2.20; 866s, \$2.50; 888s, \$2. Vacuum Tube Exchange, Ridgefield, N. J.

SPECIAL—two 866s, filament transformer, \$5.95; two 888s, transformer, \$4.95. Hudson Service, Piermont, N. Y.

TRANSFORMERS—400 watt 1100-1500 C.T. \$7.50 250 watt 1100-1500-2000 C.T. \$825 600 watt 2000-4000-6000 C.T. \$15.00 Polyphase, 25 cycle transformers, etc. W9CES—Frank Greben, 1917 S. Peoria St., Chicago, Ill.

QSLs. Get our samples and prices before ordering. Maleco, 1512 Eastern Parkway, Brooklyn, N. Y.

FREE this month only. A 210 type tube, 15 watt rating, with all orders of \$7 or more. Power crystals. Guaranteed. X cut, one inch square scientifically ground for maximum power. Your approximate specified frequency. Calibration within 0.1%. 3500 and 1750 kc. bands — \$4.50. 7000 kc. band — \$3. Plug-in, dustproof holder — \$2. Type 866 rectifier tubes — \$2.25 each. Type 888 — \$1.95. Mercury vapor 230M — \$1. 210's, 15 watt rating — \$1.50. 866 and 888 filament transformer, semi-mounted — \$2.25. 50 watt sockets — \$1. Please include postage. Precision Piezo Service, 427 Asia St., Baton Rouge, La.

RECEIVERS, converters, cheap. Orville Alexander, Cairo, Missouri.

NEW time delay complete with relay \$6.50. Aluminum angle ¼ inch cut to length 1½ per inch. Ham supply list on request. Harvey Robey, East Lansing, Michigan.

QSLs. W6DOU, 1562 B Street, Hayward, Calif.

USED Weston plate milliammeters, \$3.75; thermocouple ammeters, \$6.25. Transformers, chokes, windings. Aluminum shields, chassis. List free. W6ELA, 105¼ E. Ave. 38, Los Angeles.

EVERYTHING in ham stuff! What do you need? 3 tube screen grid receivers, d.c., \$11.50; a.c., \$13.50; 4 tube pentode receivers, d.c., \$14.95; s.c., \$17.10. All compact, band spread, and shielded; 1 mid. cased, 1000 volt filter, 67¢ 211Es, \$3.75; monitors, \$8.90, complete; xmitters, \$9.25. Anything else, write and ask. Edbern Radio, 1340 Merriam Ave., N. Y. C.

CONDENSERS, .3, .5, 1., 2. to 4 mfd. 1000 and 750 volt guaranteed, \$1.00 each cash. H. O. Barschdorf, Adams, Mass.

PANELS. Hard rubber. ¼ inch. \$1 one-hundred square inches. W8BSR, 2626 Sixth St., Cuyahoga Falls, Ohio.

"R9" has lowdown on things others ignore. Subscription \$1.00, sample 20¢ (Canada, \$1.75, 25¢). Box 666, Hollywood.

QSLs. T. Yachovetz, Elmsford, N. Y.

TUBES, filter condensers, meters, transformers and miscellaneous accessories, cheap. List. Howard, 5508 Fulton St., Chicago.

WANT SW3. Dispose bench lathe, Corona portable, mercury arc, binoculars. 501 receiver, Radiola portable superhet, IRE's, QST's, etc. W1DAD.

HAVE \$100 credit International Correspondence Schools. Can be applied any their courses including radio course. Trade for radio equipment or make cash offer. W9CAA, 4325, Xavier, Denver, Colo.

CRYSTALS — 1750 Band \$3.50; 3500 Band \$5. Blanks one finished side \$2. A-1 Blanks \$1.25. Crystals unconditionally guaranteed. Holders \$1.50. QSL's 2-color 200 — \$1.50. Send for samples and price list. Tested and guaranteed 245s, 247s, 50¢. M-K Radio Supply, Riverdale, Ill.

HEL278s \$25.65; SW3s \$20.87; REL five meter sets; Hammarlund Pro Supers; any transmitting apparatus. Inquiries welcome. — W9ARA, Butler, Mo.

GE211s new \$12; RCA 204-As \$32; RCA 851 \$70; WE212Ds \$24; WE387 mikes \$15; DCSW5W \$22. W9ARA, Butler, Mo.

NEW QSL cards at new low prices. Two colors 85¢ per hundred. Free samples. W8DTY, 257 Parker Ave., Buffalo.

DON'T buy a crystal until you investigate Standard Radio Laboratories silvered crystals in sealed mountings. Year guarantee. See July ham-ad.

NOW. Original "GH" cartoon QSLs. Station wall cards. By QST cartoonist, Phil Gildersleeve, W1CJD. Details Box 119, West Hartford, Connecticut.

QUARTZ — make your own crystal oscillators. Write us for full details. Direct importers from Brazil of best quality pure Quartz suitable for cutting into Piezo electric crystals. The Diamond Drill Carbon Co., 720 World Building, New York City.

GENERAL Electric rectifier bulb, brand new. Best cash offer or will trade for meters. Write W1KP, c/o QST.

FOR sale cheap. Receiving transmitter. Must sell. 1316 E. 24th St., Topeka, Kans.

CQ Midwest — Colorado to Ohio, Texas to Dakota, special offer for August only, \$1.50 per year, (\$2 regular), for Modern Radio, the live, accurate, concise radio magazine edited by Robert S. Kruse and L. W. Hatry. 20¢ per copy postpaid. Modern Radio, Hartford.

MAPS! Showing all radio districts, call letters of ham stations. (Size, 42" x 52") Send \$1. to G. W. E. Chamberlain, W9CAO, Rock Port, Mo.

Q R A SECTION

50c. straight with copy in following address form only:

W3BYK — Stanley M. Ladage, 923 N. 27th St., Camden, N. J.

W9JNV — B. P. Hansen, Cottage 49-B, Woodmen, Colo.

If you want to be a High Speed, Expert Operator write CANDLER for Free Advice

GET YOUR SPEED

where the
Champions got theirs
CANDLER
Scientific Method, High
Speed Telegraphing

If you want to copy press — send perfectly at 35 wpm or more with bug or key — copy 3 to 5 words behind — O. K. instantly — write Candler for free advice. THE CANDLER SYSTEM of High Speed Telegraphing trains your Brain, Muscles and Nerves to COORDINATE in doing fast, accurate work. It gives you CONFIDENCE, natural CONCENTRATION and banishes Nerve Strain. Original CANDLER METHODS have developed over 45,000 of world's fastest Morse and Radio operators including the champion.

TELEGRAPH-TOUCH-TYPE-WRITING — only method for operators. Shows how to use "mill" in receiving.

FREE advice. If you are a beginner and want to learn code the scientific way, or if you want to become a real EXPERT, write Candler and receive the benefit of his 20 years' experience in developing EXPERTS. Your questions will be answered promptly and personally. No obligation.

3 Times World Champion Operator Candler Trained

"By applying Candler System methods I won the Radio Telegraphic Championship of the World 3 consecutive years at 50, 55 1/10 and 56 3/4 wpm. I say to all Commercial and amateur operators, by all means take Candler High Speed Telegraphing and 'Mill' Courses."

THEODORE R. McELROY,
Official Radio Champion of
the World, Retired, Boston.

WALTER H.
CANDLER
World's Only
Code Specialist,
Instructs
You Personally



Candler System Co., Dept. 5-C
6343 South Kedzie Ave. Chicago, Illinois

LOWEST PRICES ON CRYSTALS!
For month of August only

Power oscillating Xtals, precision made, GUARANTEED. Calibrated to 0.1%. 3500-4000 Kc. \$3.75; 1715-2000 Kc. \$3.75. Finished and oscillating blanks \$2.25; unfinished blanks \$1.25. Dust-proof Xtal holder \$1.50. Write for our low prices on any Xtal you need, and bulletin on radio parts. Deposit required with order, balance C. O. D. You pay postage. Only certified personal checks accepted.

MAURICE SCHWARTZ & SON
710-712 Broadway Schenectady, N. Y.

Do you know that the latest Radio Amateur's Handbook is available in stiff buckram binding—\$2.00 per copy, postpaid?

When ordering a copy of this 9th edition, look at your present copy and determine if you want your next copy in more permanent form.

BLILEY CRYSTALS

Quartz and Tourmaline

Nationally recognized for their high standard of quality.

Quartz crystals supplied by your dealer close to specified frequency in 1750 and 3500Kc bands, \$5.50. Mounting, \$2.50.

Tourmaline Discs within 7,000Kc band, \$12.00; 14,000Kc, \$14.00. Special mounting, \$2.50.

Send for literature.

BLILEY PIEZO-ELECTRIC COMPANY
Masonic Temple Bldg., Erie, Pa.

To Our Readers who are not A.R.R.L. members

WOULDN'T you like to become a member of the American Radio Relay League? We need you in this big organization of radio amateurs, the only amateur association that does things. From your reading of *QST* you have gained a knowledge of the nature of the League and what it does, and you have read its purposes as set forth on the page opposite the editorial page of this issue. We should like to have you become a full-fledged member and add your strength to ours in the things we are undertaking for Amateur Radio. You will have the membership edition of *QST* delivered at your door each month. A convenient application form is printed below — clip it out and mail it today.

A bona fide interest in amateur radio is the only essential qualification for membership

AMERICAN RADIO RELAY LEAGUE
West Hartford, Conn., U. S. A.

I hereby apply for membership in the American Radio Relay League, and enclose \$2.50 (\$3 in foreign countries) in payment of one year's dues, \$1.25 of which is for a subscription to *QST* for the same period. Please begin my subscription with the issue. Mail my Certificate of Membership and send *QST* to the following name and address.

.....

.....

.....

Do you know a friend who is also interested in Amateur Radio, whose name you might give us so we may send him a sample copy of *QST*?

.....

.....

Thanks

For Your Convenience QST'S INDEX OF ADVERTISERS IN THIS ISSUE

Allen Bradley Company	4
American Sales Company	83
Arcurus Radio Tube Co.	83
A. R. R. L. Application Blank ..	84
A. R. R. L. Bookshelf	91
A. R. R. L. Booklet	87
A. R. R. L. Emblem	81
A. R. R. L. Handbook	Cor. II, 88
A. R. R. L. Supplies	77
Blan, The Radio Man, Inc.	83
Billey Piezo-Electric Co.	93
Bud Speaker Company	89
Candler System Company	93
Capitol Radio Engineering Institute ..	85
Cardwell Mfg. Corp., Allen D.	1
Central Radio Laboratories	90
Cornell Electric Mfg. Company	83
Empire State Radio Labs.	81, 87
General Dry Batteries, Inc.	2
General Radio Company	79
Gross Radio Company	89
Gulf Radio School	90
Hammarlund Mfg. Company	85
Harrison Radio Company	85
Jewell Radio Company	78
Leeds	96
Littelfuse Laboratories	81
National Carbon Company	87
National Company	80
Odeon Mfg. Company	81
Port Arthur College	89
Premier Crystal Labs.	83
<i>QST</i> Binder	79
<i>QST</i> Combination Offer	Cor. III
Radio Engineering Laboratories	86
Radio Supply Company	89
Schwartz and Son, Maurice	93
Scientific Radio Service	88
Shallcross Mfg. Company	89
Teleplex Company	90
Thordarson Electric Mfg. Co.	82
Uncle Dave's Radio Shack	84
United Radiobuilders	95
Universal Microphone Co.	87
Ward Leonard Electric Company	87

HELLO GANG-WE JUST GOT ANOTHER SHIPMENT OF THE FINEST AMATEUR RADIO SUPPLIES WHICH MUST BE SOLD TO YOU AT BELOW COST - NOW'S YOUR CHANCE TO RE-BUILD YOUR STATION WITH THE HIGHEST QUALITY SUPPLIES-AT PRICES THAT WOULD MAKE YOU WANT TO BUY ALL

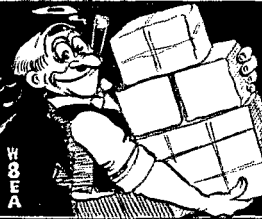

DO WE HAVE IT- I'LL SAY WE HAVE. WE MAKE IT OUR BUSINESS TO SEE THAT YOU GET THE HIGHEST IN QUALITY AT THE LOWEST PRICE...

SEND FOR OUR LATEST- AMATEUR RADIO SUPPLY CATALOG

866-888 or 871 MERCURY VAPOR RECTIFIERS\$1.95
 Mercury Full Wave Rectifiers, 300 Mill. 280M....\$.95 282....\$.75
 281M-300 Mill 15 volt drop.....\$1.75 872 Power 2.5 amp 10,000v Mercury Rectifier.....\$11.95

NEW 46 Dual Grid Class "B" NEW TUBES (RCA Licensed) NEW SPECIALS !!!
 56 Super-Triode Amplifier ea. 75c
 57 or 58 Triple Grid Super Amplifier
 2 volt tubes New 6 volt tubes
 230 Det-Amp.....\$.75 Can be used on AC or DC
 231 Amp......75 236 Screen Grid......75
 232 RF Screen Grid......75 237 Det-Amp......75
 233 Pentode......75 238 Pentode......75
 234 RF Pentode......75 239 RF Pentode......75

Radiobuilders Special UX210 15 Watt Transmitting Tube\$1.50
 Made especially for us and now in use in over 16 countries. Ask any ham that's using them. Double your present output. Use up to 750 volts on the plate. Use in Class "B" amplifiers. Oscillators, RF amplifiers. They oscillate as low as 4 meters with ease.
 UX250's 100% modulators - 281 110 mill 750 volt rectifiers Special Heavy Duty, ea.\$1.50
 NEW 50 WATERS - 203A - 211 or 845's, each\$12.00
 CG1162 Navy Transmitting Tubes, 550 plate, 7.5 volt fil.\$2.25
 All tubes unconditionally guaranteed ninety days against mechanical and electrical defects

MORRILL TRANSMITTING CONDENSERS

Test voltage.....	3000v.	3000v.	4000v.	6000v.	10,000v.
Working voltage.....	1000v.	1500v.	2000v.	3000v.	4000v.
1 mid.....	\$1.50	\$2.55	\$3.90	\$6.60	\$15.00
2 mid.....	3.00	4.65	6.90	10.05	24.30
4 mid.....	6.00	7.80	11.90	19.50	45.00

Condensers, guaranteed one year against defects

Special This Month
 Beehive Standoff Insulators - Best Quality Brown Glaze finish. Each.....\$.08
 Per dozen.....\$.85



Dubilier Condensers, 8 mid 500 volts working.....	\$.65
1/4 KW Silver Contact Transmitting Keys, Each.....	\$.95
Latest Amateur Call Books.....	\$.35
85 watt grid leaks, 10,000, 15,000 ohms, Each.....	\$.65
Copper Coil, 3" diameter, 1/4" tubing, per turn.....	\$.07
CT resistors, 10, 25, 50, 75 ohm.....	\$.15
85 Milhenry RF chokes.....	\$.15
100 Watt.....	\$1.40
Bleeder [50,000, 75,000 or 100,000 ohm.....	\$1.40
Resistances [75,000 ohm with six adjustable taps.....	\$1.90
9 1/2" long [100,000 ohm with six taps.....	\$2.00
GE 1/4-1 watt neon lamps.....	\$.55
Pilot Midget var. condensers 100, 50.....	\$.60, .25 or .15
Accurate black flange flush panel mount meters.....	\$.50
Milliammeters 0-10, 0-50, 0-100, 0-150, 0-200, 0-300.....	\$1.00
A.C. Voltmeters, 0-3, 0-5, 0-7 1/2, 0-10, 0-15, each.....	\$2.50
Another batch of those 1000 volt oil impregnated condensers, (Uncased) - Make a 1000 volt filter at practically no cost.....	\$.80
1 mid., \$.15, 2 mid., \$.40, 3 mid., \$.50, 4 mid., \$.60, 6 mid., \$1.00	
5" x 6" x 9" Monitor cans.....	\$.04
Red Devil Standoff Insulators, Each.....	\$.04
Mica Condensers, all capacities 800 volts, \$.15, 1000v.....	\$.20
Crowe Full Vision Dials, Complete.....	\$1.10
Tube Shields, For all standard tubes, Each.....	\$.15

Double-Button Mike Transformers Pri. 200 ohms each side of C.T. Sec. Matches Grid. Fully Cased. Special Price.....\$1.95

PLATE POWER TRANSFORMERS
 250 watts - 750-0-750 and 7 1/2\$5.50
 350 watts - 1000-0-1000.....\$7.50
 500 watts - 1500, 1000-0-1000, 1500.....\$9.60
 850 watts - 2000, 1500-0-1500, 2000.....\$12.75
 900 watts - 2500, 2000-0-2000, 2500.....\$14.25
 Fully mounted in aluminum case. Terminals on bakelite panel. Radiobuilders Class B Modulation Transformer for UX210's. Largest core used in any Class B transformer. Compare weights. Type A, Deluxe, per pair, weight 11 lbs. Price.....\$8.00

866 Transformer, In beauty of a case with Stand-off Insulators. Tested at 15,000 volts, 2 1/2 volts, 10 amps, center tapped.....\$4.00
 Uncased - Unmounted 866 transformers. Price.....\$2.75
 210 Filament Transformers, 7.6 volts, center tapped, each.....\$.95
 Same as above but fully cased. Price each.....\$1.25
 Radiobuilders Modulation Chokes
 Deluxe Choke open frame mount, weight is all choke. Beautiful jobs. Fully mounted. Dynamic steel core.

200 mills - 30 Henries - 12 lbs.....	\$4.50
300 mills - 30 Henries - 17 lbs.....	\$8.00
400 mills - 30 Henries - 24 lbs.....	\$11.50

GE Neon Lamps - Excellent for locating stray RF Ana in wave-meters 1/4-1 watt sizes, Each.....\$.55
 Midget Power Transformers 350-0-350, 5v 2 amps, 2 1/2 v 7 amps. Fully mounted, Special Price.....\$1.80
 Insulating Grommets for aluminum panels, 15 for.....\$.25
 Special Radiobuilders 2 1/2 volt 12 amps Fully Cased Transformers, 1500 volt Insulation, Price.....\$1.50
 Amateur Band Quartz Crystals 80 or 160 meters.....\$4.40
 Radiobuilders plug-in crystal holders with GR plugs.....\$1.50

RADIOBUILDERS 200 WATT FILAMENT POWER TRANSFORMERS
 11 volts 15 amps for 4-50 watters center tapped, cased.....\$5.50
 12 1/2 volts 18 amps CT for 2 to 3 - 250 watters, cased.....\$5.75
 5 volts 20 amps CT 20,000 volt insulation for 2 - 872's.....\$6.00
 The above transformers are very conservatively rated. The weight of each is 15 lbs. They are fully cased in a black crystalline finish can. Porcelain standoff insulator terminals. We invite comparison.

ALL SIZES MAGNET WIRE IN STOCK

	16-18	20-22	24-26	28-30	32-34
Enam.....	\$.15	\$.18	\$.20	\$.25	\$.30
DCC.....	.20	.23	.25	.30	.35
DSC.....	.30	.33	.35	.40	.45
SCC.....	.15	.18	.20	.25	.30

Above prices are for 1/4 lb. spools only.

All merchandise fully guaranteed, 20% deposit must accompany all C.O.D. orders. All prices F.O.B. Newark, N. J. Please include postage. New catalog will be out shortly. Get your name on our list.

OPEN EVENINGS, Phone Ea. 2-1539

VISIT OUR STORE WHEN IN TOWN

UNITED RADIOBUILDERS
 1234-36 SPRINGFIELD AVE., IRVINGTON, N.J.



LEADS THE LOWER PRICE PROCESSION

Improved 5-Meter Super-Reg. Receiver



Accepted and enthusiastically endorsed by many prominent experimenters, following its introduction last month. Setting as it does new standards of excellent performance and low price. Completely described in our July adv. It's cheaper to buy this AIR TESTED receiver than it is to assemble a kit that may not function properly. Unconditionally guaranteed at **\$12.45**

- Amplion imported, large, type A.R. 19 brand new magnetic horn unit. Bought from Custom house. Regularly sold for \$15. Special... **\$1.00**
- Small short wave R.F. honeycomb choke. 60c list. Now each... **.19**
- R.F. detector plate choke... **.25**
- Plug-in coil forms, 4 and 5 prong; fits standard sockets, marked with different colors at top; each... **.20**
- Amrad Midget variometer as described in Short Wave Craft, each... **.50**
- Black Crystalline finished steel monitor can with removable cover, 5 x 6 x 9... **1.25**
- R.C.A. 200 ohm, 30 H. 125 mill choke. Special... **.79**
- Leeds 888 Rectifier tube; 30 day guar... **2.00**
- Leeds 866 Mercury Vapor tube... **2.25**
- Leeds U X 210 tube; guar... **1.50**
- DeForest-82 full wave rectifier... **.56**
- 56 meg. antenna phasing coil completely waterproofed... **.75**

Thordarson transformers & Chokes — Drastic Cuts. Why gamble, when you can purchase nationally known apparatus at inferior merchandise prices. Items listed below are typical of the entire line.

T-2387, 2000-3000oct 300 w. List \$19. Special... **\$10.85**

T-2388, 3000-4000oct 500 w. List 25. Special... **14.28**

T-2389, 3000-4000ct 1 K.W. List 30. Special... **17.10**

T-2098, 1120ct 150 w. List 9. Special... **5.14**

CHOKES

	List	Special
T-1700, 130 amp, 28 H. 231 D.C. res.	\$4.50	\$2.54
T-1998, 160 amp, 27 H. 190 D.C. res.	5.00	2.83
T-2071, 150 amp, 18 H. 240 D.C. res.	10.00	5.70
T-2027, 300 amp, 23 H. 134 D.C. res.	13.50	7.70
T-2073, 500 amp, 26 H. 135 D.C. res.	17.00	9.68
T-4451, 150 amp, 25 H. 291 D.C. res.	10.00	5.70
T-4456, 250 amp, 25 H. 140 D.C. res.	15.00	8.55
T-3100, 200 amp, 15 H. 125 D.C. res.	10.00	5.70



Navy Type Telegraph Key

List **\$3.60**. Navy knob— $\frac{1}{8}$ " Tungsten contacts. While they last... **\$1.25**

Genuine Baldwin Phones Type C

\$12.00 List — Mica diaphragm. Limited quantity — only 2 pair to a customer. Special... **\$3.95**

Erpe imported 4000 ohm feather weight phones. **\$1.35** Special.

\$5 Eisenman Head phones; 2500 ohms; brand new; complete with head band and cords... **1.00**

LITTLEFUSES — Complete assortment of sizes at Special Prices

Leeds Monitor

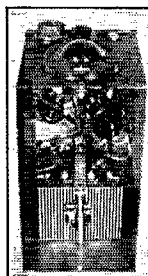

Our new individually calibrated band spread monitor is another LEEDS special that is cheaper to purchase at our new low price complete, than it is to assemble a kit following Handbook specifications. Fully outlined in our July adv. Unconditionally guaranteed. **\$9.95**

A New 5-Meter Transmitter

Simplified push pull oscillator — it certainly is a dandy. Described fully in our May advertisement.

Complete Kit— \$6.00

Wired and Tested... \$9.75

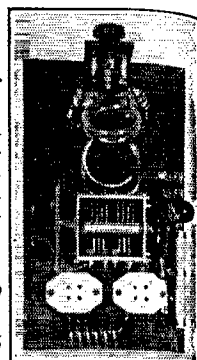

National and R. E. L. Sets and parts at lowest wholesale prices. Write us for special list.

DeForest Tubes

410 | \$2.25 | No. 510 — \$3.95
450 | | 15 watt oscillator
481 | | oscillator tubes at 50% and 10% off list price.

Leeds Transformers

For speech input mixing panels, feed your phonograph, telephone line tone &c. into your transmitter simultaneously with your speech.

Tube to line 20,000 to 500—200—50 ohms.
Line to line 200—500 to 200—500 ohms.
Line to grid 50—200—500 ohms to grid... **\$3.30**

Flechthelm Condensers

See our April 1932 advertisement for sizes and prices.

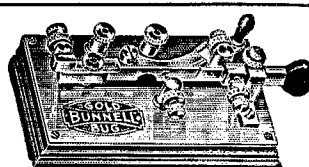

No. 398 Gold Bug Automatic Transmitting Key

\$12.50 List. Simple in construction, correct mechanically, and electrically rugged and durable $\frac{3}{32}$ " contacts, complete with cord and plug. Brand new in original cartons. While they last... **\$4.45**

No. 10202 Extra heavy $\frac{3}{16}$ " contact... **\$5.45**

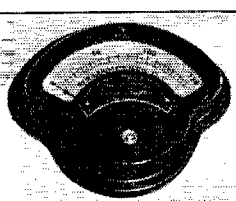

WESTON METERS

Model 267 — List **\$16.25**

Front panel mount. There are only a few of the following numbers left. **\$3.95**

0-15 V.D.C. **\$5.00**
0-20 M.A.D.C.
0-30 " " "
0-150 " " "

Other sizes at **\$16.25** net



Leeds SUPREME transmitting key. Mounted on whitewood painted base; without switch. Ideal for beginners practice set. List **\$1.75**. Special... **.55c**

Filament Transformer $2\frac{1}{2}$ v. 10 amp, 1,000 volt insulated. Special... **\$1.25**

Leeds mounted 866 filament transformer; $2\frac{1}{2}$ v. at 10 amps, 10,000 volt insulation... **2.95**

Leeds mounted filament transformer; $7\frac{1}{2}$ v. center tapped; 5 amps... **2.95**

Leeds special 866 filament transformer; our latest model; steel encased with Bakelite panel at top; tapped primaries; $2\frac{1}{2}$ v. 10 amps, 10,000 volt insulation... **3.95**

Leeds swinging choke — 2-40 H. 150-0 mits... **4.75**

For other transformers see April issue.

Hundreds of other items at Big Special Prices. Constant changing of prices and merchandise makes it impossible for us to issue a catalog. Let us quote you on your needs

NOTE—Add 5% Gov. tax on all orders from our prices



45 Vesey Street, New York City
New York Headquarters for Transmitting Apparatus
WHEN IN TOWN VISIT OUR STORE

MAIL ORDERS FILLED SAME DAY

10% Cash
Must Accompany All
C. O. D. Orders

THE

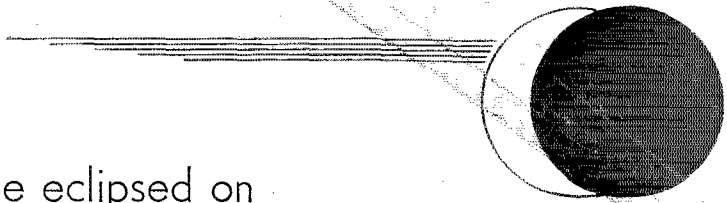

Sun will be eclipsed on

AUGUST THIRTY-FIRST

so will our special offer announced in the July issue of QST

**THE RADIO AMATEUR'S
HANDBOOK**

and a year's subscription to

QST

for THREE DOLLARS

(In United States, its possessions and Canada — Other countries, \$3.50)

Even if you are already a member of the League and a subscriber to QST, you may take advantage of this offer. Simply mention that fact and instead of entering it as a new subscription we will extend your present subscription for another year.

THE AMERICAN RADIO RELAY LEAGUE

West Hartford, Conn.



