

*Clyde* *Haydason*  
W-1K P W-1K W.

# QST

DEVOTED ENTIRELY TO

# AMATEUR RADIO

PUBLISHED SINCE 1915 BY THE AMERICAN RADIO RELAY LEAGUE INC.

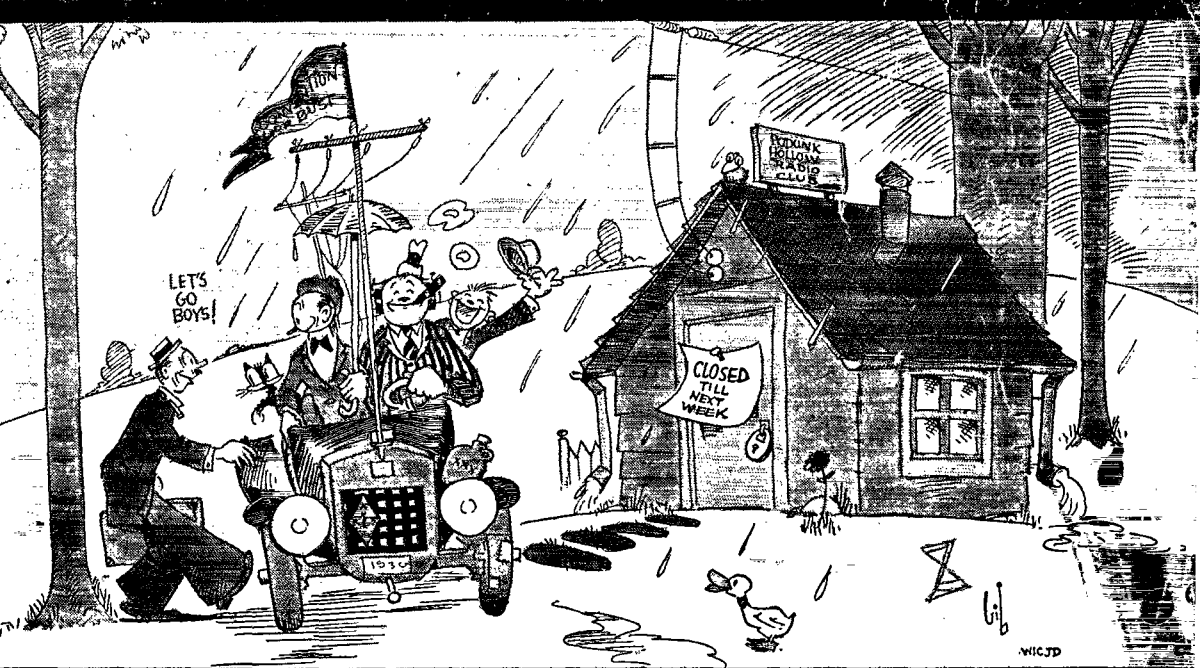

## Convention Time

**APRIL, 1930**

**25¢**

# Spreads

## Narrow Ham Bands

See Nearest Dealer or  
Write Direct for Details

Kit K-115: The A. C. Super Wasp. Use your own ABC pack or Pilot K-111 at \$16.50, specially designed for the Super-Wasp. Power Pack and Tubes Extra

**\$34<sup>50</sup>**

Kit K-110. The battery-operated Super-Wasp. Batteries and Tubes extra . . . .

**\$29<sup>50</sup>**

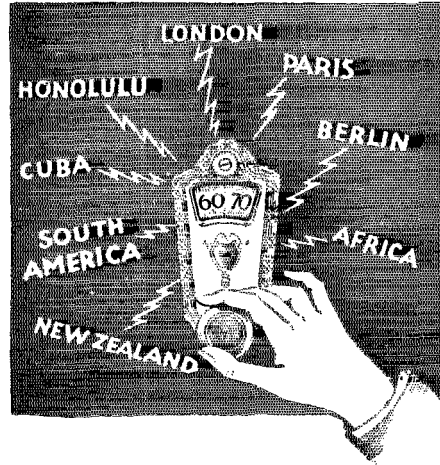

## Over Entire Dial!

### PILOT SUPER-WASP Short Wave and Broadcast Receiver

*In kit form for A. C. or battery operation  
including 5 pairs of plug-in coils, 14 to 500 meter range*

Removing all but two plates from the tuning condensers and adding two midgets on sides of cans, spreads the ham bands beautifully over the whole scale.

Designed by Robert S. Kruse ("LQ"), David Grimes, and John Celoso, the Super-Wasp embodies TUNED screen-grid R. F. stage, feeding a regenerative detector and two straight audio stages.

Individual shield cans for the R. F. and detector stages, with double shielding provided by metal front panel. Plenty of room on sub-panel for your own pet A.F. system.

We have two technical booklets that describe the battery and A. C. Super-Wasps in great detail. If you want copies, just write "Send me No. 7 and No. 115 data sheets" on one of your QSL cards.

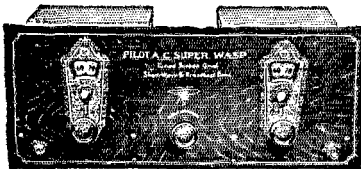

## PILOT RADIO & TUBE CORP.

323 BERRY STREET  
BROOKLYN  
N. Y.



Chicago Office: 234 South Wells Street  
San Francisco Office: 1278 Mission Street

## JOINING THE RADIO INTERNATIONAL GUILD

H

Costs only 50c and includes lapel pin, certificate and "Radio Design" Construction Quarterly Magazine, the Guild's Official Organ. Enclose 50c coin or stamps to Radio International Guild, 103 Broadway, Brooklyn, N. Y.

Name .....

Address .....

City ..... State .....

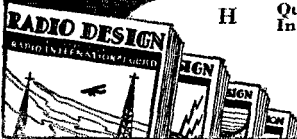

# De Forest

## AMATEURS, EXPERIMENTERS, SPECIALTY DESIGNERS

Don't overlook the possibilities in the new De Forest Audions 422 and 422A. The high mutual conductance and low plate resistance to these Audions make them far superior to the ordinary type—22 tubes. An extremely high gain is obtained both at broadcast and high frequencies when used as Radio Frequency Amplifiers. That these Audions give outstanding performance is evident from the manner they have been accepted and speci-

fied by many experimental laboratories and amateurs in the short period they have been offered to the public. Two additional advantages to be gained by use of the Audion 422 or 422A are—long, satisfactory life, and absence of microphonic disturbances so common with ordinary—22 type tubes. These features are the result of tireless efforts of De Forest Engineers, whose aim is to give to radio as fine a product as is possible to produce.



### Characteristics of Audion 422

Filament Voltage	3.3 volts
Filament Current	.132 amps
Plate Voltage	185 volts
Screen Grid Voltage	45 volts
Control Grid Voltage	1.5 volts
Plate Resistance	250,000 ohms
Amplification Factor	150
Mutual Conductance	600

### Characteristics of Audion 422A

Filament Voltage	3.3 volts
Filament Current	.08 amps
Plate Voltage	185 volts
Screen Grid Voltage	45 volts
Control Grid Voltage	1.5 volts
Plate Resistance	250,000 ohms
Amplification Factor	150
Mutual Conductance	600

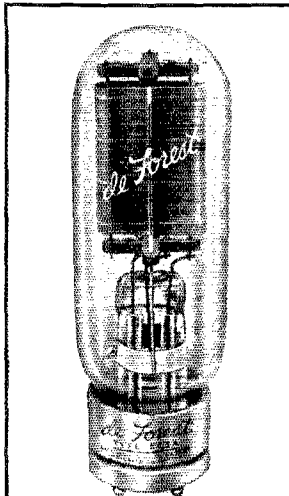

### Audion 503A

Filament Voltage	10.0 volts
Filament Current	3.25 amps
Max. Plate Voltage	1000 volts
Max. Plate Current	.175 amps

The "fifty-watter," is back again to stay! The new Audion 503A is just the tube for the 3500 K. C. phone, or any moderate power intermediate frequency work. Audion 503A is a very sturdy oscillator or radio frequency power amplifier. Interchangeable with UV-208A.

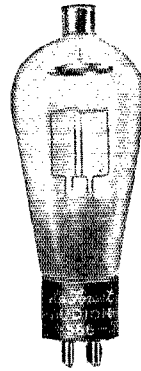

### Characteristics of Audion 566

Filament Voltage	2.5 volts
Filament Current	5.0 amps
Max. Inverse Peak Volt.	7500 volts
Max. Peak Current	.6 amps

New Audion 566 is especially designed to withstand high voltage surges without breakdown, and is rated 7500 inverse peak volts at peak current load of .6 Ampere. Audion 566 is interchangeable with UX-866.

*For further information consult your local dealer or address*

**DE FOREST RADIO CO.  
PASSAIC, NEW JERSEY**

# TEMPERATURE-CONTROL BY GENERAL RADIO

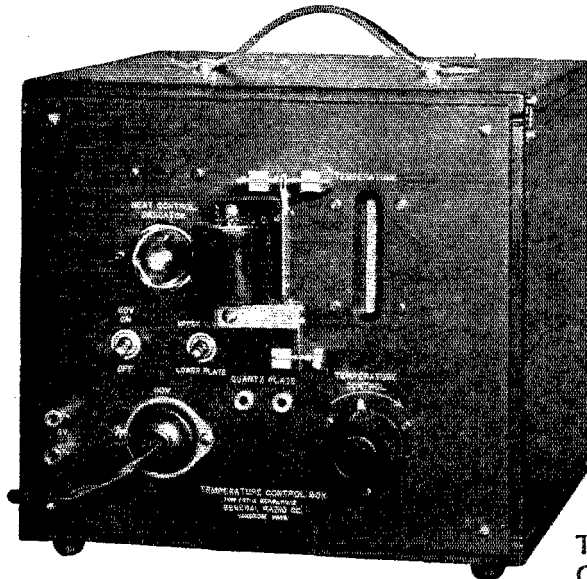

Type 547-A  
Temperature-  
Control Box

**I**N the course of research that has extended over more than a year, the General Radio Company discovered that a temperature-control unit which is to operate satisfactorily outside of a constant-temperature room must be more than an assembly of thermoregulators, heaters, and insulating materials. As a result of this work, we announce two single-stage constant-temperature boxes with excellent characteristics.

The Type 547-A Temperature-Control Box maintains its temperature at any assigned value between 40 and 60 degrees C. within  $\pm 0.1$  degrees C. for a variation in room temperature of  $\pm 20$  degrees F. The heater operates from the 110-volt power supply. There is provision for controlling two Type 376 Quartz Plates, but the box is by no means limited to that use. Price: \$150.00.

The Type 547-B Temperature-Control Box is similar, but it maintains its temperature to within  $\pm 1.0$  degrees C. under the above-mentioned conditions. Its price is \$140.00.

## GENERAL RADIO COMPANY

30 STATE STREET

CAMBRIDGE A, MASSACHUSETTS



# QST



## The Official Organ of the A.R.R.L.

VOLUME XIV

APRIL, 1930

NUMBER 4

Editorials . . . . .	7
The Federal Radio Commission Reports . . . . .	8
NKF Experiments Above 28 Megacycles . . . . .	<i>James J. Lamb</i> 9
A Low-Power Transmitter . . . . .	18
Radio Control of Airport Lights . . . . .	<i>Belgrave F. Gostin</i> 19
The High-Frequency A. C. Receiver at W8AYO . . . . .	<i>D. C. McFarlin</i> 23
Revolutionary — and How! . . . . .	<i>Otto Lulher</i> 27
President Maxim Testifies at Washington . . . . .	29
The ABC of Filter Design . . . . .	<i>Paul D. Zottu</i> 34
Finding the Expeditions . . . . .	39
Say, Son . . . . .	<i>The Old Man</i> 40
Crystallizing Crystal Grinding . . . . .	<i>James J. Lamb</i> 41
The Superiority of Screen-Grid Detectors . . . . .	<i>A. E. Rydberg and J. W. Doty</i> 43
New England Division Convention . . . . .	45
Experimenters' Section . . . . .	46
Financial Statement . . . . .	49
Silent Keys . . . . .	49
WIAOF . . . . .	50
I.A.E.U. News . . . . .	53
Calls Heard . . . . .	55
Correspondence Department . . . . .	56
Midwest Division Convention . . . . .	88
Babcock Re-elected . . . . .	88
Hamads and QRA's . . . . .	92
QST's Index of Advertisers . . . . .	94

QST is published monthly by The American Radio Relay League, Inc., at Hartford, Conn., U. S. A. Official Organ of the A.R.R.L. and the International Amateur Radio Union

**Kenneth B. Warner** (Secretary, A.R.R.L.), *Editor-in-Chief and Business Manager*

**James J. Lamb**  
*Technical Editor*

**Beverly Dudley**  
*Assistant Technical Editor*

**Clark C. Rodimon**  
*Assistant Editor*

**David H. Houghton**  
*Circulation Manager*

**G. Donald Meserve**  
*Advertising Manager*

**Advertising Offices** . . . . . 55 West 42d Street, New York City  
**Editorial Offices** . . . . . 1711 Park Street, Hartford

Subscription rate in United States and Possessions, Canada, and all countries in the American Postal Union, \$2.50 per year, postpaid. Single copies, 25 cents. Foreign countries not in American Postal Union, \$3.00 per year, postpaid. Remittances should be by international postal or express money order or bank draft negotiable in the U. S. and for an equivalent amount in U. S. funds.

Entered as second-class matter May 29, 1919, at the post office at Hartford, Connecticut, under the Act of March 3, 1879. Acceptance for mailing at special rate of postage provided for in section 1103, Act of October 3, 1917, authorized September 9, 1922. Additional entry at Concord, N. H., authorized February 21, 1929, under the Act of February 28, 1925.

Copyright 1930 by the American Radio Relay League, Inc. Title registered at United States Patent Office.

# CRYSTAL CONTROL TONE

## for C. W. Transmission

REL Cat. No. 215 Basic CW Telegraph Unit is the typical modern multi stage transmitter for the amateur who desires to use the best. Frequency flexibility throughout each amateur band with crystal controlled note at all times. Shift quickly and easily anywhere in the bands.

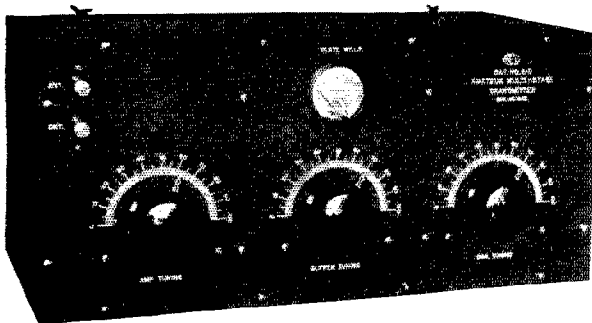

**CAT. 215 TELEGRAPH UNIT**

The Cat. No. 215 CW transmitter kit has been specially priced to meet the demands of every amateur. The price including one set of plug-in coils for any of the three popular bands is **\$56.00.** (When ordering specify for which band you desire the coils.) Additional coils to cover other bands may be purchased at \$7.00 per set of three.

## 100% MODULATION

### for Phone Work

REL No. 225 modulator and speech amplifier unit designed to operate in conjunction with Cat. No. 215 CW telegraph transmitter functions as 100% system modulator. When used with Cat. No. 215 unit will deliver 30 watts on modulation peaks into the antenna.

The REL Cat. No. 225 modulator and speech amplifier kit comprises all apparatus necessary and also includes metal cabinet and drilled and engraved aluminum front panel. The cabinet has the same height and depth dimensions as the transmitter. The modulator may be placed directly alongside of the Cat. No. 215 thereby giving a very neat appearance.

The same type of power supply may be used except that the plate voltage necessary will be 550 to 600 volts. The UX-250 tube is employed as modulator and the UY-227 tube is employed as speech amplifier. The No. 225 modulator kit sells for **\$42.00.**

W2XV transmits every Wednesday and Friday evenings between 8 and 10 p. m. Eastern Standard Time on 8,650 KC.

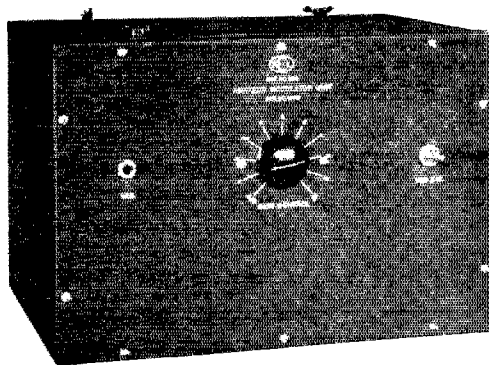

**CAT. 225 MODULATOR UNIT**

The amateur who desires a modern station should install both of these units. He will then have a perfect CW transmitter and a clear 100% modulated phone set. REL will be glad to forward you literature describing these two units.

**RADIO ENGINEERING LABORATORIES, INC.**  
100 WILBUR AVENUE, LONG ISLAND CITY, N. Y.

# Section Communications Managers of THE COMMUNICATIONS DEPARTMENT, A. R. R. L.

Eastern Pennsylvania	W3ZF	<b>ATLANTIC DIVISION</b>	Don Lusk	116 West Wyoming Ave.	Germantown, Phila.
Maryland-Delaware-District of Columbia	W3BBW		Forrest Calhoun	1636 Thomas Ave.	Baltimore, Md.
Southern New Jersey	W3BWW		Norman R. Weible	120 Frazer Ave.	Collingswood
Western New York	W8PJ		C. S. Taylor	598 Masten St.	Buffalo
Western Pennsylvania	W8CEO		A. W. McAuly	309 Third St.	Oakmont
		<b>CENTRAL DIVISION</b>			
Illinois	W9APV		Fred J. Hinds	3337 Oak Park Blvd.	Berwyn
Indiana	W9CYO		D. J. Angus	310 N. Illinois St.	Indianapolis
Kentucky	W9BAZ		J. B. Wathen, III	Mockingbird Valley	Louisville
Michigan	W8CEP		Dallas Wise	9187 Falcon Ave.	Detroit
Ohio	W8BYN		H. C. Storck	694 Carpenter St.	Columbus
Wisconsin	W9VD		C. N. Crapo	443 Newton Ave.	Milwaukee
		<b>DAKOTA DIVISION</b>			
North Dakota	W9DYV		B. S. Warner	309 4th Ave.	Enderlin
South Dakota	W9DGR		D. M. Pasek	780 Illinois St.	Huron
Northern Minnesota	W9BVH		Carl L. Jabs	1822 James St.	St. Paul
Southern Minnesota	W9EFK		J. C. Pehoushek	60 Melbourne Ave., S. E.	Minneapolis
		<b>DELTA DIVISION</b>			
Arkansas	W5ABI		H. E. Velte	315 No. Jackson St.	Little Rock
Louisiana	W5WF		F. M. Watts, Jr.	1716 Park Ave.	Shreveport
Mississippi	W5AKP		J. W. Gullett	1708 23rd Ave.	Meridian
Tennessee*	W4SP		James B. Witt	832 N. Fifth Ave.	Knoxville
		<b>HUDSON DIVISION</b>			
Eastern New York	W2QU		H. J. Rosenthal	Box 740	New Rochelle
N. Y. C. & Long Island*	W2BGO		V. T. Kenney	1836 Home Ave.	Bronx
Northern New Jersey	W2WR		A. G. Wester, Jr.	50 Princeton St.	Maplewood
		<b>MIDWEST DIVISION</b>			
Iowa	W9DZW		H. W. Kerr		Little Sioux
Kansas	W9CET		J. H. Amis	915 Lincoln Ave.	Topeka
Missouri	W9RR		L. B. Laizure	8010 Mercier St.	Kansas City
Nebraska	W9BYG		C. B. Deihl	5605 Cedar St.	Omaha
		<b>NEW ENGLAND DIVISION</b>			
Connecticut	W1CTI		Frederick Ellis, Jr.	7 Union Ave.	Norwalk
Maine	W1AOL		G. C. Brown	269 No. Main St.	Brewer
Eastern Massachusetts	W1WV		M. W. Weeks	40 Norfolk Rd.	Chestnut Hill
Western Massachusetts	W1UM		Dr. John A. Tesemer	8 Schafner St.	Worcester
New Hampshire	W1ATJ		V. W. Hodge	227 Main St.	Claremont
Rhode Island	W1BCR		C. N. Kraus	92 Keene St.	Providence
Vermont	W1IT		Clayton Paulette		North Troy
		<b>NORTHWESTERN DIVISION</b>			
Alaska	WWDN		W. B. Wilson	U. S. LHT Fern	Ketchikan
Idaho	W7ACN-JL		James L. Young	303 13th Ave., So.	Nampa
Montana	W7AAT-7QT		O. W. Viers		Red Lodge
Oregon	W7UN		Wilbur S. Claypool	1059 Greenwood Ave.	Portland
Washington	W7ACS		Eugene A. Piety	912 No. Ainsworth St.	Tacoma
		<b>PACIFIC DIVISION</b>			
Hawaii	K6CFQ		F. L. Fullaway	2714 Manoa Rd.	Honolulu
Nevada*	W6UO		C. B. Newcombe		Verington
Los Angeles*	W6ASM		C. A. Nichols,	1217 So. Normandie Ave.	Los Angeles
Santa Clara Valley	W6NX		F. J. Quemont	1348 Hanchett Ave.	San Jose
East Bay	W6CZR		J. Walter Frates	439 62nd St.	Oakland
San Francisco	W6WR		C. F. Bane	262 Castro St.	San Francisco
Sacramento Valley	W6DON		Everett Davies	Rt. 5, Box 380	Sacramento
Arizona	W6BWS		Russ Shortman	519 W. Madison St.	Phoenix
Philippines	K1CY		S. M. Mathes	Army-Navy Club	Manila
San Diego	W6EOP		Harry A. Ambler	4101 Hamilton St.	San Diego
		<b>ROANOKE DIVISION</b>			
North Carolina	W4TS		Hal S. Justice	Box 552	Canton
Virginia	W4CA		J. F. Wohlford	118 Caubridge Ave.	Roanoke
West Virginia	W8JM		D. B. Morris	703 Maryland St.	Fairmont
		<b>ROCKY MOUNTAIN DIVISION</b>			
Colorado	W9CAA		C. R. Stedman	1641 Albion St.	Denver
Utah-Wyoming*	W6BTX		L. D. Stearns	Westminster College	Salt Lake City
		<b>SOUTHEASTERN DIVISION</b>			
Alabama	W4AHP		Robt. E. Troy, Jr.	516 Cloverdale Rd.	Montgomery
Florida	W4AH		Harvey Chain	6002 Swanee Ave.	Tampa
Georgia-So. Carolina-Cuba-Isle-of-Pines	WARZ		M. S. Alexander	79 Rogers St., S. E.	Atlanta
Porto Rico-Virgin Islands	K4KD		E. W. Mayer	Box 103	Ensenada, P. R.
		<b>WEST GULF DIVISION</b>			
Northern Texas	W5BG		J. H. Robinson, Jr.	522 Cumberland St.	Dallas
Oklahoma	W5GF		W. J. Gentry	5388 Pottenger St.	Shawnee
Southern Texas	W5OX		R. E. Franklin	1806 Valentine St.	Houston
New Mexico	W5AHI		Leavenworth Wheeler, Jr.	Box 33	Valmora
		<b>MARITIME DIVISION</b>			
Maritime*	VE1DQ		A. M. Crowell	69 Dublin St.	Halifax, N. S.
		<b>ONTARIO DIVISION</b>			
Ontario	VE3FC		E. C. Thompson	266 Queensdale Ave.	Toronto, 6
		<b>QUEBEC DIVISION</b>			
Quebec	VE2AC		Alphy Blais	Box 221	Theftord Mines
		<b>VANALTA DIVISION</b>			
Alberta	VE4EC		Fred Barron	Warwick Apts., 95th St.	Edmonton
British Columbia	VESAL		J. K. Cavalsky	4868 Blenheim St.	Vancouver
		<b>PRAIRIE DIVISION</b>			
Manitoba	VE4HR		A. V. Chase	109 Lanark St.	Winnipeg
Saskatchewan*	VE4FC		W. J. Pickering	514 19th St. W.	Prince Albert

\*Officials appointed to act until the membership of the Section concerned choose permanent SCMs by nomination and election.

# The American Radio Relay League

The American Radio Relay League, Inc., is a non-commercial association of radio amateurs, bonded for the promotion of interest in amateur radio communication and experimentation, for the relaying of messages by radio, for the advancement of the radio art and of the public welfare, for the representation of the radio amateur in legislative matters, and for the maintenance of fraternalism and a high standard of conduct.

It is an incorporated association without capital stock, chartered under the laws of Connecticut. Its affairs are governed by a Board of Directors, elected every two years by the general membership. The officers are elected or appointed by the Directors. The League is non-commercial and no one commercially engaged in the manufacture, sale or rental of radio apparatus is eligible to membership on its board.

"Of, by and for the amateur," it numbers within its ranks practically every worth-while amateur in the world and has a history of glorious achievement as the standard-bearer in amateur affairs.

Inquiries regarding membership are solicited. A bona fide interest in amateur radio is the only essential qualification; ownership of a transmitting station and knowledge of the code are not prerequisite. Correspondence should be addressed to the Secretary.

## DIRECTORS

*President*  
HIRAM PERCY MAXIM  
Drawer 2102,  
Hartford, Conn.

*Vice-President*  
CHARLES H. STEWART  
St. David's, Pa.

*Canadian General Manager*  
ALEX. REID  
169 Logan Ave.,  
St. Lambert, P. Q.

*Atlantic Division*  
EUGENE C. WOODRUFF  
234 W. Fairmount Ave.,  
State College, Pa.

*Central Division*  
Election in Progress

*Dakota Division*  
CY. L. BARKER  
Henning, Minn.

*Delta Division*  
M. M. HULL  
P. O. Box 274,  
Natchitoches, La.

*Hudson Division*  
A. LAFAYETTE WALSH  
220 West 42d St.,  
New York City

*Midwest Division*  
LOUIS R. HUBER  
718 N. Gilbert St.,  
Iowa City, Iowa

*New England Division*  
FREDERICK BEST  
13 East Crescent St.,  
Augusta, Maine

*Northwestern Division*  
K. W. WEINGARTEN  
3219 No. 24th St.,  
Tacoma, Wash.

*Pacific Division*  
ALLEN H. BABCOCK  
65 Market St.,  
Southern Pacific Co.,  
San Francisco

*Roanoke Division*  
W. TREDWAY GRAVELY  
Box 245,  
Danville, Va.

*Rocky Mountain Division*  
PAUL M. SEGAL  
Box 1771,  
Denver, Colo.

*Southeastern Division*  
HARRY F. DOBBS  
245 Spring St., N. W.  
Atlanta, Ga.

*West Gulf Division*  
FRANK M. CORLETT  
2515 Catherine St.,  
Dallas, Tex.

## OFFICERS

*President* . . . . . HIRAM PERCY MAXIM, Hartford, Conn.  
*Vice-President* . . . . . CHARLES H. STEWART, St. David's, Pa.  
*Secretary* . . . . . KENNETH B. WARNER, Hartford, Conn.  
*Treasurer* . . . . . ARTHUR A. HEBERT, Hartford, Conn.  
*Communications Manager* . . . . . F. EDWARD HANDY, Hartford, Conn.

## GENERAL COUNSEL

PAUL M. SEGAL, 1010 Shoreham Bldg., Washington, D. C.

ADDRESS ALL GENERAL CORRESPONDENCE TO THE EXECUTIVE HEADQUARTERS AT HARTFORD, CONN.



# EDITORIALS

---

**B**OARD meeting coming! The Board of Directors of the American Radio Relay League meets in its annual two-day session on May 2d and 3d at Hartford. From all over the country they will come, including your own director, to put their heads together around a big table and go over the problems of amateur radio. The position of the League will be examined in minute detail, reports and recommendations received from the officers, decisions made on every question confronting the League, and plans made and instructions given to the officers for the coming year.

Your director is your spokesman at this meeting. It is one of his duties to be able to tell the other directors what the members in his division want. He needs to hear from members in his division, to guide him in expressing the views of his territory. Are you all hot and bothered about something? Have you a suggestion that may improve amateur radio? Have you some convictions on some of the big problems of our art? Then tell them to your director. His address is to be found on page 6 of this issue. He will present your ideas at the Board meeting. The Board will appreciate all the help it can get.

Members in the Central Division, largest of A.R.R.L. divisions, have no director just now. An election is being held and the new director will be chosen on April 15th, in ample time to enable him to attend the meeting. Central Division members should watch for an official broadcast about that time, announcing the result and thus enabling them to write to their new director before the meeting.

**W**E'RE very pleased to see the increased use which is being made of our 14,000-kc. (20-meter) band, but it still isn't as great as it should be. There are several excellent reasons why more amateurs should work on 14,000-14,400. It's a splendid band, too little appreciated. It's the least congested of our three principal bands. Most important, from our standpoint, is the sheer necessity of our greater occupancy of that band to prove our need for it. Times have changed. At the time of the Washington Convention the frequencies in the vicinity of 7000 kc. ('40') were most popular with the transocean companies and there is where they fought us the hardest, where they pinched us the worst. The story changes. Twenty meters is now much more important commercially than forty; the channels in the neighborhood of our 14,000-kc. band are much more valuable for business purposes than those around 7000. It is around '20,' we suspect, that we'll feel the greatest pressure at the next international conference, if things stay as they look now.

Which is why it is important for us to demonstrate need and prove occupancy. Every amateur who uses 14,000-14,400, in addition to being repaid by his results, will have the consciousness of helping the game in this other important respect.

**W**HICH reminds us: The useful range of high frequencies seems to change from year to year. Remember how, back in 1923, we were working transatlantic on 110 and 117 meters? Try to do it now! Ever hear about a certain big commercial station which was put up on this continent about a year later, to work with England, after lengthy tests had shown a wavelength around 90 meters to be best? By the time the station was done it wouldn't work — not over many hours of the day, at any rate —

and it had to be rebuilt for a shorter wave. Lots of little things like this, coming to our attention, give us the hunch that there is one curve that Doc Taylor hasn't drawn yet, for the simple reason that high-frequency work isn't old enough to supply the data. That's the long-time variation we're speaking of. It has been suggested that this long-time cycle may be of the same duration as the so-called sun-spot cycle, about eleven years. We've noticed that this seems to coincide with the influenza cycle, too. Perhaps that isn't strange when we remember that mild winters and influenza seem to keep company and recollect that there is indication of some slow drift in our weather conditions of about that duration. And of course if our "weather" is slowly changing, so is that irrepressible Kennelly-Heaviside Layer, and hence the performance of various frequencies. Somebody ought to do something about this. We can see trouble coming. Imagine all the small-fry nations engaging in research in 1932, just when that long-time cycle gets back on the wrong peak, in preparation for the Madrid conference. The Kingdom of Petruvia, after laborious effort by her experts, discovers that a certain frequency is the only one which will enable her to maintain communication with her distant possession, the Island of Herpicide. Coming to the conference armed to and including the teeth, Petruvia demands and is awarded the channel and signs a treaty for five years. Only to discover, as time rolls by, that the frequency has become perfectly useless for her purpose, whereupon she immediately assassinates a federal radio commissioner and starts another World War. Somebody, we repeat, ought to do something. Personally we think somebody ought to get out an injunction restraining that Layer.

K. B. W.

## The Federal Radio Commission Reports

**T**HE third annual report of the Federal Radio Commission, covering the period October 1, 1928, to November 1, 1929, is now available in printed form from the public printer. It is a document of 120 pages, treating in detail the administration and policy of the commission. One of its most interesting features is an inserted colored chart, 22" x 31", showing the distribution of channels to services for the entire radio spectrum. We have frequently recommended that the student of radio regulation obtain these government publications. Every amateur would profit to see and study this colored chart and note the complicated allocation system made necessary by modern communications, the relative proportions of the amateur assignments, the locations of the different services, who our immediate neighbors are. A very limited supply of copies of the report, including the chart of course, remain on hand and may be obtained by sending 35 cents (not in stamps or uncertified check) to the Superintendent of Documents, Government Printing Office, Washington.

Mention of the amateur occurs frequently through the discussion of the high frequencies. On page 24 of the report the commission specifically reports on amateur stations, as follows:

"Both the radio act of 1927 and the International Radio Telegraph Convention specifically

recognize amateur stations as an already existing service. The inference follows that they are to be continued and regulated as such.

"An amateur station in the words of the convention and the commission's regulations (General Order No. 24) 'is a station operated by a person interested in radio technique solely with a personal aim and without pecuniary interest.' It follows that they are not under the head of public utilities or subjected to a common-carrier obligation.

"In applying the standard of 'public interest, convenience, or necessity' to amateur stations, the commission must obviously consider other elements than in the case of commercial stations. Amateurs should unquestionably continue to be licensed, but on the theory their activities are in the public interest and so reconciled with the legislative standard. In addition, it is quite clear that in the case of amateur stations there is no need for choosing among applicants but only the necessity for recognizing an established radio service. In so doing the commission is acting under a general rather than a legalistic interpretation of the phrase 'public interest, convenience, or necessity.'

"The principles here expressed must necessarily guide the radio supervisors of the Department of Commerce when they are called upon to approve the issuance of amateur-station licenses by the Radio Commission. The administrative organization needed for this phase of the

(Continued on page 86)

# NKF Experiments Above 28 Megacycles

## New Ultra High-Frequency Transmitters and Antennas at the Naval Research Laboratory

By James J. Lamb, Technical Editor

**N**O institution of organized radio research holds such place in amateur esteem as the Naval Research Laboratory, and no radio call letters are more familiar to amateurs the world over than the historic combination, "NKF." The Naval Research Laboratory has been directly instrumental in encouraging a great deal of the development of amateur high-frequency communication and, in no small degree, has made many of our accomplishments possible.

From time to time, since away back when, it has been *QST's* rare privilege to chronicle Naval Research Laboratory developments pertinent to amateur problems and valuable for amateur adaptation. Invariably these contributions have proven inestimably valuable in the advancement of amateur technic, the progress in crystal control and oscillator-amplifier transmitters being, perhaps, the most outstanding instances of this influence. Contemporaneous experiments at the Naval Research Laboratory are no less applicable to our game, and recent NKF accomplishments in tests on frequencies above 28 megacycles fit right into the amateur picture. The Navy is doing things with the "ten-meter" band.

They have a way of doing things at NKF which is particularly appealing to us amateurs. Everything involving radio communication is given an experimental trial and there is a special shack for this work. It is called the "field house" and is "a veritable amateur paradise." It was from there that the transmissions for round-the-world and echo measurements on NKF signals were made and it is there that

the experiments on the 28-mc. band are being carried on. The time of our visit was fortuitous and we spent the day as eye-witnesses — and ear-witnesses — to the eye-opening communication tests between NKF and one of the Navy's ships stationed off the coast of California. NKF used a frequency of 30,000 kc. and the signals were reported "strength 10 plus" over a period of five hours — from 11:00 a.m. to 4:00 p.m. Now 30.0 mc. is the frequency at the very top end of our 10-meter band (the wavelength is 10.0 meters) and the power output of the transmitter was not over 500 watts. Moreover, the receiving conditions on a ship are by no means the best for high-frequency work, and no special receiving antennas or other equipment were used at the western end. The explanation for the success of the tests, therefore, lies in considerations other than those of power and special receiving apparatus. Happily, these considerations are within the scope of amateur radio. They are simply *frequency stability on the part of the transmitter and concentration of the transmitted wave on a "favorable angle."* The necessary frequency stability is made possible by crystal control and the concentration of the wave on a favorable path is obtained by use of a beam antenna.

### THE HIGH-FREQUENCY TRANSMITTERS

There are no radically new ideas involved in the design of *THIS EXPERIMENTAL TRANSMITTER IS DESIGNED TO OPERATE AT FREQUENCIES BETWEEN 3500 AND 30,000 KILOCYCLES*

*It has a normal output rating of 7½ watts, is crystal controlled, and is completely self-contained.*

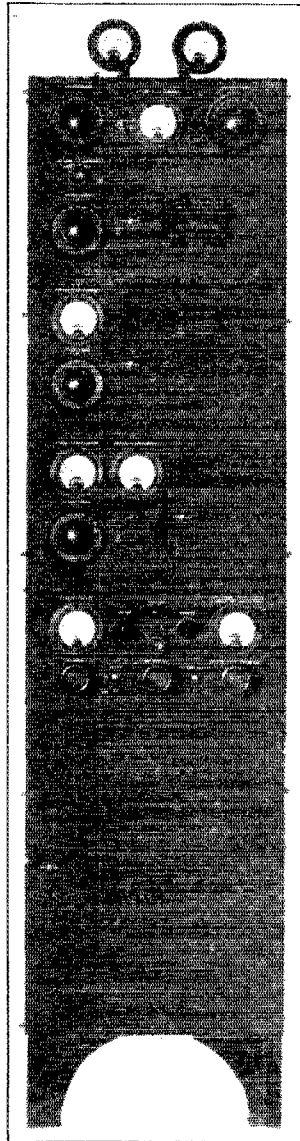

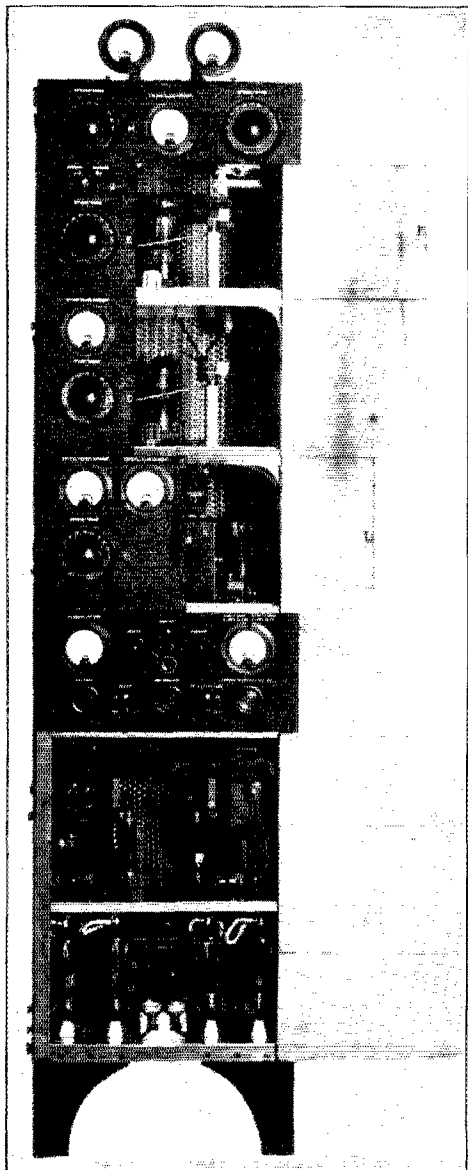

THE DOORS OF THE VARIOUS COMPARTMENTS OPENED TO SHOW THE ARRANGEMENT OF THE EQUIPMENT

The lower compartment contains two full-wave, mercury-vapor rectifiers, one for plate supply and one for grid-bias voltages. The compartment immediately above this contains the filters, resistors, and relay equipment. The panel above the latter compartment carries the filament voltmeter, pilot lights, voltmeter switch and the volt-meter. Then, progressing upwards, are the oscillator, first amplifier, and second amplifier compartments. The top panel carries the plate milliammeter for the last amplifier and the antenna tuning condensers. The antenna ammeters are at the very top. The unit is  $16\frac{1}{2}$  inches wide,  $14\frac{1}{2}$  inches deep and 72 inches high. The frame is made of aluminum angle.

transmitters satisfactory for operation on frequencies of 28 mc. and up, but slipshod assembly and careless adjustment simply cannot be tolerated. Although it is possible that the better self-excited transmitters may be capable of sufficient frequency stability for operation above 28 mc., the best assurance of the necessary elimination of frequency wobble and creeping is the use of crystal-controlled oscillator-amplifier circuits with frequency multiplication in the intermediate stages, and perhaps in the last stage as well.

This recommendation is supported by observations on amateur signals made at NKF. With but few exceptions, the amateur signals heard have been impossible to copy or barely readable just because of their violent frequency variations. It is quite probable that the scarcity of results amateurs have experienced on this band is partly due to unreadable signals. The "signals" may have been heard — but were mistaken for power leaks!

In the transmitters which the Navy has been using on frequencies of the order of 28 mc. — and on lower frequencies also — the primary excitation and frequency control is provided by crystal-controlled oscillators, usually with temperature control on the crystals and in some cases temperature control of the entire oscillator. This is not unusual or unduly luxurious in the practical sense; rather, it is often a necessity. Without such precautions crystal temperature will vary; and the frequency of oscillation must change with variation in crystal temperature.

When the transmitter's output frequency is the crystal frequency, the ultimate frequency change is the same as that of the oscillator; but when a series of frequency multipliers intervene between the crystal oscillator and the output amplifier, the ultimate frequency variation will be directly proportional to the number of times the frequency is multiplied. If a 3300-kc. crystal oscillator has a frequency drift of 5 kc. as it warms up in operation (a not at all unusual variation) and the oscillator is furnishing the control for a 29.7-mc. amplifier through frequency multipliers, the output frequency will shift 9 times as much as the oscillator frequency or 45 kc. The receiving operator would have to do some tall retuning to keep up with the transmitter, to say the least, and a few minutes of operation might suffice to put such a transmitter completely out of tune with its antenna system — and perhaps out of the band. There are other angles to this business of frequency stability, of course, but we have seen enough already to convince us of its importance.

The experimental transmitter used at NKF in the tests we have mentioned consisted of an output stage containing two 500-watt UV-861 screen-grid power tubes in parallel, preceded by the necessary frequency multipliers and the

crystal-controlled oscillator. The output amplifier was operated as a frequency multiplier and its plate input was 1400 watts. The efficiency of amplifiers operated at such high frequencies is undeniably low, particularly when they are used as frequency multipliers. The transmitter output, therefore, was probably below 500 watts. The relatively tremendous punch of the 30.0-mc. signals is obviously due to something other than brute power. The secret lies largely in the antenna system, which will be described later.

Not many amateurs can afford to become very much interested in a 1-kw. transmitter, however, and we have a hunch that the little 7½-watt rig illustrated in the photographs and diagrammed in Fig. 1 will have wider appeal than anything else we might talk about. This transmitter is really a little gem. True enough, it is considerably more elaborate in detail and refinement than most of us consider necessary, but it contains every feature — except power — that a transmitter possibly could have. Duplicating it either in its entirety or in its essentials is heartily recommended.

**THE LOW-POWER EXPERIMENTAL TRANSMITTER**

This transmitter was built by the Naval Research Laboratory for the Bureau of Engineering of the Navy Department in accordance with general specifications furnished by the Bureau. It was built for experimental purposes to determine what could be done with low power combined with modern design and with the frequency rigidly maintained by a constant-temperature-controlled crystal.

Essentially, it consists of a crystal-controlled oscillator and two stages of amplification, the latter serving as frequency multipliers (doubling or tripling) when necessary. It is intended

particularly for operation at frequencies between 3500 and 30,000 kc., although its maxi-

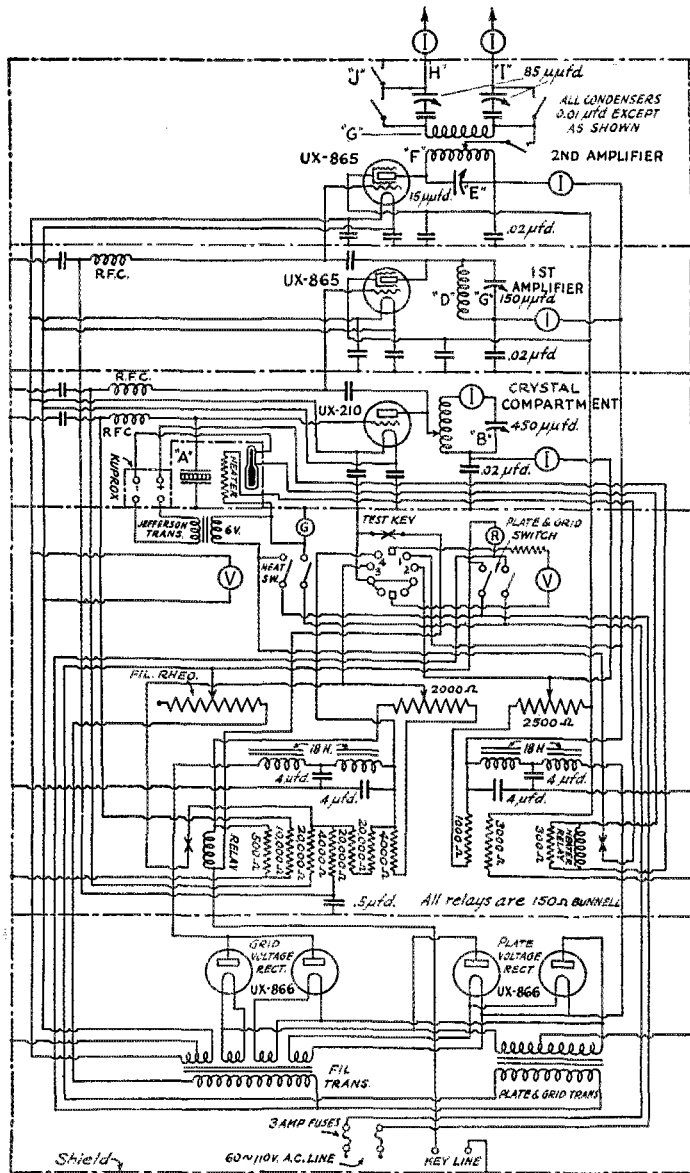

FIG. 1. — COMPLETE CIRCUIT OF THE 7.5-WATT EXPERIMENTAL TRANSMITTER

The circuit diagram closely follows the arrangement of apparatus in the transmitter assembly. "D" and "F" are the plug-in coils of the amplifier stages. The one oscillator inductance is used for all output frequencies. Note that the plate connection to this coil is clipped on near the low-potential end. "G" and "R" are pilot lights in the heater and 110-volt supply circuits, respectively.

imum possible frequency limit could be extended. The transmitter is a single unit 16½ inches wide, 14½ inches deep and 72 inches high; it is

divided into five shielded compartments arranged one above the other. The bottom compartment contains the plate- and grid-supply transformer, filament transformers, and two full-wave rectifiers using UX-866 mercury-vapor type tubes. One rectifier is for plate supply and the other is for grid-bias supply.

can be kept constant with variations in line voltage. The center-tap of the secondary is grounded to the aluminum frame of the transmitter; this is the "minus-B" and "plus-C" connection to the supply. An ingenious trick is employed in using the same high-voltage winding for both grid- and plate-voltage, and will be described later.

The transformer to the left supplies filament power to all the tubes in the transmitter and has one 7½-volt and three 2½-volt windings. The former is for the oscillator and amplifier tubes; the latter are for the rectifier tubes.

GRID BIAS SUPPLY

Fig. 2 is a simple schematic diagram of the rectifier circuits. The plate rectifier is quite usual — but the grid rectifier is not at all usual in amateur practice. The high-voltage transformer is made to do double duty. On one half of each cycle, when the end "A" of the transformer is positive and "B" is negative, tube "3" passes plate power and tube "2" passes grid voltage. On the other half of the cycle, when "A" becomes negative and "B" goes positive, tube "4" passes plate power and tube "1" passes grid voltage for the transmitting tubes. Each rectifier operates full-wave, with the two tubes connected to the same end of the transformer winding working

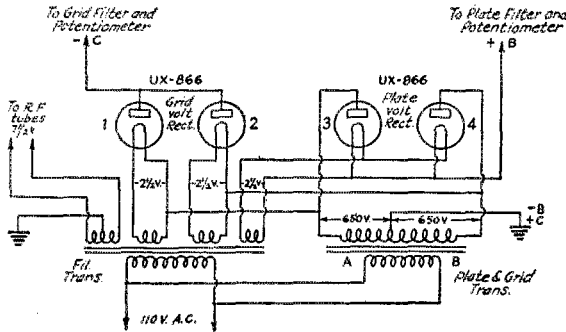

FIG. 2

The control compartment is immediately above and contains the filters for the plate- and grid-bias supplies as well as all the resistors for the transmitter and the two relays, one for keying and the other for the crystal heater. The third compartment is for the crystal-controlled oscillator and the next two above are for the first and second amplifiers.

THE POWER SUPPLY

The transmitter is designed to operate entirely with power supplied through a single connection to the 110-volt a.c. line. The filaments are all supplied with alternating current through step-down transformers while the direct current necessary for plate supply, grid-bias voltages and relay operation is obtained from rectifiers.

Two convenience outlets are mounted on the back of the transmitter near the bottom, one being for the 110-volt connection and the other for the telegraph key. The attachment plugs for the two are not interchangeable, so there is no danger of their being improperly connected. The 110-volt outlet is connected to a fuse block on the bottom deck near the front of the set, and thence to the "heater" and "plate and grid voltages" switches in the front of the second compartment. These two switches are used to put the transmitter in operation, the heater switch being turned on first and the temperature of the crystal box brought to normal before the other switch is closed.

The two rectifier tubes on the left of the bottom deck are for the grid-bias supply; those on the right are the plate supply rectifiers. The high-voltage transformer is immediately behind the latter. This transformer delivers 650 volts each side of its secondary center-tap and its primary is tapped so that the secondary voltage

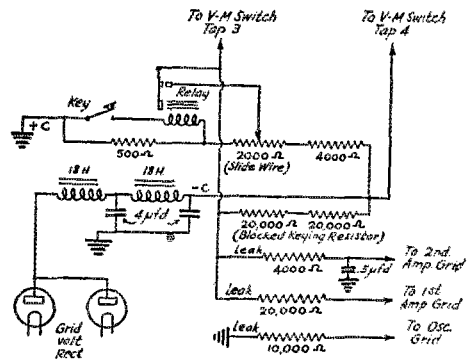

FIG. 3

on opposite half cycles. Two separate filament windings, well insulated from each other, are necessary for this type of grid-bias supply since the two filaments are connected to the opposite ends of the high-voltage winding and are always at high potential difference with respect to each other as well as to ground.

Fig. 3 is the schematic circuit of the portion of the transmitter involving the grid-voltage rectifier output, filter and bias resistors. It also shows the connections for the keying circuit. The arrangement has been made somewhat different from that of Fig. 1 for the sake of clarity.

The output of the filter has across it a 4000-ohm fixed resistor, a 2000-ohm slide-wire potentiometer and a 500-ohm fixed resistor in series. The solenoid of the keying relay and the key are connected in series across the 500-ohm resistor. The drop across the latter is thereby utilized in operating the keying relay; at the same time, the 500-ohm resistor serves to absorb any sparking at the key contacts and minimizes thumps and clicks which might cause interference.

Grid-leak bias is furnished normally to all three transmitting tubes. With the contacts of the relay opened, however, the full negative voltage (approximately 600 volts) is applied to the grids of the amplifier tubes, thus effectively blocking them. This type of keying is particularly effective and could be used more generally in amateur transmitters. It can be used with either battery

PLATE SUPPLY

The plate supply equipment — additional to the rectifier and transformers previously described — consists of the filter and resistors shown schematically in Fig. 4. The resistors are connected across the output of the filter as a

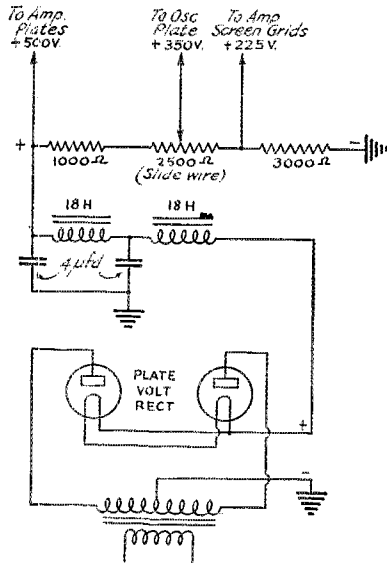
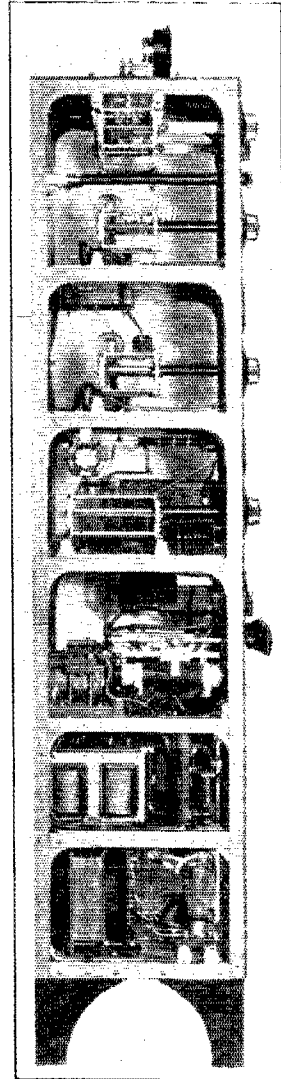

FIG. 4

or rectifier grid-voltage supply and is applicable to both oscillator-amplifier and self-excited circuits.

The adjustment of the slider on the potentiometer permits the application of grid bias additional to that obtained through the two grid leaks to the grids of the amplifier tubes. The 0.5-μfd. condenser connected between the lower end of the second amplifier's 4000-ohm grid leak and ground is for the purpose of minimizing thumps and clicks as the transmitter is keyed.

The slider of the potentiometer is connected to a contact of the voltmeter switch so that the grid-bias voltage with the key closed can be read while the transmitter is in operation.



LOOKING AT THE TRANSMITTER FROM ITS RIGHT SIDE

Note the crystal compartment on the fourth shelf from the bottom. Insulated extension shafts are used on the variable condensers.

potentiometer and arc of such values as to provide plate- and screen-grid voltages in the proper proportions. The plate voltage to the oscillator

tube is set at the proper value (350 volts) by adjustment of the slider on the 2500-ohm resistor. The current drain through these resistors is approximately 100 milliamperes; therefore

exceeding their respective power dissipation ratings.

The high-voltage end of the filter and the slider of the potentiometer are connected to taps on the voltmeter switch so that the two voltage values may be read while the set is in operation.

The voltmeter switch is mounted on the power-control panel and it has four positions, the same voltmeter being used for all readings. These positions are "plate voltage on amplifier tubes," "plate voltage on master oscillator," "keying bias voltage on amplifier tubes," and "blocking voltage on amplifier tubes."

#### THE CRYSTAL-CONTROLLED OSCILLATOR

The oscillator compartment contains the crystal oscillator circuit and the crystal (which is mounted in the removable box, "A") is maintained at a constant temperature of 50° C. by a heater operating in conjunction with a mercury-column type thermostat. The heater is supplied with power from the 110-volt supply through the heater switch and the contacts of the heater relay. The latter is in the compartment below and is energized by a 4-volt d.c. supply. This is obtained from a Kuprox rectifier connected in the 6-volt secondary of a small transformer operated off the 110-volt supply. A 300-ohm resistor is connected across the coil of the heater relay to absorb the inductive kick generated in the windings, thus preventing burning of the relay contacts and interference from sparking. The relay is of the back-contact type and is energized only when the contacts are open.

At ordinary room temperatures, the heater box will come up to 50° C. in approximately 25 minutes. The heater should be turned on, therefore, about a half hour before the transmitter is operated.

A green pilot lamp is connected across the heater unit and its glow indicates that the heater is on, thereby giving a visible check on the operation of the unit. After the box has warmed up, the heat will be on normally from 35 to 40 seconds and off approximately 70 seconds. Failure of the lamp to light or its remaining continuously lighted for more than two minutes (after the warming-up period) are indications of improper operation and an investigation of the circuit is in order.

The oscillator circuit is shown in Fig. 1 and in the simplified schematic diagram, Fig. 5.

It will be noticed that the plate of the oscillator tube is not connected to the high-potential end of the oscillator inductance but is clipped on down near the low-potential end. This is a commendable feature and is discussed in the article, "Crystallizing Crystal Grinding," elsewhere in this issue. In short, this adjustment permits control of the grid excitation of the oscillator and increased oscillator output with a minimum of

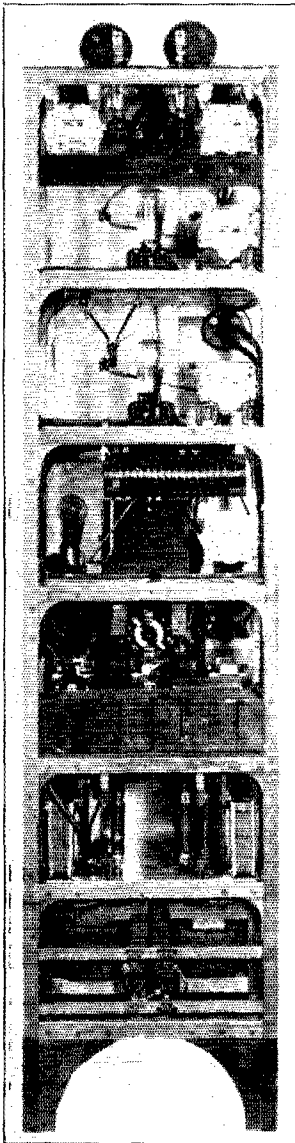

THE BACK OF THE 7½-WATT EXPERIMENTAL TRANSMITTER

The two outlets at the bottom are for the 110-volt a.c. supply and the telegraph key connections. The crystal oscillator inductance is suspended from the top of the oscillator compartment. Amplifier inductances are not in place.

they must be capable of carrying this amount of current plus the necessary load current without



crystal heating. The excitation for the first amplifier is taken off at this same tap.

#### THE RADIO FREQUENCY AMPLIFIERS

Two stages of screen-grid amplification follow the crystal-controlled oscillator, the tubes used being 7½-watt UX-865's. The UX-865 tubes have the advantage over three-element tubes in that they do not require neutralization when the amplifier output circuit is tuned to the excitation frequency. They have no advantage over tubes of the UX-210 type, however, when they are used as frequency multipliers. In a transmitter intended for operation on the 14- and 28-mc. bands only (both amplifiers operating as frequency multipliers) UX-210 tubes could very well be substituted with no circuit changes except the elimination of the screen-grid connections and making the proper control-grid connection. The circuit of the amplifiers would then be identical with that of the 14-mc. 'phone transmitter described in March *QST*.

When frequency multiplication is necessary, either one or both of the amplifiers can be operated as either frequency doublers or triplers. For an output frequency in the 7-mc. band, the first amplifier would be operated as a doubler (the crystal frequency being in the 3.5-mc. band) and the second amplifier would be run as a "straight" amplifier. For 14-mc. operation, both amplifiers would be operated as doublers with a crystal in the 3.5-mc. band. On 28 mc. both amplifiers would be operated as frequency triplers with a crystal having a frequency one-ninth the output frequency. This precludes the use of a crystal having a frequency in the 3.5-mc. ham band, since the crystal must have a frequency between approximately 3111 kc. and 3333 kc. to have a ninth harmonic in the amateur frequency band lying between 28 and 30 mc. However, since only two frequency multipliers are necessary to get to the 28-mc. band by tripling while three are necessary for doubling, the acquisition of another crystal for 28-mc. operation is not such a hardship.

The adjustment for operation of the transmitter on the various frequencies within its range is quite simple. With the proper crystal in the oscillator circuit, the various plate circuits are tuned to whatever combination of frequencies may be necessary for the achievement of the desired output frequency — and there you are.

The illustration of the group of coils designed for this transmitter gives a pretty good idea of their dimensions. No details as to their specifica-

tions are available but the general specifications for such coils given in past issues of *QST* and in the Radio Amateur's Handbook will serve as a satisfactory guide.

The antenna-coupling arrangement of the transmitter is shown in Fig. 1. It is so arranged that almost any type of antenna may be used

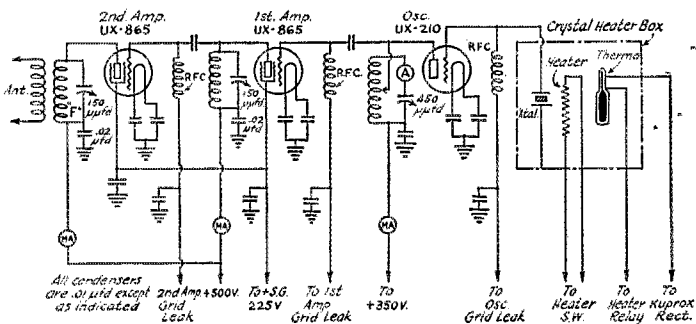

FIG. 5

with either inductive or conductive coupling. Two 85-μfd. tuning condensers are provided. These are at maximum capacity when the dial reading is "15" and are short circuited at zero. Fixed condensers of .01-μfd. capacity in series with the tuning condensers keep high direct-current voltages off the antenna when conductive coupling is used.

#### BEAM ANTENNAS

The necessity for concentration of the radiated energy on the most favorable transmission angle is equally as important as frequency stability in communication at frequencies above 28 megacycles, and the tests at NKF offer positive proof that this is so. During one of the testing periods, a vertical beam was substituted for the low-angle beam normally used. This vertical beam is almost identical in construction to the low-angle beam, with the exception that its antennas are in a horizontal instead of a vertical plane. The network is suspended on short poles and is slightly more than a quarter wavelength above ground. The concentration of the electric field of this system is, therefore, straight up — at right angles to the earth's surface (Warner "splatter system" style).

With the change from horizontal to vertical concentration of the radiation, the signal strength at the western end dropped from "10 plus" to around "3." This is about the signal strength resulting from feeder leakage. The vertical component of the radiated energy was entirely valueless for communication. Before going into any details on specific beam-antenna arrangements, however, let us get together on the terms involved in the above so that all of us will understand what we are talking about.

First off, just what does the term, "favorable angle of radiation" mean? To what extent is it important in high-frequency communication and by what is it determined?

Now it is well known that the angle at which a radio wave apparently is reflected from the Heavyside layer is dependent largely on the frequency of the wave. The existence of "skip-distance" effects is sufficiently general proof of this. Moreover, organized experiment, as well as the general experience of amateurs and others, has shown that this angle becomes smaller as the frequency is increased. In agreement, the skip-distance increases with the frequency. When the frequency is of the order of 28 or 30 megacycles, the angle of reflection becomes very small indeed — so small that the wave reaches the earth at the receiving point almost horizontally, or misses the earth entirely.

It is therefore evident that the useful portion of the 28-mc. energy radiated by a transmitting antenna is that which goes off at an angle of

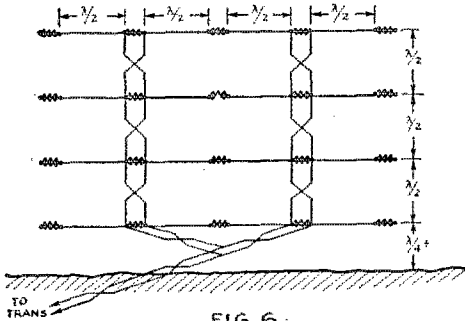

almost zero. In other words, the useful component is nearly horizontal. The "favorable angle of radiation" is, then, that angle on which is radiated the portion of the transmitted energy that will give the best signal at the receiving point. Energy radiated at all other angles is of little or no utility, and the over-all efficiency of the transmitting system is pitifully small. If a greater proportion of the transmitted energy can be concentrated on the useful angle of radiation, transmitter efficiency is improved and lower power input to the antenna is required for reliable communication. The problem is, then, to realize the concentration of energy on the favorable angle. This is readily accomplished with a beam-type antenna.

The antenna used at NKF in the 30.0-mc. tests is shown schematically in Fig. 6. It consists essentially of 16 half-wave Hertz antennas all operating in parallel and *in phase*. It transmits a horizontally polarized wave, since all the antennas are horizontal; it is directional "front and back" in both the horizontal and vertical planes, along a line perpendicular to the plane of the

antennas. If the whole thing is suspended with the antennas running north and south, it is strongly directional east and west — with a low angle of radiation. The accomplishment of these radiating properties is interesting and merits some detailed explanation.

There are two general types of directive antennas used in radio transmission. The first is that utilizing the parabolic reflector and the second is that utilizing wave interference resulting when two or more suitably spaced antennas are simultaneously excited from the same transmitter. The parabolic type of directive antenna is not much favored except for extremely high frequencies, since it must have dimensions of several wavelengths and therefore becomes practically impossible at communication frequencies. The second general type (spaced antenna system) is thoroughly practical, however, and it is this type of antenna which is considered here.

If two antennas are spaced a half wavelength apart and are excited from the same source through a two-wire feeder, the electric fields of the two antennas will be in phase at a point several wavelengths (or several thousand miles) away in a direction at right angles to the plane of the two antennas. If the number of antennas is increased to four, eight, or sixteen, the same phase relations of their respective electric fields exist — but the total intensity of the field at a point in a direction normal to the plane of the antennas is increased by an amount almost directly proportional to the number of antennas added.

Such an antenna system is shown in Fig. 6, and it is this antenna which is being used for the 30.0-mc. transmissions from NKF. It might well be referred to as "four-by-four," since it is four half-wave antennas high by four wide. This makes a rather elaborate system for the amateur to contemplate for his own use, and something like the arrangement shown in Fig. 7 is perhaps more in line with what the average ham can seriously consider.

This "two-by-two" antenna takes advantage of another scheme of antenna spacing which gives a directive effect.

If a half-wave antenna is parallel to and spaced a quarter wavelength from another half-wave antenna which is being excited by a transmitter, the first antenna will be parasitically excited by the antenna which is coupled to the transmitter. The fields from the two antennas will cancel in the direction of the parasitically excited antenna but will add in the opposite direction. The parasitically excited antenna, therefore, is usually referred to as a "reflector antenna." By adding a system of reflector antennas to a bilateral beam antenna the radiation becomes essentially unidirectional.

This may or may not be advantageous. If simultaneous transmission in two opposite directions

is desired, the reflector antenna is undesirable; if transmission in one direction only is wanted, then it is just what we want. There is a considerable "power saving" to be realized with either type of transmission, and approximate figures for the antenna shown in Fig. 7 can be given. These figures are based on data obtained with a similar arrangement by the Research Department of the Bell Telephone Laboratories.<sup>1</sup>

Considering the field strength at a point in the direction normal to the plane of the beam antenna (along the apparent line of transmission) the "two-by-two" arrangement without reflectors will give a field strength as great as a simple Hertz antenna excited with *four times the power*. Addition of the "two-by-two" reflector system increases the power-saving ratio to eight. In concrete ham terms, this means that a UX-210 rig working into the antenna system shown in Fig. 7 would give about the same field strength in Sydney, Australia, on 28,930 kc. (the frequency for which this antenna is designed) as a 75-watter would have working into an ordinary non-directive half-wave Hertz. "Range" and "field-strength" are synonymous, so the little fellow would have the same effective range as the more powerful outfit. It, looks as if directive antenna systems had their merits.

#### FEEDING THE BEAM ANTENNA

The attainment and preservation of the proper phase relations in the various antennas of the beam is imperative if the possible directive properties are to be realized to the utmost. This means that the feeders must be designed and adjusted to operate without unbalancing the system.

The feeders of the big beam at NKF are so arranged, and the method is extremely simple.

Standing waves on the feeders are eliminated by transposition of the feeders about every half wavelength, as shown in Figs. 6 and 7, and by adjusting the impedance of the feed-line. The transposition insulators are of the type shown in the photograph. They are of Isolantite and are approximately  $3\frac{1}{2}$  inches long by  $2\frac{1}{4}$  inches wide by  $\frac{5}{16}$ -inch thick. The notches cut in the sides facilitate assembly of the feeder system and the insulators give a spacing of approximately  $1\frac{5}{8}$  inches between the wires. Since such transposers are not widely available at this time, many will wish to make up their own. Paraffined wood or some other good high-frequency dielectric material which is easily worked will be satisfactory.

Matching of the feeder impedance to the load impedance is easily accomplished by the cut-and-try method. The matching instrument is the small two- or three-turn coil designated "phasing coil" in Fig. 7. It is arranged so that its terminals hook over the feeder wires permitting it to be slid along the feeders.

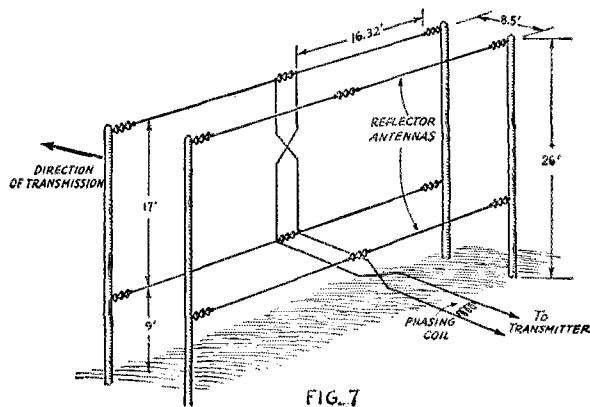
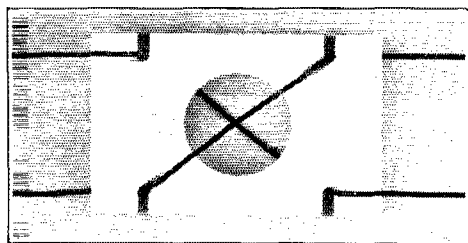

FIG. 7

Since the optimum concentration of field in the desired direction will accompany proper phasing of the system, measurement of the field strength as the phasing coil is moved along the feeders is the most direct method of determining when the adjustment is the best. The field-strength measuring equipment consists of a portable one-tube receiver with a sensitive milliammeter connected in its plate circuit — and a step ladder.

A visiting ham may be pressed into service as an assistant. He should mount the step ladder — which is placed in front of the beam and several wavelengths from it — carrying the receiver with him, and watch the plate milliam-



ONE OF THE ISOLANTITE TRANSPOSITION INSULATORS

The insulator serves also as a spacer for the feeder wires. The spread between the wires is  $1\frac{5}{8}$  inches. This insulator was developed by the Isolantite Company for the R. C. A.

meter while the owner of the station moves the phasing coil along the feeder. When the milliammeter of the receiver indicates maximum cur-

<sup>1</sup> Short-Wave Transmitting Antennas, *Bell Laboratories Record*, Aug., 1929.

rent, the field strength is a maximum and the phasing coil is at the proper point.

A similar method of matching the feeder im-

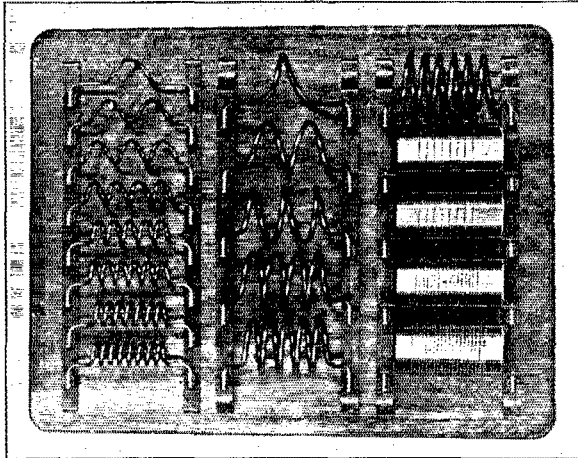

THE COMPLEMENT OF PLUG-IN COILS FOR THE FIRST AND SECOND AMPLIFIERS

*The coils terminals fit jacks mounted on a stand-off insulator and the tuning condenser of the respective amplifier stages. The coils have a frequency range of 3220 to 30,000 kilocycles when used in conjunction with the proper tuning capacitances.*

pedance to the antenna impedance has been used at the Naval Research Laboratory with good results.

#### THE FUTURE OF THE 2S-MC. BAND?

We must confess that adoption of the 2S-mc. band by amateurs has not been as whole-hearted as might be wished. However, it can be recalled that the 14-mc. band had to go through a similar period of trial—before it came into its own—in growing from the status of pure experimentation to that of reliable communication, and we need not be disheartened. The band gives indications of being reliable during the middle of the day over a minimum range of approximately 1200 to 1600 miles (the first zone of reception), 2400 to 3200 miles (the second zone of reception), and so on.

Intelligent application of the information on constant frequency transmitters and low-angle antennas made available to us by the Naval Research Laboratory in this article can do much towards making 2S megacycles a real ham band.

## Strays

Denstaedt, builder of W8VH is now in charge of WCK, the radio transmitter of the Detroit Police Dept. We are mentioning this for the benefit of those hams who might be "pinched" in Detroit. Incidentally, WCK is R9, QSA5 in Hartford.

When Fred Hill, W9BHX, and ex-4GL, heard a string of v's being emitted from his cellar recently, he was surprised to find that the "transmitting station" was a bullfrog. Fred couldn't determine the frequency of the transmitted signals, but says the waves were damped.

Anyway, that's W9FO's story — and he sticks to it.

Voight's "hot dog" cans make ideal tube shields. They may also be used as a housing for a Ford coil in peaked audio amplifiers.

— WSCM

## A Low Power Transmitter

**A**MATEURS who prefer to purchase their transmitting equipment ready-made will probably be interested in the two transmitting units recently marketed by the Radio

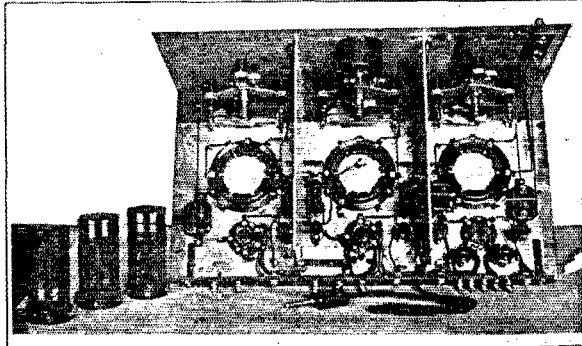

Engineering Laboratories. The two units, consisting of a Type 215-c.w. telegraph unit, and a Type 225 speech amplifier and modulator may be used as a radio telephone transmitter in the 3500-kc. band, or the 215 unit alone may be used as a telegraph transmitter.

The two units represent essentially a manufacturer's version of the low cost 'phone transmitter

(Continued on page 84)

# Radio Control of Airport Lights

By Belgrave F. Gostin\*

**T**HE provision of adequate lighting for emergency landing fields and also for main landing fields has been one of the most difficult problems in air transportation. The trans-continental lines must provide a series of emergency landing fields along their routes, so that in case of necessity the transport planes will be able to land and make the necessary repairs to continue their trip. To date these emergency fields are not lighted for night landing, but this will soon be necessary for safe travel during the dark hours.

Assuming that these fields were provided with flood lights, it would obviously be necessary to

three circuits is completely shielded. This aluminum box is packed with sponge rubber into the outer copper box. The sponge rubber packing is necessary to reduce vibration of the transmitter to a minimum. The copper box measures 8" X 9" X 16".

The two leads coming out of the top of the box are antenna and ground. The cable on the right is for power supply lines and the cable on the left is for the control panel lines.

Fig. 1 is the circuit diagram of the transmitter, control panel and power supply. It will be noticed that the "field selector" is an audio oscillator tube. This selector is so adjusted that

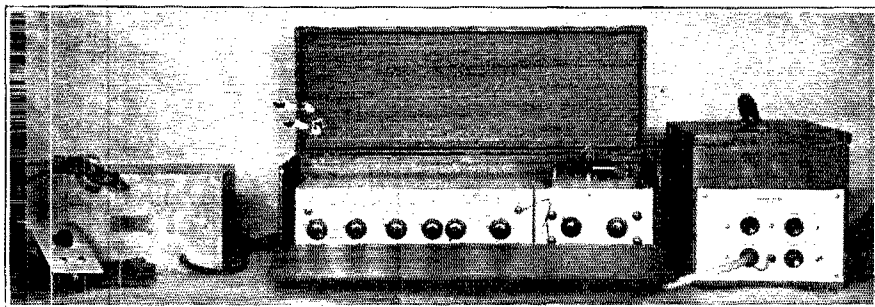

THE COMPLETE RADIO EQUIPMENT FOR AIRPORT LIGHT CONTROL

The transmitter and its control panel are at the left. The units in the carrying case constitute the receiver, the master relay being mounted on the right-hand unit. The power relay equipment is in the box at the right.

provide an attendant or some other means at each field to control the lights when a plane had to land. However, with the development of radio control, all of these fields can be equipped with landing lights and the necessary control apparatus so the pilot of the plane can light the field while he is still in flight and thus be assured of a safe landing.

The equipment described in this article was designed and built by the author and has been demonstrated both publicly and privately. Every demonstration has worked perfectly and no trouble has been experienced even with poor location of the receiving equipment.

Fundamentally the transmitting equipment consists of a 15-watt oscillator-amplifier and the necessary power supply and antenna system. The transmitter is located any place in the ship that may be convenient and the control panel is mounted on the plane's instrument board. The complete transmitter is built into an aluminum box which measures 5" X 7" X 14". Each of the

the selector switch places in the circuit such value of capacity as to cause the emitted wave to be modulated at some pre-determined frequency. The purpose of this modulation will be discussed later.

In the tests, the transmitter and receiver were worked at a carrier frequency of approximately 1875 kc. The constants of the transmitter and a description of its parts follow.

The antenna coil,  $L_1$ , is 12 turns of No. 14 solid copper wire spaced one eighth of an inch between turns and is wound directly over  $L_2$  and separated one fourth inch from it, fiber strips being used for spacers. The tube form is 3-inch diameter micarta.

The plate coil,  $L_2$ , is wound with 60 turns of No. 20 d.c.c. wire and is not spaced. No capacity is placed in this circuit as its natural period is approximately 1875 kc.

The oscillator coils are both wound on one form and not spaced. The coil form is a 3-inch diameter micarta tube. The coils  $L_p$  and  $L_g$  are each  $12\frac{1}{2}$  turns of No. 18 d.c.c. wire. All fixed

\* W8AET, 2207 Auburn Ave., Cincinnati, Ohio.

condensers are the moulded-mica type made by Sangamo. This type of fixed condenser was chosen because they are not affected by moisture. The grid circuit transformer, "T," is an R.C.A.

plate potential. The storage cell would still be used to supply the filaments of the tube, since all planes equipped for night flying carry storage cells to supply power to the wing-tip lights.

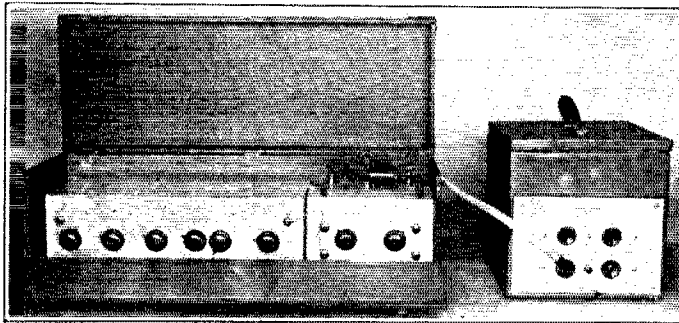

THE RECEIVER AND RELAY EQUIPMENT

These are experimental models and are mounted in carrying cases for portability. The left-hand unit contains the receiver and one section of the band-pass filter. The unit immediately to the right of the receiver contains the second section of the band-pass filter and the relay amplifier. The relay on top of this unit is connected to the output of the amplifier by leads inside the shielded box. Leads from the contacts of this relay run to the power-relay unit through the BX cable. The antenna and ground connections are made to the binding posts on the left end of the receiver.

The relay equipment was designed by Mr. D. S. Schnell.

amplifying transformer having a ratio of 1 to 10.

The audio oscillator inductance,  $L_o$ , is the secondary winding of an input push-pull transformer. Inasmuch as the inductance values vary over quite a range, their tuning capacities,  $C_t$ , cannot be definitely stated. The condensers must be tried in the circuit until the proper audio frequency is obtained.

The instruments on the control panel are so arranged as to give the operator complete control of the transmitter. The switches  $S_1$  and  $S_2$  are mounted so that when  $S_1$  is turned from "off" to "No. 1,"  $S_2$  is closed.

The key,  $S_3$ , is merely a small push button and controls the negative plate voltage circuit to the transmitter.

The indicating lamp,  $L$ , is a green pilot light and is connected to the "A" battery circuit. It shows the operator when the transmitter is ready to operate.

The battery and control panel cables should be shielded with tinfoil and the shield should be grounded to the frame of the ship. This is done to prevent interference from the motor's ignition system.

The power supply used in all of the demonstrations consisted of a six-volt storage cell and 300 volts of "B" battery. "B" batteries were used merely for convenience in handling, although in actual service some form of wind-driven generator probably would be used to supply the

smooth sides, a pair of fins should be mounted on the base of the cone to minimize spinning.

3. The antenna should not be fastened directly to the fish but to a swivel joint mounted on the apex of the fish.

4. If the antenna is to be used for any great

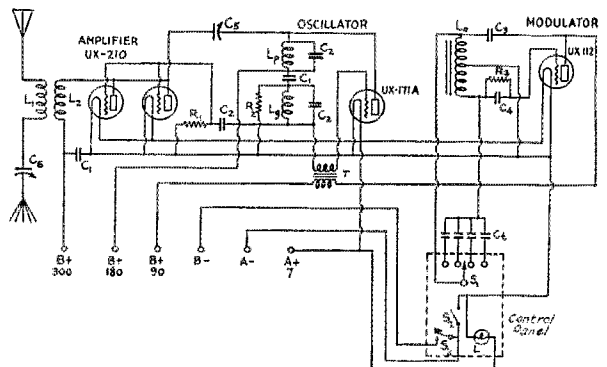

FIG. 1.—THE TRANSMITTER AND CONTROL PANEL CIRCUIT

$C_1$  — .005- or .006- $\mu$ fd.

$C_2$  — 500  $\mu$ fd.

$C_3$  — .001  $\mu$ fd.

$C_4$  — 500  $\mu$ fd.

$C_5$  — 5-plate midget neutralizing condenser.

$C_6$  — 23-plate midget condenser.

$C_7$  — See text.

$R_1$  — 10,000 ohms.

$R_2$  — 25,000 ohms.

$R_3$  — 3,000 ohms.

The inductance values are given in the text.

Grid modulation of the oscillator is employed.

length of time, copper braid is not durable enough; therefore, use a braided steel wire. Approximately No. 12 gauge cable is sufficient.

5. A good ratchet stop on the antenna reel should be provided since this will enable the operator to "drop" the right length of antenna for the frequency he is using.

The trailing wire has several advantages over the "V" type antenna, but is rather more cumbersome to handle. It will float away from the ship and thus have less antenna-to-ground ca-

stick antenna for the receiver. The latter is nothing more than a six- or seven-foot length of stream-lined brass or steel tubing carefully insulated from the ship and mounted rigidly enough not to require guy wires.

#### THE RECEIVER AND RELAY EQUIPMENT

The receiver, diagrammed in Fig. 2, is an especially designed neutralized r.f. circuit with heterodyne detector, band pass filters, and a relay amplifier. Inasmuch as this is only used as

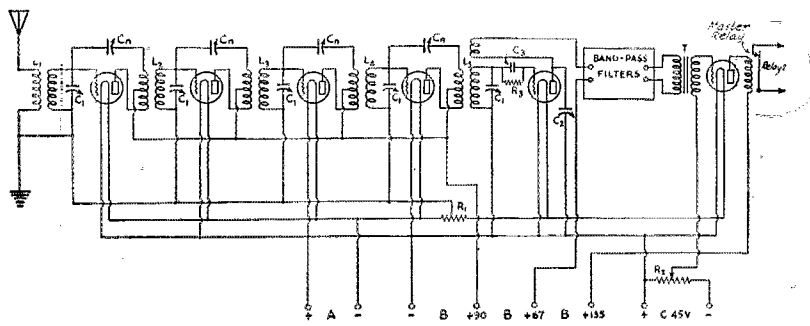

FIG. 2. — CIRCUIT DIAGRAM OF THE RECEIVER

$L_1$  — Primary: 10 turns No. 28 d.s.c. wire on 2-inch diameter Micarta tube. Secondary: 74 turns No. 28 d.s.c. wire on same form as  $L_1$  and spaced  $\frac{1}{4}$ -inch from primary.

$L_2, L_3, L_4$  — Primary: 10 turns of No. 28 d.s.c. wire on 2-inch diameter form, winding center-tapped. Secondary: 74 turns No. 28 d.s.c. wire on same form and spaced  $\frac{1}{4}$ -inch from primary.

$L_5$  — Primary: 10 turns No. 28 d.s.c. wire on 2-inch diameter form, tapped at seventh turn. Secondary: 74 turns No. 28 d.s.c. on same form and spaced  $\frac{1}{4}$ -inch from primary. Ticker: 8 turns No. 28 d.s.c. on same form and spaced  $\frac{1}{4}$ -inch from secondary.

$C_1$  — 135- $\mu$ fd. midget variable condensers.

Locked in tuning position by set-screw through condenser bearing.

$C_2$  — 135- $\mu$ fd. midget variable. Only variable control necessary in normal operation.

$C_3$  — 15- $\mu$ fd. midget variable neutralizing condensers. Set and locked same as  $C_1$ .

$C_4$  — 250- $\mu$ fd. grid condenser.

$R_1$  — 15-ohm filament resistor tapped at 10 ohms for grid bias.

$R_2$  — 2,000-ohm potentiometer for grid-bias control on output tube. This tube is biased to "cut-off," drawing plate current only when a signal is impressed on its grid.

$R_3$  — 5-meg. grid leak.

The radio-frequency amplifier tubes are UX-199's, the detector tube is a UX-201-A, and the relay-amplifier tube is a UX-171-A.

capacity than the "V" type. It is ideal for a small plane where the "V" type would be entirely too small.

One very interesting point has been discovered in connection with the "V" type antenna when used on the Ford Tri-motor ship. Although we were able to control perfectly the ground equipment within a radius of ten miles, the signal strength received by the ground set when the ship was directly overhead was so powerful as to momentarily paralyze the detector tube. From this incident it is obvious that a great deal of the signal is deflected or reflected, straight down by the ship, which is all metal. No solution of this effect is offered. A moment's thought reveals that very little of the antenna is under a part of the plane and that it runs at approximately 45° to both the wings and the cabin.

Practically all of the commercial planes that are radio equipped employ the trailing wire type of antenna for the transmitter and a vertical

ground equipment, it is not essential to keep the weight as low as possible. The r.f. circuit employs UX-199 type tubes; the band-pass circuit employs UX-201-A or 171-A type tubes. The band-pass circuit is designed to pass the audio frequency desired for the operation of the equipment.

Each unit of the receiver is carefully shielded and the whole set is built into an aluminum cabinet which measures 5'  $\times$  10'  $\times$  21'.

A "listen in" arrangement is provided by connecting a pair of telephones to the binding posts on the right of the relay amplifier unit. The 'phones are not connected directly across the circuit but are in series with a .001- $\mu$ fd. condenser and then across the circuit. This arrangement prevents the 'phones from taking unnecessary power.

The band-pass filter is the conventional combination of high-pass and low-pass filters which are designed for audio frequency and employ UX-201-A tubes.

The circuit diagram of the band-pass filter is given in Fig. 3 but no constants are specified because they all depend on the frequency for which the filter is designed to operate.<sup>1</sup>

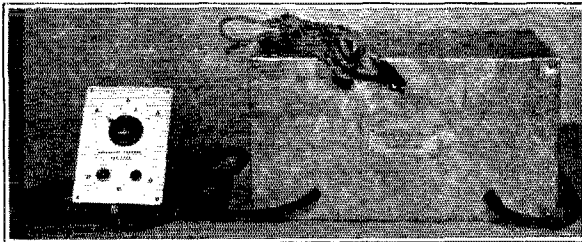

THE OSCILLATOR-AMPLIFIER PLANE TRANSMITTER

The outer case is of copper. Between it and the inner aluminum case is a layer of sponge rubber to absorb vibration. The small control panel, which mounts on the ship's instrument board, is in front of the shielded transmitter.

The audio transformer between the filters and the relay amplifier has a ratio of 1 to 9.

The relay system shown in Fig. 4 may at first glance appear to be quite complicated, but it is relatively simple in action. The whole system is operated from a 110-volt a.c. source. All relays, with the exception of the master relay, are manufactured by Westinghouse. The "M.C. 9" relay (B) is a time relay which may be set for any duration from one to twenty seconds.

The "M.C." relay (A) is a double-pole double-throw magnetically operated switch for reversing the action of the relay "C." The latter is a type "H.G." relay to which has been added a coil "X" for releasing the armature and thus breaking the circuit to the flood lights. The relays "D" and "E" are also type "H.G.," one with contacts normally open and the other with contacts normally closed. These two relays control the "B.B.T." landing light which is a part of every field equipment. The action of the relay system will be described later on in this article.

#### OPERATION

Obviously, it is not possible to control the range of the transmitter, and the lights of two fields located close to one another could not be operated independently without the use of the filter circuits. As an example of this, suppose that two fields are located ten miles apart and a plane coming into one field desires to light the field as he approaches it. The pilot turns the selector switch to the number indicated on the chart for the modulation frequency to which the receiver is tuned, at the field he desires to land upon. Say

this modulation frequency is 400 cycles. His transmitter sends out a signal which is modulated at 400 cycles and this signal will pass the filter and set the relays, thus lighting the field. The band-pass filter in the receiver at the second field is tuned to 700 cycles and therefore will not pass the 400-cycle signal and that field will remain unlighted.

Ordinarily, emergency fields are located approximately 25 or 30 miles apart, so that it is necessary to have but three or four selector taps. A plane leaving its main field, No. 1, will travel 25 miles to the first emergency field for which is designated No. 2 on the selector; this position modulates the transmitter at 400 cycles. Then the plane is taken another 25 miles to the next field, designation No. 3 on the selector, modulation 700 cycles. Then the next 25 miles is to the field designated as No. 4 on the selector, modulation at 1000 cycles. Now as the next field is 100 miles from his starting point, this field can also be designated as No. 1 and its lights can be controlled without interfering with

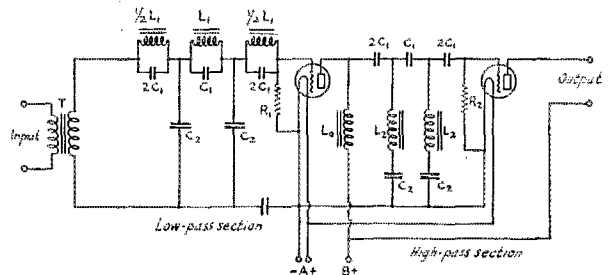

FIG. 3.—THE BAND-PASS FILTER CIRCUIT

No constants are given, since they depend on the band-pass frequency chosen.

the lights back at the main field. This same system can be used over and over on the whole transcontinental route.

The relay system is so arranged that the contractors do not close the flood light circuit until twenty seconds after the signal has been received. As the system is designed so that the first impulse lights the field and a second impulse turns the lights off, it is necessary to provide a time relay in order that the incoming signal will not cause the lights to flicker on and off. In operating the equipment, the pilot presses the button for about five seconds and then releases it. Fifteen seconds later, the lights go on and the relay circuits automatically set so that the next signal transmitted will trip the circuits and turn the lights off.

This equipment is relatively inexpensive and is

(Continued on page 80)

<sup>1</sup> For design data on band-pass filters, see A B C of Filter Design, in this issue. — Editor.



# The High-Frequency A.C. Receiver at W8AYO

By D. C. McFarlin\*

**W**HEN the writer started experimenting with a.c. high-frequency receivers, the sole object in mind was to get a good receiver for c.w., especially in the 14,000-kc. band, and one that would be reasonably free from hum. During the testing and experimenting, it became evident that the set was also going to be fine for 'phone reception; accordingly, necessary steps were taken to provide high quality reception of ham and commercial broadcasting signals as well as c.w.

It further became evident — after listening to the television transmissions of W3XK — that the set was also going to be fine for that class of reception, so a separate resistance-coupled amplifier was constructed because transformer-coupled audio amplification is "not so hot" for television on account of the wide frequency range of this class of transmission. This amplifier is much different from the ordinary run of resistance-coupled amplifiers, however, and will not be described in this article.

The original design incorporated a tuned stage of radio-frequency amplification using a 224 screen-grid tube, a 221 screen-grid detector and one resistance-coupled audio stage using a 227 tube. While a definite gain was obtained by tuning the radio-frequency stage, the tuning was somewhat bothersome due to the use of two tuning dials, and it became out of the question to write with one hand and with the other try to follow a signal whose frequency was wandering more or less aimlessly around. Therefore, the tuned stage has been abandoned for the present, although its possibilities are convincing.

## GENERAL CONSTRUCTION

The shielding at the start consisted of a copper plate on top of the baseboard, shielded leads to the control grids of both r.f. and detector stages, and two aluminum cans covering the tuning coils and condensers. After the set was placed in operation, the value of the shields was determined by removing them and noting the effect on signal strength — and whether or not there was any radio-frequency feed-back into the power supply. This method of checking the value of the shielding

resulted in eliminating everything except the copper plate on top of the baseboard and the shielded wires leading to the control grids of the r.f. and detector stages, although the wire to the control grid of the r.f. amplifier does not necessarily have to be shielded. Removing the shield from the wire to the control grid of the detector stage resulted in a lot of weird radio-frequency feed-back and caused the set to go "haywire," although a local ham (W8BHW) who built his set along the same lines has not experienced this trouble.

Removing the connections from the grounded side of the by-pass condensers,  $C_3$ , resulted in

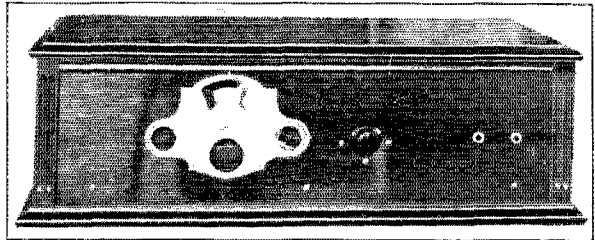

W8AYO'S A.C. RECEIVER

*The variable resistor for volume control of broadcast signals is at the right of the main tuning knob in the center of the escutcheon plate. The knob to the left is that of the variable resistor in the screen-grid circuit of the r.f. amplifier tube. The control in the center of the panel is for the regeneration condenser. The single-circuit jack at the extreme right is for the 'phones and the one to its left is for the speaker.*

strong r.f. feed-back into the power supply although this effect was hardly noticeable with the condenser by-passing the detector screen-grid lead. This test was made to determine the efficiency of the by-pass condensers, and they sure "do their stuff."

An audio-frequency oscillation also occurred in the 245 stage, but this was very effectually cured by connecting the core of  $L_4$  to the copper plate.

Close attention should be paid to the heater wiring of the a.c. type tubes due to the heavy current required at low voltage. Each 224 and 227 tube requires  $1\frac{3}{4}$  amperes at  $2\frac{1}{2}$  volts, while the 245 tube requires  $1\frac{1}{2}$  amperes at  $2\frac{1}{2}$  volts, making a total load of  $6\frac{3}{4}$  amperes at  $2\frac{1}{2}$  volts. The filament transformer used is an Aero designed to furnish heating current for six 226-type tubes at 2.2 volts when the line voltage is 110. Now a No. 16 wire is plenty large to carry  $6\frac{3}{4}$  amperes,

\*W8AYO, 29 West Marion Ave., Youngstown, Ohio.

but not at  $2\frac{1}{2}$  volts without a very appreciable drop in voltage. When using No. 16 wire, the voltage was found to be  $1\frac{3}{4}$  (representing a drop of about 30%) which is not sufficient for proper emission. The No. 16 wire was replaced with No. 10 extra-flexible, and the heater voltage then

high tap will fill the bill nicely. However, an eliminator having an effective filter system should be used.

Two sources of plate supply are used chiefly because they were available without further purchasing. Furthermore, by removing the 210 tube and cutting a 5000-ohm heavy duty resistor in series with the dividing resistor already in the Powerizer, the 250 volts necessary for the plate of the 245 tube is easily obtainable. "B" batteries are also feasible when using three tubes only, as the total load on the three tubes is only 7.2 milliamperes, divided as follows: 2.2 on the plate of the screen-grid tube (plate voltage, 135; bias,  $1\frac{1}{2}$ ; screen voltage, 60), detector plate,  $\frac{1}{2}$  milliamperes (actual plate voltage, 60; screen voltage,  $22\frac{1}{2}$ ), and 4.5 mils on the first audio stage (plate, 135; bias, -9). At least four 45-volt blocks of "B" batteries will be required, however.

The use of such high voltage in the detector plate circuit is absolutely necessary if some of the possibilities of the 224 tube are to be realized. An actual test with accurate instruments revealed that when the voltage on the high side of the plate resistor was 200, the voltage on the

plate was 60 (when  $\frac{1}{2}$  milliamperes current was flowing) and that there was a drop of 140 volts across this resistor. This is probably not absolutely accurate, but nevertheless is close enough to indicate the reason for high initial voltage at this point. To obtain maximum results from this tube, resistance coupling is necessary because of the high plate impedance.

Screen voltage on the detector tube was found to be best at from 20 to 25 volts and no benefit was derived from using higher voltage. In fact, the results were much poorer when the screen voltage was raised to 45. Screen-grid voltage can be obtained easily from the "B" substitute through a suitable resistor if no  $22\frac{1}{2}$ -volt tap is available, although it was found that for absolutely best results, the use of a small  $22\frac{1}{2}$ -volt "C" battery was preferable. The voltage on the screen grid of the r.f. amplifier can be 60 to  $67\frac{1}{2}$  volts, not being critical, and the variable resistor in the circuit can be used as a volume control when tuning c.w. and using all four tubes with loud speaker — although its use will throw the set out of oscillation under certain conditions if

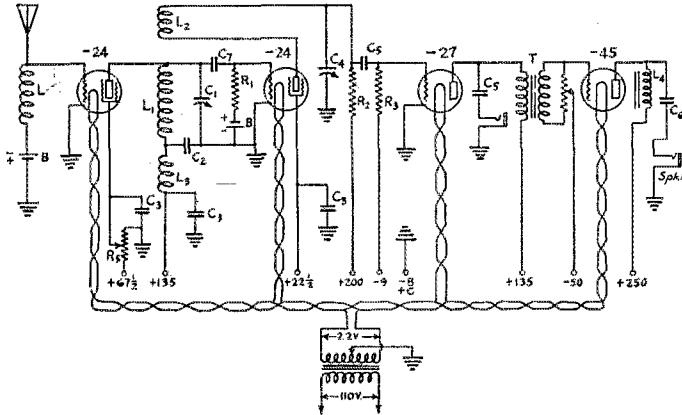

FIG. 1. — THE CIRCUIT IS NOT A COMPLICATED ONE

*L* — National No. 10 high-frequency impedance.

*L*<sub>1</sub> — Tuning inductance (see text).

*L*<sub>2</sub> — Tickler (see text).

*L*<sub>3</sub> — No. 277 Silver-Marshall radio-frequency choke.

*L*<sub>4</sub> — Amertran No. 85 30-henry choke.

*C*<sub>1</sub> — Remodeled National No. B27 condenser (see text).

*C*<sub>2</sub> — 100μfd. mica fixed condenser.

*C*<sub>3</sub> — 1μfd. by-pass condenser.

*C*<sub>4</sub> — 350μfd. variable condenser (regeneration control).

*C*<sub>6</sub> — 100μfd. mica fixed condenser.

*C*<sub>5</sub> — 2μfd. speaker-coupling condenser.

*C*<sub>1</sub> — 100μfd. mica fixed condenser.

*R*<sub>1</sub> — 2-megohm grid-leak.

*R*<sub>2</sub> — 250,000-ohm fixed resistor.

*R*<sub>3</sub> — 2-megohm grid-leak.

*R*<sub>4</sub> — 500,000-ohm variable resistor.

*R*<sub>5</sub> — " " " "

*R*<sub>6</sub> — " " " "

*B* — 1 1/2-volt flashlight battery.

*T*<sub>1</sub> — Filament-heating transformer (see text).

*T* — Audio-frequency coupling transformer.

"Grounds" indicate connections to copper sheet on base-board.

rose to 2.2, with line voltage of 112. The heater leads should be twisted all the way from the transformer and the transformer should be kept out of the set proper to prevent pick-up from the vibration of the core. This is an easy matter when No. 10 wire is used. It is also advisable to keep all line-voltage a.c. out of the set, the entire power supply being turned on from a switch external to the set.

Plate voltage for the r.f. amplifier, detector, and first audio stages is obtained from a Bremer-Tully "B" substitute, and the plate voltage for the 245 stage is furnished by a Model PXY-1 Powerizer, originally made for a model 20 Radiola broadcast receiver. This Powerizer is designed to furnish 45 and 100 volts for the set and about 325 volts for the 210 tube used as a power amplifier. The cost of this unit was \$15.

The rectifier for the power amplifier is a 280 full-wave type tube, and by changing the value of the voltage dividing resistor, it will furnish the necessary power for the entire set. For the person who desires to use only three tubes, a good "B" substitute having about 200 volts available on the

not handled properly. It is seldom used when using three tubes and 'phones only.

By-pass condensers are very important and they should be connected to the supply leads right where they come through the copper plate on top of the baseboard, one terminal of each condenser being effectually connected to this plate. Use high grade condensers, rated well over the working voltage, and no trouble will be experienced with radio-frequency feed-back.

The variable condenser tuning  $L_1$  is a National type E27, remodeled to a suitable range. The three-plate section was reduced to two, and the twenty-four plate section was reduced to two stator and two rotor, with a home-made switch to cut them in when needed. The two plate section is used when tuning on the ham bands (except 1715-ke., when all plates are used), and the bands are well spread out. The four plate section is cut in when it is desired to listen to broadcasting and other activities outside the ham bands.

Not much need be said about the other condensers except that they be high grade and rated well over the working voltage. The 2- $\mu$ f. condenser coupling the speaker to the output of the 245 must be at least that size if it is desired to pass the low frequencies transmitted by modern broadcast stations.

The variable air-condenser controlling regeneration can be any well constructed condenser of either straight-line capacity or straight-line frequency. The coupling condenser between  $L_1$  and  $C_1$  does not necessarily have to be of that value, although it has been found very good. To omit this condenser and connect  $C_1$  across  $L_1$  would result in short circuiting the plate supply.

Capacity control of regeneration is preferred to a variable resistor in the screen lead of the detector tube, due chiefly to its being quiet, although it seems to have more effect on the tuning than the resistor. Variable resistors have an annoying habit of becoming noisy, and capacity control of regeneration that does not have to be touched while tuning over a given band is preferable.

The fixed resistors in the detector grid circuit, and the coupling resistors between detector and first audio tube should be of the highest grade. Care should be taken to get the grid resistor in the detector stage connected to the grid side of the grid condenser. Otherwise a path will be provided for "B" supply to ground, and no d.c. path for grid return will be available. The variable re-

sistors used as volume controls can be any good make.

The bias voltage for both r.f. and detector stages is obtained from single 1½-volt flashlight batteries. A screw is soldered on the end of the cell having the proper polarity and fastened to the copper plate on top of the baseboard. Care



BEHIND THE PANEL

The apparatus is well spaced. The radio-frequency amplifier tube is at the extreme right. The tube in the center is the screen-grid detector and the audio-amplifier tubes are at the left.

should be taken that the battery for the r.f. stage has the center or positive terminal fastened to the copper plate, while the battery for the detector-stage grid bias has the outside or negative terminal fastened to the copper plate. The use of batteries at these points undoubtedly contributes very much to the absence of hum in the 'phones, although there is a very slight hum present in the speaker, because of the characteristics of the plate supply of the power stage.

RADIO-FREQUENCY INDUCTANCES

The question of inductances can always start an argument, but the inductances used here are doing their stuff and that is the one and only requirement. It has long been the impression that high frequency inductances used in receivers must be of heavy gauge wire, space wound, with a minimum of dielectric in the field, and other things too numerous to mention. A generous supply of No. 22 and No. 25 d.s.c. and No. 30 enameled wire being available, inductances were wound with all three sizes on Silver-Marshall bakelite coil forms and were tried on all ham bands, with the result that No. 30 enameled wire coils were found just as good as the coils wound with the larger sizes of wire. Accordingly, the No. 30 wire is preferred since it is easily wound on the forms and will not be affected by moisture. No attempt has yet been made to determine the limit of oscillation of the 224 tube, although it oscillates very readily at 19,000 kc., which was the limit for the coil which was wound.

The inductance data follow:

BAND	PLATE COIL $L_1$ (Turns)	TICKLER $L_2$ (Turns)	WIRE SIZE	SPACE BET. COILS
3500 kc.	30	10	No. 30 Enamel.	¼"
7000 kc.	10	8	"	"
14,000 kc.	5	6	"	"

When it is desired to listen to commercial broadcasting, all the condenser plates are used. It will be necessary to construct a coil with about 8 plate turns to fit in between 14,000 kc. and 7000 kc., and two coils with about 13 and 16 plate turns to fit in between 7000 kc. and 3500 kc. if it is desired to cover everything. The set goes in and out of oscillation beautifully when the coils are properly proportioned and "fringe howl" is absent using grid leaks up to 9 megohms.

Undoubtedly the set could be condensed considerably, but having a 7" x 26" cabinet available, the set was built to fit the cabinet and there is enough room so that it is not necessary to "stand on your ear" to get at some inaccessible connection. The ornamental (?) dial and controls were removed from a defunct broadcast set. The figures being about 1/8" high, stick out like a sore thumb and are very easily read.

Attention is called to the method of connecting the 'phones. They are so connected that they monitor the output of the first audio stage and the sound in them represents the audio-frequency output of this tube. There is, of course, no d.c. in the windings. The 'phones can be used to keep a check on the output of the speaker and assist in the location of distortion should it be present in the speaker when receiving radiophone. The condenser coupling the 'phones can be made larger if it is desired to pass lower frequencies, although this has not been found necessary.

#### BREAK-IN AND OTHER THINGS

One of the most surprising things found after the set was put in operation was that break-in was easily possible, even though the transmitter was only six feet away and the plate supply to the transmitter being good r.a.c. It has been impossible to satisfactorily account for this, especially since the set is so sensitive.

The receiver is ideal for the ham 'phones. (I rise to remark that there are some fine 'phones on both 3500 and 14,000 kc.) As for 100% modulated broadcast signals — well, the audio end of the set speaks for itself.

The 245 type of tube is strongly recommended for the reasons shown in the following table:

TUBE	PLATE VOLTAGE	MAX. UNDISTORTED OUTPUT (Milliwatts)
210	250	340
250	250	900
245	250	1600

It is readily seen that when the 245 tube is worked at maximum plate voltage (250), the undistorted output is almost five times that of the 210 and about 80% greater than the 250 when worked at the same plate voltage. Further advantages of the 245 tube are that its filament requires the same voltage as the other tubes in the set and may be obtained from the same source.

Also, the plate voltage of 250 makes it possible to reduce both size and cost of the plate supply unit.

If high quality broadcast reception is desired, then high grade audio transformers should be used of course.

An interesting possibility, and one that was given a brief try, is to replace the 227 tube in the first audio stage with a 224, connected screen grid, into another stage of resistance-coupled amplification using a 240 and a final stage with resistance coupling using the 245. This would be a fine arrangement for television as well as general broadcasting. A brief trial of this idea proved it logical, although a separate resistance-coupled amplifier is now used for television.

If a Powerizer is used and it is desired to take advantage of the fact that it is already equipped for a 210 tube as power amplifier, then the "F" terminal on the audio transformer should be connected to the copper plate on top of the baseboard, since the necessary bias for the grid of the 210 tube is furnished by the Powerizer itself.

One thing which will be noticed particularly is the strength of harmonics from some of the broadcasting stations. On a previous receiver (employing one untuned stage of r.f. amplification, detector and two audio stages) these harmonics were present, but inaudible as far as voice or music modulation was concerned. With this receiver, however, some of the harmonics are brought up to speaker strength from stations as far away as Chicago, the third harmonic being apparently the strongest. The third harmonic of a large broadcast station about 65 miles from here comes in so strongly that the use of the volume control is necessary.

Even though the builder is interested in c.w. only, it is very advantageous to have the 245 stage because it permits doing about 80% of the copying from the loud speaker, even on VK, ZL, ZS, ZT and ZU stations. Wearing the 'phones for hours at a stretch is very tiresome even though rubber ear pads are used, and it is a distinct relief to shift the burden onto the speaker.

Of course the up-to-date ham station will have also an emergency receiver adapted to battery operation, preferably using 199 type tubes, for use during emergencies — when storms tie up the power lines and communication depends on the ever willing ham.

The day of the a.c. ham receiver is here to stay and anyone who builds such a receiver will be amply rewarded by the results, especially when he listens to ZS4M, ZT1T, ZL2AC, ZL4AO, VK3CP, VK3JK, VK7DX, PY1AW, PY1AA, PY2AK, and dozens of others pound in the loud speaker.



Is your receiver "micro synchronized?"

# Revolutionary—and How!

## Or a Radio Bug's Dream

By Otto Luther\*

### CHARACTERS

**MULTI-RANGE:** A mistreated hand-made model of a new type of radio condenser.

**HIS FATHER:** The guy that gave birth to the idea.

**THE NURSE:** Madame "X".

**T**HIS is a very sad story of a little condenser called "Multi-Range."

Multi-Range's hard luck started the day he was born. His father, who is not well-to-do, has not been able to provide the luxuries Multi-Range should have had. However, in consideration of his age, Multi-Range's development has been remarkable.

Multi-Range has never been disheartened and he is confident that some day he will be a success. Already people have expressed a desire to adopt him, but as he is his father's only child, and although his father would be glad to have his son get a better home, he too is confident of his

*Multi-Range and his old man. (Multi-Range plears with father.)*

**FATHER:** Multi-Range, why do you wish to have thousands of brothers?

**MULTI-RANGE:** So we may give them away.

**FATHER:** To give them away?

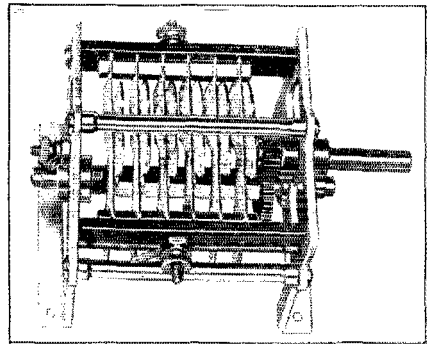

A SINGLE MULTI-RANGE CONDENSER

The design is such that there is a longitudinal motion of the rotor shaft in addition to its usual rotational motion.

With each clock-wise rotation of the shaft, the rotor plates are brought closer to the stator plates and the ratio of maximum to minimum capacity of the condenser is increased. This automatic variation in spacing is accomplished by means of the threading on the rear end of the shaft which screws into the threaded journal on the rear plate of the condenser frame. Since six revolutions of the rotor are possible, six different ratios of maximum to minimum capacity are available. The minimum capacity is substantially constant for all six capacity ranges. Wide spacing between adjacent stator plates is requisite to insure satisfactory capacity variation with longitudinal movement of the rotor plates.

The dial to be used in conjunction with the condenser has an auxiliary indicator to show which revolution the rotor is in. This indicator is additional to the usual scale showing the position of the rotor throughout one revolution.

Since the rotor shaft moves forward and backward, it is necessary that the dial be mounted on a sub-shaft which is geared to the rotor shaft. The opinion on the dial-shaft is sufficiently wide to mesh with the rotor-shaft pinion in any position of the latter.

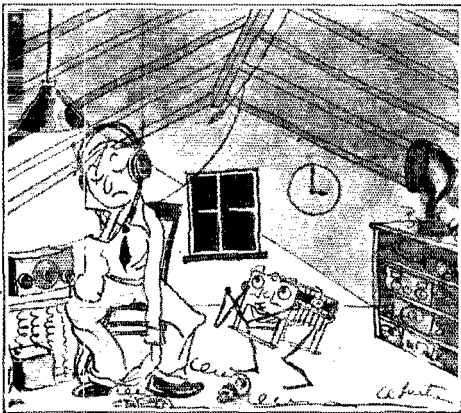

*Father, oh, Father, you are so dumb,  
Have you no deduction?  
Why don't you read between the lines  
And put me in production!*

son's future success and feels that the boy will provide for him in his old age.

Multi-Range is ignorant of his father's difficulties and wants brothers . . . thousands of brothers.

### ACT ONE

SCENE ONE: Attic full of radio junk. *Enter*

\* Belltown Road, Stamford, Conn.

**MULTI-RANGE:** To give them away. . . . To give them away.

*Voice from the rear:* To give them away.

**MULTI-RANGE:** To give them to your tampering friends who are always trying to pull me apart. My upper and lower plates are already bent.

**FATHER:** But thousands of brothers would cost more money than I can afford.

**MULTI-RANGE:** If I do not get what I want, I fear I shall break down. My bearings are already giving away.

**FATHER:** They should have been bronze.

**MULTI-RANGE:** Oh, Father, we might sell my brothers!

**FATHER:** Sell your brothers!!! Who would buy them?

**MULTI-RANGE:** Have a slogan!! Have a slogan!!

"With multi-range you spread the bands,  
You tune your set to foreign lands.  
From frigid north to desert sands,  
With multi-range you spread the bands!!!"

**MULTI-RANGE (continues):** Oh, for the proper environment! I would revolutionize radio.

**FATHER:** Revolutionize radio!!!!?

**MULTI-RANGE:** I myself am revolutionary in more ways than one for is it not possible to turn my rotor completely around several times, giving

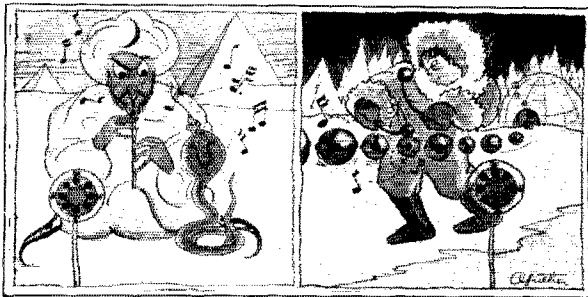

"With multi-range you spread the bands,  
You tune your set to foreign lands.  
From frigid north to desert sands,  
With multi-range you spread the bands."

me a different capacity range for each revolution? Daddy, if I could have the proper environment I could realize my ambitions.

**FATHER:** But what might that be?  
(Multi-Range produces Fig. 1.)

**MULTI-RANGE:** You see, Father, with my variable maximum feature I could win the hearts of radio listeners throughout the world, for it is this that would make possible the construction of a multiple-range receiver in which a 15-meter wave is almost as easy to tune to as one of 600 meters.

(Father lays Fig. 1 aside.)

**FATHER:** What's it all about?

**MULTI-RANGE:** This circuit is not radically different from anything that has ever been used before excepting  $C_1$  and  $C_2$  which are the sections of a double ganged multi-range condenser.  $C_3$  is a small-capacity trimming condenser.

Two stages of radio-frequency amplification and a regenerative detector are used. The first

stage is of the untuned type employing a 10,000-ohm resistor,  $R_1$ , between the antenna and ground.

The second stage is tuned by a section of the multi-range condenser. The other section of the condenser tunes the detector circuit.

The inductances are of the plug-in type with a range of fourteen to six-hundred meters. A balancing condenser is used across the secondary of each inductance. These condensers are integral with the coils.

It will be seen that a regeneration control of only 50,000 ohms is shown. With this low resistance, regeneration may be effected very efficiently on all frequencies higher than the broadcast band. With apparatus of this type it is possible to design a multiple-range receiver with full regeneration control on the high frequencies, but only a little feedback on the broadcast band. Such design would give the receiver (when tuned in the broadcast range) considerable sensitivity without the objectionable "squawk" of the oscillating detector.

**FATHER:** Son, your imagination is running away with you . . . you are out of control. . . . What you need is a means of control.

*Enter Nurse. (Multi-Range leaps with a joy and loses his bearings.)*

**FATHER (to Nurse):** Is it a boy?

**MULTI-RANGE (shouts with glee):** Ah . . . Now I have a brother.

*(Nurse looks sadly at Multi-Range and shakes her head. Then she whispers to his father.)*

**FATHER:** Multi-Range, you have a little sister. We shall call her "Dial," for she can keep tabs on you and by the flash of a color she can tell us what revolution your rotor is in.

*Exit MULTI-RANGE (crying):* I want brothers . . . thousands of brothers.

*(Stranger in audience is moved by drama.)*

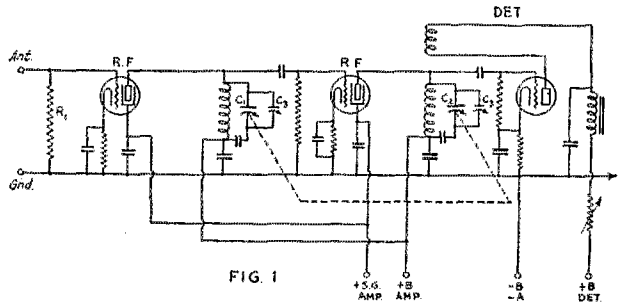

FIG. 1

**STRANGER:** Why don't you give the kid what he wants?

**FATHER TO STRANGER:** Wish I could.

CURTAIN

## President Maxim Testifies at Washington

**T**HERE is pending in the United States Senate a bill (S. 6) introduced by Senator James Couzens of Michigan to create a Communications Commission which would administrate all forms of interstate communication, land-line telephone and telegraph as well as radio. The bill was referred to the Senate Committee on Interstate Commerce, of which Senator Couzens is chairman, and this winter the committee has held extensive hearings on every phase of communications in this country. Pursuant to instructions from the A.R.R.L. Board of Directors at its 1929 meeting, our president, Hiram Percy Maxim, appeared before the committee and testified on behalf of amateur radio. Every amateur should read his statement. We publish it in full, not only to indicate what the League has done to represent our interests at these hearings, but because it in itself is most interesting reading. It tells the story of American amateur radio in condensed form and will bring home forcibly the value our amateur radio possesses to our country as well as to ourselves.

**M**R. CHAIRMAN AND GENTLEMEN:  
My name is Hiram Percy Maxim, my residence is Hartford, Conn., and I represent the American Radio Relay League, the national organization of the radio amateurs of the United States, numbering over 17,000.

In considering the matter of regulating communications, as proposed in Senate Bill No. 6, it seems that the Senate Committee on Interstate Commerce would do well to know certain facts regarding the amateur in radio. These facts are more important than appears upon the surface. Because the radio amateur does not represent a business or an industry, little is generally known about him. However, he is of great importance to our country, and it is for this reason that I believe this committee will be glad to receive what I have to offer to it.

Amateur radio is unique in history. Nothing quite like it has ever before existed. It is as old as radio, the great Marconi himself having started as an amateur and being truly typical of one. From the earliest days there has been something about communicating across space that has fascinated those of us who are technically inclined. There is a scientific romance to it that profoundly moves certain of us regardless of the social or financial status to which we happen to have been born. Rich and poor, uneducated and educated, old and young, we become more self-respecting men when, with the product of our own hands and our own brains, we are able to

reach out into the empty ether and make contact with another intelligence. This irresistible appeal began with the first announcements of Hertz in the '80's, when he discovered and laid down the laws that govern electro-magnetic radiations. These were reported in the daily press and inspired hundreds of technically inclined minds to try something themselves. Marconi was one of these and came to be the outstanding figure among us all. The wide-spread character of this peculiar appeal was not suspected at the time. It was not until 1900 or thereabouts, when Marconi had advanced far enough to make a trial of transatlantic communication, that it became known that there were many amateur experimenters who had devised and built their own apparatus and who had listened upon that eventful night along with Marconi for those three dots that would mean the prearranged letter S sent from a spark transmitter in the British Isles.

Long before there was any radio law at all, amateur radio experimenters by the scores were engaged in two-way telegraphic communication with each other. I venture to say that the members of this Committee will be surprised to learn that before the first radio law, that of 1912, was two years old, this amateur organization which I represent, the American Radio Relay League, was a going concern. I furthermore wonder if this committee realizes that instead of being wholly small boys in short trousers, we amateurs are in many cases men of your own age. The great majority of us, however, are between the ages of 17 and 25. We radio amateurs have absolutely no interest in the pecuniary side of radio. Our interest is 100% noncommercial. The only reward that appeals to us is the satisfaction and the thrill that accompany the successful achievement of a difficult bit of telegraphic or telephonic two-way communication.

From the earliest days we amateurs in the aggregate have been purchasers of considerable quantities of electrical supplies and raw materials. Furthermore, from the beginning our achievements have exerted a very real influence upon the art. From our ranks have been supplied practically all of the skilled personnel for the new industry. A radio amateur is always preferred by the commercial companies. I doubt if there is one single important radio broadcast station or one single radio manufacturing or operating company in the country to-day that has not at least one ex-amateur in some important position.

By the year 1915 we amateurs had accomplished unbelievable records in transmission and reception for those days. It was about this time that the older of us began seeking the reason for

the amateur with home-made equipment, representing an investment of approximately \$100, being able in some cases to excel the professional with equipment that represented an investment of many thousands of dollars. We found that reason eventually, and it is worthy of the careful consideration of this committee, for it is fundamental and may portend something of incalculable value to our nation. It is the backbone of the amazing record of amateur achievements down through the years. This reason was, and it still is, that with the amateur radio communication it is labor of love, whereas with the professional it is labor for a day's pay. There is a tremendous difference between these two. Money return counts for naught with the amateur. It is the whole thing with the professional. No sacrifice is too great for the amateur to make, if he can but get his signals through and the answer back. Sitting up all night, sacrificing pleasures in order to save a dollar for the purchase of better equipment, trying innumerable experiments, rebuilding his apparatus time on end, never giving up, are a religion with the amateur. This passionate intensity of purpose is really nothing short of sublime. I shall cite a few instances later to prove this.

This state of affairs was vaguely known to the authorities when the radio law of 1912 was being considered. The amateurs were beginning to organize at that time and during the hearings they requested to be heard, just as they have requested to be heard here to-day. Their sincerity and earnestness led the Congress of those days to provide for them in the radio law. The years have proven that it was an infinitely wise step.

The Congress in the radio law of 1912 specifically provided that there should be amateurs and it allocated to them the waves below 200 meters. They were considered the "useless waves" at that time, but there was room enough and the amateurs set about seeing what could be done with them. It was an historic occasion in the art of radio communication for it marked the birth of short-wave radio. The amateurs of the country went at their problem with the enthusiasm that only love of the work could arouse. I hope to show you beyond all question of doubt that the legislative act which led to this enthusiasm was one of the wisest steps a Congress ever took, and I submit that if it is wisdom to judge of the future by the past, then we here to-day may safely assert that it will further the art of radio communication during the eighteen years to come just as much as it furthered the art of radio communication during the eighteen years that have passed, if this Senate Committee on Interstate Commerce, in working out the details of Senate Bill S. 6 see to it that our radio amateurs are protected, encouraged and adequately provided for.

In the midst of things we entered the world war. The amateur had advanced a long way in learning how to make use of the short waves. His

numbers had grown into the thousands. His American Radio Relay League had become a highly successful and efficient organization. Through this organization he had established a network of amateur communication lines that covered the entire United States and the Dominion of Canada. The Canadians, being so close to us, were taken in as brothers and given full representation in League affairs, just as though they were American citizens. When the United States entered the war our Army and our Navy had immediate need for thousands of radio operators. To make them from plumbers, farm hands, clerks and laborers in the time available was an insurmountable task. The organized radio amateurs were appealed to. In sixty days we induced over four thousand of our membership, the most enthusiastic and skillful radio operators the world possessed, to enlist in the Army and Navy. Their record is one of the classics of the war.

After the war the ranks of the amateurs were augmented by the thousands who had been trained in the two services. Altogether they made of amateur radio an imposing institution. This was proven in the case of various radio bills that were introduced in Congress which threatened the existence of the amateur. The tremendous improvements made in radio apparatus during the war, under the stress of war conditions, were all known to the amateurs, since they had to operate them, and thus it came about that a tremendous increase in amateur interest ensued. Their American Radio Relay League, or their A.R.R.L. as they affectionately term it, was put together again and the conquest of the short waves was taken up with unprecedented enthusiasm. It is difficult for me to convey to those not informed upon this subject of amateur radio the intensity of purpose of these young fellows. They unquestionably are the pick of the land when it comes to mentality and resolute character, or they would not have taught themselves the science of radio and the telegraphic code in the first place. Furthermore their path was no easy one, for they were in the overwhelming majority of cases the sons of parents in very modest circumstances. But lack of money only whets the intensity of the amateur. One case that came to my notice is worth the attention of this committee. A certain young man, aged seventeen, in a mid-western city was known to possess a particularly efficient station. Attention became directed to him because of his long distance records and his superior operating. Investigation disclosed the surprising fact that he was the son of a laboring man in very reduced circumstances. The son had attended the ordinary school until he was able to work and then he had assisted in the support of the family. They were very poor indeed. Surprise was manifested that under these oppressive conditions this young fellow should have such a fine radio station. It was found that this station was



installed in a miserably small closet in his mother's kitchen, and that every bit of it had been constructed by himself. This meant that such things as head-phones and vacuum tubes were home-made. Asked how he managed to make these products of specialists, he showed the most ingenious construction of head-phones built from bits of wood and wire. In the case of his vacuum tubes he had found where a wholesale drug company dumped its broken test-tubes, where the electric light company dumped its burned-out

glances at the broad Atlantic. One of the results of the war had been the establishing of friendships with English, French, Belgian and Italian amateurs. There grew up an ever-increasing ambition to communicate with them. And he realized that the "useless waves" below 200 meters were to be used.

The radio laws in European countries were very restrictive upon amateurs and as a result short-wave communication was very backward. Tests were organized, nevertheless, and a concerted



MODERN BROADCASTING HAS A HUGE DEBT TO AMATEUR RADIO

*Amateur developments have played a large part in making possible the extensive radio entertainment afforded by present-day American broadcasting. Many of the pioneer broadcasters were amateurs. Our photograph shows an interesting early broadcasting station, circa 1921, operated by the well-known amateur John C. Stroebel, for many years 8ZW at Wheeling, West Virginia.*

bulbs, and had picked up enough glass to blow his tubes and enough bits of tungsten wire to make his own filaments and had literally home-made vacuum tubes — and good ones at that.

To exhaust his vacuum tubes he had built his own mercury vacuum pump from scrap glass. His greatest difficulty was securing the mercury for this pump. He finally begged enough of this from another amateur. The greatest financial investment that this lad had made in building his radio station was twenty-five cents for a pair of combination cutting pliers.

This case illustrates the amateur spirit, a knowledge of which I consider it my duty to convey to this Committee. No explanations are necessary or called for. The case points its own moral.

The short waves gradually reached out so that direct contacts could frequently be made all over the country. This led to the casting of wistful

effort made by American and European amateurs. Contacts could not be made, however, and something had to be done. After careful planning, what has been termed "the greatest sporting event in the history of science" was pulled off. With their own hard-earned funds the American amateurs sent one of their number to Europe with American home-made apparatus. His name was Paul F. Godley. After looking the ground over, Godley set his little station up at Ardrossan, Scotland, amid the skeptical remarks of the Europeans. When the appointed night and hour arrived for the tests to be made, a terrible storm arose and Godley, located in a tent, faced the most discouraging conditions that could be imagined. Cold and wet, but jealously protecting his instruments, he maintained his night-long watch and established dozens of contacts with his American brothers. The Englishmen were forced to listen for themselves and generously acknowledged the

superiority of the American amateur methods. The tests were repeated every night for a week and every amateur in America had his chance to get his signals overseas. At the end of the test transatlantic communication on the "useless" short waves with apparatus representing less than \$200 was an accomplished fact.

Things went furiously from here on. It began to be suspected that waves as short as 100 meters might be controlled. I remember vividly one of the early 100-meter tests in the Fall of 1923. A French amateur named Deloy had agreed to call an American amateur in Hartford, Conn., on precisely 100 meters at precisely nine o'clock, Eastern Standard Time, on a certain Sunday evening. The receiver in Hartford was set at precisely 100 meters and the American amateur had sufficient confidence in the precision of amateur methods to make no preparations for searching around on other waves. Exactly as the second hand of a carefully set watch indicated nine o'clock the little signals from faraway Nice, France, began, calling Hartford, Conn., U. S. A.

It is difficult to explain the thrill that accompanies an experience such as this. It is sublime and carries with it a sort of uplift that makes us better and deeper-thinking men. The precision of it all, the picture of the Frenchman sitting in his little den in France, waiting for the precise second to come around, hand on key, the Americans sitting in their little shack in a little street in New England, silently listening and watching the time, the miles and miles of lonely black ocean over which the little electro-magnetic oscillations must travel, are utterly compelling to us amateurs.

It did not take long to find that 100 meters was marvelously better than 200 meters. And it did not take long to find that 80 meters could be controlled and was even better than 100 meters for certain conditions. Then a way was found to keep 40-meter oscillations steady, and unbelievable records in long-distance communication in daylight were hung up. Then 20 meters was tamed and the amateurs in the Antipodes—in Australia, New Zealand, South Africa, the Philippines and Japan—were brought within reach. By 1926 the amateur on his short waves and his home-made apparatus bridged the ultimate of terrestrial distance.

Thus was short-wave radio developed by the amateurs. They had been given these super high frequencies in 1912 as the "useless" end of the spectrum and they turned them into useful channels for the longest distances we have on earth.

As radio spread into wider popularity and new channels became desirable for commercial uses, the amateur was made to give up part of the territory he had pioneered. This did not sit comfortably, especially since his numbers had grown to many thousands in the United States alone. More and more continued to be taken from him until the International Radio Conference in 1927,

when he was all but sacrificed by a conference of delegates from some eighty countries, colonies and protectorates, most of which had no radio amateurs and where every form of communications is a State monopoly. Our American delegates from our Army and Navy and Department of Commerce fought valiantly for their American amateurs but they were in the hopeless minority. All that was left of the territory the amateur had so brilliantly chiseled out of the solid were extremely narrow bands of frequencies around 160, 80, 40 and 20 meters. Here we find him to-day, 16,928 in number in the United States as of July 1, 1929, crowded beyond all conception and almost beyond endurance, suffering from what he feels is injustice and ingratitude and in constant danger of losing even the little that he still retains.

By dint of the most careful management and team-play the amateur as a whole is still constantly training himself, and those new amateurs who constantly join, to become expert radio operators, to take positions in the industry and to be available to our Government in time of need. The War Department and the Navy Department both have offered every encouragement and are fully aware of the incalculable value of the amateur. For many years not a single major break-down in general communication has occurred that amateurs have not played a major part in providing radio communications for summoning and directing relief. Some of these are probably not suspected by the members of this Committee.

To refer to recent emergencies which can be easily remembered: There were two hurricanes in Florida, one in 1926, the other in 1928. The first one completely wrecked a good share of the city of Miami. When the gale was at its height and after every means of communication, including amateur radio, had been completely wiped out, two amateurs, realizing the situation, located a few dry batteries and some automobile ignition batteries, salvaged such of the wreck of their radio stations as could be used, and in the midst of the hurricane improvised and erected an emergency radio transmitter and receiver and got into communication with fellow amateurs beyond the storm-torn area. They relayed a telegraphic message to the Governor of Florida, giving the state of affairs, advising what was most needed and giving information as to the best route to get into the city. Day and night these two young heroes kept that little miserable collection of apparatus in operation and handled hundreds of the most important messages. They of course had the whole-hearted cooperation of their fellow amateurs outside the stricken zone, and these are only second in deserving our gratitude.

At Tampa a group of amateurs borrowed a motor truck, equipped it with some of their home-made apparatus, drove to the devastated area be-

low Tampa and established themselves as a communication station.

When the second hurricane struck, again every kind of communication was wiped out, including the amateur stations. This time, when it became evident that trouble was again brewing, Forrest Dana, a young civil engineer, and Ralph Hollis, a fireman, each an amateur, started at 1:30 a.m. to prepare an emergency radio station. The hurricane came, and this time carried away the building in which the emergency station had been housed. In the worst of the storm these undaunted heroes started in all over again. This time they found a place where their antenna would remain up, and with a station erected under the conditions that can be imagined they carried on without a break from Monday until Thursday, handling all the communications that went out or came into West Palm Beach. Everything that the Red Cross did and everything the Army did was from information handled by Dana and Hollis. Surely the special knowledge that these young men had been induced to acquire, which enabled them to improvise a radio transmitter and receiver from miscellaneous material that could be picked up in an emergency, was of value to the nation.

The Vermont flood came in 1927. Every means of communication was obliterated. The amateurs were sought out by the authorities. They were ready—like the Marine Corps the radio amateur is always ready. They had rebuilt their stations, expecting to be called to serve, and were actually organizing outside amateurs to handle the expected traffic when their aid was sought. Red Cross, Army, press, railroads and general public were furnished communication for several days.

Santa Paula, California, had a terrible flood and here again the amateur and his splendid country-wide organization were ready and provided the Army and Red Cross communications. There was the terrible Mississippi Valley flood, also in 1927. Again did the amateur supply the emergency communications. In all there have been sixteen major disasters in the past decade when the amateurs and their organization supplied for days at a time the only communications.

Does it not mean something that this invaluable service has been developed by the amateur voluntarily? There is nothing in any amateur's federal license that requires him to perform this service. He serves without compensation, he desires none. He works for the pure love of the thrill of doing a public service by means of his beloved radio. Is this 100% altruism or no? Is it worth preserving, or no?

These records of achievement in public emergency so aroused the War Department Signal Corps that arrangements were made for an affiliation whereunder our amateur stations are joined in a country-wide network for emergency

communications under the direction of the Army in its constitutional duty of caring for the population when there occurs a general breakdown of the civil authorities' abilities to cope with the situation. Thus some thousands of the best amateurs of the country are to-day joined in the Army-Amateur Radio System. Are the members of this committee aware of this official government recognition of the value to the nation of amateur radio?

In the case of the Navy, the latter has opened a special classification for radio amateurs and already has enrolled some thousands as Naval Reservists in various grades from enlisted operators to commissioned reserve officers up to the rank of Lieutenant-Commander. The writer has the honor of holding a Lieutenant-Commander's commission in the U. S. N. R.

This picture of amateur radio is not complete without a word about the amateur's organization, his American Radio Relay League. This League is sixteen years old next May. It is a vast organization of substantially every worth-while radio amateur in the United States and Canada. It publishes its own magazine, and it is appropriate to the rest of this story that this amateur magazine is recognized internationally as leading the radio industry in the short-wave field. The A.R.R.L. is strictly non-commercial. No person may serve as an officer or as a director who has any business connection with the radio industry. Its Board of Directors is elected by the membership from each of 14 divisions in the U. S. and Canada. It meets annually, the expenses of all directors being borne by the League. It maintains a volunteer communications field force that numbers several hundreds, who supervise the practical operating activities, and insuring at all times a smoothly-working communications machine. The present President of the United States when he was Secretary of Commerce personally presented cups to be competed for by the amateurs annually. The amateur accomplishing the outstanding radio feat of the year was awarded the Herbert Hoover Cup. Radio amateurs for many years have been very proud of the type of person whose respect they have gained.

This finishes an abbreviated summary of the radio amateur. He is the product of the wise Act of 1912 which gave him a standing under the law. This act, I submit, was one of the most constructive and valuable bits of legislation that a Congress has ever enacted. Permitting those of our young men who have the natural attainments, regardless of their status in life, to pursue amateur radio, has contributed to the placing of our country in the present position at the head of the radio communication art; it added to our national wealth in providing encouragement and opportunities to thousands of young Americans who probably would never have possessed them otherwise. As their leader I appear before you now in

*(Continued on page 82)*

# The A B C of Filter Design

By Paul D. Zottu\*

UNFORTUNATELY for the amateur, most of the information available on filter design is in rather deep technical language and treated with such mathematics as to discourage him from further investigation. Therefore it is the purpose of this article to present the practical formulas necessary for the design of simple low-pass, high-pass and band-

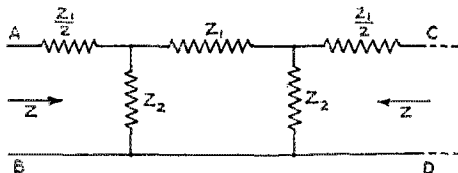

FIG 1

pass filters and to point out some of the conditions and limitations of filter theory and formulas. A problem dealing with each of the above named filters is considered and solved so that the procedure may be made more evident.

Before taking up the specific problem of filter design a few general remarks concerning filters may not be out of place. Fig. 1 shows a recurring

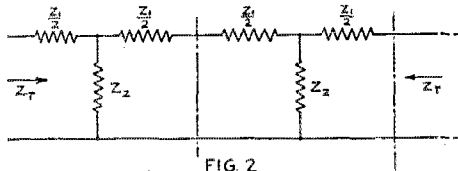

FIG 2

symmetrical electric network of the ladder type.  $Z_1$  is the series impedance and  $Z_2$  is the shunt impedance. If  $Z_1$  is considered to be made up of two like impedances  $\frac{Z_1}{2}$  in series, then the network would appear as in Fig. 2. The elements of each section are seen to resemble "T" from which the name "T section" is derived. Such a section is isolated by dotted lines in Fig. 2.

By dividing each shunt impedance,  $Z_2$ , into two equal parallel sections—each equal, of course, to  $2Z_2$ —the network is seen to consist of "π sections." Such a "π section" is isolated by dotted lines in Fig. 3. The same identical network of Fig. 1 is thus seen to be analyzed into either "T" or "π" sections as desired. The only difference resulting from the two ways of resolving the filter lies in the termination. Analysis into "T sections" yields a filter ending with a series

element  $\frac{Z_1}{2}$ ; analysis into "π sections" gives a final shunt element  $2Z_2$ .

If one measures the input impedance of a filter with its far end terminated in some impedance, the resulting input impedance will be found to depend both on the characteristics of the filter and upon the terminating impedance. When this terminating impedance is properly chosen, the input impedance will have a certain characteristic value,  $Z_T$  or  $Z_\pi$ , depending upon the type of section used. That  $Z_T$  and  $Z_\pi$  are different in value is evident from the fact that one type of section ends with a series element and the other with a shunt element.

The theory of filters is usually treated upon the assumption that there is an infinite number of sections. Obviously, this condition cannot be ful-

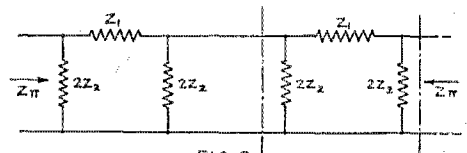

FIG 3

filled in practice, but thanks to a clever trick the same result can be secured. By terminating the filter with a load impedance equal to the impedance that the rest of the sections would have had, (called characteristic impedance) we make it believe that it is working into an infinite number of sections. In practice it is usually desirable to terminate a filter externally with an impedance approximating its characteristic impedance, for it is only then that the filter approaches in performance the type after which it was designed. Formulas have been derived which express the attenuation for standard types of sections properly terminated. Filters will work even though their ideal conditions are not fulfilled, but the effect of incorrect termination is less the greater the number of sections. It is this difference in termination which partially explains why a given filter behaves in accordance with its design formulas in one instance while its performance is untrue to type in another.

In the theory from which design formulas are derived the effect of resistance in the coils and condensers has been neglected. In filter construction it is kept as low as practicable. The effect of resistance is to introduce some attenuation in the pass-band and to round out the abrupt changes of

\*Senior Student, Wesleyan University, Middletown, Conn.

<sup>1</sup> See appendix.

characteristics that mark the transition from pass to stop frequencies in the ideal filter.

The inductances used preferably should have an air gap when an iron core is used so that their

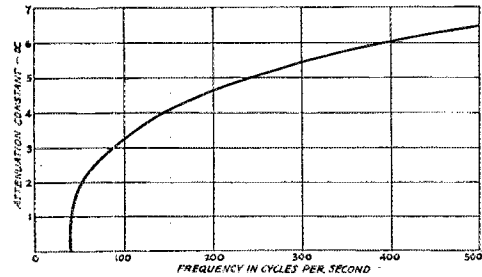

FIG. 4.—ATTENUATION CONSTANT PLOTTED AGAINST FREQUENCY FOR A SINGLE SECTION OF A LOW-PASS FILTER

Cut-off is at 40 cycles.

values will not change appreciably with changing current. They may also need to be shielded from each other, as any coupling will change the characteristics of the filter. In radio-frequency circuits they should be preferably of the low loss type.

DESIGN OF LOW-PASS FILTERS

Low-pass filters may be classified conveniently according to the use to which they are to be put: First, filters designed to pass with very little at-

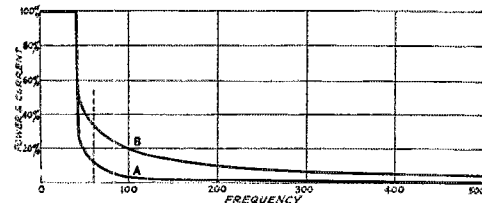

FIG. 5.—RELATIVE CURRENT AND POWER-OUTPUT PLOTTED AGAINST FREQUENCY FOR A SINGLE "T" OR "π" SECTION OF A LOW-PASS FILTER

Cut-off frequency is 40 cycles.

Curve A shows the percentage of input current available at the load terminals as the frequency is varied. Curve B shows the percentage of input power available at the load terminals at various frequencies. Note that at 60 cycles the percentage of current is 10.5 and the percentage of power is 31.5.

tenuation all frequencies up to a cutoff frequency  $f_c$  and attenuate all frequencies above  $f_c$ ; second, filters desired to pass only d.c. and to attenuate as much as possible any pulsations whatsoever. In the low-pass filter the elements  $Z_1$  and  $Z_2$  of Fig. 1 are replaced by elements  $L$  and  $C$ .

DESIGN OF THE FIRST TYPE

In a low-pass filter of the first type a cut-off frequency  $f_c$  must be assumed such that below

$f_c$  all frequencies can pass without attenuation and above  $f_c$  all frequencies are attenuated. The impedances of the power line and load must be determined, and thus the proper value for  $Z_T$  or  $Z_\pi$  of the filter is established. With these constants given  $f_c$  and  $Z$ , the values of  $L$  and  $C$  can be computed from the following relations:

$$L_h = \frac{.32Z}{f_c} \tag{1}$$

$$C_{\mu fd.} = \frac{320000}{f_c Z} \tag{2}$$

Where  $L_h$  stands for inductance in henries and  $C$  for capacity in microfarads;  $Z = Z_T$  or  $Z_\pi$  according to the type of sections considered. Fig. 7

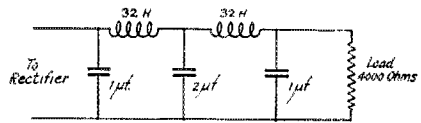

FIG. 6-a

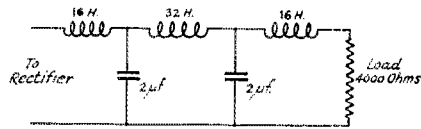

FIG. 6-b

shows the variation of  $Z_T$  and  $Z_\pi$  with frequency for a filter with  $f_c = 40$  cycles. In order that any particular frequency up to  $f_c$  shall pass without any attenuation whatsoever, the impedance of the filter must be equal to the value given by Fig. 7 for that frequency. These curves were plotted from the following equations:

$$Z_T = \sqrt{Z_1 Z_2 + \frac{Z_1^2}{4}} = \sqrt{\frac{L}{C} - \frac{\omega^2 L^2}{4}} \tag{A}$$

$$Z_\pi = \frac{Z_1 Z_2}{Z_T} = \frac{L}{C \sqrt{\frac{L}{C} - \frac{\omega^2 L^2}{4}}} = \frac{L}{\sqrt{LC - \frac{1}{4\omega^2}}} \tag{B}$$

Similar curves may be plotted for a filter with any cut-off frequency.

If a low-pass filter is to be used to eliminate all frequencies, leaving only d.c., then the problem of building coils and condensers to have a cut-off very nearly zero becomes physically impracticable and financially undesirable. The best that one can do is to construct a filter with as low a cut-off frequency as one can afford. The cut-off frequency is given by

$$f_c = \frac{1000}{\pi \sqrt{L_h C_{\mu fd.}}} = \frac{318}{\sqrt{L C_{\mu fd.}}}$$

"Transmission Line Theory," Franklin and Terman, page 158.

Knowing  $f_c$  and assuming either  $L$  or  $C$ , we can find the value of the other variable. The characteristic impedance of the filter at the cut-off frequency will be given by

$$Z = \frac{L f_c}{.32} \text{ or } Z = \frac{320000}{f_c C}$$

Since the problem is to attenuate all frequencies, a mis-match between either input or output impedance and the filter impedance will help to-

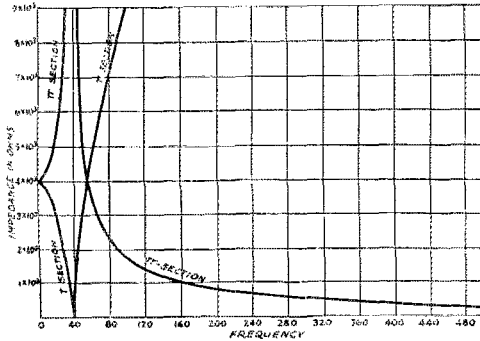

FIG. 7.—COMPARISON OF IMPEDANCE OF A T SECTION WITH THAT OF A  $\pi$  SECTION AS THE FREQUENCY IS VARIED

Cut-off frequency is 40 cycles.

wards this end by introducing attenuation due to reflection losses at the input and output terminals.

Example: A half-wave mercury vapor rectifier is to be freed from its ripple. (See appendix for the calculation of the line impedance.) It is found that the rectifier output impedance is 4000 ohms. The output of the filter is the plate supply of the power amplifier. If the total current to be drawn from the filter is 200 ma. at 1000 volts, it follows that the d.c. impedance of the load must be  $\frac{E}{I} = \frac{1000}{.2} = 5000$  ohms. If the load is simply the plate circuit of a tube, then its a.c. impedance is approximately 2500 ohms.<sup>3</sup> The filter is seen to be terminated differently at both ends, but the difference is not great enough to cause undue trouble. Let us take 4000 ohms for our filter impedance. As the rectifier, being of the half-wave type, will have its largest ripple at 60 cycles we might take 40 cycles as the cut-off frequency. Then  $f_c = 40$  cycles,  $Z_T$  or  $Z_\pi = 4000$  ohms.

From (1)  $L = \frac{.32 \times Z}{f_c} = \frac{.32 \times 4000}{40} = 32 \text{ h.}$

From (2)  $C = \frac{320000}{f_c Z} = \frac{320000}{40 \times 4000} = 2 \mu\text{fd.}$

<sup>3</sup>Thermionic Vacuum Tubes," Van der Bijl, page 195.

The filter will then have the structure shown in Fig. 6a if two " $\pi$  sections" are used or the structure shown in Fig. 6b if two "T sections" are

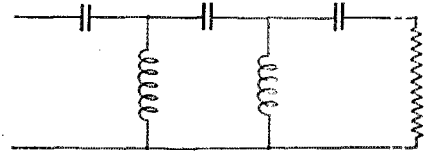

FIG. 8

used. Whether to use end sections of the  $\pi$  or T type depends on the problem in hand. The " $\pi$  section" type of filter ends with a condenser and advantage may be taken of this fact to use this same condenser to by-pass any radio frequency currents present. The other factor that determines the type of end section to use is the terminating impedance. Fig. 7 shows how this impedance varies with the frequency for the two types of sections. The sum-total of capacity and inductance used in both types is the same for equal number of sections. This filter will pass with relatively no attenuation all frequencies up to  $f_c$ .

Fig. 7 shows the variation of  $Z_T$  and  $Z_\pi$  for the above filter. It will be noticed that  $Z_T$  and  $Z_\pi$  are equal only at  $f=0$  or at d.c. Therefore, we are justified in letting  $Z = Z_T = Z_\pi$  if we wish to pass only d.c. If we actually wanted to pass any other frequency up to  $f_c$  with no attenuation, then the load and line impedances terminating the filter should have values as shown by the curves of Fig. 7.

DESIGN OF HIGH-PASS FILTERS

The simplest type of a high-pass filter is of the form shown in Fig. 8. Here the elements  $Z_1$  and  $Z_2$  of Fig. 1 are replaced by a capacity and an inductance. In this type of filter also the values of

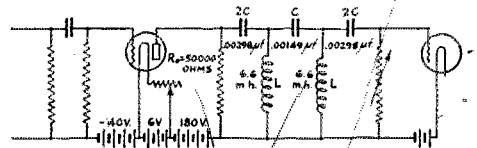

FIG. 9

the section may be considered to be of either the T or the  $\pi$  form. The values of the elements composing the filter are given by the following expressions:

$$L = \frac{.0797Z}{f_c} \tag{3}$$

$$C_{\mu\text{fd.}} = \frac{79700}{f_c Z} \tag{4}$$

$Z$  is again the characteristic impedance of the filter and should match the load and line impedances while  $f_c$  is the cut-off frequency below which attenuation takes place.

*Page 36 QST*

Example: Radio and audio frequencies are fed into an amplifier. It is desired to separate them

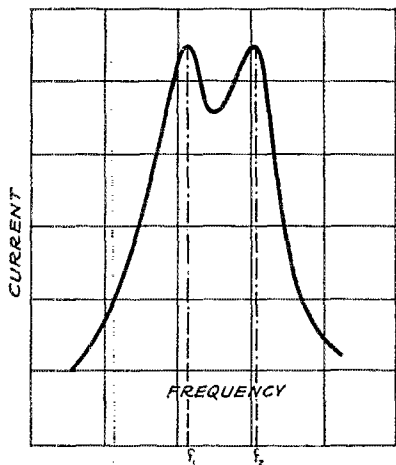

FIG 10

and to amplify the radio frequencies. Assume 20,000 cycles as the limit of audibility.

The amplifier circuit with its constants is shown in Fig. 9.  $r_p$ , the internal a.c. plate resistance of the tube, and  $R_o$  are in parallel so their total resistance is

$$R = \frac{r_p \times R_o}{r_p + R_o} = \frac{20 \times 10^3}{12} = 1666 \text{ ohms.}$$

The filter, therefore, should be designed for 1666 ohms, care being exercised to terminate the other end with approximately the same load resistance. We now have

$$Z_T \text{ or } Z_\pi = 1666 \text{ ohms.}$$

$$f_c = 20,000 \text{ cycles.}$$

Substituting in (3) we obtain for  $L$

$$L_h = \frac{.0797 \times 1666}{20000} = .0066 \text{ h.}$$

And using (4) we obtain for  $C$

$$C_{\mu f a} = \frac{49700}{20000 \times 1666} = .00149 \text{ } \mu\text{fd.}$$

The values of the filter elements are indicated in Fig. 9. The filter shown is made up of "T sections" and therefore the impedance of the first and last series elements must be  $\frac{Z_1}{2}$ , giving these condensers a capacity of  $2C$ .

It is realized that it is practically impossible to obtain the exact values of  $L$  and  $C$  as computed by the formulas. In practice values of available coils and condensers as close as possible to the computed values should be used and the filter recomputed to see how  $f_c$  and  $Z$  have changed.

BAND PASS FILTERS

All filters can be thought of as consisting of an infinite number of coupled circuits, but the

similarity is particularly apparent when the band pass filter is studied. Let us consider for a moment the resonance curve of two coupled circuits. It will be remembered that there are two frequencies at which the current becomes a maximum. As the number of circuits is increased, the number of resonance peaks is also increased. In the limiting case the combined resonance curve has a flat top with steep sides. The length of the flat top can be varied by varying the degree of coupling between the circuits. Fig. 10 shows the resonance curve of the circuit in Fig. 11a. As the degree of coupling is varied,  $f_2 - f_1$  is also varied. Similar resonance curves can be obtained from circuits shown in Fig. 12a and 12b. If we had an infinite number of coupled circuits, as in Fig. 11b, and their resonant frequencies were adjusted to lie within a definite band, then the network would transmit all frequencies within the band and would attenuate all other frequencies. This is in effect a band pass filter, and since circuits 12a and 12b can be made equivalent to circuit 11a, it follows that the properties of cir-

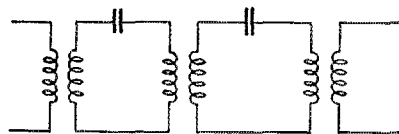

FIG. 11-a

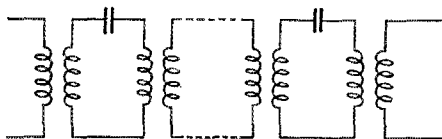

FIG. 11-b

cuit 11b can be duplicated by a network of circuits of 12a or 12b.<sup>4</sup> By doing this we arrive at a conventional band pass filter, such as is shown in Fig. 13. As in the other filters considered, proper termination is essential for best results.

DESIGN OF A BAND PASS FILTER

In designing a band pass filter we usually have three things given: The impedance of the filter, and the upper and lower cut-off frequencies. With the use of these data,  $C_1$ ,  $L_2$  and  $C_2$  are found from the following formulas:

$$C_1 = \frac{f_1 + f_2}{4\pi f_1 f_2 Z} \tag{5}$$

$$C_2 = \frac{f_1}{\pi f_2 (f_2 - f_1) Z} \tag{6}$$

$$L_{22} = \frac{(f_2 - f_1) Z}{4\pi f_1 f_2} \tag{7}$$

<sup>4</sup>L. S. Palmer, "Wireless Principles and Practice," Chapter IV.

In practice the impedance selected is usually that of the line for some frequency near the middle of the pass-band.

Example: It is desired to make a band pass filter for a super-heterodyne; the filter is to pass a band 10 kc. wide and is to have its cut-off frequencies at 100 kc. and 110 kc. It is to be termi-



FIG. 12-a

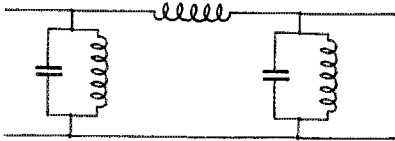

FIG. 12-b

nated at one end by a resistance of 50,000 ohms, which is in the plate circuit of a UX-201-A. At the other end it is terminated by a variable grid

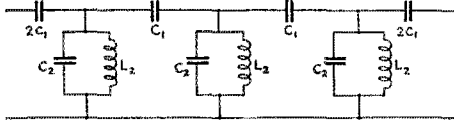

FIG. 13

leak which is adjusted to match the impedance of the filter.

Impedance of circuit feeding into the filter,

$$Z = \frac{r_p \times 50000}{r_p + 50000}$$

$r_p$  of UX-201-A = 10,000 ohms

$$Z = \frac{10000 \times 50000}{60000} = 8350 \text{ ohms}$$

Substituting in (5), (6), and (7).

$$C_1(\mu f.d.) = \frac{100000 + 110000}{4 \times 3.14 \times 100000 \times 110000 \times 8350} = .0000953 \mu f.d.$$

$$C_2(\mu f.d.) = \frac{100000}{3.14 \times 110000 \times 10000 \times 8350} = .003345 \mu f.d.$$

$$L_2(h) = \frac{10000 \times 8350}{4 \times 3.14 \times 100000 \times 110000} = .000605 h.$$

APPENDIX

CALCULATION OF THE LINE IMPEDANCE OF A MERCURY VAPOR RECTIFIER

The circuit of which the impedance is to be determined is shown in Fig. 14. The impedance

measured across terminals "AB" is principally due to the high tension winding and the impedance of the filament windings, the few ohms resistance in the mercury rectifier being small in comparison. The circuit can then be represented approximately by a single transformer as in Fig. 15.

$$Z_{line} = \frac{E_p \times Z_0}{I_p \times Z_r} = \frac{E_p n_s^2}{I_p n_p^2} = \frac{E_p r^2}{I_p}$$

where

$$r = \frac{n_s}{n_p} = \frac{E_s}{E_p}$$

$$\therefore Z_{line} = \frac{E_s^2}{I_p E_p}$$

It is to be noted that in the above calculation the value of the frequency does not appear. The values of the separate quantities employed in the

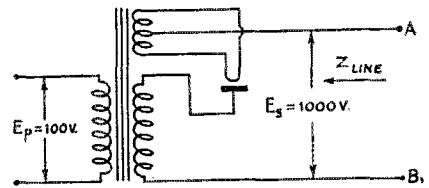

FIG. 14

calculation will, of course, depend on the frequency, but the final impedance of the line can be expressed in terms of currents and voltages alone.  $I_p$  can be measured readily, and, knowing the applied primary voltage and the developed voltage of the secondary, the impedance is found easily.

In the low-pass filter problem considered the

impedance of the line =  $\frac{(1000)^2}{100 I_p}$ .  $I_p$  is measured

with the transformer operating at normal load. When 0.2 ampere are drawn at 1000 volts,  $E_p = 100$  and  $I_p = 2.5$ , the impedance of the line =

$$\frac{(1000)^2}{100 \times 2.5} = 4000 \text{ ohms.}$$

ATTENUATION OF FILTERS

The quantity  $\alpha = \log_e \frac{I_1}{I_2}$  (where  $I_1$  is the current

entering a section and  $I_2$  is the current leaving the section) is called the *attenuation constant*. It is a measure of the effectiveness of the filter in attenuating the undesired frequencies. It varies with the frequency — for a low-pass filter it is zero at  $f_c$  and theoretically infinite at  $f = \text{infinity}$ . Fig. 4 shows the variation of  $\alpha$  with frequency. Fig. 5a shows the attenuation of current with frequency and Fig. 5b shows the attenuation of power with frequency. These attenuation curves are for only one section of a properly terminated



filter; for  $n$  identical sections,  $\alpha' = n\alpha$  and is the same for either "T" or "π" sections.  $\alpha'$  = total attenuation of the filter.

The attenuation per section of any ladder type

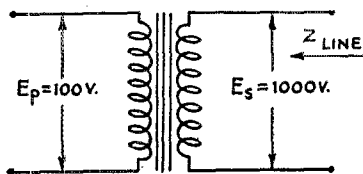

FIG. 15

filter is given by  $\cosh \alpha = 1 + \frac{Z_1^2}{2Z_2^2}$ . For the different types of filters considered  $\cosh \alpha$  takes the following forms:

**Low Pass**

$$Z_1 = j\omega L$$

$$Z_2 = \frac{1}{j\omega C}$$

$$\frac{Z_1}{2Z_2} = \frac{j\omega L}{j\omega C} = \frac{-\omega^2 LC}{2}$$

remembering that  $j^2 = -1$ ,

$$\cosh \alpha = 1 - \frac{\omega^2 LC}{2}$$

**High Pass**

$$Z_1 = \frac{1}{j\omega C}$$

$$Z_2 = j\omega L$$

<sup>6</sup> Hyperbolic functions are found in almost all good mathematical tables. Such a table is found in MacMillan's "Logarithmic and Trigonometric Tables."

$$\frac{Z_1}{2Z_2} = \frac{1}{2j\omega L} = \frac{-1}{2\omega^2 LC}$$

$$\cosh \alpha = 1 - \frac{1}{2\omega^2 LC}$$

**Band Pass**

$$Z_1 = \frac{1}{j\omega C_1}$$

$$Z_2 = \frac{L_2}{C_2 \left( j\omega L_2 + \frac{1}{j\omega C_2} \right)}$$

$$\cosh \alpha = 1 + \frac{\frac{1}{j\omega C_1}}{2L_2}$$

$$jC_2 \left( \omega L_2 - \frac{1}{\omega C_2} \right)$$

$$\cosh \alpha = 1 + \frac{C_2 \left( \omega L_2 - \frac{1}{\omega C_2} \right)}{2\omega C_1 L_2}$$

$$\cosh \alpha = 1 + \frac{C_2 \left( L_2 - \frac{1}{\omega^2 C_2} \right)}{2C_1 L_2}$$

**BIBLIOGRAPHY**

- (1) Transmission Circuits for Telephone Communication, by K. S. Johnson.
- (2) Transmission Line Theory, by W. S. Franklin and F. E. Terman.
- (3) Transmission Networks and Wave Filters, by T. E. Shea.
- (4) U. S. Patent No. 1, 227, 113, by G. A. Campbell.

"Transmission Line Theory" contains the most non-technical treatment and is recommended for further reading on this subject. Shea's book is comprehensive but mathematical.

## Finding the Expeditions

Expedition Station	Frequency (kc.)	Call Signal	Remarks
S.S. City of New York, Byrd Antarctic Expedition (Homeward Bound).	8810	WFBT	Leaving Dunedin, N. Z., April 1 for the U. S. A. Operator, H. L. Shrimpton of ZL4AO. Schedules W1XV daily at 1030 GCT.
International Pacific Highway Path-finding Tour (Mexico and Central America). Sponsor, The Automobile Club of Southern California.	7320	IPH	This expedition is exploring and mapping the jungle and expects to return in June. After schedules with Los Angeles at 6 a.m. and 6 p.m. P.S.T., IPH1 will CQ for general amateur contact. Operator, B. E. Sandham of W6EQF.
Yacht "Betty R," in vicinity of Nassau and Bahamas until April 5.	5525 3420	KDTF	Mr. E. C. Crossett, W1CCZ and owner of KDTF schedules W1XV (6155 kc.) Monday and Thursday 9 p.m. E.S.T. and desires general amateur contact.
Pilot Radio South American Good Will Flight and Stinson Plane 4876. Flight begins March 25.	7500	W2XBQ	Trip from New York through Colombia, Ecuador, Peru, Chile, Argentina and Brazil to map a safe land-plane airway and to demonstrate utility of airplane radio over distances in excess of 4000 miles. Operator, Zeli Bouck.

# SAY, SON—



—in which our oldtime friend "The Old Man" lets loose some vital statistics about Radio Mavericks.

**S**AY, son, now listen — and Kitty, come alongside.

I've been gumming over this outside-the-bands business some more. It seems that busting the transocean phone is becoming more and more fashionable. It's actually got to the point where the phone companies have logged so many amateurs on their phone channels that they have plotted curves and can predict to within a small percent the number of amateurs there will be splashing around in the 14,440 and the 6,990 channels, at any time of day or night you want. Don't ask me how I know this, but I do just the same. Hundreds of amateurs have been logged outside the amateur bands, and written down in the black list, and when the lawyers say a rotten enough case has been built up, the word will go out and some people will have their tickets pulled.

You don't have to put your glasses on to see that when some hundred or more amateurs get their tickets pulled for causing interference with other regular services, it is not going to do amateur radio any good. I can imagine several things that would be more beneficial to its health.

How is it going to look when K.B. or our President goes up against the authorities, fighting our battles, and puts up a yarn about how the amateur is so doggoned smart he can build himself a radio set out of a few hairpins, tomato cans and some worn-out dry cells, and in a helpsplitting hurricane send out radio messages and get in help, and some wise-cracking Congressman asks how come, if he is so doggoned smart why doesn't he know how to stay in his own bands? It's going to sound real musical, isn't it, when the Chief and K.B. have to acknowledge that the amateurs have busted the transocean phone service so many times that a hundred or more amateur tickets had to be pulled!

Now let me ask a few questions. Why is it there are so many of us over the fence? What kind of ham is it that is found off the reservation? What answer do they usually give to the A.W.O.L. charge? What's the general attitude of these mavericks? No one can tell me it's just plain cussedness. It isn't in the blood of most of us

hams to be cussed. The Wouff-Hong and the Uggerumph and the Rettysnitch attended to this years ago. Well, then, what is it?

It's because there are a lot of us suffering from extreme youth and the lack of the wherewithal to go and buy, or the opportunity to otherwise acquire, a precision heterodyne wave-meter. These mavericks who stray off the reservation simply don't know where the reservation lines are. All right, then it's up to us older heads to mark the channels somehow, so that it's easier to stay in them. How are we going to mark them? We amateurs don't expect painted buoys and flashing lights and the depths in fathoms. Any old kind of a stake or a bush indicating the limits of the channel is good enough for us. Now why not get up some kind of a marking for the limits of the various bands that we use? Let A.R.R.L. maintain these radio "lighthouses." Then the young squirts, who have to get from Dad the underwriting funds for everything they buy, and who are too busy to bother with calibrating their receivers, can tell at once if they are over the fence or not.

And then, by Gorm, every maverick that is caught off the range will get branded by the Radio Supervisor, and this brand will begin with a big R, and this big R will mean *Rotten*. For instance, W9ROT or WSRAT or W2RMV. We might put up a job with the Supervisors to let us work this. Wouldn't it be elevating to be using a call beginning with an R!

Make a maverick use his R-call for three months, or else stay out of the game, and then give him something respectable. Sort of a radio dunce-cap which he would have to wear for three months.

How about it, Handy?

*The Old Man.*

**Strays**

"Zinc will probably be satisfactory as a shield although aluminum would be copper" — from a letter that almost left Hq.

# Crystallizing Crystal Grinding

By James J. Lamb, Technical Editor

UNTIL quite recently the proper grinding of quartz crystal plates intended for use as frequency control elements in vacuum tube oscillators has been surrounded by an atmosphere of mystery and overlaid with a number of misconceptions. These have seriously handicapped the experimenter in obtaining success as a reward for long hours of meticulous care in grinding his quartz plate to the desired frequency. Many have had the sad experience of finding that the plate stopped oscillating as the proper thickness was approached. Resumption of oscillation in such cases is usually attained after more surface grinding. The oscillation picks up again but often occurs at a frequency too high for legal operation — and the experimenter has to start all over again with another blank or quit in disgust.

Approaching the desired frequency of oscillation is often accompanied by a marked falling off in power output on the part of the oscillator. This appears to be just as much of a mysterious and inexplicable phenomenon as the complete cessation of oscillation, and continued grinding on the same surface to bring the power output up generally leaves the hard-working experimenter with a plate far too high in frequency for his use.

Happily, there is a simple and straight-forward explanation for such apparent peculiarities of quartz plates and with the understanding of the principles of quartz crystal construction and modes of vibration now available, better and simpler grinding practice becomes easy.

## CRYSTAL CUTS AND MODES OF VIBRATION

It seems impossible to talk about crystal grinding without sooner or later bringing in a typical crystal structure sketch such as that shown in Fig. 1. This represents a slab cut from a crystal so that its major surfaces (top and bottom) are perpendicular to the electric (X) axis and parallel to the optic (Z) and mechanical (Y) axes. The electrical or "X" axis is the one generally used as a reference, and such a cut is therefore referred to as the "X" cut. It is also known as the "perpendicular" and "Curie" cut.<sup>1</sup> Herb. Hollister calls it the "thick cut," because the thickness is greater for a given frequency than that of a crystal cut on the "parallel" or "30-degree" cut.<sup>2</sup> The "X" cut has a number of advantages over the

"30-degree" cut, particularly at amateur frequencies, and will be the only one considered in this little squib. However, since we may rest assured that the above statement will not go unchallenged, these advantages of the "X" cut had best be summarized briefly.

The "X"-cut plate has but one major response frequency which is a function of the thickness of the plate, whereas the 30-degree cut plate may have two such frequencies, a kilocycle or so apart.<sup>1</sup> A plate having the latter characteristic is obviously not so useful, as many of us have

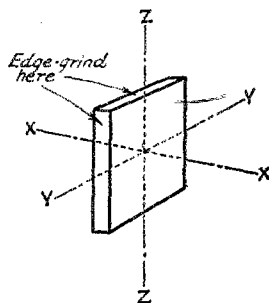

FIG. 1.—RELATION OF THE AXES IN THE "X"-CUT PLATE

learned by experience, because in addition to likelihood of breaking into oscillation at either one of its two higher frequencies as the oscillator circuit is tuned, it may attempt to oscillate at both frequencies simultaneously and wreck itself. Moreover, the 30-degree cut plate is some 30% thinner for a given frequency than the "X"-cut plate and becomes a quite fragile bit of material at amateur frequencies.

The temperature coefficient of "X"-cut crystals is negative while that of the 30-degree cut variety is positive. Sometimes slabs are cut between the "X" and "Y" cuts to obtain plates with a zero temperature coefficient but better practice dictates that it is preferable to operate the crystal at constant temperature in an oven rather than to employ tricky cutting as a means of realizing constant frequency. The 30-degree cut crystal is generally more erratic in its characteristics than the "X-cut" plate although it must be admitted that the 30-degree cut plate will oscillate more readily in the usual crystal oscillator circuit.<sup>1</sup> When weighed against the numerous disadvantages, however, this latter advantage is negligible for our purposes — and we persist in advocating "X-cut" plates.

<sup>1</sup> Observations on Modes of Vibration and Temperature Coefficients of Quartz Crystal Plates, *Proc. of I.R.E. and Bell System Tech. Journ.*, July, 1929.

<sup>2</sup> Quartz Crystal Facts, *QST*, Jan., 1930.

If blanks or finished crystals of unknown cut are purchased, the cut can be determined quite certainly provided it is either the "X"- or the 30-degree cut. For either of these cuts, the product of thickness and frequency of oscillation is a known constant. Knowing the thickness and frequency of oscillation, for the "X"-cut,

$$f \times t = 112.6$$

For the 30-degree cut,

$$f \times t = 77.0$$

Where:  $f$  = frequency in kilocycles  
 $t$  = thickness in inches.

This constant for the 30-degree cut holds only when the plates are thin and of comparatively

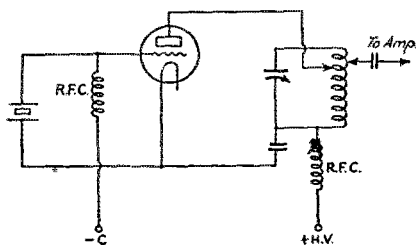

FIG. 2.—CRYSTAL OSCILLATOR CIRCUIT WITH PROVISION FOR VARYING THE TANK INDUCTANCE TURNS IN THE PLATE CIRCUIT

large area. However, amateur frequency plates usually have dimensions to meet this requirement.

If the product of frequency and thickness lies between the two values given above, it is likely that the cut is somewhere between the "X"- and 30-degree cuts.

If it is necessary to grind the plate to a higher frequency the proper thickness can be predetermined to a close approximation from the above relations. For the "X"-cut,

$$t = \frac{112.6}{f}$$

For the 30-degree cut,

$$t = \frac{77.0}{f}$$

Where  $t$  = thickness in inches  
 $f$  = frequency in kilocycles.

As pointed out by Dr. A. H. Taylor at the recent Southeastern Division Convention in Atlanta, the "X"-cut crystal has a second major response frequency in addition to that which is a function of its thickness and it is this second frequency which causes most of the trouble in keeping the plates consistently oscillating throughout the grinding process. This second major frequency is a function of the dimension parallel to the "Y" axis (Fig. 1) and is much lower than the useful higher frequency which is a function of the plate's thickness ("X" axis). Nevertheless, the plate can and does oscillate at this lower frequency and a ratio of thickness to

width of the plate may be reached in the grinding process such that the frequency of oscillation along the "Y" axis may buck the oscillation along the "X" axis and seriously reduce the amplitude of the high-frequency oscillation or stop it altogether. The usual process for correcting this condition is to continue grinding on the face until oscillation again picks up—but then the frequency may not be that intended. One other method suggested, and practiced to some extent, is to grind the faces slightly concave. This has the effect of slightly increasing the face dimensions of the crystal, because a curved line between two points is longer than a straight line, and the bucking effect of the two modes of oscillation thus may be corrected. In the process of concave grinding, however, the frequency of oscillation generally is affected seriously. This method of grinding to increase power output or make a crystal which has gone dead resume oscillation is decidedly make-shift. There is a better way of accomplishing the purpose. It is referred to as "edge-grinding" and was also described by Dr. Taylor.

#### EDGE-GRINDING

Since the cause for reduction in amplitude of oscillation or complete stoppage of oscillation is interference between the two modes of vibration, the obvious method of correcting the condition is to change one of the active dimensions of the plate. Obviously, the dimensions cannot be increased. Further reduction of the thickness will cause a jump in frequency of oscillation which may land us out of the band. There remains edge-grinding or reduction in the face dimensions of the crystal, and it is this method which Dr. Taylor suggests.

Edge-grinding should not be left until the crystal has entirely stopped oscillating—as the faces are ground down—but should be started before the final surface-grinding is done. Edge-grinding should be preferably on the "Y" edge and it can vary the frequency of oscillation as much as 1 kc. Therefore, it may be used to change slightly the frequency of oscillation of a finished crystal or to bring the frequency exactly to a desired precise frequency.

Proper edge-grinding can be used effectively also to increase the amplitude of oscillation of a poor crystal and may as much as triple the output of the crystal oscillator.

For optimum amplitude of oscillation and oscillator output at frequencies in the vicinity of 3500 kc., plates substantially 1 inch square are considered best. Crystals intended for use in the oscillators of crystal-controlled transmitters should be of this size. Crystals cut and ground for transmitting purposes are known generally as "power crystals," and plates specified as such are usually of the above dimensions. The major sur-

(Continued on page 84)

# The Superiority of Screen-Grid Detectors

By A. E. Rydberg and J. W. Doty\*

**B**EING intensely interested in the development of the amateur high-frequency receiver, it was with a great deal of enthusiasm that we welcomed the data given by Louis C. Brown and John A. Baker in the Experimenters' Section of *QST* for October, 1929, concerning the functioning of the screen-grid tube as a detector. We proceeded at once to construct for ourselves an experimental model of such a receiver using a circuit practically identical with that of Mr. Brown's receiver, with the exception that an r.f. choke between the tickler and plate resistor was found to be advantageous. It is not the purpose of this paper to dwell at length on the results obtained with this receiver other than to say that it very admirably bore up the claims made by Mr. Brown and Mr. Baker concerning their respective receivers. However, we experienced one quite serious drawback. We found that the UX-222 as a detector tube is quite capable of offering stiff competition to any company of Swiss bell-ringers that might come along: microphonics of a sort that would make a 199 tube seem as quiet as the grave are a by-product of its operation. Often the scratch of the operator's pencil while copying signals would cause ringing noises of such intensity as to almost completely obliterate the signals themselves. Of course we tried a cushion socket, but it seemed to help matters little or none.

Naturally we had not overlooked the mention made in the Experimenters' Section to the effect that the UY-224 offered intriguing possibilities as a detector and we lost no time in changing our experimental receiver to use a UY-224 detector followed by a resistance-coupled stage of audio amplification using a UY-227. The circuit and its constants are shown in Fig. 1.

From the very first we noticed a marked absence of microphonic noises. It was even possible to drive nails in the operating table without causing the slightest ringing noise in the phones. It was also apparent that signals were substantially stronger than those obtained with the UX-222 detector, the increase resulting, we believe, from the higher amplification factor of the UY-224 as well as to its lower plate resistance, which facilitated the attainment of a reasonably good match between detector output and audio input impedances. We played around with this receiver for several days, and have become convinced that it represents the most satisfactory

amateur receiver which it has ever been our privilege to operate.

We were fortunate enough to have at our disposal a very excellent volume indicator unit formerly used to monitor the output of the transmitter here at KOIL. For the benefit of readers who are unfamiliar with this piece of equipment, a word might be said regarding the operation of a volume indicator.

Referring to Fig. 3 it may be seen that we have nothing more than a vacuum-tube voltmeter so connected as to indicate by deflections of the galvanometer, *G*, alternating voltages across the input-transformer secondary. The tube, which is a Western Electric 102-D,<sup>1</sup> has a high amplification factor which means that it requires a comparatively low negative grid bias to com-

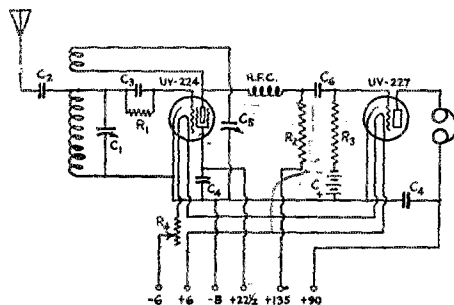

FIG. 1. — THE RECEIVER CIRCUIT

- C*<sub>1</sub> — Three-plate, double-spaced tuning condenser.
- C*<sub>2</sub> — Antenna-coupling condenser.
- C*<sub>3</sub> — 100- $\mu$ fd. grid condenser.
- C*<sub>4</sub> — 0.5- $\mu$ fd. by-pass condenser.
- C*<sub>5</sub> — 250- $\mu$ fd. variable condenser.
- C*<sub>6</sub> — .006- $\mu$ fd. coupling condenser.
- R*<sub>1</sub> — 5-megohm grid-leak.
- R*<sub>2</sub> — 250,000-ohm resistor.
- R*<sub>3</sub> — 2-megohm resistor.
- R*<sub>4</sub> — 6-ohm rheostat.
- C* — 4.5-volt "C" battery.

pletely cut off all plate current flow. The voltage divider *R*<sub>3</sub> is adjusted until cut-off bias is obtained and *R*<sub>1</sub> is set so that the a.e. voltages to be measured will not cause the galvanometer reading to exceed full scale. When the alternating voltages to be measured are applied across the input terminals, the grid of the tube will swing alternately negative and positive. As the tube is already biased to the cut-off point, any increase in

<sup>1</sup> The UX-240 tube has similar characteristics and may be used in place of the 102-D with change in filament resistor value as indicated in Fig. 3. — EDITOR.

\* W9AED and W9GDG, Mona Motor Oil Co., Council Bluffs, Ia.

the negative voltage will have no effect on the plate current, but when the grid swings positive plate current will flow in proportion to the amplitude of the positive cycle.<sup>2</sup> As the needle of the galvanometer is incapable of following the rapidly occurring positive impulses, it will be

TABULATION OF THE RESULTS OF THE SIGNAL-STRENGTH EXPERIMENT

Stations heard	Galvanometer Deflection	
	Receiver using 201-A detector and two transformer coupled audio stages	Receiver using UY-224 detector and one stage of resistance coupled audio
W9EFE	2	40
W9BGB	Too slight to read	20
W9DFY	1	30
W9GJC	2.5	45
W9DXP	3	60

FIG. 2. — THE ABOVE FIGURES REPRESENT DEGREES OF GALVANOMETER DEFLECTION ON THE VOLUME INDICATOR

The purpose of this table is to indicate the comparison between the signal strengths delivered by the two receivers — not a comparison between the stations with regard to the effectiveness of their respective signals. Signal quality ranged from fair r.a.c. to pure crystal-controlled d.c. See text for further information regarding this test.

held at a constant indication so long as the alternations of unvarying amplitude continue. The source of a.c. voltage may be the output of a receiver and in this case we have a means of obtaining a visible indication of signal strength. It is to be understood that the galvanometer scale reads from 0 to 100 arbitrary units and is not calibrated in volts, amperes, decibels, or any other quantitative units. Readings are simply in degrees of galvanometer deflection and are useful for comparison purposes only. The relation between the galvanometer reading and the input voltage to the volume indicator depends on the  $E_g-I_p$  characteristic curve of the tube. However, we did not consider that calibration would be necessary in order to demonstrate the superiority of the UY-224 as a detector.

We next confiscated the receiver from the shack of W9GDG. This receiver is a three-tube affair employing a 201-A detector followed by two stages of transformer-coupled audio amplification. The coils of this receiver, like those of the UY-224 set, were wound on Silver-Marshall forms. A switching arrangement was arranged to permit us to quickly couple the volume indicator to the output of either this receiver or the UY-224 set at will. We stationed ourselves at the two

receivers and each of us swapped one headphone so that we could each listen to the output of both receivers, thus facilitating the identification of various signals. When a given signal had been tuned to maximum volume on the 201-A set, the number of degrees of galvanometer deflection on the volume indicator was at once noted and then the other operator proceeded to tune in the same signal to maximum volume on the UY-224 set and another reading was taken. Readings were taken on five different signals and are tabulated in Fig. 2. The entire test was conducted at noon, C.S.T., on the 7000-ke. band, the apparatus being located in the operating room of KOIL in Council Bluffs, Iowa. Incidentally, the same antenna was used for both receivers.

As can be seen from inspection of the tabulation, the deflections caused by the 201-A receiver were so minute that it was impossible to read them with any degree of accuracy in spite of the fact that the same signals gave average deflections of from 20 to 60 in the case of the UY-224 set, which employed a lone stage of resistance coupled (low-gain) amplification, in competition with the high gain of the two transformer-coupled stages which followed the 201-A detector.

Right here let it be said that no pretense is made of offering the results of this comparison of signal strength as concrete proof that the UY-224 is a more sensitive detector than tubes of the 201-A type. Thus far we have proved but one thing: that the UY-224 detector is capable of providing much louder signals than a detector of the 201-A type. However, a crystal detector with two stages of audio is capable of providing louder signals from a local station than a one-tube regenerative receiver in spite of the fact that the consistent range of the one-tube "blooper" is many times that of the crystal set. This, we believe, aptly illustrates the assumption that loud signals are necessarily the result of one or both of two things; a high overall gain and high sensitivity. It is also at once apparent that if the loud signals afforded by the UY-224 set are due to a high overall gain, the signals or other disturbances originating less than one wavelength away should be received by the UY-224 set with the same increase in volume as in the case of the more distant signals listed in the tabulation. To satisfy our minds on this point, we measured the comparative strength with which a signal emitted by a monitor box located less than one wavelength distant from the two receivers was received. We found that there was not enough difference in the volume indicator readings for the two receivers to allow us to say that either one was the louder. Therefore, although we had no means of measuring the sensitivity in microvolts per meter, we believe that we are justified in assuming that the loud signals of the UY-224 are due almost entirely to its greater sensitivity. At least we do know that signals are louder with

<sup>2</sup> The galvanometer readings are directly proportional to the a.c. input voltage only so long as the tube operates on the straight portion of its grid voltage — plate current characteristic. — Editor.

absolutely no increase in the volume of locally generated disturbances such as static, power leaks, and the other thousand and one sources of background noises and QRM. Furthermore, we found it entirely possible to tune in on the UY-224 set good readable signals which could not be heard at all with the 201-A receiver.

With the UY-224 and the UY-227 tubes connected as shown in the circuit of the experimental receiver (Fig. 1) we found that very excellent operation could be had when the storage battery source of heater supply current was replaced with a filament transformer supplying 60 cycle a.c. at

needs as it is to the needs of the c.w. operators. As to the quality of the output on 'phone — well, it's just nobody's business what that resistance-coupled amplifier puts out.

The thought occurred that there might be some improvement in the receiver if another UY-224 were used ahead of the detector (1929 fashion) as an untuned r.f. stage, thus providing better coupling to the antenna and, at the same time, increasing somewhat the r.f. gain and resulting sensitivity. We have at hand little or no data regarding the results which we obtained in our brief experiment with this combination. No startling increase in signal strength was noticed when listening to the set and we made no effort to determine by measurement whether or not the output was increased by the addition of the r.f. tube. Of course, such an arrangement minimizes radiation and provides a very excellent coupling to the antenna. However, we found that it made the receiver much more sensitive to local interference. The receiver with the r.f. stage was set up at the shack of W9AED about three blocks from KOIL, which broadcasts on 238 meters and KOIL came in loudly all over the dial. When the r.f. stage was removed no interference from KOIL was experienced.<sup>5</sup>

It may be that a peaked a.f. choke could be substituted for the resistance in the detector plate circuit, thus adding another 1929 feature much valued by many amateurs.

<sup>5</sup> This interference can be eliminated by substituting an inductance (plug-in choke) approximately resonant at the receiving frequency in place of the grid resistor of the coupling tube. Further details will be found on page 13, QST, January, 1930. — Editor.

## New England Division Convention

April 25th and 26th at Worcester, Mass.

“HAMS,” the Worcester Radio Association is extending to you all a cordial invitation to this year's convention which it is sponsoring. The Hotel Bancroft is the place chosen for all activities and reservations for rooms can be made in advance at reasonable rates. Remember the dates, Friday and Saturday, April 25th and 26th, Hotel Bancroft, Worcester, Mass. A big hamfest Friday evening which will include an elaborate program of entertainment, such as good music, movies, stunts and a playette by the Worcester Radio Association. Saturday will be another big day with good speakers. K. B. Warner, Secretary-Editor, and Everett L. Batty, Assistant Communications Manager, will be official delegates from the A.R.R.L., but other members of the staff will also be present.

Further information may be obtained by writing to the Chairman, Mr. Clarence J. Green, Worcester Radio Association, 274 Main St., Worcester, Mass.

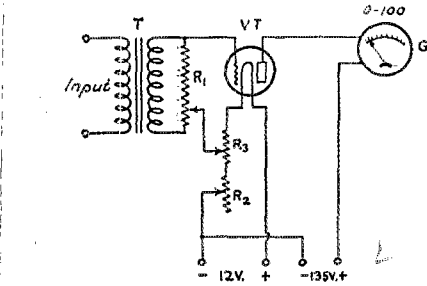

FIG. 3. — VOLUME INDICATOR CIRCUIT

- T — Audio-frequency transformer.
- VT — W. E. 102-D tube. (A UX-240 may be used.)
- R<sub>1</sub> — 500,000-ohm potentiometer.
- R<sub>2</sub> — 6-ohm rheostat.
- R<sub>3</sub> — 6-ohm potentiometer for W. E. 102-D, 30-ohm for UX-240.
- G — Galvanometer.

a suitable voltage. In our case a five-volt transformer with a center-tap was used, and when the center-tap was grounded to earth not the slightest a.c. hum was noticed. The cathodes were not connected to either ground or heaters. This was found essential to avoid a.c. hum. It is entirely possible that different constructors of such receivers will encounter difficulties peculiar to their own equipment. Nevertheless, we are confident that in nearly all individual cases a proper connection of heaters, cathodes, grounds, and transformer-windings can be found experimentally so that hum-free a.c. heater-operation may be enjoyed. When one considers the rather heavy current consumption of heater type tubes, it will be realized that successful a.c. operation is an attainment well worthwhile from standpoints of both economy and convenience.

We are firmly of the opinion that a receiver built along the lines suggested by this paper will answer a long felt need for a better amateur receiver without sacrificing the simplicity and compactness of the faithful old two-tube autodynes which have been serving amateur needs for years. With the detector in a non-oscillating condition, signals with even slight modulation are copied consistently. Of course this includes 'phone signals. 'Phone men will find the UY-224 detector to be just as much an improvement for their

## Experimenters' Section

### INDUCTIVELY COUPLING TO "ETHEREAL ADORNMENTS"

By Harry F. Washburn\*

THE writer lives in an apartment house where it would be impractical to put up a two-wire feed Hertz, and after using a grounded Marconi antenna for awhile, it became apparent that a Hertz would be better even if it did not work at maximum efficiency. Accordingly, a single-wire feed Hertz was put up conforming to Windom's specifications in September QST. The flat-top is 64 feet long and the feeder tapped on at a point 9 feet 1 inch from the center. The system peaks near the upper end of the 7000-kc. band. Upon operating very encouraging results were obtained with a low-power arrangement consisting of a 210 in a Hi-C Hartley circuit with 600 volts r.a.c. on the plate. However, neighboring BCL's complained of a wicked hum and click every time the key was pressed. When the antenna was disconnected everything was all right.

A tuned tank was constructed from junk-box parts and coupled up to the main tank. The thing was tuned until proper input was indicated,

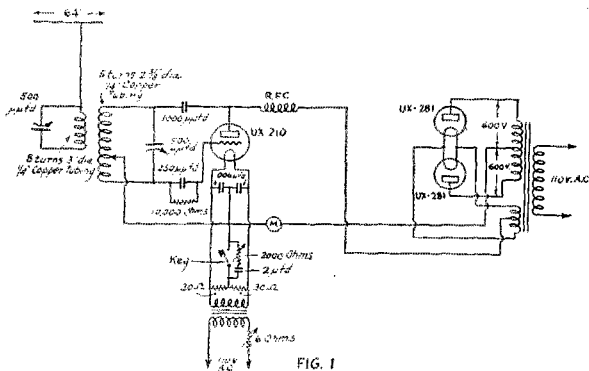

and then the feeder clipped on one side of this make-shift tank. The plate milliammeter went off scale and the antenna tank was detuned until the input was normal again. A BCL receiver in the next room gave forth only a faint click with absolutely no hum. The remaining click can be very effectively eliminated by any of the numerous thump-filters described in QST.

The results are as good as with the direct coupling. One station tested with gave me R5 with inductive coupling and R3 with direct coupling. All stations worked gave better reports

\*W2CL, 354 E. Mosholu Parkway, New York City.

on the note and steadiness, frequently report "crystal rac."

There is one thing to be observed in tuning up the system, however. When the antenna tank is tuned to the proper point so that the input is normal the feeder clip should be removed from the tank. The input should drop back to the usual low figure obtained when no antenna is connected. If, when removing the clip, the tube should go out of oscillation, tune the antenna tank to the other side of resonance. This will make the whole thing steadier and often improve the note. The two tank coils are in my case about six inches apart, and the antenna detuned quite a bit.

### A SIMPLE RESISTANCE BRIDGE

The real radio experimenter is, to a certain extent, a laboratorian, for he must know the constants of the electrical equipment used in his experiments. But laboratory apparatus is out of the reach of most radio amateurs because of the high initial cost and the relatively infrequent use of such equipment. Nevertheless, Don P. Whitacre, of the A. T. and T. Co. at North Platte, Nebr., has solved the problem of measuring resistance with a simple and inexpensive slidewire Wheatstone bridge that any amateur can build for a nominal sum.

The wiring diagram of the bridge is given in Fig. 2. The parts required are: a buzzer (preferably one having a high pitch), dry cells, a headset, standard resistors, and a potentiometer. The potentiometer had best be a high resistance unit wound with fine wire; a 200- or 400-ohm unit will be quite satisfactory. Ordinarily these potentiometers are so constructed that the center arm rotates through an arc of 270° or 300°. If this is the case, the wire should be removed from part of the unit until the arm acts through an arc of exactly 180°. This is done simply as a matter of convenience and simplicity in making measurements.

The unknown resistor to be measured is connected in the circuit at the points marked  $R_x$ , and with the known resistor in the circuit at  $R_s$ . The slide-wire potentiometer is adjusted until the sound produced by the buzzer in the headset is at minimum. This is the condition for balance, and for minimum current in the headset, or zero current in the headset if the bridge is perfectly balanced and the buzzer output has no harmonic content. In order that there be no current through the headset, the points  $N$  and  $M$



must be at the same potential. This requires that the voltage drop,  $E_a$ , across  $R_z$  is equal to the voltage drop across  $R_a$  and that the drop  $E_b$  across  $R_z$  is equal to the drop across  $R_b$ . If  $I_a$  is

quite accurate, for upon its accuracy depends the success of the bridge. Suitable resistance standards may be obtained from such laboratory supply houses as General Radio Co. of Cambridge, Mass., Leeds and Northrup of Philadelphia or Central Scientific Co. of Chicago. A less expensive but very satisfactory standard resistor may be obtained from the Shalleross Mfg. Co. of Collingdale, Penn. Several of their type 6M resistors have been measured and found to be well within the 1% tolerances claimed for these units by the manufacturer.

The entire bridge may be assembled in a small wooden box, and may be constructed for as little as \$5.00. The accuracy of the bridge will depend upon the accuracy of the standard resistor and the care with which the bridge is constructed. Using the type of equipment suggested, the average amateur can expect to make resistance measurements which are accurate to approximately 2% or 3%.

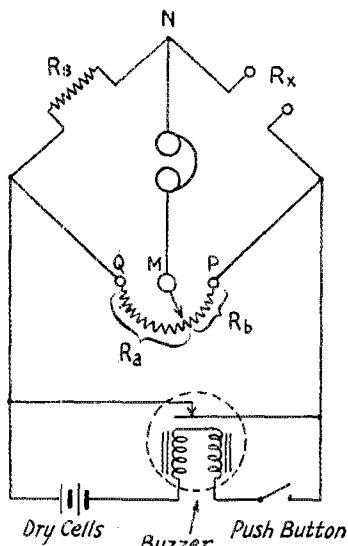

FIG. 2

the current flowing through  $R_z$  and  $R_x$ , and  $I_b$  is the current flowing through  $R_a$  and  $R_b$ , then

$$E_a = I_a R_z = I_b R_x$$

$$E_b = I_a R_a = I_b R_b$$

Dividing the first equation by the second, and cancelling,

$$R_z/R_a = R_x/R_b$$

from which we have,

$$R_z = R_a(R_b/R_x)$$

The advantage of providing the potentiometer with a 0-100 scale will be apparent, for it is possible to obtain the ratio  $R_b/R_a$  directly from the dial. If the dial is adjusted so that a reading of zero is obtained when the potentiometer arm is at the point  $P$ , and 100 when at the point  $Q$ , the ratio

$$R_b/R_a = PM/(100 - PM)$$

where  $PM$  is the actual dial reading obtained at the bridge balance.

A standard resistor,  $R_s$ , is required, and for most accurate results, the value of this resistor should be such that a balance may be obtained when the arm of the potentiometer is near the center of the dial scale. The standard should be

CALCULATING CAPACITY OF THE MICRO-CONDENSER

On page 24 of the January QST, Mr. Dingee described a very useful type of vernier condenser. Perhaps the following notes will be useful to those who wish to make one of these condensers.

The capacity in micro-microfarads of such a condenser is given by,

$$C = \frac{0.2416 L}{\log_{10} \frac{r_2}{r_1}}$$

where:  $r_1$  is the radius of the outer cylinder,  $r_2$  is the radius of the inner cylinder,  $L$  is the distance the small cylinder is inserted into the larger cylinder.

All dimensions in Fig. 3 are in centimeters.

This equation neglects the effects of fringing of the field at the end of the electrodes, but will be approximately correct when  $r_2 - r_1$  is small. It gives accurately the change in capacity if for

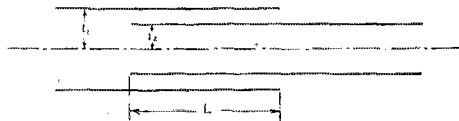

FIG. 3

$L$  we put the distance the cylinder is moved in or out, provided  $a$  and  $b$  are large compared with  $r_2 - r_1$ .

— C. K. Stedman, 4480 9th Ave., West, Vancouver, B. C., Canada.

IMPROVING THE TRANSMITTER

Notwithstanding the vast amount of material which has been published concerning the proper operation of transmitters, there are an unusually

large number of perfectly rotten signals cluttering up the amateur bands. In many cases a few simple alterations in the transmitter would assist admirably in changing the transmitter from one emitting a broad, creeping, a.c. note to one emitting a sharp, clean-cut signal.

Mr. Arthur C. Egan, W1WL, suggests as one very effective method of improving the transmitter, the use of variable grid and plate blocking condensers instead of the rather large fixed condensers usually employed. If these variable condensers are adjusted while listening to the note of the transmitter on a monitor, the transmitter may be adjusted to emit a clean-cut d.c.

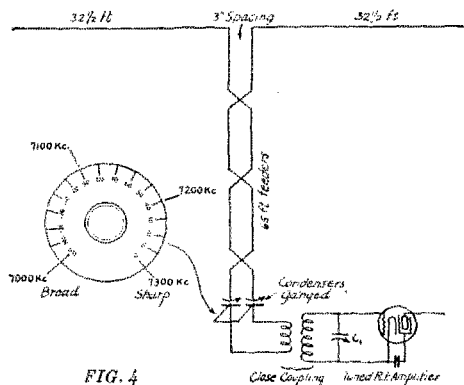

FIG. 4

signal providing some sort of plate-supply filter system is used.

#### HAM BAND ANTENNA

With regard to the problem on radio frequency amplifiers in the amateur band, I have been doing some more experimenting along that line.

This is based as an extension of Colonel Foster's article several months ago. The type of antenna as explained by Colonel Foster, and now used by many of us on the coast, is such that the noise level goes down because the feeders from the antenna are transposed as shown in Fig. 4 and neutralize each other.

I have been experimenting on coupling arrangements with an idea to making the coupling close for maximum volume and tuning the feeders in much the way as a transmitter. By ganging through National equicycle condensers a three-quarter revolution spread may be had. Two condensers having a capacity of 350 $\mu$ fd. ganged with a dial as shown in the attached diagram make an ideal arrangement. With the condenser set at zero the coupling is slight and the selectivity of the antenna coupling device is considerable. The first stage condenser,  $C_1$ , has very little effect even if turned 10 or 15 degrees so that the action is very broad and is extra good for looking up foreign stations.

I think that this serves as an ideal arrange-

ment for coupling to radio frequency sets of the tuned variety. It would hardly be satisfactory for coupling on sets not using radio frequency amplification because the close coupling which is required would stop the detector tube from oscillating.

— D. C. Wallace, 209 Pine Ave.,  
Long Beach, Calif.

#### FREQUENCY STANDARDIZATION

The precise determination of frequency is a most important radio engineering problem. It is not only highly desirable that the frequencies within the range of audibility be known quite accurately as a matter of practical interest, but the increasing political, economic, and social importance of radio channels makes the precise determination of radio frequencies an absolute necessity. The matter is not a simple one, for because of the international scope of radio communication, the problem is international in scope.

The precise determination of frequency has advanced to such a point that frequencies as high as those encountered in our 28-megacycle band are known quite accurately to the sixth decimal integer, and it appears that before any further advancements of importance can be made in frequency determination, the precision with which we measure time must be increased. For the time being as far as the scientific and engineering aspect of radio communication is concerned, the limit has been reached in precise frequency determination. There is certainly a feeling of satisfaction in knowing that such precision in frequency determination has been attained.

But what about the amateur?

"The days of frequency indication in terms of 'two notches below WIZ' and 'about a half-meter below 1MK' are long since past — although many seem unaware of it." An accuracy of 1% in frequency measurements is meaningless, for such accuracy — or lack of it — may be hardly sufficient to assure the amateur that his transmitter is actually operating in the frequency bands assigned to amateur operation. Accuracies of 0.1% are more reasonable, but are certainly nothing to brag about, and the sooner the amateur learns to think of frequency determination in terms of 0.01% the better.

Frequency determination in amateur stations is important — mighty important — and a good frequency meter is just as essential to the operation of an amateur station as a transmitter. There are no tolerances at the edges of the various amateur bands. If an amateur transmitter operates at 7000 kc. as determined by a frequency meter accurate to 0.1 of 1%, the actual frequency of the emitted signals (assuming them to remain at a fixed frequency) can be anywhere from 6993 kc. to 7007 kc., and the probability is that the amateur will be operating "out of band."

Because of the importance of frequency determination, especially as applied to amateur radio, we list the following references on frequency standardization and methods of measurement:

BIBLIOGRAPHY ON FREQUENCY MEASUREMENTS

QST REFERENCES:

- Checking up Wavemeter Methods, Lidbury, page 50, June, 1925.
- Extending Wavemeter Ranges, Lampkin, page 59, October, 1925.
- Receiver and Wavemeter Calibration, Baker, page 18, December, 1925.
- Calibrating Your Wavemeter from a Quartz Crystal, Clayton, page 39, February, 1926.
- Using Wavemeters Without Indicating Devices, Clayton, page 19, September, 1926.
- Quartz Crystal Calibrators, Crossley, page 23, March, 1927.
- Your Wave From the Broadcast Receiver, Gale, page 46, May, 1927.
- The Identification of Radio Frequency Harmonics, Waters, page 34, August, 1927.
- Calibrating Short-Wave Receivers and Wavemeters from Broadcasting Stations, Huddy, page 41, October, 1927.
- A Combination Fieldmeter-Wavemeter-Voltmeter, Woodruff, page 39, May, 1928.
- A Resonance Testing Method, Teachman, page 41, July, 1928.
- The Frequency Measurement Problem, Hull, page 9, October, 1928.
- A Frequency Meter Combined With the Receiver, Woodruff, page 41, December, 1928.
- Some Suggestions for the Monitor, Grammer, page 43, December, 1928.
- Coupling to the Monitor, Experimenters' Section, page 78, February, 1929.
- Notes on "A Frequency Meter Combined with your Monitor," Experimenters' Section, page 43, March, 1929.
- Calibrating the Heterodyne Frequency Meter or Monitor, Grammer, page 46, April, 1929.
- Utilizing the Standard Frequency Transmissions, Lausingsh, page 36, September, 1929.
- A Worthwhile Combination, Pollack, page 17, October, 1929.
- A High-C Heterodyne Frequency Meter, Dudley, page 9, November, 1929.
- Notes on the Monitor, Grammer, page 51, February, 1930.
- Frequency Standardization, Clapp and Crawford, page 9, March, 1930.

PROCEEDINGS OF THE INSTITUTE OF RADIO ENGINEERS:

- A Method of Measuring Radio Frequency by Means of a Harmonic Generator, Hund, August, 1926.
- Piezo-Electric Crystals at Radio Frequencies, Meissner, April, 1927.
- A Precision Method for the Determination of High Frequencies, Aiken, February, 1928.
- Precision Determination of Frequency, Horton and Morrison, February, 1928.
- Thermostat Design for Frequency Standards, Marrison, July, 1928.
- The Dependence of the Frequency of Quartz Piezo-Electric Oscillators Upon Circuit Constants, Terry, November, 1928.
- Magnetostriction Oscillators, Pierce, January, 1929.
- A System of Frequency Measurements Based on a Single Frequency, Hall, February, 1929.
- A High Precision Standard of Frequency, Marrison, July, 1929.

TEXTBOOKS:

- Radio Instruments and Measurements (Bureau of Standards Circular 74).
- Principles of Radio Communication, by Morecroft.

Electric Oscillations and Electric Waves, by Pierce.  
Thermionic Vacuum Tube, by Van der Bijl.  
Radio Amateur's Handbook.

Financial Statement

BY order of the Board of Directors the following statement of the income and disbursements of the American Radio Relay League for the fourth quarter of 1929 is published for the information of the membership.

K. B. WARNER, *Secretary.*

STATEMENT OF REVENUE AND EXPENSES FOR THE THREE MONTHS ENDED DECEMBER 31, 1929

REVENUE	
Advertising sales, QST.....	\$19,388.46
Newdealer sales.....	11,722.44
Advertising sales, Handbook....	2,215.00
Handbook sales.....	5,564.82
Dues and subscriptions.....	11,046.76
Back numbers, etc.....	495.87
Emblems.....	72.76
Interest earned.....	374.80
Cash discounts earned.....	264.72
Bad debts recovered.....	4.00
	\$51,149.63
Deduct:	
Returns and allowances.....	\$3,824.75
Provision for news stand returns..	450.13
Discount 2% for cash.....	340.62
Exchange and collection charges..	16.33
	4,631.83
Net revenue.....	\$46,517.80
EXPENSES	
Publication expenses, QST.....	\$13,311.52
Publication expenses, Handbook..	2,161.19
Salaries.....	15,305.38
Forwarding expenses.....	664.14
Telephone, telegraph and postage.	1,720.73
Office supplies and general expenses.....	3,075.54
Rent, light and heat.....	917.57
Traveling expenses.....	2,386.70
Depreciation of furniture and equipment.....	497.74
Communications Department field expenses.....	112.54
Headquarters Station expenses...	130.55
Bad debts written off.....	90.30
	40,373.90
Total expenses.....	40,373.90
Net gain from operations...	\$6,143.90

**Silent Keys**

It is with deep regret that we record the passing of these amateurs.

- Emerson T. Showell, W3OQ, Abescon, N. J.
- Arthur R. Boyce, W6DIB, Phoenix, Ariz.
- Arthur B. Strong, W6DOO, Mariposa, Calif.
- Clyde O. Amos, W8BNR, Altoona, Penn.
- George J. Strum, W9FTU, Macomb, Ill.

## W1AOF

**T**HE average radio amateur has difficulty sometimes in constructing his own equipment, for modern apartments and flats are not conducive to bringing out the best constructional abilities of the amateur even if he is fully equipped with the necessary tools. But if the amateur owns his own home in the Berkshires and in addition has a machine shop in which transmitting and receiving equipment can be assembled and constructed, as does H. C. Wing, of 62 Pierce St., Greenfield, Mass., there is little to prevent him from building a neat

two keys are at the right. The Telechron (electric) clock is a mighty useful piece of equipment around the amateur station, for it never has to be wound. The aluminum box in front of the transmitter is a self-contained receiver which may either be used as a portable set during the summer or, as is usually the case, as a monitor for checking the performance of the big panel mounted transmitter at the west end of the two fine operating desks. The transmitter is shown more in detail in another photograph which shows a rear view of the frame.

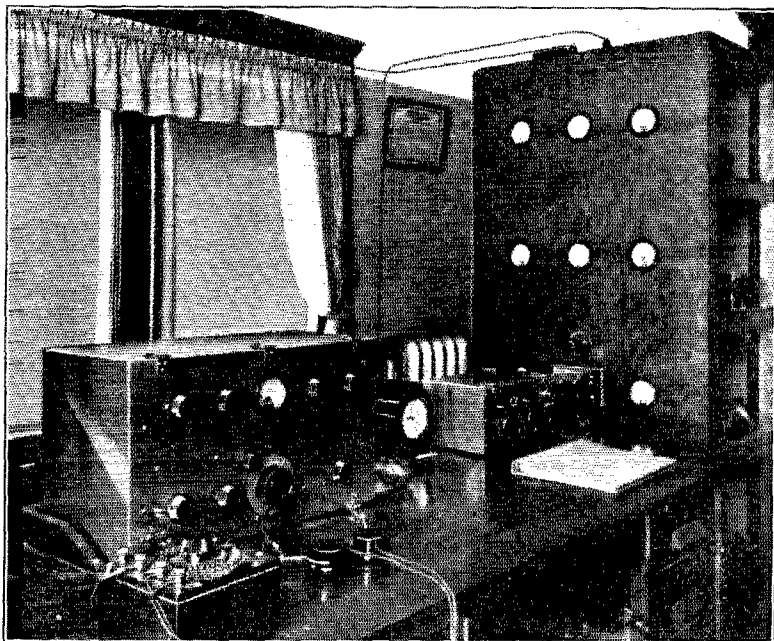

W1AOF HAS CONVENIENCES FOR GOOD OPERATING RIGHT AT HAND

and complete amateur station. The owner of W1AOF is a machinist by trade, as those who saw the story of his receiver in the December, 1929 issue of *QST* may have suspected. He has his station located in a cozy room on the second floor of his home, and this room like *QST* is "devoted entirely to amateur radio."

The general view of the station is shown in one of the photographs. The receiver occupies the center of the photo, and to the left and in front of the receiver is a General Radio audibility meter which is used to give accurate audibility reports on the weaker signals. A pair of Baldwin phones is immediately in front of the receiver, while the

### THE RECEIVER

The receiver at W1AOF covers the frequency spectrum from 2000 kc. to 15,000 kc. without raising the lid to change coils or condensers. It uses one stage of untuned radio frequency amplification with a screen-grid tube, a triode detector, and either two stages of quality audio amplification or a three-stage peaked audio amplifier. The wiring diagram of the set is given in Fig. 1. Further comment on the receiver will be unnecessary, since the set was thoroughly described in the December, 1929 issue of *QST*. Those who are interested in a mighty worth-while receiver are advised to hunt up that issue.

THE TRANSMITTER

Like the receiver, the transmitter is of good design and excellent construction. The transmitter is built on a wooden frame 6 feet high, 30

The general view of the station does not show very much of the transmitter except the meters. On the top row, from left to right, the meters are: 0-3 thermo-ammeter antenna meter, 0-1000 d.c.

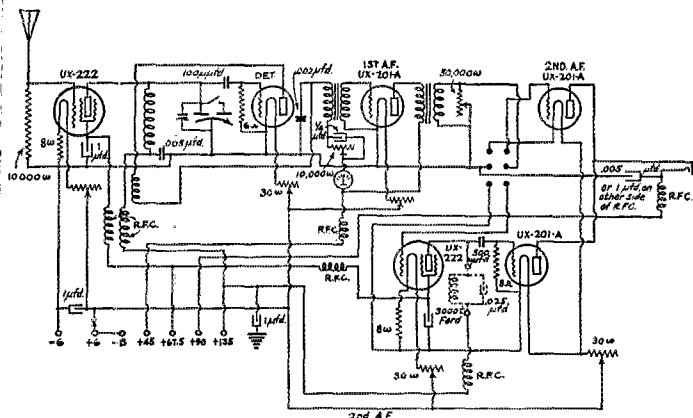

FIG. 1.— WIRING DIAGRAM OF THE RECEIVER AT W1AOF  
 Details of this receiver were published in the December, 1929, QST.

inches wide, and 21 inches deep. The panels are made of 3/8-inch five ply veneer wood which is inexpensive, has a very pleasing appearance, and is a thoroughly satisfactory radio frequency insulator when given a coat or two of varnish. The transmitter is a crystal-controlled oscillator-amplifier set operating principally in the 7000-kc. band. The oscillator is a UX-210 tube with 40 milliamperes at 300 volts applied to its plate. The frequency of the oscillator is controlled by a quartz plate whose frequency is 3589 kc. The current in the tank circuit, as read by a thermo-ammeter, is 1.75 amperes.

From Fig. 2 it will be seen that the output of the oscillator tube is fed to a UX-203-A tube, which is a frequency doubler operating on 7178 kc. The output of the crystal circuit is capacitively coupled to an intermediate amplifier which draws 125 milliamperes at 900 volts.

The output of this amplifier feeds the 1/4-kw. intermediate amplifier which also operates on 7178 kc. The UV-204-A tube draws 130 milliamperes at 2000 volts. Keying is accomplished in this stage by opening the filament center tap with a relay operated from a six-volt storage battery.

The final amplifier is a UV-861 operating at 7178 kc. The plate voltage is 2000, and the plate current is 225 milliamperes. Screen-grid voltage is obtained from the 900-volt tap on the motor generator and is reduced to 400 volts by means of a 20,000-ohm series resistor. Edgewise wound ribbon is used for the tank inductance and the circuit is tuned with a 3000-volt 23-plate National condenser. The antenna is inductively coupled to the tank circuit of the 861. Antenna current of 2.5 amperes is obtained.

milliammeter for the plate of the 861, and 0-1500 d.c. voltmeter. The voltmeter is provided with long flexible leads so that all voltages except the plate voltage of the 861 may be checked regularly. In the second row, may be seen the 0-500 d.c. milliammeter in the plate circuit of the 204-A, the 0-300 d.c. milliammeter in the 203-A plate circuit and the 0-5 thermo-ammeter in the tank circuit of the 203-A. Two meters are used in the third or bottom row. The meter at the left (which is only partly visible above the monitor) is a 0-15 a.c. voltmeter for the filament of the 204-A and 861 tubes. The

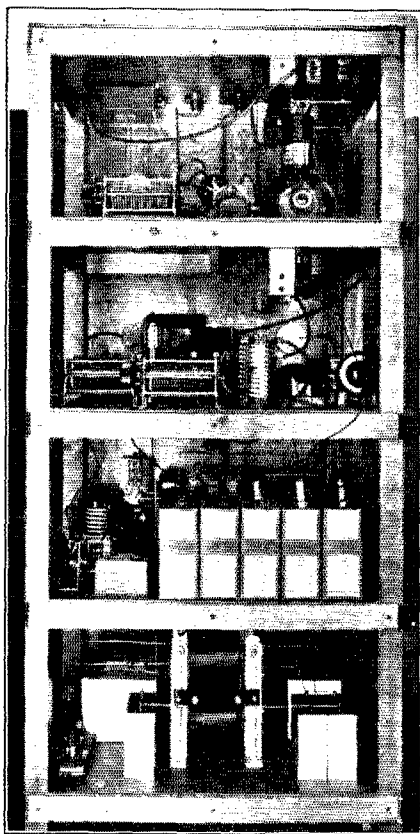

THE TRANSMITTER AT W1AOF

other meter is the 0-15 a.c. voltmeter provided with a double pole, double throw switch for the filament circuits of the 210 and 203-A tubes. Filament voltages are adjusted with Bradley-

the filaments of the tubes are kept lighted and since separate receiving and transmitting antennas are used, it is only necessary to throw the switch at the operator's desk to start the transmitter.

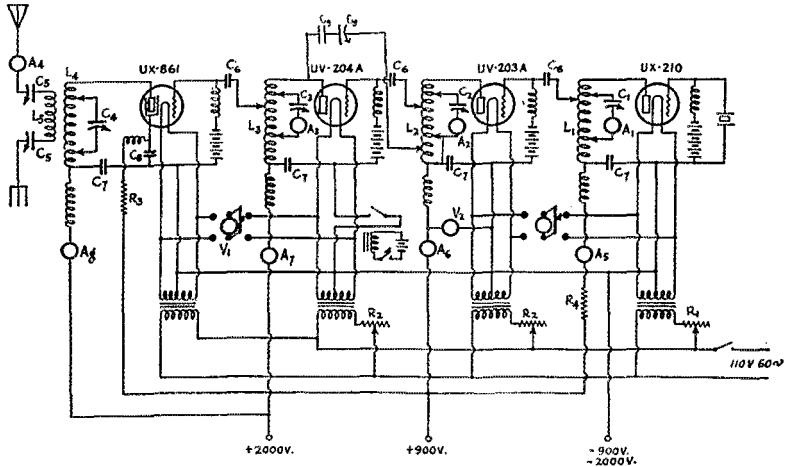

FIG. 2. — A SCHEMATIC DIAGRAM OF THE TRANSMITTER

- $L_1$  — REL type L inductance.  
 $L_2$  — REL type S inductance.  
 $L_3$  — REL type S inductance.  
 $L_4$  — REL type S inductance.  
 $L_5$  — 9 turns of  $\frac{1}{2}$ -inch copper tubing, 3 inches in diameter.  
 $C_1$  — 100- $\mu$ fd. condenser made from 500- $\mu$ fd. National condenser.  
 $C_2$  — 450- $\mu$ fd. tuning condenser.  
 $C_3$  — 450- $\mu$ fd. tuning condenser.  
 $C_4$  — 450- $\mu$ fd. tuning condenser.  
 $C_5$  — 450- $\mu$ fd. tuning condenser.  
 $C_6$  — 2000- $\mu$ fd. coupling condenser.  
 $C_7$  — 2000- $\mu$ fd. by-pass condensers.  
 $C_8$  — 0.5- $\mu$ fd. by-pass condenser.

- $R_1$  — Allen-Bradley radiostat.  
 $R_2$  — Power Clarostat.  
 $R_3$  — 20,000-voltage dropping resistor.  
 $R_4$  — 15,000-ohm voltage dropping resistor.  
 $A_1$  — 2.5 ampere thermo-ammeter.  
 $A_2$  — 5-ampere thermo-ammeter.  
 $A_3$  — 8-ampere thermo-ammeter (shunted).  
 $A_4$  — 3-ampere thermo-ammeter.  
 $A_5$  — Oscillator plate current meter.  
 $A_6$  — Plate milliammeter for 203-A tube.  
 $A_7$  — Plate milliammeter for 204-A tube.  
 $A_8$  — Plate milliammeter for 86I tube.  
 $V_1$  — 0-15 a.c. filament voltmeter.  
 $V_2$  — 0-1500 d.c. plate voltmeter.

stats. The three switches between the filament voltmeters are for turning on the 110-volt line feeding the filament transformers, and for switching the filament voltmeters to the proper tube circuit.

A rear view of the transmitter frame shows in detail the construction of the frame, which is made in four separate tiers or decks. On the bottom tier are the filter chokes, filter condensers, and overload relay. The second deck contains the oscillator and its associated equipment and the grid bias battery. The third tier contains the 203-A frequency doubler and the 204-A intermediate amplifier, while the final amplifier and its equipment is mounted on the top deck. It will be noticed that the variable condensers are at the left of the frame, so that the transmitter may be tuned from the side for convenience since space is somewhat limited.

A 2000-volt, 1-kw. motor-generator with a tap at 1000 volts is kept in a room in the basement and the switch at the right of the operator's desk controls the motor generator. During operation

A 40-foot mast in the back yard supports the far end of a 7000-kc. Zeppelin antenna. A single wire strung around the room, or either side of the Zeppelin may be used for the receiving antenna. Because of the sensitivity of the receiver, a small wire is all that is required, however.

## Strays

On the circuit diagram of the tube-tester shown on page 22, February QST, the lead from the plate prong of the plug should be connected to the "10 ma." jack instead of to the plate terminal of the tube socket. This places the milliammeter in the plate circuit for plate current readings.

In the article in February QST, "Passing the Government Examinations for Amateur Operator's License," the legends for Fig. 1 and Fig. 2 were transposed. In Fig. 1 of the same article the filament return lead to the negative high voltage was omitted.

# I. A. R. U. NEWS

Devoted to the interests and activities of the

INTERNATIONAL AMATEUR RADIO UNION

President: H. P. MÁXIM

Vice-President: C. H. STEWART

Secretary: K. B. WARNER

Headquarters Society:

THE AMERICAN RADIO RELAY LEAGUE, Hartford, Conn.

## MEMBER SOCIETIES

American Radio Relay League

Asociacion E. A. R.

Associazione Radiotecnica Italiana

Canadian Section, A. R. R. L.

Deutscher Amateur-sende-und Empfangsdienst

Experimenterende Danske Radioamatører

Nederlandsche Vereeniging voor Internationaal Radio-amateurisme

New Zealand Association of Radio Transmitters

Norwegian Radio Relay League

Radio Society of Great Britain

Reseau Belge

Reseau Emetteurs Francais

South African Radio Relay League

Wireless Institute of Australia

## Conducted by A. L. Budlong

**I**N the previous issue of *QST* we announced the completion of arrangements whereby the I.A.R.U. had taken over all W.A.C. Club details. It is a pleasure to reproduce herewith a cut of the new certificates which have been made up especially for the purpose. It is to be regretted that the cut can't do justice to the certificate. The new certificate is on green stock and is somewhat larger than the old ones, in addition to having a specially-made heading and new wording throughout.

Approximately a dozen of the new W.A.C. awards have been sent out so far. Why not send in your cards now and get yours?

Also in the previous issue we mentioned the possibility of a special arrangement for the issuance of W.A.C. certificates to foreign amateurs who are members of societies which are duly registered as national sections of the Union. We are happy to announce that this plan, which was originally proposed to the Union by Mr. De Neck and the Reseau Belge, has been approved. The procedure under it is as follows:

Any amateur who wishes to send in his cards to Union headquarters for the necessary confirmation of six-continent QSO may still do so. But if the amateur is also a member of one of the national sections of the I.A.R.U. he does not need to send his cards to Hartford. Instead, he may submit his cards to the headquarters officers of his own national society, which will examine them and, if they are found to be satisfactory, will return them to the amateur with a signed statement saying that the cards have been examined, that the various requirements necessary for the issuance

of a W.A.C. certificate have been complied with, and that it is therefore recommended that the amateur be given his W.A.C. The amateur then sends this statement *only* to Union Headquarters, and a W.A.C. certificate will immediately be issued.

We believe this suggestion will meet with favor, since it does away with the necessity for sending valuable QSL cards half way around the world, with the chance of their being lost in transit. The various national sections of the Union have been advised of the approval of this plan, and are now ready to do their part. Foreign amateurs, we are sure, will join in thanking our Belgian fellow-hams for this excellent arrangement.

The list of W.A.C. awards for the year 1927 will be found at the end of this department this month; 1928 next month. This listing started, it will be remembered, with the March issue, in which those receiving the award in 1926 (first year of W.A.C.) were listed.

About the time this report gets into print, Union Headquarters should be receiving replies from the various members of the Union to the questions proposed in the January calendar of the Union. One of the principal pieces of business is the admission of several new societies to membership in the Union. We are still growing!

Several Australian amateurs have "called" us on the address of the Australian QSL Bureau as given in this department a short time ago. It

seems that the correct address is now: QSL Bureau, W.I.A., Box 3120P, G.P.O., Sydney, N.S.W., Australia.

Our thanks to those who so kindly informed us of the change.

From the looks of things, the traffic and international DX contests organized by the Communications Department of the A.R.K.L. are keeping everybody pretty busy. Only one DX Table this month. We hope to have more in time for the June issue, however, and in the meantime take pleasure in presenting the recommendations of W7ABII, Edwin Lofquist, of Portland, Oregon, for the best times to look for DX in the 7000-ke. band. We are giving both Pacific Standard Time and G.C.T., it will be noted. Perhaps this will help some of our members who have trouble making the conversion from G.C.T.

and have been worked many times by our boys. Our general annual meeting was held on the last Sunday of January. We hope to have a report for the next issue.

Those who think that there is not much to do in running a QSL Bureau may be interested in the report of our very graceful and active YL, Mrs. Ulrich, wife of our Hon. Secretary, who is managing this section of the Reseau Belge. She tells us that since last March more than 20,000 cards have been sent or received through her office! YL ON4OU is also well known as acting as the very "dolce" speaker of 4OU's 'phone, and has done some very fine dx, being heard R8 in Northern Scotland.

Amateurs who speak French might be interested in taking out membership in the R.B. (\$1 per year) and getting our monthly paper QSO. We also have some very pretty membership certificates, for their station walls! Hi!

7000-Kc.

Pacific Coast, U. S. A.

Philippines.....	5:30-8:30 a.m. P.S.T. (1330-1630 G.C.T.)
Japan.....	6:30-8:00 a.m. P.S.T. (1430-1600 G.C.T.)
China.....	7:00-8:30 a.m. P.S.T. (1500-1630 G.C.T.)
Straits Settlements.....	7:30 a.m. P.S.T. (1530 G.C.T.)
Malay State.....	7:30 a.m. P.S.T. (1530 G.C.T.)
Java.....	6:00 a.m. P.S.T. (1400 G.C.T.)
Siam.....	7:30 a.m. P.S.T. (1530 G.C.T.)
New Zealand.....	10:00 p.m.-9:00 a.m. P.S.T. (0600-1700 G.C.T.)
Australia.....	Midnight-9:00 a.m. P.S.T. (0800-1700 G.C.T.)
South Africa.....	6:30-8:30 a.m. P.S.T. (1430-1630 G.C.T.)
Hawaii and Alaska.....	9:00 p.m.-9:00 a.m. P.S.T. (0500-1700 G.C.T.)
South America.....	3:30-11:30 p.m. P.S.T. (2330-0730 G.C.T.)
Central America.....	7:00-11:00 p.m. P.S.T. (0300-0700 G.C.T.)
Europe.....	10:00-11:00 p.m. P.S.T. (0600-0700 G.C.T.)

BELGIAN SECTION

By Paul de Neck, Pres., Reseau Belge

DX stations have at last come back in the 14-mc. band! Also, some very good work has been accomplished by our leading hams.

One of our new amateurs, ON4GK, did an excellent job in working New Zealand with low power and an indoor aerial, being received by ZL4AJ about R6! FB, indeed!

In the Liege district ON4JJ, also working on 14-mc., had two good contacts with the Yukon, while the "little qrp dx stn" ON4FP is perking better than ever and making lots of contacts with Australia and W6 daily, from 0600 to 1600 G.C.T.

In our Brabant district, ON4RO and ON4FT did good work, and ON4WX was heard on 'phone R3 by W2AZO.

ON4UU has now worked WAC on 'phone! (FB — A.L.B.) In several continents the speech was reported as of loudspeaker audibility. ON4UU works with an input of about 100 watts, Hartley push-pull circuit, and about 60% modulation. Skeds and reports are welcome.

ON4FE made the first contact with Fanning Island. The South African stations are coming in regularly at about 1700 G.C.T. on the 14-mc. band

BRITISH SECTION

By J. Clarricoats, Hon. Sec'y, R.S.G.B.

During the early part of this year a marked increase in activity was noticed on the 28-mc.

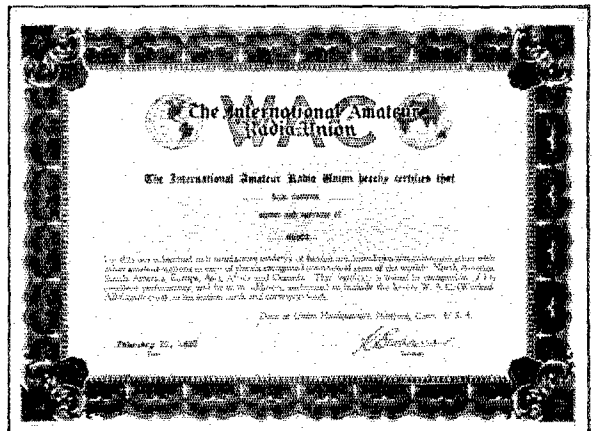

THE NEW WAC CERTIFICATE

band. Following the first British contact with South Africa made by G5WK we record that G6LL and others have made connections. European QSO's have occurred with some regularity,

(Continued on page 62)



# Calls Heard



*W. Clyde Townsend, Radio Operator, S.S. "Ripley Castle," 76 Wilton Ave., Southampton, England*

7000-6000 Miles S. E. New York

7000-ke. band

w1ala w1mk w1mx w2bai w2bjo w2xac w3apf w3awm w3ov w4ft w8ay ct1aa ct1bv ct1cc ct1cw ct2am ear98 ef8jq frear155

14,000-ke. band

wladw wiard w1axh w1bil w1bob w1dp w1ds w1jr w1og w1ra w1ve w2amr w2atx w2box w2bih w2el w2fp w2vd w3aex w3ake w3pf w8aau w8bai w8bkb w8box w8brh w8cfr w8nen w8nxy w8em w8rd w8tk w8ql w9abu w9euh w9erg w9mt ct1aa fklr2 g2bm g2ma g3ml g5vm py2bf py8ia uw2z ve2ca xearn x9a z4ft zu6s

6000-5000 Miles S. E. New York

7000-ke. band

w1ajb w2amr w2avm w2bvy w2ju w2ku w2qn w3aag w3dh w4atk w4eg w4ty w8cm1 w8dgd ct1am ct1cc cx7 ear98 ear153 frear149 frear153

14,000-ke. band

w1aao w1adp w1ez w1ve w2fr w2anj w2aog w2ayt w2baa w2box w2bjg w2bux w2bvk w2el w2jn w2mb w2zg w3jn w3vb w4ef w4aef w8bek w8bud w8avv w9bdw w9dre w9dxx w9ftz w9gty w9mt pylah py2ad ve2aa vo8aw zs5u

5000-4000 Miles S. E. New York

7000-ke. band

w1agn w1bds w1bvr w1ej w1ia w1mk w1on w2ajp w2bai w2bdj w2cbp w4ft 36am w6oj w8ag w8baz w8bkb w8bug w8cdr w8pm w9dbj w9nk d4ha ear ill ve8cz

14,000-ke. band

w1avu w1aze w2amr w2bbv w2bwo w2zg w3ajh w3bdv w3wy w4il w6btd w7adb w7fi w8afg w8bet w8bey w8bpz w8bti w8cfr w9ded w8dma w8dwm w8em w8oz w9bpl w9bie w9fiz w9flh w9ftz w9gbx w9gz ce3c ct1bd f8ma g6wt helle on4hc py2ba ve2ca z56wt

4000-3000 miles S. E. New York

7000-ke. band

w1abz w1adw w1auk w1bds w1cmz w1cid w1lk w1mh w1mk w2ann w2aoo w2arj w2atx w2ayz w2bai w2bse w2eud w2eud w2oa w2uk w2ve w3abp w3and w3anh w3apf w3ard w2awm w3aws w4afw w4aid w4ox w4ft w4fx w4ge w4nn w4il w6akw w6amw w6ui w8ayw w9bgy w8bdj w9bqu w8edi w8em1 w8daa w8dyk w8pm w8rj w8vl w9bly w9dpv w9ebo w9ftt w9zd cm8yb ve2ax ve3oq vo7av

14,000-ke. band

w1rw w1vc w2aaw w2ary w2box w2bvk w4agr w4er w7ajw w8dgt w9bnu g5is helfg k4kd lu6fc pylcm py2ik oa4r ve2ca ve9sj

3000-2000 Miles S. E. New York

7000-ke. band

w1aow w1apz w1awe w1hop w1bvw w1cv w1eu w1fl w1lz w1mk w1vp w2ahr w2alk w2bdh w2bgv w2bpn w2bri w2bst w2baw w2kj w3apn w2au w2aiw w3anh w3bnu w3lh w3mt w3pm w3vr w4ahi w4arh w4el w4ew w4is w4ft w4x w4yh w5abj w5bdd w6bam w6bxv w6djp w6ky w7gf w7mc w8ahe w8akt w8bp' w8bpf w8bvp w8bxw w8can w8crr w8dvi w8ld w8uj w8aah w9aew w9bdl w9coo w9dmg w9enc w9fpd w9gdm w9gdv w9ggi w9yo

14,000-ke. band

w1bh w1zz w2aey w2bg w2bia w2rd w2zg w3acw w3aty

w6in w6ts w8abe w8bek w8djp w8dju w8gu w8ma w9abh w9def w9ftz w9sj helfg ve2ca

2000-1000 Miles S. E. New York

7000-ke. band

w1ff w2ags w2bdh w2bph w2eb w2ns s2uk s2vt w3anh w3bkt w3la 35amk w6bh w8aes w8afk w8bkw w8cei w8dkt w8yp w8yb w9ayd w9bbr w9civ w9dek w9dud w9ell w9fyp cm8yb d2be f8jma

14,000-ke. band

w1abg w1agn w1aig w1kh w1lk w2bse w2el w3bph w4sy w8auu w8bcd w8bet w8cpc w9bdw w9exw w9sj w9zo lu2dj

*VK3CX, Alan G. Brown, 8 Mangarra Rd., Canterbury E7, Victoria, Australia*

14,000-ke. band

w1aqt w1ry w1ve w2aog w2arb w2avm w2el w2jn w2tp w2vd w4aef w4dv w4ej w4ft w5jv w5ly w5qu w5rg w5za w6bax w6bvz w6dmk w6dre w6epz w7lq w8bug w8cfr w8dju w8tk w9dqu wfa wfat w8as ac1bd ac3fr ct1aa ct1vx cv5or d4uak f8da f8ex f8fk f8gdb f8rko f8wb f8xbk file fm8bg fm8am g5by g5bz g5wk g6hp g6vp j1zx j3fz k6bhl k6boe k6rl lu3dh oa4s oa4t ok1rv on4au pk1jr pk3bm pk4az pk4bo su8an su8wy vq2bh vu2dr vs3ab vs6ae vs6ag vs6ah vs7ap yilac yillm zs5b zs6z zt2e zt5r zt6x zu6w

7000-ke. band

w1cdx w1cid w1opt w2eal w2ns w2wr w3wy w5ol w5pg w5yw w6ad w6am w6auk w6axe w6bkw w6ci w6cww w6dvi w6ekr w6wa w6xbb w7kt w7ts w8bau w8baz w8bcq w8ds w9cjb w9doc w9ez w9gv w9yc kalce kalem kaldj ka1hr ka1pw ka1xn kd6yc k6eqm ac2az bw

*W4AKH, Ed. Connell, 230 Sorrento Rd., South Jacksonville, Fla.*

ce2ab ce3ab ce3fb ce3ci ce3da ce3dg ce3ws ce5aa cx1oa cx2ak cxewk f8da g5yg g6hp g6vp g6wy helfg hc2jm k6acw k6boe lu1ba lu2aa lu2dj lu3dh lu3za lu3oa lu4dq lu6fc lu8dj lu6dy lu9dt oa4j oa4q oa4z pylah pylaw pyiem pyler pylia py2ay py2bf py2bg py2ih py2qb sn1aa vo8ae vo8mc x9a vk2jz vk2no vk5dx z1ap z1ba z1lhm z1lr z1zac z1zbe z1zbh z1zgh z1zas z13em z14ba

*AC8HM, H. MacGowan, c/o American Club, Shanghai, China*

7000-ke. band

k6avi pk3bm w6ad w6afa w6am w6arv w6bdx w6bjr w6cas w6cub w6cut w6dip w6dvz w6ebg w6ebn w6ea w6eoz w6ehi w6erg w6ten w6wee w6hm w6wa w7ahx vk2jq vk2mr vk3jy vk3pr vk3rb vk4og vk4hg vk5it vk5lf vk6aj vk6mo vk6pk z1aa z1lb z1bi z1zaw z1zda z1zgd z1bi z14bn

14,000-ke. band

ce3ag ce3dg fi8lr lu6aj lu3dh lu2ea vk2rx vk2jj vk2no z1fc z1fv z1fu z1fw z1ws z1an z1ap z1zbb z1zgh z13aj z13em

*EAR117, Luis de la Tapia, Tabern 26, Barcelona, Spain*

7000-ke. band

w1abn w1aw w1axj w1ba w1mk w1zh w1anh w1amr  
*(Continued on page 72)*

# Correspondence

The Publishers of QST assume no responsibility for statements made herein by correspondents.



## Splendid Cooperation

War Department,  
Office of Assistant Secretary,  
Washington, D. C.

The President,  
American Radio Relay League,  
Hartford, Conn.

My dear Sir:

I have learned of the splendid cooperation of the American Radio Relay League in connection with the recent flight of the First Pursuit Group from Selfridge Field to Spokane and back, and desire to express my sincere thanks to the members of the League for their help.

Such devotion to a purely voluntary duty as has been displayed on this occasion has not been without considerable personal sacrifice. This fact is fully appreciated, and is perhaps the most significant factor in the success of an organization which has come to be highly regarded for its accomplishments.

Please convey my thanks to the officers at the headquarters of the American Radio Relay League and to the amateurs concerned for the help they gave and for their untiring efforts in handling messages pertaining to the flight.

Sincerely yours,

—*F. Trubee Davison, Assistant Secretary of War*

## A Word from Dr. deForest

318 East 48th Street,  
New York City, N. Y.

Dear Mr. Maxim:

Nothing I have read in late years from Washington regarding attempts at radio regulation or "relief" has so forcibly appealed to me as your recent words before the Senate Interstate Commerce Committee begging the preservation to the American amateur of the four bands of wavelengths still allotted to them.

As perhaps the first to design and sell to the amateur regular receiving equipment, who opened the first show-rooms for this purpose, I have felt the keenest sympathy with all the efforts, ambitions, and aims of the radio amateur.

To these youthful pioneers in wireless telegraphy I looked first to take up the idea of the radio broadcast. For these, with a scattering of ships' operators, constituted for years the only radio audiences.

Had it not been for the American amateur

there could have been no radio broadcast, and no radio industry as it exists today.

To one familiar with the actual conditions existing fifteen years ago this truth seems self-evident. The world at large, the radio industry with its \$600,000,000 annual turnover, little realizes this fact.

If they did, the world and the industry would to-day be erecting memorial tablets and dedicating monuments of appreciative recognition to the radio "ham"; instead of seeking at Washington to strip from him what scant vestige remains of the once wide and unexplored regions of short-wave channels, then considered by commercial interests as worthless, which he first of all proved valuable.

These youths, the Magellans and DaGammas of radio, toiling sleeplessly through unnumbered nights, explored new seas of ether and discovered there uncharted realms of communication where commercial interests had refused to venture—yet how quick thereafter to seize and claim their own!

And on how many occasions have these tireless amateurs alone heard the faint SOS from some sinking vessel, or alone have been the means of communication with some explorer's expedition lost to the world save for them?

What the technique of modern short-wave radio owes to our amateur the world is never told, or is loath to admit. Discoveries which the paid commercial engineer would never dare attempt to make, simple and compact constructions which only poverty, necessity, and an untutored common-sense could ever evolve, have time and again emanated from the ham's work-bench to confute and confound the professional into speedy confiscation.

All these things, priceless in themselves, we owe the radio ham.

But more than these material gifts we owe to him the invaluable spirit of discovery, of wide-awake experimentation not shackled by book-knowledge and predetermined notions of the engineer; of youthful enthusiasm, the tireless spirit of quest—that which was chiefly responsible for the radio at its inception, and for its matchless rapidity of growth.

This spirit alone is beyond all price.

And little does the amateur ask in recompense for all of this. Merely to be left alone in a now cramped cranny in the wide fields of higher frequencies which he discovered and gave to mankind.

# New Screen Grid Neutrodyne Power Speaker Radio at New Low Prices

With the perfection of the new Crosley "Companionship" Series there is ushered in a new era in the development of radio receiving sets for the home. For the first time in radio history it is possible for the public to obtain radio receiving sets, complete in magnificent low console utility cabinets with improved power speakers built in, using Screen Grid tubes, having Neutrodyne circuits, operating from electric light sockets, at prices so low that everyone can afford to own one.

## THE BUDDY

This handsome "Buddy" model has a metal case with panels in beautiful burl walnut effect. The trim is silver and ebony inlay finish. The legs as shown are standard equipment. An improved Crosley Dynacone power speaker is included at the price, and is installed under the cabinet. Uses six tubes — two Screen Grid No. 224, one No. 227 as a bias-type power detector feeding into two No. 171-A's connected push-pull, and a No. 280 rectifier tube. Has built-in power supply unit incorporating genuine trouble-free Mershon condenser. The dimensions of the "Buddy" are: 24" high, 17 $\frac{3}{4}$ " long, 10 $\frac{1}{2}$ " deep.

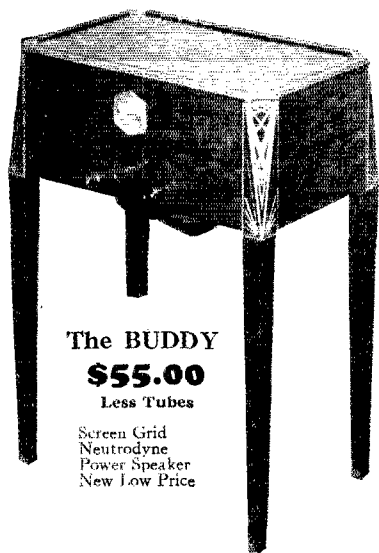

The BUDDY  
**\$55.00**  
Less Tubes

Screen Grid  
Neutrodyne  
Power Speaker  
New Low Price

## The PLAYMATE

This beautiful wood model, shown below, is built of two-tone walnut veneer. This set incorporates the seven-tube refined Crosley Monotrad chassis. It uses two Screen Grid tubes No. 224, one No. 227 tube as a bias-type detector, one No. 227 resistance coupled first audio, two No. 245 tubes in push-pull, and one rectifier No. 280. The "Playmate" incorporates the latest refined Crosley Type "M" Dynacoil power speaker, concealed in the cabinet. The dimensions of the "Playmate" are: 29 $\frac{1}{2}$ " high, 28" long, 16 $\frac{1}{2}$ " deep.

## The COMRADE

This set is enclosed in the same cabinet as the "Playmate" but incorporates the refined Crosley Unitrad eight-tube chassis, giving somewhat greater sensitivity and performance due to the use of three Screen Grid tubes instead of two. You've never seen so much value in radio for only \$105.00 less tubes.

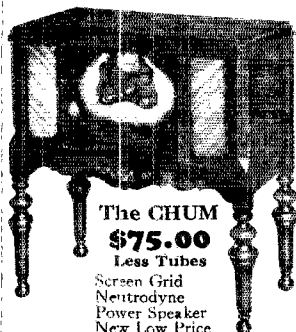

The CHUM  
**\$75.00**  
Less Tubes

Screen Grid  
Neutrodyne  
Power Speaker  
New Low Price

The "Chum", shown to the left, is a useful, inconspicuous, low table for use anywhere. It is constructed of 3- and 5-ply walnut veneer with matched Oriental walnut front panels. The center panel is of rich golden maple. An improved Dynacone moving armature electromagnetic power speaker is concealed in the cabinet. Uses six tubes — two Screen Grid No. 224, one No. 227 as a bias-type power detector feeding into two No. 171-A's connected push-pull, and a No. 280 rectifier tube. Has built-in power supply unit incorporating genuine trouble-free Mershon condenser. The dimensions of the "Chum" are: 28 $\frac{1}{2}$ " high x 26 $\frac{1}{2}$ " long x 14" deep.



The PLAYMATE  
**\$90** Less Tubes  
Screen Grid  
Neutrodyne  
Power Speaker  
New Low Price

Phone a Crosley Distributor today — or, if you prefer, write us direct  
Western Prices on All Models Slightly Higher

**THE CROSLEY RADIO CORPORATION**  
Powel Crosley, Jr., Pres.  
CINCINNATI, OHIO

Home of WLW — "The Nation's Station"

YOU'RE THERE WITH A CROSLEY

# CROSLEY RADIO

Say You Saw It in QST — It Identifies You and Helps QST

# Cunningham RADIO TUBES

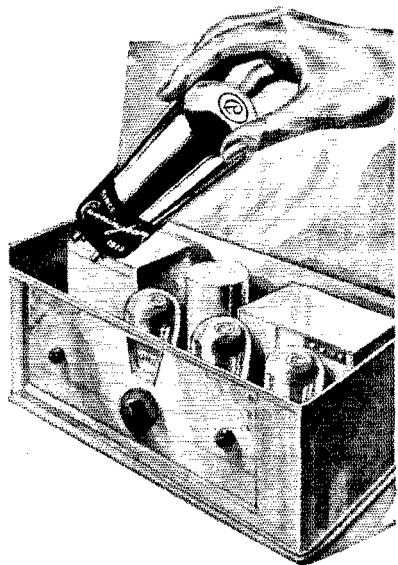

PIONEERS of the air  
since 1915 that enjoy  
the endorsement of  
millions of set owners

*Choice of Millions*

**E. T. CUNNINGHAM, INC.**

New York      Chicago      San Francisco  
Atlanta      Dallas

Manufactured and sold under rights, patents,  
and inventions owned and / or controlled by  
Radio Corporation of America.

More power to you, Mr. Maxim, in your fine efforts to save the amateur, and therefore to all America, the meager channels for work which Washington has still vouchsafed them; and which is all they ask.

May the nation stand behind you in this task.  
Most sincerely yours,

— Lee deForest

## Check — and Double Check!

425½ Neches St., Dallas, Texas.

Editor, *QST*:

I have been reading *QST* for several years and have noted the many articles on off-band operation, but it seems that operators nowadays pay little or no attention to them.

Most of us will no doubt remember the days when we might call CQ under 37.4 meters (NAA) and get called by almost everyone on the dial and three or four days later get from four to five cards from official observer stations reporting us off wave. But nowadays in our 1929-30 period of operation we have no NAA at the bottom of the band — no marker that is known of at 7300 kc. Therefore many of us wander off down into the unknown and lower regions near WEM at 7400 kc. and sometimes even under him and holler our heads off trying to raise some one. Maybe, finally we raise some one, but even then just what have we done?

This is one thing that is really getting serious. I have helped several fellows get into the band who were unconsciously operating somewhere between WEM and the bottom of the band, thinking, that WEM marked the exact bottom of 7300 kc. It seems to me that it was high time something was being done, for every time we get down under the band and work some one we are contributing to the cutting of our own throat. Some one of authority is bound to be listening, not only in this country but in others. In saying this I would like to bring to your attention the attitudes of various other countries toward the amateur at the last radio conference.

May I offer the suggestion that all of us who would really be interested in helping the other fellow get out of the cellar, take say an hour or so per week searching the regions below and above the bands for 100 or 200 kc. and call some of them or drop them a card, *but get them inside the bands*. Should you get a tough customer who wants to argue tell him to build a monitor and check it against W9XL or W1XV. Then he can very easily see for himself. Some of the gang seems to be suffering under the old illusion that the bands are not large enough when actually there is plenty of room for all. In this day of 1929 the old "Spirit of 1776" is not in order since the cry of "Give me liberty or give me death" might quickly be changed to "I took liberties and they gave me death."

I usually take ten or fifteen minutes of my various operating periods listening under 7300 kc. for stations out of the band and call them. Oftentimes I get thanked very much for this,

# Fool Proof Condenser Performance

Compare the new Sprague Electrolytic with any other condenser. Use it—test it—and judge for yourself its amazing performance. And here are just a few of the reasons why Sprague Electrolytic Condensers can give you better service.

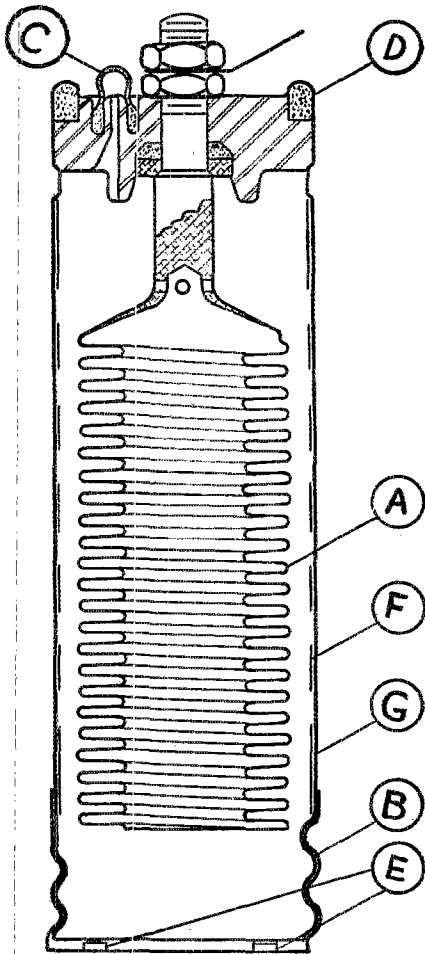

- A One piece anode made entirely of pure aluminum; no welded or riveted joints either above or below the electrolyte.
- B Screw type socket mounting making for maximum flexibility in receiver design.
- C Protected vent eliminating the possibility of damaging the nipple.
- D Pressure seal, with no possibility of cutting gasket.
- E Locking lugs in socket to prevent condenser shaking loose during shipment.
- F Shield, precluding possibility of internal short circuit.
- G Individual container allowing space to be utilized with maximum flexibility.

Individual cathodes eliminate all leakage between anodes and allow maximum flexibility in circuit design. Increased life, less leakage and much better shelf characteristics due to anode with edge effect of less than 10% of spiral type. Leakage current guaranteed not to exceed .2 milliamperes per MFD at 400 volts after 5 minutes or .065 milliamperes per MFD at 350 volts after 5 minutes.

*And there are the well known paper condensers made by Sprague—made with the same precise skill as the Sprague electrolytic. Types and sizes to fit your every condenser need.*

**SPRAGUE SPECIALTIES COMPANY**  
QUINCY, MASSACHUSETTS

SPRAGUE ELECTROLYTIC AND PAPER CONDENSERS  
WILL SOLVE YOUR CONDENSER PROBLEMS



NO [REDACTED]  
 NOTE [REDACTED]  
 [REDACTED] CAN  
 [REDACTED] ESCAPE  
**Thordarson**  
 POWER ▲ ▲ ▲ ▲  
 AMPLIFICATION

Realistic reproduction for all occasions . . . and in every circumstance . . . that's what Thordarson's new line of complete Audio Amplifiers means to the listening world. And nothing short of actuality in sound reproduction will be accepted today.

Thordarson Amplification Equipment  
 Means Consistent Audio Excellence

The engineering laboratories of Thordarson . . . with years of research and experience behind them . . . have succeeded in solving the problems of sound reproduction. And with the utmost in manufacturing facilities, the most exacting specifications are faithfully and efficiently fulfilled.

Why not make use of Thordarson engineering service in your work? We can give you installation suggestions that will make your work easier and more profitable.

**THORDARSON**

Transformer Specialists Since 1895

**THORDARSON ELECTRIC  
 MANUFACTURING COMPANY**

Huron, Kingsbury and Larrabee Streets  
 Chicago, Illinois, U. S. A.

4436

but again there are fellows who cuss me out in a nice way. What I am kicking about are the ones who do not appreciate what I am trying to do for them and tell me I am all wet. I would like to see 100% coöperation and sportsmanship. My instruments are kept calibrated regularly and I am not very far from right.

— L. E. Harrison, W5BAM

### "Little Modgey" Lends a Hand

3843 Boyce Ave., Los Angeles, Calif.

Editor, *QST*:

Thank you very, very much for your Technical Information Service letter of recent date which put a finger right on my trouble and helped me right out of a slough of despondency as far as modulation and quality of my 'phone is concerned. My modulation is now the pride of these parts; my "modulometer" says so and the hams say so too.

While we are on the subject of the modulometer, let me thank you again for advising me to build one. When the article describing it appeared I did not give it much thought. Other hams seemed to get passable modulation with the use of simple apparatus mostly from the "5 and 10" store. I have invested in about 12 tubes counting the rectifiers and could not seem to get out of the back yard. Instead of investing in still more apparatus to find the trouble, why not throw out eight or nine tubes and associated equipment. This "reasoning" was the composite opinion of most of the hams who visited the layout and tried to get it perking.

My trouble baffled them all. We all sweated with voltmeters, milliameters, C biases, tubes and everything changeable. Then I built my modulometer, in a nice little carrying case with batteries enclosed. Right off I found the trouble was in my microphone. When I put the modulometer on the grid of the first tube I could whistle every tooth out of my head and get no deflection. I bought a new high class mike and the modulometer said "plenty gain." Then I hooked the modulometer on the final amplifier and what a racket! I had plenty audio and radio feed-back. I located them both with the little modulometer and fixed them as *QST* suggested.

— James Kirk

### Why Not Dummy Antennas?

407 Eleventh St., Gothenburg, Nchr.

Editor, *QST*:

Although I do not belong to the A.R.R.L., I am very enthusiastic about amateur radio and shortwave communication. I own stations W1AU and W9DYU.

During the first three days W9DYU was placed in operation I arranged skedules with several stations for the purpose of handling traffic. While working one of these skedules the other evening I noticed a lot of unnecessary QRM from fellows who were thoughtlessly clamping their keys down. (By the way, their notes didn't help matters a bit!)

# Headquarters for Radio Instruments

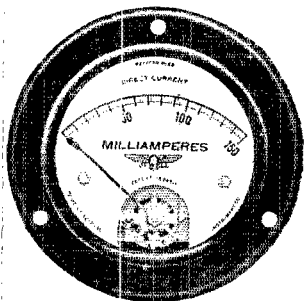

Jewell Instruments have been the favorites of amateur broadcasters since the very inception of popularized radio. Today the Jewell line of Miniature Instruments for amateur broadcasters is more complete than ever before. To the old favorites has been added a new line of bakelite case instruments for flush type mounting. New ultra sensitive D.C. and high frequency meters are also available. Equip your 1930 transmitter with these new instruments.

## Jewell 199 Set Analyzer

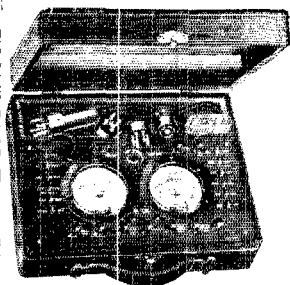

This is the lowest priced complete set analyzer on the market. It is remarkably simple to operate and makes every essential field service test. Thousands of radio service men have found the Jewell Pattern 199 the key to profitable service work. The Jewell Pattern 199 plus Jewell Radio Service Data, when used with the Jewell Chart Method of set analysis, eliminates guesswork in servicing.

## Jewell 409 Set Analyzer

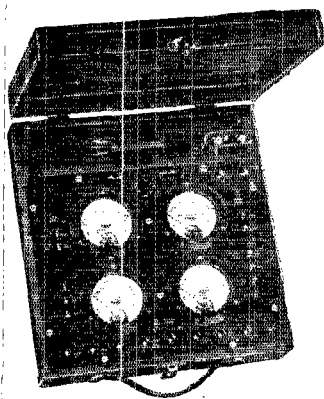

Similar to the well known Pattern 199 but has four instruments instead of two. Gives filament, grid, and plate voltages as well as plate current, simultaneously, for instant comparison. Unquestionably the deluxe kit for those who want the last word in portable set analyzers. Pattern 409 is backed by the same complete data service which has been a great factor in the popularity of the Jewell Pattern 199.

Every service man should have a Jewell Pattern 199 or 409 Set Analyzer. For sale by leading radio jobbers.

Jewell offers a complete instrument service to radio amateurs, service men, and manufacturers. Write us about your instrument problems

33 YEARS MAKING GOOD INSTRUMENTS  
**JEWELL**  
JEWELL  
**409 SET ANALYZER**

Jewell Electrical Instrument Company  
1642-C Walnut Street, Chicago, Ill.  
Please mail booklet entitled, "Instructions for Servicing Radio Receivers," and circular describing the complete line of Jewell Radio Instruments.

Name.....

Address.....

# Solid Molded

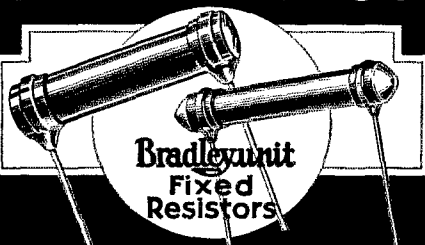

**Bradleyunit  
Fixed  
Resistors**

## Rugged-Accurate-Permanent

**SOLID MOLDED**—that is the secret of the superior performance of the Bradleyunit. Made in ratings from 500 ohms to 10 megohms, these accurate, noiseless fixed resistors are the choice of the leading set manufacturers for grid leaks and plate coupling resistors.

All Bradleyunits are color-coded for quick and easy identification. They are not fragile. There are no production losses due to breakage. Tem-

### Compare These Oscillograms



Oscillogram showing noiseless performance of Bradleyunit Resistors.

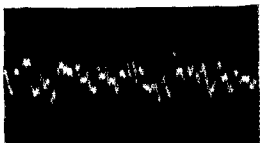

Oscillogram showing noisy performance of other types of resistors

perature, moisture, and age do not affect Bradleyunit accuracy.

Follow the example of leading radio manufacturers, and standardize on the Bradleyunit. Write for further information and prices.

ALLEN-BRADLEY CO.  
277 Greenfield Ave. Milwaukee, Wis.

**Allen-Bradley**  
PERFECT RADIO **AB** RESISTORS.

Can't some system of tuning up be suggested to these fellows who persist in warming up and checking wave every two minutes? If they would only disconnect their antennas? Or perhaps a dummy antenna?

—C. M. Brauer, Ex-Op. WBET, KFUM, KFEL

Box 223, Hampden-Sydney, Va.

Ye Editor—*QST*:

Hear ye the sayings of Solomon, for in these days, my good children, I do tell ye that *QST* is the basis of all evil. Lo, these many years have I fought the omen striving to break the chains that bind me to this infernal game of ham radio, but the opposition grows stronger with each issue of ye olde parchment.

Yea, for 'twas back in the time when hams were men and glad of it when the epoch was started, and lo, these hams carried the well-known retty-snitch and even the murderous wouff-hong in those days. For their enemies were fierce, and strong men dwelt among the land who would kill them for the noise of their rock-crusher working through the night and slaying the sleep of those who had good sense.

Then came the lowly B.C.L. In those past annals he was a most deadly vermin. Twisting the knobs on his whistle box, listening for the anvil chorus, or somebody else trying to sing, and faking a brass band in falsetto, he waxeth strong. The rattle and thunder of the hams was as the dashing of the storm waves on a lonely rock-bound shore, and lo, the B.C.L. heard nothing but the din! But the hams stuck by their Cue Ess Tee and felt no harm.

Anon, the war is over. The hams no longer wear striped clothes, nor do they carry even a lonely wouff-hong. But the old call to arms makes the hands itch for the feel of the brass and the ears for the chirp of the Hamwich Islands, and lo! the night is without sleep and the day without work, and why should not Cue Ess Tee be called the root of all evil?

But here's my two bucks and four bits — I'm just one of the boys.

—J. Gray McAllister, Jr.  
W3AEV, W3GX, W4BT

P.S. — I'm sober, and the check's good.

## I.A.R.U. News

(Continued from page 54)

Finland producing the most contacts. Three British stations, G2OL, G2OW and G6XN, have begun experiments on 56-mc., but except for short-distance contacts between themselves no marked progress can be mentioned as yet.

The Society has been presented with several valuable trophies which are open for competition by members interested in ultra high-frequency work.

Conditions in the 7000- and 14,000-ke. bands were normal during the first month or so of 1930. No outstanding work has been noticed. Foreign and colonial amateurs interested in some specific



# A SAFE GUIDE

in the selection of insulation for Radio Transmitting and Receiving Sets

**PYREX**  
**RADIO INSULATORS**

Where they are used  
 and what leading authorities say  
 about their performance

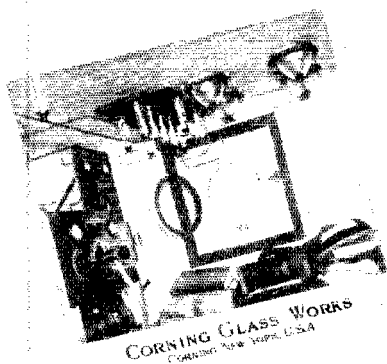

CORNING GLASS WORKS  
 CORNING, N. Y., U.S.A.

OVER 300 broadcasting stations, leading radio telegraph systems, the United States Army, Navy, Air Mail, Coast Guard and Ice Patrol Services, explorers like Commander Byrd, and exacting amateurs everywhere have utilized PYREX Insulators in many spectacular achievements.

Regardless of whether you are sending or receiving — on land, sea or airplane — you should be thoroughly familiar with the PYREX Antenna, Strain, Entering, Stand-off and Bus-bar Insulators that are helping these leaders to make radio history.

The new PYREX Radio Insulator booklet lists all types and sizes with data that you will want for ready reference.

Return the coupon for your copy, and if you want further advice on any insulation problem, our Technical Staff will answer your questions promptly.

Send  
 the coupon  
 for your copy

CORNING GLASS WORKS  
 Corning, N. Y.

Gentlemen:

Please send me copy of your new bulletin on Radio Insulators.

Name

Address

QST 4-30

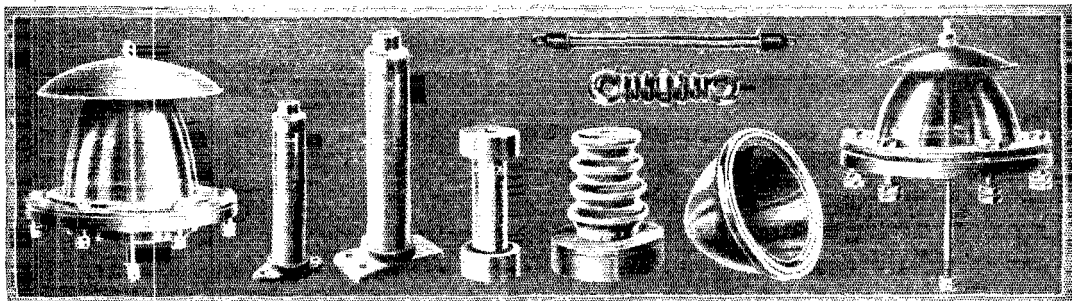

# New Amateur Band Oscillating Quartz Discs

A DELUGE of orders for oscillating quartz discs from amateur stations throughout the country has forced us to specialize in oscillating discs *exclusively* for operation within the amateur frequency bands.

In accordance with this new policy of quartz discs specially ground for amateur band operation we have revised our price schedule and *lowered* prices on precision crystals as follows:

## NEW PRICE SCHEDULE

Class 1 Discs	3550-4000 Kc (80λ Code)	\$10.00
Class 2 Discs	3500-3550 Kc (80λ Phone)	\$15.00
Class 3 Discs	3500-3650 Kc (40λ Code)	\$12.00
Class 4 Discs	7000-7300 Kc (40λ Code)	\$15.00
Class 5 Discs	3500-3600 Kc (20λ Code)	\$14.00
Class 6 Discs	7000-7200 Kc (20λ Code)	\$16.00
Class 7 Discs	3525-3575 Kc (20λ Phone)	\$15.00
Class 8 Discs	7050-7150 Kc (20λ Phone)	\$20.00

All crystals are perfect discs, ground for power use, to absolutely correct setting of optical and electrical axis, and are fully guaranteed to lie within the band specified and to be within 1% of the *exact frequency specified by the user.*

Each crystal comes complete with spring pressure type of holder, free of charge. A laboratory certificate of exact frequency is supplied with each crystal.

Orders shipped within 24 hours, or money refunded. Cash with order or C. O. D.

ORDER DIRECT FROM THIS ADVERTISEMENT

## CLIFFORD E. HIMOE

W2AW 318-320 Lafayette Avenue  
ex-WNP Passaic, New Jersey, U.S.A.

subject connected with radio communication are reminded that the Contact Bureau section of the Society is open to receive into its various groups all such persons.

It is pleasing to record the progress of the B.E. R.U. (British Empire Radio Union), especially in South Africa, where some thirty active members have joined. The new W.B.E. (Worked the British Empire) certificate will shortly be available and will be presented to members who have succeeded in working some part of the British Empire situated in each of the five continents of the world.

Full particulars of the Society and a free copy of the T.&R. Bulletin will be forwarded to any amateur who has not seen our Journal. Address R.S.G.B., 53 Victoria St., London, S. W. 1.

### DUTCH SECTION

By H. Pomes, Ass't Traffic Mgr., N.V.I.R.

Although, generally speaking, conditions have not altered recently, there are a few facts worth mentioning as regards work in the three bands used mostly these days. In the 3550-kc. band the American stations were heard more persistently than in the 7000-kc. band. As for European eighty-meter 'phone we must say that there are not many. Unfortunately, most newcomers choose the 7000-kc. band for this purpose, in spite of the fact that 'phone on "eighty" has been shown to have excellent possibilities. It would seem in the interest of all European countries to settle on some coöperative scheme with regard to the use of 'phone in the various narrow bands now open for amateur work. (The French Section, through its president M. Reynt, has made tentative proposals to the I.A.R.U. along this line. — A.L.B.)

In the 7000-kc. band it is still the same old story: many 'phone stations with strong carriers and bad modulations fill the band during the daytime. Only a small percentage is of good quality, most of the German and a few English 'phones only being in this class. When not interfered with, good code work was possible with all countries of Europe. At night many United States amateurs were logged with good strength. This represents some improvement over previous months.

In the 14-mc. band conditions are just about normal. March, however, should "wind up" the best season for this band, if the experience of former years is any criterion. Australia, New Zealand, South Africa and British India are heard and worked frequently. North and South American work was not so good, for some reason. China, Japan and the Dutch East Indies were heard well at times.

### GERMAN SECTION

By W. Rach, Sec'y, D.A.S.D.

We are very pleased to announce that licensed German amateur stations are now permitted to

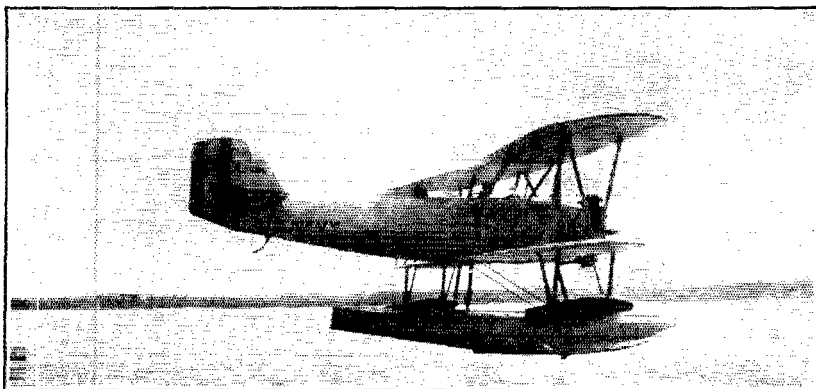

# ★ THE NAVY'S EAGLES! ★

The super-rigid TAPER PLATE CARDWELL receiving condenser is used by the Navy for aircraft receivers. Unaffected by shock and vibration, absolute constancy of calibration insured, the taper plate CARDWELL is superior for *any* short wave or broadcast receiver. CARDWELL TRANSMITTING CONDENSERS are selected by experts for service on land, sea and in the air because they are mechanically sound, sturdy and *fundamentally* right, their worth proved over a decade of hard, exacting service.

Take a tip from the experts and leave nothing to chance—that outfit you expect so much of *deserves* CARDWELLS.

There are CARDWELL transmitting condensers for Amateur, Commercial and Broadcast use and receiving condensers in several types and a broad range of capacities.

All good dealers carry Cardwell Condensers. If you are unable to obtain them, write direct. Send for literature.

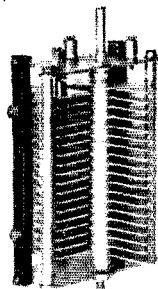

T199—A super transmitting condenser. Cap. .00033. Air-gap— $3/32$ " measured from stator to adjacent rotor.

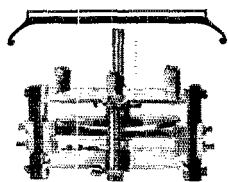

The 201-E (2 plates). A taper plate condenser for short wave receivers. The stator plate is adjustable, affording maximum capacities of from 50 to 10 mmfd. Price \$4.

## CARDWELL CONDENSERS

THE ALLEN D. CARDWELL  
MANUFACTURING CORPORATION

81 Prospect Street, Brooklyn, N. Y.

*Since broadcasting began*

“ THE STANDARD OF COMPARISON ”

## TESTING INSTRUCTIONS FOR SERVICE MEN



For  
use  
with

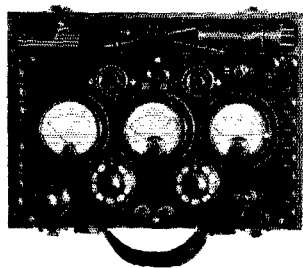

Model  
547

### RADIO SET TESTER

This Instrument, and this Manual which is furnished with it, together provide the most complete and up-to-date equipment available for servicing radio receivers. Electrical data for practically every set on the market is contained in this book — which is made up in loose-leaf form so that purchasers of the instrument who turn in registration cards are automatically supplied with latest information.

This instrument has achieved wide success among dealers and service men. It is preferred because of its dependability, ingenious design providing ease of operation, compactness and light-weight portability. It will make all the required tests on any A. C. or D. C. set. Durable bakelite case and fittings. Provided with 3¼" diameter instruments.

**Weston**  
PIONEERS  
SINCE 1888  
**INSTRUMENTS**  
WESTON ELECTRICAL  
INSTRUMENT CORPORATION

602 Frelinghuysen Avenue

Newark, N. J.

use a part of the 80-meter band, from 85.71-83.33 meters. It is hoped that this privilege will help to relieve the congestion on the 7000-ke. band. Already several German amateurs have moved up to the new territory, two of the first to go being D4ABV and D4ADU.

Although spoiled by QRM, quite a few W-amateurs were heard on 7000-ke. with good strength as early as 2200 G.C.T, and quite a few German amateurs worked them, among them being D4ABR, D4UAL and Dφφ7. The latter is using a brand new transmitting system, which will be dealt with in an early issue of our official organ, CQ.

Some good low-power QSO's with American amateurs were effected, among them being those made by D4BY (6 watts) and D4GY (7 watts).

On 14-mc. much European traffic was carried on, in addition to some excellent DX. D4GO (4 watts) worked ZS6N and FK4RM, and D4GJ (2.5 watts!) had QSO's with FM. D4GW (3 watts) worked FM and YI.

#### NORWEGIAN SECTION

By G. H. Petersen, Vice-Pres., N.R.R.L.

Conditions during the first part of the year were bad, most stations reporting QSS and weak signals. However, some U. S. A. stations have been worked by LA2B and LA2X. The last-named station, QRA Bergen, is a very active newcomer to our ranks, and the operator — 17 years old — is always on the lookout for DX QSO's. At present he is working in the 7000-ke. band. LA2C and LA2K are increasing power to 50 watts, hoping to warm the Zeddie detectors soon. Hi!

One of our members who is now a ship operator worked amateurs practically every night while lying in the Black Sea recently. He was QSO both the East and West Coasts of the United States, among other things, although this was done later when the ship was off Algiers. All work was accomplished in the 7000-ke. band.

14-mc. conditions have been rotten. LA1G says his only DX has been a long ZL.

Our new regulations have not yet been issued, negotiations still being under way. Our government officials are steadily pursuing their activities against unlicensed transmitters in Norway. In this work the members of the N.R.R.L. are anxious to assist, since we have been receiving every support from the authorities. To this end we would like to request all foreign amateurs to refuse to communicate with unlicensed Norwegian transmitters. All licensed Norwegian stations have calls following the form of LA1A, LA2A, etc. Up to the present time no LA3 calls have been issued. Cards for unlicensed Norwegian stations will not be forwarded by our QSL Bureau.

#### SPANISH SECTION

By Miguel Moya, Pres., Asociacion E.A.R.

One of the most noteworthy events in the Spanish amateur world this winter was the con-

**Easy to Get into  
 this BIG  
 Money Making  
 Work**



**\$60 to \$125<sup>00</sup>  
 A WEEK  
 Radio  
 Operator**

**\$8 to \$15<sup>00</sup>  
 A DAY  
 Servicing and  
 Repairing Radios**

**\$5000<sup>00</sup> A YEAR  
 AND UP  
 Radio Engineer  
 for Broadcasting Station**

**\$85<sup>00</sup> A WEEK  
 Installing and  
 Repairing Talking  
 Picture Equipment**

**GOOD JOBS** Right at Your Finger Tips  
 WHEN YOU ARE R.T.I. TRAINED IN  
**RADIO-TELEVISION - Talking Pictures**

**BIG PAY JOBS! SPARE TIME PROFITS! A FINE BUSINESS OF YOUR OWN!** They're all open to you and other live wire men who answer the call of RADIO. The fastest growing industry in the world needs more trained men. And now come Television and Talking Movies—the magic sisters of Radio. Will you answer this call? Will you get ready for a big pay job now and step into a BIGGER ONE later on? You can do it EASILY now.

**R. T. I. Home Training Puts You in This Big Money Field**

Radio alone, pays over 200 MILLION DOLLARS a year in wages in Broadcasting, Manufacturing, Sales, Service, Commercial Stations and on Board the big sea going ships and many more men are needed. Television and Talking Movies open up other vast fields of money-making opportunities for ambitious men. Get into this great business that is live, new and up-to-date, where thousands of trained men easily earn \$60 to \$100 a week—where \$10,000 a year jobs are plentiful for men with training plus experience.

**Easy To Learn At Home—  
 In Spare Time**

Learning Radio the R. T. I. way with F. H. Schnell, the "Ace of Radio" behind you is EASY, INTERESTING, really FUN. Only a few spare hours are needed and lack of education or experience won't bother you a bit. We furnish all necessary testing and working apparatus and start you off on practical work you'll enjoy—you learn to do the jobs that pay real money and which are going begging now for want of competent men to fill them.



**FRED H. SCHNELL**  
 Chief of R. T. I. Staff  
 Twenty years of Radio Experience. First to establish two-way amateur communication with Europe. Former Traffic Manager of American Radio Relay League, Lieut. Commander U. S. N. R. Inventor and Designer Radio Apparatus. Consultant Radio Engineer. Now in charge of R. T. I. Radio Training—and you will like his friendly manner of helping you realize your ambition.

**Amazingly Quick Results**

You want to earn BIG MONEY, and you want some of it QUICK. R. T. I. "Three in One" Home Training—Radio-Television-Talking Movies—will give it to you, because it's easy, practical, and is kept right up-to-date with last minute information. In a few weeks you can be doing actual Radio work, making enough EXTRA MONEY to more than pay for your training. In a few short months you can be all through—ready to step into a good paying job or start a business of your own. A BIG JOB—BIG MONEY—A BIG FUTURE. There is no other business in the world like it.

**Investigate—Send  
 For R. T. I. Book Now**

Don't waste a minute. Find out what the great Radio industry, which has grown faster than the Automobile and Motion Picture business, has to

offer you. Find out what other men are earning. SEE HOW EASILY YOU CAN GET STARTED. Get the facts about Radio, Television and the Talking Pictures firsthand, in the big R. T. I. FREE BOOK. Learn what this R. T. I. "Three in One"

Home Training can do for you. Mail the coupon for FREE BOOK NOW. RADIO & TELEVISION INSTITUTE Dept. 104 4806 St. Anthony Court, Chicago



**R.T.I. Training  
 Brings Big Jobs  
 Like These!**



**\$500 EXTRA MONEY  
 IN 2 MONTHS**

Your radio course has enabled me to earn over \$500 in two months. This is all spare time work, as I have a permanent position with my father in our store. I give you all the credit for the above.

—J. NORFINGER, R. I. Box 37, Greenville, Ky.



**MAKES \$25 A DAY**

I make as high as \$25.00 per day and have made \$600.00 in 2 months from Radio work. That's not so bad when I'm only 19 and in a small town. You did all you said you would and much more.—FLOD KINSELY, Box 91, St. Joe, Ind.



**SALARY RAISED 33 1-3%**

I am now Radio Service Manager for the H. N. Knight Supply Co., distributors for Eveready Radio Receivers in Oklahoma, and Texas Panhandle, with an increase in salary of about 33 1-3% since I enrolled with your school. —EARL P. GORDON, 318 E. 6th St. Oklahoma City, Okla.

**RADIO & TELEVISION INSTITUTE**

Dept. 104, 4806 St. Anthony Court, Chicago

Send me Free and prepaid your BIG BOOK "Tune In On Big Pay" and full details of your three-in-one Home Training (without obligating me in any way).

Name.....

Address.....

City..... State.....

**R. T. I.** R. T. I. TRAINS YOU AT HOME FOR A GOOD JOB OR A PROFITABLE PART TIME OR FULL TIME BUSINESS OF YOUR OWN

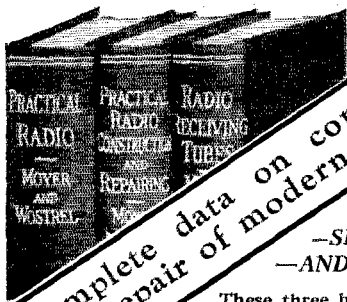

**Complete data on construction and repair of modern radio sets**

—for  
—DEALERS,  
—SERVICEMEN,  
—AND AMATEURS

These three books cover the entire field of building, repairing and "trouble-shooting" on modern broadcast receiving sets. The Library has been brought right up-to-the-minute in every respect, including the very latest developments in the design and manufacture of equipment. The recent interest in short wave reception is reflected in a section which deals with the construction of this type of receiver.

## THE RADIO CONSTRUCTION LIBRARY

Three Volumes, 6x9, 993 pages, 561 illustrations

THESE three books embody not only a thorough home-study course, but a ready means of reference for the more experienced radiotician. Step-by-step information is given on wiring, "trouble-shooting," installation and servicing to get the best tone quality, distance and selectivity in broadcast reception from all types of sets.

Data is given on equipment, such as loudspeakers, antenna systems, battery eliminators, chargers, vacuum tubes, etc. The text is profusely illustrated throughout.

**NO MONEY DOWN — SEE THESE BOOKS FREE**  
Simply clip and mail this coupon

### MCGRAW-HILL FREE EXAMINATION COUPON

McGraw-Hill Book Company, Inc.  
370 Seventh Avenue, New York

You may send me the Radio Construction Library, three volumes, for 10 days' free examination. I agree to remit an initial payment of \$1.50 at the end of 10 days and \$2.00 a month until the price of \$7.50 is paid—or—I will return the books.

Name.....

Home Address.....

City and State.....

Position.....

Name of Company..... (QST 4-3)



### Short Wave Instruments or Special Receivers and Transmitters built to order

Under Engineering Supervision  
We would be pleased to quote prices on any special apparatus you might require.

Please send complete Specifications.

Still the best in Short Waves. The Short Wave "Four"..... \$69.50

W.E.E. Calibrated Wavemeter in a handsome Walnut Cabinet..... \$12.50

W.E.E. Audio Oscillator..... \$17.50

Send for information on these three items.

**Wireless Egert Engineering, Inc.**  
179 Greenwich St. New York City

vention of the Asociacion E.A.R. at Barcelona. It was a thoroughly enjoyable affair, and everyone got much pleasure from the program of lectures, demonstrations, visits to local radio stations, etc., which had been arranged. Our technical talks were particularly interesting and featured such people as Professor Mesny and Professor Cabrera.

In the "Palacio de Proyecciones" at the International Exposition there was installed an amateur booth where transmitting and receiving apparatus was on display. There was also a very fine collection of QSL cards from all over the world, loaned for the exhibit by various Spanish amateurs.

The Executive Committee of the E.A.R., acting on behalf of all Spanish amateurs, paid a very nice tribute to the President, Mr. Moya, when it presented him with a gold and enamel medal and an inscribed parchment thanking him for his efforts in behalf of amateur radio in Spain and for his work in founding the Asociacion E.A.R. Mr. Moya recently collaborated with the government authorities in working out regulations which provided Spanish amateurs with the maximum of privileges under the provisions of the Washington Conference of 1927 and the Hague Technical Conference of 1929.

The compiler of this department also wishes to express his thanks to Dr. Luis Cirera, of Barcelona, for his kindness in forwarding full details of the amateur convention of the E.A.R., including a copy of the program, and photographs of



SOME OF THE CONTESTANTS IN THE TRANSMITTING AND RECEIVING CONTEST HELD FOR SWEDISH AMATEURS BY THE S. S. A. AT THE RECENT THIRD ANNUAL MORSE COMPETITION.

There seem to have been excellent facilities available for this judging by the amount and arrangement of equipment on the tables.

the amateur booths. It is unfortunate that the photographs did not turn out sufficiently well to reproduce in QST, but we can assure the American hams that the Spanish gang did a thoroughly good job and one which any American club would have to work hard to equal. Congratulations, EAR's!

SWEDEN

By Osborn Duner, Sec'y, S.S.A.

All Swedish amateurs were interested recently in the Third Annual Morse competition of the

# Be a Radio Amateur!

OWN AND OPERATE  
YOUR OWN SHORT-WAVE  
SENDING STATION



• **W**OULD'N'T you like to have your own home-made station and talk to your friends all over the world by dots and dashes? 25,000 radio amateurs in every country of the globe are doing it, 17,000 of them right here in the United States. Join them and get in on the fun. It can be done easily and cheaply!

Every evening thousands of amateurs talk to each other over their home-made stations in almost every city and village in the land, sending messages back and forth. You can do it too! Imagine the thrill of communicating anywhere you wish, of making hundreds of new friends over the air. When storms destroy the telegraph lines in your community you can help in the emergency communication for which amateurs are famous. You can send messages almost anywhere, you can tune in and talk with polar exploring parties and expeditions in the jungles! Amateur radio is the most entrancing of hobbies.

## Send 10c for This Booklet Which Tells You How!

The amateur's association has prepared a fascinating booklet that tells the story of becoming an amateur from start to finish. It tells you about the short waves, how to get started, how to build a fine but simple transmitter and receiver at home from inexpensive parts, how to learn the code easily, how to talk to other amateurs in amateur language, how to operate your station. Everything is here and in simple words — nothing left out. Complete descriptions, detailed instructions, many clear illustrations, and written so you can understand it.

Send in your 10c to-day for a copy of "How To Become a Radio Amateur." It will start you in the most thrilling hobby you ever entered, and we'll guarantee it will be the biggest dime's worth you ever received!

### A SUGGESTION TO AMATEURS

**T**HIS beginner's booklet is the finest thing that has ever been published for those friends of yours who would like to be amateurs but don't know how to start. It has been most carefully prepared, handsomely printed, 32 pages  $7\frac{1}{2} \times 10\frac{1}{2}$ , large clear illustrations. It is being sold for considerably less than the cost of publishing and distributing. You need a few copies. Special quantity price, \$1.00 per dozen copies, postpaid.

## AMERICAN RADIO RELAY LEAGUE

1711 Park Street

+ + +

Hartford, Connecticut

## Build Your Own Voltage Multiplier

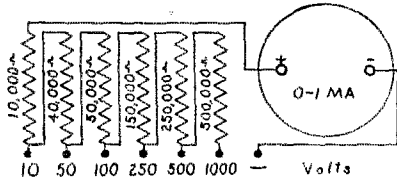

The Super Akra-Ohm wire-wound Resistor is especially adapted for use as a Voltage Multiplier as shown in the above diagram. It is carefully designed to insure an accuracy of 1 per cent and a constant permanency of calibration. Its use is also highly recommended for Laboratory Standards, High Voltage Regulators, Telephone Equipment, and Television Amplifiers, Grid and Plate Resistors, etc.



500—80,000 ohms	.....	\$1.50
90,000—150,000 ohms	.....	2.00
175,000—250,000 ohms	.....	2.50
300,000—500,000 ohms	.....	3.00

**SHUNTS** for increasing the range of milliammeters, \$3.00 each. Let us know your requirements. Specify make, model and range of instrument.

### Ask for Bulletin 62-C

containing voltage multiplier data for the use of Super Akra-Ohm Resistors with milliammeters.



**Shalleross Mfg. Company**



**ELECTRICAL SPECIALTIES**  
100 PARKER AVENUE  
Collingdale, Pa.

## DOUBLE YOUR SPEED

### Make MORE MONEY

Through The **CANDLER SYSTEM** Courses in **Speedhand—High-Speed Telegraphing and Telegraph Touch-Typewriting.**

**Speedhand** — A complete system of telegraphic-code shorthand. Increases transmitting speed 50% in one day. Send whole words instead of single letters. Big demand for Speedhand-code operators.

**The Candler System Course in High-Speed Telegraphing** — A course of training for Radio Operators, designed to bring about complete **Co-ordination** of all the facilities used in telegraphing so that sending and receiving becomes **easy and natural**. McElroy, world's champion radio operator endorses no other course.

**Telegraph Touch-Typewriting** — the only typing course teaching the correct use of the "mill" in telegraphy. Doubles typing speed in few days. Employers of radio operators are constantly seeking operators who have the ability and courage to do **FAST** work. These courses are **guaranteed** to develop **SPEED** in any operator. **Money back if not satisfied.** Write for particulars. State if interested in combined or separate courses.



**THE CANDLER SYSTEM CO.**  
6343 S. Kedzie Ave., Dept. RL  
Chicago, Ill.



Walter H. Candler  
Former World's Champion Operator and Author of The Candler System Courses

Swedish Transmitting Amateur Clubs (S.S.A.). The winner was Mr. Goran Kruse, SM5TN, with a speed of 25 words per minute. FB! He received a silver cup and also the first challenge cup for the championship trophy which consists of a golden key (Ericsson type) presented by SM6UA and SM5TC.

The competitors in the match were divided into three classes: the first class was for speeds between 20 and 25 w.p.m.; the second class for 12-16 w.p.m. and the third class from 6-10 w.p.m. Prizes were distributed for the winners in each class; there was also an honorary prize for the best transmitter. The competition was held in the rooms of the Royal Swedish Telegraph Administration, and a great deal of interest was shown by hams from all over the country. The photograph shows some of the contestants about to start.

W.A.C. CLUB

### Certificates issued during 1927

E. F. Reynolds, nu2MK; C. E. Jackson, nu-2AHM; Martin Solotar, nu2CYX; J. C. and L. A. Primavesi, nu2AK; A. F. Parietti, nu1BU; L. U. and T. E. Bryant, nu4BL; W. P. Ingersoll, nu9BHT; Lyndon Farwell, nu6ZAT; J. W. Riddiough, eg5SZ; Harold Hartman, nu5QL; A. Balling, nu8ALY; R. Munday, eg5MA; A. J. Jacobs, foA5X; Robert Baer, nu1VC; Horatio Seymour, nu6VZ; Walter G. Smith, nu6CCT; Everett Kick, nu7EK; H. L. Palmer, eg6TD; Leon Schlegel, sc2AS; John F. Grinan, nj2PZ; Jack Nutt, nu6VC; Robert E. Henry, nu9ARA; R. W. Bailey, eg2QB; V. Gramich, ek4UAH; H. H. Green, nu5AQ; W. J. L'Ecuyer, nu1ALR; the station of the 12th Signal Co., Phil. Div., U. S. Army, Ft. William McKinley, Rizal, P. I., op1HR; J. M. Hayes, nu6BAV; Leo Wilber, nu1MV; G. W. G. Benzie, ai2BG; H. L. O'Hefernan, eg5BY; Orrin H. Brown, nu6CKV; B. Hill, foA3Z; E. A. Dedman, eg2NH; R. Pollock, eg5KU; H. Brian Wilson, ac8HB; Bruce Boyd, nu1PY; F. J. Quement, nu6NX; Melvin D. Whiteman, nu6CDW; N. Shrimpton, oz4AO; David Buchanan, oz3AR; Charles Nagata, nu7DF; Stanley W. Lang, nu1AZD; G. N. P. Alloway, foA3X; F. J. Singleton, eg5UW; Bruno Brunacci, ei1GW; L. E. Martin, nu6KB; R. Chilton, oa2RC; Louis Fra, eb4BC; T. C. Simonsen, sb2AS; German Sarbach, saGA2; Dave Sloan, nu7RL; C. Merwin Lewis, nu9CCS; Robert Oxenham, foA4L; Walter M. Bolinger, nu6BUX; Carlos E. Juele, nu1FB; Marcus F. J. Samuel, eg5HS; Nat Pomeranz, nu2APD; station of the A.R.L., ei1RM; William Crim, nu6AZS; Walter Jennings, nu1ON; Charles H. Green, eg6YD; G. W. Thomas, eg5YK; Russell D. Valentine, nu2GX; Oliver Seely, nu6BJI; Wayne Taylor, nu5AUZ; J. F. de Younge, nu2MD; A. E. Bessey, nu6DFE; C. W. Park, nu6AOI; Ricardo Walder, nu1CD; G. I. Jones, nu9AEK; Lawrence Higgins, nu6CAE; Don C. Wallace, nu6AM; W. M. Crockett, oz4AM; Tom Jentges, nu6BXI; William J. Zeidlic, nu5WZ;



# PERRYMAN

## Rectifiers

P. R. 872 - P. R. 866

### HOT CATHODE MERCURY VAPOR TUBES



**P. R. 872**  
 Fil. Volts 5  
 Fil. Amps. 10  
 Peak Inverse Volts, 5,000  
 Peak Plate Amps., 2.5  
 Voltage Drop 15  
 Overall Length 8 1/2"  
 " Diam. 2-5/16"  
 Price . . . \$18.00

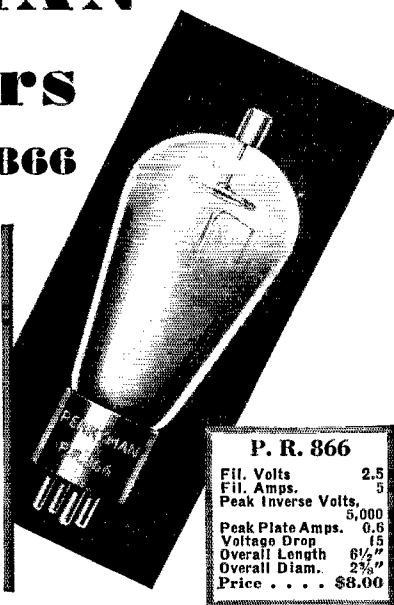

**P. R. 866**  
 Fil. Volts 2.5  
 Fil. Amps. 5  
 Peak Inverse Volts, 5,000  
 Peak Plate Amps. 0.6  
 Voltage Drop 15  
 Overall Length 6 1/2"  
 Overall Diam. 2 3/8"  
 Price . . . \$8.00

**T**HE P. R. 872 and P. R. 866 have met with instant acceptance by transmitting amateurs. Transmitting amateurs tell us these two new tubes fill their need for a reserve supply of rectified current.

The P. R. 872 furnishes an extra large supply of rectified current. It has more than four times the capacity of the P. R. 866. The P. R. 866 is suitable for the transmitting amateur who needs 0.6 ampere maximum output. Because the P. R. 872 and the P. R. 866 possess a low and practically constant voltage drop, both tubes furnish a stable source of plate voltage.

Built with the same rugged strength for which all Perryman Tubes are famous, combined with the low operating temperature of the oxide-coated filament and the extremely low voltage drop resulting from the mercury content, the P. R. 872 and the P. R. 866 open new fields for amateurs.

### SPECIAL, ATTRACTIVE PROPOSITION FOR LICENSED AMATEURS

#### FOR LOW-POWER TRANSMISSION

P. A. 250 . . . \$11.00

P. A. 245 . . . 3.50

P. A. 210A . . . 9.00

(Oxide-coated filament, standard 210 characteristics)

The same rugged construction which has made Perryman tubes famous, assures extremely uniform characteristics. These tubes operate on guaranteed grid current at the rated voltages. Each of these tubes is specially selected and tested to suit the particular requirements of radio amateurs.

PERRYMAN ELECTRIC CO., INC., 4901 Hudson Boulevard, North Bergen, N. J.

Please send me the following tubes:

..... P. R. 872 @ \$18.00  
 ..... P. R. 866 @ 8.00  
 ..... P. A. 250 @ 11.00  
 ..... P. A. 245 @ 3.50  
 ..... P. A. 210A @ 9.00

for which I am enclosing (Money order) for \$.....  
 (Check)

Name..... Station.....

Street.....

City..... State.....

# Heavy going!

PROPER power control is necessary to propel your automobile through the winter drifts.

The music from your radio receiver, wallowing through the sleets of static and the storms of internal self-inflicted noises, needs ample power PROPERLY CONTROLLED.

That's where the scientifically calibrated CENTRALAB volume control plays a major part in the proper performance of your radio.

For smooth, quiet operation insist that your radio be CENTRALAB equipped.

Write Dept. 320 F, For Free Booklet  
"Volume Control  
Voltage Control  
and Their Uses"

## Centralab

Central Radio Laboratories

Dept. 320 F, Keefe Ave. and Humboldt.

MILWAUKEE, WIS.

## America's

most highly endorsed, best written and most up-to-date radio text and reference book

# "RADIO THEORY & OPERATING"

992 Pages

800 Illustrations

By MARY TEXANNA LOOMIS

President, and Lecturer on Radio, Loomis Radio College, Member Institute of Radio Engineers

Now nearing 50,000 circulation. Adopted and used by all the Government radio schools, all the leading radio schools of this country and Canada, and nearly 400 universities, technical colleges and high schools. Why bother about having a dozen or more radio books when this covers everything? And the price is only —

**\$3.50 — Postage Paid**

47 chapters covering the entire subject, including Television, Radio Construction, Radio Repairing, Radio Servicing, Marine Radio Operating, Radio Compass Work, Land Radio Operating, Broadcasting, Airways Communications, Message Forms, 1929 Radio Laws, Latest Diagrams, Junior Engineering.

For sale by practically all bookdealers this and foreign countries. Or sent, postage paid, on receipt check or money order.

**LOOMIS PUBLISHING COMPANY**

Dept. 5

WASHINGTON, D. C.

Eric Megaw, gi6MU; Jorge Bernain, sc2AB; A. R. Goodman, foA6A; John A. Lucas, oh6BDL; G. Homem de Mello, sb2AX.  
Some list, isn't it!

## Calls Heard

(Continued from page 55)

w1ajq w1zaf w1axn w1rm w1aio w1aj w2asn w2rq w2ato w2man w2amr w2bai w2mbi w2kj w2zai w2nr w2tau w2wa w2afj w3pa w3anh w3au w3arp w4pr w4tn w8dax w8ddq w8ell w8upa w8anb w8at w8at ce3ae w8rv w8rux w8mb w8t2a w8il w8lot w8uaw w8uca w8utr w8uor w8uca w8am fm8ax fm8kr fm8ht fm8tr149 frear153 freari g5fj g5hz g5vu g5zn g5ak g5br g5wf haf3a haf3a haf9a k4am k4us oh1j oh2nd oh4ow ok1kt ok1ex ok1va ok2ua ok3ha ok4ar ok4ka oz1k oz7mk pa0vz pa0xa pa0xyz pa0la pa0ja pa0uv pa0jr pa0xf sm5tn sm6ua sm7rv tiaac z1lav z1las z54f

OZ1A, Niels Jacobsen, 29 Bredgade, Copenhagen, Denmark

7000-kiloocycles

ap7ax au7bg au8at ka1ze yi2gq

14,000 kiloocycles

aulac au1ap au7ab au7ae au7kad au7kap fa8bak fk2ms fk6er fmsbg fmsgko fmskik fmsrit fu6er lu2fi pk1jr pk4ba pw2ad pylah suskw su8rs su8uy us7ap velbr ve3fl ve4ou ve5ao ve8aw vk2ho vk3ox vk6mu v08ae vu2dr vq2ac w1ae w1aep w1afb w1anz w1apq w1aze w1ber w1bil w1bkg w1bsm w1ecz w1eck w1da w1dai w1dp w1kr w1om w1ra w1rw w1vc w1wb w2ady w2aox w2aoi w2arb w2bih w2biv w2bjg w2bka w2bjk w2fp w2jn w2mb w2rs w3ajd w3eq w3mv w4aef w6zzk w7ed w8axa w8eab w8eep w8dme w8hx w9et y1lac y1mdz z1lar z1lfr z1lfw z1zaw z1zaj z1zas z51p z52n z53m z55w z6za z6zn

Lawrence R. Mitchell, 1106 Kenneth Drive, Lakewood, Ohio

3500-3550-kc. 'phone stations

w1bmn w1qo w1ajt w1aby w2box w2baa w2alk w2hk w2nj w2fr w2aja w2aow w2ced w2uay w2bsh w2fu w2bre w3pz w3ain w3ak w3qo w3aer w3alz w4an w4oo w4ce w4pd w4akt w4abo w4bx w4awp w5tx w5awg w7ant w8bin w8dpd w8ou w8axx w8aou w8rsw w8ih w8wm w8bok w8ahz w8adf w8bux w8dbq w8doo w8rl w8ddl w8akw w8ajh w8bao w8bjw w8dal w8dbu w8ce w8bnc w8cea w8ewu w8bvc w8afq w8azo w8aos w8bxv w8buw w8awa w8bri w8bf w8dot w8ej w8aju w8blu w8diz w8wf w8aer w8dia w8pd w8qsl w8aoo w8bxb w8did w8bwx w8ard w8auf w8brz w8def w8rd w8dke w8awt w8bao w8lt w8hi w8agu w8bat w8aol w8dce w8dap w8aiw w8ahf w8dvn w8ald w8dec w8afe w8bys w8dep w8cjb w9mm w9gin w9dep w9day w9avu w9eme w9agx w9ahq w9eme w9fnt w9fot w9esl w9flz w9efq w9auf w9eng w9eym w9fld w9lew w9abh w9eno w9gik w9agx w9dho w9aeg w9ful w9fuj w9eyv w9bag w9bch w9lff w9dt w9for w9dj w9ent w9aum w9gkx w9dkx w9deq w9aer w9fls w9dxo w9eri w9eqx w9aei w9gkl w9gw w9fke w9dxt w9fmi w9bty w9gaj w9efe w9ewx w9gaq w9bwi w9daq w9bce w9dho w9edg w9ejw w9fio w9ceg w9ewo w9cem w9cei

F8XD, QSLL via R.E.F.

7000-kc. band

w1ajx w1pk w1cja w1aol w1abn w1aw w1auk w1aje w1afb w1aje w1ja w1ara w1ejj w1bds w1aw w1afq w1cpt w1bds w1eou w1ekd w1ea w1ard w1ent w2fa w1gn w2sm w2cvj w2eny w2ewk w2boa w2af w2enn w2kj w2bjb w2avm w2bvy w2cxl w2bmm w2bjg w2bpx w2afz w2bia w2aur w2ku w2alo w2auu w2bai w3bre w3bm w3nt w3la w3ard w3or w3eab w3aah w3nk w3kr w3ux w3bph w3aiy w4ua w4ng w4we w4af w4ft w4aef w4gl w4ei w4ik w4ec w4mm w4akt w4aii w4fr w4ajk w4adm w4efm w4enh w4bti w4bpy w4baz w4da w4ec w4eld w4bd w4eca w4oa w4nnc cm2ek

## THORDARSON TRANSFORMER

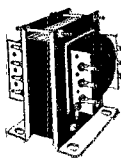

150 watts, 400 volts each side of centre tap at 375 M. A. 5 volt filament, centre tap. Fine for power supply for 7½ water or for crystal control power supply. Specially priced for a short time only. Each \$3.95

# LEEDS

The Home of RADIO  
45 VESEY STREET  
NEW YORK

New York's Headquarters for  
Transmitting Apparatus  
When in Town Visit Our Store

## THORDARSON B-Eliminator TRANSFORMER

using the Raytheon B-H tube. Will carry the maximum current consumption without overheating. 285 volts on each side of centre. Lower voltage may be obtained if desired. Listed at \$5. Special NOW only ..\$1.65

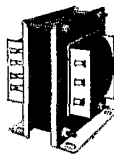

Make your own transmitting and receiving coils. Copper tubing transmitting inductance.

	Size of tubing		
Inside Dia.	3/16"	1/4"	5/16"
2 1/8"	9c	10c	12c*
2 3/8"	9c	10c	15c*
3 1/8"	16c	12c	17c*

Prices per turn

Ham Green, double silk covered, No. 16 receiving inductance.

2" diameter ..... 30c per inch  
3" diameter ..... 35c per inch

EVERYTHING IN  
ACME JEWELL PYREX  
BRADLEY FLERON  
THORDARSON  
ELECTRAD NATIONAL  
LYNCH SIGNAL  
FLECHTHEIM  
NATIONAL RECTOULB  
GENERAL RADIO  
CARDWELL  
IN STOCK



## NEON GLOW LAMPS

For wave meter and other uses; candelabra base. ½ watt, 5/8 inch diameter. 1 3/4 inch long over all. Special.....\$1.75

Aluminum Shield cans and panels of every description to order.

## SPECIAL NOTICE

The 6th edition (second printing) of the Handbook contains 6 pages of items you need from time to time. Look for Them.

Write for special folder and prices

## DUBILIER HIGH VOLTAGE FILTER CONDENSER

4 MFD. D.C. Working Voltage 600 V

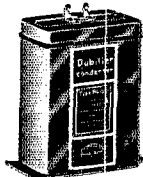

These Filter Condensers are designed for use in filter circuits in Transmitters, and all high Voltage Socket power devices and Power Packs.

**SPECIAL \$2.25**

TYPE PL 571  
List Price \$7.25

## THORDARSON DOUBLE FILTER CHOKES

CONTAINS TWO 18 HENRY 250 MILL CHOKES

Heavy duty, rugged double Filter Reactor for Filter Circuits in Transmitters, Power Amplifiers, "B" Eliminators and various other purposes. Each Choke has a 2000 Volt insulation and the D.C. resistance of each Choke is 108.5 ohms. When connected in series this Filter Reactor has a capacity of 36 henries at 250 mills, and when connected in parallel 18 henries with 500 mills carrying capacity.

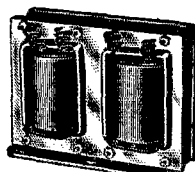

**SPECIAL \$6.25**

MODEL T-2458  
List Price \$19.50

## 1930 SHORT WAVE RECEIVER

A short wave receiver that's got them all beat. Best circuit design and finest mechanical construction. 3-Tube Receiver—detector—2 audio, using three 201-A tubes. Universal type, continuous range 15 to 100 meters; amateur type covers Ham bands 20-40-80 meters with generous spread on the dial. List price \$60. **\$37.50\***  
Special Offer, net .....

## SHORT WAVE X-MITTER

7½ Watt Kirtley type Transmitter. Will operate with a 201-A tube, with 90 volts on the plate, up to a UX-210, with 30 watts input; has plug in transmitting coils. List price—kit \$55. Completely constructed \$70. **\$57.50\***  
Special Offer, completely constructed .....

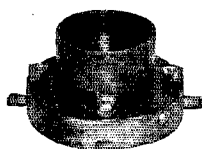

By  
Insistent  
Demand

LEEDS 50-watt socket, positive contact; heavy phosphor bronze springs, heavy brass shell; highest grade porcelain insulated base; will hold your tube in one position. Specially priced.

## LEEDS RADIO LABORATORIES

Precision Custom Built Short Wave Receivers and Transmitters

This department under the supervision of the Short-Wave Specialist Jerome Gross. We design, construct and advise on any material for the "Ham" Broadcasting station or laboratory. Write Jerry Gross for advice on any of your problems.

PLEASE PRINT YOUR NAME AND ADDRESS FLAINLY to AVOID DELAY

WRITE FOR SPECIAL PRICE LIST

MAIL ORDERS FILLED SAME DAY  
10% Cash Must Accompany All C. O. D. Orders

**WHY  
WAIT?**

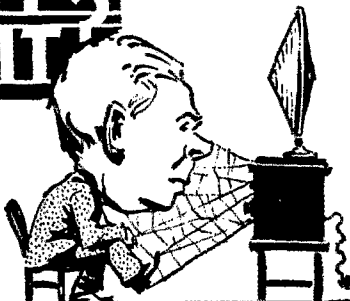

**ARCTURUS**  
*Quick Acting*  
**RADIO TUBES**



**GET PROGRAMS  
IN 7 SECONDS**

**ARCTURUS RADIO TUBE COMPANY**  
NEWARK, NEW JERSEY

14,000-ke. band

k4aan k4acf w1coz w1bux w1fc w1zw w1bw w1eck w1bcb w1cio w1jr w1bit w2ai w2arb w2amr w2acm w2ek w2bjg w2bai w2btr w2evj w2rs w2av w2jn w3ard w3acx w3ajd w3ao w4akt w4ahl w4ajj w4x7f w8ben w8dqv w8sbbj w8wpo w8sadg ve2be ve2bd ve2ap ve5ao ve8z em2jt

**W4AV, William T. Golson, 501 South Appletree St., Dothan, Ala.**

3500-3550-ke. 'phone stations

w3bms w4ia w1hn w4hb w4tm w4co w4qz w4ajb w4an w5awp w5die w5tu w5bhf w5bi w5adf w5aku w5ajh w5dce w5bbd w5afn w5ske w5enu w5aux w5dax w5stv w5djw w9dwi

1750-ke. 'phone stations

w4t w9ojh

**ZI4BH, S. W. Boon, Box 66, Stratford, New Zealand**

w1pi w1ayo w2hse w2so w2dgi w2dqy w7ae w8if w8ber w8daq w9bni w9fxi w9ehx w9bzo w9dnz w9bbl w9bqu x4i

3500-ke. 'phone

w6dix

**ZL1FV, A. Evans, Wairoa Rd., Papakura, Auckland, N. Z.**

w1anz w1aue w1asu w1gh w1cgt w2amr w2arb w2bae w2bjg w2bvq w3jn w3pf w4aei w4kh w4nf w4l w5aep w5awd w5bzg w5bez w5mtu w5mz w5qe w5rg w5za w6aak w6agd w6aye w6bgf w6bhm w6bwf w6bzy w6chd w6exy w6dai w6fs w6sf w6ud w7aao w7aat w7aax w7abh w7aiz w7bb w7ek w7fb w7it w7li w7ll w7lz w7pp w7un w8afh w8axz w8onz w8dbs w8dl d w8dsi w8gz w8ze w8ez w8ex w9fbv w9fid w9gj w9lf w9pp ac1bd ac1sm ac3fr ce1ak ce1av ce3hm ce3ei ce3ci ce3dg ce7aa d4yt f8ey f8fr f8ha f8ho f8lgb f8ltp g5bz g5tz g6vp g6wt j2cb j2gk j3fa j4dk lu3pa lu8ei lu9dt oa4h oa4j oa4r oa4s oa5a pk4bf pk4bo vs6ab vs6ae vs6af vs6ah sp3ba

**W8EZ, Thomas Hale, 2412 Front St., Cuyahoga Falls, Ohio**

14,000-ke. band

w6ael w6afi w6al w6aoe w6bam w6bax w6bev w6bip w6bnj w6bpn w6brk w6bto w6bux w6cks w6evi w6exw w6dgn w6dmk w6dqx w6dyv w6egy w6ehi w6eie w6eje w6eqb w6esf w6esq w6eug w6fe w6id w6lk w6qc w6uz w6vq w7aar w7acx w7adb w6aiz w7ame w7anj w7ic w7be w7li ce2bm ce5aa cm8uf et1aa et1ce f8fk f8go f8hr f8jm f8lgb f8lx g2op g5ms g6qo he2jm lu1ba lu2oa lu3del u5ao lu5ad lu8en lu9ce lu9dt n2pa nn1ic oa4j oa4t oa4bo oa4gn oa4hp oa4j oa4j py1aw py1fm py1fb py2ay py2ba py2ik ve5ao ve5am ve5bh vk3mo vq2pa z13as za4m z5ip z5u z4lr

7000-ke. band

en1nn f8lr f8tpz z12be z13az w6ake w6ajm w6axm w6awg w6bck w6beb w6ben w6bpc w6bq w6ban w6bva w6by w6ch w6cjr w6crj w6bgg w6dni w6dpa w6edy w6eh w6ehz w6em w6ew w6tq w6ys w7abq w7ajh w7kt w7li w7mo w7jt

**W2RD, Kenneth MacLea, 7 Brook Rd., Bronxville, New York**

7000-ke. band

w6ahp w6akw w6al w6am w6aoj w6asg w6aui w6auk w6aum w6avh w6bex w6beb w6bet w6bft w6bif w6bjf w6bq w6btz w6bui w6bxv w6by w6egx w6ei w6eks w6eq w6osq w6eto w6exw w6czk w6dgv w6dj w6djw w6dkw w6dlx w6dpj w6dqf w6dsp w6dss w6eau w6ebg w6edg w6eks w6eqy w6eva w6ewf w6ft w6jn w6jq w6sf w6sj w6tm w6ud w6wb w7aah w7aar w7acq w7ah w7aho w7ait w7aiz w7aju w7auj ex7 k4acf k4aan k4kd k4dk k4fr6 kd5v kvd k4z nncab nn1ic nn1so nn7s nn7ex x1nq x3a x3q x29a x55 cm1bu cm8uf cm8ex cm2sh cm8yb hel1g en8mb en8mc en8rx ear21 ear91 ear98 ear113 ear153 ill f8dy f8er f8el f8ney f8bk f8nox f8jq et1as et2ao

**PIERCE AIRO** Cardwell Connector  
Dubilier Weston Electrical Instruments  
RADIO ENGINEERING LABORATORIES  
Gordon  
Raytheon  
Ward Leonard  
Farrand  
Rajah  
Knapp  
ELKON  
PARVOLTS  
HOWARD  
AD. AURIEMA, INC.  
Manufacturer's Export Managers  
216 Broad Street, New York, N. Y.  
Scientifically equipped to economically export dependable receiving and transmitting radio apparatus

# BARGAINS

# ARMY AND NAVY RADIO SURPLUS

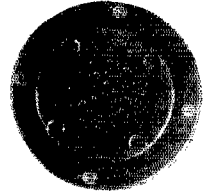
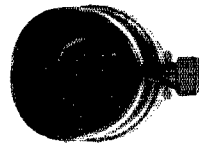
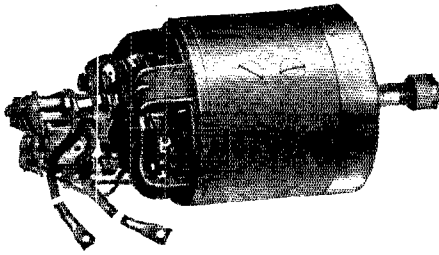

Generator, airplane. Signal corps, with shaft, can be used as motor, 12 volt 33.6 amps. 5000 R.P.M.....	\$10.00
Generators, 12 volt, 60 amp. has automatic controls.....	20.00
West. Elec. Dynamotor, C.W. 927, two D.C. 32/350 volt dynamotors in noiseless hangar. Used in parallel gives 160 mls at 350 volts, series gives 80 mls. 700 volts, suitable for xmitters and receivers.....	25.00
Single dynamotor 32/350 volt.....	15.00
West. Elec. switchbd. control panel for above dynamotors, has switches, 0-50-500 voltmeter, complete filter system, etc. Special.....	8.00
Ampere hour meter, Sangamo, battery charge and discharge, type MS 0-500 scale, capacity 15 amp.....	10.00
Milliammeter, Westinghouse, 0-150 surface mtg., b. con.	5.00
Ammeter, Weston No. 425 thermo-couple 0-2 amp., mtd. on large bakelite base with D.P. hi voltage switch.....	7.50
Milliammeter, Westinghouse, type C.A. 0-500, zero adjustment, flush mounting.....	5.00
Voltmeter, Westinghouse, type C.A. 0-25, zero adjustment, flush mounting.....	5.00
Voltmeter, Westinghouse, A.C. 8" diameter with external resistance 0-175 volts, 60 cycle power house type.....	12.50
Voltmeter, Westinghouse model P.T. 3 scale, 0-5, 0-7.5, 0-150 for measuring A, B and C voltages, portable bakelite case. Special.....	3.00
Motor generator, Crocker Wheeler, 110 D.C. 220 A.C., 500 watt, 500 cycle. Ball bearing.....	50.00
Complete line 500 cycle motor generators ¼ to 5 K.W. Prices on request.	
Transformers, General Electric, 125 to 2500, with center tap, 60 cycle, 200 watt.....	7.50
Transformers, Simon, 220 to 11,500 closed core, ½ K.W., 500 cycle, "pancake" secondary.....	5.00
Transformer, Amertran, oil immersed, 1 K.W., 500 cycle, 220/8000 volt.....	10.00
Condensers, transmitting, Murdock .0017 mfd. 12,000 volt, ideal for plate blocking.....	2.50
Condensers, Wireless Specialty, copper glass leyden jar, 10,000 working voltage .002 mfd.....	2.00
Condenser, Dubilier, mica, op. volts 12,000 cap .0004.....	10.00
Condenser, Dubilier, mica, volts 40,000 cap .0012-.001-.0008 or .003.....	30.00
Condenser, Dubilier, mica, op. volts 8500 cap .004.....	10.00
Condenser, Dubilier and Wireless Specialty, op. volts 12,500 cap .004.....	12.50 to 20.00
Headphones, West. Electric No. 194W same as C.W. 834, 2200 ohms.....	5.00

Holtzer Cabot, Utah type, carbon granular transmitter. Special.....	\$ .95
Western Electric Radiophone Transmitter unit, 320W. Special.....	\$1.50
Dynamotor, GE Navy Airplanes 24/750 volts. Aluminum frame, unusually good for airplane test work. Specially priced, 200 mls.....	25.00
NAVY Dynamotors General Electric 24/1500 volt. 233 mls.....	37.50
Edison storage battery cells, nickel alkali, 225 amp. hour, 1.2 volt type A-6, weight per cell 20 lbs.....	4.00
Coils, Retardation, West. Elec. Co. 57C, 83 ohm, 2 windings.....	1.00
Telegraph and buzzer portable sets, mahogany case, 2 tone 4 contact platinum contact high frequency buzzer, 2 telephone toggle switches, potentiometer, sending key, 3 mfd. condensers, transformer and 2 choke coils, receiver, \$30. value.....	5.00
Magnetos, Army mine and ringer type, 4 large magnets..	1.00
Battery, U. S. Army, lead-acid type, 10 volt, 20 ampere hour. Consisting of 5 individual 2 volt cells in carrying case.....	5.00
Sounders, Signal Corps, 120 ohms, adjustable.....	2.50
Generators, Westinghouse 110 volt, A.C. 900 cycles, 200 watts, self excited.....	15.00
Voltmeters, D.C. portable new Weston model 45, 3 scale 0-3-15-150 guaranteed ¼ of 1% accurate.....	40.00
Ammeters, D.C. portable, new Weston model 45, 3 scale 0-1.5-15-150 with 3 scale external shunt and leads ¼ of 1% accurate.....	40.00
Headphones, Holtzer Cabot, U. S. Navy, 80 ohm.....	.75
Headphone, Army, with strap, 120 ohm.....	.75
Headphone, Radio School, leather headband, 75 ohm....	1.50
Keys, transmitting, Navy, back connected on bakelite base. 2 kw., ½-inch silver contact.....	5.00
Keys, transmitting, Airplane flameproof, silver ¾" contacts, with blinker light mounted on bakelite base..	2.00
Charging panel, Navy type, S.E. 839, 32 volt, Ward-Leonard, var. and fixed res., Weston voltmeter and ammeter, Sangamo ampere hour meter. Complete with all switches.....	30.00
Buzzers, Western Electric. Extra quality, high frequency	1.50
Receivers, Navy, C.N. 113, 300-2500 meters, crystals....	7.50
Receivers, Navy, C.N. 240, 1000-10,000 meters.....	50.00
Receivers, S.E. 143 and I.P. 500.....	100-150
Amplifier, W.E. Radiophone, C.W. 926.....	15.00
Heterodyne, Signal Corps, type B.C. 104, 1000 to 3000 meters, with detector.....	15.00
Loudspeaker Unit, Western Electric, 193 W. Ideal for monitoring transmitter.....	3.00
Receiver, Type 122, 175-775 meters. Especially recommended for "standby" for coastal Broadcast stations as required by Dept. of Commerce.....	50.00
Air compressors, Kulllogg, Model T, 1 ¼ cu. ft. per min. weight 6 lbs., 600 R.P.M., 125-lb. pressure. Requires ¼ h.p.....	3.00
Motor generator, R & M, 110 D.C. 3 ¼ h.p., 2 kw, 20 volt D.C. 80 amp. Great for large station filament supply. Price on request.	125.00
SPECIAL — U. S. Army instruction book on telephony and telegraphy. Hundreds of pictures and diagrams..	1.00

Largest Radio and Electric Supply House in U. S. specializing on Army and Navy Surplus. Sufficient postage and deposit of 20% required on C.O.D. orders. NO C.O.D. ON CANADIAN ORDERS. DUE TO LIMITED GOV'T SURPLUS, WE DO NOT ISSUE CATALOGS.

**MANHATTAN ELECTRIC BARGAIN HOUSE, Dept. Q, 105-7 Fulton St., New York City**

# SAY OB

We have important news for you if you are an Active Ham and desire to get the best results from your station — new circuits and new tubes have just been developed by us and will be released to Amateurs immediately thru our descriptive circular — A penny is all that it costs to be informed — Send in your station card **RIGHT NOW** — find out about the "PHONOFORMER" and the new tubes!!!

A new **RECTOBULB** now available which will handle a peak load of 4 amps. — this is the R4 and uses 10 volts filament at 2.5 amps. — Peak inverse voltage 9000 V.

Type R3 a 3000 volt rectifier at 250 mls. Type R81 a 750 volt rectifier at 150 mls. Do not overlook the fact that our **RECTOBULBS** with heavy cathode are more rugged and long lived than a ribbon type tube and cost no more. **INSIST ON RECTOBULBS.**

### PRICES

TYPE R4.....	\$24.00
TYPE R3.....	10.00
TYPE R81.....	7.00

### New Tubes

N10. Class "C" amplifier.....	\$12.50
N65. Screen Grid amplifier.....	12.50
N50. Power Amplifier.....	11.00

### NATIONAL REPAIRS

UX852-UX860.....	\$16.50-\$25.00
UV203A-UV211-UV845.....	19.00
UV204-UV204A.....	40.00- 60.00
WE211-WE212.....	15.00- 35.00

### FOR LIVE HAMS!!!!

We have some new circuits — new tubes! It will be some time before they are released for the general public — If you will mail in your station card or a letter we will place your name on our mailing list and you will get the advance dope — **WRITE TO-DAY.**

## NATIONAL RADIO TUBE CO.

3420 EIGHTEENTH ST. SAN FRANCISCO.

# THE A.R.R.L. LOG SHEET

A well-kept log gives proof of station transmissions. When visitors (which may include the Supervisor of Radio) inspect your station, the presence of a log at once identifies your station as a systematic one. It is invaluable in checking up the records of your work.

Next only to an accurate frequency standard, a log is the indispensable adjunct to the operation of an amateur station.

To encourage greater use of the standard A.R.R.L. log sheet its price has been greatly reduced.

100 sheets.....	50c
250 sheets.....	\$1.00
500 sheets.....	1.75

(Postpaid)

## THE AMERICAN RADIO RELAY LEAGUE

Hartford, Conn., U.S.A.

on4ac on4pr dn4fq on4ug t88do ok2bj czlk cx1ew g5by sn1aa par wsq eu2ac ei8b pa1ml ym2iq vk2ak vk2kj vk2hu vk2no vk2ns vk2ow vk3bq vk3hk vk3mm vk3pp vk3qi vk3rg vk3tl vk4cm vk5do vk5gi vk5hg vk5lf vk5vr vk6il z1ft z2gl z3ci z3cm

14,000-ko. band

cm8uf cm2jt cm2sh cm2jm ce5aa ce3bf ct1aa ct1bx cx1fo d1bj ear21 f8fr g2ad g2bm g2op g5by g5ml g5wk g6aw g6vp g6vr hc2ea hc2jm lu2aa lu3de lu5ak nj2pa on4j on4r on4he on4rd on4uf py1ah py1au py1aw py1ax py1cr py2ik ti2hv vk3go vo8ae vo8aw vo8mc wdde wia k4aan k4kd k4kl vq4er ve5ao x9a x7c zs2n z44m z55u zt1t

*W8DDK, Hosea Decker, 44 Campbell St., Delaware, Ohio*

7000-ko. band

cm5fl ct1bx ct2ao cn8rux hel1g k4kd k4kl nj2pa vk2hu vk3es vk4cm vk3kr vk3ml vk3mw vk5bj vk5hg vk7bq ve1da vo8mc uoljh

14,000-ko. band

cm8uf ct1aa ct1bx f8fr f8gb f8hr g2ao hc2jm lu2aa on4fp on4hp on4uu py1aw py1bx py21h ve2ca ve3ao vo8ae vo8aw zslz zslp z44m zt1j zt5r

*Elliott C. Hagar, 30 Adams Ave., West Newton, Mass.*

14,000-ko. band

w6aqj w6de ear65 f8es f8da f8dh f8ls f8px f8toy g2gm f8dh f8lx f8px f8toy g2gm g2ma g5fa g5jf g5io g5ml g6vp g5wk g6wt hel1g hj5x k4dr lu2aa lu9dt nj2pa oa4j oa4q on4dk on4fp on4ro on4uu py1aa py1aw ve5ao x9a z1fe z12ac z12aw z12bg z14ap z44m zt1r zt1s

*Mark H. Churton, "Seakew," Wharf Rd., St. Heliers Bay, Auckland, N. Z.*

w1sw w1bdx w1ayo w1fx w1pi w2ag w2sc w3ans w3awu w3agr w3oe w4rn w4zw wr1b w4ll w5om w6bgo w1apa w6ajf w6byh w6emy w6czx w6eqj w6fo w6rj w6dli w6eop w6cte w6anc w6akw w6evr w6dqv w6dfr w6bex w6bdn w6dgc w6bhs w6edk w6dgi w6anui w6atm w6eu w6ar w6bwq w6ayg w6bao w7abq w7ago w7adx w7lf w7nt w7hn w7ew w7wl w7un w8daq w8ahc w8che w8fea w8xe w8ber w8arx w9bca w9bfb w9hdh w9awy w9byf w9ber w9fud w9dle w9bwp w9ael ve4lo

'Phone

w6bbj w6abf w6bjq w6kt

*W8AUU, T. W. Klingel, 205 Crestwood Ave., Buffalo, N. Y.*

1ap ce1av ce2bm ce3ag ce3bg ce3bm cm2jt cm8uf cm2iq ct1aa ct1bx ear21 ear16 f8mrg f8wh f8sm g2nh g5by g5bd g5lw g5yx g6wl g6rb g6vp hc2jm klaq k4aan k4akv k4kd ktu5 lu3dh lu3fa nj2pa on4j oa4o oa4q on4ea on4jj paow pa1bm py1ah py1br py1cr py1cl py2af q41a sp3xx ti2hv vk2ax vk2rx vk2no vk2hc vk4rj wia w1at x9a z1lan z1lfo z1fb z1fw z1lre z1lrx z12be z12bg z13aj z13cm z14ak zslp z44m

*G6YL, Miss B. Dunn, Felton, Northumberland, England*

w1baf w1bds w1mk w1si w2amh w2amr w2box w2ewk w2exl w2ju w2kj w2ku w2nq w2tw w3anh w4ft w4va w8baz w8em w9bsh frear149 frear153 frear1 fm8asun fmsbg fm8mt fm8rit fm8tui cn8eis cn8mc cn8rux xeu2ao oy5or k4aan k4kb k4kd ts4sbr ts4sun ux7oc yi2gg au7aa au8an z44e z12ab z1g1om g1yz kgfc

*W2HY, George Petersen, S20 40th St., Brooklyn, N. Y.*

3500-ko. band

w1aar w1aby w1afa w1aji w1ajt w1aky w1adx w1awy w1aud w1bbm w1blh w1bmb w1bdd w1cz w1qk w1ry w2aca w2aja w2ajx w2alk w2ami w2adm w2apf w2baj w2bcv w2bdz w2doz w2bqu w2byy w2obe w2ocd w2ckg w2fr w2gj w2gl w2sh w2st w2wk w2abn w3aek w3aex w3ain w3alq w3alz w3bfz w3cgd w3cew w3jz w3mp w3vb w3wi w42f w4ev w4hn w4pw w4aed w4ael w8ajh w8apn w8ars w8bal w8bth w8bys w8cib w8css w8dbq w8dtk w8iit

# SM

## And Now the 677B —a Really Humless '45 Amplifier!

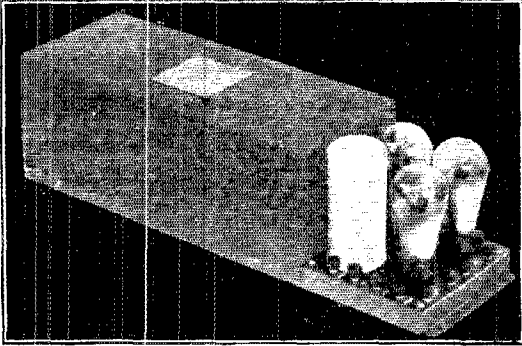

### Finest of Tuners

The S-M 712 Screen-Grid Tuner (ideal companion to the new 677B) is absolutely guaranteed to out-distance and out-perform all competition regardless of price.

And it should lead the field—it's a refinement of the famous Sargent-Rayment 710, that led the field all last season. It employs five tuned circuits, the first two in a pre-selector, followed by three cascaded tuned circuits—the sharpest combination known. Tubes required: 3—'24, 1—'27.

Tuner, wired, less tubes, \$64.90. Parts, \$40.90.

A combination amplifier and power supply with plenty of wallop for dancing in any home—and as quiet as a mouse! That describes the new S-M 677B.

It is designed for those who want the best possible amplifier for a 712 or similar tuner, to furnish the necessary heater and plate supply current. It takes its input from the detector of the receiver, and its power from any 105-120 volt, 50-60 cycle source.

It also supplies field excitation to an 1800-2000 ohm d.c. speaker. The S-M 851 type is recommended, since it not only has the proper d.c. field resistance, but sufficient effective inductance to insure proper filtration.

The 677B has an excellent frequency characteristic—flat (to within 2 decibels) from 60 to 6000 cycles. It may be used with a pickup input by using an external 255P, 255R, 255M or standard 255 transformer.

If you have a 677 amplifier that you want to make absolutely humless for home use, write for the 677B Conversion Sheet.

Tubes required: 1—'27, 2—'45, 1—'80.

677B priced complete, less tubes, \$56.20. Parts total \$41.00.

The S-M 677, ideal amplifier for small auditorium work, is priced, completely wired, at \$58.50. Parts total \$43.40.

### New Auditorium Speakers and New Prices

Four new auditorium speakers have been added to the S-M line—the 860, 861, 862, and 863. Sound tests and curves run on them by three of the best laboratories in the country show them to be far in advance of any others. The 862 and 863 are the 860 and 861 (illustrated) less input transformer and are especially adaptable for use with amplifiers like the new S-M 692, having a low output impedance.

860—110 v., 60 cycle, auditorium....\$36.00	861—110 v., d.c..\$29.12
862—(860 less input trans.)..... 33.12	863—110 v., d.c... 26.20

Universally bought because of their superior performance, irrespective of price, the S-M 850 and 851 speakers at new prices (made possible by market conditions) are more than ever real "buys."

850—110 volt, a.c. electro-dynamic...\$27.12	851—110 v., d.c...\$20.12
852—Same as 850 less input trans.... 23.32	853—110 v., d.c... 16.32

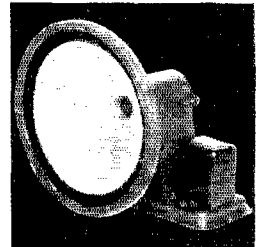

The Radiobuilder, Silver-Marshall's publication telling the very latest developments of the laboratories, is too valuable for any setbuilder to be without. Send the coupon for a free sample copy. If you want it regularly, enclose 50c for next 12 issues.

Over 3,000 Authorized S-M Service Stations are being operated. Write for information on the franchise.

**SILVER-MARSHALL, Inc.,** 6409 WEST 65TH ST. CHICAGO, ILL. U. S. A.

Silver-Marshall, Inc.  
6409 West 65th St., Chicago, U. S. A.  
... Send your latest catalog, with sample copy of the Radiobuilder.  
... For enclosed 10c, send five new S-M Data Sheets, including those on the 677B and the 712.

Name.....

Address.....

# T M U

New Model  
Transmitting  
Condensers

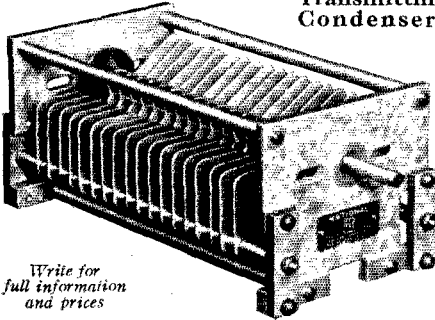

Write for  
full information  
and prices

Made in two series: 5000 volt and 7500 volt, with all the very latest features for efficiency and steadiness of signal. Plates have rounded edges, and similar fine points of design and sturdy construction will be found throughout. We can furnish Micalex insulation for condensers intended for experimental and non-commercial uses and are also equipped to furnish Krolite hard-rubber or other standard insulating materials.

## NATIONAL TRANSMITTING EQUIPMENT

NATIONAL COMPANY, Inc.  
MALDEN, MASS.

Est. 1914  W. A. Ready, Pres.

## Look at These Bargains!!

EVERYTHING GUARANTEED  
MONEY RETURNED IF NOT SATISFIED

More Parcon condensers at less than manufacturer's cost. Every one brand new and tested. Transmitting Filter Condensers, 1000 Volt DC Working; 2 Mid. — \$2.40, 4 Mid. — \$3.95, 6 Mid. — \$5.15, 8 Mid. — \$6.90, 1750 Volt DC Working; 1 Mid. — \$3.70, 2 Mid. — \$5.30, TOBE 800 Volt tapped, metal-cased block; 10 Mid. — \$3.00, 15 Mid. — \$4.25 RCA Stromberg-Carlson 7 Mid., 650 Volt DC working metal-cased filter condensers. — \$2.75, 2 Mid. 450 volt metal-cased. — \$7.75. High-grade unmounted 850 Volt DC Working filter condensers. A quantity of these units may be series-parallelled for any desired capacity and voltage, 2 Mid. — \$7.00 each, four for \$2.60, eight for \$4.80, twelve for \$6.00, 1 Mid. — half-price, U. S. Tool .00014 variable S.F.F. condensers. — \$.98. Heavy Power-pack or transmitter transformer, 100 Watt. Tapped primary. Gives 1 1/2 & 2 1/2 volts and 5, 5, & 650 volts center-tapped. — \$3.60. Special RCA Power Transformer. Designed for use with UV-276 to keep voltage steady. (A resistor may be used in place of the tube.) Gives 7 1/2, 7 1/2, & 1100 Volts center-tapped. Ideal for UX-210 transmitter, master oscillator, or crystal oscillator, 175 Watt, 11 Lbs. WHILE THEY LAST — \$3.95. AmerIran 250 Watt, 7 1/2, 7 1/2, & 1200 center-tapped. — \$3.95. Metal-cased filament transformers. Well-constructed, 75 Watt, 7 1/2 Volts — \$2.80, 7 1/2 Center-tapped. — \$3.60, 7 1/2 & 7 1/2 CT — \$4.25, 10 Volt — \$2.95, 10 Center-tapped. — \$3.75. RCA Power Amplifier Audio transformers. Input — \$1.75. Output to dynamic — \$2.10. Well-made power chokes, 30 Henry, 175 Milliamperes. — \$2.25, 30 H, 120 MA — \$1.75, 2 1/2 Ampere A Eliminator chokes. — \$3.25. Ward-Leonard 5000 ohm, 60 Watt MOUNTED grid-leaks. — \$.85. RCA 5000 ohm, 30 Watt. — \$.55.

Many Other Bargains. Send for "Specials" List

Harrison Radio Co., 35 Ft. Washington Ave., N. Y. City

## AMERICAN SOCIETY OF INVENTORS, INC.

Invites all inventors and prospective inventors to become members. It is a mutual aid society which secures for inventors the greatest returns from their ideas. It is not operated for profit, has no stockholders and its sole aim is to be of service to its members.

For further information write

AMERICAN SOCIETY OF INVENTORS, INC.  
609 Crosby Building, Buffalo, N. Y.

w8il w8mq w9bag w9bjm w9bjw w9bml w9bwi w9cmr  
w9ehd w9fke velak veidq ve2dn

Arthur S. Dean, Box 207, Vegreville, Alberta,  
Canada

'Phone

w5ql w9dd w9ahx w5kx w8acj w8aen ve4hw w8aee w6brg  
w6brk w9abh w9ame w7ant w6dxx w6bjq w6adn w7ane  
w8aik w6ep w9bbg w6biu w6aik

C. W.

w7aww w9dt w6blx w9fwe w9deq w8era f8fx w5adp w7aar  
w8gdh w9ef w9erw w5rg w7ia w9evp w7bhl w6dga w8box  
w8afw w9eqt w8owe w8dxx w9cix ve4bbf w9bpe w9fra  
w7ti w9avi w9fia w4um w9dft w9bpe w9fra w7ti w9avi  
w9fia w4um w9dft w9bpe w9fra w7ti w9avi w9fia w4um  
w9dft w9def w9yc w9gdh w5rg w9dft w9deq w8frq w9bex  
w6auj w9bmx ve4bb ve4el ve4jq ve4gr ve4ee ve4ej ve4se  
w7adb w9bpl w6gi w9ekj w9eps w9bey w6ehi

W7AAR, Fred Clark, Eugene, Oregon

7000-kc. band

z12bx z13cm z1lft z1z1 z13as z1ias z1z2r z13cr vk3es vk2rf  
vk5gr vk2ku vk3gr vk2hk vk4do vk2rt vk3up vk3ow vk3ag  
vk4kt vk0sl k6avi k6alm k6oa k6kx k7aag helig om8uf  
nn7e k4kd ex7 k7abm ae1ts ae8jk x5z x29a kalae kalce  
kaley kalcm kalhr kaltd kaljd kalzc kalxn kalre kalpw

14,000-kc. band

k6boe k6z1z k6bhl ve5aw lu9ce ce7aa ce5aa

W6PQ, Robert J. Woolverton, Presidio of San  
Francisco, Calif.

w2box w4ahl w5ayi w5aan w7aoq w7iz w7wb w7pc w7iz  
w7pe w7tx w7mw w7oj k7aop w8eb w8aab w9cmf w9dvo  
w9qf w9eol w9ciy w9fe

W9FLK, J. M. Gowen, 924 Second Ave., West 10th  
St., Sibley, Iowa

ve2ay ve3cz ve3dd ve3zz ve4aj ve4arv ve4bo ve4ou ve4ee  
ve4fk ve4fr vk3jk vk3pa vek3pp vk7lj et1aa

W8BRJ, Oakmont, Pa.

f8er heldr helig k4aan k4kd nn7j rx1ae vk3kr vk3jy  
vk3or vk3rg vk4cm vk4lu vk5it z13cm z13ms

W8LA, Ralph E. Jackson, Box 226, Frankfort,  
Mich.

f8dh nn1nic em8yb em8lc nn1fx nj2pa k4aof k6evw on4ka  
k4kd z1zdg z14ao z12be vk3eh vk2hk vk2ku vk2aw vk5hg  
vk2sg s11az

W2AJP, Norman B. Krim, 227 Haven Ave., New  
York City, N. Y.

em2jm em2yb em2xa em8uf em5f8 emz6 em8rux et1bd  
et1ep et2ac et2am d4td ear2l ear98 f8dh f8gi f8jq f8lg  
f8rsj f8er hb9g helig i1dl k4kd k4kd k6avi k6efw nj2pa  
nn1nic nn8nc nn8m nn8nj ok1na ok2et on4iv on4pr oz7eh  
ti2ra ti2wd va2ae ve4bm ve4bq ve4bu ve4ee ve4ih ve4sd  
ve9aj vk2nk vk3ax vk3kr vk3pa vk4ap vk4eq vk5iw z11aa  
z11bb z11be z1flu z12ab z12ac z12df z12gn z13bb z13be z13bu  
z13cm w7aar w7ahw w7agj w7ce w7er w7ek w7fx w7gj  
w7mh w7td w7tj w7ua w7vy w7wp x2x x5z x9a x29a xw1m

NNCAB, G. R. Williams and G. R. Lubnan, U. S.  
Marines, Radio Station, Puerto Cabezas, Nicaragua

emz5 em2ay helig kd5v nj2ap w1adw w1ae w1akt w1bea  
w1bsb w1bv w1cje w1emz w1enz w1lr w1mk w1rv w1wu  
w2alu w3amr w2anx w2aof w2apq w2aqk w3as w2ayj w2bak  
w2bmc w2bpf w2bpn w2bsw w2edp w2eal s6gx w2lx w2oa  
w2wt w3afw w3ahs w3aiy w3anh w2api w3ard w3awk  
w3aws w3bph w3bpi w3cdq w3cpe w3jo w3om w3qn w3uh  
w3ut w4abs w4ae w4ag w4ah w4al w4ah w4ao w4apk  
w4apq w4aq w4ax w4em w4dy w4ft w4he w4hu w4ms  
w4ne w4nn w4oi w4pe w4qv w4ru w5aj w4aki w5bex  
w5bhv w5bhw w5bhq w5bil w5bit w5bke w5ke w5mzr  
w5qj w5sy w5ux w5vo w5zg w6am w6bbm w6beb w6bet  
w6bpe w6ei w6ey w6ea w6efe w6eib w6elz w6oj w6xb  
w6zk w8aid w8aj w8bjq w8bpk w8beq w8bt w8bd w8bkp





## Power Transformers

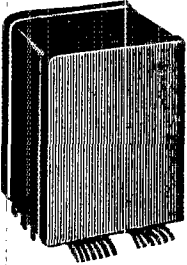

**For UY-224 Screen Grid and UX-245 Power Tubes**

**TYPE GW-380**

This shielded Power Transformer was made by General Electric Company. It is an excellent Power Transformer for making up A. C. Receivers, Power Packs, or converting Battery Sets for A.C. operation.

Size: 5 3/8 x 4 3/4 x 3 1/4"  
Weight 6 1/2 lbs.

Primary voltage 110-120 volts, 50-60 cycles A.C. current, filament rating 60 watts. Rated to supply filament voltage for two 224, three 226, one or two 245 and one 280, also high plate voltage of 600 volts center-tapped for UX-280 tube. This Power Transformer is very conservatively rated and is exceptionally well built.

**SPECIAL \$5.75**



## Double Filter Chokes



**Contains Two 30 Henry 80 Mill Chokes**

This heavy duty, rugged, double Filter Choke is excellent for all types of filter circuits and experimental work in receiving sets, power amplifiers, eliminators, transmitters and various other purposes.

Made by General Electric Company for Radio Corporation of America, and is RCA Replacement Part No. 8336 for the Radiola 33, 18 and 17.

Each Choke has a 1000 Volt insulation test and the D.C. resistance is 500 Ohms.

When connected in parallel these double Filter Chokes have a capacity of 30 Henries at 160 Mills, and when connected in series have 60 Henries at 80 Mills.

Fully shielded in metal case with special insulating compound. Made of the best parts, including the highest grade of silicon steel.

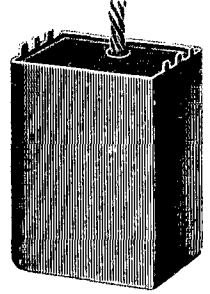

Weight 6 lbs.

Size: 5 1/4 x 3 3/4 x 2 3/8"

**List Price: \$10.05**

**SPECIAL \$3.75**



TYPE PL 571

List Price \$12.00

## Dubilier High Voltage Filter Condenser

**4 MFD. D. C. WORKING VOLTAGE 600 V**

These Filter Condensers are designed for use in filter circuits in Transmitters, and all high Voltage Socket power devices and Power Packs.

**SPECIAL \$2.25**

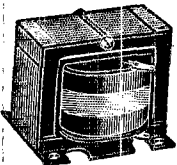

**30 HENRIES**

## FILTER CHOKES

**120 MILLS**

*Manufactured by the Chicago Transformer Corp.*

These Filter Chokes have a D.C. resistance of 400 Ohms. Made of Armco extra special transformer steel. Extra size core. Tested at 1600 Volts. With Mounting brackets.

Fine for any type filter circuits.

**SPECIAL \$2.25**

## THORDARSON POWER TRANSFORMERS

**150 WATT**

Delivers 800 Volts (350 m. a.) center-tapped, also 5 Volts (4 amps.) center-tapped.

Excellent for use in furnishing power supply to a Transmitter or Power Amplifier.

Using this Thordarson Power Transformer in conjunction with a Filament Transformer is all that is necessary to build up the finest and most powerful A. C. set.

Operates on 90-125 Volts, 50-60 cycles A. C. current.

This rugged, heavy duty Power Transformer weighs 10 1/2 lbs.

**SPECIAL \$3.95**

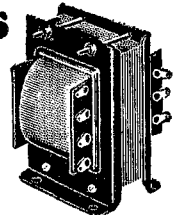

Model T-2430-A

Size: 6 1/4 x 4 1/2 x 5"

List Price: \$24.00

**SEND FOR OUR BARGAIN BULLETIN**

**AMERICAN SALES CO., 19-21 Warren Street, New York City**

# New Super Wasp AC Short Wave Receiver

Comes in kit form or completely constructed. Especially adapted for Amateur band at slight, extra charge.

## 1930 Ham-Book FREE

Everything for Hams. Crystals and Crystal Holders. 3000-volt new type R3 Recto bulbs (\$10.00) and all other types of Recto bulbs. If it's good, we've got it!

*Send today for your free copy*

**Chicago Radio Apparatus Co.**

Dept. Q

415 S. Dearborn Street Chicago, Ill.

## DODGE RADIO SHORTKUT

1920 - 1930

W5AVQ-W6GLM-W8AAT-W8LY-W9FFN mastered code in 60 minutes or less - and reported. W2ATK-W6CYA-W8ARZ-W8FM-W9CNC stuck at 10 or less; copied at 25 in few hours. Report too much trouble for most users.

### DODGE HIGH SPEED

W2BXY-W5AHM-W8CJ K-W8BFA-W8GPO speeded up from 25 to 35 in few hours - ex1BJH from 27 to 42 in 8 hours - 15 min. sessions.

### DODGE MORSE SHORTKUT

W2BXY-W5ANW-W8CJ K (KDIW)-W9EBF (KMMJ) after few hours' attention no mixup.

CONSECUTIVELY used, these three methods will in least time with least effort QUALIFY for highest code test required. Good investment if desire front seat. Communication end of the game expeditiously secured. Dividend of Dollars for Dimes - in Time Saved.

Radio Shortkut \$3.50. High Speed or Morse \$2.50. Money Order. Foreign Add 50 Cents. C.O.D. & Postage in U. S. if remit One Dollar. Effective May 1st. Each Method \$5 or the SET - Three - one order \$10.

B. C. L.'s ATTENTION: Ever really want to read code? LEARN Radio Code by Pencil Exercises. No dots - No dashes. Continuous Line. NEW symbols - easily fixed in mind - stay put. Quick results. Paper and Pencil only required. Mail prepaid \$5 - Money Order.

**C. K. DODGE**

Box 100 Mamaroneck, New York

w8ee w8ema w8dex w8bdk w8drh w8eyp w8lt w8mb w8pe w8sg w8tg w8vy w8zy w9akv w9aniv w9abs w9ayw w9bea w9bef w9bez w9bgl w9bnh w9box w9bto w9cfa w9cfz w9cfr w9ciy w9cns w9cuq w9cwn w9cvt w9dna w9dbj w9dgz w9dif w9dmg w9dno w9dpx w9eaj w9ebo w9ecj w9egw w9ema w9epa w9eqe w9ery w9erw w9dxw w9fem w9fis w9fma w9fqn w9fx w9gac w9gac w9fgo w9gix w9gje w9kd w9of w9oiv w9qi w9zdk w9rp

AUIAK, G. Egorov, Frunze St. 28, Tomsk, Siberia

14,000-ka. band

wlang wlanz wida w1zs w2ai w2box ce2ab ce3ac ct1oo ct1bl ct1br ct1bx d4aar d4abg d4on d4olo d4don d4fw d4jl d4vp d4yt d4za ear21 ear113 ei7e es3ex f8aup f8azo f8brd f8da f8dot f8faf f8gdb f8gi f8glm f8he f8jd f8jt f8klm f8lb f8rom f8rko f8zzz f8em f8tan f8whg f8wrg f8sf f8xh fa7edk fm8gke fm8lgs fm8jo fk8oz fk2ms g2al g2bm g2dz g6mo g2ol g2ux g5bj g5ey g5js g5jg g5jw g5lw g5mg g5ms g5ml g5sy g5tz g5ub g5uq g5uw g5ux g5wk g5wp g5yk g5yx g6br g6da g6ge g6hp g6ll g6mf g6nt g6pa g6oh g6qb g6rb g6ra g6uh g6uw g6vy w6vp g6wl g6wt g6xd g6xj g6xn g6zq g6yk g6yv g6zd g6zmu hof3e ilgl la1w oa4s oh2nab oh2nad oh2nag oh3np oh3ux ok1fm ok1m ok2kw on4bz on4fh on4fm on4fp on4ft on4gm on4gw on4ho on4hl on4hp on4ia on4ja on4jj on4ko on4my on4zs on4zv on4us on4iu on4vo onr33 oz2j on5d oz7ag oz7ly oz7y xoz7sch pa0xe pa0hb pa0kb pa0mm pa0pb pa0qf pa0vn pa0wx pa0zf pb7w pk1jr pk3bm pk4az py2be sm5ory sm5tm sm6ua sm6zb sdpa sp3ar sp3kv sp3kx sp3lm sp3pb su8kw su8rp su8rs un7ww vk4ab vs3ab vs7ap y1lmdz y12gq za4m zs5w

W. Lockerby, 4 Mess. H.W.S. "Dahlia," c/o C.P.O., London, England

ce6ln ct1ep d4wt d4go d4oa d4gl d4tah d4kqe e4ual d4xh d4gb ear98 ear141 ear153 eu3ef eu2bv eu2dw eu2kbf eu2ev f8lx f8lgl f8xd f8awf f8lg f8wba f8gbd f8wiz f8il g5zn g6ms g5jo g6xe g5kl g2vn hb9gw ilto k4aan k4uel k5uk on1vu on4gu on4dj on4en on4sa on4sc on2pco oz7fp oz1ko oz7to rx1aa sb1a w2ku w3aws w4aq w4ft w4qe w4ql w4rb w4se w6anl w8ay y12gm y12gq

## Motion Control of Airport Lights

(Continued from page 22)

easy to handle. The only necessary adjustments are made when the equipment is installed. After that it works automatically. An occasional in-

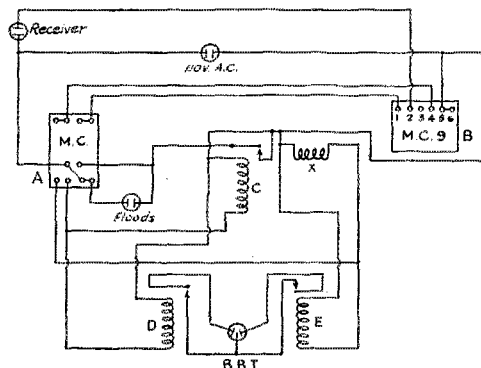

FIG. 4. — THE CONNECTIONS OF THE RELAY SYSTEM

*The functioning of the arrangement is described in the text.*

spection is made, however, to see that the relay contacts are in good condition - and that the receiver tubes are burning.



# Every Transmitting Amateur Uses These Forms



—a reminder that  
your supply may be low—

AMERICAN RADIO RELAY LEAGUE LOG OF STATION							SHEET NO. _____
DATE	TOWER	CALLED BY	BY	MESSAGE	REPLY	REMARKS	

### Member's Correspondence Stationery

One color (black) heading now being used at greatly reduced cost to members. Write your radio letters on League stationery — it identifies you. Lithographed on 8½ x 11 heavy bond paper.

- 100 sheets ..... 50c
  - 250 sheets ..... \$1.00
  - 500 sheets ..... \$1.75
- (Postage Included)

### A.R.R.L. Log Sheets

Designed by hams for hams. 8½ x 11 bond paper, punched for standard three-ring loose-leaf binder.

- 100 sheets ..... 50c
  - 250 sheets ..... \$1.00
  - 500 sheets ..... \$1.75
- (Postage Included)

THE AMERICAN RADIO RELAY LEAGUE HEADQUARTERS HARTFORD CONN. U. S. A.			
RADIOGRAM			
CITY OF ORIGIN HARTFORD CONN.	STATION OF ORIGIN W1EA	NUMBER 479	DATE OCT 6 47
TO: BERN E SCHWAB W9BCA		THIS MESSAGE WAS RECEIVED AT OTHER STATION	
IN ENCODE FORM (SEE INSTRUCTIONS)		STATION ADDRESS	
RELAY CHAIN BEING ORGANIZED BY HAMS OF ILLINOIS TO OPERATE BETWEEN THE PACIFIC COAST AND CHICAGO CALLS FOR CLOSEST COOPERATION BETWEEN IOWA AND ILLINOIS STOP SURE BEST THAT YOU COMMUNICATE WITH W9APY ON THE SUBJECT			
LOUIS P. HUBER			
Rec'd	DATE	TIME	OPERATOR
Sent	TO STATION 99BCA	LOCATED AT PORT RADISON IOWA	DATE 10/8/28 8:30 p 2P

### Official A.R.R.L. Message Blanks

Most convenient form. Designed by the Communications Department of the A.R.R.L. Well printed on good bond paper. Size 8½ x 7¼. Put up in pads of 100 sheets. One pad postpaid for 35c or three pads for \$1.00.

MESSAGE DELIVERY CARD FOR RADIOGRAM VIA AMERICAN RADIO RELAY LEAGUE	
From	Date
To	
Time received	Date
At Radio Station	
Name	
THE AMERICAN RADIO RELAY LEAGUE HEADQUARTERS, 1711 PARK STREET, HARTFORD, CONN.	

### Message Delivery Cards

Neatest, simplest way to deliver a message to a near-by town. On U. S. stamped postals 2c each. On plain cards (for Canada, etc.) 1c each, postpaid.

## American Radio Relay League

1711 Park Street



Hartford, Conn., U. S. A.

# Which ? ..

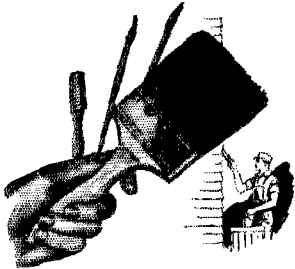

## would you buy to paint a house?

You can tell at a glance. So many of the smaller items we use are easy to choose, that sometimes we take for granted the very things that *should* have our special thought — such as **RESISTORS**, for example.

We specialize in wire-wound Resistors of every type, size, capacity and style of mounting. Samples, exactly to your specifications, are mailed within 72 hours.

We are ready to work closely with your own engineering department to give you more compact installations — greater efficiency in current control — more satisfactory performance in every respect. We have already achieved them for many of the country's largest users.

Ask for  
our new  
Catalog

Our catalog No. 429 is a complete Resistor handbook, containing Resistance Tables for your use. We will be happy to forward a copy to you. Ask for it.



# RESISTORS



**HARDWICK, HINDLE, INC.**  
215 Emmet St. Newark, N. J.

## for phones or C. W.

This husky well filtered power supply is just the thing.

Get that 1930 pure D. C. note and laugh at QRN. Send us your order today and build your new station around this wonderful unit. Uses two 281s as rectifiers.

Supplies both filament and plate current for four 210 tubes. Priced for less than you can buy the parts to build it.

**Price \$25.00**

without tubes



**GENERAL ENGINEERING CORP.**  
CHARLOTTE MICHIGAN

## President Maxim Testifies at Washington

(Continued from page 33)

1930, as I have appeared many times before, to plead that at all hazards you look out for the amateur of to-day and also for those amateurs who are to come.

We have no comment to make upon the wisdom of the provisions of S. 6. We wish merely to point out that whether it is a Radio Commission, or the Department of Commerce, or a Communications Commission that is given jurisdiction over radio, provision should be made for the amateur.

We have fared very well under the administration of the 1927 law by the Federal Radio Commission and the Radio Division of the Department of Commerce. They both appreciate the value of the radio amateur. The Federal Radio Commission has put at our disposal the maximum of the facilities made possible for radio amateurs by the 1927 international treaty and in a recent analysis of the high-frequency spectrum publicly expressed regret that the treaty so limited it that it could not continue the previous more extensive allocation of channels to this important group, the radio amateur. We shall be very well satisfied if the government communications commissions of the future deal with us as fairly as have the existing agencies.

However, any governmental regulative agency will be besieged by commercial interests to grant ever greater numbers of channels to them. It will be urged upon such an agency that the amateur channels are worth thousands of dollars in earning ability. Let me entreat that you believe that those few radio channels which have been left the amateur constitute a value to our nation incalculably greater than any possible money earnings that could conceivably be developed from them by any commercial company.

Finally, in considering a means of regulating communications let me urge you with all the force and sincerity I can command that you bear in mind the radio amateur and make possible his continuance. To do less would be nothing short of a national catastrophe.



# QST Oscillating Crystals

REDUCED PRICES EFFECTIVE APRIL 1st, 1930

## AMATEUR BANDS:

Summer is coming, and no doubt you are going over your transmitter removing those weak links so as to get the most possible efficiency from your set.

One item of great importance is the *frequency stability* of your set. Does it *stay on one frequency*? If not, our *power crystals* will solve that problem. **SCIENTIFIC RADIO SERVICE** crystals are *known* to be the best obtainable, having **ONE** single frequency and highest output. With each crystal is furnished an accurate calibration guaranteed to *better than a tenth of 1%*. *New prices for grinding power crystals in the amateur bands* are as follows:

1715 to 2000 Kc band. . . . . \$15.00 (unmounted)  
 3500 to 4000 Kc band. . . . . \$20.00 (unmounted)  
 7000 to 7300 Kc band. . . . . \$40.00 (unmounted)

## BROADCAST BAND:

*Power crystals* ground in the 550-1500 Kc band accurate to plus or minus 500 cycles of your specified frequency fully mounted for \$55.00. In ordering please specify type tube, plate voltage and operating

temperature. All crystals absolutely guaranteed regards to output and frequency and delivery can be made within two days after receipt of your order.

## CONSTANT TEMPERATURE HEATER UNITS:

We can supply heater units guaranteed to keep the temperature of the crystals constant to *better* than a tenth of 1 degree centigrade for \$300.00. Two matched crystals, ground to your assigned frequency in the 550-1500 Kc band with the heater unit complete \$410.00. More detailed description of this unit sent upon request.

## ATTENTION AIRCRAFT AND COMMERCIAL RADIO CORPORATIONS:

We invite your inquiries regards your crystal needs for Radio use. We will be glad to quote special prices for **POWER** crystals in quantity lots. We have been grinding *power* crystals for over *five years*, being *pioneers* in this specialized field, we feel we can be of real service to you. We can grind *power crystals* to your specified frequency accurate to plus or minus .03%. All crystals guaranteed and prompt deliveries can be made. *A trial will convince you.*

## SCIENTIFIC RADIO SERVICE

"THE CRYSTAL SPECIALISTS"

P. O. Box 86

Dept. P-12

Mount Rainier, Maryland

## TALKS TO LONDON FROM PLANE IN AIR

Reporter in Craft Speeding Over City Has Conversation Across the Ocean.

### THREE CALLS ARE MADE

Words Understood Clearly in Spite of Static—Electric Experts Pleased With Results.

Special to The New York Times.  
**LEADLEY FIELE**, N. J., June 25—Flying at ninety miles an hour today with a thick fog blanket blotting out the earth below him, W. W. Chaplain, Associated Press reporter, casually turned to a microphone and asked for the London office of the news association. The request, relayed through the laboratories of the Bell Telephone Company, passed on to the radio ocean radio telephone station at Belfast, Me., and then carried again on the air across 3,000 miles of ocean to London.

The connection was made quickly and Chaplain asked that Miss Marjorie Dalrymple of the London office be called to the phone. The conversation, once greetings were over, Chaplain said later, had to do mostly with the weather. It was broken somewhat by static but the two persons talking, one in a fog-bound plane a half-mile in the air and the other in a fog-bound London office, understood each other and exchanged greetings.

## "ESCO" Airplane Generators provided the power for this remarkable achievement

Two "ESCO" Airplane Generators (wind driven) were mounted on the Bell Telephone Airplane. One supplied power to the transmitter and the other to the receiver. Both were of standard "ESCO" design which insures reliable service under the severe operating conditions common to aviation.



Low wind resistance, light weight, non-corroding parts, ball bearings, tool steel shafts, steel shells, cast steel pole pieces, weather proof construction, many sizes to choose from, high voltage and low voltage windings to suit individual requirements, are a few of the many reasons for "ESCO" generators being the first choice.

**ELECTRIC**  **SPECIALTY**  
**COMPANY**

225 SOUTH ST.

STAMFORD, CONN.

Manufacturers of motors, generators, dynamotors and rotary converters

## DON'T YOU BE DISAPPOINTED TOO!

Every day we are requested to furnish back copies of *QST* — which we gladly do if they are still in print. The request frequently reads something like this "Please rush a copy of the . . . . . issue of *QST*. Mine is lost or misplaced. Can't proceed with my new transmitter until I get that copy."

What a sad blow if that issue is out of print! Unfortunately, we frequently have to give the bad news.

Now, knowing that *QST* probably has greater reference value than any other radio publication, you should resolve to keep past and future issues in a

## QST Binder



Note the wire fasteners. Unnecessary to mutilate copies. Opens and lies flat in any position.

One-fifty each  
postpaid

A binder will keep your *QST*'s always together and protect them for future use. And it's a good-looking binder, too.

**QST**  
1711 Park St., Hartford, Conn.

## Crystallizing Crystal Grinding

(Continued from page 42)

faces, of course, should be plane and parallel for best results.

### TUBES AND CIRCUITS

When the crystal-controlled oscillator is used in a transmitter maximum output compatible with frequency stability and safety is the prime consideration. The upper limit on plate voltage for the oscillator tube is generally accepted as 400 volts, although instances of successful operation at higher voltages with carefully designed and adjusted circuits have been reported. The present trend is towards lower oscillator plate voltages, however, and voltages of the order of 200 are in favor. The reduction in voltage is in the interest of greater frequency stability and less frequency creeping because of variation in temperature of the crystal.

With such low plate voltages the greatest power output is obtainable with low-impedance type tubes such as the UX-171-A, UX-842 and UV-211, operated with a maximum of grid bias. Not all low impedance tubes, however, are satisfactory as oscillators. Because of inherent characteristics, tubes of the UX-250 and UX-245 type are not recommended for such service.

The proper amount of inductance in the plate circuit is determined largely by the type of tube used and with the low-impedance tubes the plate turns should be kept at a minimum. As Dr. Taylor pointed out at Atlanta, power output is the first consideration and plate efficiency is secondary. The number of turns in the plate-tank circuit of the tube should be kept at a minimum. The d.c. plate current may be allowed to run high if necessary. The circuit of Fig. 2 is a good one for adjustment.

Push-pull oscillator circuits allow the realization of comparatively high oscillator output at low plate voltages and are recommended where greater excitation than that obtainable with a single tube is desired. The push-pull type of circuit seems to have other advantages over the single-ended type and is much preferred in some services. Since amateur transmitters as a rule do not require such high output from the oscillator, single-ended oscillators are usually entirely satisfactory for our purposes.

Increasing familiarity with crystal-controlled transmitters is bringing about the simplification of technique which always accompanies advancement in amateur radio; better and more straightforward design is to be expected as time goes on.

## A New Low Power Transmitter

(Continued from page 18)

designed by *QST*'s technical staff and described in the September, 1929, *QST*. The radio frequency portion uses a 227-type tube as the oscillator, a 224-type buffer amplifier, and a 245-type output tube. Being a single-ended push-pull oscillator and amplifier, the power output

# AERO SHORT-WAVE Automatic TUNING UNIT

(Protected by patents pending.)

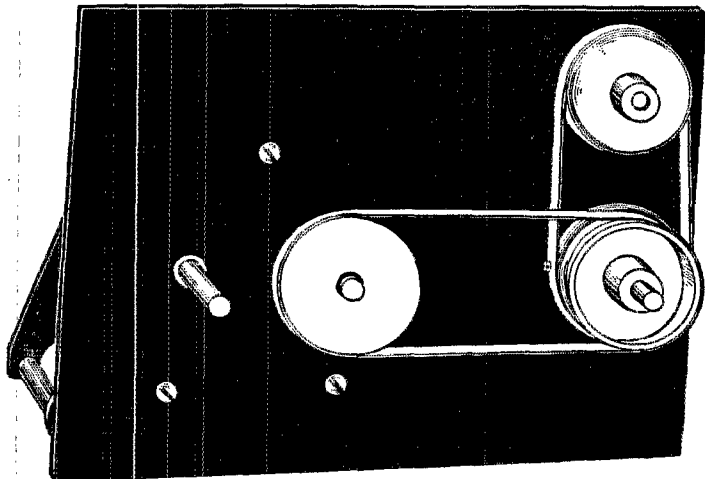

## Features

Automatic range, 15 to 90 meters; full range, up to 200 meters.

No plug-in coils used in automatic range.

Easiest tuning device known.

Tunes even more slowly than broadcast receiver.

Special attachment enables it to reach 200 meters.

Anyone can operate it.

The days of fooling with plug-in coils are over. Amateurs can now have a real thrill by this new automatic tuning device. Read the complete story in February *QST* and then mail your order to Aero Products for the complete built-up unit. Be first to use this remarkable short-wave apparatus.

## A Marvelous Improvement

### NO PLUG-IN COILS

Range 15 to 90 meters. Easiest tuning short-wave receiver known. The tuning unit consists of two controls. The right-hand control, which will be termed the shift control, and the left-hand control, the actual tuning device. In addition to these two controls it will, of course, be necessary to have a regeneration control. For those who desire to employ it for television or the upper phone band, a special attachment may be secured.

### OPERATION

The tuner is operated in the following manner. As a specific example, with the right-hand dial set at nine degrees, revolving the left-hand dial through 180 degrees, you will cover from 19.1 to 22.6 meters. The next step will be to move the shift dial to 13 and tuning over 180 degrees, as before, this time covering from 21.9 to 25.7 meters. This process is continued through 180 degrees on the shift dial until you have reached the maximum automatic wave length, which is 90 meters.

You will note that the tuning dial, in the first instance, when tuned through 180 degrees, covers only 3½ meters, whereas ordinarily when using plug-in coils your tuner, when passing through 180 degrees, generally covers at a minimum of 25 meters. This same speed of tuning is maintained throughout the entire short-wave spectrum, and it is for this reason that this tuning arrangement surpasses any known method.

This unit is furnished completely assembled to the amateur, and may be built into either a short-wave converter or receiver.

*For those desiring to go from 90 to 200 meters a special device may be had, making its range then from 15 to 200 meters.*

A general chart is furnished with each unit, specifying the settings for the shift dial, which will enable you to approximate the wave length for each setting on the shift dial.

This tuner is not sold through the usual trade channels, but is sold to amateurs only direct from factory at special low net price. Be sure to send post office or express money order for \$19.50 with your order. Shipments will be made in the order received. Be first to order. Attach your money-order to coupon below and mail today — NOW!

**AERO PRODUCTS, INC.**

4611 E. Ravenswood Ave., Dept. 330, Chicago, U.S.A.

Dear Sirs:

I want to be one of the first to secure the new Aero Short-Wave Automatic Tuning Unit. Enclosed is money order for \$19.50 which is your low opening net price to amateurs only.

Name.....

Street and No.....

City.....State.....

PRICE ONLY \$ **19**<sup>50</sup> NET

**AERO PRODUCTS**  
INCORPORATED

4611 E. Ravenswood Avenue

Dept. 330

Chicago, Illinois, U.S.A.

## CURRENT SUCCESSES IN P. A. TRANSFORMERS

### for Service and Amplifier Engineers

Your check or money order will secure immediate delivery on any of these 245 Tube Parts.

- No. 994 P. A. TRANSFORMER.....\$12.00  
 No. 2189 PUSH PULL OUTPUT TRANSFORMER.....\$12.00  
*with No. 2142 Push Pull input Transformer..... \$4.50*  
*or No. 3107 Straight Output Transformer.....\$12.00*  
*with No. 2158 Audio Transformer..... \$4.50*  
 D-946 STANDARD CONDENSER UNIT.....\$22.50  
 No. 5554 DOUBLE CHOKE (use in Filter Circuit).....\$11.00  
 No. 2124 TRANSFORMER (Radio and Phonograph Amplification) ... \$6.00

*Ask for information on the New Variable Voltage Testing Transformer*

**Dongan Electric Manufacturing Co.**  
 2999-3001 Franklin St., Detroit, Mich.

### TRANSMITTING COILS

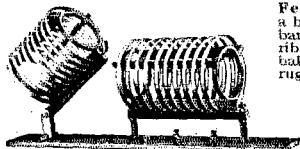

Features—Interchangeable 20-40-80 meter bands; 7/8 in. wide heavy ribbon wound on grooved bakelite framework; very rugged! Distributed capacity of these coils very low!

*Ideal for Fone, MOPA or Xtal circuits, GRID COIL and mounting . . \$4.50*

Price.....\$7.50 Extra coils each 3.50  
 State Band Wanted When Ordering and whether for High-C. Will Ship C.O.D. if \$1.00 enclosed with order

# Arthur L. Munzig

**RADIO MANUFACTURER**  
 W6BY REDLANDS, CALIFORNIA

### QUARTZ OSCILLATING CRYSTALS

Scientifically Prepared for Maximum Power and Unconditionally Guaranteed 2 in. square sections, of your approximate specified frequency, supplied at the following prices:

- |  |         |
|--|---------|
| 75-100 meters .....                                  | \$12.50 |
| 100-200 meters .....                                 | 10.00   |
| 200-600 meters .....                                 | 15.00   |
| 1 in. Teated Bakelite, 200-400, 400-600 meters ..... | 5.00    |
| Dustproof Bakelite mounts .....                      | 3.00    |

For 1 1/2 in. sections, above prices are doubled.

Sections of any practicable dimensions made to order. Prompt Delivery

J. T. Rooney, B. Sc., 4 Calumet Bldg., Buffalo, New York  
 "Twelve years' crystallographic experience"

## BROWNING-DRAKE

### screen-grid RADIO

The same quality in construction that won for Browning-Drake kits such a lasting reputation.

*An unusually attractive franchise offer for dealers*

**BROWNING-DRAKE CORPORATION**  
 228 Calvary St. Waltham, Mass.  
*1,500,000 people listen in on Browning-Drakes*

is half that obtainable from a push-pull system such as was described in September.

The oscillator may be crystal- or self-controlled. In the latter case a High-C Hartley oscillator circuit is used. Although no provision is made within the unit to accommodate a crystal, minor changes may be made in the grid circuit of the oscillator to permit the oscillator to be crystal-controlled. A 0-100 Jewell milliammeter, provided with a plug and flexible cord, is used to measure plate current in the various plate circuits by means of three jacks at the back of the set. A fourth jack is provided for keying. The Type 215 telegraph unit operates from a plate supply delivering 100 milliammeters at 250 and 180 volts, and a filament supply delivering 5 amperes at 2.5 volts. The cut shows the construction of this unit. The apparatus is mounted on a wooden base-board covered with copper. An aluminum panel is used, and each tube circuit is partially shielded with aluminum. The set is encased in a metal cabinet.

The Type 225 modulator unit, a companion to the radio frequency unit is similar in design to the speech amplifier and modulator described in the September QST. It uses a 227-type speech amplifier, and a 250-type modulator. Heising modulation is employed and, since the modulator operates at a higher plate voltage than the modulated amplifier, high modulation factors are possible.

## The Federal Radio Commission Reports

*(Continued from page 8)*

commission's activities was found to be already existing in the organization of the radio division of the Department of Commerce with the result that all amateur licenses are first approved by the department before being issued by the commission. The details of this work would have constituted a tremendous burden for the commission had it not been thus relieved by the radio division.

"As various legal questions are presented concerning applications for amateur-station licenses, they are usually referred to the general counsel of the commission for opinion. In this way the status of the amateur under the radio act is being gradually defined so as to permit more certainty.

"The latest available figures disclose that during the year ending June 30, 1929, there were 12,646 amateur-station licenses issued. The total number of such station licenses outstanding at the same date was 16,829.

"The licensees of amateur stations are not restricted by any regulations other than those embodied in their own code of ethics and the commission's General Order No. 24. These have proved very broad in scope and offer the amateur a wide latitude in the pursuit of his art. The commission having adopted this policy of encouraging the amateur, much greater progress may be expected than ever before."



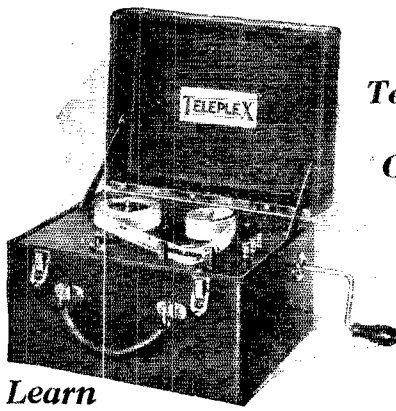

It  
Teaches  
the  
Code!

# WARNING!

A Personal Message to Every  
Fair-Minded Reader of *QST*  
from R. G. MILLER, *Inventor*  
of *Teleplex*, the original code instructor  
Manager, *Teleplex Company*

Certain manufacturers of meritorious products, carefully conceived, honestly manufactured and legitimately advertised and merchandised, suffer from the unfair competition of imitators. These imitators infringe upon the patents and designs of products that have become established in the confidence of the public.

It has come to our attention that such a concern is now selling a machine which is an imitation of the Teleplex Code Instructor. Legal action is being taken, and steps have been instituted to protect our rights — and the rights of the public who have come to recognize the Teleplex as the original invention approved by the U. S. Army, U. S. Navy, prominent radio schools and other leading authorities in the field of telegraphy. The action of the courts is necessarily slow, and until such time as the case has been tried this imitator will endeavor to foist upon the public his copy of a genuine product.

## Learn Telegraphy with **TELEPLEX**

**TELEPLEX TEACHES YOU THE CODE** (Morse or Radio) — quickly, easily and efficiently. A practical machine that works automatically. Waxed tapes send signals like a real operator. Complete code instructions furnished. *Endorsed by U. S. Army, U. S. Navy and Leading Schools.*

**FREE 10 DAYS' TRIAL**

You can try the genuine TELEPLEX in your own home for 10 Days' Free Trial. If Teleplex does not teach you the code — if it does not demonstrate its superiority over any other device — it costs you nothing. Can be used by advanced students as well as beginners. Write to-day for full details of *Free Trial Offer*.

**TELEPLEX COMPANY**

76 Cortlandt St., Dept. Q-12 New York, N. Y.

**DON'T BE MISLED BY IMITATIONS.**  
**TELEPLEX IS THE GENUINE CODE INSTRUCTOR.** *It is the instrument that is used by the U. S. Dept. of Commerce, Schools Everywhere, Navies (Our Own Navy), Radio and Telegraph Institutes.*

**Build your**  
**Write Dept. Q1**

**LOFTIN-WHITE**  
*Direct-Coupled*  
**AMPLIFIER**  
with the **ELECTRAD KIT**  
*Approved by the Designers*  
175 Varick St., New York, N.Y.  
**ELECTRAD**  
INC.

**TRANSMISSION CONDENSERS**



Send for interesting data and price sheet on Transmission Condensers with working voltages up to 3000 D.C. for use with the following tubes: 203A, 204A, 210, 500W, 851, 852, 860, 865.

**CORNELL ELECTRIC MFG. CO.**  
Long Island City New York

**P A C E N T**  
Duo Lateral  
**COILS**

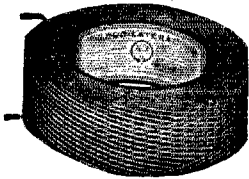

The complete line of all standard turn ratios preferred by leading laboratories and engineers.

*Write for information and prices*

**PACENT ELECTRIC CO., Inc.**  
91-7th Avenue New York City

## RADIO TRAINING offers Travel . . . New Sights, Good Pay and Comfortable Living . . . Abundant Leisure for Study

That is the interesting adventure which radio offers to young men. Our training qualifies you for government examination. We place our graduates in positions. Tuition may be paid by the month or for full course.

. . . Fill in attached coupon for details

**PORT ARTHUR COLLEGE**  
PORT ARTHUR (world-known port) TEXAS

Port Arthur College, Port Arthur, Texas  
Please send details concerning Radio Course to  
Name.....  
Street or Box.....  
City and State.....

# BANKRUPT RADIO STOCKS FULLY GUARANTEED

Tubes UX type, fully guaranteed, No. 210, \$2.25; No. 250, \$2.35; No. 281, \$1.85; No. 280, 95c; No. 275, \$1.25; No. 224, \$1.65; No. 227, 75c; No. 226, 65c; No. 171, 75c.

Auto Radio, specially designed for operation in automobiles, motor boats, etc. Tremendous volume. Wonderful tone quality. Single dial control. Compact. Will fit in any car. Price including tubes.....\$39.50

7-Tube A. C. Sets.....\$26.50

250 or 245 Power Condenser Blocks, 12 Mfd., 1000 volt A. C. test, tapped 2,2,2,4,1 and 1 mfd.....\$4.75

2 Mfd. Condenser Packs, 2000 volt A. C. test \$7.90  
1500 volt.....\$3.80

Double Chokes, 30 henry each, 160 mls., 1500 vt. test, shielded.....\$4.95  
130 mls.....\$3.75

Short Wave Sets, one tube complete with 5 coils, 50 to 550 meters.....\$6.45

A. C. Power Filament and Choke Pack.....\$4.00

No. 1003 Power Transformers, shielded, Sec. 600 V. for one 281, one 250, one 227, four 226 tubes and 2 chokes.....\$5.00

A. B. C. Power Packs, completely assembled, \$8.75. 250 V. B. also has A. C. filament for up to 9-tube set. Can be used as B eliminator. Make your battery set all electric, or build your A. C. set around this pack. 280 tube for this pack, 95c extra.

## CHAS. HOODWIN CO.

4240 Lincoln Ave., Dept. D-8, Chicago, Ill.

DEALERS IN BANKRUPT RADIO STOCKS

## It's EASY to Get a HANDBOOK

(Sixth Edition)

DIRECTIONS:

Realizing that Handbook must be had, proceed as follows:

- (1) Fill out below, tear off.
- (2) Reach in pocket, produce U. S. A. \$1 bill, old or new size (we don't care).
- (3) Clip together, mail us.

Handbook Factory,  
1711 Park, Hartford.

SEND IT AT ONCE.

(Name)

(Street or P. O. Box)

(City and State)

## Midwest Division Convention

May 9th and 10th at Ames, Iowa

WITH our new Director, Louis R. Huber and Mr. D. C. Faber, Director Engineering Extension Course, Iowa State College, in charge of this year's annual convention, there is being prepared a program which will outdo all previous conventions. A cordial invitation is extended to all radio amateurs and others interested to attend this annual affair which does so much to create a spirit of good fellowship.

All make a notation of the dates — May 9th and 10th, at Iowa State College, Ames, Iowa. The Campus Radio Club is sponsoring the convention and its members will be there with the glad hand. As in the past, prominent speakers will be present to address the delegates, and A.R.R.L. Headquarters are sending F. E. Handy, Communications Manager and Beverly Dudley, Assistant Technical Editor, as official representatives. If you want further information write Louis R. Huber, 718 North Gilbert St., Iowa City, Iowa.

## Babcock Reëlected

IN the elections of last fall to choose a Pacific Division director for the 1930-1931 term, the Executive Committee ruled that this election would be regarded as incomplete pending the receipt of ballots from Hawaiian members up to December 15th last, and from members in the Philippine Islands up to February 15th.

All ballots now being in, a final count has been made by the Executive Committee, sitting as a committee of tellers, with the following tally:

A. H. Babcock.....	482 votes
J. E. Waters.....	200 "
M. E. McCreery.....	58 "

As a result, Mr. Babcock has been declared re-elected as director from the Pacific Division for the two-year term.

## Strays

Miscellaneous Publication No. 92 of the Bureau of Standards is intended to "meet the definite need for standards of practice in connection with lightning protection." The pamphlet is "Code Protection Against Lightning." The book is written in three sections. Part I deals with the protection of persons, while Part II deals with the protection of buildings and miscellaneous property, and Part III deals with the protection of structures containing inflammable liquids and gases. A half page is devoted to radio installations and wires entering buildings. An appendix on lightning, its origin, characteristics and effects, as well as another appendix giving a bibliography of the most important references concerning lightning and lightning protection are also included. The "Code for Protection Against Lightning" may be obtained from the Govern-

# Vitrohm Stabilizing Resistors

When the plate potential of radio transmitters is supplied by filtering rectified A. C. it is common practice to connect a stabilizing resistor across the output of the plate supply.

The advantages are:

1. Protects the filter condensers from high peak voltages, which lengthens their life.
2. Steadies the note.
3. Tends to eliminate chirps.
4. Discharges condensers when key is open.

Send for circular 507, describing Vitrohm Resistors for radio. It will be sent without charge upon request. You will find in this circular Vitrohm Resistors to meet every radio requirement.

Output Voltage	Total Resistance	Vitrohm Resistors
250	25,000 ohms	1—Cat. 507-65
550	50,000 ohms	1—Cat. 507-68
1000	50,000 ohms	2—Cat. 507-65 in series
1500	60,000 ohms	3—Cat. 507-5 in series
2000	80,000 ohms	4—Cat. 507-5 in series

**WARD LEONARD ELECTRIC CO.**  
Mount Vernon, New York

## BECOME A RADIO OPERATOR

See the World, Earn a Good Income, Duties Light and Fascinating  
**LEARN IN THE SECOND PORT U.S.A.**

Radio Inspector located here. New Orleans supplies operators for the various Gulf ports. Most logical location in the U. S. A. to come to for training. Our students qualify for the various branches of radio Ashore and Afloat. Every graduate placed. Runs to all parts of the world. Special courses. Day and Night classes. Enroll any time. Oldest and Largest Radio School South.  
Literature on request.

**GULF RADIO SCHOOL**  
844 Howard Ave. New Orleans, La.

## EASTERN AMATEUR HEADQUARTERS



**SPECIAL**  
**\$7 Weston**  
**Volt Meter \$1.79**

*We pay postage*  
7 volt d. c. Not many at this price  
**Complete Parts**  
**Loftin-White Power Pack**

R. C. A. Sockets for Transmitting, \$1  
Hams, send for Special Amateur Catalog  
**M. & H. SPORTING GOODS CO.**  
512 Market St., Phila., Pa.



## TRANSMITTING GRIDLEAKS

5000 OHMS

These genuine General Electric wire-wound Gridleaks have a rating of 55 watts in continuous duty.

Large enough for 250 watters.  
**SPECIAL 65c**  
AMERICAN SALES CO., 19-21 Warren St., N. Y. C.



## ALUMINUM BOX SHIELDS

Beautiful Silver Dip Finish  
Genuine Alcoa Stock  
5" x 9" x 6", \$1.89. Any size made to order in 24 hours. Genuine Baldwin Type "C" phones \$3.65 pr.  
**BLAN, The Radio Man, Inc.**  
898 Cortlandt Street New York City

**SUPER-POWER** For greatest range, sharp, clear-cut signals, absolute reliability of schedules. A Mercury Vapor Rectifier for every transmitting requirement. For the operator with a burning ambition to make his call famous — but with just so many \$\$\$s to do it — the Mercury Arc — lowest in cost per watt output, minimum renewal expense. No filament to blow or lose emission. Output remains at peak thruout long life, far above any transmitter demand. Power transformers designed specifically for rectifier service. *QST* ratings, 5000 volt layer insulation, 50,000 volt major insulation, heavy duty windings for highest regulation, lowest losses. 860 low-power rigs, 872 single and polyphase broadcast rectifiers, filter and interphase reactors. Your station a sure winner — Here's How.

**RECTIFIER ENGINEERING SERVICE, 4837 Rockwood Rd., CLEVELAND, OHIO**

# FROST-RADIO

We are equipped to produce Frost Radio Volume Controls in either wire wound or carbon element type, clockwise or counter-clockwise knob rotation, and with absolute accuracy in all resistance gradations from 5 ohms to 1 megohm. Our service is unique, speedy and satisfying. Ask us to submit samples based on your particular specifications.

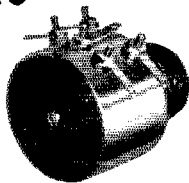

No. 890, Double depth metal shell unit in rheostat or potentiometer type. Rotors in same electrical connection. Composition elements, 5,000 ohms to 1 megohm in each unit. Diameter, 1 7/8 in. Depth of shell, 1 3/16 in.

## HERBERT H. FROST, Inc.

Main Office and Factory: ELKHART, IND.

HERBERT H. FROST, Inc. Q.S.T. 4-30  
160 North LaSalle Street, Chicago

Send me your Parts Catalog by return mail. I understand that it will be sent to me FREE and postpaid.

Name .....

Address .....

City ..... State .....

## TRANSFORMERS

Guaranteed — Mounted — Complete

600 watt 800-1200-1800 each side ..... \$17.00

700 watt 1000-1500 each side ..... 14.50

250 watt 500-750-1000 each side

unmounted \$9.75; mounted \$11.50

Auto-Transformers, Chokes, Polyphase and 25-cycle

Transformers. Add \$2.00 for fil. winding

QCES FRANK GREBEN

1927 So. Peoria Street, Pilsen Sta. Chicago, Ill.

## Massachusetts Radio and Telegraph School

18 Boylston Street, Boston

Send for Catalogue

Tel. Hancock 8184 Established 1905

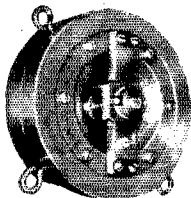

## Microphones

from \$10.00 to \$300.00  
also stands, transformers, etc.

Catalogue just out

UNIVERSAL  
MICROPHONE CO., LTD.

Inglewood, California

Chicago, Garner Co., 126 N. Clinton; Detroit, Spencer, 69 Seward; Cincinnati, Bocs, 622 Broadway; Omaha, Kohn 304 Baum Bldg.; Pittsburgh, Bittner Co., 405 Penn.; St. Louis, Benke, Arcade Bldg.; Philadelphia, Engineering Sales, Bourse Bldg.; San Francisco, Langevin, 274 Brannan; Oklahoma City, Southern Sales, 130 W. 3rd; Wichita Falls, Radio Supply Co.; Kansas City, Am. Radio, 1416 McGee; Export, Auriema, 116 Broad St., N. V.

ment Printing Office, Washington, D. C., for twenty-five cents.

Other call books which may be obtained either from the International Bureau of the Telegraph Union, Berne, Switzerland, or from the Radiomarine Corporation of America are:

"International List of Ship Stations," an alphabetical list by ship names.

"Annex to the List of Ship Stations," also alphabetically by ship names.

"List of Aircraft Stations," alphabetically by call letters.

"List of Broadcasting Stations," alphabetically by name of stations in the various countries.

"Recapitulatory Supplement No. 2 to the List of Fixed and Land Stations," alphabetically by name of station in the various countries.

H. E. Hurley, W6CKK, makes a few suggestions about tube base coil forms which will interest other amateurs using these forms of winding coils. W6CKK suggests that the prongs of the coils may be cleaned of solder by applying the tip of the soldering iron to the end of the prong. By blowing through the bakelite tube while the prongs are still hot, the solder will be effectively cleaned from the tube base prongs.

Another idea he uses is to boost the minimum capacitance of the circuit by using a small fixed condenser across the tuning condenser. This small condenser is made by twisting two insulated wires together, the length of the twisted pair determining the magnitude of the minimum capacitance of the coil.

If anyone has an accurate schematic wiring diagram of the tank circuit, George Grammer would like to have a copy of it. He has had one or two requests for this circuit on the Technical Information Service desk.

The following QST articles may be obtained in Lefax form from Lefax, Philadelphia, Pa:

"Vacuum Tube Definitions," by Dart and Atwater.

"Photo-electric Cells and Methods of Coupling to Vacuum Tubes," by Dewhurst.

"Cascading Rectifiers," by Grigg.

"Official Frequency Standard Transmissions," by Lamb.

"The Inductor Dynamic Loudspeaker," by Westman.

"A Simple 1750-ke. and 3500-ke. Receiver," by Dudley.

"Resistance Control of Regeneration," by Dudley.

"An Effective Low-Cost 'Phone and C.W. Transmitter of Modern Design," by Lamb and Dudley.

The Single Control Transmitter which was described in the December 1929 QST cannot be satisfactorily used as a 'phone transmitter. For that matter, no self-excited transmitter can be satisfactorily used for 'phone transmission; it takes an oscillator-amplifier transmitter to do the job right.

# SPECIAL Colored Official League Emblem

for  
SECTION

COMMUNICATIONS MANAGERS

and

OFFICIAL RELAY STATIONS

SEE MENTION IN COMMUNICATIONS  
DEPARTMENT — THIS ISSUE



RED BACKGROUND  
(for S.C.M.'s only)

BLUE BACKGROUND  
(for O.R.S.'s only)

**\$1**

Each, Postpaid  
ONE-HALF INCH SIZE

## AMERICAN RADIO RELAY LEAGUE

1711 Park Street  
Hartford, Connecticut

## The NEW Easy-Working GENUINE MARTIN VIBROPLEX No. 6

Reg. Trade Marks: Vibroplex; Bug; Lightning Bug

IN COLORS: Blue — Green — Red

10 New features.  
Easy to operate. Easy on the arm. Fast or slow. Transmits signals unequalled for strength, clarity and beauty.  
Black or Colored, \$17  
Nickel-Plated, \$19

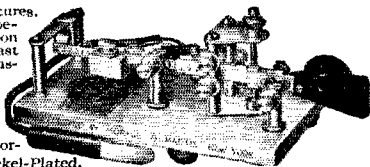

\$19

**Improved  
MARTIN  
Vibroplex**

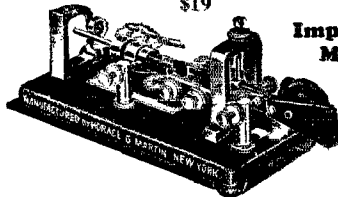

Black or Colored, \$17  
Nickel-Plated, \$19

Special Martin Radio Bug — Extra large. Specially Constructed Contact Points for direct use without relay. Black or Colored, \$25

Your old Vibroplex accepted as part payment

Remit by Money Order or Registered Mail

**THE VIBROPLEX COMPANY, Inc.**

825 Broadway, New York City

Cable Address: "VIBROPLEX" New York

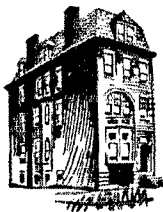

## C. R. I.

Trains men for all branches of  
radio work, including:

Commercial Radio	Radio Service
Radio Broadcast	Navigation
Radio Mathematics	Laboratory
Vitaphone — Movietone	

DORMITORY — LABORATORY — WORKSHOP

Literature on Request

## COMMERCIAL RADIO INSTITUTE

38 W. BIDDLE ST. **FOUNDED 1920** BALTIMORE, MD.

## Oscillating Quartz Crystals



Guaranteed — easy oscillators, carefully selected for maximum output, and ground to your approximate frequency which is stated accurately to within one-tenth of one percent.

1715-2000 Kilocycle band..... \$12.50  
3500-4000 Kilocycle band..... 17.50  
One-inch oscillating blanks..... 5.00

We also supply "POWERTYPE" crystals to broadcast and commercial stations.

Write for literature

**American Piezo Supply Company**  
1101 Huron Building Kansas City, Kansas  
Specialists in frequency precision

## H I L E T

high-grade radio equipment is used thruout the world because it is backed by a guarantee to give and keep giving service. Adding to the art of amateur radio, we now offer a **TRANSMITTER NAME PLATE** for your panel; shows call letters, power, wave length, designer, etc. Blanks 75c; Stamped to order, \$1.50; Engraved and black filled, \$2.00. Send for circular. **CHOKES**—with gap adjustment 500 M.A., 30 H. \$25.00; 250 M.A. \$7.50; 160 M.A. \$6.00; 100 M.A. \$3.00. **TRANSFORMERS**—700 Watts 1000-1500 each side, \$14.50. 500 Watts 1000-1500 each side, \$13.00. 250 Watts, 500-750-1000 each side, \$10.50. 150 Watts, 375-525 each side, \$9.00. **QUARTZ CRYSTALS** 1715 to 2000 KC \$12.50; 3500 to 4000 KC \$17.50; 1-inch Blank \$5.00. *Specials to order — write for specifications. (One day delivery.)*

HILET ENGINEERING CO., Orange, N. J.

# HAM-ADS

**PLATE** power for your set, the very heart of its performance. For quietness, DX ability, life-long permanence, absolute dependability, the most ultimate cost, no other plate source even approaches the achievement of an Edison steel-alkaline storage B battery. Built painstakingly; every joint pure nickel, upset electrically welded. Genuine Edison Electrolyte. Our list describes complete batteries, construction parts, enameled aerial wire, silicon steel. Available immediately, filament and plate transformers for the new 872 rectifier, complete plate power units. Rectifier Engineering Service, radio W8ML, 4837 Rockwood Road, Cleveland, Ohio.

**AMATEURS** — experimenters, builders. We serve over 4000 I.R.E., A.R.R.L., etc., experimenters and "nuts." Full discounts. \$50,000 stock approved parts — no sets. Over four pounds catalog, circuits, data, prepaid, 50c. Weekly bulletins (new items, results of experiments, etc.), 20 weeks, \$1. Sample experimenters "Over the Soldering Iron" magazine, 125c. Transmitting data, price list, etc., 25c. Kladag Radio Laboratories, established 1920, Kent, Ohio.

**SPECIAL** rectifier aluminum, \$1.25. Lead, \$1.00 square foot. Elements 1 x 4 15 cents, 1 x 6 17 cents pair. All prepaid. Best silicon transformer steel cut to order, 25-35 cents pound. Postage extra. George Schulz, Calumet, Mich.

**THE** finest in radio for amateur, broadcast and marine. The most modern short-wave receivers. Four to ten tube designs. Radiophone CW transmitters of any power or type. We make a complete line of apparatus, including speech amplifiers, filter coils, inductances, power units, etc. Any special apparatus, designs, built to order, using your parts if desired. Prices on request. New bulletin lists complete line of apparatus. Write for copy. Ensell Radio Laboratory, 1527 Grandview St., S. E., Warren, Ohio.

A.R.R.L. sweater emblems should be worn by all League members. They are yellow and black 5" x 8" diamond, felt letters and embroidered symbol. Only \$1.00. Money order or currency only accepted. Eric Robinson, 135 Jefferson Road, Webster Groves, Mo.

**TELEGRAPHY** — Learn Morse and wireless telegraphy. Big salaries. Tremendous demand. Expenses low, can earn part. Catalog free. Dodge's Institute, Wood St., Valparaiso, Ind.

**PRINT** your own radio call cards, stationery, circulars, advertising, etc. Junior press, \$5.90; job presses, \$11, rotary, \$149. Print for others; big profit. Easy rules furnished. Write for catalog presses, type, paper, etc. Kelsey Company, Q-54, Meriden, Conn.

**POWER** crystals for broadcast and amateurs, ground to your frequency. Write and get our prices. Filter condensers, 1000 volts, d.c., \$2.50. All absolutely guaranteed. Fitz-gerald Harrison Laboratories, 43 Summit Ave., New London, Conn.

**WANTED** Navy Standard Receivers SE143 SE1220 SE1420 IP500 IP501 also spark gap units, Paul Trautwein, 38 Park Place, New York.

**EX-NAVY** dynamotors ideal for battery operation also supplied with extension shafts for external motor or engine drive. General Electric 24/1500 volt, 233 amperes \$37.50; 24/750 volts \$27.50; 12/350 volts \$15. Westinghouse 6-15 volts 500 watts \$15; 10/350 \$18; 27.5/350 \$12.50. Twins for 700 volts \$20; Shaft extension \$3.00, 900 cycle \$25; 1/2 KW 500 cycle with exciter \$15. 1 KW Crocker-Wheeler motor generators \$135. Complete list, Henry Keinze, 501 East 84th Street, New York.

**PIEZO** quartz plates — guaranteed perfect oscillators 700 kc., \$40, 3500 kc., \$15, 1750 kc., \$10. Dr. Gerald W. Fox, physicist, W8BNT, 419 W. State, Ann Arbor, Mich.

**QSLs**, \$1 per hundred. W9BEU, 9032 Windom, St. Louis, Mo.

**UNUSUALLY** selective broadcast 5-tube screen grid battery set, 3 or 5 volt, for farms, boats, camps, low B drains, fully shielded. Write for price. Hatry & Young, Hartford, Conn.

**QSLs** de luxe. Two colors, 100 for 80 cents. Ritzy, modernistic, futuristic cartoon cards, 100 at \$1.20. Samples, Radio Press, Dwight E. Harkins, 3306 Eastside Ave., Cincinnati, Ohio.

**SELL** four tube tuned screengrid receiver, 17 to 200 meters. \$20. Also transmitter to sell or trade. Neal Brown, Richland Springs, Texas.

**W9DOE** — Ensign A. L. Bergtold, C-V(8), U.S.N.R., Unit Commander-Volunteer, Communication Reserve, Naval Reserve Armory, Duluth, Minn.

**SELL** — complete station, xmtr, receivers, tubes, world globe, A and B eliminators, new Corona portable typewriter. H. P. Brewer, Oskaloosa, Iowa.

**WANTED** — 3 radiotrons UV203A. Also 1000 or 1150 volt motor generator. New or used. V. P. Baughn, Washington Court House, Ohio.

**NEW** Hilet transmitter panel name plates, also chokes and transformers. See Hilet advertisement in this issue. Jewell No. 54, 0 to 200V meters, 100 ohms per volt, \$14. M. Leitch, Park Drive, W. Orange, N. J.

**TRADE** guaranteed crystals for 50 or 75 watt tubes. W9ZZE.

**WESTERN** Electric transformers, tubes, mikes, amplifiers, speaker, pickup 4D radio set. Frequency meter oscillator, wavemeter, potentiometer. H. Jones, 438 S. Leavitt St., Chicago, Ill.

**TELEVISION** Kit — 12-inch scanning disc; shaft and bearing frame; motor hub and driving disc; synchronizing screw; neon lamp and lamp holder; \$7.50, parcel post prepaid. Jenkins Laboratories, 1519 Connecticut Ave., Washington, D. C.

**WANTED** — 0-2500 a.c. voltmeter. W1KM, Malden, Mass.

**SELL** dynamotors, 12/500 volts, 24/750 volts. Diedrich J. Thies, Arlington, Minn.

**MIKES** — broadcast, 4 Kellogg 2-button completely rebuilt and in A1 shape, \$25 each. Station WHBF, Rock Island, Ill.

**SELL** 300 volts of Edison B batteries, set up. Used very little. Price \$10. George Goblisch, Vesta, Minn.

**FOR** sale Western Electric broadcasting transmitter, 100 Watt type 2-A, including motor-generator (with spare armature), transmitter (with five W. E. fifty watt tubes), and power panel. This equipment has been used an average of seven hours a week and is in excellent condition. Price, \$1050. Tremont Temple Baptist Church, Boston, Mass.

**HAVE** you the dope on the HY-7, 6-tube shortwave double detection receiver? Get it now. Hatry & Young, Hartford, Conn.

**FOR** sale — back copies QST, October 1916, May, June, July and August 1917, June and July 1919. All except January, February and March of 1920. From 1921 to 1929 inclusive — 1926 in binder. Few with covers missing, but all articles complete. Also old Telephonys, Radio Broadcasts, etc. One set old edition Halkins Electrical Guides. Eugene Davis, Box 331, Salina, Kans.

**LICENSED** by R. C. A. "Marathon" tubes in original cartons, UX250, \$2.00, UX281, \$1.75, UX280, \$1.35. 0-300 milliameters, \$1.00. Ed. Keers, 319 Garsney Ave., Joliet, Ill.

**FOR** sale or trade — one Robbins and Myers, 110 volt a.c. 600-volt d.c. motor-generator. Want spark transformer tubes or what have you? Radio WIASG, Cedar St., Belfast, Maine.

**WANTED** — phone transmitter with or without power supply. Will pay cash or trade UX210s, UX250s or UX281s or Weston meters. All new. L. G. Arnold, Roseland, N. J.

**SALE** — pair 5 inch REL inductances. 40-80 meters. New \$11, sell \$4. W9BK, Frankfort, Ind.

**FOR** sale — like new Grebe CR18, \$30. Also Silver-Marshall Round-World-Foam, assembled, but not wired, \$25. Remit with order. G. DeHolmes, 666 Hawthorne Ave., Palo Alto, Calif.

**QSLs** 100 two color \$1.00. Samples, W9CKA, Corwith, Iowa.

**WANTED** — Complete parts for one or two 100 watt transmitter. Would consider station ready built. Must be best of parts and of ample capacity for 180 meter. Have new Conn "C" melody sax, brass, complete in case. Sale or trade. You must have real bargain. C. L. Umberger, Harlan, Ky.

**CRYSTALS** — highest quality quartz crystals at half price. Write W6EBV.

**NEW** MX210s, \$2.00; MX250s, \$3.00. K and H Laboratory, 1131 Pearl St., Kansas City, Mo.

**COMPLETE** parts for 50 watt transmitter for sale or trade. What have you OMs? W9BFE, Tustin, Calif.

**SELL** or trade two 7000-ke. transmitters, 10 or 50 watts other 10 watts, complete with power supply and tubes. Details on request. Box 21, Seaford, N. Y.

**FOR** sale — Pilot super wasp d.c. 17-500 meters, \$25. W9OP, 2405 Jenny Lind St., McKeesport, Pa.

**MUST** sell even at great sacrifice, 25 watt transmitter, d.c. power pack, receiver, wavemeter, etc., \$85, individual parts at discount cost, \$126. First money order takes outfit. J. B. Floyd, W4AFW, Oxford, N. C.

**TUBES** — nationally known manufacturer. First quality, tested in ham transmitter. Guaranteed. Type 8X210 oversized oscillator, 6 inches overall; large plate, \$3.59. X231 750 volt rectifiers, \$2.84. W9DWA, 5508 Fulton St., Chicago, Ill.

**TUNGAR** rectifiers. Full wave. Can be used half-wave. Two apertures. Mogul base. Only one required for "Keep-alive." See January advertisement. \$2, prepaid. W9DWA.

**RECTOBULBS**: hi-power, \$10; 231 type, \$5.25; Super-Wasp, \$29.40; WE & RCA tubes; power Xals; 25% off on REL, Ward Leonard, Jewell, Signal Leach; 30% on Thordarson, Sangamo, Cardwell; 35% on Tobe and Flechtheim. Any other apparatus. Henry's Radio Shop, W9ARA, Butler, Mo.

**SELL**: transmitter, dynamotor, rectifiers, transformers, condensers, other idle parts. What do you need? Want: Zepp lighting switch. W8BJO, Dundee, N. Y.

**VIBROPLEXES**, Teleplexes, transmitters, receivers, wasps, Omnigraphs, 50, 75, 100 watters, mikes, portables. Bought, sold, traded. Ryan Radio Co., Hannibal, Mo.

**CARDWELL** condensers, Sangamo, Weston and Jewell transmitting meters, microphones, Thordarson power packs and chokes, Pilot parts, transmitting tubes, amateur supplies. Hatry & Young, Hartford, Conn.

**FROST** hand mike SM240 modulation transformer, SM242 microphone transformer. All practically new. Reasonable, or what have you? W8QH, Box 24, Matamoras, Pa.

275 volt new generators, \$8. Used, \$5. 500 cycle motor generators, a.c. drive  $\frac{1}{4}$  k.w. \$30. D.c. drive, \$20. 200-watt generators, \$10. 500 cycle voltmeters, \$10. R. Wood, 4620-102nd St., Corona, N. Y.

QSL cards, two colors, \$1.00 per hundred. Free samples, WSDTY, 257 Parker Ave., Buffalo, N. Y.

WE supply parts for that receiver, transmitter and power supply. Push-pull specialists. Special apparatus, Bulletin available. Pontiac Engineering Co., 1100 Avenue I, Brooklyn, N. Y.

**GUARANTEED** X281s, \$2.50. Filter chokes 75 cents and up. Nassau Radio, Sae'ord, N. Y.

**FOR sale:** Sync Rectifier with Robbins-Myers motor, \$20;  $\frac{1}{2}$  k.w. Acme Spark transformer, \$5.00; 600 watt, 1500-volt plate transformer, \$5.00. W9DUN, Akron, Iowa.

**TRANSFORMER specials.** 550-0-550, 7 $\frac{1}{2}$ , 7 $\frac{1}{2}$ , 150-watt \$6; 650-0-650, 7 $\frac{1}{2}$ , 7 $\frac{1}{2}$ , \$7; 550, 750 each side, 7 $\frac{1}{2}$ , 7 $\frac{1}{2}$ , 250 watt, \$10.50; 0-550, 7 $\frac{1}{2}$ , 7 $\frac{1}{2}$ , \$3. 10-volt 75 watt center tapped filament transformer \$3; 7 $\frac{1}{2}$ , 7 $\frac{1}{2}$ , 75 watt, \$3; 2 $\frac{1}{2}$ , 2 $\frac{1}{2}$  volt \$3; 350-0-350, 5, 2 $\frac{1}{2}$ , 2 $\frac{1}{2}$ , \$4.50; 30H 85 MA double choke, \$1.75; 50H 100 MA \$3; 30H 100 MA single choke, \$4; 250 MA, \$5.75; 2 MF 1000-volt mounted filter condensers, \$2.40; 3 MF, \$3.25; 450-volt condenser blocks, 2-4-4-1-1 MF, \$3.65. Prices are net F. O. B. Philadelphia Electrone Labs., S34 N. Randolph, Philadelphia, Pa.

**At last!** Another batch of those General Electric 5 watters type CG1162, made especially for U. S. Navy. Their characteristics make them ideal for short wave work, low internal capacity, filament 7.5 volts, plate voltage up to 750. This is the last of these tubes left. A wonderful buy for all brother hams. A genuine General Electric 5 watter for only \$1.25 each. Neon tubes for frequency meters 50 cents each. Try our surprise package, \$1.00. Money back if not satisfied. 0-100 calibrated milliammeters, \$1.25. 0-300 Westinghouse milliammeter indicators 5 point rough calibration, \$1.25. 0-500 voltmeters \$4.00. R.C.A. or Cunningham UY227s, \$1.60. All merchandise guaranteed new. Sent P.P. or C.O.D. E. Hufnagel, 879 So. 18th St., Newark, N. J.

2000-v, 1000-w, 3-phase drive motor generator, \$225; 2000-v, 500-w, 1-phase drive, \$195; 1500-v, 400-w, 3-phase drive, \$125; 1000-v, 300-w, \$95; 1000-v, 250-w, \$85;  $\frac{1}{2}$ -hp. 3450 speed motors \$10.50;  $\frac{1}{2}$ -hp. synchronous 1800 speed motors, \$20; 8-v. 5-ampere generators, \$6.50; converters, 110-v. d.c. to 75-v. 60-cycle, 1-phase 250 watt, \$27; 300-watt, \$35. Queen City Electric, 1734 Grand Ave., Chicago.

**TYPE 866** seconds (new tubes). All characteristics normal. Mercury vapor, 2.5 volt filament. Guaranteed perfect operation and safe delivery, \$5 each. E. Ewing, Jr., 29 S. LaSalle St., Chicago, Ill.

**QSL cards and amateurs' printed supplies.** Seldens', Cranesville, Pa.

G. E. 1000-watt transformers, 1100-2200-4400 each side c. t. Used by over 225 hams. Guaranteed unconditionally, \$12 f.o.b. Detroit.

**WESTERN** Electric dynamos, two 32/350-volt in shock proof frame as advertised in QST, \$20. W61UC.

**TELL** me your radio requirements. I carry the best nationally known lines of parts and transmitting equipment, and ship to hams and set builders all over the world. Regular trade discounts. Since 1921. Roy C. Stage, Wholesale Radio, Syracuse, N. Y.

**SELL** or trade: RCA 211, 203-A, 204-A; WE211D, 212D; power Xtals; 210- and 50-watt Xmitters complete; Eico 1500-volt generator; mercury arc outfit; other apparatus. W9ARA, Butler, Mo.

**CRYSTALS** carefully ground for highest output demanded by modern transmitters. Frequency precision, 1% at room temperatures. 7000 kc., \$15; 3500 kc., \$12; 1750 kc., \$9; guaranteed blanks, \$4. W9DRD, Herbert Hollister Edwardsville, Kans.

**SYNO** — new large Marlo. \$25 takes it. W9ELY, 5868 Barmer, St. Louis, Mo.

**PRICED** right for immediate sale: UX852, holder, 500-watt 3000-volt Thordarson transformer, pair type S REL inductances, Cardwell transmitting condensers, meters and other apparatus. W9CNM, 7512 Indiana Ave., Chicago, Ill.

**TWO** 5 kw. W. E. 220D, 10,000-volt water-cooled tubes, list price \$375 each, not abused or used for more than half their natural life, \$100 each. For particulars, write or wire KXL, Portland, Ore.

**WANTED:** 1-kw. spark transformer, with gap and condenser. F. & H. Radio Labs., Fargo, N. Dak.

**WHAT** am I offered for every issue QST from June 1919, to February, 1923? Raymond L. White, 212 Hollywood Ave., Dallas, Texas.

**HEADS** up fellows — look at these tube prices. UX210, \$3.15; UX250, \$3.60; UX245, \$1.75; UX171A, 95 cents; UX112A, 95 cents; UX224, \$1.95; UX280, \$1.10; UX281, \$2.35. Limited number; standard make tube. First quality, guaranteed. W9CKU, Heron Lake, Minn.

**TELEVISION** — Listen in on announcements from W3XK, 2900 k.c., 8 o'clock, E.S.T., or send for descriptive literature. Jenkins Laboratories, 1519 Connecticut Ave., Washington, D.C.

QSL cards. Write for prices and samples, WINE Press, 230 West Ave., So. Norwalk, Conn.

**NEW** and unused 1-kw. plate transformer, 2200-3300-4400 each side center tap, filament transformer for four 866 tubes, W8ML type, 4 new R.C.A. 866 rectifiers in original sealed cartons. All the above, \$40 cash. G. J. Schulmerich, 1015 Chestnut St., Philadelphia, Pa.

**FOR sale** — one 200 watt Acme power transformer, 750 volts each side of center tap, two filament windings. One DeForest "H" tube, used about 30 hours. Highest offer gets 'em. C. H. McIntyre, 2815 Cortelyou Road, Brooklyn, N. Y.

**HAVE** 6 months' old 32-volt 100-ampour lighting battery with  $\frac{1}{4}$  h.p. motor for sale for \$35. W9AAQ, F. R. Schmidt, Catherine, Kans.

**SERVICE MEN:** Microfarad meter of low price and reliability. Hatry & Young product. Write for information. Don't pay \$30. Save \$15 or more. Hatry & Young, Hartford, Conn.

**FLECHTHEIM** 1500-volt condensers, porcelain insulators, 2 mfd., \$4.50; 4 mfd., \$7.00, used. Mershon condensers, \$1.75. New National 3000-volt. 00045 with vernier dial \$9.50; 00023-6000 volt, \$12.85. Jefferson 300-volt center tapped transformers, \$1.65. Pilot D. C. Super Wasp kit, \$28.90, with a pair of Timmons phones free. Pilot A. C. Super Wasp kit with cone speaker and power pack, \$50.00. Newest type Rectobulbs R3 mercury vapor, \$10.00 prepaid. 281 type mercury vapor, \$7.00 prepaid. Allen Bradley radiostat, new type 500 watt, \$5.50. Aero Monitors, \$10.85. REL Wavemeters, \$16.00. Pilot and Silver Marshall coil forms, \$39. Wire-wound 5000-ohm grid leaks, \$39. Freshman 375-volt, not center tapped, and two 7 $\frac{1}{2}$  center tapped filament windings, \$2.25. Signal High Frequency buzzer, \$95. New Cardwell 00035 SLF condensers, \$79. No. 14 cotton covered enameled aerial wire, \$30 hundred feet. No. 12 solid enameled aerial wire, \$95 hundred feet. \$1.80 two hundred feet coils. REL 50 watt sockets, \$1.50. Used Kellogg double button microphones, \$35.00. Sangamo 5000-volt 00025, 0005, .001, .002 mica condensers, \$1.50. Thordarson key click filter chokes  $\frac{1}{2}$  Henry 200 mill, \$2.95. Thordarson modulation transformers, \$2.95. Latest Amateur Call books, \$35. Used Western Electric 212D 250 watters, \$35.00. REL sockets for same \$9.00. New U. X. 852, \$28.00. Slightly used R.C.A. 211, \$17.00. Slightly used 204As \$50.00. R.C.A. UV 217As \$7.50 each. U. X. 866s, \$11.85; New UX 851 1000 watter, \$250. Western Electric 211A, D, or E 50 watters, \$15.00, slightly used. New 211Ds, \$30.00. Jefferson 30 Henry chokes, 100 mills, \$3.25. Thordarson twin chokes, 20 Henry, 250 mill, each \$6.25. 2500-volt lamp 133 segment Spaulding generator, directly coupled to G. E. five-horse-power motor, cost \$650, special \$225. Here's a real buy. Limited quantity new original cartons Gold Seal UY 227 tubes, \$.89 each; UX 245, \$1.15; UX 280, \$1.05; R.C.A. High Mu U. X. 240, \$1.00; R.C.A. Voltage Regulator U. X. 874, \$3.25. Broadcast microphone cases, \$2.25. Thordarson 400-volt each side center, 150 watt, \$3.90. Uncle Dave, 117 No. Pearl St., Albany, N. Y.

**SIX** Tobe 1300 line 2 mfd. condensers for sale, \$1.50 each. W1BNP

**WANTED** — For personal file, Volume I of QST complete or single copies. State condition and price asked. K. B. Warner, 1711 Park St., Hartford, Conn.

**SUPERHETERODYNE** — Send 30 cents stamps for blue print and data of 10 to 80 meter screen-grid superheterodyne; one spot; single control. Transformers, low loss coils and mountings, price \$11.50. Guaranteed. W6BY, Arthur L. Munzig, Redlands, Calif.

QSL cards \$1 per 100. Two colors. W8AAM, 533 Manhattan, Hazleton, Pa.

## Q R A SECTION

W1AU — Edward Norris, 29 Monroe St., Brockton, Mass.

W1MQ — Thos. F. Reynolds, 19 Granville St., Dorchester, Mass.

W2BJI — Hackensack Radio Association, Y.M.C.A. Building, Hackensack, N. J.

W2HY — Geo. Pertersen, 820-40th St., Brooklyn, N. Y.

W5BKY — Fred P. Coleman, Box 267, Big Spring, Texas.

W9CVV — Walter O. Goss, Box 225, Hunter, N. Dak.

W9DKJ — Verten M. Hasse, R. F. D., Warner, S. Dak.

### W1MK

#### A.R.R.L. Headquarters

R. B. Parmenter, Chief Op. "rp."

The following calls and personal sines belong to members of the A.R.R.L. Headquarters gang:

W1AL B. Dudley "bd."

W1BAW R. B. Beaudin

W1BDI-W1XLF E. Handy "th."

W1CEI J. J. Lamb "jim."

W1DF Geo. Grammer "hg."

W1FH K. B. Warner "kb."

W1ES A. A. Hebert "ah."

W1FL-W2JR G. Donald Meserve "dm."

W1SZ-W1BIZ C. C. Rodimon "rod."

W1UE E. L. Battey "ev."

# To Our Readers who are not A.R.R.L. members

WOULDN'T you like to become a member of the American Radio Relay League? We need you in this big organization of radio amateurs, the only amateur association that does things. From your reading of *QST* you have gained a knowledge of the nature of the League and what it does, and you have read its purposes as set forth on page 6 of this issue. We should like to have you become a full-fledged member and add your strength to ours in the things we are undertaking for Amateur Radio. You will have the membership edition of *QST* delivered at your door each month. A convenient application form is printed below — clip it out and mail it today.

*A bona fide interest in amateur radio is the only essential qualification for membership*

AMERICAN RADIO RELAY LEAGUE  
Hartford, Conn., U. S. A.

I hereby apply for membership in the American Radio Relay League, and enclose \$2.50 (\$3 in foreign countries) in payment of one year's dues, \$1.25 of which is for a subscription to *QST* for the same period. Please begin my subscription with the ..... issue. Mail my Certificate of Membership and send *QST* to the following name and address.

.....  
.....  
.....

Do you know a friend who is also interested in Amateur Radio, whose name you might give us so we may send him a sample copy of *QST*?

.....  
.....

Thanks

## For Your Convenience QST'S INDEX OF ADVERTISERS IN THIS ISSUE

Aero Products, Inc.	85
Allen-Bradley Company	62
American Piezo Supply Co.	91
American Sales Company	79, 89
American Society of Inventors	73
Amrad Corporation	96
Arcturus Radio Tube Co.	74
Auriema, Inc., Ad.	74
A.R.R.L. Apparatus	81
A.R.R.L. Application Blank	91
A.R.R.L. Booklet	69
A.R.R.L. Emblems	91
A.R.R.L. Handbook	88
A.R.R.L. Log Sheets	78
Blan, The Radio Man, Inc.	89
Browning-Drake Corporation	86
Burgess Battery Company	Cover 4
Candler System Company	70
Cardwell Mfg. Corp., Allen D.	65
Central Radio Labs.	72
Chicago Radio Apparatus Co.	80
Commercial Radio Institute	81
Cornell Elec. Mfg. Co.	87
Corning Glass Works	63
Crosley Radio Corp.	57
Cunningham, Inc., E. T.	58
DeForest Radio Company	1
Dodget, C.	80
Dongan Elec. Mfg. Co.	86
Electrad, Inc.	87
Electric Specialty Company	83
Frost, Inc., Herbert H.	90
General Engineering Corp.	82
General Radio Company	2
Greben, F.	90
Gulf Radio School	89
Hardwick Hindle, Inc.	82
Harrison & Company, Wm.	78
Hilet Engineering Co.	91
Himoe, Clifford E.	64
Hoodwin & Co., Chas.	88
Jewell Electrical Instrument Co.	61
Leeds Radio Company	73
Loomis Publishing Co.	72
McGraw-Hill Book Co.	68
Manhattan Electric Bargain House	75
Massachusetts Radio & Telegraph School	90
M. & H. Sporting Goods Co.	89
Munzig, Arthur L.	86
National Carbon Company	95
National Company	78
National Radio Tube Co.	76
Pacent Electric Co.	87
Perryman Electric Co.	71
Plot Radio & Tube Corp.	Cover 2
Port Arthur College	87
<i>QST</i> Binder	84
Radio Engineering Labs.	4
Radio & Television Institute	67
Rectifier Engineering Service	89
Rooney, John T.	86
Sangamo Electric Company	Insert
Scientific Radio Service	83
Shalross Mfg. Co.	70
Silver-Marshall, Inc.	77
Sprague Specialties Co.	59
Teletex Company	87
Thordarson Elec. Mfg. Co.	60
Universal Microphone Co.	90
Vibroplex Company	91
Ward Leonard Elec. Co.	89
Weston Electrical Instrument Corp.	66
Wireless Egert Engineering	68



# YOU CAN "HEAR THE DIFFERENCE AND SEE THE REASON IN EVEREADY RAYTHEON 4-PILLAR TUBES"

Here is an entirely new type of tube . . . Eveready Raytheon! It combines the highest degree of sensitivity with lasting, rugged strength. The patented Eveready Raytheon 4-Pillar construction—a revolutionary improvement—safeguards fragile elements against the dangers of shipment and handling. Eveready Raytheon elements are assembled on jigs, to put them in most sensitive relation to each other. The 4-Pillar construction anchors these elements where they belong—assuring you of a new standard of reception.

You can see this exclusive construction inside an Eveready Raytheon. Look at the diagram on this page. See the solid, four-cornered glass stem. Notice, imbedded in it, the four sturdy pillars supporting the elements. That shows why Eveready Raytheons are stronger than ordinary tubes—and why they give you the best

reception you can possibly get from your present receiver. No other tube can be made like this, because the 4-Pillar construction is patented.

Eveready Raytheons come in all types. They fit the sockets in every standard A. C. and Battery-operated receiver in use today. They are built by the makers of the famous Eveready Layerbilt "B" Batteries—another radical improvement in radio. Get a set of new Eveready Raytheons from your dealer, and enjoy their superior reception today.

## 4-PILLAR TUBES

Eveready Raytheon's exclusive, patented 4-Pillar construction cross-anchors the tube elements top and bottom, conquering the hazards of shipment, ending tube distortion, preventing tube noises.



## 4-PILLAR SCREEN GRID TUBE

New Eveready Raytheon Screen Grid Tube, ER 224. The weight of the four large elements in this type of tube makes the exclusive Eveready Raytheon 4-Pillar construction vitally important.



NATIONAL CARBON COMPANY, INC.

General Offices: New York, N. Y.

Branches

Chicago Kansas City  
New York San Francisco

Unit of Union Carbide  
and Carbon Corporation



Trade-Marks

Say You Saw It in QST — It Identifies You and Helps QST

# MERSHON ELECTROLYTIC CONDENSER



*Why*

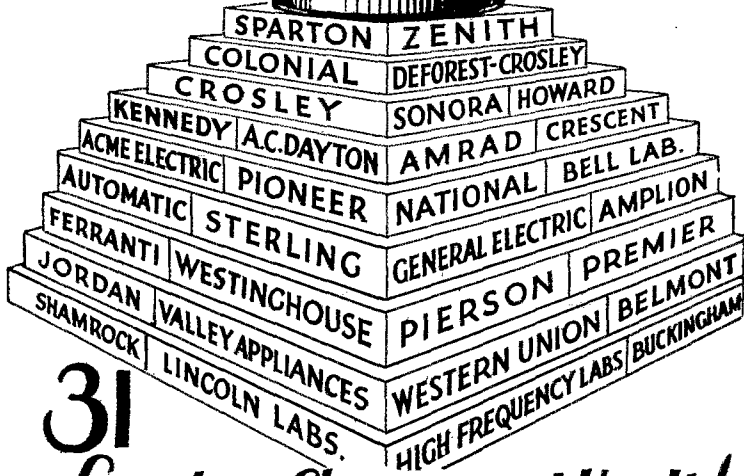

**31**  
*Leaders Choose and Use It!*

Thirty-one leading radio manufacturers specify the Mershon Electrolytic Condenser as standard equipment.

It has enormous capacity in small space — 72 MFD. In 32 cu. ins.

. . . saves weight . . . self-healing . . . humless

The Mershon costs less per microfarad than ordinary condensers, is practically indestructible and makes possible a reduction in size and weight of chassis while assuring uninterrupted efficiency.

Special information is available covering the use of the Mershon in Television, Short Wave Transmitters and Receivers, Sound-Projection Apparatus, etc. Write us explaining which field you are interested in — or use the coupon and let us send you these new and interesting bulletins, diagrams and booklets.

Mershon Division  
THE AMRAD CORPORATION  
Medford Hillside, Mass.

## SELF-HEALING

Mershon Department Q-2  
THE AMRAD CORPORATION  
Medford Hillside, Mass.  
Please send full information  
about the Mershon Con-  
denser to:  
Name \_\_\_\_\_  
Address \_\_\_\_\_

# HAS YOUR HANDBOOK A BLUE COVER?

If not, it isn't the modern Sixth Edition  
and you're missing a lot

Each successive edition of the Handbook has been revised, hot modern material substituted for the practices that have been outgrown. The Sixth Edition has information on Crystal Control and Radiotelephony that did not appear in previous editions, in addition to everything else that the A.R.R.L. can think of for the guidance of a practical radio amateur.

Good as the editions were with the brown and the green covers, they are only QSA1 by comparison with

## THE RADIO AMATEUR'S HANDBOOK

*The Sixth Edition of*

*By Handy & Hull*

NOW IN ITS SEVENTY-THIRD THOUSAND

This book is a publication of the American Radio Relay League, the amateur's own organization, written by amateurs for amateurs. It is hailed everywhere as the greatest help that an amateur ever saw. ¶ Because it starts in at the very beginning of the story and tells what amateur radio is, how to become an amateur, how to learn the code and how to operate a simple station, it is an invaluable and a sympathetic guide for the beginner. ¶ Because it progresses through working descriptions and building instructions for many varieties of receivers, transmitters, power supplies and antennas, and because it goes into all the intricacies of station operation and message handling, it is an indispensable necessity for the proficient amateur.

A world of valuable information, printed in "QST" format and bound in durable paper covers so that the price may be modest.

---

*Blue-and-Gold Paper Cover, \$1.00*

*Stiff Buckram Binding, \$2.00*

---

◀ *We honestly don't see how you can get along  
without the Handbook. Order yours to-day!* ▶

American Radio Relay League, Hartford, Conn., U. S. A.



No. 21308  
 PERFORMANCE RECORD  
 100% EFFICIENCY  
 100% CAPACITY  
 100% LIFE  
 100% RELIABILITY  
 100% SAFETY  
 100% ECONOMY  
 100% CONVENIENCE  
 100% PROTECTION  
 100% GUARANTEE  
 100% SATISFACTION  
 100% ENDORSEMENT  
 100% RECOMMENDATION  
 100% ADOPTION  
 100% FAVORABLE  
 100% OPINION  
 100% VERDICT  
 100% CONCLUSION  
 100% RESULT  
 100% EFFECT  
 100% IMPRESSION  
 100% INFLUENCE  
 100% POWER  
 100% AUTHORITY  
 100% CREDIBILITY  
 100% TRUSTWORTHINESS  
 100% INTEGRITY  
 100% HONESTY  
 100% FAIRNESS  
 100% JUSTICE  
 100% EQUITY  
 100% BALANCE  
 100% MODERATION  
 100% TEMPERANCE  
 100% SELF-CONTROL  
 100% DISCIPLINE  
 100% ORDER  
 100% REGULARITY  
 100% PUNCTUALITY  
 100% DILIGENCE  
 100% INDUSTRY  
 100% PERSEVERANCE  
 100% PATIENCE  
 100% CALMNESS  
 100% COMPOSURE  
 100% COURAGE  
 100% BRAVERY  
 100% VALIANTNESS  
 100% HEROISM  
 100% GALLANTRY  
 100% MANLYNESS  
 100% FORTITUDE  
 100% ENDURANCE  
 100% STAMINA  
 100% RESILIENCE  
 100% FLEXIBILITY  
 100% ADAPTABILITY  
 100% VERSATILITY  
 100% MULTI-TALENTEDNESS  
 100% POLY-VALENTNESS  
 100% MULTI-FACETEDNESS  
 100% MULTI-DIMENSIONALITY  
 100% MULTI-DIRECTIONALITY  
 100% MULTI-ANGULARITY  
 100% MULTI-PLANARITY  
 100% MULTI-LEVELNESS  
 100% MULTI-DIMENSIONALITY  
 100% MULTI-DIRECTIONALITY  
 100% MULTI-ANGULARITY  
 100% MULTI-PLANARITY  
 100% MULTI-LEVELNESS

# Outstanding ...

To the amateur and to every other user of dry cell batteries. Outstanding because of unequalled performance under most severe as well as all ordinary circumstances.

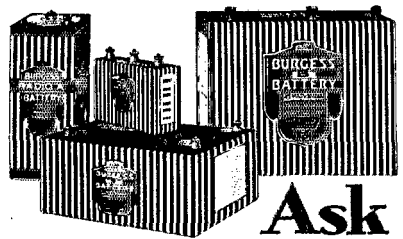

**Ask any Radio Engineer"**

**BURGESS BATTERY COMPANY**  
 MADISON, WISCONSIN

# The Communications Department

F. E. Handy, Communications Manager  
E. L. Battey, Asst. to Coms. Mgr.  
1711 Park St., Hartford, Conn.

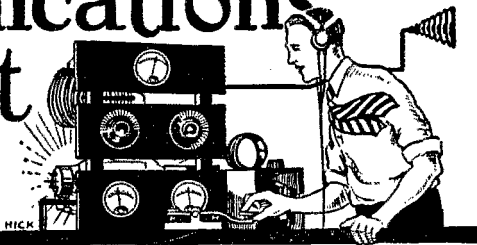

## Is This Operating?

By E. W. Mayer \*

THE year 1930 should be the logical time to clean up operating tactics and etiquette in addition to notes and plate supplies. How much longer are we to expect a directional "CQ" to bring an answer from every other district or from the opposite direction than the one wanted? It is hoped that not much longer, otherwise here is one who will forward SCM reports by mail, and let them appear a month late rather than to go through the present painful process of trying to land the message near to its destination.

With the idea of clearing our monthly report to Mr. Handy via radio, we arose in the early morning hours (as we earn our bread and butter in the evening) and tried a "CQ north QTC WIMK," not having heard any stations in that vicinity working. Tuning across the band we heard a nice DC signal QSA5 giving the usual signal report, and asking QSP? MK? He replied with a signal report stating that he was very glad to hook some DX, but *was not looking for traffic!* This from a well-known "nine" whose several operators are not newcomers to the game seems rather surprising. Evidently there still are DX fiends of the rabid variety. What would you suggest for the fellow who wastes your time for his personal DX satisfaction when you are trying to clear a message in limited operating time? Why answer a CQ QTC if you are not in the direction called and if you do not intend to QSP, but are only looking for DX. I'm interested in DX, too, but I don't answer a directional CQ to get it unless I happen to be in the particular direction and willing to QSP. Such operators deserve a little severity in the reply. Perhaps a frank statement of the case, "That you answered CQ north because you could QSP. Had I known you were after DX only, you would not have found it here SK" would be most appropriate.

CQ DX still brings replies from station 100, 200, 500 or 1000 miles away, altho 1500 miles is the minimum in calls heard lists. Local amateurs do not consider anything east of the Mississippi as DX. CQ VK or ZL is likely to bring replies from all U. S. A. districts. By the time we discover who we are hearing all the VK and ZL stations that may have called us have signed off. This may not mean anything to you fellows who have plenty of time to do your operating, but to the man with limited time, it means more than you would suppose.

Many times I have signed off, shifted the receiver to the top of the band and started down listening for calls, and ran across a man I signed off to, still going strong. When a man says "SK," make your own sign off short and snappy, fellows, give the other man who has been QRX for ten or fifteen minutes a chance to QSO you, or the other fellow. Never use "SK" (or "VA.") unless you mean it. Let's have a little house cleaning in our operating methods. Stick to the rules and regs and if you have misplaced the copy of the R. & R. you received with your membership certificate, drop a line to Headquarters for another. Let's have a little show of courtesy and common sense in this game of ours. One can get DX in plenty. Why waste the traffic man's time to have a QSO of doubtful pleasure and given grudgingly by the man whose directional CQ you have answered to satisfy your craving for LX or what have you?

\* K4KD, 8CM Porto Rico-Virgin Islands.

## Traffic Briefs

Schenectady amateurs have made their bid for recognition in amateur radio by organizing the "Schenectady Amateur Radio Association." The officers are W2OP, President, W2AAL, Vice-President, W2AMM, Secretary, and W2LU, Treasurer. The future plans of the club and the enthusiasm of the members predict a brilliant future for this organization.

W8VY at Dayton, Ohio, wants schedules throughout the world on 14, 28 and 56 mc. He is interested only in reliable, sure-fire schedules that can be maintained over a reasonable period of time, so that experiments may be conducted and comparisons made. Any amateurs on 56, 28 or 14 mc. who would be interested in experimental work with W8VY should write to him direct.

Capt. McClelland of the U. S. Army Air Corps says that all 'phone stations operating off-frequency should be "dropped without a parachute." The bad interference caused by 'phone stations on WIMK's 3575-kc. frequency during the Spokane flight brought out this statement.

W4HN reports much 'phone activity in the Fourth District. In a little over two months on 3500-kc. 'phone he has worked 162 stations. W4IA, W4QZ, W4PD, W4HN, W4HM, W4PW and W4AFQ have been working sixes and sevens. A Fourth and Sixth District's 'phone party was held February 1st and 2nd, with good results.

At about 4 a. m., on January 19, WSBRI overheard some very good 'phone work on the 3500-kc. band 'phone channel. W2ACA, W8AJH, W9EWO, W6BIU and W6BJQ were holding a five-way QSO, forming a coast-to-coast 'phone chain. W6BIU and W6BJQ reported all other stations as coming in fine and W2ACA, the most distant, as coming through R4, steady. This speaks well for the 3500-kc. 'phone band.

"14,000-kc. 'phone is sure FB," says W2BIV. He has worked eight U. S. districts, Cuba, France, England and Porto Rico, and feels there are great possibilities for "real" 'phone work in that band.

Traffic for Cuba moves speedily through W3CBT-ZZC, who keeps daily schedules with CM2SH and CM8UF. W3CBT also schedules ZU1A each Thursday and Saturday.

W2BIV lets out a little secret about the Extra First-Class Amateur ticket. He suggests that hams become familiar with the cable count message check, as it must be explained on the examination. The Radio Amateur's Handbook fully explains the cable count.

One of the 28-mc. pioneers, W2JN, tells us that he still finds that band very FB each Sunday, contacts with Europe taking place between 8:30 a. m. and 2:30 p. m., E.S.T. W2JN says that 28 mc. is the only band that produces really strong signals from Europe.

W5AOM and W4AG have started a relay chain which will later extend from coast to coast. At present the chain begins in Cuba, goes through Florida, Alabama, Mississippi, and ends in Texas. W5AOM wants schedules west, and W4AG wants one to the north. Both stations are desirous

of joining other chains. Any one interested should write either W4AG or W5AOM, stating operating frequency and time.

Efficient QSP? Listen to this. WIAMU took a message from a friend for transmission to Charlotte, N. C. He was fortunate in hooking W4AEN in that city, who took the message and, after acknowledging receipt, told WIAMU that his wife was talking on the telephone at that very moment with the person to whom the message was addressed. An answer was forthcoming immediately, and WIAMU's friend was very much surprised to receive the reply the following morning.

New York 'phone enthusiasts have organized the "Metropolitan Amateur Radiophone System," consisting of W2HY, W2CRB, W2BCV, W2AVE, W2GJ, W2AOC, W2BQU, W2ACG and W2AVR. They meet every Sunday at 10 a. m. in the 3500-ke. 'phone channel. They will stand by for any stations within a radius of 25 miles from New York City who wish to join them.

Here's a new way to work 'em. While listening for an answer to his CQ, K4KD ran across W3AKO calling him. W3AKO signed off saying, "Haven't heard you yet. Please go ahead — long call." It turned out that W3AKO had heard another station calling K4KD, and wanting a QSO had taken the chance of giving him a blind call. He won! Hi.

Having tried every method known to him for curing key clicks with no favorable results, W4WR-W1AEM turned despairingly to his QST index. Eagerly scanning the list of articles he saw the title "Silent Keys." He thought that he had at last found the solution to his problem. Now he wonders if it wouldn't be better if his call were listed there . . . surely there would be no clicks then!

While on a recent business trip through the South and Southwest, W3CAB visited several hams and had some interesting experiences. At St. Louis he saw W9ZK, who rents wires from the 'phone company and operates his station from downtown by remote control. He also met W9BEJ, who is a postman. At Kansas City, W9ZD was visited, and it was learned that his son is radio operator on the yacht *Corsair*. W9CVT is a dentist, specializing in X-ray work. At Oklahoma City, W5SW was found running an electrical repair shop, with the transmitter in one corner. When W3CDQ worked W5SW recently and told him that he was working an "OW station," he came back, "OK FB abt u Official Wave station." Hi. At Montgomery, Ala., W4AAQ reported hearing many low-power 'phones. W4AHP is an enthusiastic set builder. At Birmingham, Ala., W4VC was found to be an old Morse operator, now in the hardware business.

W6DW has left for the island of Guam to take up his duties as assistant engineer for Heintz & Kaufman. He will have a 100-watt outfit operating under the call OM6DW.

When a lady in Washington, D. C., wanted to notify her husband, who is with the Marines in Nicaragua, of the death of his uncle, she telephoned a message to W3AWS at Quantico, Va. The message was filed at W3AWS at 8:05 p. m. W3AWS heard NN1NIC calling CQ and made contact. At 8:25 p. m. the message was received at NN1NIC and 'phoned to the addressee. An answer was received at W3AWS at 8:35 p. m. and 'phoned to Washington at 8:50 p. m. Quite a lively 45 minutes!

We quote from a clipping taken from *Sea Stories* for April, 1929, and sent us by W4SI: "Naturally I was reminded of the past, when the S O S call was more of a novelty than it is today. S O S — save our souls! It used to be C D Q, which meant: come, damn quick! That showed the urgency — it meant that unless great haste were made another sea tragedy was about to be consummated." How we radio men have been deceived all these years! Instead of C Q D (which, by the same reasoning, should mean "Come quick dammit!"), we have C D Q. Now, how's a feller going to know??

We notice that some amateurs still omit the "W" in front of their call letters. That "W" is just as much a part of your call as the number and following letters, and it *must* be sent.

## Amateur Radio at the All-American Air Races

At the All-American Air Races held at Miami, Fla., January 13th, 14th and 15th, amateur radio operators once again showed their ability to quickly and efficiently handle an important communication job. Upon very short notice, members of the Miami Amateur Radio Club installed three complete stations, one at each outlying pylon, and one at the Timer's stand. The permission of the Radio Supervisor was obtained to use the calls of three of the club members — W4MD, W4AGY and W4QL.

W4AGY and W4MD were installed at the pylons, and each used 7½-watt transmitters, the filaments being fed by storage batteries and the plates by dynamotors. W4QL was at the Timer's stand. As AC plate supply was available there, an 852 supplied by Rectobulbs was used. Zeppelin antennas were used at the three stations. The operators were W4MD, W4AKW, W4NB, W4AEQ and W4QL. They were assisted by W4AGY, W4WT, W4CJ and W4NE.

The communications work consisted of reporting the progress of the planes around the course to the Official Timer. Two forced landings and one crash were also reported. The manner in which the amateurs carried out the work was highly commended by officials in charge.

## Traffic Briefs

Here's another boost for the 3500-ke. band. The following is quoted from the Holland report in the February issue of the *T. & R. Bulletin*: "Conditions generally have shown little real improvement. We noted that on 3.5 mc. the Americans were more consistent than on 7 mc. and regret that more of our newcomers do not use this band in preference to the higher frequencies."

And now there is the "A. T. & T. QRM Club" which has been organized out in the Mid-West. Only those who have been called by American Telephone & Telegraph Co. for being out of band and QRMing their trans-oceanic telephone work are eligible. Get in touch with W9FZO for further particulars!!

*Amateur* comes from the Latin word *amator* — lover. An amateur is not necessarily a novice, a beginner, as those unversed in amateur radio sometimes like to think, but an amateur is an individual who does something for the love of it.

## A Warning

REGARDING THE ILLICIT USE OF CALL LETTERS

WE regularly receive complaints from various amateurs that their calls are being used unlawfully by some unlicensed station. Many of these complaints are also referred to the Supervisor of Radio's office. One of the most recent cases called to the attention of the Third District Supervisor is from W3QW, Pottstown, Pa. Although this station has not been on the air since late in December, numerous confirmations of QSOs during January have been coming in.

It is bad enough when a complaint such as the above is received, *but*, when a Radio Supervisor's call is used unlawfully, we think a climax has been reached. Mr. Herndon, Supervisor of Radio for the Third District, reports that he has received a card confirming a QSO with his station, W3FW. W3FW was not on the air at the time specified on the card.

This item applies only to a very small percentage of amateurs, but it is time a warning was given. The Radio Act of 1927 provides suitable penalties for the illegal use of call letters, and the use of false call letters. If caught, the guilty parties are liable to those penalties. We hope that the offenders referred to above (those using the calls W3FW and W3QW) will heed our word of caution — "If you play with fire, you are likely to burn your fingers."

Careless or sloppy sending often results in an amateur reporting some one using his call. All amateurs are urged to watch their sending so that they do not garble the letters and unintentionally use some one else's call.

# W1MK

A.R.R.L. Headquarters' Station W1MK operates on frequencies of 3575 kc. and 7150 kc. Robert B. Parmenter, "RP," is the chief operator; his fist is familiar to most of the amateur fraternity. Occasionally other members of the Headquarters' staff operate at W1MK. Their personal signs may be found in the QRA Section of QST.

Throughout the following schedules Eastern Standard Time will be used.

**OFFICIAL AND SPECIAL BROADCASTS** are sent *simultaneously on 3375 kc. and 7150 kc. at the following times:*

8:00 p.m.: Sun., Mon., Tues., Thurs., and Fri.

10:00 p.m.: Mon. and Fri.

12:00 p.m. (midnight): Sun., Tues., and Thurs.

**GENERAL OPERATION** periods have been arranged to allow every one a chance to communicate with A.R.R.L. Headquarters. These general periods have been arranged so that they usually follow an official broadcast. They are listed under the two headings of 3500 kc. and 7000 kc.; to indicate whether the watch is devoted to listening on the 80-meter band or to the 40-meter band.

3500 kc.

8:10 p.m. to 9:00 p.m. on Sun., Mon., Tues., Thurs., and Fri.

10:00 p.m. to 11:00 p.m. on Tues. and Thurs. (No OBC sent before these periods.)

12:00 p.m. to 1:00 a.m. (or later) on Sunday night (Monday morning).

7000 kc.

10:10 p.m. to 11:00 p.m. on Sun., Mon., and Fri.

12:00 p.m. to 1:00 a.m. on the following *nights* (actually on the morning of the day following): Mon., Tues., Thurs., and Fri. (*Only* on Tues. and Thurs. does the OBC precede these periods.)

**SCHEDULES** are kept with the following stations through any of which traffic will travel expediently to A.R.R.L. Headquarters, on 3500 kc.: W1ACH, W1BXB, W1ZA, VE1AY, W2JF, VE2AC, W3BWT, VE3DA, VE3ET, W8CUG, W9APY, W9OX, VE9AL; on 7000 kc.: W4AGR, K4KD, W6AKW, W6CIS, W6OJ, W9DFG, W9DYU and W9YC.

## Official Broadcasting Stations

### CHANGES AND ADDITIONS

(Local Standard Time)

W3CKL (7040) Mon., Wed., Fri., 6:45 p.m.; W5AJL (7240) Tues., Thurs., Sat., 6:00 p.m.; W9AIR (1750) Mon., (3900) Wed., Fri., 8:30 p.m.; W9COS (7060) daily, except Sun., 7:00 a.m. or p.m.; W9FYM (7150) Tues., Thurs., Sat., 9:00 a.m., Sun., 2:00 p.m.; W8SO (1739) Mon., Wed., Fri., 1:00 p.m., also between 5:00 and 7:00 p.m. as schedules permit.

## Traffic Summaries

(JANUARY-FEBRUARY)

Pacific led by Los Angeles.....	10,312
Central led by Ohio.....	7659
Atlantic led by Maryland-Delaware-D. of C. ....	6895
Midwest led by Missouri.....	5122
New England led by Eastern Massachusetts.....	4591
Dakota led by Southern Minnesota.....	3931
Hudson led by Northern New Jersey.....	3716
Southeastern led by Florida.....	2730
Northwestern led by Oregon.....	2283
Rosnoke led by West Virginia.....	1957
West Gulf led by Southern Texas.....	1759
Delta led by Tennessee.....	966
Rocky Mountain led by Utah-Wyoming.....	879
Vanalta led by Alberta.....	507
Prairie led by Saskatchewan.....	440
Quebec.....	251
Ontario.....	72
852 stations originated 14,376; delivered 27,077; relayed 27,077; total 54,070. (87.5% del.)	

The Los Angeles Section in the Pacific Division leads the country with a total on 3277 and again carries the Traffic Banner. The Maryland-Delaware-District of Columbia

## BRASS POUNDERS' LEAGUE

Call	Orig.	Del.	Rel.	Total
W31A	77	154	1094	1325
W2CXL	84	105	814	1003
K1IHR	266	221	496	983
W6AD	125	239	490	854
W9COS	137	199	442	778
W8IB	186	122	435	743
K4IDJ	276	220	159	655
W3AHM	618	18	4	640
W6EIB	60	15	476	551
W9EQJ	26	45	458	529
W3BWV	152	102	251	505
W2QU	219	249	32	490
W9BN	214	112	162	488
W1MK	144	153	181	478
W8YA	62	88	300	450
W6AKW	56	10	362	428
W7AAT	201	29	198	428
W8CNO	38	22	340	400
W9CTW	37	14	338	379
W1WV	100	119	144	363
W1ADW	150	162	46	358
W8DFJ	59	60	227	346
W3ARU	32	52	238	322
W9EGU	14	10	302	326
WYE-W8SL	146	23	148	317
W7AJR	293	6	4	303
W3NF	236	36	27	299
W8BCM	105	73	98	276
VE4GD	100	86	78	264
W2SC	56	93	114	263
W6ERK	24	106	128	258
W9DNZ	33	22	202	257
W41A	10	41	198	249
W9DGS	73	53	125	249
W8AEQ	4	12	20	245
W9BJA	40	36	166	242
W8DGT	20	67	154	241
W9GBT	21	14	203	238
W8DLG	28	40	169	237
W1RY	37	51	146	234
W9DDB	117	94	92	222
W8DQP	54	30	148	232
AC8RV	106	52	74	232
W6BSH	85	15	122	222
W6ETJ	36	75	110	221
W7AJW	81	12	122	220
W1CGX	10	16	194	220
W9EBO	29	31	158	218
K4KD	103	97	18	218
W8AQ	81	115	20	216
W9AKZ	70	9	138	215
W8YG	179	10	26	215
W8BJO	82	92	41	213
W1ATO	28	42	142	212
W8E	74	59	78	211
VE4IH	43	41	128	210
W6AKD	17	10	180	207
W4OZ	110	97	—	207
K6EWB	101	64	38	203
W9ERU	56	68	84	202
W6DYJ	48	63	89	200
W6BZY	35	10	155	200
W9BOQ	22	11	167	200
W4ALH	48	51	100	199
W8EJ	85	87	27	199
W5AJL	78	62	56	196
K6DPG (Dec.-Jan.)	4	166	20	190
W5ABI	21	62	106	189
VE2AC	59	57	68	184
W6CBW	12	65	104	181
W6KXC	77	56	48	181
W8BGY	59	50	44	163
W9CFL	22	60	6	156
W5AOP	86	56	12	154
W8DSE	59	72	12	143
W6LN	30	62	48	140
W9DFG	20	53	64	137
W6BET	14	86	64	134
W6HM	48	75	6	129
W6YU	38	54	34	126
W9GHI	60	53	8	121
W6AM	41	56	20	117
W9EF	24	59	26	109
W9BSH	45	50	12	107
W2RD	13	52	32	97
W2BSW	18	55	23	96
W8FY	10	55	30	95
W3AHZ	9	55	28	90
W9CDU	26	52	9	87
W2AVP	12	66	10	78

The several amateur stations responsible for the best traffic work — the ones that are "setting the pace" in worthwhile traffic handling — are listed right up near the top of our B.P.L. the figures giving the exact standing of each station accurately.

All these stations appearing in the Brass Pounders' League are noted for their consistent schedule-keeping and dependable message-handling work in amateur radio. Special credit should be given to the following stations in the order listed responsible for *over one hundred deliveries* in the message month: W2QU, W6AD, K4IHR, K4IDJ, W9COS, K6DPG, W1ADW, W31A, W1MK, W9CFL, W8IB, W1WV, W8AQ, W9BN, W6ERK, W2CXL, W3BWT.

Deliveries count! A total of 200 or more bona fide messages handled and counted in accordance with A.R.R.L. practice, or just 50 or more deliveries will put you in line for a place in the B.P.L. Why not make more schedules with the reliable stations you hear and take steps to handle the traffic that will qualify you for B.P.L. membership also!

Section in the Atlantic Division made a mighty fine try and came out with a total of 3126. Los Angeles had better tighten her grip on that flagpole! The Traffic Banner goes each month to the section with the largest total of *real* messages. A traffic summary showing the standing of the various divisions for the past month is printed above. What place does yours take? What section will carry the Banner next month and help its division head the list?

#### ARMY-AMATEUR NOTES

**FIRST CORPS AREA:** Although this area has been rather quiet for some months, a complete reorganization is now under way, and it is expected that the "First" will be in a healthy and active condition very shortly. W1AYN, W1PM and W1KR continue to be the active stations. A. L. Budlong, at A.R.R.L. HQ, has recently been temporarily appointed the Radio Aide to the Signal Officer of the area.

**SECOND CORPS AREA:** This area continues to be one of the most active. New A-A stations are W2HF, W2UV and W2ACD in the Westchester District Net of the Southern N. Y. State Net; W2AVE in Kings County Net; W3AIW is the alternate N. C. S. of the Delaware State Net. During the month of December, alternate Corps Area N. C. S. W2PF handled over 200 messages on Monday night schedules.

**FIFTH CORPS AREA:** The West Virginia Net under W8OK and the Ohio Net under W8JC have been very active during the past month. W8ATZ has been added to the West Virginia State Net. W8BAS, W8CNO, W8EH, W8VP and W8CCS have been added in Ohio. With the addition of W8CNO, the Fifth Corps Area claims the honor of having the first XYX as an A-A Net member. W9BAZ and W9EZ are expected back strong next month in the Kentucky and Indiana Nets. Official certificates are being issued as fast as the stations prove their reliability. W8GZ-ZG again solicits applications.

**SIXTH CORPS AREA:** The following stations are functioning every Monday evening on schedule: Illinois State Net — W9BNI, W9DOX, W9BYX, W9CTX, W9RPX, W9ERU; Michigan State Net — W8BGY, W8CEP, W8CCM, W8DYH, W8SB, W8ACU; Wisconsin State Net — W9CD, W9DJK, W9OT, W9GEX, W9DKS, W9DXL. Mr. Kamin, W9US, is Sixth Corps Radio Aide and also Corps Area Net Control and now operates on the special Army frequency of 6990 kc. with crystal control. Amateurs in this area interested in joining the A-A system should write to W9ANR, Signal Officer, Hqtrs., 6th Corps Area, 1819 West Pershing Rd., Chicago, Ill.

**EIGHTH CORPS AREA:** W5AIN is Net Control Station for the area. A new transmitter is in the course of construction by local personnel of station W5AIN.

**NINTH CORPS AREA:** W7AAT is State Net Control for Montana. W6EVR is a newcomer to the Area. W6BDX, N. C. S. 1st District of California, is a "regular" on drill nights. W6DQV, N. C. S. 5th District of California, reports activity in his section. W7GL, District N. C. S. at Jerome, Idaho, is on regularly. The following stations are still among the stand-bys: W6BDD, W6DFR, W6DLI, W6DQV, W6ADQ, W6AKW and W6EAF.

## Traffic Briefs

'Phone is being used by many amateurs for traffic handling. For the reporting month just past, December-January, W4IA at Union Springs, Alabama made the BPL using 'phone entirely.

The fifth annual hamfest of the Twin City Radio Club, Minneapolis-St. Paul, Minnesota, was held on January 17th with a good attendance of 65. The program included eats, short talks and movies of the Cleveland Air Races and several old time Twin City stations.

On January 1 W6BAX worked all continents between 9:10 a.m. and 7:50 p.m. P.S.T., ten hours and forty minutes. He believes he is the first to work all continents in 1930.

During the sleet storm in western New York state December 17th to 21, W2BOK kept the Lockport Light Co. in touch with the Associated Gas and Electric Co. in New York City through W8AFM.

Speaking of BCLs, W7AAT was called ten miles to service a new a.c. receiver only to find the perplexing problem to be that the terminal lead going to the screen grid contact at the top of the tube was not connected. Hi.

W9CEE and W9GAQ extol the possibilities of the 3500-kc. band when they tell of an all-night vigil on that band at W9CEE. Eighteen states and an average of seven stations an hour were worked. The transmitter was a T.P.T.G. using two 210s in parallel with 100 watts input from 281s. The antenna was a 134 foot zepp.

W7AAT was reported QSA4 on 3500 kc. in Auckland, New Zealand, and says if more of the gang would cut down their speed on this band, they would probably receive reports from such distant points.

Following the emergency work done by western New York state amateurs during the ice storm in that section last December, the Radio Association of Western New York appointed a committee to organize a network of stations to operate in case any such emergency should again arise. The committee, made up of W8CTK, W8AFM, W8OA, W8ADE, W8TH, W8CHG and W8CPC, is working on emergency transmitters and special schedules.

A club has been organized by west coast amateurs for the sole purpose of bettering the art of "rag chewing." It is called the "Sunday Morning Breakfastless Club" and meets every Sunday from 9 a.m. until noon on approximately 7050 kc. All members operate on the same frequency and use break-in, thereby saving time and eliminating QRM. Those desiring further information or wishing to join this club should write to any of the following member-stations: W6BET, W6BVS, W6CTO, W6DEH, W6ETA, and W6YU.

Louis R. Huber, the new Midwest Division Director, is able to keep up his brasspounding talents while attending the University of Iowa by making use of the "U" station, W9YA. "Ou" expects to operate there quite regularly and hopes to work many stations in both his and all other divisions. W9YA is tuned to 7139 kc.

D. L. Edmondson, W5ARA, Official Observer states that over 90% of the stations observed off-frequency were calling CQ at the time logged and that in most cases the calling continued *without any answers being received*. The rest of the off-frequency stations were calling some one they never raised. Mr. Edmondson states that it is remarkable how promptly they do answer a call when one tries to notify them of their off-frequency position. It shows the small amount of communication that can be expected when operating out of the amateur band! All of which points to the fact that adjustments and frequencies should be checked daily before starting operation. Carelessness and inattention to these matters is the basic cause of most of the off-frequency operation that hurts our good reputation. Every station should have the most accurate frequency standard or monitor that can be afforded. This should be checked frequently and used regularly.

Traffic from the Observatory of the Department of Terrestrial Magnetism at Watheroo, West Australia travels to Washington, D. C., on regular schedule via VK6MO-KA1HR-W6TM-W1MK-W3BWT. Return traffic travels via the same route.

As a result of the disaster to the *Carnegie* in Apia Harbor, Western Samoa, on November 29, 1929, the following is the last report to be received from the *Carnegie* on the work of WSBS. It covers the operation from October 2nd until the arrival at Pago Pago. This report is chiefly of interest in those portions which record vagaries in conditions in the transmitting medium due to sun spots or a variety of causes. "Since leaving Honolulu KUP has been worked regularly, and on Saturday nights a schedule with W6AM has been maintained. Amateurs in and near Honolulu (K6CIB, K6CJS, K6CH, K6AVL, K6BRA) have been very kind in handling messages to friends in Honolulu and occasionally relaying messages to the States. KA1HR in the Philippines has relayed several messages to Waterloo for us, all the



above on 9015 and 7000 kc. Many personal messages have been relayed through United States amateur stations, W6CUT, W9ERM, W9IUS and others. W6DZY, on 14,000 kc. (October 22nd), took a 188-word technical message for Washington without a repeat, and then told us that he had three broken fingers due to the fall of a heavy piece of machinery on them a few days previous. The radio weather from October 2nd to about October 10th was good, but from then until about the 16th of November, a very noticeable decrease in signal intensity on short waves was in force; at times, however, broadcasting from eastern United States could be heard with good loud-speaker volume during this period. A rather unusual thing for us, indeed, was to sit and listen to the Crosley station in Ohio way out here near the equator, as we did on several occasions. A number of sun spots have been observed all during this period, but what their effect is we cannot say yet.

"On October 14th and November 10th communication with eastern United States was had on 7000 kc. On both nights West Coast stations faded out as the eastern stations appeared.

"While in Honolulu Harbor, not a very good place for radio communication, NKF on 20,000 kc. was strength three at least, and when we cleared the Islands, all signals increased in volume by two to three, while NKF was unheard from then on. The receiver here was working perfectly as shown by the continued reception of other signals.

"Signals from 19,000 to 23,000 kilocycles are heard all through the 24 hours of the day; that 16,000 to 18,000 kilocycle signals show daylight effect and decrease in intensity during the middle of the day; that 12,000 to 14,000 kilocycle signals have greatest intensity around sunrise and sunset, falling off more by day than by night; that 9000 to 12,000 kilocycle signals show pronounced daylight effect and signals from 9000 to 3000 kilocycles have the well-known increase with night time."

#### QSA?

"This QSA business. How many operators have got QSO and received a line like this? 'GE OM UR QSA 2 HR.' Then they go on about the weather, etc., and finally say, 'BOY UR SIGS SURE CUT THRU QRM 100 PERCENT READABLE ETC.' I've heard this, and been moved to wrath nightly. No doubt many others have, too. Now what these operators are doing is using the QSA system improperly to denote audibility. QSA5 does *not* always mean R9. They must get that through their heads! QSA5 means 100% readable but contains no comment on volume. I have noticed many using QSA5 R7, or something like that, and have used it myself. That makes a more accurate and understandable report." -- W9GJN

#### BYRD CONTACT

W1XV contacted WFA, the base station of the Byrd expedition daily during January and until February 19, the date when WFA signed off for good after a final contact with the City of New York, WFBT, 8810 kc. This work with WFA was conducted (both ends) on 14 m.c. During the same period WFA kept schedules with W1ZZ, WSCFR and W9EF. The *City of New York* docked in Dunedin, N. Z., March 10. Since amateur communication is not permitted while in port, WFBT will not be heard again until en route to the U. S. A. after April 1.

Mr. H. L. Shrimpton, ZL4AO, is coming over as operator on WFBT. On arrival in the U. S. A. he will represent the New Zealand Association of Radio Transmitters, his national amateur society.

The Byrd expedition planned to leave Antarctica in mid-February. Operator Grenlie of the *S.S. Eleanor Boling* looks for amateurs daily on the 14 mc. band between 0300 and 0500 G.C.T. WFAT transmits on 8670 kc. (34.6 meters) for these contacts. The *Boling* was half way to the Bay of Wales on January 26 according to a report from WICMX who was in contact. The *S.S. City of New York*, WFBT, operates on 8810 and 13,180 kc.

Fellow, if you are looking for a real kick out of this ham game, get in touch with your local rifle teams and tell them about the service you will give them on scores.

W2ABU, W2BTE, W2BDG and W2CQD, the New Stock Exchange stations, are on the air regularly on 14 mc. and 7 mc.

Your team may communicate with Mr. G. W. Robertson, Personnel Office, New York Stock Exchange, 11 Wall Street, N. Y. C., or any of the above stations for additional information.

--- W. G. Beck, W2CQD

A sub-office of the Ninth District has been opened at 302 Federal Bldg., Denver, Colo., with Assistant Radio Inspector G. W. Earnhart, W9CHV, in charge.

The amateurs of Astoria, Oregon, W7ALM, W7ED and W7WB, had an amateur station in operation at the Clatsop County Fair held in that city September 17 to 20. A local electrical dealer purchased a booth for the station. Mr. Lovejoy, the Seventh District Radio Supervisor, issued a temporary station license, W7AFP. Preliminary tests were run with W6DZL. The transmitted used was W7ALM's 250 watt, High-C, TPTG outfit. Primary keying was used and BCL sets could be demonstrated while W7AFP was in operation.

Traffic was handled during morning and early afternoon hours. Schedules were kept with W7AMO, W7LT, W7OJ and W6BI. These stations took traffic and secured return messages. The names of the persons to whom the return messages were addressed were announced over the public address system. This stimulated interest and more messages were filed. A total of 161 messages was handled, 136 of them being originated. Signs, together with the station license, operators' licenses, QST cards, etc., added greatly to the appearance of the station.

The above was reported by Chester A. Lamont, W7ALM, who adds that a good time was enjoyed by all in working W7AFP, and it was decided that next year there will be a bigger and better station at the Clatsop County Fair.

The returns of the City College of New York vs. George Washington University football game on October 26 were sent in regular play-by-play form from W2HJ at City College. The broadcast was received by the gang at George Washington University, and W2HJ's "Graham MacNamee" was voted one of the best announcers they had ever heard. The returns were very interesting to the University boys even though the final score was 45-0 in favor of City College.

#### BEGINNERS!

We are pleased to announce several new volunteers' schedules. All of these stations are working in the 1750-kc. amateur band and are sending code practice on regular schedules. In every case the time of schedule is given in Standard Time for the locality of the station.

Starting April 1, W2AXS in New York City will take on the code practice work. He will use 'phone and CW on 1750 kc. during the following daily periods: 7-7:30 and 11-11:30 p.m. There has long been a need for a volunteer station in the vicinity of New York, and we are certain W2AXS will receive a hearty welcome.

W9GEN, Neoga, Ill., transmits code instruction using CW only on 1875 kc. at 6 p.m. daily. He uses both straight key and Teleplex, and starting at a speed of only a few words per minute, works up to 12 w.p.m.

W9EED, Carroll, Iowa, is transmitting code lessons each evening except Sunday from 7:30 to 8:00, on a frequency of 1845 kc. A combination of 'phone and key is used to put the lessons over.

W9AKL, Decatur, Ill., using a frequency of 1935 kc., broadcasts code practice on Monday, Wednesday and Friday at 8:00 p.m.

We understand that station WCFL, Chicago, is broadcasting code instruction each Tuesday from 5:45 to 6 p.m. This, of course, is in the BCL band.

W9FLS, Ava, Ill., transmits on 1715 kc., starting at 10:30, on Tuesday, Thursday and Sunday nights. Tuesday night is "alphabet night," Thursday is "word night," and Sunday is "sentence night." The "raw recruit" will probably do best if he copies the Tuesday night lesson, while a more advanced beginner will benefit by the Thursday and Sunday night classes.

W6BUZ, Reedley, Calif., must discontinue the code practice broadcasts as he is changing his location. He may be with us again later.

W6UJ, El Monte, Calif., has revised his schedules of code practice broadcasts and is now transmitting on Mondays and

Thursdays, 9:30-10:30 p.m. on 1765 kc. He will continue the broadcasts until the middle of June.

W9BJA, Coffey, Mo., is sending Official A.R.R.L. Broadcasts on 1750 kc. on Sundays and Thursdays, 8:30 p.m., at a speed of 6 to 10 words per minute. This is excellent code practice material.

## Divisional Reports

### ATLANTIC DIVISION

MARYLAND-DELAWARE-DISTRICT OF COLUMBIA — SCM, Forrest Calhoun. W3BBW — "Bravo!" That is about all I can say regarding this report. With fewer (but better) stations we have set a record for this section. May the fine work continue. Maryland: W3LA made quite a record for traffic this month with 1325. He was QSO AB6 every night except three during its flight. FB. W3CGC says there isn't room to stand on 3500 kc. W3BBW, the SCM, visited some of the Delaware gang. W3AOO, the Western Maryland noise, sent in a nice report. W3LB is back in Hagerstown. W3AFF is rebuilding. W3GF just finished an MOPA and reports it very "potent." W3NY is going in for experimental work. W3DG works lots of DX. Another old-timer is starting up in Baltimore — W3AHG. Delaware: After visiting our ex-SCM, W3AIS, I want to apologize for raising Cain about no report. Find about four active stations in the whole state. W3ALQ reported. W3EC was QSO Michigan using a VT2 with 180 volts B on plate. District of Columbia: W3AHM, a non-ORS, visited the SCM and delivered a fine report. W3BWT, our RM, handled his usual bunch. W3RF, a new ORS, has a xtal perking FB on 3595 kc. W3PM is rebuilding a 50-watt TPTG. W3NR is back from Florida. W3ASO, one of our oldest ORS, sent in his report. W3OZ, a new ORS, handled a few. W3CDQ, our YL, assisted with the Arctic Patrol flight. W3CAB also helped out. W3AKR came back after two months off. W3LX expects to use crystal soon. W3GT's OW reported for him, via W3LA, and says he is in Panama.

Traffic: W3LA 1325, W3AHM 640, W3BWT 505, W3BF 211, W3PM 114, W3CGC 96, W3BBW 59, W3OZ 43, W3ASO 41, W3CDQ 14, W3AFF 11, W3AKR 9, W3CAB 9, W3AOO 9, W3GF 8, W3LX 2, W3NY 1.

SOUTHERN NEW JERSEY — SCM, N. R. Weible. W3BWJ — W3DH and W3ATJ were both in the International Contest. W3ASG has good totals in spite of the fact that he has no schedules. W3AWL will soon have a portable transmitter on the job every day. Exams and QRM hit W3ATP this month, but he survived both of them. W3BWJ has a new position that frequently keeps him away from the station for a week or so.

Traffic: W3DH 58, W3ASG 53, W3AWL 29, W3ATJ 19, W3BWJ 20, W3ATP 10.

EASTERN PENNSYLVANIA — SCM, Don L. Lusk. W3ZF — I received a mighty fine report on off-frequency stations from W3MC. The rest of the gang evidently forgot the fact that they, too, are observers, as no other reports were received. W3TB, a new prospective ORS, is installing an xtal set with an 852 in the last PA. Another new man comes forward this month, W3UH, who is just breaking into the game and looking for traffic. W3UX is losing interest in traffic. That won't do, Dave. OM. W3LD wants an ORS. W8AWO isn't forgetting his Sunday code class. W3AUR is almost eligible for an ORS. W8DET likes the new ORS system. W3QP delivered his total in person this month, and we had a nice long chat. Our RM leads in traffic this month and wants to know who wants skeels. W3AHZ made the BPL with his first report. Miss W3AKB reports: she will keep her ORS even if she has to break dates, hi. W8VD received a temporary ORS appointment. W3DZ is still pretty busy at school. W3ZF installed a 250-watt and is getting out nicely.

Traffic: W3NF 299, W3UX 129, W3ZF 121, W3AHZ 90, W3QP 89, W8VD 41, W3TB 61, W3UH 39, W8DHT 26, W8AWO 21, W3AKB 19, W3MC 13, W3AUR 13, W3DZ 6.

WESTERN PENNSYLVANIA — SCM, A. W. McAuley. W8CEO — W8YA takes the lead this month. They have schedules on a route to China and the Philippines. W8DLG is second with a fine total. W8CUG has taken over the schedule with PYIAW while W8CFR is visiting in South America. W8CMP is one of our most active stations. He and

the SCM have a weekly schedule. W8CEO is using a crystal-controlled oscillator for frequency check. W8BYS is in a hospital. We wish him a speedy recovery. W8AGO is slowly whipping his xtal outfit into shape. W8DNO is experimenting with fone on 14-mc. band. W8ASE and W8AGG are two new hams in Huntingdon. Welcome, boys. W8GU is back in Erie and is experimenting with neon tubes. W8ARC has resigned his job of secretary of the A. T. A. and the work has been taken over by William Todd, W8IYL. W8CHF is dusting off the old set and is going to take another fling at it. W8RG, an old-timer of spark days, is putting in a new transmitter at his home in Curtisville. W8APQ sent in a long letter with some good dope on signal wobbling. W8AJE and W8BRJ are active. W8AJU reported by radio telephone. Watch your frequency most carefully. The A. T. & T. is pegging us right along. Don't let them catch Western Pa. hams on the wrong side of the fence.

Traffic: W8YA 450, W8DLG 237, W8CUG 72, W8CMP 58, W8AAG 54, W8DUT 20, W8CEO 19, W8CNZ 5, W8AJU 3, W8APQ 112, W8DNO 14, W8AYH 10, W8AGG 8, W8ASE 1, W8AVY 8.

WESTERN NEW YORK — SCM, Charles S. Taylor. W8PJ — W8ABQ starts the month off with a report of rag chewing with some 19 or more stations. W8ADZ has a schedule and is handling traffic. W8AFM has been very busy checking off frequency hams. W8ATH reports traffic improving. W8AVM works west coast often. W8BAV reports no traffic due to YL. W8BCM handled over 276 messages this month. W8BCZ has recovered from his long illness and is back again with the A.R.R.L. spirit. W8BDV has many schedules. W8BGV reports traffic. W8BJO makes the BPL again. W8BMJ reports traffic very good. Ex-SBQK is back with the gang after floating around the central part of N. Y. state. W8BWG expects a new YL op soon. W8BYO wishes to announce the birth of a new station, W8CID, owned and operated by his son. W8CKC did a lot of relief work in the storm-stricken area around Dansville. W8CMW is trying hard to bring up his traffic by arranging schedules. W8CNX blew his pet plate transformer. W8CPC said he couldn't make 34 messages a month, but from his report he came very close — 31, and mostly foreign at that. W8CYG has schedules with OYID. W8DII reports traffic good. W8DME is handling traffic as usual. W8DQP makes the BPL and reports K4KD and W4WR visitors at his station this month. W8DSA devoted most of his time this month to building a screen-grid receiver. W8DSP makes the BPL on deliveries, and states he made 2016 points in Sweepstakes Contest. W8DYI reports good improvement in traffic. W8OA, another off-frequency checking station, reports that only two stations out of three thanked him for his services while only one did not respond to his frequency check. Amateurs who get cards from frequency checking stations should acknowledge same, as this kind of service is most beneficial to you and the A.R.R.L. in general. Western New York should have at least 5000 messages every month. Let's make that our goal.

Traffic: W8ADZ 18, W8AFM 14, W8ATH 32, W8BAV 4, W8BCM 276, W8BCC 60, W8BDV 36, W8BGV 18, W8BJO 213, W8BMJ 45, W8BYO 27, W8CKC 49, W8CMW 12, W8CNX 58, W8CPC 31, W8CYG 38, W8DII 103, W8DME 44, W8DQP 232, W8DSA 16, W8DSP 143, W8DYI 42, W8OA 31.

### CENTRAL DIVISION

ILLINOIS — SCM, F. J. Hinds. W9APY — W9BKL is having bad power line QRM. W9BMQ is building a peaked AF special receiver and new rectifier. W9AFN has a new key filter. W9PA is working on a new receiver. W9AHK gives code practice on 3.5 mc. every Sunday morning from 10:30 to 11:00 a.m. C.S.T. W9ERU did good work in the relays, using remote control. W9ETP and W9RXB will soon be moving QRA's. W9BDW took a message from

W6AFI, going to his YL, 'phoned it and sent back an answer in 15 minutes. W9DSS has been busy blowing out plate blocking condensers. W9FAJ was QSO ZS4M and hooked the latter up to W9KA at the same time. FB, OM, W9CKM is offering a case of Scotch to the fellow who can make a 210 kick out like an 852. W9ANQ reports new stations on in Waukegan. W9BHW is doing nicely with traffic in spite of some illness. A new Hertz has helped W9BZD lately. W9BEO, W9DEV, W9DAX, W9CDG, W9GHP, W9AUS and W9CBJ all met at W9E for a hamfest. W9BEO is rebuilding, in favor of a push-pull outfit. W9CYB is now on 3.5 mc. with 852's in a Hartley. W9DAX is using 2 UX250's as modulators on 1765 kc. W9DXZ handled his traffic this month with five schedules. W9DKK is again with us. DX has been poor at W9DGG, but is picking up. W9KB is back to high power with a 250-watter. W9CRR is going to grind his own crystal for 3545 soon. W9DCK has a new 211D. W9DGG has now worked 47 states by adding W7AAH of Wyoming to his list. W9BNR has been using a portable fone set reporting basketball games of his home town, as the games were played away from town. W9FDJ has a new Aero Screen grid. W9DDE has a new xtal on 3800 kc. using a 210 oscillator and a power amplifier of same size. W9CKZ is on at last with a UX860 crystal. W9BYV is getting out nicely with a 201A and 375 on plate. W9GIV says he has a good fone and it isn't a "loop." Hi. W9FPN operates on 14-mc. band. W9BSH says he enjoyed the Sweepstakes very much.

W9BZO has been busy grinding his own crystals, usually getting the hand on a CC local station. W9GJJ is going nicely on fone. W9DJ is adding crystal to his fone as well as a new monitor and wavemeter to the station. Bad power leak is going strong at W9BRX. W9KA is trying to please BCL's and is checking off-frequency stations. W9ACU did some excellent work in the International Contest with his 180 volts on the 171A. W9BVZ has moved from the DC district of Chicago to the AC power district. Sickness prevented W9FCW from doing better in the January tests. W9FO got 50 points in the Sweepstakes Contest. W9CUIH says 14-mc. DX seems to be picking up. W9FDY is looking for a new tube. W9AFF is building a MOPA xtal. W9CZL reports DX good. W9ALK will soon move to Hollywood, Calif. We want to see more stations reporting and bigger totals from those already reporting.

Traffic: W9DGG 241, W9ERU 202, W9BLL 165, W9BSH 107, W9AHL 104, W9ACU 93, W9CKM 75, W9AFN 51, W9DKK 44, W9CUIH 37, W9APY 33, W9BHW 31, W9CZL 31, W9FCW 31, W9FO 30, W9ANQ 29, W9DXZ 28, W9BZO 27, W9DCK 22, W9ALK 20, W9BNR 20, W9EAL 19, W9BKL 14, W9DOX 13, W9FPN 13, W9BMQ 13, W9PA 12, W9BDW 11, W9DCK 11, W9KB 11, W9GIV 9, W9BZD 9, W9FDJ 7, W9DDE 4, W9DSS 4, W9KA 4, W9BRX 3, W9BVZ 2, W9GJJ 2, W9DJ 1.

INDIANA — SCM, D. J. Angus, W9CYQ — The Indianapolis Radio Club is running the largest radio code class in its history with twenty-four students. W9FHM is the new U.S.N.R. section control station for Indiana at Indianapolis, operating on 3750 kc., xtal-controlled, 250 watts output. W9DBJ is building a new xtal transmitter for W9BRC. W9BWI is busy organizing a U.S.N.R. unit at Fort Wayne. W9CIC is back on the air. W9GJS is working everything east of the Rockies with one 5-watter. W9M just missed the BPL by two deliveries. W9CHC, who is old 3DYT, is going again at West Lafayette. W9BKJ says his tubes are over five years old and wonders what ails them. W9GKI and W9DSC just received their broadcast licenses. W9EWQ reports that the R. I. was in Richmond and left a trail of nine new first-class amateur ops. W9DF is working; WFA (Byrd Expedition) regularly. W9DEB heads the 1st with 193. W9AJH and W9BIA are rebuilding. W9FCX has changed over to DC. W9DPJ, Wilcox, is coming back on the air. W9EGZ is putting up a set in the Y.M.C.A. at Fort Wayne. W9GFA has started up again. W9EY and W9DWL are new stations at Fort Wayne. W9AMZ is back after a year's vacation. The Fort Wayne sewing circle (fones), consisting of W9AAI, W9GJF, W9AMZ, W9BWI and W9BYN, starts a gossip party at 8 p.m. every evening, which lasts till nearly morning, according to the code (he) men in that city. Next report will probably carry the other side of the story. W9AAI and W9BWI have condenser mikes and very good modulation. W9AFI reports fine results with a new screen-grid receiver. W9AXI and W9CLF are increasing their power. The R. I. chopped off the heads of W9GGP, W9GGY, W9ABV and W9EPU at Fort Wayne for the usual three

months. The Fort Wayne Radio Club will have a debate on the subject of whether "Fone is a detriment or an asset to amateur radio." Casualties will be reported in the next issue.

Traffic: W9DDB 233, W9EF 109, W9UM 99, W9CHC 23, W9AHB 5, W9FYB 12, W9GKI 67, W9BKJ 29, W9AKJ 44, W9GCO 41, W9AEB 4, W9GGJ 41, W9GJS 22, W9RW 4, W9DBJ 29, W9CYQ 14, W9FHM 10.

KENTUCKY — SCM, J. B. Wathen, III, W9BAZ — After the grids stopped leaking, W9AZY was one drop ahead of W9EYW. He now has one month to his credit in the "Race for the Pint." No competition yet! W9BAN requests QRA of call "Yoo-hoo." An asset, op. has put new life into W9ARU. W9CEE is giving code lessons on 1750 kc. He would appreciate reports from his students. W9AIN has received an ORS tag. W9FS lost his for not reporting. W9ELL was forced to use AC for Feb. tests, as his MG burned out. Seven countries in one evening for W9ENR. W9GGB is developing BCL's into hams. W9FZY is building a portable outfit for Kyrock County. W9FKM is in bigger and better location. W9GJE is coming along fine with a couple of skeds. W9ABG and W9EFT got their reports in this time. W9DAI changed MOPA to High C. Hartley and worked all districts. W9BWJ is still struggling with xtal. W9ZZE, ORS via remote control, sports three crystals. W9OX, home-brew artist, has rheumatiz from sitting in damp cellars. W9BAZ took his weak-end in Henderson, so they tell me. W9EYW, president of the A.R.T.S., was well pleased with turn-out at Feb. banquet. W9AJY, U.S.N.R. station, will soon be located atop Ky. Hotel. Lexington has active stations but no reporters.

Traffic: W9BAZ 102, W9AZY 63, W9EYW 62, W9BAN 35, W9ARU 28, W9CEE 23, W9AIN 17, W9ELL 17, W9ENR 12, W9GGB 10, W9FZY 7, W9FKM 4, W9GJE 3, W9ABG 2, W9FQN 2, W9ZZE 2.

OHIO — SCM, H. C. Storck, W8BYN — Well, gang, here is another report and the SCM is very much pleased. Only two made the BPL, but nearly all of the totals run consistently higher than usual. W8CNO leads again, turning in 400 even. W8AQ turns in 216 for his first time in the BPL. Congrats, OM. W8LT reports that they are building two new transmitters which will be on the air shortly. W8CRI is keeping plenty busy with work, but gets 155 anyway. W8BBR missed about ten days because of his pet QRM, but says conditions better now than for a long time. W8JC has been transferred to Dayton. W8CWC reports. W8BAC says traffic is picking up for him. W8SG reports his total by radio. W8APC says that two-piece filaments are quite the rage at his place. The SCM actually made good his promise, and has the big boy going again with FB results. W8CFL is now using just one 210 again. W8CFT has been DXing on 7000 kc. W8BCF turns in a nice total. WSQU has a new MOPA transmitter. W8LI has a DC note and is all ready for 14-mc. fone when the R. I. says the word. W8CX reports he is having BCL trouble on 14-mc. band, but not on 7 mc. W8HH turns in his first report. W8DVL now has rectifier and filter system, and gets better results. W8CXW is busy with radio service work. W8ARW is receiving fine reports. W8BKM keeps busy with A-A work. W8DTC is now W8CEI of Conneaut. W8BEA takes his plate transformer to bed with him to keep him warm. Hi. Someone reported a total by 'phone. Sounded like W8AEL, but more likely was W8ATL. Let me know. W8IF is still having a little trouble. W8ADS has been rebuilding his receiver. W8EJ says the Naval Reserve is going good and the local club is very active. W8CIY says W8ASK pulled a wonderful joke on him and he will never forgive him. What's this? W8DDK will not have very much time for traffic any more. W8PL blew the filament transformer for his 866's. W8DPF says his new receiver is going good and now for CC transmitter. W8DBK is also starting work on CC transmitter. W8BZL has a crystal rig going and says it is FB. W8BBH is building a whole new outfit. W8RN is still in Chicago. He says he is seeing W9EXA quite a bit. W8BDU and W8NP both reported. The returns from that "razzy" letter you all got are very gratifying, and they are showing the morale of the Ohio section as never before. It certainly speaks well for this section the way you fellows keep it near the top. Let's try and put it all the way to the top.

Traffic: W8CNO 400, W8AQ 216, W8LT 181, W8GZ 167, W8CRI 155, W8BRB 114, W8JC 112, W8CWC 97, W8BAC 61, W8SG 61, W8APC 61, W8BYN 58, W8CFT, 37, W8CFT 32, W8BCL 29, W8QU 25, W8LI 24, W8CX 23, W8HH 20, W8DVL 18, W8CXW 17, W8ARW 15, W8BKM 15, W8BEA 14, W8ATL 12, W8IF 8, W8ADS 8,

W8EI 7, W8CIY 6, W8DDK 6, W8PL 4, W8EDU 33, W8NP 123.

WISCONSIN — SCM, C. N. Crapo, W9VD — W9EBO is getting good results with his new set and handling a lot of traffic. W9EVE has come to life again with several schedules and wants more. W9DTK has new Naval Reserve call EX9P. W9DJK had decided to rebuild with 2 210's, 2 281's, 14 mikes filter, 30h choke and other necessary equipment. W9BWZ has schedules with W9AHK on Monday and Wednesday. W9EYH sent in a pretty good report. W9DND has new SG receiver and worked NN7XJ. He has daily schedule with W9DLQ. W9AZN regrouped his crystal to 3659 kc. from 1995 and says it works! W9SO has been playing checkers via the ether mostly with W8CVQ. W9FSS is getting organized in his new job as RM and needs a little more cooperation from the gang. He can't arrange routes and schedules for you boys unless you tell him your requirements. W9FAW handled a few contest messages. W9DLQ reports activity low due to much school work. W9FHU reports from his new location at Waussau, and is now using 2 210's in push-pull and two rectobulbs. W9ESZ is a new ORS at Bay City and wants more schedules. W9OT has a new 852 perking on 7000 kc. W9AMP is busy at Telephone Company School. W9CVI has a new MOPA transmitter, AC, S.G. receiver and a 10-pound junior op. What more can any man wish for?

Traffic: W9EBO 218, W9EVE 156, W9DTK 72, W9DJK 69, W9BWZ 52, W9EYH 51, W9DND 43, W9AZN 38, W9SO 35, W9FSS 34, W9FAW 80, W9DLQ 27, W9FHU 22, W9ESZ 13, W9OT 11, W9AMP 4, W9CVI 1.

MICHIGAN — SCM, Dallas Wise, W8CEP — W8DED resigns as Official Broadcast Station on account of being unable to keep a regular schedule. Anyone in Western Michigan who can keep a regular schedule and who will handle this work get in touch with the SCM. WYE-W8SL of Selfridge Field has been doing great work, and reports that the C. O. at Selfridge was well pleased with the A.R.R.I. work during the winter patrol flight. W8EGF is working on a crystal-controlled outfit. W8BGY is doing the usual good work at Lansing. W8PP of Monroe is having BCL trouble. W8AZD handled the final message of the Arctic flight after they landed at Selfridge on their return. W8BUH has been busy buying a hardware business. W8ACB is still pounding away in the 7000-kc. band. W8AUT is now using a Zepp antenna on 3500 and 7000 kc. and a voltage fed Hertz on 14,000. W8CU is working a 50-watter on 14,000 kc. W8DSF is teaching a BCL the code. W8CUX has a new Junior op. W8ACU is back with us again and keeping a fine bunch of schedules. W8CKZ is having good luck with the 852. W9AXE is doing fine work and reports several new hams starting up in the northern part of the state. W8BRO is working on a push-pull set using a couple of 852's. W9EQV made a new plate and filament transformer, and ruined a couple of 281's with it. W8CRL uses remote control because the attic is too cold. W9CE is now keeping a schedule with Walt of W8BKS. W8JD has the BCL trouble cleared up. W8AEQ has a fine total this month, and makes the BPL. W8SS is using both fone and CW. W8BBX is a new station at Muskegon. W9CSI is back on the job again up at Laurium. W8BRS says a lot of the old-timers at Pontiac are coming to life again. W8DWM won a 222 in a DX contest at Grand Rapids. W8BRL's transmitter is on display in connection with Boy Scout work in GR. W8LJ has moved out in the sticks. W8DQB let his license expire and lost his call. The GR gang are planning another hamfest. W8AUB is now interested in television. W8SH is rebuilding the MOPA. W8DRR, the real old timer of Marquette, is with us again. W8CPB is teaching a radio class at the Y. W8DDO is building an AC short wave receiver. W9GJX now has the set perking in all bands and is all ready to QSO the world. W8COW has a 210 on 7000 and an xtal-controlled fifty on 3500, using a 3500 Hertz antenna with both sets. W8DYH is studying for a commercial license. W8CAT is now xtal-controlled. W8DFS is the reliable contact on the west coast of Michigan. W8WO is on 14,000. W8CEP can just about find time to make this report.

Traffic: W8DED 64, WYE-W8SL 317, W8EGF 18, W8BGY 1C3, W8PP 57, W8AZD 35, W8BUH 10, W8ACB 11, W8AUT 8, W8CU 51, W8DSF 6, W8ACU 45, W8CKZ 22, W8BRO 66, W9AXE 52, W8CRL 1, W9EQV 12, W8JD 112, W9CE 16, W8AEQ 245, W8SS 56, W8BBX 34, W9CSI 21, W8BRS 45, W8DWM 61, W8SH 1, W8AHM 4, W8AOC 3, W8LJ 6, W8DFS 67, W8COW 32, W8DYH 78, W8CAT 26, W8CEP 14, W8CPB 11, W8DRR 29, W8DDO 18.

## DAKOTA DIVISION

**N**ORTH DAKOTA — SCM, B. S. Warner, W9DYV — W91K is getting out real well with his fone, but the QRM from the city power plant causes him heaps of trouble. W9FCA reports a QSO with New Zealand. W9DYA has a MOPA set going in the fone band. W9DM is very busy with school work. W9DGS, one of the new ORS, turns in a very nice traffic total, and has a nice bunch of skeds. W9DFG and the gang at Jamestown were visited by W9DGE for a couple of days. W9FHP has rebuilt his xmitter. He reports a new ham in his town, W9EKR. Welcome to our section, O.M. W9DFG has been appointed an OBS and it is hoped that every one will give him all the support possible and listen for his broadcasts.

Traffic: W9DGS 249, W9DFG 137, W9FCA 67, W9FHP 3, W9DM 3.

SOUTH DAKOTA — SCM, D. M. Pasek, W9DGR — W9DNS sends in quite a complete report on Sioux Falls. W9DES is returning to So. Dak. in April. W9DNS is still keeping his twice daily sked with W9BN. W9DB is improving his 14-mc. set and hopes to have a fone there. W9NM of Quinn is back on the air regularly and is trying to make the AA skeds. W9DIY has left K8OO and is now working on theatre sound equipment. W9DNS is taking his place at K8OO. W9CKT operates occasionally, as does W9FOQ. W9DWN sends his regards from Wis. U., and says he is working himself to death on their E.E. course. The SCM hopes that the spring "trailer announcement" that has been with us since February 1st has not affected the hams any.

Traffic: W9DNS 59, W9DB 24, W9DGR 13, W9FOQ 4, W9NM 3, W9CKT 2.

SOUTHERN MINNESOTA — SCM, J. C. Pehoushek, W9EFK — W9COS makes the BPL with 778. He is Route Manager and wants amateurs to let him know if they want schedules. W9BN also makes the BPL. During the Army flight they were on the air constantly and deserve an immense amount of credit for their splendid work. W9AIR has a transmitter on four bands. W9DSH just missed the BPL. W9YC has been going strong in the International Contest. W9BNF applied for an ORS. W9BNN at Heron Lake is getting out fine. W9BKX wants more Minnesota QSOs. W9GGA's 204A got a rest as he has been sick. W9DGE has been visiting Duluth, St. Croix and Jamestown. W9CLX has another op now and is in regularly. W9DRG at Owatonna has a complete new layout. W9GHO has a nice sig from his 210 and 281s. W9AMK worked Brazil and Peru with his 210. W9EAT, the Gopher Fone, has been reported in Calif. and Vancouver on 3.5 mc. W9BHZ is on 7 mc. regularly, as is W9FCD. W9DHP has been hot on the trail of the stations who are interfering with Transatlantic fone channels. Tack a card listing these frequencies on the shack wall where you will see them and use them. — GBW 14,440 kc., GBC and WYZ 6690 kc. Help keep all amateur stations OFF these waves as the A. T. & T. Co. and others promise TROUBLE unless amateurs watch frequencies and keep WITHIN assigned bands. WATCH OUT. Read the warning in February QST (C. D., page IV). W9EJR is a new man at Essig. W9EYL is on nearly every day with his new transmitter. W9EFK has new 8666 and hopes to have the xtal job going soon. W9BQF, a new ORS, is getting out nicely. W9BTW-W9ELA are now combined and have a 50-watt xtal set going. W9DMA entered the February tests. W9DBC has a 210 on 3.5 mc. with CW and fone. W9ELE is on 14 mc. mostly. W9DGH has rebuilt that crystal job again. Ex9ELJ just returned from Hawaii. W9EAH, W9DOP, W9EJJ, W9DPX, W9AOK and VE4BT are attending the U. of M. W9EJF, Lt. Minckler, is Signal Corps Officer at the U. of M. W9BYA, former SCM, is recovering from an appendix operation. Will exW9DUL-W9RB please send his QRA to the SCM? W9IL is getting along fine in Calif.

Traffic: W9COS 778, W9BN 488, W9AIR 184, W9DSH 167, W9YC 112, W9BNF 101, W9BNN 68, W9BKX 45, W9GGA 36, W9DGE 34, W9CIX 32, W9DRG 31, W9GHO 34, W9AMK 24, W9EAT 12, W9BHZ 11, W9FCD 7, W9DHP 6, W9EJR 6, W9EYL 4, W9EFK 5, W9BQF 2.

NORTHERN MINNESOTA — SCM, Carl L. Jabs, W9BVH — W9CTW leads the Section. The RM wants amateurs who want skeds to let him know in what direction so that he can fix them up. W9EGU is going to renew his old WFBT sked. W9DQC handled a dandy bunch. He reports a beehive of activity in Duluth. W9BVH broke his left hand, but can still wiggle a Vibroplex. W9EHI says DX

is good early mornings now. D9DOE is the unit station of Duluth volunteer communication reserve. W9GKM, a new man at Duluth, turns in his first report. W9EHO just got AC and apologizes for the rough note. W9EGN is going strong after a long layoff. W9BIW is experimenting with 14-mc. loop transmission. W9BCT is on quite regularly. W9ZC and W9CYY with W9ENN were responsible for the rescue of Miller, an air mail pilot, who crashed on Hay Island in a storm. I believe W9CYY to be the northernmost U. S. A. amateur, as he is located on Oak Island, Lake of the Woods, at the top of the U. S. Northwest angle. W9AV reports a new 852 on the way. His sister is now W9EXU. W9DFI is using a 112 with about 12 watts input. W9CIY is working lots of DX. W9BBT is very busy. M9FFL and W9FAQ are both new men at Duluth, and are getting out fine.

Traffic: W9CTW 379, W9EGU 326, W9DOQ 113, W9BWH 112, W9FHI 88, W9GGQ 55, W9DOE 19, W9GKM 17, W9EHC 16, W9EGN 12, W9BIW 10, W9BCT 10, W9AV 5, W9CIY 18.

#### DELTA DIVISION

**A**RKANSAS — SCM, Henry E. Velte, W5ABI — We are surely glad to note that we have a better traffic total this month. W5BIG and W5BLV are new stations in Little Rock. Welcome. OM's. W5BGO at El Dorado is on 7000 kc. W5FB at Fayetteville is also on 7000 kc. W5AQX, who is on 7160 kc., handed in a very nice traffic report. W5HN is on regularly. W5BDD will be on soon with a pair of new rectobulbs. W5ABI made the BPL this month. He has built a new Hertz antenna and is getting out well with it. Well, gang, I will be looking for your reports next month.

Traffic: W5ABI 189, W5AQX 32, W5HN 14, W5BGO 10, LOUISIANA — SCM, F. M. Watts, Jr., W5WF — First, I wish to thank each and every A.R.R.L. member in La. for the honor of being elected SCM for this Section. Some of you probably sent your reports to Mr. Hill in Natchitoches, La., and they were not received in time for this report. W5BDJ turned in the first report received by me. W5BKL, former second op at W5BHV, is now in Shreveport. W5ANC has moved to Dallas. W5BLL is a new fellow on 1815 kc. with fone. W5BJA has been off the air for quite a while. W5WF is on regularly and is ready for traffic schedules. Come on, fellows. Send in a report whether you are ORS or not. Reports should be sent to 1716 Park Ave., Shreveport, La. Here's hoping I will have sufficient data to turn in a bigger and better report next month.

Traffic: W5BDJ 7, W5WF 62.

MISSISSIPPI — SCM, June W. Gullett, W5AKP — W5BHI is in the BCF business at Byhalia. W5AED reports that the Radio Inspector visited Vicksburg, February 8th, and that he has a new amateur extra first license now. W5AOM is on a chain that extends from Cuba through Florida, Alabama, Mississippi and Texas. W5AJJ is pretty busy getting WOBZ, which is on his yacht, in condition for summer. W5AWP has been busy installing some speech input equipment on his 'phone set. W5AZV is using 'phone in the 3500-ke. band. WJDX at Jackson is installing an amateur station. W5AAP is working lots of stations in the 7000-ke. band. W5BBX is having plenty of QRM from the YLs. W5GQ has a new TPTG transmitter, but says he is going back to friend Hartley's circuit, as it works better for him. Hi. W5GQ is back in the 7000-ke. band with a pure DC note and works the west coast at will. W5AKP blew two UX-281s and is now using a chemical rectifier. W5BMA is a new station at Ellisville and is working good DX with a Western Electric 50-watter on 7000 kc.

Traffic: W5AKP 97, W5AAP 73, W5AOM 68, W5AZV 22, W5AWF 16.

TENNESSEE — Acting SCM, J. B. Witt, W4SP — This is the best report this section has had in several months. Keep it up, gang. W4RP leads this month. W4KH has moved and purchased a UX852 and a couple of rectobulbs. W4VK has built a new TPTG transmitter. W4FR, a new ORS, is working the largest number of skeds in this section. FB, OM. W4EE is op at W4DD. W4RO has rebuilt. W4ABR sends in a nice report. W4AFS is the AA net control station. W4CW is changing over to DC. W4KQ is a new station in Memphis. W41Q has bought a new Super Wasp. W4DR failed to get chemical rectifier to work so blew a 50-watt bottle. W4CA has been silent for two months. W4HD has 7½-watter going. W4OI is on with high power set. W4AKG, W4AGW, W4ACP, W4MH, W4ADT are all active stations. W4GL, chief op at W4NOX, is back on with 210. W4FD is on with a

new transmitter using 210s in MOPA circuit. W4AJQ, an old ORS, is back with us and looking for traffic.

Traffic: W4RP 122, W4AFS 50, W4ABR 44, W4VK 41, W4FR 27, W4RO 25, W4SP 24, W4CW 15, W4KH 12, W4FX 7, W4EE 7, W4HK 2.

#### HUDSON DIVISION

**E**ASTERN NEW YORK — SCM, H. J. Rosenthal, W2QU — The Pioneer Radio Club of Westchester now has its own clubhouse ready, and all hams are invited to drop in for a visit. A 250-watt transmitter and a complete shop are there for use of members. W2AI has two transmitters on the air now; one on 7mc. and one on 3.5 mc. W2SZ has just finished rebuilding the transmitter. W2ACB says the Schenectady hams have formed a new radio club, the Schenectady Amateur Radio Association. W2QN is keeping schedules with PY1AW and has QSOs with W2MA, who is visiting there. W2BKN is working the sixth district as early as 8 p.m. W2BJA is giving up his self-rectified job and putting in a real filter. W2LU still bats out a big traffic total on 3.5 mc. W2UO built a MOPA transmitter and will soon have it crystal-controlled. W2OT is keeping up his end of the traffic work in Long Island. W2ANV is looking for more Army net stations in Eastern New York. W2AYK keeps the New Rochelle traffic moving on 3.5 mc. W2OP expects to have charge of the Radio instruction of the C.M.T.C. at Fort Monmouth in July, and hopes to see a big bunch of Hudson Division men there. W2RD is putting in a crystal 'phone set with 100% modulation. W2QU is still handling the majority of NN1NIC's traffic.

Traffic: W2QU 490, W2LU 186, W2BAI 172, W2RD 97, W2ACB 53, W2ANV 52, W2QN 37, W2ALI 35, W2UO 27, W2OT 25, W2BJA 21, W2OP 17, W2AYK 9, W2BKN 3.

NEW YORK CITY and LONG ISLAND — Acting SCM, V. T. Kenney, W2BGO — W2SC leads in traffic and makes the BPL. W2BGO is a poor second. W2BSW and W2AVP make the BPL on deliveries. Manhattan: W2SC is working the west coast regularly on 3500 kc. W2BVF has closed that station due to a burned-out transformer, but will be back at his home town station, W9BHK, in the near future. W2AFO keeps 12 skeds weekly. W2AJP, a non-ORS, handled traffic for five continents and QSO'd four of the five. W2BDJ is forced to keep quiet hours, as his neighbors can hear his key clicks even when HDJ is at work or attending a radio meeting or pounding brass at W2BWI; it's a hard life, gang. W2BCB is looking for a new QRA due to man-made QRM at his present location. W2BBY and W2APS, both non-ORS, are getting into the traffic swing and like it. W2BNL says nothing new. W2BQK, an old-timer of pre-war days, is again a ham. He was one of the ops at W1IZ years ago. W2BCJ sends in his first report. Bronx: W2BGO gets his traffic between 3 and 5 a.m. W2CL will be heard at the keys of W2AQF and W2FT until next summer. W2VG has rebuilt, and is out for the BPL next month. W2AQG gives us his first report. W2AET keeps his same old skeds. W2AI keeps 12 skeds weekly. W2APV is spending some time in Port Antonio, Jamaica, B. W. I. Brooklyn: With his first report W2BSW-W2BVC makes the BPL on deliveries. W2BEV, soon to become an ORS, is looking for northern skeds. W2BO handled important traffic regarding a sick person. W2APK celebrates the arrival of two 50-watters by breaking in a third operator. W2PF skeds NA2PA on 3500-ke. band and moves lots of traffic. W2BIV is very QRL college. W2ARQ, a new ORS, has changed his QRA. W2BRB is again established in Brooklyn, and has his station perking. Long Island: W2AVP, RM for Long Island, makes the BPL on deliveries by keeping eight weekly skeds on 3500 kc. W2AYM-W2ATT, the Boy Scout Station at Richmond Hill, has a nice traffic total.

Traffic: Manhattan: W2SC 263, W2BVF 25, W2AFO 24, W2AJP 16, W2BDJ 12, W2BCB 9, W2BBY 5, W2APS 5, W2BNL 2, W2BQK 2, W2BCJ 2. Bronx: W2BGO 152, W2CL 20, W2VG 19, W2AQG 15, W2AET 14, W2AI 13. Long Island: W2AVP 78, W2AYM 40. Brooklyn: W2BSW 96, W2APK 90, W2BO 66, W2APK 56, W2PF 51, W2BEV 19, W2BIV 12, W2ARQ 18, W2BBY 5, W2BNL 2.

NORTHERN NEW JERSEY — SCM, A. G. Wester, W2WR — Another fine month which seems like old days. All we need now is some applications for ORS. W2CXL takes the traffic honors again going over the thousand mark. That station is working in every band. W2JF complains that schedules were cancelled because of the various tests. W2AOS has been bitten by the fone bug. W2APU's baby brother debased his 210 using a foot. W2CWK is having

tube troubles. W2JT is QRL out-of-town jobs. W2AHO will be heard as soon as some good condensers are obtained. W2BME is still struggling with xtal. W2BAU, a prewar ham, is back on the air. W2JC has a PP TGTP on 14 mc. W2CJX hooked with VU2ZX in India. W2BY is still having trouble with her xmitter. W2BIR only had a short time to operate. W2JX is on the air occasionally. W2WR works schedule with W2BJA in Albany. W2BPY received a radio comic valentine. W2AGX has a fine schedule with W8AVY. W2AI is still stepping out in all directions. W2AVO has applied for an ORS. W2AUP hopes to apply for an ORS shortly. W2CRO kept Hackensack on the traffic map. W2BQL is on 7 mc. and wants traffic. W2BIW has a portable xmitter mounted in a truck and will gladly test with anyone. W2CHD is pounding out great on 3.5 mc. W2BCA has a new 210 and plenty of spirit to work it. W2BWH is on 7 mc. and hopes to drop to 14 mc. W2DV is trying hard to get going on 14 mc. W2FL keeps things humming at the Bloomfield Radio Club. W2COT, an initial reporter, handled nice traffic. W2AWU is now located in Jersey and is an operator at WJZ. W2API is installing superpower for reliable schedules with Paris, London, Berlin and possibly Petrograd.

Traffic: W2WR 5, W2JF 116, W2AOS 42, W2APU 1, W2CWF 31, W2JC 6, W2CJX 12, W2JX 4, W2CXL 1003, W2BPY 15, W2AGX 8, W2AI 20, W2AVO 28, W2AUP 42, W2CRO 23, W2CHD 1, W2BWH 3, W2DV 33, W2FL 13, W2COT 8, W2AWU 37.

#### MIDWEST DIVISION

**I**OWA — SCM, H. W. Kerr, W9DZW — Again the RM leaves daylight between his nearest competitor. W9DNZ, a new ORS, comes right along with a dandy total in spite of power house QRL and QRM. W9FFD shows improvement at "gas alley," though the escaping gas makes his note wobble; he offers prizes for most perfect copy of his OB at 9:45 each Monday and Friday evening on 3870 kc. — listen for the dope. W9GP has the 70-footer on high. W9DXP reports the Army Net functioning nicely, and is helping out on the National Guard Signal Unit with W9CAC on a 50-watt Hartley job. W9APM is QRL building AC receivers. W9FZO got his ORS, and we found him with a fine little station and doing some good missionary work with the single wire-fed Hertz as per Sept. *QST* (1929). W9FUD has a bad burn-out after just getting nicely started in the traffic game. W9ACL is becoming enthused with traffic work by handling W9FUD's skeds. W9FQG cuts out his filter to get away from BCL yowls. W9ESP radios in a nice report. W9BCA's traffic is confined almost exclusively to C.A.B. W9CKQ is "poppa" to a Jr. op. W9EOP is doing more work on 3500-kc. band and finds skeds make traffic. W9GDG sends in a nice report for the first one. W9EIW is QRL baby chicks now. W9ELA is another first reporter. FB — he and W9DVS are schooling at Iowa State College. W9ASM is back again. W9DPL is another boy who gets BCL complaints when he puts in a filter! W9EHR is QRL shop. W9GKL is still working with crystal. W9DTA now has an xtal rig also. W9BCL is not having the best of luck with his 866s. W9EFU is a new station at Boyer, Iowa. W9DLT is on the air at Hastings. W9DUU entertained the TSRC recently. The club have their station, W9TA, ready for tests. W9DEA got the California Air Fever and last accounts had taken to the Dollar SS line. The RM and OO stations report some off-band sigs — better be careful, gang. It is also noted there are some off-band and unlicensed fones being reported. We must keep both CW and fone within the limits. The Iowa Short Course and Convention is not definitely dated for May 9th and 10th, but make your plans to be there.

Traffic: W9EJQ 529, W9DNZ 257, W9FFD 167, W9DZW 138, W9DXP 131, W9FZO 121, W9FUD 88, W9FQG 88, W9ESP 84, W9BCA 55, W9EOP 49, W9GDG 19, W9EIW 18, W9ELA 17, W9DVS 15, W9ASM 12, W9DPL 10, W9EHR 7, W9GKL 3, W9BCL 3.

**NEBRASKA** — SCM, C. B. Diehl, W9BYG — W9QY is working 'phone on all bands allotted. W9EEW finally got himself a DC note. W9DTH built a monitor and is checking up on himself. W9DFR is rebuilding at a new location. W9DVR has rebuilt, and gets much better results. W9EBF is very busy getting settled in his new home. W9FAM busts out again. W9DI is busy with school work. W9ROQ rings the bell this time with a cool 200. W9BLW is tinkering with 28 mc. W9CHB is busy with C.A.R.A. and naval work. W9BBS is very busy on the road. W9CDB still tries to get away from the high line.

Traffic: W9QY 13, W9EEW 2, W9DTH 1, W9DFR 1,

W9DVR 7, W9FAM 155, W9DI 1, W9BOQ 200, W9CHB 16, W9GDB 5, W9DHC 26.

**KANSAS** — SCM, J. H. Amis, W9CET — W9BTG leads the gang in traffic. The western Kansas RM, W9CFN, is a close second. W9GHI is on 14,000 kc. making the BPL on deliveries. W9GFO is planning a xtal rig for 7000 kc. W9FLG, the RM for eastern Kansas, has been off the air most of the month. W9DEB has had six 210s go west in the last month. W9CET is rebuilding. W9CCS is now at school at Lawrence. W9DFY is keeping a nice bunch of skeds. W9BWV won the Nemaha Radio Club Contest. W9FXV is rebuilding his receiver. W9BEZ is grinding 7000-kc. xtals now. W9ESL is still working on a new fone rig. W9GFM is on 7000 kc. W9GKT is after an ORS appointment. W9COE has rebuilt his fone using MOPA. The Imperial Brass Pounders' Club held their quarterly meeting at Wichita, February 2nd and 3rd. The SCM wishes to thank the club for the courtesies extended him at the meeting. The K.V.R.C. is making plans for the Midwest Division Convention to be held at Topeka in September or October. Watch for more details.

Traffic: W9BTG 169, W9CFN 130, W9GHI 121, W9GFO 90, W9FLG 67, W9CCS 37, W9DFY 36, W9BWV 32, W9FXV 27, W9BEZ 26, W9ESL 10, W9GFM 8, W9GKT 8, W9DEB 61, W9CET 61.

**MISSOURI** — SCM, L. B. Laizure, W9RR — St. Louis area: W9DUD led in traffic closely followed by W9PW and W9DXY. W9ZK is another 14-mc. fone on the air. A number of amateur extra first-class licenses are showing among the St. Louis gang. W9FTA is back again with a new layout. W9FUN was too busy to get on. W9AMR says school QRM too heavy for much radio. W9EDK is putting in a new layout. W9GHG sends in a lengthy list of DX heard on 7 mc. W9DZN reports from Ft. Worth, where he is op at KGUC. W9BJA seems to be the old reliable for traffic and skeds, and takes the state prize this month. W9GBT is a close competitor. W9DEN, RM, has the following relay route going: W9GBT-W9BTG-W9CFN-W9GHV-W6AM-thence to YK2AJ, KAIHR, and W9FT. Also the following route is going: W9GBT-W9BTG-W9CFN-thence Colorado, California and Montana. W9ECS is now at Moberly as W. U. op. W9CDU and W9EFR reported for the Nevada gang. W9DKG is now editor of the Rolla, Mo., *New Era*. W9CJB is going pretty well for traffic. W9ENF reports Joplin news as follows: W9CIQ has a xtal station now. W9ASY is building a new receiver. W9FEQ has a MOPA xmitter now. W9ENF keeps 4 skeds. W9DNO handled 24 messages in four days. W9GCL is still pegging away. W9FYM is now an OBS. W9DCD was QSO the SCM. W9FKR is now at Deepwater, Mo. W9AWE wants traffic skeds in any direction. W9GCL boosted DX by boosting the plate voltage on his 210. Ex-W9DZO is reported coming back on the air. W9DCD was QRL radio service job, rebuilding, etc. Kansas City news: W9AKZ led in traffic with 215 messages on 5 regular skeds, and applied for ORS. W9BMA and W9BMT kept a number of skeds and handled the next highest score. W9DQN is now working three bands with good results on all. W9CVT boosted his total over last month. W9RR was out of town on U.S.N.R. duty. W9CFL hit the BPL again. W9BSB moved to Salina, Kansas, where he is organizing a U.S.N.R. unit. W9BND applied for U.S.N.R. appointment.

Traffic: W9BJA 242, W9GBT 238, W9AKZ 215, W9BMA 182, W9DHN 166, W9CFL 156, W9CJB 117, W9CDU 87, W9DUD 87, W9DKG 86, W9PWV 79, W9DXY 79, W9DQN 63, W9CVT 41, W9ZK 29, W9ENF 27, W9DNO 24, W9FTA 24, W9RR 10, W9GCL 8, W9DCD 7, W9EFR 6, W9FUN 4, W9AMR 4, W9EDK 4, W9FYM 4, W9GHG 3.

#### NEW ENGLAND DIVISION

**C**ONNECTICUT — SCM, Fred A. Ellis, Jr., WICTI — Two stations, W1ADW and W1MK, make the BPL this month. W1BHM is on 14,300 kc. for the DX contest. W1VB has been handicapped by some BCL QRM. W1JN keeps a daily schedule with W1AFB. W1ROD keeps schedules with five different stations. W1BGC remembered to report. W1BJK reports that he is very QRL. W1AMG says QRM kept him off for a while, but he is back now. WICTI notices a lack of Conn. ORS on 3500 kc. What's the matter, gang? Use this band and QSO the local traffic bunch. W1TD is all set and begging for traffic and schedules. W1ABL is using a 50-watter on 7000 kc. It takes three months of reporting before an ORS can be granted. OM. W1AUI sends in a nice report for a starter. W1AFB hands in a nice report. W1ADW has a real report

this month, and is to be congratulated on his fine work. W1RA is engaged to be married. FB and congratulations. W1ATL is using a 210. W1BEW is using also 210. W1AEQ-W1OS visited W1ADW and had a fine time pounding the key. W1A1B reports by radio and says W1AEV is a new ham in Middletown using a 210 on 3500 kc. W1UE has been slipping on his traffic work. W1AJS sends in a nice total. W1RP has been QRL other interests. What interests, OM? W1AAM sends in his first report. Look for him on 3500 kc. When you read this, spring will be here and summer not far off. Let's keep the tubes hot and push the traffic through. W1CTI will remain on 3500 kc. all summer and keep as many schedules with the gang as possible.

Traffic: W1A1B 31, W1BHM 20, W1VB 9, W1JN 20, W1BOD 58, W1BGC 8, W1MK 478, W1BJK 10, W1AMG 11, W1CTI 91, W1TD 1, W1ABL 29, W1AU 10, W1AFB 54, W1ADW 358, W1AJS 41, W1RP 25, W1AAM 11, W1UE 66.

**EASTERN MASSACHUSETTS**—SCM, Miles W. Weeks, W1WV—Considering the opportunities offered by the traffic contest, the traffic totals this month are rather disappointing. W1RY, a former ORS, has been reappointed ORS and makes the BPL along with the SCM. W1QZ has also been added to the list of ORS. Another comer is W1RXB, an old commercial op who will soon have his ORS papers. W1ASI is changing jobs, hence has had more time for traffic this month. W1RV reports handling one 365-word message in connection with the Army Air Corps Spokane Flight. W1ACH has been busy trying out new antennas and now has seven receivers to cover all frequencies. W1AZE has installed a new filter to improve his note. W1AGS says his hi-power outfit is hitting into Australia R8. W1ACH, W1AAT, W1LM, W1WV, W1RV and W1TL took part in the traffic contest. W1YS, the Mass. Radio & Telegraph School, reports their appearance on the air, with W1AVT as op. W1AAT went back to his RAC plate supply after trying a MG. W1GG sends in a fine report of traffic handled. W1ASF, who was the highest scoring U. S. station in the last International Contest, states that he is giving all his time to this year's. The gang are urged to make early reservations for the Worcester, Mass., New England Division Convention, April 25-26.

Traffic: W1WV 363, W1RV 234, W1RXB 137, W1ASI 128, W1ACH 106, W1TL 100, W1GG 92, W1LM 90, W1AZE 79, W1CRA 65, W1AAT 57, W1LQ 51, W1BZQ 48, W1KH 46, W1AGN 23, W1AGS 19, W1QZ 12, W1BLD 3, W1YS 2.

**MAINE**—SCM, G. C. Brown, W1AQL—Mrs. W1AJC advises that there is a new club in existence to be known as the Portland Amateur Wireless Association. The officers are: President, Perry T. Johnson, W1US; Vice-President, Thomas Connean, W1IR; Treasurer, Earl Whittemore, W1BNG; Secretary, Frances Rowe, Mrs. W1AJC. Meetings are held on the second and fourth Wednesdays of each month at the Spanish War Veterans' Hall at 514 Congress St. During the recent auto show, the Association had a transmitter on the air and handled a large number of messages. A committee has been appointed to take care of the arrangements for the coming Maine State Convention to be held some time during the last of June or the first of July. Manley Haskell, W1WV, is chairman of this Committee.

On the evening of January 24, the Queen City Radio Club officially opened its new club house at 145 Parkview Ave. Amateurs from Augusta, Bangor, Brewer, Enfield and Orono made a very social party. Prof. Everett Roberts, W1CNP, of the U. of M., very ably installed the following officers: President, Philip Gould, W1ALZ; Vice-President, Lauris MacDow, W1CBV; Secretary, Elden U. Benner, W1QH; Treasurer, Harold Riley, W1CRI. On Feb. 14th the gang were entertained by W1CNP, assisted by W1BDH and Thurlow Chandler of the U. of M. Campus. Demonstrations of high voltage machines and radio equipment were very much enjoyed by all present. The Maine gang extends the hand of welcome to Leslie Heartz, W1FQ, formerly of Medford, Mass., who has taken up residence in Bangor. W1ATO is to be high liner this month. W1ANH ranks second, and reports a very bad spell of radio weather. W1AQD made a good start in the Sweepstakes, but had to withdraw due to business. Mrs. W1AJC leads the OM again this report. W1KQ has been off the air, due to a blown power transformer. W1AFA reports a good schedule with Canada. W1QH says that traffic has been slow this month. W1BFZ has received the appointment of alternate state net control station of Maine Army-Amateur stations. W1COM has an MOPA on the air and is going out for 28-mc. work.

Traffic: W1ATO 212, W1ANH 156, W1AQD 75, Mrs. W1AJC 72, W1KQ 44, W1AJC 32, W1RFZ 20, W1FQ 16, W1AHY 15, W1QH 10, W1AFA 101, W1AQL 8, W1COM 19

**NEW HAMPSHIRE**—SCM, V. W. Hodge, W1ATJ—W1IP and W1COW are tied for high place this month. W1BFT has been working hard in the tests. W1APK has a 50-watt fone on 3530 kc. using the Heising system with a speech amplifier. W1AUY reports a new station in Meredith, W1CNR. W1AEF is unable to keep regular schedules due to working away from home, but is on 3940 kc. after 7:30 p.m. W1COW has a new 204A and has worked twenty countries, four continents and two ships since Xmas. W1AOC, ex-W2AFJ, of Hanover is on with a 210 on 7150 kc. W1YB will be going soon with 250 or 500 watts. W1MB is surveying for the B. & M. R. R. W1IP is having key-click trouble, and is experimenting with various filters.

Traffic: W1IP 61, W1COW 61, W1AEF 1, W1AUY 7, W1APK 7, W1BFT 5, W1AOC 10, W1ATJ 3.

**VERMONT**—SCM, C. A. Paulette, W1IT—It gives me great pleasure to see the way things are picking up all over the state, FB, boys. We have a new ORS in W1BD in Barre. W1AJG is ill and unable to get to his radio room. Sorry, OB, and in behalf of the gang, I wish you a very speedy recovery. W1AD in Bellows Falls has another station going under call letters W1AEW, and will do most of his sked work from there. W1JR of Barre is on 3500 kc. looking for traffic. W1BDY in Burlington is on all bands and has applied for ORS. W1BJP is on the air with a 203A now. W1BDX is very QRL with BCL service work. W1BCK has cured his BCL troubles with vacuum tube relay. W1CGX makes the BPL the second time in succession this year, FB.

Traffic: W1IT 66, W1CGX 220, W1BCK 8, W1BD 73, W1JR 4, W1BJP 13.

**WESTERN MASSACHUSETTS**—SCM, Dr. J. A. Tessmer, W1UM—W1AMZ is still busy at school. W1ADO is busy putting W1BKQ on the air. W1ADO will be on soon with xtal. W1ZB is building a new super-het receiver. W1BYR has been appointed secretary of the Springfield Radio Association. W1BNL is building up an xtal rig for 3.5 and 7 mc. W1DR is on the eastern end of a two-hop west-coast traffic route and would appreciate any traffic going that way. W1BZJ is using a 50-watter with 200 volts on the plate. W1NS and W1BZJ are trying to see which one can work all districts on 3500 kc. W1JV is on 7000 kc. with 2 210s. W1AM is on 3500 kc. and is building a xtal set. W1BKF is still working plenty of Aussies and Zedders. W1DB was heard on 3500 kc. the other night. Welcome back, Old-Timer, W1BKQ is on 3500 kc. with a 210. W1ANI is Unit Commander of the Naval Reserve in Worcester. W1TN and W1BGM are busy at W. P. I. and expect to have W1YK on the air soon. W1BKG and W1AZW were entered in the all-section traffic contest and came out with good scores. W1AJJ has trouble at home which prevents her from being on during RCL hours. W1BG has 2 210s in push-pull on 7000 kc. W1BZG is a new ham in Lanesborough. W1AVU comes 22 miles by trolley every Thursday night to be at the meetings of the Berkshire Brass Pounders. FB, OM, W1ABH is on 7 mc. with a 210. W1AMN is still in the QRM jam on 7 mc. W1ARE is on 7 mc. and Mrs. W1ARE has her own call now. W1AIG, Pittsfield has two YL ops now. Meetings of the Berkshire Brass Pounders are held every Thursday evening at 8:00 p.m. at 65 Eagle St., Pittsfield, Mass. Visitors are welcome. Plans for the N. E. Convention in Worcester April 25-26 are going strong, and the Worcester Radio Association has over \$500 worth of prizes. The Worcester Radio Association holds its meetings at 274 Main St., Worcester, every Thursday evening. All hams are welcome.

Traffic: W1ZB 16, W1ADO 29, W1BNL 23, W1BYR 9, W1DR 22, W1BZJ 40, W1BKG 56, W1AZW 60, W1VC 15, W1ZA 16.

#### NORTHWESTERN DIVISION

**OREGON**—SCM, W. S. Claypool, W7UN—After a one year's rest W7AJR, the Oregon State College station, comes through with a fine total due to the annual Exposition, at which they maintained an A.R.E.L. traffic booth. W7AJW also makes the RPL. This station is maintained by the Rose City Amateur Radio Club on the battleship *Oregon*. W7ACH holds six skeds. W7ALM is rather busy with work, lodge, etc. W7UN spent an enjoyable two weeks at W7AJW during Sweepstakes Contest. W7PL

says. "Thought that spring was here, but guess winter just starting." W7AIC lost two UX281s. W7ZD is very consistent with skeds. W7MY finds 14 mc. NG so far. W7PE is working two regular skeds. W7WR seems to be finding some traffic. W7AAR mixes traffic and DX. W7SY keeps going. W7AMF will soon be an ORS. W7AIG says "traffic not hot." W7MV sends SOS for a job. W7JC works, plays and sleeps. W7QY is pulling for ORS. W7IF reports via radio. W7ALK, W7AMQ, W7FO and W7WY all report.

Traffic: W7AJR 303, W7AJW 220, W7ACH 102, W7ALM 85, W7UN 72, W7PL 81, W7AIC 86, W7MY 56, W7PE 51, W7WR 50, W7AAR 43, W7SY 41, W7AMF 24, W7AIG 29, W7MV 17, W7JC 13, W7QY 15, W7IF 6, W7ALK 5, W7AMQ 4, W7WY 3.

WASHINGTON — SCM, Eugene A. Piety, W7ACS — This section needs a good live Route Manager. If you have anyone in mind, send in his name. W7GP takes high honors due to his work in the Sweepstakes Contest. W7AMO backs him up with a fair total and, with W7AIT, helps to keep the capitol on the map. W7KT, W7MR, W7AAX and W7ACS keep Tacoma alive. On a trip to Oregon, the SCM visited W7UN and discussed policies and traffic with him. W7AJH is holding down four good schedules. W7TK at Everett is interested in U.S.N.R. work. W7EK is interested in getting delivery on a couple of 872s. W7AHT is a new one at Spokane. W7AAY, W7ALJ and W7AHO report and say that the Radio Ops Club is waking up again. W7KQ is on with a home ground xtal. W7LZ is working days again, and the traffic total shows it. Other stations reporting from Seattle are: W7RT, W7SL, W7HB, W7ID, W7KO and W7AG. W7TX is still holding skeds with his favorite Alaskans. W7OV sends in a very newswy letter and is now OBS, ORS and OO. W7ACA handles some traffic as usual. W7OJ has a new job. W7AHM is getting out well on low power. W7ANP is a new one in Yakima and is run by the two ops at KIT. W7PU is moving to Seattle to take a job with Boeing. W7MP reports after a long absence. Your individual reports may not look very big to you, OB, but when we add it to ten just like it we have quite a total. If every one that handled traffic would send in the dope, in a very short time we would have a section that would be second to none. Are you game? Let's go!

Traffic: W7GP 199, W7LZ 74, W7OV 72, W7AMO 64, W7ACS 58, W7KO 47, W7AJH 48, W7RT 40, W7KT 31, W7TX 28, W7ACA 26, W7AHO 25, W7ID 23, W7ALJ 20, W7AG 19, W7ANP 15, W7AAY 15, W7HB 13, W7AHT 12, W7TK 11, W7MP 9, W7AHM 7, W7MR 6, W7OJ 4, W7AFO 4, W7KQ 4.

IDAHO — SCM, J. L. Young, W7ACN-W7JL — The R. I. was around, and as a consequence there are a lot of new hams getting started in Idaho. W7CG is experimenting with low power 'phone, testing especially with W7ACP in Parma, Idaho. W7PR of Nampa is on 14 and 7 mc. with a pair of WE216D's and 270 volts of Bs, and reports working five Aussies, a Zedder, Jamaica, and Brazil. W7ALC is getting right out with his 3.5-mc. 'phone rig. W7AFT is keeping Elk River on the map. W7ACD in Shelley is on 14 and 7 mc. and finds DX good. W7ALW reports by radio that traffic totals are stacking up there. W7GL at Jerome has a quarter kilowatt bottle on the air. He and W7ACN pulled down their extra first-class amateur licenses at the recent exams. W7AOC and W7ST both got commercial tickets, as did W7ACK of Nampa. W7ACN has a brother who is now a full fledged ham with the call W7HG. About a dozen students at the Nampa High School also got their ham tickets, and are building transmitters. W7EJ at Mountain Home is selling out. Every Idaho ham is urged to send in his message total and radio activities report every month. WHO WANTS THOSE FREE PHOTOS MADE FOR THEM? Talk with traffic figures.

Traffic: W7ACD 23, W7PR 13, W7ALC 5.  
MONTANA — SCM, O. W. Viers, W7AAT — W7AAW is still near the bottom of the 7000-ke. band. W7FL wants reports on his new 3500-ke. phone. W7HP has been busy servicing BCL sets. W7EL has done the disappearing act again. W7ANT is still pushing out on 3500-ke. phone. W7AHN reports several new hams in Great Falls. W7HT is the newest ORS in the section. W7AIR in Forsyth wants skeds on 3500 ke. What's become of W7DD, W7TB, W7DJ, W7AEM, W7CC and a lot of others? W7AAT is still going strong on 7040 and 3755-ke. and is looking for a reliable, snappy sked east. We must have more reports gang, so get busy from now on and remember the date is the 16th of each month.

Traffic: W7AAT 428, W7HP 51, W7FL 50, W7AAW 26.

## PACIFIC DIVISION

LOS ANGELES — SCM, B. E. Sandham, W6EQF — The following make the BPL this month: W6AKW, W6ETJ, W6AKD, W6DYJ, W6BZY, W6CBW, W6LN, and W6AM, our traffic total being 3,307. The A.R.R.C. heads the section's clubs in caliber of speakers obtained this past month, having secured Capt. MacMillan, Arctic Explorer, of Bowdoin fame. Also, McRea of the Western Air Express enlightened the fellows on radio in the air mail planes. The Tri-County Club held a FB dinner and rag chew, and sponsors the section banquet to be held in June. The Pasadena Club is backing the section banquet coming in March. The Long Beach Club has a traffic contest of its own with many FB prizes. Our friends to the north of us in Bakersfield have their club going in great shape. It is called the U.S.N.R. Club of Bakersfield with virtually all members in the ranks of the U.S.N.R. W6WA is President and Division Commander of 5th Division, W6AKW is high man in traffic again, and is appealing for more Army-Amateur net stations in the section. All interested write to him. W6ETJ makes the BPL and is CM of the A.R.R.C. W6AKD sees a turtle under his shack too big to get out and still growing. Anyone seeing a hamshack going slowly down the street, please return to W6AKD. W6BZY is new ORS and makes BPL. W6CBW is QRL school. W6LN is at broadcasting station. W6AM finds tuned antenna, tuned RF and peaked audio FB for QRM. W6ESA is going good on 7 and 14 mc. W6DLI has a good total. W6UJ is sending code practice at 9:30 to 10:30 p.m., on Monday and Thursday, on 1765 kc. for beginners, with W6DYL offering same on Wednesday and Friday. W6DKV builds total by working two stations at the same time. W6EKE deserves credit for active 00. W6BZR is now W6TE. W6EAF says Army net is FB for good skeds. W6ACL has a good monitor. W6DLN hooked Africa on CQ. W6OF worked PI with 201A with seven watts input. W6BUX is working FB DX. W6ID is QRL movies. W6AWY is having good luck with single wire current feed antenna. W6BCX is putting in two 852's with xtal. W6DLN gets WAC. W6EJ and W6ASM have traffic contest between themselves. W6EGH was QSO Spain on 7 mc. and is rebuilding to crystal. W6EIF says S8IAZ is a ship en route to England. W6BGF wants more skeds. W6CBS is now W6WO. W6DIJ is moving and rebuilding. W6EQD has a xtal going. W6BBO is working his father, W6EJR, who is on movie location in Utah. W6CKS and W6EVB are both active at San Fernando. W6ERL is moving. W6ZZA's portable set was smashed by baggage man. W6BVZ is rebuilding. W6DHM is commercial op. W6EVA, YL, has been getting love letters from a Roumanian army officer who saw her picture in a foreign magazine. W6BES and W6EAN handle traffic on 3.5-mc. fone. W6CUK is Vice-President of Bakersfield Club. W6ELZ has crystal going. A traffic contest has been started between the clubs of this section. A traffic flag will appear in the *Oscillator*, the A.R.R.C. magazine, for the high club. W6BJX is handling details for L. A.-East Bay contest. The SCM would appreciate hearing from you fellows who do not report your traffic. Thanks.

Traffic: W6AKW 428, W6ETJ 221, W6AKD 207, W6DYJ 200, W6BZY 200, W6CBW 181, W6LN 140, W6AM 117, W6ESA 106, W6EIF 88, W6DLI 88, W6CQK 79, W6DUI 75, W6BCK 72, W6UJ 65, W6ZBJ 54, W6DKV 51, W6EKE 50, W6AVJ 50, W6AHP 50, W6BZY 49, W6AOB 49, W6BGF 45, W6CUY 43, W6TE 38, W6EAF 37, W6AOA 36, W6ACL 32, W6CVV 29, W6EVA 27, W6WO 24, W6DIJ 22, W6CLQ 21, W6BES 20, W6EDQ 20, W6EQD 20, W6AGR 20, W6EPH 19, W6AIX 17, W6CGY 17, W6DYK 14, W6BBO 14, W6OF 13, W6CIX 11, W6CKS 11, W6DQV 10, W6BUX 9, W6ID 9, W6EQF 9, W6ENH 9, W6CZU 8, W6DOJ 8, W6AZL 7, W6ARN 7, W6AWY 6, W6ERL 6, W6AXE 6, W6CZT 4, W6ZZA 5, W6MA 5, W6ENQ 5, W6COT 4, W6EAN 4, W6ETN 4, W6ERC 3, W6CCH 2, W6BTU 2, W6ARY 2, W6KA 1.

SAN FRANCISCO — SCM, Clayton Bane, W6WB — Activity this month was not up to our usual standard. We plan to hold a traffic contest within the section the coming month, with a very decent prize to the winner. The two S. F. clubs have expressed their willingness to donate said prize. FB! W6AD, our old standby, leads the parade as usual. W6ERK is our new RM in lieu of Mr. Kellog, who has become a full-fledged commercial op. Mesher is hot at work lining up skeds, and promises to be a real RM. Martin at W6AYC puts in a very sweet report this month. W6DFR



runs much higher than usual with his A-A work. W6WB got off to a fair start, and handled some traffic. Hi, W6BIP is in the dog house this month having fallen down (due probably to YLs). We are sure sorry to see BIP go this way after just being appointed OBS. We have a new station in S. F. in W6EKC, who comes to us from the L. A. section. He is being lined up for an ORS. W6CIS took part in the International Tests. W6WN is fixing the shack. W6ERS has been getting out nicely. W6EEC and W6DZQ report.

Traffic: W6AD 854, W6ERK 258, W6AYC 181, W6DFR 81, W6WB 72, W6BIP 42, W6EKC 16, W6CIS 22, W6ERS 8, W6DZQ 4, W6EEC 2.

SANTA CLARA VALLEY — SCM, F. J. Quement, W6NX — With W6YG, W6BET, W6HM and W6YU making the BPL, and W6BYH, W6ALW, W6DQH, W6BHY, W6DCP all turning in substantial traffic totals, the message traffic of the section reached its peak. It was the work of a large number of stations, and these stations are to be congratulated. Keep up the good work! W6YG leads the section, all traffic being handled during the day. W6BYH is very active in Merced. W6BET, a newcomer, made the BPL with his first report. W6HM continues his transpacific communications. W6YU now has five ops, contemplating new power supply. W6ALW is handling traffic on 14,000 kc. W6DQH, the RM, has been appointed Net control station of Army Net. W6BHY handled his consistent amount of messages, as did W6DCP, who has just moved to Soquel. W6BMW, the old reliable, continues handling 'em, as has been the practice for years. Hi, W6ACV, a newcomer, comes on the air with MOPA, and W6BLT has daily sked on 7000-ke. band. W6AME and W6DQH put on a real hamfest at Modesto February 15th. W6BNH is busy at the power house these days.

Traffic: W6YG 215, W6BYH 135, W6BET 134, W6HM 129, W6YU 126, W6ALW 79, W6DQH 65, W6BHY 60, W6DCP 52, W6BMW 30, W6ACV 17, W6BLT 12, W6AME 3, W6BNH 2.

EAST BAY — SCM, J. Walter Frates, W6CZR — Bad weather conditions and unusual inactivity on the main ham bands contributed this month to an exceptionally low traffic report for the section. S. C. Houston, W6AQ, has been appointed CRM to succeed W. S. Upson, W6TP, now in Chinese waters on the *President Lincoln*. ORS are asked to get in touch with W6AQ with any of their problems. W6ASJ, President of the Oakland Radio Club and an old traffic man, has been appointed chief observer to succeed W6TT, who has moved to the San Francisco Section. He will reorganize the Official Observers to work with the new Section Technical Committee in reducing QRM and educating the men in the section to the bad elements of broad notes. W6EIB, the efficient RM at Vallejo, was high traffic man again. He reports that he has a FB sked with K6DQQ with plenty of traffic from the islands. W6ASH was the next man in point of high totals. W6ALX's totals have fallen down slightly, owing to the fact that he is spending a great deal of his time teaching ham operators enough theory to allow them to pass the commercial license examinations for berths at sea. W6ATT is marking time before going to sea as a commercial operator. W6AMW at Mare Island handled a great deal of traffic considering that he has only one sked now with W6AD. W6BTZ has been training new operators for the California National Guard at the Oakland Armory. The Guard unit has been given two new calls — W6CNG, a stationary call at the armory, and W6SU, a portable call for marches, etc. W6EDEK, the original 3500-ke. bound, was up among the high traffic men. He kept in touch with the Pursuit Group Flight through Northwestern amateur stations. W6EDO is taking a training cruise to Panama with the Pacific Fleet. W6AWF is another of the men who are waiting for a berth on a passenger liner at sea. W6CGM traded his big set for a 750-volt MG. and, with two 21Us in push-pull, has been QSO KAIZC and the east coast. W6BI is still battling away on 7200 kc. and 3750 kc. W6BZU at Concord has been especially active on the air. W6EDR reports that things are looking brighter for him both on the air and with his golf. W6CZR has moved to 439 62nd St., Oakland, and all reports should be sent there in the future. W6ASJ has been kept busy with the Oakland Radio Club. The club is conducting code classes for beginners under the direction of W6BSB. W6ALV reports that he has been too busy with a YL since he got back from Alaska to get on the air. W6EY has made a lot of QSOs, but has picked up very little traffic. W6BMS reported direct to HQs.

Traffic: W6EIB 551, W6ASH 222, W6ALX 155, W6ATT 150, W6AMW 136, W6EDK 134, W6BTZ 91, W6EDO 41,

W6AWF 28, W6CGM 21, W6BI 11, W6BZU 5, W6ASJ 4, W6EDR 3, W6EDR 3, W6BMS 1.

HAWAII — SCM, F. L. Fullaway, K6CFQ — The SCM is back from a visit to California. While there he attended the Convention in Los Angeles, visited several clubs and renewed and made many friendships. While in the States he operated under the call of portable W6CXO. The star station for this month is K6EWB of Schofield. Besides making the BPL, he handled six daily schedules. K6CIB has been designated the Official Relay Station for the Institute of Pacific Relations. Good work. OM. K6ERH has been testing on 28 mc. but has failed to hear any one. K6ACW was QSO Africa four times in three days and South America every afternoon on 14 mc. Portable W7ZZE is now in the islands on a vacation and can be heard now and then. There seems to be a definite anti-law and order feeling around that MUST be done away with. Illegal operation must be stopped, both for your own good and that of your fellow amateur. All cases will be promptly reported to the R. I. It is rumored that a R. I. will be stationed here in Hawaii in the near future. K6BXW is building a 56- and 28-mc. super het. receiver using VT5 tubes. K6DTP reports that House, ex-chief of K6DTG, is working on the farm back in California. K6DPG made the BPL for December by keeping a sked with KA1HR. K6DJU has moved the shack into larger quarters. The SCM would like to have all stations on the air report monthly activity even if no messages are handled. Blank form 1 cards may be had for the asking.

Traffic: K6EWB 203, K6CIB 20, K6ERH 8, K6ACW 4, (December:) K6DPG 190, K6DJU 70.

PHILIPPINES — SCM, S. M. Mathes, KAICY — This report was received by radio via W6HM. KAICAF leaves in March to attend Notre Dame. GB and 73, OM. KAIAF is finding trouble in getting condensers for the new xmitter. KAIAW, our latest station, is conducting tests and will handle traffic for Ft. Mills. KAICE is experimenting with DC plate supply. KAICM is still holding the fort at Corregidor. Why not apply for an ORS certificate, OM? KAICY leaves for the States in April. KA1DJ is another tip-top traffic station that should be an ORS. KA1EL now sports a fifty watter and a 1930 sig. KA1HC still finds time from heavy business cares to do a little operating. KA1HR reports a new sked, with W5NW, and turns in a whopping traffic report. KA1JR worked 141 different stations during the month. KA1MC leaves in March for Third U. S. District. KA1PW makes an extended southern trip March 2, and will conduct tests on 14-mc. band with portable set. KA1RC handles considerable traffic with west coast. KA1ZC is remodeling for 1930 type note. KA9PB reports sked with KA1HR daily. KA9AH is building 100 watter TPTG and doublet antenna.

Traffic: KAICY 102, KA1DJ 655, KA1HR 983, AC8RV 232.

ARIZONA — SCM, H. R. Shortman, W6BWS — W6BJF is on the air regularly with tuned plate-untuned grid UX-210. W6EVM is a new station in Flagstaff, W6EOF is operating and announcing at KEXY. W6ANO is operating KGSL for Western Air Express. W6AWD says for me to write myself up for QST. (I got a big newspaper writeup for being at KTAR. Hi.) W6BLP is going to Roosevelt Dam again. W6CAP is back at the U. of Ariz., and has a UX852 on 14 mc. W6EFC is our newest ORS. He has a UX210 TPTG and has ordered a new Vibroplex. W6BWS is hard at the commercial game. W6EAA is going to Phoenix Union High School. W6DIE is trying to get his UX852 back on the air. W6AAM, one of our old-timers, is getting back on the air. W6DRE is operating at KOY. W6CAJ (ex), W6DGY and W6BWS compose the technical staff at KTAR. Ex-W6AZV is in the advertising department of broadcast station KTAR. W6CCL is still out on the briny deep. We heard that someone woke him up one night and told him the ship was leaking and he said, "Aw put a pan under it and go to bed." W6CDY-W6CPX is on the staff at KGAR in Tucson. W6BWS reports working his old pal, W5AHI, and having a big rag chew. W6DTU would like some consistent 14-mc. schedules with well-operated stations.

Traffic: W6DTU 83, W6EFC 58, W6AWD 11.

SAN DIEGO — SCM, H. A. Ambler, W6EOP — W6ACJ again leads this section with a nice total. W6BGL visited Dr. Waters, W6EC, and had a FB chat with him. W6EPZ has lost all skeds but handled a good total. W6EOP worked OA4Q and got RT QSA5. W6CTP reports a new station, W7YAA, at the Fullerton Jr. College. W6ADC says his 210 and 245 are working FB. W6CTR is building a new fone xmitter. W6BAM has a new Ford. W6EOM is

still looking for his license. W6HY is going to try 28 mc. W6DNW has his new 50-watt station on and is getting out in fine shape. W6QY is on 14-mc. band. W6EOL is building a new set. W6BFB is now on the air with a 50-watter. W6DOB is on with a FB fone, and his new partner, W6AET, is also heard on with fone. Anyone wishing skeds with this section, get in touch with W6ACJ or W6EPP, RMS. The SCM would like to hear from all new stations.

Traffic: W6ACJ 178, W6BGL 62, W6EPZ 61, W6EOP 27, W6CTP 23, W6ADC 16, W6CTR 7, W6BAM 2, W6EOM 4. SACRAMENTO VALLEY — SCM, Everett Davies, W6DON — W6BSQ is building a new 100-watt set. W6BDX came through with a good report this month. W6AIM just put two 12½-inch Pyrex insulators on his aerial. The Sacramento Valley Radio Club is getting ready for the 1930 convention. W6ER-DON gets on the air now and then but both are pretty busy. W6TM is moving his station but will be back on soon. W6DVD sends in his first report. W6APE will be on soon with a WE212D tube. W6DQG is now using a 1-kw. water-cooled tube on 14 mc. The SCM got bawled out recently for not mentioning several hams in this report. Well, OMs, did you report?

Traffic: W6AIM 61, W6BDX 64, W6BSQ 4, W6DVD 12.

#### ROANOKE DIVISION

**N**ORTH CAROLINA — SCM, Hal S. Justice, W4TS — The shake-up of the ORS is almost completed, and we have fewer but more active ORS now. The recent 3500 kc. QSO party was only a partial success, several stations taking part but few succeeding in QSOing many stations. W4ABV continues to lead in traffic, and has a good start toward winning the Route Manager's 210. W4UM says xmitter works better on 14 mc. with low-C. W4JR is very busy with work. W4AHH has rebuilt to C.C. and is trying to eliminate key clicks. W4AEW continues to keep a lot of skeds, John has asked to be relieved of his duties as Route Manager as soon as a successor can be found. W4AA is using fone on 3.5 and 14 mc. W4ZD has a fone on 3.5 mc., and wants some traffic skeds. This station won the 3500 kc. QSO party Feb. 1. W4TS operates mostly on 14 mc. and occasionally on 3.5 mc. W4ZB fell off his roof with the aid of a zepp antenna. "Doc," W4VZ, is going to Honolulu soon and will take an xmitter and receiver with him.

Traffic: W4ABV 186, W4AEW 169, W4ZB 62, W4ZD 41, W4AA 28, W4TS 15, W4VZ 11, W4UM 6, W4AHH 2.

**WEST VIRGINIA** — SCM, Don Morris, W8JM — This month please report on time if you want mention in QST. W8TB sets a good example with 743 messages, making the BPL both ways. W8ACZ is having trouble over his operator's license. W8DPO is our best DX man, having worked 35 countries. W8JM wants someone to take the job of OO in West Virginia. W8CAY keeps 10 skeds regularly. W8OK works A-A schedules on Mondays. W8TI is a new ORS in Elkins. Also expect to see W8BTV have an ORS before long. W8BCN works 7000 kc. before breakfast. W8DNN still has that FB sked with W9AZY. W8CBV is one of our new hams in Wheeling. W8AUL's ORS is cancelled because of inactivity.

At this time I want to express my thanks to those who elected me to the office of SCM. We have a fine bunch of stations in the state and we should be able to keep up to any other section in U. S. Schedules will do the trick. How many do you keep?

Traffic: W8IB 743, W8ACZ 78, W8DPO 69, W8JM 50, W8CAY 33, W8OK 14, W8TI 13, W8BTV 12, W8BCN 7, W8DNN 5, W8DFP 2, W8CLQ 2, W8AYI 1.

**VIRGINIA** — Acting SCM, T. P. Mathewson, W3FJ — W3ARU makes the BPL again. W3CKL traded a 250-watt jug for a flock of condensers. W3CA is rebuilding his outfit for a fone for local work. W3WO is now an ORS. W3ZA completed his 'phone outfit. W3BZ is QRL his business. W3AQW has gone to New York to attend radio school. W3BDZ is testing his new 'phone outfit. W3BGS blew plate transformer and it rewound itself. W3AHW is badly QRM'd by the YLs. W3APT has new 281 rectifiers. W3MO is active with W3MT's rig. W3AJA remodeled his xmitter much to the delight of the BCLs. W3NO and W3ASA will soon be representing Richmond with 100-watt rigs. W3AMB says the west coast is just local to his 210. W3AHK promises us a 50-watt outfit in the near future. W3HO threatens to make WAC, BPL, et al., with his new xmitter. W3FJ, the Asst. SCM, had a nice visit from Corporal Arthur of NNINIC. W3ANT is a new ham at Fort Monroe. W3AJT, W3APF, W3PO, W3IE, W3ARD, W3ALP, W3FE, W3II, W3AHH, W3ABC and W3TJ were heard working at times during the

past month. We are on the lookout for an efficient operator with the facilities for our Official Observer. W3ARU is our very efficient Route Manager. W3CKL is the Official Broadcasting Station.

Traffic: W3ARU 332, W3FJ 23, W3APT 14, W3WO 13, W3AHW 11, W3AMB 15.

#### ROCKY MOUNTAIN DIVISION

**C**OLORADO — SCM, C. R. Stedman, W9CAA — W9CAA runs off with the traffic honors again this month. W9AAB comes next on the list. He has also been appointed an official broadcasting station. W9GBQ is doing some very nice work. W9ESA built a new filament transformer and is now all set. W9DGT complains that he can't run an 852 on 600 volts and do any good. W9CDE still finds little time for radio, due to work. W9CSR has finished his new transmitter and says it's a bearcat. W9CLJ, which is nothing more nor less than the school QRA of W9DQD, is back in the game in spite of school QRM. W9EDM says he can't make a monitor work as yet. W9DITY is now working out on a pair of amplifying tubes and a B eliminator. W9EFD has been sort of under the weather lately and hasn't been doing so much with radio. W9BQO says he can't keep a YL and radio going, too, so is quitting the radio. Hi. W9EAM continues to pound away on 7000 and 3500 kc. W9AAC may leave town. W9GGW is now a ship operator. W9BTO got a report from Japan, and now the rest of the gang can't see his nose without using a step ladder. Hi. W9FRK turns in a good first report. W9DCA, W9FTF and W9BVC are rebuilding. A number of the gang still seem to be somewhat confused as to the date monthly reports should be in the hands of the SCM. Reports should be in the mail to the SCM not later than the 16th of the month.

Traffic: W9CAA 135, W9AAB 86, W9GBQ 40, W9CLJ 19, W9FRK 29, W9EDM 8, W9EAM 20, W9CSR 1, W9CDE 1.

**UTAH-WYOMING** — SCM, Parley N. James, W6BAJ — This is the last report to be written by the present SCM, who has to resign because of leaving the section. Until an election is held, reports should be addressed to L. D. Stearns, W6BTX, Westminster College, Salt Lake City. W6DPJ makes the BPL. He was home three weeks with the mumps and, besides handling a lot of traffic, worked twelve countries. W7AAH was able to keep in touch with his brother by amateur radio. W6BTX has been very busy with school work. W6CNX was busy with traffic this month. W6DJT is a new station in Salt Lake on 7000 kc. W6DZX found out that it is possible to overload a WE fifty and is now off the air until he gets a new tube. W6BAJ is going to Calif. for an indefinite time.

Traffic: W6DPJ 346, W7AAH 112, W6BTX 41, W6CNX 41.

#### SOUTHEASTERN DIVISION

**A**LABAMA — SCM, Robt. Troy, Jr., W4AHP — I am your SCM now, fellows. Please give me your cooperation. The gang extend many thanks to Jeff Bayne for his fine work as SCM. W4LM is doing fine work in the A.A. net. W4CB has worked 28 states and 8 districts with a 245. Most of the work was on fone. W4JX and W4AKP are having a DX race. W4JY is on 7 mc. now. W4JQ received a card from Lwow in Poland. W4AQ is back on after generator trouble. W4PAI was in Illinois. W4AKB just bought a 50-watter. W4AHR has been bitten very badly by the YL bug. W4AKM has a new push-pull set and is after traffic. W4AJR is installing a pair of rectobulbs. Welcome W4FI from Tennessee. He operates at W4PI. W4AG leads the state in traffic. Very FB, OM. W4AHP has an AC screen-grid set that is the last word. W4HB is working DX with his fone outfit. W4IA worked eight sixes in two days on fone. W4TI has been on his vacation, but is going strong now. Selma boasts of two new stations. W4OH has a very fine fone set and W4DS is using a 201A there. Welcome, both of you. W4AAQ has been working all the DX in the International Contest. The Montgomery gang have the pleasure of having W4ADN from Georgia with them. The fellows in Troy are fighting for fone room on 3530 kc.

Traffic: W4AG 121, W4AAQ 66, W4AHR 65, W4FI 63, W4AKM 52, W4LM 48, W4CB 46, W4AHP 39, W4JY 24, W4JX 23, W4AQ 10, W4PAI 6, W4TI 4, W4AJR 3.

**GEORGIA-SOUTH CAROLINA-CUBA-ISLE OF PINES** — SCM, M. S. Alexander, W4RZ — W4KV, Army-Amateur net control station for the Fourth Corps Area, has been revamping his transmitter to use crystal control. W4AEQ is in the Army-Amateur net for Georgia

and keeps a schedule with W4PM every Monday night. W4AA4 has put in 100% Heising modulation on his 'phone set. W4AJH and W4DV have 852's, but are using 210's on account of blowing their filter condensers. W4ABS is now using a crystal-controlled transmitter. W4CL has been working 'phone on 3500 kc. and CW on 7000 and 14,000 kc. W4KI has just been appointed ORS. W4RZ has been experimenting with antennas. The single wire voltage fed Hertz working at full wave on 14,000 kc. and half wave on 7000 kc., gave the best all around results. W4CM has been seen in the company of a good-looking YL, but has not been on the air much. There is still lots of room for ORS in this section, and I am very anxious to hear from you fellows who are interested.

Traffic: CM8UF 150, W4ABS 113, W4SI 107, W4KV 63, W4AHA 41, W4AFQ 30, W4JL 21, W4AJH 21, W4RZ 20, W4PX 14.

PORTO RICO—VIRGIN ISLANDS—SCM, E. W. Mayer, K4KD—K4AAN allowed his station license to expire on the eve of International Tests, but was operating during tests at K4DK. K4AKV did a fine job of handling rifle match scores between N. Y. Stock Exchange and University of Porto Rico clubs. K4ACF has been appointed ORS and is installing an 852. K4KD makes the BPL two ways due to contest traffic. He got an R9 report from IRAQ and has visions of a WAC certificate on the wall. There are four live stations in the section with promise of one or two more. Let's show them that we are alive, OMs.

Traffic: K-KD 218, K4AAN 35, K4AKV 13.

FLORIDA—SCM, Harvey Chafin, W4AI1—W4OZ and W4AI1 make the BPL and lead the section. W4OZ was appointed ORS. W4AGR is using two DeForest 500-watt tubes on 14 mc. W4AKW sends in a report for the first time. W4TG is a new station at West Palm Beach. W4QA says there are eleven operators in Gainesville and that they are going to start a radio club soon. W4QA sends in a report that W4ABF is a new station there. W4MS reports one sked with her OM, now at the U. of F. W4QL has stopped all skeds until he works Asia. W4NE is keeping two schedules, with W8BJO-W1KH. W4SK is using 14 mc. mostly. W4AKH entered the International Contest, but he says that he knows he won't have a chance. KDV5 reports by radio. W4MM is a new station in Clearwater. W4TK is promising more time for radio after this month. W4JM has just received his appointment as ORS. W4QN reports for the first time. W4OO says that the Radio Club is going fine. W4TB is starting up again. There are nine active stations in St. Petersburg, and I would surely like to have a report from each station over there. W4SQ, an old-timer, is back on the air. The Western Union hasure been QRming W4AGY's time this month. The SCM would like to hear more about the Army-Amateur work that W4ACZ is doing. Our state traffic banner for this month goes to W4OZ. Each month the highest scoring station will receive the banner. W1QV and W4AKA report. W4ALH is sure keeping that 852 red.

Traffic: W4AI1 249, W4OZ 207, W4ALH 199, W4AGR 98, W4QA 88, W4AKW 72, W4MS 70, W4QL 64, W4NE 58, W4SK 54, W4AKH 44, W4MM 21, W4TK 7, W4JM 6, W4AKA 6, W4QN 5, W4OO 3, W4AGY 1, W4NB 21, KDV5 41.

#### WEST GULF DIVISION

SOUTHERN TEXAS—SCM, Robert E. Franklin, W5OX—W5AQY, as usual, sends in a nice report. W5AJD sent his report in by Western Union. W5BKE and W5BBY are receiving quite a bit of publicity from Kerrville and San Antonio newspapers for their good work in reporting football games between Kerrville and Corpus Christi. W5BKE sent in his first report. W5BKG is trying a little 3500-ke. fone work. W5AEA is using the old W5OX 50-watt transmitter. W5MS has skeds with W5BBY, H12, NN, J, YK, and expects to do plenty of DX traffic handling. W5AQK worked YK with a 210. W5NW had to terminate his sked with KALHR on account of leaving Baytown, and requests the gang to look out for his portable station W5MZ. Baytown has a new ham, a convert of W5NW's, in Mr. P. E. Bohannon, W5DS. W5BBV sold his complete station to the Houston unit of the National Guard. W5OX has just finished an xtal transmitter to be operated on 14,204 kc. and 7102 kc., using three UV852's in parallel in the last stage. W5TD is having trouble making his 212D work on 14,000 kc. W5NK and W5AE, a couple of old-timers, have been heard on the air lately with nice signals. W5KI, a new Houston station, packs a mighty wallop.

Traffic: W5AQY 169, W5BBY 146, W5AJD 127, W5BKE

85, W5AEA 69, W5MS 55, W5NW 25, W5OX 22, W5TD 21, W5ARI 6.

NORTHERN TEXAS—SCM, J. H. Robinson, W5BG—W5HY has a complaint to make about Dallas operators. He says there are nothing but lids over there that try to QSP, and he wants to know if ORS Nr. NT7 call letters W5BAM ever QSPs. He says W5BAM leaves him calling his hand off when he has traffic for Dallas. How about it, fellows? W5HY is keeping skeds with W5AQY and W9DUD on Tuesdays, Thursdays, and Saturdays. W5BAM is keeping skeds with the west coast and South Texas. He tells us that Mr. Frank Corlett, W5ZC, and old Rip Bennet, W5IP, will very shortly be contributing to the 7000 kc. QRM. This is difficult to believe, but the writer believes in miracles and is patiently waiting for these signals. W5JV reports for the first time. He is keeping skeds with W5AQY. W5BBF says the same old things are happening down his way. The SCM, W5BG, has been on quite a lot lately, trying to work with all the fellows in the fifth district. Let's have a QSO, fellows. W5RJ got the crystal set started, then the bank in cow town went west and the xtal set will have to be QRX for a while. It didn't affect his supply of 852's, though, so he will still be heard regularly. W5ES, out at El Paso, bootleggers' HQ, reports again. Seems the set doesn't want to work with a filter on it. We wonder if that is the trouble the rest of the AC fellows are having? Hi. The following ORS failed to report this month: W5BAD, W5WW, W5DF, W5ATZ and W5EV.

Traffic: W5HY 95, W5BAM 90, W5JV 29, W5BBF 27, W5BG 25, W5RJ 16, W5ES 13.

OKLAHOMA—SCM, W. J. Gentry, W5GF—W5CB is again the best traffic station in Oklahoma. And in comes W5AUV with a nice second. Keep it up, fellows. W5AGN hopes to have a crystal going soon. W5APG is going well in the Naval Reserve. W5AAV had a 50-watter going, but changed back to a 210. Hi. W5GF has been very busy with his service dept. W5AFH has rated two 245 tubes now and worked a Canadian. W5BJJ is on the 14,000-ke. band. W5AYF, our star official observer, is doing excellently. Tulsa has been slack in sending in reports and now we need a new RM. W5ADK is building a 250-watter using 'phone. W5KX reported. We need some more Official Observers. Let's hear from some of you fellows. W5MM made the fatal leap about two months ago. Congratulations, OM.

Traffic: W5CB 72, W5AUV 66, W5AAV 9, W5APG 13, W5AGN 7, W5GF 2.

NEW MEXICO—SCM, Leavenworth Wheeler, Jr., W5AHI—W5AJL and W5AOD came through with the goods and made the BPL. FB. W5AJL is now OO for this section and will be OBS very shortly. Wish more of you fellows could match his enthusiasm. W5AOD has joined the League in order to be in line for an ORS appointment. W5ZM is establishing a bird banding station for the Bureau of Biological Survey. Hope it doesn't give you one of those "birdy" notes, OM. Hi. W5TV gets better reports with his new voltage fed Hertz. W5ABV, who operates KGFL, will be active again soon. W5BH lost a 210 and is temporarily chewing up 14,000 kc. with pure AC. The traffic total at W5AHI suffered on account of a week's layoff during which the SCM learned to know the YL better. Hi. Send in your lists of high quality signals and well operated stations.

Traffic: W5AJL 196, W5AOD 154, W5AHI 118, W5TV 71, W5ZM 29, W5BH 2.

#### CANADA

ON account of no nominations being received before January 21st, we have again to call for nominations for SCM in Maritime and Saskatchewan Sections. It does not take much time to start a petition. Pick out the man of your choice, or the man you hear on the air most. He will be proud to become your leader and give of his time for the betterment of amateur radio. A section without an SCM is like a ship without a captain.

We are very pleased to congratulate VE2AC, Alphy Blais, and VE4EC, Fred Barron, on their election as SCM for Quebec and Alberta. Both take command with fine reputations of being consistent and progressive amateurs.

It is a great pleasure to have Newfoundland again represented. Acting SCM Jerrett is showing wonderful organizing ability, and turning in very interesting reports. King

Cavalisky of Vancouver, Ernie Thompson of Ontario and Chase of Manitoba have things running very smoothly in their respective divisions. Traffic in particular never was better.

**DON'T FORGET ALL-CANADA NIGHT EVERY WEDNESDAY AT 11:00 p.m. E. S. T.**

#### QUEBEC DIVISION

**Q**UEBEC — SCM, Alphy L. Blais, VE2AC — Greetings to the gang from the new SCM! If you will give me a hand, report monthly and send in suggestions and criticisms for the improvement of this division. I am sure we will make a real success of the game this year. Two fine prizes will be given for the two best traffic totals from May to October, four super B Burgess batteries and two UX281 tubes. Start now boosting your totals. All ORS appointments are cancelled. Prospective ORS apply for your ticket. VE2BE skeds VE4IC and VE2AC. VE2BB clicks Ontario and handles traffic fine. VE2CA has two xmitters and receivers going, so the Mrs. gets her share of traffic and fun. VE2AP held a hamfest in honor of G6WL. Over twenty attended, enjoying a fine time. The SCM makes the BPL again. VE2BE and VE2BB are ORS now under the new régime. VE2AY and VE2BZ are in line for ORS appointment. Our Canadian Traffic Route is almost completed now, and messages are going across regularly. VE2AC has skeds with W1MK and W8DIL.

Traffic: VE2AC 184, VE2BE 26, VE2BB 21, VE2CA 20.

#### ONTARIO DIVISION

**O**NTARIO — SCM, E. C. Thompson, VE3FC — Central District: VE3BC still leads the way in traffic and sets new marks for the rest to shoot at. VE3BO is runner-up with a fine total, all obtained on the 7-mc. band. Our other RM, VE3DA, is next in line with another fine showing of traffic, which is the outcome of many well-kept schedules on 3750, 7055 and 14,110 kc. VE9AL ran into a lot of grief when his MG again failed at the critical moment — for the last time. A new rectifier will replace it. VE9BJ is heard regularly on 3750 kc. VE3FC operates regularly using 3810 kc., 7080 kc. and 14,080 kc. A chain of stations known as the "Pink Elephants" has been formed with VE3FC as convener. This chain operates three times a week on 3800 kc. The main idea is that six stations can be contacted at one and the same time, working in rotation. The following report has arrived from Kingston through the kindness of VE3VS. VE3XQ operates at VE3VS. VE3FG has a new daughter; congrats, OB. VE3VS is very active on 14,200 kc. and is keeping a schedule with VE5AP up in Hudson Straits. VE3DO has come back under the call VE3XC, and is hard at it on 3500 kc. over week-ends. Welcome, OB. VE3DW at Beamsville is now getting out in fine shape using one flea power. "DW" attributes his success to VE3AD. Southern District: C. D. Lloyd, VE3CB, ASCM: — VE9CI is transmitting television on 2000 kc. using 48 lines per inch and 1200 RPM under the call VE9AU. VE3ER is using 'phone on 3500 kc. VE3CB-VE3DD have been having a little grief through a filter and the 281s going west. VE3FD is now using a push-pull oscillator on 3500 kc. VE3HB is still playing with 'phone on 3500 kc. Northern District: G. V. Lawrence, VE3ET, ASCM — VE3GC makes his bow as a traffic handler. FB, OM. VE3CO has been QSO W4 and W5 on 28 mc. VE3HU is pumping out a strong sig on 3.6 mc. VE3DM is on regularly. The baby of our family, VE3CR, is not yet 17. VE3AR is applying for an OBS appointment. VE3KB is a new fone man at Midland. VE3BH is building a real portable. VE3AW is holding the fort at Kenora, but VE3EJ will soon share the responsibility. VE3AG would like to know if anyone has heard his sigs on 3.5 mc. An old-timer, VE3BG, will soon be on with 100 watts. VE3CH doesn't get much time for radio. VE3GG reports a big radio class at Fort William. VE3TU has a combination fone and CW set.

Traffic: VE3ET 58, VE3GC 12, VE3DM 1, VE3HU 1.

#### ALBERTA DIVISION

**A**LBERTA — SCM, G. F. Barron, VE4EC — Well, gang, this is my first report as SCM. Some very nice traffic totals have been turned in this month, with VE4GD the leader and VE4EI a close second. VE4AF and VE4DZ are considering joining forces and planning a 250 crystal-control rig. VE4EA expects to be on shortly, with 3500-ke. 'phone. VE4EC hooks everything but! Hi. VE4HA is on once in a while and VE4HM when time permits. VE4CU has a new super-het receiver as per QST and reports it very FB. By the time this is in print, we will have a new

ham at Fort Saskatchewan if his ticket comes through. VE4FJ at Manville is on with a 201A. VE4CT pounds brass week-ends. VE4CC is tied up with school work. VE4HG is planning to come back to his first love with an MOPA. Some splendid work has been done this month. Let us hope that we may have your continued support.

Traffic: VE4EI 92, VE4EC 55, VE4EA 4, VE4GD 264.  
BRITISH COLUMBIA — SCM, J. K. Cavalisky, VE5AL — VE5CL is the anchor on the western end of the all-Canadian traffic route. The net extends to Winnipeg. Parry Sound is coming to the rescue to link east and west. VE5BC has junked his TPTG for a Hartley. VE5CF is a real busy man these days, so isn't on very often. VE5DR has made a couple of contacts on low power. VE5BM is busy building a set for a new ham in P. R. VE5FI is a new license which we expect to hear on soon. VE5AC managed to spear the odd message, as did VE5CR, who is using a Hartley. VE5DD is on again with a new model. VE5AL is trying to eliminate some key thumps. VE5BR was in town recently with his portable and kept in touch with home through VE5BL. Victoria: VE5CO gives us the glad news that the Victoria Short Wave Club has already twenty-six members and more coming in. New stations on the air are VE5EC, VE5DU, VE5DQ and VE5EK while three others have their tickets and are waiting for calls. The SCM is pleased to see Victoria coming back stronger than ever. VE5BU has a hard time putting his sigs over the mountains, but still gets a kick out of his set.

Traffic: VE5AC 3, VE5DD 17, VE5AP 2, VE5AL 10, VE5CL 44, VE5CR 5, VE5CF 8, VE5AK 3.

#### PRAIRIE DIVISION

**M**ANITOBA — SCM, A. V. Chase, VE4HR — Things took a turn for the better this month. VE4FN is back on the air with an ultraudion. VE4BQ has been heard in England and South Africa on 28 mc. VE4JB has switched to a push-pull ultraudion. VE4IC took the lead this month in traffic handling. He has regular skeds with VE2BE, VE4IH and W9YC. VE4RI has received his official call, VE4FP. VE4AR has sold his equipment to VE4JR. VE4AR is now building a phone transmitter for 3.5 mc. VE4BU is keeping a daily sked with W4UM on 14 mc. and VE4IH on 7 mc.

Traffic: VE4IC 51, VE4AR 33, VE4HR 24, VE4DJ 14, VE4BQ 13, VE4BU 12, VE4DK 5.

SASKATCHEWAN — SCM, W. J. Pickering, VE4FC — Things have certainly shown a decided improvement in this section. Keep it up, fellows, and we should be able to beat our sister section in traffic. VE4IH makes the BPL. He is now keeping five skeds and is the Saskatchewan link in the trans-Canada hookup. VE4GR also turns in a nice total. VE4BB, a new reporter at Biggar, comes up with a good total. VE4BY who has been using 'phone, is now pounding the key from 1 to 3 p.m. daily. VE4GO says that Sask. is the most active in the 4th division. VE4FC is not on very much, but one message managed to squeeze in.

Traffic: VE4IH 210, VE4GR 41, VE4BB 19, VE4GO 17, VE4FC 1.

#### MARITIME DIVISION

**N**EWFOUNDLAND — Acting SCM, E. V. Jerrett, VE8SZ — We are glad to note an increased activity amongst the boys on 7000 kc. VE8C has a brand new Jewell testing outfit. VE8L is a newcomer with a good DC note. VE8AN has been absent from home a lot lately, and we have missed his FB sigs. VE8MC has a phone and wants reports on it. VE8AW has erected some new wires with much success. VE8AE has skeds with W2KU, and this is a good route for traffic coming to the Greutell Mission either for Labrador or St. Anthony. VE8WG is still making his emergency plate supply of B batts do their bit and is keeping regular bi-weekly skeds with VE8Z. VE8Z hopes to hear more from the boys as to what they are doing, so as to make our report more interesting.

#### LATE AND ADDITIONAL REPORTS

K4ACF reports by air mail. He is on again with a new tube.

Traffic: K4ACF 6.



What does *your* set say  
to  
"the man who knows"?

*"Who really buys your set?"*

*"What points actually sell it?"*

THE success of today's manufacturer and builder depends upon how well he knows the answers to these two questions.

The man who knows enough about radio to understand causes as well as results is becoming an increasingly important sales factor in the receiver market. Those who are not radio-wise hesitate to purchase sets without relying upon the advice of an acquaintance who has some knowledge of radio. To this man, Sangamo Transformers stamp your set as O.K. Sangamo in

the "audio end" means true TONE!

TONE QUALITY is the magic key that finally opens the purse and closes the sale.

Transformer building is a science in itself—best left to an organization like Sangamo, whose research, experience and precision manufacturing facilities guarantee results. Sangamo "A" Line Transformers are built for the custom set maker or manufacturer who wants a "tone" advantage over competition. They cost a little more, but the set is easier to sell.

SANGAMO ELECTRIC CO.

SPRINGFIELD, ILLINOIS, U. S. A.

*Manufacturers of Precision Electrical Apparatus for 30 years*

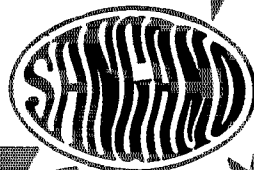

See Reverse  
Side

# "A" Line Transformers

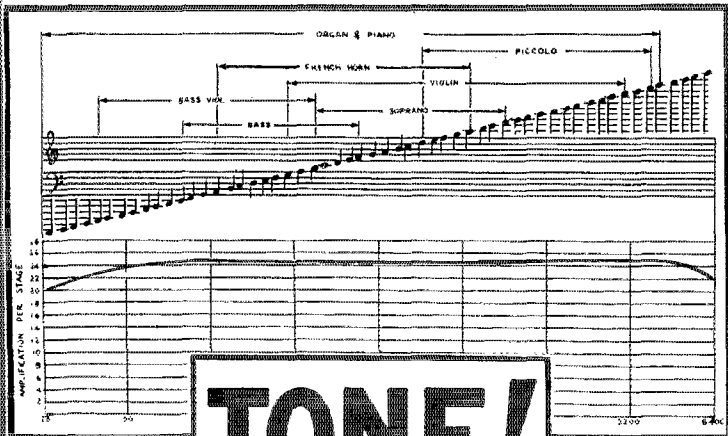

Curve of Type "A" Sangamo Straight Audio Transformer showing uniformity of amplification at all audible frequencies.

## TONE!

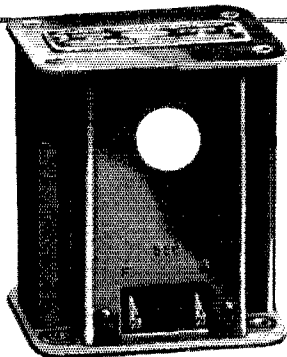

Type "A" straight audio amplification. List price..... \$10

Type "B" Push-pull Input Transformer for all tubes. List price..... \$12

Type C-171 Push-pull Output, for 171 or 250 type power tubes with cone speaker. List price..... \$12

Type D-210, same as C, except for 210 and 112 power tubes. List price..... \$12

Type H-171, Push-pull Output for 171 or 250 power tubes for Dynamic Speaker. List price..... \$12

Type G-210, same as type H, except for 210 and 112 power tubes. List price..... \$12

Type F Plate Impedance for use as a choke to prevent oscillation and for impedance coupled amplifiers. List price.... \$5

*Unusual facilities for furnishing transformers with or without cases ready for mounting and quick assembly with the receiver. Prices on application.*

## SANGAMO Type "A" Condensers

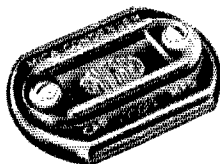

No item can cost so little and cause so much trouble in a receiver as a fixed condenser. This fact is especially appreciated by the manufacturer with an eye to the service problem. Likewise, experience has shown that a fixed condenser is not necessarily a good condenser just because it is molded in Bakelite.

The immunity to thermal changes and to mechanical damage rendered by the Bakelite enclosure is supplemented in Sangamo Condensers by accurate rating and sound construction of the mica condenser within the Bakelite casting.

The standard line of Sangamo Fixed Condensers leaves the factory tested to maximum variation of 10%. Also furnished with closer ratings and in high voltage types.

## SANGAMO "Illini" Condensers



"Illini" Condensers are standard with those manufacturers who insist on ratings being actually what the specifications call for. Manufactured by exclusively designed equipment, held to the tolerances your engineering department demands, Sangamo Condensers will reduce to a negligible quantity inspection department rejects and "re-assembly" losses in profit.

**PIN THIS TO YOUR LETTERHEAD AND MAIL**

SANGAMO ELECTRIC CO.  
Springfield, Illinois, U. S. A., Dept. S-94

- (For manufacturers) I am interested in engineering data regarding your transformers and condensers.
- (For set builders) Please send circulars describing your apparatus and latest audio hook-ups. I enclose 10c to cover cost of mailing.

Name \_\_\_\_\_  
Address \_\_\_\_\_

Prices on request