

QST

DEVOTED ENTIRELY TO

AMATEUR RADIO

PUBLISHED SINCE 1915 BY THE AMERICAN RADIO RELAY LEAGUE INC.

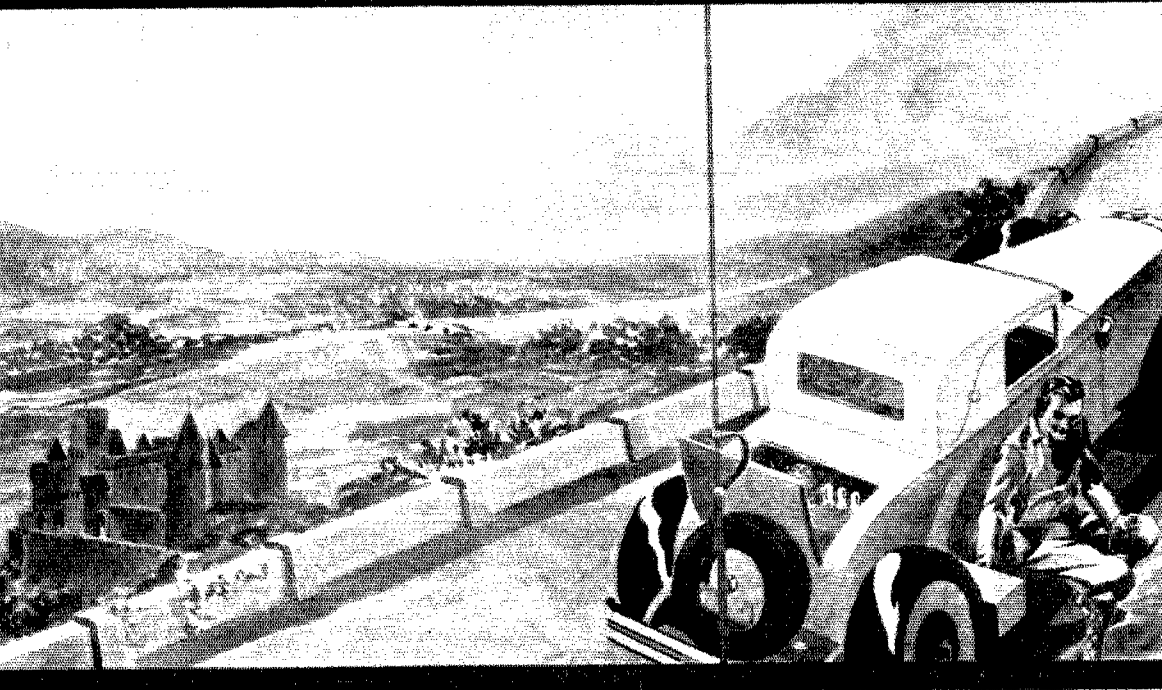

AUGUST
1929

25^c

You Have Until
AUGUST THIRTY-FIRST
To Take Advantage

**of the special offer
announced in the
July issue of QST.**

THE RADIO AMATEUR'S HANDBOOK

(Fifth Edition — in its 53rd thousand)

A N D

a year's subscription to



F O R

\$3.00

Even if you are already a member of the League and a subscriber to QST, you may take advantage of this offer. Simply mention that fact and instead of entering it as a new subscription we will extend your present subscription for another year.



The American Radio Relay League

1711 Park Street, Hartford, Conn.

RCA RADIOTRON UX-852

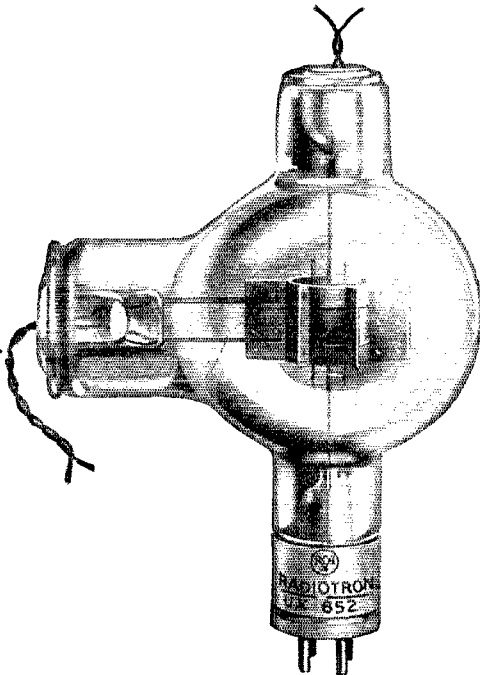

The low internal-capacity 75 watt tube so popular among amateurs.

Filament Voltage 10 Volts
 Filament Current 3.25 Amperes
 Amplification Factor 12

Oscillator or RF Power Amplifier

Max. Operating Plate Voltage
 Modulated DC Plate Volts 2000
 Non-modulated DC Plate Volts 3000
 AC Plate Volts (RMS) 3000
 Max. DC Plate Current (Milliamp's) 100
 Max. Plate Dissipation (Watts) 100

FOR more than two years now, amateurs have been using Radiotron UX-852 in their high frequency transmitters. Its stable and reliable performance at 15,000 kilocycles (20 meters) is now a matter of record.

At the still higher frequencies of 30,000 to 50,000 kilocycles, amateurs will find Radiotron UX-852 entirely practical. It has even been made to oscillate at more than 340,000 kilocycles— $\frac{1}{8}$ th of a meter—in the designing laboratories.

If your dealer cannot supply you, the RCA District Office nearest you will be glad to send you Radiotron UX-852 prepaid, on receipt of money order and call letters of your station.

List Price \$32.50

RADIOTRON DIVISION
RADIO-VICTOR CORPORATION OF AMERICA

New York—261 Fifth Avenue

*San Francisco—235 Montgomery Street
 Chicago—100 West Monroe Street*

*Atlanta—101 Marietta Street
 Dallas—Santa Fe Building*

JEWELL 409 Set Analyzer for Expert Servicemen

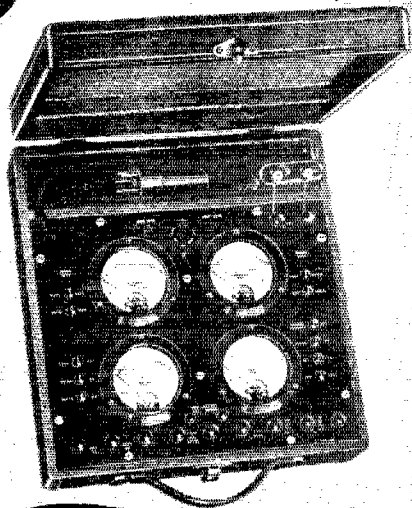

**JEWELL
199 Set
Analyzer**

**TESTS
SCREEN
GRID SETS**



The pattern 199 includes the 199 set analyzer in a large case with drawer and compartments for tools and replacement tubes.

List Price Pattern 199 - \$110.00
Dealers' Price \$82.50

The improved Pattern 199 is still the leader in the popular priced set analyzer field. It tests screen grid sets, and handles every other requirement. The two large instruments are of highest quality, and assure accuracy of service that is a sure foundation for profitable service work.

List Price Pattern 199 - \$97.50
Dealers' Price \$73.12

AGAIN Jewell takes the lead with a Set Analyzer that accurately meets service needs. In the Jewell Pattern 409 the dreams of expert radio servicemen are realized. This remarkable instrument gives filament, grid, and plate voltages, as well as plate current, simultaneously.

Two of the four $3\frac{1}{2}$ inch face Jewell Instruments read plate voltage and current continuously. Pressing the A. C. and grid voltmeter buttons gives the remaining values of the stage under test for instant comparison and analysis.

A Complete Portable Laboratory

The Jewell Pattern 409 tests all receivers—including those equipped with the new screen grid tubes—A and B eliminators, tubes, batteries, circuits, grid, plate, and cathode voltages, plate current, chargers, and line voltages. Comes equipped with test leads, adapters, a pad of Jewell Set Analysis Charts, and "Jewell Instructions for Servicing Radio Receivers."

Commands Confidence of Servicemen

The professional appearance of the Pattern 409 commands the confidence of radio set owners. The $3\frac{1}{2}$ inch face Jewell Instruments in bakelite cases, the engraved bakelite panel, push button switches, combined with the excellent finish and workmanship of this instrument, instill confidence in servicemen.

The Pattern 408 includes the 409 in large case with drawer and compartments for tools and replacement tubes.

List Price Pattern 409 - \$122.50 List Price Pattern 408 - \$127.50
Dealers' Price - \$91.88 Dealers' Price - \$103.13

Sold by
radio jobbers
everywhere

29 YEARS MAKING GOOD INSTRUMENTS
JEWELL
JEWELL

409 SET ANALYZER

Jewell Electrical Instrument Company
1650 Walnut Street, Chicago, Illinois

Please mail booklet entitled, "Instructions for Servicing Radio Receivers," and circular which gives complete data on Jewell Set Analyzers.

Name.....

Address.....

Section Communications Managers of THE COMMUNICATIONS DEPARTMENT, A. R. R. L.

Eastern Pennsylvania*	W3ZF	ATLANTIC DIVISION	Don Lusk	Box 188	Ardley
Maryland-Delaware-District of Columbia*	W3BBW	Forrest Calhoun	1636 Thomas St.		Baltimore, Md.
Southern New Jersey	W3CFG	M. J. Lotysh	Box 49, R. F. D. 1		Cranbury, N. J.
Western New York*	W81FI	C. S. Taylor	598 Masten St.		Buffalo
Western Pennsylvania	W8CBO	A. W. McAuly	309 Third St.		Oakmont
		CENTRAL DIVISION			
Illinois	W9APY	Fred J. Hinds	3337 Oak Park Blvd.		Berwyn
Indiana	W9CYQ	D. J. Angus	310 N. Illinois St.		Indianapolis
Kentucky	W9RAZ	J. B. Wathen, III	Mockingbird Valley		Louisville
Michigan	W8CFE	Dallas Wise	9187 Falcon Ave.		Detroit
Ohio	W8BYN	H. C. Storck	694 Carpenter St.		Columbus
Wisconsin	W9VD	C. N. Crapo	443 Newton Ave.		Milwaukee
		DAKOTA DIVISION			
North Dakota	W9DYV	B. S. Warner	309 4th Ave.		Enderlin
South Dakota	W9DGR	D. M. Pasek	780 Illinois St.		Huron
Northern Minnesota	W9RVH	Carl L. Jabs	1822 James St.		St. Paul
Southern Minnesota	W9EFK	J. C. Pehoushek	130 Warwick St., S. E.		Minneapolis
		DELTA DIVISION			
Arkansas	W5ARI	H. E. Velte	315 No. Jackson St.		Little Rock
Louisiana	W5EB	M. M. Hill	1708 23rd Ave.		Oakdale
Mississippi	W5AKP	J. W. Gullett	c/o Radio Station WBAW		Meridian
Tennessee	W4FI	Polk Perdue			Nashville
		HUDSON DIVISION			
Eastern New York	W2CNS	F. M. Holbrook	2 Livingston Ave.		White Plains
N. Y. C. & Long Island*	W2BGO	V. T. Kenney	382 Wardsworth Ave.		N. Y. C.
Northern New Jersey	W2WR	A. G. Wester, Jr.	50 Princeton St.		Maplewood
		MIDWEST DIVISION			
Iowa	W9DZW	H. W. Kerr			Little Sioux
Kansas	W9CET	J. H. Amis	915 Lincoln Ave.		Topeka
Missouri	W9RR	L. B. Lazure	8010 Mercier St.		Kansas City
Nebraska	W9BYG	C. B. Deihl	5605 Cedar St.		Omaha
		NEW ENGLAND DIVISION			
Connecticut	W1ZL	C. A. Weidenhammer	33 Washington Place		Bridgeport
Maine	W1AQL	G. C. Brown	269 No. Main St.		Brewer
Eastern Massachusetts*	W1ACH	E. K. Sharp	9 Fairbanks St.		Brookline
Western Massachusetts	W1UUM	Dr. John A. Tessmer	8 Schaffner St.		Worcester
New Hampshire	W1ATJ	V. W. Hodje	227 Main St.		Claremont
Rhode Island	W1BCR	C. N. Kraus	92 Keene St.		Providence
Vermont	W1IT	Clayton Paulette			North Troy
		NORTHWESTERN DIVISION			
Alaska	W7WDN	W. B. Wilson	U. S. LHT Fern		Ketchikan
Idaho*	W7ABB	H. R. McBirney	1720 Washington St.		Boise
Montana	W7AAT-7QT	O. W. Viers			Red Lodge
Oregon	W7UN	Wilbur S. Claypool	943 E. 30th St., S. E.		Portland
Washington	W7FD	Otto Johnson	4340 30th Ave. W.		Seattle
		PACIFIC DIVISION			
Hawaii	K6CFQ	F. L. Fullaway	2714 Manoa Rd.		Honolulu
Nevada*	W6UO	C. B. Newcombe	209 Pine Ave., Room 410		Yerington
Los Angeles	W6AM	D. C. Wallace	1348 Hanchett Ave.		Long Beach, Calif.
Santa Clara Valley	W6JQ	D. J. Quement	368 62nd St.		Oakland
East Bay	W6ZR	J. Walter Frates	262 Castro St.		San Francisco
San Francisco	W6WB	C. F. Banc	Rt. 5, Box 380		Sacramento
Sacramento Valley	W6DON	Everett Davies	519 W. Madison St.		Phoenix
Arizona*	W6BWS	Russ Shortman	257 Galicia St.		Manila
Philippines*	K1AU	M. J. Felizardo	4101 Hamilton St.		San Diego
San Diego*	W6EOP	Harry A. Ambler			
		ROANOKE DIVISION			
North Carolina*	W4TS	Hal S. Justice	Box 552		Canton
Virginia*	W3CA	J. F. Wohlford	118 Cambridge Ave.		Roanoke
West Virginia	W8VZ	F. D. Reynolds	Box 1200		Fairmont
		ROCKY MOUNTAIN DIVISION			
Colorado	W9CAA	C. R. Stedman	1641 Albion St.		Denver
Utah-Wyoming	W6BAJ	Parley N. James	430 "D" St.		Salt Lake City
		SOUTHEASTERN DIVISION			
Alabama	W4AAQ	S. J. Bayne	9 Park Ave.		Montgomery
Florida	W4AII	Harvey Chain	6002 Suwanee Ave.		Tampa
Georgia-Su. Carolina-Cuba-Isle-of-Pines	W4RM	James G. Cobble	1124 Mayland Circle		Atlanta
Porto Rico-Virgin Islands*	K4KD	E. W. Mayer	Box 103		Ensenada, P. R.
		WEST GULF DIVISION			
Northern Texas	W5AKN	J. H. Robinson, Jr.	522 Cumberland St.		Dallas
Oklahoma	W5GF	W. J. Gentry	619 Pottenger St.		Shawnee
Southern Texas	W5OX	R. E. Franklin	1806 Valentine St.		Houston
New Mexico	W5TT	L. E. Radka			Tucumcari
		MARITIME DIVISION			
Maritime*	VE3DQ	A. M. Crowell	69 Dublin St.		Halifax, N. S.
		ONTARIO DIVISION			
Ontario	VE3FC	E. C. Thompson	266 Queensdale Ave.		Toronto, 6
		QUEBEC DIVISION			
Quebec	VE2BE	Alex Reid	169 Logan Ave.		St. Lambert
		VANALTA DIVISION			
Alberta	VE4HA	E. J. Taylor	10107-87th Ave.		Edmonton
British Columbia	VE5BJ	E. S. Brooks	2987 Camosun St.		Vancouver
		PRAIRIE DIVISION			
Manitoba*	VE4HR	A. V. Chase	109 Lanark St.		Winnipeg
Saskatchewan*	VE4FC	W. J. Pickering	514 19th St. W.		Prince Albert

*Officials appointed to act until the membership of the Section concerned choose permanent SCMs by nomination and election.
**Acting for the summer.

FOR FIFTEEN YEARS

the General Radio Company has been manufacturing instruments for the amateur which have made a reputation for sound design, quality, and reliability. Among these are

Frequency Meters
Quartz Plates for
Piezo-Electric Oscillators
Audio Amplifier Transformers
Power-Supply Transformers
Variable Air Condensers (for
work on short waves)

New items are under development. Send for Bulletin 931-R and ask to receive future announcements as they appear in the *General Radio Experimenter*

GENERAL RADIO COMPANY

30 STATE STREET
CAMBRIDGE, MASSACHUSETTS

274 BRANNAN STREET
SAN FRANCISCO, CALIFORNIA



QST



The Official Organ of the A.R.R.L.

VOLUME XIII

AUGUST, 1929

NUMBER 8

Editorials	7
The Modulometer	<i>James J. Lamb</i> 8
The President's Corner	<i>Hiram Percy Maxim</i> 16
The Amateur and the Naval Reserve	<i>R. H. G. Mathews</i> 17
Standard Frequency Transmissions of WWV	19
Bear-Cat, Model 3B	<i>A. W. McAulby</i> 20
Coming — A Low-Power 'Phone Transmitter	22
Resistance Control of Regeneration	<i>Beverly Dudley</i> 23
Northwestern Div. Convention	28
The Inductor Dynamic	<i>Harold P. Westman</i> 29
Midwest Division Convention	30
W1WV	31
New England Division Convention	36
Introduction of Losses in Radio Circuits by Coupling	<i>Rinaldo DeCola</i> 37
New "X" Regulations	39
Getting the Most Out of Your Meters	<i>Elmore B. Lyford</i> 40
Some Changes in Our Staff	41
Helping the Beginner	<i>Alphy L. Blais</i> 42
An Effective Break-In System	<i>Rienzi B. Parker</i> 44
Experimenters' Section	45
Communications Department	49
I. A. R. U. News	65
Calls Heard	67
Correspondence Department	68
Hudson Division Convention	78
The Atlantic Division Convention	82
Book Reviews	84
Hamads and QRA's	92
QST's Index of Advertisers	94

QST is published monthly by The American Radio Relay League, Inc., at Hartford, Conn., U. S. A.
Official Organ of the A.R.R.L. and the International Amateur Radio Union

Kenneth B. Warner (Secretary, A.R.R.L.), Editor-in-Chief and Business Manager

James J. Lamb
Technical Editor

Beverly Dudley
Assistant Technical Editor

Clark C. Rodimon
Assistant Editor

David H. Houghton
Circulation Manager

G. Donald Meserve
Advertising Manager

Advertising Offices 55 West 42d Street, New York City
Editorial Offices 1711 Park Street, Hartford

Subscription rate in United States and Possessions, Canada, and all countries in the American Postal Union, \$2.50 per year, postpaid. Single copies, 25 cents. Foreign countries not in American Postal Union, \$3.00 per year, postpaid. Remittances should be by international postal or express money order or bank draft negotiable in the U. S. and for an equivalent amount in U. S. funds.

Entered as second-class matter May 29, 1919, at the post office at Hartford, Connecticut, under the Act of March 3, 1879. Acceptance for mailing at special rate of postage provided for in section 1103, Act of October 3, 1917, authorized September 9, 1922. Additional entry at Concord, N. H., authorized February 21, 1929, under the Act of February 28, 1925.

Copyright 1929 by the American Radio Relay League, Inc. Title registered at United States Patent Office.
Member of the Radio Magazine Publishers' Association.

The American Radio Relay League

The American Radio Relay League, Inc., is a non-commercial association of radio amateurs, bonded for the promotion of interest in amateur radio communication and experimentation, for the relaying of messages by radio, for the advancement of the radio art and of the public welfare, for the representation of the radio amateur in legislative matters, and for the maintenance of fraternalism and a high standard of conduct.

It is an incorporated association without capital stock, chartered under the laws of Connecticut. Its affairs are governed by a Board of Directors, elected every two years by the general membership. The officers are elected or appointed by the Directors. The League is non-commercial and no one commercially engaged in the manufacture, sale or rental of radio apparatus is eligible to membership on its board.

"Of, by and for the amateur," it numbers within its ranks practically every worth-while amateur in the world and has a history of glorious achievement as the standard-bearer in amateur affairs.

Inquiries regarding membership are solicited. A bona fide interest in amateur radio is the only essential qualification; ownership of a transmitting station and knowledge of the code are not prerequisite. Correspondence should be addressed to the Secretary.

DIRECTORS

President
HIRAM PERCY MAXIM
Drawer 2102,
Hartford, Conn.

Vice-President
CHARLES H. STEWART
St. David's, Pa.

Canadian General Manager
A. H. K. RUSSELL
5 Mail Bldg.,
Toronto, Ont.

Atlantic Division
EUGENE C. WOODRUFF
234 W. Fairmount Ave.,
State College, Pa.

Central Division
CLYDE E. DARR
137 Hill Ave., Highland Park,
Detroit, Mich.

Dakota Division
C. M. JANSKY, JR.
Dept. of Elec. Eng., U. of M.,
Minneapolis, Minn.

Delta Division
BENJ. F. PAINTER
424 Hamilton Nat'l Bank Bldg.,
Chattanooga, Tenn.

Hudson Division
A. LAFAYETTE WALSH
220 West 42d St.,
New York City

Midwest Division
PORTER H. QUINBY
817 Lauderdale Building,
St. Louis, Mo.

New England Division
FREDERICK BEST
13 East Crescent St.,
Augusta, Maine

Northwestern Division
E. W. WEINGARTEN
3219 No. 24th St.,
Tacoma, Wash.

Pacific Division
ALLEN H. BABCOCK
65 Market St.,
Southern Pacific Co.,
San Francisco

Roonoke Division
W. TREDWAY GRAVELL
Box 245,
Danville, Va.

Rocky Mountain Division
PAUL M. SEGAL
Box 177L,
Denver, Colo.

Southeastern Division
HARRY F. DOBBS
245 Spring St., N. W.,
Atlanta, Ga.

West Gulf Division
FRANK M. CORLETT
2515 Catherine St.,
Dallas, Tex.

OFFICERS

President HIRAM PERCY MAXIM, Hartford, Conn.
Vice-President CHARLES H. STEWART, St. David's, Pa.
Secretary KENNETH B. WARNER, Hartford, Conn.
Treasurer ARTHUR A. HEBERT, Hartford, Conn.
Communications Manager F. EDWARD HANDY, Hartford, Conn.

ADDRESS ALL GENERAL CORRESPONDENCE TO THE EXECUTIVE HEADQUARTERS AT HARTFORD, CONN.

EDITORIALS

12

IT is both a privilege and a duty to present in our columns this month an article explaining the "Volunteer Communication Naval Reserve — Class V-3," the naval radio reserve so largely made up of amateurs. We commend this subject most earnestly to the attention of our members. In time of mobilization the Navy has urgent need for a great number of radio operators and communications people in general. It looks largely to the ranks of the amateur to fill this need.

Both the Army and the Navy have as their chief reason for encouraging and protecting amateur radio the basic fact that amateur radio is a vast training school for the production of skilled radio operators. Let us look for a moment at this question of national defense. We all hope that it will be a long, long time until there is another war. Nevertheless such things do happen and it is silly to believe that there will never be another one. Modern science will make the next war terrible beyond description. The best known safeguard against these horrors, the most valuable undertaking to stave off such a fatal day, is adequate national defense. Americans do not acquire military training for the purpose of waging wars of aggression; they do it for the purpose of being so adequately prepared that other folks will think better of the idea of starting something. There's another angle, too: we amateurs know that if another national emergency comes, war or anything else, all of us will be in it, whether we like the idea or not. In such event it is infinitely preferable to have made our individual arrangements in advance for a line of work we know something about, where benefit can be had from such talents as we possess, and where our skill will give us opportunity for preferment.

It seems to us, then, that such appeals from our Government should have the serious consideration of every able-bodied amateur. It is our patriotic duty to make our peculiar talents

available to the Government; it is but common sense to be arranging leisurely for a good berth if ever we must see service again; and in the meantime there is much profitable and pleasurable experience to be gained from such an association in the instruction, the drills, and the cruises of the Naval Reserve.

The false impression is current in many quarters of the amateur world that the Army-Amateur Radio System and the Naval Communications Reserve are competing for the favor of the amateur. It is not true; there is no conflict. The Army-Amateur System is a great emergency peace-time organization designed for the prompt placing of relief information where it will be of value. It has no concern with war service and it does not involve enlistment. The Army hopes, no doubt, that participation in its work will make amateurs Army-minded and desirous of choosing the Army for service in event of mobilization; but the Army at this time has no enlisted communications reserve. The Navy's offer, on the other hand, is one of outright enlistment, rating and training in the reserve, with service purely voluntary until a national call is sounded and with a good berth then secure. Since the Army Signal Corps now has no enlisted reserve, there can be no objection at this time to an amateur serving in the peace-time Army-Amateur System and yet being enlisted in the Naval Reserve; and there are many amateurs who have both affiliations.

There is a place in these organizations for every amateur. As American citizens it is both a privilege and a duty for us to offer our skill and our assistance to them — via the Army-Amateur System to the people of our community in protecting their lives and property by prompt organized relief efforts, and via the Naval Reserve to our country as a whole by establishing places for ourselves in the organization for national defense.

K. B. W.

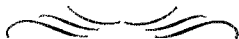

The Modulometer

A Simple Device for Measuring the Percentage of Modulation and Generally Checking the Performance of the Phone Transmitter

The modulometer is a further contribution of the QST Technical Staff to the development and improvement of amateur radio telephony. If given general application it should prove as great a boon to phone as the monitor has to c.w. A succeeding issue of QST will describe an inexpensive and effective modern low-power phone transmitter which is now in the process of design and construction. — EDITOR.

By James J. Lamb, Technical Editor

AMATEUR radiotelephony reached the toddling stage in the days following the close of the Great War and was given its real impetus in 1921 with the publication in the July and August issues of *QST* of the first comprehensive technical phone article, "Modulation in Radio Telephony," by none other than R. A. Heising. It is notable

modulation thus made available to the amateur fraternity, amateur phone reached its majority and, apparently self-satisfied, rested on its laurels while amateur c.w. and commercial broadcasting rushed on to new fields of conquest.

It is odd to observe that, even when everything below 200 meters was open territory, no new bands were ever opened up on amateur phone.

No first contacts with foreign countries have been made on phone. No new transmitting circuits have been first developed on phone. Crystal control, High-C and all the rest have first come as c.w. achievements and for the most part have not even at this time been whole-heartedly adopted for phone use. This is no idle indictment but is a bare statement of irrefutable facts as they are. What is the explanation? Is it because phone enthusiasts are reactionaries and will not leave the old order? We know this is not so. Is it because we have been lacking in ingenuity and initiative in technical development? This cause is not acceptable. The real reason? It is hard to put a finger on it but perhaps a little searching will throw some light on the subject.

In the development of any art, such as radio telephony, close scrutiny and ardent attention must be primarily given to basic requirements. The most fundamental requisite for successful phone transmission is radio-frequency stability approaching the absolute. This has for some time been available. The next is that the system of modulation used be capable of varying the amplitude of the carrier in faithful reproduction of the sounds occurring before the microphone. This has long been possible. The third is that the carrier be modulated as completely as possible without detracting from this essential fidelity or, in other words, without distortion. Recent modifications of the Heising sys-

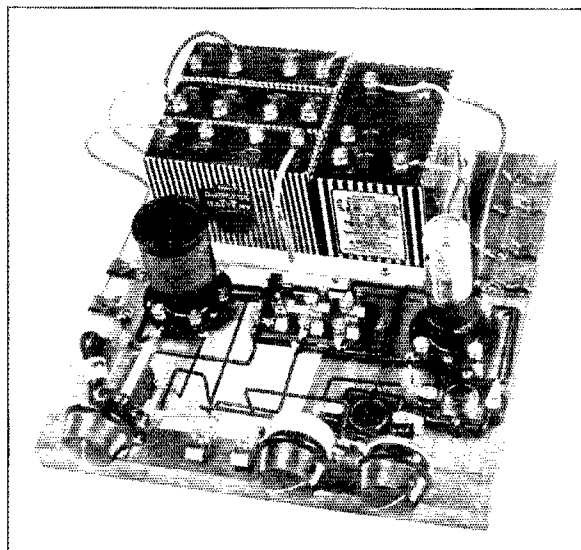

THE EXPERIMENTAL MODEL OF THE MODULOMETER

Everything is on the top of the breadboard with the exception of part of the battery wiring, which is underneath. The resistor, R_1 , is at the extreme left, partially hidden by the mutual variable condenser. The Fahnestock connectors immediately behind the resistor are for connection to the pick-up coil. The connectors at the front are for the d.c. voltmeter, while those at the right and extreme rear are for the audio-frequency input. The pair immediately in front of these connects to the plate milliammeter. The rest of the equipment is self-identifying.

that this treatment of the subject is as authoritative in this year of grace, 1929, as it was in 1921. With the why and wherefore of methods of

completely as possible without detracting from this essential fidelity or, in other words, without distortion. Recent modifications of the Heising sys-

tem permit this.¹ To achieve these three ideals, the transmitter must, fundamentally, be properly designed and constructed. The fundamentals of this design could be no more comprehensively covered than they have been in the phone article in the April, 1929, issue of *QST*, and the more the article is studied (not simply read) the more the above statement will be appreciated.

Following proper design and construction, proper adjustment, intelligently planned and logically accomplished, is next in order. The adjustment should start at the speech amplifier and continue through to the antenna circuit. Nothing can be taken for granted. Distortion may occur in any portion of the most scientifically designed and well constructed transmitter. Adjustments are largely inter-dependent and in eliminating distortion any attempt to check only the performance of the transmitter as a whole is unsatisfactory to the point of discouragement. The proper procedure in adjustment is the checking of each unit independently and in ordered sequence: The microphone circuit; the speech amplifier; the modulator, and finally the radio-frequency portion of the transmitter.

In the c.w. transmitter a check on the radio-frequency portion only is necessary, and for this we make use of the monitor.² This check is also necessary—in fact, more necessary—in the case of the phone transmitter; but it in itself is inadequate. The monitor can only check the frequency stability of the carrier and very approximately indicate the quality of transmission. For checking the degree or percentage of modulation it is almost useless; for, to the ear is delegated the actual measurement and, while the ear may be a fair judge of quality, it is a consummate liar in the measurement of quantity. It is at this point that we catch a glimmer of light, dawning to a full glow of realization and finally illuminating with startling clarity one great reason for the comparatively slight advance in amateur radiotelephone development. We have been feeling our way in the dark, estimating progress by means of approximate aural measurements, while the rest of the radio world has rushed ahead with the guidance of accurate, absolute, visible measurement of performance.

The eye is infinitely more sensitive to variations in quantity and quality than the ear. If, therefore, visible measurements indicate good "looking" performance, good "sounding" performance is assured. In the development of their radio-telephone transmitting equipment, commercial interests have long had available the relatively expensive oscillograph for making such visible checks on performance and their success in transmitter

development has clearly indicated the value of this type of measurement. Up to the present time the untold advantage of such measurement has been denied the amateur. It is for this reason that the modulometer is presented.

Right here, with curiosity aroused and objections taking form, assurance is given that meas-

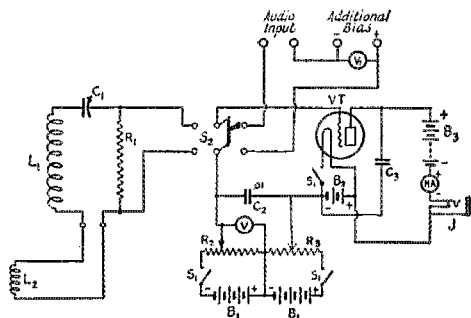

FIG. 1. — THE MODULOMETER CIRCUIT

- L₁ — For 3500 kc, use 40 turns of No. 28 d.c.c. wire on a Silver-Marshall plug-in coil form. The same number of turns wound in a 2-inch diameter "hank" would serve as well.
- L₂ — Pick-up coil. 2 or 3 turns of lamp cord, any size convenient.
- C₁ — 100- μ fd. Pilot midget variable condenser. Any variable will do.
- C₂ — 01- μ fd. Pilot fixed condenser. Any fixed condenser of this size or larger will be satisfactory.
- C₃ — 1000- μ fd. Pilot fixed condenser.
- R₁ — 1500-ohm Ward-Leonard resistor No. 507-55. Any good "non-inductive" resistor of 1500 or 1000 ohms might be used.
- R₂ — 200-ohm wire-wound potentiometer.
- R₃ — 2000-ohm potentiometer.
- B₁ — 4.5 volt "C" batteries.
- B₂ — 2 dry cells in series (5 volts).
- B₃ — Small size 22.5-volt "B" battery.
- S₁ — Triple-pole single-throw switch, any type.
- S₂ — Double-pole double-throw battery type switch.
- V — See text.
- VT — See text.
- MA — Weston Model 275 Student Type Galvanometer.
- Other instruments will serve as well. See text.
- J — Closed circuit phone jack.
- VT — UX-199 tube.

urements with the modulometer are simple and easy. The device is comparatively cheap. The accuracy of the results is many times that obtained by guessing methods and the deal of satisfaction that comes of a job well done is infinite repayment for the slight expense, little time and few pains required in the realization of the best adjustment of a potentially good phone transmitter.

WHAT IT IS — WHAT IT DOES

The modulometer (so named in the interest of providing a convenient handle and to make a long story short) is nothing more than an old friend, the peak vacuum-tube voltmeter in a new combination rôle.³ There is no other instru-

¹ The recently developed method of realizing 100 percent undistorted modulation is described in detail in the article, "Modern Practice In High-Frequency Radiotelephony," appearing in the April, 1929, issue of *QST*.
² *QST*, October, 1928, page 17.

³ "The Use Of The Electron Tube Peak Voltmeter For The Measurement Of Modulation," by C. B. Jolliffe, *Proceedings of the Institute of Radio Engineers*, April, 1929; "Thermionic Vacuum Tube," by H. J. Van Der Bijl, page 367.

ment or device more valuable, more widely applicable, more simple and cheap in construction — and less used by the radio amateur, than the vacuum-tube peak voltmeter. It requires no expensive standard or elaborate equipment for its calibration because it is self-calibrated. It requires no deep knowledge of vacuum tube characteristics or mathematics for its construction and operation. Anyone capable of reading a common direct-current voltmeter, twisting a potentiometer knob and having the most utterly fundamental conception of what he is trying to measure is fully capable of using it to complete advantage. Any amateur who may insist that so simple an instrument as the peak voltmeter is “too compli-

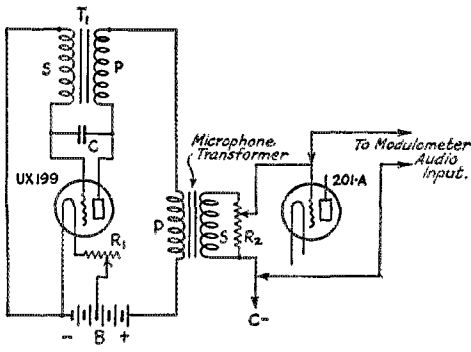

FIG. 2. — THE SIGNAL GENERATOR

T_1 — Old audio-frequency transformer. Some “perk” better than others. The ones poorest as amplifying transformers are usually best as oscillators. Try reversing connections to windings.

C — Fixed condenser, between 100 and 5000 μfd . Not always necessary. Try various sizes until oscillator delivers a signal of desired pitch.

B — 4.5-volt “C” battery or 3 dry cells in series. Filament tapped off 3 volts.

R_1 — 20-ohm filament rheostat. Controls pitch to some extent.

R_2 — Gain control of speech amplifier.

ated” or “too high-hat” has no right to a station or operator’s license. In fact, he is not a true amateur in any sense of the word.

The principle of the vacuum-tube voltmeter is the simple principle of the vacuum tube itself. The negative bias is first adjusted until the plate current, as indicated by a milliammeter in the plate circuit, is at zero or a predetermined point just above zero which point is known as the “false zero.” An alternating voltage, the value of which is desired, is then applied to the grid circuit of the tube. The tube acts as a rectifier or detector and, the grid becoming less negative, the plate current increases. Additional negative grid bias is then applied until the plate current is reduced to the same value as that before the alternating input voltage was applied. This additional bias cancels out the effect of the alternating voltage in causing an increase in plate current and the value of the

additional negative grid bias required to balance out the alternating voltage is the peak value of the alternating voltage which is being measured. That’s all there is to it. What is actually measured is the additional grid bias required to “wash out” the a.c. voltage and it is measured with an ordinary d.c. voltmeter. The accuracy is dependent largely on the ability of the operator as a meter reader and upon the accuracy of the d.c. voltmeter.¹

The photograph graphically illustrates the utter simplicity of the modulometer. Throwing the double-pole, double-throw switch to the left gives the proper connection for measuring percentage of modulation, checking neutralization of r.f. amplifiers or making other radio-frequency measurements the ingenuity of the experimenter may suggest. Throwing this same switch to the right permits the ready measurement of audio-frequency signal voltage on the grids of speech amplifier and modulator tubes, the detection of the undesired presence of radio-frequency current in audio circuits, the ferreting out of unwanted audio-frequency feed-back from modulator to speech amplifier, the measurement of the actual voltage gain from the secondary of the modulation transformer to the modulator grid and, finally, the checking of the overall performance of the transmitter from the input of the speech amplifier to the antenna circuit. If it is desired, it is entirely possible to plot a curve from the data so secured showing graphically the proper or improper performance of the transmitter as a whole. In addition, a head-set may be connected in the plate circuit of the modulometer by means of a jack provided for the purpose and the device be made serve as an excellent listening monitor for checking the quality of either the audio system output or the r.f. output of the transmitter. As a matter of fact, the head-set may be used in place of the plate meter as an indicator in making some approximate aural measurements, as will be explained later.

DESIGN AND CONSTRUCTION OF THE MODULOMETER

The experimental model of the modulometer is shown in its photograph and the circuit diagram in Fig. 1. The plate circuit milliammeter, direct-current voltmeter, triple-pole, single-throw battery

¹ When the “false zero” system of measurement is used, a slight error in absolute measurement is introduced since the grid becomes slightly more negative on the negative portion of the alternating voltage cycle. This results in the measured voltage being slightly less than the actual voltage. The practical error will, however, be less than if the true zero were used since, due to the very gradual slope of the grid voltage-plate current characteristic as it approaches zero plate current, it is possible to bring the milliammeter pointer more exactly on a scale division slightly above zero than on true zero. If the false zero is chosen very near in value to true zero the accuracy is sufficiently high for practical purposes on all but very small input values. When the final results are in the form of ratios, as they usually are, the error is practically eliminated. A method of applying a correction when extreme accuracy is required will be found on page 369 of Van Der Bijl’s “Thermionic Vacuum Tube.”

switch and phone jack are shown in the circuit diagram but do not appear in the photograph. The milliammeter may be any good standard type requiring not more than 1.5 milliamperes for full-scale deflection. It would be preferable to have a meter requiring 200 or 500 microamperes for full-scale deflection, since the accuracy of the true zero or false zero setting will be in proportion to the sensitivity of the meter. It is not necessary that this meter should have a scale calibrated in units of current as only the true or false zero point is ever used. For this reason a galvanometer, such as the Weston Model 375 student type, requiring 22 microamperes per division (660 microamperes full scale for 30 scale divisions) will be entirely satisfactory. The voltmeter may be of the double range "B" substitute type, the low scale (0-7.5 volts) being used for peak-voltage measurements up to 6 or 7 volts and the 150-volt scale for higher readings. Any good d.c. meter available will fill the bill, however, provided it has a range not too great to allow accurate readings. As will be seen later, most of the readings will be in the range between zero and 5 volts.

The battery switch may be of any type handy, and should most certainly be incorporated. It is readily seen that it is not only essential to switch off the filament when the modulator is not in use but also necessary to open the bias battery circuits on both sides. Otherwise the bias batteries will drain continuously through the potentiometers. If portability is desired, the whole thing might be built in a carrying case similar to those used for tube and receiver test sets. Potentiometers, tube, switches, etc. could be mounted on a panel with the batteries inside the case. Many modifications to meet the requirements of the service desired will readily suggest themselves. Details of the assembly are quite completely covered in the photograph and diagram with its accompanying list of parts, and no further explanation of the construction should be necessary.

OPERATION — AUDIO FREQUENCY MEASUREMENTS

In making measurements of both audio- and radio-frequency performance of the transmitter, it is essential that a signal source capable of delivering an alternating voltage output of practically constant intensity and pitch be provided.

While it is possible to realize such a signal mechanically or acoustically by means of a buzzer, electric bell, musical instrument or even by vocally sounding a prolonged "ah-h-h" before the microphone, the use of electrical input, direct from a suitable signal generator to the speech amplifier, is far more satisfactory.

There are a number of such devices readily available and the simplest, cheapest and most generally satisfactory is the vacuum-tube audio-frequency oscillator. The parts required will be

found in almost every station junk box and the assembly takes but a few minutes. The circuit diagram and a satisfactory method of connection to the speech amplifier are shown in Fig. 2. If

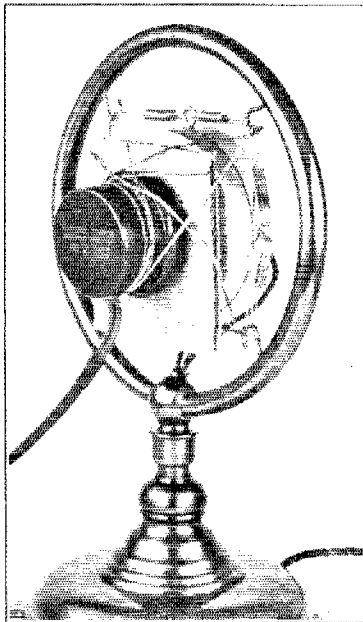

A SUGGESTED METHOD FOR CONSTANT AMPLITUDE SOUND INPUT TO THE MICROPHONE

The Baldwin phone, connected in the output circuit of an audio-frequency generator, is held in place by means of rubber bands. A thick piece of card-board with a hole in its center serves as a baffle between the receiver and E. F. Johnson's double-button microphone.

desired, the arrangement shown in one of the photographs may be used, the headphones being connected in place of the microphone-transformer primary in the plate circuit of the audio oscillator. The latter arrangement permits the use of "sound" input to the microphone itself, and is valuable if it should be considered desirable to as nearly as possible simulate actual operating conditions.

If a single stage of speech amplification is used, the modulator input terminals designated as "audio input" should be connected to the grid circuit of the speech-amplifier tube as shown in Fig. 2. If two stages of speech amplification are used, it will be advisable to connect to the grid circuit of the second stage. In any case, connection should be made to a grid circuit in the amplifier where signal voltages of as high as 5 volts may be obtained under normal operating conditions. This maximum value should be attainable on the grid of the speech amplifier tube immediately preceding the modulator when the latter is a UX-250 and the speech amplifier tube is a 201-A. Otherwise, it will not be possible to

realize the full permissible grid voltage swing required on the input to the modulator tube to attain full modulator power output. This is an important point and merits a little more detailed consideration.

A single stage of transformer-coupled audio-frequency amplification using a 201-A tube may be expected to give a voltage gain of 18 or 20. The UX-250 modulator requires a maximum grid swing of 90 volts for maximum output in its plate circuit when it is operated at a plate voltage of 500 and a grid bias of 90 volts. It will therefore be necessary to have available signal voltages as high as 4 or 5 volts on the grid of the speech amplifier tube, as this voltage multiplied by the

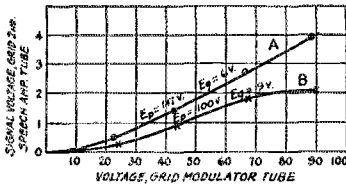

FIG. 3. — TYPICAL INPUT SIGNAL-GAIN CURVES OF SPEECH AMPLIFIER

Curve A with proper ratio of grid bias to plate voltage.
Curve B with improper bias for plate voltage used.

gain of the amplifier (18×5) is the modulator input voltage. When using the standard single-button microphone, voltages of the above value may be realized with a single stage of amplification. When using a microphone of the double-button type, however, additional amplification is required. In the experiments conducted in conjunction with the modulometer, an E. F. Johnson double-button microphone was used and two stages of 201-A transformer-coupled speech amplification, having a measured over-all gain of 800 (40 in the first stage, utilizing a Silver-Marshall type 255 "transformer") were used and found entirely adequate. Microphones of lower sensitivity will, of course, require additional amplification. The signal voltage must be controllable and for this reason the gain control shown in Fig. 2 should most certainly be provided.

With the modulometer completed and in working order, it is advisable to spend a little time in getting used to its operation before starting actual measurements on the transmitter. Since it has been found advisable to always work from a predetermined value of signal voltage at some point, such as the grid circuit of a tube in the speech amplifier, the procedure most satisfactory will be as follows: Connect the audio-frequency input terminals of the modulometer to the grid circuit of the speech-amplifier stage immediately preceding the modulator. Connection should be made as shown in Fig. 2, and not directly between the grid and filament of the speech-amplifier tube. If the latter should be done, it is obvious that the "C" battery voltage of the speech amplifier

would be applied between the grid and filament of the modulator tube and cause inaccurate measurements. Throw the d.p.d.t. switch to the right. Turn the modulometer and speech amplifier on but do not start the transmitter or modulator. With the gain control of the speech amplifier turned to the full "off" position and potentiometer, R_2 , so set that the voltmeter, V , reads zero, adjust R_3 until the pointer of the plate milliammeter, MA , is brought to the scale division next above zero. This is the false zero setting and should be the same throughout a run. Now adjust R_2 until the voltmeter, V , indicates some desired value of signal voltage, say 1 volt. The plate milliammeter indicator will move from the false zero setting towards true zero. Turn the gain control of the speech amplifier up (with the audio oscillator running) until the signal applied to the grid circuit of the speech amplifier tube just brings the pointer of MA up to the false zero setting. A signal of 1 volt, peak value, is now being applied to the grid circuit of the speech amplifier tube.

In operation of the transmitter, signal input from the microphone only is desired. In addition to this, however, many amateur transmitters are afflicted with audio-frequency feed-back from the modulator circuit and sometimes radio-frequency feed-back from the transmitter itself to the modulator and speech amplifier. Either of these conditions is likely to cause distortion in the best of speech amplifier systems, and before going further a still hunt for audio- and radio-frequency feed-back will be found well worth while.

AUDIO- AND RADIO-FREQUENCY FEED-BACK

In checking for audio-frequency feed-back, the procedure outlined above is followed with the modulator switched off. After obtaining the desired signal voltage on the speech amplifier grid, the modulator is turned on with the oscillator of the transmitter still off. If, when the modulator is switched on, it should be found necessary to further increase the voltage indicated by V to bring MA back to the false zero setting, audio-frequency feed-back is clearly indicated and its elimination will be necessary before proceeding. Grounding of the modulator choke case as well as the cases of the audio transformers in the speech amplifier will be found helpful. One terminal of the primary of the microphone transformer should also be grounded; this should be the center terminal if a two-button microphone is employed. If these efforts fail to entirely eliminate the audio-frequency feed-back, it will be necessary to further isolate the speech amplifier from the modulator apparatus by moving the two apart.

After getting rid of audio-frequency feed-back, radio-frequency feed-back should next be attacked. With the modulator and speech amplifier running and a known value of signal voltage applied to the grid circuit of the speech amplifier

tube, start the oscillator. If the plate current as indicated by MA of the modulator should increase and an increase of negative bias as indicated by V be found necessary to return to the false zero setting, radio-frequency feed-back to the speech amplifier is undoubtedly present. Isolation of the speech amplifier from the r.f. portion of the transmitter will be found most effective, the whole audio system including the modulator being removed fifteen or twenty feet if necessary. If a common plate or filament supply is used for the whole transmitter, radio-frequency chokes in the leads to the speech amplifier and modulator may be necessary. In any case, feedback should be reduced to the point where little or no apparent increase in signal voltage is indicated when the oscillator is switched on.

The presence of radio frequency in the modulator grid circuit should also be checked, as it may be found there when there is no indication of it in the speech amplifier circuit. The same general procedure outlined above is followed, with the exception that additional bias (say 67.5 volts) should be connected at the point marked "additional bias" on the diagram in Fig. 1. The total signal voltage in this case will be this additional bias plus that indicated by the voltmeter, V, since the two are in series with respect to the grid of the modulator tube. R.f. feed-back to the modulator grid circuit can best be eliminated by connecting r.f. chokes in the plate supply leads to the modulator and, if necessary, in the modulator grid lead.

MEASURING THE GAIN OF THE SPEECH AMPLIFIER

The speech amplifier should be capable of delivering to the modulator grid a signal of sufficient voltage amplitude to give full modulator output *without overloading the microphone or speech amplifier*. In other words, it should be possible to secure full output from the modulator without having to shout into the microphone and without distortion in the speech amplifier. The single-button microphone is designed to give distortionless output only when spoken into at normal voice intensity. The diaphragm should not move over about .001 inch. Operating under these conditions, a signal voltage of about 3 or 4 volts may be realized across the secondary of the microphone transformer on the peaks, and a voltage of 60 to 80 may be expected at the grid of the modulator tube when using a single stage of transformer-coupled speech amplification.

When using a double-button microphone, a peak signal voltage of about 0.1 or 0.2 volt is realized at the grid of the first speech amplifier tube with normal speech input and 80 volts or more at the grid of the modulator tube. The speech amplifier should give a gain of about 800. In order to check the gain of the speech amplifier and to assure the realization of full grid swing at the modulator without distortion, measurement

of the voltage gain from the secondary of the microphone transformer to the grid of the modulator tube should be made.

Assuming that a single-button microphone and one stage of amplification are being used, the modulator audio input terminals should be connected to the grid circuit of the modulator.

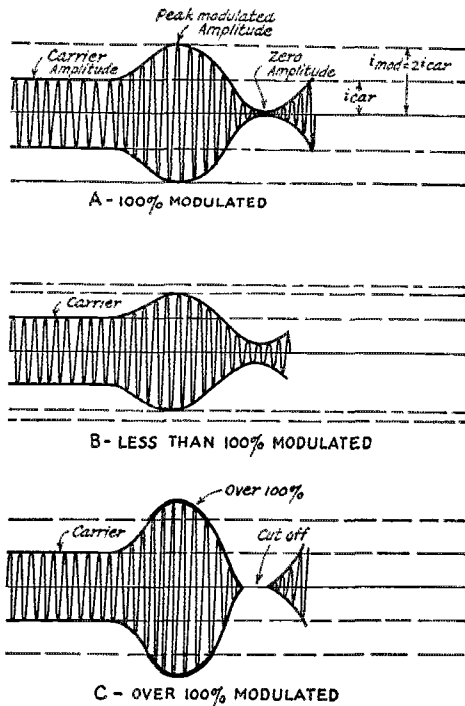

FIG. 4. — THE WAY THE MODULATED CARRIER WOULD LOOK

A — Modulated 100 per cent. The amplitude varies between zero and twice the unmodulated carrier amplitude.

B — Modulated less than 100 per cent. The amplitude never reaches zero or twice the unmodulated carrier amplitude.

C — Modulated over 100 per cent. The amplitude varies between zero and more than twice the unmodulated carrier amplitude. This gives a distorted wave form, resulting in poor quality and serious interference.

By means of the previously described method, adjustment should be made for a signal voltage of, say, 80 volts. The voltage should then be measured at the speech amplifier input. The ratio of these two voltages indicates the gain of the amplifier. If desired, various values of signal voltage may be measured and a curve such as that shown in Fig. 3 plotted. If the curve is not a straight line over all but its extreme lower portion, distortion in the amplifier is indicated and a check should be made on the plate, filament and grid voltages as well as on the tubes. Such a condition, due to improper grid bias for the plate voltage used, is indicated by the lower curve of Fig. 3. The upper curve indicates proper con-

stants for distortionless amplification over a wide range of signal voltages at constant frequency. If the pitch of the signal obtainable from the oscillator can be varied, a second run may be made with a constant value of signal input voltage and various signal frequencies. If, however, the coupling devices are of good quality it will not be necessary to make such a test on a system intended to operate at speech frequencies only.

MEASURING PERCENTAGE OF MODULATION

In the final analysis, the effectiveness of a phone transmitter of given carrier power output depends more upon the degree of undistorted

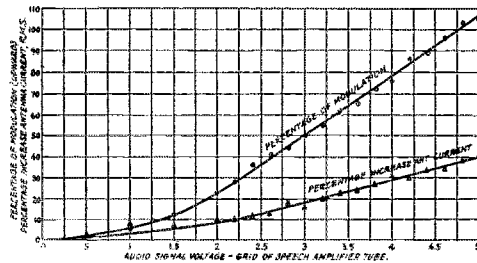

FIG. 5.— TYPICAL PERFORMANCE CURVES OF THE TRANSMITTER

modulation than on any other one of the three essentials which have been mentioned. The degree of modulation is more specifically important in the case of the low-powered amateur transmitter than in the case of a higher-powered transmitter. A transmitter having a 10-watt carrier modulated 80 per cent has the same effective range as one with a 40-watt carrier modulated 40 per cent. In addition to this, the 40-watt transmitter would have twice the interference range, since the carrier would be twice as strong. This will be more readily understood upon an analysis of the graphical representation of modulated antenna current as shown in Fig. 4. The degree of modulation is expressed in terms of antenna current amplitudes only. The percentage of modulation is defined as the ratio of one half the variation in antenna current amplitude to the unmodulated carrier amplitude, multiplied by 100.¹ Since the modulated antenna current amplitude varies above and below the unmodulated carrier amplitude to an equal degree when modulated sinusoidally, the percentage of modulation may be expressed by

$$\text{Percentage of modulation} = \frac{i_{\text{mod}} - i_{\text{car}}}{i_{\text{car}}} \times 100$$

¹I. R. E. Definition: "Percentage Modulation—The ratio of half the difference between the maximum and minimum amplitudes of a modulated wave to the average amplitude, expressed in percent." With sinusoidal modulation carrier and average amplitudes are identical.

Where: i_{mod} = peak modulated antenna current.
 i_{car} = peak unmodulated antenna or carrier current.

It is therefore only necessary to have some means of measuring the peak modulated antenna current value and the peak unmodulated carrier current value and substitute in the above equation. The modulometer provides the means of measuring these values.²

Referring again to Fig. 1, a current flowing through the circuit L_2, L_1, C_1, R_1 will cause a voltage drop, directly proportional to the value of the current, across R_1 . Ratios of voltage drops measured across R_1 will therefore be the same as the ratios of the currents causing these voltage drops. If the pick-up coil, L_2 , is coupled loosely to the antenna circuit of the transmitter the current through this coil and its associated circuit will be directly proportional to the current in the antenna.

In making a measurement of the percentage of modulation, the d.p.d.t. switch of the modulometer is thrown to the left, thereby placing the resistor, R_1 , across the grid circuit of the tube. The usual false zero setting is obtained and the oscillator of the transmitter switched on, no modulation being yet applied. The potentiometer, R_2 , is adjusted so that the voltmeter, V , indicates about 1 volt. The pick-up coil L_2 is coupled to the antenna circuit and the coupling varied until the current through it and its associated circuit is such as to cause a voltage drop across R_1 just sufficient to bring the plate milliammeter reading to the false zero value. The drop across the resistor is now 1 volt and is proportional to the current through the resistor. This value, 1, can therefore be tabulated as i_{car} . Modulation is now applied and the voltage drop across R_1 again measured. Suppose it is now found to be 1.5 volts. This value may be tabulated as i_{mod} . Substituting in the equation, the percentage of modulation is found to be 50 per cent.

By taking various values of input signal voltage and making measurement of percentage of modulation for each, a curve such as that shown in Fig. 5 can be plotted. This curve should be a straight line over the upper portion. If it is not, and droops before reaching 100 per cent modulation, it clearly indicates that the transmitter as it is adjusted is not capable of this degree of modulation without distortion, and it should either be operated below the point where distortion is introduced or so modified as to make it capable of a higher percentage of distortionless modulation.

The lower curve of Fig. 5 indicates the percentage increase in antenna current as indicated

²The accuracy of measurement is approximately 5 per cent. The formula holds good only as long as i_{mod} does not exceed $2i_{\text{car}}$. This is obvious from the definition of percentage of modulation. When i_{mod} exceeds $2i_{\text{car}}$, $\frac{1}{2}i_{\text{mod}}$ should be substituted for $i_{\text{mod}} - i_{\text{car}}$ in the equation.

by the antenna ammeter for various signal input voltages. It is notable that the increase due to modulation is about 37.5 per cent at 100 per cent modulation. This figure has been found to hold quite consistently in a number of runs which have been made on the transmitter described in the April, 1929, issue of *QST*, and on this transmitter, at least, this percentage increase in antenna ammeter indication is taken as an approximate indication of 100 per cent modulation.

Since the modulometer indicates upward modulation only, indications of modulation in excess of 100 per cent are obtainable. Upward modulation above 100 per cent is obtainable with the above mentioned transmitter with sufficiently high values of input signal voltage, but with such excessive modulation the distortion is terrific and the interference created is not to be tolerated.

While on the subject of interference, attention is called to the fact that when making a run to obtain sufficient data on a transmitter to permit plotting such curves as those shown in Fig. 5, considerable interference will be caused if the run is made with the transmitter connected to the regular antenna system. It is therefore recommended that a dummy antenna such as that shown in Fig. 6 be substituted. The value of the resistance should be such as to make the unmodulated antenna current as indicated by the antenna ammeter the same as that when the regular antenna is used. It is a good policy to make use of such a dummy antenna on any transmitter when making such tests as do not require actual transmission of the signals. By so doing, much needless interference in our crowded bands is eliminated.

After obtaining complete data on the transmitter with an "artificial" signal source, the next step is to secure the best adjustment with vocal input through the microphone circuit. The microphone is connected in place of the signal generator. The gain control is turned to the "off" position and the modulometer put into action. Remembering that the greater proportion of vocal energy is contained in the vowel sounds (a, e, i, o and u), it is best to set the gain control so that about 80 per cent modulation is obtained when making such a sound before the microphone at normal speaking intensity.¹ Consulting the performance curve of the transmitter, Fig. 5 in this case, it is seen that at 80 per cent modulation the signal voltage on the grid of the speech amplifier tube is .4. Throw the modulometer switch to the right, obtain the false zero setting and then adjust R_2 so that the voltmeter, V , indicates

4 volts. Now sound a prolonged "ohhhh" before the microphone at normal and constant voice intensity. At the same time slowly turn the gain control up until the modulometer plate milliammeter indicates false zero. The percentage of modulation will now approximate 80 on the vowel sounds and leave a margin of 20 per cent for peaks of greater intensity which may occur. In connection with speaking before the microphone, it is recommended that "talking across" the microphone be practiced rather than speaking directly into it. This will eliminate much of the "hissy" effect caused by the breath striking the diaphragm and also tend to make the general response of the microphone to the sounds occurring before it more faithful.

With an assistant talking into the microphone an approximate check on the peak percentage of

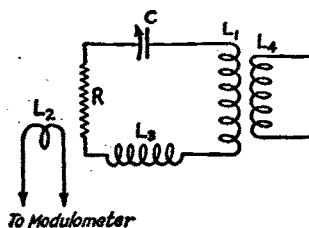

FIG. 6. — THE DUMMY ANTENNA

- L_1 — Usual antenna inductance.
- L_2 — Modulometer pick-up coil.
- L_3 — Loading inductance. 10 turns of antenna wire on a 5-inch form.
- L_4 — Plate inductance of transmitter.
- C — Usual antenna condenser.
- R — 3 or 4 100-watt, 110-volt, electric light bulbs in parallel. A 550-watt heater element would serve practically as well.

modulation occurring may be obtained in the following manner: With the modulometer switch to the left, adjust the milliammeter indication as nearly as possible to true zero. Measure the voltage due to the unmodulated carrier in the usual manner. With the headset plugged into the modulometer jack, listen to the signal while increasing the negative bias by means of adjusting the potentiometer, R_2 , until the last "peaks" of undistorted or clear speech just disappear. After a little practice, the point at which this occurs can be detected with surprising accuracy; more accurately, in fact, than it is indicated by "kicks" of the milliammeter pointer. The voltmeter is now read for v_{mod} and substitution made in the equation.

OTHER USES OF THE MODULOMETER

The modulometer may be used to advantage in neutralizing r.f. amplifier stages in the transmitter. The pick-up coil is loosely coupled to the plate inductance of the stage being neutralized, the plate voltage of this stage being turned off but the filament lighted and excitation applied

(Continued on page 84)

¹ "The energy in speech is carried almost completely by frequencies below 500 —" Page 573, "Principles of Radio Communication," (Second Revised Edition) by John H. Morecroft. The vowel sounds are for the most part within this range.



The President's Corner

A WORD FROM HIRAM PERCY MAXIM

PRESIDENT OF THE AMERICAN RADIO RELAY LEAGUE AND
OF THE INTERNATIONAL AMATEUR RADIO UNION

Bucking

SOME of us always buck every change. We come by it honestly enough, for some of our forefathers bucked good and plenty over the steam engine and the railroad. I am old enough to remember the bucking that followed the advent of the telephone, the bicycle and the electric street car. Probably many A.R.R.L. members recall the bucking that accompanied the introduction of the automobile. Half a dozen buckers threatened to shoot me in 1895 because I ran a "horseless carriage" around the streets.

Unfortunately for the buckler, he cannot prevent changing conditions and restrictions attendant upon progress. I used to drive my "horseless carriage" without registration numbers or operator's license. The streets and roads were as free as the air used to be for radio amateurs prior to 1912. But increased traffic changed all this. We had to get license number plates, we had to carry lights, we had to have mirrors and wind-shield wipers and operator's licenses. Lately we have had to obey red and green traffic signals and accept highly restricted parking privileges.

Bucks and howls galore always come over each of these added restrictions. Many of us were almost driven to do murder over the red and green traffic lights. A few of us still froth at the mouth over them. But they are necessary and justified and proper because they serve the public interest.

In radio the same old inexorable rule works in the same old inexorable way. In 1912, when traffic began to make trouble, amateurs had to get down off any old wave and limit themselves to 200 meters and below, a pure wave, a fair decrement, and limited power. We thought at the time we were done for, and how some of us did buck!

When congestion grew worse and hundreds of broadcasting stations and millions of the public added themselves to radio, amateurs had to be still further restricted. It was perfectly just and proper that they should be, since the public interest required it. But such bucking!

When the ultra-efficient high frequencies came into use, the problems of traffic control became international. A congress of delegates from most of the nations of the earth was called in 1927 to agree upon still further restrictions. The amateurs, together with the other interests, had to give ground again.

Of what avail is it to buck this sort of thing? Just about as much as it was for the red Indian to buck the white man when he came, or for those rebellious souls to buck the traffic lights.

So, fellow radio amateurs, don't be misled by the hooey that is dished up to us every so often by the well-intentioned but misguided buckler. He cannot stop the progress of the world. He cannot change the traffic lights and he cannot change the radio regulations that seventy-three nations laid down in 1927 after a month of the hardest kind of hard work.

The Amateur and the Naval Reserve

By R. H. G. Mathews*

"One of the important duties of the Navy, in time of peace, is to encourage the organization and training of a Naval Reserve. During the World War, naval radiomen increased from 979 on 31 January 1917 to 8700 about the time of the armistice, with a proportionate increase in officers. This rapid expansion was made possible by the amateur but, even so, lack of training was a handicap that made expansion slower than otherwise would have been the case. The Naval Communication Reserve is today voluntarily training itself to remedy any similar deficiency in the future. The regular service is assisting in this training in every practicable way." — CAPTAIN S. C. HOOPER, U. S. N., Director of Naval Communications.

IN reading over his valued back files of *QST* recently, the writer came across the issues of about twelve years ago. The dissimilarity between amateur radio as it existed in 1917 and as it is today was never more evident than in the difference between the lack of preparation as to radio operators for the Navy and the present

In a few short weeks it was necessary to do the work of years and the result was, as could have been expected, unsatisfactory at best.

Learning from this experience, the Navy Department has fostered the formation of a special class of the Naval Reserve, organized to consist entirely of, and officered entirely by, radiomen

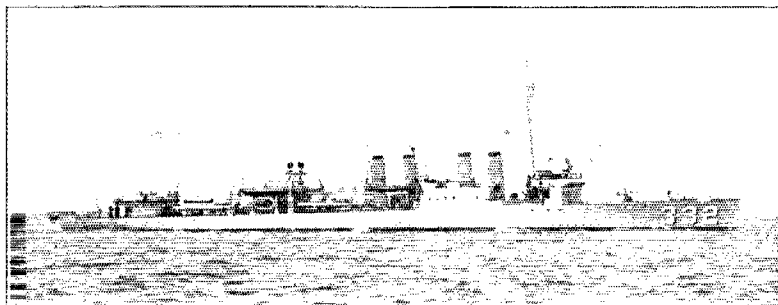

NAVAL RESERVE CRUISES ARE MADE IN THIS TYPE OF SHIP
This is the U.S.S. "Farenholt," a destroyer.

condition of a splendid organization of amateur radiomen, trained in naval operating and procedure, and capable of going on active duty at a moment's notice in case of emergency.

During those early days of our entry into the Great War it developed on the writer and several other officials of the American Radio Relay League in this part of the country to attempt to interest and enlist capable amateur radio operators in the Naval Reserve for active duty during the war. The Navy suddenly took over many ship and shore stations which theretofore had been commercially operated. The limited forces of the regular Navy were, of course, inadequate to meet this new need. The Naval Reserve was only in its early stages of organization and no such thing as a Communication Reserve existed.

taken from amateur and commercial operators' ranks. This organization has been made voluntary in every sense of the word, there being absolutely no obligation involved except that during war or other national emergency. Its purpose is to provide men with training which will fit them for actual naval operating duty without the necessity of continued attendance at a Naval Radio School.

This training is accomplished in several different ways. All men of Class V-3 (as this group is called) are provided with all available literature to be studied at their leisure. This literature consists of news bulletins, technical bulletins, the regular Navy Radio Operators' Training Course booklets, instruction in cryptanalysis, etc. The regular Department of Commerce amateur call book and supplements thereto are sent, without cost, to all men of the Reserve. This forms the "mail order" end of the training.

The Volunteer Communication Reserve is divided in the same manner as the regular Naval

* W9ZN, former Vice-President of A.R.R.L., Lieutenant-Commander, C-V(S), U.S.N.R., Volunteer Communication Reserve Commander, 9th Naval District, Great Lakes, Ill.

establishment into districts, these districts being as follows and comprising states as shown:

- 1st District — Maine, New Hampshire, Massachusetts.
 3rd District — Vermont, New York, Connecticut and northern part of New Jersey.
 4th District — Pennsylvania, Delaware and southern part of New Jersey.
 5th District — West Virginia, Maryland, Virginia, North Carolina.
 6th District — South Carolina, Georgia.
 7th District — Florida.
 8th District — Tennessee, Alabama, Mississippi, Louisiana, Arkansas, Oklahoma, Texas.
 9th District — North Dakota, South Dakota, Nebraska, Kansas, Missouri, Iowa, Minnesota, Wisconsin, Michigan, Ohio, Indiana, Kentucky, Illinois.
 11th District — Arizona, New Mexico.
 12th District — Nevada, California.
 13th District — Washington, Oregon, Idaho, Montana, Wyoming.
 14th District — Hawaiian Islands and islands to westward, including Midway.

Each district is administered by a Volunteer Communication Reserve Commander and the necessary assistants to carry on the work of the Reserve, under the direction of the Commandant of the District. The districts are subdivided into



A V-S MAN REPORTS FOR THE TWO-WEEKS' CRUISE

sections, these sections comprising one or more states, according to population, and each section being administered by an officer designated as Section Commander, who also has a staff of assistants as necessary to carry on his work. In each section there are an unlimited number of units, these units consisting of ten or more men of the Volunteer Communication Reserve residing close enough together to hold meetings.

Regular drill schedules are carried on nightly between the stations of the Volunteer Communication Reserve Commander of the district and his Section Commanders, and other schedules are maintained between the Section Commanders and the Commanders of the various units. The Unit Commanders in turn carry on radio sched-

ules with the men connected with their units. These drills consist of the handling of regular-form Navy traffic, both in English and in code, following the regular Navy tactical procedure. This procedure is strikingly different from ordinary amateur and commercial practice and is in itself extremely interesting. Stations of the Communication Reserve are supplied with a code approximating that of the regular service and much of this work is carried on using this code, giving the operators practice in coding and decoding messages.

In addition to these two means of training, men fortunate enough to reside in localities where a unit may be formed have further advantages. Active units of the Communication Reserve have been supplied, as far as possible, with various forms of Navy radio apparatus for instruction purposes. Classes of instruction are held weekly, which may be attended voluntarily by the officers and men of the unit. The instructors are supplied with the various publications of the Naval Radio Laboratory and other branches of the Navy, so that they may keep their men advised of the latest technical and other developments of the Navy.

Since the organization is yet in a growing stage, many officers are needed throughout the country. These will be chosen largely from the better-qualified amateurs and opportunities therefore exist for those who are ambitious to secure commissions in this class of the Reserve. The advantages of having a rating as a radio operator of the naval establishment cannot be over-emphasized. Should our country be involved in another war, there is no doubt that practically 100% of the amateur fraternity would serve again as they did in the last war. Naturally, service as a radio operator is infinitely preferable to a radioman than service in any other capacity.

Many of the leading officials of the American Radio Relay League have interested themselves in the Volunteer Communication Reserve and are enrolled as officers or enlisted men. Our President, Mr. Hiram Percy Maxim, and our Treasurer, Mr. A. A. Hebert, as well as several of the Directors of the League, hold commissions and are active in its administration.

The Volunteer Communication Reserve represents the turning over of Navy hopes and plans as to radio operation in war time to the amateur. It is up to the amateur to make good and to justify the many efforts which the Navy has made in his behalf during some of the times the amateur's status was endangered by other interests.

The Volunteer Communication Reserve in no way interferes with participation in the Army-Amateur Radio System. The purposes and plans of the two organizations are not the same and they do not conflict in any way.

It is the patriotic duty of every radio amateur to interest himself in some branch of the Govern-

ment's radio activity. The Volunteer Communication Naval Reserve presents an opportunity for patriotic service, combined with an opportunity on the part of the individual to learn something which will be of value to himself in a civilian capacity, and to do this without obligating himself to spend any given amount of time, except in case of a war or other national emergency.

Inquiries as to the details of the organization and information as to how you can participate can be secured from the Commandant of the Naval District in which you reside, as shown on the table in the first part of this article.¹

The amateur has always expressed a desire to do something more than send CQ and "chew the rag." The radio organization of the Communication Reserve presents an opportunity for you to use your station in an interesting way to handle important traffic along lines which cannot be

receiving apparatus. The signals are transmitted from the Bureau's station WWV, Washington, D. C. They can be heard and utilized by stations equipped for continuous-wave reception at distances up to about 1000 miles from the transmitting station.

The transmissions are by continuous-wave telegraphy. A complete frequency transmission includes a "general call" and "standard frequency" signal, and "announcements." The "general call" is given at the beginning of the 5-minute period and continues for about 2 minutes. This includes a statement of the frequency. The "standard frequency" signal is a series of very long dashes with the call WWV intervening. This signal continues for about 4 minutes. The "announcements" are on the same frequency as the "standard frequency" signal just transmitted and contain a statement of the frequency. An announcement of the next frequency to be transmitted is then given. There is then a 4-minute interval while the transmitting set is adjusted for the next frequency.

Information on how to receive and utilize the signals is given in Bureau of Standards Letter Circular No. 171 which may be obtained by applying to the Bureau of Standards, Washington, D. C. Even though only a few frequency points are received persons can obtain as complete a frequency meter calibration as desired by the method of generator harmonics, information on which is given in the circular letter. The schedule of standard frequency signals is as follows:

standard frequency signals is as follows:

Eastern Standard Time (P. M.)	Frequencies in Kilocycles					
	July 22	Aug. 20	Sept. 20	Oct. 21	Nov. 20	Dec. 20
10:00	1500	4000	550	1800	4000	550
10:12	1700	4400	600	1800	4400	600
10:24	2000	4800	700	2000	4800	700
10:36	2300	5200	800	2400	5200	800
10:48	2700	5800	1000	2800	5800	1000
11:00	3100	6400	1200	3200	6400	1200
11:12	3500	7000	1400	3600	7000	1400
11:24	4000	7600	1500	4000	7600	1500

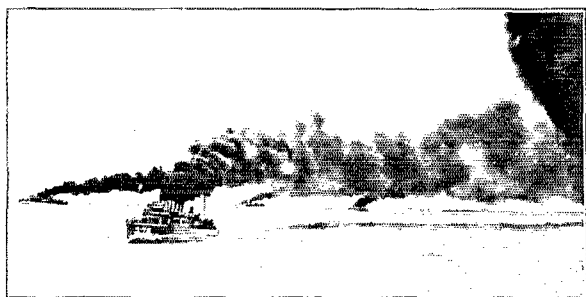

DESTROYERS STARTING A SMOKE-SCREEN
The smoke has not yet settled on the water.

found in ordinary amateur work. The Communication Reserve is growing by leaps and bounds. Its only limitation has been the fact that the majority of the amateur fraternity did not know of it or did not understand it.

It is sincerely hoped that this article may serve to further explain it.

The writer will be more than glad to hear personally from anyone who desires further information and prefers to get it from an amateur, rather than from an official source.

Standard Frequency Transmissions of WWV

THE Bureau of Standards announces a new schedule of radio transmissions of standard frequencies for use by the public in calibrating frequency standards and transmitting and

¹ Addresses of the Commandants, by districts: (1) U. S. Navy Yard, Boston; (3) South & Whitehall Sts., New York; (4) U. S. Navy Yard, Philadelphia; (5) Naval Operating Base, Hampton Roads, Va.; (6) U. S. Navy Yard, Charleston, S. C.; (7) U. S. Naval Station, Key West, Fla.; (8) U. S. Naval Station, New Orleans; (9) U. S. Naval Training Station, Great Lakes, Ill.; (11) Naval Base, San Diego, Calif.; (12) 100 Harrison St., San Francisco; (13) Pier No. 1, Seattle; (14) Naval Operating Base, Pearl Harbor, T. H. — Editor.

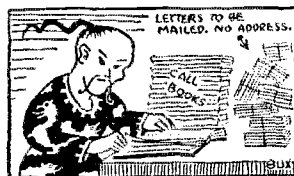

☞ THE CHINESE PUZZLE EXPERT ☞
THE MYTHICAL MEMBER OF THE HEADQUARTERS STAFF WHO LOOKS UP ALL THE HAM'S ADDRESSES WHO WRITE OR TELEGRAPH OR RADIO IN SIGNING ONLY THEIR CALL LETTERS

Bear-Cat, Model 3B

A Three-Band Tuner for the Busy Amateur

By A. W. McAuly*

WHEN K. B. Warner described his test of the four-tube receiver at the heading of the article on receivers in the November, 1928, issue of *QST*, he called it a "bear-cat." The name stuck and to dozens of hams, in Pennsylvania at least, the name "bear-cat" is synonymous with the four-tube model employing the screen-grid antenna-coupling tube and the screen-grid, peaked audio-frequency amplifier. It is just about the best amateur receiver we have ever had and many of them are being built. The one to be described in this article could well be called "Bear-Cat, Model 3B" in view of the fact that it is a three-band affair.

It was designed to cover the three most popular bands, 3500, 7000 and 14,000 kc. without the necessity of changing coils or condensers while at the same time spreading each band over the tuning dial by the desired amount. In order to do this, the three tuning condensers are ganged and operated simultaneously from a single dial. Each of the three grid coils is connected permanently to its own condenser and detector socket, each socket being fitted with its own grid condenser and grid leak.

The plate connection for each socket goes to the tickler coil corresponding to the particular frequency band for which the socket is used and the opposite end of each tickler coil is connected

responding to the band desired, and when this is done, the proper coils and condensers are connected in the circuit.

Coupling from the r.f. stage to the proper secondary circuit is made by means of a single-pole triple-throw switch, which throws the screen-grid coupling tube plate lead to the cou-

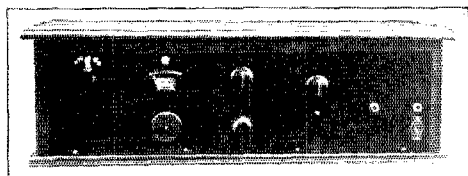

THE EXTERNAL APPEARANCE IS VERY MUCH THAT OF THE BROADCAST RECEIVER ORIGINALLY HOUSED IN THE CABINET

The switch in the upper left-hand corner determines which detector will be supplied with the output of the r. f. stage.

pling coil of the desired circuit. The switch must not be located too near the tuning dial or hand capacity will be troublesome. It would be better to locate the switching arrangement behind the shield, possibly extending a bakelite rod through the panel.

Magnetic coupling is used making three windings for each band; namely, coupling or primary coil, grid coil and tickler. These three coils are wound on a piece of small tubing, three such pieces of tubing being used.

It was found that when the number of turns in the coupling coil approached that of its corresponding grid coil best results were obtained. This adjusts the impedance of the coupling-tube plate circuit to the best value and when this is done the transfer of energy seems to be just as good as when tuned impedance coupling is employed.

Adjustment of the coupling affects regeneration in much the same manner as coupling an antenna to the grid coil by magnetic coupling. When a coupling coil of the proper high impedance is used, close coupling will stop oscillation. Adding turns to the coupling coil will throw the dead spot in one direction on the dial, removing turns will throw it in the opposite direction. It may be run off the scale in either direction or placed in the center and the coupling loosened

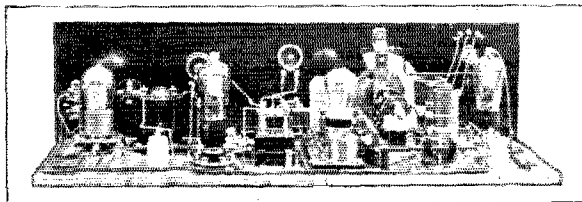

A REAR VIEW OF THE SET

The choke for the peaked audio amplifier may be seen between the two tubes at the left. It has been mounted in a piece of bakelite tubing and occupies part of an old R.C.A. r.f. transformer case at the end carrying the terminals.

to a common lead running to the primary of the single audio amplifying transformer and to the by-pass condenser, thus allowing a single variable resistor to provide regeneration control for the detector, regardless of which socket it occupies. The detector tube is placed in the socket cor-

* WSCEO, 309 Third Street, Oakmont, Penn.

enough to give smooth regeneration control. There is no detrimental effect of having the cold end of the coupling coils connected together and the receiver works every bit as well as though single coils and condensers were used.

The coils are wound on thin bakelite tubing in solenoid fashion. Corks of the proper size were glued to the baseboard and the bakelite tubing forced down upon them. The grid coils and their condensers were designed to cover each of the three bands with a little to spare so that a few marker stations could be reached for an occasional check on the scale setting.

It was found desirable to employ a larger diameter tube for the 3500-ke. coil than for the other two which are one and a quarter inches in diameter. The 3500-ke. coil form is one and five eighths inches in diameter. All coils are close wound and of a single layer. The spacing between the grid and primary or coupling coil is three eighths of an inch and one eighth of an inch is allowed between the grid and tickler coils. The number of turns in the coils, number of plates in the tuning condensers and the number of divisions of dial rotation to cover the particular band are given in the following table:

Band	Number of Turns Primary	Number of Turns Grid	Number of Turns Tickler	Tuning Condenser	Dial Spread
3,500	29	29	5	9 plates	37°
7,000	20	19	5	5 plates	21°
14,000	12	8	5	3 plates	24°

All windings are of No. 27 s.c.c. wire. By reducing the number of plates in the tuning condenser and increasing the number of turns in the grid coil it is possible to obtain a larger dial spread for a given band if this is deemed advisable.

A Pilot illuminated dial was selected for the tuning control. This dial is of the disc type which allows the condensers to be arranged in a line at right angles to the panel. The first two condensers are Hammarlund midgets, chosen because their shafts extend straight through to take Hammarlund couplings of the flexible type. The shafts are a little over 1/4 inch in diameter and since the couplings are bored to that size the shafts will have to be turned down on the rear end or the coupling reamed out to fit the shafts. The third condenser is a Pilot midget. The whole

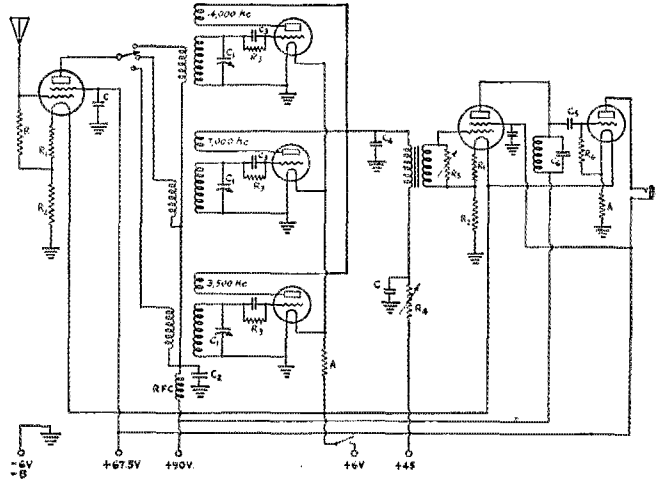

FIG. 1 — IN THE SCHEMATIC SHOWN ABOVE, THREE DETECTORS ARE INDICATED

It should be understood that only one detector tube is employed: it being shifted to the socket connected to the tuning equipment to cover the desired frequency band. It is possible to use three detector tubes and provide a switch to turn on the filament current to the particular tube desired. In this way it will be only necessary to operate two switches on the front of the panel to shift to any of the three bands. The constants are as follows:

- C — 1- μ d. by-pass condensers.
- C₁ — Midget tuning condensers (see chart in text).
- C₂ — 100- μ d. fixed condenser.
- C₃ — 2,000- μ d. by-pass condensers.
- C₄ — 6,000- μ d. fixed condenser.
- C₅ — 0.1- μ d. fixed condenser.
- R — 10,000-ohm resistor (grid leak type).
- R₁ — 10-ohm fixed resistor.
- R₂ — 5-ohm fixed resistor.
- R₃ — 6-megohm grid leak.
- R₄ — 50,000-ohm Frost variable.
- R₅ — 200,000-ohm Frost variable.
- R₆ — 8-megohm grid leak.
- A — Amperite for '01-A tubes.

assembly operates without play or backlash and is perfectly satisfactory for tuning. The coils and condensers may be arranged to give full-dial or part-dial coverage according to the choice of the builder, and the calibration will remain fixed as long as the apparatus is not tampered with. However, different detector tubes sometimes make a big difference in the dial settings, especially on the high frequencies, and it is a good plan to try out a few tubes for detectors, selecting for spares those that do not change the calibration materially. Bayonet type sockets (UV) were used for the detector tube to allow changing from one socket to another readily.

The tickler coil on each band should have as few turns as possible and still cause oscillation. Too many turns result in weak signals, even though regeneration may be easily controlled. A good guide is the amount of resistance used in the plate circuit at the oscillation point. The tickler turns should be reduced until it is necessary to cut nearly all of the resistance out before the tube goes into oscillation.

The ground connections indicated in the diagram were run to copper strips 1/2 inch wide fastened to the top of the baseboard. A shield

extends upward behind the panel covering a space about ten inches long and six inches high, with the tuning dial shaft in the approximate center. Shields and strips are connected to the condenser rotors and to the negative leads of both batteries. Battery connections are made by

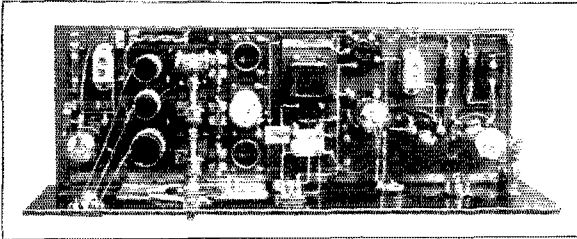

A TOP VIEW OF THE SET WHICH SHOWS THE GENERAL ARRANGEMENT OF THE PARTS EMPLOYED

The three tuning condensers are ganged and operated by the single vernier dial. The coils for each band are wound on a separate form, that for the 8500-ke. band being somewhat larger than the other two. The three detector sockets are mounted in a row and are of the UV variety to reduce the amount of trouble in inserting the tube in its proper position. The extra socket behind the #22 used in the audio stage acts as the terminal for all battery leads.

means of a five-prong tube base and socket. Amperites are used in the filament circuits of the 201-A tubes and the usual 5- and 10-ohm resistors in those of the screen-grid tubes. A flashlight bulb is inserted in the negative "B" battery lead as a protective device.

Several coils were tried in the tuned audio-frequency circuit and there is a wide difference in coils. The Ford coil secondaries are good, but it is possible that other coils may be at hand which would work even better. Peaks on several coils were measured with a calibrated a.f. oscillator and vacuum-tube volt-meter, which gave their amplification value at the same time the peak was determined. It was found that the higher the inductance employed, for a given peak frequency, the higher the amplification available. This means a large coil and low values of capacity if high amplification is wanted. The predicted results of coils measured were found to check when tried in the receiver and after some practice peaks on coils tried in the receiver before measuring could be estimated very closely. The best coil among those available was one half of a secondary from a Western Electric ignition coil. This is a layer wound affair, with a sheet of very thin insulation between layers and is wound with about No. 40 enamelled wire on a paper tubing about one-half inch in diameter. The coil is two and one quarter inches long and about two inches outside diameter. The d.c. resistance is 2000 ohms, and it peaks to 1500 cycles with a 0.01- μ fd. condenser across it. The peak is quite sharp which is no disadvantage at all. Introducing resistance into the tuned circuit does not broaden the amplification curve at its base. It only limits the value of amplification at the peak which flattens the curve by wiping out the sharp peak.

The volume on steady d.c. signals will be high and great selectivity may be had on such signals because the volume control may be lowered, thus shutting out signals that cannot be held on the peak and whose volume is proportionally low. Experiments with iron-core chokes in this circuit indicate that there may be possibilities in them. Much less wire could be used and the resistance would be much lower. Just how sharply such a circuit could be tuned has not been determined but it is suggested that all available coils be tried and the choice made according to results.

The coil selected may be dressed up by enclosing it in some sort of casing. The one used here was put into a bakelite tube and one half of an R.C.A. r.f. transformer case turned out to fit over the tubing. A round wooden base was grooved in the same manner and the whole thing glued together and filled with paraffin. One binding post was removed from the R.C.A. case and the other two used for the coil connections. Enamelled black, it doesn't look so bad.

An old broadcast set was dismantled and the panel, baseboard and cabinet used for the receiver. It is somewhat larger than necessary but allows plenty of room to get at the parts. The signal volume available is much too great for comfortable headphone reception but is easily controllable by means of the variable resistor across the a.f. transformer secondary.

Coming—A Low-Power 'Phone Transmitter

THE Technical Editors of *QST* have designed and built a transmitter which will be of interest to all amateurs, especially* to those who enjoy radiophone communication. This transmitter is designed to use receiving tubes throughout; it will be capable of 100% modulation (undistorted). This set will use new tubes recently announced by manufacturers and described in *QST*. Now the article, with complete constructional specifications, is being written for our next issue.

If the 14,000-ke. amateur band is opened to radiotelephony, as is expected, this 'phone will be one which you will want to have in your possession to use to work the Antipodes.

We are whooping up this article in advance because we are firmly of the opinion that it is just what has long been looked forward to; now for the first time is it possible to build a telephone transmitter of the calibre we desire and still remain within the realm of low power. Something to look forward to next month!

Don't miss September *QST*.

Resistance Control of Regeneration

By Beverly Dudley, Assistant Technical Editor

IT has been well demonstrated that the autodyne receiver is, generally speaking, the best all around high-frequency receiver for continuous wave reception. Because the strength of incoming continuous wave signals varies with each signal, it is desirable, in order to obtain a beat note of the proper audibility, to be able to vary the strength of the locally generated oscillations at will. Regeneration control is of importance in high-frequency phone reception also, where it is usually desirable to push regeneration almost to its limit.

A considerable amount of thought has been given to the various methods of controlling regeneration. We have passed through the stage where a large moving tickler at the grid end of the coil was the last word; the smaller tickler at the filament end of the coil gave way to the capacitive reactance method of control, and this, in turn, was followed by a non-inductive resistance control. Each was an improvement over its predecessor but even now we have not yet arrived at a perfectly desirable form of regeneration control.

The perfect regeneration control should, first of all, have excellent control over regeneration and oscillation. It should reduce regeneration sufficiently to permit the reception of radio telephone or other modulated signals without distortion; it should permit the circuit to oscillate sufficiently to produce a beat note with the strongest incoming signal; it should give the same degree of regeneration for a given dial adjustment of the control, and should maintain that adjustment so that, if it were necessary and practical, the regeneration control could be calibrated to give a certain degree of regeneration. Any regeneration control should permit a perfectly silent transition from oscillation to regeneration (and *vice versa*) and should be noiseless. Finally, the regeneration control should cause no change in frequency. Although there is not a perfect agreement on this point, it is generally conceded that the regeneration control should not be a tuning device.

While none of the regeneration devices generally employed possess all of these desirable features at the high frequencies, resistance control seems to be the most satisfactory. Unfortunately, most resistors are noisy and objectionable from this standpoint. A number of tests were made with various circuits and resistors of different manufacture and construction in an effort to determine which circuit and which type of resistance control was generally the most satisfactory.

It was desired to build up a test set that would show up the faults of the regeneration systems and controls employed. It was also desired to approach actual operating conditions as nearly as possible in making the tests. With these two ideas in mind, the test set shown in Fig. 1 was built up, bread-board style. It consisted of two units, the receiver proper, and the unit containing the measuring equipment. The receiver consisted of a tickler-coil circuit operating approximately between 5000 and 7000 kc., a stage of transformer-coupled audio amplification, and two stages of resistance-coupled audio amplification. The output of the final amplifier was passed through an output filter and then to a headset through an audibility meter. The measuring unit contained an audibility meter, a voltmeter for measuring the plate voltage and a milliammeter for determining the plate current of the detector tube.

The resistors used in these tests were of three general types. The first type made use of carbon discs or grains, the resistance of which was varied by means of a screw device which compressed the carbon. With this type of control, several complete turns of the knob were required to pass from the maximum to the minimum resistance of the unit, in consequence of which the control was usually very smooth and fine. The following units were in this class:

- No. 1. 0.25-10 ohms. Carbon grain. (Clarostat)
- No. 2. 0-500,000 ohms. Carbon grain. (Clarostat)
- No. 3. 10,000-100,000 ohms. Carbon disc. (Allen-Bradley)
- No. 4. 0.25-10 megohms. Carbon disc. (Allen-Bradley)

The second type of resistor consisted of an insulated strip upon which was painted or otherwise deposited the high resistance element. In general this resistance element was apparently some graphite compound. A contact arm was provided to introduce the desired amount of resistance into the circuit. Those in this class were:

- No. 5. 0-50,000 ohms (Centralab)
- No. 6. 0-100,000 ohms (Centralab)
- No. 7. 0-50,000 ohms (Frost)
- No. 8. 0-200,000 ohms (Frost)
- No. 9. 0-50,000 ohms (Electrad)

The third type consisted of a high-resistance element somewhat similar to that employed in Type 2, upon which resistance wire was wound, the wires later being cut so that in effect the resistor element was surrounded by a number of

wire bands, none of which closed upon themselves or made contact with adjacent turns. These were:

No. 10. 0 — 500,000 ohms (Carter)

No. 11. 500 — 50,000 ohms (Electrad)

In addition a regular wire-wound rheostat of 6 ohms manufactured by Carter was tested and is indicated as No. 12.

The four-tube receiver, measuring unit, and high-frequency oscillator were rigged up in making the measurements. Five coils, with tickler windings of from three to seven turns were made to take care of all reasonable tickler requirements. A number of flexible leads, provided with soldering lugs were also provided so that

the constant impedance audibility meter was then adjusted until the noise caused by varying the regeneration control just disappeared, or until the limit of the meter was reached. The noise produced by the control with the detector tube regenerating (but not oscillating), with the tube on the verge of oscillation, and in an oscillating state was observed and is denoted by R (regenerating), S (spilling over) and O (oscillating). The plate voltage, plate current and size of tickler for best operations were all observed. The smoothness of the regeneration control was estimated by noting how gradually the circuit went in and out of oscillation and was rated as being excellent, good, fair or poor. Similarly, the

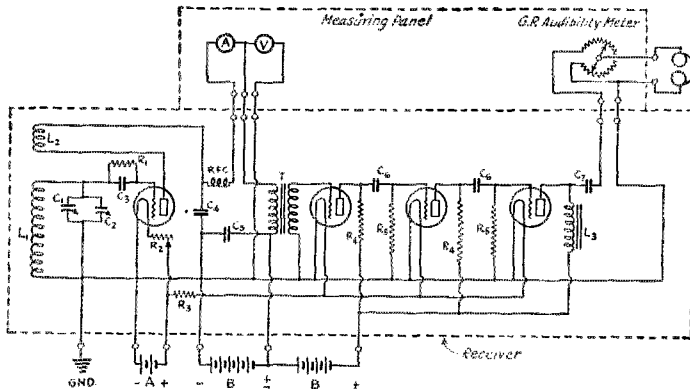

FIG. 1

- L_1 — 10 turns No. 36 wire on tube base.
- L_2 — 3-to 7-turn tickler.
- L_3 — 45-henry "B" battery substitute choke coil.
- C_1 — 75- μ fd. Cardwell taper-plate condenser.
- C_2 — 12- μ fd. General Radio midgep condenser cut down to two spaced plates.
- C_3 — 250- μ fd. grid condenser.
- C_4 — 2,000- μ fd. radio frequency by-pass condenser.
- C_5 — 1- μ fd. by-pass condenser.
- C_6 — 0,000- μ fd. coupling condenser.
- C_7 — 2- μ fd. filter condenser.
- R_1 — 2-megohm grid leak.
- R_2 — 10-ohm filament rheostat.
- R_3 — 1.5-ohm filament resistor.
- R_4 — 250,000-ohm coupling resistor.
- R_5 — 500,000-ohm grid leak.
- RFC — Radio frequency choke coil.
- A — 0-5 milliammeter.
- V — 0-150 voltmeter.
- T — Audio frequency transformer.

the circuit changes shown in Fig. 2 to 11 should be made with a minimum of trouble. The observations were then made by mounting the resistor to be tested on the bread-board test set, making the necessary changes to obtain any of the desired test circuits and choosing the tickler coil best suited to normal operation. The plate battery voltage was kept at 45 except in such cases as it was absolutely necessary to reduce or increase the plate voltage in order to obtain reasonably good operating characteristics. The receiver was tuned to a silent portion of the dial (even without an antenna it was possible to pick up amateur and commercial high-frequency signals) and the regeneration control was varied, with the usual result that the diaphragms in the phones clicked loud and lustily. The resistance of

constancy of control (that is, the amount of regeneration at the zero end of the dial, compared with the amount of regeneration at the 100 end of the dial to make the circuit barely oscillate) was noted and estimated as being excellent, good, fair, or poor. Finally, the oscillator was turned on, and the circuit was tuned to zero beat with the driver when the detector circuit was just oscillating. The regeneration control was advanced so that the detector oscillated more persistently and the relative detuning caused by the change in the dial reading of the auxiliary tuning condenser required to bring the circuit back into zero beat with the driver. This same procedure was followed for each circuit and each resistor used in the tests.

The diagram of Fig. 2 made use of the resistor

in series with the plate supply lead of the detector tube. The resistor therefore carried the plate current of the tube and controlled regeneration by varying the voltage applied to the plate. The control was at ground potential as far as radio-frequency currents were concerned so that no body-capacity effects were present. With most of the controls used, five tickler turns were required. The circuit broke into oscillation with a plate voltage of about 22 or 24 volts. In general the 50,000-ohm units gave the best results as to noise produced although the 10,000 to 100,000-ohm Allen-Bradley was considerably less noisy than any other single unit. The representative noise audibilities produced by changing the regeneration control are: Regeneration, S00; spilling over, S00, and oscillating 1350. The average smoothness of control was good, although the two carbon-disc resistors gave better than average results (Allen-Bradley). The manner in which regeneration was kept constant as the frequency was varied may be designated as from fair to good. The detuning caused by the regeneration control varied from 1 to 8 degrees of the auxiliary condenser, 5 degrees being representative of the circuit. The two units employing wire wound on the resistance strip were found to be very noisy due to the fact that the resistance was not adjustable in sufficiently fine steps. The resistance of the unit, instead of being gradually variable, was varied in steps each time the contact arm slid over another wire, there being as many steps in the control as there were turns of wire wound on the resistor strip. In effect this type of control might be replaced with a multi-point switch connected to various separate resistors. This type of control was quite unsatisfactory.

Fig. 3 is a high-resistance potentiometer shunted across the "B" battery. The plate voltage of the detector is varied in much the same manner as that of Fig. 2, but because of the potentiometer arrangement, slightly better results were obtained. Unfortunately, the two Frost resistors were the only ones provided with three terminals and were the only two units which could be used in this circuit. A tickler coil of 5 turns was used, the circuit coming into oscillation with about 22 volts on the plate of the detector. For both units, the noise audibility was: Regenerating, S00; spilling over, 1000-1500; and oscillating, 500 to more than 2000, the better set of figures being for the unit of less resistance. The smoothness of control was good in both cases, while the constancy of control was from fair, with the lower resistance unit, to good. Detuning of 10 degrees was noted in both cases.

Filament control of regeneration was employed in the diagram of Fig. 4. A wire-wound filament control resistor was found to be very noisy, having noise audibilities of greater than 2000, whereas a carbon-grain unit of the screw-compression type was noiseless (audibility 1) for all degrees of

regeneration and oscillation. The plate voltage on the detector was maintained at 42 during the run of the filament regeneration control. The Carter resistor permitted the circuit to make a rather smooth transition from regeneration to oscillation, but was noisy and critical in adjustment. It was found that a 6-ohm rheostat was not of sufficiently high resistance to control regeneration without some auxiliary control. The 10-ohm Clarostat gave fair results as to smoothness and constancy of the regeneration control, but, while perfectly noiseless, it was found that a lag or loop effect was present. That is, for a given angle of rotation of the regeneration control, oscillation would start at a certain point when decreasing the filament resistance, but on increasing the resistance to pull the circuit out of oscillation, an entirely new setting of the rheostat was required. The fact that oscillation occurred at different settings of the rheostat knob is no doubt attributable to the fact that after the carbon grains are tightly compressed, it takes considerably more space to loosen them and obtain the same resistance than it did to compress them. This objectionable feature was offset by the fact that no detuning effects were noted as the strength of oscillations was varied.

In Fig. 5 we have the regeneration control at relatively high audio and d.c. voltages and low r.f. voltages. The plate current for the detector passes through the control. The plate-battery voltage was 42 volts and a tickler of 5 turns was usually sufficient, although with the two Allen-Bradley units, the minimum resistance was too high to permit oscillation even with a tickler of 7 turns and a plate-battery voltage of 90. As might be expected, this control circuit was very noisy with all of the regeneration control units. In practically all cases the noise audibility for regeneration, oscillation, and spilling over, was greater than 2000, the best results being obtained with the 0-500,000-ohm Frost unit which gave audibilities of: R, S00; S, 650; and O, 1000. In general the smoothness of oscillation was from poor to fair although the circuit maintained its constancy of control to a sufficient degree to be averaged as good. The amount of detuning with the various controls varied from 3 to 50, and it may be said that this arrangement was generally unsatisfactory.

Fig. 6 has the regeneration control shunted across the tickler and because the direct current resistance of the tickler is so very much lower than that of the regeneration control practically no direct current flows through the control. A 5-turn tickler with 45 volts on the plate of the tube represented average conditions for all types of resistors. In general, all were quiet in operation when the circuit was regenerating but caused considerable noise when spilling over or when oscillating. The two Allen-Bradley carbon-disc resistors were the only ones tested that gave good

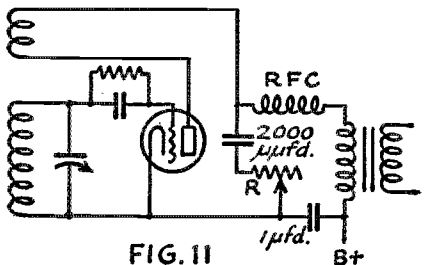
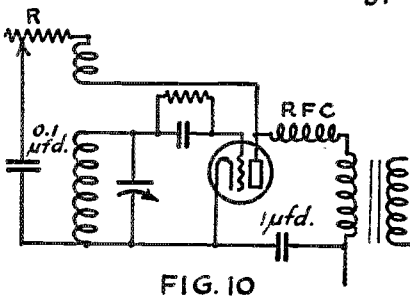
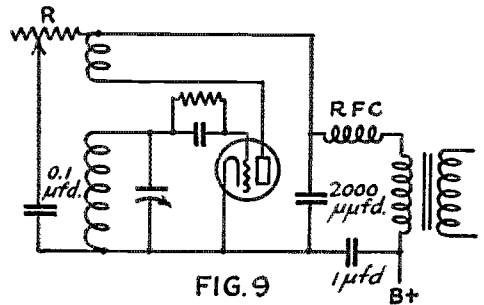
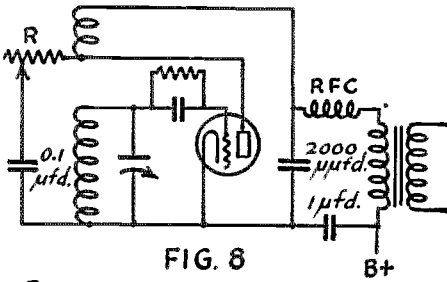
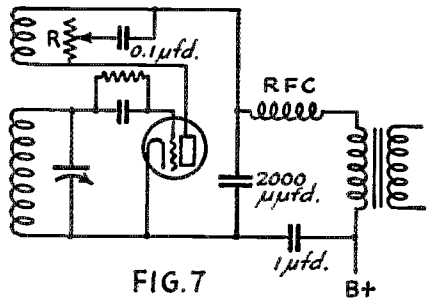
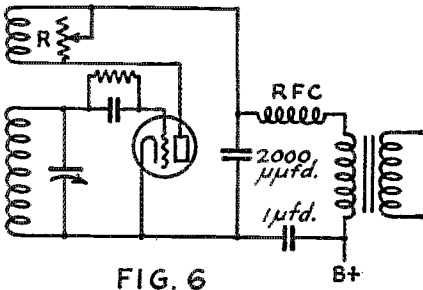
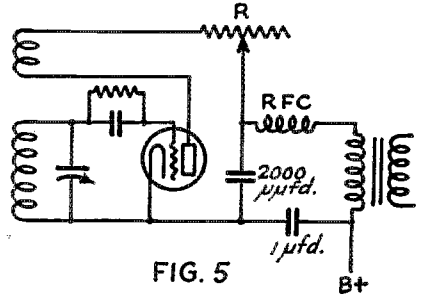
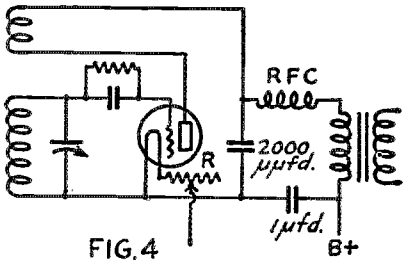
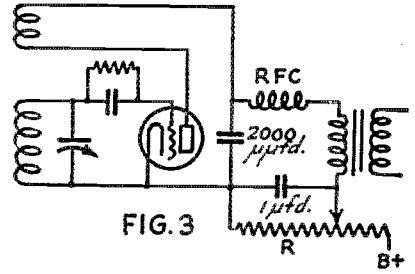
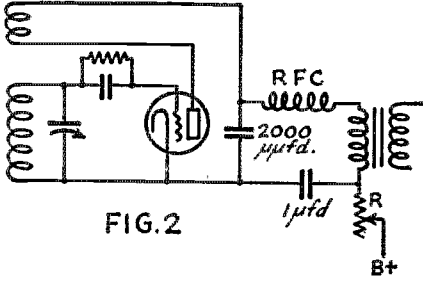

results and both of these units showed no noise, regardless of the amount of regeneration in the circuit. All in all the smoothness of control was poor, while the constancy of the control was fair. Body capacity effects and detuning were considerable, the amount of detuning varying from 10 to 60 degrees. This type of control was, on the whole, not very satisfactory.

The diagram of Fig. 7 was similar to that of Fig. 6, except that a 0.1 μ d. condenser was used in series with the resistor, which blocked out even the slightest trace of direct current which might be flowing through the control. As might be expected the results obtained with this control were the same as those obtained with the circuit of Fig. 6.

In Fig. 8, a shunt resistor was used between the plate and filament with a series condenser of 0.1- μ d. to prevent short circuiting the "B" battery. A tickler of 4 or 5 turns represented normal operating conditions when the plate voltage of 45 was applied to the tube. All of the controls were quiet with the detector tube regenerating, but at the verge of oscillation, noise in excess of 2000 audibility units was observed, and maintained, in the majority of cases, with the tube oscillating. The $\frac{1}{4}$ - to 10-megohm and the 50,000-ohm Electrad unit of their new construction (5-watt size in metal case) gave the best results and were practically noiseless. The smoothness of regeneration control varied from poor to fair while the constancy of control averaged about good. This circuit, too, had serious

results were poor. The noise with the detector tube starting to oscillate was in excess of 2000, as was the noise with the tube in a state of oscillation. The smoothness and constancy of control was poor, body-capacity effects were present, and the circuit was not at all practical. Fig. 10 was not even made to oscillate. No doubt both of these circuits could have been made to oscillate with larger tickler coils, but this was not deemed advisable since there might be danger, if the tickler coils were increased in size, of the ticklers becoming resonant with the grid circuit and thus producing results not dependent upon the factors under consideration.

Fig. 11 made use of a variable high resistor between the filament and the ground side of the radio-frequency by-pass condenser. In cases where the circuit would oscillate a tickler coil of 5 turns with a plate voltage of 45 was found to give the best all-around results. The circuit was very noisy when regeneration was varied, gave poor results as to smoothness in going in and out of oscillation, and only fair results as far as maintaining the constancy of regeneration with tuning of the grid circuit. Except in one case when a value of 60 degrees was obtained, the amount of detuning as the regeneration control was varied was in the neighborhood of 2.5 to 5 degrees.

Table 1 gives a summary of the circuit conditions in a more compact form. A casual glance at the table seems to indicate that none of the circuits were very good. This is not exactly so.

TABLE 1

SUMMARY OF CIRCUIT CONDITIONS

Circuit No.	Noise			Smoothness	Constancy	Average Detuning in Degrees	Remarks
	R	S	O				
2	Good	Fair	Poor	Good	Fair to good	4.5	Noisy but otherwise O.K.
3	Good	Fair	Fair	Good	Fair to good	5	Noisy but otherwise O.K.
4	Depends on control Type 1, noiseless Type 3, very noisy			Good to excellent	Poor to fair	1	Type 1 had bad lag and overlap.
5	Very poor	Very poor	Very poor	Fair	Good	18	Noisy and critical.
6	Excellent	Poor	Good	Fair to good	Fair to good	30	Critical, body capacity effects, oscillates abruptly.
7	Excellent	Very poor	Poor	Poor	Fair to good	30	Critical, body capacity effects. Generally poor.
8	Excellent	Poor	Poor	Fair	Good	33	Body capacity effects.
9							Couldn't make circuit oscillate.
10							Couldn't make circuit oscillate.
11	Fair	Very poor	Very poor	Fair	Fair	12	Fair.

detuning (from 11 to 55 degrees) and body capacity effects.

Circuits No. 9 and 10 were found to be poor oscillators. By using a tickler coil up to seven turns and plate voltages up to 90, the circuit of Fig. 9 could only be made to oscillate with the 5-watt Electrad resistor, and in this case the

The table represents the average of all tests made and as there were considerably more rotten controls than excellent, or even good controls, the average is therefore stated in conservative terms. It is possible with a good resistor to get a quiet, smooth, constant circuit and to obtain very good operating conditions.

So much for the circuits.

Table 2 summarizes better than can six type-written sheets, the general operating features of the three types of control. Of course individual units in any one class varied from the general summarized conditions, but taken all in all, Table 2 is pretty well representative of the results obtained in these tests.

As to a final summary of the results, it was found that the best controls were those operating at low radio-frequency voltages, and preferably

Northwestern Division Convention

At Portland, Oregon, August 30th-31st

THE Rose City Amateur Radio Club extends a cordial invitation to the radio amateurs of the Northwestern Division and surrounding divisions to come to Portland, Oregon, to attend the annual A.R.R.L. Convention. August 30th and 31st have been chosen as

TABLE 2
SUMMARY OF RESISTORS FOR REGENERATION CONTROL

Class	Representative Resistors	Noise			Smoothness	Constancy	Remarks
		R	S	D			
1	Allen-Bradley Clarostat	Excellent to good	Excellent to good	Excellent to good	Very good	Good	Generally very satisfactory. By far the best type of control tested.
2	Frost, Centralab. Electrad (new 5-watt unit)	Good	Fair	Fair to good	Fair	Good	Noisy. Represents average present practice. Only mediocre in results.
3	Carter Electrad	Very poor	Very poor	Very poor	Poor	Fair	Noise much louder than signal. Totally unfit for regeneration control.

changing the plate voltage. Those controls operated at high radio-frequency voltages had had body-capacity effects, and those circuits which employed the resistor in a series arrangement were more noisy than those such as Fig. 6, which used the resistor in shunt with another portion of the circuit. Generally speaking, Figs. 2 and 3 were best, with Figs. 9 and 10 very unsatisfactory.

The resistors of the compressed-carbon type were much superior to any other type. The Allen-Bradley units were head and shoulders above any other control, and if a unit having a minimum resistance of a few hundred ohms and a maximum resistance of between 10,000 and 50,000 ohms of this make were available (particularly in a potentiometer type) it is almost certain that we would have a much better regeneration control than anything now in general use. The units employing the sliding contact arm on a high resistance element were fair and are now in general use. The third class of resistors was absolutely out — except for those rather rare cases where it is desired that the noise produced should be several times the signal strength. One might use such a resistor, fed through a 2- or 3-stage amplifier and a pair of phones or loud speaker, to rid the station of a particularly obnoxious visitor.

It should be clearly understood, though, that although most of these resistors are unsuited for regeneration control of high-frequency receivers, this must not be construed as meaning that they are not perfectly satisfactory for the many uses for which they were originally designed.

the dates on which it is hoped to give everybody the best of convention with plenty of visits, technical talks, and contests for which many trophies have been given.

A.R.R.L. Headquarters is sending A. A. Herbert, Treasurer and Fieldman, and there will be representatives from the Army and Navy. Remember the place — Hotel Heathman.

The convention secretary, R. H. Wright, 310 Ross St., Portland, Oregon, will be pleased to hear from any one who intends to be present.

Strays

Wobbly signals are not necessarily transmitted by the I. W. W.

Ouch! Payne is the owner of W9CRY in St. Louis.



The Inductor Dynamic

By Harold P. Westman*

DURING the past few years, the chief advances in loud speaker design have been along lines of refinement rather than the development of new types operating upon different principles. We thus have today, two distinct types of reproducers, the so-called magnetic type which usually employs a balanced-armature motor to drive a controlled-edge cone and the so-called dynamic type which usually consists of a free-edge or plunger-type diaphragm driven by a motor, the moving portion of which comprises the coil through which the voice currents flow.

Both of these types have their advantages and disadvantages. The magnetic type is not particularly responsive at the lower frequencies because its operation requires that the air-gap between the armature and the pole pieces be varied and in order to maintain suitable sensi-

current is the chief draw-back of the dynamic speaker and a suitable power supply for its generation increases the cost of the speaker considerably and in many cases causes a damaging hum.

A type of speaker which does not require an electrical source of energy for the generation of

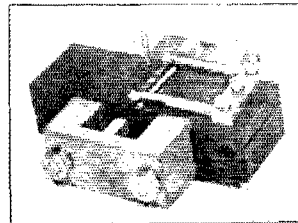

A VIEW OF THE ASSEMBLY WITHOUT THE COILS OR MAGNETS

The thin springs which hold the armature bars are in the form of channels for rigidity and strength. A piece of soft rubber fastened into the channel provides damping and prevents resonance effects at the natural period of the springs.

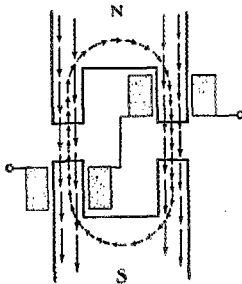

FIG. 1.—IN THE MAGNETIC CIRCUIT ABOVE, THE LONG ARROWS INDICATE THE FIELD DUE TO THE PERMANENT MAGNET WHILE THE SHORTER ONES SHOW THE PATH TAKEN BY THE LINES OF FORCE PRODUCED BY THE CURRENT FLOWING IN THE COILS

Any current through the coils will cause a reduction in the effective field across one air-gap and an increase in the number of lines of force threading across the other gap.

tivity and still prevent chattering, it is essential to use a small air gap and a very stiff spring suspension of the armature. The dynamic has not these limitations, however, because the armature moves across the pole-piece faces and the air-gap remains constant regardless of its movement. It is, however, relatively inefficient and requires an exceedingly strong magnetic field to obtain suitable performance. It is not practical to obtain such a field from permanent magnets and recourse is had to an electro-magnet requiring several watts of direct current for its operation. The obtaining of this magnetizing

a magnetic field and the armature of which moves parallel to the faces of the pole-pieces has recently been developed by C. L. Farrand. Its principle of operation is similar to that of the induction type a.c. motor and it has been called the inductor dynamic loud speaker.

Let us consider the arrangement shown in Fig. 1. We have the ends of a permanent magnet which will cause a steady magnetic field to be produced across the air gaps in the direction of the long arrows. If the two coils shown are connected in the proper way, a current flowing through them will set up another field which in its effort to follow the path of least reluctance will travel along the path shown by the short arrows. From this we see that the second field will increase the number of lines of force crossing the right-hand and will reduce the number crossing the left-hand gap. If, now, the current through the coil is reversed, the direction of its magnetic field will also be reversed and the effect will be that of increasing the field across the left gap and decreasing it across the right one. Thus if we pass an alternating current through the coils, the field across any one gap will alternately increase and decrease in strength while that across the other will do the same but will be 180° out of phase. When one is increasing the other will be decreasing in strength.

To make use of this characteristic an armature which is composed of two light iron bars is

* Retiring Technical Editor.

employed. The bars are separated by suitable tie rods and are supported between the pole faces as shown in Fig. 2. To prevent the armature bars from moving in the direction of the lines of force but still be free to move across the field and parallel to the faces of the pole pieces, they are supported in position by means of exceedingly light strip springs which are in channel form

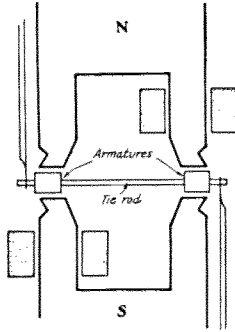

FIG. 2.—THE ARRANGEMENT BY WHICH THE ARMATURE IS ALLOWED TO "FLOAT" WITHIN THE GAP BETWEEN OPPOSING POLE PIECES AND STILL NOT MOVE IN A DIRECTION THAT WILL ALTER THE LENGTH OF THE GAPS IS INDICATED HERE

The light thin springs allow plenty of motion in a direction parallel to the pole-piece faces and supply no force tending to restore the armature to its initial position. Restoration is due entirely to the magnetic field caused by the permanent magnet.

and are fitted with strips of soft rubber to prevent distortion due to vibration at their natural period. These springs do not supply any restorative force whatever.

As Fig. 2 indicates, the armature bars are not completely within the pole pieces and the lines of force in their endeavor to follow the shortest

suck the armature bar completely within the pole pieces in order to materially shorten the length of the air gap and reduce the reluctance of the magnetic circuit. However, the distance between the bars is fixed by the tie rods and the assembly will take a position in which the magnetic pull on both bars will be equal and opposite. This may be considered as the magnetic center.

When the coils are energized, the magnetic flux across one gap will be increased and that of the other will be decreased, resulting in an unbalance and a movement of the armature until a position is reached in which the pull on each bar is equal and opposite. Changes in the amount of current passed through the coils will, therefore, result in motion of the armature which will be transmitted to the plunger-type diaphragm, resulting in an acoustic output. The pole pieces are cut to the shape indicated to reduce the leakage and concentrate the field in the most desirable position.

The entire armature assembly including the support springs is extremely light, weighing but 4.5 grams as compared with the weight of the moving coil assembly of a dynamic speaker of from 8 to 15 grams. The allowable motion of the armature is approximately one-eighth of an inch which is ample for high-volume reproduction of the lowest notes broadcast. This speaker, therefore, combines the advantageous characteristics of the moving-coil dynamic with the simplicity of operation of the magnetic type.

A regulation output device should be interposed between the speaker and the amplifier although this may be eliminated if a push-pull stage is employed. In this case a tap is taken from the lead connecting the loud speaker coils together, which then corresponds to the mid point of the usual output transformer or choke.

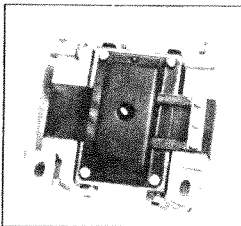

A COMPLETE MOTOR

Two long bolts clamp the permanent magnets, mounting brackets and pole pieces together into a solid unit. A metal cover protects the coils and armature from mechanical injury.

magnetic path travel from the ends of the pole pieces to the armature bars and thence to the opposite pole pieces. The tendency will be to

Midwest Division Convention

Kansas Section, Topeka, Kans.,
September 13th-14th

THE Kaw Valley Radio Club is again the host for this year's convention and extends a cordial invitation to all radio amateurs. An interesting program is being prepared which will be satisfactory to every one, so be sure to reserve September 13th and 14th and visit Topeka.

All sessions proper will be held in the Chamber of Commerce, and the convention banquet, Saturday evening, will be at the Hotel Jayhawk. Please let the Secretary, Frank K. Tiffany, 1204 Tyler St., Topeka, Kans., know that you will be there.

W1WV

A 100 Per Cent 1929 Amateur Station

This, the fourth published entry in the Station Description Contest, puts a First District W station in the running. Seven more W districts, all Canada and numerous foreign countries yet to be heard from! — EDITOR.

W1WV, owned and operated by Mr. Miles W. Weeks, 40 Norfolk Road, Chestnut Hill, Mass., came into being largely as a result of code interference.

In the earlier days of broadcasting many of the best programs were ruined by frequent bursts of code as some of us may remember and to find out what it was all about was primarily the reason that resulted in putting W1WV on the air in July, 1927.

Two 210's in parallel have marked the limit of transmitting tube equipment used as it was de-

of traffic. At the time of this writing over 2400 contacts in five continents have been made. Concerning the operator and owner, it is interesting to note that he was over 40 years of age when he obtained his operator's license, thus proving that you can sometimes teach an old dog new tricks.

Before any station equipment was installed it was of course necessary to obtain a suitable location for a shack. After considering various possible locations, one corner of the cellar was selected as combining practically all the desirable qualifi-

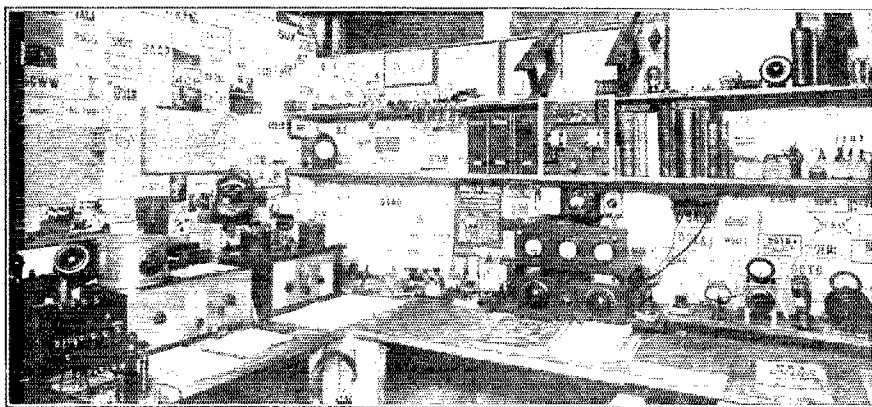

THE BASEMENT OPERATING LOCATION

In the left foreground can be seen the telephone on its extension bracket and receiver holder; above it on the wall, the world map marked with each country "worked." At the left on the bench are the two receivers; on top of them appear the Monitor or "Growler," and the two G.R. wavemeters. On the shelf in the corner is the Telechron Electric clock. Further along on the bench are the keys, the Leach keying relay and the thorny filter. Then comes the Hartley transmitter over which may be seen the control panel and the lightning switches for the 2000-kr. Zeppelin. At the extreme right is the 14-mc. 1-p.l.u. transmitter and part of its antenna system and below it is the correspondence file and card index for stations worked. On the wall just over the telephone can be seen the battery switches for the receivers. The transmitter change-over switches can just be made out at the upper left corner of the Hartley transmitter. The codes are all from stations actually worked.

sired merely to have a reasonably efficient low powered station. As a result there is nothing complicated or unusual at W1WV; everything has been kept as simple as possible. Considerable time was given to planning the layout and great care has been used in all construction work to obtain satisfactory performance and the results would seem to justify it. The station obtained an O.R.S. certificate three months after it first went on the air and has always been active in matters

of operations; warmth in winter, coolness in summer, quietness and privacy, and, what was most important, proximity to a good antenna location were all obtained. A room ten feet square was constructed by the owner in such a way that the sheathing was all inside to give a smooth background for future "wall-paper." A broad work-bench lines the wall on two sides of the room and ample shelving gives convenient storage space. Electric wiring was run in for the necessary lights

and wall outlets and an extension telephone installed and work was begun on a long wave receiver. While the code was being learned with the help of this receiver, work was progressing on a short-wave receiver, a transmitter and other station equipment. The placing of the apparatus

quality of note justified this lower input. Operation on the 14,000-ke. band was effected on this transmitter from time to time but it was found that each time the change was made from one band to the other considerable time was necessary for satisfactory adjustments to be made. To save time and in addition to allow adjustments once made to remain the same, a second transmitter was built in April, 1928, again using the Hartley circuit, for use solely on the 14,000-ke. band. Only one 210 tube was used in this. While considerable success was obtained in DX work, trouble was experienced in main-

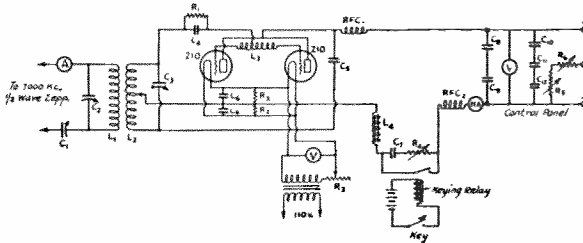

FIG. 1.—THE HI C HARTLEY TRANSMITTER

- C_1 —500- μ fd. G.R. receiving condenser.
 C_2 —250- μ fd. double-spaced transmitting type, National.
 C_3 —250- μ fd. double-spaced transmitting type, National, bridged by 250- μ fd. fixed air condenser.
 C_4 —4000- μ fd. Sangamo receiving condenser.
 C_5 & C_6 —2000- μ fd. Sangamo receiving condensers.
 C_7 —2- μ fd. 1000-volt Tobe condenser. Transmitting type.
 C_8 & C_9 —2- μ fd. 1000-volt Tobe condensers. Power pack type.
 C_{10} —2- μ fd. 550-volt Polymet condenser.
 C_{11} & C_{12} —1- μ fd. W.E. 559-volt condensers.
 L_1 —11 turns of $\frac{1}{4}$ -inch copper tubing, 3 inches in diameter.
 L_2 —13 turns of $\frac{1}{4}$ -inch copper tubing, $2\frac{1}{2}$ inches in diameter for 3500 kc. 5 turns for 7000 kc.
 L_3 —20 turns of No. 24 d.s.c. wire for grid choke, $\frac{1}{2}$ -inch in diameter, center-tapped to C_4 . (2 210's being used in parallel.)
 L_4 —1 $\frac{1}{2}$ henry Acme choke, in key-thump filter.
 R_1 —10,000-ohm grid leak.
 R_2 —Filament center-tap resistors. (G.R. Type 437.)
 R_3 —2-ohm rheostat. (G.R. Type 214.)
 R_4 —2500-ohm variable resistance. (G.R. Type 214.)
 R_5 —Bradley carbon disc variable voltage resistor.
 R_6 —Ward-Leonard contact point field rheostat.
 RFC_1 —Plug-in coil, 3 inches in diameter, scramble wound with 200 turns of No. 24 d.s.c. wire, for 3500 kc. An R.E.L. r.f.c. is used for 7000 kc.
 RFC_2 —R.E.L. r.f.c.

was decided upon by locating the keys centrally with the receivers on the left and the transmitter on the right just under the windows and convenient to the antenna outlets. A Telechron electric clock was also obtained to assure accuracy in keeping schedules.

THE TRANSMITTERS

The Hartley circuit was selected for its simplicity and has always been used for the 7000- and 3500-ke. bands. One 210 was used for the first six months of operation and two in parallel since that time. In August, 1928, the transmitter was rebuilt to obtain the high capacity feature and copper tubing inductances installed. Increased steadiness resulted. It was found that with a voltage of 800 and an input of approximately 135 watts this transmitter would run steadily and cool. Although a very sharp d.c. note was obtained at this input it was found that a very slight decrease in signal strength resulted when only 110 watts input was used and the improvement in

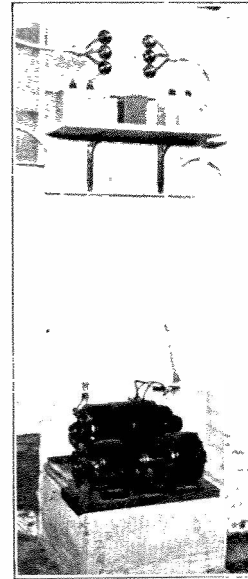

THE HIGH VOLTAGE
PLATE SUPPLY AND
FILTER SYSTEM

taining a steady frequency. As the tube warmed up the wave length would begin to creep up very slowly. During the summer and fall of 1928 this transmitter was used on the 3500-ke. band with two 210's but when it was desired to return to the 14,000-ke. band it was thought advisable to find some circuit which would obviate this annoying slow frequency creeping. Therefore in February, 1929, this transmitter was radically rebuilt to the push-pull t.p.t.g. circuit as detailed in December, 1928, QST, using two 210's. Some difficulty was experienced in getting this circuit to work properly but increasing the grid leak to 20,000 ohms and inserting grid chokes of 60 turns brought good results. Frequency creeping there is none. The note obtained has always been good d.c. and much better than any note obtained with the Hartley 14,000-ke. transmitter. Keying is accomplished in the negative lead.

As soon as a second transmitter was added some method had to be provided for quickly changing from one to the other. This is very simply accomplished by running the filament and plate power wires through two double pole double throw switches. The keying relay is common to both transmitters. These switches are located on the wall above the keys within easy reach of the operator.

To effect a change from one band to another on either of these transmitters, it is merely necessary to change the primary inductances and reset the variable capacities to the frequency desired. While this can be done in a few minutes if necessary, it has been found that better results are obtained by changing, in addition, certain fixed values such as plate and grid blocking condensers and grid leak and making more careful changes and adjustments of secondary inductances and capacities. This was one of the reasons why a second transmitter was added and has permitted a good note to be obtained on either of two bands at a moment's notice. It also has the advantage of allowing the station to be on the air continuously on at least one band at the same time that adjustments and changes are being made on the other transmitter. Nothing is ever considered as permanent or finished at this station for as soon as any new ideas come out that the owner desires to try, any piece of apparatus may be disassembled and rebuilt at a moment's notice. This is not to say, however, that any of the construction work is done in any but a most thorough way as there is no knowing how long it may be before the next change is made.

Comparatively few individual parts are home made although considerable work is often done on commercially manufactured parts to adapt them for use in receivers or transmitters which so far have always been home constructed. Performance is of primary importance although the time element has to be considered also. Articles that

primary inductance in the center, as in this way the plate and grid terminals were brought on the side towards the inductance and thus shorten the wiring leads. In the same way this brought the filament terminals to the rear where the connections to filament split-resistance and condensers could be made well away from the grid and plate connections. All the fixed condensers used in the

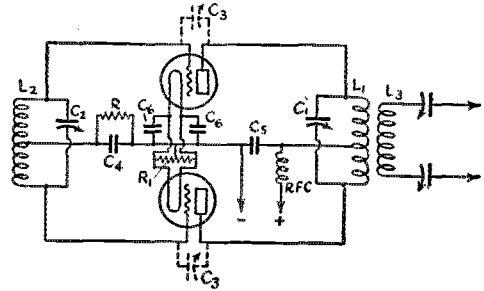

FIG. 2.—PUSH-PULL TUNED-GRID, TUNED-PLATE TRANSMITTER

- C_1 —500- μ fd. taper plate Cardwell receiving condenser.
- C_2 —1000- μ fd. receiving condenser, National.
- C_3 —None used.
- C_4 —150- μ fd. Sangamo receiving condenser.
- C_5 —500- μ fd. Sangamo receiving condenser.
- C_6 —2000- μ fd. Sangamo receiving condenser.
- L_1 —Plate coil of $\frac{1}{4}$ -inch copper tubing, 3 inches in diameter, 2 turns for 14,000 kc.
- L_2 —Grid coil of $\frac{1}{4}$ -inch copper tubing, 3 inches in diameter, 2 turns for 14,000 kc.
- L_3 —4 turns of edge-wise wound copper strip, 7 inches in diameter, directly around L_1 .
- K —20,000-ohm grid leak.
- R_1 —Filament center-tap resistors.

transmitters are of the receiving type not primarily intended for transmitting use but able, nevertheless, to stand voltages considerably in excess of any in use at this station. The variable condenser used to tune the primary circuit was of large enough capacity for the old type Hartley circuits but with the adoption of the High C type of circuit, this condenser, of 250 μ fd., was too small. In order to still use this particular condenser, which is a relatively expensive one, additional capacity was obtained by adding in parallel a fixed air condenser of similar capacity, thus doubling the capacity and giving a sufficient amount.

POWER SUPPLY

The question of power supply was carefully gone into and a motor-generator was decided upon. Theoretically generators are not rated as high in the scale of power supply sources as some others, due to the alleged high cost and troubles in eliminating QRM. The motor-generator has been found quite satisfactory at W1WV, however. First-cost has been practically last-cost so far and there is the consideration in the saving made in

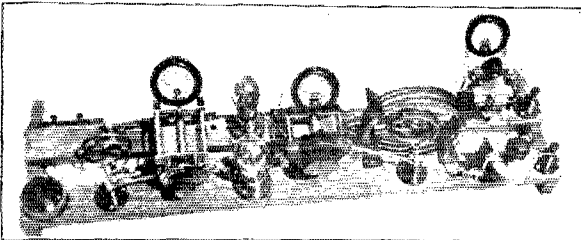

THE 14,000-kc. PUSH-PULL, TUNED-GRID, TUNED-PLATE TRANSMITTER

could be home made are purchased when it would take too long to make them.

In examining the Hartley transmitter, it might be of interest to note certain peculiarities in arrangement of parts and the reasons therefor. The tube sockets were placed at the rear, with the

not having to use large and costly filters. Various methods were tried to eliminate QRM with slight success until the present type of receiver was built. Apparently getting rid of a ground connection in the receiver has a good deal to do with stopping the QRM while the generator is running. At the start an old type of generator was used which supplied about 500 volts. When it was found that two 210's could stand considerably in excess of this efficiently, an Esco motor-generator

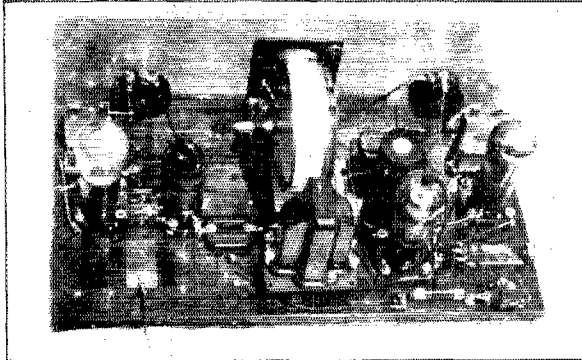

A REAR VIEW OF THE THREE TUBE SCREEN-GRID RECEIVER

The inductance for the peaked audio amplifier is to the right of the drum dial.

was acquired in September, 1928. Although rated at only 750 volts, it delivers nearer 1000. Both generators are shown on the concrete pedestal in the illustration, over which is the filter choke with its bank of condensers. The generators are located at the far end of the cellar about 75 feet away from the shack to reduce QRM. No shielding or grounding is now employed. The power line runs through two field rheostats, both located in the shack, and then through an adjustable overload relay on the control panel (shown just above the Hartley transmitter in the illustration) to the change over switches. The field rheostats are used to control the voltage and the overload relay breaks the transmitter plate circuit in case the current should suddenly exceed the maximum desired. The 110-volt, 60-cycle a.c. line to the motor is led through the control panel also and in addition there is a line running to a tumble switch at the keys for conveniently starting and stopping the generator. A 1000-volt meter located just under the control panel shows the plate voltage at all times.

Keying is accomplished through a Leach relay in the negative line to each transmitter, bridged by a key thump filter consisting of a 2500-ohm variable resistance and a 2- μ d. condenser in series, with the addition of a $1\frac{1}{2}$ henry choke in the line between the thump filter and the transmitter. The resistance is varied until the contact spark is at a minimum and has stopped key

thumps in the neighborhood. Any of three keys can be used; the Vibroplex for fast work, the other two, straight keys, for DX or as desired.

MONITOR AND FREQUENCY METERS

A monitor heterodyne oscillator, identical in appearance and arrangement to the one described in the fourth edition of the Handbook, equipped with tube-base plug-in coils, is in frequent use to check the quality of the transmitter notes. It is also used to locate the transmitter waves on the receivers as an additional check on being sure the transmitter waves are within the band limits. Conversely it is used to locate favorable spots in the various bands to which to set the transmitter waves, so as to be free of interference. To determine accurately any desired frequency on receivers or transmitters, two General Radio Amateur type wavemeters are in use. One of these wavemeters (Type No. 358) covers all wavelengths from 15 up to 235 meters while the other (Type No. 558) covers merely the amateur bands and is therefore of greater accuracy. The Type No. 358 is still very useful in locating frequencies when calibrating new coils which at first try may not come within amateur band limits and which would

not come within the limits of the Type No. 558 meter.

For a quick shift in frequency within each band, each transmitter is calibrated so that it is known approximately what frequency it will transmit on at any particular dial setting. Due to the fact that climatic and other conditions cause some variations, this method of determining frequencies is not relied on for very accurate results. If, for example, it was desired to set either transmitter very near the limits of any band, an additional check would be made with a wavemeter to assure operation within band limits.

One of the most popular and efficient ways of testing used at W1WV is the "Station-to-Station Phone Method." This is accomplished by calling up by wire phone a neighboring station owner who lives about ten miles distant and having him listen to the transmitter note on his receiver. At this distance the note is usually strong enough to be retransmitted over the phone wires back to W1WV by simply holding the receiver earphones against the telephone mouthpiece. In this way adjustments can be quickly made and as quickly reported on or actually heard. It is a great time saver over the air method of testing and has been used continuously since W1WV first went on the air. It is of course needless to remark that in return similar tests are made for this obliging station owner whenever he so desires. There are many uses in having a telephone handy in the

shack. It has made it easy and practical when working a DX station, we will say, to quickly phone this neighboring station so he can also QSO. It has effected a number of DX contacts for both stations in turn. Likewise, messages can be delivered and answers returned with a minimum of delay while holding a station on the air.

ANTENNA SYSTEMS

Two antennas are used at WIWV. One is a half-wave 7000-kc. Zeppelin, with a $\frac{1}{4}$ -wave feeder and the other a $\frac{1}{2}$ -wave 14,000-kc. Zeppelin with a $\frac{3}{4}$ -wave feeder. Originally a bent form of Hertz was used with a very short counterpoise with moderate success. Considerable time has been spent adjusting the Zeppelins to the proper length to bring the voltage nodes in the exact center of the secondary inductance to obtain maximum efficiency and the minimum of losses and the results have been so satisfactory that no attempt has been made to try other forms.

The 7000-kc. antenna has a flat top length of 72 feet and the feeder is 32 feet long, measured to the center of the secondary inductance. The 14,000-kc. antenna is 32 feet long on the

to the eaves and the further ends are attached to braided window cord and run through pulleys and kept taut by 20-lb. iron window weights. The 7000-kc. antenna runs to a large tree and the other to the stable eaves. While neither of these

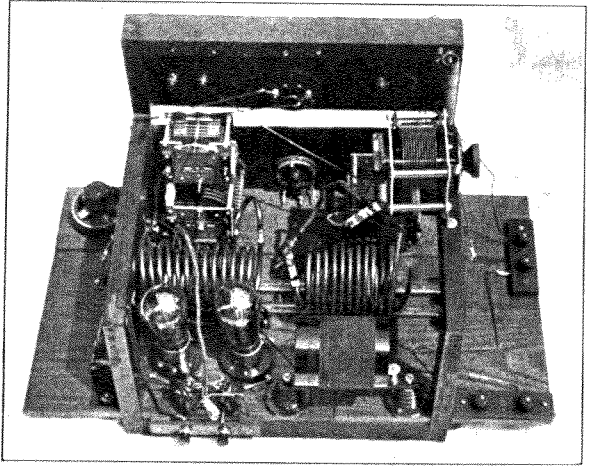

THE 3500- AND 7000-KC. HIGH C HARTLEY TRANSMITTER

antennas was designed to be used for 3500 kc. it was found that either one of them seemed to work equally well on 3500 kc. At present the 14,000-kc. antenna is being used for that band and the 7000 kc. one for 3500 kc. Due to the crowding and preponderance of notes that are not of the 1929 type on 7000, no work has been done on that band since the middle of March. As the station has been reported heard in Europe on 3500 with this 7000-kc. antenna and can frequently handle traffic with it as far west as St. Louis and Chicago, no attempt has been made to erect a special 3500-kc. antenna, particularly as the space available does not permit. A separate 60-foot antenna is used for receiving.

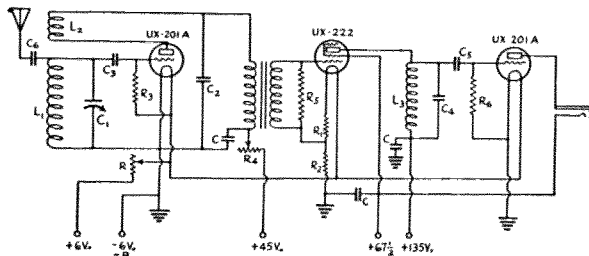

FIG. 3. — THE RECEIVER

- C* — 1- μ fd. Tobe by-pass condensers.
- C*₁ — Plug-in Pilot midget tuning condensers. A National Drum Dial, Type F, is used.
- C*₂ — 2000- μ fd. Sangamo by-pass condenser.
- C*₃ — 100- μ fd. Sangamo by-pass condenser.
- C*₄ — .01- μ fd. Sangamo audio tuning condenser.
- C*₅ — .006- μ fd. Sangamo audio grid condenser.
- C*₆ — Home-made 2-plate adjustable antenna tuning condenser.
- R* — Filament ballast resistor, for .75 amperes.
- R*₁ — 10-ohm Yazley fixed resistor.
- R*₂ — 5-ohm Yazley fixed resistor.
- R*₃ — 6-megohm gridleak.
- R*₄ — 50,000-ohm Frost variable resistor.
- R*₅ — 200,000-ohm Frost variable resistor for volume control.
- R*₆ — 8-megohm gridleak.
- L*₁, *L*₂ — Grid and tickler coils wound on Pilot coil forms.

flat top and has a feeder 49 feet long. No. 12 gauge enamelled copper wire is used and insulated with Pyrex glass insulators. Feeder spreaders are wooden dowels well soaked in paraffin, $\frac{1}{2}$ inch in diameter and $7\frac{1}{4}$ inches in length spaced three feet apart. The ends nearest the house are guyed

THE RECEIVERS

Until December, 1928, the receiver used was the familiar type of regenerative detector and two stages of audio using a well known type of plug-in coils. While this form of circuit always gave plenty of volume, in comparison to the present receivers now in use here it was very noisy and inferior. When the new bands came into being on January 1, 1929, even though this receiver had been adapted to spread them over a great part of the dial, the same troubles persisted and it was finally entirely abandoned, disassembled and rebuilt to match the four tube screen grid receiver

described in November, 1928, *QST*. This was not done, however, until an entirely separate receiver had already been built following the four tube screen grid hookup and then rebuilt to the three tube hookup which was preferred as being quieter and just as efficient. The second receiver was then changed to the three-tube screen-grid type. Like many others, the owner first made the mistake of reversing the grid connections on the screen-grid tubes of the four-tube set and much

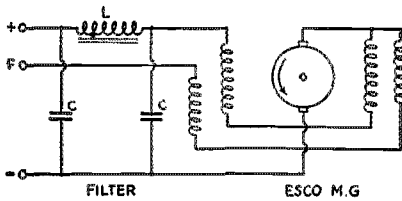

FIG. 4.—THE GENERATOR AND FILTER CIRCUIT

L — 18 henry filter choke.
C — $\frac{1}{4}$ - μ fd. 1000-volt filter condensers.

grief was experienced before the error was discovered; in fact, he began to wonder how *QST* could have been so taken in by Mr. Ross Hull in recommending such a receiver. Suffice it to say, the owner has still to find any receiver as simple, efficient or as eminently satisfactory as this one has proved to be. The arrangement of parts in the four-tube set was preferred and followed for the three-tube set. As a matter of convenience, the audio transformers are all mounted on G. R. plug-in bases so as to be interchangeable. This feature was also applied to the peaking condenser across the Ford coil. The two sets are actually four tube sets with the screen grid tube removed from the r.f. stage and the wiring changed where necessary. Therefore this station is now equipped with two of these three tube screen grid Ross Hull receivers which still further simplifies the task of quickly changing from one band to another. One receiver is kept on 3500 kc. and the other on 14 mc. so calibration in dial settings is never disturbed. Separate sets of "B" batteries are used and while not necessary it is found convenient to make use of two "A" batteries (each with a self contained charger) which, through a simple switching arrangement, can either one be used on either receiver and in addition can be switched into emergency use for the transmitter keying relay. One or both of them is also used for the eleven tube home built super-heterodyne broadcast receiver in the living room upstairs. Many of us have worked stations who would remark they were not getting us well because they had a dying "A" battery. It is not intended that this calamity shall ever happen at W1WV. While on the subject of batteries, arrangements have been made whereby dry "B" batteries could be substituted

for the generator in case the electric current was cut off in time of emergency.

Complete records of everything are kept at W1WV. Full notes are made of each QSO and are entered in the log book in condensed form and similarly entered on a 3 x 5 card kept for each station worked, ready for instant reference when that station is worked again. Changes in receiver or transmitter adjustments are carefully noted and have proved very valuable as time goes on in increasing efficiency. In fact, everything possible is done to make W1WV a model station in matters of equipment and operating; a simple station in which any operator could be at home in a moment.

New England Division Convention

Maine Section, Bangor, Maine
September 6th-7th

THE convention committee of the Queen City Radio Club cordially invites all those interested in amateur radio to attend its annual convention, to be held in Bangor, Maine, on September 6th-7th, and especially asks that you bring your YL or OW.

The convention activities will take place at the Y. M. C. A., and the big banquet at the Penobscot Exchange. The committee desires to say that it hopes to so plan the affair that the convention expense will not exceed \$2.50.

Let G. C. Brown, Secretary, 269 North Main St., Brewer, Maine, know if you will be present.

Strays

W1GZ makes a good suggestion for the "original" QSL card which should appeal to the chap with ingenuity and a little artistic ability:

"Sketch and letter your ideas on a post-card size piece of white paper using black india ink and avoiding extreme detail. Send the copy to any commercial engraving company with the request that a zinc plate be made. Such a zinc plate of post-card size costs about \$3.50, and the cost of printing from the plate is very small."

It Works While You Sleep

W6FHE has found a new way to increase his code speed. He tuned in a commercial station (one of the never-stop kind) and went to sleep with the cans on. After a week of this subconscious mind activity code speed had increased 3 words per. The total increment for a month's treatment was about eight words per minute. Psychologists, please note.

Introduction of Losses in Radio Circuits by Coupling

By Rinaldo De Cola*

THE subject of coupling and its effect upon the effective resistance and inductance of coils is very probably one of the most important problems encountered in the design of modern radio equipment. This is particularly true for such equipment as is designed for operation on the high frequencies. That this fact is not generally recognized is quite evident by the numerous difficulties usually encountered by amateurs in the design of coils.

The mutual effects of coupled circuits upon effective resistance and inductance in such circuits is a subject which is usually well analyzed in most serious books dealing with electrical theory. However the subject cannot be satisfactorily treated without the use of some mathematics, and the equations usually arrived at to show different conditions in such circuits are very cumbersome at best. This probably explains why the effects of coupling on the resistance and inductance of coils is regarded so mysteriously by many amateurs.

THEORY

Since the effect of coupling varies greatly with different arrangements of the secondary and primary circuits, only the system shown in Fig. 1A will be discussed. This system is shown in its equivalent form in Fig. 1B. Where in the primary circuit R_1 is the resistance; L_1 the total inductance, that is both the inductance of the antenna system and the primary coupling coil; and C_1 is the capacity of the aerial. In the secondary circuit R_2 , L_2 , C_2 , stand for resistance, inductance, and capacity respectively.

Using the notation designated above, the effective resistance of the secondary due mainly to the presence of the primary circuit can be represented by the following equation. (See: Colebrook-Alternating Currents and Transients. McGraw-Hill.)

$$R_2^1 = R_2 + \left(\frac{\omega M}{Z_1}\right)^2 R_1 \quad (1)$$

Where R_2^1 is the effective secondary resistance ω is equal to $2\pi f$.

M is the mutual inductance in henrys.

Z_1 is the primary impedance. ($Z_1 = R_1 + jX_1$).

The effective reactance of the secondary, as influenced by the presence of the primary is expressible by the equation:

$$X_2^1 = X_2 - \left(\frac{\omega M}{Z_1}\right)^2 X_1 \quad (2)$$

Where X_2^1 is the effective secondary reactance.

X_2 is the secondary reactance usually equal to 0.

$$\left(\omega L - \frac{1}{\omega C_2}\right) = 0.$$

X_1 is the primary reactance.

$$\left(\omega L_1 - \frac{1}{\omega C_1}\right) = \pm X_1.$$

By using $2\mu fL = X$ we can reduce the various reactance terms in terms of inductance if necessary.

By the use of equations (1) and (2) we can readily predict the effects upon R_2^1 and X_2^1 for different frequencies impressed upon the system. The following three cases will be considered: (1) Where X_2 is zero, and X_1 is positive or inductive. (2) Where X_2 is zero, and X_1 is negative or capacitive. (3) Where X_2 is zero and X_1 is also zero. M , R_1 and R_2 will be considered as constant in all the above cases.

Substituting the conditions assumed in Case (1) in Equation (2) we obtain a negative value for X_2^1 , which means that the inductance of the secondary circuit has been decreased by the pres-

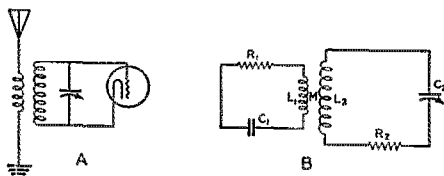

FIG. 1.—AN ANTENNA AND A CLOSED CIRCUIT COUPLED TOGETHER

At B is the equivalent circuit in which all the distributed constants have been lumped.

ence of the primary. This decrease in secondary inductance can be best illustrated by considering a small series capacity introduced in the secondary circuit. Since, however, X_2 is zero, the secondary circuit is now actually the equivalent of a small capacity in series with the total resistance of the circuit, which includes that introduced into the circuit by the presence of the primary. This condition is shown in Fig. 2A. This shows that the circuit is not resonant for the frequency where X_2 is zero, but will be resonant at a fre-

*Stmr. Cletus Schneider, Detroit, Mich.

quency somewhere above this. The effect of the added resistance R_c in this circuit will be to lessen the amplitude of any oscillations in this circuit.

Substituting conditions designed in case (2) we find that if the value of X_1 used in cases (1) and (2) are equal in magnitude but opposite in sign that the inductance of the secondary in case (2) has been decreased by exactly the same

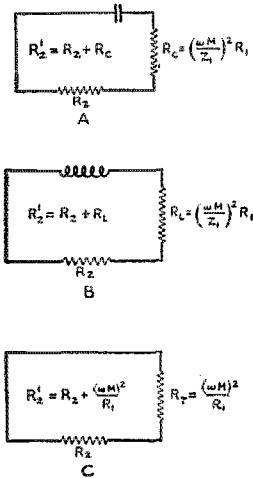

FIG. 2. — FORMULAS FOR THE CALCULATION OF THE EFFECTIVE RESISTANCE OF THE SECONDARY CIRCUIT WHEN THE PRIMARY CIRCUIT'S REACTANCE IS CAPACITATIVE, INDUCTIVE OR ZERO AND THE EQUIVALENT NETWORKS ARE GIVEN ABOVE

amount that it was increased in Case (1). The value for R_2^1 in this case is the same as in the first case considered. Since X_2 is also equal to zero in this case, the secondary circuit can now be represented by an inductance in series with the total resistance of the circuit, which is R_2^1 . This is illustrated in Fig. 2B. This shows that the circuit is not resonant for the frequency which makes X_2 equal to zero, but is resonant at a frequency somewhere below this.

When the conditions in Case (3) are satisfied by Equation (2) we find that the inductance of the secondary has not been effected whatsoever by the presence of the primary. In this case the secondary circuit can be represented by a simple resistance R_1 , shown in Fig. 2C. However, it is readily evident from Equation (1) that the effective resistance of the secondary circuit R_2^1 has assumed a much higher value than in the two previous cases. This is due to the fact that the value for Z_1 has been reduced to the value for R_1 which is usually very small. For this condition Equation (1) can be reduced to the form,

$$R_2^1 = R_2 + (\omega M)^2 / R_1 \quad (3)$$

It can be seen from this that for small values of R_1 the value of R_2^1 will be enormous. Condi-

tions of this nature frequently make themselves very annoying in many radio circuits. The three cases analyzed above are probably best illustrated by means of the graph in Fig. 3. It can be clearly seen here just how any variation in frequency effects the inductance and resistance of the secondary circuit. Fig. 3 also shows the effects of coupling on the circuit's resistance and reactance. The greater the value of coupling the greater the effective resistance, and also the greater the variations in secondary inductance.

HOW THESE LOSSES SHOW UP IN RADIO CIRCUITS

Many radio men after painstakingly designing an inductance to cover a certain frequency range when used with a known value of capacity, check up their calculations by testing for resonant

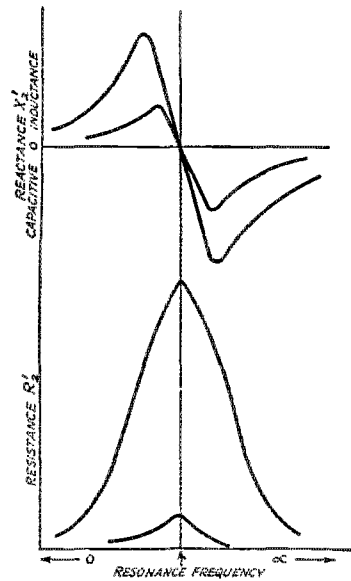

FIG. 3. — THE EFFECT UPON THE REACTANCE AND RESISTANCE OF THE SECONDARY CIRCUIT BY CHANGES IN FREQUENCY IS SHOWN

The smaller values for X_2^1 and R_2^1 were obtained by decreasing the coefficient of coupling, M .

clicks in some calibrated oscillating circuit and then find that when this coil is inserted in a radio system and coupled to some other circuit that it will no longer tune over the frequency range it was designed to cover. Why this is true can be seen from a consideration of Cases (1) and (2) and an inspection of Fig. 3 for these two cases. The remedy for conditions of this nature is to either redesign the coil or to reduce the value of the coefficient of coupling. This difficulty is most frequently encountered in tuned r.f. systems, where the plate circuit of the preceding tube is coupled rather closely to the next tuned circuit

with the result that the effective inductance of this tuned circuit is decreased. This is the condition considered in Case (1).

One of the most frequent examples of the condition discussed in Case (3) is to be found in almost every high-frequency receiver where for certain positions of the secondary condenser the circuit will stop oscillating. These positions are commonly called "dead spots" and are due to the primary circuit falling in resonance with the secondary. The reason for this has been shown

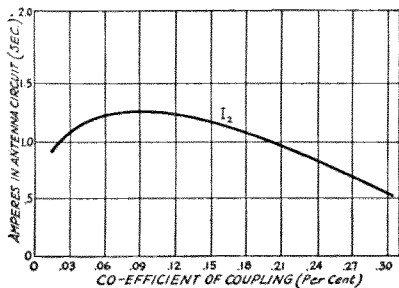

FIG. 4.—THE EFFECT UPON THE CURRENT CAUSED TO FLOW IN AN ANTENNA CIRCUIT OF CHANGES IN THE COEFFICIENT OF COUPLING INDICATES THAT MAXIMUM CURRENT IS NOT OBTAINED WITH THE GREATEST VALUE OF COUPLING

to be due to the relatively large value of resistance introduced into the secondary circuit, which exceeds the critical maximum value of secondary resistance which will allow sustained oscillations. The width of "dead spots" is greatly dependent on this critical value of secondary resistance and becomes wider, the smaller the value of this critical resistance. An inspection of Equation (3) shows that in order to decrease the value of R_2^2 and therefore eliminate the dead spots, we have three possible solutions. Changing the resonant frequency of the primary by inserting either a small series capacity or inductance in the primary circuit, decrease the value of the coupling, or insert a resistance in series with the primary. The first two methods are really not sure cures, since they only serve to change the resonant frequency of the system, and the "dead spots" will only show up at some other position of the secondary condenser. The third method eliminates this difficulty entirely, since it really gets to the base of the trouble, that is, it decreases the secondary effective resistance at the resonant frequency of the primary. The necessary value for this resistance was found to be about 5000 ohms, and should be inserted in series with the primary circuit. If your particular set happens to be directly coupled to the antenna circuit insert this resistance in series with the ground lead.

In Fig. 4 is shown a graph showing the variation of the secondary current with different values of mutual inductance. These values were plotted

from a transmitter circuit where the secondary current I_2 is the current in the antenna system. It is quite evident that the maximum value of secondary current is not obtained when the coupling is made a maximum. This is quite in contrast to the general opinion among amateurs that the coupling should be a maximum for the maximum antenna current. The reason for this apparent irregularity is due to the excessive values of resistance introduced into the oscillator circuit when high values of coupling are utilized.

Although there was found to be some capacitive coupling in the arrangement discussed, it was generally found to be sufficiently small as to not seriously interfere with the validity of these results.

New "X" Regulations

NEW regulations governing experimental licenses have been issued by the F.R.C. Hereafter these licenses will be issued for a year instead of quarterly, but holders must file reports every three months stating the nature of the experiments conducted and the results attained. "Experimental stations may be used only for experimental purposes. They are not licensed to conduct message traffic of any kind."

The above provisions apply to the usual variety of experimental station and also to the special types engaging in experimental work on relay broadcasting, television and aircraft work. The latter type receive frequency assignments in the allocations made for their special fields. The general experimental stations receive licenses to operate only on the eight frequencies set aside by the F.R.C. for general experimental work: 1604, 2398, 3256, 4795, 6425, 8650, 12,850 and 17,300 kc. All the classes of experimental licenses receive "X" calls.

No experimental license authorizes operation on any amateur frequency. For the most part these licenses are held by commercial companies. Amateurs holding experimental licenses, of which there are a few cases, may not now use such calls on the amateur bands. If the experimenter is a bona-fide amateur he may also take out an amateur license if he desires to work on amateur frequencies.

—K. B. W.

Strays

W2AS calls attention to the fact that the use of larger-than-usual filament by-pass condensers in the transmitter is effective in reducing key-clicks. By using by-pass condensers having a capacity of .1 μ fd. or larger in conjunction with the Xmas tree bulbs, an effective keying filter is obtained without additional apparatus.

Getting the Most Out of Your Meters

Ask the Man Who Ohm's One!

By Elmore B. Lyford*

THERE are two reasons for having a large assortment of meters of various kinds and types on the panel of an amateur transmitter. The first is to tell approximately what is going on behind that panel and the second is to impress visiting hams, OW's or what have you, with the high-and-mighty importance of the layout. It is certainly impressive to see a nice lot of meters reading assorted voltages and currents but if the main object is simply to tell what is going on all but one or two of these meters may be dispensed with — and that is the point of this article.

Lots of meters mean the investment of lots of money and since that is something with which the average amateur is not blessed, any scheme for saving some of the money should be interesting. This particular one takes a little time and figuring, but does save the money — and it is relatively simple.

The idea is one which is in quite general use with the larger radio, telegraph and telephone companies, but which is not, as far as the writer knows, generally made use of by the ham fraternity. It consists simply of using one or two meters with a variety of shunts and multipliers to cover each measurement being made — but with the shunts and multipliers at the point of measurement rather than all collected near the meter with some complicated switching system to select the one needed.

If it is necessary to make measurements of direct currents and voltages only, one meter is all that is necessary, but if a.c. measurements are desired, a second meter will be needed. Let us talk only about the d.c. measurements here — that will be sufficient to get the idea over and any amateur will be able to apply similar methods to his a.c. measurement problems.

The idea in a nutshell is the mounting of one low-range milliammeter with a suitably calibrated scale in some convenient place on the panel, and attaching to its terminals a cord and phone plug, the cord being long enough to reach any desired point of measurement. For each point in the circuit where it is desirable or necessary to make voltage or current measurements, a closed-circuit jack is mounted on the panel. Fig. 1A shows the connections of this jack when current is to be measured, and Fig. 1B shows the connections for a voltage reading.

It will probably be found most convenient in practice to use a ten-milliamperere meter and have all the shunts and multipliers so arranged that the readings will be in easy multiples of ten of the meter scale. That is, for a ten-milliamperere measurement there will be no shunt, for a hundred-milliamperere reading there will be a shunt equal to one-ninth of the internal resistance of the meter and so forth.

When this meter is being used as a voltmeter the series resistance should be of such size as to pass ten milliamperes when the voltage is at maximum. In other words, to measure ten volts

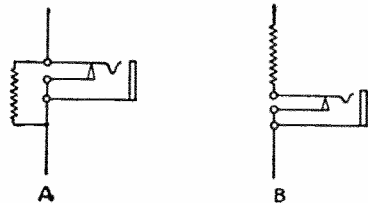

FIG. 1. — AT A IS THE CIRCUIT ARRANGEMENT FOR THE USE OF THE METER TO MEASURE CURRENT VALUES, WHILE AT B IT IS EMPLOYED FOR THE MEASUREMENT OF VOLTAGE

The range of the meter under either of these conditions is dependent upon the value of the external resistor as compared with the internal resistance and range of the meter

the series resistance should be one thousand ohms, to measure a hundred volts the series resistance should be ten thousand ohms, and so on. The meter resistance will be small enough to be disregarded when the meter is used as a voltmeter.

It will be noticed from Fig. 1B that the series resistor used when voltage readings are being made, is *always* in the circuit. This keeps the load at that particular part of the circuit always constant, regardless of whether the meter is in the circuit or not. This may be important in some cases where the additional drain caused by the insertion of the meter into the circuit might be sufficient to lower the voltage and give an incorrect picture of the operating conditions.

As an example of the application of this scheme Fig. 2 shows two jacks connected in the plate circuit of a tube, one for measurement of the current and the other for measurement of the voltage. The same meter plugged first into one jack and then the other makes both measurements and if desired may be left plugged into the voltage jack as a constant check upon the plate supply to the tube.

* 117 Waverly Place, New York City, N. Y.

If it is desired to make a.c. measurements as of the filament voltages, the input voltage to the power transformer, etc., the same scheme is applicable so that all the measurements may be

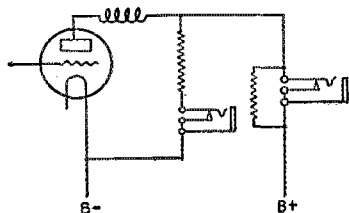

FIG. 2.—THE WIRING DIAGRAM SHOWN HERE PROVIDES FOR THE USE OF THE METER TO MEASURE THE PLATE CURRENT OR VOLTAGE DEPENDING UPON THE JACK INTO WHICH ITS PLUG IS INSERTED

The measurement of grid current and bias-battery potential may be similarly made.

made with one meter. In this case, however, the meter should be of the hot-wire or thermogalvanometer type, or a regular a.c. meter.¹ Care should also be taken to use nothing but non-inductive series and shunt resistors. If either of the first two types of meters are used, they will be equally as good on d.c. as on a.c., and only one will be necessary to make every measurement desired, including those at radio frequencies.

This scheme is deserving of wider application in ham circles than it is receiving, particularly in those cases where time and ingenuity are much more plentiful than is money.

Some Changes in Our Staff

WE announce the appointment of Mr. G. Donald Meserve as Advertising Manager of *QST*, succeeding Mr. F. Cheyney Beekley, who leaves *QST* to join the Maxim Silencer Company at Hartford. Meserve will have his office in New York City, from which better point of vantage he will pursue *QST*'s advertisers for larger and oftener advertising. It will be recalled that Meserve, for long 1FL of Hudson, Mass., and now W2JR of Woodside, L. I., has been with *QST* for something more than a year as Assistant Advertising Manager, for the past few months having been in charge of our newly instituted New York advertising office.

Miss Ursula M. Chamberlain, the w.k. "UMC" of the Advertising Department, becomes Assistant Advertising Manager and will carry on in Hartford. She remains Empress of the

¹ This is not strictly true of the thermo-couple meters, the deflections of which will vary with the direction of a direct current flow through them. However, for practically all d.c. measurements about the transmitter this is not damaging. At commercial frequencies they are accurate, this effect not being present.—EDITOR.

Hamad Department and will now conduct the other duties incidental to the publication of *QST*'s advertising.

For the past six years Mr. Beekley, W1KP, has been a major factor in the life at the *QST* factory. Joining us in August, 1923, as Assistant Editor in charge of production, he became Managing Editor in 1925 and in early 1926 also took over the post of Advertising Manager, carrying the combined duties for the past three years. An active amateur whose experience goes back into those dim early days of the craft, his has been the month-to-month responsibility for guiding, assembling and producing *QST*, and in the other branch of his work he produced much of the revenue which keeps the A.R.R.L. wheels rolling. This sounds rather like an obituary. Let us say that the gentleman is very much alive and kicking, and advances now to a field of larger opportunity, to which he carries the fondest wishes of our gang.

Naturally one man couldn't run Beek's two departments unaided. For the past three years the Managing Editor's office has had the assisting services of Mr. Clark C. Rodimon, W1SZ and other calls, proud operator of a pair of UV-861's. Mr. Rodimon now becomes our Assistant Editor, in charge of *QST* production, in which capacity he inherits the major portion of Beek's editorial duties.

We have now to announce the advancement of Mr. James J. Lamb to the post of Technical Editor of *QST*, succeeding Mr. Harold P. Westman; and the similar advancement of Mr. Beverly Dudley to Assistant Technical Editor, succeeding Mr. Lamb. Detailed specifications on these two gents were published in our May issue and will not here be reviewed. Suffice it to say that they both know their stuff thoroughly, particularly from the good old solid ham angle (in spite of the fact that they are both graduates of engineering schools), and will make an excellent editorial team.

To our deep regret Mr. Westman has decided to sever his connection with *QST* to become the Assistant Secretary of the Institute of Radio Engineers at New York City, a location which will enable him to pursue some technical studies in which he is keenly interested to better advantage than could be done from Hartford. Joining the Headquarters crew in early 1926 to conduct our Technical Information Service, he became Assistant Technical Editor the first of 1927 and Technical Editor in April of 1928. His was the technical responsibility for *QST* during one of our most difficult years, the preparation for "1929 conditions." Our readers know how well he succeeded in those duties. On the I.R.E. staff he will again be associated with John M. Clayton, one-time pal on the *QST* crew, so again our loss in the I.R.E.'s gain.

(Continued on page 43)

Helping the Beginner

By Alphy L. Blais*

TWO amateurs, representing the average in their class, were kept in mind while compiling these notes. The beginner, for one; the other, that fellow who has been in the game for some time but who lives far away from other amateurs. Consequently, these lines are not intended for the old timers, the full-fledged amateurs, the engineers and the like who would find here but little to interest them.

By beginner we mean the new arrival in our ranks who is just back from the Inspector's office where he passed his examination and has obtained his amateur ticket. Also, there is the beginner who has done very little active operating on his set; finally, the amateur who has little or no knowledge of the operation and maintenance of his transmitter and its strange behavior at times — when not continually.

Much has been done and said to help the beginner. Instructive and constructive articles have been published in *QST*, *The Radio Amateur's Handbook* has been printed, revised and filled to the limit with the most useful help one can find, amateur stations and broadcasting stations have put on the air special programs, clubs have been organized, tests held, contests made, prizes offered, much correspondence has been going and coming through the mails—in fact we wonder if the beginner has not had all the help he could wish for.

Yet we offer more help in a somewhat different setting. Let us say that the new amateur is, in some way, the baby of the family. A very pleasant addition to our ranks as he brings with him new vitality, ambitions and visions of wonderful work to be done; he is so full of "pep" that he becomes a stimulant for the other members of our fraternity. A young member, as counted in months and actual knowledge, he shall not long remain. In a short time he will have graduated from the hardships of the first month into a full-fledged amateur. But, until this time comes, when he can rely upon his experience, we must help him along, giving advice, communicating with him, slowing down our speed at the key and creating good will between him and ourselves. We must make things easy for him because he is the baby of the house and it is up to us to treat him as such, not as a spoiled child but as a future master of our art. His ABC of radio we must reach him with sugar-coated lessons, pictures, examples,

comparisons, suggestions that will do more than theories and formulas.

In the following notes we have left aside the theories and formulas to adopt, what we might call the service-manual method, wherein the symptoms of a set functioning poorly are described and remedies suggested, minus any technicalities other than those which we believe the beginner can easily understand.

This service-manual method appeals to us as having so many good points that we have chosen it with the firm belief that it will enlighten some of the new members and speed them along into becoming first-class amateurs.

It is important to mention some of the necessary equipment needed to assure the proper operation of the transmitter. The *monitor* is an essential unit; no amateur should be without it and expect to adjust his transmitter for maximum results. The frequency-meter is a close second, though one can do without it if he has a calibrated monitor. For full particulars on the construction and operation of such instruments see *QST* or *The Radio Amateur's Handbook*, chapter IX. The filament voltmeter and the plate milliammeter are two useful instruments to incorporate in the transmitter, the latter will help us considerably in detecting trouble and correcting it.

Due to the simplicity of construction and the low price of component parts the average amateur has either the Hartley transmitter or the tuned-plate tuned-grid arrangement. For this reason we will confine our remarks to these two sets, though other circuits are subject to almost the same troubles.

A few words on the UX-210 tube, used by the amateurs on a great scale. The constants which interest us most are those for the filament and plate.

The filament, for best results, is supposed to be heated from direct or alternating current, the voltage being from 6 to 7.5 volts, the latter being the customary voltage used. At no time should this voltage be higher than 7.5 if we expect our tube to have a long and useful life.

The plate voltage may be from 400 to 750 though this last value seems rather high. With 500 volts on the plate, the plate milliammeter should read between 50 to 70 milliamperes. If the reading is higher than 70 ma. this does not indicate that the tube is not functioning properly as different circumstances may bring the current as high as 100 ma.

And now for some trouble hunting. Let us

* VE2AC-VE2AS, R.M., Quebec Division, Box 221, Thetford Mines, Quebec, Canada.

suppose that the beginner has his set ready to work.

The filament is burning, the voltage adjusted to 7.5, and everything seems to be normal.

The key is pressed and we find that the plate current is high (100 mils or so) and the tube plate gets red. Even if there are no defective parts this is likely to happen because we cannot accurately guess the correct position of the filament tap on the tuning inductance of our Hartley circuit. High plate current usually indicates that there are too many turns between the filament tap and the grid tap. The filament tap should be slid along towards the grid and the key pressed again. Keep repeating this until the plate current again jumps to a high value. This indicates that the number of turns between the grid and filament are too few and the tube has stopped oscillating. The tap should be brought back a bit towards the plate end of the inductance. This, with very loose or no antenna coupling, will give a low reading of the plate meter (usually about 20 mils). The adjustment of the filament tap in this manner has very little effect upon the frequency of oscillation which is controlled by the condenser slanted across the coil and the number of turns across which it is connected. Now let us suppose that all does not work out so prettily and regardless of our juggling of the filament tap we have no reading on the plate milliammeter. Some possible causes may be as follows:

NO READING ON PLATE METER

- (a) Defective meter.
- (b) Reversed connections on meter.
- (c) Defective or broken connection between power supply and transmitter.
- (d) Defective tube.
- (e) Defective or broken connection in plate circuit.
- (f) Defective socket, poor contact at plate or grid prong.
- (g) Open grid circuit.
- (h) Defective grid leak.
- (i) Plate choke coil defective, open-circuited.
- (j) Defective plate or grid fixed (blocking) condenser.
- (k) Defective or broken connection in keying circuit.
- (l) Short-circuited filter condenser.

LOW READING IN PLATE METER

- (a) Defective meter.
- (b) Poor connection, loose high-resistance soldered joint.
- (c) Defective tube.
- (d) Poor connection in plate circuit, choke, socket.
- (e) Poor or defective plate or grid condensers.
- (f) Poor connection in keying circuit.
- (g) Defective grid leak.

HIGH READING IN PLATE METER 100 MA. OR MORE AND/OR PLATE GETS HOT

- (a) Plate voltage too high.
- (b) Defective tube.
- (c) Antenna coupling too close.
- (d) Defective tuning condenser.
- (e) Antenna circuit, too close to resonance point.
- (f) Defective grid or plate condenser.

METER GOES OFF SCALE OCCASIONALLY, SIGNALS BREAK AND/OR PLATE GETS HOT

- (a) Too high plate voltage.
- (b) Filament tap too close to critical position.

- (c) Antenna coupling too close.
- (d) Antenna circuit tuned too close to resonance point.
- (e) Defective grid leak.

AUDIO NOISE HEARD IN TRANSMITTER WHEN KEY IS CLOSED

- (a) Flashing between plates of tuning condenser.
- (b) Defective grid leak.
- (c) Short-circuit in plate condenser.

WHEN ANTENNA CIRCUIT IS TUNED TO RESONANCE PLATE METER GOES OFF SCALE

- (a) Too close coupling.
- (b) Antenna circuit tuned too closely to resonance point.

NO ANTENNA CURRENT

- (a) Coupling too loose.
- (b) Antenna meter too high range.
- (c) Antenna not suitable for frequency of operation.
- (d) Tuning condenser too small.
- (e) Incorrect method of coupling (mainly encountered when operating antennas at a harmonic).

Most of the trouble indicated here will be quickly cured if the amateur will check up on all connections and replace the suspicious accessory. It is well to remember that working the transmitter with overloaded tubes and poor equipment is a cause of much trouble. Cut down the power, and follow directions given by the manufacturers on the operation of their equipment.

No remedies to the troubles described have been suggested as we believe that they are apparent without mentioning them. A careful reading and study of *The Radio Amateur's Handbook* will give the new amateur much of the information he cannot find elsewhere.

We keep a notebook at hand when tuning a new set or when making adjustments, any abnormal thing that happens is written down and, after a few hours of experimenting, these notes are examined and 95% of the troubles cured by a careful study of them and the conclusions arrived at put into practice.

Some Changes in Our Staff

(Continued from page 41)

Our readers will again note that openings occur on the League's Headquarters staff. We desire, whenever possible, to fill these vacancies from the ranks of A.R.R.L. membership, so that we have people not only professionally proficient for their duties but possessed of amateur experience and A.R.R.L. background. It will be noted that there are many fields of duty at Headquarters. We shall be pleased to enter into correspondence with candidates interested in future Headquarters openings.

— K. B. W.

An Effective Break-In System

By Rienzi B. Parker*

THE desirability of break-in in commercial operation has been recognized, and its advantages in amateur communication have been stressed in QST. The difficulty which confronts the amateur who attempts to install a break-in system is mainly one of expense, for the recognized systems employ a double relay which is very difficult to make and expensive to buy. Another point which the amateur must keep in mind is the quietness of the system, as most of the stations worked out a pretty faint signal into the headset and a break-in which produces any noticeable degree of clicking cannot be tolerated. The system about to be described is now in use at the writer's station. It appears to be infallible. It is silent, and is easily made out of standard parts.

Referring to Fig. 1, it will be seen that the keying circuit contains two relays. One of these, Relay No. 1, is used to key the set in the usual manner, while Relay No. 2 functions in the break-in system.

The output from the receiver is fed through an output transformer. This may be any type of audio transformer, and if there is an old one lying around it can be put to good use. The receiver output goes to the primary and the phones are connected across the secondary.

The terminals for the relay contacts are also connected across the secondary of the transformer. As a result, when the relay closes the secondary of the transformer and the phones are shorted and the phones are dead. When the relay opens, the connection is reestablished through the transformer to the receiver. The closing and opening of the contacts on the break-in relay, Relay No. 2, cause no click of any kind.

In order to make the system function effectively, the keying relay should be adjusted with a moderately wide gap and a moderately stiff spring, while the break-in relay is adjusted very close and with as slack a spring as possible. When the proper adjustment is secured, the keying relay, due to the wider spacing between contacts, closes one split second later than the break-in relay; and it opens, due to the stiffer spring, one split second faster than the break-in relay. The effect of this is not to start the transmitter until *after* shorting out the phones, and not to put the phones back in circuit until *after* the transmitter has stopped. As a result, key clicks from the transmitter are eliminated. This adjustment is very simple to make. It consists

chiefly of regulating the spring of the break-in relay after setting the contacts as close as possible, and once made no further trouble will be experienced.

The only source of click in the headset is from the relay circuit proper. This cannot be eliminated as it is necessary to close the circuit before the relays act and open it before they cease functioning. The click can be minimized by using the lowest possible current in the relay circuit.¹

At the writer's station the relays are standard pony relays of 20 ohms each and are operated by one dry cell. It is possible, of course, to make the relays from old telegraph sounders, but if home made it is advised that the magnets used have enough resistance so that the relays will function with only a small current. The writer has experimented with home-made relays and has found

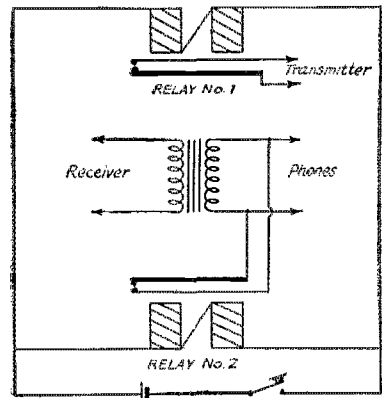

FIG. 1.

the pony relay to be highly satisfactory and superior to anything which ever came from the home work-shop.

It is advisable to run the relay circuit from a separate dry cell. It does not run down quickly. If the relays are run off a coil of the receiver "A" battery, there is a tendency for the clicks of the relay circuit to be stronger in the receiver.

It is possible to use the break-in relay to short the secondary coil of the receiver instead of an output transformer, and this method will give

(Continued on page 80)

¹ A 1- μ d. by-pass condenser in series with about 50 ohms should overcome this difficulty entirely by absorbing the energy in the spark that occurs at the key contacts.

* W1AJZ, 138 Forest Ave., West Newton, Mass.

Experimenters' Section

PROBLEM T-26 — KEYING METHODS

APPARENTLY the problem of how best to key the transmitter will always be with us. It is not the sort of question that can be given a short answer with the expectancy of its being forever relegated to the "once upon a time stumped us" list. It seems that every factor that has anything whatever to do with making a tube oscillate is involved in the problem of starting and stopping these oscillations and with such a varied and complex assembly of important items it is little wonder the results of operating the key are not always what we most desire them to be.

During the past, many contributors to *QST* have supplied what they considered to be the final answer to this problem. It was — as far as their own transmitter was concerned — but when the same arrangement was applied to a

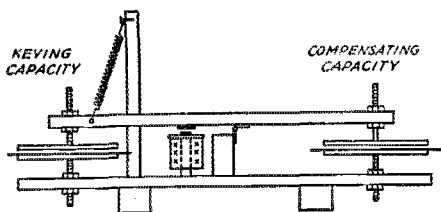

FIG. 1—COMPENSATED KEYING

different transmitter employing the same circuit and power the results were not so gratifying. Apparently it is necessary to treat each case as an individual problem and with this thought in mind we have presented in *QST* many articles concerning this subject.

The bibliography that follows lists articles concerning all manner of answers to the problem of keying. Not all are devoted to the elimination of clicks and thumps; some are devoted to break-in systems while others cover various types of keying relays and semi-automatic keys. Following the bibliography are three additional items on this subject:

QST

- Arless Keying (Keen), July, 1925, p. 71.
- Key-Thump Filters (Kruse), Nov., 1925, p. 31.
- A.C. Relays (Westman), Feb., 1926, p. 42.
- Non-Chattering A.C. Relays (Hayes), April, 1926, p. 60.
- Simplifying Operating (Clayton), May, 1926, p. 21.
- Bugs—Hints on Operation (Handy), May, 1926, p. 61.
- Break-In and Remote Control (Clayton), Sept., 1926, p. 9.

- A Sensitive Vacuum Tube Relay (Hoffman and Schnell), Nov., 1926, p. 20.
- Break-In (Mason), Nov., 1926, p. 52.
- A Break-In Relay (Brainard), Dec., 1926, p. 34.
- Break-In With Motor Generator Supply (Walzele), Dec., 1926, p. 63.

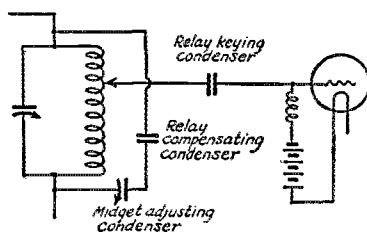

FIG. 2

- Concerning Break-In (Stinson), Dec., 1926, p. 65.
- Keying Battery Operated Transmitters (Walker), Feb., 1927, p. 56.
- An Overload Relay (Westman), April, 1927, p. 14.
- Some Convenient Relays (Kruse), May, 1927, p. 27.
- Keying the Amplifier (Shafer), July, 1927, p. 32.
- Clickless Keying (Buening), Sept., 1927, p. 68.
- More About Clickless Keying (Cross), Nov., 1927, p. 42.
- Another Suggestion on Keying (Griffith), Nov., 1927, p. 52.
- A Possible Method of Voice or Key Modulation (Kruse), Dec., 1927, p. 34.
- Keying Master Oscillator Circuits (Dudley), April, 1928, p. 37.
- Relays for the Amateur (Lampkin), July, 1928, p. 33.
- Keying for Break-In (McCormick), Nov., 1928, p. 31.
- Remote Control Relays (Fixman), Dec., 1928, p. 28.
- The Requirements of Transmitter Keying (Hull), Feb., 1929, p. 9.
- Keying the Oscillator-Amplifier (Loudon), May, 1929, p. 30.

RADIO AMATEUR'S HANDBOOK

- How to Grip the Key, p. 13.
 - Keying Circuits, p. 125.
 - Key Clicks, p. 124.
 - Keying Filter, p. 124.
 - Keying the Transmitter, p. 124-125.
- The pages specified in the above handbook references are for the fourth edition and although the same material appears in the older editions, the pages upon which it will be found will not be

the same. Refer to the index if you have not the fourth edition.

COMPENSATED CAPACITATIVE KEYING

The use of a capacitive relay in the interstage feed line of an oscillator-amplifier transmitter is by no means a new method of keying. However it has some drawbacks chief among which is the fact that a change in the capacitive coupling between the two circuits involved causes sufficient detuning when the capacity is smallest (the key open) to cause the preceding tube to run warm

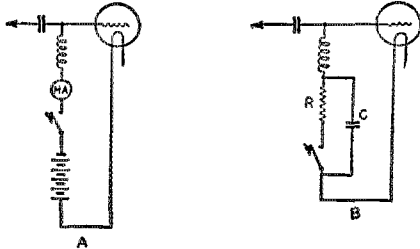

FIG. 3—MINIMIZING KEY THUMPS

or even run hot depending upon the degree to which it is loaded when the key is down.

G. W. Hamilton of W6AWZ at Long Beach, Calif., encountered this difficulty and cured it by employing a compensating relay as shown in Fig. 1. The armature bar which is of insulating material is pivoted at the center, a small hinge being used. The condenser discs fastened to each end of the armature are of 1/16" aluminum, 1.5 inches in diameter. The surfaces of all the discs were ground flat on a piece of plate glass with the aid of a little emery powder. A sheet of mica was glued to the lower stationary plates to prevent short circuits and increase the maximum capacity. The spring holds the keying plate about an eighth of an inch from the lower plate and keeps the compensating plates in contact with the mica sheet. When the key is closed it energizes the magnet which was removed from a bell and attracts a small piece of iron which is fastened to the armature just above it. This causes the keying disc to be drawn toward its stationary plate thereby increasing the capacity of that unit. At the same time the compensating disc is moved away from its stationary plate and the compensating capacity is reduced.

The circuit arrangement is indicated in Fig. 2. The circuit is adjusted in the normal fashion with the key down. When the key is opened, the preceding stage should be brought into resonance again by means of the midget condenser in series with the compensating capacitor. A flashlight bulb connected into a single turn of wire will do nicely for an indicator. The minimum capacity of the keying and compensating units are, apparently, low enough to prevent any damaging de-

tuning by their addition into the circuit. When properly adjusted the input to the preceding stage does not vary with the keying and key clicks are conspicuous by their absence. A receiver tuned to the exact wave of the transmitter and located but ten feet away merely blocks quietly without any sign of click or thump.

MINIMIZING THE THUMP WITH GRID BLOCKING KEYING

Many amateurs employing oscillator-amplifier transmitters key in the grid bias lead to one of the amplifier tubes. In a large number of cases this results in a bad click or thump which refuses to yield to readjustment of bias voltage, plate input and such factors. Louis F. Leuck, W9ANZ, of Lincoln, Neb., comments upon this as follows:

"Fig. 3A shows a method of keying that is rather common and while it does not always produce a key thump, it has considerable possibilities along that line. The method illustrated in Fig. 3B is, however, far superior and is my excuse for taking up this valuable space. With this method there is absolutely no thump when the key is opened and only a very slight thump when it is closed. This is when listening in on the same frequency as the transmitter.

"On looking at 3A we note that when the key is closed the bias applied to the grid is -90 volts. When the key is opened the grid immediately assumes a higher bias. This is due to the grid current charging the grid as one plate of a condenser, the other plate being the filament circuit and everything connected directly to it. This "blocks" the tube and due to the very small capacity between the grid and associated equipment this happens almost instantly. When the key is closed this small condenser is short

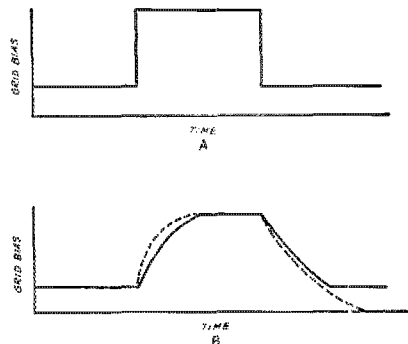

FIG. 4

circuited and the charge disappears in an exceedingly short period of time. The bias again becomes -90 volts due to the battery. This change of bias with keying is approximately illustrated in Fig. 4A.

"Fig. 4B shows approximately the conditions that exist with the method illustrated in Fig. 3B. In this case when the key is opened the bias gradually assumes a high blocking value. When it is closed the change is again gradual. The dotted lines indicate the charge of a condenser from a fixed voltage and its discharge through a resistor. The charge and voltage across the condenser will be slightly modified in this case and is indicated by the heavy lines.

"When the key is closed the grid current for the tube will flow through the resistor causing a voltage drop across it which takes the place of the bias battery. Under these conditions the condenser, C, is maintained at this bias voltage because it is shunted across the resistor. However, its capacity is large and when the key is opened it tends to act as a momentary short circuit across the key and leak. The grid continues to accumulate electrons which charge the condenser until its voltage reaches a value that will block the tube. When the key is closed, the condenser cannot discharge instantly because it can only discharge through the resistor. This causes the

its exciting tube. This should be arranged for a quick change-over to be used at such times when the back-wave is bothersome. Decreasing the

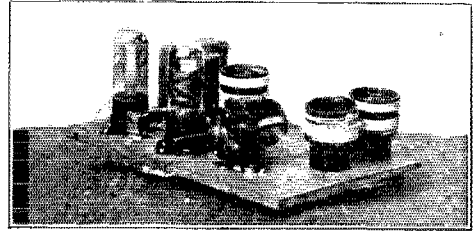

THE RECEIVER

The two plates of the midjet condenser that are turned half way around to increase the minimum of the condenser and spread out the tuning band are apparent. The condenser is driven through a flexible coupling to reduce alignment troubles as the panel is not fastened to the base.

coupling seems to decrease the strength of the signal more than that of the back-wave.

"No key thump is discernible in the semi-a.c. broadcast receiver located less than five feet from the transmitter.

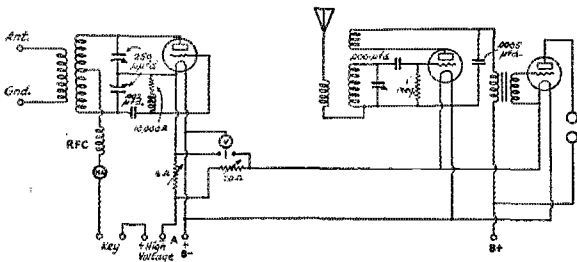

FIG. 5 — PORTABLE IN AN AUTOMOBILE

charge to leak off at a slow rate and the bias drops gradually to the value maintained by the grid current flowing through the resistor.

"The resistor may be a variable one or its value may be computed from Ohm's Law provided the grid current and required bias are known. In my particular case the grid current was 0.01 amperes and the desired bias 90 volts.

$$R = \frac{90}{0.01} = 9,000 \text{ ohms.}$$

The capacity of the condenser, C, determines the slope of the charge and discharge curves and the larger the capacity, the flatter will be the curves. A 1- μ f.d. unit works well although it may be reduced to 0.5 μ f.d.

"Both of the methods shown in Fig. 3 fail to completely block the tube and a slight back-wave will be apparent. I have noticed that the only time this back wave is objectional is when the signal is strong enough to tend to block the detector at the receiving end. A remedy for this is to reduce the plate input to the last tube as by decreasing the plate voltage or increasing the bias of

SEMI-AUTOMATIC KEYS

"There is a broad variation of opinion regarding the speed at which semi-automatic keys should be operated. Some operators are very skilled in their manipulation at a high rate of speed and appear to be handling a large number of messages per hour. However, at the end of a few hours it will usually be found that the more deliberate and steady sender has handled as much

if not more business than the high speed operator. Among the many things responsible for this is the capacity of the receiving operator to handle the higher speed without the necessity of repeats besides transmission and receiving conditions.

"The general rule for the adjustment of the instrument for land line work is that approximately eleven dots per second shall be made. The stationary contact on the dot side should be so set as to pass one half the current that is passed when the dash lever is pressed. This adjustment is made with a milliammeter in the circuit.

"For radió work this dot adjustment has been found to be too light and there are two ways in which it can be overcome. One method is to slide the speed control weight to the extreme outer end of the vibrating reed and the other is to close up the stationary dot contact until the current is about two thirds that when the dash is made. When once adjusted to give the desired spring tension for the levers, no further change should be made as one adjustment is as good as another

after the operator has become accustomed to the key."

— L. C. McIntosh, *Ultimate Transmitter Co.*,
4136 Builong St., Los Angeles, Calif.

A PORTABLE FOR THE AUTOMOBILE

We are showing herewith some photographs and the circuit arrangement of a portable transmitter and receiver constructed by Herman Radloff, W9AIR, of Sleepy Eye, Minn. The outfit was devised to be carried around in an automobile and accordingly does not have to be pruned down to the last ounce and thousandth of an inch.

The receiver portion of it comprises a pair of '199 tubes in a detector and one step combination. It, as well as the transmitting portion, is mounted upon a baseboard which fits into

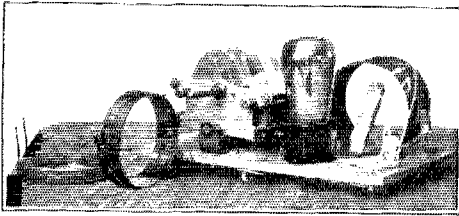

THE TRANSMITTER

The strip visible within the coil clamps down on it and the antenna coupling coil when it is in place. It holds the coupling at a constant value in spite of most bouncing. The clip making contact to the center of the coil may be seen at the extreme right of the coil.

grooves in the cabinet wall. This allows either unit to be removed from the cabinet for any necessary work that must be performed, a factor that is particularly advantageous if something goes hay-wire "on location."

The panel is not fastened to the baseboards and to prevent trouble in getting the tuning condensers properly aligned, a Hammarlund flexible coupling and extension shaft is employed. The power leads are lead to Fahnestock clips mounted on the center partition and to remove a unit calls for the loosening of three leads and the tuning dial set screw. When in place, the rear cover fits snugly against the units and allows no play when the set is being handled.

A 50- μ fd. Pilot condenser of the midget variety is employed for tuning the receiver. In order to spread out the tuning band, two of the rotor plates have been turned half way around so as to give in effect two circular plates which increase the minimum capacity considerably at the same time robbing from the number of plates available for varying the capacity.

Tube base coils are employed and the antenna coupling coil is wound around the socket into

which the coils plug. In portable sets used in the past, trouble was experienced in keeping all the coils together; they showed a keen desire to always get lost at about the time they were needed. To overcome this difficulty, two extra sockets are provided to hold the two coils that are not in use. This has proven to be quite effective and we hope to end the season with the same set of coils which were initially provided.

Inasmuch as extreme sensitivity is not essential, no control of regeneration has been provided. If desired, though, a resistor could be connected in the battery lead to the detector tube and mounted at any convenient position. The filament voltmeter is provided with a switch which allows it to be connected across either the receiving or transmitting circuit filaments.

The transmitter employs a 201-A in a Colpitts circuit. Plug-in inductances are used so as to allow shifting from one band to another. The inductances are made of Hammarlund 3-inch coil material and the two outer ends slip into a pair of XL binding posts. These posts are so constructed that the wire is released when the head of the post is depressed. This simplifies the change of coils and does away with any chance of the binding post tops being vibrated loose and getting lost. A short section of the wire at the center of the coil is bared and allows the power supply lead to be clipped to it.

A Cardwell dual section 250- μ fd. condenser is used for tuning the oscillator circuit. The key is plugged into a pair of posts on the top of the cabinet which is of hard maple boiled in paraffine and fitted closely enough to be practically dust proof. The plate supply for the transmitter is obtained from a magneto out of a megger. This device was described on page 52 of the March, 1928, issue of QST.

For 7000-ke. operation, the antenna consists of a single piece of No. 14 rubber-covered wire



A REAR VIEW OF THE SET WITH THE BACK OF THE CABINET REMOVED

The transmitter is to the right while the left side houses the receiver. The extra coils for the transmitter are stored away under the receiver baseboard.

strung to the nearest suitable support. An eight-foot counterpoise is employed and the set is operated from the rear seat of the car, the two wires passing through holes drilled in the rear window. A suitable strain rope to prevent the window from being pulled out of the car is pro-

(Continued from page 78)

The Communications Department

F. E. Handy, Communications Manager
L. R. Huber, Asst. to Coms. Mgr.
1711 Park St., Hartford, Conn.

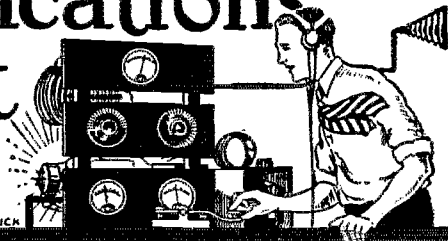

W1ZZA—A Practical Portable

By Harold T. Mapes*

The term portable, when applied to radio, is one that can be investigated rather closely before one bursts forth with an exclamation of enthusiasm. There are two reasons why this is so. First, if a radio transmitter-receiver actually is portable, the sacrifice that is made in apparatus and power supply in order to decrease weight will usually render the set ineffective as a means of communication. Second, if a radio transmitter-receiver actually does perform well, it is often so bulky and heavy that, even though it is designed to be portable, it is actually nothing of the sort, unless one wishes to consider hiring several porters and a Mack truck for every trip that is to be made.

The best compromise between portability and practicability always seems to be an unhappy one. While it is feasible to build a high-frequency receiver that can be carried about by one person, with antenna, batteries, and 'phones, the problem of making a combined transmitter-receiver is one that calls for a more adequate means of transportation than one man physically by himself can provide. Especially is this true if the transmitter end of the combination is to be one on which reliance may be placed.

The portable set described in this article is one which, the builder frankly admits, is not portable without the use of an automobile. Therefore at the start it is necessary to sound a warning "hands off" to those who are looking for an outfit that can be carried all in a handbag. In our modern age of gasoline and motor cars, however, there are apparently few who will balk at this limitation. Heigh ho! what're a few dollars burnt in oil? For most amateurs such a set as Mr. Mapes describes will prove to be a full answer to all expectations where portable radio is concerned. — EDITOR.

AFTER the day's run, when the tent had been erected, camp set in order, supper eaten, and the beds made, it was no trouble to stake out the two antenna wires, hook on the "A" and "B" supply, and pound brass from portable W1ZZA. There was seldom a slip anywhere during the several long trips on which this portable accompanied me. Hundreds of contacts were made on the 14-mc. and 7000-ke. bands. Reliability was so good that on several occasions, for periods of many days at a time, regular schedules were maintained at appointed hours—usually at make of camp in the evening, and sometimes just before breaking camp in the morning—with distantly located amateurs. Those who followed the progress of W1ZZA on these trips always seemed to get a real thrill from hearing the new "TR" report at the end of the day. Aside from the schedules a good deal of general work was done. I never found it difficult to work within a radius of 500 miles, during day or night, on one of the two bands for which the outfit was equipped. Occasional feats of DX to the extent of a thousand miles or more were not at all uncommon, depending on the sort of a location at hand. Last winter, when I spent a month in touring Florida, a regular schedule was maintained with W1RP in Bridgeport, Connecticut, so that the folks at home were informed of the progress made, the interesting incidents of the day, etc. On a tour of the West last summer, consistent schedules were maintained with W6DYE of Salt Lake City, Utah, and with W9FUY of Cragmor, Colorado.¹

The set itself, shown in Fig. 1, is contained within an ordinary 12" by 24" suitcase. The cloth straps shown in

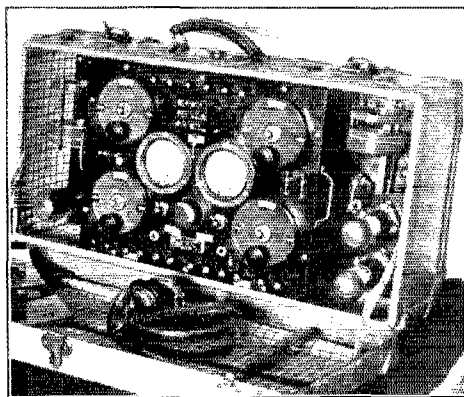

FIG. 1.

this photograph have since been removed to allow the use of hinges designed to permit removal of the cover when the

¹ At this time it is understood that Mr. Mapes is again spending several months in the western states with Portable W1ZZA.

* 200 Hazelwood Ave., Bridgeport, Conn. For eight years operator of Mexican BX; ex-3AUC; at present W1BK and W1ZZA. Also ex-KDWN and other commercial ship stations.

outfit is in use. The entire set can be lifted out of the suitcase and operated from a table or stool.

In the camp trailer that was hauled on all of the long trips I built four special compartments to accommodate the

The construction of the set was attempted after considerable deliberation on design. The suitcase was selected as the most conveniently adaptable container for the working portion (coils and dials as distinguished from "A" and "B" supply) of the outfit. In order to make the set fit this container, it was necessary to construct it as flat as possible. The combination of parts finally adopted consisted of an arrangement partly panel style and partly breadboard style, with the tube sockets so arranged that, whether the set was used flat on its back or sitting in an upright position, the axes of the tube elements would be vertical. All of the controls were mounted on the panel portion. Whereas the tubes and coils are mounted in breadboard style at each end of the panel, on a lower level. The photograph (Fig. 1) will show this clearly. The dimensions of the panel-breadboard combination are shown in Fig. 3.

On the left side of the suitcase are the transmitting tube, plug-in inductances, etc., and on the right side are the receiving tubes, plug-in coils, etc.

The coils of both the transmitter and the receiver are of Hammarlund 3" coil material, mounted on plug-in base material. It is entirely possible, of course, and in many ways desirable, to use tube-base coils in the receiving circuit in place of the 3" coil material. Greater compactness could be had in this way. The two transmitter coil sets each have the antenna coupling coil mounted along with the primary coil. While this set was fitted only for the 14-mc. and the 7000-ke. bands, it should not be difficult to construct coils suitable for the 3500-ke. band, or even the 28-mc. band, if proper precautions and provisions be made. In the 7000-ke. coil set for the transmitter, the primary consisted of three grid turns, six plate turns, and was spaced a distance of $2\frac{1}{4}$ inches from the antenna coil, which had five turns. The 14-mc. coil set for the transmitter had a primary consisting of one grid turn

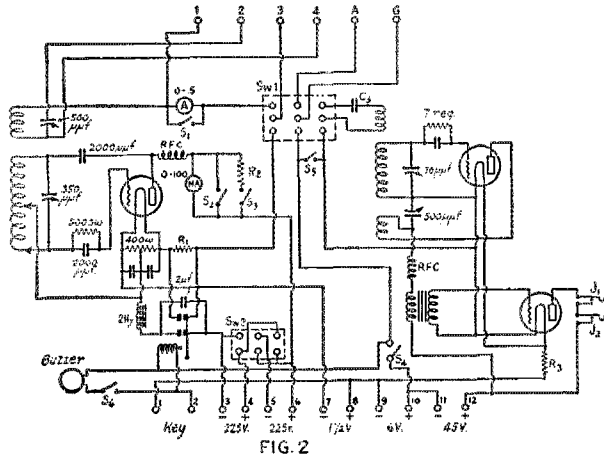

FIG. 2

C₁ and C₂ — 2000 µfd.

C₃ — 100-µfd. fixed condenser to be plugged in for shifting dead spots

R₁ — 3-ohm fixed resistance used in conjunction with extra relay contacts to keep transmitter tube filament temperature constant

R₂ — Multiplier resistance of value sufficient to double reading of the 0-100 m.a. meter

R₃ — Filament rheostat for receiver tubes

radio set and its accoutrements. Sponge-rubber cushions were provided in one compartment into which the transmitter could be placed, if so desired. The next compartment held the receiver "B" battery and five 1½-volt booster cells (No. 6 dry cells connected in parallel by themselves but in series with the main "A" battery) which were necessary to bolster up the potential for the filament of the 6X210 of the transmitter. The third compartment was fitted with a three-gang socket mounted on spiral steel springs. The three

turns, and was spaced a distance of $2\frac{1}{4}$ inches from the antenna coil, which had five turns. The 14-mc. coil set for the transmitter had a primary consisting of one grid turn

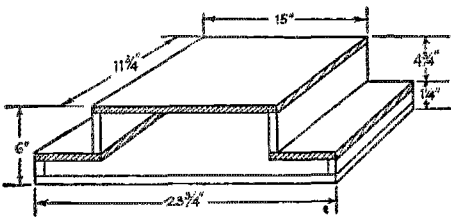

Shaded portions are bakelite. Plain portions are wood.

FIG. 3

tubes of the set were carried in this compartment for protection against mechanical jarring and jolting when the car was on the road. The fourth compartment contained spare coils, phones, and the several antenna systems when coiled up. There was a fifth compartment in the form of a box built to house the Burgess "R" battery of 450 volts (two sections of 225 volts each). This box was bolted beneath the trailer.

In the Chrysler roadster was contained the extra six-volt filament battery, connected permanently in parallel with the auto's battery. At no time was I without adequate filament power, even when some particularly pleasant camp site called for a few days' extra stay, during which time the automobile was used but little, consequently with but little charging of the filament batteries.

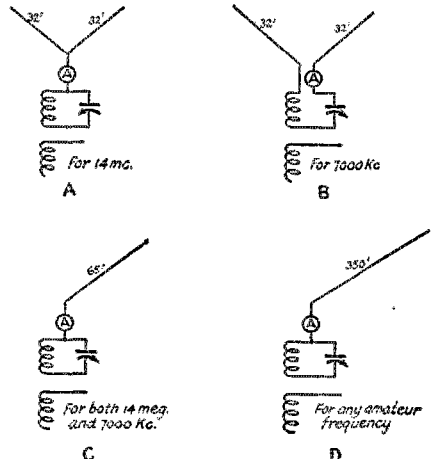

FIG. 4

and two plate turns; the primary was spaced three inches from the antenna coil, which had three turns.

The circuit diagram is shown in Fig. 2. For clearer explanation of the positions of switches, jacks, binding posts, etc., Fig. 5 is shown with these parts labeled corresponding to the diagram in Fig. 2. The photograph (Fig. 1) unfortunately is not clear enough to show these details, which are necessary to anyone wishing to construct a similar outfit. As will be seen readily, the three-pole double-throw switch,

Sw1, is used for changing from the transmitting position to the receiving position, and *vice-versa*. The filaments of the receiver are cut out of the battery circuit when the transmitter is in use, unless the switch S5, which was provided for

could not be erected in all locations, but seemed to be more effective for DX when it could be used.
The writer has constructed a number of portables and, generally speaking, has had very good luck with them, but this one eclipsed all previous sets, and has proved in every way to be worth the money and time that has been spent on its construction.

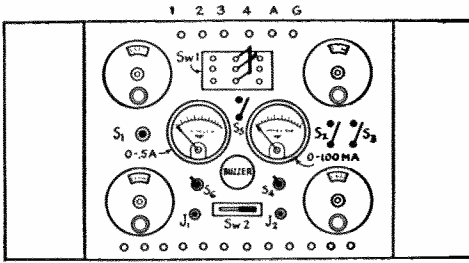

Showing arrangements of switches, meters, and jacks in circuit diagram of Fig. 2
FIG. 5

the express purpose of allowing use of the receiver during transmission, is closed. The transmitter tube's filament is cut out of the battery circuit when Sw1 is thrown to the receiving position.

The two-pole double-throw switch at the lower side of the panel is a Federal toggle switch used to permit the use of either high power or low power. For high power the two 225-volt sections of "B" battery are connected in series, and for low power they are connected in parallel, thus assuring longest battery life and conservation of power.

Switch S1 is used as a multiplier for the antenna ammeter, so that the current flowing in the circuit is twice the amount indicated by the meter. The first arrangement of S1 that was tried was similar to the connection of S2 on the plate milliammeter, but proved to be of poor multiplying quality. As a solution a knife switch was mounted directly on the terminals of the antenna ammeter. An extension handle through the panel permitted the operator to open and close this switch at will. The extension handle is indicated as S1 in Fig. 5.

A similar arrangement is made for the plate milliammeter although in its case the one-pole single-throw Muter switch on the panel, shunted across the milliammeter by wire connection, is sufficient to short out the meter entirely, so that no reading is obtained when operating the set. S3, connected with resistance as shown, carries one-half the plate current when closed, so that the milliammeter indicates, as in the case of the antenna ammeter described above, only one-half the current in its circuit.

S4 is the main power switch for both the transmitter and the receiver. It handles only filament current.

S6 permits the buzzer to be connected in shunt with the keying relay so as to permit the operator to hear his own sending. This has proven very helpful.

Two receiver jacks, J1 and J2, permit two persons to listen in at one time.

The first four binding posts at the top of the panel allow several combinations of connection between the antenna systems and the antenna coil and tuning condenser. Fig. 4 shows the different methods that were used. The remaining two binding posts at the top of the panel are for the antenna connections.

The usual method of stringing the current-fed antennae (A and B of Fig. 4) was to stake the two far ends on each side of the eight-foot-high tent, bringing the leads down from the ridge. The 65-foot voltage-fed antenna, when used in camp, had a length of rope attached to its "mast" end, with a railroad nut for a heaving weight. A nearby tree's limb was all that was necessary for the "mast." This antenna was most useful when putting up at a hotel. The wire could be lowered gently out the window (reservation always being made for a top-floor room). All of the foregoing antenna (A, B, and C of Fig. 4) were made of rubber-covered auto ignition cable. The fourth type of antenna, D in Fig. 4,

Traffic Briefs

W9BHF sends in some suggestions for the fellow with a fat pocketbook, who likes to build his own apparatus:

The nearest police station will sometimes supply free of charge enough copper beer coil from confiscated stills for a couple of good transmitting coils.

Stores often throw out whole armfuls of old file papers and bills, many of which can be cut into uniform sizes for use as scratch paper, message blanks, log sheets, and the like. (In addition to these uses, one can often find out what the neighbors' grocery bills amount to each month, what they eat, etc. — hi.)

Wonderfully fast little keying relays can be made from old doorbell magnets and Ford coil contacts.

An old rubber storage battery case when cleaned out with soda (not the beverage variety) and water makes a dandy filter case or transformer case — and it has nice handles, too.

A Mason jar half full of a fairly strong solution of blue vitriol or salt water in which a wire makes contact, with a movable brass collar on the outside of the jar as the other plate, makes a suitable plate blocking condenser that can be used for a couple of two-fifties.

The nearest commercial photographer will usually supply you with old glass plates that can be used as dielectric for grid and plate fixed condensers, using tin foil for the plates. The glass can be used with or without the emulsion on one side. The photographer will tell you how to take it off.

The fellow with a small set using raw a.c. and not very high voltage can profitably make use of a couple of dead Tungar bulbs that no longer can be used for battery charging (provided the filament is still in one piece). These are hooked up in the same manner as any half-wave rectifier outfit. It seems that the deader the bulbs are for battery charging, the better they are for higher-voltage rectification. Two of the 2-ampere size have been used for running a 201A directly off the 110-volt line, and another pair stood up to about 300 volts without flashover.

Flattering reports in many cases fool no one but yourself. The fellow with a monitor who knows that his signal has a slight ripple to it will laugh at the fellow who tells him "pure d.c. xtal. OM."

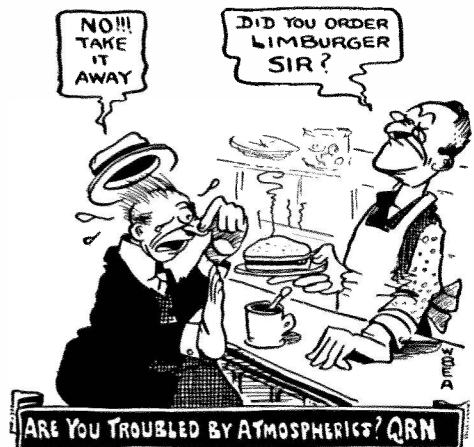

Own a Pediplex

By William M. Atkins*

In March QST, page 62, the Communications Department invited contributions on every phase of amateur communication activity, offering prizes for the best article selected from those submitted during each month of 1929. A wide variety of subjects on which articles would be welcomed were suggested in the original announcement. In addition to these articles receiving a good position in QST, the authors whose articles appear to have the greatest value of those sent in for consideration each month have the choice of (1) a copy of the Radio Amateur's Handbook bound in Algerian, (2) six pads of A.R.R. L. message blanks, or (3) 500 A.R.R. L. log sheets.

The prize winning article by Mr. Atkins suggests that adjusting and "tuning up" work be carried out with increased care and thoughtfulness. It is most certainly wrong and inconsiderate to adjust and test for long periods during the hours when our different amateur bands are most congested. A foot operated device which is helpful when one is adjusting his transmitter and which has been aptly called the "pediplex" is quite fully described by Mr. Atkins. We hope that this will be useful in improving testing conditions without, however, encouraging regular use of the feet in the course of ordinary operation. There has been too great a tendency to "put a book on the key" at any and all times when testing in the past.

Modern amateur stations demand new and better testing methods and equipment. Also, it must not be forgotten that station owners and operators must meet their responsibilities in raising the standards of amateur construction and operation by installing first class transmitters, receivers, monitors, and the like. — EDITOR.

A RADIO amateur is a person who is possessed of the desire to accumulate quantities of coils, condensers, etc., that he can connect together."

In quoting from the article in June QST written by John Escobar, I feel that I have made a fairly good start toward the process of "unloading an idea."

In the same issue of QST appeared another article, useful for the purpose of reference. It is "Don'ts for DX" by Frank E. Dailey. In this nicely written article Mr. Dailey presents a few of the present day "evils," namely, improper CQs, broad sloppy notes and holding one's key down for minutes at a time. The cure for the first and second evil is known; just reach for the Handbook and there 'tis. The third evil, that of holding the key down for lengthy periods, has been mentioned only as an evil and thoughtless practice, which it certainly is. We are warned against the use of same. The operator of the *Carnegie* (WSBS) also appeals to amateurs to improve such inconsiderate, thoughtless and inefficient operating practices. All of which is very good as far as it goes.

I have visited stations in all U. S. districts and have formed the opinion that the process of tuning the transmitter, generally speaking, is to light the tube filament, place a heavy object on the key, and twiddle the dials, coils, etc., until the operator is completely satisfied with the result as shown by a plate milliammeter, antenna ammeter and by the use of the monitor. Then the key is opened and depressed again . . . and perhaps it is discovered that due to too-close coupling, the set will not again resume the previous "steady" values that obtained while the key was held close. Or the monitor may disclose unsteadiness or a tendency to chirpiness or keying not entirely clear and clean. All of which means that the whole process will be repeated many times before a satisfactory adjustment is obtained.

The evil of holding the key down for lengthy periods is known. Not only do we run the danger of placing heavy overloads on the tube and composite parts (which are often overloaded to begin with), but the resultant QRM to other stations is terrible. If a continuous wave, unbroken by key, be confined to a fixed frequency, conditions would not be so bad for others could stay clear of that frequency. As that same unbroken wave is tuned back and forth across the band, it is impossible to stay clear, and the result is "Rotten QRN." The Headquarters Staff then receives a steady flow of letters complaining of QRM and terrible operating conditions. One remedy will be increased thoughtfulness and care in tuning . . . the avoidance of "tuning up" practices during the heavy operating hours. We must look for a new order in adjusting. We must use system, proceed methodically and arrange controls and gadgets so that the time spent

tuning will be minimized and the process of finding the "best" adjustment facilitated.

At my station, an unusual piece of home-made control equipment is used which I feel is essential to make tuning of the transmitter an easy matter and to avoid putting on the air such an interfering signal as described in the above paragraph. It is a foot key and may be readily constructed in a number of ways† from material in any amateur's junk box.

On the under side of a foot rest for a motor car accelerator, is mounted a contact point secured from a Ford spark coil. The foot rest is then mounted on a small wooden base, together with another contact point which is well insulated from both base and upper contact. A coil spring is arranged to keep the foot rest in the "up" position and a little pressure from the operator's foot will close the contact and circuit. The key is fitted with a long telephone cord and with a plug which fits the standard radio 'phone jack. This jack, at my station, is mounted alongside the regular hand keys and, is connected across them.

When transmitter adjustment is necessary the foot key is plugged into the keying circuit, and the key itself placed on the floor below the transmitter, with these conditions following:

1. Both hands are free to tune the transmitter.
2. Means of keying without removing the hands from the equipment being tuned, is secured.
3. No needless QRM for, after a little practise, it is easy to QRV and even sign call with the foot key.
4. If fireworks start it is much easier to lift foot and stop same than to rush madly for the weight on the key or to throw control switches.
5. A good adjustment that will key properly must be obtained. The possibility of keying and adjusting at the same time makes this far superior to the "book-on-key" method.
6. An unbroken wave being placed on the air as a source of QRM to others is eliminated, for the transmitter is being keyed while the set is tuned.
7. While any signal may give rise to a certain amount of QRM, this method will with a little practise, cut the time spent in tuning to one third or possibly one fourth, thus materially bettering operating conditions at stations making use of such a device.

† A Dictaphone foot control, a burned-out or discarded sewing machine motor foot-rheostat speed control, two hinged wood strips with a spring holding two contacts apart, or an old telegraph key with a foot lever substituted for its knob are constructional ideas which will immediately come to mind. — F. E. H.

* W9TJ, W9CAL. ORS, Raymore, Missouri.

It might be well to add that both the foot and hand keys at my station are used with a keying relay, which makes possible the use of standard phone cord for all key connections since a small current is flowing when the keys are closed. So much for the foot key or Pediplex as it is more properly called. It is a good item to have around the 1929 station.

Our mothers used to warn us, when we were children, to stay out of the cookie box, which we would do, *providing* the jar of jam was placed in a more accessible position than it previously held. The same idea now applies to all of us, as radio operators. If an evil is present, it is far better to describe a means, easily secured, which will eliminate same than to threaten the wrongdoer with boycott, punishment, etc.

What I want and what we all want, I believe, is instruction; instruction that will point the way to better amateur radio. The staff at QST headquarters is doing wonderful work and is helping us on toward that goal, but their capacity is limited. We, who are vitally concerned can help out by submitting to that staff, plans and ideas which we feel are good and will help others. After all, we are working toward the same goal and it makes no difference which one of us or group of us reach it first. Let's help each other and we will get there together.

TRAFFIC BRIEFS

An incident in the history of W6ZZA which was somehow omitted from the recent article in QST was the calamitous burnout of the power transformer on the occasion of an attempted QSO while the set was hooked to the direct current mains of Hotel Davenport, in Spokane, Wash.

 During this summer weather it sometimes gets up to empty-ump degrees Fahrenheit in the attic, or wherever the shack happens to be. Of course a fellow can take his shirt off, or drink iced tea, or wear a wet sponge under his chin, but an even better stunt is to go to bed at the proper time, forget the hot weather, and get up *early in the morning*, when the cool breezes are blowing—then you can pound brass without even sweating

 W8GZ gives the following extract from an actual QSO that he heard. It is proffered as an example of what a well-operated station ought not do:

"Thanks OB for dope OB ur sigs fb OB hr OB sa OB do u know Bill Mueller . . . (etc.) . . . well OB gess nil hr OB QTC? ar k . . . ok OB tnx fr all OB wl OB QRU hr OB so 73 hope cuagn OB ar sk."

Umph

 W4WS, after having "shot" a UX210, discovered that radio frequency leakage on the tube base could be avoided by drilling a 1/8" hole between the plate and grid prongs. A sharp drill must be used, and one must drill carefully when the drill is almost through.

 W4WS has been doing some good DX on the 14-mc. band using a power input of only 45 watts. Most of the United States districts, as well as Chile, Mexico, and Canada, have been worked. The 14-mc. (20 meter) band ought to be FB for summer work.

 Some noteworthy low power work has been done by W1BLV of Woonsocket, R. I. in contacting successfully and handling traffic with W1BJD of Haverhill, Mass. A plate voltage of 5 was used on the plates of two UX210 tubes. At a later date, W1BLV tried lowering the plate input when working W3GS in Red Hill, Pa. The voltage was dropped from 90 to 45, then from 45 to 22, and finally to 9 and then to 5. The signal strength decreased after the 45 mark, and finally dropped to about QSA1.

 Although the Beginners' Code Practice has been postponed during the summer months until the good radio

weather comes back next fall, there are still a few enthusiastic beginners, and even one or two volunteers who are willing to put practice on the air for those who care to listen. We are pleased to announce that W6EEQ, owned by Mr. Charles C. Way, of 393 Oaks Blvd., San Leandro, Calif., will keep schedules at the following times:

Sunday—8:00 to 9:00 a.m., P.S.T.—1950 kc. (154 m.)
 Weekdays—5:30 to 6:15 p.m., P.S.T.—1950 kc. (154 m.)
 Interested beginners should get in touch with Mr. Way.

 The value that amateur radio can prove itself to be in some circumstances was recently brought out again to us in a letter that we received from Mr. E. B. Elliott, K7ALC, of Ketchikan, Alaska:

"When I had my amateur station out at Akutan, Alaska. I went through about as unfortunate and heart-breaking a tragedy as can befall anyone. My wife and three others were drowned on Christmas morning, leaving me the sole survivor at the whaling station there. If it had not been for my amateur station I could not have sent word out for fully a month, and in that length of time I am sure that I would have gone mad if I had not been able to communicate with the States and have two men sent up to remain with me until Spring. It is something like this that really brings home to one the great part Amateur Radio plays in this World of ours."

 During the past season W6EAF conducted regular transmissions of code practice with our Beginners' Code practice work. We received a letter from him the other day, telling us that his "class" of two has graduated. The first graduate, a service station man, is now W6CGY; and the second, a lawyer, is now W6CGF. Both obtained high marks in their examinations. W6EAF opined that he is now fixed for gas, and if he needs protection of any sort . . . well, he has two friends, anyhow!!

 W9AAW, one of Chicago's best-known old timers, recently "stepped off" into married sublimity. The lucky girl was formerly Miss Mary Louise Scheidenhelm. Good luck, Bill!!!

 The Poly Radio Club, of the Polytechnic High School in San Francisco, has during the past year been trying to start a communication network between various high schools. Its amateur station, W6QC, has kept one schedule a week with W6YG, the amateur station of the Santa Cruz High School. The arrangement has worked out very nicely, facilitating the exchange of up-to-the-minute news for the school papers, reports of athletic contests, reports of debates, etc. Other high schools with radio amateurs should take note of this worthy adaptation of amateur radio. FB!



Expeditions

TO facilitate work between amateur stations and small craft, expeditions, and the like, we have started a concise directory of active expeditions, listing the call signal, the frequency used for amateur contacts, and where possible operating schedules. We request and invite advance information concerning the route and duration of proposed trips, so that we may print in this section of *QST* material that will be mutually helpful and advantageous to both expeditions and amateurs. Our tabulation will be re-

vised from month to month in accordance with the most recent information received. Expeditioners are also invited to send us radio reports that may be published concerning the communication work and the different matters that arise in their travels that might be of general amateur interest. Messages sent through amateurs and mailed reports being equally welcome. These will be used as freely as space permits or the subject matter justifies.

Frequency (kc.)	Call Signal	Station	Remarks
9945	WSBS	Yacht <i>Carnegie</i>	Carnegie Institute of Washington, Dept. of Research in Terrestrial Magnetism, starting second year of a three-year cruise.
8370, 468, 500	WHDC	Yacht <i>Nomad</i>	On first lap of world cruise, sailed from San Francisco QRD the South Seas, Opr., Stephens Miranda.
8350	WIDJ	Yacht <i>Tempress</i>	Cruising to Tahiti, Opr., exW6CZX.
8230	WIDC	Yacht <i>Abacana</i>	Last reported when cruising in the West Indies.
8290, 5525	KPLF	Yacht <i>Ripple</i>	Sailed from Bradenton, Fla. for Maine, stopping at larger cities along coast.
7350	PMZ	Bandjermasin, Dutch Borneo	All American Lyric Malaysian Expedition, spending year in jungle conducting research work. Opr., Harry W. Wells.
8810, 13,180, 6580	WFA	Base, Byrd Antarctic Expedition, Lat. 78 34 S., Long. 163 30 W.	WFA calls CQ after regular schedules are finished, also at 0400, 0700 and 1000 GCT daily, using 6580 or 8810 kc. depending on conditions.
8830, 7310	WFAT	S.S. <i>Eleanor Bolling</i> , of Byrd Expedition	Worked W9CSB with traffic using 7310 kc. from port at Dunedin, N. Z. on June 25.
8650	KVUA	S.S. <i>Lake Ormoc</i>	Ford Motor Company, bases at rubber plantation at Santa Ream, Brazil.
8300 and 11,200 for press	WDDE	Schooner <i>Bowdoin</i> , MacMillan Expedition to Northern Labrador	Sailed from Wiscasset Maine in mid-June. Expects to drop to 20-meters after reaching the Straits of Belle Isle. Operation starts nightly at 6.30 p.m. E.S.T. A schedule is kept with W9FF.

WFA

Little America, Antarctica, June 12. — The continuous night enshadowing the Byrd Expedition winter base at Little America, Antarctica, has brought with it changed radio conditions. Summer static in the states has made our signals more difficult to copy there and the increased amount of darkness en route has resulted in lowering the optimum frequency for best communication. Of late the Aurora Australis has caused relatively dead periods of unreliable contacts.

Every one of the forty-two men expresses thanks to those amateurs who have heard our signals sufficiently well to allow their relaying some word to our homes and to us. We are contacting them whenever time permits. Unfortunately, official expedition schedules with "WFAT," S.S. *Eleanor Bolling*, and "WHDC," *The New York Times*, for the regular transmission of press, take precedence over all other communication work, leaving only a few hours a day for hamming. Our gas supply is limited, too, so we must confine our amateur contacts to those operators who can copy words single and who receive us well. Best contacts have generally followed "CQs." We are carrying as few schedules as possible. Conditions vary greatly, and a strong signal from one part of the country on one schedule many times has been passed over as unreadable on the next schedule.

"WFA" calls CQ after finishing other regular schedules and at 0400 0700 and 1000 GCT daily, employing either 6580 or 8810 kcs. (45.59 or 34.05 meters), depending on conditions. For those who ask "QRA?" "Please QST card." WFA is at latitude 78:34 south and longitude 163:30 west, the southernmost radio station in the world. Put a tack there on your map if it goes down that far. We are 2100 miles from

the nearest post office or other human habitation. The next boat will reach us in January, 1930, and we will be pleased to send cards then. Receiving conditions are generally good here. Expedition business, and press totalling over twenty-five thousand words a month is handled with "WHDC." Hundreds of messages have been marked via amateurs.

Stations worked to date include all U. S. districts, Hawaii, Canada, Greenland, Norway and LGS at Spitzbergen, which is almost at the antipodes from us. The special voice programs from Pittsburgh and Schenectady are eagerly listened to every Saturday night and enjoyed when audio squealing is not too bad. Formerly KDKA on 25.4 meters was superior but, as the winter advanced, conditions have changed until now WGY's 33-meter wave is much the better. Hanson (MP) and Petersen (Pete) join me in best regards.

— Mason (MN).

WNAEC, W9MM-W9UM, W2QF, and W2BFF were each in contact with WFA several times during the month of June, handling and delivering several long messages from the Byrd Expedition on these occasions.

WSBS

Yacht *Carnegie*, WSBS, Nr. 1, June 26 (relayed WSBS-W6AKW-W1MK). A.R.R.L., Hartford, Conn. — We reached Pago Pago, Samoa, April 1st, made an overnight sail to Apia, April 5th, proceeding to Guam in the *Marinas*, arriving May 20th and departing May 25th. The next port was Yokohama, where we stayed from June 8th to June 24th. We are now bound for San Francisco, where we shall remain about a month. Hope to reach there July 29th on

schedule. Radio conditions have been uniformly good since my last report and schedules have worked well with W6CIS, W6AKW, W6HM, K1AF, K6DTG, OM1TB, J1CT and KUP. W6HM has now discontinued his schedule, and J1CT has not yet resumed since leaving Japan. The others are still going strong. Manila observatory weather reports, sent us through the kindness of K1AF, were very helpful in two little skirmishes with typhoons. Running into a storm center, the expedition met high seas and strong winds, and the barometer dropped rapidly. Knowledge of magnetic effects enabled those aboard the *Carnegie* to use the radio information in plotting a predicted course of the storm center, after which the course of the ship was changed, resulting in a rising barometer, moderating winds, and danger averted. OM1TB, in Guam, made pilot arrangements for us before our arrival. He is a very enthusiastic amateur and interested in ten-meter work. All mentioned have worked hard to handle our traffic. Thanks to everyone. Hope our old schedules direct with W1MK and W9BCA may be resumed as we proceed across the Pacific. In the meantime very 73 to all.

— Larry Jones, Radio Operator, Yacht "Carnegie."

Official Broadcast Stations

CHANGES AND ADDITIONS
(Local Standard Time)

W9EPX, 7000 kc. daily, 12:30 p.m.; 7000 kc., daily, 6:00 p.m. and 9:00 p.m.

W6TK, 7280 and 7020 kc., Daily except Sunday, 3:00-5:00 p.m., 6:30-7:30 p.m., 6:30-7:30 a.m.; W9DXZ, 3560 kc., Mon. 6:30 and 10:45 p.m., Wed., Fri. 6:30 p.m. SCNZ (7015) Mon., Wed., Fri. 10:30 p.m.

High-Quality Signals

REALLY good signals with the requisite sharpness, steadiness, and clarity of tone, which meet our present-day standards of perfection are not too numerous to judge from all reports.

To "make" our list it is necessary that the signals be heard (by the individuals reporting) several different times and also reported to Headquarters from more than one source as proof of the consistency of the station and its regular use of a good signal. Each month Section Managers and Route Managers select the outstanding signals considered as representative of the "best" consistently operated stations in each band. Those having the steadiest and sharpest tuning signals are reported for QST mention. Of course stations with perfectly good signals must do a certain amount of operating to be generally heard and reported. Our lists thus credit both the *outstandingly good* signals and consistency or reliability. No stations with choppers or uncalled-for broadness can qualify, and the attention of observers has been called to this fact so that even the prettiest of signals will not be reported if guilty of being broad and inconsiderate of others. Since our reports come from all over the country they are equally fair to all station owners.

All operators are invited to recommend small lists of (1) the outstandingly good signals and (2) the well-operated stations consistently heard. These should reach Headquarters through your Section Manager. The individual reports should classify stations heard according to different frequency bands. The reports should cover stations heard regardless of the part of the country in which these stations are located. The future of our column depends on your cooperation in submitting increasing quantities of accurate reports from which our tabulation may be made up.

The operators of crystal controlled stations reported in our columns below are requested to drop us a postal giving the regular frequency employed, so that we may list this in parentheses following the appearances of the call signal in the future. If you plan to operate quite a bit so that you will undoubtedly get reported in the future (and if you know the frequency of your crystal accurately) we want you to

let us know your frequency so that we may use it and make a "calibration point" available to other amateurs who hear you. Many reports of "1929 signals" from each Section in the U. S. A. and Canada will place more emphasis on good station PERFORMANCE—less emphasis on a small DX record accomplished perhaps with brute power and wobbly signals.

Our lists are "more exclusive" this month, as no reports from a single source have been allowed to appear in print. We want to make sure that those stations listed really deserve the honor, and we want to maintain the reputation of this column. We are sorry that some who deserve mention have quite likely been reported but once, but trust that a few hours more of operating with that "good signal" may suffice to bring about the desired result next time. Detailed reports compiled from all those received and tabulated according to frequency bands are given below. More reports are needed, and observers are asked to include the 14,000-kc. band in their work. Start a sheet of "observations" today and keep it at hand to be forwarded to your S. C. M. with the monthly report!

Reported by four or more observers:

(3500 kc.) W1CGR, W1MK, W9DXZ.

(7000 kc.) W1MK, W8CAU, W8CSS, W9CVN, W9DBJ.

Reported by three observers:

(3500 kc.) W3ZF, W8ARX, W8ZZ, W9CYQ, W9DXZ.

(7000 kc.) W8ADS, W8WO, W9COS, W9DBJ, (7000.4) W9EGU.

Reported by two observers:

(3500 kc.) W3HL, W8CMP, W8DAQ, W8EB, W8KR, W8RD, W8XE, W9BKJ, W9BWZ, W9BZO, W9DSC, W9EKW, W9EQJ, W9FHU.

(7000 kc.) W1EK, W4AFM, W4PF, W5AMA, W5PA, W8DQK, W8DRJ (7142), W8GZ, W8LT, W8PL, W8RH, W8UK, W9RIW, W9BFB, W9CET, W9CTW, W9DXP. (14,000 kc.) W6HB.

Well-operated stations: W1MK, W2ALU, W2CIU, W5AHL, W5BFL, W6AD, W6AKW (broad), W6AM (broad), W6ANO, W6BJL, W6BZR, W6CGM, W6CIH, W6CII, W6FH, W8BYN, W8GZ, W9DOE, N2PA, K1CM, K1HR.

HARK YE CHAIR WARMERS!

Fellows of the sick bed and wheel chair, rejoice in these tidings that a club, newly organized by a coterie of disabled amateurs who have banded together for social intercourse, invites all of you to join. The name of the club is "The Chair Warmers." Its aim will be both social and technical. It will enable you to meet your brother invalid over the air in greater numbers than hitherto has been possible. It will give you, through correspondence and through the monthly bulletin that is printed by W8DIK, all of the available dope on how best to build your bedside transmitter and receiver. Monthly dues are ten cents. You are invited to join whether you are on the air or not. All correspondence should be addressed to Mr. Walter J. Colpus, W8BRS, 23 Henderson St., Pontiac, Michigan.



BRASS POUNDERS' LEAGUE

Call	Orig.	Del.	Rel.	Total
K1HR	196	104	424	724
W6BYY	205	320	155	680
W1MK	62	402	71	535
W6EEO	68	233	175	476
W9FLG	85	200	156	441
W6IP	54	127	238	419
W6CHA	23	55	272	350
W9ESL	230	68	28	326
W6ALX	10	30	282	322
W6AKW	6	5	310	321
W6DTU	174	38	103	315
K6DU	262	35	4	301
W6CHW	68	36	182	286
W9GHI	190	71	24	285
K1AF	128	48	104	280
W6ASH	12	12	226	250
W7PE	14	8	216	238
W6CIH	14	6	218	238
K6DWS	18	39	174	231
W6DKY	15	18	194	227
W6ETA	21	15	184	220
W6AVJ	154	11	54	219
W9BWZ	50	14	150	214
W6EAA	7	54	148	209
W6EFA	7	9	192	208
W9BGT	72	10	120	202
W6ERK	34	65	80	179
VE2AC	65	35	49	169
W7UN	62	76	24	162
W2QU	65	94	—	159
W7RY	61	65	22	148
W9CUA	30	98	17	145
W7KO	51	87	2	140
W9EJO	26	51	62	139
W1AFO	34	54	28	116
W1BIG	25	58	33	116
W9COE	51	63	—	114
W9DTK	46	52	16	114
W6HI	23	91	—	114
W9BKL	34	53	18	105
K7ABE	25	56	22	103
W6BIP	25	52	20	97
W7TX	37	59	—	96
W8CFR	34	51	4	89
W9BCA	5	56	18	79
W6JN	12	52	14	78

The several amateur stations responsible for the best traffic work — the ones that are "setting the pace" in worthwhile traffic handling — are listed right up near the top of our B.P.L., the figures giving the exact standing of each station accurately.

All these stations appearing in the Brass Pounders' League are noted for their consistent schedule-keeping and dependable message-handling work in amateur radio. Special credit should be given to the following stations (in the order listed) responsible for over one hundred deliveries in the message month: W1MK, W6BYY, W6EEO, W9FLG, W6IP, K1HR.

Deliveries count! A total of 200 or more bona fide messages handled and counted in accordance with A.R.R.L. practice, or just 50 or more deliveries will put you in line for a place in the B.P.L. Why not make more schedules with the reliable stations you hear and take steps to handle the traffic that will qualify you for B.P.L. membership also!

W1MK

A.R.R.L. Headquarters' Station W1MK operates on frequencies of 3575 kc. and 7150 kc. Robert B. Parmenter, "RP," is the chief operator; his fist is familiar to most of the amateur fraternity. Occasionally other members of the Headquarters' staff operate at W1MK. Their personal signs may be found in the QRA Section of QST.

Throughout the following schedules Eastern Standard Time will be used.

OFFICIAL AND SPECIAL BROADCASTS are sent simultaneously on 3575 kc. and 7150 kc. at the following times:

8:00 p.m.: Sun., Mon., Tues., Thurs., and Fri.

10:00 p.m.: Mon. and Fri.

12:00 p.m. (midnight): Sun., Tues., and Thurs.

GENERAL OPERATION periods have been arranged to allow every one a chance to communicate with A.R.R.L. Headquarters. These general periods have been arranged so

that they usually follow an *official broadcast*. They are listed under the two headings of 3500 kc. and 7000 kc.; to indicate whether the watch is devoted to listening on the 80-meter band or to the 40-meter band.

3500 kc.

8:10 p.m. to 9:00 p.m. on Sun., Mon., Tues., Thurs., and Fri.

10:00 p.m. to 11:00 p.m. on Tues. and Thurs. (No OBC sent before these periods.)

12:00 p.m. to 1:00 a.m. (or later) on Sunday night (Monday morning).

7000 kc.

10:10 p.m. to 11:00 p.m. on Sun., Mon., and Fri.

12:00 p.m. to 1:00 a.m. on the following nights (actually on the morning of the day following): Mon., Tues., Thurs., and Fri. (*Only* on Tues. and Thurs. does the OBC precede these periods.)

SCHEDULES are kept with the following listed stations, through any of which traffic will travel expediently to A.R.R.L. Headquarters. The frequency included within parentheses indicates the band in which each individual station keeps the schedule with W1MK:

W1ACH, Brookline, Mass. (3500): Sun. and Thurs.

W1BIG, Augusta, Maine (3500): Mon., Thurs., and Fri.

W1KY, Cambridge, Mass. (3500): Mon. and Fri.

W1VB, Newtown, Conn. (3500): Tues. and Fri.

W2JF, Jersey City, N. J. (3500): Sun., Mon., Tues., Thurs., and Fri.

W3BWT, Washington, D. C. (3500): Sun., Mon., Tues., and Fri.

W3DZ, Danville, Va. (3500): Mon. and Fri.

W3EC, Fort Monroe, Va. (3500): Thurs.

W3SN, Fort Howard, Md. (3500): Tues. and Thurs.

W3ZF, Ardley, Pa. (3500): Sun. and Thurs.

W3ZS, St. David's, Pa. (3500): Mon. and Thurs.

W1AEF, Lakeland, Fla. (7000): Sun., Tues., and Fri.

W6AKW, Lancaster, Calif. (7000): Mon. and Thurs.

W6CIS, Sacramento, Calif. (7000): Mon. and Fri.

W6EEO, Williams, Calif. (7000): Sun. and Tues.

W8AAG, Oil City, Pa. (3500): Sun.

W8ARX, Oneonta, N. Y. (3500): Mon., Tues., Thurs., and Fri.

W8BYN, Columbus, Ohio (3500): Mon., Tues., and Fri.

nn8NIC, Niagara (7000): Mon.

W8ZZ, Detroit, Mich. (3500): Sun. and Thurs.

VE9AL, Toronto, Ont. (3500): Tues. and Fri.

W9APY, Berwyn, Ill. (3500): Tues.

W9ERU, Rockford, Ill. (7000): Sun. and Fri.

W9OX, Louisville, Ky. (3500): Sun. and Thurs.



DIVISIONAL REPORTS

ATLANTIC DIVISION

EASTERN PENNSYLVANIA — Acting SCM, Don L. Lusk, W3ZF — Greetings, fellows, this is my first report as Acting SCM. Please notice the new QRA, Box 188, Ardley, Pa., and forward reports here so that we may get them to QST on time. W3CWO is in Chicago enjoying himself and visiting hams there. W8IS is busy with exams and trying to make a sideswiper. W3NF of Easton has been appointed route manager. Give him your support, fellows, and let's make things buzz in this section. W3LC requests renewal of his ORS now that school is over and he is back on the air. W3BJM reports working WIIMDZ and making his WAC on 14,000 kc. W8AWO has a temporary power supply to his new transmitter. W3MC reports several good QSOs on 14,000 kc. and wants an ORS. W8VD complains of QRN and YLs. W3CDS manages to handle some traffic but complains of vacations hurting his skeds. W3ZF burned out four of the new UX866's and was off 3500 for a while, but made WAC with a 210 on 14,000.

Traffic: W3MC 11, W3CDS 9, W8CIS 6. W8AWO 25, W8VD 33, W3ZF 88.

MARYLAND-DELAWARE-DIST. OF COLUMBIA — Acting SCM, Forrest Calhoun, W3BBW — Maryland: Things are very slow in this section. We have a few new ones on the start, tho, and things may take a change soon. W3MH has moved again, so is off temporarily. W3AJR, W3AMU and W3VM are new and very promising hams in Baltimore. W3BBW is still on every now and then but it seems that the old traffic routes are missing fire. Delaware: W3AJH is going to Bethany Beach with the Naval Reserves. W3ALQ is experimenting with television and trying to get a 28-mc. receiver and transmitter going. District of Columbia: W3BWT has had a QSO with a Russian in Leningrad. FB, OM. W3WG is a new ham in Washington. W3ALE is ready to go again. Sorry to say had to make a few cancellations this past month but as you all know you MUST report regularly.

Traffic: W3BWT 124, W3AJH 14, W3BBW 7, W3AJR 6, W3ALQ 4.

WESTERN NEW YORK — SCM, C. S. Taylor, W8PJ — W8ABQ has taken advantage of the nice weather by experimenting with three types of antennas. W8ADE now has his crystal transmitter completed and reports traffic. W8AFG now handles foreign traffic with h8MRG. W8AYB is now using fone for the summer. W8BBP has about completed his new radio shack. W8BCM now works Hungary, South America and locals, using a UX210. W8BGV says anyone expecting to come to the Auburn get-together in August should practice up on Q sigs as a prize is offered for best Q ops attending the hamfest. W8BHK works PY1AW on a UX210. He will be silent until fall due to the opening of his other station, W8FC. W8BJO is experimenting with antennas. W8BLV has been building a new transmitter. W8BMJ has fair traffic on 3500. W8BLP is off the air but will be with us again soon. W8JEZ, a new station with a 201A, is now handling traffic. W8CSW is handling fair traffic from Montour Falls, N. Y. W8CPC has just finished another crystal controlled set. W8DII will be off until Sept. W8DME has schedules with W8AHK and NDB on 76 meters. He also states W8CVJ is sexton in a cemetery and answers all calls from old timers. W8BDV has trouble with BCLs. W8DSP has schedules with W8OA and W8ARX.

Traffic: W8ADE 2, W8AFG 6, W8AHC 26, W8BCM 41, W8BGV 21, W8BHK 18, W8BLV 25, W8BMJ 35, W8CZE 3, W8CSW 14, W8DII 15, W8DME 17, W8DSP 12.

WESTERN PENNSYLVANIA — SCM, A. W. McAuly, W8CEO — It appears that the optimism of last month regarding summer traffic was hardly justified, in view of this month's reports. W8CER's work was all done on the 14,000-kc. band. W8CUG, a new ORS, is second in line this month. Six schedules at W8CEO are still cliking feebly. W8DKQ, W8DQZ and W8DVZ are building a large station out of town a mile or so. W8AGO is making a low power set. W8GI has only two schedules left. W8CNZ lost \$60 worth of stuff in one week. That's hard luck, OM. W8DVZ wants a Philly schedule. W8AVY went to the Convention.

W8CMP went to Michigan right after the Convention and W8CIK will take the place of W8CMP for the summer. W8DLG needs only an aerial to complete his new crystal control set. W8AYH is remodeling his antenna system. W8OW is building a couple of fine transmitters. W8DHU, for ten years high school principal in Oakmont, is going into business for himself. The Secretary of the Erie Radio Club sends in the following: W8CZE is a benedict now and will make his home in Port Jefferson, L. I. W8CSS was a visitor in Erie and gave a talk to the members of the Club on Zepps and Mercury ares. ex8DRU has returned from college for the summer vacation and intends to get that call with a strange hold. W8BHN attended the Convention, representing the Club. The Club holds its meeting every other Friday evening at the Y.M.C.A., fourth floor. All local members and others are invited.

W8BFD reports a few messages handled.

Traffic: W8FRX 89, W8CUG 59, W8CEO 52, W8DKQ 48, W8AGO 12, W8GI 9, W8CNZ 5, W8DVZ 3, W8CMP 42, W8DLG 14, W8AVY 7, W8AYH 7, W8BFD 13.

CENTRAL DIVISION

KENTUCKY — SCM, J. R. Wathen, III, W9BAZ — W9FS leads for the third time. W9GGB says low totals are due to lack of funds for new xmitter. W9GBX's first report came in with a bang. W9FBV has settled down to steady operation. W9CIS pursues the elusive DX on 14 kc. W9GJG still tries his hand at grinding stals. The Kyrcock people keep W9FVZ rather busy. The R. L. made a business trip to Louisville and gave blue tickets to the lucky ones. W9CEE will be on deck at the Cincinnati Convention. W9GAT is sojourning in Tennessee. W9AAZY says mosquitoes are brutal in his new location. Q9ARU and W9EYW are thinking of rebuilding. W9BPB uses 50 w. C. C. for local work and is installing 1 kw. for his DX. W9FQN and W9DRC are showing signs of life. W9ATA is increasing power for fone work. W9OX sends in a good report. W9BAN thinks there is a deaf-mute in the fifth district. W9BWJ will open up at a new QRA soon. Several ORS failed to heed the hand-writing on the wall and are no longer among the elite. We cannot afford any dead-wood. Sorry to lose you, OMs.

Traffic: W9FS 56, W9BAZ 40, W9OX 40, W9FBV 30, W9GBX 26, W9AZY 17, W9GJG 11, W9FQN 10, W9BAN 9, W9CEE 8, W9ARU 4, W9DRC 4, W9GGB 3, W9EYW 1, W9FVZ 1.

WISCONSIN — SCM, C. N. Crapo, W9VD — W9BWZ leads this section this month. W9BGT is keeping three schedules and handling a lot of traffic. W9DTK leads the ninth district for handling of Naval traffic. W9FBJ will be off for the summer attending Army and Navy training camps. W9BPW is also getting off the air and doesn't know when he will be with us again. W9FSS is moving his outfit to the basement and will use remote control. W9DLD has put up a 60-foot lattice tower. W9BNB is on every Monday for Army traffic at 8 p.m. and will handle traffic from Camp Grant this summer. W9CVI has new 4-tube screen grid Hull receiver working and reports very excellent results. W9OT is off the air because somebody borrowed his pet 210 tube and other articles. W9ASL says static cuts down DX on 3500. W9BIB wants Army Net schedules. W9VD is going on 14,316, 7158, 3579 and 1789 kc. Regular schedule is Monday, Wednesday and Friday, 8 to 10 p.m. on 3579 kc.

Traffic: W9BWZ 214, W9BGT 202, W9DTK 114, W9FBJ 49, W9BPW 39, W9FSS 39, W9DLD 30, W9BNB 27, W9CVI 8, W9OT 8, W9ASL 4, W9RTR 4, W9VD 8.

MICHIGAN — SCM, Dallas Wise, W8CEP — W8DHC will operate W8NO at Platte Lake this summer on 7000 kc. W8DYH sends code practice on 3604 kc. every Sunday from 12 noon until 1 p.m. W8CAT has moved across the street. W8PP has a new 852 and a pair of 866's, and expects to have the big noise ready soon. W8AX up at Muskegon is none other than old W2BRB of Brooklyn. W8BR8 is now one of the Army Net stations. W8AZW has the call changed to W8GG and will be off the air until fall. W8BGY blew the 210, but keeps going with a couple of 201A's. W8DFS is rebuilding. W8ACB says the chemical rectifier is still doing

its stuff. W8CKZ manages to be on now and then. W9AXE has a new transformer and wants to become an ORS. W8KD had his call changed to W8BRO. W8AAH will have a tifty going soon. W8AUB took the commercial exam. W8AUT is working on both 7000 and 14,000 kc. now. W8ASO has a 1-kw. tube, but doesn't know what to do with it. Hi. W2DX is at present in Detroit with the Edison Storage Battery Co. W8DAQ is putting out a fine signal and turns in a nice total for the month. W8DYH, W8HL, W8JD, W8ALN and W8CEP are the Army Net stations in and around Detroit. W8DYH is the star traffic man for the month. The SCM will give a good 160-meter crystal to the station handling the most *bonus fide* messages for the month of Aug. 16th to Sept. 15th. Will grind the crystal to any point in the band the winner desires. Just send me your report together with the messages. Let's go!

Traffic: W8JD 88, W8ZZ 56, W8CAT 15, W8DCH 28, W8DAQ 64, W8ASO 7, W8AU 17, W8AUB 3, W8AAH 11, W8BRO 15, W9AXE 26, W8CKZ 3, W8AX 2, W8ACB 10, W8DES 2, W8BGY 65, W8DYH 106, W8BRS 13, W8PP 29, W8CEP 59.

OHIO — SCM, Howard C. Storck, W8BYN — W9RN never misses a report. W8GZ leads Ohio this time, which seems like olden times. W8BYN and W8CRI come next. W8CIY has fallen for a YL. W8AYO gets his traffic scheduling with Brazil. W8ADS is off the air at present, building a MOPA set. W8BKM bewails his lack of time for radio since getting hitched. W8DDF is also W8BPV now. W8BBR says QRN and QRM have him licked. W8BAC says traffic has slowed down. W8CFT has been busy school and work. W8CMU works every other night, so is not on much. W8DDK is still plugging away. W8CFL is still playing baseball to the exclusion of radio. Hi. W8APB has changed to 14,000 kc. W8LI is trying 14,000 for the summer. W8QU turns in a few. W8BMX turns in his first report. W8CCS heard his signals while away from home, and they sound just like they do in his monitor. W8CNU is in bed with pneumonia, and W8CCS says he is a very sick boy. Here's hoping you get over it soon, OB. W8OQ and W8DES will be off the air for most of the summer. W8BKQ is busy with BC work and is moving his transmitter. W8ARP is working in Columbus and thinks it is permanent enough to warrant bringing his set down. W8ALC will be on the air again soon. W8PL must be pretty busy with the Fords as with two outfits, he still has no traffic. W8BYN is almost silent now on account of too much work and too tired when he does have time. W8GL has bought himself a microscope and is looking for that far-famed radio bug. W8CNO is visiting in Chicago. W8CQU is in New Orleans indefinitely. W8BNA should be back from school by now.

Traffic: W8GZ 121, W8BYN 111, W8CRI 53, W8CIY 51, W8AYO 43, W8ADS 29, W8BKM 13, W8DDF 12, W8BBR 12, W8BAC 12, W8CFT 10, W8BML 9, W8CMU 9, W8DDK 7, W8CFL 6, W8APB 6, W8LI 6, W8QU 4, W8BMX 4, W8CCS 3, W8OQ 2.

ILLINOIS — SCM, F. J. Hinds, W9APY — Traffic and stations seem to be going along fine in the Army-Amateur Nets. W9DWA reports DX poor, due to QRN and dead air conditions. W9BEF is out for an ORS. W9CNY is still getting fine results on 160 meters. W9GJJ is one of the new Army Net stations. The 210 at W9ERU has gone West after a splendid record of 1400 messages and DX. W9ETP has a new MOPA on 14 mc, reporting DX very good. W9BOL is doing well with DX. W9BXB is District Army Net Control station. FB, OM. W9DSS has a new crystal. W9DLI has a DX—getting 852. W9CZZ is getting started again. W9CRR has a new "Home-Brew" transmitter using 201A's as rectifiers, and reports results better than with the old M. G. W9BZD, Austin Radio Club, has its TGTP going fine with a Hertz. W9GJ had an operation, but is now OK and going along as strongly as ever. W9BKL is doing fine work with the help of schedules. W9KA has a new bug. W9PU is installing a new mast and MOPA. Our ex-9AQA is at KMIC in California. W9EAI is back on the air. W9GIV is in line for an ORS. W9AP has a MOPA and is helping W9PU get things in shape for the summer. W9BNA and W9AFB have graduated from school. (What next, OMs?) W9EGY is a new member in our ranks. W9BNI is doing fine work in the Army net. W9ACU is experimenting with some phone. W9FDY has some nice DC like some of

the rest of us ought to have. W9BZO is about to rebuild the crystal. W9BVP is rebuilding. W9CNH is going strong with Army traffic. W9FCW complains of lack of schedules. W9EGR is looking for a good receiver. All W9FDJ needs for WAC is Asia. W9BNR has a new 210 and rectifier. W9DJ is local Army Net Control station. W9CKZ is installing higher power. W9EJO was the first station WDDE worked this year, and he took their first message. W9BRX says the best time for 28 mc. DX is from 10 p.m. to midnight. W9NV had open house and reports fine work on a new Zepp. W9CCZ is rebuilding for 3500 kc. W9DGK can't seem to hear foreigners. W9KB has a new quarter on 14,000 kc.

Traffic: W9EJO 139, W9BKL 105, W9DGK 31, W9FDY 30, W9DWA 26, W9AP 23, W9ERU 21, W9BNI 19, W9FDJ 17, W9DOX 15, W9GJJ 15, W9CNY 14, W9AFB 13, W9APY 13, W9GIV 12, W9KB 12, W9CUA 11, W9BRX 10, W9BEF 8, W9BPK 8, W9CKZ 8, W9CRR 8, W9CNH 7, W9BNR 6, W9NV 6, W9BZO 4, W9ACU 2, W9EGR 2, W9FCW 2, W9KA 2, W9DJ 1.

INDIANA — SCM, D. J. Angus, W9CYQ — W9GKI is looking for skeds, as all the stations he works have no traffic for him. W9DHI is doing most of his work in daylight on 1 UX210 in 1929 type xmitter on 7500 kc. W9EFF left July 6th for Naval Reserve cruise. He works WDDE (old WNP) on sked. W9AHB has been trying out 28 mc. W9BKJ reports that a bad power leak early in evening hinders his operation. W9AIN keeps a sked with W9APY. W9DBJ is on 7000 kc. W9FYB has a Hertz antenna that works FB. W9GCO says, "Now for home and some ten-meter tests at W9EGE, Whoopee!" W9EEY is only able to keep two skeds now, on account of QRN. W9EKW says it's too hot for radio. W9BZZ had three skeds on 3500 kc. but QRM raised havoc with them. W9ASX is going fine at Dodge's and expects to take his commercial exam in July. W9EVA was back on a few hours' visit. W9GGJ and W9RW have tried 7000-kc.

Traffic: W9BZZ 131, W9EKW 76, W9EEY 43, W9GCO 6, W9AIN 22, W9EF 25, W9DEJ 8, W9GKI 15, W9FYB 3, W9DBJ 8, W9BKJ 21.

DAKOTA DIVISION

SOUTHERN MINNESOTA — SCM, J. C. Pehoushek, W9EFK (D. F. Cottam, Acting) — Well, gang, it seems rather good to have a chance to speak to you through QST once more, and I am doing it because your good SCM went and got married. He has had no chance to pound brass because of wedding preparations, but there will be more brass pounding from W9EFK because his OW will push the key, too. FB, OM, and congratulations! W9COS is now on his vacation, consequently skeds had to go for a time. W9DBW has worked 34 countries of four continents on 14,380 kc. W9AMK says DC is all he handles, has a xtal in use and wants skeds on 20 and 40. W9AIR has left for the golden West for a trip. W9EYL has a new Ford and now divides his time between it and his junk. W9DRG is a brand-new ham and will very much appreciate attention by any of the gang hearing him.

Traffic: W9COS 59, W9DBW 24, W9AMK 17, W9AIR 11, W9ELY 3.

SOUTH DAKOTA — SCM, D. M. Pasek, W9DGR — W9DLY is the proud owner of South Dakota's only WAC certificate. Congrats, OM. Nick Jensen called on W9DGR and W9DWN on his way to a term of Federal Court. All the gang along the main highway were paid a visit by W9AIR from Sleepy Eye, who was on his way to the Black Hills. W9DIY operates his outfit occasionally. W9EJR and W9DNS were heard the other day on 7 mc., so they are still on. W9DGR has been on hardly at all the past month and will be out of town part of the summer. W9EJU reports a new ham in Mitchell — W9CIR. W9AZR reports action with his key on three schedules in spite of heavy work schedule.

Traffic: W9DWN 30, W9DLY 13, W9DIY 2, W9EJU 3. NORTH DAKOTA — SCM, B. S. Warner, W9DYV — W9FCA reports that he is too QRL with farm work to do any radio work, but reports hearing several foreign stations. W9BVF reports a very nice traffic total, the results of keeping three skeds. W9DYA reports no traffic this month. W9DYV is building a screen grid receiver.

Traffic: W9BVF 123.

NORTHERN MINNESOTA—SCM, Carl L. Jabs, W9BVH—W9ADS has a new 852 and mercury are that works FB. W9EHO reports the DX still rolling in. W9CIY keeps skeds with W9DYN, W4LL and W6DYV. W9DOQ reports several new hams on the air in Duluth. His 50-watter went west on him, so he's using 210's now. W9GGQ is rebuilding his station for the coming season. W9CF is the weather interferes with his operating. W9BCT will use portable call W9FOZ while on his vacation trip this month. W9BBT is QRL work and fishing. W9BMX reports that SCM Jabs is ill. Hope it isn't anything serious. OM.

Traffic: W9ADS 29, W9EHO 17, W9CIY 9, W9DOQ 4, W9GGQ 9.

DELTA DIVISION

ARKANSAS—SCM, H. E. Velte, W5ABI—Our report is small this month due to the fact that only a few stations reported. W5ARA, our new official observer, says that he is going to be on the job. W5JK has been having trouble with his rectifier, W5AAJ as net control of the Army-Amateur network is busy getting the fellows in his net lined up. W5CX leads the gang in traffic handling this month. W5RDD is back from the Radio Show full of new ideas. W5HN is planning a large tone set for this fall.

Traffic: W5CX 30, W5ARA 14, W5JK 2.

MISSISSIPPI—SCM, J. W. Gullett, W5AKP—Hereafter when any ORS fails to report for two months straight, the SCM is going to cancel his appointment, so you had better sit up and take notice of this. W5QQ has moved to Meridian and is installing the equipment at WCOC, where he is chief operator. W5FQ has his Western Electric 250 watter going fine but when he asks anyone to take a message, they tell him CUL 73. W5GQ has a new transmitter on and is working a raft of other stations over the country. W5BDE, who has his pile of junk up in his attic, says that it is too hot to operate up there so he is moving the key and receiver downstairs where he will use remote control on his transmitter. W5AGS is going on a Naval Reserve cruise this summer. W5AQU is going also and will be an instructor in life saving at a Boy Scout camp this summer. W5AKP has had quite a bit of QRM from business the past month.

LOUISIANA—SCM, M. M. Hill, W5EB—From the number of reports received this month, summer QRM and vacation has cut down activity in this section. W5WF fell from the BPL but still has a nice total. W5VX has gone to 14-mc. band for the summer. W5BDY is being QRMED by the YLs but has time to put a tone on the air. The YL that W5PG delivered the messages to is really keeping him away from the key. W5BDJ has a 1929 Hartley all going. We regret to learn that W5LY has left us and gone to Arkansas. W5BAY and W5EB have located in Bastrop, La., for the summer. YSLDN called on W5WF and brought him a parrot to send CQ.

Traffic: W5WF 51, W5PG 20, W5BDY 10, W5YX 3.

HUDSON DIVISION

NEW YORK CITY AND LONG ISLAND—Acting SCM, V. T. Kenney, W2BGO—Manhattan: W2BGO will be known as portable W2AAR and W8CYA, the eighth district station being located at Wurtsboro, N. Y. W2SC is putting in a new motor-generator. W2BDJ is looking for skeds. W2AOY will be in Allenhurst, N. J., until September, using the call W2BDD. W2CUQ is still working DX as well as handling traffic. W2AFQ sure handles his job as OO very well and keeps the gang in the bands. Bronx: W2AET will be with us again as soon as he recuperates after an operation. W2AFT and W2AI are doing their share of traffic work. W2ABS is rebuilding. W2FF has changed his QRA and wants to thank the boys in Kansas, Nebraska and Iowa for keeping him in touch with his brother in Nebraska. Brooklyn: W2APB has gone to sea. W2BIV reports consistent QSO will all continents with an 852 after blowing a 50-watter. W2PFP, our Army-Amateur radio aide, reports a good traffic total, and says W2BRB is now W8AX in Muskegon, Mich., on 3500 kc. Staten Island: W2BCZ explains that most of the gang that way are sea-going ops. W2BEY, W2AFV, W2CIS and W2BCZ are all going strong, and the only active volunteer Naval Communication Reserve station is W2BCZ. W2AFV has re-

turned from college and is op on WLCH, Long Island: W2AVP has left us for a short time aboard the S. S. *Ironia* bound for Honduras. W2BKZ is soon to be heard with a new outfit. W2TV is still keeping traffic moving.

Traffic: Manhattan: W2BGO 36, W2CUQ 20, W2BDJ 17, W2AOY 5, Bronx: W2FF 86, W2AET 45, W2AFT 13, W2AI 7, W2ABS 6, Brooklyn: W2BIV 60, W2PF 40, W2APB 14, Staten Island: W2AFV 87, W2BCZ 5, Long Island: W2AVP 60, W2BKZ 36, W2TV 11.

EASTERN NEW YORK—SCM, F. M. Holbrook, W2CNS—W2QU makes the BPL with schedules with n1NIC daily on 14,280 kc. W2LU handled good traffic through QRN. W2AYK likes 3890 kc. for traffic. W2ANV keeps only Army-Amateur schedules now on account of hot weather. W2BKN worked 20 stations this month and reports W2AHW is after commercial license. W2AUQ requests cancellation of ORS as RR work and other business interfere, but he will still be on the air. W2AGR is leaving Boston for his home in Catskill, so listen for him in second district this summer. W2SZ has closed his station for the summer. W2JF is again rebuilding as hard to raise anyone now. W2ANX wrote a full page of short wave dope, boosting amateur radio and A.R.R.L., in Sunday Knickerbocker Press. He worked PY2AD on 28 mc., so thinks set is now OK. W2ALI reports new ham, W2AQT, in Poughkeepsie on 3500 kc. W2BLN has new QRA at 578 Park Ave., Yonkers.

Traffic: W2QU 159, W2LU 40, W2AYK 26, W2ANV 17, W2BKN 2.

NORTHERN NEW JERSEY—SCM, A. G. Wester, W2WR—This month finds the smallest traffic totals ever handled in our section and the fewest stations reporting. ORS who do not report will find no mention of their calls or activities in this column. W2WR is getting plenty of cards from Europe. W2JF, our new ORS, handled the greatest amount of traffic through fine skeds with W1MK, W2AOS does all his work in the Army Amateur Net. W2CTQ sent in his report while vacationing at Lake George, N. Y. W2CJX has been very busy installing a HF set on a yacht. W2BY has been placed on the inactive list for the summer, but she promises a good comeback for the fall. Between the BCL station and YLs. W2IS has a hard job finding time to operate. W2AOP is sporting a new Ford roadster, with all extras, and burns up all roads at night.

Traffic: W2JF 54, W2AOS 17, W2CJX 8, W2AOP 5.

MIDWEST DIVISION

IOWA—SCM, H. W. Kerr, W9DZW—Honors to the new reporter, W9CMA, as top man with both he and W9BCA in the BPL on deliveries. FB, W9CUA wants Nebraska and Kansas schedules. W9FZO is on all bands. W9BRH is on 28 mc. with self-rect. outfit. W9DWU is another new reporter by radio. W9FFD finds time from gas pumping to work a few. W9EIW is QRL strawberries. W9EHN now located at Grand Rapids, Mich., and will rebuild there. Kruse, ex-9BKV, is with W.U. in Des Moines. W9GDR gets nice reports for his 201A from both coasts. Ames is to have two new stations. W9GFQ has new rig MOPA, and W9CCY is active. W9BIJ is now an op at WLBW and works W8BFD occasionally. W9DZW is on daily from 7:30 a.m. to 8:30 a.m. and 12:45 noon.

Traffic: W9CUA 145, W9BCA 79, W9FZO 35, W9EJQ 26, W9DZW 24, W9DWU 18, W9FFD 15, W9EIW 9, W9GDR 2.

KANSAS—SCM, J. H. Amis, W9CET—Traffic is booming in this section even with the hot weather. W9FLG is setting the pace for the rest of the gang and says his new SG receiver is the best yet. W9ESL is trying hard to beat W9FLG for first honors and says he has the traffic bug now. W9GHI is also after the honors and lost a 210 in the race. W9COE is a newcomer in the section and starts out with a bang. W9DEB using 2 112A's is giving a lot of the high-powered boys something to shoot at. W9B7CG has a new 210. W9GFO has completely rebuilt his transmitter and getting out FB now. W9HL has been very busy at the power plant putting in a new 400-h.p. turbine. W9FIG finds 7000 kc. much better than 3500 kc. W9FTS is too busy with the YLs to fool with radio. Hi, W9BHR won't be any good until he goes fishing. W9CET is getting ready to put the crystal on 14,000 kc. for the summer. W9CFN got his sheepskin and now has to go out in the cold world and labor. W9CKV can't

get any traffic with a 210. W9FLG, W9ESL and W9GHI make the BPL, FB, fellows. The SCM would like to have reports from more Kansas stations who are active.

Traffic: W9FLG 441, W9ESL 326, W9GHI 285, W9COE 114, W9DEB 95, W9CET 86, W9BTG 38, W9GFO 25, W9HL 23, W9FIG 19, W9BHR 13, W9CFN 6.

MISSOURI — SCM, L. B. Laisure, W9RR — W9DOE led traffic in St. Louis, with W9DZN second and W9GHG third. W9DOE is going to Duluth for the summer and expects to be on at the new QRA. W9DZN does not have much luck keeping skeds with W9DQN due to job QRM at W9DQN, W9GHG had 6 skeds, but dropped all because they did not give him any return traffic. W9EDK is going after DX this summer. W9ZK has put in a remote control line so that W9GSF and ex-W6QL who stays at the same QRA can operate the ZK station. W9GSF is President of the Order of Railroad Telegraphers, well known to all railroad and W. U. operators, and St. Louis is the National Headquarters. W9EPX takes the prize for traffic in the state at large, W9BJA coming second with considerable QRM from new job and moving. W9EPX is applying for membership in the U.S.N.R. W9BJA is trying a cooperative WX report sked in connection with air lines. W9ERM reports on at times and tries to make a ham out of the YL. W9FVM had job QRM temporarily, but found time to handle some traffic. W9FBF landed a RCC certificate this month. W9DHN reports more QSO but less traffic since school is out. W9GCL rebuilt the works. W9ASV and W9DAE are on the shelf for the summer. W9CDF is temporarily in Sedalia on W. U. job. W9DQN handled the only traffic reported in K.C. this month. W9ALC rebuilt everything and QRT due to long hour job. W9CFL is the new Unit Commander of the U.S.N.R. Kansas City Unit. W9RR is off the air, but pounding the typewriter vigorously boosting for the U.S.N.R. He has been appointed Section Commander for Nebraska, now handling U.S.N.R. organization work for Missouri, Kansas, and Nebraska.

Traffic: W9DOE 22, W9DZN 19, W9GHG 14, W9EPX 80, W9BJA 67, W9ERM 10, W9DHN 2, W9FBF 4, W9FVM 10, W9DQN 40.

NEBRASKA — SCM, C. B. Diehl, W9BYG — W9BBS, W9QY and W9DI are very busy at this time. W9EEW is also very busy, and can't be on much. W9DVR reports, but has nothing to say. W9DNC is still at 'em with his 1929 xmitter. W9BOQ says the weather puts him out of business on 1750 and 3500 kc. W9CHB is studying for commercial. W9BQR is just back from vacation. W9FAM is back with us and will be going soon. W9DTH says this weather slows him up, so not much traffic to date.

Traffic: W9QY 4, W9DVR 6, W9DNC 11, W9DI 2 W9CHB 6, W9BQR 2, W9DTH 3, W9DRF 3, W9FJL 9.

NEW ENGLAND DIVISION

EASTERN MASSACHUSETTS — SCM, E. L. Battey, W1UE — This will be my last report as your SCM, as I am filling the vacancy at Headquarters made by the resignation of Mr. L. R. Huber, who returns to Iowa. I have enjoyed my term with you and want to thank each of you for the fine support given me. Mr. E. R. Sharp, W1ACH has accepted appointment as Acting SCM until a new man can be elected. All reports should be sent to him at 9 Fairbanks St., Brookline, Mass. W1LQ is doing fine work on 3950 kc. and keeps skeds with W1AWQ and W1TB. W1RL went on another U.S.N.R. cruise. W8DVL paid W1BBT a visit. W1LM reports everything quiet except the QRN. DX has been FB at W1AZE during the past month. He says that K6CLJ is coming to M. I. T. this fall for an education. The two 210's at W1KH were two years old this month. Tennis takes quite a bit of W1ACH's time these days. High temperature is holding up production at W1ASI. Hi. W1KY is letting up a bit on skeds. She says DST raises havoc with skeds. W1AOT handled a batch of traffic from an exhibition at the Saugus High School. W1ACL, W1BGN, W1LQ and W1UE all paid him a visit during the past month. W1BVL is QRL making tubes. W1RL has just been made ORS, and promises to be a very good man. W1WV has been very active both in DX and traffic work. He has submitted description of his station to Headquarters. The wedding bells will soon be ringing merrily for W1WU to the tune of a never-ending

QSO. Good luck, OM. W1ARS has dropped his skeds until fall. The least an ORS can do is report, and that takes but a couple of minutes. Won't you all fill out a card each month and show us that you are alive? Remember to back up the next SCM with even more pep than you did W1UE, and I wish you all good luck. Very 73.

Traffic: W1LQ 109, W1UE 100, W1AOT 90, W1ACH 85, W1WV 57, W1ARS 37, W1LM 35, W1KY 33, W1WU 32, W1KH 31, W1RL 18, W1ASI 12, W1AZE 12.

CONNECTICUT — SCM, C. A. Weidenhammer, W1ZL — W1BVW is a new ham in New Haven. W1AMG has embellished his outfit with a pair of 866's. W1MK has added a new schedule — NN8NIC. W1AFB worked WFA, Byrd's base ship and handled some Antarctic traffic. W1ATG states that he will be inactive until September 15. W1AOI is active on 14 and 3.5 mc. W1BNS will enter Howdoin in the fall, and he feels that his radio days are over temporarily. W1CTI is still observing his sunrise schedules. W1BDI still keeps his W6AKW schedule on 7.06 mc. W1TD has just completed a new transmitter and has started the construction of a monitor box. W1CKP is working NX1XL several times a week, as he has been doing for months. W1RP handled a few. W1VE is now passing judgment on the senioritas in Habana. W1ZL built a new receiver and a frequency meter. He is a WAC now, having worked Y1IMDZ, Mosul, Iraq.

Traffic: W1CKP 37, W1BDI 30, W1CTI 8, W1BNS 5, W1AOI 33, W1AFB 60, W1MK 535, W1AMG 22, W1RP 40, W1ZL 6.

MAINE — SCM, G. C. Brown, W1AQL — By the time that this report has reached the readers of QST, the advanced information on the Maine Convention will be in the hands of the Maine gang and also some out-of-state hams. If there is anybody who has not received a copy and has any intentions of attending the convention, please notify the SCM at once. The Queen City Radio Club is holding its meetings regularly twice each month. W1AUR seems to be leading the gang this month. W1ATO sends in a fine total again, even though being QRL with work and U.S.N.R. W1BIG has a good showing this month. There is a newcomer in our midst this month with a fine total. W1CDX reports bad weather conditions. W1AQD was not on the air much. W1COV states that W1CDX and himself have a regular schedule with EAR94. W1TB sends in his third report and says that schedules are FB for traffic. W1KQ is due for an ORS ticket. W1AHY almost got left this time, W1BFZ, one of our old traffic men, is back on the 4000-kc. band again and is ready for business.

Traffic: W1AUR 144, W1ATO 116, W1BIG 116, W1QH 112, W1CDX 92, W1AQD 74, W1KQ 59, W1AQL 61, W1BFZ 46, W1TB 41, W1COV 25, W1AHY 11.

RHODE ISLAND — SCM, C. N. Kraus, W1BCR — W1BCR is now being operated by the Radio Club of Rhode Island. A set is on 21 meters using an 852. Official broadcasts will be transmitted every Monday at 8:00 and 10:30 p.m. E.D.S.T. W1BLV is still working FB on low power. W1MO has his new transmitter perking and has QSO'd many foreigners. W1BLS will probably be off the air during the summer. W1AWE is still using a 50 and works 'em all. W1AMU has been on 3500 with a low power fone which works FB. W1BLV is back on 3500 kc. He reports working W1BJD in daytime with but 5 volts on the plate.

The Radio Club of R. I. held its first annual banquet and meeting June 1st at Brown University. Many noted speakers were present and gave interesting talks, license examinations were conducted and a good time had by all.

Traffic: W1BLV 22, W1BCR 9, W1MO 9, W1AWE 3.

WESTERN MASSACHUSETTS — SCM, Dr. J. A. Tessmer, W1UM — W1BWY says that when he is not at the key he is at the "Ole Swimmint' Hole." W1BSN is working Hawaii regularly. W1BSJ says that Rolls Royce cars are creating QRM with his brass. W1BYR will be on the air for the summer starting June 18th. W1AMZ says he is also going to be on this summer. W1BIX is on 3600 kc. and has schedules at 7 and 8 p.m. W1BIV's QRH is 3900 kc. W1ADO is on Naval Reserve drills Tuesday nights, and believes that the future of the hams lies in belonging to the Naval Reserve as well as the Army Nets. W1BGM has schedules every evening except Sunday from 8:30 to 9:30 with W1CQ, W2AIJ and W8DHT. W1BKQ, the Worcester

Radio Association, had an enjoyable social gathering June 7th.

Traffic: W1BGM 43, W1AMZ 1, W1BIX 25, W1NS 18, W1COS 22, W1CTF 8.

VERMONT — SCM, C. A. Paulette, W1IT — There was a fine gathering of the boys in Vermont at the summer camp of W1IT, and a FB time was had by W1CGX, our CRM, W1BCK, W1BJP, W1AIO, W1BDX and, of course, W1IT. Let us all enjoy the summer months now, OBs, and when fall comes, let's get old Vermont on the map. What say?

Traffic: W1AIO 29, W1BDX 37, W1CGX 12, W1IT 20, W1JR 3.

NEW HAMPSHIRE — SCM, V. W. Hodge, W1ATJ — Although this Section is experiencing the usual summer slump, considerable traffic is being handled. W1MS is now using crystal-control on 14 mc. with good reports. W1BFT is managing an orchestra and will be on next fall with a new outfit. W1AEF says that the summer weather has kept him away from the key. W1AUU is doing considerable work with phone in the 3500-ke. band. W1APK reports being heard in New Zealand on 3600 kc. W1AUE has been handling traffic with WFA in the Antarctic. W1IP is doing a little DXing on 7000 kc. W1MB is rebuilding and expects to be on soon.

Traffic: W1APK 16, W1ATJ 15, W1IP 11, W1AUE 7, W1UN 2, W1AUU 1.

NORTHWESTERN DIVISION

OREGON — SCM, W. S. Claypool, W7UN — W7PF wants traffic south as all he handles goes north.

W7PP claims to have a half KW input to a pair of UX852 in push-pull TPTG circuit with a mercury arc pushing them westward. W7MV tries 28,000 kc. again. The new SCM is considering a change of ORS if the present ones continue to be so indifferent about reporting. W7WR will be off until fall. W7JC reports a new ham at Roseburg. W7ABH is out for traffic. W7AIX, W7AIG, W7ACG, W7EC and W7GQ all hit the ether once in a while. W7WL and W7QK are active and report FB. W7AMQ, a new ORS, is attending camp with the National Guard. W7ALM lost his sked with AC7XOT but says the mercury vapor tubes are sure FB. W7RR moved to Portland. W7UN spent a week in Seattle having a good time in general. The RM requests that he get more and better cooperation from ORS. The Northwestern Division Convention is being successfully planned for August 30th and 31st. W7AJW on the Battleship *Oregon* is ready to go now with TPTG UX852 with mercury arc and screen grid receiver. W7PP will resume the duties of OO for Oregon.

Traffic: W7PF 238, W7UN 162, W7WL 60, W7MV 57, W7AMQ 38, W7ALM 28, W7QK 26, W7ACG 14, W7JC 9, W7GQ 8, W7ABH 7, W7AIG 2, W7EC 1.

WASHINGTON — SCM, Otto Johnson, W7FD — W7RY and W7KO take the honors this month. FB, OMs. W7TX proves his consistent work as usual, handling the bulk of the Alaska traffic. W7AFO, W7MW, W7GA, W7ACY and many others have turned in some fine DX, some of them working XW7EFF while he was in the Indian Ocean. W7PH reports being on the sick list but is OK again. W7BR and W7AG are on 7000. Many of the gang are planning to attend the big 7th district convention on August 30 and 31st at Portland. W7ACS has been out of town most of the month.

W7LZ is the proud daddy (and how!) of a 6-pound Junior Op. Chris says his sigs are R11, DC and not too steady! Congratulations, OB, and more power to you all. W7FD is preparing his equipment for a move to his permanent location in the early fall. Reports from some of the Alaskan boys were received through W7TX as usual. K7ABE, K7HL, K7MN and K7AER are the mainstays and handle lots of traffic.

Traffic: W7RY 148, W7KO 140, W7TX 96, W7AFO 34, W7ACY 29, W7AG 14, W7MW 10, W7PH 7, W7BR 6, W7UI 5, W7AEV-KK 5, Alaska: K7ABE 113, K7HL 85, K7MN 24.

MONTANA — SCM, O. W. Viers, W7AAT — The SCM is sick in bed at this time, so the report is being made up at HQ. Hope you'll be better soon, OM. W7AAW sends in his first report. W7FL is going home for an indefinite time

so off the air temporarily. W7DD worked ZL, AC, TI and Chile. Nothing the matter with his DX! W7HT keeps a daily except Sunday schedule with W7HP.

Traffic: W7HT 26, W7DD 24, W7AAW 19, W7FL 10, W7AAT 7.

PACIFIC DIVISION

SAN FRANCISCO — SCM, C. F. Bane, W6WB — The honors this month all go to two new boys, W6ERK and W6BIP. Both men make the BPL with W6ERK having a considerable edge. W6AC reports no traffic on account of night work. W6DSS says traffic fair and busy installing new "50." W6WN reports and says very busy. W6AVQ reports taking a message to A.R.R.L. from Japan. W6DZZ says not much traffic but lots of rebuilding. W6ERK is running skeds twice daily except Wednesday. W6AYC-W6ZF reports for the first time with a nice total. Says W6AYC now has his portable call. W6CIS drops down this month on account of business. W6DZQ is rebuilding his receiver. W6DYB is now president of the S.F.R.C., taking W6CLS's place. Lots of luck, Al. The Polytechnic High station, W6QC, is handling some traffic. W6FEH reports for the second time and says he is hot to make the BPL next month. W6DFE reports for the first time.

The S.F.R.C. held their quarterly dinner this month and everyone enjoyed himself immensely. Owing to his business taking him from town frequently, W6WN, our RM, finds it necessary to resign. Too bad, Art. A new RM will be appointed immediately. W6PW reports and says the crystal is putting out in fine shape. Mr. Babcock gave us all the dope on the Directors' meeting in Hartford at a recent meeting of the A.R.A. Many thanks. W6EEG reports and says going to put in a 50. W6FK working great DX on 14 mc. W6DBD was QSO Russia with a UX210. FB. W6WB handled two European messages direct to Belgium.

Traffic: W6ERK 179, W6BIP 97, W6ETP 52, W6AYC 44, W6EEH 46, W6DSS 20, W6PW 19, W6QC 22, W6WB 15, W6WN 12, W6CIS 9, W6FK 6, W6EEG 6, W6DZZ 6, W6DYB 5, W6DZQ 7, W6AVQ 2.

LOS ANGELES — SCM, D. C. Wallace, W6AM — W6AKW, W6CBW, W6DKV, W6EFA, W6AVJ and W6CHA make the BPL this month. W6CHA reports a 5000 word press message from WFA, handled without a fill and it took four hours solid to copy. W6AKW is keeping some good skeds. W6CBW says a lot of skeds have kept the traffic up in spite of final exams at school. Chain skeds are being arranged by the Pasadena Short Wave Club for various parts of the country. W6DKV has been busy getting ready for graduation from high school. Second op of his station is in the east visiting the fellows and is on with portable W6ZZL. W6AVJ sends in a fine total as usual. W6EFA is getting an 852 and is moving June 30th. W6AHP was QSO WFA several times and sigs reported R9. The YL op at W6AHP is now W6EVA owning and operating her own station. W6ZBJ is just rushing off to Boy's Camp. W6ETJ is going to try to make the BPL on deliveries. W6EQF has no regular skeds but constant QSO's with Philippines and Hawaii account for his traffic total. W6DYJ, W6EPH, and W6DYL send in good reports. W6BSL has been on the air about two months. W6UJ has a fine new baby girl born Memorial Day. FB, OM. He is working in spare time with W6DYL on portable power supplies and with W6ELV on "Treasure Finders". W6FT was QSO WFA on June 5th and had a nice chat with the boys at the South Pole. W6ESA worked his first Canadian station. W6DHM is going to rebuild. W6EKC has portable call. W6CVS, W6CUH worked an F and G during the month on 14 mc. W6BZR wants to enter the A.R.R.C. cup contest. W6ABK sends in a little gossip — W6DHM had a visit from W6ETA — W6DOW blew his fifty watter. W6BRO has been on the *Nonna* for a week at Catalina Island, then San Diego. W6AM reports the tuned doublet receiving system working better than ordinary receiving antenna. W6APW has been busy with school but still finds time to handle some traffic. W6DZK reports that W6DYJ worked VS3AB in Malay States, Asia. W6COT is keeping a good daily sked. W6DZI had a visit from W6DSS who will be down to the convention. W6HT has been on 28 mc. working a lot of DX including France. W6AGR has had several

early morning QSO's with P. I. stations. W6EVA is keeping a sked with another YL — W6ETA — and is on every night at 7:45. W6AKD is coming back strong. W6ASM reports that the A.R.R.C. will announce some convention news in the near future. W6AXE was QSO with X29a and K7pb both in the daytime. W6DSG has been on 28 mc. all month and QSO'd Europe easily at times. W6DLI is very busy getting ready for Albacore season. W6AWY is trying 28 mc. W6DAG is keeping two good skeds. W6ZZA portable has been traveling 1½ years now keeping skeds. W6MA kept schedules with W6ZZA. W6DPY is trying out a Zepp antenna and it works FB. W6CZT, W6CRC report. W6HS reports his new receiver is nearly built and will soon have new location. W6EJ just finished copy of Felco receiver. W6EAF graduated two from volunteer code sked, from under his tuition. W6AEC hopes to have more traffic next time. W6DLK and W6DOW report as usual.

THE PACIFIC DIVISION CONVENTION will be at LOS ANGELES and the dates are — NOVEMBER 29TH AND 30TH.

Traffic: W6CHA 350, W6AKW 321, W6CBW 286, W6DKY 227, W6AVJ 219, W6EFA 208, W6AHP 127, W6ZBJ 108, W6ETJ 94, W6EQF 84, W6DYJ 76, W6BSL 68, W6UJ 49, W6FT 47, W6ESA 43, W6DYL 41, W6DHM 38, W6FKC 38, W6CUH 38, W6BZR 31, W6ABK 25, W6EPH 24, W6BRO 20, W6AM 20, W6APW 19, W6DZK 14, W6COT 14, W6DZI 13, W6HT 11, W6AGR 10, W6EVA 10, W6AKD 10, W6ASM 8, W6AXE 8, W6DSG 7, W6DLI 7, W6AWY 6, W6CAG 6, W6ZZA 6, W6MA 5, W6DPY 4, W6CZT 3, W6CRC 1, W6HS 1.

SANTA CLARA VALLEY — SCM, F. J. Quement, W6NX — With 680 messages, 320 of them deliveries and mostly all important traffic, W6BYV maintained a daily sked with AC8RV and PI which was noted for its reliability. He has now enlisted in the Signal Corp of the Army and will be stationed at Presidio, San Francisco. W6AME took a decided slump this month, due to the lure of the trout streams in his vicinity. W6BMW reports the 7000-ke. band cluttered up with so many signals as to make any DX work impossible except during early mornings. W6JU made the BPL this month all due to the sked with the YL W6ETA and K6CFQ. Hi.

Traffic: W6BYV 680, W6JU 78, W6BMW 26, W6AME 6, W6NX 6.

EAST BAY — SCM, J. W. Frates, W6CZR — The summer months are beginning to have their effect on the section traffic totals. Everybody is either on vacation or preparing for one. However, there is the usual group who take portables with them to the seashore, the woods, or the mountains, and these keep a steady stream of messages coming in for their folks at home. W6IP is high man this month. W6ASH, a new man in the section, came into the traffic work with a splash this month. W6EIB is doing very FB trans-Pacific work. W6EDO is doing his stuff in fine shape. W6CGM considers his month gone to waste if he can't garner a couple of fistfuls of traffic from P.I. W6HJ is washing up in Vallejo before moving back to his home in San Francisco. W6BPC is still tuning up, which he has been doing for the last six months. Hi. W6BIW expects to have a four tube screen grid receiver working soon. Houston of W6SR with W6BTZ and others are operating W6SR and AV3 at the Calif. Nat'l Guard Camp. W6ALX is still the traffic eater of the section in spite of his Army-Amateur work. W6RJ has had W6AJM from San Diego and W6QL from San Bernardino as guests during the month. W6OT, the station of the Oakland Radio Club, is back on the air again under the care of W6DUR. W6BMS has been on his vacation so hasn't been able to do much traffic work. W6BUX reports that he will be on the air with a UX-310 this summer. W6EY says he is still too busy with his ball teams to do anything in the way of traffic. W6DWI is still pounding away on 28 mc. and other waves. W6EDK expects to come back on the air soon with a MOPA. MacClara, formerly of W6DUR, is on the air now with his own call and his OW is using the call of W6ALH. The Oakland Radio Club conducted a stunt night recently which was a great success. W6BDU now has the reputation of being the champion pie eater of the section. The club also took a trip to Stinson Beach and has other trips lined up for the near future.

Traffic: W6IP 419, W6ALX 322, W6ASH 250, W6EIB 156, W6CGM 155, W6HJ 114, W6ASJ 69, W6BIW 61, W6SR 55, W6RJ 48, W6OT 12, W6BMS 8, W6DWI 1.

SAN DIEGO — Acting SCM, H. A. Ambler, W6POP — W6ACJ leads this section but will be closed down from July 7th to July 20 to go on Naval Reserve cruise. W6EPF has a nice total and is keeping four skeds. W6EOS is now a new ORS and has six skeds. W6ERT reports handling a few. W6BGL is QRL ranch. W6BVX is still on once in a while. W6EPZ has YL QRM but expects to have his new power supply going soon. W6FOM is a new ORS and rebuilding. W6AKZ reports but very QRL. W6BAS will calibrate that wavemeter for you. Here is your chance, gang. W6CNK expects to be on regularly now. W6BAM says DX is good on 14 mc. Seven ORS failed to report this month. Better get those reports in on time, gang.

TRAFFIC: W6ACJ 140, W6EPF 123, W6EOP 99, W6EOS 74, W6ERT 68, W6BGL 60, W6BVX 31, W6EPZ 18, W6EOM 7.

ARIZONA — Acting SCM, H. R. Shortman, W6BWS — W6CRA has moved to Chicago where he will be on the air in the future. W6DIB says that the fish were calling W6DIB and so his QRA for the summer is Mormon Lake. W6DIE is on again after a trip to Los Angeles, where he saw a few of the gang. W6CWI is on using the transmitter he purchased from W6EFC. W6CWG is on with a UX210 and MG plate supply. W6DCQ has completed the new shack which he claims is the best in Arizona. We understand that W6XBC is in Kingman, Arizona and if so, would like to hear from him. W6ANO is still operating BC station KFXY in Flagstaff, Ariz., and likes the work very well. W6EOF is still at March Field learning to be an aviator. W6AUI is a traffic officer and has just been promoted to desk sergeant, so the gang can get off easy when detained for speeding, etc. Hi. W6CXW is working in a battery shop. W6EFC has been off the air getting new apparatus since he sold his equipment to W6CWI. W6DTU leads the state in traffic this month with W6EAA second. W6CDU is preparing a ham transmitter to take to the Nat'l Guard Camp at Fort Huachuca in August. W6BJF reports all his schedules cancelled and that he has been reappointed State Net Control Station for the Army network. The gang here were favored by a visit from W7ALC of Boise, Idaho, who was on his way to San Diego. W6EH was kept off the air by his commercial work and is being transferred to Kingman, Arizona, to operate KGTL for the Western Air Express Co. W6BWS sold his plate transformer and purchased a new Vibroplex and is on with a borrowed transformer. W6BWS and W6SW made a trip in an aeroplane when W6SW came up on a visit. They got quite a thrill. W6EAA reports not doing much except keeping his schedules.

Traffic: W6DTU 315, W6EAA 209, W6BWS 44, W6CDU 35, W6EH 7, W6BJF 5.

SACRAMENTO VALLEY — SCM, Everett Davies, W6DON — W6EEO again leads in traffic. He blew three 50-watters that he had not had over three weeks, and kept his China sked with two 171s. Too bad, OB. W6CIH is leaving us for a couple of months. W6ETA is still keeping skeds but says it is hot in her shack. W6AFU thinks DX and BCLs are more fun than traffic. Try giving your traffic to W6CGJ, he wants it. W6BDX is back from school and making skeds. The R.I. came to see us and as a result, about twenty happy hams have blue tickets. W6ER and W6DON passed the commercial test. W6BYB and W6FOU worked WFA. W6BSN and W6DQG says they are tired of having England answer them when they CQ. W6BSN worked Germany. W6DON and W6ER have been off, building a new MOFA set. They are going to keep it on the air 12 hours a day.

Traffic: W6EEO 476, W6CIH 238, W6ETA 220, W6AFU 35, W6CGJ 34, W6BDX 43, W6DON 6, W6CDC 9, W6FSZ 6.

PHILIPPINES — SCM, M. I. Felizardo, K1AU — This report by radio via W6EEO — K1HR keeps the following skeds: K9PB (Zamboanga, P. I.) 5:15 p.m. daily; WVN (Tientsin, China) 5:30 p.m. daily; AC8ZW (Shanghai, China) 6:00 p.m. daily; K6DTG (Honolulu, T. H.) 6:30 p.m. Wednesday only; OM1TB (Sumay, Guam) 7:30 p.m. daily; AC8AG (Shanghai) 9:00 p.m. Monday, Wednesday

and Friday; W6EEO (Williams, Calif.) 9:30 p.m. daily. Wavelength 42.8 meters.

Traffic: K1HR 724.

ROANOKE DIVISION

VIRGINIA — SCM, J. F. Wohlford, W3CA — W3EC has applied for ORS and same will be issued at once. W3MC, W3MT, W3EC and WMO went into Norfolk shopping for ham radio parts and visited W3PK, W3ARD, and went over and met W3NT and W3FP. W3PK is using TPTG circuit with two 210 tubes for 7000-ke. work. W3ARD is using 211 with 1200 volts on plates. W3AHW, an old spark ham, is back on with CW now. W3MU uses bed springs for counterpoise and his antenna is wound around the bathtub!! The gangs from Newport News and Norfolk are going to visit W3EC and see the new 250-watter. W3ALS working good DX on 28 mc. using a 201A with 135 volts. W3HY was off most of the month with antenna down and rebuilding receiver. W3BZ has skeds with W1MK, W8CMP and W8ZZ on 82 meters. W3BDD has his MOPA circuit going on 3500.

Traffic: W3EC 145, W3ALS 47, W3HY 1, W3BZ 6.

WEST VIRGINIA — SCM, F. D. Reynolds, W8VZ — W8HD is still keeping Army sked with W8OK which nets a few messages. W8DPO still works the DX, but complains about traffic conditions throughout the state. W8OK is still keeping Army and Navy skeds, but is complaining about the weather. W8JM reports xmitter all ready to go, but lacks ambition. We have a couple of new hams in Elkins now, W8AYI and W8TI. They are on 3500 kc. W8VZ has purchased a 700-cycle alternator and expects to be on when the BCs are asleep. W8DNN says he purchased a machinist's lathe and 250-tube sockets and has gone into business.

Traffic: W8HD 10, W8DPO 41.

NORTH CAROLINA — W4OC's sked with FQPM has ended, as the latter is on his way home. W4OC has worked all continents now and is waiting for WAC ticket. W4UB reports conditions very bad, QRM and QRN making QSP difficult. W4FS says the 1400 kc. band would be FB if someone would teach those CQ-DX birds how to work DX. Hi, W4TN has two skeds going now and promises a nice total for next month. W4AGH has a 210 with 600 volts on the plate. W4AB will be on all summer on 7000 and 14,000 kc. since school is over.

Paisley G. Isenhour, W4MI, died early June 22 after an illness of many years at his home in Asheville. He was one of the best amateurs ever on the air in this section and his fist will be sorely missed. He was formerly District Superintendent and also held the office of Route Manager in our new ARRL C.D. organization.

Traffic: W4OC 51, W4UB 42, W4TS 28, W4TN 4, W4AGH 10.

ROCKY MOUNTAIN DIVISION

UTAH-WYOMING — SCM, Parley N. James, W6BAJ — The traffic handled this month was pretty good, considering the usual summer slump. W6CZX leads the section. He now sports a commercial ticket. FB. W6CNX reports QSO with England on 14,000 kc. W6EKF was going fine until he was laid up with appendicitis. W6DPJ shows a nice total with only six days of operation. W6BAJ was on a few days with a new antenna. W6DPJ fulfilled his promise and handled some traffic as soon as school was out. W6DXM has a brand-new commercial ticket. W6RV has gone to Oregon for the summer.

Traffic: W6DXN 67, W6CNX 30, W6EKF 25, W6DPJ 24, W6DPO 16, W6BAJ 16, W6DXM 10.

COLORADO — SCM, C. R. Stedman, W9CAA — W9EBF is a new ORS at Greeley. W9CAA is remodeling the station. W9CCM is visiting in Utah. W9BQO is off the air temporarily, till he rakes up enough cash to buy a new B battery for the receiver. W9DGJ is back on after taking a layoff from the game. W9CDW is busy at KFEL. W9FXW is rectifying the output from a Ford coil for his plate voltage and claims a near DC note. FB, OM, W9CLD is quite active again. W9DIR, W9FLM, W9CWT and W9FXP are active at Pueblo. W9ELR is working up a schedule with W9FAM. W9DQV lost an antenna which slowed him up. W9DQD is on 7000 kc. during daylight hours. W9CJC and W9GEZ handled some traffic. W9CDE is on 7000 kc. and 14,000 kc. week-ends. W9CSR has been on his vacation, also been ex-

perimenting with MOPA circuit. W9EDM is a new ham at Greeley. W9BDY moved back to Brush and is on the air there. W9EGT is leaving the state, but turns in a good report before he goes. Sorry to lose you, OM.

SOUTHEASTERN DIVISION

ALABAMA — Acting SCM, Carroll Kilpatrick, W4AHR — I am writing the report this month as W4AAQ is out of town. W4LM is a new ham in Birmingham. Welcome, OM. W4AX is building a 150-watter for W4AIM. W4UV is trying for a commercial ticket. W4WS is busy with WBRC. W4AKM is coming along like any progressible ham station in the early stages — everything rebuilt. Hi. We are sorry to hear that W4AHQ has sold out. W4AIV says his report is going to be FB next time. W4TI wants some good schedules. Montgomery also has a new ham, W4HB. W4AHP is leaving for CMTC. W4AJR has been shooting alligators. W4MY says 28 mc. is very FB. W4AHR leads the state in traffic. W4AHO has a good set and also business QRM. W4LT, W4EW and W4JQ are hams in South Alabama. W4AAQ will be back next time, so let's welcome him home with some good reports.

Traffic: W4AHR 126, W5AHP 44, W4AX 42, W4TI 34, W4UY 33, W4AKM 21, W4LM 12, W4AAQ 12, W4AIV 10, W4AJR 9, W4WS 3, W4LT 1.

FLORIDA — SCM, Harvey Chafin, W4AH — W4ADB leads the gang this month with a FB traffic total. He says DX is rotten on 7000 kc. W4ABJ is next in the lead and sent his report via W4ABL. FB, OB. W4OB reports weather too hot for much of anything. W4MS says if the gang listens to broadcasting station WCOA on Thursday nights from 9 to 12 CST that you can hear him with his saxophone. Hi. W4ZP promises a better report next month. W4ZP's son now has a license, W4QL. Congrats, OB. W4AGY reports not much traffic. W4ABL, our college hero, is home again and is on 14,000 and 7000 kc. W4AGR is installing another M.O.P.A. with a 210. W4AFC came to Tampa on his vacation and visited the SCM and W4ABL. W4ACK, W4AJK, W4SQ and W4AC. W4QV has just received his ORS appointment. FB, OM, let's have plenty of traffic. W4VT is a new ham at Fernandina, Fla. W4TK reports that he spent his vacation in Miami. W4ACK has left Tampa and is playing in an orchestra for about three months. W4HY says little traffic and that he stays on both 7,000 and 14,000 kc. W4AKF has applied for an ORS. FB, OM. W4PAW will be operated from 506 W. Hanna Ave., Tampa and also from Indian Rocks, Fla. Address all cards to the SCM or Hanna Ave. A few cancellations are being made of inactive stations. The SCM would like to hear from all the stations in Florida that have never reported before.

Traffic: W4ADB 63, W4ABJ 35, W4OB 14, W4MI 14, W4MS 13, W4ZP 9, W4AGY 9, W4ABL 9, W4AFC-W4AGR 7, W4QV 6, W4TK 6, W4ACK 6, W4HY 5, W4SY 2, W4UY 2.

WEST GULF DIVISION

NORTHERN TEXAS — SCM, J. H. Robinson, W5BG — W5BAD heads the traffic list this month. W5BBF was QSO W5BFY at San Antonio, when a lady asked him if he could get a message through quickly. It got there and he had an answer back within five minutes. W5AUE is another good station who is starting to report. W5ATZ wants the gang to listen for his portable station (call not known yet) in his travels over North Texas. W5BAM is keeping schedules with W5KI and W5RH. W5JD is putting in his time with the official broadcast, rag chewing and traffic handling. W5DF wants schedules with anyone. W5BG is on Sunday p.m.'s mostly. W5WW is now second lieutenant in the Signal Corps Reserve and is on his way to Fort Sam Houston for a month of training.

Traffic: W5BAD 58, W5BBF 53, W5AUE 46, W5ATZ 20, W5BAM 18, W5JD 11, W5DF 11, W5BG 2, W5WW 2.

OKLAHOMA — SCM, W. J. Gentry, W5GF — Traffic has taken a jump this time, and W5FJ is the high man. FB, OM. W5AYF is OO for Okla. W5AIR is still a BC op. W5ALP is back again. Glad to see you, OB. W5BEE has some traffic all times. W5FS has all oil and no traffic. W5ASQ has had terrible QRM from that fishing pole. Hi. W5GF is on now, but won't have that xtal going until fall. W5QL still has DX with the mark. W5VH has been late with his reports. Let's keep our traffic total going up, gang.

Traffic: W5FJ 37, W5BEE 14, W5SW 12, W5GF 12, W5ALP 8, W5AYF 7, W5AYO 3, W5VH 19.

SOUTHERN TEXAS — SCM, R. E. Franklin, W5OX — The summer slump seems to have overtaken us this month, although the old reliables are still keeping some nice skeds and doing fine work. W5AHB is a new ORS in San Antonio and sends in a nice report. W5AHQ is a new station in that city. W5BFY keeps a sked with W9BCA and is conducting some tests with W2CXL prior to a sked with him. FB, OM. W5ABQ keeps a sked with W5LP and W9CKV. W5TD kept a sked with W6CWW while W5OX was on the west coast attending the Los Angeles Shrine Convention, so that he could keep in touch with home. The SCM had the pleasure of a visit from W5ABQ, the San Antonio Route Manager. He also had the good fortune to tour the west coast for three weeks and visit amateur stations in Los Angeles, San Francisco, Salt Lake City, and Denver, and must admit that the fellows out there are running the Good Old South a close second when it comes to hospitality.

Traffic: W5AHB 70, W5BFY 45, W5LP 40, W5TD 32, W5OX 12, W5ABQ 10.

CANADA

QUEBEC DIVISION

QUEBEC — SCM, Alex Reid, VE2BE — We are now in the midst of the QRN season, but the ideal time for rebuilding, and a number of the boys are taking advantage of this period to get up new antennas and other outside work. VE2AP has completely rebuilt VE2BB's station, both transmitter and receiver have been remodeled with the result that VE2BB worked six foreign stations in half an hour. VE2CA has moved to his new address and is using a Zepp and new 866 tubes, and reports good DX, eliciting Asia the second night on. VE2BE has erected a new pole, and expects good results when old man QRN gives him a chance. VE2BG is preparing for his vacation, so radio is receiving little attention. VE2AL is getting in some fine work on 1750 kc. VE2AC our old reliable at Thetford Mines, enters the BPL with a fine total. He will be going soon on three bands. Our RM sure sets the pace, and it is too bad that he does not receive better support in his traffic work from the rest of the gang.

Traffic: VE2AC 169, VE2BB 31, VE2BE 19, VE2AL 6, VE2BG 11, VE2CA 11.

ONTARIO DIVISION

ONTARIO — SCM, E. C. Thompson, VE3FC — Central District: VE9AL leads the Section in traffic handling this month. He is on the air daily on 3600 kc. keeping schedules. VE3VS has had such good luck on 14,000 kc. with a pair of 210's working everything in sight that now he says a 204A is on the way to help his signals in their wandering. VE3BC is still keeping one schedule on 7000 and expects to leave for the North very soon now on exploration work. VE3BO is hard at it again on 14,000 and also on 7000. In case any of you who read this really want traffic schedules with Toronto, get in touch with VE3BO, new QRA, 557 Willard Ave. VE3DW is a new station that we welcome this month, located at Beamsville.

Southern District: F. W. George, VE3AQ reports working a couple of Frenchmen. VE3CB advises the Junior Op. there has been assigned the call VE3DD. May we hear that sign for many moons! VE3CS has been delving into the mysteries of MOPA, but has not much time for radio. VE3DG is looking for VE skeds. He is on 3800 kc. nearly every night at 8:30 E.S.T. VE3HB did a little remodeling, and says he's getting much better reports. We welcome an old friend back in the game, Mr. Burr Graham, who has just been assigned VE3FD, and he promises some real work by the time this is read. The Southern District is putting on a hamfest this summer, under the auspices of the Western Ontario Amateur Association, so watch for the announcement, gang, and back it for all you are worth.

Central District: VE3CL has worked all U. S. districts but the 3d and 7th on 14,000 kc., and is looking for new worlds to conquer. VE3BP is using 7000 kc. in the early evenings, and he says that the fishing is good.

Traffic: VE9AL 30, VE3AQ 16, VE3HB 5, VE3VS 5, VE3BC 4, VE3CB 3, VE3FC 3, VE3CL 3.

VANALTA DIVISION

ALBERTA — SCM, E. J. Taylor, VE4HA — Nice weather has driven our gang to the woods, and there is very little to report this month. VE4GT is away most of the time, but expects to be on for a week soon. VE4BV has rebuilt, getting out FB with nice DC note. VE4EY is still gathering in DX. VE4HM works G6YQ. VE4EP is working phone at present.

Traffic: VE4HA 4, VE4EY 2.

BRITISH COLUMBIA — SCM, E. S. Brooks, VE5BJ — VE5DD, a new ORS appointee, has been QSO with AC5GO (ex-VE5GO) and handled important traffic, returning answer in 20 minutes. VE5BC is a new station in the 7000-ke. band. Welcome to our midst, OM. The S.C.A.R.A.'s club house is coming on favorably. Let's have some more reports, gang.

Traffic: VE5DD 93.

PRAIRIE DIVISION

MANITOBA — Acting SCM, A. V. Chase, VE4HR — Our SCM, VE4FV, has left the district to continue his studies at the Boston Tech., and the best wishes of the gang go with him. It is his intention to pound brass whenever time will permit. VE4GO has cleared up the QRM in his locality. He has completed a 100-wattter push-pull TPTG with a very clean note and is getting splendid reports on 14mc. On account of military duties taking VE4BD to camp for the summer, he had to discontinue a sked with VE4GO. VE4JB had his antenna system wrecked by a wind storm. With the assistance of VE4HR, a new Zepp system was erected and the transmitter is getting out better than ever. VE4DK is taking a course of instruction in flying at Camp Borden. VE4DJ worked VK3AP and VK5HG on 14 mc.

Traffic: VE4DJ 2, VE4GQ 4, VE4HR 4, VE4JB 2.

SASKATCHEWAN — SCM, W. J. Pickering, VE4FC — VE4IH has been off the air for a time and has rebuilt his transmitter into a MOPA arrangement. VE4GO is gradually adding to his list of countries worked on 14 mc., and now reports Honolulu, New Zealand and Peru. VE4GR is still on every noon and ready for traffic. VE4EF is also on every noon and evening. VE4EL has been wandering around the province and looking up the fellows.

Traffic: VE4GO 19, VE4GR 6.

LATE AND ADDITIONAL REPORTS

W7BB has been traveling through Japan, China and the Philippines. K1AF sent his report in by radio via W6EQF. Traffic: K1AF 280, K6DU 301, K6DWS 231, K6AVL 120, K6DTG 76, K6DCU 44, K6EST 39, K6ACW 16, K6ETF 16, AC8RV 111.





Conducted by A. L. Budlong

THE Prague radio conference is over. It did little that affected the amateur. The conference seems to have been primarily devoted to broadcasting and allied matters, and the amateur was given scant attention.

This does not mean that the amateur societies of various European nations can sit back and forget about radio conferences. Although the Prague conference did not affect him, it did bring out the very pointed fact that The Hague conference, scheduled for this fall, is going to consider at length amateur regulations, privileges, frequency-meter requirements, message handling status, etc.

It therefore behooves every national amateur society in Europe to get busy and endeavor to have its particular delegation to The Hague conference well instructed on amateur matters. Preparedness, in international radio conferences in particular, has been demonstrated to be more than half the battle. Do not leave matters until a few weeks before the conference, or depend upon your official delegation to get its amateur viewpoint from other sources. Start in now to acquaint your officials with your wants. Begin now your campaign of argument.

The amateur has plenty of warning for this conference. The big international conference at Washington in 1927 showed both what can happen when national delegations are uninformed and hostile to amateur radio, and also demonstrated very conclusively what can be accomplished if only a few of the nations represented are acquainted with the amateur and are prepared to stand up for him.

Make sure that your country is on the favorable and informed side this time. Draw up your proposals, place them before the proper authorities and push matters to a conclusion well before the date of the conference.

If a majority of the national delegations are turned to a favorable viewpoint *before* the conference opens — there will be no battle. It will be far better to have it thus than to have to depend upon the efforts of one or two delegations at the conference to turn the tide from antagonism to friendliness.

MORE PREFIXES

The list grows all the time. Many of the prefixes are unofficially adopted by the amateurs of the countries concerned, but in the majority of cases official sanction has been given to the prefixes which have been listed. If you hear new ones on the air, find out what countries they are, confirm them if possible by conversation with the amateur concerned, and then help your fellow-amateurs by forwarding the dope on a postcard to League headquarters.

Several amateurs are heard from regularly with information of this sort. Their coöperation is greatly appreciated.

CN — Morocco
 CP — Bolivia
 CR — Portuguese Colonies
 CZ — Monaco
 EL — Liberia
 ES — Estonia
 ET — Ethiopi (Abyssinia)
 HA — Hungary
 HB — Switzerland
 HH — Republic of Haiti
 HS — Siam
 LZ — Bulgaria
 OZ — Denmark
 PJ — Curaçao
 PK — Dutch East Indies (not UI)
 PZ — Surinam
 RV — Persia
 RY — Lithuania
 TF — Iceland
 TI — Costa Rica
 VS — Straits Settlements
 ZS, ZT and ZU — Union of South Africa

It has come to the attention of Union headquarters that amateurs in some countries are using their QSL cards as a means of disseminating propaganda along class and political lines. The Union cannot view these tendencies with favor. Amateur radio is something too precious to jeopardize by such actions. This is not playing the game, OM's. In amateur radio, the citizens

of every country in the world have something in common -- a something that is fine and clean and untainted. Let us keep it that way by keeping out of it anything that may tend to stir up racial and class hatreds. Drop the propaganda!

The semi-annual Calendar to members of the Union has been sent out, and votes on the questions brought up should be coming in by the time this item gets into print. We expect soon to be able to announce, among other things, the admission of several new societies to membership in the I.A.R.U.

The next calendar goes out in December. If you have matters to be brought to the attention of the membership as a whole, or if your society wishes to become affiliated with the Union, start your negotiations now. Address all correspondence to the International Amateur Radio Union, 1711 Park St., Hartford, Conn., U. S. A.

SOUTH AFRICA

The accompanying photograph shows the delegates who attended the Fourth Annual Conference of the South African Radio Relay League, at Johannesburg.

Fifty-four OM's were present, and from a detailed account of the conference appearing in the official publication of the S.A.R.R.L., *QTC*, it

proceedings, President White presented to OM Coombs, on behalf of Division 6, a very fine writing desk, suitably inscribed, as a mark of appreciation of his work; to Mr. McCash, a cutlery set, and to Mr. Todd a fountain pen.

This appears to be a good opportunity to comment upon the very excellent publication that the S.A.R.R.L. now issues to its membership. *QTC* is a real ham magazine, fully deserving of the success it enjoys. Congratulations, OM's.

BRAZIL

The office of the Director General of Posts and Telegraphs has issued revised amateur regulations for Brazil. In the main, these appear to be highly favorable. They are in strict accord with the provisions of the 1927 conference on amateur regulations.

Brazilian amateurs are apparently allowed to transmit in all the bands specified by the 1927 conference, and are given the full width of each. No buffer bands are mentioned. This is excellent.

Licenses must be obtained, both for the operator and the station. Messages are limited to those of a personal or experimental nature. Power is limited to 100 watts. There appear to be no unusual restrictions, although amateurs are not allowed to operate in the 1715-2000-ke. band between 9 p. m. and 12, midnight.



DELEGATES AT ANNUAL CONFERENCE OF S.A.R.R.L.

appears that some twenty YL's and OW's participated in the social doings. The actual business of the conference was confined to Saturday, but the delegates were entertained by the Johannesburg gang on Friday, Saturday evening, Sunday and Monday. A most enjoyable time was had by all, with a splendid annual dinner, a tea at the Zoo, and trips to "JB" and the City Deep gold mine.

President White, J. McCash, Hon. Headquarters Treasurer, and Raymond Coombs, Hon. Organizing Secretary, were all reelected to their respective positions. At the conclusion of the

DENMARK

By Helmer Peterson, Secretary, E.D.R.

Conditions have been bad and we have been troubled with atmospherics lately.

On the 3500-ke. band, W stations and some Europeans were heard during the first half of the month, but later on QRN was so terrible that even local QSO's were difficult of attainment.

The 7000-ke. band is fine for local traffic during the day. During the night (1-3 b.s.t.) the W 1st, 2d, 3d and 8th districts are heard.

(Continued on page 74)

Calls Heard



AI5VX, A. M. Rahim, Wellawatte, Colombo, Ceylon

14,000-kilocycle band

eb-4fe eb-4ft f8fr f8ep f8orm f8grdb f8lx f8fk f8btr f8pro f8pb f8acj f8axq f8xz f8sm f8ho flm flf fk-5cr fk-llm g5ml g5bz g5by g5wk g2nh g6hp g6qb g6wt g5yx g6ll g5vl g5wy g5lw g6uz g6uq g6rb g6qf g5yk g6vj g6vp g5wp g5ux ilog klcu k4sa pk1jr pk4az pk4au pk1bh pk1eg pa0yy pa0fp oh2um ok3sk ek2yd oz7lk on4ar vk2ek vk2hc vk2aw vk2no vk2w vk2y vk2d vk2j vk3ex vk3jk vk3pm vk3my vk3rx vk3ca vk3ep vk3bd vk4bb vk4nw vk5jh vk5hg vk5wr vk5wh vk6sa vk7eh vk2xr vk2hu vk5bw vt2kt vu2kw vs1ab vs3ab vq2bh w8za w8jn w1cek w6cuh yillm yilmdz yilac zsla ztlr zs4a zs4m zs5e zs5d zs5q zs5c zs5u zt5e zt5r zs6p zu6e zu6e zs5n zt2e zu6n zt6z zl2go d4uo d4ku et1bx su8an su8rs rxw xpa0op

G5WQ, J. R. Witty, s. s. Irion, c/o Dodwell & Co., Seattle, Wash.

14,000-kilocycle band

w1bke w1enj w1zz w2af w2are w2be w2bhq w2fp w3ann w3ans w3oh w3ux w4et w4gv w4be w4no w4pd w4wa w5ahi w5am w5amr w5awd w5bbi w5be w5lo w5ly w5pg w5pm w5ux w5yg w6aqj w6bto w6oyx w6dltz w6dwi w7afo w7agb w7akv w7lh w7li w7nr w8ahe w8avp w8ayo w8ecw w8ced w8dem w8ddk w8dnf w8dwr w8fz w9doq w9krd k4ni k6alm k6cha k6ene k6nv k7mm aclax celah ce2ab ct1by f8acj f8btr f8er f8fd f8jt f8rko f8aan fa8bak file fk5er g2ao g2lz g6qv g2sw gevz g5bd g5bj g5bz g5dn g5yg g5yk g5yx g6hp g6ia g6qb g6rb g6ta g6vp g6bx g6xj lu2fi lu4dq oa4h oa4o on4ur on4fm on4j on4p0j pk1jr pk4az py2bc rx1aa ac3fb am5tm ap3ar su8an su8ra ve2bg ve4hh ve4je ve5aw ve5eo ve5ef vk2ek vk2hu vk2j vk2kl vk2lj vk2no vk2ns vk2rx vk2tw vk3gt vk3jy vk3lp vk3ml vk3pa vk3wo vk4at vk4jr vk5hg vk5ja vk5wr vk7lj vu2kt xlpmeq yi2gq zl1fb zl1w zl2bg zl4ae zl4ba zs4m zs6p zu6d zu6e zu6n aul jdl pb7 xg6bmd xw7eff xpa0op.

G6CI, Brian W. Warren, 19 Melville Road, Coventry, England

28,000-kilocycle band

w1aqd w1bw w1bv w1emf w1xam w1zz w2aol w2ayr w2bg w2bvq w2bjv w2ws w2jn nkf wik f8kf

7000-kilocycle and 14,000-kilocycle bands

ar8ufm ai-5vx ap9frg ag-7uo ag-7kad au-lap celah ce2ab ce2ar ce3ac ce3ag ce3fb ce3bm ce3ea cep cxlna file fnum fo-lsr fvm2 fk-4ns fk-5er gd1j klaf kbg klcu kley k4ni k7mm kfr5 lu2bx lu2fi lu3dh lu4dq lu6fc lu9dt nj2pa onva pk1jr pk4az ptlee pyl1aa pylah pylaj pylaw pylbl pylca pylcl pylcm pylcr pylib pylid py2ad py2bc py2qa py3ah rx1aa su8an su8ra taf vk2aw vk2rx vk3ot vk5bw vo8rg vo8azw v81ab v81wb v83ab wsq xau-2bj xel-ldfa xpa0ep xpa0ja xw7eff yillm yi3gq zl2ac zl4ao zs4m zs5c zs5u zt2c zr5e

BRS-190, F. Pemberton, 115 Cambridge Road, Wimbledon, London, SW20

w1asu w1ame w1avf w1aqd w1alb w1aoo w1ajy w1asj w1acd w1are w1aqt w1avj w1aep w1aze w1aoi w1adw w1aci w1acm w1aea w1ebx w1bhm w1bsm w1bed w1bal

w1era w1cpb w1cpt w1cfl w1cmx w1cqr w1cfp w1cjo w1cel w1da w1dq w1dp w1ex w1fk w1jg w1jr w1kn w1om w1pd w1rp w1sa w1sf w1sw w1yb w1zz w1wy w2arb w2abu w2acd w2ajb w2azu w2aql w2api w2ahi w2ate w2avz w2adp w2aqh w2ary w2aof w2ajt w2ake w2aw w2ag w2bkv w2bjg w2buo w2blg w2biv w2bcm w2boa w2bjn w2bjv w2ch w2caz w2cyq w2dab w2el w2fl w2fk w2gp w2hq w2hj w2mb w2nd w2nt w2qu w2ra w2sv w2ws w3ahh w3apo w3acx w3bhx w3bph w3cee w3cgs w3eq w3ex w3fb w3jm w3jn w3pl w3ut w3vw w3wm w4abv w4aaq w4act w4adb w4aef w4eq w4ft w4rb w4uv w4we w5akp w5atf w5bj w5avj w5arn w5ri w5uf w5vz w7kf w8ady w8ako w8axa w8adm w8avn w8ajn w8aop w8aur w8amr w8agy w8afg w8ayo w8apn w8ank w8arb w8uhk w8bvp w8bwu w8bdp w8bmc w8cnh w8cye w8evq w8enz w8cmg w8cut w8ejo w8efl w8doa w8dyz w8ded w8ddg w8ddf w8ddy w8dkx w8dre w8dsa w8dhe w8dae w8dtn w8drs w8djv w8hx w8lv w8uk w8jm w9ans w9aji w9anb w9abd w9ark w9ant w9aok w9axx w9afx w9ahc w9awd w9ahz w9ama w9bld w9bga w9fbf w9bpm w9bmx w9bny w9bht w9bhh w9bil w9bba w9bge w9cmx w9cki w9cok w9cn w9cmv w9cfn w9doq w9dce w9dhh w9dku w9dku w9dly w9enr w9env w9ef w9cey w9eta w9eas w9eaj w9fwg w9fbw w9fdj w9fxm w9fvd w9fxj w9ggv w9gij w9dxx w9mt w9tm w9hm w9dij velar velbr velco velce velap ve2ax ve3ca ve2am ve2bh ve2bg ve2al ve2be ve3bk ve3ce ve3bm ve4hr ve5aw vo8ae vo8rg vu2kt vs1ab vs1wb vs3ab vs3gg vk2ek vk2rx vk2lj vk2aw vk2no vk2jj vk2rf vk2ns vk2kl vk2hl vk2hc vk3pm vk3ca vk3wx vk3cp vk3lp vk3bd vk3ra vk3my vk5ex vk3ot vk3pa vk3bq vk3jr vk3wo vk3rj vk3go vk4bb vk5by vk5hg vk5ja vk5bw vk5xg vk5wh vk5jh vk5kr vk5cm vk7lj vk7jk vk7ch zsla zs2n zs4a zs4m zs5c zs5d zs5n zs5t zs5w zs6p ztlj zt5e zt5r zu6e zl2ac zl2bg zl4ao zl4ba z4hg vq2bh pk1jr pk4az klcu k4ni su6sw su8an su8ar su8rs nj-2pa em2ac em7sh fq-pm fk-llm fk-4ms fk-5cr yilac yillm yilmda celai celah ce2ab ce3ac ce3ag ce3fb ex11en cx1na cx1oa cx2be lu2az lu2bx lu2ca lu3de lu8de lu3dh lu4dq lu9dt lu6fo lu3fk lu2fi pylaa pylah pylaj pylat pylaw pylbs pylca pylcl pylcm pylcr pylib pylid pylls py2ad py2ag py2ak py2al py2ax py2bc py2fb py2bg py2ig py2ih py2ii py3ah

28,000-kilocycle band

w1aqd w1bv1 w1a w1z w1bw w1cmf w1cos w1ry w1bae w2nm w2jn w2bg w2brb w2ayr w2aw w2aol w2acn w2bvq w2bhq w2xbi w4nh w5yg w8axa w8zg w9dhh nkf ve2ac

Thomas McGeachy, 28½ Pelham Road, St. Catharines, Ont., Canada

w4aaq w4aau w4abv w4act w4acx w4adb w4aef w4afe w4afq w4agn w4ago w4aha w4ahm w4ahq w4ail w4aim w4aip w4aiq w4aiw w4aiy w4aj w4ajk w4akg w4akh w4aq w4ch w4ck w4cw w4cd w4db w4ca w4em w4et w4fr w4gr w4kh w4kl w4kn w4my w4ne w4oa w4rm w4rn w4sd w4si w4tn w4uv w4we w4zp w4zz w5abi w5ad w5afi w5afs w5ahv w5ain w5ajk w5alp w5amw w5aod w5aot w5aqe w5ara w5ark w5aro w5arq w5atd w5atf w5auz w5awd w5axm w5axs w5axx w5ay w5ayb w5aye w5ayu w5aay w5ayz w5azr w5azw w5azw w5bat w5bbc w5bbh w5bbi w5bcm w5bec w5bek w5bf w5bv w5bh w5bj w5bp w5cq w5ex w5ef w5eg w5he w5im w5jc w5jd w5jk w5lp w5ly w5mi w5mm w5pr w5qj w5rd w5rg w5rh w5tl w5tp w5wn w5ww w5yd w5yg w5za w5zm w6aax w6abg w6ac w6acj

(Continued on page 86)

Correspondence

The Publishers of QST assume no responsibility for statements made herein by correspondents



A Good Example of Back-Seat Driving

Carmel, Calif.,
May 8, 1929.

Editor, QST:

Well, you have been hollering for copy. Hi! Please wire, my expense, if this will get in not later than July number, or not at all.

It's my say, and it's going to be said. If the Directors don't care to say it for me in QST, *das macht nichts aus*. Which is German, or Czechoslovakian, or something, for I don't give a damn. If I have to buy a few papers in the country (I mean pages in papers) I'll say it that way.

This may sound like a threat. I'm in a hurry, and I neither know nor care what it sounds like. It is merely a statement of unalterable intention.

Can hear you say, "Thought he said he was going to keep his nose out of A.R.R.L. affairs." So I did. And if this is sticking it in again, so be it. Any time I see anyone running around legging for the commercials, throwing a scare into these kids, making harder for me my fight for my own individual rights, I'm going to get my say into every quarter where I think it will do me the most good. If it helps the other fellers, too, so much the better. . . .

73,

— Clair Foster, W6HM

ROCKING THE BOAT By Clair Foster, W6HM

President Maxim's article on page 10 of QST for May has attracted much attention in California. The San José Club being the occasion of it, and I being the club's most voluble critic of some of the policies of the Board of Directors of the American Radio Relay League, I send you this response.

Mr. Maxim's words to the amateurs are always temperate and kindly. He never descends to personalities and always talks on the plane of high-minded consideration — the outstanding quality that elevates one man above his fellows. Nobody who knows Mr. Maxim personally could conceive of any reason for slamming him, much less actually subjecting him to the slamming process itself. And nobody who knows him doubts for one moment his integrity. In fact, it is almost a discourtesy even to mention the word.

Therefore we must accept his article, "Rocking the Boat," as the picture he sees in his mind and sets down on paper. An artist paints the picture his mind visualizes; a writer describes what his mind sets before him. And it is a sad blow to many of us to see the President visualizing amateur radio as the cargo of a very frail and unstable little boat that may be capsize by only a few of its passengers stepping to one side.

I, myself, cannot see amateur radio in any such predicament. If I regarded Mr. Maxim's metaphor as happily chosen I should see 17,000 admirable citizens of this country

on a ship so huge and sturdy that the whole passenger list might chase their fool selves from one rail to the other without endangering the ship. If a boat were so frail and tippy that no one dared stand up to see whither it was drifting, then amateur radio — if it were in such a boat — might as well capsize and submerge forthwith. It might better at once die courageously, as it has lived, than to sit continually in a quaking fear and merely hoping for some eventually less than death. A few brave words about "common sense coming to the rescue" do not efface the fearsome picture already painted.

If amateur radio has any justification for continued existence surely rocking the boat will not harm it. A boat (if we must adhere to this rocking-boat metaphor), if it cannot advance through the water, *should* rock. A boat that lies in still waters becomes so heavy with barnacles that it might as well be waterlogged. It is the motion of a ship that keeps it from becoming fouled. Perhaps those hardy mariners, the Directors, believe the little craft they see carrying all that is left of amateur radio is moving fast enough *backwards* to keep the barnacles off her.

This picture of Mr. Maxim's is a perfect example of what I have contended long and loud — to the folks at Hartford and to all and sundry — that for at least as long as I have been using my eyes and ears on the subject A.R.R.L. has been standing on the fundamentally unsound footing that the class of radio men known somewhat erroneously as "amateurs" never until this last conference of commercial delegates had any right to exist — a radically wrong assumption in these here United States. The belief that this class of citizens had no rights that need be respected; that such rights as we had been permitted to exercise were "privileges" granted for only so long as we remained subservient to the interests of those who have no thought except the fattening of their own pocketbooks; and so long as we appeared to be properly grateful for these "privileges."

In other words, FEAR is the guiding motive of the Directors; not the abiding conviction that the amateurs as a class cannot in this country have their rights taken from them and turned over to some other class of citizens. And A.R.R.L., through its voices, its publications and its attitude continues to express its fear and to inculcate a like fear in the whole body of amateur radio. Fear can and does make men sick; fear can and does make amateur radio sicker'n a dog. The very start of losing something — your health, your life, your rights — is fear that you are going to lose it. Gosh, I'd die and be done with it before I'd live a life like that!

Because the space formerly occupied by the amateurs was coveted by those who saw big money to be made out of it, and because the amateurs had been taught to believe they hadn't the rights of other citizens, they lost at the International Conference two-thirds of what they had. To say that "radio is world-wide and that this country alone no longer says what shall go on" is just of a piece with the rest of this fear propaganda. There is another "International Conference" coming, another dog-fight of commercial delegates from this and foreign countries. And to infer that the rights of a large body of the citizens of the United States shall be jeopardized, as at the last "conference," by the stubborn representatives of three or four foreign countries, is unthinkable. Since when has this country learned to bow the knee to the wholly self-centered importunities of a few foreigners! It never has yet. Now let's see you laugh that one off. To listen to this talk you'd think that the determinations of a few commercials at the last conference were as inexorable as fate, and that there was no way possible under Heaven for a wrong to be rectified! But if the Directors adhere to the same unsound reasoning, and continue to

HAMS KNOW

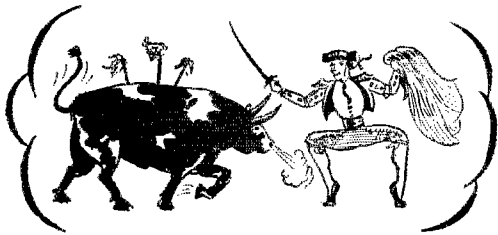

THIS FROM A HAM IN SAN SALVADOR

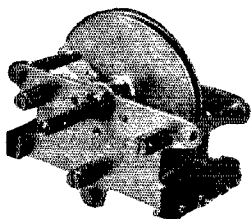

*Taper plate 191-E
Ideal for short wave receivers*

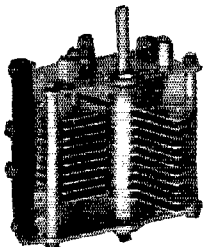

*Transmitting type 164-B
Capacity—.00022 mmfd.*

"It is a genuine pleasure for me to write to tell you that during the last five years I have been the most happy user of your wonderful Cardwell receiving condensers and although I have used and tried in comparison with yours, many other condensers of very high quality, I have always found the Cardwell to be the best by every test. So please let me congratulate most sincerely the organization that is building such a product in which the highest quality is its keynote.

"I have used your types 'C' and 'E' in broadcast receiving sets that I have built myself, but now I am making experiments, for I want to make a short wave super-heterodyne receiver. So I will greatly appreciate if you will have the kindness to send by return mail descriptive literature and price of the Cardwell condensers suitable for a short wave set.

"Thanking you very much in advance for this favor and again congratulating you for your wonderful product."



Receiving Condensers in all standard capacities. Transmitting Condensers for powers up to 50 K.W.—Fixed (Airdielectric) transmitting condensers. One for every tube and purpose. Literature will be promptly sent on request.

CARDWELL CONDENSERS

Allen D. Cardwell Mfg. Corp.
81 PROSPECT STREET
Brooklyn, N. Y.

IF YOUR DEALER DOES NOT
STOCK † † ORDER DIRECT

KEEP PACE WITH THE NEWEST!

EVEREADY RAYTHEON

TUBES FOR

TELEVISION

AND TALKING PICTURES



Eveready Raytheon
Kino-Lamp

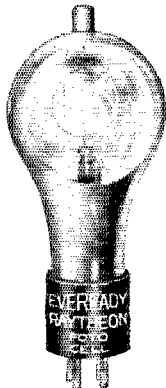

Eveready Raytheon
Foto-Cell

ARE OF PROVED DEPENDABILITY AND PERFORMANCE

The Eveready Raytheon Kino-Lamp for Television reception is the first tube developed commercially which will work with all systems.

With its uniform glow over the entire plate . . . tested performance . . . long life . . . perfect reproductive qualities . . . the Eveready Raytheon Kino-Lamp is a great step forward in Television.

The Eveready Raytheon Foto-Cell is a long-life transmitting tube for Television. Used also for talking pictures. Made in two sizes, either hard vacuum or extra-sensitive gas filled.

Correspondence is invited from everyone interested in Television. Foto-Cells to special specifications will be made at reasonable prices.

NATIONAL CARBON CO., Inc.

New York, N. Y.

Unit of Union Carbide and Carbon Corporation



shiver in their pants, they can just as easily lose for amateur radio at the next conference what they almost lost at the last one. It is common belief among men interested in commercial radio that amateur radio, so called, is but a passing phase; and this belief is strengthened all the time by the attitude of the amateurs themselves. Oh, wake up, gang! When an official of A.R.R.L., or just a brother amateur, preaches caution to you, make sure before you take it in that it really is caution that motivates his actions, not just goose-pimples. In nine cases out of ten you will find that it is a leaning towards the cause of the commercials or else just plain blue-funk.

As matters stand now the men who want the channels at present held by the amateurs don't need to do a thing but sit back and let the amateurs scare one another to death. Those amateurs who go about, officially or unofficially, warning other amateurs to be careful not to claim any rights for fear of losing the few "privileges" they now exercise, ought to be drawing monthly salaries from the commercials; for their actions are just as surely in the interests of the commercials as if they were indeed on the payroll.

What do you suppose is thought by the men who direct the commercial companies and other corporations or individuals who have been granted short-wave channels, when they see an organized body of 17,000 citizens scared stiff! The one body of men in radio that can most completely fulfill the requirement, "Public interest, convenience or necessity!"

And instead of making the most of our ability to meet the requirement, the Directors petition the Radio Commission to relieve the amateurs of the necessity of stating in what manner their stations will aid the public! And then—having had their petition granted—serve it up to us in *QST* as a concession, another "privilege," if you please, secured for amateur radio by the acumen of the Directors. They might just as well have broadcast to the world that the amateurs themselves were admitting their stations could not be operated for the public interest, convenience or necessity.

My friends in amateur radio (if I have any left), just keep in mind a few fundamentals. President Hoover has made a pronouncement that, coming from him, has almost the weight of a proclamation: "The domain of the air is vested in the people of the United States. The ether is a public medium and its use must be for the public benefit. The use of a radio channel is justified only if there is public benefit." That is sound logic and it will be sound law. The radio laws will be changed. They may even be altered to permit the R. C. A. Communications and the International Telephone & Telegraph to combine into a more extensive commercial monopoly. The presidents of both of these corporations announced about April 1st that the proposed and previously announced combination would not be consummated just then, but that an "accord" had been arranged pending changing the radio laws which at present forbid combinations of competing communication systems. Now, if Congress can be induced to change the law to suit the plans of the commercial companies it can likewise change it to rectify any injustice that may have been done to amateur interests. To cause this to be done and to stop all further talk about the right of the amateur to handle any kind of message, traffic is the next job for the Directors of A.R.R.L. But they won't accomplish a thing by sitting still in their little dinky boat and yelling their heads off for fear of somebody's rocking it.

But that clause about public interest, convenience or necessity will remain in the laws, however much they may be altered otherwise. And if the amateurs can't prove that their stations are being used, as President Hoover has said, for the public benefit, then they will be and should be barred from the air. You will prove no such thing unless you do it by showing that in handling messages of any character whatsoever you are performing a public service. Fortunately the aforesaid public will have a personal interest in helping you to prove it because the public is securing from amateur radio a valuable service for nothing. But you aren't going to prove it by soft-pedaling every reference to "business correspondence" — this hush, hush, the Bogie-man stuff.

Another fundamental to keep in the old bean: The U. S. Supreme Court, when it handed down its decision in the case of WGY against the Radio Commission, established two points that will stand as sound law. In the re-allocation of broadcast frequencies in June, 1928, WGY was practically barred from the air at night. The General Electric went into court and had the Radio Commission enjoined from enforcing its order, charging two points: first, that the Commission had made an unreasonable regulation; second, that the

\$7. THORDARSON R-195 TRANSFORMER

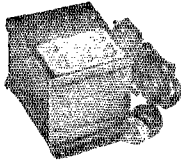

for B-Eliminator using the Raytheon B-H tube. Will carry the maximum current consumption

without overheating. Low 235 volts either side of centre tap—high 285 volts either side of centre.

While they last, only.....**\$2.95**

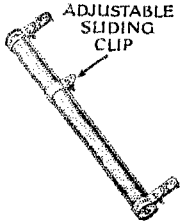

ELECTRAD Truvolt Wire

Fixed Resistances
from 1 ohm to 100,000 ohms—can be tapped at any resistance.

We carry a complete line of Electrad products.

Make your own transmitting and receiving coils. Copper tubing transmitting inductance.

Size of tubing			
Inside Dia.	3/16"	1/4"	5/16"
2 1/8"	9c	10c	12c*
2 3/8"	9c	10c	15c*
3 1/8"	10c	12c	17c*

Prices per turn

Ham Green, double silk covered. No. 16 receiving inductance.

2" diameter.....30c per inch
3" diameter.....35c per inch

Aluminum Shield cans and panels of every description to order.

LEEDS

The Home of RADIO
**45 VESEY STREET
NEW YORK**

**New York's Headquarters for
Transmitting Apparatus
When in Town Visit Our Store**

Everything in
Cardwell

- Acme
 - Thordarson
 - Jewell
 - Flechthelm
 - Signal
 - Bradley
 - Tobe
 - Pyrex
 - Fleron
- IN STOCK**



We carry the largest stock of General Radio Parts in the country.

*Prices subject to change without notice.

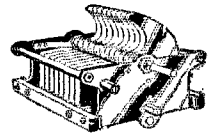

Cardwell condensers, double spaced for transmitting, .00025 cap. **\$4.45**



NEON GLOW LAMPS

Made by General Electric Co., type G-10, standard base. 101 uses, as illustrated in QST May issue page 17. Price only.....65c



By
Insistent Demand

LEEDS 50-watt socket, positive contact; heavy phosphor bronze springs, heavy brass shell; will hold your tube in one position. List \$2.50.

Special.....**\$2.50**

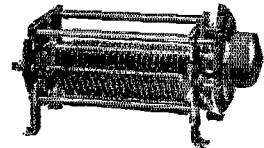

National Transmitting Condenser

We carry a complete line of parts made by "NATIONAL."

FEATURING

3 new items — Leeds Radio Lab. — others to follow in future issues. This department under the supervision of the Short Wave Specialist Jerome Gross. We design, construct and advise on any material for the "Ham" Broadcasting station or laboratory. Write Jerry Gross for advice on any of your problems.

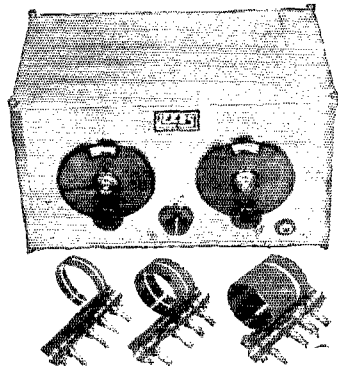

New LEEDS all aluminum plug in Short Wave Receiver. Coils not exposed, thereby insuring 100% shielded job. Short Wave — 3-tube Receiver — detector — 2 audio, using three 201-A tubes. Universal type, continuous range 15 to 100 meters; amateur type covers Ham bands 20-40-80 meters with generous spread on the dial.

List price \$60.
Special Offer, net.....**\$37.50***

New LEEDS 7 1/2-watt Hartley 1929 type Transmitter. Ideal for the beginner or anyone desiring a transmitter extremely simple to adjust and operate. Will operate with a 201-A tube, with 90 volts on the plate, up to a UX-210, with 30 watts input; has plug in transmitting coils. List price —kit \$55. Completely constructed \$70.

Special Offer, completely constructed.....**\$57.50***

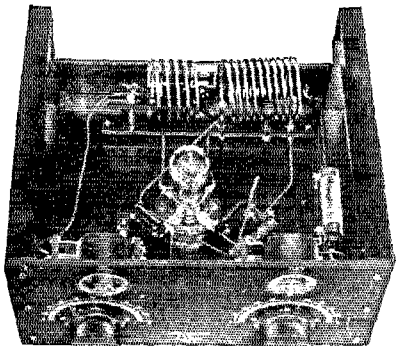

PLEASE PRINT YOUR NAME AND ADDRESS PLAINLY to AVOID DELAY

WRITE FOR SPECIAL PRICE LIST

MAIL ORDERS FILLED SAME DAY
10% Must Accompany All Orders

Inside facts about Tube Quality

Exact, uniform construction in all

Cunningham RADIO TUBES

is reflected in their absolute dependability. Ask for them by name.

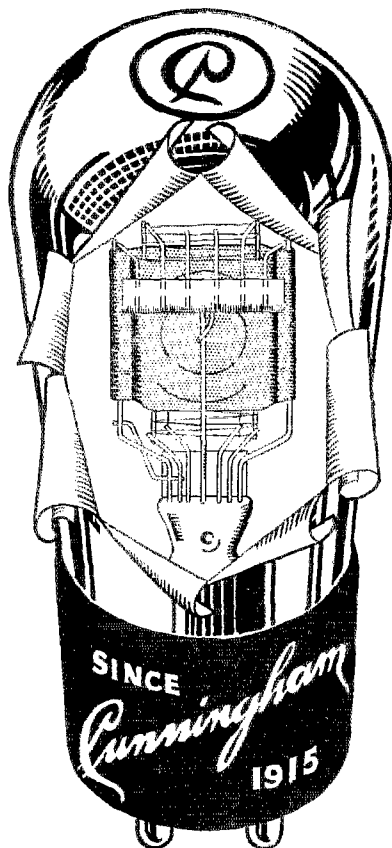

E. T. CUNNINGHAM, INC.
New York Chicago San Francisco
Dallas Atlanta

General Electric by its continued use of its previously assigned frequency had established "property rights" in this WGY channel. By "property rights" it meant that if restricted in its use of this channel its property would have been confiscated — an unconstitutional act. The Supreme Court established the law of the land when it held that while the Radio Commission was empowered to make regulations such regulations must be reasonable; that this particular regulation was not reasonable; and that, therefore, the injunction against the Commission was made permanent. And — even more far-reaching in its effects — that the General Electric was wrong in its second contention; and that there was no such thing as the establishment of property rights in a channel.

It doesn't take much of a head to see how either or both of these decisions may be invoked in the aid of the amateurs and of the public benefited by their message traffic.

Keep in mind that in our country a large body of citizens, some 17,000, serving the public free of charge with its heavy message traffic, cannot lawfully be put out of business so that some other class of citizens may have a monopoly of this traffic for its own private gain. Do not keep in mind all that amateur radio has done for the art. Of course that is where you think it may get you something; but just remember that appreciation and gratitude are rare qualities in the human race. If you do a wonderful job the folks in the old home town will name a street after you; and then proceed to the next order of business, in the satisfied consciousness that they have done handsomely by you. We are told pointedly in Mr. Maxim's article that the Directors of A.R.R.L. have full responsibility for A.R.R.L. policies; that nobody at Headquarters makes a move except by orders of the Directors. Now, when I think about boats the picture I have in my own mind is of a large body of amateurs on a big liner that has a solid keel of constitutional right, ribbed by outstanding achievements, and sheathed with service of inestimable value to the public. Then I see the Directors in their own little tippy boat, a picture of which Mr. Maxim has painted for us so vividly. And I see that little boat badly in need of a rocking. Not that I enjoy seeing anyone distressed, but I just have a hunch that if those old seadogs, the Directors, grew qualmy enough in your tummies they'd be so busy being afraid they *wouldn't* die that they would forget for a while to be afraid they *would*.

The Right System

Moline, Ill.

Editor, *QST*:

I read Mr. S. Schuffe's letter in the April issue of *QST* concerning beginner's difficulties. I just want to compliment Mr. Schuffe for presenting his views where some of the older hams can read them. I am in practically the same position.

I am only 16 years old and have subscribed to *QST* since July, 1928. I have the fourth edition of the Handbook and use it constantly. I am now building the four-tube receiver of the November *QST* and have already learned that the control grid is at the top of the tube. Hi!

I knew very little about radio before I subscribed to *QST* last July. Now I read everything in it and try to understand it. Everything which I do not understand I took up in the Handbook or in the public library.

— Bruce A. King, Jr.

Low Power Still the Berries

Editor, *QST*:

Having read OM Carr's (WICTC) letter on page 70, March *QST*, I believe that I can approach his low-power DX record. During the latter part of February, 1928, I tuned my hay-

Radio Operators!

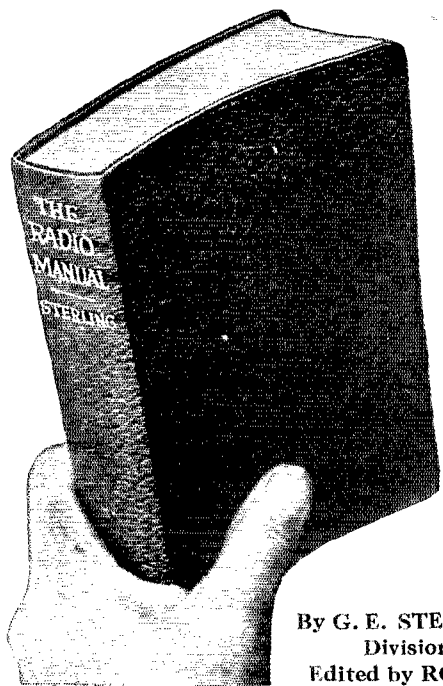

Here's the answer to every question about the principles, methods, or apparatus of radio transmitting and receiving. A complete course in radio operation in a single volume. A handbook for students, amateurs, operators, inspectors. For the first time an entire course of training in one book — the most complete and up-to-date work on radio. Developed simply and clearly from the elementary stage right through all phases of principles, practice, and apparatus so that a beginner with no knowledge of electricity may get all he needs either for amateur operation or to qualify for a government license as operator or inspector.

THE RADIO MANUAL

A Complete Handbook of Principles, Methods, Apparatus for Students, Amateur and Commercial Operators, Inspectors

By G. E. STERLING, Radio Inspector and Examining Officer, Radio Division, U. S. Dept. of Commerce.

Edited by ROBERT S. KRUSE, for five years Technical Editor of QST

Complete Preparation for Government License.

16 Chapters Covering

1. Elementary Electricity and Magnetism
2. Motors and Generators
3. Storage Batteries and Charging Circuits
4. Theory and Application of the Vacuum Tube
5. Fundamental Circuits Employed in Vacuum Tube Transmitters
6. Modulating Systems Employed in Radio Broadcasting
7. Wavemeters, Piezo-Electric Oscillators, Wave Traps and Field Strength Measuring Apparatus
8. Marine Vacuum Tube Transmitters including detailed description of Model ET-3626
9. Radio Broadcasting Equipment including, for the first time in any text book, the complete equipment of Western Electric 5 Kilowatt broadcasting Transmitter used in over 75% of American broadcasting stations
10. Arc Transmitters including description of Federal Marine 2 Kilowatt Arc Transmitter Type AM 4151; also models "K" and "Q"
11. Spark Transmitters including description of Navy Standard 2 Kilowatt Transmitter
12. Commercial Radio Receivers and Associated Apparatus including, for first time in any text book description and circuit diagram of Western Electric Superheterodyne Receiver Type 6094C
13. Marine and Aircraft Radio Beacons and Direction Finders
14. The Development of Amateur Short Wave Apparatus. Complete details of construction, operation and licenses
15. Radio Laws and Regulations of the U. S. and International Radio Telegraph Convention. Quotations of all important sections
16. Handling and Abstracting Traffic

Examine It Free

Never before has so complete a treatment of radio theory and operation been compressed into a single volume. Here is information that otherwise you could secure only by consulting many different books. And every detail is vouched for by authorities of the first rank. The Manual is profusely illustrated with photographs and diagrams. There are 700 pages, bound in flexible fabricoid that is extremely durable. The immediate demand for so valuable a handbook has already nearly exhausted the fifth large edition. To be sure of receiving your copy without delay, order at once. The volume will be sent for free examination. Pay or return in 10 days.

Order On This Coupon

D. VAN NOSTRAND CO., INC., 8 Warren Street, N. Y.
Send me THE RADIO MANUAL for examination. Within ten days after receipt I will either return the volume or send you \$6.00. — The price in full.

Name

St. and Number

City and State

(QST 8-29)

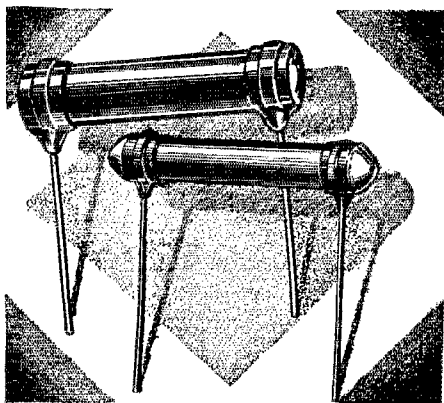

Quietness — Permanency Two Big Features of the Bradleyunit Resistor

THE outstanding noiseless performance of the Bradleyunit Resistor compared with other types of resistors is clearly revealed by laboratory tests. Quiet performance and permanence of resistance rating are highly essential qualifications for fixed resistors used in modern receivers of high amplification. Continued repeat orders from leading set manufacturers is ample proof that the Bradleyunit maintains its remarkable performance for the life of the set. It is unaffected by moisture, temperature and age. Use the Bradleyunit on your set for insurance against noise and distortion.

Standard Bradleyunits are furnished in ratings from 500 ohms to 10 megohms. Special ratings supplied on request. Units are equipped without leads or with leads up to six inches in length. Color coded for quick identification and checking purposes.

Write today, giving complete specifications, for data and prices.

ALLEN-BRADLEY CO.
277 Greenfield Ave., Milwaukee, Wis.

Allen-Bradley
PERFECT RADIO  RESISTORS.

wire to "80," said haywire consisting of an X201-A in the Hartley circuit with approximately 120 volts of ancient Layerbilts (adv.) on the plate. The transmitter at that time was built on a soft pine panel free from paraffin or any other treatment. In a few days over one month I was able to work all districts except the Third, which has, for some reason, always been a difficult district for me to work, as I have only worked about a dozen stations there in all.

I believe that the greatest thrill I have experienced in amateur radio was on the second morning that I operated on "80" when W6CCJ heard my call and we clicked for a short time. That even eclipsed the kick when I hooked my first Zedder. The gang on "80" is more considerate of beginners, I believe, than on any other, because for every one who cuts you off with a snippy "CUL73" there are six who slow down and chat with the chap who is struggling along about 8 or 10 per.

The apparatus here has progressed since that time until, while the power is still low, the efficiency has improved considerably. For the past six months the transmitter in use here has consisted of either one 112-A or two 201-A's in parallel with 180 volts of "B" on the plates in the Hoffman adaption of the Colpitts circuit. Plug-in coils permit operation on any of the frequency bands open to U. S. amateurs with the exception of the two highest. The entire transmitter is built on plate glass or Pyrex insulation.

The DX that the lid here boasts of loud and long to any one who will listen is: all districts, all states but one (Nevada), all VE districts, all provinces but two, Peru, Australia and New Zealand.

I heard several fellows say, late in 1928, that after the first of the year the low power stations would be crowded out and wouldn't be able to work, but I'm having the time of my life as long as the "B" holds up and the 112-A doesn't go west. In closing, I wonder why some of the guys who are crowding 2000 raw a.c. on a 204-A don't sell it for enough to buy a 210 and some filter and learn how to operate a real station?

— Carroll (Tick) Smith, W9EOQ

I. A. R. U. News

(Continued from page 66)

On 14 mc. conditions were excellent for the first part of the month, but went from bad to worse later. Although DX stations are heard, it is difficult to establish QSO's. During the evenings Australia and W 1, 2 and 3 are heard with fairly good strength; from 22 to 1 (b.s.t.) South America comes in QSA 4-5, and at 23 the K stations and Porto-Ricans have been heard. VK and ZL are heard in the morning.

On 28 mc. OZ7T and OZ7GL have been working hard, but so far without much success. OZ7GL has heard SP3KX QSA2, and obtained QSO with G6SQ, but lately nothing has been heard. Both stations would greatly appreciate reports on their transmissions.

SM

They said—

“S-M will do it this year”

—and S-M has done it!

BUILDING upon the experience of last year—when the S-M 720 and 710 Screen-Grid receivers set new high marks of accomplishment, both in extreme distance reception (such as Australia to New York on the broadcast band) and in musical excellence—Silver-Marshall announces a development as important to the 1930 builder as was the 1929 S-M supremacy in screen-grid receiver design. This year there is an entirely new keynote in designs for the setbuilder: **CONVENIENCE**. Formerly considered as the one feature monopolized by factory-built sets, *perfect convenience in operation* is now brought within the reach of all—and yet with even *better performance than the best “kit sets”* of last year—the S-M 720 and 710.

And this, too, at lower cost rather than higher—for the great new S-M factory, five times the size of last year's, and one of the largest in America, is bending its mighty power to bring still lower the cost to the setbuilder of those phenomenal results he feels a right to expect from any S-M receiver.

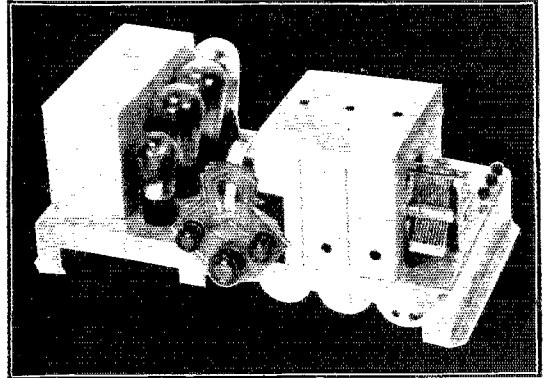

S-M 722 Band-Selector Seven

Far better in actual performance than the famous 720 and 720AC Screen-Grid Sixes, as well as more convenient, the 722 Band-Selector Seven is strictly all-electric, and tuned entirely by a single illuminated drum. It embodies a.c. screen-grid amplification in two r.f. stages, band-selector tuning, screen-grid power detection followed by resistance-coupled first r.f. stage, push-pull 245 output tubes, and provision for dynamic speaker. The 722 makes top-notch 1930 quality no more costly than merely mediocre reception.

And If That Sounds Startling—Read This

The Seven-Twelve Tuner

A Refinement of the Sargent-Rayment

For the setbuilder who wants the best regardless of cost, S-M is able to repeat the promise made and kept a year ago. The Sargent-Rayment 710 was acknowledged to stand head-and-shoulders above all other receivers offered at any price—and the same laboratory which perfected it now offers a further refinement in the S-M Seven-Twelve Tuner. Though not high-priced, the Seven-Twelve will this year duplicate the achievement of its illustrious predecessor and will far surpass in performance anything offered to the setbuilder at any price whatsoever. Built to realize every advantage of a precision band-selector tuner entirely separate from its audio amplifier, the Seven-Twelve uses 224 a.c. screen-grid tubes in three r.f. stages, band-selector tuning, and power detector. Perfectly adapted to give to the 712 a tone quality in keeping with its own outstanding sensitivity and selectivity is the new 677 two-stage power amplifier (245 push-pull). The 712-677 combination will be the setbuilder's ace for 1930—and at a price that will astonish the most skeptical.

735 Round-the-World Six

All-Electric—Short-Wave and Broadcast Band

The first completely a.c.-operated short-wave receiver to be offered upon the American market. Built on the same chassis as the 722 illustrated above, the 735 demonstrates in short-wave reception the same mastery of design for the 224 a.c. screen-grid tube which distinguishes the new S-M broadcast receivers. Built into it also is a typical S-M two-stage audio amplifier with push-pull 245 tubes. Plug-in coils give a range of from 17 to 650 meters. Strictly one-dial tuning, full-a.c. operation, and provision for dynamic speaker unite to make the 735 a real milestone in short-wave development.

Get your order in right away to your S-M parts distributor, for one or more of these 1930 receivers. Net prices will be found in the new S-M fall catalog; see coupon.

Have you seen the intimate description of these three all-new S-M receivers as first printed in the S-M **RADIOBUILDER**? If you want to keep up-to-date on the new developments of the S-M laboratories, don't be without the **RADIOBUILDER**. Use the coupon.

Custom-builders who use S-M parts have profited tremendously throughout the past season through the Authorized S-M Service Station franchise. If you build professionally, let us tell you about it—write now.

SILVER-MARSHALL, Inc., 6409 WEST 65TH ST. CHICAGO, ILL. U. S. A.

Silver-Marshall Inc.
6409 West 65th St., Chicago, U. S. A.

- Send your new fall catalog, with sample copy of the Radiobuilder.
- Forenclosed 10c, send five selected Data Sheets, including those on 722, 712, and 735.

Name.....

Address.....

SPREAD THE BANDS

EVERY amateur receiver must spread each band over the entire tuning condenser scale. Modernize your present set by installing the REL amateur coil and condenser tuning combination. Maximum efficiency can only be obtained by using correct LC ratio. Each coil in the REL Cat. Number 182 coil kit is correctly designed to adapt itself to any type of short wave circuit which requires inductances having one, two or three independent windings. Slotted grooves hold coil to original calibration as each turn is held fast in place. Key slot assures proper plug in as coil will only fit base in correct position. The coil shown is one of a kit covering the 14,000, 7000 and 3500 KC bands. The one piece construction means rigidity, insures permanency unattained with any other type of coil. Ask for Cat. Number 182. Price, \$10.00 including three coils and base.

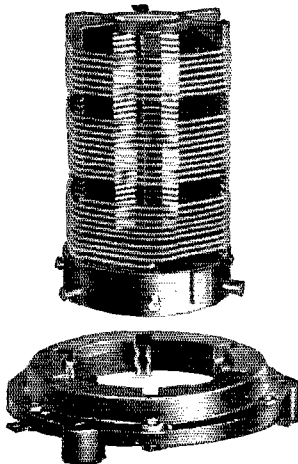

Here is the only variable condenser which will give full spread tuning over any narrow frequency range desired. Its design and construction is far above the usual types now available. It's a receiver condenser constructed more rigidly than most transmitter condensers. Tank capacity, 115 mmfd. Capacity of single plate vernier when spaced 1/16" — 30 mmfd. Ask for Cat. No. 187E. Price, \$6.25.

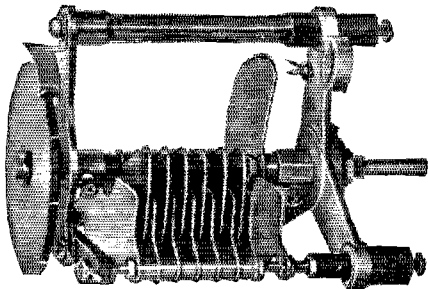

IF YOUR DEALER DOES NOT STOCK
THESE ITEMS, — ORDER DIRECT

REL manufactures a complete line of amateur short wave transmitting and receiving equipment. Write today for your free copy of our new 16 page folder showing latest circuits.

Radio Engineering Labs.
100 Wilbur Ave., Long Island City

FRANCE

28 mc. work is coming along in great shape in France. Quite a few of the French hams are having notable success with this frequency. F8CT works the United States and Finland with ease, and has heard W6XQ, in California. F8AAP with a Mesny circuit, and F8JT, with a modified Colpitts, have had many contacts with European stations. Other stations most frequently heard are WIK, WIY, HJO, W2JN, W2ALW, CH2NAG and FM8RIT.

GERMANY

It is understood that the annual convention of German amateurs, held on May 18th-20th, in Frankfort an der Main was a huge success. We hope to receive a definite report on it for inclusion in these columns.

BELGIUM

By Paul de Neck, President Reseau Belge

After much hesitation on the part of our amateurs which took place at the beginning of this year owing to the lack of knowledge of just what our officials intended to do about radio regulations, we are glad to report that most of our best-known Belgian hams are now beginning to come back on the air. The indications are that they will be shortly followed by many newcomers.

On the 7000-kc. band, work is mostly confined to European contacts.

Most of our hams are coming down to the 14-mc. band and very good DX contacts are the immediate result of this "downfall" — U. S. A., the Far East and South Africa have been easily reached these last weeks.

Testing phone DX on this band, ON4UU achieved a fine record, being fully understood by PK4AZ, in Sumatra, Dutch Indies.

Our training sailing vessel, *L'Avenir*, is back in Antwerp after a successful radio trip. During the 119 days that comprised the voyage, daily contacts were maintained with amateurs in Belgium, and only five days were recorded when contact failed. These occurred south of Cuba, when the ship was en route from Martinique to Tampa, Fla.

ON4FT made about 165 contacts with *L'Avenir*, which is certainly good work. The ship is now leaving for Charleston, S. C., U. S. A., with an official operator and commercial short-wave set this time. Hi!

ITALY

From Mr. Franco Pugliese, the Secretary of the A.R.I., we learn that amateur work at Italy is virtually at a standstill, as the Italian government failed to renew their transmitting licenses.

We hope that this condition is soon changed, and that many of the old familiar Italian calls are again heard in the amateur bands.

▶▶▶ A MARVELOUS NEW IMPROVEMENT

IN RADIO TUBES

EVEREADY RAYTHEON TUBES

GIVE A SUPERLATIVE DEGREE OF PERFORMANCE

INSTALL a set of new Eveready Raytheon Tubes in your radio receiver and note the unusually clear reception, greater volume and sensitivity. Quick heating and quick acting.

Behind all this is a revolutionary improvement in construction.

The elements in each Eveready Raytheon Tube are firmly supported by *four strong pillars*, cross-anchored top and bottom. They are accurately spaced within one-thousandth of an inch when they are made. And so rigidly braced that the spacing cannot change with the knocks and jolts of shipment and handling.

In tubes of the 280 type and the 224 screen-grid type, which have heavier elements, this rugged *4-Pillar construction* is of particular importance.

Only with Eveready Raytheon Tubes can you have this construction advantage. It is exclusive and patented. Eveready Raytheon Tubes come in every type, including tubes for television transmission and reception.

Eveready Raytheon Tubes are sold by dealers everywhere.

NATIONAL CARBON CO.
Incorporated
General Offices
New York, N. Y.

Unit of Union Carbide
and Carbon Corporation

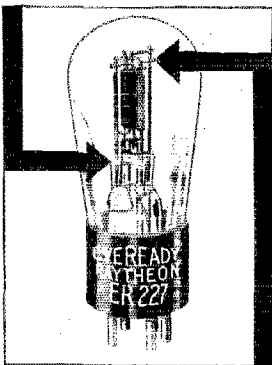

Showing the exclusive patented Eveready Raytheon 4-Pillar construction. Note the sturdy four-cornered glass stem through which the four heavy wire supports pass, and the rigid mica sheet at the top.



Eveready Raytheon ER 224 Screen-Grid Tube. The 4-Pillar construction permanently holds the four heavy elements of this super-sensitive tube in the perfect relation which assures laboratory performance.



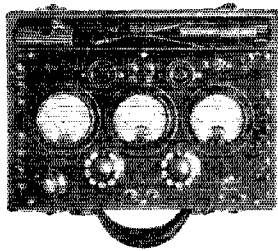

The New Radio Set Tester

THE radio industry is familiar with the Weston Model 537 Radio Set Tester — for A.C. and D.C. receivers. Service men hailed it with great acclaim a year ago, noting its many advantages over the Weston Model 519 — for D.C. only.

And NOW — here is another great advance — the Weston Model 547 — incorporating many additional features to meet the service testing requirements of radio's latest developments.

But with this NEW SET TESTER radio servicing is still further simplified, even taking into account the number of new tubes, sets and circuits.

Space won't permit description here — nor would words alone do this new set tester justice. You must see it for yourself — operate it — try to think up some service problem it can't solve. Try as you will the Model 547 will give you a quick and accurate answer every time. Convenient — complete — light and rugged. Handsome in appearance — and it will yield you handsome profits. It will increase your business and your prestige. **YOU CAN BANK ON IT!**

This instrument has many outstanding service features. But first of all it is a Weston — assuring you exquisite workmanship and complete service reliability. It is provided with three instruments — all $3\frac{1}{4}$ " diameter and furnished with bakelite cases. Carrying case, removable cover, panel and fittings are also made of sturdy bakelite.

WESTON ELECTRICAL
INSTRUMENT CORPORATION

602 Frelinghuysen Ave., Newark, N. J.

Weston
PIONEERS
SINCE 1888
INSTRUMENTS

JAPAN

From J2LL we get a radiogram, relayed through W6AVQ, stating that the gang need not expect to hear J4AK, J4CK and J4DK on the air as they were caught by government agents and prosecuted.

Our sympathies, OM's. As a matter of fact, the compiler of this department understood from pretty good authority that some of these stations, at least, were officially licensed. Apparently this is not so.

We might again caution amateurs who are sending QSL cards to Japanese stations to send them in a plain envelope. Don't send the card alone, or we will be getting the Japanese hams in trouble.

If you are in doubt, play safe and send the card to A.R.R.L. headquarters for forwarding. Include sufficient postage.

Don't forget to send us in your experiences on the best hours to work DX. We want this information from amateurs everywhere.

Experimenters' Section

(Continued from page 45)

vided. For 3500-ke. work a seventy-foot counterpoise is added or the eight-foot lead is run to a ground. Either method will provide an antenna system of the proper fundamental frequency.

Hudson Division Convention

FOR the fourth time the Hudson Division has held its annual convention under the sponsorship of its director and committee appointed by him. The Pennsylvania Hotel, which has seen so many of our conventions, was again the meeting place for all "hams" who attended on May 24th-25th. Contrary to most A.R.R.L. convention, there is not very much to do in the afternoon, but "Barney" Fuld, Ensign, U.S.N.R. started things going with a good plea for the fellows to enroll in the Naval Reserve. Then followed James J. Lamb, Asst. Technical Editor, *QST*, with something entirely new — a Modulometer. It's a new "gadget" for the use of the 'phone crowd and the lecture proved most interesting. Jim says it will be published in a future issue of *QST*.

Mr. C. E. Hoffman, Chief Engineer, Jenkins Television Corporation, was the last speaker of the evening, and with chalk and black board gave a good history of the new science. Saturday afternoon was devoted mostly to contests and stunts under the able leadership of Sargeant, who was one of the busy men of the convention. A new "liar" has arisen on the horizon and W1AOZ

BARGAINS ARMY AND NAVY RADIO SURPLUS

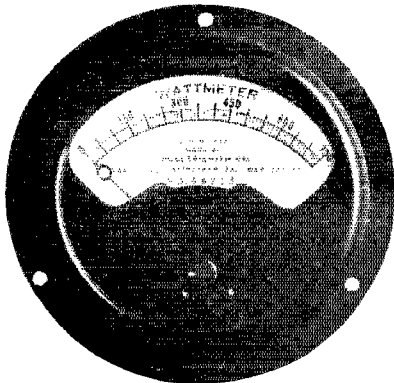

Wattmeter, Roller-Smith. Operates on either A. C. or D. C. Max. volts 150. Max. Amps 7.5. Zero Adjuster. Actual size 4 1/2" diam., 3" deep, black frame, flush mounting. Original price, \$28. Our price, \$3.50.

Voltmeter, Westinghouse, No. 492419 cabinet portable, 2 scale 0-5-150, List \$6.50	\$ 2.50
Milliammeter, Westinghouse, type C.A., 0-250, zero adjustment, flush mounting	5.00
Ammeter, Westinghouse, type C.A., 0-1, zero adjustment, flush mounting	5.00
Voltmeter, Westinghouse, type C.A., 0-35, zero adjustment, flush mounting	5.00
All above type C.A. meters operate on either A.C. or D.C. Regular price	
Amp. hour meter, Sangamo, bat. charge and discharge, type MS 2 sizes, 0-300 and 0-500, List \$50.00	10.00
Voltmeter, Westinghouse, A.C. 3" dia. with external res. 0-175	12.50
Dynamotors, twin, Westinghouse, C.W. 927, 30/750 volt, .08 amp.	25.00
Dynamotor, single, Westinghouse, C.W. 927, 30/375 volt, .08 amp.	15.00
Transformers, Peerless, 120 input, 5-10-15 volt output, 1/4 K.W., 60 cycle	7.50
Transformers, G.E. current type, 125 to 2500, with center tap, 60 cycle, 200 watt	7.50
Transformers, Amer. Tran., 220 to 8000, closed core, 1 K.W., 500 cycle	15.00

Largest Radio and Electric Supply House in U. S. devoting eight floors to and specializing on Army and Navy Surplus. Due to rapidly moving stock and as new items are continually arriving we are unable to publish a catalog. Write us your particular requirements. Sufficient postage and deposit of 20% required on C.O.D. orders. No C.O.D. ON CANADIAN Orders.

MANHATTAN ELECTRIC BARGAIN HOUSE, Dept. Q, 105-7 Fulton St., New York City

TRANSFORMERS

Guaranteed — Mounted — Complete

2 K. W. 2000—2500 each side	\$40.00
700 watt 1000—1500 each side	14.50
250 watt 500—750—1000 each side unmounted \$8.75; mounted \$10.50	
Auto-Transformers, Chokes, Polyphase and 25-cycle Transformers. Add \$2.00 for il. winding	
9CES FRANK GREBEN	
1927 So. Peoria Street, Pilsen Sta.	Chicago, Ill.

Transformers, Simon, 220 to 11500 closed core, 1/2 K.W., 500 cycle	\$ 5.00
Transformers, Amer. Tran., 220 to 12500 closed core, 2 K.W., 500 cycle	25.00
Gasoline Engine, 1 cylinder 2 cycle Smith 2 horsepower, complete	25.00
Gasoline Engine, 2 cylinder 2 cycle Sterling 5 horsepower, complete	50.00
Condensers, West. Elec. 21AA 1000 volt 1 mid. A.C. test, very good value	1.00
Condensers, Century, 500 volt, 4 mfd.	1.25
Condensers, Dubilier, mica, working volts 40,000, cap. (3) .002-.001-.0008	40.00
Condensers, Dubilier, mica, working volts 12,000, cap. .0004	10.00
Condensers, Dubilier, mica, working volts 3,600, cap. .32	10.00
Condensers, Dubilier, mica, transmitting, 8500 working voltage .004 mfd.	1.25
Condensers, Dubilier, mica, transmitting, 12500 working voltage .004 mfd.	10.00
Condensers, Wireless Specialty, transmitting, 12500 volt .004 mfd. Prices on request	
Keys, transmitting, Army practice	1.00
Keys, transmitting, Airplane flameproof, silver 1/4" contacts	1.50
Keys, transmitting, Airplane flameproof, silver, 3/8" contacts, with blinker light mounted on bakelite base. List \$7.50—Special	2.00
Keys, transmitting, Navy 1/2 K.W., "Mescos" silver	2.00
Radiophone transmitter unit, Western Electric CW326	1.50
Telephone and telegraph portable sets, aluminum case leather covered and carrying strap, including condensers, induction coil, key, micro-transmitter and receiver	3.50
Telegraph and buzzer portable sets, mahogany case, 2 tone platinum contact high freq. buzzer, 2 telephone toggle switches, potentiometer, sending key, 5 mid condensers, transformer and 2 choke coils, receiver, \$30 value	5.00
Receivers, Signal Corp type B.C. 14A, 200-600 meters, with cry. det. and Century buzzer in portable case	7.50
Receivers, Signal Corps, 300-3000 meters, with built-in tube detector, portable	20.00
Receivers, Marconi, 300-2500 meters, type 106, commercial ship type	35.00
Receivers, Navy, C.N. 240, 1000-10000 meters	50.00
Receivers, S.E. 143 and I.P. 500. Prices on request	
Insulators, Electro, strain 7-15, 12-35, 18"	.35
Coils, Retardation, West. Elec. Co. 57C, 83 ohm, 2 windings	1.00
Buzzers, West. Elec. extra quality high freq.	1.50
Air compressors, Kellogg, Model T, 1 1/2 cu. ft. per min., weight 6 lbs., 600 R.P.M., 125-lb. pressure	3.00

WANTED

RECEIVERS — 1-501, SE-1420, SE-143, CGR-1, SE-1120, C.N-204
DETECTORS, TUBE — SE-1071, SE-1071A.

FREE INFORMATION NOW READY
WRITE FOR YOURS NOW!

Transcontinental Coils

Gotham Engineering & Sales Co., Nat'l Agts.
50 CHURCH ST., Room 370, NEW YORK CITY

QST OSCILLATING CRYSTALS

Constant Temperature Control Equipment

We are now in a position to supply you with Thermostatically Controlled Heater units for accommodating two crystals (one used as a spare) with provision for instantaneous change-over, said unit maintaining a guaranteed constant temperature to a tenth of one degree Centigrade. This unit is easily adjusted and is entirely automatic, operating from the 100-volt supply mains. Delivery 10 days after receipt of order. Price \$400.00. More details upon request.

We also grind crystals for use in the Broadcast Band accurate to plus or minus 500 cycles of your assigned frequency for \$55.00 fully mounted.
Prices for grinding crystals in the Amateur bands are as follows:

1715 to 2000 Kc band	\$20.00, unmounted
3500 to 4000 Kc band	\$27.50, "
7000 to 7300 Kc band	\$45.00, "

SCIENTIFIC RADIO SERVICE

P. O. Box 86, Dept. F

The Crystal Equipment Specialists

Mount Rainier, Maryland

**The value of your back-copy
file of QST is determined
only by your ability to
find a certain issue
when you want it.**

Can you always find the refer-
ence copy you seek?

Your answer will always be in
the affirmative if you preserve
each year's issues, and each
copy as issued, in a

QST Binder

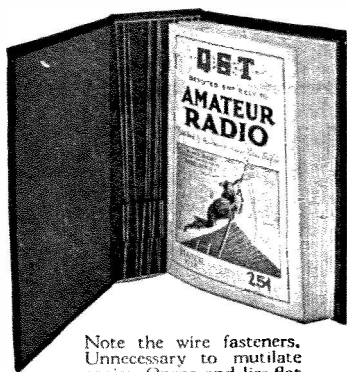

Note the wire fasteners.
Unnecessary to mutilate
copies. Opens and lies flat
in any position.

**\$1.50 each
postpaid**

A binder will keep your QSTs always
together and protect them for future
use. And it's a good-looking binder, too.

QST

1711 Park St. Hartford, Conn.

is making quite a reputation, having displaced
Doc. Walsh, famous for so many years.

Surprisingly, although to be expected, a great
number of old timers were present and seem to
enjoy themselves renewing old acquaintances.

Following the precedent of former years the
banquet proved the big drawing card and the
small ball room was filled to capacity. Director
Walsh, acted as Toastmaster. Hiram Percy
Maxim, President of the A.R.R.L., was able
to attend and with his wonderful vision carried us
to heights that made us all feel happy at being
radio amateurs. The Army and Navy were well
represented; Colonel J. B. Allison and Captain
Hoorn spoke interestingly about the Army-
Amateur Net; Commander C. R. Clark, of the
Third District, Naval Communication Service,
as well as Lieutenant Ferguson talked on the
Naval Reserve. We all realize that both the Army
and Navy are behind the amateurs and it's up to
us, fellows, to show them that it is appreciated by
giving full support to any scheme whereby we
shall become more closely united.

Frank Frimerman, W2FZ, who had charge of
the menu, outdid himself this year, and we are all
thankful to him for the good "cats" and plenty of
them too. Treasurer Hebert, from A.R.R.L.
Headquarters was roped in for the distribution of
prizes, and in that way escaped having to make
the long speech he had prepared; and instead ex-
pressed his appreciation to all the manufacturers
who so generously contributed pieces of well
worthwhile apparatus that help so much in mak-
ing our conventions successful.

Our thanks to Walsh, Talley, Kay, Sargeant
and the rest of the committee for their hard
work.

— A. A. II.

An Effective Break-In System

(Continued from page 44)

nearly as quiet operation. It does not seem ad-
visable, however, to add wire and apparatus to a
carefully made, low-loss secondary circuit. The
output transformer not only gives a quieter
break-in but also leaves the receiver's efficiency
unimpaired.

It must be kept in mind that the receiver is
wholly operative during the period of transmis-
sion. This system is, therefore, not applicable to
very high transmitting powers because paralysis
of the tubes would result. The transmitting power
at W1AJZ is 75 watts input at 600 volts to a
UV-203-A. The plate supply is R.A.C. plus a very
good filter, and the set is keyed in the center
tap.

The system outlined is, of course, applicable
to lesser powers but it is not known to what
degree the power can be carried without spoiling
the effectiveness of the system. The proximity
of the receiving aerial to the transmitting aerial
would undoubtedly affect this feature consid-
erably.

With an Audio-System really Designed for Short-Wave Work

Operates from
NATIONAL
Velvet — B

Write us today
for full details

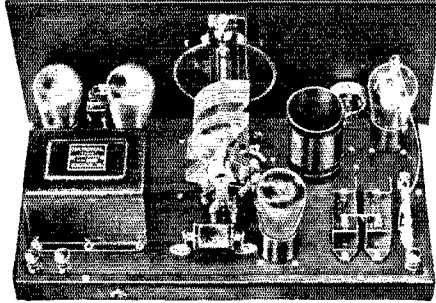

A special audio system has been built for this Double-Duty National THRILL BOX SW-4. It embodies new improvements on the former NATIONAL Impedance-formers, permitting the use of a high- μ audio tube and giving a very high audio-gain. The two audio-units are placed in one case for compactness and to make wiring more simple. And the SW-4 is designed for stable and quiet operation with a 200-A detector — an added and unusual advantage.

Every other detail is just as carefully thought out. The SW-4 is not a copy — it bristles with new and ingenious details for your convenience and pleasure.

NATIONAL

4 Tube THRILL BOX SW-4

NATIONAL CO. INC., Malden, Mass.

Est. 1914

RADIO IN BRASIL

When in Brasil, apply to M. BARROS
& CIA for anything you need in
connection with radio.

M. BARROS & CIA

70 sob. Rua S. José 70 sob.
Postal Box 89

Rio de Janeiro

Telegraph address, Radioparte, Rio de Janeiro
Branch: Avenida S. João 4, S. Paulo, Brasil

QUARTZ OSCILLATING CRYSTALS

Scientifically Prepared for Maximum Power and Unconditionally Guaranteed
1 in. square sections, of your approximate specified frequency, supplied
at the following prices:

75-100 meters.....	\$12.50
100-200 meters.....	10.00
200-600 meters.....	15.00
1 in. Tested blanks, 200-400, 400-600 meters.....	5.00
Dustproof Bakelite mounts.....	3.00

Sections of any practicable dimensions made to order
Prompt Delivery

J. T. Rooney, B. Sc., 4 Calumet Bldg., Buffalo, New York
"Twelve years' crystallographic experience"

DAY AND EVENING CLASSES IN

RADIO OPERATING

Next terms start July 15th and Sept. 1st

For further information and circular, address

The Registrar

FEDERAL RADIO AND RAILWAY INSTITUTE

517 Wells Street

Milwaukee, Wisconsin

FOR WANT OF A NAIL

*Everybody remembers the verse
about the courier in the battle of
Waterloo speeding to get rein-
forcements for Napoleon. His
horse faltered and fell. For want
of a nail a shoe was cast . . . and
the battle lost.*

*A radio receiver is much the same.
You may have the reinforcements
in the form of many good parts
and yet there may be a nail that
causes trouble. Look to the volume
control for a great amount of
this grief.*

*Then turn to Centralab controls
whose quality is vouched for by
the fact that most of the large
manufacturers use them.*

Central Radio Laboratories

20 Keefe Ave.

Milwaukee, Wis.

Type 866 Rectifier Tubes

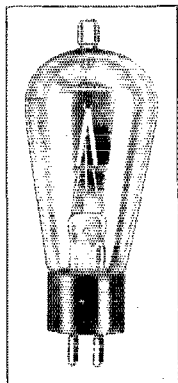

CHARACTERISTICS

Mercury Vapor	
Voltage Drop	15
Fil. Volts	2.5
Fil. Amps.	5.0
Peak Inverse Volts	5000
Peak Plate Amps.	0.6
Total Height	6½"
Diameter	2¾"

LIFE GUARANTEED
\$3.00 Money Order

EDWIN C. EWING, JR.
Room 930, 29 S. LaSalle St.
Chicago, Illinois

DODGE RADIO SHORTKUT

Kills Hesitation—Increases Speed
Corroborative Evidence

Few REPORTS stating SPEED GAINED—
Listen Good

W1ATO	up 10 to 25—Quick come back
W2AIR	up 6 to 22—Little practice
W3OA	up 5 to 26—in three weeks
W4QY	up 15 to 30—in five hours
W5AHM	up 6 to 18—in few evenings
W5QN	up 3 to 25—Spare time 4 months
W5SN	up 12 to 25—Little effort
W5TX	up 15 to 25—Easily and quick
W6BVX	up 12 to 20—Soon; little effort
W7AH	up 5 to 18—in two evenings
W8AJA	up 6 to 19—in two weeks
W8ARZ	up 8 to 25—in two weeks
W8BEV	up 12 to 24—Very easily and soon
W8BFA	up 20 to 25—in few days. Comcl
W8BFG	up 8 to 20—Little effort
W8BPJ	up 12 to 20—Soon as got code pat
W8CGS	up 12 to 30—Very soon, spare time
W8CJK	up 8 to 25—in few weeks
W8FM	up — to 25—Soon; little effort
W9AOQ	up 8 to 20—in two weeks
W9CEC	up 10 to 18—in one week
W9CMW	up 15 to 25—in 3½ hours
W9CNC	up -5 to 25—in few weeks. Comcl
W9CSK	up 13 to 22—in few weeks
W9DKZ	up 10 to 25—And from QSZ to OSQ
W2ATK	From scratch to 25 very easily
W6BNT	Doubled speed. Now Comcl First
W6BWW	From scratch to 18 very soon
W6GYA	Had failed—made 25 quick
W6DXX	From scratch to 25 easily

DODGE HIGH SPEED

THE Booster—Comcl Op; speed 27 raised to 42 in 4 weeks—few min. practice each evening.

Radio Shortkut \$3.50. High Speed \$2.50. Money Order. Foreign Add 50 Cents. C.O.D. if send One Dollar.

C. K. DODGE

Box 100

Mamaroneck, New York

The Atlantic Division Convention

WITH delegations from Buffalo, Pittsburgh, Washington, New York City and several other cities, the fourth annual Atlantic Division Convention opened auspiciously in Philadelphia, Friday, June 21st, at the Hotel Walton, with one of the largest registrations ever noted on the first day; and for the first time a goodly number of "fone" hams were present.

Harry W. Stark, President of the Philadelphia Radio Association, who sponsored the convention, opened the proceedings in due form and after a cordial greeting to the delegates turned the meeting over to Director Woodruff, whose versatility is well known. As usual the Doctor proved most interesting with his lecture — it is not for this reporter to try describe it — one must attend. A. A. Hebert, A.R.R.L. representative, took charge of the Traffic Meeting, in the absence of Communications Manager Handy, and during the meeting discussions of interest to both the "fone" and C.W. men took place. Jim Lamb, Assistant Technical Editor, *QST*, had the whole evening to himself and gave a lecture on his new "pet" — the Modulometer; every fone man should have one of the gadgets in the shack.

Our YL Acting SCM, W3CDO, and her sister, with a number of OM's, started making the rounds of ham stations after the evening meeting and returned to the hotel as members of the "Boiled Owls." Notwithstanding all the "ham-festing" of the night before, every one was "on deck" at 9:30 Saturday morning for the trip to the Navy Yard to see NAI and other points of interest. The delegates were courteously received by Lieutenant-Commander Wynne, and under the leadership of Ensign Weinstock we all had an opportunity to see "Communications" and the radio laboratory; afterwards we were taken through the aviation section. The afternoon was spent competing for the very good prizes so generously contributed by our good friends the manufacturers. Those of you who fortunately won these prizes should make it a point to write the donors.

The banquet proved to be one of the big events, and Frigar, W3AIF, covered himself with glory, as chairman of that committee. Through him and the kindness of Dr. Levy, owner of WCAU, and Mr. Leitch, engineer of WCAU, the staff of fourteen (14) performers of that station entertained us during the dinner. Director Woodruff acted as toastmaster — another accomplishment to his credit — and with speeches from Commander Langworthy, representing the Navy; Jim Lamb, Radio Aide, 1st Corps Area, for the Army; Hebert, Treasurer of the League, on "Our A.R.R.L.," and Mr. Calvert, a friend of the "Fone Ham"; some food for thought was given all those present. Concluding with the distribution of prizes and a wholesome cheer to the committee, the 1929 convention came to a close.

—A. A. H.

Synchronous Motors for Television

In addition to building reliable and satisfactory motor generators, "Esco" has had many years of experience in building *electric motors* for a great variety of applications.

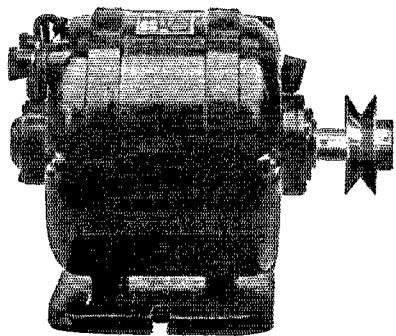

Synchronous motors, small, compact, reliable self starting are now offered for *Television* equipment. They require no direct current for excitation, are quiet running and fully guaranteed.

Other types of motors suitable for Television may also be supplied.

Write us about your requirements.

ELECTRIC SPECIALTY CO.

25 South St.

Trade "ESCO" Mark

Stamford, Conn.

WIRELESS EGERT ENGINEERING INC.

179 GREENWICH ST., N. Y. City

WE { eliminate any type of man-made static.
design and construct special Radio and Electrical relaying systems.
build Special Transmitters, and long or Short wave receivers to order. Amplifiers constructed and designed to order.

See the new **SHORT WAVE 4** Just Announced by our Company. The Best Short Wave Set you can buy to-day.

BROADCAST MICROPHONE

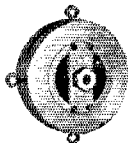

Finest broadcast microphone made. Double button. Stretched diaphragm type. Covers entire frequency range. Write for circular.

\$50

Broadcasters Service Bureau
San Jose California

... FORCE ...

Your signals thru with the Mercury Arc, the most powerful of rectifiers. Overload capacity beyond any transmitting demand. Instantaneous action, completely automatic. Long life, full wave, single and six phase for any load or voltage. Remarkable offering of Edison batteries.

RECTIFIER ENGINEERING SERVICE

Radio W8ML 4837 Rockwood Rd., Cleveland, Ohio

Wholesale Prices

for Dealers, Agents and Set Builders—prompt deliveries



OUR huge Wholesale Radio catalog No. 19 (2ND EDITION) is a valuable encyclopedia — a liberal Radio education. Mailed immediately on request — absolutely

FREE

1500 Illustrations and
6000 articles

FROM many years in the Radio Mail Order Business, we have learned how an organization must be efficiently run to gain and retain the good will of our customers. Radio Specialty Co. ships orders promptly! — offers you 100%

quality merchandise on a strict money-back basis if not thoroughly satisfied — and sells at rock-bottom net prices. Our catalog contains the largest assortment of completely assembled all-electric AC Receivers at amazingly low prices, and other Radio Merchandise including such lines as Pilot-Silver-Marshall — Carter-Aero — Vaxley — Tobe — Hammarlund — Amer Fran — Cunningham — Dongan — Thordarson — Muter, etc., etc. The latest improvements in Radio are listed and thoroughly described in this great catalog: AC All Electric Sets with self-contained ABC power supply — Public Address Amplifier systems — A.C. Set Converters — A and B eliminators — Dynamic Speakers and Units — Magnetic Speaker Chassis — 245 and 250 Tube Amplifiers — Airplane Cloth Speakers — Push-Pull Power Amplifiers — Electric Phonograph Turn-Tables — Combination Radio and Electric Phonograph Consoles — Speaker Tables — Short Wave Sets and Adapters — Shield Grid Tube Kits — Television Parts — Electric Household Appliances, Tools, Workshops — CAMERAS — etc.

Send for Catalog No. 19 (2ND EDITION) today

Radio Specialty Co. 100S Park Place

New York Radio's Oldest Mail Order House

How to select, operate
and care for radio
receiving sets—

Practical Radio

Including the Testing of Radio Receiving Sets

New Third Edition

By JAMES A. MOYER, Director of University Extension, Mass. Dept. of Education, and JOHN F. WOSTREL, Instructor in Radio Division of University Extension, Mass. Dept. of Education

378 pages, 5¼ x 8, 223 illustrations
\$2.50

THE book presents the fundamental principles of radio so simply and clearly that any person of average training will be able to read, understand and apply them. Both the inexperienced amateur and the technically trained specialist will find the book valuable. In Chapter XI there are accurate working drawings as actually used in radio shops together with complete lists of materials required for constructing eight typical receiving sets.

The book tells you:

— what radio is — how a radio set works — how to select, operate and care for radio receiving sets — how to construct your own receiving set — how to test your set — how to select a loud speaker — how to select, test and use vacuum tubes properly — how to locate common troubles — how to remedy them.

See
this
book
FREE



McGRAW-HILL FREE EXAMINATION COUPON

McGraw-Hill Book Co., Inc.
370 Seventh Avenue,
New York, N. Y.

You may send me Moyer and Wostrel's PRACTICAL RADIO, third edition, \$2.50 net, postpaid. I will either return the book, postage prepaid, in 10 days, or remit for it at that time.

Name

St. and No.

City

State

Name of Employer

Official Position

(on approval in U. S. and Canada only) QST 8-29

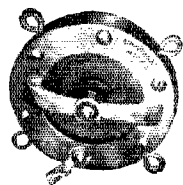

MICROPHONES

2-Button Type

For Public Address, etc., list, \$25

Standard Broadcast Model, list, \$75

Condenser Models for Film and Record Work, list \$250.00, \$300.00

Also Desk and Floor Stands, Covers, Cords, etc. Miniature Microphone, Paper Weight, Radiator Ornament, Die Cast, Bronze finish; prepaid on receipt of \$1.00.

EXPERT MICROPHONE REPAIRS

Dealers everywhere

UNIVERSAL MICROPHONE CO., Inglewood, Calif.

Chicago: Fred Garner Co., 9 S. Clinton St.
New York: Gotham Eng. & Sales Co., 30 Church St.
San Francisco: C. C. Langwin Co., 274 Brannon St.

Book Reviews

By H. P. Westman, Tech. Ed.

Radio Receiving Tubes, by Moyer and Wostrel. Published by McGraw-Hill Book Company. 281 pages and 181 figures.

This book advances somewhat beyond the so-called popular treatment of the subject and the use of vector diagrams and a more mathematical treatment of many problems is incorporated than will usually be found in a text directed to the non-engineer. This is altogether desirable in many respects but it is felt that it will limit somewhat the advantages the technically inclined but not-so-well educated amateur and experimenter will obtain from it. It does, though, fill a need for a stepping stone between the engineering text and the many insipid ABC books written for consumption by the non-technical reader who cares to consider nothing other than well-polished English entirely void of anything resembling even arithmetic.

It would be advisable, perhaps, considering the bulk of the book to drop off some of the very elementary material in the introduction. The printer might also have stocked a few honest-to-goodness μ 's instead of using an italicized μ .

List of Fixed and Land Stations, published by International Bureau of the Telegraph Union, first edition, January, 1929.

This is usually referred to as the "Berne" list and is the official international list of stations. It lists all fixed and land stations of the world giving for each station its assigned call, the exact geographical position of the transmitting aerial, the type and frequency of transmission, radiation power, antenna height, nature and hours of service and message charges. Additional information is given concerning any special services. No alphabetical listing by call letters is included which makes it extremely inconvenient to locate the identity of a station from such information.

Cram's Radio Atlas, published by George F. Cram Company of Indianapolis, Ind. 32 pages.

Broadcasting stations of the United States and Canada are listed by call letters, states, wave lengths and frequencies. In addition other broadcasting stations are listed by countries as are high-frequency stations located throughout the world. Several maps are provided to show the positions of the broadcast stations in the United States, Canada and the rest of the world.

The Federal Radio Commission, Department of Commerce and A.R.R.L. radio divisions are indicated on maps and a list of the directories, officers and S.C.M.'s of the League is included.

The Modulometer

(Continued from page 15)

to the grid of the amplifier. Bias on the modulometer tube is adjusted so that the plate milliammeter shows near full-scale deflection with the stage un-neutralized, complete neutralization being indicated by minimum reading of this meter.

With the modulometer removed some distance from the transmitter and a headset plugged into its jack, it may be used as a very effective monitor for checking the quality of the modulation by the aural method. When so used, it simply serves as a non-regenerative receiver.

Many other measurements may be made with the device, including the gain of audio-frequency amplifiers in receivers, gain of r.f. amplifiers and numerous other possible audio- and radio-frequency measurements which will suggest themselves to the ingenious experimenter.



Care-Free, Long-Life Reception

— use Dongan Power Parts
and get the Best in Radio

You can have this kind of radio at a moderate cost. The new UX 245 Tube has made possible an even lower gross cost than was necessary with UX 250 Tube. It will pay you to find out about this new tube and the accompanying parts.

- No. 994 — Power Amplifier Transformer.....\$12.00
 - No. 2189 — Push-Pull Output Transformer.....\$12.00
 - No. 2142 — Push-Pull Input Transformer.....\$4.50
 - No. 3107 — Straight Output Transformer.....\$12.00
 - No. 2158 — Audio Transformer.....\$4.50
- Two Secondary Windings (for either No. 2189 or No. 3107), one for Magnetic type and the other for Dynamic type Speaker.
- D-946 — Standard Condenser Unit.....\$22.50
- This Condenser Unit is also designed for use with No. 994 Transformer for Power Amplification.
- No. 5554 — Double Choke, use in Filter Circuit.....\$11.00
- For Push-Pull Radio and Phonograph Amplifier:
- No. 2124 — Transformer.....\$6.00

Dongan Electric Manufacturing Co.
2999-3001 Franklin St., Detroit, Mich.

"TRANSFORMERS of MERIT for FIFTEEN YEARS"

Radio Operators

Send for this Folder **FREE**
Now It is

If you really want to be a First Class operator — you can. Nature plays no favorites. She has given you the tools — The Candler System shows you how to use them. Overcomes every handicap. **DOUBLES** speed of slow operators. Makes fast operators **FASTER**. Puts you in **BIG PAY** class in few weeks. McElroy, world's champion radio operator endorses no other system. Satisfactory results or no pay. Folder tells all about it. Send name and address now!

THE CANDLER SYSTEM CO.,
6343 So. Kedzie Ave., Dept. RL. Chicago, Ill.



RADIO INSULATORS

Write for Catalog.

CORNING GLASS WORKS, Dept. 64
Industrial and Laboratory Division, Corning, N. Y.

P. A. HORNS

Cast aluminum and fibre horns, 93" long, 31" dia. \$65.00.
Other sizes to your order.

Broadcast or P. A. standard two-button microphones, precision made. Excellent quality. Guaranteed, \$50.00. Desk stand, ring type, \$10.00. Floor stand, \$15.00. Either nickel-plated or statuary copper finished. State finish wanted for mikes and stands.

E. E. PATTEN
5606 42nd Avenue S.W. Seattle, Washington

for Short-Wave SUCCESS

There's no bunk about tuning in GSSW of England, PCJ of Holland, and other overseas stations, right in your own neighborhood, day in and day out. Many radio fans are doing it, but—

Many have tried and failed. Perhaps you have. Why? The cause may be traced to crude regeneration control. Those weak, overseas signals thrive in the threshold oscillation zone—that point in regeneration just before the detector "spills over." Unless your regeneration slides gradually into oscillation, with a soft hiss and a gentle pop, you won't get real distance in short-wave work.

Irrespective of what short-wave setj you are using, it can be improved by means of the

CLAROSTAT

REG. U.S. PAT. OFF.

the micrometric resistance for every resistance requirement—micrometric regeneration, proper plate voltages, accurate grid bias, volume control, sensitivity control, and so on.

WRITE for data regarding the complete CLAROSTAT line and how to apply same for better radio results.

CLAROSTAT MFG. CO. Inc.,
Specialists in Radio Aids
283 North 6th St.,
BROOKLYN, N. Y.

GOOD NEWS FOR RADIO ENGINEERS

THE new addition to the Hardwick-Hindle Plant cuts the time it takes to make resistor deliveries in half. Now, within just 72 hours, we can supply you with resistor samples, designed to your specifications. And we can turn them out almost as fast in quantities.

HARDWICK, HINDLE, Inc.

Sales Dept.
122 Greenwich Street
New York City



Factory
215 Emmet Street
Newark, New Jersey

RESISTORS

GUARD



against
BURNOUTS

ARCTURUS
BLUE A-C **LONG LIFE TUBES**

ARCTURUS RADIO TUBE CO.
Newark, New Jersey

Calls Heard

(Continued from page 67)

w6acp w6acc w6ad w6adp w6aiv w6agk w6ags w6aie
w6ajm w6akd w6am w6aob w6aos w6aov w6app w6apw
w6aqj w6ary w6asl w6avj w6awa w6awp w6awz w6bam
w6bax w6bec w6bes w6bf w6bhr w6bjq w6bjf w6bjj
w6bpm w6bro w6bsp w6bto w6btz w6buk w6bvs w6byb
w6byy w6bzad w6bzs w6bop w6ctu w6cha w6chy w6chw
w6chy w6cjh w6cis w6civ w6clz w6cpm w6coq w6cix
w6cub w6cuc w6cuh w6cui w6cut w6evj w6evn w6cwh
w6cyx w6czk w6czm w6dbl w6dcv w6ddy w6dfe w6dgg
w6dhs w6diy w6dix w6dmd w6dms w6dpa w6dpl w6dpg
w6dpl w6dqe w6dqj w6drb w6dsg w6dte w6dto w6dtu
w6dwi w6dwp w6dyb w6dyj w6dyo w6dzd w6dzm w6dza
w6eau w6ebp w6ebv w6ecm w6eez w6efe w6egm
w6ehf w6ehw w6eif w6eii w6eiu w6ekw w6eic w6emd
w6eog w6eop w6eot w6evz w6epf w6ept w6epz w6eqj
w6erm w6eug w6eva w6evg w6iff w6ikf w6igm w6gn w6hb
w6hm w6ju w6kg w6nh w6nx w6pu w6qa w6ql w6qy w6ry
w6ue w6uf w6vz w6wb w6wn w6yf w7aac w7abg w7aby
w7acb w7aes w7acy w7agb w7ago w7ahx w7aii w7aij
w7aj w7aja w7ajx w7akj w7akp w7aky w7akz w7alc w7aof
w7apd w7be w7bw w7dr w7ek w7fe w7fh w7ga w7hx
w7id w7if w7ig w7js w7kg w7kt w7le w7li w7mo w7mx
w7ua w7ur w7ny w7ov w7pb w7pv w7sl w7am w7sr w7ub
w7ui w7un w7vk w7vg w7wg w7wi nl-green nr2fg nr2ho
nr2wd rx1aa sm6ua su8an cetah celai ce2ab ce3ac ce3bf
cm2ac cm5fc cm5fl cm7sh ct1aa ct1by ct1bx ct1by ct1en
ct3ub ct4nw cw2uk d4abg ear65 ear74 ear96 f8aap f8acj
f8aqm f8btr f8cp f8ct f8tc f8fr f8hm f8hr f8ix f8jd f8jt
f8kz f8lgb f8mst f8orm f8pro f8rr f8sm f8so d8wb x8wb
fq-pm g2ao g2lz g2qv g2zv g5bj g6by g6bz g5lv g5ls g6ml
g5uw g5ux g5vi g5wk g5wp g5yg g6yx g6bd g6gc g6ll
g6nt g6gb g6rb g6rw g6vp g6wv g6wl g6wy g6xb g6xe
g6xj g6xn g6yv g6nj k4aan k4akv k4kd k4ni k6alm k6eat
k6efc kdv5 kfr5 kfr6 lu2fi lu3dh lu4dq lu6ic lu9dt oa4h
oa4q oa4s ob7nh on4di on4fo ob4fp ob4ft on4ij oz7z
pa0fo pa0gw xpa0ja pa0qf xpa0zz pylaa pylah pylaw
pylcm pylib pylid py2qa haf3an haf3ar hel3g uolkr ve4ur
ve4as ve4db ve4dj ve4dk ve4dp ve4fb ve4ft ve4fn ve4fv
ve4gd ve4gq ve4gu ve4he ve4hl ve4hm ve4hr ve4hu
ve4ib ve4ie ve4io ve4ij ve4jw ve4sw ve4sr ve4el ve4he ve4js
vk2ek ve2hu vk2ku vk2ns vk2rx vk2tw vk3ep vk3ex
vk3de vk3go vk3jr vk3lp vk3ot vk3pa vk3pm vk3ra

28,000-kilocycle band

w5jc w6hxy w8pzs 3500 kc fone: w1shy w1aft w1aii w1ajt
w1aoz w1erc w1qo w2abi w2aob w2aow w2bey w2bhr
w2brb w2cyp w2gl w2iu w2js w3acm w3acq w3aex w3atq
w3ao w3ap w3asa w3bfz w3cgd w3cev w3iadg w4ald w5kx
w8aci w8ael w8afg w8ahf w8ahz w8aij w8aky w8aos
w8awu w8bhf w8bjj w8bxy w8cxy w8ejx w8epf w8ewo
w8ded w8ih w8rd w8rl w8rw w8sw w8yv w9bag w9bbw
w9cby w9cfa w9cjj w9dgp w9db w9dpg w9eqm w9eel
w9ewx w9fke w9fob

OH2NAB, V. I. Eloranta, Box 36, Helsinki, Suomi, Finland

14,000-ke. band

w1bfz w1bkf w1bux w1cfi w1j w1mo w1ry w1zl w1zz
w2adp w2arb w2ary w2bob w2el w2gp w2mb w2rs w4ael
w6czm w7af0 w7nr w8adm w8ced w8ddm w8dvw w8djv w8hx
w8z w9dce w9dgs ce2ab ce3ac ce3am ex1na fq1m lu2fi
lu3dh lu8ad pk1jr pk4az pylaw pylca pylcl pylcm pylil
pylld py2ad py2bc py3ah su8an ve1br y12gq z44m

A. Edwards, 7 Sherbourne Rd., Acocks Green, Birmingham, England

14,000-ke. band

w1acm w1aze w1bal w1bux w1cek w1cib w1cmx w1cox
w1g w1j w2abu w2adp w2atz w2bjg w2blg w3acx w3adm
w8dw ve1br ve1bv ve2be py1aw pylca pylcl pylcm py2qa
py2bf lu2ca lu3dh lu4dq lu8ad lu9dt ce2ab ce3ac ex1na
fk2je vk3go vk3pm vk5hg vk5ja z44m su8an su8rs fk5en
ik5er pk4az vu2kt y1ac y1mdz y12gq eu2nt eu6ak ryle
xpa0ja

VK3CX, Alan G. Brown, 8 Manqurra Rd., Canterbury, E. 7, Victoria, Australia

14,000-ke. band

w1bkf w1bux w1cqr w1dq w1ry w2ag w2evj w2gp w2fp
w2jn w2rs w2tp w3pf w3sh w3ut w4aq w5acc w5epa

HELP WANTED

The little article in this issue entitled "Some Changes in Our Staff" shows that promotions and consequent vacancies occur occasionally on the Headquarters Staff of the League. We prefer, when possible, to select additions to the Headquarters Staff from A. R. R. L. membership, so that every member of the staff, whether pursuing radio work or not, has knowledge of amateur radio and A. R. R. L. background. We would like to establish contact with amateurs interested in joining the staff, with a view to communicating with them as vacancies occur. A. R. R. L. Headquarters' needs cover many fields: technical radio knowledge, editorial-staff writing ability, correspondence, traffic work, credits, collections, advertising, circulation, office management, legal work, proof-reading, publicity — all the fields of work in which you know A. R. R. L. engages.

If you have experience in these lines and would care to be considered for a Headquarters position, write giving full particulars of your schooling, technical radio experience, business experience, age, etc.

American Radio Relay League
Hartford, Connecticut

The NEW Easy-Working VIBROPLEX No. 6

Reg. Trade Marks: Vibroplex; Bug; Lightning Bug

In Attractive Colors *Blue* *Green* *Red*

The NEW Easy-Working Vibroplex now available in attractive colors at no additional cost. Blue, Green, Red or Black...\$17 Nickel-Plated.....\$19

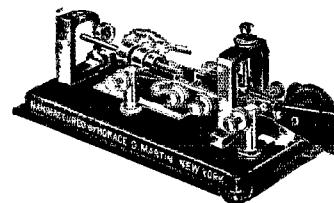
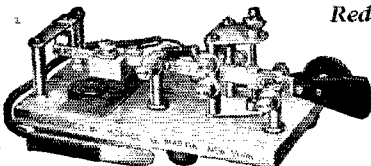

Famous Improved VIBROPLEX
Used by tens of thousands of operators because of its ease and perfection of sending. Colors: Blue, Green, \$17 Red or Black \$17 Nickel-Plated.....\$19

Special Radio Model Extra Large, Specially Constructed Contact Points for direct use without relay. Colors Blue, Green, Red or Black..... **\$25**

Specify color when ordering

Remit by Money Order or registered mail
THE VIBROPLEX COMPANY, Inc.
825 Broadway, New York City
Cable Address: "VIBROPLEX" New York

BECOME A RADIO OPERATOR

See the World, Earn a Good Income,
Duties Light and Fascinating
LEARN IN THE SECOND PORT U.S.A.

Radio Inspector located here. New Orleans supplies operators for the various Gulf ports. Most logical location in the U. S. A. to come to for training.

Nearly 100% of radio operators graduating on the Gulf during the past seven years trained by Mr. Clemmons, Supervisor of Instruction.

All graduates placed. Runs to all parts of the world.
Member of the A.R.R.L. — Call "W5GR"

Day and Night Classes — Enroll any time.

Write for circular

GULF RADIO SCHOOL

844 Howard Ave. New Orleans, La.

HILET POWER TRANSFORMERS

Mounted 700 watts, 1000-1500 volts each side, \$14.50, unmounted 250 watts, 500-750-1000 each side, \$8.75, 100 watt 325 volts each side, two 7 1/2 V windings, \$5.50, 100 watt filament any voltage \$4.50. Chokes with adjustable core 250 MA \$6.75, 160 MA \$5.00. Specials to order. Write for lists. High-grade material and all guaranteed.
RADIO PARTS SALES CO. ORANGE, N. J.

Put Your Voltage Control Problems up to Electrad

Write Dept. Q8 for useful data

175 Varick St., New York, N.Y.

ELECTRAD
INC.

See You Saw It in QST — It Identifies You and Helps QST

FROST-RADIO FROST-RADIO FROST-RADIO FROST-RADIO FROST-

FROST-RADIO

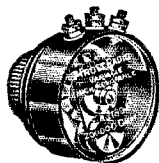

Volume Controls

YOU can secure Frost-Radio Volume Controls of any resistance gradient you desire, in units of from several hundred ohms up to and including those having a total resistance of several megohms. Frost-Radio Variable Resistors are made in several sizes. They are wonderfully smooth-running, are non-inductive and are not affected by changes in temperature or humidity.

Your dealer can show you exactly the right Frost Volume Control you need to get best results from your receiving set. You will marvel that such precision parts can be bought for such small prices. See your dealer today, and write us for special information about Frost apparatus for control of oscillation and volume.

HERBERT H. FROST, INC.

Main Office and Factory
ELKHART, IND.

FROST-RADIO FROST-RADIO FROST-RADIO FROST-RADIO FROST-

THE RADIO BOOK

that has been endorsed and is in constant use by United States Gov't and over 300 Universities, Schools and Technical Colleges in this and foreign countries.

"Radio Theory and Operating"

By Mary Texanna Loomis

President, Loomis Radio College
Member Institute of Radio Engineers

Fourth Edition revised and enlarged to 992 pages, 800 illustrations and right up to date. Flexible Kraft Leather binding.

Price \$3.50 — Postage Paid

For sale by bookdealers throughout U. S. and many foreign countries, or may be purchased direct from the publishers. Send check or money order to

LOOMIS PUBLISHING COMPANY

Dept. 5

Washington, D. C.

Engineers

ELECTRICAL COMMUNICATION

A well-established company will employ engineers, age 25 to 35, to supervise installation and service of Talking Movie Equipment. Pleasing personality, good address, tactfulness and supervisory ability necessary, combined with basic knowledge of vacuum tube communication theory and practice. Salary based on education, experience and ability. Expenses paid while traveling. Give full details first letter.

**Box T 203-Room 200
Times Bldg., N.Y. City**

w5bk w5bc w5ig w6adp w6ajm w6app w6arj w6awp
w6ax w6bau w6bax w6bsp w6bto w6bsv w6cpu w6cuc
w6euh w6eui w6ent w6dhs w6dzt w6dyo w6hl w6ju w6nh
w6vz w7afo w7akv w7be w7hy w7mo w7ui w7vk w8axa
w8ecw w8era w8ddf w8djv w8gs w9aid w9dga w9dat
w9eac w9ef w9eny w9frq w9gij w9mt w9ph ve2ca k6ahm
k6bxw k6dpg k7mn k1em wat xw7eff celah celai ce2ab
ce3ac ct1aa ct1by ct1oa d4uj ear96 f8eo f8pro f8gdb
g5by g5bz g5mi g5mq g5wk g6qb g6pv g6yq g5nj jltx
j4gn oa4o on4di on4fe on4fp pk1jr pk4az py2qa nosx
rwx kfr5 x9a x9b

*G6YL, Miss B. Dunn, Felton Northumberland
England*

7,000-ke. band
w1ah w1ag w1axx w1awk w1ckp w1cni w1ie w1ink
w1xy w2alu w2amr w2axg w2bda w2cal w2dab w2dff
w3ard w3lz w4agr w4akg w4kq w4we w4zp w5bh w5dlg
fmear50 freara cv5af cv5or zoxyzu aaidh au7ba ti2hy
kfr5 kfr6

*R076, A. Commender, Burg. Meineszlaan 91b.,
Rotterdam, Holland*

w1adw w1agj w1aks w1aqd w1atm w1aur w1aze w1axx
w1bkl w1bmn w1bux w1caw w1cuf w1cmx w1cpy w1da
w1ka w1kn w1xm w1xy w1yb w1zz w2asw w2adh w2ag
w2apy w2arb w2atz w2bhq w2biv w2bkg w2erb w2evj
w2el w2fl w2fn w2hq w2jn w2mb w2mw w2ot w2rs w2rz
w2sv w2vd w2ws w3bnu w3ej w3fb w3kj w3ut w4act
w4it w4ie w5adm w5ag w5ask w5ayd w5bdp w5bvu
k1em nyle ai5vx au1ap au7aa au7as au7au au7ba au7kad
au7kw ce2ab ce3bf cm2cf fm8cfr fm8ev fm8gke fm8ept
fm8hq fm8kk fm8rit fntun2 totsr fqpm i8de pk1jr
pw1ef py1aa py1aw py1be py1cm py1fb py2ad su8au
su8rs velap velar velbr ve2al ve2bg ve3bm vk3cp vs3ab
vu2kt z55u z1lj xpa0ja xpaop

*W2CRB, Joseph Goldstein, 5917 14th Ave.,
Brooklyn, N. Y.*

cm5cx k1hr k6ejs kflf w1azd w1ban w1fc w1mp w1on
w2age w2ags w2alo w2alu w2avq w2bjg w2bjm w2bhy
w2boa w2box w2jfl w2jo w3anh w3apq w3aur w3avo
w3ekl w3ee w3ep w3vb w4aeq w4aer w4afq w4ct w4ne
w4pf w4qv w4rp w4zv w5afu w5jc w5mi w5ph w5aj
w6aro w6bj w6bl w6dj w6ebg w6eib w6ejz w6eq
w6wb w8ap w8axz w8civ w8dl w8iq w8aru w8asy
w9azy w9ef w9cwg w9ffd w9fig w9fq w9gal w9gar
z1go z14ao z14av

*Jacques de MauSSION, Coulommiers (Seine et
Marne), France*

w1mr w1cib w1adw w1kn w1cic w1dq w1bsk w1aeh
w1kd w1cmx w1apq w1jr w1cpj w1agj w1bkr w2hq w2bx
w2rp w2bf w2amm w2an w2bt w2ciz w2biv w2bh
w2cp w2bac w2avr w2bdh w2all w2el w2bui w2ahi w2cyp
w2adh w2an w2rs w2ate w2atz w2big w3fb w3cee w3adm
w3pf w3bp w3ar w3uk w3afx w3ae w3jn w3bph w3jk
w3ln w4bv w4au w4ajh w4akh w4ag w6bx w6aps
w7afe w8uxa w8au w8cfr w8ct w8dyi w8dre w8cib
w8cib w8bec w8ber w8adm w8azo w8aps w8drh w8chi
w8dhe w8ef w9ffb w9dgy w9fx w9dqs w1cm kfr5 kfr6
k4kd vo8ae oas cm2jt w2rx vk5cm z14ae z14ao py1aw
py1be py1el py2ak ep1ab su8an lu2ea lu2bx lu2dk lu2fi
lu4dq lu4le ve2br ve2bb ve3da ve3bk ce2ac ce3ae ce3bf
fq8hpg pm au1ap laig la2k yilmz xeu2an

*VK7CH, C. Harrison, Rikaby Rd., Bellaria,
Tasmania*

w1gw w1emp w1avf w1bux w1bjd w1bal w1anz w1aks
w1ang w1yb w1sf w1cmx w2cvj w2aqa w2beb w2api
w2alu w2jn w2sv w2ws w2of w2r w3db w3ot w3ut
w4nek w4we w4ll w4ib w4bdg w5je w5ts w5ux w5bcq
w5aot w5rg w5ams w6avj w6egr w6cm w6dzp w6cy
w6dq w6idw w6dky w6bhi w6i w6imu w6ax w6cm
w6cu w6eiy w6dtd w6dwi w6ru w6cuc w6cbw w6kyj
w6am w6deg w6dzt w6jl w6ry w6agy wyapp wydyo
w6awp w6eg w6cub w7xf w7q w7kt w7adr w7pv w7cy
w7afo w7p w7ek w7aav w7sn w8ecw w8dvm w8oc w8uk
w8dpo w8adm w8aak w8ecw w8euy w8bu w9alm w9lk
w9cex w9bga w9ef w9dku w9ecz w9dzt w9dzz klaf k1em
k1re k1jr k4ni k6aron k6dpg k6ekx k6cha k7mn kfr6
kdv5 ve2bg ve2al veico ve4ey va1ab va3ab va3ag pk1bh

PIERCE AIRO Cardwell Spencelott
Dubilier THE ACME WIRE CO.
Weston Electrical Instruments
RADIO ENGINEERING LABORATORIES
Gordon
Raytheon
Ward Leonard
Farrand
Rajah
Knapp
ELKON
PARVOLTS
LIONARD
RADIO
Scientifically equipped to economically export dependable receiving and transmitting radio apparatus

AD. AURIEMA, INC.
Manufacturers' Export Managers
116 Broad Street, New York, N. Y.

ACME WIRE PRODUCTS

Coils — Magnet Wire Wound
Magnet Wire All Insulations
Varnished Insulations
Parvot Filter and By Pass Condensers

All products made to Recognized Commercial Standards including those of:

National Electric Mfrs. Assn.
Radio Manufacturers Assn.
American Society for Testing Materials

For 25 years manufacturers and suppliers to the largest and most discriminating users.

THE ACME WIRE CO.

NEW HAVEN, CONN.

Branch Offices:

New York Cleveland
52 Vanderbilt Ave. Guardian Bldg.

Chicago

842 N. Michigan Ave.

National Products Rectobulb

A RELIABLE and efficient rectifier tube — low impedance due to mercury vapor — long life due to low temperature filament and oxide coated cathode of large area — of sturdy design which defies the rough handling incident to shipping them

Normal Rating 250 Mills
Normal Plate Volts 3000
Filament Amps 1.7
Filament Volts 10

The accepted standard for Ham Work—of increasing appeal to the Engineer in small Fone Transmitters as used in Patrol Work and Air Service—Ideal for Small Broadcasters.

Sent postpaid if cash with order — Safe delivery anywhere in U. S. A. GUARANTEED

Price, \$10 each

Announcing repair of UX852. . \$16.50
We repair 203A tubes \$19.00
204A tubes \$75.00
WE 211 tubes \$16.50
WE 212 tubes \$40.00

ALL REPAIRS FULLY GUARANTEED

National Radio Tube Co.

3420 18th Street

San Francisco, Calif.

P A C E N T Duo Lateral COILS

The complete line of all standard turn ratios preferred by leading laboratories and engineers.

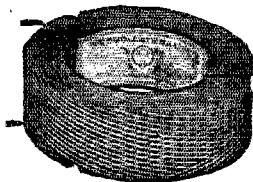

Write for information and prices

PACENT ELECTRIC CO., Inc.
91-7th Avenue New York City

Just Off the Press

A NEW YAXLEY Catalog



Send for it today for complete listings of Radio Convenience Outlets, Connector Plugs, Rheostats, Fixed and Grid Resistances, Jocks, Jack Switches, Phone Plugs, etc.

YAXLEY MFG. CO.

Dept. S, 9 So. Clinton St., Chicago, Ill.



Specialists in STANDPEAK

TRANSMITTING AND FILTER CONDENSERS

GERD ELECTRIC CO., INC.
187 SYLVAN AVE. NEWARK, N. J.

SPECIAL TO AMATEURS

Barawik's new short wave dept. has everything that amateurs desire. The Barawik Radio Guide gives full details. Send for it.

FREE RADIO GUIDE

SEND FOR IT!

Shows the latest wrinkles, newest developments in radio at startlingly low prices. Get the set you want here and save up to 50%. The best in parts, kits, complete factory-built sets and supplies. Orders filled same day received. Write for free 264-page copy NOW. Wholesale prices to set builders, dealers, agents.
BARAWIK CO. 118 Canal Sta., CHICAGO, U. S. A.



RADIO OPERATORS WANTED

THE EASTERN RADIO INSTITUTE can train you quickly and thoroughly because:
MODERN AND EFFICIENT METHODS
THOROUGH INSTRUCTION under staff of LICENSED COMMERCIAL OPERATORS
MODERN APPARATUS including SHORT WAVE TRANSMITTER

SIXTEEN years a RADIO SCHOOL
THE OLDEST, LARGEST and MOST SUCCESSFUL school in New England, RECOMMENDED BY THE A. R. R. L.

Day or Evening Classes Start Every Monday
SPECIAL CODE CLASSES

Write for Illustrated Prospectus

EASTERN RADIO INSTITUTE

899 BOYLSTON STREET

BOSTON, MASS.

Power Transformers and CHOKES

At Less Than Manufacturer's Cost

This is the bankrupt stock of the Scanlan Transformer Co.

- Scott Power Amplifier Transformers No. 643, Secondary 800 Volts — 0-800 Volts. 7½ volts and 7½ volts. **\$6.75**
- For two 281 Tubes and two 250 Tubes
- No. 505 Power Amp. Secondary 600 volts — 600 volts. 1½, 7½ and 7½. Center Tapped and 2 Chokes **\$6.50**
- For two 281, two 266, two 250
- No. 500 Secondary 300 volts — 300 volts, 1½, 2½, 5 and 5. Center Tapped and 2 Chokes **\$4.50**
- Will take care of a 10 tube set or less
- No. 875 Secondary 375 volts — 375 volts, 5, 5, 2½, 1½ and 1½. High and low primary and 2 chokes **\$4.25**
- Suitable for a 10 tube set or less
- No. 413 Filament Transformers for six 226, one 227, and 2 171 A tubes. **\$1.95**
- No. 644 Scott double chokes. **\$1.90**
- No. 641 Scott Audio input transformer. **\$1.90**
- No. 642 Scott Audio output transformer. **\$1.90**
- No. 640 Scott Audio copper shielded. **\$1.90**
- No. 30 Henry Chokes, unmounted. **.90**
- No. 102 2½ Amp. Dry Charger, less Raytheon cartridge. **\$1.50**
- Vitrified Power Pack Resistances 180 volt, 16600 ohms, tapped at 1500, 7800, 15100 and 16600. **.95**

Write for list

Chas. Hoodwin Co.

4240 Lincoln Ave. Dept. 827, Chicago, Ill.
Bankrupt Radio Stocks

pileg pk1jr pk4az g2xy g5by g5bz g5wk gtml g5ux g5yk
g0hp g6qb g6cr g6rb g6wi g6wt g6xq g6vp f8pro f8tan
f8wb f8eo f7rlt f8gi f8ral f8am f8bl f8rko f8gdg f8rmf
filzq f8mmp f8xz f8acj f8ep f8rrr f8faf f8axq f8jf f8hs
f8ct f8orm on33 on4fe oh2nm oh2nap ok1fm okasa2 x9a
xlj su8an celah celai cel2ge ce7aa cxley cxida cxina
file yillm afib uosp5 haf3ab haf3an d4nx d4jl d4uoa
j1tx j2dx o4ts o4to o4at et1aa la1g cl6wg as2rh raow
eu3hj ae2aj ai2kx ai2kv ai5vx lu3dh rwz uz2 wiat wfbt
wsq xw7eff x2ke

G5UM, J. Hum, 17, Eastwood Rd., London, N. 10,
England

w1aci w1ack w1adm w1adw w1aep w1af w1agy w1ali
w1alz w1apq w1aqs w1arc w1are w1ark w1ary w1ase
w1asf w1awm w1awq w1axx w1aze w1bal w1bwa w1cmx
w1epo w1ea w1da w1fe w1gw w1lq w1pk w1px w1qh
w1rp w2adh w2aeb w2aeh w2agw w2ahz w2aiq w2alu
w2asg w2ata w2aya w2ayb w2abz w2bdh w2bjg w2cal
w2evj w2fi w2fl w2gj w2hq w2mb w2md w2aha w2ams
w2apx w3aqi w2aqs w3aao w3bee w3bns w3che w3cy
w33vb w3wm w4acv w4og w4mi w5tn w5vh w5ayh w5bex
w5je w5pa w5ak w6aoj w7ta w8acf w8bwy w8ced w8chp
w8cln w8cyr w8czm w8dgt w8dkq w8dov w8dro w8dsa
w8ni w8kr w8la w8np w8vo w8uon w8any w9aay w9cvt
w9dek w9der w9diy w9dy w9emp w9fyd w9fgj w9fpw
w9fyv w9fqr w9gaw w9gty w9um velap ve2ap ve2ay
ve4ar py1al py1ld py2ad su8rs helif 55x xpa0ja xpa0za

William Ronald Jardine, 284 Buckley St.,
Essendon W5, Victoria, Australia

w1bux w1awe w1bvl w1ry w1emx w1ack w1bbz w1akm
w1cek w1cjc w1acd w1aqt w1fs w1gh w2aiu w2avb w2bae
w2aof w2mb w2md w2tp w2ws w3ayl w3ut w3bnu w4tk
w4rn w4ze w4aef w4sh w4ct w4ahm w4rb w4we w4wq
w4nf w4aq w4abv w4aim w5kl w5mx w5th w5aal w5atf
w5ux w5aot w5bbe w5je w5rg w5ahb w5aay w5awd
w5yg w5wr w5bek w6ab w6am w6amm w6cuh w6dr
w6aqq w6ax w6eof w6tdt w6tk w6bes w6etn w6aif w6wn
w6ft w6do w6dte w6adp w6czm w6eqf w6cha w6hs
w6dwn w6eke w6bqk w6asl w6eoz w6ceg w6vj w6cot
w6djw w6bvy w6bam w6bax w6bpm w6epf w6avq w6eop
w6app w6uz w6dhs w6dki w6dyo w6eru w6drb w6ery
w6dqq w6czm w6ebv w6djq w6bpc w6eje w6ebw w6cut
w6dlu w7ia w7mh w7bb w7be w7adb w7aky w7alo w7as
w8mb w8cww w8avp w7era w8djv w8of w8bvu w8bau
w8bud w8djv w8of w8bbj w8bn w8cm w8ny w9i w9dwa
w9epa w9aok w9ert w9aas w9def w9ef w9ek w9bqo w9ama
w9bxj w9bez w9gv w9ctg w9dsh w9dy w9go kicm k1hr
k1gz k1af k1re k1jr k1bd k1pw k1bj k1ab k1cy k3aa
k6ha k6alm k6cjs k6acw k6dju k6bxw k7mn pk4az
pk3bm ac8ag ac8az ac8rv ac8ry vs8gg kw g5by g5wp
g5yx g6wi g2xy g6bx g6wk f8axq f8trr f8fxh f8orm
f8fd on4di on4fp om1tb eliae o0bam celah kfr5 uz2 apl
rwx

Lawrence W. Jones, 50 King St., Cambridge,
England

ar8umi au7kad ce3ac ce3bf ct1cc ct1bx d4skl d4we d4hz
d4vpi ei0b ei2b f8ten f8hm f8act f8ij f8rko f8fr f8mtn
f8ddx f8mas f8rot f8zic f8wrg f8wrg f8lwg f8ral f8mesr f8mtunz
fk5er g6wt g6bx g6vp g6so g6sn g6dg g6ly g6tw g6rr
g6bn g2an g3pj g6pa g6ad g6dc g6tz g6bg g2vg g2km
g5yz g6lk g2yv g2yd g5ey g5bz g5tj g6wy g5ph g6xo
g5oa g5rv g2bg hp99 ear16 ear18 ear27 ear53 ear105 ear116
ear128 ear132 ear2dy ear2by ear2du ear0x9 ear3bf ear5v
k49f la19l la2e on4bt on4jj on49wa on4lp on4uy on4us
oh2na oh2nae oh2np oh2naw oh2oc oh3np oh5nl ok2lo
py2ad py1bl py1ld py2bf py2bc sm6wl sm5tm sp3sm
sp3lm sp3pyl sp3kx sp3mb sp3ar su8an su8ra pa0im
pa0wim uo5lk ve2be w1alw w8bta w8asa w1xh w2bjr
w8dyi w8cyg w2gbi w2nj w1jr w1bkl w1z w1rd w1bx
w1km w1yb w2ac w2hj w2adp w3bdb w8gz w8ako xw7eff

WSQ, U.S.C. and G.S.S. Lydonia, off Cape
Canaveral, Fla.

py1aa py1ah py2ak ys1aa paowim xpa0za vo8ae on4fp
fkr5 sp3pb t2hvw f8pam f8ypz f8wb f8zk g6ze g6rb g6lk
g6vp g6bd g6yg k6aiy k6bjo k7gm k7anq k7avj k6dte
k6dtu k6dwi 6kbgk 6kefc k6eko k6ehi k7ui wfa wfbt rwx

Potter RR-245 Condenser

for

Successful
Operation
of

R-245 Power
Compact

GET one to-day

and enjoy the beautiful tone quality. \$19.75

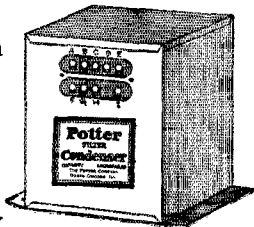

Potter

Dynamic Speaker Filter

will reduce the hum in an A. C. operated dynamic
speaker using low voltage rectifier. \$4.75

The Potter Co.

North Chicago, Illinois

A National Organization at Your Service.

The Radio Amateur's HANDBOOK

Fifth Edition
By **HANDY** and **HULL**

**For Those Who
Don't Know It:**

THE Handbook is a practical manual of amateur radio in all its phases, published by the American Radio Relay League, the amateur's own organization. It starts at the beginning and tells the whole story: What amateur radio is, How to be a radio amateur, How to obtain your licenses, How to build the simple apparatus of a simple station, How to build the best known apparatus for the most modern station, How to operate the station. Enough information to keep you busy and interested for five years.

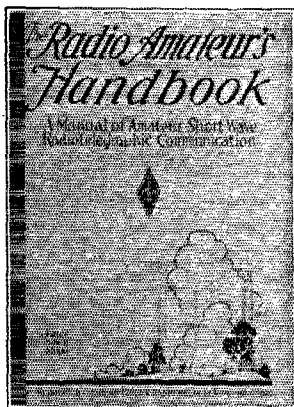

**For Those Who
Do Know It:**

FOR years the Handbook has been the practical working guide of successful amateurs the world over. It has been completely revised in terms of 1929, by Mr. Handy, the League's Communication Manager, as to all the aspects of operating procedure, and by Mr. Hull, the director of the League's Technical Development Program, as to all its features of apparatus and technical matters. Everything in it is on a 1929 basis, replacing the 1928 methods which used to be good enough but aren't any more.

**[MUCH THAT IS NEW]
[ALL THAT IS GOOD]**

NOW IN ITS FIFTY-THIRD THOUSAND

232 Pages

6½ x 9½

188 Illustrations

In wealth of treatment and profusity of illustration the Handbook is a big book. Printed in usual textbook style it would bulk 500 pages and cost at least \$4, but its publication in the familiar *QST* format makes for handiness and enables its distribution at very modest cost.

In keeping with our policy of constantly

revising the Handbook the copies now being distributed, although not advertised as a new edition, contain a completely revised chapter on Power Supply, Keying and Interference Elimination, with particular reference to the new mercury-vapor rectifiers; the latest list of amateur prefixes; Canadian regulations; etc.

Blue-and-Gold Paper Cover, \$1.00

Stiff Buckram Binding, \$2.00

POSTPAID ANYWHERE IN THE WORLD

AMERICAN RADIO RELAY LEAGUE

Hartford, Connecticut, U. S. A.

HAM-ADS

(1) Advertising shall pertain to radio and shall be of nature of interest to radio amateurs or experimenters in their pursuit of the art.

(2) No display of any character will be accepted, nor can any special typographical arrangement, such as all or part capital letters be used which would tend to make one advertisement stand out from the others.

(3) The Ham-Ad rate is 15c per word, except as noted in paragraph (6) below.

(4) Remittance in full must accompany copy. No cash or contract discount or agency commission will be allowed.

(5) Closing date for Ham-Ads is the 25th of the second month preceding publication date.

(6) A special rate of 7c per word will apply to advertising which, in our judgment, is obviously non-commercial in nature and is placed and signed by a member of the American Radio Relay League. Thus, advertising of bona fide surplus equipment owned, used and for sale by an individual or apparatus offered for exchange or advertising inquiring for special equipment, if by a member of the American Radio Relay League takes the 7c rate. An attempt to deal in apparatus in quantity for profit, even if by an individual, is commercial and takes the 15c rate. Provisions of paragraphs (1), (2), (4) and (5) apply to all advertising in this column regardless of which rate may apply.

PLATE POWER for your set, the very heart of its performance. For quiescent DX ability, life-long permanence, absolute dependability, lowest ultimate cost, no other plate source even approaches the achievement of an Edison steel-alkaline storage B battery. Built painstakingly; every joint pure nickel, upset electrically welded. Genuine Edison Electrolyte. Our list describes complete batteries, construction parts, enameled aerial wire, silicon steel. Available immediately, filament and plate transformers for the new 866 rectifier, complete plate power units. Rectifier Engineering Service, radio W8ML, 4837 Rockwood Road, Cleveland, Ohio.

THE most complete line of modern short wave receivers for every particular service. Four to nine tube designs. Radiophone-CW transmitters, of any power or type. We make a complete line of apparatus including speech amplifiers, filter coils, transformers, rectifiers, variable condensers, inductances, etc. Any special apparatus, designs, made to order using your parts if desired. Prices on request. New bulletin lists complete line of apparatus. Write for copy, Ensell Radio Laboratory, 1208 Grandview Ave., Warren, Ohio.

SPECIALLY made rectifier aluminum with small percentage copper, stand more amperage, last longer, square foot \$1.25. Lead \$1.00. Elements, holes punched with bolts and nuts, new kind 1" x 4" 15c, 1" x 6" 17c, pair prepaid. Best Silicon steel .014" cut to order 25-35c lb. Postage extra. Geo. Schulz, Calumet, Mich.

AMATEURS—experimenters, builders. We serve over 4000 I.R.L.E., A.R.R.L., etc., experimenters and "nuts." Full discounts, \$50,000 stock approved parts—no sets. Over four pounds catalog, circuits, data, prepaid, 50c. Weekly bulletins (new items, results of experiments, etc.) 20 weeks, \$1. Sample experimenters "Over the Soldering Iron" magazine, 25c. Transmitting data, price list, etc., 25c. Kladag Radio Laboratories, established 1920, Kent, Ohio.

NEW UV217A, \$17. New 217C, \$23. Unmounted, 1000-volt condenser, 2 mfd., \$1.50; 3½ mfd., \$1.85. Freshman 375-volt two 7.5 volt center tapped windings, \$2.75. Thoradson 220 and 285 center tapped transformer, \$1.95. Microphone cases, \$2.25. C.P. aluminum, \$7.00 sq. ft. Signal Corps 3 16" silver contact keys, \$.95. Grebe CR18, \$35. RCA 210 tubes, new, \$6. UV866, \$12. New rectobulbs, \$10 prepaid. 284 V microphones, \$4. Sangamo .00025, .001, .002, 5000-volt mica condensers, \$1.60 each. 30 Henry 150-mill chokes, \$1.90; Signal high frequency buzzers, \$.95. Aerovox 5000 ohms grid leaks, \$.40. Used Mercury arcs cheap. New Flechtheim \$100-volt, digital leads: 1 mfd., \$3.50, 2 mfd., \$4.50, 4 mfd., \$6.50. Westinghouse aeroplane 275-volt generators, \$6.50. Guaranteed UX210, same size plate as UX250, \$4.50. One REL Waveneter, list \$22—special \$12.50. New Patent phonovoxes, \$7.50. Amateur call books, \$.85. New UX852, \$28. Used, \$20. Thousand of other buys. Send for monthly ham sheet. We want transmitting tubes. What have you for sale or trade? David L. Marks, 125 Madison Ave., Albany, N. Y.

PANEL engraving—finest workmanship on radio laboratory apparatus. Request price list. A. L. Woody, 19 S. Wells St., Chicago.

FOR Sale—UV204A, \$50, very slightly used. UV203A, UX250's, UX210's, priced proportionately. Bug, meters, mercury arc, m.g., etc. W5AKY, 3222 Aurora St., El Paso, Texas.

SELL—Complete station 7½ transmitter, 3-tube receiver. Write for details. Carrier No. 413, Stapleton P. O., Staten Island, N. Y.

WANTED—860, 861 and 865 tubes. One each burnt out, soft, broken, or otherwise defective. State price or what you need. Knight and Link, W2ALU, 533 Riverside Drive, New York City.

FIRST \$35 takes new Sampson pam 17 amplifier, public address system, with Jensen dynamic, cost \$100. Dope? W. Ryder, Hibbing, Minn.

SELL—4-tube screen grid short-wave receiver as described in November QST. Tubes supplied. First \$30 takes it. S. Landes, 676 Riverside Drive, New York City.

SELL—QST's from May, 1922, to December, 1928, inclusive. W3BSE.

WANTED—your radio wants. Parts for that receiver, transmitter or power supply. Special apparatus. Pontiac Engineering Co., 1100 Ave. I, Brooklyn, N. Y.

CRYSTALS—Guaranteed power crystals, easy oscillators and selected for maximum output, ground to within 0.1% of 1% of your requested frequency—1715 to 2000 kilocycles, \$17.50; 3500 to 4000 kilocycles, \$22.50. Power crystal holders, \$4. This same type crystal furnished to broadcasting stations fully mounted and ground to within 500 cycles plus or minus your assigned frequency for \$50. Write for literature regarding our complete line of frequency precision instruments for amateur and commercial radio stations. American Piezo Supply Co., Dept A, 300 East 33rd St., Kansas City, Mo.

SELL—Rotary converter 110 d.c. drive, 250 watts. Transformer to match 500-750 volts each side, two filament windings, 7½". Write for details. W5ARA.

QUARTZ plates and tested oscillating blanks. Power type. Limited quantity priced for quick sale. Write W6EBV.

JEWELL 34 voltmeter with external resistor, 1000 ohms per volt, scale 0-2000 volts, \$14; 0-1000 volts, \$13; Jewell 64-thermo coupled 0-1 ammeter, \$7.50; Edison 6-volt battery, \$15; Hilet 2000-volt transformer, \$8.75. Send for complete list of material. M. Leitch, Park Drive, West Orange, N. J.

HAMS: Get our samples and prices on printed call cards made to order as you want them. W9APY Hinds, 19 S. Wells St., Chicago Ill.

3000 volt, 4000 watt, 7½ h.p. 3-phase drive double commutator motor-generator, complete, \$550, 500 cycle, 1 kw. ball-bearing motor-generator, 110 v. d.c. drive, \$175, 250 cycle 1½ kw. ball-bearing motor-generator, 110 v. d.c. drive, \$165, 2-5 kw. Rotary Spark Gap 110 v. d.c. drive, \$35, 1000 volt 300 watt Escoc 1-phase drive, \$75; 300 watt G.E., \$95, 750 volt, 250 watt new General Electric motor-generators, \$52.50; 200 watt, \$42.50, 32 v. drive motor-generators, 750 v. 150 watt, \$37.50; 200 watt, \$42.50; 300 watt, \$65, 400 v. 100 watt generators, \$8.50; ½ h.p. 3-450 speed motors, \$10.50; ½ h.p., \$12.50. Converters 110 v. d.c. to a.c. 500 watt, \$65. Queen City Electric, 1734 Grand Ave., Chicago.

UV204A for sale or trade for xtals, etc. W9ERU.

TRANSFORMER specials—500-0-500, 7½ volt, 150 watt mounted, \$4.50, 0-600, 7½ v., \$3.750-0-750, 7½ v. 7½ v., 250 watt, \$9, 10 v., 75 watt filament transformer, \$3, 300-0-300, 5 v. 5 v. 2½ v. 1½ v., \$4, 2½ v. 2½ v. for 224 and 245 tubes, \$3.75, 30 H 85 M.A. double choke, \$1.75, 50 H 125 M.A. double choke, \$2.50. Adjustable 10 to 50 H 250 M.A. choke, \$5, 600-volt condenser block 2-2-4 M.F., \$3.75. Silicon transformer steel .014" cut to size, 22c per pound. Stock sizes shell type core laminations. Send 25c for samples. We build special transformers and chokes to your specifications. Send for list, Electrone Laboratories, 834 N. Randolph St., Philadelphia, Pa.

TRANSFORMERS—100 watt, 110 volt, 60 cycle, 750 volts each side center tap, one 7½ volt filament winding, \$7.25. Same as above, but two filament windings, \$8. Above will operate two 210 tubes. Same as above, but 150 watts for operating two 250 tubes, \$9.25. Same as above, but 250 watts for operating two to four 210 or 250 tubes, \$11.50. Heavy construction, no heating, all mounted. Heavy duty transformers and chokes for amateur or broadcast stations supplied to specifications. Scott Coil & Transformer Co., New Albany, Miss.

OMNIGRAPHS, Teleplexes, transmitters, receivers, Vibroplexes, meters, 50-wattors, 5 tubes, motor generators, dynamometers, AC receivers, bought, sold, traded. Ryan Radio Co., Hannibal, Mo.

SELL parts. List for stamp. W9FVM, Monett, Mo.

SELL—Complete aero coil kit, slightly used, \$6.50; also Silver Marshall 330 power transformer, never used, \$5. Lawrence Cincotta, 155 W. Emerson St., Melrose, Mass.

LISTEN fellows, here's another one of our bargains. We have obtained another lucky buy of 1500 genuine V114 Navy five watters, all in original cartons and guaranteed. Rated voltages same as UX210. Plate dissipation 15 watts, and we are passing them on to you for only one buck each. At this price they will be gone quickly, sent c.o.d. if desired. Write G. L. Lang, 1128 Springfield Ave., Irvington, N. J.

FILTER condensers—Dubilier 2½ mfd., 1000 volt working, \$2.75. Spiltdorf 19 mfd., 1000 v. working, metal case, \$1.20. Power chokes: 30 Henry, 100 milliamperes, \$1.75, 50 H, 150 MA, Dudlo-wound, \$2.40. American power transformers, 250 watt, 1100, 7½, 7½ volt center-tapped secondaries, Special, \$11.75. UX-210's, 1X-250's, \$3.95. Silver-plated inductances. Send for "Specials." William Harrison, 35 Ft. Washington Ave., New York City.

THORDARSON 650 volt power-filament transformers for 7½-watters, \$6.90. R.C.A. 210's, \$5.25. Aluminum square foot, 85c; Lead square foot, 85c. Potter Condensers: 1 mfd. 2000 test voltage, \$2.50; 2500 test, \$3.25; 2 mfd. 1000 test, \$2.50; 2 mfd. 2000 test, \$4. Send 4c for Curtis's Greatest Bargain List. Curtis Sales Company, 1109 Eighth Ave., Fort Worth, Texas.

NAVY Dynamotors General Electric 24/1500 volt, \$37.50; 24/750 volt, \$27.50; 12/350 volt, \$18. Crocker-Wheeler 24/1500 volt, 450 watt, \$15. Holtzer-Cabot 12/500 volt, \$20. Westinghouse 6-15 volt, 500 watt, \$15; 10/350 volt, \$18; 27.5/350, \$15. Twins for 700 volts, \$28. 900 cycle, \$22.50; ½ kw. 500 cycle, \$15. Complete list, Henry Kienzle, 501 East 84th St., New York.

FREQUENCY precision is the most urgent need of modern radio. Let us calibrate your new frequency meter from Piezo standards, American Piezo Supply Co., Dept. B, 300 East 33rd St., Kansas City, Mo.

WANT: 204 A; 860. Sell or trade: WE212D; 12-400 v. dynamotor; 24-1500 dynamotor; Leach relay; 85 and 170 meter Xtals; 500 v. mg. Other apparatus. What do you need? W9ARA, Butler, Mo.

IN stock — The new Rectobulb, \$10; R.C.A. 852, \$27; imported power crystals; 10 mfd. 1000 v. conds, \$4.90; 200 mil. 30 Henry chokes, \$4.90; 500 v. 200 mil. mgs., \$29; TB1 kenotrons, 95c. Jewell, Leach, R.E.L., Ward Leonard all 25% off; Thordarson, 30%; Tobe and Flechtheim, 35%. I build 1929 transmitters. Prompt service. Write for anything not listed. R. E. Henry, W9ARA, Butler, Mo.

GREBE cone speakers list \$35, special \$6.95, new type Jewell meters 25% discount; Acme variable ratio audio transformers, \$2.00; General Radio Audio transformers, types 285D-H, \$2.25; Flechtheim transmitting condensers, 50% discount. Sun Radio Company, 64 Vesey St., N. Y. C.

QSL cards, stationery, etc. H. M. Selden, Cranesville, Pa.

SELL — Westinghouse M.G. 800 volts, including field rheo., \$45. WSAGK.

WANTED — UX852 tube in good condition. State price. Ralph Porter, 87 Locust St., Danvers, Mass.

AMAZING screw-holding screw driver! Factories, garages, workers buy on sight! Profit 75c each. Exclusive territory. Free trial offer. Jiffy 1153 Winthrop Bldg., Boston.

SELL or trade — transformers, chokes, condensers, meters, tubes, etc. Write for list. Want cash, portable typewriter, or what have you? Owens, 329 Merrill Ave., Muskegon, Mich.

QSL cards, two colors, \$1.00 per hundred. Free samples. WSPTY, 257 Parker Ave., Buffalo.

WANTED — Navy standard receivers, SE143, SE1220, SE1420, IP500, IP501 — also spark gap units. State price and condition. Paul Trautwein, 38 Park Place, New York City.

SPECIAL summer prices on crystals. 3500 Kc band \$14.00. 1700 Kc band \$9.00. Blanks \$4.00. W9DRD, Herbert Hollister, Edwardsville, Kansas.

PILOT Super-Wasp kits, \$27.50 net. Immediate delivery. Fine shortwave sets. Send money order or certified check. Hatry & Young, Inc., Hartford, Conn.

HATRY & YOUNG build that special set. QST all-purpose superheterodyne, four-tube short-wave set band-spreading, anything special. Transmitters, broadcast receivers. Send specifications or state desires. We repair or reconstruct eliminators or sets. 126 Ann St., Hartford, Conn.

CRYSTAL-HOLDERS for sale. Dustproof, Nickel-plated. A beautiful job, metal and bakelite machined and ground. Convenient plug-in mounting. Must dispose of extra number ordered by several of us who needed holders for our personal stations and obtained the benefit of a quantity price which you may share. The best holder you have seen. A quality product not duplicatable elsewhere at twice the price. While they last — postpaid to any point in U. S. A. or Canada. \$5! Clark C. Rodimon, 1711 Park St., Hartford, Conn.

G. E. transformers 1100-2200-4400 each side center tap, used by Michigan, Cornell and Naval Reserve, \$12 f.o.b. Detroit. F. G. Dawson, 5740 Woodrow Ave., Detroit, Mich.



TRANSMITTING GRIDLEAKS

5000 OHMS

These genuine General Electric wire-wound Gridleaks have a rating of 55 watts continuous duty.

Large enough for 250 watters.

SPECIAL 65c Ea.

AMERICAN SALES CO., 19-21 Warren St., N. Y. C.



Q R A SECTION

50c straight with copy in following address form only:

- W2BAE — Benj. G. Davis, Jr., R. F. D. 1, Yorktown Heights N. Y.
 W2BCH — A. S. Harrison, 6941 62nd St., Glendale, L. I.
 W8A1W — A. A. Rhoads, 234 S. Second St., Lehighton, Pa.
 W8AX — Edward M. Glaser, 1182 First St., Muskegon, Mich.
 W8BLH — Wilfred L. Philbin, 321 First Ave., Frankfort, N. Y.
 W9AKA — Kendall M. North, 5331 Winthrop Ave., Chicago, Ill.
 W9DSK — Edw. L. Kelly, 2315 A St., Omaha, Neb.

WIMK

A.R.R.L. Headquarters

R. B. Parmenter, Chief Op. "rp."

The following calls and personal signs belong to members of the A.R.R.L. Headquarters gang:

W1BD1-W1XL F. E. Handy "fh."
 W1BEH-W9BR — B. Dudley "bd."
 W1EH K. B. Warner "kb."
 W1BUD A. L. Budlong "bud."
 W1CEJ J. J. Lamb "jm."
 W1ES A. A. Hebert "ah."
 W1FL-W2JR — G. Donald Meserve, "dm."
 W1PX C. G. Kenefiek "ek."
 W1SZ-W1BIZ C. C. Rodimon "rod."

SET Builders



Barawik, the first and oldest radio specialty house, offers you unusual service this year. Bigger stocks, quicker shipments, lower prices. Deal with an old established, reliable house. Get honest goods, honest service, honest prices. Barawik service makes you more money. Send now for big new catalog showing lowest whole sale prices on sets, parts, short wave, etc.

BARAWIK CO. 118-A CANAL ST., CHICAGO, U. S. A.

It
Teaches
the
Code!



**Learn
Telegraphy with TELEPLEX**

TELEPLEX is the practical code instructor. Works like a phonograph. Waxed tape records send signals like a real operator. Complete code instructions furnished with every Teleplex. Sends messages, radiograms, etc. — regular code traffic like an expert operator. Used by all leading schools. Endorsed by U. S. Navy. **Guaranteed to teach you the code or it costs nothing.** Speedy, simple, clear. Ideal for advanced students or beginners.

FREE 10 DAYS TRIAL!

So sure are we that you will be absolutely satisfied with your purchase, that we will let you try it in your own home ON 10 DAYS FREE TRIAL! You are the sole judge. Where can you match that astounding offer? ACT TO-DAY! Write for full facts about Teleplex. No obligation.

TELEPLEX CO., Dept. H12, 76 Cortlandt St., New York, N. Y.

To Our Readers who are not A.R.R.L. members

WOULDN'T you like to become a member of the American Radio Relay League? We need you in this big organization of radio amateurs, the only amateur association that does things. From your reading of *QST* you have gained a knowledge of the nature of the League and what it does, and you have read its purposes as set forth on page 6 of this issue. We should like to have you become a full-fledged member and add your strength to ours in the things we are undertaking for Amateur Radio. You will have the membership edition of *QST* delivered at your door each month. A convenient application form is printed below — clip it out and mail it today.

A bona fide interest in amateur radio is the only essential qualification for membership

AMERICAN RADIO RELAY LEAGUE
Hartford, Conn., U. S. A.

I hereby apply for membership in the American Radio Relay League, and enclose \$2.50 (\$3 in foreign countries) in payment of one year's dues, \$1.25 of which is for a subscription to *QST* for the same period. Please begin my subscription with the issue. Mail my Certificate of Membership and send *QST* to the following name and address.

Do you know a friend who is also interested in Amateur Radio, whose name you might give us so we may send him a sample copy of *QST*?

Thanks

For Your Convenience

QST'S INDEX OF ADVERTISERS IN THIS ISSUE

Acme Wire Company	89
Acru Products, Inc.	3rd cover
Allen-Bradley Company	74
American Sales Company	93, 96
Arcturus Radio Company	86
Aurigma, Inc., Ad.	88
A.R.R.L. Application Blank	94
A.R.R.L. Handbook	2nd cover
A.R.R.L. Help Wanted	86
Barawk Company	89, 93
Barros & Cla., M.	81
Broadcasters Service Bureau	82
Burgess Battery Company	7th cover
Candler System Co.	85
Cardwell Mfg. Corp., Allen D.	69
Central Radio Labs.	81
Claroostat Mfg. Co.	85
Corning Glass Works	85
Cunningham, Inc., E. T.	72
Dodge, C. K.	82
Dongan Elec. Mfg. Co.	85
Eastern Radio Institute	89
Electrad, Inc.	87
Electrical Research	88
Electric Specialty Co.	83
Ewing, Edwin C.	82
Federal Radio & Railway Institute	81
Frost, Inc., Herbert H.	87
General Radio Company	4
Gerd Electric Co.	89
Greben, F.	79
Gulf Radio School	87
Hardwick, Hindle, Inc.	85
Hoodwin Co., Chas.	90
Jewell Electrical Instrument Co.	2
Leeds Radio Company	71
Loomis Publishing Co.	87
Manhattan Electric Bargain House	79
McGraw-Hill Book Co.	84
National Carbon Co.	70, 77
National Company	81
National Radio Tube Co.	89
Parent Electric Co.	89
Patten, E. E.	85
Potter Company, The	90
<i>QST</i> Binder	80
Radio Engineering Labs.	76
Radio Parts Sales Co.	87
Radio Specialty Co.	83
Radio-Victor Corp. of America	83
Rectifier Engineering Service	83
Rooney, John T.	81
Scientific Radio Service	79
Silver-Marshall, Inc.	75
Teleplex Company	93
Thordarson Elec. Mfg. Co.	95
Transcontinental Coils	79
Universal Microphone Co.	84
Van Nostrand Co., D.	73
Vibroplex Company	87
Weston Electrical Instrument Corp.	78
Wireless Egert Engineering, Inc.	83
Yadley Mfg. Co.	89

YOU'VE BEEN SUCH A
GOOD LITTLE BOY - THAT
MOTHERS GOING TO GIVE
YOU THE WHOLE HAM
FOR YOUR OWN LITTLE
PARTY



THORDARSON ELECTRIC MFG. CO.
HURON, KINGSBURY & LARRABEE STS.
CHICAGO III.

ASTOUNDING RADIO VALUES



LIST
\$10.00

P. T. 537 FILAMENT RHEOSTATS

Rated to carry 15 amps.

An absolute necessity for the control of U.V. 203, 203A, 204, 204A and U.V. 851 Transmitting Tubes and 217, 217A, 217C and U.V. 1651 Rectifying Tubes.

Special **\$3.75 ea.**

PORCELAIN LOW-LOSS SOCKETS

MODEL U.R. 542

For use with U.X. 866, 852, 865, 860, 245, 210 and 250 rubes

On account of its low specific inductive capacity and its high insulating qualities, these Sockets are excellent for Short Wave work and especially adapted to the above tubes.

Special **50c ea.**

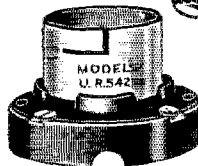

LIST
\$1.00

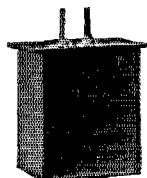

Designed to carry 250 mills

2 HENRY FILTER REACTORS

D. C. Resistance 20 ohms

Fine for use as Generator Filter, also as plate or Grid Reactor.....

Special **\$3.50 ea.**

Manufactured by the world's largest electrical concern whose name we cannot mention.....

List price **\$10.00**

AEROVOX OR Dubilier HIGH VOLTAGE FILTER CONDENSER BLOCKS



SIZE 6" x 5" x 3 1/2"

CAPACITY	RATED D. C. WORKING VOLTAGE
2.0 MFD.	1000 V
1.0 " "	800 V
1.0 " "	800 V
3.0 " "	400 V

Finest non-inductive High Voltage Filter Block ever made. Designed for use with UX-250 Power Tubes but can be used safely in filter circuits of transmitters or high power Amplifiers in any combination of capacities desired.

Each Unit is equipped with long, heavy, flexible leads, convenient for easy wiring, and also has mounting brackets.

The insulation resistance of these Condenser Blocks is in excess of R.M.A. and N.E.M.A. standard requirements.

Due to the request of manufacturers of these Condenser Blocks we cannot divulge the high list price of same.

All brand new, never been used, latest design.

Special **\$3.25 ea.**

KOLSTER KS DYNAMIC REPRODUCER IN WALNUT CABINET WITH BUILT-IN 210 POWER AMPLIFIER. LIST \$175. SPECIAL **\$49.50**

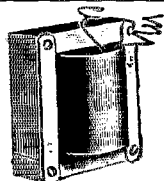

FILTER CHOKES

20 HENRIES

250 MILLS

Just what you want for obtaining a pure D. C. note for your Transmitter. Also can be used in "A" or "B" Eliminators.

Weight 5 pounds. Wiring heavily insulated. New and packed in individual cartons.

SPECIAL **\$2.50 ea.**

LAST MINUTE SPECIALS

	SPECIAL
R.C.A. Uni-Rectron Power Amplifiers — Model A. P. 935 List \$88.50 ea.	\$19.75 ea.
E210 BRADLEYSTATS, list \$4.00, fine for A.C. Line Voltage Control	1.60 "
Koister K 5 Dynamic Reproducer. List \$175	49.50 "
U. S. ARMY Aeroplane Spark Transmitters. Gov. cost \$47 ea.	4.75 "
G. E. Kenotron Rectifying Tubes (Type T.B.1.)	1.25 "
Gould Kathode Unipower, Automatic Radio "A" Power (6 volt), list \$39.50	13.75 "
G. E. V.T. 14 — 5 watt Transmitting Tubes (A good power amplifying tube)	1.50 "
Eby A. C. Adapter Harness with volume control for 6 tube sets. List \$10.00	3.75 "

AMERICAN SALES CO., 19-21 Warren Street, New York City

ALL MERCHANDISE SOLD IS BRAND NEW

AERO COIL

ANNOUNCEMENT!

New Radio Apparatus
Soon to be Announced

For Benefit of Radio Amateurs

AERO PRODUCTS, INC., will have some unusual new developments to announce within a short time. For a considerable period, our laboratories have been working on some outstanding improvements of particular interest to every radio amateur. These new items will be very desirable, particularly to the amateur who wants the very latest in short-wave apparatus.

Send Now for Advance Information

Readers of *Q.S.T.* and all amateurs who read this message may write in now to secure advance information on these new developments the minute they are ready to be released. It will pay you to have the information on these new products before you.

Mail This Coupon for Advance Information

AERO PRODUCTS, INC., Dept. 399
4611 E. Ravenswood Avenue, Chicago

Dear Sirs:

Please send me advance information on the new short-wave developments now being perfected in your laboratories as announced in September issue of *Q.S.T.*

Your Name

Street and Number

City.....State.....

Q.S.T. 9-29

4611 E. Ravenswood
Ave., Dept. 399

AERO PRODUCTS
INCORPORATED

Chicago, Illinois,
U. S. A.

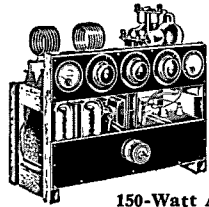

Aero
High-
Power
Xmitter
and

150-Watt Amplifier

For operation on 10-20-40-80-100M. Bands. The first high-power amplifier to use the UX-860 screen grid tubes. 1929 in every detail. 150 Watts of pure D.C. signals with a stability which has caused favorable remarks everywhere. Flexibility that fills every Ham need.

Kit No. 52 — Including the power supply, but not including tubes. List Price.....\$259.00
Kit No. 53 — Less power supply and tubes. List Price.....\$114.00

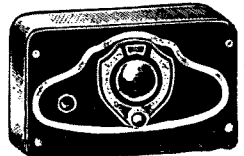

Only
\$15

Aero Listening Monitor

Enables any amateur transmitter to check his own note, to know whether it is pure D.C. or not. It is a safe, sure and accurate way of knowing your station without depending upon the reports of others. Watching the ammeter won't help you — you need the Aero Monitor to be absolutely positive.

Model M-29 Aero Monitor, including Dry Batteries, but no tube. List Price.....\$15.00

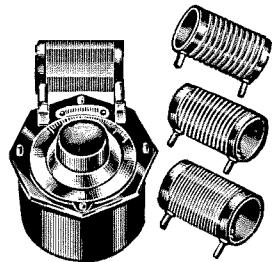

Aero Wavemeter

Using the principle of the "series gap" condensers, and having a definite fixed minimum capacity, the amateur wavelength bands are spread over a great many dial divisions. The velvet vernier dial has 100 divisions, each of which may be read to one-tenth of a division. Each wavemeter is individually hand calibrated. Standard coils shown are 20, 40 and 80 meters, included in price. 5- and 10-meter coils extra.

List Price, each.....\$24.00

Aero Shield-Grid Coils

LWT-11 Kit of 3 coils (16 to 90 meters).....\$11.50
LWT-10 Kit of 3 coils. List.....\$10.50

Aero Transmitting Coil Kits

2040-K — 16 to 52 meter kit \$12.00
4080-K — 36 to 90 meter kit \$12.00
9018-K — 72 to 190 meter kit \$12.00



"Ask any Radio Engineer"

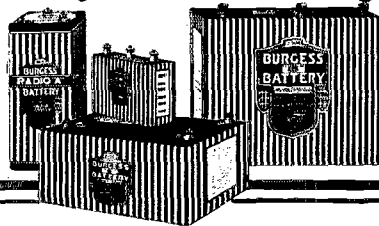

BURGESS BATTERY COMPANY

MADISON,

WISCONSIN