

# QST

DEVOTED ENTIRELY TO

# AMATEUR RADIO

PUBLISHED SINCE 1915 BY THE AMERICAN RADIO RELAY LEAGUE INC.

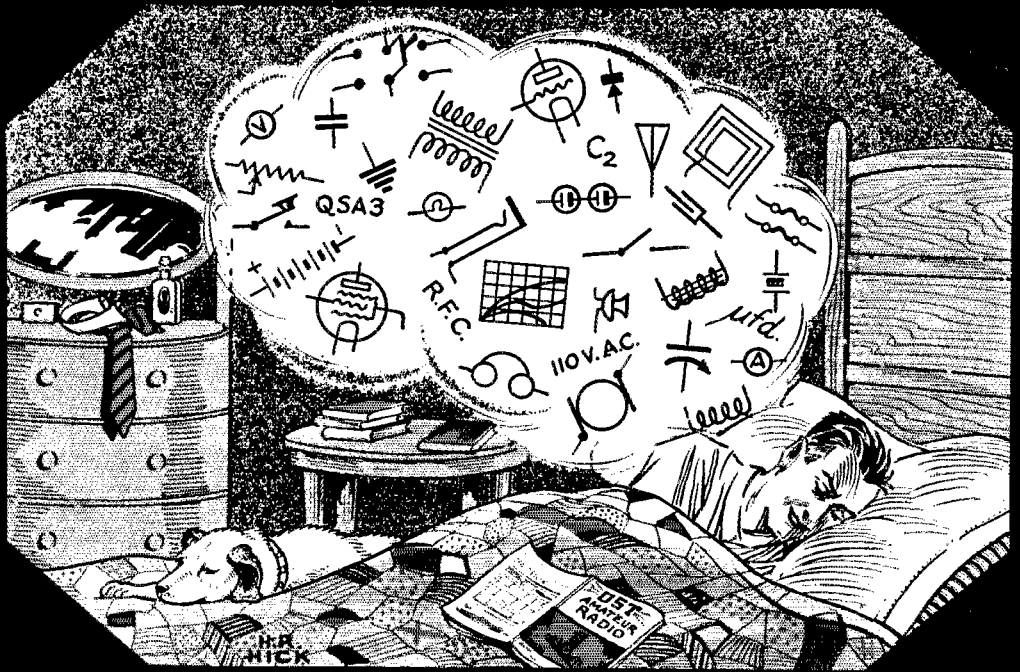

MAY

1929

25¢

The New Fourth Edition of

# The Radio Amateur's Handbook

By HANDY and HULL

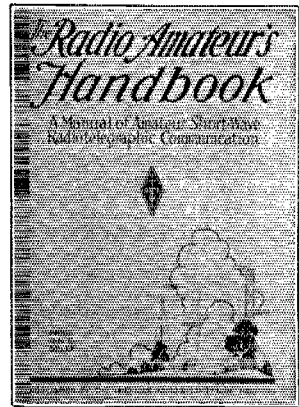

## FOR THOSE WHO DON'T KNOW IT:

The Handbook is a practical manual of amateur radio in all its phases, published by the American Radio Relay League, the amateur's own organization. It starts at the beginning and tells the whole story: What amateur radio is, How to be a radio amateur, How to obtain your licenses, How to build the simple apparatus of a simple station, How to build the best known apparatus for the most modern station, How to operate the station. Enough information to keep you busy and interested for five years.

## FOR THOSE WHO DO KNOW IT:

For years the Handbook has been the practical working guide of successful amateurs the world over. Now it has been completely revised in terms of 1929, by Mr. Handy, the League's Communication Manager, as to all the aspects of operating procedure, and by Mr. Hull, the director of the League's current Technical Development Program, as to all its features of apparatus and technical matters. Everything in it is on a 1929 basis, replacing the 1928 methods which used to be good enough but aren't any more.

## MUCH THAT IS NEW — ALL THAT IS GOOD

*Like QST, "Devoted Entirely to Amateur Radio"*

*Now in its 43d thousand*

*240 pages, 6½ x 9½, 188 illustrations*

In wealth of treatment and profusely of illustration the Handbook is a big book. Printed in usual textbook style it would bulk 500 pages and cost at least \$4, but its publication in the familiar *QST* format makes for handiness and enables its distribution at very modest cost.

**ALGERIAN PAPER COVER \$1**

**STIFF BUCKRAM BINDING \$2**

*Postpaid anywhere in the World*

**American Radio Relay League, Hartford, Conn., U. S. A.**

# RCA RADIOTRON UV-211

## An excellent Oscillator, Modulator and Power Amplifier



For the amateur who has his transmitter working at frequencies below 3000 kilocycles (wave lengths above 100 meters), Radiotron UV-211 may be advantageously used.

Tested and tried through years of service, it has proved its worth as a general purpose transmitting tube. It is stable as an oscillator, excellent as a modulator, and powerful as an amplifier.

Filament Volts .....	10
Filament Amperes .....	3.25
Amplification Factor .....	12

### *Oscillator and RF Power Amplifier*

Max. Operating Plate Voltage	
Modulated DC Plate Volts	1000
Non-modulated DC Plate Volts	1250
AC Plate Volts (RMS)	1500
Max. DC Plate Current (milliamperes).....	175
Max. Plate Dissipation (watts).....	100

### *A. F. Power Amplifier*

Normal Operating Plate Volts.....	1000
Grid Bias Volts.....	-55
DC Plate Current (m.a.).....	72
Plate Resistance (ohms).....	3400
Plate Dissipation .....	72
Undistorted Power Output (watts).....	10

### *Modulator*

Normal Operating Plate Volts.....	1000
Grid Bias Volts .....	-70
DC Plate Current (m.a.) .....	20
Plate Dissipation (watts).....	20

Radiotron UV-211 may, for certain amateur use, be obtained through the RCA District Office nearest you.

Firm Net Price (subject to change without notice)..... \$30.00

## RADIO CORPORATION OF AMERICA

New York, - - 261 Fifth Ave.    San Francisco, 235 Montgomery Street  
Chicago, 100 West Monroe Street    Atlanta, - - - 101 Marietta Street  
Dallas, Santa Fe Building, Unit No. 1

Most Astounding Value Ever Offered!

# K O L S T E R

## ELECTRO-DYNAMIC REPRODUCER

Combined with 210 Power Amplifier and "B" Supply Unit

**T**HESE Dynamic Reproducers are Kolster built, packed in the original Kolster cases and cartons, shipped direct to us from the Kolster factory from whom we have purchased all of these Dynamic Reproducers. Every Dynamic Reproducer is brand new, each bears the Kolster guarantee tag and the original serial number.



Such opportunity as herein presented is seldom available. And they won't last long at this low price. We suggest quick action — there's quality here — at a price heretofore unknown.

**T**HIS finely matched, rugged unit, comprises a complete heavy duty Electro-Dynamic Reproducer, including a 210 Power Amplifier with "B" supply unit, all self-contained on a steel frame. It weighs 45 pounds without the cabinet. The cabinet itself is of pencil-striped walnut, beautifully designed with Cathedral grille. It is equipped with switch for control of house current to reproducer, power unit and amplifier. A pilot light indicates when the Reproducer is in operation.

If desired the 210 Power Amplifier will also supply 22, 67 and 90 volts "B" current, sufficient for any set using up to 8 tubes. An automatic voltage regulator tube, UX-874, maintains the "B" voltage silent and steady.

This Electro-Dynamic Reproducer can be used with any battery or A.C. set, replacing the last audio stage or be used with all tubes of the set. Wherever used, it will bring out every shading and range of tone; every note is reproduced with utmost faithfulness, pure and undistorted. It will modernize any radio receiver.

The following tubes are required for its operation: 2-UX-281 (for full-wave rectification); 1-UX-210 (for super power amplification); 1-UX-874 (for voltage regulation). For use with phonograph pick-up, one additional audio stage is recommended between the pick-up and the Reproducer.

A 20-ft. cable is included with each instrument. Operates direct from 50-60 cycle, 110-120 volt A.C. current.

*Licensed under patents of the RCA and Lektophone Corp.*

### MODEL K-5

Height ..... 42"  
Width ..... 25½"  
Depth ..... 19"

### Features:

1. Electro-Dynamic Reproducer (10¼-in. dia.).
2. 210 Power Amplifier, Fine tone quality.
3. Supplies "B" voltage, if desired.
4. Can be used with any electric or battery set.
5. Complete A.C. Electric operation.
6. Beautiful pencil-striped walnut cabinet.

LIST PRICE \$175.00    *Never*    \$54.00  
 (Without Tubes)    *Before*

Terms: 20% cash with order, balance C.O.D., F.O.B. New York  
 AMERICAN SALES CO., 19-21 Warren Street, New York City



# SPECIALS IN R.C.A. PRODUCTS



## P. T. 537 FILAMENT RHEOSTATS

Rated to carry 15 amps.

An absolute necessity for the control of U.V. 203, 203A, 204, 204A and U.V. 881 Transmitting Tubes and 217, 217A, 217C and U.V. 1651 Rectifying Tubes.



LIST  
\$10.00

Special **\$3.75 ea.**

## ROTARY GRID CHOPPER WHEEL

MODEL P.X. 1638

and Contact Brush Model P.T. 1642

For use with C.W. Vacuum Tube Transmitters. Gives 100 per cent modulation since oscillation can be completely started and stopped at audio frequencies. The note obtained can be varied to any desired pitch by changing the driving motor speed.

Complete with shaft bushing for 5-16" or 1 1/4" motor shaft. When ordering mention size wanted.



LIST  
\$7.45

Special **\$1.25 ea.**

## VARIABLE MICA CONDENSER

MODEL U.C. 1819

Capacity .0001 to .005 Mfd.

A Mica Condenser which may be varied continuously from a minimum to a maximum value. Its capacity curve is a straight line, it has a very low electric loss. Used as a grid, antenna, or secondary tuning condenser.

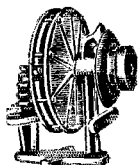

LIST  
\$8.75

Special **\$1.75 ea.**

## PORCELAIN LOW-LOSS SOCKETS

MODEL U.R. 542

For use with U.X. 866, 882, 865, 860, 245, 210 and 250 tubes

On account of its low specific inductive capacity and its high insulating qualities, these Sockets are excellent for Short Wave work and especially adapted to the above tubes.

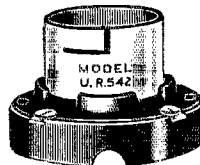

LIST  
\$1.00

Special **50c ea.**

# Dubilier High-Voltage Filter Condensers

(Newest Types, Nos. 902 and 903)

These Dubilier Filter Condensers are tested from 3 to 5 times their rated value, thus assuring a sturdy, scientifically designed product, far exceeding the average Filter Condensers now being used. Widely separated soldering lugs are provided to insure long leakage path and to facilitate neat wiring. Each condenser brand new and packed in individual cartons.

### TYPE No. 902

Rated D.C. Working Voltage 400 V.

Capacity: 1 Mfd.

List Price \$2.50 ea. . . . . SPECIAL **75c ea.**

Capacity: 2 Mfd.

List Price \$3.50 ea. . . . . SPECIAL **\$1.05 ea.**

Capacity: 4 Mfd.

List Price \$5.50 ea. . . . . SPECIAL **\$1.65 ea.**



### TYPE No. 903

Rated D.C. Working Voltage 600 V.

Capacity: 1 Mfd.

List Price \$3.00 ea. . . . . SPECIAL **90c ea.**

Capacity: 2 Mfd.

List Price \$5.50 ea. . . . . SPECIAL **\$1.65 ea.**

Capacity: 4 Mfd.

List Price \$9.50 ea. . . . . SPECIAL **\$2.85 ea.**

## FILTER CHOKES

20 HENRIES

250 MILLS

Just what you want for obtaining a pure D. C. note for your Transmitter. Also can be used in "A" or "B" Eliminators.

Weight 5 pounds. Wiring heavily insulated. New and packed in individual cartons.

SPECIAL **\$2.50 ea.**

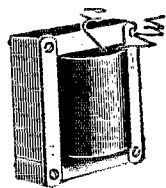

## LAST MINUTE SPECIALS

R.C.A. Uni-Rectron Power Amplifiers — Model A, P. 935	List \$88.50 ea.	SPECIAL	\$19.75 ea.
E210 BRADLEYSTATS, list \$4.00, fine for A.C. Line Voltage Control			1.60 "
Genuine Black Bakelite Panels 38" x 43", 3-16" thick. Reg. Price \$29			8.75 "
U. S. ARMY Aeroplane Spark Transmitters, Gov. cost \$47 ea.			4.75 "
G. E. Kenotron Rectifying Tubes (Type T.B.L.)			1.25 "
Gould Kathanode Unipower, Automatic Radio "A" Power (6 volt), list \$39.50.			13.75 "
G. E. V.T. 14 — 5 watt Transmitting Tubes (A good power amplifying tube)			1.50 "
Western Electric Type 2A Filters			2.50 "

AMERICAN SALES CO., 19-21 Warren Street, New York City

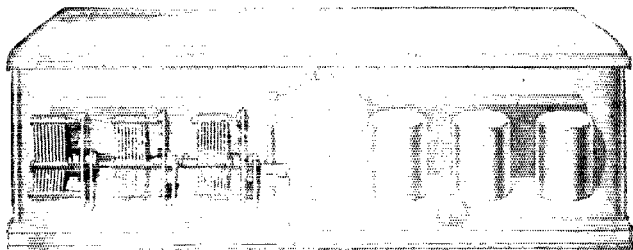

## ALUMINUM SHIELDING

*A notable contribution  
to radio design*

**S**INCE the beginning of 1929, five more prominent manufacturers have adopted Aluminum Shielding. Twenty-seven leading sets are now designed for Aluminum Shielding—an almost universal acceptance.

The reason is evident. Aluminum is highly efficient electrically—especially at radio frequencies. It works easily and well in the shop. It appeals to both purchaser and producer—because it is attractive in appearance, light in weight and non-corrosive.

And Aluminum Shields are economical, from the standpoint of first cost—in production—and in finishing. We solicit your inquiries.

ALUMINUM COMPANY OF AMERICA  
2439 Oliver Building, Pittsburgh, Pa.  
*Offices in 18 Principal American Cities*

**ALUMINUM**  
*The mark of quality in Radio*

# Section Communications Managers of THE COMMUNICATIONS DEPARTMENT, A. R. R. L.

Eastern Pennsylvania W3QP  
Maryland-Delaware-District  
of Columbia W3A1S  
Southern New Jersey W3CJG  
Western New York W3PTJ  
Western Pennsylvania W3CED

Illinois W9APY  
Indiana W9CVO  
Kentucky W9BAZ  
Michigan W8CEP  
Ohio W8BYN  
Wisconsin W9VD

North Dakota W9D4V  
South Dakota W9DGR  
Northern Minnesota W9FVH  
Southern Minnesota W9EFK

Arkansas WSAB1  
Louisiana W5EB  
Mississippi W5AKP  
Tennessee W1FI

Eastern New York W2CNS  
N. Y., C. & Long Island W2KR  
Northern New Jersey W2WR

Iowa W9DZT  
Kansas W9CET  
Missouri W9RR  
Nebraska W9BYG

Connecticut W1ZL  
Maine W1BK  
Eastern Massachusetts W1UE  
Western Massachusetts W1UM  
New Hampshire W1ATJ  
Rhode Island W1BCR  
Vermont W1T

Alaska WWDN  
Idaho W7ACN-7JL  
Montana W7AAT-7QT  
Oregon W7PP  
Washington W7FD

Hawaii K6CFQ  
Nevada W6LO  
Los Angeles W6AM  
Santa Clara Valley W6NX  
East Bay W6CZR  
San Francisco W6WR  
Sacramento Valley W6BS  
Arizona W6ANO  
Philippines\* K1AU  
San Diego W6BQ

North Carolina W4SJ  
Virginia W3CA  
West Virginia W8VZ

Colorado W9CAA  
Utah-Wyoming W6BAJ

Alabama W4AAQ  
Florida W4AAH  
Georgia-S. Carolina-Cuba-  
Porto Rico-Isle of Pine W4KU

Northern Texas W5AKN  
Oklahoma W5GF  
Southern Texas W5OX  
New Mexico W5TT

Newfoundland VE8AR  
New Brunswick VE1EI  
Nova Scotia VE1DO  
Prince Edward Island VE1BZ

Ontario VE3FC

Quebec VE2BE

Alberta VE4HA  
British Columbia VE5BJ

Manitoba VE4FV  
Saskatchewan VE4FC

## ATLANTIC DIVISION

J. B. Morgan, 2nd 431 E. Willow Grove Ave. Chestnut Hill, Phila.  
Dr. H. H. Layton 805 Washington St. Wilmington, Del.  
M. J. Lotysh, Box 49, R. F. D. 1 Cranbury, N. J.  
C. S. Taylor 508 Maston St. Buffalo  
A. W. McAuly 309 Third St. Oakmont

## CENTRAL DIVISION

Fred J. Hinds 4337 Oak Park Blvd. Berwyn  
D. J. Angus 310 N. Illinois St. Indianapolis  
J. B. Warthen, III, Box 97, R. F. D. 1 Louisville  
Dallas Wise 6187 Falcon Ave. Detroit  
H. C. Storck 691 Carpenter St. Columbus  
C. N. Crapo 443 Newton Ave. Milwaukee

## DAKOTA DIVISION

B. S. Warner 309 4th Ave. Endorlin  
D. M. Prosek 280 Illinois St. Huron  
Carl L. Labs 1822 James St. St. Paul  
J. C. Pehoushek 1370 Warwick St., S. E. Minneapolis

## DELTA DIVISION

H. E. Volte 5408 U St. Little Rock  
M. M. Hill Oakdale  
J. W. Gullett 1708 23rd Ave. Meridian  
Polk Purdue c/o Radio Station WBAW Nashville

## HUDSON DIVISION

F. M. Holbrook 2 Livingston Ave. White Plains  
M. B. Kahn 617 W. 141st St. N. Y. C.  
A. G. Westler, Jr. 50 Princeton St. Maplewood

## MIDWEST DIVISION

H. W. Keir Little Sioux  
J. H. Amis Torock  
E. B. Lazure Kansas City  
C. B. Deihl 5605 Cedar St. Omaha

## NEW ENGLAND DIVISION

C. A. Weidenhammer 33 Washington Place Bridgeport  
Frederick East 15 E. Crescent St. Augusta  
E. Battery 39 Royal St. Watlington  
Dr. John A. Tessner 8 Schaffner St. Worcester  
V. W. Hodge 227 Main St. Claremont  
C. N. Kraus 92 Keene St. Providence  
Clayton Paulette North Troy

## NORTHWESTERN DIVISION

W. B. Wilson U. S. LHT Fern Ketchikan  
James L. Young 303 13th Ave. So. Nampa  
O. W. Viers Red Lodge  
R. H. Wright 310 Ross St. Portland  
Otto Johnson 3440 30th Ave. W. Seattle

## PACIFIC DIVISION

F. L. Fullaway 2714 Manoa Rd. Honolulu  
C. B. Newcombe Verinington  
D. C. Wallace 209 Pine Ave., Room 410 Long Beach, Calif.  
D. J. Queument 1348 Hanchett Ave. San Jose  
J. Walter Frates 308 62nd St. Oakland  
C. E. Bane 362 Castro St. San Francisco  
C. F. Mason 2530 N St. Sacramento  
D. B. Lamb 229 W. First St. Mesa  
M. I. Felizardo 252 Galicia St. Manila  
G. A. Sears 236 Bonair St. La Jolla

## ROANOKE DIVISION

Enno Schuelke R. F. D. No. 1 Ridgevay  
J. F. Wohlford 118 Cambridge Ave. Roanoke  
F. D. Reynolds Box 1200 Fairmont

## ROCKY MOUNTAIN DIVISION

C. R. Stedman 1641 Albion St. Denver  
Parley N. James 430 "D" St. Salt Lake City

## SOUTHEASTERN DIVISION

S. J. Bayne 9 Park Ave. Montgomery  
Harvey Chain 6002 Suwanee Ave. Tampa  
H. L. Reid 11 Shadowlawn Ave. Atlanta

## WEST GULF DIVISION

J. H. Robinson, Jr. 522 Cumberland St. Dallas  
W. J. Gentry 610 Pottenger St. Shawnee  
R. E. Franklin 1806 Valentine St. Houston  
L. E. Radka Tucumcari

## MARITIME DIVISION

Loval Reid Avalon House St. Johns  
F. B. Lacey c/o N. B. Power Co. St. John  
A. M. Crowell 69 Dublin St. Halifax  
F. W. Hyndman 25 Fitzroy St. Charlottetown, P. E. I.

## ONTARIO DIVISION

E. C. Thompson 266 Queensdale Ave. Toronto, 6

## QUEBEC DIVISION

Alex Reid 169 Logan Ave. St. Lambert

## VANALTA DIVISION

F. J. Taylor 10107-87th Ave. Edmonton  
E. S. Brooks 2987 Causton St. Vancouver

## PRAIRIE DIVISION

D. B. Sinclair 205 Cambridge St. Winnipeg  
W. J. Pickering 514 19th St. W. Prince Albert

\* Temporary official appointed to act until the membership of the Section concerned choose permanent SCMs by renomination and election.

# One FREQUENCY METER for Five AMATEUR BANDS

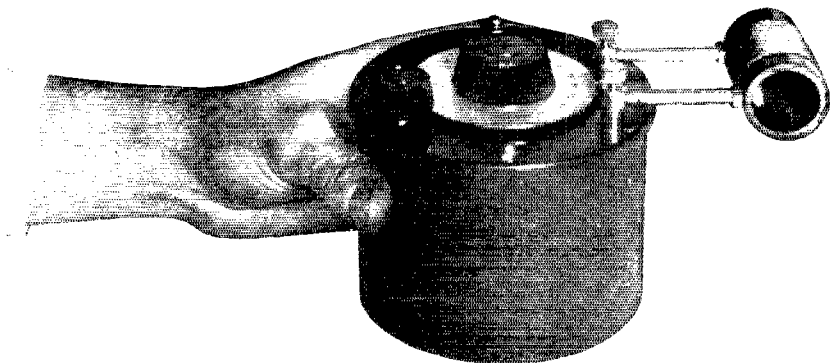

The TYPE 558-P Amateur-Band Frequency Meter does give you five instruments for the price of one, but there are other just as important reasons for your choosing it.

It's handy and easy to operate. Hold it in one hand and tune it with the other. The vernier tuning control makes exact adjustment possible.

But, above all, it is calibrated with an accuracy of  $\frac{1}{4}$  of 1% against the same laboratory standard used to calibrate the General Radio line of Precision Frequency Meters.

Price \$18.00

*Ask to see Bulletin P-1*

## GENERAL RADIO COMPANY

30 STATE STREET  
CAMBRIDGE, MASSACHUSETTS

274 BRANNAN STREET  
SAN FRANCISCO, CALIFORNIA



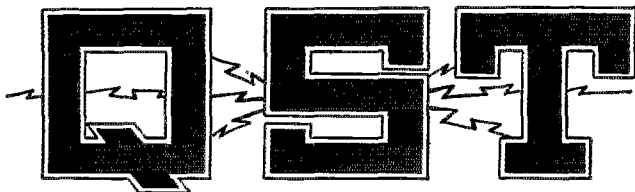

# The Official Organ of the A.R.R.L.

VOLUME XIII

MAY, 1929

NUMBER 5

Editorials . . . . .	9
Standard Frequency Transmissions of WWV . . . . .	10
Rocking the Boat . . . . . <i>Hiram Percy Maxim</i>	10
WSARO . . . . .	11
Another "1929-Type" Receiver . . . . . <i>P. S. Hendricks</i>	15
Some Changes in Our Staff . . . . .	18
Wired Wireless . . . . . <i>J. E. Smith</i>	19
The Glutton . . . . . " <i>Felix</i> "	21
Concerning the Super-Heterodyne . . . . .	22
Single Control for the High-Beat Super-Heterodyne . . . . . <i>J. M. Grigg</i>	23
Hull Returns to Australia . . . . .	26
The Governors-President Relay . . . . . <i>William M. Smith</i>	27
Keying the Oscillator-Amplifier . . . . . <i>C. L. Loudon</i>	30
Official Frequency System . . . . .	32
Alternating Current Rectification as Applied to Radio -- Part II . . . . . <i>R. J. Kryter</i>	33
Commission Doings . . . . .	40
Experimenters' Section . . . . .	41
Hudson Division Convention . . . . .	45
The Communications Department . . . . .	46
I.A.R.U. News . . . . .	62
Calls Heard . . . . .	63
Correspondence Department . . . . .	64
QST's Station Cup . . . . .	89
Roanoke Division Convention . . . . .	90
Statement of Ownership . . . . .	91
Ham-Ads and QRA's . . . . .	92
QST Index of Advertisers . . . . .	94

QST is published monthly by The American Radio Relay League, Inc., at Hartford, Conn., U. S. A.  
 Official Organ of the A.R.R.L. and the International Amateur Radio Union

**Kenneth B. Warner** (Secretary, A.R.R.L.),  
*Editor-in-Chief and Business Manager*

**F. Cheyney Beckley**,  
*Managing Editor and Advertising Manager*

**Harold P. Westman**,  
*Technical Editor*

**James J. Laub**,  
*Assistant Technical Editor*

**David H. Houghton**,  
*Circulation Manager*

Subscription rate in United States and Possessions, Canada, and all countries in the American Postal Union, \$2.50 per year, postpaid. Single copies, 25 cents. Foreign countries not in American Postal Union, \$3.00 per year, postpaid. Remittances should be by international postal or express money order or bank draft negotiable in the U. S. and for an equivalent amount in U. S. funds.

Entered as second-class matter May 29, 1919, at the post office at Hartford, Connecticut, under the act of March 3, 1879. Acceptance for mailing at special rate of postage provided for in section 1103, Act of October 3, 1917, authorized September 9, 1922. Additional entry at Concord, N. H., authorized February 21, 1929, under the act of February 28, 1925.

Copyright 1929 by the American Radio Relay League, Inc. Title registered at United States Patent Office.  
 Member of the Radio Magazine Publishers' Association.

# The American Radio Relay League

The American Radio Relay League, Inc., is a non-commercial association of radio amateurs, bonded for the promotion of interest in amateur radio communication and experimentation, for the relaying of messages by radio, for the advancement of the radio art and of the public welfare, for the representation of the radio amateur in legislative matters, and for the maintenance of fraternalism and a high standard of conduct.

It is an incorporated association without capital stock, chartered under the laws of Connecticut. Its affairs are governed by a Board of Directors, elected every two years by the general membership. The officers are elected or appointed by the Directors. The League is non-commercial and no one commercially engaged in the manufacture, sale or rental of radio apparatus is eligible to membership on its board.

"Of, by and for the amateur," it numbers within its ranks practically every worth-while amateur in the world and has a history of glorious achievement as the standard-bearer in amateur affairs.

Inquiries regarding membership are solicited. A bona fide interest in amateur radio is the only essential qualification; ownership of a transmitting station and knowledge of the code are not prerequisite. Correspondence should be addressed to the Secretary.

## DIRECTORS

*President*  
HIRAM PERCY MAXIM  
Drawer 2102,  
Hartford, Conn.

*Vice-President*  
CHARLES H. STEWART  
St. David's, Pa.

*Canadian General Manager*  
A. H. K. RUSSELL  
5 Mail Bldg.,  
Toronto, Ont.

*Atlantic Division*  
DR. EUGENE C. WOODRUFF  
234 W. Fairmount Ave.,  
State College, Pa.

*Central Division*  
CLYDE E. DARR  
187 Hill Ave., Highland Park,  
Detroit, Mich.

*Dakota Division*  
C. M. JANSKY, JR.  
Dept. of Elec. Eng., U. of M.  
Minneapolis, Minn.

*Delta Division*  
BENJ. F. PAINTER  
424 Hamilton Nat'l Bank Bldg.,  
Chattanooga, Tenn.

*Hudson Division*  
DR. A. LAFAYETTE WALSH  
220 West 42d St.,  
New York City

*Midwest Division*  
PORTER H. QUINBY  
817 Lauderman Building,  
St. Louis, Mo.

*New England Division*  
FREDERICK BEST  
13 East Crescent St.,  
Augusta, Maine

*Northwestern Division*  
E. W. WEINGARTEN  
3219 No. 24th St.,  
Tacoma, Wash.

*Pacific Division*  
ALLEN H. BABCOCK  
65 Market St.,  
Southern Pacific Co.,  
San Francisco

*Roanoke Division*  
W. TREDWAY GRAVELY  
Box 245,  
Danville, Va.

*Rocky Mountain Division*  
PAUL M. SEGAL  
Box 1771,  
Denver, Colo.

*Southeastern Division*  
HARRY F. DOBBS  
c/o Dobbs & Wey Co.,  
245 Spring St., N. W.,  
Atlanta, Ga.

*West Gulf Division*  
FRANK S. CORLETT  
2515 Catherine St.,  
Dallas, Tex.

## OFFICERS

*President* . . . . . HIRAM PERCY MAXIM, Hartford, Conn.  
*Vice-President* . . . . . CHARLES H. STEWART, St. David's, Pa.  
*Secretary* . . . . . KENNETH B. WARNER, Hartford, Conn.  
*Treasurer* . . . . . ARTHUR A. HEBERT, Hartford, Conn.  
*Communications Manager* . . . . . F. EDWARD HANDY, Hartford, Conn.

ADDRESS: ALL GENERAL CORRESPONDENCE TO THE EXECUTIVE HEADQUARTERS AT HARTFORD, CONN.

# EDITORIALS

12

THE formal course of the A.R.R.L. Technical Development Program has come now to an end. Once more passing time gives us a perspective as we look back upon a long job; again we have occasion to take stock of our situation and see where we are.

When the League's Board of Directors met in early 1928, amateur radio was confronted with numerous technical difficulties arising from the Washington Convention. In 1929 our bands were going to be reduced and we didn't know how to make our receivers sharp enough, our transmitters stable enough, and our frequency determinations accurate enough to assure ourselves of successful operation. It was one of those emergencies for the very handling of which we amateurs have banded ourselves into a league. Plainly it was the League's duty to do something about it. So came the Technical Development Program, a year's effort which the League financed from the reserve which it has for just such purposes.

As we look back upon it now, we find it a good A.R.R.L. job. It has produced the answers to those problems of a year ago and now every amateur knows, or should know, how he can operate with success regardless of the Convention difficulties, and that without appreciable increase of effort or expense. The program results have been published in *QST*. Counting them up we find studies of low and high powered self-excited transmitters, of oscillator-amplifier transmitters, of peaked-audio receivers for code and of superheterodynes for 'phone, of keying for the code men and of 'phone design for the voice men, of frequency-measurement and monitoring for both of them, of the use of a.c. plate supply, and of the possibilities of the 28-mc. band. A formidable list! These studies have altered the whole course of amateur radio, they have set the new standard for 1929 performance.

We have learned many new lessons. We have come to know that even the simplest transmitter may be made adequately stable by the proper choice of  $L/C$  ratio; that in code work the simplest receiver plus our old acquaintance, the "distortion amplifier," will provide selectivity for any conceivable interference; that our 'phones may have beautiful quality and greatly extended range by the application of modern engineering principles. We know now that the "superhet" principle is the ideal one for selectivity in 'phone work; that it is essential to monitor all transmissions, whether key or voice; that with the aid of the monitor and even the crudest frequency-

meter, or no frequency-meter at all, we can set our transmitters legally and keep them so. And we know just how to build the apparatus to do these jobs.

This knowledge is worth much. It meant, in fact, salvation technically in 1929. That is why we say that it was a good A.R.R.L. job and one more reason why every amateur ought to be a member of our League.

But, invaluable as this technical knowledge is, it does not mean that we have attained to perfection — far from it. At best the Program skimmed the surface of possible solutions; its need was to find a workable answer for a pressing amateur problem and move on to another equally pressing problem. The conclusion of the program leaves much to be done by amateurs themselves. The program has provided the essentials to existence, it has roughed out the principles. No one is to expect that the brilliant amateur radio of our country will not carry those ideas forward to a greater and yet greater success, building up and polishing, as it were, the original program work.

A.R.R.L. Headquarters therefore can feel content to draw a line now and call the planned work of the organized program completed. It is now up to the membership to carry on the work. To a considerable extent we return to our old basis, a co-operative association of workers whose technical successes are published in our mutually-owned magazine for the common good. During the past year there has been perhaps too much of a "let-George-do-it" spirit. You know who we mean by "George"—we mean O.M. Geo. Program. He's dead now, but his work lives on forever. We shall have more space in *QST* available for reporting the work of individual members. We want to hear about it. We know that there were other solutions to our technical problems than those presented by the program, and we know that the program answers have been carried to a more polished state by numerous individual amateurs. A cordial invitation is extended to them — to you — to make these results available to the rest of the amateur world through *QST*'s pages. That is the spirit of the A.R.R.L.

Let it not be thought that the editors of *QST* expect now to rest on their respective posteriors and let the rest of the world go by. That is why we emphasized the formal program. That, yes, is concluded, but there will be more than the usual amount of experimental work continuing at Headquarters. But we need help, fellows, to make our *QST* everything that it can and ought

to be, and every one of you who has a successful 1929 station has an interesting story to tell, something which will help other amateurs to succeed—which, again, is the spirit of the A.R.R.L. The postman could still stagger into our place if he carried a few more 1929 articles, and if necessary we'll agree to send a truck down to the post-office after them. Right? Shoot!

K. B. W.

## Standard Frequency Transmissions of WWV

**T**HE BUREAU OF STANDARDS announces a new schedule of radio signals of standard frequencies for use by the public in calibrating frequency standards and transmitting and receiving apparatus.

Information on how to receive and utilize the signals is given in the Bureau of Standards Circular No. 171 which may be obtained by applying to the Bureau of Standards, Washington, D. C. The schedule of standard frequency signals is as follows:

<i>Eastern Standard Time (P.M.)</i>	<i>May 20</i>	<i>June 30</i>	<i>July 22</i>
10:00-10:08	125	350	1500
10:12-10:20	150	600	1700
10:24-10:32	200	700	1900
10:36-10:44	250	800	2300
10:48-10:56	300	1000	2700
11:00-11:08	375	1200	3100
11:12-11:20	450	1400	3500
11:24-11:32	550	1500	3900

The figures given above are the transmission frequencies in kilocycles.



## The President's Corner

A WORD FROM

### HIRAM PERCY MAXIM

PRESIDENT OF THE AMERICAN RADIO RELAY LEAGUE AND  
OF THE INTERNATIONAL AMATEUR RADIO UNION

## Rocking the Boat

**T**HERE always have been "boat rockers" and it is reasonable to suppose there always will be. Ever since there has been such a thing as amateur radio there have been those among us who were unable to appreciate what happens when the "rocking" business is carried too far.

Our A.R.R.L. "boat" is a typically American structure. Our members in the U. S. A. correspond to American citizens. Our Divisions correspond to the American States. Our Board of Directors corresponds to the American Congress. Our President and our Vice-President are selected by the Directors and are added to the Board. Our Secretary, Treasurer and Communications Manager are hired by the Directors. They have no vote or voice. Their job is to carry out the orders of the Directors.

Of what use is it to start "rocking the boat" because the Secretary or the Treasurer or the Communications Manager does or does not do something or other? He was told to do it or told not to do it by the Directors. And the Directors were elected in every Division by the members.

There has been "boat rocking" in the past but just before the green water started coming in over the side, common sense has come to the rescue, and the "rockers" have stopped "rocking," and the good old A.R.R.L. ship has been saved. Today there is "rocking" because amateur privileges have been restricted.

The officers, acting under the Directors' orders, resisted this restricting to the danger point. Another ohm of resistance might have brought total extinction of amateur radio. Radio regulation is not what it was once. No longer has our U. S. A. the entire say of what goes on. Radio is world-wide and it is the combined action of all the nations of the earth that determines what is to go on and what shall not go on — not the action of a single nation.

Let's understand this clearly when we start rocking this fine old boat of ours.

# W8ARO

## A Successful "1929 Type" Station

*In the March QST, on page 37, we detailed the opening of a station-description contest. According to the rules of the contest the best description on hand each month is to be printed in QST until the end of the year, at which time the four best published descriptions are to be selected by the judges and the awards made. Herewith we present the first station-description of the series — the description selected by the judges as being the best of those received to date. — EDITOR.*

**I**N December, 1923, S.A.R.O. went on the air for the first time with a pair of UV-202's supplied from a 750-volt motor-generator. Operation at that time was in the band between 150 and 200 meters and results were never very impressive. Later, a 50 wattor replaced the smaller tubes and attention was turned to the higher frequency bands then being opened. Some

and in consequence a high-voltage transformer, a mercury-arc and a "brute force" filter were installed.

After reading the articles on "1929 type" equipment in the August, 1928, QST and in the issues that followed, enthusiasm ran high. In the late summer of that year experiment was started on apparatus for 1929 operation. A UX-210 supplied

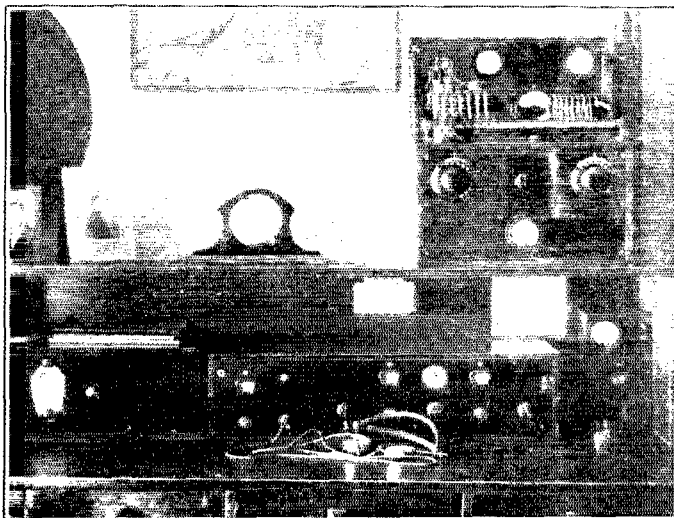

THE OPERATING POSITION AT W8ARO

satisfactory results were obtained but the press of personal affairs caused a suspension of activities for almost two years. The progress of the game was followed carefully, however, and early in 1927 the 50 wattor was again put into commission to provide an outlet for enthusiasm generated by reading of the work made possible by the Hertz Antenna on the 40- and 20-meter bands. The results obtained were immediately highly satisfactory and when the 50 wattor was later replaced by a UX-852 fed from the old 750-volt generator 17 countries in all continents except Asia were worked. It was realized that the tube, at this low voltage, was decidedly handicapped

from a power-amplifier "B eliminator" was used for the first experiments, this tube being arranged in a High-C transmitter modeled closely after that described in the August, 1928, QST. From the start and almost without exception the note was reported "d.c. crystal controlled" in marked contrast to the signals of previous transmitters, the reports on which were invariably r.a.c.

Thus encouraged, work with the UX-852 was started. Considerable difficulties were experienced at first on account of the failure to give any consideration to the fact that the difference between the plate impedances of the UX-210 and the UX-852 undoubtedly would necessitate the

use of different inductance-capacity ratios in the tank circuit. When the inductances had been increased to a value which permitted efficiencies similar to those obtained with the UX-210 the transmitter really started to perform! Excellent signals were obtained in the monitor and flutter-

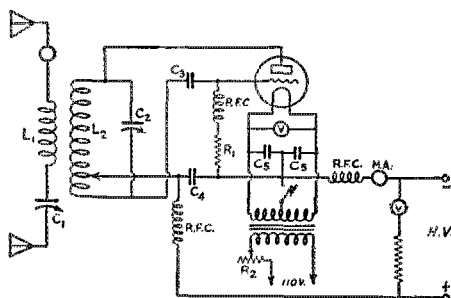

FIG. 1.—THE WIRING OF THE HIGH-C TRANSMITTER

- C1* — 450- $\mu$ fd. receiver type variable condenser.  
*C2* — 450- $\mu$ fd. double-spaced transmitter type condenser.  
*C3* — 2000- $\mu$ fd. fixed grid condenser, 5000-volt rating.  
*C4* — 2000- $\mu$ fd. fixed by-pass condenser, 5000-volt rating.  
*C5* — 2000- $\mu$ fd. fixed by-pass condensers, 500-volt rating.  
*R1* — 2,000-ohm gridleak.  
*R2* — 50-ohm power rheostat.  
*L1* — 8 turns of  $\frac{3}{8}$ " copper tubing, turns  $3\frac{1}{2}$ " diameter for 3500 kc. 11-turn R.F.L. coil  $4\frac{1}{2}$ " diameter for 7000 kc. 8 turns of  $\frac{3}{8}$ " copper tubing, turns  $2\frac{1}{2}$ " diameter for 14,000.  
*L2* — 3 turns of  $\frac{3}{16}$ " copper tubing, turns  $3\frac{1}{2}$ " diameter for 3500. 7 turns of same tubing and same diameter for 7000 kc. 7 turns of same tubing, turns  $2\frac{1}{2}$ " diameter for 14,000 kc. The inside diameter of turns is specified in all cases.

ing reports from all stations worked confirmed their excellence. Reports of "very steady d.c." and frequently "crystal control" were obtained from stations throughout the country on the 3500-, 7000- and 14,000-ke. bands and from foreign countries on the 7000-ke. band. In all cases the reports of readability were highly satisfactory. In many instances the signals were reported as readable through the interference only because of the clean steady note.

The circuit of the transmitter in its present form is given in Fig. 1. From this circuit and the photograph it can be seen that the chief considerations involved in its construction were simplicity, mechanical stability, and efficiency (consistent with a good steady signal).

Most of the apparatus is visible in the photograph of the transmitter alone. On the lower panel from left to right are: The tank condenser dial; shorting switch for antenna series condenser, and antenna series condenser dial. Below is the plate voltmeter. The latter is very useful as an indicator that the arc is operating, aside from its primary purpose. On the platform above, in the foreground, are two glass rods supporting the tank coil and antenna coupling coil. These rods are in turn supported on formica mountings. As may be seen, the tank coil is secured to heavy copper strips which are bolted and screwed to the

tank condenser located immediately below the platform. Rapid change of tank coils is made possible by the use of large binding posts bolted to the copper strips. The plate lead from the UX-852 bolts directly to the right hand strip. At the top of the left hand strip is located the grid condenser. Wires from it lead directly to the grid condenser and grid-leak, the latter being of 20,000 ohms resistance. Filament and high-voltage by-pass condensers are located beneath the tube. The antenna coupling coil is at the right end of the glass rods. The antenna condenser, of course, is below the platform. On the upper panel from left to right are the plate milliammeter, the filament voltmeter, and the antenna r.f. ammeter. Other apparatus inside the cabinet comprises the resistor for the plate voltmeter, the shorting switch for the antenna condenser, and the r.f. chokes. The latter are of 160 turns of d.s.c. No. 30 on a  $\frac{3}{4}$ " tube. The shorting switch mentioned is simply a s.p.s.t. knife switch mounted on the antenna condenser, and connected to the control knob on the lower panel by means of a formica extension arm.

The circuit, as drawn in Fig. 1, has proven very satisfactory at WSARO. One good feature of it is that the r.f. load on the chokes is very low. Of course the tank inductance is at high voltage, as are a number of other parts, but with 2000 volts on the transmitter all parts should be treated with the utmost care anyway. The diagram gives the constants of most of the apparatus. The filament transformer is rated at 150 watts. The filament voltage drops about .2 volt when keying. As stated earlier, attempts at using inductances in the tank circuit designed (as to number of turns) for a UX-210 proved out of the question when using 2000 volts d.c. due to impossibility of keeping the plate current at normal values. The



• THE RECEIVER AND MONITOR, ENCLOSED IN THE ONE CABINET

On the left are the tuning control, switch and phone plug of the monitor. Grouped on the right are the controls of the four-tube receiver.

coils used correspond closely to those specified for use with the self-rectified transmitter described on page 26 of the February, 1929, QST. The latter, however, are slightly smaller than those used at WSARO — the difference, no doubt, resulting from consideration of the type of plate supply. Obviously a higher C would be desirable in a transmitter not supplied with pure d.c. All tank coils are wound with  $\frac{3}{8}$ " copper tubing the spacing between about  $\frac{1}{2}$ " except in the case of

the 3500-ke. band coil where the spacing is  $\frac{1}{16}$ ". The adjustment of the filament clip has not been found very critical and the change from one band to another is merely a matter of a few moments.

The two stand-off insulators on the right side of the cabinet are for the leads to the antenna system. Similar insulators are fitted at the back

75 mils is 2200. Regulation: 6.8%. Recently, a 2000-volt, 1000-watt transformer was installed. Its load voltage (1500 volt taps) at 72 mils is 2075; no load voltage 2150. Regulation: 3.1%.

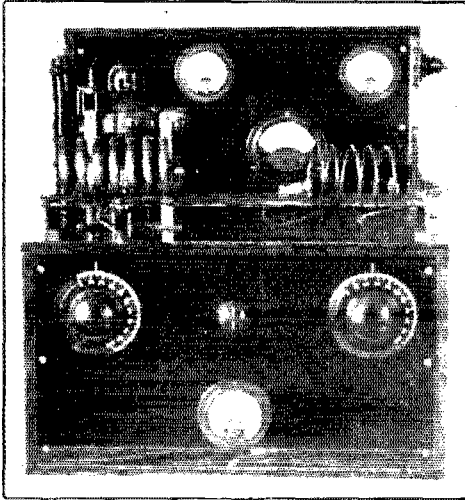

THE SELF-EXCITED HIGH-FREQUENCY HARTLEY TRANSMITTER

*This arrangement, while permitting ready access to the inductances provides protection for the condensers from dust.*

of the transmitter for the high-voltage leads, which are of heavy rubber covered ignition wire. Keying in the center tap lead has proven completely satisfactory though it is quite possible that some other form of keying would be necessary if the transmitting antenna were closer to near-by broadcast listeners' antennas.

Power to the transmitter is supplied from a high-voltage transformer. The a.c. after being stepped up from 110 to over 2000 volts is rectified by a mercury arc, and filtered by the filter as shown in Fig. 2. The large galvanized can shown in the photograph of the power supply contains the arc tube in an oil bath and the shaker mechanism. Immediately above is the keep-alive transformer and its choke wound on the same core. On the shelf above are the high-voltage transformer, the filter choke and the filter condensers. The condensers are all rated at 2000 volts d.c. The 1- $\mu$ d. condenser is all that is left of one formerly rated at 2- $\mu$ d! The filter choke is of 30 hys. inductance, rated at 500 mils. The high-voltage transformer is rated at 1500 volts on each side of the center tap at 500 watts. In the power circuit above it delivers 2350 volts at no load to the transmitter. The load voltage at

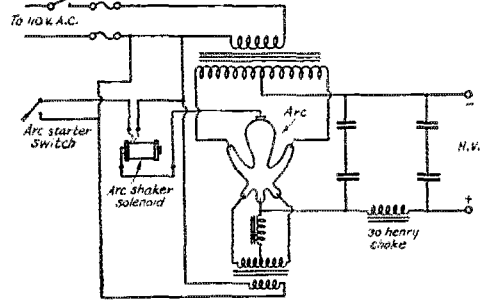
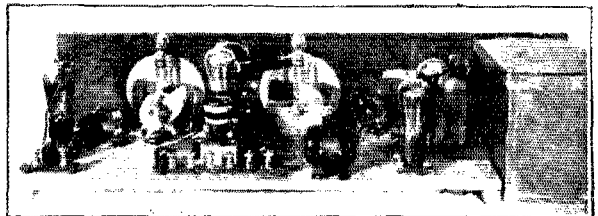

FIG. 2 — THE CONNECTIONS OF THE POWER SUPPLY UNIT

The power switch S and the arc starter switch are at the operating table.

The antenna system first used with the transmitter was a voltage-feed Hertz with a fundamental on the 7000-ke. band. The antenna together with the feeder happened to be of such a length that the whole could be operated as an end feed Hertz for 3500 ke. work. The present system is a large bent Hertz with a fundamental of about 3150 ke. Operation in the 3500-ke. band is made possible in increasing the fundamental frequency with a series condenser. For use on the 7000 band the antenna is loaded to 2330 ke. and operated on the third harmonic. For 14,000-ke. work is loaded to about 2800 ke. and operated on the fifth harmonic. The approximate length of each half of the antenna is 82 feet. The system is quite practical and simple, and permits changing from one band to another without difficulty. The only disadvantage is that the two halves of



AN INSIDE VIEW OF THE RECEIVER AND MONITOR

*To the left is mounted the UX-222 antenna coupling tube, the tuning condenser with its switching arrangement and the detector tube. At the right of these units can be seen the "probed" audio amplifier, the Ford coil secondary belonging to it being mounted inside the tube shield. Inside the shield at the extreme right is the apparatus constituting the monitor.*

the system are not, in this particular case, sufficiently well separated to avoid some cancellation of the fields around the two wires similar to the effect obtained in the feeder of a "Zeppelin" system. Though its effectiveness appears to be quite high it is certain that results would be im-

proved if it were possible to extend the two halves of the antenna away from the station in opposite directions.

The wiring of the receiver is shown in Fig. 3. Some idea of its arrangement can be obtained from the front and rear views given.

Looking at the front view the apparatus mounted on the panel are from left to right: The phone and filament lighting jack for the monitor (which is built into the receiver cabinet); the monitor tuning dial; the receiver filament switch for the receiver; the receiver phone jack; the volume control; the regeneration control; detection voltmeter and rheostat knob, the tuning dial and the tuning condenser control switch. The first three tubes of this receiver were assembled and were being tested as a receiver when the Nov. QST containing the article on amateur receivers arrived. The first UX-222 r.f. tube, the detector and one UX-201-A in a stage of transformer-coupled audio had been found satisfactory but a second UX-222 was then added as a "peaked" audio stage. The receiver is smooth and stable in operation and more selective than the old two-tube standby. The transformer used is a UV-712, R.C.A. The tuned impedance consists of a Ford coil secondary enclosed in tube shield to left of monitor shunted by a capacity of .01 $\mu$ fd. Volume is controlled by a Centralab 200,000-ohm resistor, connected across the transformer secondary. Regeneration control is by means of variable capacity in the detector plate circuit. The detector tube is mounted on sponge rubber. Coils are wound on tube bases fitted with a rim at the top to assist removal. Chokes used are the small Silver-Marshall receiver chokes. The tuning condenser consists of a National .0005- $\mu$ fd.

stators insulated from each other as suggested by Mr. Westman in September QST. One condenser

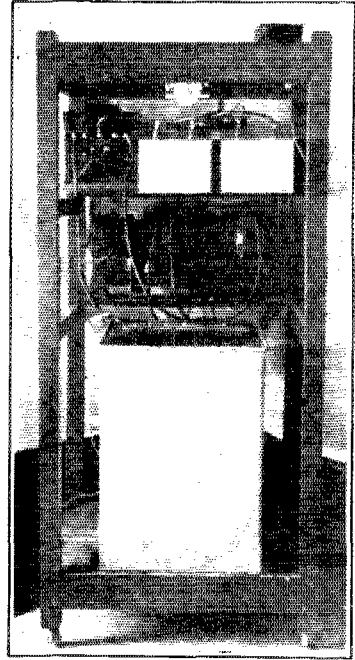

#### WSARO'S POWER SUPPLY UNIT

The mercury arc is in the tank at the bottom of the frame. Above it are to be seen the regenerative transformer, the high-voltage transformer, the filter condensers and the two chokes.

containing a single stator and rotor is used for the 7000 and 14,000 bands. For the 3500-kc. band this condenser is connected by a switch to the other part consisting of two stators and a rotor making five plates in all. This makes a very flexible and handy arrangement. A choke is shunted across the grid circuit of the first UX-222. The antenna, a single 60-foot wire, is connected to the grid end of the choke, while the other end is connected to the ground. It is hardly necessary to say that the signal strength available is generally much more than can be comfortably used with head phones.

The operation of the tuning condenser control switch can be seen fairly well in the rear view. Two jaws from a knife switch are mounted on the horizontal bar of a T shaped piece of formica. On the vertical part of the T is a standard which carries a shaft to which is fastened (by nuts) a lever carrying on one end a counterweight, and on the other two pieces of copper which form a square

U which engages the two jaws, each of which is

(Continued on page 22)

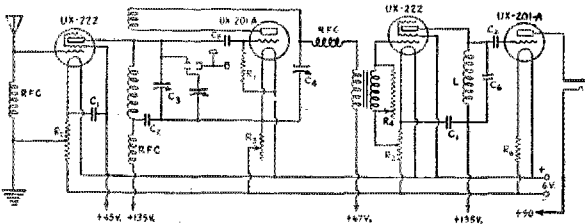

FIG. 3.—THE CIRCUIT OF THE RECEIVER

- C1 — 1- $\mu$ fd. by-pass condensers.
- C2 — 6,000- $\mu$ fd. fixed condensers.
- C3 — Special tuning condenser (see text).
- C4 — 250- $\mu$ fd. receiver type variable condenser.
- C5 — 150- $\mu$ fd. fixed condenser.
- C6 — 01- $\mu$ fd. fixed condenser.
- R1 — 2-megohm gridleak.
- R2 — center-tapped 20-ohm filament resistors.
- R3 — 10-ohm rheostat.
- R4 — 200,000-ohm variable resistor.
- R5 — 8-megohm gridleak.
- R6 — 2-ohm fixed resistor.
- L — Ford coil secondary.

Equitune variable which has been reconstructed. It now consists of two condensers in one, with the



## Another "1929" Receiver

By P. S. Hendricks\*

**T**HE following is a description of a simple and practical three-tube receiver for amateur c.w., phone and general high-frequency reception. It has a continuous frequency range from 2800 to 15,150 kc. with a coil for the 28,000-ke. band. The maximum range of the 28,000-ke. band coil is from 25,000 to 30,000 kc., although, when being used for the amateur band, its range is from 27,780 to 30,300 kc., giving a more suitable amount of overlap and coverage. The arrangement providing a double range may be understood from the coil table and a later portion of this text.

The range between 15,150 and 25,000 kc. is not covered because it does not contain much of interest to most amateurs or other high frequency listeners. However, that range could

Such schemes help to make a receiver more compact and simplify the wiring.

### CIRCUIT ARRANGEMENTS

The circuit consists of one untuned r.f. coupling stage, isolated from the rest of the circuit by a Silver-Marshall No. 638 copper stage shield; a 201-A detector and one 201-A high quality audio stage.

The antenna is coupled to the grid of the r.f. amplifier tube through a Pilot midget variable condenser, which is placed within the shield with the r.f. stage. Its adjustment may be set for a given antenna and tuning range and does not need further attention while the set is in operation. As may be seen in a photograph, on account of the limited space within the shield, this antenna condenser is fitted with a handle of Bakelite tubing instead of a knob. This tubing is  $\frac{1}{2}$ " o.d. by  $\frac{1}{4}$ " i.d. and  $1\frac{1}{2}$ " long. The input to the r.f. tube is coupled across a 50,000-ohm resistor of the gridleak type, which fits into the

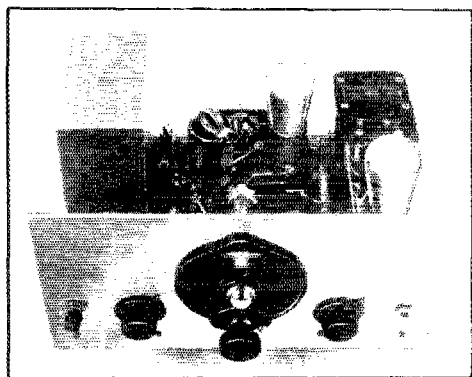

FRONT VIEW SHOWING CONTROLS

The r.f. stage shield, plug-in coil, detector tube and audio frequency amplifying transformer with tube, are in their respective positions, from left to right, behind the panel.

readily be covered with one or two more coils. The windings for them could be judged fairly accurately because they would be between the sizes for the 14,000- and the 28,000-ke. coils. For the territory between 1500 and 2800 kc., coils could readily be made by winding them on the same type form with somewhat smaller wire.

The receiver is assembled on an aluminum panel  $12'' \times 7'' \times \frac{1}{8}''$  and a wooden baseboard  $12'' \times 8'' \times \frac{3}{4}''$ . The top of the baseboard is covered with a sheet of 30 mil. copper on which the various parts are mounted. The r.f. chokes form one of the legs of the detector and a.f. tube socket supports and the a.f. transformer is mounted on top of one of the by-pass condensers.

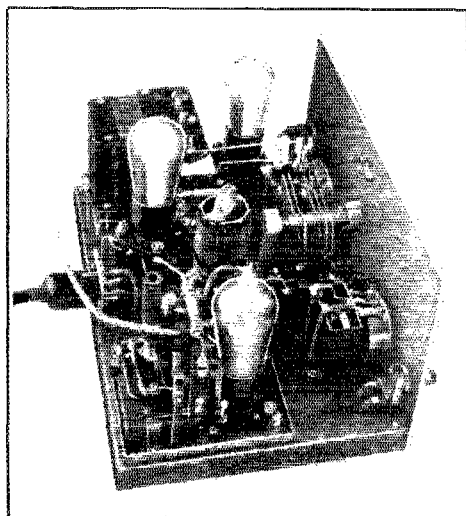

SIDE VIEW WITH TOP AND SIDES OF THE R.F. SHIELD REMOVED, SHOWING THE ASSEMBLY OF THE INPUT CIRCUIT

mounting that may be seen between the antenna coupling condenser and the screen-grid tube. A Silver-Marshall type 277 r.f. choke, shown in one of the photographs, is fitted with the ends of an old gridleak so that it may be used instead of the 50,000-ohm resistor, for the input coupling.

\*A. K. R. L., Technical Development Program.

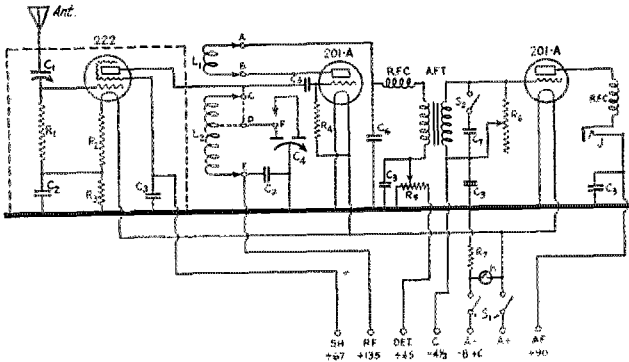

FIG. 1

- A-B-C-D-E — Contact points on Pilot plug-in coil forms and the VY socket into which they fit.
- F — Small General Radio jack and plug. (See text.)
- L<sub>1</sub> — Ticker winding, No. 24 A.S.C., placed at bottom end of Pilot coil form.
- L<sub>2</sub> — Tuning inductance, No. 20 enameled wire, placed at upper portion of Pilot coil form. Grid end at top.
- C<sub>1</sub> — 50- $\mu$ fd. Pilot magnet variable condenser.
- C<sub>2</sub> — 600- $\mu$ fd. Sangamo fixed condenser.
- C<sub>3</sub> — 1.0- $\mu$ fd. by-pass condenser.
- C<sub>4</sub> — Tuning condenser. (See text.)
- C<sub>5</sub> — 100- $\mu$ fd. Sangamo fixed grid condenser.
- C<sub>6</sub> — 901- $\mu$ fd. Sangamo fixed condenser.
- C<sub>7</sub> — 902- $\mu$ fd. Sangamo fixed condenser.
- R<sub>1</sub> — 50,000-ohms. (See text.)
- R<sub>2</sub> — 10-ohm Varley fixed resistor. (See text.)
- R<sub>3</sub> — 5-ohm Varley fixed resistor. (See text.)
- R<sub>4</sub> — 8-megohm grid leak.
- R<sub>5</sub> — 100,000-ohm Frost potentiometer.
- R<sub>6</sub> — 200,000-ohm Frost variable resistor.
- R<sub>7</sub> — 2-ohm Varley fixed resistor. (See text.)
- J — Output jack.
- K — Dial lamp.
- S — D.P.D.T. Filament switch.
- S — Small S.P.S.T. switch.
- RFC — Radio frequency choke.
- AFT — Audio frequency transformer, Sangamo, high quality.

These coupling devices seem to be about equally effective. A satisfactory clip for connecting to the control grid contact at the top of a screen-grid type tube, can be made by winding about four turns of springy No. 14 or 16 wire on a diameter such that when slipped on the contact of the tube it will fit snugly enough to make a good connection.

TUNING SYSTEM

The tuning condenser is a National Girder Frame type which originally had 21 plates. The stator of these condensers is assembled on long threaded brass rods with spacing washers. By cutting these rods and adding a few nuts, the stator can be made into two sections; one being supported from each end. In this case the condenser was re-assembled with the plates double spaced, one section having three plates, the other, five plates. The three-plate section is just large enough to cover

the 3500- and 28,000-ke. bands with a little margin at each end. For the 7000- and 14,000-ke. bands it is too large. Therefore, in order to get a satisfactory dial spread on the latter bands, the extra contact on the coil form and UY socket is utilized to tap the tuning condenser across only part of the coil, as is indicated in Fig. 1. On the rest of the coils, where the condenser is across all of the turns, a "jumper" is soldered between the contacts "C" and "D" on the coil form and no tap is taken from the coil winding. When it is desired to cover the larger territory between the amateur bands, the five-plate section of the stator is added to the three-plate section by means of one of the small G.R. plugs and jacks. The plug is fitted with an insulated handle and the whole affair mounted conveniently on a small hard rubber strip to the right of the tuning condenser. The eight-plate double-spaced condenser formed by adding the five- and three-plate sections, gives a capacity which covers a fairly large territory without crowding the scale too much.

AUDIO AMPLIFIER

The secondary of the audio transformer is loaded with a resistor to prevent fringe howl. The resistor is made variable and thus also serves as a volume control. In addition, it allows one to cut down the noise in the phones if the receiver gets too much pickup from the transmitter. A fixed condenser across the audio transformer secondary with a switch to cut it in or out, is provided to partially by-pass the

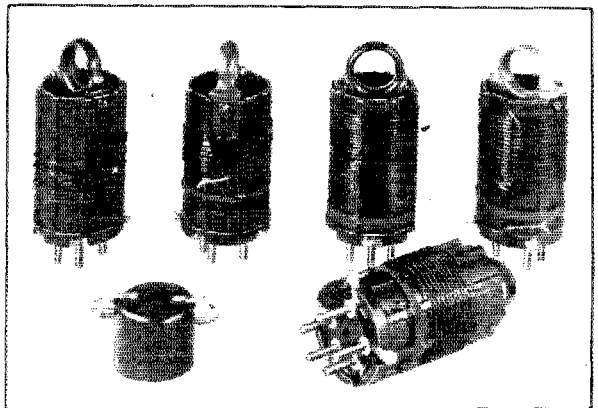

A FEW PLUG-IN COILS AND A PLUG-IN R. F. CHOKE

higher frequencies thus improving the selectivity and keeping the background level down somewhat. A value of  $.002 \mu\text{fd}$ . is a satisfactory compromise between a sharp cut-off and a minimum loss of signal strength. Larger or smaller values

## GENERAL

By-pass condensers and r.f. chokes are used wherever there is a possibility of their doing any good and they certainly repay their cost in smoothness of operation of the receiver.

The battery connections are made by means of a seven-wire Yaxley cable and connector plug. All battery wires pass from the connector plug through a hole in the baseboard and are then brought up from below the baseboard through holes near the point where they connect to the apparatus. The circuits are by-passed where they leave the apparatus and go through the baseboard, thus completely isolating the low side of the circuit from the high r.f. side. The battery wires which pass through the baseboard are a light grade of high tension auto or ignition wire, which has rubber insulation covered with a very tough fabric, thus avoiding the possibility of a short circuit where the wires pass through the copper sheet on top of the base-board.

A small flashlight lamp is placed in the "jumper" which connects the minus "B" to the minus "A", outside the receiver. If any part of the plus "B" circuits come into contact with the plus "A" in the receiver the flashlight lamp

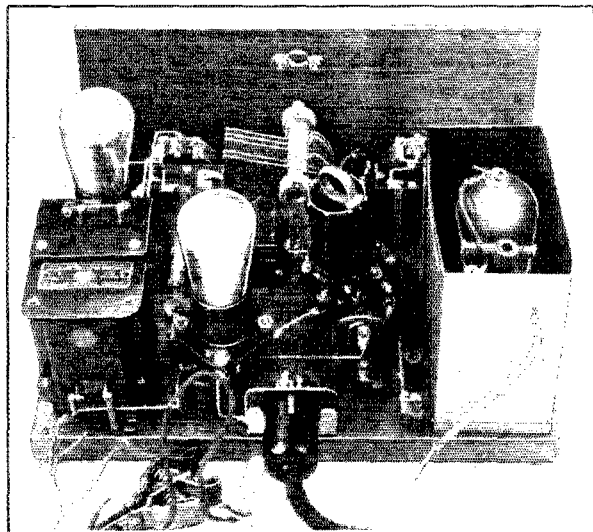

REAR VIEW WITH THE TOP OF THE R.F. SHIELD REMOVED, SHOWING BATTERY CABLE WITH PROTECTIVE LAMP

may be used to suit individual taste and transformer characteristics. This switch and  $.002 \mu\text{fd}$ . condenser may be seen mounted on a small piece of hard rubber, which is attached at the top and extends to the front of the audio transformer.

## REGENERATION CONTROL

The regeneration control is a Frost 100,000-ohm resistor, connected as a potentiometer. This arrangement gives very smooth control and allows the adjustment for the point of oscillation to remain in nearly the same position for the entire range of any one coil. It should be noted, though, that the negative "B" must be connected to the negative "A" on the battery side of the filament switch and that the filament switch must open both sides of the "A" battery circuit, otherwise the potentiometer will cause a slight but continuous drain of about  $\frac{1}{2}$  mil. on the detector section of the "B" battery whether or not the set is in use. It is not necessary to raise the "B" battery voltage on the detector tube when the 28,000-ke. coil is being used.

The movable contacts on the Frost variable resistors are connected to the metal shell of the unit and must therefore be insulated from the metal panel. This has been done by drilling a  $\frac{1}{2}$ " hole in the panel and using a piece of  $\frac{1}{2}$ " o.d. x  $\frac{1}{4}$ " i.d. bakelite tubing, slightly less than  $\frac{1}{3}$ " long, and cutting washers for the front and back of the panel from 1/16" bakelite sheet.

will blow instead of the tubes.

It may be found that the specified values of the fixed resistors  $R_3$  and  $R_7$  are a little too high. In

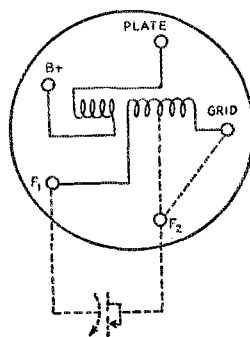

FIG. 2—THE CONNECTIONS TO THE UV SOCKET ARE SHOWN ABOVE

The arrangement for the secondary coil is of most importance inasmuch as the tuning condenser is not always connected across the entire winding. If the tuning condenser is connected across the entire winding, a "jumper" is connected on the coil form between the pin marked Grid and the one marked F2. When the condenser is across only part of the coil, this "jumper" is omitted and a tap off the coil is connected to F1.

order to get just the correct voltage at the tubes it is advisable to connect a voltmeter directly across the tube socket terminals and adjust the resistors by removing a few turns of their winding

or short circuiting the excess turns by soldering across them.

The large National dial in the center of the panel operates the tuning condenser C<sub>4</sub>. A lamp to illuminate the scale and to serve as a telltale, will fit on to the rear of the dial and is provided for, though it was not in place when the photos were taken. The receiver is calibrated to read in terms of frequency and therefore the dial is set at zero

COIL TABLE

The necessary coils and their ranges are given below.

Coil	Tuning turns	Tickler turns	kc. range small sect. C <sub>4</sub>		kc. range both sect. C <sub>4</sub>		Spacing of turns
			Min.	Max.	Min.	Max.	
No. 1	2½	3	27,750 (10.8)	30,300 (9.9)	25,000 (12)	29,410 (10.2)	* 1-D
No. 2	8	4	13,050 (23)	14,490 (20.7)	11,540 (26)	14,080 (21.3)	2-D C across 5 turns.
No. 3	20	6	6,980 (43)	7,390 (40.6)	6,250 (48)	7,230 (41.5)	1-D C across 10 turns.
No. 4	38	7	3,490 (86)	4,050 (74)	2,800 (107)	3,520 (78.4)	13 top turns 1-D, rest close.
No. 5	7	4	13,330 (22.5)	15,150 (19.8)	10,530 (28.5)	14,630 (30.5)	2-D.
No. 6	11	5	9,520 (31.5)	10,910 (27.5)	7,440 (40.3)	10,710 (28.0)	2-D.
No. 7	18	6	6,670 (45)	7,710 (68.9)	5,310 (56.5)	7,480 (40.1)	1-D
No. 8	25	6	3,000 (60)	3,660 (55)	3,980 (75.4)	3,560 (56)	13 top turns 1-D, rest close.

Note. — All tickler turns close wound except on coil No. 1, where they are spaced 1-D.

1-D indicates turns spaced by diameter of wire.

2-D indicates turns spaced by two times diameter of wire.

Close indicates turns wound close to each other. Approximate wavelength in meters, in parenthesis.

and the condenser at maximum when the set screw is tightened on the shaft. The small knob at the left is the regeneration control, with the filament switch near it. The one at the right is the volume control with the output jack alongside.

## Some Changes in Our Staff

WE have pleasure in announcing the appointment of Mr. James J. Lamb, W1CEI-ex3CEI-ex0CEI, as QST's assistant technical editor, succeeding Mr. Ross A. Hull. Our readers know Mr. Lamb as the author of half a dozen pleasing and pertinent articles in the past year. A.R.R.L. members generally know him as the manager of the League's Technical Information Service, in which work he has written something like ten thousand letters of technical advice to members in the past year. Believe us, a fellow learns what an editor ought to know from that job. Mr. Lamb is a North Dakotan by birth, a graduate electrical engineer (C.U.A., 1922), a highly skilled amateur and an indefatigable experimenter.

Mr. Beverly Dudley, W9BR, of Chicago, has joined our staff to succeed Mr. Lamb on the Technical Information Service. He too is the author of several QST articles. For five years he was a member of the technical editorial staff of the radio department of the Chicago *Evening Post*, concluding as their technical editor, and

comes to us from the Long Lines Dept. of the A. T. & T. Co., Chicago.

With the conclusion of our formal program, Mr. Paul S. Hendricks leaves our staff to return to W1CCZ, the splendid station of Mr. E. C. Crossett at Wianno, Mass., whence we "borrowed" him for the duration of our work. During this time Mr. Hendricks has acted as assistant to Mr. Hull and has participated in much of the shop work unfolded in our program articles.

Although we speak of the end of our Technical Development Program, we refer only to the termination of the specially-organized work which was undertaken for the 1929 "emergency" and we do not imply a cessation of technical activity at Headquarters. Technical Editor Westman and his staff will continue to be heard from, our readers may be well assured. This month's editorial, we suggest, should also be read in this connection.

— K. B. W.

## Strays

The recently appointed Junior Radio Inspector at the Office of the Supervisor of Radio for the First District is none other than Irving L. Weston, WIBHB, active amateur and member of the League. Mr. Weston, a graduate of Northeastern University, completed a course at the Massachusetts Radio School prior to taking over his present duties.

The Radio Corporation of America has separated its communications business from its other activities, placing the former in a new subsidiary, wholly owned by it, which is known as R. C. A. Communications, Inc. All station licenses, frequency assignments, etc., are now in the name of the latter company.

Well-meaning experimenters still manage to get splendid key-click elimination with condensers or resistors across the key when they are using a relay. At least, they still send in their latest circuits and tell of the success they have had with them. Quite possibly an improvement in the click may be noticeable in the receiver alongside the transmitter but any such check usually is quite useless. Apparently it is not obvious to all that resistors or condensers specified for use across a key when the key is directly controlling the transmitter should be connected across the contacts of the relay when one is used.

Fred Schnell (further identification unneeded) has received a year's leave of absence from the Burgess Battery Co., during which time he will be with the Aero Products Co. of Chicago, well-known manufacturers of amateur gear.

# Wired Wireless

By J. E. Smith\*

**W**HEN the transmission of signals from one place to another without the aid of intervening wires was first developed, it was logically referred to as wireless transmission. Later on, the use of the term "radio" became prevalent and carried to most of us the same thought.

However, it is perfectly possible and practical to transmit currents at radio frequencies over

addition to the telephone and telegraph facilities normally afforded by the circuit. Other systems are arranged to furnish as many as ten duplex carrier telegraph circuits over each line in addition to the usual telephone and telegraph facilities afforded by the circuit. Think what this means! Without stringing up more wire on poles, or lying them in conduits under the street, it is possible to multiply the number of channels of communica-

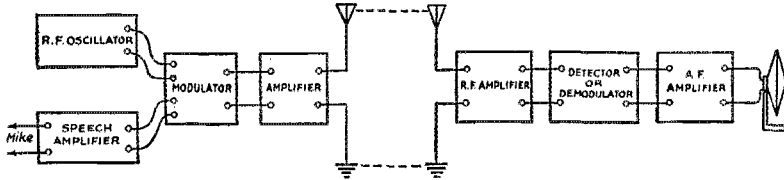

FIG. 1

metallic circuits as well as through space and there have been great developments in this branch of communication engineering during the past few years. Such transmission is generally referred to as carrier-current or wired-wireless transmission, and it is assuming greater and greater commercial importance as time goes on. Perhaps a few points concerning the general principle underlying this system of communication and some of the reasons for its adoption may not be amiss.

We are all well acquainted with the transmission of speech in the ordinary manner over the telephone. Such speech is transmitted at its own frequencies which in commercial practise varies from about 200 cycles per second to about 2000 cycles. It has been found very practical for reasons which shall be unfolded as we proceed to transmit speech over wires at radio frequencies in much the same manner as today we are transmitting programs through empty space from the broadcasting studios.

This matter of utilizing a carrier wave for the transmission of speech is not new. The beginning of the work dates way back in the nineties, and is due to such men as Pupin, Leblanc, Hutin, Squier, Stone, and others. Then, later on we may include DeForest for his wonderful contribution; G. A. Campbell for his electrical filters, and many more.

Carrier-current systems in use at the present time furnish simultaneously as many as four two-way telephone conversations over each line in

tion by five, ten, twenty — who knows how many?

The general principles involved in carrier-current communication are fairly well understood by many of our radio readers. We encounter it every day; in operating our radio receiver, or, if we are amateurs, in operating our transmitters.

Suppose we start at the transmitting station. First we have an oscillator which generates the radio-frequency currents. Next we have a micro-

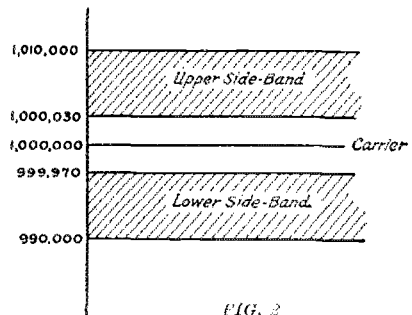

FIG. 2

phone into which the performer sings or speaks. The speech sounds are amplified by the speech amplifier and pass on into the modulator tube. Into this tube the radio-frequency current from the oscillator is passing at the same time, so the modulator is really a "mixing" tube. Next, from the modulator, the mixed currents may pass on through an amplifier and thence to the transmitting antenna and off into space. (See Fig. 1.) One of the most interesting factors to be considered is

\* President, National Radio Institute, 16th and U Streets, N. W., Washington, D. C.

the many and various frequencies involved. The oscillator may be generating power at a frequency of a million cycles a second. The speech frequencies range from perhaps 30 cycles to 10,000 cycles. After being mixed in the modulator these frequencies are considerably changed, and instead of two frequencies we have many. The most important of these frequencies are known as the

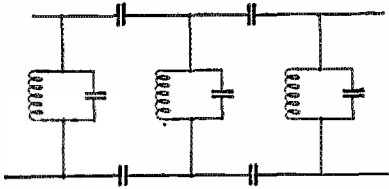

FIG. 3

“carrier” frequency and the two “side-band” frequencies.

In order to make this clear let us suppose that, instead of singing or talking into the microphone we play a single sustained note on a flute and that this note has a frequency of 1,000 cycles per second. Also suppose that the “carrier” frequency is 1,000,000 cycles per second. The two side-band frequencies are then 1,001,000 and 999,000 cycles per second. The same rule holds when there are a number of frequencies coming from the microphone and in general we will have a situation somewhat as represented in Fig. 2. We have the carrier at 1,000,000 cycles; the upper side-band, ranging from 1,000,030 to 1,010,000 cycles, and the lower side-band ranging from 999,970 to 990,000 cycles.

And now we can go another step farther: we have a system whereby several telephone conversations and a few telegraph messages can be

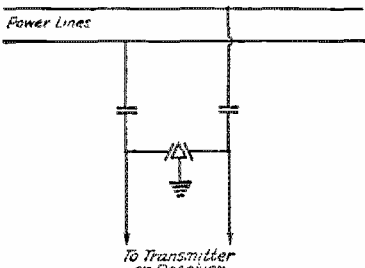

FIG. 4

transmitted over the same circuit simultaneously. Why not transmit power over the same lines at the same time? To tell the truth, this is exactly what is being done today. But it is the other way around: the telephone or telegraph wires are not being used for power transmission, for they are too small, but the power lines are being used for the transmission of speech and code. Quite a lot of

work is being done along this line, for in addition to affording a means of communication for the public at large, it is exceedingly important that the different power plants of the same company, or the central power plant and the sub-stations, keep in very close touch with each other.

It is clear how this may be done in the case of alternating current power for this can be transmitted as a certain particular frequency, say 60 cycles, and occupy its own channel (with no side-bands in this simple case) just as each band of speech frequencies or telegraph code occupies its own channel. And going still a step farther it is clear that constant or direct current can be just as easily transmitted along with the communication channels for direct current has a frequency of zero and occupies its own channel of zero frequency.

However, when we come to the matter of transmitting intelligence over power lines operating at high voltages other problems arise, the most important of these being the manner in which the transmitter and receiver of the carrier currents are connected to the power lines. There are two

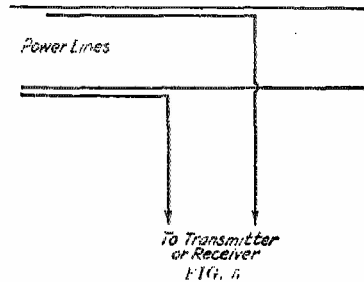

methods of doing this. One of these methods is shown in Fig. 4, where the transmitter or receiver is coupled to the power lines by high-voltage condensers of small capacity, these two being arranged with a protective ground connection. Fig. 5 shows the other method, which merely consists of stringing a pair of wires parallel with the power lines for a distance of a thousand feet or more. These wires act exactly like antennas.

In addition to the difficulties of properly insulating the system in these high voltage power lines there are other difficulties encountered. For instance, where sectionalizing switches in the lines are opened it is necessary to erect what might be termed a “by-pass antenna” in order that the carrier currents may pass over the gap. This incurs losses, to be sure, but at least the gap is bridged, and it is only necessary to increase the power of the transmitter sufficiently to overcome the loss.

Another difficulty encountered occurs when great loads are thrown on the power lines as when large mills are running or at night when the lighting load becomes great. The short-circuiting ef-

(Continued on page 22)

# The Glutton

By "Felix"\*

**I**F there's one bird in this world whose capacity for being on the receiving end of punishment can't be touched, it's I, 5LS—beg your pardon, W5LS—himself. For pure unlimited catch-as-catch-can ability to get the bum end of all breaks, I take the original silver-plated gridleak. The only kind of deals I get from life are raw ones, off the bottom of the deck. If the Radiocorp began giving away 204-A's today the chances are 100 to 1 that tomorrow I'd get a job on a farm where the only power available was kerosene.

These cheerful conclusions occur to me as the result of a trip I just returned from as the one and only wireless op on board a little coaster that plugs down through the Canal and up the West Coast. Listen while I tell you why op's go sour.

I suppose the whole business started when, toward the end of a year at school, I got the brilliant idea of taking out a "commercial" and earning a little money on the side while seeing the world through a lead-in insulator.

I got the ticket all right, and soon after that landed an assignment, sight unseen. That was tough break No. 1. The "liner" proved to be a ratty collection of boiler plating held together with paper clips and going under the name of the *S. S. Rancid*. To top it off our run was not to Hawaii or some place like that, but was up to the Gulf of California. For those who are not familiar with this collection of mud and sand I might say that it was God's official dumpheap during the Creation. In addition, it is used as a storage region for all the heat that is too hot to use in Hades. After it cools off for a few centuries around the Gulf, small consignments are billed to the lower regions and after diluting them with 90% Alaskan glacier they are just about right for the hottest furnaces. From which you might infer that the Gulf is hot—which is right.

The morning we pulled out of the harbor I spent a couple of hours getting acquainted with the radio equipment. This consisted of a 2-kw. cement-mixing spark and associated liabilities, and a three-circuit tuner with a detector and two stages of loose connections and haywire transformers. The serial on the generator was No. 2, and when you fired her up she sounded like a 1913 model fliy with ten college boys in. on and around her. Whenever she got going good the firemen in the engine room got restless and worked with one eye on the ladder that led to the deck.

Things began happening right away. I went

into the shack to give K—— a lonesome call, noticing absentmindedly that a Swede deckhand was on the crosstrees painting the foremast, but giving it no particular thought. Half way through the K—— call I had to go out on deck to help revive said deckhand, who was lying on deck with a busted leg and temporary paralysis. After that I spent a couple of hours bending on new antenna insulators to replace the ones that had sparked over and wrecked the Swede.

Next thing, the storage batteries began acting up. I had to operate the set off batteries instead of the regular ship juice, because if I'd put a 2-kw. load on the ship's generator it would have chewed up the bolts that held it down and walked right out on deck. When I wasn't babying the transmitter I was trying to reason with the storage batteries, which is about as foolish as trying to reason with the R. I. when he catches you operating off-wave a month after your license has expired.

Eventually, things settled down a little and I began to wonder if maybe Fate hadn't finally seen the light as far as I was concerned. I should have known better.

About a week out, the purser came skipping into the shack with a tin ear full of news. But first, let me wise you up to this purser. He was one of those wise birds who knows more than anybody about anything. Once upon a time he'd owned a single-tube single-circuit bootleg receiver, hence he knew more about radio than Mary Texanna Loomis and John L. Reinartz.

The second day out he had come up to advise me that if I'd put a wavetrapp in my receiver I'd get 90% better reception and no QRN. I began thinking of the nice impression a 45-volt "B" battery would make on his dome, but he must have been a mind-reader, because he shut up and went below to flunky for the Old Man.

This bright a.m. he had some real news, though.

"Oh, I say, Sparks. The skipper's bought a new ten-tube receiver and wants you to come down to hook up the batteries."

"Me?" queries I. "I thought you once owned a one-tu—"

"Yeah," he hurries on, "I could hook it up all right, but the Old Man's in a rush and I got to string the serial."

Well, I went down and hooked up the set, wondering meanwhile who had the bad taste to start the institution of pursers.

When I came back on the boat deck the purser had just completed the most superb piece of artistic clothes-line stringing in history. And the dumb decimal-wit had put that antenna parallel

\*W5LS, J. C. Johnson, Denton, Texas.

with my leadin and spaced it fully six inches at places!

"Take a look at that," he gurgles, in a patting-himself-on-the-back tone. "You know, when I was with the Louisiana Power and Light Company —"

"— you rolled up guy wire and carried wrenches for the electricians," I added. "Do you realize." I continued, "that antenna is just about as dangerous a combination as nitroglycerine and heebie-jeebies?"

"Why?" he asks.

"Simply because the antenna will absorb enough juice when I'm on the key to electrocute a piece of pyrex."

"Aw, that old set of yours ain't strong enough to electrocute an idea."

"Never mind that," says I. "And as for an idea, you furnish one and I'll be the guy who is shocked to death."

He skips off without answering, leaving me with quite a few thoughts. True enough, the old roekrusher didn't have much range, but she sure had a powerful kick close to home, as I found out one day when I drew a nice hot spark off a rack in the wall. Thinking of that gave me an idea.

After supper I knew that purser would be up listening in on the skipper's new job, so I skipped up to the shack and fired up the old boiler. I jammed the coupling and hoisted in another bale of hay, so to speak, and when I hit the key for a dit-dit-dit-da-a-w-w-dit, the ammeter read 18 healthy, able-bodied amps! I gave the key another couple of punches, and then sat back and pretended to read a magazine, waiting for things to happen. They did, immediately!

The purser came up the boat-deck gangway five steps at a time (it only had four).

"Hey, sparks, what's happened to the skipper's set? The blamed thing's smoking hot!"

"You ought to know," I returned. "You once owned a single-tu —"

"Oh, can it! C'mon down and do something. The thing is burning up!"

I went down, and sure enough the insulation was burned completely off the primary of the tentuber, while the primary itself was merely a couple of blobs of copper in the bottom of the case.

I think I mentioned a while back that I was the King Glutton for punishment, I am, brothers. I am, I was the guy who got the job of rebuilding the front end of that receiver!

## WSARO

(Continued from page 14)

connected to a stator. Thus the two stators are electrically joined. The shaft is controlled by a knob on the front of the panel.

In the general view of the station the placement

of the apparatus can be seen. At the extreme left is the broadcast receiver with its loud speaker. To the right of this receiver is the high frequency receiver with its built-in monitor. Mounted on the shelf above it is the transmitter, the antenna terminals being convenient to the window through the panes of which the leads are run. On a small shelf to the right of the table are mounted the power switches and the rheostat in the primary of the filament transformer. The arrangement though not very imposing, is a very practical and a neat one. All controls and adjustments are readily available and almost all condensers, small fittings and wiring are protected from dust. Throughout the work a definite attempt was made to avoid "hay-wire" construction and appearance.

## Wired Wireless

(Continued from page 20)

fect produced by the turning on of so many feeder lines causes changes in the characteristics of the lines which makes it necessary to employ more power in the transmitter at such times.

And, finally, before concluding, the carrier current system has been used successfully as a means of communicating from moving trains. In this case the antenna wires were strung along the tops of the cars parallel with the telephone wires along the road.

## Concerning the Super-Heterodyne

**T**HE following modifications of the circuit of the Superhet described in the March issue of *QST* are suggested:

The oscillator should be connected as shown in Fig. 9, page 14 and not as shown in Fig. 7, page 13. The blocking condenser  $C_7$  should be located between the  $+B$  end of  $L_6$  and the grounded rotor of the condenser  $C_2$ , as otherwise the  $B$  battery is short-circuited.

It has also been found advantageous to eliminate the potentiometer  $R_1$  as a control of oscillator plate voltage and use it as a volume control on the secondary of the audio frequency transformer, the connections being identical with those for the gain control shown in Fig. 3, page 12, April, *QST*. Satisfactory adjustment of the oscillator plate voltage is obtained by bringing out a separate "B" battery lead, connected to the end of the oscillator radio frequency choke which goes to  $C_6$ .

On strong signals blocking of the 201-A second detector tube is not at all unusual. It has been found decidedly worth while to use a 112-A or 210 type tube in the second detector circuit in eliminating this tendency to block. It is quite possible that plate detection could be used to good advantage, particularly if the set is to be used for reception of strong broadcast signals.



# Single Control for the High-Beat Super-Heterodyne

By J. M. Grigg\*

**S**INGLE control in a radio receiver means greater convenience and a better usefulness. Even an approximation, adjustable with trimmers, will get more stations in a given time than individual tuning. In addition to these advantages there is a manifold saving of time due to which any successful effort toward eliminating the extra dials should be amply repaid. It must be understood, however, that a good single control is an achievement. It represents not only a piece of mechanism, but also a thoughtful electrical design. It is an intelligent adjustment of inductance and distributed capacity against the mechanical variations in equipment itself.

To make the point, suppose a curve is plotted with frequencies against dial settings. The path of the line illustrates the composite effect of inductance, distributed capacity, and the capacity variation of the condenser itself. In the case of a gang any deviation, say a slightly different plate thickness, a warped plate, or an inaccurately centered rotor, results in a different curve. The difference may amount to 4 or 5 points. Whatever it may be, no readjustment of inductance will properly compensate it; correction must be made in the condenser itself, and trimmers used only to get the equivalent distributed capacity effects.

In the case of the super-heterodyne the task of single control assumes larger proportions due to the fact that a fixed beat difference must be tuned. Moreover, the difficulty increases somewhat in proportion to the magnitude of the beat. Where the difference is small, say 50 to 100 kc., the use of S.L.F. condensers offers a simple and passable solution. Where it amounts to several hundred kilocycles a special arrangement must be devised.

To explain why the S.L.F. arrangement will not do, it is necessary to explain the S.L.F. ar-

angement. Essentially there are two S.L.F. condensers rotating at fixed angular displacement in conjunction with frequency lines that are both parallel and straight. To be straight, compensation must be had in the plate shape itself for the particular characteristics of the circuit, otherwise the line may droop at the upper end.† To be parallel it is required that the circuit characteristics be similar, namely that inductances, capacities, etc., be quantitatively equal.

Both circuits therefore cover exactly the same frequency band. Consequently if the desired frequency difference amounts to several hundred

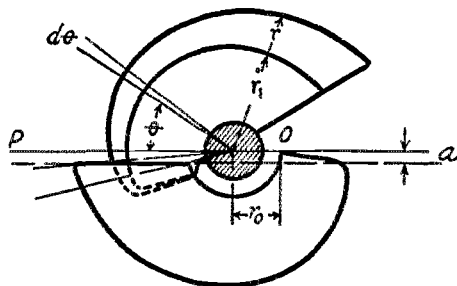

FIG. 1

kilocycles, the angular displacement, or detuning, may amount to 90 degrees, with a corresponding practical rotation of one-quarter turn. Result — the broadcast band cannot be covered. Moreover, if one tries to work one half the dial on the upper beat and the other half on the lower, the oscillator frequency will have a point of coincidence with the amplifier frequency, and interference will occur.

Obviously if S.L.F. condensers are to be used, only upper beat tuning will do, and the large angular displacement must somehow be avoided. That is, the circuits must cover different frequency ranges, and this achievement, in its most obvious solution, requires unequal constants and gear reduction between condensers.

Such an arrangement is difficult and expensive to construct; besides it is bunglesome and it may be subject to the errors of distributed capacity. A better and perhaps the very best of all arrangements is one in which the rotor plates of a gang condenser have been cut to the required design. In this, since the first circuit is taken as it actually

\* 5951 S. Tripp Ave., Chicago, Ill.

† It is straight between two successive points only if the following relation is satisfied; namely, that

$$\frac{r_1^2 - r_2^2}{r_1^2 + r_2^2} = \left[ 1 - \frac{A(r_1^2 - r_2^2)\theta}{4l} \right]^2$$

in which  $\theta$  is the angle separating two radii  $r_1$  and  $r_2$ ,  $A$  is a constant as defined in the expression

$$C = \frac{1}{2} \int A r^2 d\theta$$

and  $q$  is the total capacitance corresponding with  $r_1$  and including, of course, the distributed capacity.

tunes, no special type of condenser is required. Moreover, the expense is little more than the labor, while the job itself is compact and dependable with an expectation of performance in direct proportion to the care and skill of the workmanship.

Referring to Fig. 1, consider two rotor plates, similar or dissimilar, and of any shape whatsoever, but rigidly fixed to rotate together. Designate the full radius by  $r$ , the clearance radius of the stator plate by  $r_0$ , and the capacity of a small sector is

$$dC = \frac{A}{2} (r^2 - r_0^2) d\theta \quad (1)$$

with a similar expression in subscripts for the other plate. Dividing

$$\frac{dC}{C_1} = \frac{A}{A_1} \left( \frac{r^2 - r_0^2}{r_1^2 - r_0^2} \right) \quad (2)$$

in which the ratio  $A/A_1$  will cancel out if both rotors have the same number of plates, same plate thickness, same plate spacing, etc.

The frequency of the circuit will be

$$f = \frac{K}{\sqrt{L(C+q)}} \quad (3)$$

in which  $C$  may represent a variable capacity, and  $q$  a capacity which does not vary. Obviously  $q$  is a sum, including the distributed capacity of both the coil and condenser, and it may include whatever fixed capacity is due to that portion of plate area permanently below the origin line  $OP$ . Differentiating

$$f = \frac{K}{\sqrt{L(C+q)}} \quad (3)$$

$$dC = -\frac{2K^2}{L f^3} df \quad (4)$$

which upon substitution in (2) gives

$$\frac{r^2 - r_0^2}{r_1^2 - r_0^2} = \frac{L_1}{L} \left( \frac{f+i}{f} \right)^2 \quad (5)$$

In this  $f$  may be taken to represent the antenna frequency,  $i$  the intermediate frequency, and consequently  $f$  plus  $i$  the oscillator frequency. The symbols with subscripts will in all cases refer to the oscillator circuit. In the foregoing, if arbitrarily chosen initial values of frequency and radius,  $K$ ,  $B$  and  $B_1$  be substituted, the inductance ratio may be eliminated. Thus substituting and solving for  $r_1$  (5) becomes

$$r_1 = \sqrt{(r^2 - r_0^2) \left( \frac{B_1^2 - r_0^2}{B^2 - r_0^2} \right) \left[ \frac{F+i}{F} \cdot \frac{f}{f+i} \right]^2 + r_0^2} \quad (6)$$

\* Taking account of the clearance width  $a$ , Fig. 1, the exact expression is

$$\frac{A}{2} \left\{ (r-r_0) \left[ r - \frac{a^2}{r} + \sqrt{r^2 - \frac{a^2}{r^2} (r^2 - r_0^2) + a^2} \right] \right\} d\theta$$

which reduces to the above when  $a=0$ .

an expression involving only frequencies and radii.

In the foregoing the origin line may be taken on any radius, values corresponding being parameters connecting frequencies and radii on either side. The equation holds for any radius and frequency, assumed or real, within the proper physical limitations; that is, the calculation must not obtain impossible frequencies, nor run outside the bounds of plate dimensions. The limits of possible frequencies are those of the circuit itself, to which distributed capacity may be added but from which it cannot be taken away. To put it another way, a given coil and condenser will cover a band which may be made narrower but not broader.

At the very best it is difficult to make the antenna circuit cover a band sufficiently wide, while the oscillator band, with its higher frequencies, will be wider than necessary. The general plan therefore consists of taking the antenna circuit just as it tunes and broadening the oscillator to it by reshaping the rotor and adding distributed capacity.

A good gang condenser should be chosen, one with sections similar and rigid on the same shaft. Preferably the construction should be substantial and the plates rugged enough to withstand the cutting process. For the first step one section should be connected with a suitable antenna inductance, taking care, as this inductance is final, to see that the proper band is covered. In general, and in particular with a loop, .0005  $\mu$ f.d. condensers will be needed to cover the present broadcast allocations.

Using a separate condenser on the oscillator, and with the antenna trimmer set for minimum capacity, get an accurate log of the antenna circuit. By accurate it is meant that the readings be those of actual, future working conditions as nearly as possible. Also, if there is any doubt about the upper terminal reading discard it and keep the next highest.

After the logging remove the rotor from the frame, and with a file and tin snips make a template of thin metal, the exact shape of the rotor plate. Lay this template on a sheet of paper, Fig. 2, and scribe around it with a very sharply pointed pencil, and mark in the center of rotation  $O$ . The importance of exactness in locating this center cannot be overstressed. Accuracy may be had, however, if the rotor is laid on a plane surface and measurements from this to the shaft center taken: the same results may be had with the use of a combination square. After the center is located, lay a tuning dial over the sketch, mark the dial settings of the log, and draw in the various radii to the center  $O$ . Then with a decimal scale, metric or tenths, and a glass if possible, measure the radii, center to periphery, estimating fractional divisions to tenths. These measurements are those of the column headed  $r$ .

In calculation, if the origin line is chosen on the radius of highest frequency, errors due to several sources may result; errors of logging and errors of measurement, both due to sparsity of plate area in this region; besides there is likely to be a distributed capacity which is not constant. For these and the additional reason that a small error in determining the beat frequency may have been made it is far better to take the origin line somewhere near the mid point. To do this it will be necessary to assign some arbitrary value less than unity to the ratio

$$\left( \frac{R_1^2 - r_0^2}{R^2 - r_0^2} \right) \quad (7)$$

and which in calculation fixes the values of  $r_1$  not in excess of  $r$  on the radius of highest frequency. One or two trials should determine a value that will be satisfactory. Thus in the example shown a ratio of .6 was taken, and this upon substitution in the equation with other values from the table gives

$$r_1 = \sqrt{.6 \times .690 \times 1.41 - .212} = .894$$

slightly less than  $r$ .

Using the same ratio, namely .6 and  $F=870$ , the remaining values of  $r_1$  are then calculated by substituting the corresponding figures for  $f$  and  $r$  in (7), the labor of this being materially aided if the progress is tabulated in columns. The new radii are located on the sketch, a smooth curve drawn through the various points, and then a template for use in cutting is made. In going about the latter task first of all scribe on the metal the axes  $XX$  and  $YY$  for use in aligning and comparison. In this connection it might be pointed out that in the entire scheme the requirements for success are these: Proper location of the center point 0; the correct beat frequency, and on the template, location marks that will insure accurate comparisons. For the calculations themselves slide rule figures will do.

In the actual cutting the plates may be roughed by grinding if tallow is put on the wheel, but a very coarse file and a sharp knife to trim off the feather edges is just as good. All cutting should be done parallel with the plane of the plates to avoid chattering and bending. Most of the metal may be removed with a hacksaw if the individual plate is caught between two suitable pieces of steel and thus clamped in a vise. In the plate design shown, 75% of the metal was sawed off in 15 minutes. For the finishing a file must be used, the design being scribed on the first plate of the adjacent rotor, and a straight edge extending across being used to check up and locate high spots. And finally, when the rotor is put back, care must be taken to see that the reassembly has not deranged the previous antenna logging. Better to check a few points, as these readings are needed in the next step.

Thus, the finishing task is the adjustment of oscillator inductance and distributed capacity to the remodelled rotor. That is, the frequency range must be fixed within the proper limits by changing the inductance and distributed capacity,  $q, C$  having been pro-rated in the cutting.

This is done in the simplest fashion by trial. In preparation an auxiliary variable condenser should be paralleled across the oscillator condenser. Also, since the rotor has been cut down, very likely, turns will have to be added to the coil, say 10 or 12 for a trial, as the surplus is removed easily. Then with the gang set at some low reading, say 31 from the log, try to get in the station by tuning the auxiliary variable. If it

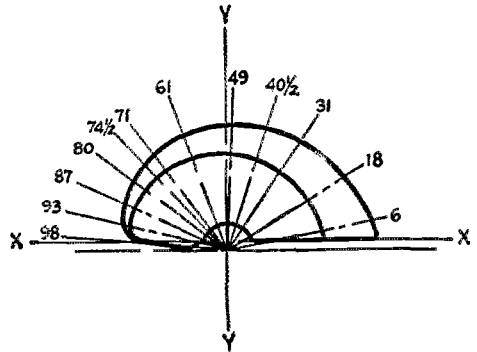

FIG. 2

cannot be done, turns must be removed until it can be done. Then move to a higher frequency and reset the auxiliary to get in the station. Assuming an increased capacity was needed, more turns must be removed from the coil. Repeat, spreading the frequency by removing one turn at a time until the two circuits keep in step all the way through; against the prospect of taking off too much wire it is best to keep the equivalent of one or two turns folded up.

Upon completion the auxiliary condenser may be permanently replaced by a midget, such as a 13-plate Pilot for instance.

If the beat frequency, as needed for the calculations, is not known it may be determined in the following ways. First, if a frequency meter is available it is necessary only to measure it directly, or to measure the frequency of the oscillator and subtract the corresponding antenna frequency. In another method first calibrate the oscillator in terms of the antenna frequency by getting in stations, upper beat, on the low frequency end of the dial. Then tune in some high frequency station, lower beat, and determine by interpolation what antenna frequency this corresponds with, upper beat tuning. Suppose it is 598 kc. and the broadcast frequency is 1360. Then 598 plus 2 $\times$  = 1360, or

$$i = \frac{1360 - 598}{2} = 381 \text{ kc.}$$

As a closing remark it might be pointed out that only the oscillator rotor is cut; hence the principle may apply to multi-stage amplification ahead of the frequency changer. Redesign for lower beat tuning is advised against since, in the probable case, the antenna rotor would have to be cut, with consequent loss in width of band. As regards the possible accuracy of tuning that may be expected, it might be said that the example used in illustration tunes uniformly sharp without trimming up to 1310 kc. or 93 on the dial, beyond which point the distributed capacity of the condenser practically determines its capacity; this of course with the clearance width  $a$ , fig. 1, neglected.

1	2	3	4	5	6	7	8	
Dial	$f$	$f+1$	$\left[ \frac{f+1}{f} \times \frac{f}{f+1} \right]$	$f$	$f_{\text{assumed}}$	$0.6 \times \text{Col. 4}$	$\sqrt{\text{Col. 7} + f^2} = 7$	
6	570	951	.633	2 125	1 913	.7275	.972	
18	620	1001	.704	2 02	1 808	.766	.99	
31	670	1051	.768	1 85	1 638	.755	.983	
49.5	720	1101	.828	1 74	1 528	.760	.985	
49	770	1151	.888	1 705	1 493	.803	1 008	
61	870	1251	1 000	1 64	1 428	.859	1 035	
71	970	1351	1 09	1 539	1 327	.866	1 04	
74.5	1020	1401	1.128	1 50	1.288	.875	1.046	
80	1100	1481	1 21	1 47	1.258	.914	1 062	
87	1210	1591	1 307	1 355	1.143	.899	1 054	
93	1310	1691	1.386	1 254	1.042	.87	1 043	
98	1360	1741	1.41	.908	.690	.854	.894	
		$i = 381 \text{ kc.}$		$r_p^2 = (7/16)^2 = .212$				

assumed  $\frac{R^2 - r_p^2}{R^2 - r_p^2} = 0.6$  at 870 kc.

### Hull Returns to Australia

WE hope that our readers have remembered that Mr. Ross A. Hull, for the past year our associate technical editor and director of the A.R.R.L. Technical Development Program, is an Australian and but a visitor in America. With deep regret we announce that he has now reached the end of his stay in this country and has returned to Australia, leaving behind him a remarkable record of work accomplished, and carrying with him the admiration and best wishes of our staff.

Mr. Hull has made an enduring name for himself in amateur radio, not only in this country but in every country where *QST* is read — which, incidentally, means every country. When the League's special technical program was undertaken, a Headquarters' council was formed to shape its destinies, consisting of Technical Editor Westman, Mr. Hull, and the League Secretary. Mr. Hull was appointed director of the program. It was his formidable duty to undertake to dis-

cover the answers to the numerous problems which came to amateur radio with the advent of the Washington Convention. How well he has succeeded our readers know. His "program" articles have been the high-lights of *QST* of the past year. The work was often carried out under very



ROSS A. HULL

trying conditions, with the great desirability of finishing a certain problem in time to report the work in the next issue of the magazine, necessitating the pouring out of an unbelievable number of hours of effort. His labors have answered our difficulties and his articles have set the new 1929 standard in the literature of our hobby.

Mr. Hull joined our staff in December of 1926, primarily to obtain contact with American amateur radio and its methods. When the "program" came along he had his real work cut out for him. He is a most versatile chap. Architect, journalist, amateur sketcher, builder of model airplanes, expert amateur photographer — these are a few of his accomplishments besides radio. One day he dashed off a proposed new design for the *QST* cover which we liked so much that we have used it ever since. The illustration on our January cover is a bit of his handiwork. In fact he made the portrait of himself which graces this column.

We don't know whether the Aussies will know him or not. We've worked him pretty hard and we've made profound changes in the way he talks and eats and drinks — he's almost an American now. He carries back to Australia two and a half years' experience at A.R.R.L. Headquarters, watching the wheels of amateur radio the world around. From this contact we hope for even closer relations with the Aussies, whose honorary federal secretary Mr. Hull was before coming over. Personally we think he ought to be elected president of the Australian outfit, appointed technical advisor to the amateur empire, and presented with 1000 assorted tubes by the Radio Corporation.

In other words, we shall miss him.

— K. B. W.

# The Governors-President Relay

By William M. Smith\*

**T**HE Governors-President Relay of 1929 is over but it has left with the amateurs of the United States and its possessions fond memories of accomplishment. The 1929 Relay was by far the most successful and most satisfactory that has ever been accomplished in the annals of amateur radio. Those who took part in it may well be proud of their work, not only participating in an outstanding event on Inauguration Day but in again demonstrating the real inherent value of amateur radio as an item of national defense and as a means of emergency communication.

As previously and completely announced in QST, the Relay did not start until 5:00 p.m. Eastern Standard Time, March 3rd. It was absolutely prohibited to put any congratulatory messages on the air to President Hoover before that time. At 5:00 p.m. the following day, forty-one messages were safely in the hands of Washington, D. C., amateurs ready for delivery to the President. Included among these were messages from such distant points as Alaska, Philippine Islands, Virgin Islands and Nova Scotia. Several messages from private organizations, such as the Bronx Board of Trade, the Pah Ute Tribe at Yering-

ton, Nevada, and others had been received. However, these private messages were not counted in the Relay as it was considered to be a strictly Governor-President contact.

At the request of Headquarters, the Washington Radio Club undertook to organize a special Committee to handle this Relay, under the Chairmanship of Mr. G. L. Bidwell. Unfortunately, Mr. Bidwell was taken sick and Mr. E. N. Dingley, Jr. (W3HL), Chief Operator of the Washington Radio Club, assumed charge. The result of the work of this Committee in organizing

and handling the messages speaks for itself. The following Washington stations took part in the Relay:

Station	Owner and Operator	Messages Received
W3BWT	E. W. Darne	12
W3GT	K. D. Wilson	10
W3HL	E. N. Dingley, Jr.	6
W3CDQ	Miss Elizabeth Zandonini	3
W3BKW	Brewster Marshall	2
W3KR	E. D. Redington	2
W3ALF	E. T. Johnson	2
W3AHP	Roland Fowler	1
W3AKO	S. M. Grimes	1
W3AKR	L. W. Holt	1
W3AU	W. H. Leeth	1

Total 41

The method of operation on the part of the Washington stations was to call CQ-GPR and listen for replies. In response to these calls, some amateurs answered and wanted to know who GPR was, even though the Relay had been mentioned prominently in QST. Of course, such stations had no traffic and had to be cut short, as there were plenty of the "initiated" who had looked forward to the Relay and were

"on deck" with GPR traffic.

Exceptionally good work was done (as the foregoing list of stations-and-messages-handled will show) by W3BWT, W3GT and W3HL. The Governors-President Relay served only to intensify the activity of these three stations which in ordinary everyday operation are so efficient. It is significant, also, to note that W3BWT and W3HL were ably assisted by their respective wives, Mrs. W3BWT and Mrs. W3HL.

The delivery of the messages to the White House was, of course, the climax to the Relay. At the request of the Special Committee of the Washington Radio Club, the writer had the



\* W3GP, President, Washington Radio Club.

extreme honor of delivering the actual messages to President Hoover, in company with most of the amateurs who took part in the Relay in Washington. The President afforded us an exceedingly cordial reception and inquired very closely whether or not all of the messages presented had been received by amateur radio. He was, of course, assured that such was the case and he complimented us profusely on the work that had been done. We all know, of course, that the President, while Secretary of Commerce, evidenced a very clear conception of not only the general radio situation, but was particularly a friend of the amateur. In fact in years past, amateur radio has had a place in his home. One of President Hoover's sons was not only a prominent amateur but a member of the Washington Radio Club.

Of course we want to mention all of the individual participants throughout the country. To do this adequately it is necessary to take each Governor's message separately and trace it from

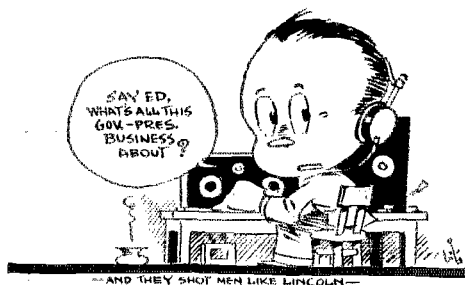

the time it left its originating station until it reached Washington. Wherever possible, frequency bands will be noted in the following tabulation, which is made up from the reports that were submitted to A.R.R.L. Headquarters after the conclusion of the Relay. Where there have been several routes and branch-routes, all of them will be traced, the best one coming first — the rest following in chronological order of time of delivery to Washington. After each route will be given the time of arrival, in Eastern Standard Time. The Relay lasted, it will be remembered, just twenty-four hours from 5:00 p.m. of the third until 5:00 p.m. of the fourth. Therefore all p.m. time from 5:00 to 12:00 will be of the third of March; all a.m. time from 00:00 to 12:00 will be of the fourth of March; and all p.m. time from 00:00 to 5:00 will be of the fourth of March. Tabulation of routes by states follows:

## ARKANSAS

(1) W5HN — W5BCZ — W3GT (Ar. 7:00 p.m.)

## CALIFORNIA

(1) W6AFU (7 mc.) — W6CIS (14 mc.) — W8CCW (3500 kc.) — W8OF (7 mc.) — W3AU (Ar. 9:00 p.m.)

(2) W6DGQ (14 mc.) — W8BKM (3500 kc.) — W3BWT (Ar. 9:45 p.m.)

(3) W6AFU (7 mc.) — W6CIS (14 mc.) — W1AQD (7 mc.) — W3AQZ (Ar. 10:25 p.m.)

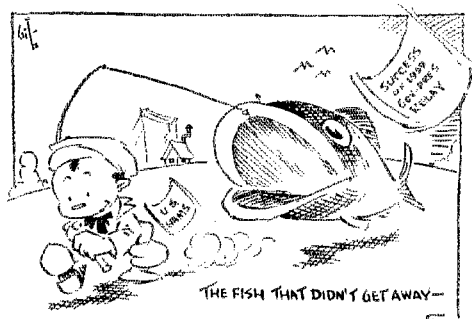

(4) W6DON — W6BAM — W6BQ — W5OM — W9DXZ — W3ZF — W3BWT (Ar. 2:19 a.m.)

## COLORADO

(1) W9CAA — W3BKW (7 mc.) (Ar. 3:45 a.m.)

(2) (Too late) W9DKM — W5OM — W9DXZ — W3ZF — W3BWT (Ar. 7:45 p.m., 6 March)

## CONNECTICUT

(1) W1MK — W3KR (7 mc.) (Ar. 3:09 p.m.)

(2) W1MK — W3HL (7 mc.) (Ar. 4:30 p.m.)

## DELAWARE

W3ALQ, after attempting many times to secure a message from the Governor, was informed that the Governor was too busy to attend to the business of writing a congratulatory message.

## FLORIDA

(1) W4QR — W4AEF — W4JR — W3BWT (Ar. 7:30 p.m.)

(2) W4ACC — W3GT (Ar. 7:45 p.m.)

(3) W4MS — W4AHM — W3AHZ — W3BWT (Ar. 11:35 a.m.)

## GEORGIA

(1) W4RN — W3GT (Ar. 5:20 p.m.)

(2) W4RM — W3CFG — W3BWT (Ar. 9:00 p.m.)

(3) W4RN — ??? — W1DV — W3KR (Ar. 11:30 p.m.)

(4) W4PM — W3BAS — W3BWT (Ar. 2:30 a.m.)

## IDAHO

(1) W7YA — W3CDQ (Ar. 1:55 a.m.)

(2) W7AB — W9DKM — W9CAA — W3BKW (Ar. 3:45 a.m.)

## ILLINOIS

(1) W9BNI — W9APY — W9DXZ — W3ZF — W3BWT (Ar. 12:00 p.m.)

INDIANA

- (1) W9DSC — W8CNO — W8BAS — W3BWT (Ar. 11:30 p.m.)

IOWA

- (1) W9DXP — W3GT (Ar. 00:50 a.m.)
- (2) W9DXP — W8AVS — W8DUW — ????

KANSAS

- (1) W9CET — W3BWT (Ar. 1:40 a.m.)
- (2) W9CET — W3KR (Ar. 1:05 a.m.)

KENTUCKY

- (1) W9BAZ — W3BKW (Ar. 8:25 p.m.)
- (2) W9BAZ — W3ATU — ????

LOUISIANA

- (1) W5YW — W5EB — W3AHP (Ar. 11:30 p.m.)

MAINE

- (1) W1BIG — W1ACH — W1MK — W3BWT (Ar. 8:45 p.m.)
- (2) W1BIG — W1ACH — W1PE — W3CFG — W3BWT (Ar. 11:00 p.m.)
- (3) ??? — W1DW — W3KR (Ar. 11:00 p.m.)

MARYLAND

- (1) W3BBW — W3ALF (Ar. 5:01 p.m.)

MASSACHUSETTS

- (1) W1ACH — W1LM — W1KY — W1UE — W1RL — W1VR — W1ACA — W1ARS — W1KH — W3GT (Ar. 8:30 p.m.)

MICHIGAN

- (1) W8BGY — W8DED — W8DYH — W1PE — W3ALF (Ar. 11:58 p.m.)

MINNESOTA

Governor went to Washington without leaving message. W9BVH tried the Lieut. Governor but he, likewise, fell down on the job.

MISSISSIPPI

- (1) W5AKP — W4RN — W3HL (Ar. 7:25 p.m.)
- (2) W5BDE — W5QQ — W4RN — W3HL (Ar. 7:25 p.m.)
- (3) W5AZV — W3CDQ (Ar. 3:35 a.m.)

MISSOURI

- (1) W9DQN — W3GT (Ar. 3:25 a.m.)

NEBRASKA

- (1) W9ANZ — W8BTH — W3BWT (Ar. 4:50 p.m.)

NEVADA

- (1) W6UO — W7YA — W3CDQ (Ar. 1:20 a.m.)

NEW HAMPSHIRE

- (1) W1AVJ — W1IP — W1TA — W1AEF — W1AYN — W1ATJ — W1BIG —

W1ACH — W1PE — W3CFG — W3BWT (Ar. 9:00 p.m.)

- (2) W1AVJ — W1IP — W1TA — W1AEF — W1AYN — W1ATJ — W1ART — ??? — W1DV — W3KR (Ar. 11:00 p.m.)

NEW JERSEY

- (1) W3CFG — W3BWT (Ar. 5:30 p.m.)
- (2) W3CFG — W3ZI — W2AOS — W2PF — W3HL (Ar. 11:15 p.m.)

NEW YORK

- (1) W2BGB — W2PF — W3HL (Ar. 11:26 p.m.)

NORTH DAKOTA

W9DYV, SCM of North Dakota, attempted by mail to obtain a message from the Governor, but without success.

OHIO

- (1) W8BYN — W8CNO — W8BAS — W3BWT (Ar. 7:00 p.m.)

OKLAHOMA

- (1) (Too late) W5APG — ??? — W5OM — W9DXZ — W3ZF — W3BWT (Ar. 7:22 p.m., 6 March)



"THE GANG" AT THE WHITE HOUSE

Following the reception by President Hoover, members of the Washington Radio Club were "shot" by Messrs. Underwood & Underwood. From left to right we see Brewster H. Marshall (W3BKW), Paul H. Thomsen (W3LA), Willard Leath (W3AL), Willard R. Burton (W3NR), Marie Zandonini, Fenner Grimes (W3AKO), Edward N. Dingler, Jr. (W3HL), E. D. Reington (W3KR), Mrs. E. N. Dingler, Jr. (W3HL), K. D. Wilson (W3GT), W. M. Smith (W3GP), Lawrence Holt (W3AKR), Elizabeth M. Zandonini (W3CDQ), and E. F. Culver.

OREGON

- (1) W7UN — W6DON — ??? — W9DEX — W3CJ — W3KR (Ar. 7:20 p.m., 3 March)

PENNSYLVANIA

Attempts to obtain a message from the Governor were made by W3ADE and W3ZF without success.

RHODE ISLAND

- (1) W1BCR — W1MK — W3HL (Ar. 7:04 p.m.)
- (2) W1BCR — W1MK — W1CDX — W3NF — W3ALF (Ar. 2:10 a.m.)

(Continued on page 31)

## Keying the Oscillator-Amplifier

By C. L. Loudon\*

**P**ERHAPS one of the most effective methods of starting and stopping oscillations in an oscillator is that so long advocated by Hoffman of W9EK. It is shown in Fig. 1.

Let us assume that we have a plate supply of 600 volts. With the key open, the two resistors will be across the supply and there will be a drop of 500 volts across the 50,000-ohm unit and 100 volts across the 10,000-ohm resistor. The filament is connected to the junction of the two resistors and the 100 volts across the smaller unit will be impressed between grid and filament with the negative end at the grid. The 500-volt drop across the larger resistor will be applied between the filament and plate with the positive end at the plate. The tube, therefore, has 500 volts positive on the plate and 100 volts negative on the grid. Under these conditions, the plate current will be zero or very nearly so and oscillations will cease.

When the key is closed, the 10,000-ohm unit is shorted and there can be no voltage drop across it so that the high negative bias is removed from the grid. The total drop is then across the larger unit and we have the full 600 volts applied to the plate, the grid obtaining its normal bias through the condenser-leak arrangement. We have, then, a condition whereby we may shift 100 volts of the plate supply to the grid circuit which does two desirable things; it reduces the plate voltage and increases the negative grid bias. Both of these act towards the stopping of oscillations.

If it is desirable, the grid leak may be replaced by a bias battery without affecting the operation of the circuit. The battery will allow the grid to be blocked with less voltage across the resistor shunted by the key because it is operative regardless of whether grid current is flowing or not.

Such a system has several advantages. The key is at low potential and the current to be broken is small so there are no vicious arcs to be upsetting things and requiring additional filter equipment. Since the key is not in any part of the oscillatory circuit there is no need for a relay even when long keying leads are necessary.

When this system is used to key the amplifier tube in an oscillator-amplifier arrangement, an added advantage is obtained. Suppose we are using a pair of 210's, one as an oscillator and the other as an amplifier and both obtaining plate power from a single source. When the key is open and the amplifier is taking no power from the supply source (assuming a rectifier-

filter proposition) the voltage will be dependent upon the load taken by the oscillator. Now, when the key is closed and the amplifier takes power, the supply voltage will drop and the amplifier will draw less current because of the reduced plate voltage. Regardless of what the supply voltage may be, unless the supply is very much larger than is really required, the regulation will be poor enough to make a fluctuation in voltage that will be injurious to the stability of the oscillator.

We found in Fig. 1 that we could start and stop our oscillator by transferring part of the supply voltage from the plate to the grid circuit and back again. The same thing will apply to an amplifier although it may be necessary to increase the amount of voltage on the grid to stop the operation of the tube.

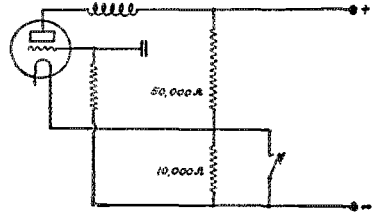

FIG. 1

Going a step further, it is possible to subtract the biasing voltage from the plate supply to the oscillator so that when the reduced load on the power supply causes the voltage of it to increase, the amount subtracted will just compensate for this increase and keep the voltage to the oscillator constant even though the load on the power supply may change considerably.

Since the oscillator is drawing current continuously, it is unnecessary to use the voltage divider shown in Fig. 1. A resistor of much smaller value may be inserted in the negative supply lead to the oscillator and the voltage drop across it applied to the grid of the amplifier. This is shown in Fig. 2.

Suppose the plate supply voltage is still 600 and we want somewhat over 100 volts to block the grid of the amplifier tube. If we make R1 of about 4000 ohms and have an oscillator plate current of 30 mils, a voltage drop of 120 will be had across it. Now if we want to run the oscillator on a voltage of 300 or so in order to minimize heating and its attendant troubles, we can insert additional resistance at R2. With 6000 ohms there, the plate voltage will be 300 with a plate

\* W2ALW, 3291 Hull Avenue, New York City, N. Y.



current of 30 mils. When the key is closed and the resistor, R1, shorted, the drop that was across the resistor will be applied to the plate of the oscillator to compensate for the drop in supply voltage caused by the increased load on the rectifier-filter system.

If the drop in the power supply unit due to the change in load is lower than the voltage necessary

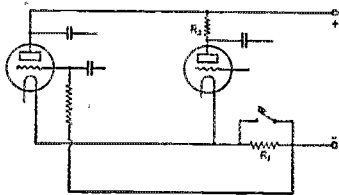

FIG. 2

to block the grid of the amplifier tube, the oscillator plate current will increase slightly because its plate voltage will go up. A resistance of a few hundred ohms inserted in either the positive or negative high voltage lead will cause a greater fluctuation in the voltage supplied to the transmitter. Such a resistor can then be adjusted to give exact compensation.

If the oscillator plate current drops when the key is opened it indicates that the voltage change in the plate supply system is greater than that necessary to block the grid of the amplifier. R1 can be increased in value and the lead to the grid of the amplifier may be connected across but a part of the resistor. In this manner the greater voltage drop in the supply unit may be compensated for without putting too much voltage on the grid of the amplifier.

In an extreme case where the value of R1 must be very large to take care of the bad fluctuation in supply voltage it may be necessary to decrease the value of R2 for although the effect of R1 has been to keep the plate voltage of the oscillator constant, it has also reduced the voltage.

If a biasing battery is used for the amplifier it may be substituted for the grid leak and the value of R1 lowered because less additional voltage will be necessary to block the amplifier grid.

A steady oscillator voltage will go a long way towards obtaining a constant frequency transmitter. Here is a method of keeping it constant.

## The Governors-President Relay

(Continued from page 29)

### SOUTH DAKOTA

- (1) W9DWN — W9COS — W3CDQ (Ar. 7:03 p.m.)
- (2) W9DYX — W8DJV — W3CJ — W3BWT (Ar. 3:40 p.m.)
- (3) W9DYX — W9CZF — ????

### TEXAS

W5VV, after repeated attempts to obtain a message from the Governor, had to go home with an empty sack.

### UTAH

- (1) W6BVB — W9BVH — W3GT (Ar. 11:45 p.m.)
- (2) W6BVB — W9BVH — W2CUQ — W3AKO (Ar. 10:05 a.m.)

### VERMONT

- (1) W1BEB — W3CFG — W3BWT (Ar. 5:30 p.m.)

### VIRGINIA

- (1) W3BN — W2CUQ — W3GT (Ar. 6:40 p.m.)

### WASHINGTON

- (1) W7GP — W9CWA — W3GT (Ar. 12:30 a.m.)
- (2) W7GP — W3GT (To check above)

### WEST VIRGINIA

- (1) W8CAY — W8BYN — W8CNO — W8BAS — W3BWT (Ar. 11:30 p.m.)

### WISCONSIN

- (1) W9EK — W4JR — W3BWT (Ar. 10:00 p.m.)

### WYOMING

- (1) W6BAJ — W9DVR — W9AP — W3AKR (Ar. 10:45 p.m.)

### ALASKA

- (1) K7TO — W7TX — W6CIS — W9TJ — W3BWT (Ar. 3:17 a.m.)
- (2) K7TO — W7TX — W6CIS — W3BWT (Ar. 2:04 a.m.)
- (3) K7TO — W7TX — W6CIS — W1ANX — W2CUQ — W3AKO (Ar. 11:00 a.m.)

### HAWAII

- (1) K6CFQ — W6TK — ??? — W3CJN — W3ALF (Ar. late at 2:11, 5 March)

### PHILIPPINE ISLANDS

- (1) K1AF — W6AKW — W1MK — W3HL (Ar. 1:12 a.m.)
- (2) K1AU — W6BVY — W9BCA — W3CJ — W3BWT (Ar. 7:30 a.m.)
- (3) K3AA — W6AMM — W8CNR — ???

### VIRGIN ISLANDS

- (1) K4AAN — W4AEF — W4JR — W3BWT (Ar. 10:00 p.m.)
- (2) K4AAN — W8XE — W3HL (Ar. 6:30 a.m.)
- (3) K4AAN — W4ACC — W3BWT (Ar. 7:20 a.m.)
- (4) K4AAN — W2BHV — W3AKO (Ar. 8:30 a.m.)
- (5) K4AAN — W3ARD — ???
- (6) K4AAN — W9CRD — ???
- (7) K4AAN — W2CVJ — ???

# Official Frequency System

**T**HE Official Frequency Station Committee, a part of the Experimenters' Section of the A.R.R.L. has arranged the services described below for the benefit of the members of the League and others.

1. Standard Frequency Transmissions are sent by Standard Frequency Stations (known as O.F.S.-S.F.) on definite schedules with a high degree of accuracy. All the principal amateur bands are covered, several points being given in each so that frequency meters may be accurately calibrated. These transmissions are based on piezo-electric frequency standards that are regularly checked by one or more of the leading scientific laboratories of the country.

2. Official Frequency Transmissions are sent by Official Frequency Stations (known as O.F.S.) at a somewhat lesser degree of accuracy. These stations do not transmit on regular schedules but announce their frequency at the end of at least every other transmission during their regular amateur operation. Such stations will measure the frequency of your emissions upon request.

3. Special services will be announced from time to time as occasion requires.

Practical suggestions are always welcome and should be sent to a proper member of the Committee which is composed of the following: Don C. Wallace, W6AM, Chairman in charge of O.F.S., Room 410, 209 Pine Avenue, Long Beach, Calif.; Prof. C. M. Jansky, Jr., of radio station W9XI, and Killian V. R. Lausingh, in charge of O.F.S.-S.F., Box 731, Hollywood, Calif.

### STANDARD FREQUENCY SCHEDULES

Time (P.M.)	Evening Frequency			Time (P.M.)	Sunday Afternoon Frequency		
	A	B	AB		C	D	CD
8:00	5700	7300	7300	3:00	14400	30000	30000
8:12	4000	7250	7200	3:12	14350	29750	29000
8:24	3900	7200	7100	3:24	14300	29500	28000
8:36	3800	7150	7000	3:36	14250	29250	14400
8:48	3700	7100	4000	3:48	14200	29000	14200
9:00	3600	7050	3850	4:00	14150	28750	14000
9:12	3550	7000	3850	4:12	14100	28500	
9:24	3500		3300	4:24	14050	28250	
				4:36	14000	28000	

Time is the local standard time at the transmitting station and frequency is in kilocycles.

### DIVISION OF TIME

- 4 minutes — QST QST QST de (call letters).
- 3 minutes — "Characteristic letter" sent very slowly and broken by call letters each half minute.
- 1 minute — Statement of frequency in kilocycles.
- 4 minutes — Time allowed to change to next frequency.

### TRANSMITTING STATIONS

W1XV — Massachusetts Institute of Technology, Communications Experiment Station, Round Hill, Dartmouth, Mass., H. A. Chinn in charge. Uses Eastern Standard Time and characteristic letter "G".

W9XL — Gold Medal Station, R.F.D. No. 3., Anoka, Minn., H. S. McCartney, in charge assisted by Lyall K. Smith, Ivan H. Anderson and George Collier. Uses Central Standard Time and characteristic letter "D".

### ACCURACY

The transmissions of these Standard Frequency Stations will be within 1/10 of 1% of the announced frequencies. It is expected that those of W1XV will have a much higher degree of accuracy, the exact figures to be announced during the running of the schedule. Those in a position to utilize an accuracy of better than 1/10 of 1% may write W1XV for further data. While no responsibility, financial or otherwise, is assumed for the accuracy of these transmissions, every effort will be made to have it exceed the figures given.

### STANDARD FREQUENCY SCHEDULES FOR MAY AND JUNE

Date	Schedule	Station
May 3, Friday	A	W1XV
5, Sunday	CD	W9XL
10, Friday	AB	W9XL
17, Friday	B	W1XV
19, Sunday	C	W1XV
24, Friday	AB	W9XL
June 2, Sunday	CD	W9XL
7, Friday	A	W1XV
14, Friday	AB	W9XL
16, Sunday	C	W1XV
21, Friday	B	W1XV
28, Friday	AB	W9XL

### OFFICIAL FREQUENCY STATIONS

(Required accuracy 3/10 of 1%)

W1AAC, W1AVW-W1ZL, W1AWW, W1AXA, W1BD, W1BZQ, W1CCW, W1CK, W2BRB, W2CDC, W2CLA, W2DS, W2EF, W2MU, W2UV, W4BY, W4LK, W5EW, W5MN, W5OX, W5SP, W5ZAV, W6AKW, W6AM, W6AYC, W6AVJ, W6BB, W6BGM-W6CVO, W6BMW, W6BRO, W6BZU, W6CAE, W6CDY-W6CPX, W6CMQ, W6EC-W6XE, W6QL, W6QX, W6WN, W6XAO-W6ZV, W7AAT, W7GQ, W8APZ, W8BAV, W8BZT, W8FEQ, W8GZ, W8ZG, W9AHQ, W9AVG, W9AXQ, W9BGH, W9BGK, W9BVC, W9CPM, W9EFO, W9EGU, W9IG, G2OD, G2NM, G5BY, G5YK, G6CL, G15NJ, VE2BE, VE3CO, VE3FC, VE1BT, VE9AL, VK5BG, VK5LF, VK7CW and ZL2AC.

(Continued on page 89)

# Alternating Current Rectification as Applied to Radio

(In two parts—Part II)

By R. J. Kryter\*

## GAS-CONDUCTION RECTIFIERS

**G**AS-CONDUCTION rectifiers are similar in many respects to the above described thermionic rectifiers, differing chiefly in the fact that they are less highly evacuated and as a result much of the current through the tube is carried by gas ions instead of electrons.

The electrons shot off heated bodies normally travel neither rapidly nor far, as they are quickly stopped by the accumulated blanket of negative particles, the "space-charge." If, however, an electric field of proper direction be applied in the vicinity of the hot body, part of the "space-charge" will be neutralized and the electron will acquire a high velocity in "falling" through this field. If the field be sufficiently intense, the electron will be endowed with such energy that if it accidentally collides with a gas molecule it will literally tear one of the electrons out of that molecule. The new electron travels on under the influence of the field, leaving behind a gas molecule which has lost an electron and is therefore positively charged. This positively charged particle also moves under the influence of the field but in an opposite direction to that taken by the electron, the particle being called a "gas ion." Thus we see that by virtue of this process of "ionization by collision" it is possible to produce many more charged particles than were originally available, and since the number of charged particles present determines the current which can be carried, this process makes it possible to greatly increase the output of a rectifying tube. If the amount of gas in the tube be vanishingly small (as in the thermionic rectifier) the probability of an electron colliding with a molecule is very remote and therefore ionization does not occur. On the other hand, if the amount of gas is large (near atmospheric pressure, for example) the heavy gas molecules are so closely packed that they stop the electrons before the latter ever reach high enough velocities to cause ionization. Therefore, the phenomena of gas ionization are limited to a certain low range of pressures, usually about 1/10 mm. of mercury, and it is in gases of this degree of rarefaction that gas-conduction rectifiers operate.

## TUNGAR AND RECTIGON TUBES

The simplest gas-conduction rectifier is the well-known Tungar or Rectigon bulb. This is a simple two-element tube comprising a tungsten filament and a graphite plate, enclosed in an atmosphere of argon at low pressure. The hot filament emits electrons which travel over to the plate when the latter is positive just as in the case

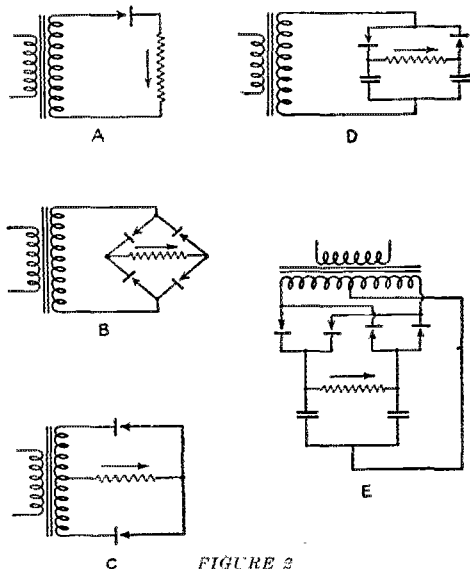

FIGURE 2

of the thermionic tube. In addition, however, the swiftly flying electrons ionize many of the argon atoms and the positive ions thus formed then travel to the filament, reducing the internal resistance of the tube and increasing its current-carrying capacity.

When the plate is negative the electrons are restricted to the vicinity of the filament by the space-charge and cannot reach high enough velocities to ionize any gas. The ions which were produced during the previous half cycle immediately re-combine with stray electrons to re-form neutral atoms and as a result the tube becomes non-conducting. The ionization occurring between filament and plate is evidenced by an intense blue glow when the tube is under load.

\*Research Engineer, Prest-O-Lite Storage Battery Corporation, Indianapolis, Ind.

The Tungar bulb is essentially a heavy current, low-voltage device. It is made in three sizes, the full-load d.c. output ratings being approximately: 1 ampere at 15 volts, 2 amperes at 30 volts and 5 amperes at 90 volts. The efficiency of the tube is low, about 20-25%, the overall efficiency of battery chargers being 15% and 20%. The tube is very rugged, however, and its life is long, 1000

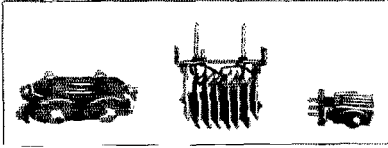

THREE EXAMPLES OF CONTACT RECTIFIERS

At the left is a Rectar; in the center, a Kuproc and at the right, an Elkton unit.

hours being normal. The efficiency of the tube increases with the load voltage. The filaments of the 1-ampere and 2-ampere bulbs take 7 amperes and 14 amperes respectively at 2 volts. The 2-ampere tube has a breakdown voltage of about 60 volts. After the tube has once started, the filament current may be extinguished without interfering with the operation of the tube; in fact, the efficiency will be slightly increased. It is necessary to heat the filament, however, to make the tube self-starting.

#### MERCURY ARC

The mercury arc rectifier is similar in operation to the Tungar tube except that the gas is mercury vapor at low pressure and the source of electrons is a "hot-spot" on a pool of mercury. This type of rectifier has been applied with great success to many purposes, covering a wide range of currents and voltages. Glass bulb types are available in 5- to 50-ampere sizes and capable of rectifying several thousand volts. The mercury arc rectifier is characterized by its extreme efficiency which runs from 75% to 95% overall for the complete rectifier plant. Its chief drawbacks are its high initial cost and the fact that it is not self-starting. Its overload capacity is limited — a 25% current overload being allowable only for 30 minutes. Current overload will cause the anodes to heat, resulting in short circuiting of the bulb. The breakdown voltage depends upon the degree of vacuum in the bulb and upon the operating temperature, but ranges between 2000 and 15,000 volts. Cooling the bulb by means of a fan greatly raises the breakdown voltage. The life of a mercury arc rectifier is limited only by mechanical breakage or loss of vacuum. The voltage regulation is the best of any known type of rectifier, being only about 10% between no-load and full load. The efficiency of the device is practically constant above one quarter load, but increases with the voltage being rectified. The voltage drop in the tube is practically constant independent

of the circuit in which it is placed or the load handled and is 15 to 20 volts.

#### RAYTHEON

A third type of gas-conduction rectifier is represented by the Raytheon tube. In this tube, which is designed for full-wave rectification, two anodes in the form of short metal rods are mounted side by side within an umbrella-shaped metallic cathode, the whole being enclosed in an atmosphere of helium at low pressure. The exact mechanism of rectification is quite complicated but is due partly to the difference in area of the electrodes and partly to their shape and placement and the nature of the resultant fields. If the rod-shaped anode be connected to the positive side of a d.c. circuit, a voltage of 200 to 300 volts will start a discharge through the tube. If the cup-shaped cathode be made positive, however, a voltage of 750-1000 volts will usually be necessary to cause any considerable current to flow. It is to be noted that at a voltage about the same as that in which the arc strikes in the conducting direction, a small leakage current starts in the insulating direction, although a much higher voltage is necessary to cause the valve to pass current freely. This leakage current is one respect in which the Raytheon tube is inferior to thermionic tubes, although the leakage is small and relatively constant and does not produce the pernicious effects that were observed in electrolytic valves.

It is characteristic of the type of discharge occurring in this tube that the voltage necessary to start the arc is greater than the voltage necessary to maintain it. In a d.c. circuit the minimum

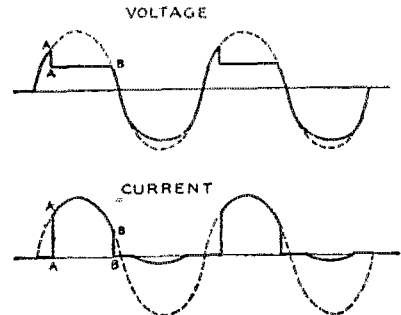

FIGURE 3

voltage at which the discharge can be maintained is usually about 150 volts below the starting voltage. The voltage across the tube has a peculiar wave-form, shown diagrammatically in Fig. 3. This peculiarity of the tube not only causes a certain distortion of the output wave, but also generates surges, or "transients" in the high voltage circuit which must be absorbed by buffer condensers placed across the transformer secondary. This peculiarity also makes it necessary

for the tube to feed directly into a capacitive rather than into an inductive or resistive load. The significance of this fact will be appreciated in the latter section on "Filters."

The Raytheon Type "BH" tube has a rated full-load output of 125 ma. at 300 volts d.c., and the type "BA," 350 ma. at 200 volts d.c. The maximum rated r.m.s. voltage per anode is 350 for both tubes. Actually, picked "BH" tubes may be worked as high as 550 volts per anode, giving outputs of 450-500 volts d.c. The Raytheon tube is more sensitive to voltage overload than to current overload, high voltages causing insulation troubles. Its guaranteed life at full load is 1000 hours, but it will usually operate for 2000 hours or more. Its output is remarkably steady during its entire life, the tube usually failing rather suddenly by open circuiting. The tubes are very uniform, the output voltages of new tubes being within plus or minus 2% limits. The voltage regulation is considerably better than that of filament tubes of equal size, due to the "negative resistance" characteristic of the gaseous arc. The maximum efficiency of the tube itself is about 55%; the overall efficiencies of B-supply devices for receiving sets usually being between 30% and 45%.

#### DRY CONTACT RECTIFIERS

Dry contact rectifiers include a wide assortment of devices which, though similar in structure, operate on various principles. All of them comprise a junction between two dissimilar substances, generally a metal and a crystalline metallic salt which is electrically conductive. The detailed modes of operation of these devices are complex and are not thoroughly understood but in general they involve thin films in which the molecules are so oriented or "polarized" that the transfer of electrons in one direction requires much less work than a similar transfer in the opposite direction. In some cases the conduction is metallic in nature, i.e., no decomposition of the conductor occurs (such as the copper-oxide valve) whereas in other cases electrolytic conduction occurs, i.e., the conductor itself is decomposed by the passage of current and new chemical products appear at the electrodes (such as the copper sulphide valve).

Probably the oldest dry contact rectifier is the humble crystal detector. Although this device can handle only very minute currents and voltages, its efficiency is high and its output wave-form good. Operating in much the same fashion, commercial devices are now available which will handle considerable power. Two main types are popular at present, the aluminum (or magnesium) copper sulphide valve, such as the Elkon and Benwood-Linze devices, and the copper-cuprous oxide valve, such as the Rectox and Kuprox units.

In general, contact rectifiers are simple in construction and have a high efficiency. All contact rectifiers, however, suffer from the fact that their

characteristics vary with the condition of the contact surfaces and with the pressure upon these surfaces. In the copper sulphide type of rectifier this fact is most noticeable, inasmuch as the rectifying junction is at the contact between two separate bodies of material. A change in pressure will change the area of contact between these dissimilar bodies and will also affect the nature of any absorbed gas film on the surfaces. In the case of the copper oxide device, the rectifying action takes place in the interior of a disc, at the interface between the mother copper and the cuprous oxide formed chemically thereon. Thus a complete rectifying element is made up of only one physical body and the active junction that is formed during the manufacturing process is not altered subsequently by pressure, abrasion, corrosion or the like. Pressure does affect the copper oxide rectifier, however, insofar as it determines the resistance of the contact made between the external conductor and the crystalline copper oxide sur-

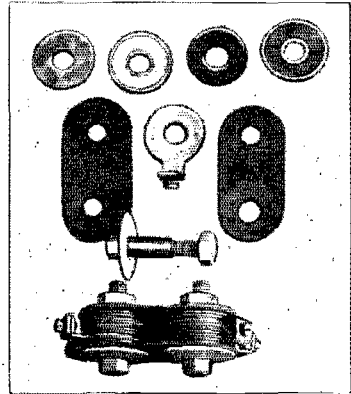

THE PARTS OF A RECTOX UNIT ARE SHOWN ABOVE

Along the top row from left to right appear the oxidized face of the rectifying disc, the mother copper face of a similar disc, a lead contact washer and a complete disc with washer. Below these are the bakelite end plate, the terminal disc and the copper strap. A tie-bolt may be seen just above the completed unit at the bottom of the picture.

face. Insufficient pressure will cause a high resistance joint between the rectifying element itself and the connection thereto, thus increasing the resistance in the open valve direction and decreasing output and efficiency. The Kuprox unit is a riveted assembly and no adjustment of pressure can be made, but the other units are bolted construction and their outputs can often be improved by tightening; other units are of bolted construction and their outputs can often be improved by tightening up the bolts and thus increasing the pressure on the elements.

Contact rectifiers resemble electrolytic rectifiers in possessing a definite breakdown voltage and breakdown temperature. If either critical

value be exceeded, the rectifier will pass current freely in both directions. After the unit cools down, or after the high voltage is removed, it will immediately function again much as if it had never been overloaded. Rectox rectifiers have been broken down in this way ten times in succession without showing any permanent ill effects.

Contact rectifiers, furthermore, all show leakage. Like the electrolytic rectifier, this leakage increases rapidly with temperature and to a certain extent with the age of the unit. For this reason it is extremely important that such devices be adequately ventilated; the unit itself should not operate appreciably above 90°-100° F. The leakage current in a Rectox full-wave unit charging a 6-volt storage battery will be 2-6 milliamperes at 70° F., 15-25 milliamperes at 90° F., and 60-100 milliamperes at 140° F. The characteristics of a single element from such a rectifier are shown in Fig. 4. A peculiar leakage phenomenon is demonstrated by some copper sulphide rectifiers which show markedly increasing leakage

about 50 ma. per square inch and the normal density 200-500 ma. per square inch. The Rectox rectifier unit has an efficiency of 60%. The breakdown voltage is about 11 volts a.c. per disc and the critical temperature about 160° F. The life is probably the greatest of any commercial low power rectifier and is measured in years. A typical battery charger has been operating 18,350 hours (24 hours per day for 765 days) and has delivered 9,620 ampere hours to date. Its original charging rate was 0.59 ampere and its present rate is 0.43 ampere, the average rate over the entire period being 0.52 ampere. The original overall efficiency, including transformer losses was 34% and the present efficiency is 28%.

#### MEASUREMENTS AND CALCULATIONS IN RECTIFIED CIRCUITS

The peculiar symmetrical wave-forms met in rectified circuits necessitate certain precautions when making measurements or calculations on such circuits. In the first place, the difference

between d.c. and a.c. meters must be kept in mind. Strictly d.c. meters are always of the D'Arsonval type (permanent magnet and moving coil) and such meters read only the "electrolytic" value of the current flowing, that is, the net value in the predominant direction only. Such meters are specially adapted to measuring the useful output of rectifiers as they show the value of current or voltage which is useful for charging a battery or producing plate current in a vacuum tube. A d.c. meter reads zero when placed in an ordinary a.c. circuit. A.c. meters may be of the moving ion, dynamometer, hot-wire, or thermocouple types. They read the heating value of any current, regardless of wave-form or polarity. Mathematically stated, a.c. meters indicate the square root of the mean square of the current passing

through them and their readings are called "effective" or "r.m.s." values. (Note that both positive and negative quantities become positive when squared; thus the a.c. instrument eliminates polarity.) An a.c. meter placed in a pure d.c. circuit will read the same as a d.c. meter, but in any other type of circuit, specifically in rectifier networks, the readings of the two types of instruments will be different. A.c. meters are adapted to reading the input voltage to a rectifier, but their readings when placed elsewhere in the circuit require special interpretation.

Consider the case of an a.c. ammeter and a d.c. ammeter placed in series in the output circuit of a perfect rectifier, assuming a non-reactive load so that the wave-form will be either as "B" or "C" of Fig. 1. The geometrical properties of the sine curve are such that in the half-wave circuit, "B," the d.c. meter will read 63.6% of the a.c.

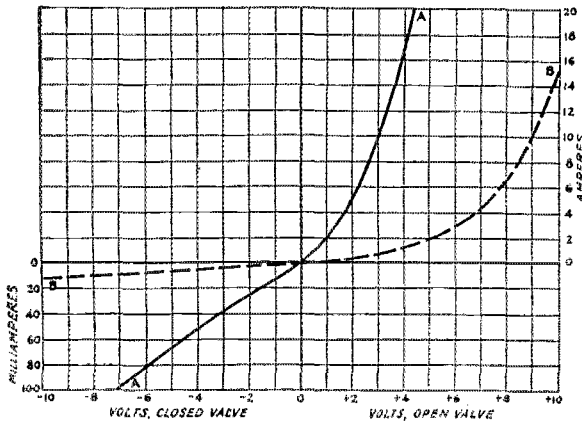

FIGURE 4

with age. This is due to the formation by electrolysis of minute threads of metallic copper in the copper sulphide. These copper threads carry current in both directions. If the rectifier output be short-circuited for a time, these threads will burn off, the leakage will be greatly reduced and the output and efficiency will be improved.

Contact rectifiers have one other peculiarity in common with electrolytic valves, namely, that the completeness of rectification is affected prominently by current density or, what is similar, by the voltage applied to a given unit. In the contact rectifier this does not come about as a result of capacity effects but rather because the ratio of "closed" and "open" resistances depends upon the voltage applied. This means that any given design of rectifier requires a certain minimum current to cause the rectifier to function properly. For a copper-oxide valve the minimum density is

meter reading; in the full wave circuit, "C," the d.c. meter will read 90.1% of the a.c. meter reading. These ratios are frequently spoken of as "the rectification ratio" and serve as an indication of the completeness of rectification. The above ratios are the highest that are possible to obtain in any circuit of the type described, all ordinary rectifier circuits showing ratios poorer than the above. From these figures it follows that the maximum obtainable d.c. power in a perfect half-wave rectified circuit is only 40.4% of the total power in that circuit, in a perfect full-wave circuit the maximum d.c. power is 81.2% of the total.

Any rectified wave may be considered as a pure direct current plus a super-imposed symmetrical alternating current. If an a.c. and a d.c. ammeter are placed in series (or voltmeters in parallel) the value of the true alternating current (or voltage) is the square root of the difference of the squares of the meter readings.

$$I_{ac} = \sqrt{(I_{eff})^2 - (I_{dc})^2} \quad (1)$$

Although this method is theoretically correct for any condition, it is not useful practically when the d.c. is more than ten times the a.c. and therefore is not applicable to filter circuits. In the case of a rectifier output smoothed by a single choke or condenser, however, the percentage a.c. may be 10% or greater and the above method may be used for measuring the same.

Another property of sine curves must be taken into account in rectifier circuits. In a pure sine wave, such as "A" in Fig. 1, the maximum or "peak" value of the wave is 1.41 times the "effective" value which is indicated by an a.c. meter. Thus, if an a.c. voltmeter reads 100 volts, it means that the voltage on the line varies between limits of zero and 141 volts in each direction. Obviously, when a rectifier is in the "closed" value position, it must withstand this 141 volt peak, and not merely the 100 volts read by the meter. Furthermore, if the rectifier feeds any reservoir of voltage, such as a battery or a condenser, this voltage will also be impressed on the rectifier in the closed valve direction in addition to the above peak voltage. In the case of a rectifier supplied from a 750-volt transformer, and having a condenser connected directly across its output, the d.c. voltage across the condenser being 800 volts, the peak of the input wave to the rectifier will be  $1.41 \times 750 = 1060$  volts, and the maximum voltage across the rectifier will be  $1060 + 700 = 1760$  volts. The fact that the peak voltage is 41% higher than the "effective" voltage explains why at light loads the d.c. output voltage of a rectifier may be higher than the a.c. input voltage. In the case of the rectified output wave "B" in Fig. 1, the peak voltage is 3.14 times the d.c. voltage, and in wave "C" the peak is 1.57 times the d.c.

The input power to a rectifier must be meas-

ured by means of a wattmeter; voltage and current readings are of little value inasmuch as the power factor is usually unknown. In connecting the wattmeter care must be taken to see that it includes the power to the filaments of thermionic or Tungar tubes, or to the "keep-alive" circuits of mercury arcs: A wattmeter in the output circuit

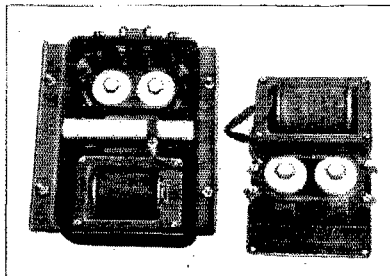

THESE TWO UNITS ARE BATTERY CHARGERS AND BOTH EMPLOY RECTOX RECTIFIERS

The box at the left is perforated to allow ventilation for the dissipation of heat.

of a rectifier reads the true power in the circuit, but not the useful power. The useful power output of a rectifier is the product of the d.c. output volts by the d.c. output amperes. The useful overall efficiency of a rectifier plant is the output d.c. volt-amperes divided by the total input watts.

#### SERIES AND PARALLEL OPERATION OF RECTIFIERS

Certain cautions should be noted regarding the operation of rectifiers in series or in parallel. "Perfect" rectifiers, as described under the heading "The Problem," can be conducted indiscriminately in series or parallel and the behavior of the resultant combination deduced from Ohm's law. Thermionic rectifiers approach this condition. When "leaky" rectifiers are placed in series, however, there is always a tendency to a non-uniform distribution of load which may cause much trouble unless properly provided for. If one of the valves has less leakage than the majority, it will carry more than its share of the load and shorten its life. When this valve fails, the voltages across all the other units will be proportionately increased and their failure hastened. This process will go on until ultimately the entire group of rectifiers fails. For this reason it is important when connecting leaky rectifiers in series, to use an increasing factor of safety as the number of units is increased. This applies especially to electrolytic and contact rectifiers.

On the other hand, rectifiers which have a "negative resistance" characteristic will not divide a load in parallel. Examples of this are found in the gaseous conduction rectifiers. They cannot be paralleled directly to increase current carrying capacity, but must be supplied from separate transformer windings.

## CONNECTION OF RECTIFIERS

There are several different methods of connecting rectifiers, the choice of method being governed by the characteristics of the rectifier and the load.

The simplest form of rectifier circuit is the single-phase, or half-wave circuit shown in "A" of Fig. 2. In this circuit the rectifier is merely connected in series with the supply transformer and the load. The flow of current through the rectifier unit itself is in the direction indicated by the arrow-head which symbolizes one of the elements; the direction of the direct current through the

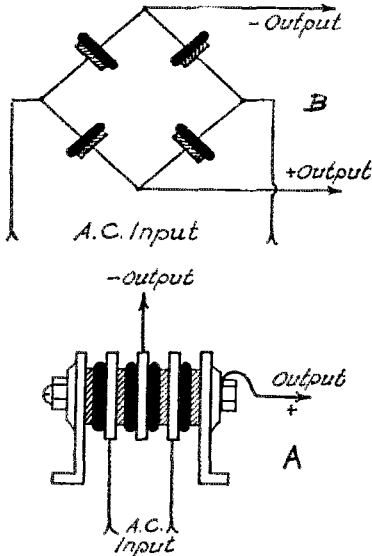

FIG. 2.—THE GENERAL ARRANGEMENT OF A SMALL "ELKON" RECTIFIER USED IN AN "A" SUBSTITUTE IS SHOWN ABOVE

The rectifier discs are connected in a bridge-connected circuit as shown at B. In actual practice the discs are mounted on a tie-rod which holds them under proper pressure and connections are made as at A.

load is shown by the arrow adjacent to the load resistance in the sketch. When the top of the transformer secondary is positive, current flows through the rectifier and load and back to the bottom of the winding. When the bottom is positive the rectifier closes and no current flows until the polarity of the transformer secondary again reverses. The load current is therefore a series of intermittent pulses. In general the wave shape will be similar to "B" of Fig. 1. In this circuit the rectifier unit must carry the entire load current, and during the closed valve position must withstand the peak voltage of the transformer plus the voltage across the load. The output contains an infinite series of frequencies, but the predominant frequency is sixty cycles (in case that is the frequency supplied to the input transformer).

If it is desired to have a more "smooth" output wave than is produced by the above arrangement, or if better regulation of output voltage with load current is necessary, then two or more rectifiers may be connected so that both halves of the a.c. wave are utilized, one rectifier filling in the gaps in the output of the other. One of the oldest of such full-wave circuits is the "Graetz Bridge" or "4-cell bridge" shown in "B" of Fig. 2. Here, four rectifiers are connected in series in a closed loop. Each half of the loop is made up of two units connected in the same direction, but the two halves of the loop are opposed to one another. The two junctions of unlike elements form the a.c. input terminals, while the two junctions of like element form the d.c. output terminals. In the sketch, when the top of the transformer secondary is positive, the current flows through the upper left unit, through the load, and thence through the lower right unit to the bottom of the secondary. Current is prevented from flowing in the opposite direction by the upper right-hand valve. When the polarity reverses and the bottom of the secondary becomes positive, the current flows through the lower left unit, through the load, and thence through the upper right unit back to the transformer. The output of such a rectifier will resemble the output of two of the half-wave rectifiers described in the preceding paragraph, one being shifted a half cycle relative to the other. In general this will yield the wave-form shown in "C" of Fig. 1. In this circuit any given unit carried only one-half of the total load current, although this current must pass through two units in series. In the closed valve position, one unit must withstand the peak transformer voltage plus half the load voltage. The output wave again contains an infinite series of frequencies, but is predominantly one hundred and twenty cycles.

Another full-wave connection in the bi-phase or "split-secondary" circuit is shown in "C" of Fig. 2. In this common hookup, the transformer is wound for twice the desired voltage and a rectifier is placed in each leg of the transformer output, the two rectifiers facing in the same direction. The load is connected between the center-tap of the transformer secondary and the common connection of the two rectifiers. In the sketch, when the top of the secondary is positive, no current can flow because the upper valve is closed. However, the center of the secondary is also positive with respect to the bottom of the secondary, so current flows through the load, through the lower valve and back to the bottom of the winding of the transformer, only the lower half of the winding being active. Similarly, when the bottom of the secondary becomes positive it is rendered inactive by the lower valve, while the upper half becomes active, current flowing through the load and upper valve. Thus this connection achieves with two valves the same output wave that was obtained by the circuit of "B" from four valves, though with different con-



ditions prevailing in the rectifier circuit. In this circuit each unit carries one-half of the load current and that load current flows through only one unit at a time. In the closed valve position, however, each unit must withstand the peak of the total transformer voltage plus the load voltage. The total transformer voltage is twice the voltage which is useful at any given instant in the circuit. Since the peak voltage of one side of the transformer is nearly one and one-half times the "effective" or "r.m.s." voltage, and since twice this voltage is applied to the valve plus the load voltage (which is generally nearly equal to the effective voltage of one side of the transformer), it follows that each rectifier unit must withstand approximately four times the output load voltage. This consideration is very important and limits the use of this circuit to rectifiers whose breakdown voltage is sufficiently high to permit safe operation under such conditions. The thermionic tube and the mercury arc are in general best suited for use in this circuit.

#### VOLTAGE DOUBLING

A radically different connection is the "inverted valve" or "voltage doubling" circuit shown in "D" of Fig. 2. This circuit is used where no transformer capable of supplying a sufficient voltage is available or where transformer insulation presents difficulties. In this scheme the opposite elements of two rectifiers are connected to one side of the transformer secondary and the remaining elements are connected through condensers back to the other side of the transformer. The points of connection between the rectifiers and condensers form the load terminals. In the sketch, when the top of the transformer secondary is positive, a surge of current flows through the left-hand valve, through the load, through the right-hand condenser and back to the bottom of the transformer. At the same time additional current flows through the valve to charge the left-hand condenser. When the polarity reverses, a surge flows through the left-hand condenser, the load and the right-hand valve, while the right-hand condenser charges. Thus the entire d.c. load is carried in the form of a.c. surges through the condensers. These surges are in such a direction that the voltage of the condenser is added to the voltage of the transformer. The result is full-wave rectification with two valves producing a voltage across the load of twice that produced by circuit "B" or four times that of circuit "C," assuming the transformer secondaries to be wound for the same voltages in each case. The current through each valve is equal to the current through the load, because the valve must supply half the load current and charge the condenser besides. In the closed position, each valve must withstand the peak of the transformer voltage plus the peak of the condenser voltage plus half the load voltage. This amounts to about four times the load voltage,

just as in the bi-phase circuit, "C." The output wave is similar to that from circuits "B" and "C," the predominant frequency being one hundred and twenty cycles. The feature of this peculiar circuit is the ability to obtain a high output voltage from a given transformer winding.

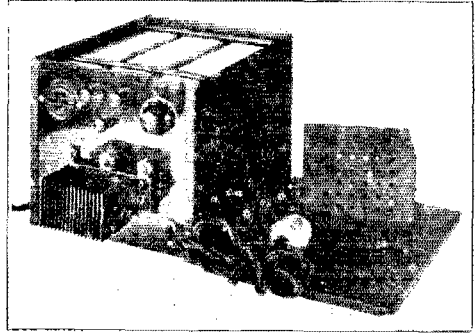

THE "A" BATTERY SUBSTITUTE SHOWN HERE USES AN "ELKON" RECTIFIER UNIT WHICH IS MOUNTED OUTSIDE OF THE MAIN HOUSING FOR BETTER VENTILATION

A small cover shown at the side of the box is fastened to the panel over the rectifier unit for mechanical and electrical protection. The long narrow cans inside the box contain electrolytic condensers of large capacity which are used in the filter network.

This is achieved at the expense of carrying the entire load in the form of a.c. through a pair of condensers.

By splitting the transformer secondary and using four rectifiers it is possible to compound the circuit of "D" as shown in "E," Fig. 2.

In all of the above diagrams and discussions each rectifier necessary in the circuit was considered as being a single unit. It should be borne in mind that the above circuits are perfectly general and in each place where the diagram shows a single rectifier, this single unit may be replaced by a group of any number of rectifiers connected in series to withstand greater voltage, or in parallel to carry greater current. In case this replacement is carried out uniformly for all the rectifiers shown in any given circuit the fundamental properties of the circuit will not be altered in any way except that the statements made regarding current through and voltage across any given valve will now apply to the group of valves which replaced the original single unit. For example, when using tantalum cells for B-socket-Power service, six to eight cells are used in series in circuit "A" to supply 150-180 volts d.c. Similarly, in early B-supply devices using 201-A tubes as rectifiers, it was customary to wire two sockets in parallel (using circuit "A") employing a single tube for light loads and two tubes for heavier loads. Likewise, Fig. 4 shows not only the characteristics of a single Rectox disc, but also the characteristics of a standard 0.6 ampere, 6-volt battery charging unit

consisting of 16 discs. These 16 discs are arranged in circuit "B," there being two discs in series in each leg of the bridge in order to hold the back voltage and two such pairs of discs in parallel in each leg in order to carry sufficient current, thus making a total of four discs in each leg of the bridge.

Another point which must be borne in mind is the nature of the load; the above diagrams all show pure resistance loads whereas the ordinary rectifier usually feeds into a reactive load. The effect of the load is to change somewhat the conditions imposed upon the rectifier without rendering invalid the above described general conditions for any given circuit. Thus, if the rectifier feeds into an inductance instead of a resistance, the current will be smoothed and the output will resemble "G" in Fig. 1 rather than "C" (in case of full-wave rectification). This smoothing is accomplished, however, by virtue of the counter e.m.f. developed by the inductance and the result is that the voltage across the valve reaches higher peaks than it would in the case of a resistance load. This must be taken into account if the valve is working near its breakdown voltage. Similarly, if a rectifier feeds into a capacitance, the output voltage will be smoothed and will resemble "G" instead of "C." The smoothing in this case is accomplished by virtue of the charging current taken by the condenser with the result that the current through the valve reaches higher peaks than it would for a resistance load. This point will be discussed further in a later article on "Filters." Furthermore, if the valve feeds into a pure resistance load containing a counter e.m.f., such as a battery charging circuit, another set of conditions obtains. No current will flow through the valve until the instantaneous value of the applied a.c. exceeds the counter e.m.f. This changes curve "C" to curve "F," the cut-off point being shifted toward the peak of the curve as the battery voltage is raised.

The last point worthy of note is the care which must be accorded the auxiliary circuits of certain types of rectifiers. In any rectifier network, the highest voltage existing anywhere in the circuit is that prevailing across the elements of the valve when the latter is in the closed position. In case either of the elements is connected to any auxiliary circuit, such as the filament winding feeding a thermionic tube, it must be remembered that this auxiliary circuit has an extreme potential against other parts of the circuit; in the case of the thermionic tube the filament winding is at the maximum positive potential. This not only necessitates adequate insulation of the auxiliary circuits, but even requires duplication of these auxiliaries in arrangements where dissimilar elements are connected together. Thus, continuing with the example of the thermionic tube, a single filament winding will suffice for one tube in circuit "A" or two tubes in circuit "C," this winding being at

the maximum high voltage. Circuit "D," however, would require two separate filament windings, while circuits "B" and "E" would require three separate windings.

#### BIBLIOGRAPHY

The reader who desires more detailed information on any of the points discussed in the above article should consult the following references:

1. *Alternating Current Rectification* — Jolley — John Wiley & Sons.
2. *The Thermionic Vacuum Tube* — Van der Bijl — McGraw-Hill.
3. *Theory and Performance of Rectifiers* — Holler & Schredt — Tech. Paper, Bureau of Standards, No. 265.
4. *Thin Film Rectifiers* — Slepian — J. Am. Electrochem. Soc., Sept., 1927.
5. *A New Electronic Rectifier* — Grondahl & Geiger — J. A. I. E. E., March, 1927.
6. *Cunningham Tube Data Book* — E. T. Cunningham, Inc.
7. *Electrical Measurements* — Laws — McGraw-Hill.
8. *Standard Handbook for Electrical Engineers* — McGraw-Hill.

### Commission Doings

IT seems that we went off half-cocked in our last issue in hailing the appointment to the Federal Radio Commission of Prof. C. M. Jansky, Jr., A.R.R.L. Dakota Division Director, and Supervisor Arthur Batcheller. We're so used to seeing the commissioners named by recess appointments of the President that we forgot that Congress was in session at the time and that therefore the appointees could not take office until they were confirmed.

They were President Coolidge's appointees, made during the closing days of the old Congress. Just before it signed off, that Congress finally decided to extend the life of the commission as the licensing authority until the end of this year, but it did not act upon these appointments and Messrs. Jansky and Batcheller therefore have not taken office. It is now up to President Hoover. He can renounce these candidates or he can choose others. Until he acts the Commission has but three members: Chairman Robinson, Judge Sykes, and Mr. Lafont.

In the act extending the commission, Congress authorized an expansion of its legal department. We are happy to announce that Mr. Paul M. Segal of Denver, W9EEA, Rocky Mountain A.R.R.L. director, has been named assistant general counsel to the Commission. For the past several years he has acted as general counsel of the League, a position he necessarily resigns upon taking office at Washington. Although the League loses his legal services, amateur radio benefits by having on the Commission's legal staff a man who knows his amateur radio backwards and forwards.

— K. B. W.

## Experimenters' Section

**D**URING the past few months there has been an intensive experimental program in progress at League Headquarters, the findings of which have been chronicled in various issues of *QST* beginning with the August, 1928, number. This program has covered many of those problems appearing in the list of problems before the members of the "Experimenters' Section."

As a consequence of the rapid developments reported most every month by the Program, the individual experimenter has felt that by the time he was able to get started on a problem an article concerning the work of the Technical Development Program on that problem would appear in print and little benefit would accrue from his efforts. This effected a slackening in the pace of the individual experimenter during this period in which it seemed more practical to await the results of the efforts of the Technical Development Program.

This program has now come to a close and many important questions concerning amateur operation have been answered. However, the members of the Section should not feel that all the "1929" problems have been solved for there are many, both major and minor, that deserve all the consideration they can be given. Now is the time to dust off the lab table and get after those problems that have not been covered by the T.D.P.

All the problems that confront the Section are not electrical in nature and probably one of the most important is that concerning its general maintenance. The present arrangement calls for the Technical Editor and the individual in charge of the Technical Information Service to keep the wheels going around.

Theoretically, the man on the Information Service desk is supposed to devote half of his time to the answering of letters requesting information and the remainder to matters pertaining to the Experimenters' Section. Practically, this is not the case because the answering of the hundreds of letters received each month requesting information of various sorts necessitates that all of a man's time be given to the task of digging out the proper answers. The Section has, therefore, muddled along with what attention it has been possible to give it at odd moments.

These conditions were not unsuspected when the Section was originally organized and precautions were taken to keep the routing paper work covering enrollments, etc., to a minimum in order that the time spent in this work produce the greatest amount of good.

The general method of enrolling in the Section

ran somewhat as follows: In answer to a request for enrollment in the Section, a set of blanks in duplicate were forwarded with the idea that they were to be filled out and one set returned to Headquarters for further handling. The other set was

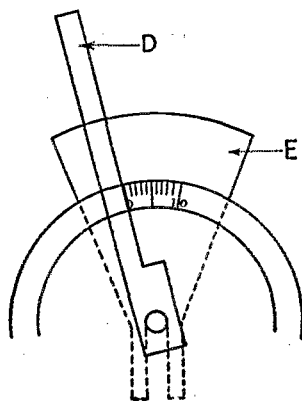

FIG. 1

for the experimenter's file. Upon receipt of the returned set of blanks, a mailing stencil was cut for each of the problems in which the experimenter was enrolling and he was sent a list of other men who were working on that problem. This list was supplied so that it would be possible for the experimenter to get in touch with his co-workers on a given problem and aid in the general coöperation which is usually so helpful and which in many cases is absolutely essential.

There are, however, a number of men who make no use of these lists and as they represent a considerable amount of work, their general issuance will be suspended in the future. These lists may be obtained upon request and will be made up only when needed. This will probably entail some delay but that cannot be readily avoided.

In addition to the list of men working on the problem, the experimenter also received an outline which covered the major considerations of the problem. In general, the outline gave some of the past work that had been accomplished and indicated methods that might be pursued in the further attack of the problem. A brief bibliography listing the more important references was included.

These outlines consumed a large amount of the available time in their preparation and constitute one of the major problems confronting those of us who are responsible for the continued operation of the Section. They also result in a large number of enrollments by applicants who apparently have

no fixed intention of doing any constructive work on a problem but who enroll merely to see what information they can obtain with no particular amount of effort on their own part. While it is, of course, impossible for us to read the minds of these applicants and prove such to be the case,

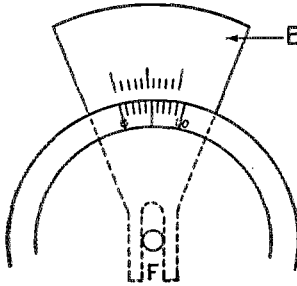

FIG. 2

the rapidity with which they lose interest in the problem after receiving the outline indicates either the above thought or an exceedingly poorly prepared and unsalesmanlike piece of writing on the part of the authors of the outline. Even if we do say it ourselves, the outlines are not quite that badly made up, so we have come to the conclusion that a large part of our membership is composed of men with more curiosity than ambition. Needless to say, this is an extremely unhealthy condition and needs some attention to prevent the dead wood from completely choking off all life that is existent. Every such enrollment represents a certain amount of wasted time in handling as well as in the carrying along of the names of such "experimenters."

Perhaps the simplest and quickest method of attacking this condition would be to do away with all outlines and let every experimenter dig up his own past history as he sees fit. This, however, would be very inefficient and is likely to be exceedingly wasteful of the time of a large number of men, which means that less time than should be will be available for the actual carrying on of constructive experimentation. It has been decided that the most satisfactory answer will be to continue to supply outlines but to materially change their form and scope.

In the future, all outlines will be much briefer than they have been. They will all follow a definite form which devotes a few short paragraphs to a simple and concise explanation of what constitutes the problem. This will be followed by a bibliography covering articles published in past issues of *QST*. In addition to these, references to the *Proceedings of the Institute of Radio Engineers* will also be included. Other pertinent references may or may not be appended as the case may warrant.

It is not believed that this type of outline will work any hardship upon an experimenter who is really interested in a problem. He would in the course of his investigation consult all material having a bearing upon the problems and such a bibliography will be of great aid to him. On the other hand there will be little of immediate interest to the man who is more curious about the outline than he is concerning the problems.

For the benefit of those who may be but mildly interested in such bibliographies, it is our intention to present them from time to time in these columns. This will save such members the trouble of enrolling in order to get the list and at the same time save us some work in the handling of the enrollment.

#### OUTLINE ON PROBLEM A-10 ANTENNA AND FEEDER SYSTEMS

This problem will concern itself with the design of antenna systems for use in general amateur transmitting work. Special designs to give a particular characteristic that may be desirable under normal or abnormal working conditions will also be included. Some of the major factors to be considered are given below:

1. Radiation. The main reason for an antenna is to dissipate a large percentage of the energy supplied to it in the form of useful radiation that may be made to actuate receiving equipment at a

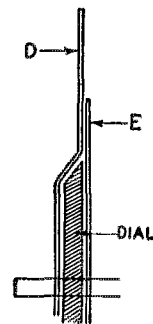

FIG. 3.

distance. Unless an antenna has this characteristic it is of no use in transmitting work. This, therefore, is the chief consideration.

2. Flexibility. The antenna should be capable of being operated at more than one frequency and preferably in any part of the present-day amateur bands. This is an extremely important consideration and deserves much attention.

3. Space required. All antennas require some space in which to be erected although the amount varies greatly. A design that does not allow the erection of an antenna within the limits of the

average back yard is unusable by most amateurs. One should also consider the problem of a suitable system for use in apartment houses and under other cramped conditions.

4. Cost. Mighty few amateurs are millionaires!

5. Miscellaneous. Under this heading one should consider such matters as the complexity of the original adjustment, rapidity with which the system can be shifted for operation on different frequencies, amount of accessory equipment required for its operation, its practicability and directional properties. Other considerations will undoubtedly present themselves to the experimenter and should be given that attention they deserve.

#### QST

Antenna Fundamentals, Feb., 1925 (53).

A Simple Way to Find the Fundamental, Jan., 1925.

A Special Short-Wave Antenna (Zeppelin Type), June, 1925.

Canadian 2CG's Capacity Coupled Antenna, May, 1925 (57).

Counterpoise or Ground? ("X" Sec.), Aug., 1925.

Direct Current Resistance of Antennas, Feb., 1925 (39).

Harmonic Transmission, Sept., 1925 (51).

Our Friend the Node, Jan., 1925 (34).

Practical Lecher Wires, Sept., 1925 (11).

Some Thanks *re* Underground Antennas, May, 1925 (62).

Steadying Our Notes, June, 1925 (38), including antenna suggestion.

The Hertz Antenna on 20 and 40 Meters, July, 1925 (24).

Low Power Report (Includes Data on Loop Transmission) June, 1925 (44).

Top Loading Antennas and Loops, May, 1925.

Transmitting Hints, Sept., 1925 (35).

Underground Antennas, May, 1925 (62).

Antenna-Counterpoise Fundamentals, May, 1926 (46).

Feeding the Antenna, July, 1926 (8).

Horizontal Reception, Feb., 1926 (9).

Picking a Good Antenna for the Short-Wave Station, May, 1926 (27).

Straightening Out the Antenna, Aug., 1926 (30).

Super DX with the Indoor Antenna, Sept., 1926 (58).

The Length of the Hertz Antenna, Oct., 1926 (16).

Adjusting the Current Feed Hertz Antenna, Dec., 1927 (46).

A Portable Antenna Tester, May, 1927 (38).

Concerning Antennas for Several Bands, "X" Sec., Feb., 1927 (43).

Long Antennas, "X" Sec., Aug., 1927 (48).

Pipe Antennas, Feb., 1927 (48).

Receiving Antenna Tuning Systems, Nov., 1927 (43).

Reducing Static at Short Waves, Aug., 1927 (32).

Matching the Transmission Line to the Antenna, Jan., 1928 (43).

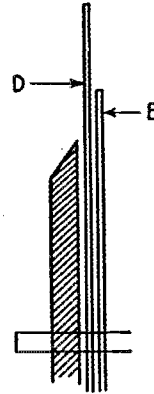

FIG. 4

Directional Properties of Transmitting and Receiving Antennas, March, 1928 (17).

Some Investigations of Short Waves At Nijni-Novgorod, April, 1928 (9).

A Combination Fieldmeter-Wavemeter-Voltmeter, May, 1928 (39).

Some Notes on a Visit to the Naval Research Laboratory (contains antenna data), July, 1928 (9).

Tests on a Method of Voltage-Feeding the Antenna, July, 1928 (37).

Reducing the Cuss-Quotient (data on adjusting feeder), July, 1928 (44).

An Effective Antenna Tuning System, Aug., 1928 (36).

The Zepp., Sept., 1928 (33).

High Angle Radiation, Oct., 1928 (31).

What Length Antenna, Oct., 1928 (49).

The 7,000-ke. Zepp. for 3,500-ke. operation ("X" Sec.), Jan., 1929 (31).

Distributed Coupling ("X" Sec.), Jan., 1929 (33).

Antenna Systems — A Rehash, Jan., 1929 (36).

Before the Guy-Wire Breaks, Jan., 1929 (40).

Increasing Transmitting Antenna Efficiency, Jan., 1929 (43).

#### I. R. E. PROCEEDINGS

The Polarization of Radio Waves, April, 1926 (205).

Field Distribution and Radiation Resistance of a Straight Vertical Unloaded Antenna Radiating at One of Its Harmonics, Oct., 1926 (675).

The Insulation of a Guyed Mast, March, 1927 (225).

Some Aspects of Short-Wave Operation at High Power, June, 1927 (501).

Radio Communication, Jan., 1928 (40).  
Beam Transmission of Ultra Short Waves, June, 1928 (715).

Characteristics of Certain Broadcasting Antennas at the South Schenectady Development Station, July, 1928 (872).

Radio Aids to Air Navigation, July, 1928 (890).

Aircraft Radio Installation, July, 1928 (921).

Effect of the Antenna in Tuning Radio Receivers and Methods of Compensating for It, Aug., 1928 (1077).

On the Determination of the Optimum Radiation Angle for Horizontal Antennas, Jan., 1929 (35).

Page numbers are in parentheses. Back issues of QST may be obtained from the Circulation

Department at 25 cents each. All issues mentioned above are not available, though. Issues of the *Proceedings of the Institute of Radio Engineers* may be obtained from the Institute of Radio Engineers, 33 West 39th St., New York City, N. Y., at \$1.00 per copy.

*Electric Oscillations and Electric Waves*, by George W. Pierce, McGraw-Hill Book Co., 239 West 39th St., New York City.

Chap. IV (Stationary Electric Waves on Wires) *The Principles of Electric Wave Telegraphy and Telephony*, by J. A. Fleming, Longmans, Green & Co., New York City.

Chap. IX (Antennas and Radiation) *Principles of Radio Communication*, J. H. Morecroft, John Wiley & Sons, Inc., New York City.

All of the outlines are not yet available. As they are prepared and suitable for distribution they will be sent to those enrolled. Please do not write in requesting outlines that have not as yet been prepared as they will be made up in the order of their importance as indicated by the number of men enrolled in the problem.

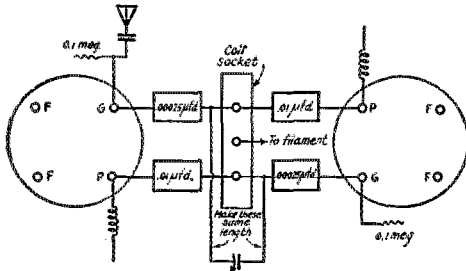

FIG. 5—THE SCHEMATIC DIAGRAM OF THE SUPER-REGENERATIVE CIRCUIT IS GIVEN ABOVE

The constants are as follows:

- C1 — 350- $\mu$ fd. variable condenser with "dead" shaft. A Rember was used.
- C2 — 250- $\mu$ fd. fixed Sangamo condensers.
- C3 — .01- $\mu$ fd. fixed Sangamo condenser.
- C4 — 1- $\mu$ fd. by-pass condenser.
- C5 — 6,000- $\mu$ fd. by-pass condenser.
- R — Universal Clarostat.
- RFC — Samsom No. 85.

#### MISCELLANEOUS

Distribution of Current in a Transmitting Antenna by R. M. Wilmoite, B.A. *Proceedings of Wireless Section, Institute of Electrical Engineers (British)*, June, 1928.

Natural Period of Linear Conductors, C. R. Englund, *Bell System Technical Journal*, July, 1928.

#### BOOKS

*Wireless Direction Finding and Directional Reception*, by R. Kenn, Illiffe & Sons, Ltd., Dorset House, Tudor St., London, E. C. 4, England.

Chap. XVII (Electric Waves on Wires) *Elec-*

#### VERNIER SCALES FOR DIALS

In this day when tuning adjustments must be so much more accurate than they have been in the past, there is a distinct need for dials which allow greater accuracy in the reading of their position. While dials with vernier scales that may be read to a tenth of a division are now on the market, they are quite expensive and one can afford but one or two at the most. It is, however, nice to have such dials on the receiver and monitor as well as on the frequency meter and it is possible to fit your present dial with a "tenth" scale without a great deal of trouble or expense.

The first operation is to cut a strip of metal to the shape of the piece D of Fig. 1. The hole at the lower end is just large enough to slip over the condenser shaft and it should be cut so the right side face of the piece, if continued, would run accurately through the center of the shaft.

Next a second piece of metal similar in shape to E in Fig. 2 should be provided. The upper end of this piece will constitute the "vernier scale" when you are finished. The slot F cut in the lower end should be a sliding fit over the condenser shaft. This piece is slipped between the panel and the dial with the slot straddling the shaft as deeply as possible. It should then be tightly clamped in place by means of C clamps or similar instruments.

The strip D is next slipped over the shaft and bent as shown in Fig. 3. This will work only on dials where the knob may be detached, exposing the shaft. In other cases where this is not possible, the arrangement shown in Fig. 4 is resorted to. Because D does not pass directly over the scale of the dial under these conditions, more care will be required to obtain accurate results.

When the pieces are all in place, ten adjacent lines of the dial should be extended onto the piece E using D as a straight edge. This is shown in Fig. 1.

Piece E is then raised until its first and tenth marks coincide with the first and ninth marks on the dial and again clamped in position, Using D

once more, the lines on E are extended to the edge of the dial and a line is drawn on E at the edge of the dial. Trim along this line with a pair of snips and finish with a file or sandpaper.

Piece E may then be fastened just above the dial so that the two scales are opposite each other. When reading the dial position, first note which line on the dial is just below the first line on the vernier scale. This reading indicates the number of full divisions. If the dial is set at exactly a whole number of divisions, the line on the dial will exactly coincide with the first line on the scale. If its position is not a whole number of divisions, these two lines will not coincide. However, there will be some line of the vernier scale that does exactly coincide with a dial marking and if we count its position from the first line on the scale, it will indicate the number of tenths of a division to be added to the number of whole divisions. — C. L. Jabs, W9BVH, 1822 James St., St. Paul, Minn.

#### SUPER-REGENERATION

In the course of developing a satisfactory high-frequency laboratory oscillator that would not have a second harmonic the following experimental set was made. Its use is limited by certain of its features. The set is relatively broad in tuning and does not oscillate so it cannot be used as an autodyne receiver. However, it seems to have a field of use in the reception of modulated c.w. at high frequencies where little or no antenna may be used and seems to be particularly valuable for plane reception of high frequency telephony. The circuit is shown in Fig. 5.

The idea of a push-pull oscillator is certainly not new, but here it is used in a super-regenerative circuit in an attempt to cut down the characteristic super roar and to increase sensitivity. Success was not complete but reduction of this roar was marked and when any c.w. wave was tuned in the remaining noise disappeared. C.w. stations without modulation may be read as dots and dashes of silence. In telephony, however, the result was eminently satisfactory due to the continuous presence of a carrier wave.

The important points in construction are few. The first is the arrangement of the coil stand and its associated leads and condensers so that the same physical characteristics may be had for the leads to each tube of the push-pull arrangement. This is indicated in Fig. 6. The second is the use of a tuning condenser with a dead shaft such as the Remler. The coils I use are wound  $1\frac{1}{2}$  inches in diameter with No. 13 d.c.c. copper wire and are of the usual self-supporting type. The mid-tap and each end connection are soldered to G.R. plugs which fit into suitable jacks on the coil stand. It is important that the leads to each side of the tuning condenser from this coil be of equal length. There is little or no hand capacity even though each side of the tuning condenser is connected to a grid.

Antenna couplings of various types were tried but the most satisfactory seemed to be direct coupling to one grid by means of a small variable condenser in the usual manner.

There is no oscillation control as the set will not oscillate when properly constructed. Volume is controlled by means of a Clarostat in the common "B" lead to the push-pull circuit. This variable resistor is by-passed by a 1- $\mu$ d. paper

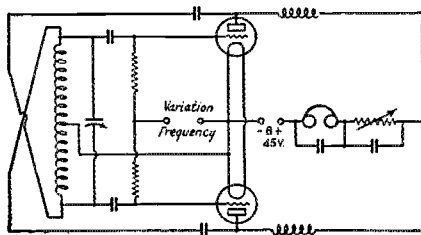

FIG. 6 — A GENERAL IDEA OF THE PHYSICAL LAYOUT IS SHOWN HERE

As is the case with all push-pull arrangements, the balanced circuits should be symmetrical if satisfactory operation is to be obtained.

condenser. Separate Sanson No. 85 r.f. chokes are used in the plate lead of each tube of the push-pull circuit to provide the proper feed back and to help keep the r.f. out of the common circuits.

The variation frequency may be any type of oscillator at 15,000 to 17,000 cycles. I used a G.R. air core 30-ke. filter from an old super tuned with a 350- $\mu$ d. condenser. This frequency is lead to each grid in the push-pull circuit through a 0.1 megohm resistor. It would seem that for best results these resistors must match within 1%. A one-step audio amplifier may be added if the operator so desires. — L. Dow Inskip, M.D., Second floor, Medford Bldg., Medford, Oregon.

— H. P. W.

## Hudson Division Convention

May 24th–25th at New York City

THE Director and the committees are working hard to make this year's convention one of the best ever held in this division. Well known men will be present to give lectures of importance to our amateur radio enthusiasts; and the entertainment features will not be forgotten.

The Hotel Pennsylvania is the place chosen for all events. From all reports the banquet will leave nothing more to be desired.

Fellows of the Hudson Division, you are all cordially invited to attend. Don't forget to put down on your calendar Friday and Saturday, May 24th and 25th, and drop a note to Director A. L. Walsh, 220 West 42nd St., New York City, and tell him that you will be present.

# The Communications Department

F. E. Handy, Communications Manager  
L. R. Huber, Asst. to Coms. Mgr.  
1711 Park St., Hartford, Conn.

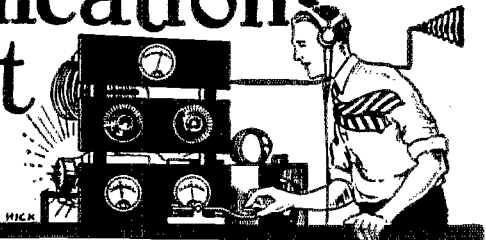

## How to Learn the Code

By Karl O. Bornen\*

*In March QST, page 42, the Communications Department invited contributions on every phase of amateur communication activity, offering prizes for the best article selected from those submitted during each month of 1929. A wide variety of subjects on which articles should be welcomed were suggested in the original announcement. In addition to these articles receiving a good position in QST, the authors whose articles appear to have the greatest value of those sent in for consideration each month have a choice of (1) a copy of the Radio Amateur's Handbook bound in aluminum, (2) six pairs of A.R.R.L. message blanks, or (3) 500 A.R.R.L. log sheets.*

*This month two articles of the five submitted for consideration in connection with our contest have been selected as prize winning contributions. The article by Mr. Bornen contains suggestions calculated to assist beginners in learning code most easily and correctly, these suggestions being backed by several years' experience in teaching code in Army circles. The fact that proper sending, which is not necessarily speedy sending, is essential to securing the greatest effectiveness in all communication work is brought out in this article.*

—EDITOR.

**M**UCH has been written about "bad fists" — yet little has been said about how these "bad fists" develop or how they may be cured. It is my intention to explain in this paper that there is a cure which, peculiarly, lies in prevention rather than correction. By this it will be understood that my treatment is not for the operator confirmed in poor practices as much as it is for the beginner who is learning the use of the key.

The first step for a student in Continental (International Morse) Code work is to acquire in his mind a "mental echo" of the characters of the alphabet. In thinking of the letter A, for example, he should not visualize it as . - . nor should he think of it as "dot dash" but rather he should think of it in sound as "dit dah." In this connection it is helpful to use a key and buzzer, or to listen in on slow signals sent by another operator. When this method is followed the pupil automatically grasps the idea of both the sound and the time element involved. The letter B will not seem to him as "dash and three dots," but will be "dah dit dit dit." The letter C will not be "dash dot dash dot," but will be "dah dit dah dit." Those two little sounds, "dit," and "dah," are used in place of "dot" and "dash" because they are of the correct phonetical dimensions. "Dit" is short, and actually sounds similar to a dot as it comes through the 'phones. "Dah" is long, and likewise represents the actual dash as the student will hear it when he begins to

copy signals. The length of the space between the parts of a letter is equal to one dot, the space between letters is equal to two dots, and the space between words is equal to one dash. In Army classes the code is thus taught by the "dit dah" method; the men are not allowed to see the code written down at all, but are required to learn by sound alone.

It is surprising to note the accuracy with which a beginner will start to use a key after learning the characters by this method. He has the sound and time element tucked away in the back of his head, and his fingers will automatically respond to what he is thinking. The element of accuracy is secured at the very beginning.

When all of the letters of the alphabet and all of the numerals have thus been memorized, actual practice with key and buzzer should begin. In Army classes the students are required to transmit to each other. This is a very efficient method, for it teaches transmission and reception at the same time; but obviously it can not be used where there is only one student in the class, and he the instructor as well as the student. In such a case, the student can listen to slowly transmitted code from an omnigraph, teleplex or he can build himself a receiving set and listen in on slow signals from the low frequency stations\* or from some of the Volunteer Code Practice Transmitting Stations in the 1750-ke. band.† At the same time he should make constant use of his own buzzer, transmitting to himself at slowly increasing speed. Never should he try for speed in transmitting until he is able to copy nine-tenths of the signals he hears on the air. Speed in transmitting will come without any conscious effort on the part of the student. His chief concern must be accuracy in forming the characters.

The business of receiving deserves a good bit of study on the part of the student. Before listening in he should make up his mind that he will not stop for missed letters. When he misses (fails to recognize temporarily) a letter, he will forget it as quickly as possible and go on to the next one he hears. When a student stops and tries to remember what was missed, he acquires a hesitancy, a faltering, in his reception, whereas if he forgets about his error and goes after the next letter, he will gain confidence, and before long will not miss any.

The business of transmitting also deserves a good bit of study on the part of the student. He must learn at the very first to grasp of the knob of the key correctly. He must learn to sit upright in a chair of the proper height at a table of the proper height — viz., thirty inches. He must set the knob of the key about eighteen inches from the edge of the table, and the key must be adjusted so that the spring is "heavy" and so that there is a vertical motion of the lever of about one-sixteenth of an inch at the knob. He must not hold the key tightly. His index finger and second finger should touch the back edge of the knob, and his thumb should touch lightly on the side of the knob. His third and fourth fingers should be free from the key — they will take care of themselves. His elbow and finger tips should be the only points of contact to the table and key. His wrist should move up and down

\*See "Getting Started" chapter in the "Radio Amateur's Handbook," fourth edition.

†See announcements in C. D. sections of past issues of QST.

\*Staff Sergeant, U. S. Army (Signal Platoon) Headquarters 3d Infantry, Fort Snelling, Minn.



(not sidewise) freely as he transmits. None of his muscles should be tense, but they all should be under control. His finger tips should not leave the key knob as he forms the characters.

Gradually he will gain speed *without consciously trying to gain speed*. When he has reached a speed of ten words a minute he can go on the air with a transmitter of his own. This is always the most momentous occasion in initiation of a beginner, and many a man has been "scared to death" at the time he first hears someone answering his call. But if he has practised faithfully and followed all of the rules he will sail through the ordeal, albeit "scared to death." Of course, he will at first be a slow operator. He must realize this and look on the business of going on the air as his final step in learning the code. Just as actors must overcome "stage fright," so he must overcome timidity on the air. This is usually a small thing, though quite exciting while it happens, and the man who has spent his apprenticeship with key and buzzer and slow-signal-copying will soon be laughing at himself for his temerity on his "first QSO."

As a further bit of good advice to operators a word or two regarding speed vs. effectiveness in operating is in order. If a man keeps up a good, steady, well-timed, twenty-word-per-minute speed, he will move twice as much traffic and be able to say twice as much in a given time as most of the "speed artists" heard on the air. Just listen closely to some of the rapid operation you run across some night and note the number of repeats due to mistakes of QRX. You will find that the rate of transmission will average about fifteen words or thereabouts unless exceptional operators happen to be working under unusually good conditions. Every operator should remember that transmissions sent hurriedly are often poorly spaced. They are ineffective also when directed at operators of limited code speed. It is a good working rule never to pound out your signals any faster than you can take them in return, too. Above all, if someone goes faster than you can conveniently copy, do not hesitate to ask him to put on the brakes. If he is a real ham and an intelligent operator he will come down to the speed that you are sending just as soon as you make a necessary request of this sort.

## Phone Versus C. W.

By Lewis B. Coe \*

"Phone vs. C. W." by Mr. Coe is in reality an appeal for tolerance and broad-mindedness on the part of the owners of these different classes of amateur radio stations. Mr. Coe wins second prize this month.

—EDITOR.

FOR some reason there seems to exist a feeling of slight hostility between the operators of phone stations and the operators of c.w. stations. A certain number of the phone station owners seem to think that their respective type of transmission should rule the air. The phones get peeved if some brasspounder interferes with their ragchewing. The brasspounder gives vent to warm exclamations when a phone messes up his traffic or DX. The law does not prohibit c.w. stations from operating in the phone band, but it certainly does prohibit the phone from going into the c.w. band. The phone men say this is unjust. However this may be, if both the phones and c.w. stations lived up to the standard of quality set by QST, interference as we now have it would be a thing of the past.

Some of the phones think they are entitled to exclusive ownership of the 1750-ke. band and regard the c.w. station working there as an intruder. There is certainly no reason why all the valuable kilocycles in that band should be reserved for an occasional Saturday night spree by a phone station. The 1750-ke. band offers excellent possibilities for

the traffic man who has local schedules. It gives the amateur the best chance he has to duplicate the snappy sounding signals found in the long wave commercial bands. Let us hope that some of the traffic men will recognize these possibilities and act on them.

Now let us consider the respective functions of phone and c.w. in amateur work. The primary value of the phone is its use for good old fashioned chats among men bound together by mutual interests. It also offers more technical difficulties in construction and adjustment than c.w. This gives the experimenter something to shoot at. And, of course, there is the thrill that we all feel of conversing with a distant ham with the ease of land line conversation. The two most important functions of c.w. are traffic and DX. It is also a good ragchewing medium but it is not so well adapted for this purpose as phone. Of course, traffic and DX can be handled on phone but the advantages of c.w. are more apparent to anyone.

Thus the amateur has two types of communication at his disposal, each ideally adapted for different purposes. Every station should use phone as well as c.w., employing each type of transmission for the purpose to which it is best adapted. Unfortunately, the cost of a really excellent phone station is rather great and of course, the builder will wish to install only the very best in equipment regardless of type. However, if the plan of balanced operation can be followed, the operators will derive the greatest pleasure from all his work, and have the satisfaction of knowing that he is making full use of the opportunities given him. Besides this, the prejudice that now has a tendency to exist will then cease to have any foundation.

## High Grade Stations — 1929 Signals

EACH month Section Managers and Route Managers report the outstanding stations which they consider the "best" ones operating in each band.

Really good signals with the requisite sharpness, steadiness, and clarity of tone which constitute our present-day standards of perfection are not too numerous if we may judge from all reports. To "make" our list it is necessary that the signals be heard *several different times* and if possible reported from *more than one source* as proof of the *consistency* of the station and its *regular* use of a good signal. Of course stations with perfectly good signals must do a certain amount of operating to be heard and reported. Our list thus credits both *outstandingly good* signals and consistency or reliability. No stations with choppers or uncalculated broadness can qualify, and the attention of observers has been called to this fact so that even the prettiest of signals will not be reported if guilty of being broad and inconsiderate of others.

Operators of stations listed in our reports consistently month after month should be well satisfied with their performance and for good reason. Our column will grow, too, especially if you help your SCM and RM in deciding on their recommendations to QST by submitting small lists of the outstandingly good signals and reliable consistent operators that you hear. Other stations not in our present list will no doubt be able to qualify shortly. Separate reports from each Section in the U. S. A. and Canada will place more emphasis on good station PERFORMANCE. . . less emphasis on a small DX record accomplished perhaps with brute power and wobbly signals. Since our reports come from all over the country they are equally fair to all station owners. This month our list is too long to permit publication of reports from each of the twenty-four Sections contributing to the success of this column. From all the reports received we have compiled an alphabetical summary which credits the stations reported more than once by separate mention. The future of our column depends both on your cooperation in submitting accurate reports and on our new space requirements for this portion of QST. Comments on how you would prefer to see the reports modified to do the greatest good would be appreciated. Separate lists should be turned

\* W9CNY, 805 3rd Ave., N. W., Calva, Ill.

in for each different amateur band. Detailed lists of "1929" high-quality signals on the several amateur bands follow:

Reported by four or more observers:  
(3500 kc.) W1CGR, W1MK, W2AG, W8ARX, W9DLD, W9D1Q, W9DXZ.  
(7000 kc.) W1MK, W4EL, W8UK, W9EGU, W9EK, W9CET.

Reported by three observers:  
(3500 kc.) W8DAQ, W8XE, W8ZZ, W9DSC.  
(7000 kc.) W1SZ, W6AM, W7AAT, W8CYL, W8LT, W8XE, W9CTW, W9GEX.

Reported by two observers:  
(3500 kc.) W2PF, W2SC, W3CFG, W4KV, W8AHC, W8CAF, W8EB, W9AZR, W9CYQ, W9EJQ.

(7000 kc.) W1AXX, W5ZG, W6EEO, W8AKV, W8NU, W8YS, W9AYU, W9BYH, W9CJG, W9CRD, W9DSC, W9DXP, W9EKW, W9ESD, W9ELX.

Reported from one source:  
(3500 kc.) W1ACA, W1ACH, W1ANS, W1ARS, W1BED, W1BE, W1BK, W1BK, W1CGX, W1IF, W1KQ, W1KR, W1JE, W2ALP, W2AVQ, W2BCB, W2BGB, W2BGM, W2BME, W3AQR, W3BO, W3ZF, W4GL, W4PM, W5APG, W6BQ, W6BAW, W6EAF, W6KD, W6OT, W7ABY, W7ACY, W7DD, W7PG, W7UN, W8AKV, W8BAU, W8CNO, W8CUG, W8DME, W8DSY, W8IS, W8JA, W8PL, W8RD, W9ASX, W9AZR, W9BKJ, W9BZO, W9CGM, W9CJQ, W9CNS, W9CWO, W9DZW, W9EBO, W9EKW, W9ELX, W9ELZ, W9ERO, W9ESZ, W9FBU, W9FJD, W9FLK, W9FQJ, W9PX.

(7000 kc.) VE3CP, OM1TB, K1CM, W1CRA, W1OF, W1WV, W3AEH, W2AKX, W2AWQ, W2AXX, W2BDJ, W2CXN, W2FM, W2JV, W2OT, W2SE, W3AMZ, W3ANH, W3AU, W3KR, W3NB, W3QL, W4AAH, W4AAQ, W4AC, W4ACC, W4ACT, W4AEJ, W4AGZ, W4AHZ, W4AJY, W4BK, W4GW, W4MI, W4SH, W4SM, W4ZC, W5AAV, W5APG, W5AHZ, W5AMR, W5AXS, W5HAT, W5BCB, W5BDY, W5EB, W5NZ, W5RG, W5VW, W6AP, W6BVX, W6BYB, W6DPC, W6EHL, W6FU, W7ACY, W7PL, W7RZ, W7SX, W7UN, W8AFM, W8AUT, W8BBL, W8BEK, W8CAU, W8CFT, W8CRA, W8CSS, W8CUG, W8CVQ, W8DAQ, W8DRD, W8DHC, W8DQK, W8DSY, W8HE, W8HL, W8LD, W8ML, W8RHL, W8UJ, W8VX, W9ABD, W9ACS, W9AEQ, W9AEZ, W9AKQ, W9ARA, W9BCA, W9BEQ, W9BPQ, W9CAA, W9CEC, W9CJL, W9CJZ, W9CPO, W9CSI, W9CT, W9CTW, W9CVN, W9CZW, W9DFY, W9DND, W9DOE, W9DRI, W9DXL, W9EHO, W9EJO, W9EME, W9EQQ, W9EPE, W9EPG, W9EVA, W9EYV, W9FDI, W9FHY, W9FJL, W9FIS, W9FPI, W9GCX, W9GEX, W9GFT, W9GAE, W9GGB, W9GHV, W9GIL, W9GQ, W9NM, W9MQ.

(14,000 kc.) W1ADW, W1BUX, W1CMX, W1KH, W1MR, W2FL, W2FP, W2BOA, W4UV, W5BDX, W5CQ, W6HB, W6UF, W7AJJ, VE2BG, VE4FN.

WELL OPERATED STATIONS: (Reported by several observers) W1MK, W9DXZ, W6AM. (Reported from one source only) W1ATJ, W1CMX, W1SZ, W2AG, W2FL, W3CFG, W3ZF, W6AKW, W7PG, W8PL, W8XE, W9ASX, W9DSC, W9CYQ, W9DLD, W9ERU, W9EK.

## Official Broadcasting Stations

### CHANGES AND ADDITIONS

(Local Standard Time)

W2APV (7205 kc.) Mon., 7:00 p.m.; Thurs., 10:30 p.m.  
W3ALE (3845 kc. CW and 3523 kc. fone) 7:00 p.m., Mon. and Thurs.; (7223 kc.) 10:30 p.m., Mon. and Thurs.  
W4HK (3896) Mon., Wed., Fri., 11:00 p.m.  
W4TS (7125 kc.) Sun., 2:15 and 7:30 p.m.; Sat., 8:00 p.m.; Tues., Thurs., 7:30 p.m.  
W5ACL (7292 kc.) 7:00 p.m., Tues., Thurs., Sat., (14,420 kc.) 4:30 p.m., Sun.  
W8DSY, Sat., 5:15 p.m.; Sun., 2:30 p.m.  
W8HD (3614 kc.) Mon., 7:00 p.m. and 10:00 p.m.; Sun., 1:00 p.m. (Also daily during daylight each Sunday.)  
W9EGU (7094 kc.) 7:15 p.m., daily except Sunday.

## Phone QRM—Terrell Asks Coöperation

THE Washington Radio Club held its annual banquet Saturday, March 23, Captain Hooper, Chief of Naval Communications, Mr. W. E. Downey, Assistant Radio Supervisor, Mr. Barron, Radio Supervisor, Mr. E. P. Guthrie of R. C. A., Dr. E. C. Woodruff, Atlantic Division Director, Dr. Kendrick of the University of Pennsylvania and members of the club were present. Mr. W. D. Terrell, Chief of the Radio Division, who had expected to attend, could not do so owing to the fact that he was on his way to the Prague conference. Mr. Terrell sent a letter by Mr. Downey to be read to the club members. Since this contains information of some concern to amateurs outside Washington, the Washington Radio Club has suggested that we include the letter in QST so that all may note. The letter follows, emphasizing the value of full cooperation of all concerned in cases where interference exists.

DEPARTMENT OF COMMERCE  
RADIO DIVISION  
WASHINGTON

March, 1929.

Mr. WILLIAM M. SMITH, President,  
Washington Radio Amateur Club,  
4817-36th Street, N. W.,  
Washington, D. C.

My dear Mr. Smith:

I wish to thank you for your kind invitation to be present at the Amateurs' annual banquet on Saturday evening, the 23rd instant, but as indicated to you by phone, it will not be possible for me to be present through to my regret, for as you are undoubtedly aware, I have always enjoyed being with and talking to Amateurs.

There is one thing that I would like to bring to your attention, and by you in turn to the Amateur organization of which you are president, and that is that the Division is receiving numbers of complaints of interference with broadcast reception by the operation of amateur phone stations.

Investigation has shown that in the majority of cases the phones were operated in the amateur band above 150 meters, although I must say that the complaints received have been largely from points outside of Washington, and in most cases the amateurs have shown a willingness to cooperate even to the extent, in some cases, of discontinuing phone operation. Undoubtedly, as phone transmitters are improved and broadcast receivers improved, the interference will gradually disappear.

I am sure that the amateurs as a whole will do their part, and it is because of this fact, the expressed desire on the part of the amateurs to cooperate with the Department as well as those with whom they interfere, that has caused me always to hold them in the highest esteem.

I will be pleased if you will indicate to the amateurs present at the annual meeting of the organization the fact that I am very sorry that it is not possible for me to be with them.

Sincerely yours,  
W. D. TERRELL,  
Chief, Radio Division.

## 28 Megacycles

SUNDAY March 3, VE2AC established communication with G8LL in London at 10:30 a.m. E.S.T. using a single UX210 and an indoor half-wave horizontal antenna with Zeppelin feeders 7½ feet long. After this QSO VE2AC listened and heard three other English stations calling him, all on 28 mc. VE2AC is ready to make schedules with any amateur working on this frequency at any time during the week, hoping to be able to arrive at data sufficient for drawing more definite conclusions regarding transmission phenomena at this frequency.

Mr. Blais (P. O. Box 221, Theftord Mines, P. Q.) of VE2AC makes an interesting report on a test recently made involving a change in the antenna system used for 28 mc. work at his station. He says: "In connection with 28 mc. work the following results might be of interest. Exactly three feet from my half wave (16' 2") horizontal antenna, on the same plane and at the same height, I have a 17½-foot wire strung across the room, with a vertical wire seven feet

\* It should be mentioned again that the Communications Department will gladly offer suggestions toward reduction or elimination of phone or c.w. interference caused by amateur stations. Amateurs are invited to write for suggestions or help when necessary, describing the type and extent of the interference as fully as possible in writing Headquarters.

long hanging from one end (this used to be part of a former counterpoise arrangement). This wire is kept taut by a weight at the loose end. I was recently QSO W5AOT, W9EVC, and G6LL receiving reports of QSA3 and QSA4. Then I took down this unused (?) wire and used the half-wave antenna as before. Signals were reported not so loud, QSA1 and QSA2. So I put back the former arrangement and my signals were at once reported QSA4 again. As I think of it, this wire has probably been acting as a reflector. The incident is being reported for any value it may have, pointing to the importance of the correct antenna or antenna-reflector arrangement more than anything else."

W1AQD and VE2AC both reported neither foreign or American stations identified in spite of long watches and numerous calls during the British 28 mc. tests. It is believed that local conditions were poor for this frequency as the few signals heard at all were weak and QSA1. WIBVL got a QSA5 report from England, using 28 mc. G. G. Hall of Victoria, Australia, says that several W's have been heard there on this frequency. W6BA being copied by himself. He reports that VK3CP was the first Aussie to hear American signals on this frequency.

At last there seems to be something stirring south of the equator on the 28 mc. band. PY1AC reports hearing W2ALW at 11.50 a.m. EST March 24 QSA3. On the same day he heard W6BCS and G2OD very faintly. No European signals were heard at W2ALW on this same date. Mr. C. L. London of W2ALW has worked England twice and Ireland once on this frequency and been heard by G5ML and several BR's. The QSO's were with G5VL, G2OD, and E18B.

PY1AC reports W2ALW the first U. S. A. 28 mc. signals to be heard in Brazil. PY1AC is experimenting with PY1AA on this frequency. W2JN and W2ALW have had schedules with both these Brazilian stations without success so far. It is believed that the first two-way 28 mc. contact with South America is not so far away.

-----

WSBS

The Yacht *Carnegie*, of the Department of Terrestrial Magnetism, Carnegie Institute of Washington should be nearing Guam as you read this report. Leaving Guam about May 16th she is due at Yokohama May 30th and will probably remain in the Japanese port three weeks or more before sailing for San Francisco. Due to the increasing distance and the poor conditions obtaining in the amateur 7000 kc. amateur band, 9045 kc. work with W1XV, W1MK and other east coast stations has been discontinued temporarily by WSBS. Reliable communication with a number of west coast amateur stations is taking care of the traffic to the Washington, D. C., headquarters of this expedition in a highly satisfactory way. W9CCH reported copying WSBS QSA3 when calling KUP.

WSBS transmitted the monthly radio report for the month of March to W9BCA on March 28th and it was relayed to W1MK the day following:

"We are having real tropical weather now with plenty of static. Signals from the fifth, sixth and seventh districts of the U. S. A. are fine, the ninth district stations come through just fairly good. Amateurs in other districts are seldom heard. I am sorry the W1MK schedule failed. Messages continue to go through reliably. Thanks are due particularly to W6CIS, W6HM and W9BCA. Schedules are working well at present with W6BPC, W6CIS, W6HM, W9BCA and K6DTG. KUP, NPU and oobAM are also being worked irregularly. We were in Tahiti from the 13th to the 20th and found it a dandy place. Since the ship's transmitter couldn't be operated in port, I kept our schedules a couple of nights from BAM. We expect to reach Pago Pago April 1st or 2nd, proceeding to Apia after three or four days there. It is hoped that contacts continue as good as they have been lately. The hams are standing by us wonderfully handling about 150 messages per month. W8BF and W6FK are the only non-schedule stations worked this month as traffic with regular schedules takes most of the possible operating time. More next month. 73. — L. A. Jones, Radio Operator, Yacht *Carnegie*, WSBS."

## The Scandinavian Contest

THE Scandinavian-American Short-Wave Tests were held during the week of 23 to 30 October, 1928. Several American amateurs who participated were rewarded with some very nice prizes in recognition of their deftness in contacting with a very few Scandinavian stations who likewise received prizes. The one regrettable feature of the contest was the scarcity of signals from the vicinity of "the land of the midnight sun"; had the Norwegian, Swedish, and Danish stations been on the air in fuller force we might now be able to chronicle a contest filled with zest. As things turned out there were not enough stations on the other side of the Atlantic to make contact with all of the American stations that operated during the contest.

Some of our men did very well, however, and we are pleased to announce the following stations and the respective prizes they won:

- W1AKS 1 Operadio Tone Chamber  
1 No. 21308 Burgess "B" Battery  
1 No. 507-3 Ward Leonard Grid Leak
- W1CJC 1 Operadio Tone Chamber  
1 No. 21308 Burgess "B" Battery  
1 No. 507-2 Ward Leonard Grid Leak
- W18I 1 Operadio Tone Chamber  
1 No. 21308 Burgess "B" Battery  
1 No. 507-2 Ward Leonard Grid Leak
- W2CUQ 1 Operadio Tone Chamber  
1 No. 21308 Burgess "B" Battery  
1 No. 507-3 Ward Leonard Grid Leak
- W2VC 1 Operadio Tone Chamber  
1 Set of Aero Products Receiving Coils
- W3AFU 1 Operadio Tone Chamber  
1 \$25 00 Credit Letter from the Sprague  
Specialties Co.
- W8ADG 1 Operadio Tone Chamber  
1 Allen D. Cardwell Transmitting Condenser

The Scandinavian prize-winning stations are SMUX, the Royal Technical University, Valhallavegen, Stockholm, Sweden, and OZ7Z, H. T. Peterson, "Fribo," Oesterg., Norresundby, Denmark. As reported to us by *Radiolytteren*, the sponsor of the contest, prizes were distributed as follows:

- SMUX 1 Orfeus Loud Speaker (A. V. Holm, Stockholm)
- OZ7Z 1 150 watt Foto Transmitting Valve (P. Elme-gaard, Copenhagen)

Of the two Scandinavian prize winners, SMUX did by far the greater amount of work, having contacted all of the winning American stations during the contest.

There were two American stations, W2UK and W1RY, who participated in the contest, according to data given to us by *Radiolytteren*. The former is reported to have worked SMUX, and the latter to have worked OZ7Z (at that time ed7ZG). No reports were turned in to the A. R. R. L., however, and we were totally unaware of the work of W2UK and W1RY at the time the distribution of American prizes was made. This is very unfortunate; the A. R. R. L. would like to give everyone a square deal, but can not do so when there is no information at hand. The moral seems to be that contestants should read *QST* very closely; in our September, 1928, issue it was stated very clearly that all American reports should be sent to the A. R. R. L.; and in these cases no reports were sent either to the A. R. R. L. or to *Radiolytteren*.

Credit is due *Radiolytteren* of Copenhagen for the arranging of the contest, and the A. R. R. L. for the tabulating of log data and distribution of prizes to the American stations.

— L. R. H.

-----

### ELECTION RESULTS

In the Oklahoma Section of the West Gulf Division, Mr. Wm. J. Gentry, W5GE, 610 Potenger St., Shawnee, Okla., Mr. LeRoy Moffett, Jr., W5ZAV, 132 Page St., Norman, Okla., and Mr. Lyman M. Edwards, W5FJ, 515 S. Lincoln St., Enid, Okla., were nominated. Election results: Mr. Gentry, 16; Mr. Moffett, 15; Mr. Edwards, 11. Mr. Gentry, therefore, has been declared elected, his term of office beginning March 30, 1929.

## WIMK

A.R.R.L. Headquarter's Station WIMK operates on frequencies of 3575 kc. and 7150 kc. Robert B. Parmenter, "R.P." is the chief operator; his fist is familiar to most of the amateur fraternity. Occasionally, other members of the Headquarter's staff operate at WIMK. Their personal signs may be found in the QRA Section of QST.

Throughout this notice time will be given as Eastern Standard Time, which is also known as "75th meridian" or "Zone Plus 5" time.

**OFFICIAL AND SPECIAL BROADCASTS** are sent simultaneously on 3575 kc. and 7150 kc. at the following times:

8:00 p.m.: Sun., Mon., Tues., Thurs., and Fri.

10:00 p.m.: Mon. and Fri.

12:00 p.m. (midnight): Sun., Tues., and Thurs.

**GENERAL OPERATION** periods have been arranged to allow everyone a chance to communicate with A.R.R.L. Headquarters. These general periods have been arranged so that they usually follow an *official broadcast*. They are listed under the two headings of 3500 kc. and 7000 kc., to indicate whether the watch is devoted to listening on the 30-meter band or to the 40-meter band.

3500 kc.:

8:10 p.m. to 9:00 p.m. on Sun., Mon., Tues., Thurs., and Fri.

10:00 p.m. to 11:00 p.m. on Tues. and Thurs. (No OBC sent before these periods.)

12:00 p.m. to 1:00 a.m. (or later) on Sunday night (Monday morning).

7000 kc.:

10:10 p.m. to 11:00 p.m. on Sun., Mon., and Fri.

12:00 p.m. to 1:00 a.m. on the following *nights* (actually on the morning of the day following): Mon., Tues., Thurs., and Fri. (*Only* on Tues. and Thurs. does the OBC precede these periods.)

**SCHEDULES** are kept with the following listed stations, through any of which traffic will travel expediently to A.R.R.L. Headquarters. The frequency included within parentheses indicates the band in which each individual station keeps the schedule with WIMK:

WIACH, Brookline, Mass. (3500): Sun. and Thurs.

WIBIG, Augusta, Maine (3500): Mon. and Thurs.

WIBQD, Newport, R. I. (3500): Mon. and Fri.

WIKY, Cambridge, Mass. (3500): Mon., Tues., and Fri.

WIVB, Newtown, Conn. (3500): Tues. and Fri.

WJF, Jersey City, N. J. (3500): Sun., Mon., Tues., and Fri.

NJ2PA, Port Antonio, Jamaica (7000): Sun., Mon., and Fri.

W2SC, Bedloe's Island, N. Y. C. (3500): Sun., Mon., and Thurs.

W3HL, Washington, D. C. (3500): Sun., Mon., Tues., Thurs., and Fri.

W3ZF, Philadelphia, Pa. (3500): Sun., Tues., and Thurs.

W3ZS, St. David's, Pa. (3500): Mon. and Thurs.

W4EF, Lakeland, Fla. (7000): Sun., Wed., and Fri.

W4RM, Atlanta, Ga. (3500): Mon. and Thurs.

W5AQY, College Station, Texas (7000): Fri.

W5JC, San Antonio, Texas (7000): Thurs.

W8AAG, Oil City, Pa. (3500): Sun.

W8ARX, Oneonta, N. Y. (3500): Mon., Tues., Thurs., and Fri.

W8AYB, Buffalo, N. Y. (3500): Tues.

W8BYN, Columbus, Ohio (3500): Mon., Tues., and Fri.

W8DED, Holland, Mich. (3500): Tues. and Thurs.

W8ZZ, Detroit, Mich. (3500): Sun. and Thurs.

W9APY, Berwyn, Ill. (3500): Tues.

W9BCA, Ft. Madison, Iowa (7000): Mon. and Fri.

W9BLI, Alton, Ill. (3500): Sun. and Fri.

W9DWS, Kansas City, Kans. (7000): Wed. and Fri.

W9ERC, Rockford, Ill. (7000): Sun. and Fri.

W9ON, Louisville, Ky. (3500): Sun. and Thurs.

W9XI, Minneapolis, Minn. (7000): Mon. and Fri.

VE9AL, Toronto, Ont. (3500): Tues. and Fri.

WSBS, Yacht *Carnegie* (9090): Sun., Mon., and Fri.

## BRASS POUNDERS' LEAGUE

Call	Orig.	Del.	Rel.	Total
W8CHC	150	300	452	802
W9ELX	109	52	400	561
K1HR	152	99	306	557
W6EEO	37	152	317	506
W6EOF	84	96	267	447
W8XE	157	50	202	409
W6AKW	13	7	366	388
WIMK	42	84	237	363
W5AOY	135	20	155	310
W0DLD	13	11	238	262
W6AD	20	122	117	259
WIAUR	72	104	72	248
WIANH	51	135	54	240
W0EGU	9	6	224	239
W9EJO	30	26	172	228
W2BFO	49	120	50	219
W0DKV	15	10	192	217
W0DKZ	15	40	161	216
W8DED	42	11	158	211
W8CRI	63	34	114	211
W9EKW	64	51	92	207
WIAJC	48	46	112	206
W8DYH	43	46	112	201
W3BBW	17	37	146	200
W8CNK	54	118	28	200
WIBIG	40	70	66	176
W6ALX	17	56	84	157
WIBBE	59	70	14	143
W0COS	51	57	26	134
W3BWT	19	53	59	131
W7HP	48	53	18	119
W3ALF	6	74	30	110
W2QU	41	54	10	105
W7HT	45	56	—	101
W5ASM	27	53	18	98
W4JY	—	74	—	74

This month the requirements for the B.P.L. were a bit stiffer due to the unusually short reporting month — February 26th to March 15th inclusive. We are glad to see so many of the consistent stations still on the honor roll in spite of the temporarily increased requirements.

The several amateur stations responsible for the best traffic work — the ones that are "setting the pace" in worthwhile traffic handling — are listed right up near the top of our B.P.L., the figures giving the exact standing of each station accurately.

All these stations appearing in the Brass Pounders' League are noted for their consistent schedule-keeping and dependable message-handling work in amateur radio. Special credit should be given to the following stations (in the order listed) responsible for *over one hundred deliveries* in the message month: W8CHC, W6EEO, WIANH, W6AD, W2BFO, W8CNK, WIAUR.

Deliveries count! A total of 200 or more bona fide messages handled and counted in accordance with A.R.R.L. practice, or just 50 or more *deliveries* will put you in line for a place in the B.P.L. Why not make more schedules with the reliable stations you hear and take steps to handle the traffic that will qualify you for B.P.L. membership also!

## Beginners

The following new schedules have been received from volunteer transmitting stations:

W3VN, Audubon, N. J., transmits on C. W. from 7:30 to 8:30 p.m., E.S.T., on Tuesdays and Thursdays.

W3AWQ, Collingswood, N. J., transmits on C. W. and one from 7:30 to 8:30 p.m., E.S.T., on Tuesdays and Thursdays.

W9FVM, Monett, Mo., will transmit from 4:30 to 6:00 p.m., C.S.T., on one with buzzer practice. These transmissions will take place regularly each Sunday, although later more periods of practice may be added — if enough enthusiasm is shown by listeners-in.

# Order Your Parts

By Col. Xavier McKenzie

Away back in the grand old year of 1908 the call signals XZ and MH were perhaps the best known of all in the Mississippi Valley. Old timers of that day will recall how each budding Marconi invariably would ask, sooner or later, "How do XZ and MH make their notes sound so nearly alike?" Thereupon it became disclosed that XZ and MH emanated from the same transmitter. Capt. Xavier McKenzie and Dr. Mitchell Hastings, neighbors and boon companions, had pooled their "wireless" interests and had built one transmitter for both operators. It was located in an operator-less shack between their respective homes, and was controlled remotely from their two houses. Separate receivers, of course, were used. In those days, it will be remembered, ethereal signals were few and far between, and it was much more blessed to give than to receive. So, when XZ and MH combined could raise no one, XZ proceeded to work MH; and thus the mystery arose.

Since "the good old days" before licenses were required, Captain McKenzie and Dr. Hastings have been separated, the former serving for fifteen years in China, and the latter spending most of this time as surgeon for a large rubber plantation in South America. But late in 1927 both returned home, the Captain a Colonel and retired from service, and the Doctor searching for a cooler climate. The two old friends have again pooled their interests, this time in a beautiful country home, "Baldor Heights," overlooking the Mississippi River. Amateur radio again becomes their common hobby, and has resulted in the building of a "1929 type" station atop the bluff on which rests their home.

Unfortunately for amateur radio, their station will not be on the air a great deal, as each of them has his separate interests to look after. The doctor has a private sanitarium not far off, and the Colonel has a troop of Boy Scouts, the local Red Cross, the American Legion, the Spanish War Veterans, a gun club, and in addition is protagonist for the erection of a Carnegie Library.

A hobby is a hobby for "the Kernel" and "Doc," however, and they boast that, although their time will be limited, they will engage in every phase of amateur radio: Traffic work; experimenting; DX; rag-chewing; ham-festing; in brief, all the activities that make up the good old "ham" game. This article is the first of a series of observations on amateur radio that Colonel McKenzie will write for us. — EDITOR.

WHEN an old bullet-dodger like me comes out of the bushes to settle down and pass the remaining days of his life in peace and quiet, he needs some engaging and interesting amusement to keep him from wandering back to the barracks. He needs some ballast to hold his bulwarks down and keep the enemy from firing

when he sent a contingent of artillery around by my left flank and caught me unaware with heavy enfiladed fire.

Of course, I had to give in. The terms originally were "unconditional surrender," but after the armistice, Doc told me that all I needed was a new command, which he gave me in the form of License to Radio Operator, Amateur Class.

Then he detailed me on construction. I tell you, I was surprised at the way I fell in on all the new orders of the day. With several years of QST on hand, and four Handbooks (nothing like having your reserves in good order), it was only a matter of a few weeks before I knew all about kilocycles and QSA5, and even had a little time to spare in reading the newspaper articles about Einstein's new theory.

By and by, I got the mail order catalogs down from the shelf and picked out what I thought ought to make a good station. Condensers, tubes, and all gadgets that I was unable to make were bought outright, whereas most of the coils and other parts that could be made at home were manufacturing things. The receiver took shape first. Then came the antennas, the transmitter, and the monitor. Finally I had them all finished and ready for installation in their permanent (more or less) locations in the shack.

Here I found a problem. What kind of an arrangement should I have? Would the transmitter be better off on the same table with the receiver, or should it be placed at the opposite end of the room, nearer the leads-in? I decided that it would undoubtedly be much better to put it in the latter location, where it would cause less QRM to the receiver. I decided to keep on the operating table only the necessary controls that must be handled in order to operate.

Directly in the center and rear, I put the shielded receiver. To the left I put the message rack, which contains eight divisions, the first three of which are labeled for traffic that has been handled — originated, delivered, and relayed messages. The next four divisions are for message on the hook. Their labels designate the directions in which the messages

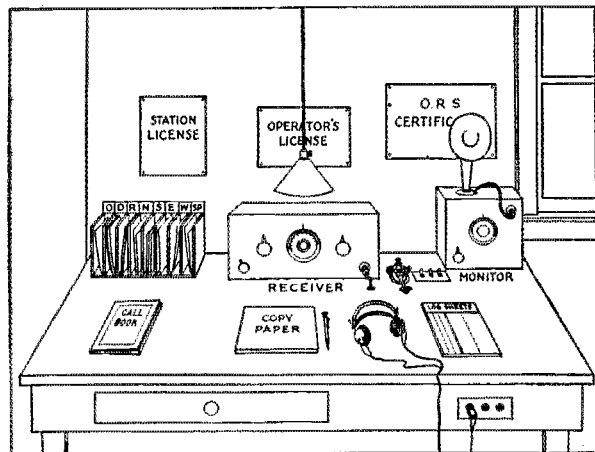

through and upsetting the cook's wagon in the rear. He needs to be put on a sort of permanent detail that will keep his troops busy.

I was speculating on amateur radio for this purpose a bit before I settled down, and I had just about decided that the game nowadays is too difficult, that there is too much for an old man to learn, when Doc marched into camp, surrounded the guns, and forced me to a hand-to-hand battle. I staved him off to the last trench, retreating by a series of forced marches, and almost won the fight, in face of heavy odds,

are going — north, south, east, and west. The last division is *special*, in which will be kept a copy of schedules, a copy of dial settings for various stations, and other useful information. Immediately to the right of the receiver is located the key, which is set just eighteen inches back from the front edge of the table. To the right of the key are the toggle switches that control the transmitter. On the extreme right is the monitor box, on which sits a small and inexpensive loudspeaker. During all transmissions the monitor is in operation, and the operator can check the signal's frequency by the dial reading. A pad of copy paper lies directly in front of the operator, and an "Eversharp" type pencil, fully loaded, lies in place on the table. To the left is the call book, and to the right, the log.

Yes, sir, everything on that little table went just where it was meant to go. I found that most parts had to be ordered twice; once by mail, and the next time when I came to put them in their places. *It is just as important to order them correctly the second time as the first.*

#### TRAFFIC BRIEFS

The Cleveland Amateur Radio Association is conducting a "fly power" contest. The rules stipulate that competing transmitters must use a tube of the 210 type or smaller. Maximum plate voltage is 90. To date W8CMB holds the lead with contacts as far off as nzER5. W8DJV is second, having worked a Canadian 4, and W8APB is third, having worked several 8's. Go to it, boys!

KVUA on 8650 kc. is the S. S. *Lake Ormoc* of the Ford Motor Company, now up the Amazon River in Brazil on a six months' trip which includes a visit to the Ford rubber plantation near Santa Ream, Brazil. W9BCA keeps regular schedules with KVUA, handling worth while traffic that helps him to hold that nice position in the B. P. L. This is a good channel for routing South American traffic — through W9BCA.

VZ seems to be the Spanish Honduran S. S. *Lempira*. W2BJK reports working him on about 8720 kc. (34.4 meters) recently.

W6AKW and W6HM have had a number of consistent QSOs with XW7EFF, the S. S. *Duelo*, in the Indian Ocean. In mid-January the *Duelo* was near Port Singapore in the Orient, bound for Batavia. The *Duelo* was near Port Said February 9. In spite of the call signal, XW7EFF, we understand that the operator is not a former American amateur. When first worked XW7EFF used a frequency of approximately 7275 kc., dropping to 7200 kc. for subsequent contacts. Early evening work (6 p.m. to 8 p.m. PST) is now being attempted.

In addition to keeping daily schedules with K1AF and K1CM, W6AKW has followed the *Duelo* consistently from port to port. W6AKW recently hooked up with XW7EFF as late as 8 a.m. PST through fierce local interference. A schedule was made for 9 a.m. when the two stations were QSO again. XW7EFF, Q8A3, W6AKW, Q8A4 through very bad QRN. The QSO was still going fine at 9:20 a.m. PST at which time one operator had to close down. Not so bad for 1929 QRM-band work we think!

W1XV, station of the Massachusetts Institute of Technology, keeps a daily schedule that runs clear around to the Philippines and China. The route is as follows: W1XV-W9EGU-W6EEO-K1HR-XU7. We understand that W3GT also is a branch of this relay chain. Messages to the Orient can be handled well through any of the above stations.

The QRA of BX is Puerto Cabezas, Nicaragua, with QSL address of "Radio Operator Albert Krog, c/o Bragmans Bluff Lumber Company, Box 830, New Orleans, La." BX's frequency is at the top of the 7000 kc. band. Top? Yes, that means near 7300 kc.

W6HS is now the official west coast QRA station for W9FO's *Radio Amateur Call Book*. This brings us to mention that there are three official QRA stations for the United States: W9FO, W6HS, and W2AGU. Any one of these sta-

tions will be glad to furnish QRA's that are not to be found in the *Radio Amateur Call Book*. Also, it must be mentioned, W9FO, W6HS, and W2AGU will be overjoyed to receive news of changed addresses, new QRA's, and other information of the sort that is useful in preparing an up-to-date amateur call book.

#### AN INGENIOUS WRINKLE

An often-asked question is: — "Is there any use for used 'B' batteries?"

They are always handy when your neighbor wants to borrow one.

From the *Oscillator* of the Amateur Radio Research Club in California we learn that W6BJX took 50 messages from K1HR inside of four consecutive hours, while working the key at W6AMM. As all of these messages were mailed in that time, too, W6BJX claims that he holds the record for making the BPL in four hours. Who can tie that one?

Changes in Japanese call letters have reached us through Col. Clair Foster, W6HM, of Carmel, California: JXIX is now J3DC; JXAX is now J3CB; JXBX is now J1DA; and JXCX is now J1CZ.

C. M. Shoemaker, formerly of Dayton, Ohio, and 8DKR, writes in that he is now on the U.S.S. *West Virginia* and would be pleased to hear from some of the gang around Dayton.

W1CQL (Wilson Trolan, 256 Connecticut Ave., New London, Conn.) was elected President of the newly formed New London Radio Club. He would be pleased to hear from active amateurs in or near New London. Visitors are welcomed at the club meetings at all times.

"VA" in radio shorthand means abandoning ship. — The *Podunk Daily Growl*.

Since seeing this new definition I can recall quite a few cases of improper use of the old "dit dit dit dah dit dah." The ops ought to be more careful. Yeh, we agree, OMI, but we thought that "VA" was the abbreviation for "Virginia." Guess we'll have to learn our shorthand all over again. Now, as to "SK," which is also "dit dit dit dah dit dah," we rise to suggest that this one might mean "sure kumming" — meaning that the ship was not going to be abandoned after all. What do you say, Alexander?

K1HR at Fort Wm. McKinley, Philippine Islands, has a kind of QRM that most of us are unacquainted with. It is caused by a species of lizard that hide in the walls of the shack, unnoticeable in the daytime, but vociferous with "shouts" at night.

The Tri-State Amateur Radio Club (Iowa, Nebraska, and South Dakota) of Sioux City, Iowa, keeps schedules with other organizations, and would like to hear from any clubs throughout the country that may be interested in regular two-way work.

A wife of one of the Marine officers in Nicaragua received as a Christmas gift an invitation to join a group of friends on a European trip. Wishing the counsel of her husband before accepting the offer, she called upon W8AKZ to serve as a link in communication. The message was relayed and received an immediate reply, which was sent to the wife, residing in Washington, D. C., after which the trip was made. Communication by mail ordinarily requires about four weeks.

S. C. M. Kerr of Iowa suggests that American Legion posts are apt to have some nice traffic that they would be glad to turn over to amateurs in their respective cities. Inter-post correspondence could be handled nicely in this manner, and after it was established there could very well be post activities that could be reported from one city

to the next by amateur radio. The Army-Amateur system could be worked into such a schedule, with benefit both to Amateur Radio and the American Legion. How about it, fellows?

W1XV recently made contact with RWX, a ship in the Red Sea that operates on 14 mc. Schedules were arranged, but the ship has only been heard spasmodically in recent times.

### WUXTRY!

Herewith we attempt to satiate a longing that has been expressed from all corners of the United States. Route Managers especially will be pleased to find below the long expected picture of Miss W1KY. From left to right we find the receiver, then Gladys, then the transmitter, and — lastly — Griff, the station's monitor box!!



W1KY is the Route Manager for the Eastern Massachusetts Section of the New England Division. Regular schedules are kept with several brasspounders and, in addition to keeping the traffic moving through her part of Massachusetts, Miss Hannah holds the important position of Chief Waffle Cooker and Official Ice Cream Passer for the monthly Route Managers' parties over the air.



### AN INVESTIGATION OF PHONE INTERFERENCE WITH B.C.L.s.

As soon as the new crystal controlled 3550-ke. phone transmitter at W2BRB was working in a satisfactory manner (approximately 50% modulation of 60 watts max output at the time of the test) the address and telephone number were given regularly and reports of interference were invited so that they might be taken care of properly. Two neighbors reported the signals but did not complain of interference. Two other threatening phone calls were received. A letter was written at once to the local Supervisor of Radio anticipating the two complaints and presenting details of the situation. A thorough survey of the conditions in the immediate neighborhood of the station was planned at once and Mr. Glaser of W2BRB assisted by Mr. Talley of W2PF set out to do the necessary investigation and missionary work.

The antenna-counterpoise system of the transmitting station was noted to be parallel to 220-110 volt lines, telephone and telegraph lines, and 11,000-volt 25-cycle high tension feeders, all 20 to 50 feet away. The Long Island Railroad runs 60 feet away. In examining the receiving installations it was found difficult to compare or judge the selectivity of the different sets. The owners seldom knew anything about the length of their antennas or anything concerning antenna characteristics either. The interference did not appear to conform to the circle pattern. At one location over 800 feet distant and not in line with the maximum radiation from the inverted L type radiator the interference was so bad as to compete with the strongest local broadcast stations. This set was a homemade affair with a single tuned r.f. stage with about 100 feet of antenna, and electrified. A neighbor across the street from W2BRB with a regenerative tuner and 80-foot antenna did not hear the phone at all. Also the phone was not audible in a 1927-type neodyne broadcast receiver located but five feet from the transmitter using a short indoor antenna. The signals were audible in an electrified tuned-r.f. receiver on the first floor, but not much above 25 degrees on the dial, this representing a different type of interference than was experienced in the local hunt. The transmitter plate supply is from a motor generator and filament transformers all have grounded center taps so that interference via internal 110-volt lines is probably nil in this case. In one case a receiver over a half mile away was practically paralyzed when the phone started up.

The results (in brief):

1. Interference, where present, always appeared in the same form, all over the dial with the same intensity, no noticeable peaks. Straight c.w. is not heard at all, there being no clicks in keying. The QRM appeared to be of the impulse excitation type, independent of frequency.
2. The amount of interference was not proportional to the proximity of the transmitter, given similar receiving installations.
3. Series condensers in the antenna-lead of receivers had no noticeable effect on the signal-QRM ratio.
4. Some nearby installations received not the slightest interference.
5. In every case a wavetrap tuned to the frequency of the transmitter, inserted directly in the antenna-lead, resulted in eliminating the interference altogether or cutting it to a low value so as not to be bothersome. Motto: All receivers should be supplied with wavetraps.

## Divisional Reports

### ATLANTIC DIVISION

MARYLAND-DELAWARE-DISTRICT OF COLUMBIA — SCM, H. H. Layton, W3AIS — Maryland: W3BBW made the BPL last month

and kept a 16-hour watch during the GPR with the assistance of W3AHG and W3AVL, W3RA and W3AVL are both in Baltimore. W6DON, W9ELX, W9AJM, W3BBW, W3ALF and W2BGO in the "Round the World Route" provide 24-hour service to Hawaii, New Zealand and

Nicaragua, W3MH is still active. We welcome W3BHX a newcomer but an old-timer.

Delaware: W3ATQ had hard luck with the Delaware GPR message.

District of Columbia: W3HL and Mrs. W3HL were on full blast during the GPR. W3HL also is very active in the USDA Net. W3BWT, with the assistance of Mrs. W3BWT, handled 18 states during the Relay. Skeds are maintained with W3ZF and W3BAS. Also made the BPL. W3GT has a three-way contact on sked with W9LGV and W6AD. We clear each other at same time to save time. GPR went off nicely handling ten states. W3AIF has had exam QRM, but did good work even so.

Traffic: W3BBW 200, W3MH 17, W3BHX 10, W3BWT 131, W3GT 82, W3AIF 110, W3HL 46.

SOUTHERN NEW JERSEY — SCM, M. J. Lotysh. W3CFG — Traffic seems pretty plentiful and all are quite active. W3CFG had a score of 9 in the GPR. W3ARC continues to be our most consistent station. W3RWJ had a fine total. W3CT reports after a long silence. Always glad to get reports from non-ORS. W3ARN contemplates installing crystal control. W3ATJ will be on the air more as his father recuperates. W3KJ and W3ATP are rebuilding.

Traffic: W3CFG 102, W3ARC 58, W3RWJ 55, W3CT 25, W3ARN 27, W3ATJ 12, W3KJ 4, W3ATP 2.

EASTERN PENNSYLVANIA — SCM, J. B. Morgan. 2nd, W3QP — Rather good turn out this month, fellows, in spite of its being much shorter than usual. We regret the loss of two good ORS, reducing the number to nine, but have several fellows lined up to step in soon. None of us were able to qualify for the BPL although W3ZE came within a short throw with 37 deliveries. Too bad, Don and Pat. W3WJ and W3ADE report having a lot of worries — going to sign off for present. We hope it won't be long. OM's, W3DHT, W3AWO and W3CWO, the Three Musketeers from Scranton, report all sorts of different colored trouble with YLS to skeptical neighbors. Things are looking brighter down W3AKS's way. W3CDS has been on the sick list again. W3NF was QSO KDV 5 recently. W3MC has moved to 3500. W3VD is a newcomer. W3AHZ is gradually making an impression on the ether. W3BQ is making a nice start. W3KZXS reports some traffic handled aided by Bob Creighton of W3HMC.

Traffic: W3ZF 168, W3AKB 112, W3NF 41, W3KZXS 35, W3BQ 32, W3AHZ 10, W3WJ 8, W3CDS 6, W3VD 6, W3DHT 4, W3CWO 2, W3AWO 1, W3ADE 1, W3MC 1.

WESTERN PENNSYLVANIA — SCM, A. W. McAuly. W8CFO — W8CHC again tops the list and says that he is resuming nightly schedules. Most of the work was on 7000 kc. W8XE was all set to break their record when they learned of the new reporting date. They will take on some OB work soon. W8CFR is starting to build a new transmitter. W8CNZ is troubled with some QRM from BCL's. Hi, W8CEO has put a lot more C in the transmitter with improved results all around. W8CMP, our operating, traffic handling, reporting director, is on the air regularly. Look for him on the 3500-ke. band any Sunday p.m. up to his neck in QSO's with A. T. A. members and others. W8BNR is having difficulty with license renewal. W8CUG is handling a bunch of traffic and is very active. Storage B battery is responsible for that DC note.

W8CRA, W8HGW and W8AVY are looking for traffic. W8CQN is attending school in Boston. W8GI is working on ital again. The Amateur Transmitters' Association will hold another banquet this time in honor of Field Man Herbert and Director Woodruff. There is a noticeable tendency toward better notes and general station adjustment. The old idea of sending "double" has about disappeared and better operating is being practised by a greater number.

Traffic: W8CHC 802, W8XE 409, W8CFR 27, W8CNZ 12, W8CEO 7, W8BGW 2, W8AGO 1, W8GI 18, W8CUG 142, W8AVY 12, W8CMP 7, W8CRA 5.

WESTERN NEW YORK — SCM, C. S. Taylor. W8PJ — W8AHC reports WFA QSO now. W8BBP, W8DQP and W8APD complain of poor sigs. W8BSM has schedules with W2CXL and W8IS. W8BUP handled a few. W8BWG has quite a total for a beginner. W8CMW and W8CYG are still after traffic. W8CNX made the BPL twice over this month. FB! W8CPC is working hard on his

transmitter. W8DDL finds 80-meter band best for traffic. W8DII states traffic poor now. W8FC is moving his station to W8BHK.

Traffic: W8AHC 18, W8BBP 9, W8BSM 64, W8BUP 6, W8BWG 62, W8CMW 18, W8CNX 200, W8CPC 21, W8CYG 16, W8DDL 32, W8DII 18, W8DQP 17, W8FC 10.

#### CENTRAL DIVISION

ILLINOIS — SCM, F. J. Hinds. W9APY — W9AHC has a M.O.P.A. going FB. W9KA has joined the USNR. W9DJ has rebuilt entirely. W9BNI originated the Illinois GPR message. W9FDJ says he is the youngest operator in the State of Illinois. W9FQS has a pair of Rectobulbs. W9FCW is rebuilding his rectifier. W9EJO dropped a pair of pliers on the 852. W9ERU says the QRM is so bad that he can hardly work his schedules. W9KB is rebuilding parts of his set. W9BFX is working on his fone. W9FDY has a brand-new monitor. W9DXZ has his fifty about worn out. W9CIA and W9AFB say DX is very good. W9DGK is rebuilding. W9CKZ has rebuilt. W9RZO has some nice Philippine traffic this month. W9GJ is worried about power peak QRM.

Traffic: W9DXZ 216, W9ERU 145, W9BZO 81, W9BLL 46, W9CIA 46, W9EJO 46, W9AHC 36, W9GJ 26, W9FQS 26, W9FDJ 22, W9AEB 20, W9FCW 18, W9APY 18, W9BSH 16, W9FDY 15, W9CCH 9, W9DOX 8, W9KA 7, W9CKZ 7, W9GK 6, W9KB 3, W9AVL 3, W9ACT 1, W9BNI 1, W9DGO 1.

INDIANA — SCM, D. J. Angus. W9CYQ — The Indianapolis Radio Club has appointed a committee to put on a hamfest. Who all can come? W9ELX again leads the state with 561 even though the month was short. W9EKW is building a new shack. W9EYB shut down by female QRM. W9DBJ reports that he will soon be going on crystal. Looks as though that will shut W9KJ down. W9BKJ reports that he is on again as he has borrowed W9DBJ's crystal. W9GCO is changing to 3500 kc. W9AEB is putting up a new Zepp antenna. W9DGB and W9CMJ are going to college at Earlham. W9FGH is a new ham at Richmond. W9EPH has the scarlet fever, so don't work him unless you have had it. W9DHJ and W9EKW are changing over to 7000 kc. for the summer heat. W9BZZ is in the BC set repairing business with W9CMQ. W9DSC is the new RM and district superintendent of District No. 4, which takes in central Indiana, Indianapolis, Marion, Bloomington and Terre Haute and the territory between. If you are not an ORS, send your reports and requests for schedules to W9DSC. W9FYB has a new antenna. W9AUP, W9CTD and W9CYQ visited hams at Dayton and Richmond, March 9th and 10th. Hamilton Ohio gang was at Richmond, so it nearly turned out to be a convention. W9ASX is using radio to arrange his Chicago dates. W9EVA is back on again. W9GFA moved to Marietta, Ohio. W9BQE has a new M.O.P.A. going. W9FKE, W9BWI and W9AAI have fone. W9CVX cracked his new crystal using it on fone. The Radio Traffic Association of Fort Wayne reports packed meetings since they are having regular speakers. W9EVB is using 180 volts of battery.

Traffic: W9ELX 561, W9EKW 207, W9ASX 164, W9DHJ 10, W9EXW 20, W9AHB 7, W9DBJ 6, W9BKJ 19, W9FCG 6, W9GCO 8, W9DPV 5, W9FQ 33, W9EVA 16, W9EEY 20, W9CMQ 8, W9DSC 25, W9GRF 11, W9EMR 8, W9CYQ 21, W9PF 8, W9MQ 2, W9BQE 8, W9EVB 14.

KENTUCKY — SCM, J. B. Wathen, III. W9BAZ — W9ARU has about given up television. W9ETD has a fone. W9FZY is putting in screen-grid. W9ELL works Aussie's any old time. W9BAN has had time finding reliable QSP points. W9MN has his new screen grid perking. W9BWJ is waiting for his U-X-866. W9BAZ hit the hay for a solid week per doc's orders. W9GAL says QRM bad on 7000 kc. W9JI is still knocking 'em dead. W9CEE installed a new filter and gets out better. W9BGA was QSO a French X station using low-power. W9FQN, assisted by W6RPM, talked to a friend in L. A. direct. Due to the shortened month, no one came within the prize zone. W9OX is still high with one month to his credit. Where is all the big competition that was talked of?

Traffic: W9JI 79, W9BAN 34, W9FQN 30, W9BAZ 16, W9FZY 16, W9GAL 12, W9CEE 11, W9ELL 9, W9BGA 6, W9ETD 6, W9ARU 8, W9MN 4.



MICHIGAN — SCM, Dallas Wise, W8CEP — W8BLA has been offered a contract with the Firestone Tire & Rubber Co. to op at their experimental short wave station in Liberia, West Africa. W8DJR-WOOD is using a vertical Hertz fastened to the top of the broadcast antenna mast and is 109 ft. high. W9CE and W9AXE reported on time this month. W8KD is a newcomer just starting up at Lapeer. Steck of W9BTQ is spending his time making hams out of the BCLs. W8AUB is busy lining things up for the coming hamfest in Grand Rapids April 20th. All Michigan hams are invited. A good feed and lots of entertainment are on the program. Drop W8AUB a line if you intend to come. W8ZF has a shortage of operators. W8CU and W8ASO are having xmitter troubles. W8CAT has a new transformer ordered. W8VH, Case High School transmitter is about finished. W8DSF says the bad weather and work knocked his schedules out for the time being. W8DSF of St. Joseph reports a mistake in his traffic total for February which should read 75. Sorry about the mistake, OM, and hope to do better. W8ACB is still off the air due to deflated pocket-book. W8CKZ wants report cards. Babcock of W8BGY has gone to Philadelphia. W8BGY started the Governors-President message on its way. FB, W8AUT is using a low power TPTG set with 250 volts. W8BV has visions of a 75-watter. Russ of W8DED says he will probably not make the BPL any more due to business, but he has told me that so often only to come right back same as ever. W8DYH is the new RM for the eastern section of Michigan and any traffic problems, dope on schedules, etc., can be submitted to him via radio or letter. His is also USNR and you can find him on 3500 kc. any night. W8DMS received several responses to the call for "Ops" for the National Guard Encampment, but says he has room for several more, so don't be bashful, fellows, if you would care to spend a couple weeks at camp with them. Get in touch with W8DMS direct or thru the SCM.

Traffic: W8DYH 201, W8JD 7, W8CVN 8, W9CE 19, W8AZW 11, W8KD 2, W9AXE 7, W9BTQ 12, W8AUB 11, W8ZW 7, W8ASO 18, W8DSF 3, W8DFS 42, W8DMS 24, W8CKZ 8, W8BGY 64, W8AUT 6, W8CFM 15, W8BV 4, W8DED 211, W8CEP 8.

OHIO — SCM, H. C. Storek, W8BYN — The personnel in Ohio is very good now and new appointments will be out long before the next report. Harry H. Porter, W8CRI of Athens, Ohio has been appointed Route Manager General of Ohio. Ed Nau, W8CMB, Cleveland is RM for Northern Ohio, Ed Anspach, Cincinnati, W8BBR, is RM for Southern Ohio, under W8CRI. Congratulations to all three of you, and best of luck. In spite of the short period, W8CRI made the BPL. The XYL, W8CNO, had the tough luck to blow one of her rectobulbs. W8BBR is busy. W8CMB turns in a nice total and reports that there will be a northeastern hamfest April 20th. It is with regret that we announce that W8JA plans to leave this section for work in the east. W8BAC proves that traffic can be gotten on most any band without schedules, if it is looked for and the operator is in earnest to do his best. W8GZ got most of his total with Army-Amateur messages. W8BKM did good work in the GPR. W8APB has been saving his shekels to go to the next convention. W8DVL is GRL school. W8DDF sends in his first report as ORS. W8DJG sprained his operating wrist cranking a "Lizzie." W8CXW is working on a net for public utility emergency work. W8AYO and W8BKQ are busy with BCL trouble-shooting. W8ADS has built a new monitor. W8DHS is going to have a good set. W8PL needs some tubes. W8OQ is busy. W8AMI blew his tubes. W8CNU reports it was a rotten month for traffic. W8EJ is constructing a new vertical antenna. W8DDK is now associated with W8BYN in business and says his ambition to pound brass at the SCM's has been realized.

Traffic: W8CRI 211, W8CNO 156, W8BYN 118, W8BBR 98, W8CMB 69, W8JA 52, W8BAX 40, W8GZ 30, W8BKM 19, W8APB 19, W8DVL 13, W8DDF 12, W8DJG 10, W8CXW 7, W8AYO 6, W8ADS 6, W8DHS 2, W8PL 3, W8OQ 2, W8AMI 1.

WISCONSIN — SCM, C. N. Crapo, W9VD — W9DLD again got into the BPL by the aid of his sixteen schedules although the Aurora tried hard to blanket his signals. W9ARE sends his final report before again reporting for duty on the Lakes with the Reiss Steamship Company. W9DNB will

be going to school. W9DLQ got in almost too late with a nice total. W9DND is building a 100-watt xtal layout. W9BWZ says deliveries were terrible this month because they had to be made in a boat. W9GEX is on 3581, 7162 and 14,324 kc. W9DJK says the local paper published five station photos and write-ups of ham stations. W9CVI is on the air consistently. W9FBJ seems to be about the only reliable contact at Madison. W9FHU says traffic is slow at Mosinee. W9DEK's xtal outfit coming along fine. W9FAW is getting a new screen grid receiver. W9LV, W9FZK, and W9VK were on for a few. W9DTK has improved his filter.

Traffic: W9DLD 262, W9ARE 119, W9DNB 45, W9DND 42, W9BWZ 26, W9GEX 20, W9DJK 15, W9CVI 14, W9FBJ 14, W9FHU 13, W9DEK 10, W9FAW 7, W9LV 3, W9FZK 1, W9VD 5, W9DTK 27, W9DLQ 83.

#### DAKOTA DIVISION

NORTHERN MINNESOTA — SCM, Carl L. Jabs, W9BVH — W9EGU has discontinued the WFBT schedule, but still has eight left, so his traffic total looks as good as ever. He also has a portable call, W9GZ, to use at his summer cottage. There will be no traffic slump at W9EGU-W9GZ this summer. W9FRB is second in traffic. W9CTW is moving. W9CT reports some 1929 signals. W9EGF is operator at WHDF, Calumet, Mich. W9CWA and W9BVH handled GPR messages. W9EHO ground his crystal until it stopped perking. Tough luck! W9BCT plans to use 3500 kc. W9DPB is rebuilding. W9EHI and W9BBT are both busy. W9GGQ and W9AMK are new hams for our section — welcome, OM's!

Traffic: W9EGU 239, W9ERB 32, W9CTW 27, W9CF 25, W9EGF 23, W9CWA 20, W9BVH 10, W9EHO 9, W9BCT 9, W9DPB 4. (February traffic) W9AOK 35, W9CF 29, W9CIY 9, W9DOQ 7, W9DPB 7.

SOUTHERN MINNESOTA — SCM, J. C. Pehoushek, W9EFK — W9COS handles half the Section's traffic each month. He is the RM so drop him a line more often, fellows, telling him what skeds you have and what you want. W9XI is having exams and QSK. W9AIR has a new Skatterbolt Six. W9ERT also busy with exams. W9EOH has now a 75-watt bottle. W9DOP is building xtal control. W9BHZ is on again consistently. W9BKK has the new MG working. W9ELA says 3500 kc. has lots of traffic. W9EFK had a 50-watter given to him. W9FCD finds his operating time restricted. W9DMA is house cleaning. W9DHP got back on 14 mc. W9BTW has a crystal. W9GGA handled quite a few. W9EYL is having a session with apt. BCL's who cut into his time.

Traffic: W9COS 134, W9XI 29, W9AIR 20, W9ERT 17, W9EOH 14, W9DOP 11, W9BHZ 10, W9BKK 8, W9ELA 7, W9EFK 7, W9EOH 6, W9GGA 9, W9EYL 2.

NORTH DAKOTA — SCM, B. S. Warner, W9DYV — W9BVF turns in a very nice message total for a short reporting month. W9DYA is a new Army state net control station. W9FCA handled a few. W9CDO has been on the 1750-kc. band with a couple of schedules.

Traffic: W9BVF 104, W9DYA 3, W9LYV 3, W9FCA 2, W9CDO 2.

SOUTH DAKOTA — SCM, D. M. Pasek, W9DGR — W9AZR comes through with the best traffic report. He has several skeds on 3500 kc. W9DB has given up on 28 mc. and comes through strong on 3845 kc. W9DWN handled the Governor's-President message OK. W9DLY sent in the best report last month, but it was too late for QST. He hears WFA, WFBT and WPAT regularly. W9DNS and W9DGR are trying to organize their Army-Amateur nets, but are having a hard time to hear the State Net Control Station — W9CKF. The Sioux Falls gang are rejoicing over a rumor that ex9DES is returning to the state (So am I — SCM). When W9EJ gets his new shipment of B batteries he should have a real rig. He (or his pocketbook) bemoans the fact that he hasn't good old A.C. W9DLY may be heard xtal on 3500 late in the evenings. W9BDF at Timber Lake has been using fone on 1750 kc. for the last few months, but is dropping to 3500 for AA schedules.

Traffic: W9AZR 40, W9DGR 31, W9DB 19, W9DWN 15, W9DLY 10, W9DNS 9.

## DELTA DIVISION

**ARKANSAS** — SCM, H. E. Velte, W5ABI — W5CX is a new reporter with a nice total. W5EP handed in the largest total and reports that he has rebuilt his station completely for 1929. His best DX was CM2CO, W5SS is selling out and will not be on the air until next fall. W5AQX is still busy at K.L.R.A. W5ARA has been very busy notifying offwave 7000-ke. stations to get where they belong. This is FB, OM, and we are hoping that you will keep up the good work. W5HN has been having business QRM. W5ABI has been getting out FB on 14 mc. W5BDD has replaced his 50-watter with an 852 tube and has been getting out FB. W5BCZ worked Africa on his 852. It is impossible for the SCM to know what is going on over the state if the gang doesn't drop him a line. Come on, fellows, let's see who will be in the line-up next month.

Traffic: W5EP 61, W5CX 21, W5AQX 17, W5ABI 17, W5HN 15.

**LOUISIANA** — SCM, M. M. Hill, W5EB — W5WF, high man for last month, has a commercial ticket and has gone to Port Arthur for a trip to sea. W5AWL is second up and says he will keep the bottles warm. W5BDY has replaced his 210 with 5-watter and gets out as well as ever. W5NS has that xtal transmitter all fixed, but has trouble with his MG. W5BDJ is having trouble with his MOPA. W5LY has business QRM. W5ANS has had his shack painted. W5AFE handles traffic with m7NIC and YSLDN. W5ANA is a new ORS. W5AYZ had the pleasure of starting our governor's message as W5YW was not in proper working order at the time scheduled to start. W5EB is building another xmitter for the 14,000-ke. band.

Traffic: W5WF 117, W5ANS 40, W5EB 38, W5AFE 18, W5LY 8, W5BDY 7, W5ANA 2.

**MISSISSIPPI** — SCM, J. W. Gullett, W5AKP — W5QQ has schedules with W5YD, W5WF, W4KY, W5AQY and W5AAD. W5FQ has been appointed bypass condenser blower in this section. W5LY is now trying out 14 mc. W5BEV is now on 7000 kc, using five 201A tubes, with an input of 21 watts. W5AYB, W5BDZ and W5GQ are making quite a bit of noise on 7000 kc. W5BDE is busy playing in an orchestra. W5BBX has his transmitter going. W5AKP forgot and put his hand on the power switch of his transmitter and 1100 volts floored him, but he got up and kept on working DX as if nothing had happened. The radio inspector visited Meridian yesterday and gave examinations for both amateur and commercial licenses. It is with sincere regret that we report the passing of W5AYP from this world to the next, as he was killed in an airplane accident near Oakland, Miss., a few days ago. He was a licensed aviator and was liked by all who knew him.

Traffic: W5QQ 83, W5FQ 7, W5AKP 75.

## HUDSON DIVISION

**EASTERN NEW YORK** — SCM, F. M. Holbrook. W2CNS — W2QU makes the BPL with lots of traffic daily with m7NIC and lets PYLAW use key to reach his home in Brazil. W2BGB procured GPR message. W2LC makes good first report. W2ANY is busy with air mail reports. W2AYK is working on 3965 kc. and finds plenty of traffic. W2AQL is working South Africa regularly and reports Yonkers Radio Club now flourishing with meetings first Tuesday each month and all hams welcome. W2AXX and W2FE find weather bad. W2BLN is quitting the air temporarily on account of health. W2BHV handled St. Virgin Islands GPR message. W2AUC handled his share. W2BEF entertained five White Plains hams at his shack. W2BKN is active. W2BJJ saw W2ALC QSO Byrd Expedition.

Traffic: W2QU 105, W2BGB 47, W2LC 47, W2ANY 27, W2AYK 18, W2AQL 8, W2AXX 3, W2BEF 30, W2AUC 20, W2BJJ 4, W2BHV 2.

**NEW YORK CITY AND LONG ISLAND** — Acting SCM, V. T. Kenney, W2BGO — Manhattan: W2BGO leads his borough with 171. W2BNL reports a few.

Bronx: W2BPQ leads the Bronx, and keeps his Army sked regularly. W2SF is keeping his skeds as they should be kept. W2CYX and W2AFT are doing some good work.

Brooklyn: W2BEQ is the ring-leader this month and makes the BPL two ways. W2PF's antenna came down in

the recent storm but he managed to get it up again well enuf to keep the Second Corps Area AARS Net working. W2BRB is putting together a new "de luxe plus" xmitter (all wave, quick change, CC) and will be heard again on 28 mc. very soon. A general house cleaning is going to take place and all active ORS are urged to take care to send in their reports in order that they may retain their appointments.

Traffic: Manhattan: W2BGO 171, W2BNL 2. Bronx: W2BPQ 52, W2SF 21, W2CYX 37, W2AFT 17. Brooklyn: W2BEQ 219, W2PF 16, W2BRB 1.

**NORTHERN NEW JERSEY** — SCM, A. G. Wester, Jr., W2WR — W2WR is now on 7000 kc. and will be glad to work his various ORS. W2AOS is handling lots of traffic in the Army network. W2DX has been doing Naval Communications each Friday with NDB. W2AMG connected with the west coast on fone. W2JG is working all districts with his new MOPA on 3500. W2IS has two xmitters in operation. W2GO has xmitter perking fine but cannot dig up traffic.

Traffic: W2AOS 20, W2DX 10, W2JC 12, W2BDF 5, W2IS 4, W2CO 3, W2JG 8.

## MIDWEST DIVISION

**IOWA** — SCM, H. W. Kerr, W9DZW — A short month and a pretty good traffic total, thanks to the faithful. RM W9EJQ tops the list and reports the select signs. W9BCA's DX is West Africa on 14,000 kc. and WSBS at Tahiti. W9EIV reports W9PB applied with the YL, congrats from the gang. W9DPL desires popularity, if only a small traffic report. Wait till he gets the 25-cycle merc he bought of W9CK going. W9CK is waiting the HI line with 60 cycle to try the prize ESCO MG. W9AYU was QSO m8NIC and sends traffic report. W9FQG shot his old S tubes but nice traffic, tho. W9CZC has a new station license and is going again. W9DXP put over the GPR for Iowa with a lot of kick to it and is making permanent improvements. W9EHR totals 23 and the two fifties went west, 210's now. W9DEA has his MOPA perking and gets a start on traffic. W9ESP reports, has skeds for SW, wants traffic. W9EFH is playing with fone. W9DGW is away on a job and the station is closed. W9BTL is in radio school. W9YI, the Iowa State College, Ames station, reports the Campus Club will have their call and be going soon. W9BCA handled the GPR msg from Manila. W9CVU got a three-column write-up and picture in the Sunday edition. W9FLK is trying the 7000-ke. band. W9BKV says 73 to the old gang. Plans for the Midwest Division Convention at Ames are materializing and the SCM would like the address of every chap that is desirous of a program — there will be lots doing and we know you will want to get one. Fieldman Hebert will give us the life history of "Our A.R.R.L." Assistant to the CM, Huber, will take on "Communications Activities," and Mr. Turner, Acting U. S. Radio Supervisor, will speak on Rules and Amateur's Problems. Others are planning strong. Go thou and do likewise! for Ames, May 10th and 11th. W9FFD and W9DXP reported almost too late for fair totals.

Traffic: W9EJQ 228, W9BCA 140, W9DZW 131, W9EIV 57, W9FQG 45, W9CZC 42, W9ESP 38, W9FFD 33, W9FZO 36, W9DXP 32, W9FLK 35, W9BJJ 24, W9EHR 23, W9AYU 15, W9DEA 13, W9FVC 12, W9DPL 1.

**KANSAS** — SCM, J. H. Amis, W9CET — Due to a short month, no one made the BPL. W9LN leads the gang with a nice total and still works his daily sked with the Aussies. W9CFN says school is easing up a bit and he expects to make the BPL next month. W9FLG has been appointed Army Amateur control for Kansas and is keeping 10 skeds. W9FUG is going strong on 14,000 kc. and is building a S. G. receiver. W9ENL has been appointed A-A net control for the first district. His fone was reported in Alaska. W9BHR is on 3500 kc. and has to call on W9FLG when he needs an op. He is also trying to convince the SCM that push pull is better than xtal. HI. W9CKU says business is good so the radio must suffer. W9FRO is complaining about QRN, and says he wants a sked west and can't get it. Will someone please arrange this for him? W9FTY thought his 210 went west, but made a new RF choke, and now it perks FB. HI. W9FYP changed from ultraudion to Hartley and now gets pure DC. W9CET has installed a pair of 866's as rectifiers on the last stage of his xtal rig, and says they are

FR. W9BFZ is going strong with his M.O.P.A. rig on 7000 kc. W9GHI is on 3500 kc. fone and CW. W9BII lost his license and has been very QRW work, but will be on regularly now. W9ECF is on 3500 kc. fone and says he is going down on 7000 kc. soon. A number of ORS are not reporting and can expect to be cancelled if this continues. W9FTG, the RM, reports ORS night progressing nicely with a lot of interest from the gang. Listen for him on Wednesday nights at 8 p.m. 3500 kc. The SCM would like to hear from every one in Kansas who is doing anything of interest.

Traffic: W9LN 188, W9CFN 10, W9FCG 56, W9ESL 10, W9BHR 40, W9CKV 11, W9CET 160, W9FLG 115, W9ERO 51, W9FTY 113, W9FYP 78, W9BEZ 29, W9HL 7, W9GHI 8.

MISSOURI — SCM, L. B. Laizure, W9RR — St. Louis: W9GEK is now ready for traffic. W9DSU broke his mercury and had to QSY chem rect. again. Sked with W9FLG going line. W9BHF tried to make a better antenna. W9DZN reports low power exp. at his station. QSO W2BNY with 4.7 watts on the QRM band. W9BMU joined A-A net among other activities. W9BDI of Pierce City just got license. He is a member of Battery A, 203rd C.A. (Anti-aircraft section) and plans on being in the A-A net. W9DKG has a new sked. CM5BY five days a week. W9BAS is a new station in Columbia. W9DAE was a visitor in K. C. lately. W9FVM received his A-A appointment. W9DHN reports another new station coming up at Fayette. Ex-W9CHG is now in Toledo. W9DMT is still a traffic handler when possible. W9ECS turned in an excellent total. W9ERM writes that W9AJW is now at Michigan U working W8BEK. W9BUL is rebuilding. W9CJB is working in a plate glass factory and tends the furnace. W9GJF is now on the QRM band with 1929 Hartley and 200 volts B batt. W9BJA says he blew everything but key and antenna. W9EPX lost his QST in the mail. W9GCL is still on the traffic band and holding out against QRN.

Kansas City: W9TJ played a heavy hand in the GPR. W9DQN put the Missouri GPR message direct into W3GT without QSP. W9RR is still at W9DQN, reporters take notice! W9ACX has a 210 rig going on the fourth floor of the Wurlitzer Building. W9EQC handled a wad of traffic. W9DQN helped rebuild the works at W9WV. W9AYK is working over in K. C., Kansas. (QRA Mace-Reynolds Co.)

Traffic: W9DOE 67, W9DSU 27, W9DKG 108, W9DAE 43, W9DHN 26, W9DMT 3, W9ECS 146, W9FRM 40, W9BUL 4, W9CJB 12, W9BJA 34, W9GCL 2, W9DQN 14, W9EQC 53, W9GEK 6.

NEBRASKA — SCM, C. B. Diehl, W9BYG — W9ANZ breaks in on the President-Governors Relay. FB. W9QY experimenting with crystal, from grinding on up. W9EEW is sick in bed with the flu but still reports. W9DTH reports for the first time as ORS and looks like a "stepper." W9DVR is very busy observing. W9EAM is remodeling again, but still keeps schedules. FB, OM. W9DNC still holds his skeds and is studying for commercial ticket. W9BOQ reports W9DTH in Marquette about ready to bust the air. W9BLW is very chesky over his commercial ticket and hopes to be an I.R.E. soon. W9BBS is remodeling for fast QSY. W9BQR has sickness in family. W9CHB in University at Lincoln is tinkering with portable xtal-control. W9CBK is now operating at WOW. W9DHC again sends in a fine report, also says that he is busy sending code lessons on 165 meters Saturday, Sunday, and Monday. That is sure fine.

Traffic: W9ANZ 1, W9QY 4, W9DTH 6, W9DVR 2, W9FAA 4, W9DNC 5, W9BOQ 1, W9BLW 5, W9DNC 3, W9BQR 1, W9BBS 3, W9DHC 8, W9CBK 2.

NEW ENGLAND DIVISION

CONNECTICUT — SCM, C. A. Weidenhammer, W1ZL — Unfortunate circumstances forbade compilation of the February report in time for March QST. We trust that we shall not be forced to do that again. WIBOD is doing splendid low power traffic work. W1AMC worked ten countries on his UX210. W1OS has new auto parts in place of radio junk. W1VB is still battling out his schedule traffic. W1AFB's totals continue to be wholesome. W1BLQ is another of our ORS candidates. W1AOX gets crystal reports. W1NE is on 7000 and 3500 kc. W1BWM has a new tube rectifier unit. W1ADW is doing good traffic work. W1BJK cleaned up his set. W1BDI continues to

handle much Philippine traffic. W1BHM has schedules with W1CTI. W1A0I and W1AFB. W1TD got the surprise of his life when W6ADW answered his call on 3500 kc. W1B-1BQH has a B battery set in operation. W1CKP is back on the air. W1HJ has a 250-watt and several other transmitters. W1BNS has been very busy. W1AVT lost his faithful 50-watt. W1AMG handled an important Army message from KDV5. W1BJF has a new TP-TG push-pull circuit. The same old Nicaraguan schedule is kept by W1IM. W1PF is getting a new power transformer. W1BGC is on 7100 kc. W1CTI states that W1VB will be off the air until settled in his new location. W1RFP reports a schedule with W1BIK who is plying between New York and Texas and signing NAI-BX. W1VE hopes to be brass-pounding on the bounding main very shortly. W1ZL erected a new antenna. Traffic was handled with 55X. W1BM is working on 7000 kc.

The figures in parenthesis are last month's.

Traffic: W1CTI 33 (70), W1BGC (11), W1PF 11, W1IM 30, W1BLF (15), W1AMG 47 (69), W1AVT 2 (3), W1BNS 4 (12), W1HJ (18), W1CKP (16), W1B-1BQH (1), W1TD 14 (18), W1BHM 12 (22), W1BDI 110 (164), W1BJK 9 (20), W1ADW 9 (85), W1BWM 49, W1NE 13, W1A0X 17 (17), W1BLQ 12 (15), W1AFB 66 (80), W1VB 18, W1AMC 6, W1RP 62, W1BOD 5 (17).

RHODE ISLAND — SCM, C. N. Kraus, W1BCR — W1AWE is pleased with his 866's. W1BLV and W1BQD are on again. W1BCR was QSO W1CHP on 5 meters. HI. W1AGI would like to make skeds for traffic. W1CHP and W1AVH are two more new hams. FB, W1MO has been rebuilding, with a new Zepp and pair of 866's. W1BLS is on. The R.C. of R. L. holds its meetings every Monday in Newport Rogers Hall, Brown University. All persons are invited to attend.

Traffic: W1BCR 88, W1BQD 6, W1BLV 4, W1BLS 2, W1AWE 2.

EASTERN MASSACHUSETTS — SCM, E. L. Battey, W1UE — W1ACH, W1LM, W1KY, and W1CQ turned in very good totals. The Governors-President Relay went off very well in this section with the following stations taking part: W1ACH, W1LM, W1KY, W1UE, W1RL, W1VR, W1ACA, W1ARS and W1KH. W1WU is interested in ORS. W1KY is now a USDA station. Gladys asks that active Q.R.S. take her recent letter with a grain of salt. It was written to further activity and no offense meant!! W1ABA has taken a YL unto himself. Good luck, OM! W1CQ was QSO an airplane in Texas which was 1000 ft. up. FB. W1ACA has new HI C circuit and worked e8YTPZ. W1BVT got report of QNA5 from England on 28 mc. and worked NJ2PA on 14 mc. DX has been just as good as ever at W1WV. W1ARS has one of the desirable 1929 signals. ORS not mentioned in this report — please make every effort to report next month.

Traffic: W1ACH 188, W1LM 108, W1CQ 83, W1KY 62, W1WU 24, W1ARS 21, W1ACA 17, W1KH 12, W1WV 4, W1UE 4.

NEW HAMPSHIRE — SCM, V. W. Hodge, W1ATJ — W1AUY is going slowly with his new 50-watt MO-PA. College work is keeping W1BFT busy as usual. W1AEF is carrying on with a 201A. W1UN and W1LP are handling a bunch of traffic. W1ACE handled a few. W1COW has been sick. W1XN is getting out well with his xtal outfit. W1AFD is putting out a PDC sig now. W1AVJ has a new screen grid receiver. W1BST reports the arrival of a brand-new YL. Congrats, OM. The SCM has been having trouble with the xtal at W1ATJ.

Traffic: W1ATJ 156, W1LP 83, W1ACE 18, W1AEF 15, W1AVJ 18, W1BFT 13, W1COW 10, W1XN 9, W1BFT 3.

MAINE — SCM, Fred Best, W1BG — W1ANH has been experimenting with a 14-mc. Zepp antenna. A push-pull transmitter for 14-mc. operation has proven to be the real thing. Good work, Harry. W1CDX turned in a good enough total to land him sixth position. W1BBE turned a mighty fine total in. Fine work, Ernest. Mrs. W1AJC joined the BPI. this month. She says that the fifty blew shortly after making the grade and that the extra traffic was evidently too much for it. W1CPT is a new ham in Portland. W1AHY turned in his usual fine total. W1AUS is going great guns on 3500. W1BEZ is going back to 3500. OM W1AJC handled a good string this month in spite of the fact

that the OW was busy making the BPL. Hi. W1AQD handled the California GPR message. W1AQL turned in a mighty fine Official Observer report. W1KQ has been rebuilding. W1ASJ handled an urgent message from EF8CT to California on 14,000 kc.

The SCM has been away for fifteen days on active duty with the Naval Reserve, and reports a fine time, with plenty to do, and lots of hams visited. Due to a late return, as well as sickness in the family after his return, the report for last month could not be gotten up in time to reach HQ in time for printing. W1BIG is rebuilding his transmitter, and plans on trying pure DC for a change.

Traffic: W1AUR 248, W1ANH 240, W1AJC 206, W1BIG 176, W1BBE 137, W1CDX 64, W1AHY 40, W1AUS 36, W1BEZ 25, W1AJC 20, W1AQD 19, W1AQL 13, W1KQ 11, W1ASJ 1.

**WESTERN MASSACHUSETTS**—SCM, J. A. Tessmer, W1UM—The activity in the section is increasing. FB! W1BIX is looking for some good active stations to arrange schedules. W1BKG is active in Pittsfield. W1WQ has rebuilt TPTG. W1PY is on 5 to 6 p.m. week days. W1AJK and W1ANI are busy with Naval Reserve drills. W1ADO is an active worker in the Worcester Radio Club. W1BVR is on 7248 kc. W1BTV is on 3800. W1GR got his new shack all painted. W1ASU has been reelected president of the Worcester Radio Association, 274 Main St., Room 301, where meetings are held each Thursday evening. All hams are welcome to visit. W1AWW will be on regularly.

Traffic: W1BVR 2, W1BIV 4, W1ADO 7, W1ANI 17, W1BIX 10, W1BKG 15, W1WQ 3, W1PY 8, W1ASU 8, W1UM 11.

**VERMONT**—SCM, C. A. Paulette, W1IT—Several ORS cancellations have been made on account of inactivity. I wish to say here that I will honorably cancel any station with the privilege of re-instatement any time upon request if things are so that you can't possibly be active. We have four reporting stations this month, and they are W1CGX, who is high man again this month. FB. OB. Thanks. W1BJP for your report, also, W1BEB. Glad you fellows stand by the game. W1AAO says there's lots of traffic on 3500 kc.

Traffic: W1CGX 132, W1IT 31, W1BJP 7, W1BEB 3, W1AAO 173.

#### NORTHWESTERN DIVISION

**OREGON**—SCM, R. H. Wright, W7PP—W7ALM of Astoria is using a 204A with only 90 watts input.

W7AMQ will have a separate xmitter for the 7000 and 3500-ke. bands from now on. W7JC is now located at Roseburg. W7PE has business QRM. W7EO has been active in phone work. W7MV is the new Route Manager for this Section. Inquiries regarding schedules should be addressed to him. W7ABH is busy with a ship job. W7UN, W7PG, W7ALK, W7AIG and W7UB are all reliable traffic stations and are on consistently.

Traffic: W7UN 34, W7UB 18, W7WR 15, W7AMQ 14, W7PG 6, W7ALM 4, W7ALK 3, W7AIG 2, W7MV 2, W7PE 1.

**MONTANA**—SCM, O. W. Viers, W7AAT—W7HP takes traffic honors again this month and W7HT ranked a close second. These two stations hold down heavy daily traffic skeds and handled seven death messages in twenty days. W7AAT worked KFR5 in the Canal Zone and was reported QSA4. Why not have a report from all the gang at once next month?

Traffic: W7HP 119, W7HT 101, W7AAT 31.

**WASHINGTON**—SCM, Otto Johnson, W7FD—Unfortunately, word of the changed reporting dates did not reach the SCM until too late last month, so this is a combination of February and March reports. Activity is on the increase throughout the state, with many of the gang getting ready for the annual exodus to Alaskan stations. DX is still to be had in spite of the narrowed bands. W7GP in Olympia handled the Governors-President Relay in fine shape. FB. Red. OB! W7PH of Everett staged a nice piece of work during the Washington Basketball Tournament at the U. of W. pavilion, erecting a portable station there (W7KZ) and keeping his home school informed of the progress of the tournament.

Interest in the coming Seventh District A.R.R.L. Convention, to be held in Portland, is evident throughout the

state, and a record attendance can be expected. We understand this convention will be held about the first of September as usual. Don't forget to bring the OW or YL to the banquet. Hi. AND, do not forget the new reporting date is the 15th!!!

Traffic: W7ACY 88, W7VK 65, W7GV 54, W7EK 53, W7PH 62, W7AAE 47, W7PK 46, W7KT 41, W7GR 37, W7AOB 33, W7GP 27, W7BB 23, W7ACA 18, W7KZ 18, W7WG 14, W7ALQ 14, W7FA 12, W7BR 9, W7ACS 7, W7AF 6, W7ED 6.

**IDAHO**—SCM, James L. Young, W7ACN—W7CG and W7FN are two newcomers. W7ACP is going to rebuild. W7II and W7HE are both on the job. W7GU is on 3500 with fone and 7000 with CW. The KIDO gang is putting on a second KIDO ball. W7YA handled the Idaho and three other Governors-President Relay messages right to Miss W3CDQ in Washington, D. C. Good work, Austin. They report three new ops coming on right away from W7YA. W7HR and W7ACD are right on the job. W7JF needs a receiver. W7ACN has been enjoying trying to get a new MOPA to perk. W7FB is on 7000 quite a bit.

Traffic: W7YA 34, W7ACD 9, W7HR 9, W7JF (Feb.) 126.

#### PACIFIC DIVISION

**LOS ANGELES**—SCM, D. C. Wallace, W6AM—Two stations make the BPL this month, W6AKW and W6DKV. Forty-six stations reported to this office, with thirty-seven handling traffic. W6ZBJ and W6AVJ send in fine reports. W6AM was QSO 7 countries on March 15th on 7200 kc. 1929 is sure fine for DX on the 7000-ke. band. W6BZR talked to VZ when he was 2700 miles off Cape Hatteras. W6CZO and W6CHA reported. W6UJ and W6DJJ keep some good skeds. W6TK just came on the air February 28th. The station is owned by Whittier College, operated by W6ALZ and W6CZU. W6FT has been selected as the base station by the Glendale Union High School on their annual trek to Death Valley. All messages will be handled through W6FT from Death Valley and other points, using portable transmitter. W6DLL, W6EMG and W6AWQ send in good totals. W6ESA has new antenna system. W6ELZ, president of the Long Beach Associated Radio Amateurs, is going to put on a stunt at the quarterly banquet on March 29th at Pasadena. W6EKE handled quite a few messages for England from actors in the D8Oyly Carte Opera Co. at the Mason Theatre one week. W6OF had another snowstorm this month. W6EKC reports that W6DKV worked 3 ZL and 2 VK in one week. W6CUK has crystal control. W6CNH is back on the air with a pretty net. W6HS has been doing fine work in the USDA Net. W6MA kept schedules with portable W6ZZA. W6COT reports that the L. A. High School has recently organized an amateur radio club and will soon be on the air with 75 watts using call W6DSO. W6BVM reports plenty of active stations in Fresno now. W6EAF is trying for Army and Navy Reserves, and is sending code practice to beginners. W6AKD, W6EFA, W6CZT, W6EQF and W6DYL send in good reports. W6DZI is working at Miller Airplane Products. W6DHR and W6EPH send in good reports. W6AXE's antenna blew down in a recent windstorm. W6DEM thinks he will come back on the air. W6ZH is building 1929 receiver for W6BJX who is QRW as usual. W6CUH has been working on new transmitter. W6ABK has just gotten on the air again. W6BGC is on 3500 with fone. W6BTA has been rebuilding. W6ASM is building a new frequency meter. W6AEC got new crystal xmitter. W6AOS thinks 1929 conditions just as good as 1928 or better. W6BRO has changed his transmitter over to TPTG. W6OPY is putting a fone set on 3500.

Report of March 9th to all RM's shows our section highest in U.S.A. in number of reporting stations. Three more reported than any other section in the USDA. We are second in traffic total for the U.S.A. Fine work, gang!!

The Quarterly A.R.R.L. banquet will be held Friday, March 29th, at the Hotel Maryland at 7:30 p.m. Prizes include a pair of W6EX's new Mercury Vapor Rectobulbs. Director Babcock will be present. YLs are especially invited. It is sponsored by the Short Wave Club of Pasadena.

Radio Doings Short Wave Class is back on the air, permanently this time, every Monday and Thursday evening, 7:30 to 8 p.m. Code instruction is transmitted by W6ELZ.

Signals will be found at 3530 kc. with ten minutes very slow sending, about three words per minute. The second ten minutes is a bit faster, and the third ten minutes is about eight words per minute.

Traffic: W6AKW 386, W6DKV 217, W6AJJ 107, W6ZBJ 104, W6AM 71, W6BZR 58, W6CZO 54, W6CHA 52, W6UJ 46, W6DLJ 51, W6TK 43, W6FT 32, W6AWQ 32, W6FMG 30, W6DLI 28, W6ESA 23, W6ELZ 21, W6EKE 20, W6OF 15, W6EKC 10, W6HS 12, W6MA 10, W6COT 8, W6BYM 8, W6EAF 8, W6CZT 6, W6DYL 6, W6AKD 5, W6EFQ 5, W6DAI 5, W6EQT 5, W6DHR 4, W6EPH 3, W6ARE 3, W6DHM 2, W6BJY 2, W6ZZA 2.

EAST BAY — SCM, J. Walter Frates, W6CZK — The Board of Directors of the Oakland Radio Club have practically completed arrangements for the next tri-section hamfest of the East Bay, San Francisco, and Santa Clara sections in Oakland at the F or d'Italia restaurant on Friday evening, April 26th. They agreed to sponsor the affair after authorization by the last section meeting. There will be entertainment, a chicken dinner, and prizes. W6ZA, Mr. S. G. Culver, W6PU, and W6ALX have been appointed a committee of four to determine the best way of handling the \$235 treasury owned by the section now as part of the profits of the last division convention. The appointment of a section secretary-treasurer and committee is being considered. W6PU, W6DCZ and a local auditor have been appointed an auditing committee to audit Mr. Culver's accounts on the convention. East Bay section men under W6IP attended a recent hamfest of the Sacramento and San Joaquin Valley men in the Lido Hotel in Stockton and discussed traffic routes. The two traffic teams of the Oakland Radio Club also held a dinner at an Oakland restaurant, the losers paying for the winners. Hi, W6IP is high man again in traffic. He has a 50-watter in a High C Hartley and has moved to 3500 kc. due to his appointment as a CPO in the Naval Reserve. W6ALX, the section's old reliable, was next with a good total on the 7000-ke. band. W6AWF handled a good amount of traffic in spite of his interminable experimenting. W6DWI is still doing DX traffic on 7000 and 14,000 kc. W6EBA's skeds stood by him nobly. W6DUR, Burke and MacClara, are still pounding away on 3500 kc. W6RJ has been handling traffic from Webb, W6MI, under W6ZZG. W6ZA, son of W6ZD, made his bow as a traffic man this month on 3500 kc. W6BI is keeping a sked with K7AER. W6EDK has a new metal smokestack on the roof of his apartment house. W6BZU is flirting with the MOPA. W6CGM has gotten settled in his new QRA but not doing much consistent work yet. W6IJJ has resumed his sked with K7AER and reports Oliver as experiencing the worst snow-storm he ever saw, lasting four days. W6EDR is another of the men who favor 3500 kc. W6EY is swinging into his traffic work, and says next month will be big. W6EBM has two UX-210's in push-pull. W6EDT is rebuilding with a screen grid four-tube receiver. W6BFO has a new 250-watter going in. W6MI still experimenting. W6PU is experimenting and handling QRM complaints. W6BTCX blew all his filter condensers recently and expects to have xtal control this summer. W6IT is swinging the Oakland Radio Club into spring and summer program. W6CTX has a Hartley xmitter and his old stand-bys, panake inductances.

Traffic: W6IP 194, W6ALX 157, W6CTX 125, W6DWI 91, W6AWF 82, W6EBA 69, W6DUR 42, W6RJ 33, W6BI 14, W6EDK 13, W6ZA 12, W6ALV 10, W6BZU 7, W6CGM 7, W6HJ 7, W6EDR 5, W6EY 2, W6EBM 2, W6EDT 2, W6RFO 2.

SANTA CLARA VALLEY — SCM, F. J. Quement, W6NX — Reports should be forwarded on the 15th together with a list of "good and consistent" stations. W6BMW is waiting for a pair of 866's. W6AME increased his power to 75-watts. W6BAX was QSO all continents on 14 mc. during the month. W6BNH is located in a deep mountain ravine. W6AMM is president of the Radio Club at State Teachers College. W6EBP and W6RIY are on consistently. W6AAZ is on 14 mc. now. W6AJZ is off the air at present. W6NX and W6BYH are on 3500 kc. now.

Traffic: W6NX 10, W6BAX 3, W6EBP 9, W6BNH 8.

SAN FRANCISCO — SCM, C. F. Bane, W6WB — With the resignation of Mr. Morrison, former Route Manager, taking place immediately, I have appointed in his stead,

W6WN. Art Arrigoni. He will be very glad to help line up some good skeds or help in any way possible.

W6AD leads everyone else in the section by miles, and makes the RPL in two ways. FB, OM. W6PW has at last made good his threat and ground himself a crystal. W6DPF is having some bad luck with his new receiver. W6UF-W6HB report DX fair on 14,000 kc. Hope Bill can repeat some of his 28 mc. DX from S. F. W6DFS is still thinking about reporting. W6AWA is now back on the air in earnest. W6KJ is secretary of the new radio club, known as the Associated Radio Amateurs of San Francisco. W6WB was elected president, and W6WN treasurer. W6ERK reports some good DX. W6CIS has been keeping skeds with W8BS and W1MK. W6DZZ and W6DYB report as usual. W6CZM starts out with a nice report.

Traffic: W6WN 20, W6DYB 33, W6AWA 15, W6CZM 18, W6DZZ 12, W6ERK 4, W6KJ 2, W6AD 259, W6CIS 64, W6BMM 20.

ARIZONA — SCM, D. B. Lamb, W6ANO — W6EOF, working on the 7000-ke. band, leads the section this month. Fiddler, second op, has gone into aviation at Riverside, Calif., with the Army. W6BJF on 3500 kc. mostly with lots of traffic. W6EAA is back on the air with push-pull again. W6CDU has a new Ford. W6ANO is planning on rebuilding. W6CAP is using an 852 and getting out OK. W6EFC is on 14 mc. and 7000 kc. W6DGY is planning on getting a commercial ticket soon. W6SW was over visiting the gang in Phoenix. W6CRA has exam QRM. W6DCQ is building a new shack. W6BWS hooked ZS2B, who is ex FOA50. W6CDY expects to have crystal soon. W6DTU hears a lot of DX on 14 mc.

Traffic: W6ANO 9, W6EOF 447, W6EAA 12, W6BJF 56, W6BWS 46, W6CAP 3, W6DTU 23, W6CDY 25.

HAWAII — SCM, F. L. Fullaway, K6CFQ — K6AVL handled the most traffic for the month. He kept skeds with W6FT on the 7000 and 14,000-ke. bands. K6ENE is a new station on the 7000-ke. band with a 210 tube. K6DQQ is rebuilding his transmitter. K6AFF is a new ORS. K6DTG is on 7188 kc. with three skeds. K6DPG has a tone set on 3500 and code sets on 14 mc. and 7000 kc. K6ALM has a new mercury arc rectifier. K6CLJ has a rebuilt W6EX 204A tube on 14 mc. and 7000 kc. K6ACW is a new ham on the air with a 210. Wish all the fellows that are on the air and not reporting would do so. We need the dope, fellows. How about a record year for 1929?

Traffic: K6AVL 153, K6ENE 24, K6DQQ 23, K6AFF 17, K6DTG 12, K6DPG 9, K6ALM 6, K6CTJ 4.

SAN DIEGO — SCM, G. A. Sears, W6BQ — W6AJM reports QSO several European stations on 14,000-ke. band recently. W6BQ installed a new antenna so can QSY all bands now. W6DNS reports important traffic handled this month and five skeds. FB. W6ACJ has three regular skeds. W6HAM is going to try 28 mc. soon. W6EPZ has one regular sked now. W6EC is busy with USNR activities and 28-mc. tests. W6QY reports official intermediates for Chile as CE and Peru as OA. W6CNK is arranging sked with W7WN.

Traffic: W6AJM 121, W6BQ 108, W6DNS 103, W6ACJ 89, W6RAM 67, W6EPZ 39, W6EC 39.

PHILIPPINES — SCM, M. I. Felizardo, K1AU — W6EEO again handled the report by radio — FB! K1HR at Fort McKinley keeps the following regular schedules: K9PB, Zamboanga, P. I., 5:15 p.m. daily; WVN, Tientsin, China, 6:00 p.m. daily; K6TB, Sumay, Guam, 7:30 p.m. daily; K1RC, Radio School at Cavite, P. I., 8:00 p.m. daily; VK6HE, Geraldton, Australia, 8:30 p.m. daily; W6EEO, Williams, California, 9:30 p.m. daily. Frequency regularly used is 7010 kc. (42.8 meters).

Traffic: K1HR 557.

SACRAMENTO VALLEY — SCM, C. F. Mason, W6CBS — W6EEO reports with a whoop and a bang — just look at his total!! Attaboy, OM. Daily schedules are kept with W9EGU, K1HR and W6AJM, and more are planned for the future. W6DON comes across with a good number and is active with the USDA Net. W6AFU was one of the official starters-out for the GPR. W6BDX and W6EKC both worked a bit. A meeting of the Superior California Amateur Radio Club was held at Stockton recently with a large attendance. The Sacramento Valley Section is after the Convention for 1930.

Traffic: W6EEO 506, W6DON 162, W6AFU 42, W6BDX 22, W6EKC 9.

NEVADA — SCM, C. B. Newcombe, W6UO — W6CDZ claims that Reno is going to be known as "the center of ham activities in Nevada" from now on. Let's watch him keep his claim. The Reno Radio Club, recently reorganized, now contains the following members: W8ZO, W6EAD, W6BBD-W6BPPW, W6CHG, KFWL, W6CDZ-W6DKKE, Herb Pennington, W8AJP, W6GA, Walter Mulcahy, W6XAL-KZAEZB-W6CNG-W6CWO, and W6EUF. FB, fellows — now let's see you handle some traffic.

#### ROANOKE DIVISION

WEST VIRGINIA — SCM, F. D. Reynolds, W8VZ — W8ACZ and W8CLQ take the honors this month for highest message totals, W8DPO coming in a close third, and handling a fair amount of reliable DX. The best being NR2WD, X9B, XBX and Z88KF. The latter being Chief Radio Station of Fort Flatters, Sahara, North Africa, this contact being made on 14,000 kc. W8OK keeps two A-A sked on 3500 kc. and is a proud papa now. W8SP is working on his screen grid receiver. W8DCM has a fifty on 7000 kc. W8AMX was heard on fone. W8BPU, W8CSR, W8APN and W8ACZ attended the Roanoke Division Convention in Charlotte, N. C. and had a grand and glorious time. W8BPU was looking over the new 5-kw. xtal job at WBT. W8VZ is busy with BC work.

Traffic: W8DPO 36, W8CLQ 55, W8OK 14, W8ACZ 57, W8APN 20.

VIRGINIA — SCM, J. F. Wohlford, W3CA — W3AAJ handled an emergency message to Nebraska when wires were down. W3HY has baseball QRM. W3KR handled eight GPR messages. W3BDZ is still rebuilding. W3CKL is using the 1929 self-rectified circuit and says it's the berries. W3BZ attended the convention at Charlotte and reports a big time. Fieldman Hebert attended the Charlotte Convention and, on the way back to Hartford, stopped over at Richmond and had a round with the gang there.

Traffic: W3HY 2, W3KR 14, W3CA 34.

NORTH CAROLINA — W4TS leads the section this month and rejoices on being a new Route Manager. Give him your cooperation, fellows. W4OC keeps his weekly schedule with FQ-PM and expects to have a crystal set soon. W4AFW enjoyed the Charlotte Convention.

Traffic: W4TS 26, W4OC 22, W4AFW 4.

#### ROCKY MOUNTAIN DIVISION

COLORADO — SCM, C. R. Stedman, W9CAA — The Rocky Mountain loses this month one of its most valuable amateurs if not THE most valuable: Mr. Paul Segal, W9EEA. Mr. Segal has gone to Washington to take over the job as Assistant Counsel to the Radio Commission. His loss will be severely felt by the rest of the gang. W9DKM and W9CAA handled a couple of the Governors-President messages. W9CAA is still working on all waves. W9DND and W9CSR get out in fine shape. W9DQD is back as an ORS. W9FXW is doing some fine DX work on low power. W9EUR at Pueblo has been on 3500-kc. fone. The Denver Radio Club is making another trip down to Pueblo for another joint meeting with the Pueblo Club. These joint meetings seem to do a great deal in the way of keeping the interest up in the state.

Traffic: W9CAA 14, W9DKM 5, W9CND 12, W9FXW 3.

UTAH-WYOMING — SCM, Parley N. James, W6BAJ — W6DYE lost a couple of his skeds. W6BUV is on the air now. W6EKF is still kicking out with the 201A, and reports two new hams in Ogden. W6CNX was up at Salt Lake on the 16th and applied for ORS. W6DXM is still waiting for the parts he ordered for his new transmitter.

Traffic: W6BUV 10, W6DYE 10, W6CNX 10, W6EKF 6, W6BAJ 2.

#### SOUTHEASTERN DIVISION

ALABAMA — SCM, S. J. Bayne, W4AAQ — W4JY reports business QRM and several good schedules. W4AAH has a 1929 signal. W4AHZ helped a rudderless airplane by making arrangements for its safe landing at Maxwell Field. W4AX is on again with a 50-watter. W4AJY has a YL and several fine schedules. W4AIY has built a screen grid receiver. W4MB has a new bottle, and

promises to keep it hot. W4IA handled some flood relief traffic. W4UV has a schedule with New Zealand on 14,350 kc. W4AQ works the Byrd Expedition. W4AIM has made his application for ORS. W4TI handles all of Selma's traffic. W4AHY is working on a 250-watt High C outfit. W4AHP is experimenting with antennas. W4AHR is now Army Amateur State Control Station. W4AJR is having quite a time with his xmitter. W4AKB is getting out better than ever. W4AAQ got in on some flood work. This is an opportune time to express the need of more active stations in South Alabama. Can't some of us help?

Traffic: W4JY 74, W4AJY 64, W4AAQ 33, W4AX 30, W4AQ 30, W4AHZ 19, W4UV 19, W4AHR 15, W4TI 11, W4AHP 8, W4IA 5, W4AJR 5.

FLORIDA — SCM, Harvey Chafin, W4AII — I want to thank all the gang for reporting while Mr. E. M. Winters, W4HY, was acting SCM. I will appreciate all suggestions and cooperation from all the gang. W4ACC turns in a FB report this month. W4SD complains of no messages from his QSO's. W4SK-ex9EUA will have an 852 and MG going at Melbourne soon. W4AEF has just accomplished WAC on both 14 and 7 mc. W4IE keeps a schedule with n4NIC and with KFLA, the yacht "Ripple," en route from California to Bradenton, Fla. W4AII keeps schedules with NJ2PA and two ships, API and XPAOJA. W4AGY says the Miami Radio Club is still going strong with twenty-five members. W4AJD has his 852 xmitter about ready. W4NF has just rebuilt his receiver. W4AFU has rebuilt. W4SY-W4JV are new hams in Tampa and are ready to QSO all of the gang. W4BL has left the state and will be gone about a year. W4TK is longing for DX. W4HY says the Silver Marshall screen grid receiver works very FB. W4ZP keeps a schedule with the SCM. W4OB plans to pound brass later. W4CK will be back in Miami in a month or so. W4CT handled some messages. W4ACK is now building all of the 1929 type xmitters as per QST. W4ACS worked Africa on 4 watts. The following ORS appointments will be canceled if I do not hear from them by next report: W4MS, W4BN, W4PB, W4IG, W4DD, W4AAO, W4CH, W4OO, W4QY, W4RK, W4LK. Fellows, please send your reports in by the 16th, to me at 6002 Suwanee Ave., Tampa, Fla.

Traffic: W4ACC 157, W4IE 87, W4AII 51, W4AGY 47, W4SD 19, W4AEF 18, W4CT 14, W4AFU 8, W4AJK 7, W4JV 6, W4BL 4, W4TK 3, W4HY 2, W4AJD 7.

#### WEST GULF DIVISION

OKLAHOMA — Acting SCM, L. M. Edwards, W5FJ — Your Acting SCM takes the reins of office, and asks you to help your section by reporting to him. W5AMO is in Texas doing geological prospecting. W5AAV is on with xtal now and surely sounds FB. W5AZG is constructing a MOPA set for better results. W5AYF is the lone reporter for Tulsa this month. W5VH has a sad case of YLitis. W5PA had a sore foot until he attended a dance with W5FJ, and now he's OK. W5BAG says 14 mc. is FB for DX in daytime. W5APG is busy grinding xtal for W5FJ. W5ASC wore out his adding machine. W5GF is busy campaigning for SCM in the coming election. W5AYQ and W5ANT are both at KCRC in Enid. W5OH is practising speed copying. FB. OM. W5AIR broke his right arm, so can't pound brass for a while. W5QL is still working on the "Question Mark," W5VM, the Alpha Sigma Delta station is planning a stunt for St. Pat's celebration at the Univ. of Okla. W5APG is a member of the 20th century Relay Route now. — W8DXZ, W5APG, W6BQ on 80 meters.

Traffic: W5FJ 179, W5PA 46, W5GF 18, W5BAG 11, W5AYF 7, W5APG 25, W5AAV 14.

SOUTHERN TEXAS — SCM, R. E. Franklin, W5OX — W5AQY and W5ASM make the BPL this month. Congrats, OM's! W5LP and W5JC are doing nice work. W5FS has a sked with W5ZM. W5UX is back on the air. W5AHP has just purchased one of W5AFG's excellent xtals. W5OO is a new fone station in San Antonio, operating on 1750 kc. with low power. W5AF is on the 7000-kc. band. W5EJ let his license expire and is now trying to get a new one. L. C. Wall, W5ZAE, has been sick, but is now well on the road to recovery. Route Manager Morgan, W5ABQ, reports the San Antonio gang held their annual "Boiled Owl" party at Dr. E. H. Cunningham's (W5LN) place on Lake Medina,

and says a wonderful time was had by everybody. He also says the Doc does a mean barbecue-pit. Hi.

Traffic: W5AQY 310, W5ASM 98, W5LP 62, W5JC 35, W5ES 16, W5ABQ 7, W5AHP 2.

**NORTHERN TEXAS**—SCM, J. H. Robinson, W5AKN—W5HY heads the list for this month. W5WW is fixed up with a MG set now. W5BAD has QRM from school and baseball. W5BAM is on regularly Saturday nights and Sunday p.m.'s. W5ATZ says that W5DO sent him a new 5-watter. W5AKN is glad to see any and all you fellows when in Dallas. W5BBF is moving again. W5AVD has a schedule with W5LY. W5ANK is leaving for Los Angeles, Calif. He will be on with a six call soon. W5APB and W5DF handled a few.

Traffic: W5HY 23, W5WW 12, W5BAD 11, W5BAM 11, W5ATZ 6, W5AKN 4, W5BBF 4.

#### MARITIME DIVISION

**PRINCE EDWARD ISLAND**—SCM, F. W. Hyndman, VE1BZ—VE1AP has been on the air and has done some fine DX, working ZL3GO and receiving a report from Bombay, India. VE1CO is rebuilding.

Traffic: VE1AP 13.

**NOVA SCOTIA**—SCM, A. M. Crowell, VE1DQ—All the N. S. gang are urgently requested to get going on our new Canadian allotment in the 3500-ke. band for Canadian work. Do your part to help the showing of activity here by having your station on this wave on Wednesday evenings. The SCM is now out of town and this report is possible by the cooperation of VE1CC, who reports much DX on 14,000 kc. and softening of his 210. Hi. VE1DQ got a fine report on his fone from Salem, Ore., saying "fine modulation." VE1BV is giving fone work a heavy swat. VE1AW is heard often plugging away. VE1AS is doing fine work with his 171. VE1BW is a new man from Halifax. The gang are all sorry to hear that VE1BN is leaving us and hope to hear his call on the air again soon from another QRA if possible.

Traffic: VE1BV 4, VE1AS 3, VE1CC 1.

#### QUEBEC DIVISION

**QUEBEC**—SCM, Alex. Reid, VE2BE—The big event of the season will be a banquet at the Queens Hotel, Montreal, April 13th. Mr. Menholtz, of the *New York Times*, and a technical man from headquarters will be with us, and the committee in charge expect a record breaking gathering of Second Division members and their friends. VE2BB is giving valuable aid to the Montreal and Albany air mail route by giving daily weather reports to Albany. FB, VE2AC has been QSO the west coast and England several times on 23 mc. Alpha is busy establishing a cross-Canada relay route. VE2CG is on the air at a new location and says conditions are ideal. VE2AP is now turning his attention to traffic. VE2AB of Quebec City is now on regularly. He is an old-timer at the key, so watch your step, boys. VE2CA and VE2BG are on 14,000 kc. for the summer. VE2BH is QRW at college. VE9CX is on 1818 kc. with xtal fone and puts out a fine signal. VE2BE has arranged his summer sked with Patty of New Zealand.

Traffic: VE2AC 31, VE2AP 8, VE2BB 16, VE2BE 10, VE2AL 14, VE2AM 7.

#### VANALTA DIVISION

**ALBERTA**—SCM, E. J. Taylor, VE4HA—Calgary Radio Club goes on the air soon with a pair of 250's. VE4IO is the new president. This station is one of the oldest and most consistent in Alberta. VE4AF is the DX station for this report, having worked a couple of VK's and ZL's. VE4CC is the traffic star again this month. VE4GD says power leak cut his total. VE4GM is going strong. VE4AG is busy designing QST cards. VE4GX is a very consistent station. VE4GD and VE4GE have an xmitter in their place of business for visiting hams. VE4HM has his eye on the short waver in March QST. VE4CU is on every Sunday. He is an OBS and will take dope for SCM. VE4FT is on again going good. VE4GT is doing good work with his 250. VE4EY is a nice station and turns in a good traffic total this month and is also new secretary of the radio club here. VE4HA gets on 7000 kc. Sundays to round up the gang. VE4FF is after AC power now.

Traffic: VE4CC 27, VE4GM 15, VE4AF 12, VE4GD 12, VE4EY 23, VE4HM 4, VE4FT 2, VE4HA 3.

#### PRAIRIE DIVISION

**MANITOBA**—SCM, D. B. Sinclair, VE4FV—VE4DJ has at last satisfied his great ambition by working pylon on the 14-mc. band. VE4GQ is usurping VE4FV's laurels in the DX line. He received reports from VK, ZL and G lately. VE4DP is using a 210 again. VE4HR is using an Ultraudion circuit. VE4IC has been QSO England. VE4EK has been experimenting with MOPA. VE4DB has plenty of leisure to pound brass. Hi. VE4FN is still our most consistent traffic station and is now using a MOPA on 7 mc. VE4DI is working on a TPTG circuit for 3.5-mc. phone. VE4HY gets a nice steady signal from his MOPA. We are gratified to observe that VE4GG, VE4DU and now VE4DY are threatening to come back on the air again. VE4DY is now married. He is a real old-timer, and will be a welcome addition to the gang. VE4AR and VE4JB are on 14 mc.

Traffic: VE4FN 22, VE4GQ 10, VE4DJ 5, VE4FV 1, VE4HY 5.

**SASKATCHEWAN**—SCM, W. J. Pickering, VE4FC—The traffic for the period has increased a great deal owing to more stations reporting promptly and to VE4CM who tops the list. He says he is going to try for 100 next time. VE4JG reports a new ham, VE4HW in Swift Current, who uses phone on 3500 kc. VE4IH is getting lined up to work the 28-mc. band. VE4CB is always to be heard Sunday afternoon. VE4BG says that he will be on 4000 kc. for QSO's with Canadians.

Traffic: VE4CM 79, VE4JG 39, VE4IH 36, VE4CB 16, VE4BG 1.

#### ONTARIO DIVISION

**ONTARIO**—SCM, E. C. Thompson, VE3FC—Central Dist.: VE9AL and VE3BC tie for traffic honors this month, both having regular schedules, the former using 3550 kc. and the latter, 7000 kc. VE3DA is using both bands. VE9BJ is on 3900 kc. VE3AY heard WFAT. VE3BP is looking for traffic. VE3BO writes a wonderful report as usual. VE3CL is experimenting with 7000 kc. VE3AR is rebuilding again. VE3BL has the 500 watter going full blast. Southern Dist.: VE3CS has been appointed ASCM to succeed VE3IA in this district. VE3DG uses 7000 kc. and 3950 kc. with good results. VE3AO is operating on 3950 kc. VE3AQ is using 14,000 and 3500 kc. VE3CB uses all three frequency bands. VE3CS is planning DX schedules on 14,000 kc.

Traffic: VE3BC 23, VE9AL 23, VE3CB 10, VE3BPL 9, VE3AY 7, VE9BJ 7, VE3ET 5, VE3DA 4, VE3AQ 2, VE3AR2, VE3BO 2, VE3CL 2, VE3FC 4, VE3BL 4.

#### LATE AND ADDITIONAL REPORTS

W4ABR almost forgot to report on account of the new reporting date. W8DSP handled quite a few this month. Keep up the good work, OMI. K4AAN sends in his report this month via W1RP. Good work, OMI.

Traffic: W4ABR 6, W8DSP 57, K4AAN 32.



TO BE OR NOT TO BE

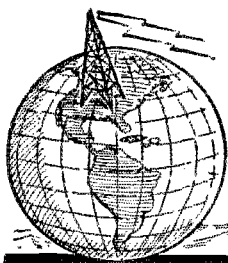

# I.A.R.U. NEWS

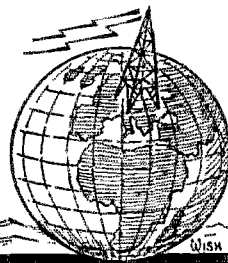

Conducted by A. L. Budlong

**B**Y the time this account gets into the hands of *QST*'s readers, there will have been held at Prague, Czechoslovakia, a European radio conference very similar in its aspects to the recent North American Radio Conference held recently on this continent.

As we write this, however, the European conference is nearly a month in the future, being scheduled for April 4th to 13th. The conference, which is a sort of sequel to the Washington Conference, is intended to iron out difficulties now being experienced with radio allocations on the Continent, and to bring about a state of harmony and unified standards among the various countries represented.

Much interest is expected in short-wave allocations. I.A.R.U. Headquarters is particularly interested to note that one of the subjects on the agenda is "Amateur Radio" and is still more interested to discover that the country which is apparently championing the cause of the amateur at the Prague conference is Holland. When it is remembered that Holland for years was a country where amateur radio was strictly forbidden under any circumstances, we must admit that the authorities have made great strides and that Dutch amateurs can be justly proud of what they have accomplished through their society, the N.V.V.R., in gaining recognition for amateur transmission and reception. Well done, OM's!

Union Headquarters has obtained copies of the Dutch proposals regarding amateurs, and has given them much study. The two American representatives at the Prague conference have also conferred with us, and are thoroughly familiar with both the American and foreign amateur situations. We hope that they are able to be of assistance in obtaining for European amateurs the very best privileges possible, and that our next issue of *QST* will be able to announce as satisfactory an outcome for amateurs at the Prague conference as we were able to announce for our own North American conference.

Good luck, OM's.

#### INTERNATIONAL PREFIXES

Additions to the international prefixes are coming in steadily, and we would like to take this

opportunity to thank those amateurs who see to it that we are kept continually advised of new prefixes. Information is still needed on many countries, however. Particularly would we like to hear from our section in South Africa, where they seem to have not only two prefixes, but an entirely new system of call signs. We haven't information of a definite nature on either of these, OM's. Please advise us promptly. The complete list to date is as follows:

Argentina.....	LU
Austria.....	UO
Australia.....	VK
Belgium.....	ON
Brazil.....	PY
Canada.....	VE
Chile.....	CE
Cuba.....	CM
Czechoslovakia.....	OK
Dutch East Indies.....	UI
Ecuador.....	HC
Egypt.....	SU
England.....	G
Finland.....	OH
France.....	F
Germany.....	D
Holland.....	PA
Indochina.....	FI
Irish Free State.....	EI
Italy.....	I
Japan.....	J
Luxembourg.....	UL
Mexico.....	X
Newfoundland.....	VO
New Zealand.....	ZL
Northern Ireland.....	GI
Norway.....	LA
Panama.....	RX
Peru.....	OA
Poland.....	SP
Portugal.....	CT
Roumania.....	CV
Salvador.....	YS
South Africa.....	ZS (also ZT)
Spain.....	EA
Sweden.....	SM
United States (terr.).....	W
"    (poss.).....	K
Uruguay.....	CU
U.S.S.R.....	RQ

#### AMATEUR REGULATIONS

I.A.R.U. Headquarters wishes to request that all foreign amateurs advise us immediately their countries are issued definite amateur regulations. Many times it is of great importance and help for

(Continued on page 76)



# Calls Heard



G. A. Parslow, 21 Eastbourne Road, Tooting Junction, London S. W. 11, England

wfasa wiajc wiakd wiajl wiaro wiaef wiaot wiaks wiafb wlaa wiaj wiboc wbin wterw wicpi wiece wlemp wifs wifn wiga wigzw wikh wipra wiooo wirt wissp wltb wluw wlyb wisp w2af w2atr w2agw w2any w2ap w2bkn w2nlk w2bnk w2bhc w2bhy w2biv w2brw w2bw w2bjr w2bia w2cn w2evj w2eu w2ja w2nd w2rz w2sfr w2tr w2xog w3ajc w3adm w3ax w3ajj w3ajf w3ahp w3ard w3afw w3bz w3bhz w3bnu w3chg w3ekl w3kiw w3pf w3ql w3shp w3sz w3wbo w4acz w4ael w4ahc w4ahr w4abl w4aef w4es w4ft w4obw w4ta w4xx w5ky w5yb w8adh w8adm w8bev w8dgu w8bao w8box w8bys w8ent w8doa w8duw w8dre ve9ap velda clbk clbx xw7ef pylcm on7adh

W2EI, Robert Langmuir, 159 Everett Place, Englewood, N. J.

w6pdl w6bam w6bey w6bpm w6ppo w6tto w6dys w6chy w6era w6evj w6cys w6cak w6dak w6dzt w6dyb w6kb w6kg w6nq w6wr w7acy w7aw w7ax w7aw w7dd w7ff w7ga w7li w7ph w7pu w7ub w7yk sadt9 pylid ve4ek ve4et ve4k ve4hb ve4hx ve5ae ve5ep em5ll nj2pa

DEO33, H. Littmann, Stuttgart-Degerloch, Waldstr. 15, Germany

7000-ke. band

wiaax wiaed wiaek wiaew wiafs wiafy wiaji wiauk wiavk wiawu wiaxx wibal wibeu wibl wlee wlerw wikh wlkn wile wllx wlon wlsi wlsz wltb wluw wlxh wlyb w2aaj w2aed w2afe w2afu w2afz w2aft w2ajt w2ak w2aku w2aub w2azs w2baq w2bec w2bfy w2btj w2blr w2blx w2evj w2dr w2fn w2k w2uk w2lx w3aaj w3aal w3adp w3afj w3afw w3anu w3ard w3as w3bhf w3bnu w3ft w3ky w3ld w3nk w3qw w3rie w3sn w3sz w3ut w4aac w4ab w4aef w4agr w4hr w4ft w4h w4le w4rb w4rkl w4sv w4to w4va w4zp w8ajy w8boy w8cfn w8ehd w8enh w8era w8dbc w8drj w8duw w8dw w8bre w9kd k4aau velda ve2be ve2bg zl2ab xeurda wq rxw ogrz nzz

10,000-ke. band

ap9fzg ce2ab thx sufoa xeb4wk

14,000-ke. band

wladw wlaeh wlam wlamc wlanz wlaqd wlafe wlafe wlbzf wleek wleel wlopt wlur wlry wlye wlyw wlyb w2abu w2acg w2aur w2aqf w2aqj w2arj w2arb w2bae w2cix w2ozr w2zj w2gt w2md w2rs w2ry w2xy w3bhx w3jm w3eg w3ej w3vz w3vq w4ahl w4aeb w8adm w8afg w8sil w8asl w8axa w8azg w8hx w9che pk4az pylcl ve2cd vo8rg zsn2 zszs z4a z4m z5dd z5se a5vix ur8ufm fkllm fk5cr nkf rxw

XPA0JA, J. Arends, c/o Radio Wereld, 250 NZ Voorburgwal, Amsterdam, Holland

wlahd wladw wlab wlae wlav wiaq wialh wlbhm wlbkr wlcmx wlia wlkq wlmr wlpd wlmow wlyz w2abu w2ajt w2api w2aqf w2bia w2bjg w2bjv w2bpe w2bvg w2atr w2bir w2cix w2hq w2mb w2rs w2up w3ahh w3auj w3bd w3cec w3jm w3jn w3kz w4aef w4abr w4ft w5ayy w5bg w5bh w6cl w6dq w6hf w7aes w7afo w7ga w7li w8adm w8axa w8brh w8bpx w8cbd w8csw w8ra w9aas w9aol w9bld w9bmx w9bnd w9ce w9cek w9eyo w9dku w9ef w9ehi w9enr w9exw w9fy w9fta w9hm i8eo i8er

f8fd i8wb g5bz g5ml g5wp g6wy g6xu k4ak laiw on4ip pylcm pylib pylid sp3mc sp3pm sadq4 sadt9 velap ve3bu velbr vo8rg su7rt klcm ve3bq yl2ad oz7bl oz7h z55u sc3bf py3ah rxw wfat wft

WSQ, S. S. Lydwin, off Mosquito Lagoon, Fla., Ed. Kampf, Opr.

f8btr f8axq f8ceo f8aap f8dmi f8hx on4gw on4hp on4fe on4yo ct1bx ct1by erlen ct1bd ear69 ear62 earo pa0ajz d4ka d4vr sp3ar ilfu utqe sb2ay ne8au ne8azw em2eu em5ni em7sh x9a e7z klpw zllax z12rp vk2fp vk2sa vk2su vk2ld vk3jk vk5jh vk5wr vk5hg vk6sa vk7ch vk7kj vk7lj vk7dx wsbs hsp wfat wft

G5UM, J. Hum, 17 Eastwood Road, London, N 10, England

14,000-ke. band

wladk wladw wlagk wlagu wlaik wlab wlaiz wlavf wlaix wlbj wlbux wlcux wlcnt wloea wlia wlik wlmr wlpd wlrj wlyz w2abe w2abu w2ahi w2ajz w2ary w2aub w2azu w2ba w2br w2bv w2bjr w2blx w2bok w2boz w2cvt w2cyq w2uk w2vy w3afw w3ahp w3aqi w3awn w3eq w3lp w3tr w4aef w4fy w4hy w4e w4ju w4ea w4ft w4y w4r w4kt w4mc w5ben w6avj w7ke w8aem w8adm w8afg w8amr w8bc w8be w8enx w8dew w8dlp w8dm w8dsi w8dtj w9aas w9dur w9ejt w9fhy w9gak w9gfg ve2ap ve3be ve3he ve4dj ve4dk ve5ct ve5fs z4a z4m z5m z6z z9d

BR8188, Basil Hall, 25 Coombe Gardens, New Malden, Surrey, England

Above 11,000 kilocycles

wiafb wiafs wibux wif wimd wimy winq wlf wli wlu wlxm w2agp w2aib w2aub w2auk w2azu w2bem w2bda w2bia w2blg w2blx w2boz w2dp w2dw w2ov w2sz w2vy w3afw w3ag w3bvg w3ez w3nk w4aef w4ft w8axa w8axz w8beu w8bdw w8bhz w8bti w8enx w8duw w9dpy n3kx au1as au1ap au7as au7au au7ba au8ae q8bhp velak velbr fnj shma x8ger x8hpg xw7ef

Below 11,000 kilocycles

wlahd wladw wlaef wlaeh wlaep wlakm wiaq wialb wialc wiauz wiaq wiaqd wiaqt wiare wiaxj wlaur wlap wlaw wlawe wlawf wlaqd wlaqt wlafe wlasj wlaur wlavp wlaw wlawe wlawd wlaux wlaze wlab wlbm wiber wlbz wlbhm wlvj wlvk wlvk wlvbr wlvbp wlvbx wlvbl wleek wlefp wlehe wleje wleml wlemx wlept wldi wldl wldp wldg wlia wllf wljr wlk wlkq wlmr wlny wlnx wlp ipw wly wlyz wlyu wlyv wlyz w2abu w2aed w2aen w2adl w2aeb w2aah w2ahi w2alw w2ap w2api w2aqf w2arb w2ary w2at w2ate w2avb w2avd w2avz w2ays w2azk w2baa w2bae w2bao w2bg w2bir w2bv w2bjc w2bjn w2bjy w2bmk w2bms w2bnh w2bda w2bpn w2buo w2cix w2cyp w2cqd w2es w2cuq w2cyj w2dp w2f w2gt w2hq w2jn w2mb w2md w2rs w2sj w2up w2ws w3adc w3adm w3afw w3ahm w3ajj w3auj w3auj w3bhx w3bbm w3bmc w3bvy w3cee w3chk w3cl w3eg w3ex w3ff w3fx w3jm w3ju w3vg w4act w4aef w4afe w4ahl w4aju w4ft w4ke w4ne w4nh w4nl w4pk w4tz w5aj w5abe w5acm w8adm w8ady w8afg w8al w8agx w8arg w8arx w8axa w8baz w8bdv w8brh w8bxp w8cbd w8cbg w8cec w8cfn w8cl w8en w8gz w8j w8s w9aas w9as w9bfo w9ba w9bl w9bpl w9cfs w9cki w9cmx w9dar w9dku w9doq w9eac w9ef w9ehi w9eho w9enr w9eta

(Continued on page 82)

# Correspondence

The Publishers of QST assume no responsibility for statements made herein by correspondents.



1929

Box 643, Louann, Ark.

Editor, QST:

I want to thank you fellows for the great amount of painstaking effort you must have spent in the development of the 1929 equipment described in recent issues of QST.

There is no doubt in my mind that the unorganized efforts of amateurs, not guided by an organization as is working in Hartford, eventually would have written "Finis" to amateur radio. I know positively in my own case that the end of my activities would have arrived on January 1st, or immediately thereafter.

As it is, I have built the low-power m.o.p.a. transmitter as described in QST. With comparatively few difficulties (all of which could have been avoided had I paid closer attention to your instruction), it operated beautifully, and in at least 86% of the reports gets "crystal control."

I am using the three-tube 1929 receiver with the 222 peaked audio amplifier and can't see how anyone can operate without some such arrangement. The only change from the QST specifications was to shield it completely in an aluminum cabinet and use the four-tube tuning arrangement, interchangeable coils and condensers. The coils, however, are still wound on tube bases for the sake of economy and I can't believe that any efficiency has been sacrificed. Thanks again to QST. We threw away burnt out tubes for years before we knew they had any value.

If phone signals are to be received it is necessary to have a separate audio amplifier from the 222 peaked arrangement. That is not news. Such an amplifier here plugs in behind the detector tube and works above criticism. Anyone doubting the efficiency of the peaked amplifier has but to make such an arrangement and listen to the same signals on each amplifier!

The climax of the whole works appears in the "monitor box." This extremely cheap and simple and amazingly useful little device will save many a ham a lot of futile explanations and vain regrets, not to mention hard work, before 1929 is over.

Made in any old way it is useful. Made with the same care you would spend on a 10-meter receiver or a well-built wavemeter, it is indispensable. It is easily calibrated and checked by use of the standard frequency transmissions of W9XL or some similar station and will perform

in a way that no wavemeter will, regardless of price.

If you want to check the frequency of your transmitter, go to your monitor. It will not vary the transmitter frequency by 1 cycle because of its proximity to the transmitter or the body capacity effect of having to hold it all over the works to get some sort of an indication of resonance. Take it in the next room or next door if you like. At the same time listen to the quality of the emitted note of your transmitter. If you are still not satisfied, tune your receiver to beat with the monitor and see where you are in regard to the rest of the gang. Show me a wavemeter that will do that and I'll shut up. If the other fellow wants his frequency, go on listening to him and tune the monitor to beat with his signal just as he signs. You lose not a word of his conversation and can give him the dope he asks for. If you are winding coils to cover a specified frequency band, why wait for WEM, WIZ or NAA. They might not be on the air. Wind your coil, plug it in the receiver and let the faithful little monitor tell you just how far up and down the coil will go.

Reverting to the transmitter: Recently, to try out the QST m.o.p.a. transmitter as a really low-powered set, I used two old brass base UV-201-A tubes. The oscillator was run at 150 volts and drew 1.5 watts. The amplifier was run at 200 volts and drew slightly over 4 watts. On the 7000-ke. band, a "9" in Missouri reported "QSA 5 xtal," a "3" in Penna. reported "R9 xtal." This was between 8 and 9 p.m. while the band was very crowded. Why should we fear 1929, or any other year, when we have "1929 type" apparatus developed for us that serves our needs so magnificently?

— D. L. Edmondson, W5ARA, W5BCR

## In Appreciation

S.S. Pres. Harding

My dear Mr. Maxim:

On leaving this great country, I beg to thank you, Mr. President, and all other members of A.R.R.L.'s Headquarters, from the bottom of my heart for all your most gracious and hospitable attitude shown me in Hartford.

I enjoyed my stay in this great country immensely, which was not to the least extent due to the most cordial relations established with many Ws; amongst them I am particularly in-

# IT'S HERE!

## Transcontinental

### THE MOST EFFICIENT SHORT WAVE COIL EVER MADE!

**Locked joints.** Strong mechanically. Can't warp out of shape or loosen.

**Antenna coil** (primary) same low loss construction as secondary.

**Heavy posts.** 3/8" vertical pillars will not shift or bend when abused.

**No metal parts** except wire and plugs to absorb current.

**Wire wound in slots.** Small contact with dielectric. Can't slip.

**Small diameter space wound tickler** reduces dial coupling and smoothes regeneration.

**Leads outside,** where field is weak, reducing losses.

**Wide spacing of terminals** reduces leakage.

**Positive contact** between solid prongs and side wiping bronze spring can never loosen.

**Grid terminal** at bottom, shortening important lead to tube grid.

*Here is the coil you have been wishing for—low-loss, mechanically strong, small in size, and inexpensive. Skeleton construction, built up without any metal fastenings, gives 96% air dielectric with lower losses from eddy currents and hysteresis. It is solid—you can stand on it without smashing it—so it will not change when plugged in and out of the socket. The same frequency will always be at the same place on the dial. It is only 1 1/2 inches in diameter—the field is small and can be shielded. And careful construction gives every coil the same ideal shape factor, making every coil equally efficient. There are so many new and wonderful features we can't describe them all here, so mail the coupon below.*

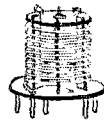
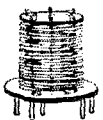
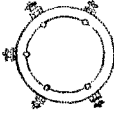
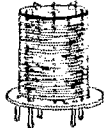
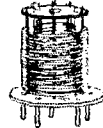
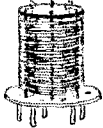
						
<p><b>10 METER</b> Coil. Covers 28 megacycle band. No. 1. Price, \$2.50</p>	<p><b>20 METER</b> Coil. Amateur 14 megacycle band or with 140 mufds., 15.5 to 39 meters. No. 1. Price, \$2.50</p>	<p><b>40 METER</b> Coil. Amateur 7000 k. c. band or with 140 mufds., 35 to 85 meters. No. 2. Price, \$2.50</p>	<p>New and efficient base with wide spacing of contacts. Base only, \$1.50</p>	<p><b>80 METER</b> Coil. Amateur 3500 k. c. band or with 140 mufds., 70 to 175 meters. No. 3. Price \$2.50</p>	<p><b>160* METER</b> Coil. Amateur 1750 k. c. band or with 140 mufds., 125 to 300 meters. No. 4*. Price \$3.00</p>	<p><b>Broadcast Coil.</b> With 140 mufds., 215 to 560 meters. No. 5. Price \$3.00</p>

\*With .0005 Condenser, covers entire broadcast band as universal t.r.f. or regenerative coil.

The No. 1, 2 and 3 coils, and Base, have been combined into Coil kit No. 100, priced at \$8.50, for amateur use. You can buy coils separately to fit your needs, without being penalized in price for not buying the whole kit. Forms alone, to wind your own, \$1.75 each. You can use them for screen grid couplers for L.F., or in a multitude of other ways. Send for folder telling how.

**IT'S FREE!**

**Transcontinental Coil, Inc.**  
**GOTHAM ENGINEERING & SALES CO.**  
 NATIONAL SALES REPRESENTATIVES  
 50 Church Street New York City

**Send Today!**

**Gotham Engineering & Sales Co.**  
 50 Church St.  
 New York City.

Gentlemen: Please send, at once, your free folder describing the new Transcontinental Short Wave Coils. Enclosed find \$..... Send me Coil No. ....

Name.....

Address.....

City.....State.....

## Fixed and Adjustable Resistors for all Radio Circuits



### Bradleyunit-B

RADIO manufacturers, set builders and experimenters demand reliable resistors for grid leaks and plate coupling resistors. For such applications Bradleyunit-B has demonstrated its superiority under all tests, because:

- 1—Resistance values are constant irrespective of voltage drop across resistors. Distortion is thus avoided
- 2—Absolutely noiseless
- 3—No aging after long use
- 4—Adequate current capacity
- 5—Rugged, solid-molded construction
- 6—Easily soldered

Use the Bradleyunit-B in your Radio Circuits

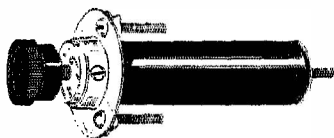

### Radiostat

This remarkable graphite compression rheostat, and other types of Allen-Bradley graphite disc rheostats provide stepless, velvet-smooth control for transmitters, scanning disc motors and other apparatus requiring a variable resistance.

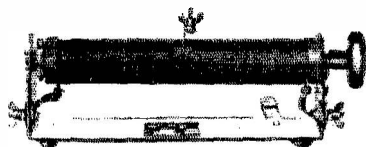

### Laboratory Rheostat

Type E-2910 — for general laboratory service. Capacity 200 watts. Maximum current 40 amperes. A handy rheostat for any laboratory.

Write for Bulletins!

ALLEN-BRADLEY CO., 277 Greenfield Ave., Milwaukee, Wis.

**Allen-Bradley Resistors**

debted to William J. Rust, WSADM of Ithaca, N. Y., and to Marshall P. Wilder, WIAWK of Cambridge, Mass., for their exceedingly kind hospitality, which enabled me to keep in close touch with my friends at home as well as to establish many pleasant QSOs with American amateurs.

Believe me, I shall not forget the wonderful time I had in this country.

Thanking you very much once more, I remain with all best wishes,

— Curt Lamm, W7CL

## Subdividing the Bands

Liggett Bldg., Seattle, Wash.

Editor, QST:

From time to time, in late issues of QST, there have been various discussions as to the advisability of dividing the present "forty-meter band" into two sections, placing all W stations in one section and all foreign stations in another section. To the best of my knowledge, this has not been seriously considered.

Why not make a division such as this? Reserve the section from 7300 kc. to 7175 kc., or a band slightly narrower, for foreign stations. Then, set the section from 7175 kc. to 7000 kc. aside for W, VE and K stations. Taking into consideration the skip distance, as it affects this particular band of frequencies, I do not believe that the interference will be as bad as it would appear, after the first glance at this suggestion.

My understanding is, that the 7000-kc. band is primarily a "DX" band. Therefore, I believe most stations using it will appreciate the idea of this outline. For those who prefer traffic and rag chewing, it would seem that under these new conditions, their place is on the lower frequencies, mainly the 3500-kc. band.

Here is another fact that may forestall some argument on the above suggestion. Over a period of twelve days, between 60 and 75% of the U.S. stations heard were operating below 7195 kc.

I hope that amateur operators will get to work and clear up a situation that is hindering both the DX man and the traffic man.

— F. R. Stevens, W7BB

## Schedules Wanted

Washington, D. C.

Editor, QST:

Many of the eastern college amateur radio clubs are arranging schedules and getting together for the purpose of handling the enormous potential traffic of colleges.

National cooperation, and perhaps national organization under the auspices of the A.R.R.L., would do inestimable good to the cause of college amateur radio. We need reliable schedules with other colleges; we want to be able to handle traffic caused by inter-college matches, reliably

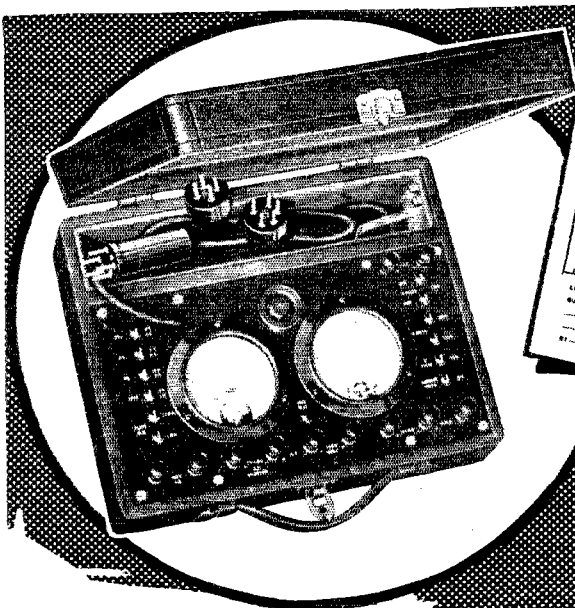

**RADIO SET ANALYSIS**

OWNER: *H. J. Miller*  
 ADDRESS: *620 Chestnut St.*  
 NAME OF SET: *Radiola 18* DATE: *1-21-1932*

TUBE NO.	TUBE TYPE	POSITION OF SET BY REF. SET.	TUBE DATA				MEASUREMENTS IN SOCKET OF SET				PLATE VOLTAGE	MAX. PLATE CURRENT
			WINDINGS	WAVELENGTH	WAVELENGTH	WAVELENGTH	WAVELENGTH	WAVELENGTH	WAVELENGTH	WAVELENGTH		
1	226	1st R. P.	1.3	124	1.2	121	7	—	4.5	R. 5	4.0	
2	226	2nd R. P.	1.4	125	1.3	122	8	—	4.8	R. 6	4.0	
3	227	5th A. P.	1.4	125	1.3	122	8	—	4.5	R. 5	4.0	
4	227	6th A. P.	2.3	129	1.2	121	7	—	3.0	S. 1	3.0	
5	179	1st. A. P.	1.3	124	1.2	121	7	—	4.0	R. 5	4.0	
6	280	Rectifier	4.3	189	4.2	187	20	—	15.7	R. 1	2.0	
									17.2	R. 2	2.0	

LINE VOLTAGE: \_\_\_\_\_ SET ON: \_\_\_\_\_ VOLT GAP: \_\_\_\_\_

INSTRUCTIONS OR CHANGES MADE BY: \_\_\_\_\_

BY: \_\_\_\_\_

VOLUME CONTROL POSITION: \_\_\_\_\_

The above analysis sheet shows actual results of test on a Radiola 18. Below is section from Jewell Service Book showing correct data on Radiola 18. Note convenience of comparison.

**RADIOLA 18**

TUBE NO.	TUBE TYPE	POSITION OF SET BY REF. SET.	TUBE DATA				MEASUREMENTS IN SOCKET OF SET				PLATE VOLTAGE	MAX. PLATE CURRENT
			WINDINGS	WAVELENGTH	WAVELENGTH	WAVELENGTH	WAVELENGTH	WAVELENGTH	WAVELENGTH	WAVELENGTH		
1	226	1st R. P.	1.3	124	1.3	122	7	—	4.5	R. 5	4.0	
2	226	2nd R. P.	1.4	125	1.3	122	8	—	4.8	R. 6	4.0	
3	227	5th A. P.	1.4	125	1.3	122	8	—	4.5	R. 5	4.0	
4	227	6th A. P.	2.3	129	1.2	121	7	—	3.0	S. 1	3.0	
5	226	1st. A. P.	1.3	124	1.2	121	7	—	4.0	R. 5	4.0	
6	179A	1st. A. P.	1.3	124	1.2	121	7	—	4.0	R. 5	4.0	
7	280	Rectifier	4.3	189	4.2	187	20	—	16.0	R. 1	2.0	
									20.0	R. 2	2.0	

# Convert Service Liabilities Into Profits!

OWNERS of Jewell 199 Set Analyzers are converting service liabilities into business-building assets. Since troubles are so easily located by using this remarkable instrument, radio dealers are actually promoting sales through service calls.

A courteous service man who is competent is an effective builder of sales and good will. The quick and accurate analysis of set troubles, made possible by Jewell 199 Set Analyzers, Analysis Charts, and data furnished in the "Instructions for Servicing Radio Receivers," makes it easy for any service man to get the best possible reception with any receiver with minimum effort.

You, too, can convert your service men into builders of good will and profit by equipping each of them with a Jewell 199 Set Analyzer.

It will pay you to investigate the Jewell Method of Radio Set Analysis which eliminates guesswork and quickly and accurately locates set troubles.

In the Jewell Method of Set Analysis, tests are made on each stage by inserting the convenient plug in the tube socket and inserting the tube in the Jewell 199 Set Analyzer. When each stage has been tested the entire result of the test is compared with the data covering the set furnished in the Jewell booklet entitled "Instructions for Servicing Radio Receivers." Radio dealers everywhere are using this effective method of set analysis to build a bigger and more profitable business. You will find a Jewell 199 Set Analyzer for each of your service men a profitable investment.

Mail the Coupon for this valuable Booklet!



**Jewell Electrical Instrument Company**  
 1650 Walnut St., Chicago, Illinois

Of course we want to know all about the Jewell Method of Set Analysis. Without obligating us send your book, "Instructions for Servicing Radio Receivers."

Name: .....

Address: .....

29 YEARS MAKING GOOD INSTRUMENTS

# JEWELL

199 SET ANALYZER

Say You Saw It in QST — It Identifies You and Helps QST

# The first practical book on radio vacuum tubes — —

Here is thorough and practical information on the most essential part of all radio apparatus—the vacuum tube. All the underlying fundamentals, every use and every function of the radio tube are discussed in this new book. It gives you full information and accurate directions for the most effective use of the vacuum tube in all types of radio receiving apparatus.

Just Out!

## RADIO RECEIVING TUBES

By JAMES A. MOYER, Director of University Extension, Massachusetts Department of Education and JOHN F. WOSTREL, Instructor in Radio Engineering and Supervisor in Charge of Industrial Subjects, Division of University Extension, Massachusetts Department of Education. 296 pages, 5 1/2 x 8, 181 illustrations.

The major portion of the book describes two and three element vacuum tubes as used in radio reception and transmission. Additional applications include the remote control of airplanes and sea-going vessels by the use of instruments which employ vacuum tubes in essential capacities, as well as methods of applying vacuum tubes to the remote control of humidity and similar uses. Every standard type of tube is included. The book discusses the tube as used for: 1. detection, 2. radio-frequency, 3. audio-frequency amplification, 4. power output, 5. oscillation. If you wish a simply written, understandable explanation of the all important vacuum tube in all its phases, see this new book FREE.

\$2.50

### Chapter Headings

I. — Introduction. II. — Construction of Vacuum Tubes. III. — Fundamental Electrical Relations. IV. — Vacuum Tube Action. V. — Reactivation of Vacuum Tubes. VI. — Testing Vacuum Tubes. VII. — Use of Vacuum Tubes as Detectors. VIII. — Use of Vacuum Tubes as Amplifiers. IX. — Use of Vacuum Tubes as Oscillation Generators. X. — Specifications for Vacuum Tubes. XI. — Special Industrial Applications of Vacuum Tubes.

See it for 10 days FREE—Order NOW

#### MCGRAW-HILL FREE EXAMINATION COUPON

McGraw-Hill Book Co., Inc.,  
370 Seventh Avenue,  
New York, N. Y.

You may send me Moyer and Wostrel's RADIO RECEIVING TUBES, \$2.50 postpaid. I will either return the book, postage prepaid, in 10 days, or remit for it at that time.

Name.....  
St. & No.....  
City.....  
State.....  
Name of Employer.....  
Official Position.....

(Books sent on approval in the U. S. and Canada only)

Q.S.T. 5-29

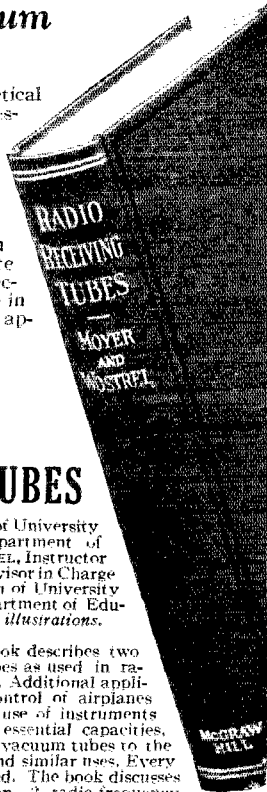

and directly with the other college; and to do this, we must know what other colleges have radio stations.

Please then, student amateurs, let's hear from you here in Washington,

— Albert W. Small, W318-W3ACY,  
Chief Operator, George Washington Univ.  
Radio Club.

### Phone

232 Lamar St., Selma, Ala.

Editor, QST:

Maybe the readers, the editors, and even the printers get tired of reading about all our troubles, but we have so many that we have to unload somewhere — hence the letter.

I am one of the hundred or more fellows who are trying to do a little phone work within the fifty kilocycles given us. We have plenty of squeaks and squeals, even without the help of any rough r.a.c. c.w. sigs up in the phone band. I do some c.w. work also but I do drop down below the phone band when I am operating ye olde keye.

Now, fellows, I know that the 85-meter phone band is also open to c.w., but why not give the phone stations that little fifty kilocycles unmolested?

What do you c.w. fellows say?

— L. F. Lee, Jr., W4IA ex-WAPI, 5LU

### Service Rendered

215 West Wayne Ave.,  
Wayne, Penna.

Editor, QST:

Last month I received a radiogram from station W9BSH at Rantoul, Ill., apprising me of the safety of my nephew, Arnold H. Clark of Greenfield, Mass., who is with the Byrd Antarctic Expedition. The last letter I had from Clark was dated October 7th, so you can easily see how welcome this news from station W9BSH was to me. I feel that the amateur who gives his own time and money to these experiments should be encouraged and backed by the governments as they have, and are still doing a wonderful work. I certainly wish to express my gratitude to the American Radio Relay League.

— Mrs. H. W. Bryan

### More About Phone

Spencer, Iowa

Editor, QST:

I have never been really interested in amateur work until the last month, although I have taken QST for several years. I recently got a short-wave set, and have listened quite a little to the amateur phone stations on the 180-meter band. What I hear rather discourages me from attempting to start up a transmitter. With only two or three exceptions, all the phone stations I have heard have sounded wretched, to say the least. Their modulation is terrible. And if

# YOUR AMATEUR RECEIVER!

Does it produce the new requirements?

Does it meet the maximum signal strength? irrespective of climatic changes?

Does it give wide spread tuning over each band?

A GOOD amateur band receiver must have these qualifications. Does yours? If not you are probably trying to get by with your old 1928 set. It can't be done. You must modernize and keep in step with progress.

The simplest way to meet these specifications is to use the correctly designed coil and condenser combination. The Radio Engineering Laboratories, exclusive short wave designers and manufacturers for the past five years are offering their Cat. No. 182 amateur band plug-in coil kit and their Cat. No. 187-E combined tank and vernier tuning condenser as a solution to every amateur's receiver problem.

If you don't want to build a new receiver, take your old set and revamp it with the REL coil and condenser combination. The results speak for themselves. Ask the OB that uses them. This is especially good news to the amateurs regularly engaged in traffic handling because they above all require selectivity.

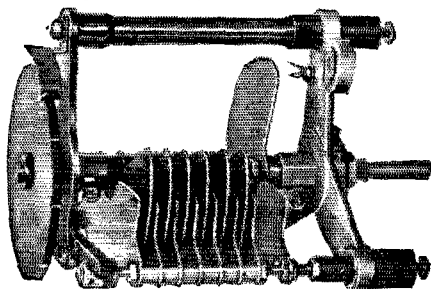

Here's the REL Cat. No. 187-E combined tank and vernier tuning condenser. There is no other condenser which affords to the amateur the features combined in this REL unit. Heavy end supports — insulated stand-off bushings — single bearing conical rotor shaft — new patented noiseless rotor contact — heavy brass condenser plates — panel mounting space  $4\frac{1}{2} \times 4\frac{1}{4}$  —  $\frac{1}{4}$ " condenser shaft fits any standard knob or dial.

Cat. No. 187-E combined tank and Vernier condenser is specially designed to tune modern high frequency receiver circuits. The large semi-variable tank condenser is controlled by means of the rear bakelite disc. This disc may be notched at desired points. The notches will then coincide with the spring ratchet locking device, in this manner it is easy to always return this tank condenser to the same setting. The small vernier single plate condenser is used to obtain full spread tuning over any desired band. Full information on how to calibrate the tank condenser is supplied with each unit.

The Cat. No. 187-E condenser has the following electrical specifications. Maximum capacity of tank condenser 115 mmfd. — maximum capacity of single plate vernier condenser when single plate is spaced 1-16" 30 mmfd. Price \$6.25.

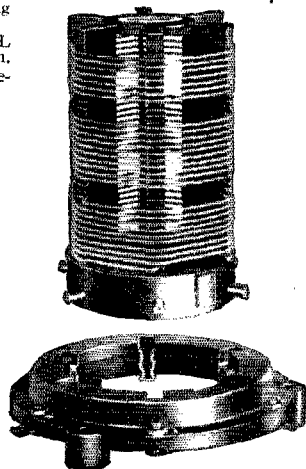

This shows one coil and the coil base which are part of the regular REL Cat. No. 182 amateur band plug-in coil kit combination. These new REL plug-in coils are radically different from other short wave inductors. The coil itself is a one piece bakelite mould with 6 threaded ribs. The heavy enamel copper wire is securely held in these threads assuring permanency at all times. The leads for each coil winding are securely soldered to the coil plugs. These plugs fit snugly into the coil base prongs. The total contact area is  $\frac{3}{8}$  square inches. The moulded coil base holds the 6 spring contacts. The base is so arranged that the coil will only fit in one position.

3 plug-in coils and one base constitute a Cat. No. 182 coil kit. The coils are designed to cover the 14000, 7000 and 3500 KC bands. Each coil form is wound with three separate windings which can be used for primary, secondary and tictler or any other combination to adapt itself to the circuit employed. — Price \$10.00

**IF YOUR DEALER DOES NOT STOCK THESE REL ITEMS, ORDER DIRECT**



manufactures a complete line of amateur short wave transmitting and receiving equipment. The new 16 page folder illustrating modern transmitting and receiving circuits is yours for the asking

**RADIO ENGINEERING LABS., 100 Wilbur Ave., Long Island City, N. Y.**

## A Remarkably Small, Light and Efficient Combination for A.C. Current Measurements 0.2 to 200 Amperes



Model 539  
Miniature  
Current  
Transformer

Model 538  
Miniature  
A. C. Ammeter

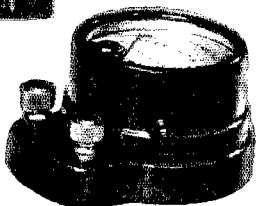

These two instruments constitute a miniature testing set for a wide range of current measurements. Exquisitely made and unusually sensitive — fully in keeping with highest Weston standards. Handsomely encased in mottled red and black bakelite.

These instruments will be found especially useful in electrical repair shops, research and industrial laboratories, educational institutions and particularly in radio and electrical manufacturing plants and commercial service organizations where relatively high current values must be determined with a reasonable degree of accuracy.

### Summary of Transformer Characteristics

Ranges: self-contained — 2, 5, 10, 20 amperes; inserted primary — 50, 100, 200 amperes. Secondary, one ampere. Secondary burden, 2 volt-amperes maximum. Accuracy, 1% from 25 to 150 cycles. Weight, 2 1/4 lbs. Self-contained ranges are changed by means of a unique range-changing switch — fool-proof, positive and easy of operation.

WESTON ELECTRICAL INSTRUMENT  
CORPORATION

602 Frelinghuysen Avenue

Newark, N. J.



the intelligence of the amateurs operating them can be judged by their conversation, they surely are a bunch of dumb-bells. I also notice that the operators of the two or three stations which did sound all right carried on a very intelligent conversation. Perhaps the modulation and the brains are inter-related.

What I would like to know is whether it is an exceedingly difficult task to adjust a short-wave phone transmitter so that its output sounds something like what goes into it. It hardly seems possible that all of them would be wrong, and yet they nearly all have the same horrible distortion.

—George A. Heald, Jr.

## A QSLL Suggestion

121 North Spring Ave.,  
Sioux Falls, So. Dak.

Editor, *QST*:

Being a student, I have little time for operating. In spite of this, I am able to experiment a little, make a few good friends, meet a few interesting people, swap a few ideas, get a few inconsequential weather reports, and handle a reasonable amount of traffic. In order to do this, I must be on the air at all times available to radio. I am sure there are hundreds in the same boat. If I were to QSL, as has been suggested, every station that I work, it would take about eight hours a month out of my operating time, and about \$36 per year out of my pocketbook. Now to the rich this may not seem very much, but to me, as it is to many others, it is the price of a good rectifier, or the means to that crystal and its accessories, or to that better frequency meter, or to that new monitor, or a hundred-and-one other things that go to make a better station.

Now if these fellows are really in earnest about this card business, I would like to suggest a little scheme which I don't think is entirely original, but which would put the load where it ought to be. Get these double government post cards, and have one side printed for the one who is to receive it, and the other side printed for the dated and signed report and return acknowledgment. As it is usually the answering station who wants the card worst, let him send the card unless some other arrangement is definitely made over the air.

This would save a lot of ill feeling, and, especially in the case of foreigners, would even up the load wonderfully.

—Howard T. Chasman, W9DN8

## Rarity

5 Melbourne Grove, East Dulwich,  
London, S. E. 22, England

Editor, *QST*:

May I take this opportunity of thanking you for your prompt attention to the QSL cards I have sent you from time to time.



# New THORDARSON AUDIO TRANSFORMERS

**ONCE** again Thordarson steps into the foreground, this time with three new audio transformers of unrivaled performance—fitting companions for the Famous R-300.

*The R-100* is a quality replacement audio transformer for use by the service man in improving and repairing old receivers with obsolete or burned out audio transformers. The universal mounting bracket of this replacement unit permits mounting on either side or end, and is slotted in such a way as to fit the mounting holes of the old audio unit without extra drilling. List price \$2.25.

*The R-260* introduces a new standard of performance for small audio transformers. Wound on a core of Thordarson "DX-Metal" this audio unit is capable of reproducing plenty of "lows." It is entirely devoid of resonant peaks and performs with unusual brilliance over the entire audible band. List price \$5.00.

*The R-300* needs no introduction to the discriminating set builder. It is commonly recognized by set manufacturers and individuals alike as the peer of audio coupling transformers, regardless of price. The high frequency cut-off at 8,000 cycles confines the amplification to useful frequencies only. List price \$8.00.

*The R-400* is the first and only audio transformer built expressly for use with A. C. tubes. It is similar to the R-300 type in appearance and performance but possesses a better inductance characteristic when working under high primary current conditions such as are encountered in coupling the first and second stages of audio amplifiers using 226 or 227 type tubes in the first stage. List price \$9.00.

*For Sale at Good Parts Dealers Everywhere*

**THORDARSON ELECTRIC  
MANUFACTURING CO.**

*Transformer Specialists Since 1895*

HURON, KINGSBURY and LARRABEE STREETS

## THORDARSON RADIO TRANSFORMERS

R-100  
Universal  
Replacement  
Audio  
\$2.25

R-260  
Audio  
Transformer  
\$5.00

R-300  
Audio  
Transformer  
\$8.00

R-400  
2nd Stage  
A. C. Audio  
Transformer  
\$9.00

**S U P R E M E   I N   M U S I C A L   P E R F O R M A N C E**

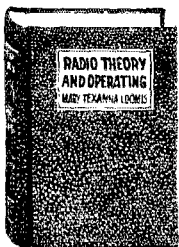

TELEVISION  
 RADIO CONSTRUCTION  
 RADIO REPAIRING  
 RADIO SERVICING  
 MARINE RADIO OPERATING  
 RADIO COMPASS WORK  
 LAND RADIO OPERATING  
 BROADCASTING  
 AIRWAYS COMMUNICATIONS  
 RADIO ACCOUNTING  
 MESSAGE FORMS  
 1929 RADIO LAWS  
 JUNIOR ENGINEERING

The above subjects and many others thoroughly covered in the best radio text and reference book ever produced.

### "RADIO THEORY AND OPERATING"

992 Pages 500 Illustrations

By Mary Texanna Loomis, President, and Lecturer on Radio, Loomis Radio College, Member Institute of Radio Engineers.

Fourth Edition—Thoroughly Revised

Used by all the Government radio schools, nearly all the radio schools in U. S. and Canada and over 200 universities, colleges and high schools.

Flexible binding — Price \$3.50

For sale by practically all bookdealers this and foreign countries. Or sent, postage paid, on receipt check or money order.

LOOMIS PUBLISHING COMPANY

Dept. 5 Washington, D. C.

The nature of my experiments demands the particulars of stations received during my test periods, and I have been fortunate enough to receive a reply from practically every American station reported upon. These replies have been of inestimable value, and have enabled me to carry out a number of successful tests.

Am I indebted to you for postal fees? If so, I shall be pleased to know to what extent, so that I can clear the amount.

—Frederic C. Rand, G2AHC

## This Chopper Racket

5269 Vernon Ave., St. Louis, Mo.

Editor, QST:

I have just been boiling over lately, regarding this ether busting, crashing, QRMing, chopper brand of e.w. that we hear on our 40-meter band during the early evening hours. I am temporarily off the air rebuilding my transmitter for an 852 with 866s for rectifiers. For a receiver, I am using the four-tube 1929 *a la* QST. It is the berries, but this i.e.w. gums up the works. Last night at about 8 p.m., I couldn't copy more than one signal out of twenty because of 8th, 5th, 4th, and 9th district i.e.w. All signals were audible all over the house, too. It has been impossible lately to hear anything less than an R7 signal here with the new receiver. Every U.S. district is readable all over the room. Now it isn't the low-power amateurs that need a little help in getting through the evening QRM that use the chopper. They are the high- and medium high-powered fellows that get through anyway and want a QSO every time they call. Is this the A.R.R.L. spirit?

This letter is written to register a healthy kick against i.e.w. on 40. If I knew T O M's QRA, I would write him, too, for I pity his cat if he gets in the way.

—Chester B. Frauz, WS6EK

## The Off-Band Birds

Box 615, Vandergrift, Pa.

Editor, QST:

This is another crack at the fellows outside the amateur bands. I have a 1929 receiver as built from good ideas in QST. Also, it's calibrated thanks to W9XL and others. Often I have been pleased to attempt to bring some of the off-wave fellows back into the fold. I have called many of them, asking to hold down the key and QSY up slowly until I get them up within the band. They appreciate it and so do I.

But there are many of them who don't give a darn, and I can't understand why. The other day I got QSA5 from one who has been in the game for four years. I asked him to QSY up as he was on 40.8. Guess he thought I was talking about 40 hommes & 8 cheveau for he says "thanks for the infor. OM. CUL 73-----" CQ CQ CQ. 15 minutes later, I heard him CQing at the same place. Perhaps I'll talk to him again some time when he learns my lingo. Hi.

## SAVE YOUR ARM!

Send with the World's Easiest-Working Bug

The GREAT NEW VIBROPLEX No. 6

(See Trade Marks: Vibroplex; Bug; Lightning Bug)

Easy to learn. Simply press the lever—the bug does the rest. Adjustable to any speed from 10 words per minute—up. Saves the arm, prevents cramp and enables you to send with the skill of an expert.

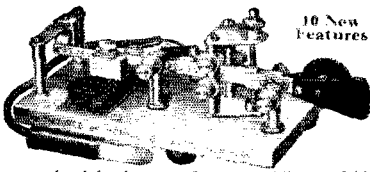

10 New Features

Japanned Base, \$17  
 Nickel-Plated, \$19

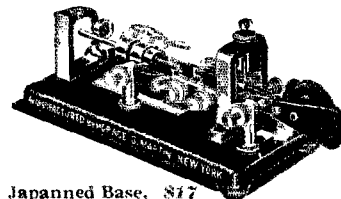

Famous Improved VIBROPLEX

Used by tens of thousands of operators because of its ease and perfection of sending.

Japanned Base, \$17  
 Nickel-Plated, \$19

Special Radio Model Extra Large, Specially Constructed Contact Points for direct use without relay. \$25

Remit by Money Order or registered mail

THE VIBROPLEX COMPANY, Inc.

825 Broadway, New York City

Cable Address: "VIBROPLEX" New York

# The NEW Crosley 7-tube GEMBOX A-C ELECTRIC

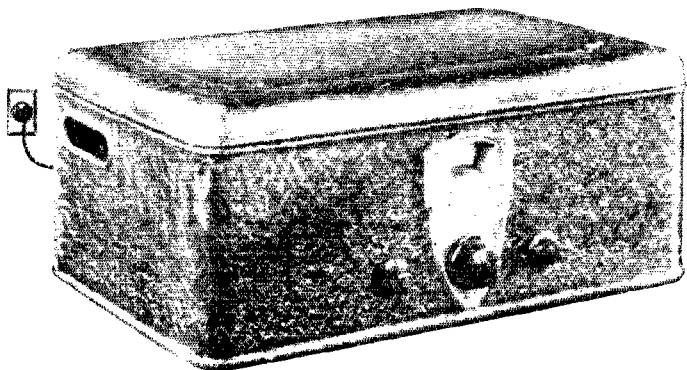

## Redesigned and improved without increasing the price

Last year the radio industry acclaimed the Crosley GEMBOX. At \$65 it was the world's greatest value. Sales showed its popularity and its customer-getting ability.

Now, even this great value is enhanced. New features are added. Proven elements are retained. The price remains \$65 — incredible — astounding — unmatched.

New full Neutrodyne circuit especially designed in the Hazeltine laboratories for this set.

A new chassis layout — efficient — rugged — with switch on front of receiver.

A new volume control of exceptional smoothness. 3 tuning condensers and regeneration in the detector tube eliminated.

With these new features are retained the modern illuminated dial, the self contained power supply equipped with the famous Mershon self healing condenser and the high voltage power output tube in the last audio stage.

- 3 stages radio amplification
- 1 detector
- 2 stages audio amplification
- 1 rectifier — 7 tubes in all

A neutrodyne-all-  
electric-self-con-  
tained-power  
speaker operating  
radio of unusual  
sensitivity and  
selectivity.

# \$65

WITHOUT TUBES

Montana, Wyoming, Colorado, New Mexico and West prices slightly higher. Prices quoted do not include tubes.



The Crosley  
Dynamic  
DYNA CONE

The Dynacone is the armature type dynamic speaker — a developed principle by Crosley that eliminates the resonant peaks of most dynamic speakers and reproduces every tone in true relation to every other.

The Dynacone is the fastest selling speaker on the market. It gives natural reproduction in satisfactory value for \$25, and ears that judge keenly consider no fancier priced equivalents.

Listen to it. Compare it with any speaker on the market. Tell if you can a \$10, \$15, or \$40 difference. Laboratory curves don't show them. Ears cannot hear them. \$25.

The Crosley Radio Corporation  
Dept. 18, Cincinnati, Ohio

Powel Crosley, Jr., President  
Owners of W L W — the Nation's Station

# CROSLEY RADIO

**PIERCE AIRO** Cardwell Connecticut  
 Dubilier THE ACME WIRE CO  
 Radio WESTON Electrical Instruments  
 ENGINEERING LABORATORIES  
 Gordon Raytheon  
 Ward Leonard ELKON  
 FARRAND PARVOLTS  
 Rajah LOWELL  
 Knapp

**AD. AURIEMA, INC.**  
 Manufacturer's Export Managers  
 116 Broad Street, New York, N. Y.

Scientifically equipped  
 to economically export  
 dependable receiving  
 and transmitting radio  
 apparatus

There are lots of "hams" like this one; let's help them up, or help them out, as I like to think that Roses of Sharon are more fragrant than Lilies of Arimathea.

— W. D. Myers, WSDGW

## Interference Problem

R.F.D. 1, Tonawanda, N. Y.

Editor, QST:

I have noticed in a number of letters printed in the Correspondence Dept. of QST in which it is said that not much more QRM is found in the new bands than before the change. The majority of stations I've worked since January 1st on the 7000 - to 3500-ke. band have mentioned the interference and it has been my experience that there is a great deal of it. In fact it is hardly possible to hold a conversation with another amateur station for any length of time. Of course, there is a great deal of improvement in the type of signal now as compared to the 1928 and earlier signals but there is still a great deal of room for improvement.

I've heard any number of stations that sounded as if they were using raw a.c. for plate supply. They covered such a broad band that it was impossible to work in the wide area in which they were located. And these broadly tuned stations were using either 25- or 60-cycle a.c.

We are using low power with storage battery plate supply, here, and get good reports as a rule. However, we have difficulty in raising fellows. This seems to me to be an indication that Mr. Average Amateur can't copy a good note if he hears one, or prefers to listen to a note many kc. wide rather than tune you in. It almost seems necessary, then, to modulate the note. This appears to work out because those stations with 240- or 500-cycle always get a reply and with low power, too. Of all the stations I've heard, not more than 15% or at the most, 20%, approached anything near a d.c.e.w. note. It seems that "hams" have to have a signal that is QSA4 and r.a.c. or their reply is usually "sorri OM but nd hr — pse rpt" or "nd OM sorri — hope 2 eu agn 73 — QSU." This all sounds as if I'm a pessimist or "calamity Jane." This is far from the truth. It is my purpose first to state things as I see them, then suggest a remedy or two and ask the gang what it thinks.

Supposing the country is divided into several sections according to the ham population, and that each section is assigned a very definite portion of each band and is requested to operate in it. I believe this could and should be done for this reason: If you desire to work a certain area or district, it would only be necessary to tune your receiver to the frequency band assigned to that district and find a station to work with. While the stations in one district might all be grouped together in the band, this would be a great thing because those stations in your own section wouldn't QRM you simply because you would be listening to another part of the band.

Another suggestion that I would offer is, that beginners, those who for the first time have re-



*It  
Teaches  
the  
Code!*

**Learn  
Telegraphy with TELEPLEX**

**T**ELEPLEX is the practical code instructor. Works like a phonograph. Waxed tape records send signals like a real operator. Complete code instructions furnished with every Teleplex. Sends messages, radiograms, etc. — regular code traffic like an expert operator. Used by all leading schools. Endorsed by U. S. Navy. **Guaranteed to teach you the code or it costs nothing.** Speedy, simple, clear. Ideal for advanced students or beginners.

**FREE 10 DAYS TRIAL!**  
 So sure are we that you will be absolutely satisfied with your purchase, that we will let you try it in your own home ON 10 DAYS FREE TRIAL! You are the sole judge. Where can you match that astounding offer? **ACT TO-DAY!** Write for full facts about Teleplex. No obligation.

**TELEPLEX CO., Dept. E12, 76 Cortlandt St., New York, N. Y.**

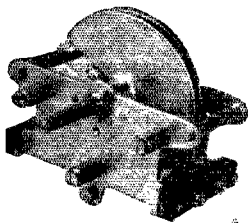

TAPER PLATE  
191-E  
IDEAL FOR SHORT WAVE  
RECEIVERS

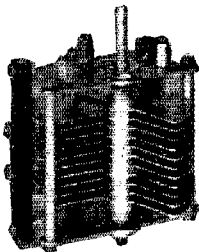

164-B  
CAP.—.00022 MMFD.

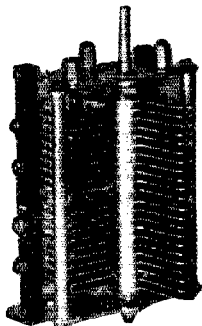

157-B  
DOUBLE STATOR

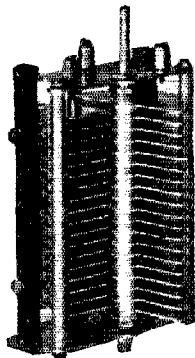

T-199  
CAP.—.00033 MMFD.

# A Well-Balanced Line!

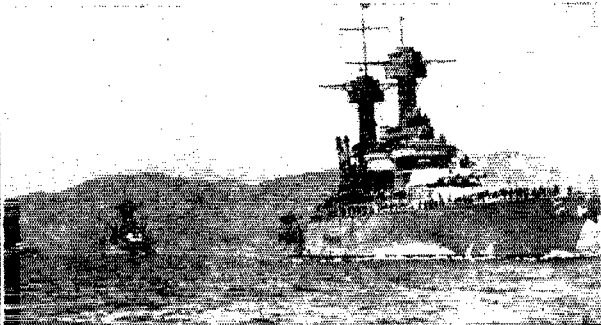

**U**NCLE SAM'S FLEET is not composed solely of ships of the line. You will find Dreadnaughts, Scout Cruisers, Destroyers and Submarines—each ship with a definite task to perform and each built so as best to fulfill its mission.

Cardwell Condensers play their part in maintaining communication between the ships and with their base and scouting planes.

Variable condensers of many types are necessary. Transmitting and receiving—large and small—and the Cardwell line meets every requirement.

Your needs may not be as diversified as those of the Navy, but somewhere in the Cardwell line is a condenser for you.

Transmitting Condensers for powers to 50 k. w. Receiving condensers in all standard capacities. Fixed (Airdielectric) transmitting condensers. Send for literature.

---

## CARDWELL CONDENSERS

THE STANDARD OF COMPARISON

---

The Allen D. Cardwell Mfg. Co.  
81 Prospect St. Brooklyn, N. Y.  
*If your dealer does not stock, order direct.*

# ACME WIRE PRODUCTS

Coils — Magnet Wire Wound  
Magnet Wire All Insulations  
Varnished Insulations  
Parvott Filter and By Pass Condensers

All products made to Recognized Commercial Standards including those of:

National Electric Mfrs. Assn.  
Radio Manufacturers Assn.  
American Society for Testing Materials

For 25 years manufacturers and suppliers to the largest and most discriminating users.

## THE ACME WIRE CO. NEW HAVEN, CONN.

### Branch Offices:

New York Cleveland  
52 Vanderbilt Ave. Guardian Bldg.  
Chicago  
842 N. Michigan Ave.

ceived their operator and station licenses, be assigned to the long-wave band (150-175 m.) say for six months, during which time they would become sufficiently familiar with operating to enable them to handle their station on the traffic and DX bands in such a manner that would be a credit to themselves — and not a source of anguish to others.

I would like to hear what others think about all this.

— Francis N. King (KG) and  
George Kovell (GK), WSATM

## I.A.R.U. News

(Continued from page 62)

us to have such information on file. At present, we have definite information only for the United States, Canada, England, Denmark and Australia. We want to hear from other countries; if your governments have issued regulations, please send us copies and full details; if regulations are being contemplated, we would like to know as much as possible just what is being considered.

Send all information to the Secretary, International Amateur Radio Union, 4711 Park St., Hartford, Conn., U. S. A., whether or not your country is a member of the Union.

### AUSTRALIA

As related last month, a great step was taken forward in amateur circles in Australia the first of this year when there was effected a merger between the Wireless Institute of Australia (the national section of the I.A.R.U.), and the Australian Radio Transmitters' League. Already the benefits of a unified effort are becoming apparent.

Perhaps the most recent development in Australia is a marked revival of interest in the 3500-ke. band. Australian amateurs have neglected to use this band in the past, and as a result suffered almost the same fate as their English cousins and were virtually prohibited from using this territory when the new 1929 regulations were issued. Fortunately, a way out is found in the new Defence system previously mentioned. Amateurs associated with the Defence network will be allowed the use of the 3500-ke. band. It is hoped that eventually it will be opened to all amateurs, but they will have to prove their right to operate there before the government takes any such steps. As a result, there is much talk in amateur circles at the moment stimulating interest in 3500-ke. operation.

Go to it, Aussies! Here in the States we consider that 3500-ke. band our most valuable national relaying band, and we know that you will become just as devoted to it after a little work there.

### BRAZIL

At this writing, the government of Brazil has not yet ratified the International Radio Treaty. As a result, Brazilian amateurs do not feel themselves bound to observe the Washington allocations, and we are advised through PY2AK that

# Potter RR-245 Condenser

for

Successful  
Operation  
of

R-245 Power  
Compact

GET one to-day

and enjoy the beautiful tone quality. \$19.75

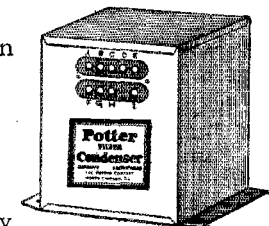

### Potter

### Dynamic Speaker Filter

will reduce the hum in an A. C. operated dynamic speaker using low voltage rectifier. \$4.75

## The Potter Co.

North Chicago, Illinois

A National Organization at Your Service.

*"Here at last is The Book that we of the Radio profession have needed for a long time. It is the best and most complete handbook ever published" says J. H. Bloomenthal, Chief Radio Operator, U. S. S. B. Steamship "East Side".*

# THE RADIO MANUAL

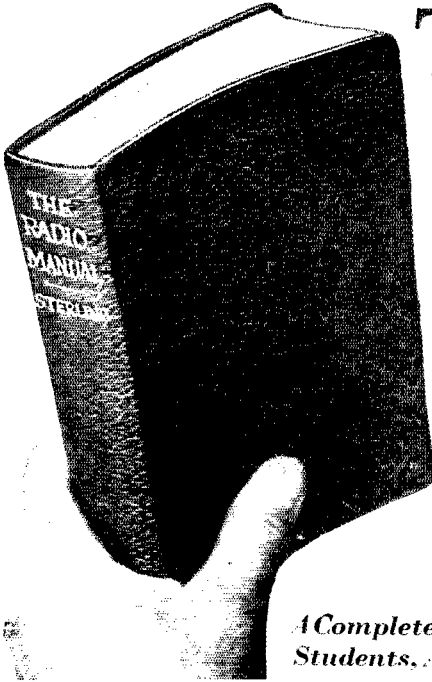

By G. E. STERLING, Radio Inspector and Examining Officer, Radio Division, U. S. Dept. of Commerce.

Edited by ROBERT S. KRUSE, for five years Technical Editor of QST.

Here's the answer to every question about the principles, methods, or apparatus of radio transmitting and receiving. A complete course in radio operation in a single volume. A handbook for students, amateurs, operators, inspectors. For the first time an entire course of training in one book — the most complete and up-to-date work on radio. Developed simply and clearly from the elementary stage right through all phases of principles, practice, and apparatus so that a beginner with no knowledge of electricity may get all he needs either for amateur operation or to qualify for a government license as operator or inspector.

*A Complete Handbook of Principles, Methods, Apparatus for Students, Amateur and Commercial Operators, Inspectors*

## Complete Preparation for Government License.

1. Elementary Electricity and Magnetism
2. Motors and Generators
3. Storage Batteries and Charging Circuits
4. Theory and Application of the Vacuum Tube
5. Fundamental Circuits Employed in Vacuum Tube Transmitters
6. Modulating Systems Employed in Radio Broadcasting
7. Wavemeters, Piezo-Electric Oscillators, Wave Traps and Field Strength Measuring Apparatus
8. Marine Vacuum Tube Transmitters including detailed description of Model ET-3626

9. Radio Broadcasting Equipment including, for the first time in any text book, the complete equipment of Western Electric 5 Kilowatt broadcasting Transmitter used in over 75% of American broadcasting stations
10. Arc Transmitters including description of Federal Marine 2 Kilowatt Arc Transmitter Type AM 4151; also models "K" and "Q"
11. Spark Transmitters including description of Navy Standard 2 Kilowatt Transmitter
12. Commercial Radio Receivers and Associated Apparatus including, for first time in

## 16 Chapters Covering

- any text book description and circuit diagram of Western Electric Superhetrodyne Receiver Type 6004C
13. Marine and Aircraft Radio Beacons and Direction Finders
14. The Development of Amateur Short Wave Apparatus. Complete details of construction, operation and licenses
15. Radio Laws and Regulations of the U. S. and International Radio Telegraph Convention, Quotations of all important sections
16. Handling and Abstracting Traffic

## Examine It Free

Never before has so complete a treatment of radio theory and operation been compressed into a single volume. Here is information that otherwise you could secure only by consulting many different books. And every detail is vouched for by authorities of the first rank. The Manual is profusely illustrated with photographs and diagrams. There are 700 pages, bound in flexible fabrikoid that is extremely durable. The immediate demand for so valuable a handbook has already nearly exhausted the fourth large edition. To be sure of receiving your copy without delay, order at once. The volume will be sent for free examination. Pay or return in 10 days.

### Order On This Coupon

D. VAN NOSTRAND CO., INC.,  
8 Warren St., New York City

Send me THE RADIO MANUAL for examination. Within ten days after receipt I will either return the volume or send you \$6.00 — The price in full.

Name..... QST-5-29

St. and Number.....

City and State.....

## National Rectobulb Type R-3

**A** RELIABLE and efficient rectifier tube — low impedance due to mercury vapor — long life due to low temperature filament and oxide coated cathode of large area — of sturdy design which defies the rough handling incident to shipping them.

Normal Rating .....	250 Mils
Normal Plate Volts .....	3000
Filament Amps .....	1.7
Filament Volts .....	40

Of equal utility for amateur and small broadcast stations — also for power amplifiers of all types — fitted with a plate connection at top and UX base at bottom — full operating instructions with each tube.

Sent postpaid if cash with order — Safe delivery anywhere in U. S. A. **GUARANTEED**

**Price, \$10 each**

We repair 203A tubes .....	\$19.00
204 tubes .....	\$50.00
204A tubes .....	\$75.00
WE 211 tubes .....	\$16.50

**ALL REPAIRS FULLY GUARANTEED**

**National Radio Tube Co.**

3420 18th Street

San Francisco, Calif.

## "The Heavy Duty Giant" POWER RHEOSTAT

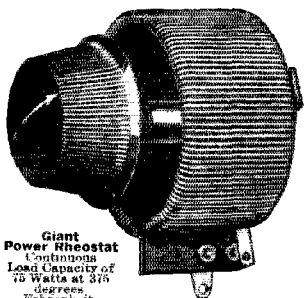

**Giant Power Rheostat**  
Continuous  
Load Capacity of  
75 Watts at 375  
degrees  
Fahrenheit.

Centralab offers a variable resistance that is capable of handling the greatest power loads under all conditions and is extremely small in size. The Giant Power Rheostat is constructed completely of metal and asbestos — no fibre to warp or burn out under heavy duty use.

The resistance wire is wound on an asbestos insulated metal core and presents a large area for heat radiation. It will carry a continuous current load through the entire resistance of 75 watts at 375 degrees Fahrenheit.

The mechanical construction is simple but very sturdy, making it an ideal unit for manufacturers. The contact is positive — smooth to the touch and noiseless. This unit is particularly adaptable to primary control of filament transformers for A.C. sets or "A" power supply units to maintain the light socket voltage of a constant average and the secondary output well within rated limits.

The current carrying capacity is so great that it can be used in any radio power circuit without danger of burning out — as the fusion point of the wire is the only limit of capacity.

Made with two and three terminals in resistances from 25 to 8000 ohms. May be had in the 3000 and 8000 ohm size with a fourth terminal for "B" eliminator control.

Priced very low. Write or visit specifications for your needs. Quotations and samples gladly furnished.

**CENTRAL RADIO LABORATORIES**

18 Keefe Avenue

Milwaukee, Wisconsin

**Centralab**

anyone wishing to QSO Brazilian amateurs will find them on the same old wavelengths, which we presume are those in the vicinity of 33 to 35 meters.

DENMARK

By Helmer Petersen, OZ7S

Conditions in Denmark were generally about the same as in February of last year, i.e., very different from day to day. Some days were excellent, and many DX stations came in with very good strength, while on other days the air was practically dead.

7 mc. is not at all good at present. During the day a few stations may be heard and generally with very low QSA; at night there is but little improvement. Southern Europe, western Asia, northern Africa and Ireland are almost the only localities heard. OZ7BL reports his best DX during February on this band: NX1XL (Greenland) QRH 42.5; tone RAC; QTU 1921 GMT.

14 mc. is absolutely the best band at present. Almost all countries may be heard; only W stations are weak, although they were heard with very good strength during the end of January. Best working hours seem to be about 10 to 15 GMT.

28 mc. has not had much progress during February in this country. Only OZ7T has been heard by BRS152 (British receiving station) QSA5, and other hams report having heard some French stations, but no W stations. However, we hope to be able to give a better report next month.

BRITISH NOTES

By J. Clarricoats, G6CL

On the 7-mc. band considerable activity occurred during February. Local European stations have again been fairly consistent during daylight, while, after dark, many distant Europeans were received. It was noted that Portuguese stations which are normally regularly heard at this time of the year were almost inaudible, most evenings. Signals from North American stations were generally very strong and made the reception of all but loud European signals very difficult. This condition seems unavoidable with the present restricted wavebands. It is again noted that very few low power British stations effected DX contacts at night on this wave. If conditions follow the same phase as in 1928, the low power stations may hope for success between 0500 and 0800 GMT, during March. Attention is again drawn to the amateurs who send very long CQ calls before signing with their station call. Many British stations lose patience waiting for them to finish.

On the 14-mc. band considerable activity has prevailed, especially during weekends. Most of the European countries could be worked during daylight with inputs under 10 watts, while occasionally communications with other continents was possible. Several of our 10-watt stations succeeded in working all continents on this wave. Fading has been very pronounced on many occasions, and has rather spoilt several interesting



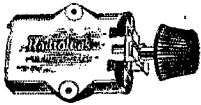

\$4 Bradleystat No.  
E-210, Special \$1.60

# LEEDS

The Home of RADIO  
45 VESEY STREET  
NEW YORK

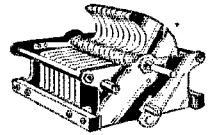

Cardwell con-  
densers, double  
spaced for trans-  
mitting, .00025 cap. \$4.45

## THORDARSON TRANSFORMER

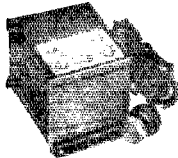

R. 195 Raytheon  
B-Eliminator  
transformer, de-  
signed as power  
supply for B-Bat-  
tery eliminators  
using the Raytheon  
B-H tube. Has 2  
secondary voltages  
— low 235 volts  
either side of centre  
tap — high 285 volts either side of centre.

Transformer will carry the maximum cur-  
rent consumption of the Raytheon tube  
without overheating.

Listed at \$7.00  
While they last, only..... \$2.95

## ACME TRANSFORMER

Listed at \$5.00. The  
universal transformer  
for Super Het. 30 K. C.  
Limited quantity at  
\$1.10.



## Television Lamp

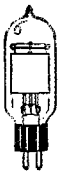

The large K. H.  
lamp 4 1/2 inches high  
—contains 1 1/2-inch  
plate—carrying 5 to  
50 M. A.  
Special..... \$5 50

New York's Headquarters for  
Transmitting Apparatus  
When in Town Visit Our Store

Everything in

Cardwell

Acme

Thordarson

Jewell

Flechtheim

Signal

Bradley

Tobe

IN STOCK



## NEON GLOW LAMPS

Made by General Electric  
Co., type G-10 standard  
base. 101 uses, as illustrated  
in QST May issue page 17.  
Price only..... .65c

## RADIO FOUNDATION TRANSFORMER



Will carry 6 or 7-327 A.C. tubes tapped  
at 2 1/2-3 1/2 volts — for 1-866 tube or  
4-345 tubes. List \$6.00.

Special..... \$2.25



Signal Buzzer Set International  
Code on Baseboard..... \$2.45

## Photo Electric Cell



The well known K. H., the most  
sensitive tube for this purpose  
—4 1/2 inches high. Lasts a  
lifetime with ordinary care.

Never sold for less than \$15.  
Now Special..... \$12



We carry  
the largest  
stock of  
GENERAL  
RADIO  
PARTS in  
the country

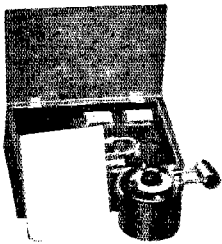

Type 558-P Amateur-Band Wavemeter.....\$18.00

**Type 558-P Amateur-Band Wavemeter**  
The increased congestion and decrease  
in width of the amateur bands make  
necessary the use of a more accurate  
wavemeter than has heretofore been  
available to amateurs at a low price.  
To meet this need the General Radio  
Company has developed a band-type  
wavemeter which employs a system  
used in broadcast station frequency  
meters in order to secure great preci-  
sion over a limited band.

Five coils are used, covering the  
following amateur bands:

Coil A..... 4.6 to 5.4 Meters  
Coil B..... 8.4 to 10.9 Meters  
Coil C..... 18.5 to 21.5 Meters  
Coil D..... 37.0 to 43.0 Meters  
Coil E..... 78.0 to 86.0 Meters

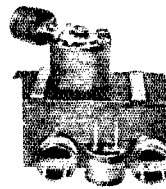

**Type 358 Wavemeter**  
The General Radio Type 358  
Wavemeter is designed particu-  
larly for experimenter use.  
The wavemeter consists of a  
mechanically rugged coil of  
low-loss construction, mount-  
ing directly on the binding  
posts of a shielded condenser.  
Mounted on the condenser  
panel and connected in series  
between the condenser and coil  
is a resonance indicator in  
the form of a small lamp. The  
lamp socket is so arranged  
that it is short-circuited when  
the lamp is removed.

The coil ranges, providing adequate overlaps, are as follows:

Coil A..... 14 to 28 Meters  
Coil B..... 26 to 56 Meters  
Coil C..... 54 to 114 Meters  
Coil D..... 108 to 220 Meters

\$15.00

# ANNOUNCEMENT LEEDS RADIO LABORATORIES!

Under the supervision of the famous Short Wave Specialist, Mr. Jerome Gross, we have installed a new department. We are equipped to design, construct and advise on any material for the "Ham," Broad-casting Station, or laboratory. Write to Mr. Gross, who can help you with your problems.

PLEASE PRINT YOUR NAME AND  
ADDRESS PLAINLY to AVOID DELAY

WRITE FOR  
SPECIAL PRICE LIST

MAIL ORDERS FILLED SAME DAY  
10% Must Accompany All Orders

# Our NEW Catalog is NOW Ready..

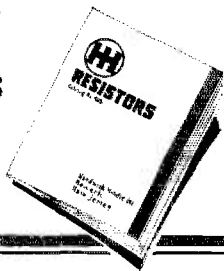

A regular encyclopedia of wire-wound resistor knowledge, this — new sizes, new mountings, special units, bracket specifications and drawings.

In fact, complete engineering data with simplified charts for working out your own requirements are within its covers.

Every electrical and radio manufacturer should have Catalog No. 429. Send for it today.



**HARDWICK, HINDLE INC.**

SALES DEPT.  
122 Greenwich  
St., New York

FACTORY  
215 Emmet St.  
Newark, N. J.

## RESISTORS

### MORE POWER PER STAGE

*Sharper Tuning and No Oscillation Difficulties*

Radio Science proves neutralization the only satisfactory method of controlling oscillation in tuned radio frequency circuits, thus increasing actual power per stage of amplification from 25% to 300%.

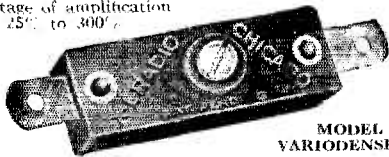

MODEL "N"  
VARIODENSER

Apply the Neutrodyne principle to your set by the simple installation of X-L Variodensers. The result is an amazing increase in the efficiency and power of the receiver.

Model "N" has Variable capacity, adjustable from 1.8 to 20 micro-micro farads, the price each \$1.00.

Model "G" with grid clips made in three variable capacity ranges. Price, each, \$1.50. New Bakelite insulated X-L Push-Post the most perfect binding post made, Plain or all standard markings. Price each 15 cents.

Write for free book of circuit diagrams showing use of X-L Units.



X-L Push  
Post

#### X-L RADIO LABORATORIES

Dept. D 1224 Belmont Avenue, Chicago, Ill.

*Do you know that the 1929 Handy and Hull Hand-book is available in bound form — \$2.00 per copy, postpaid!*

*When ordering a copy of this new edition, look at your present copy and determine if you want the 1929 copy in more permanent form.*

QSO's. The presence of static has been noticed, and this seems to have been in some way connected with the very cold and frosty weather.

Very little interest has taken place on the 28-mc. band, except that G5YK has succeeded in effecting the first contact between England and India. This was on February the 10th, when he worked AI2MT (late G2FM).

The use of the new QSA audibility code seems to have caused considerable difficulty, and it is suggested that as the new scale does not give the same degree of audibility as was the case with the old R scale, all stations should, when reporting signals QSA5 follow this with the old equivalent of R code strength. For amateur use it is considered that QSA1-QSA4 should be equivalent to R1-R4. At the moment any signals between R5-R9 is reported QSA5. The suggestion put forward will perhaps help to overcome the present difficulties. The possibilities of the adoption of a universal amateur code which would give both audibility and readability is a matter which should be considered by the I.A.R.U. before the next international convention.

The R.S.G.B. has decided to offer a limited number of their official log books to new members at a cost of 6d plus postage. New members are welcome, and applications for membership can be obtained from the Hon. Secretary, 53 Victoria St., London, S.W. 1.

Owing to the large number of QSL cards which are sent to the R.S.G.B. QSL Bureau it has been decided that in future only cards intended for British members will be forwarded.

#### GERMAN REPORT

*By E. Reiffen, Secretary D.A.S.D.*

In January, the distance conditions in the 7-mc. band continued favorable so that a number of low-power stations had good contacts with American amateurs. In the last two weeks, several dead days were noted, but we hope that these were a transient phenomenon. In the 14-mc. band, communication was comparatively unsatisfactory, and signals were weak. A few stations were reported as heard in the 28-mc. band, but actually they were working in the 14-mc. band. The audibility in the 28-mc. band must be checked carefully, therefore.

It is most confusing that the old identification signals and audibility scale are still in use. Only the real expert is able to find his way through the confusion. All I.A.R.U. sections must eventually see to it that the 1929 signals are generally used, 73 to all.

#### NOTICE! GERMAN QSLs

QSL cards for Germany amateurs which refer to a call sign having the letter D, a number, and two letters (as, for instance, D4YT) are unlicensed! QSL cards should be sent *always* to D.A.S.D., QSL Section, Blumenthalstr. 19, Berlin, W. 57. Otherwise the card is not likely to reach its destination.

# SM

## Sweetest of Loud Speakers—It's a Real S-M!

ONLY two months old is the S-M dynamic speaker; yet already it has taken its proud place among S-M audio products—the acknowledged aristocrats of tone quality. . . "Sweetness" is taking on a new meaning for owners of S-M speakers. All the mellow flow of the "lows," as well as the brilliancy of the "highs," come out smoothly on an S-M dynamic—with a surprising absence of all rumbles, roars and rattles. . . As always, there are underlying engineering reasons. Sound design in the speaker head is coordinated with similar mathematical correctness in the built-in S-M 229 output transformer, which has various taps to insure proper impedance matching for 171A, 210, 245, or 250 type tubes, singly or in push-pull. . . The 110-volt d.c. type (851), at \$29.10 net, is ideal where the field winding is to be connected as a choke in a power circuit. . . The a.c. type (850), at \$35.10 net, operates on 50 to 60 cycles, 105 to 120 volts. Thorough rectification of field current, with a 280 tube and a 2-mfd. filter condenser, reduces hum to the point of defying detection. . . Either type fits an 8½" baffle hole. . . Try an 850 or an 851 unit in the next set you build—and the S-M speaker will become your speaker!

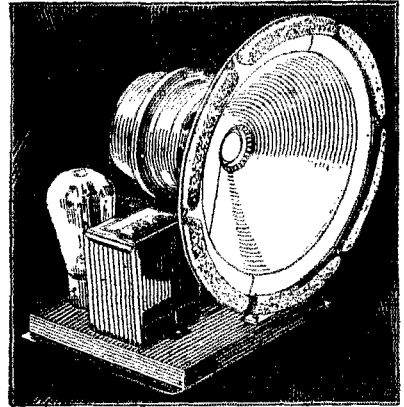

## S-M Audio Transformers—Supreme in Performance

S-M Clough-system audio transformers have accomplished—just as we predicted last June—a revolution in tone fidelity. Adopted at once by those familiar with earlier S-M triumphs in standard transformer design, these new-type transformers have since received the practical endorsement of repeated and continuous use by the foremost custom-builders in America. Now that they are available in a complete line for interstage, output, and push-pull circuits, their consistent use throughout every kind of amplifier is the surest means of enhancing a builder's reputation for tone quality.

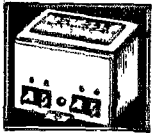

- 255 and 256 Audio Transformers, for standard use in first and second stage respectively. Each.....\$3.60 net
- 225 and 226, similar to the 255 and 256, but larger and slightly more perfect in frequency characteristic. Each.....\$5.40 net
- 257 Push-Pull Input Transformer: effective transformation ratio 1.8:1; frequency characteristic flat from 45 to 8,000 cycles when operating out of one 201A, 112A, 226, or 227 tube, into two 201A, 112A, 226, 227, 171A, 210, 245, or 250 tubes. Each.....\$4.20 net

- 227 Push-Pull Interstage Transformer: effective transformation ratio 1.8:1; frequency characteristic flat from 20 to 10,000 cycles. (Television experimenters please note!) To feed from two 201A, 112A, 226, or 227 tubes into two 112A, 226, 227, 171A, 210, 245, or 250 tubes. Housed in the new type S-M case, mounting in same space and with same holes as 251, 255, 256, 257 and 258 transformers, but 3½" high. Each.....\$4.80 net
- 248 Universal Output Choke, to feed out of two 171A, 210, 245 or 250 tubes; provided, for impedance matching purposes, with two end leads and a center tap (B+) and, in addition, two extra pairs of taps to accommodate any normal series of series-parallel arrangements of one to eight magnetic or dynamic speakers. Will handle the full undistorted power output of two 250 tubes without core saturation or observable distortion. Open-mounted; each.....\$4.20 net
- 228 (248 in case like 227). Each.....\$4.80 net
- 229 Dynamic-Speaker Output Transformer; to couple two 171A, 245, or 250 tubes in push-pull (or singly) to the moving ("voice") coil of any standard dynamic speakers under conditions of maximum undistorted power output. Equipped with impedance matching taps, and housed in 227 type case. Each.....\$4.80 net

### S-M Plug-In Coils and Coil Forms

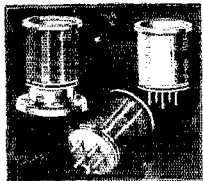

Accuracy, handiness, and dependability are found to a most satisfying degree in the new S-M plug-in coils, fitting any 5-prong tube socket. Plug-in coils with 35 different windings are accurately described in the S-M Catalog—besides unwound bakelite coil forms—such as 131P with smooth surface and 131T cut with 98 threads—either type 39c net.

The Radiobuilder, a monthly publication telling the very latest developments of the S-M laboratories, is too valuable for any scrubber to be without. Send the coupon for free sample copy, or to enter your subscription if you want it regularly.

**SILVER-MARSHALL, Inc.,** 6409 W. 65TH STREET, CHICAGO, U. S. A.

Ask about our Authorized Service Station Appointment!

Silver-Marshall Inc.  
6409 W. 65th St., Chicago, U. S. A.  
Send your new 1929 Summer Catalog, describing S-M Speakers, transformers, and other new products; also sample copy of the Radiobuilder.

Name.....  
Address.....

## DODGE RADIO SHORTKUT

### KILLS HESITATION—PRODUCES RESULTS

Users have raised receiving speed from 15 to 25 in three and half hours — 15 to 30 in five hours — 10 to 15 in one hour — 4 to 12 in four hours, etc., etc. Beginners master code and qualify in few days.

### REPORTS FROM 500 USERS

telling complete story and who's who with each order. Or with Half-Dollar Coupon for 50 cents. Specimen reports on request — sufficient to justify this ad.

**W2ATK reports:** "Surprised self by getting code pat in few hours and soon had license. Now read at 35 easy. If asked would tell any ORS to 'grab' your Shortkut." **W4QY reports:** "Method looked NG to me but by using it raised reading speed from 15 to 30 per in 5 hours. Hope you get Shortkut into the den of every Ham." **W7AAD reports:** "Long stuck at 4 per and discouraged. Four hours with Shortkut raised to 12 and license."

### DODGE HIGH SPEED METHOD

(Intensive Speed Practice)

Most efficient Code Reading booster known for 25 per Hams. User raised speed from 27 to 39 in 75 minutes' practice time. Full details in reports.  
**W5AHM reports:** By five practice sessions 15 minutes each raised speed from 27 to 39 per actual count.

### DODGE MORSE SHORTKUT

Master both codes our way and use without mixup.

**W8CJL reports:** Also tried your easy Morse method and can now copy at 20 per. Best previous effort about 8 and much confusion with Continental. That trouble entirely disappeared after memorizing Morse your way.

Radio Shortkut \$3.50. High Speed or Morse \$2.50. Money Order. None C.O.D. Foreign add Fifty Cents.

**C. K. DODGE**

Box 100

Mamaroneck, New York

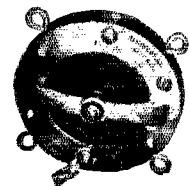

## MICROPHONES

### 2-Button Type

For Public Address, etc., list..... \$25

Standard Broadcast Model, list..... \$75

Condenser Models for Film and Record Work, list \$250.00, \$300.00

Also Desk and Floor Stands, Covers, Cords, etc. Miniature Microphone, Paper Weight, Radiator Ornament, Die Cast, Bronze finish; prepaid on receipt of \$1.00.

### EXPERT MICROPHONE REPAIRS

Dealers everywhere

**UNIVERSAL MICROPHONE CO.**, Inglewood, Calif.  
Chicago: Fred Garner Co., 9 S. Clinton St.  
New York: Cochran Eng. & Sales Co., 50 Church St.  
San Francisco: C. C. Langevin Co., 274 Brannon St.

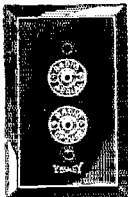

## Wire Your Home for Radio

For every radio need, in brushed brass or Bakelite. Fit standard electrical switch or outlet box. Single plates and in gang in many combinations.

No. 135 — For Loud Speaker..... \$1.00

No. 136 — For Aerial and Ground..... 1.00

No. 137 — For Battery Connections..... 2.50

No. 138 — For A. C. Connections..... 1.00

(Bakelite, 25c additional per plate)

**YAXLEY MFG. CO.**

Dept. S — 9 So. Clinton St., Chicago, Ill.

## SWEDISH NOTES

By Osborn Duner, Secretary S.S.A.

The Swedish amateur society, the S.S.A., was founded in 1925, and its progress during the past four years has been splendid. At present about 140 Swedish amateurs are members, of which 100 are the owners of transmitters.

Beginning with 1929, Sweden has been divided into seven districts, each comprising the territory covered by two degrees of latitude; the first district comprises lat. 69 degrees N. to 67 degrees N., and so on to the 7th district, 57-55 degrees. The new calls are the same as the old ones, but the figure of a district is inserted after SM, i.e., SM2ZZ.

The system of districts and new calls has been sanctioned by the telegraph administration, and were proposed by the S.S.A. In accordance with the Washington convention, the Swedish telegraph administration will probably prescribe an ability to send and receive at least ten words per minute before issuing a transmitting license. No restrictions beyond those of the convention are planned. (FB!)

QSL cards to Swedish amateurs should be sent to the headquarters of the society, S.S.A., QSL Section, Stockholm 8, Sweden.

At present the Board of the S.S.A. consists of the following five officers: President, Dr. Bruno Rolf; vice president, Goran Kruse, SM5TN; secretary Osborn Duner, SM5ST; treasurer, Emil Barksten, SM5VL, and technical secretary Evert Aulin, SM5UL.

Only a few of the Swedish amateurs are working DX with a power over 100 warts. The rest prefer to QSO with QRP transmitters on the 7-mc. band. During the dark season a few have made successful tests on 3500 kc. and it would be very fine if more European hams would use this excellent winter traffic band. A few have had fine DX results on 14 mc. and interest in 28 mc. is growing, several SM's having transmitters and receivers for this territory.

Every Sunday a radio bulletin is transmitted from the headquarters of the S.S.A. at 1400 GMT under the call SM9SA—the general call to the members of the S.S.A.—on the 7-mc. band. The bulletin contains traffic news and other news of interest, and is repeated at low speed. In addition to our own official magazine, QTC, the Swedish magazine *Popular Radio* publishes short-wave items.

It is our intention to join the I.A.R.U. in the near future, and thus take a part in international ham cooperation. (The editor is happy to announce that plans for the admission of the S.S.A. into the Union are now almost completed.)

The S.S.A. and all Swedish hams send their best greetings to amateurs all over the world.

## Calls Heard

(Continued from page 63)

w9hm a11b a12kt a12kx a15vx a8ulm ce2ar en8nb et2ab  
fk1lm ik5er im8gkc im8skk im8rit im2u2 ilem k4aky  
nj2pa pk1jr pk4az pylat pytlc pytem pyler pylib pylid  
py2ag sadt9 se1ai salter velae velaj velap velar veldq

# BARGAINS ARMY AND NAVY RADIO SURPLUS

Voltmeter, Westinghouse, No. 492419 cabinet portable, 2 scale 0-5-50, List \$6.50.	\$ 2.50
Voltmeter, Weston, No. 267 D.C., 0-70	7.50
Ammeter, " No. 267 D.C., 30-0-40	7.50
" " No. 267 D.C., 1-10	7.50
" " No. 301 D.C., 50-0-50	5.00
Voltmeter, " No. 269 D.C., 0-50	2.50
Ammeter, " No. 269 A.C., 0-10	7.50
Wattmeter, Roller Smith, A.C. and D.C., 0-750	3.50
Amp. hour meter, Sangamo, bat. charge and discharge, type MS 2 sizes, 0-300 and 0-500, List \$50.00	10.00
Ammeter, Westinghouse, A.C., 8" dia. less external shunt 0-300	10.00
Voltmeter, Westinghouse, A.C., 8" dia. with external res. 0-175	12.50
Generator, self ex., 1/2 K.W., 500 cycle, 110 volt	15.00
Dynamotors, twin, Westinghouse, C.W. 927, 30/750 volt, .08 amp.	25.00
Dynamotor, single, Westinghouse, C.W. 927, 30/375 volt, .08 amp.	15.00
Dynamotor, Gen. Elec. 12/350 volt, 143 amp.	20.00
" Crocker Wheeler, 25/275 volt, external shaft.	12.00
Motor Generator, Sperry Gyro Co., 6/400 volt, 200 watt.	15.00
Motor Generator, Crocker Wheeler, 110 D.C., 250 A.C., 500 watt, 500 cycle.	50.00
Motor Generator, 110 universal motor, 300 D.C. generator, 200 watt.	35.00
Generators, 600 volt, 2 and 5 K.W. Westinghouse and G.E.	\$200.00
Motors, Hamilton Beach, 1/20 H.P. universal, var. speed 110 volt.	5.00
Motors, Edison, universal, 50 watt, double shaft, 110 volt D.C. 10	3.50
110 volt.	(List \$10.50)
Motors, Underwood, D.C., 75 watt, double shaft 1200 R.P.M., 110 volt.	2.00
Dynamotor armatures, Gen. Elec. triple commutators, two sizes, D.C. 12/750 volt and 24/1500 volt, complete with ball bearings, (build held and save \$30)	\$10.00 and 12.50
Transformers, West. Elec. radio, 50,000 ohm impedance, input type.	1.50
Transformers, Peerless, 120 input, 5-10-15 volt output, 1/2 K.W., 60 cycle.	7.50
Transformers, G.E. current type, 125 to 2500, with center tap, 60 cycle 200 Watt.	7.50
Transformers, AmerIran, 220 to 30000, open core, 2 K.W., 60 cycle.	75.00
Transformers, AmerIran, 220 to 8000 closed core, 1 K.W., 500 cycle.	15.00
Transformers, Simon, 220 to 11500 closed core, 1/2 K.W., 500 cycle.	5.00
Transformers, AmerIran, 220 to 12500 closed core, 2 K.W., 500 cycle.	25.00
Transformers, Special 250 Primary, 30 taps stepdown, 1KVA, 60 cycle.	50.00
Resistors, Ward Leonard, 3 sizes, 600, 900, 2000, Edison base each.	.60
Rheostats, variable, 400 ohm, 3 watt.	.75
Potentiometers, var., 200 ohm, 1.5 amp. airplane type.	1.00
" 1100 "	1.00
" filament, 1 ohm, 8 amp. airplane type.	.75
Gasoline Engine, 1 cylinder 2 cycle Smith 2 horse power complete.	25.00
Gasoline Engine, 2 cylinder 2 cycle Sterling 5 horse power complete.	50.00
Gasoline Engine, 4 cylinder 4 cycle Henderson 20 horse power, air cooled with starting blower all aluminum body complete with hand starter and separate transmission.	75.00
Condensers, West. Elec. 21AA 1000 volt 1 mfd, very good value.	1.00
Condensers, Kellogg, 500 volt 2 mfd.	.50
Condensers, Wireless Specialty, copper leyden glass jar, 10000 volt .002 mfd.	2.00
Condensers, Dubilier, mica, transmitting, 8500 volt .004 mfd.	\$10.00
Condensers, Dubilier, mica, transmitting, 12500 volt .004 mfd. Prices on request.	
Condensers, Wireless Specialty, transmitting, 13500 volt .004 mfd. Prices on request.	
Keys, transmitting, Army practice	1.00
" " Airplane flameproof, silver 1/2" contacts	1.50
with blinker light mounted on bakelite base. List \$7.50 Special.	2.00
Keys, transmitting, Navy, 2 K.W. silver 3/8" contacts	5.00
" " 1/2 K.W. "Messco" silver	2.00
Headphone, Army, with strap, 120 ohm.	.75
Navy Radio School type, leather headband, 75 ohm.	1.50
Transmitter, telephone, U.S.N., 30 ohm (used)	.75
Microphone transmitter unit, Western Electric	1.00
Magnets, Army mine and ringer type, has 4 large fixed magnets, good value.	1.00
Maguetto-generator, Marconi, hand driven, 1500 volts D.C., 12 milliam.	12.50
Magnets, permanent, U shaped Western Electric, large size	.50
Variometers, Gen. Radio No. 107D and 107E, with series and parallel connections.	5.00
Telephone & telegraph portable sets, aluminum case leather covered and carrying strap, including condensers, induction coil, key, micro-transmitter and receiver.	3.50
Telegraph and buzzer portable sets, mahogany case, 2 tone platinum contact high freq. buzzer, 2 telephone toggle switches, potentiometer, sending key, 3 mfd. condensers, transformer and 2 choke coils, receiver. \$30 value.	5.00
Kolster wavemeter & decremeter, type C.N. 1215, 100-3500 meters, current 50, meter.	85.00
Receivers, Navy, C.N. 113, 300-2500 meters, with cry. det. and Century buzzer in portable case.	7.50
Receivers, Navy, C.N. 113, 300-2500 meters.	15.00
Signal Corp. 300-3000 meters, with built in tube detector, portable.	20.00
Receivers, Marconi, 300-2500 meters, type 106, commercial 4th type.	35.00
Receivers, Westinghouse, 1012, 50-1000 meters, built in tube detector.	50.00
Receivers, Navy, C.N. 240, 1000-10000 meters.	50.00
" " S.E. 952A, 30-600 meters.	75.00
" " S.E. 143 and I.P. 500 Prices on request	
Insulators, Electro-se, strain 7"-15, 12"-35, 18"	.35
Switch, Send and Receive, Navy, bakelite, back connect.	1.50
Telephone, toggle, 2-4-6-8 point.	.50
Coils, magnet, small 20 large.	.50
" induction small size.	.25
" Retardation, West. Elec. No. 57C.	1.00
Buzzers, Century high freq., 2 coils.	1.50
" West. Elect. extra quality, high freq.	1.50
Code practice sets, Navy type, 1/2 Kw. Bunnell brass key, Messco high pitch buzzer, 75 ohm headphone, mounted on Bakelite base with 5 large binding posts, some with extra D.P.D. switches.	4.50
Charging panels, Navy S.E. 839, 110 volt, Ward-Leonard with automatic release, var. and fixed res., Weston voltmeter and ammeter, Sangamo ampere hour meter. Complete with all switches.	30.00
Air compressors, Kellogg, Model T, 1 1/2 cu. ft. per min.	3.00

## WANTED

CONDENSERS — 2000 to 15000 volt, all capacities. RECEIVERS — Commercial type and wave lengths. QUENCHED GAPS — From spark transmitters. NAVY types S.E. 908-1001-1002-1005.

Give complete particulars and price.

Largest Radio and Electric Supply House in U. S. devoting eight floors to and specializing on Army and Navy Surplus. Write us your particular requirements. New items are continually arriving. Sufficient postage must accompany orders. NO C.O.D. ON CANADIAN ORDERS.

MANHATTAN ELECTRIC BARGAIN HOUSE Dept. Q. 105-7 Fulton St., New York City

## NATIONAL

### Transmitting Condensers

Designed in accordance with latest practice for securing steady transmitting frequencies.

Write for Bulletin No. 121-C

NATIONAL CO., INC., MALDEN, MASS.

## P-A HORNS

93" long — 66" of cast aluminum, large end fibre, 31" dia. Can use large end for dynamic cones. \$65.00.

Two-button broadcast microphone, standard type, precision-made. Quality second to none. \$50.00. Guaranteed — Trial allowed.

E. E. PATTEN

5686 42nd Ave., S. W.

Seattle, Wash.

**HIGH POWER** Takes a Mercury Arc to handle it — 2750 mls at 15,000 volts — Arcent installation — demonstrates the tremendous capacity of the Mercury Arc Rectifier. No voltage or current limits, single or polyphase rectifiers for broadcast, commercial stations, and amateur WIZs. If yours is a peep-peep station the 866 will make you happy. Tubes in stock. Filament transformers, time delay relays, hi-regulation plate transformers.

RECTIFIER ENGINEERING SERVICE 4837 Rockwood Rd, Radio W8ML Cleveland, Ohio

# FROST-RADIO

## FROST-RADIO MICROPHONES

Unusually sensitive, therefore able to reproduce all audible frequencies with great fidelity. Made in pony arm, hand or desk types, and priced respectively at

**\$4.50 \$6.00 \$8.75**

## FROST RHEOSTATS WITH D. C. SWITCH

Quick-acting, positive D. C. Switch mounted on Bakelite Panel makes the famous Frost Bakelite Rheostat still more useful. Air cooled frame. Nickel plated metal parts. 2 to 75 ohms. German silver springs have sterling silver contacts. Your dealer has them. **\$1.35**

## FROST GEM RHEOSTATS

Smallest, neatest, most serviceable little rheostats ever designed. Special design of contact arm insures positive contact. Resistance wire wound on die-cut flexible Bakelite strip. 3 to 30 ohms. **\$1.00** less switch. 75 ohms D. C. Switch

**HERBERT H. FROST, INC.,**  
Main Office and Factory, ELKHART, IND.,  
CHICAGO SAN FRANCISCO

ve2am ve2ap ve2ax ve2bh ve2bg vesbh ve2ed ve3br ve3kf vk2rx vk2zr vk3bg vk3p vk3vm vk3x vk4bh vk4br vk4rg yilac yillm z44m z55e z55d z55u z55w z11r z15e z06c z06e

W2ABS and W2BOZ, Harry Margolies and Sam Center, 353 E. 170th St., New York City

w6alm w6aly w6am w6ann w6aoe w6arj w6ax w6bam w6bhi w6bjg w6bkw w6brx w6cyp w6czm w6dce w6dbd w6ddq w6dfs w6dll w6dms w6dqs w6dss w6dui w6dya w6dys w6dyn w6dzy w6eau w6ee w6ehi w6eiu w6elm w6emd w6emz w6eof w6ere w6ete w6ik w6ift w6ijn w6irw w6iay w6iae w6iap w6ido w6iey w6il w6iq w6isaw nohia ve3js ve3ep vo8an vk3kj em2lj em31l em5m em75h nm1me nm7me kdv5 kfr5 l8aap l8aq l8br l8dml l8dpl l8gq l8kco l8rl l8san l8fs l8xz l8py etlhd etlbr etlbc etlby etlcl d4di on4di on4ew ob4fp on4fq on4ka on4kd d4au d4by d4klf d4g eegcl ear69 ear98 ear110 ear113 frearb oeyz im2tun

W9AFN, Paul B. Lovegren, 1846 Euclid Ave., Chicago, Ill.

3500- to 3550- kc. phone band

wlaby wlain wlafr wlayo wlbgc wlgr w2ow w2ahl w2avy w2bee w2brb w2bse w2bxc w2bnm w2bcm w2bn w2bae w2bfz w2bms w2ce w2cev w2coo w2csm w2daz w2da w2pf w2x w5na w5pp w5ean w6kt w6arj w7mu w8adi w8aei w8aeo w8ajh w8akv w8ame w8ad w8aqi w8arx w8bhl w8bhz w8byr w8bzz w8czz w8ogo w8ojb w8oke w8elg w8eow w8esa w8esc w8euu w8eyz w8dhh w8dce w8dee w8ddt w8ded w8dmx w8dml w8dor w8dpl w8dzy w8dt w8dus w8dvw w8dvw w8dxb w8t w8us w8pk w8rd w8rw w8sg w8td w8up w8uf w8um w8uo w8vy w8hah w8hag w8hch w8hch w8hei w8hdg w8hdt w8hj w8hmk w8hmu w8hwi w8chy w8cjh w8err w8ery w8eyo w8evu w8ey w8eyb w8dgp w8djh w8doz w8dpg w8drw w8dyl w8dzt w8eas w8ehm w8ein w8ein w8elz w8ess w8ewo w8ewh w8ewm w8ewx w8eyy w8fdm w8fke w8fld w8fng w8fuj w8fzl w8mm w8py w8p w8ua w8idg w8jht w8jey w8jz w8w w8egd w8ac w8aeq w8bvg w8ij w8iwb w8hfb w8eeo w8eds

Thomas McCaichy, 28 1/2 Pelham Road, Ontario, Canada

w4asa w4anl w4aaq w4aar w4aba w4abr w4ac w4ace w4ack w4acq w4aes w4aet w4aew w4aeb w4aef w4aeg w4aek w4aen w4aeo w4ate w4afg w4afw w4agd w4agg w4agj w4agr w4agz w4aha w4aic w4afl w4ahs w4aib w4aii w4aj w4aj w4aj w4aj w4aj w4aj w4aj w4ake w4aki w4akp w4akq w4al w4ale w4aq w4aqw w4ar w4as w4ay w4ay w4bky w4br w4et w4eh w4el w4es w4et w4eu w4dv w4ea w4ec w4ei w4et w4f w4f w4f w4g w4g w4g w4h w4hr w4hz w4ib w4iq w4js w4ka w4kk w4ky w4l w4me w4ms w4ny w4ne w4nl w4oa w4pa w4pau w4pf w4pk w4pp w4px w4q w4rb w4si w4ex w4tk w4tz w4ut w4uu w4uv w4uy w4va w4vb w4vi w4vc w4vw w4wa w4wc w4wm w4wo w4wy w4zp w4zzc w5aah w5aaj w4eak w5aar w5aba w5abi w5abs w5ace w5ach w5ad w5ae w5af w5ag w5adp w5adw w5aeq w5aib w5ale w5aig w5aif w5aiv w5aix w5aag w5abh w5ahx w5aiz w5aik w5aim w5ain w5aip w5am w5amo w5anr w5ana w5ane w5anq w5aot w5apo w5aq w5aqer w5aqhw w5aq w5aqy w5asq w5at w5ati w5auz w5avi w5awd w5awg w5ax w5ark w5axo w5arp w5axx w5aye w5ayo w5ayu w5ayy w5ayz w5azd w5azk w5arr w5ad w5ag w5ahj w5ahm w5at w5ay w5bce w5bbi w5bbg w5bbq w5bce w5bcm w5bex w5bec w5bdd w5bde w5bdg w5bdm w5bdj w5bdx w5bdy w5beh w5bg w5bh w5bj w5b w5eb w5ec w5ed w5eh w5ep w5es w5ff w5fg w5ft w5ge w5gl w5gi w5gr w5hm w5im w5im w5iz w5ja w5je w5kh w5ki w5kn w5lp w5mb w5mi w5mx w5os w5oo w5oh w5ok w5om w5oo w5pa w5pg w5qj w5ql w5qo w5qj w5qw w5rd w5rg w5rh w5rp w5rt w5ru w5uf w5uk w5uo w5ux w5va w5vk w5vy w5vx w5wa w5w w5x w5y w5z w5zd w5yg w5yy w5za w5zg w5zax w5ae w5ad w5ai w5alv w5ahp w5aj w5ajm w5akm w5akt w5akw w5am w5aov w5apw w5ar w5ary w5avj w5axp w5axz w5ahm w5ben w5bec w5bes w5bdx w5bgy w5bhz w5bhy w5bj w5bjq w5by w5bju w5blt w5blu w5bpm w5bpo w5bt w5btq w5bwk w5bws w5bxk w5byb w5bym w5bzt w5bz w5bzv w5cez w5ceda w5ceh w5cha w5chy w5cih w5cpz w5erx w5erz w5esv w5eue w5euh w5eul w5evj w5ewl w5exi w5ezk w5eozm w5ebd w5eca w5edc w5edv w5ddq w5dfs w5dui w5dgo w5dgl w5di w5die w5dk w5dky w5dka w5dmd w5dms w5doc w5dpa w5dpm w5daj w5dqy w5drb w5dsg w5dtd w5dtp w5dtw w5dlz w5dwm w5dwa

## Quartz Oscillating Crystals

Our crystals are guaranteed to meet all standard operating conditions with the highest possible output and with an accuracy of one tenth of one per cent.

- 1715 to 2000 Kilocycles..... **\$15.00**
- 3500 to 4000 Kilocycles **\$15.00**
- 7000 to 7300 Kilocycles **\$35.00**
- Oscillating Blanks..... **\$ 6.00**

**WEST COAST RADIO LABORATORIES**  
P. O. Box 1918 Los Angeles, Calif.

## Radio Operators

Raise Your Speed 50 to 100% in Short Time

Write at once for information about **The Candler System Course in High-Speed Telegraphing and Self-Mastery** — the only "short-cut" to greater speed, accuracy and endurance that mean **BIGGER PAY, DOUBLES** speed of slow operators. Makes fast operators **FASTER**. Takes the kinks out of sore arms. Relieves "glass" arm. Restores the grip. Prevents fatigue, cramps, paralysis and kindred ills. Over 40,000 operators have been developed by this system. **McClary**, world's champion radio operator endorses no other system. Begin now! In a few weeks you'll be **FASTER** than you ever thought possible. Our money-back guarantee protects you. Write now!

**THE CANDLER SYSTEM CO., Dept. RL.**  
6343 S. Kedzie Ave., CHICAGO, ILL.

# QSL CARDS FREE to Stations using Vitrohm Radio Resistors

Ward Leonard wants all amateur stations using Vitrohm Radio Resistors to have a supply of printed QSL cards — with our compliments.

Twenty-five of the new QSL cards, printed on both sides, ready to use, will be sent free upon request to any station using Vitrohm Resistors. More of the cards if you want them. Send in your request now. There is no charge or obligation of any kind.

## ***New Bulletin 507 Covering Vitrohm Resistors for Radio***

A complete line of Vitrohm Resistors for radio receivers and transmitters is included in this new bulletin. Every up-to-date station will want a copy. It will be sent anywhere upon request free of charge.

## **Ward Leonard Electric Company**

31 South Street

Mount Vernon, N. Y.

# The A.R.R.L. Diamond Is the Emblem of a Real Amateur!



The League Emblem comes in four different forms. Its use by Members is endorsed and encouraged by the League. Every Member should be proud to display the insignia of his organization in every possible way.

**THE PERSONAL EMBLEM.** A handsome creation in extra-heavy rolled gold and black enamel,  $\frac{1}{2}$ " high, supplied in lapel button or pin-back style. There are still a few fellows who are hiding their light under a bushel. Wear your emblem, OM, and take your proper place in the radio fraternity. Either style emblem, \$1.00, postpaid.

**THE AUTOMOBILE EMBLEM.** Introduced last spring, already more than 800 cars are proudly displaying the mark of the "Radio Rolls-Royce,"  $5 \times 2\frac{1}{2}$ ", heavily enameled in gold and black on sheet metal, holes top and bottom, 50¢ each, postpaid.

**THE EMBLEM CUT.** A mounted printing electrotpe, the same size as the lapel button, for use by Members in any type of printed matter, letterheads, cards, etc. \$1.00 each, postpaid.

**THE "JUMBO" EMBLEM.** You've taken care of yourself, your car and your printing. How about the shack wall or that 100-footer? Think of the attention this big gold-and-black enamel metal emblem will get!  $19 \times 8\frac{1}{4}$ ", same style as Automobile Emblem. \$1.25 each, postpaid.

*Mail your order and remittance NOW to*

## **The American Radio Relay League, Hartford, Conn.**

## Getting the most out of the Screen-Grid Tube

Well, O.M., you know the potentialities of the screen-grid tube as well as we do. But are you getting the most out of that tube?

Most hams are not. Why? Because they fail to bias the control grid at 1½ volts negative potential. It's troublesome; and that's why most of us don't bother.

But with the Clarostat HUM-DINGER, it's a cinch. This tiny device serves as filament resistor and grid bias in one, by connecting one end to negative A, another to filament, and center to ground side of antenna tuning unit. And oh boy! What a difference it makes!

Meanwhile, don't forget, the HUM-DINGER is also an ideal center-tap resistor for A-C power tubes.



Write for dope on the Clarostat line — a resistor for every radio purpose — fixed, adjustable, variable and automatic. Or ask your dealer to show you the Clarostats themselves.

**Clarostat Manufacturing Co., Inc.**  
Mem. N. M. A.

283-7 North Sixth Street, Brooklyn, N. Y.

**CLAROSTAT**  
REG. U.S. PAT. OFF.

w6dwp w6dws w6dxv w6dyb w6dyj w6dyl w6dyn w6dyo  
w6dyu w6dzd w6dzp w6dzs w6dzv w6dza w6dzo w6dzu  
w6dzw w6ebo w6ebp w6ebv w6ec w6ecs w6edd w6edy  
w6ee w6ef w6egm w6ehf w6ehi w6ehw w6eif w6eii w6eiu  
w6eiv w6eke w6ele w6elz w6emt w6epf w6epm w6eqj  
w6erh w6ew w6fk w6ft w6gl w6gm w6gn w6ha w6hb  
w6hm w6ju w6ju w6jv w6kg w6lx w6ma w6mz w6no  
w6ny w6ov w6qg w6ql w6qy w6tj w6ue w6vz w6wzv  
w7bbh w7acd w7acg w7ago w7aez w7ax w7adp w7aev  
w7afx w7agb w7agu w7ago w7ahg w7ahx w7ajj w7ao  
w7aja w7ajm w7akp w7alc w7ald w7anv w7aoo w7aov  
w7apd w7qj w7dd w7ek w7ey w7fh w7ga w7gf w7er w7if  
w7im w7iv w7kr w7kt w7le w7lt w7lz w7mf w7mo w7oz  
w7nm w7ov w7zv w7pe w7pv w7qv w7rv w7si w7tk w7tu  
w7tx w7zb w7ui w7vk w7vn w7wg w7wi w7xl w7zd w7ze  
zclah zelai zeldr zc3bf cm2ay cm2ef cm2eo cm2iq cm2jt  
cm2re cm2se cm2st cm5ay cm5by cm5ec cm5fe cm5il  
cm5m cm5ni cm5rh et1aa et1by et1en et1nw sulcy ez3ah  
szuk ear116 f8aaq f8btr f8cp f8dm f8eo f8gdb f8ne f8ho  
f8ki f8m o5g f8sm f8wb f8xh f8ypz g5by g5ml g5wk  
g6ab g6vp g6y g6yq g6zv k4aan k4aky k4qr ktr5 vktr6  
k6dtg kd5v l2b3x l2b3i l2hdh l2ddi l2dtd l2g7dm c6q9  
c6s4 onaa2 ondr on4hd on4ip on4di sp-jst orn4hp paosa  
paoja py1aa py1ah py1at py1aw py1bs py1ca py1em py1er  
pyled py1b py1id py2ak py2ax py3ah py3aa py7ah hefem  
he2ea si-eos vk3lp vk3pm vs8ae vs8az vs8rg nj2pa vz xai  
ze5l nm1rz x1ab x1f x1j x2a x2b x2za nm1nic nm1nic nm8nic  
ys1dn ys1fm zlfh z1ax z1zae z1zbc z1zba fo-a3v fo-a5b  
fo-a7q zsbz zsfm z5u d4dkf ea-7b iq-pm filab jctes n27ba  
ng2ge nr2ags nr2ea nr2ig nr-ge nx1lx ny1wb n22 rx4in ir-  
eorb ve4ar ve4bp ve4be ve4te ve4ec ve4ek ve4em ve4en  
ve4et ve4dd ve4di ve4dj ve4dk ve4dp ve4ek ve4ey ve4ff  
ve4fy ve4gd ve4gm ve4gu ve4hr ve4kg ve4he ve4th  
ve4hm ve4hr ve4hv ve4ix ve4ih ve4in ve4io ve4im ve4ml  
ve4aw ve4ej ve4ep ve4er ve4gt ve4hw

*Huri R. Gimer, 121 Harrison Ave., Baldwin, L. I., N. Y.*

w5afb w5anq w5awq w5ayv w5azv w5bae w5bag w5bbi  
w5bdd w5bdy w5ot w5qj w5uk w5za w5azx w5akv w5am  
w5al w5ar w5beu w5bu w5bpo w5brb w5bwa w5brm  
w5dex w5dex w5dgp w5dpa w5dvi w5dvy w5dyo w5ebv  
w5ees w5edu w5eeo w5eeh w5ehi w5elan w5ekz w5em  
w5eop w5eot w5epz w5fl w5ga w5ago w5ahk w5ahx w5ih  
w5ij w5iv w5jz w5k w5lv w5m cm2iq cm2jt cm5by  
cm5fe cm8nb cm8no eb-4d eb-4fe f8af f8btr f8eo f8ki  
f8ld f8pms f8ra f8stn f8wb g5bz g5ml g5zv g6r nr-2ic  
py1id ve1ap ve1ar ve1bc ve1zv ve3hm ve3va ve4et ve4ik  
ve4gd ve4ig ve5al ve5bl ve5ep vk2ag vk2ov vk5hg vk6he  
v85an v85rg x2a ys1aa ys1dn ys4m

*Fred Shunamm, Crane Valley, Saskatchewan, Canada*

3500- to 3550-ke. band

w5ahd w5alt w5anz w5avv w5ayq w5azj w5ed w5gb w5gg  
w5io w5es w5exp w5ahj w5avl w5brb w5bza w5day w5nus  
w5rd w5af w5yb w5al w5am w5are w5awe w5bbs w5bj  
w5bs w5bz w5bpc w5bsp w5bta w5bvb w5bwj w5bzy  
w5ebj w5ebr w5ef w5edo w5ejh w5ejv w5evi w5ewk  
w5eyu w5ezm w5dhu w5dbs w5dev w5dfe w5dge w5dky  
w5dqq w5dsi w5dvy w5dvw w5dxo w5dyo w5dzt w5ddb  
w5edu w5eed w5epv w5esh w5esl w5ezd w5ewh w5exp  
w5eyz w5fbk w5fbs w5fet w5fi w5fht w5fle w5fls w5fms  
w5foc w5faj w5fqs w5fwy w5fxv w5fyf w5gee w5ik w5ieu  
w5mm w5pz w5qy w5ua w5ue ve8at

*W.F.A.M.H, Billie Basden, 203 N. Archer Street, Groesbeck, Texas*

14,000-ke. band

w1adw w1aep w1alb w1low w1ts w1zz w2bjg w2bpg w2cuv  
w2tp w3bd w3bh w3brq w4af w4ai w4qu w6jy w6ezk  
w7abg w7ajj w7aja w7bb w8cow w8ern w83bm w83es  
ve4gq ve4io

7000-ke. band

w1ama w1api w1vy w2agp w2alo w2alu w3awb w3fb  
w3fa w3ut w4aby w4aj w4mf w4ut w5asy w5axx w5ij  
w5fq w6ah w6g w6w w6zf w6cnx w6dfl w6dtd w7ui  
w8bz w8dem w8idr w8re w9auh w9bmu w9dub w9eky  
on1nic sabal ve2ap vk5ea

10,000-ke. band  
w1bt wbs sb2ah suloa

## RADIO OPERATORS WANTED

THE EASTERN RADIO INSTITUTE can train you quickly and thoroughly because:

MODERN AND EFFICIENT METHODS  
THOROUGH INSTRUCTION under staff of  
LICENSED COMMERCIAL OPERATORS  
MODERN APPARATUS including SHORT WAVE  
TRANSMITTER

SIXTEEN years a RADIO SCHOOL  
THE OLDEST, LARGEST and MOST SUCCESSFUL  
school in New England, RECOMMENDED BY THE  
A. R. R. L.

Day or Evening Classes Start Every Monday

SPECIAL CODE CLASSES

Write for Illustrated Prospectus

**EASTERN RADIO INSTITUTE**

899 BOYLSTON STREET BOSTON, MASS.

## TRANSFORMERS

Factory Sale

Unmounted, 250 watts, 300-750 and 1000 V., each, side mounting  
18-lb. \$8.75. With legs 325 V., each side and two 75 V. windings,  
mounted, 100 watts, 10-lb. \$5.50. Write for complete list and  
specifications of transformers, also chokes with handle for gap  
adjustment, 250 MA — 30 Henry \$6.75. Specials to order. —  
High grade material, all guaranteed. Made by HILEY, ENG.  
CAN.

RADIO PARTS SALES CO. ORANGE, N. J.

## More Profits To Set Builders

Sports, baseball games, big National events  
will boost radio business this year. Set build-  
ers will reap a rich harvest. Barawik service will  
make you money. Every radio in A-C sets, short wave,  
television, parts, supplies. World's largest radio  
stocks on hand. Orders shipped same day. Lowest  
rock bottom wholesale prices.

Write for Free Radio Catalog and Ham Done  
**BARAWIK CO.** 115 Canal St., N.Y.C., U.S.A.





# Synchronous Motors for Television

In addition to building reliable and satisfactory motor generators, "Esco" has had many years of experience in building *electric motors* for a great variety of applications.

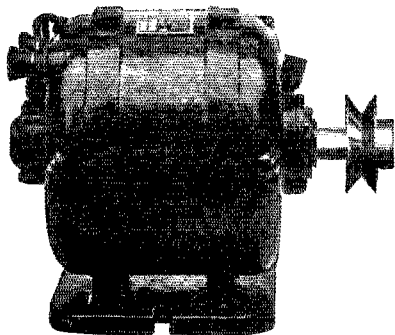

*Synchronous motors*, small, compact, reliable self starting are now offered for *Television* equipment. They require no direct current for excitation, are quiet running and fully guaranteed.

Other types of motors suitable for Television may also be supplied.

Write us about your requirements.

## ELECTRIC SPECIALTY CO.

25 South St.

Trade "ESCO" Mark

Stamford, Conn.

### 3000 V. Recto Bulbs

Now in stock — 3,000 Volt New Type R3 Rectobulbs. Net price each \$10.00. Also Leach Relays — R.E.L. Products, Omnigraphs — Vibroplexes.

#### Complete Parts for Silver-Marshall

#### No. 730 "ROUND-THE-WORLD" 4

A COMPLETE short wave receiver (17.4 to 204 meters) and two-stage audio amplifier. All wave lengths are covered with no dead spots. Amateur bands fall well to center of tuning dial. Net \$30.00. Completely constructed \$38.80. C.O.D. or cash with order. Postage or express extra.

Send for New 1929 Ham Book — FREE

#### CHI-RAD

#### CHICAGO RADIO APPARATUS CO.

415 S. DEARBORN STREET

CHICAGO

### RADIO IN BRASIL

When in Brasil, apply to M. BARROS & CIA for anything you need in connection with radio.

#### M. BARROS & CIA

70 sob. Rua S. José 70 sob.

Postal Box 89

#### Rio de Janeiro

Telegraph address, Radioparte, Rio de Janeiro

Branch: Avenida S. João 4, S. Paulo, Brasil

## QST OSCILLATING CRYSTALS

### Constant Temperature Control Equipment

We are now in a position to supply you with Thermostatically Controlled Heater units for accommodating two crystals (one used as a spare) with provision for instantaneous change-over, said unit maintaining a guaranteed constant temperature to a *tenth of one degree Centigrade*. This unit is easily adjusted and is entirely automatic, operating from the 100-Volt supply mains. Delivery 10 days after receipt of order. Price \$400.00. More details upon request.

We also grind crystals for use in the Broadcast Band accurate to plus or minus 500 cycles of your assigned frequency for \$55.00 fully mounted.

Prices for grinding crystals in the Amateur bands are as follows:

1715 to 2000 Kc band	\$20.00, unmounted
3500 to 4000 Kc band	\$27.50, "
7000 to 7300 Kc band	\$45.00, "

### SCIENTIFIC RADIO SERVICE

P. O. Box 86, Dept. E

The Crystal Equipment Specialists

Mount Rainier, Maryland

**CLEARER  
RECEPTION**  
in **7**  
**SECONDS**  
with

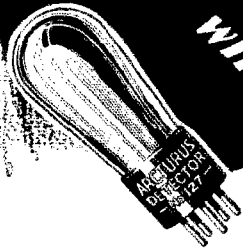

**ARCTURUS**  
BLUE LONG-LIFE TUBES

ARCTURUS RADIO TUBE CO.  
Newark, N. J.

**P A C E N T**  
Duo Lateral  
**COILS**

The complete line of all standard turn ratios preferred by leading laboratories and engineers.

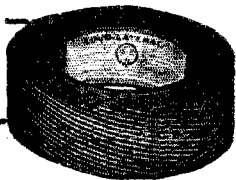

Write for information and prices

PACENT ELECTRIC CO., Inc.  
91-7th Avenue New York City

**TRANSFORMERS**  
Guaranteed — Mounted — Complete

250 watt 550 — 700 each side ..... \$10.50  
700 watt 1000 — 1500 each side ..... 14.50  
700 watt 2000 — 2500 each side ..... 21.00  
Chokes, Polyrhase and 25-cycle Transformers  
Add \$2.00 for oil winding

**OCES FRANK GREBEN**  
1927 So. Peoria Street, Pilsen Sta. Chicago, Ill.

**Type 866 Rectifier Tubes**  
\$8.00 C.O.D.

Unconditionally Guaranteed  
VACUUM TUBE EXCHANGE  
954 Slocum Avenue Ridgfield, N. J.

Henry Rukosnik, Sedlec pod Kanekem, Havlickova  
79, Czechoslovakia

em5ll en8ve en8gk en8kik vn8rit entun2 etlbd etlbr  
etlby ev5af d4abr d4abw d4acj d4adh d4af d4db d4cc  
d4es d4cy d4ddt d4dkf d4gge d4go d4gq d4hf d4hx d4ja  
d4ia d4kbo d4kbu w4kg w4kma w4ls w4mo w4nb w4nh  
w4nx w4qb w4qf w4qh w4rh w4ro w4rr w4rrd w4ry w4skl  
w4tk w4uak w4uj w4uo w4vr w4vw w4xn ear16 ear21  
ear37 ear54 ear62 War64 ear65 ear96 ear98 ear113 ear116  
ear122 ear125 et2b et7e es2so f8axo f8aly f8aup f8azv  
f8azp f8box f8btr f8cco f8cio f8ces f8cet f8dg f8dl f8er f8eo  
f8ei f8fat f8to f8gdb f8go f8glo f8ho f8h il8ja f8kl f8of  
f8kor f8lem f8msm f8nnt f8nox f8olu f8osr f8rww f8ral  
f8sm f8san f8tsn f8uip f8unl f8wb f8xzl f8yxn w8yzo  
g2ak g2ax g2eb g2go g2ky g2nh g2uk g2as g2bz g2cy  
g5lt g5ml g5rm g5tz g5yu g5ay g6br g6hy g6cg g6dp g6sb  
g6xn g6yz haf3b haf3by haf3gr haf5a haf6h hb9af hb9mq  
hb9y ilho ilum ilop ilsk ilro ilta kley k4aan ktr5 l91a  
la1b la1g la1k la1s la1w la2g la2y on1eo oh3mpo oh2nap  
oh2uaw oh2nm oh2nt oklema oklfm oklta oklrv oklly  
ok2em ok2et ok2lo ok2ny ok2pa ok2rm ok2yd ok3ek  
ok3us ok4go on4as on4de on4gr on4hm on4mm on4nn  
on4oo on4ou on4vy on4wv on4zz oz1d oz2m oz2e oz5a  
oz7b oz7bl oz7en oz7gk oz7h oz7pp oz7sch oz7t paozo  
paodw paodt paodu paofa paofb paohm paokh paonl  
pooptt poovp pooxa pooyx pk4az ea2ar ea2bj ea2ek  
ea2kk ea3bn ea3el ea4ar ea4rr ea5am ea5az ea5bj en5am  
en6ar eu6kbz eu7aa eu7ao eu7ar eu7as eu7au eu7ba eu7kad  
eu7kwd eu8tt eu9ad eu9al eu9al eu9am ra03 rkl158 rkl113  
sm5rw sm6va sm7sr sm7ve sm7ws sm7yz sm7zy sp3ar  
sp3cj sp3fa sp3fs sp3fy sp3kx sp3kx sp3mc sp3pl sp3pe  
sp3wa sp3wj sp3yl ul1ag uolr nobbz uong uolr uolrs  
uolrv uolw uoohy uoou uoof uoof w1aa w1anq w1blf  
w1es w1ep w1aux w2bbx w2wv w2ze w3ael w3alu w3blx  
w3cee w4aef w4agg w4be w4et w4du w4ei w4gl w5ah  
w8bt1 w8br w8baz y1aa y1ac y1ac y1llm y12ad y12as ym4zd  
rxw zhb

G. Vanlecamp, U. S. S. California, Box 17, San  
Pedro, Calif.

14,000-ke. band

w1wy w1pd w1eq w1zz w1ame w1alb w1awd w1aqd w1ave  
w1aub w1ald w1aqt w1aze w1bnp w1bkr w1brl w1bal  
w1bsm w1eek w1epb w1emx w2ag w2fi w2dp w2fp w2up  
w2vd w2jn w2md w2mb w2lar w2rk w2rr w2axz w2abu  
w2aaj w2aen w2aog w2agv w2aql w2biv w2big w2bib  
w2bfg w2bki w2bpg w2eyf w2eyj w2dab w3yv w3ej  
w3jm w3vm w3gi w3gv w3ln w3vj w3db w3nu w3yy  
w3ayz w3auj w3aql w3bwj w3ckl w3cee w4lq w4eq w4ei  
w4zp w4oz w4uv w4qu w4rn w4an w4ms w4ef w4oiq  
w4act w4aes w4aij w4ehw w4nik w5qo w5ta w5aj w5uk  
w5im w5aot w5ayy w5bam w6qa w6am w6uf w6bqv  
w6avj w6bax w6bvz w6bto w6era w6chy w6drb w6did  
w6dgr w6ete w6eaa w6eem w7th w7agb w7aj w7dw  
w8bd w8uk w8bv w8am w8ank w8ay w8aid w8aur  
w8axa w8awr w8aop w8arx w8ahm w8air w8bud w8brb  
w8bkm w8cew w8era w8eed w8epw w8dff w8dyr w8dhe  
w8dwg w8ex w8fs w8fh w8ex w8ek w8ej w8lp w8mt w8fp  
w8ef w8ua w8tm w8si w8aas w8aji w8ajz w8anq w8bjp  
w8bht w8bwp w8bnf w8bbg w8bba w8bud w8ook w8ckb  
w8eub w8erd w8emo w8efz w8eyd w8cex w8drb w8dco  
w8dhe w8eaj w8enl w8ebw w8fyf w8fyd w8fpn w8fed  
w8fon w8fidh w8fct w8ggb w8gbr w8gga w8aji w8ecz  
py1ib py2lh vefek vefep vefoj vefhr vefza vefzap vefeo  
veces vefet selai selah zw2ay zw9aj z84m z84a k4aky  
k4dj l44bi vk3cp per eb4wx oa4s nj2pa

7000-ke. band

w1rp w1pk w1mk w1oh w1yb w1sz w1anx w1aed w1axx  
w1blo w1bkg w1bd1 w1bal w1bks w1epo w1erw w1eap  
w2kz w2vy w2ajj w2qu w2wv w2ap w2ot w2ew w2ak  
w2as w2axq w2apd w2aqj w2aji w2aun w2ajf w2efr  
w2aoi w2alu w2aun w2atz w2baq w2biv w2bhv w2bjs  
w2bny w2blx w2bzv w2xl w2evu w2ep w3ki w3hy w3ci  
w3mo w3nt w3ut w3mt w3hl w3iz w3pf w3aws w3shp  
w3app w3afu w3anh w3awz w3ard w3atm w3asg w3btq  
w3bjy w3bel w3bnl w3ber w3ce w3et w3at w3at w3dv  
w4ie w4ft w4ni w4ne w4db w4zp w4ba w4ae w4wa w4pe  
w4ei w4adb w4agy w4aef w4akp w4aba w4aag w4va w4si  
w4ack w4wm w4zg w4ms w4ae w4mx w4fs w4be w4ip  
w5gr w5ee w5ya w5pa w5je w5fk w5uf w5oh w5oh  
w5aqe w5axs w5axi w5apb w5uin w5all w5ahv w5ayt

w5akp w5ame w5ayz w5ain w5bel w5bdd w5baj w5bdy  
w5dez w6wn w6hj w6tk w6jg w6in w6wh w6abg w6awp  
w6akw w6akm w6avj w6baa w6bsh w6bzt w6chv w6cui  
w6bzs w6bhy w6dni w6doj w6dtg w6daj w6enx w6dwy  
w6ekm w6emr w6eca w6eru w6enj w6eej w6edi w6efe  
w6edk w6ehi w7bb w7mb w7pl w7fm w7f w7sh w7af  
w7lz w7si w7dd w7qw w7akm w7aat w7ald w7ajn w8ve  
w8us w8jb w8lt w8pn w8uj w8uk w8xe w8ads w8ayc  
w8aty w8aav w8avr w8avp w8aug w8aub w8abc w8alu  
w8ayo w8bck w8bti w8bem w8bly w8ben w8blz w8dew  
w8dqk w8drs w8dyz w8zd w9lz w9eo w9ek w9ex w9mq  
w9jl w9zi w9ax w9vp w9cp w9nr w9oo w9aru w9ama  
w9are w9acs w9avj w9aqz w9aja w9beu w9blb w9bez  
w9bsh w9bpj w9bxj w9bca w9bga w9beb w9caa w9evn  
w9ees w9etg w9alm w9dws w9dfy w9dkm w9dqc w9dgz  
w9dck w9drz w9dfv w9edk w9eva w9ema w9elb w9eru  
w9eqt w9flv w9fun w9fpp w9fsl w9fey w9fxj w9ext w9cet  
w9fgw w9gfo w9ghv w9gec w9gaq w9gtu w9gdh w9gij  
w9gef w9gft w9usx cm5fl cm2ay cm7sh cm5ni kfr5  
kfr6 kdvs k4aan klhr kflf kljr k3aa k9pl z3cm zllao  
v64bb vk5wr vkzjh v6leo v6zbe v6sak v64hx yslaa  
nylmo ny3se nn7nic mlnic wsbs x29a sj8dy jes oa4l oa4q

## Official Frequency System

(Continued from page 24)

Reports on Standard Frequency Transmissions are solicited from all who take advantage of this service. Regardless of how far from or near to the transmitting station you may be, your report is of interest to us. Standard blanks which will facilitate your compilation and our handling of the reports are available on request. All reports should be directed to: Experimenters' Section, American Radio Relay League, 1711 Park St., Hartford, Conn.

After your report has been checked and acknowledged, it will be forwarded to the Standard Frequency Station upon whose signals it comments.

—H. P. W.

## QST's Station Cup

ONLY one month later than promised, here is the beautiful cup which QST offers for the best station description published in its columns during 1929. It is of sterling (solid)

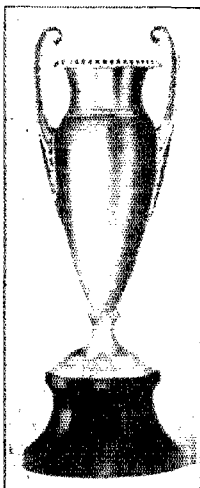

silver and the cup itself stands 9 inches high. 12 inches overall with pedestal.

# To Our Readers who are not A.R.R.L. members

WOULDN'T you like to become a member of the American Radio Relay League? We need you in this big organization of radio amateurs, the only amateur association that does things. From your reading of QST you have gained a knowledge of the nature of the League and what it does, and you have read its purposes as set forth on page 8 of this issue. We should like to have you become a full-fledged member and add your strength to ours in the things we are undertaking for Amateur Radio. You will have the membership edition of QST delivered at your door each month. A convenient application form is printed below — clip it out and mail it today.

*A bona fide interest in radio is the only essential qualification for membership.*

AMERICAN RADIO RELAY LEAGUE  
Hartford, Conn., U. S. A.

I hereby apply for membership in the American Radio Relay League, and enclose \$2.50 (\$3 in foreign countries) in payment of one year's dues. This entitles me to receive QST for the same period. Please begin my subscription with the ..... issue. Mail my Certificate of Membership and send QST to the following name and address.

.....  
.....

Do you know a friend who is also interested in Amateur Radio, whose name you might give us so we may send him a sample copy of QST?

.....

Thanks

# Raytheon

LONG LIFE RADIO TUBES

The  
"Healthy  
Tubes"

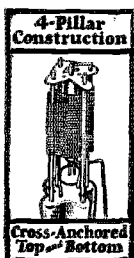
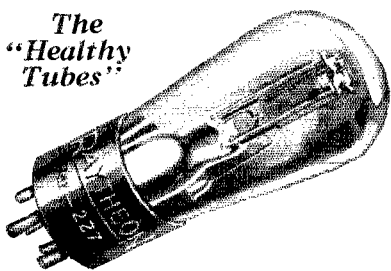

THIS exclusively Raytheon construction prevents premature debility and incidental disorders in radio tubes — hence, the "Healthy Tubes." It keeps the tube elements permanently in their original and correct relative positions.

RAYTHEON MFG. CO.  
Cambridge, Mass.

## ALUMINUM Rectifier Rods!

99.6% Pure

as specified in April QST, page 35

Cut in 6" lengths, Price Postpaid  
100 rods \$5.00    25 rods \$1.75  
50 rods 2.75    15 rods 1.00

Official station for Moore-Daniels Receiver  
Everyman Circuits

**MOORE RADIO COMPANY**  
72 CORTLANDT ST.    NEW YORK CITY

### QUARTZ OSCILLATING CRYSTALS

Scientifically Prepared for Maximum Power and Unconditionally Guaranteed 1 in. sections, of your approximate specified frequency, supplied at the following prices:

75-100 meters	\$15.00
100-200 meters	10.00
200-600 meters	15.00
1 in. Teste blanks, 200-400, 400-600 meters	3.00
Bustproof Bakelite mounts	3.00

Sections of any practicable dimensions made to order

Prompt Delivery

J. T. Rooney, B. Sc., 4 Calumet Bldg., Buffalo, New York  
"Ten years' crystallographic experience"

## SET Builders

Barawik, the first and oldest radio specialty house, offers you unusual service this year. Bigger stocks, quicker shipments, lower prices. Deal with an old established, reliable house. Get honest goods, honest service, honest prices. Barawik service makes you more money. Send now for big new catalog showing lowest wholesale prices on sets, parts, short wave, etc.

**BARAWIK CO.** 115-A CANAL ST., CHICAGO, U. S. A.



We thought at first that we might offer a silver plated cup. We had in mind that, for the same value, the cup would be enough larger to contain the works for a monitor. It would be easy to mount the control knob on a disc of metal fitting the top of the cut. You know — combining utility with beauty, and all that sort of thing. But then we decided that any station winning our prize is extremely likely already to possess a good monitor and in fact to be so good a station that nothing less than sterling would be an appropriate award for its description. So the cup is real.

We ask attention to the details of our contest offer, published on page 37 for March. QST wants to reinstitute its "Amateur Radio Stations" department, with descriptions of "1929-type" stations, and to set the ball rolling it offers four prizes. First prize is the really handsome trophy here illustrated, and then there are three cash prizes, of \$25, \$15 and \$10. The rules are very simple.

We're awfully anxious to engrave some one's name on this cup and so we're all prepared here to receive your descriptions. Come on with 'em!

—K. B. W.

## Roanoke Division Convention

WITH three directors and an A. R. R. L. Headquarters' representative present, the division was more than favored at this third annual convention held at Charlotte, March 8th and 9th. Moreover it had the largest attendance this year, and those amateurs who did not show up surely missed a very fine time.

E. J. Gluck, who acted as chairman, kept things moving from the very beginning. With the introduction of Captain Clover, W4EI, who gave us a good talk on his crystal control set, the lectures were well started and resulted in good discussions. Director Woodruff, of the Atlantic Division, proved most entertaining in the several talks he gave. The doctor always has something unique with him and this time it proved to be the smallest crystal oscillator in "captivity." Director Painter of the Delta Division gave us a surprise by showing up, driving some 650 miles from Chattanooga, Tenn. The first day ended with a theatre party at the Carolina Theatre, and a visit to the Club House where "hamfesting" was carried on till the small wee hours of the morning by a few of the "boiled owls."

With everybody registered on Saturday morning, the meetings planned for the day were well attended. One of the interesting events was a visit to the studio and to the transmitting station of WBT, located several miles out of town. This installation is the very latest unit of the G. E. and was an eye opener to all the delegates. Thanks to Gluck and Rosekrans for their courtesies.

The climax of this convention is always the banquet and this year's was no exception, and — you could have two helpings of everything, too.

Mr. Hall, President of the Charlotte Amateur Radio Association, welcomed all guests and then introduced the toastmaster, Director Cravely. The principal speaker was Treasurer Fieldman Hebert from A.R.R.L. Headquarters, who reviewed amateur radio and also talked on the 1929 requirements, emphasizing the point that we should think more and more in kilocycles instead of meters. During the evening several good stunts were staged, a film showing a number of good crystal-controlled stations taken by W2WC was thrown on the screen, and finally came the distribution of the prizes which made so many of the delegates happy. But we did surely miss Bob Morris.

With expressions of good will from every one to the committee in charge we all signed off for another year — SK.

— A. A. H.

**STATEMENT OF THE OWNERSHIP, MANAGEMENT, CIRCULATION, ETC., REQUIRED BY THE ACT OF CONGRESS OF AUGUST 24, 1912, of QST, published monthly at Hartford, Conn., for April 1, 1929.**

State of Connecticut } ss:  
County of Hartford }

Before me, a Notary Public in and for the State and county aforesaid, personally appeared K. B. Warner, who, having been duly sworn according to law, deposes and says that he is the business manager of QST and that the following is, to the best of his knowledge and belief, a true statement of the ownership, management (and if a daily paper, the circulation), etc., of the aforesaid publication for the date shown in the above caption, required by the Act of August 24, 1912, embodied in section 411, Postal Laws and Regulations, printed on the reverse of this form, to wit:

1. That the names and addresses of the publisher, editor, managing editor, and business managers are: Publisher, The American Radio Relay League, Inc., Hartford, Conn.; Editor, Kenneth B. Warner, Hartford, Conn.; Managing Editor, F. Cheyney Beekley, Hartford, Conn.; Business Manager, Kenneth B. Warner, Hartford, Conn.

2. That the owners are: (Give names and addresses of the individual owners, or if a corporation, give its name and the names and addresses of stockholders owning or holding 1 per cent. or more of the total amount of stock). The American Radio Relay League, Inc., an association without capital stock, incorporated under the laws of the State of Connecticut, President, Hiram Percy Maxim, Hartford, Conn.; Vice-President, Chas. H. Stewart, St. David's, Pa.; Treasurer, A. A. Hebert, Hartford, Conn.; Communications Manager, F. E. Handy, Hartford, Conn.; Secretary, K. B. Warner, Hartford, Conn.

3. That the known bondholders, mortgages, and other security holders owning or holding 1 per cent. or more of total amount of bonds, mortgages, or other securities are: (If there are none, so state.) None.

4. That the two paragraphs next above, giving the names of the owners, stockholders, and security holders, if any, contain not only the list of stockholders and security holders as they appear on the books of the company but also, in cases where the stockholder or security holder appears upon the books of the company as trustee or in any other fiduciary relation, the name of the person or corporation for whom such trustee is acting, is given; also that the said two paragraphs contain statements, embracing affiant's full knowledge and belief as to the circumstances and conditions under which stockholders and security holders who do not appear upon the books of the company as trustees, hold stock and securities in a capacity other than that of a bona fide owner; and this affiant has no reason to believe that any other person, association or corporation has any interest direct, or indirect in the said stock, bonds, or other securities, than as so stated by him.

5. That the average number of copies of each issue of this publication, sold or distributed, through the mails or otherwise, to paid subscribers during the six months preceding the date shown above is..... (This information is required from daily publications only.)

K. B. WARNER.

Sworn to and subscribed before me this 28th day of March, 1929.

George E. Boesch

(My commission expires February 2, 1933.)

# Are We Right?

You should have at least two of them — one for your complete 1928 file of copies, and one for each 1929 issue as published.

KEEP THEM AS A UNIT IN A

## QST Binder



Note the wire fasteners. Unnecessary to mutilate copies. Opens and lies flat in any position.

**One-fifty each  
postpaid**

A binder will keep your QSTs always together and protect them for future use. And it's a good-looking binder, too.

## QST

1711 Park St. Hartford, Conn.

# HAM-ADS

(1) Advertising shall pertain to radio and shall be of nature of interest to radio amateurs or experimenters in their pursuit of the art.

(2) No display of any character will be accepted, nor can any special typographical arrangement, such as all or part capital letters be used which would tend to make one advertisement stand out from the others.

(3) The Ham-Ad rate is 15¢ per word, except as noted in paragraph (6) below.

(4) Remittance in full must accompany copy. No cash or contract discount or agency commission will be allowed.

(5) Closing date for Ham-Ads is the 25th of the second month preceding publication date.

(6) A special rate of 7¢ per word will apply to advertising which, in our judgment, is obviously non-commercial in nature and is placed and signed by a member of the American Radio Relay League. Thus, advertising of bona fide surplus equipment owned, used and for sale by an individual or apparatus offered for exchange or advertising inquiring for special equipment, if by a member of the American Radio Relay League takes the 7¢ rate. An attempt to deal in apparatus in quantity for profit, even if by an individual, is commercial and takes the 15¢ rate. Provisions of paragraphs (1), (2), (4) and (5) apply to all advertising in this column regardless of which rate may apply.

**PLATE POWER** for your set, the very heart of its performance. For quietness DX ability, life-long permanence, absolute dependability, lowest ultimate cost, no other plate source even approaches the achievement of an Edison steel-alkaline storage B battery. Built painstakingly; every joint pure nickel, upset electrically welded. Genuine Edison Electrolyte. Our list describes complete batteries, construction parts, enameled aerial wire, silicon steel. Available immediately, filament and plate transformers for the new 866 rectifier, complete plate power units. Rectifier Engineering Service, radio W8ML, 4337 Rockwood Road, Cleveland, Ohio.

**IMAGINE** an organization with over 4,000 clients scattered throughout the world, all radiowave dealers, builders, experimenters, hams. Over \$50,000 stock of high grade receiving and transmitting parts only, no sets. Spend \$5,000 yearly on our own experimenting. Carry nothing until it passes our tests. 50¢ brings prepaid over four pounds catalog, circuits, data, etc. Weekly data (more than all radio magazines together) — 20 weeks — \$1.00, 52 weeks — \$2.50. Sample "Over The Soldering Iron," 32 page experimenters' magazine — 25¢. Full trade discounts to licensed hams and radiowave builders. We carry approved items advertised in radio. Kladag Radio Laboratories, established 1920, Kent, Ohio.

**ENSALL** Radio Laboratory receivers and Transmitters are of the most modern design and are supplied to meet any particular requirements of the radio art. Transmitter designs for radio-phone or C. W. Our long experience in the designing of special apparatus is your guarantee of quality and efficient apparatus. We also build to order any items desired. Literature on any apparatus forwarded on request. Ensall Radio Laboratory, 1208 Grandview Ave., Warren, Ohio.

**SPECIAL** made rectifier aluminum with small percentage copper, stand more average, last longer, square foot \$1.25. Lead \$1.00. Elements, holes punched with bolts and nuts, new kind 1" x 4" 15¢, 1" x 6" 17¢, pair prepaid. Best Silicon steel .014" cut to order 25-35¢ lb. Postage extra. Geo. Schulz, Calumet, Mich.

**PANEL** engraving — finest workmanship on radio laboratory apparatus. Request price list. A. L. Woody, 19 N. Wells St., Chicago.

**LITTEL FUSES:** the quickest-acting fuses in the world. See for yourself. Designed for protection of instruments, tubes and delicate equipment generally. Capacities: 1.32, 1/16, 1/8, 1/4, 1/2, 1 ampere. 1" long x 1/4" dia. Each — 15¢; doz. — \$1.50; 100 — \$10.00. Postpaid Mounting blocks — 20¢. Discount to dealers. Littell Labs., 1772 Wilson Ave., Chicago.

**POLYMET** filter condensers 2 mid. 1000 de working volts, \$2.15 each. W1A0Z, Woodrow Darrow, Waterford, Conn.

**DUBLIER** 7 mid. 600 volt condensers \$3.50; Stromberg Carlson 8½ mid. 600 volt \$2.00; Faradon 2 mid. 300 volt \$1.00; Timmons power amplifier uses 281 and 210 \$15.00; push-pull amplifier \$5.00; two tube Browning-Drake \$15.00. Herbert Ingersoll, 31 Washington Ave., Ossining, N. Y.

**SELLING** out — write for list of receivers, transmitters and parts. W9EWN, Neoga, Ill.

**QSL** cards, 40¢ per 100, samples, Radcliffe, North Sacramento, Calif.

**HAVE** for sale: One Majestic "B" Eliminator with tube \$10.00; one All American "B" Eliminator with tube \$9.00; one Valley "A" Eliminator \$5.50. All practically new and in excellent working condition. Charles F. Jacobs, 279 Park Place, Brooklyn, N. Y. (W2EM).

**USED** parts bought, sold, exchanged. Ryan Radio Co., Hannibal, Missouri.

**SELL** — Eseo M. G. Set in excellent condition. Motor: 2H.P., 110 or 220 volts, 60 cycle, single phase. 1750 R.P.M. Generator: 1K.W., 2000 volts, 0.5 amps., double commutator. Mounted on heavy base. \$200. George Rodwin, 3512 Perry Ave., New York City. W2BBD.

**CX-216B's**, \$2.00 each. Want 50 watters, will swap Ross-Hi-Power Rifle, watt hour meter, Roller-Smith antenna ammeter or what do you need? Box 21, Seaford, N. Y.

**SELL** \$60 Dayton television kit new \$30.00. 104 RCA speaker with tubes \$45.00. W3AAJ.

**SELLING** out — 204A \$55, 203A \$13. Vibroplex \$11, meters, condensers, etc. Box 1531, El Paso, Texas.

**MOVING** out of town — best offer buys 1000V Willard storage B batteries with special battery rack, s.w.s. charging system. Write W9FOK.

**WANTED:** UV204s, UV204As, 85 meter xtal. State condition, price, exact frequency. Fred Manion, Univ. of Penna. Dorms., Box 285, Philadelphia, Penn.

**SELLING** out cheap, complete 7½ watt transmitter filament power supply four meters and three tubes. Two receivers. Full wave rectifier for seven watts. Lots more. Write W9FMP, Topeka, Kansas.

**TRANSFORMERS** — 100 Watt, 110 Volt, 60 Cycle. 750 Volts each side center, 7½ Volt Filament winding. Will operate one or two 210 Tubes, \$7.25. We will build that "Hard to Find" Transformer, Choke or Coil to Your Specifications. Scott Coil & Transformer Co., New Albany, Mississippi.

**JEWELL** No. 54 special, 0-2000 voltmeter, Hush, DC, with resistor, \$13. Service man's same as above reads 10-100-500 and 1000 volts, 1000 ohms per volt. With resistor, \$15.00. Edison battery, \$12. 60 M.A. 30H choke, \$1.00. Lipeman's phone \$3.00. Weston 42A, 0-10V AC \$3.00. M. Leitch, Park Drive, West Orange, N. J.

**QUARTZ** crystals or blanks, guaranteed, write W6AHB, 294 12th, Oakland, Calif.

**PORTABLE** W6EBD for sale complete. Write for pictures and details, J. N. Ray, 520 Cowper St., Palo Alto, Calif.

**SELL** Dresser shortwave units, \$15.00 each. W8AVW.

**MAKE** your remote control a success and forget about your keying troubles with one of our guaranteed transmitter relays. Has a double set of tungsten steel contacts that will break plenty of volts. Will operate off the storage battery from your receiver or dry cells. Many other uses. Also UX 210 7½ watt transmitter tubes. Nationally known make. Brand new and guaranteed. Special at \$3.95. Prepaid. Mitchell Radio Company, 635 Waveland Ave., Chicago, Ill.

**UV204A** with mounting, perfect, \$30. Two 6EX rectobulbs, used 10 hours \$7.50 each. Thordarson 30 Henry 300 mil choke (new) \$9.50. New style Tobe condenser 2 mid. 2000 volt \$11.00. Older style Tobe condenser 2 mid. 2000 volt \$3.00. UP1016 plate filament transformer 1500 each side \$10.00. RCA rheostat for 204A \$2.00. W8CLP, 1707 Kelsey Ave., Toledo, O.

**QSL** cards, two colors, new Q signs, \$1.00 per hundred. Free samples. W8DTY, 257 Parker Ave., Buffalo.

**SELL** 1000 watt transformers, guaranteed. Made by G. I. 1100-2200-4400 each side center tap. Used by Cornell and broadcast stations. Will run 861 \$12.00 f. o. b. Detroit. F. G. Dawson, 5740 Woodrow Ave., Detroit, Mich.

**WESTERN** Electric 7A amplifier with 3 W.E. 216A tubes and W.E. 518W speaker, wonderful amplification on short wave code signals \$35. Haynes-Griffin 1926 prize winning shortwave receiver completely assembled, sharpest tuner obtainable, \$20.00. Werner, 197 Lawrence St., New Brunswick, N. J.

**3000 Volt 6000 Watt** double commutator motor-generator, 10 Hp. 3-phase drive \$685.00 complete. 500 Cycle 1 K.W., ball-bearing motor-generator, 110V. DC drive \$225.00, 250 Cycle 1½ K.W., ball-bearing motor-generator 110V. DC drive \$225.00. 2-5 Kw. Rotary Spark Gap 110V. DC drive \$45.00, 1000 Volt 200 Watt Eseo 1-phase drive \$75.00, 750 Volt, 300 Watt new General Electric motor-generators \$55.00; 200 Watt \$42.50, 32 Volt drive motor-generators 750 Volt 300 Watt \$65.00; 200 Watt \$45.00; 150 Watt \$37.50, 400 Volt, 100 Watt generators \$3.50; 1/4 Hp. 3450 speed motors \$8.50; repulsion induction motors \$10.50, 1/2 Hp. \$16.50, Converters 32V. DC to 110V. AC, new \$35.00. Large stock plate and filament generators. Queen City Electric, 1734 Grand Avenue, Chicago.

**TRADE** — Set REL transmitting inductances for 1000 volt transformer or 160 meter crystal or what have you. W9DSS.

**SELL:** Complete station, 7½ transmitter, 3 tube receiver, \$40. Write for details, W3NML, 1111 Jefferson, Charlottesville, Va.

**QSL** cards, cartoons, stationery, message blanks, wall cards. H. M. Selden, Cranestville, Penn.

**WANTED** — Navy standard receivers, SE143, SE1220, SE1430 IP500, IP501. State price, condition and manufacturer. Trautwein, 38 Park Place, New York.

**TRANSMITTING** tubes, 30 to 500 watts, specifications and prices on request. Box 21, Seaford, N. Y.

**SPECIALS** — accurate panel meters 0-100, 0-400 milliamps, \$1.15. 0-15 volt AC \$2.25, GR wall insulators 19¢. Write your needs. We have everything. Anything built to order. Finch Radio Laboratory, W8GF, 100 Grove St., Syracuse, N. Y.

**HAMS:** Get our Samples and Prices on Printed Call Cards made to order as you want them. W9APY Hinds, 19 S. Wells St., Chicago, Ill.

**SELL Grebe CR18,** full set of coils in A1 condition. Dope free. W9CHZ, Wisner, Nebraska.

**SACRIFICE — 20-40-80 M.** 50 watt trans. 1929 HC type. Cardwell dbl spaced cond. 203A coil 25 hours. 400 watt full wave pwr supply with 2 281s. Looks like BC job. \$50. One 5 watt xmitter complete tubes, all for \$15. 2 short wave receivers 3 tubes and all coils only \$8 each. Smith, W9FJS, Mo. Valley, Iowa.

**CRYSTALS — power type free oscillators —** Optically perfect guaranteed — 170-85 meter bands — \$15.00 — 18.00. Dr. Elmer White, W5AFG — Beaumont, Texas.

**QRH?—QRG?** Calibrate your receivers and frequency meters. A list of over 500 high frequency stations of the world and their exact frequencies in kilocycles. Listed alphabetically by call letters. Compiled from authentic sources by an amateur for amateur use. Price ONE DOLLAR. W3NR, 2631 Garfield St., N. W., Washington, D. C.

**SACRIFICE two W.E. 212D tubes,** used, thirty dollars, one W.E. 211D used, ten bucks. Austin, W7AGU, Boise, Idaho.

**CHOKE supplies: — 30H. 100MA — \$1.75. 50H. 150MA Dudlo-wound — \$2.40. Double-coil (15H. 100MA each coil) — \$1.95. Pure rectifier elements. Low copper-content Aluminum. Cut, drilled, bolts, complete. Per pair: 1x4-8c, 1x5-9½c, 1x6-11c. Extra Heavy: 1x4-12c, 1x5-13½c, 1x6-15c. One inch wide lead strip 7c per foot. Aluminum — 8c. Heavy copper-tubing inductance. Special manufacturer's type 2 Mfd., 400 Volt (Working) Filter Condensers — 47c each, 7½V — 215V transformers — \$1.65. Milliameters — \$1.14. 0-10, 0-15 AC Voltmeters — \$2.74. Wavemeters \$5.00 and \$8.00. Send for "SPECIALS". William Harrison, 35 Ft. Washington Ave., New York City.**

**THORDARSON 650-volt power-filament transformers** for 7½-wattors \$6.90. Aluminum square-foot 85c; lead square-foot 85c. Mueller 30-wattors \$1.45. Thordarson 1000-1500-volt power transformers \$16.00. RCA-50-wattors \$13.50. Potter 2-MFD. 2000-test voltage \$2.50. 1-MFD. 2500-tested \$3.25; 2-MFD. 2000-test \$4.00. 2-MFD. 1000-test \$2.50. "Ham-List" 4c. James Curtis, 1109 Eighth Avenue, Fort Worth, Texas.

**FIVE watt tubes, guaranteed, \$1 each.** Remko Tube Co., Atlantic, Mass.

**WANT: GR 558 band wavemeter, UX-860, 281's, 210's.** Sell or trade: Almost new WE212D \$45, new 204-A \$75, 84 meter crystal, and other parts. What have you and what do you want? W9ARA, Butler, Mo.

**GOOD conditioned used apparatus** sale as follows: 60 watt, 10-300 volt d.c. Westinghouse dynamotor \$8; 75 watt, 12-500 volt d.c. G.E. dynamotor \$8; Crocker-Wheeler half KW, 500 cycle dynamotor, 110 volt d.c. drive with control equipment \$25; 0-25 Westou RF ammeter model 431 \$10; PT537 rheostats \$1; UV204 tube mountings \$1; Write for additional list. Apparatus shipped FOB Auburn. W4AQ, W. M. Garrard, Box 837, Auburn, Alabama.

**275 volt generators used but good order \$8.** Give up to 500 volts. 200 watt 500 cycle generators, \$10. K. Wood, 46-20 102nd St., Corona, N. Y.

**IDEAL plate supply** operated from storage batteries. High speed ball bearing dynamotors and generators designed for *Vary*. May be operated by external motor or engine when ordered with shaft extension \$3.00 additional. General Electric 24/1500 volt 350 watt \$37.50. 24, 750 volt 150 watt \$27.50. 12, 350 volt 50 watt \$18. Crocker-Wheeler 24/1500 volt 450 watt \$45.00. Holtzer-Cabot 12/500 volt 45 watts \$20. Westinghouse 27.5-350 volt \$15. Two machines for 700 cycle \$28. 0-15 volt 500 watt \$15. 10-350 volt \$18.00. 900 cycle 200 watts with exciters \$22.50. 1½KW 500 cycles \$15. Suitable transformers. List with fotos. Henry Kienzie, 501 East 84th Street New York.

**Amazing screw-holding screw driver!** New patented invention! Removes, inserts screws instantly in inaccessible places. Sells \$1.50, 100% profit. Factories, mechanics, garages, electricians radio buy on sight! Exclusive territory. Jiffy 1084 Winthrop Bldg., Boston.

**SPECIAL summer prices on crystals:** 3500 kc \$14.00, 1700 kc \$9.00, Blanks \$4.00. First reasonable offer buys omnigraph with key and buzzer. Hollister, W9DRD, Edwardsville, Kansas.

## Q R A SECTION

50c straight with copy in following address form only:

W1BQQ — H. Cooper, 28 Storrs St., New London, Conn.

W2AMM — Dr. A. Korniejewski, 326 Crane St., Schenectady, N. Y.

W9A1U — Roy E. Butler, Lorraine Hotel, Wabash and Van Buren Sts., Chicago, Ill.

## WIMK

### A.R.R.L. Headquarters

R. B. Parmenter, Chief Op., "rp."

The following calls and personal sines belong to members of the A.R.R.L. Headquarters gang:

W1AL H. P. Westman "ws."  
W1BDI-W1XL F. E. Handy "fh."  
W1BHW-W1EH K. B. Warner "kb."  
W1BMM-W1FL G. D. Meserve "dm."  
W1BUD A. L. Budlong "bud."  
W1CEI J. J. Lamb "jm."  
W1ES A. A. Hebert "ah."  
W1KPF F. C. Beekley "beek."  
W1PX C. G. Kenebeck "ek."  
W1SZ-W1BIZ C. C. Rodimon "rod."  
L. R. Huber "ou."  
R. A. Hull "rah."

## BECOME A RADIO OPERATOR

See the World, Earn a Good Income,  
Duties Light and Fascinating

LEARN IN THE SECOND PORT U.S.A.

Radio Inspector located here. New Orleans supplies operators for the various Gulf ports. Most logical location in the U. S. A. to come to for training.

Nearly 100% of radio operators graduating on the Gulf during the past seven years trained by Mr. Clemmons, Supervisor of Instruction.

All graduates placed to date. Start training now for Summer runs.

Member of the A.R.R.L. — Call "W5GR."

Day and Night Classes — Enroll any time.  
Write for Circular

## GULF RADIO SCHOOL

844 Howard Ave. New Orleans, La.

## HERE THEY ARE!

The Tubes You've Been Waiting For

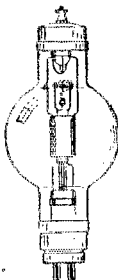

We are now making deliveries on these and several other types of transmitting tubes.

Type 550 — 50 to 85 watts input at 800 to 1000 volts, filament 5.8 volts 2.5 amps. Plate and grid terminals at top of tube. . . . . **\$12.50**

Type 560, illustrated, 150 to 200 watts input at 1000 to 2000 volts, filament 9.5 volts 0.5 amps. Plate terminal at top. This tube deserves to be the most popular of any medium power tube on the entire market. . . . . **\$23.50**

Type 570, similar to type 560 but without bases, 500 to 700 watts input at up to 5000 volts, filament 18 volts 6amps. A splendid tube for the high power station. **\$46.50**

Rectifiers. We stock and recommend the new 6EX Mercury Vapor Rectobulbs for plate supply to the above and any other tubes. . . . . **\$10.00**

**E. F. JOHNSON CO., Waseca, Minn.**

# The New Power Amplifier CX345



Most recent addition to the line of

## Cunningham RADIO TUBES

TYPE CX-345 is capable of delivering a power output equal to that of CX-310 type, but at a plate voltage not exceeding 250-volts.

This new tube is not interchangeable with the CX-371-A type, or any other Cunningham power amplifier. It has been designed for use in the last audio amplifying stage of power-line operated sets, which supply not more than 2.5 volts to the last audio socket, as well as proper grid and plate voltages. The filament is of the coated ribbon type, assuring great strength and high emission.

**E. T. CUNNINGHAM, INC.**

NEW YORK      CHICAGO      SAN FRANCISCO  
DALLAS      ATLANTA

For Your Convenience

### QST'S INDEX OF ADVERTISERS IN THIS ISSUE

Acme Wire Company	76
Aero Products, Inc.	3rd cover
Allen-Bradley Company	66
Aluminum Company of America	4
American Sales Company	2, 3
Areturus Radio Company	88
Auriema, Inc., Ad.	74
A.R.R.L. Application Blank	89
A.R.R.L. Emblem	85
A.R.R.L. Handbook	80, 2nd cover
Barawik Company	86, 90
Barros & Co., M.	87
Burgess Battery Company	4th cover
Candler System Company	84
Cardwell Mfg. Corp., Allen D.	75
Central Radio Labs.	78
Chicago Radio Apparatus Co.	87
Charostat Mfg. Company	86
Corning Glass Works	86
Crosley Radio Corp.	72
Cunningham, Inc., E. T.	94
Dodge, C. E.	82
Eastern Radio Institute	86
Electric Specialty Co.	87
Frost, Inc., Herbert H.	84
General Radio Company	6
Gotham Engineering & Sales Co.	65
Greben, F.	88
Gulf Radio School	93
Hardwick, Hindle, Inc.	80
Jewell Electrical Instrument Co.	67
Johnson Company, E. F.	93
Leeds Radio Company	79
Loomis Publishing Co.	72
Manhattan Electrical Bargain House	83
McGraw-Hill Book Co.	68
Moore Radio Company	90
National Company	83
National Radio Tube Co.	78
Patent Electric Co.	88
Patten, E. E.	83
Potter Company, The	76
QST Back Copies	95
QST Binder	90
Radio Corporation of America	1
Radio Engineering Labs.	69
Radio Parts Sales Company	86
Raytheon Mfg. Company	90
Rectifier Engineering Service	83
Rooney, John T.	90
Scientific Radio Service	87
Silver-Marshall, Inc.	81
Teleplex Company	74
Thordarson Elec. Mfg. Co.	71
Universal Microphone Co.	82
Vacuum Tube Exchange	88
Van Nostrand Company, D.	77
Vibroplex Company	72
Ward Leonard Electric Co.	85
West Coast Radio Labs.	81
Western Electrical Instrument Corp.	70
X-L Radio Labs.	80
Yaxley Mfg. Company	82



# A Rare Opportunity!

## Forty-Three Back Copies of QST for SIX DOLLARS POSTPAID

Four years of QST back copies,  
nearly complete, with index

**YOU HAD BETTER ACT QUICKLY AS MANY  
OF THESE SETS ARE FAST DISAPPEARING**

Reference is continually being made in QST articles  
to previous issues. You should have these copies. Avail-  
able at a special price.

All 1925 copies (except January, May and July)	<b>\$2.50</b>
All 1926 copies — complete	<b>\$2.50</b>
All 1927 copies (except January)	<b>\$2.50</b>
All 1928 copies (except January)	<b>\$2.50</b>

All four years for \$6.00, a saving of \$4.00, if all four  
years are ordered complete. If you do not want all  
copies, state which years are wanted.

**Binders to keep these files in order  
\$1.50 each**

Each binder holds 12 issues of QST and does not  
mutilate the copies.

**QST**

1711 Park Street



Hartford, Conn.

# Pyrex Insulators make records at the North Pole, at the South Pole —and everywhere between

North Pole  
from which  
Commander Byrd  
previously signalled  
over PYREX-equipped antenna

N.Y. Times Radio  
Station

*Little America, Antarctica, Feb. 3rd, 1929*

*Uniformly excellent satisfaction from  
PYREX Insulators employed exclusively in  
all antenna systems all our ships, airplanes,  
base and portable stations, also extensively  
in construction various transmitters.*

— Hanson 9:55 P.M.

The messages from Commander Byrd when he flew across the North Pole traveled out from an antenna equipped with PYREX Insulators.

Commander Byrd — and PYREX Insulators — recently set a new world's record in aviation radio, when near the South Pole his plane "Stars and Stripes," 3000 feet above Antarctic ice, established perfect two-way communication with the New York Times station in New York City, 10,000 miles away.

The transmitting and receiving equipment in the "Stars and Stripes" is small, weighs only about 40 lbs., and is of the short-wave (34 meter) type with a power of only 50 watts. Plane radio sets are always of low power because of weight limitation. The attainment of 10,000-mile range of short-wave signals from such a tiny set indicates the height of insulation achievement, and by many radio experts is considered the greatest feat ever performed by radio.

You will make no mistake by following the judgment of these leaders. Protect your set, transmitting or receiving, with PYREX Insulators.

*Antenna, Strain, Entering, Stand-off, Pillar and Bus-bar Types  
of various sizes offer correct selection. Buy from your dealer or at  
least write to us for complete illustrated file catalog.*

**Corning Glass Works**

Dept. 64

Industrial and Laboratory Division

CORNING, NEW YORK

Commander  
Byrd's Airplane  
"Stars and Stripes"  
3000 ft. above  
surface

T. M. REG. U. S. PAT. OFF.

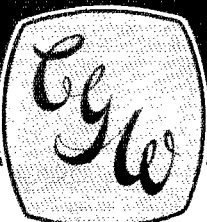

# PYREX

A MARK OF CORNING GLASS WORKS

## RADIO INSULATORS

# AERO COIL

New!

Wave-Meter

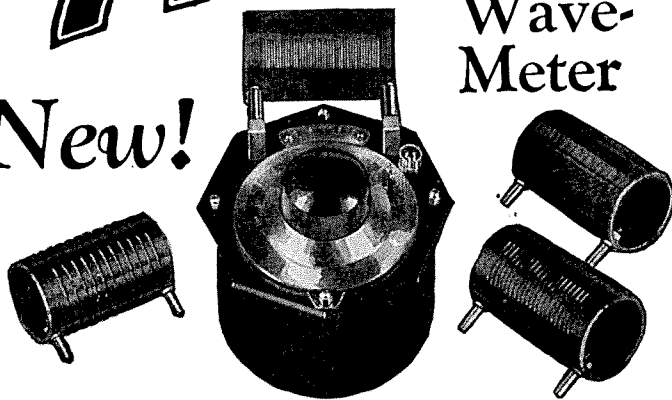

## 110 Divisions — Readable to 1-10th Divisions

The Aero Wavemeter was designed for the radio amateur and the experimenter. It is of rugged mechanical and good electrical construction and meets the exacting requirements of the properly conducted amateur station.

Using the principle of the "series gap," and having a definite fixed minimum capacity, the amateur wavelength bands are spread over a great many dial divisions. The velvet vernier dial has 100 divisions, each of which may be read to one-tenth of a division. The 5-meter band covers 40 dial divisions; the 10-meter, 40 divisions; 20-meter, 17 divisions and the 40-meter band, 25 divisions. For the 80-meter band, two coils are used.

One (72 to 82 meters) covers 45 divisions, and the other (80 to 90 meters) covers 65 divisions.

Each coil excepting the 5-meter, uses No. 18 enameled wire tightly wound into grooves of the bakelite tubing. The tubing has a 3/4 in. wall and is 2 in. in diameter. The Aero heavy duty plugs and jacks make positive contact. The heavy brass case has a black crackle finish. The 3/16" black bakelite top is hexagonal shape to prevent rolling. The indicator is a standard neon lamp. Each wavemeter is individually hand calibrated. Standard coils shown are 20, 40 and 80 meters, included in price. 5- and 10-meter coils extra.

Write for prices and special circular

## Aero High-Power Xmitter and 150-Watt Amplifier

For operation on 10-20-40-80-100M. Bands

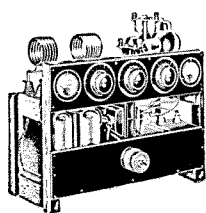

The first high-power amplifier to use the UX-860 screen grid tubes. 1929 in Every Detail. 150 Watts of Pure D.C. Signals with a 3 tube 4 tube W H e h H a s Caused Favorable Remarks Everywhere. Flexibility that F I I s E v e r y H a m N e e d.

You can use either two UX-852 tubes when using this new Aero Kit No. 52 as a single unit for a transmitter; or two UX-860 (screen

grid) tubes, employed when using with Aero Kit No. 55; or as a 150-watt amplifier in any master oscillator combination. For those desiring a master oscillator system, this unit works with a high degree of efficiency as an amplifier. With two screen grid UX-860 power tubes in this arrangement, it requires no neutralizing. Hook this unit on your present oscillator, converting it into a 1929 job, with ample power for ham use. Power supply delivers 2000 volts at 250 M.A. Employs two of the R.C.A.'s newest rectifiers, UX-866. Due to the construction of the UX-866, unusually high voltage may be applied safely to them.

Kit No. 52 — Including the power supply, but not including tubes. List Price.....\$259.00  
Kit No. 53 — Less power supply and tubes. List Price.....\$114.00

## Aero Listening Monitor

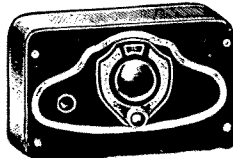

The Aero Listening Monitor enables any amateur transmitter to check his own note, to know whether it is pure D.C. or not. It is a safe, sure and accurate way of knowing your station without depending upon the reports of others. Watching the ammeter won't help you — you need the Aero Monitor to be absolutely positive.

The Aero Monitor is a completely shielded unit enclosed in a black metal cabinet, size 9 x 5 1/2 x 2 1/4 in. Filament and B supply is included. It operates with a UX-199 type of tube and employs a stable circuit, delivering a signal intensity of about R-4 or 5. Equipped with automatic filament control. The battery supply is thoroughly shielded from the wt., about 2 1/2 lbs.

Model M-29 Aero Monitor, including Dry Batteries, but no tube. List Price. \$15.00  
Send for Aero Green Book and 1929 Supplement showing newest Short Wave Products. Price.....25c

Send for new Short-wave supplement showing new 1929 products. It is free to QST readers

4611 E. Ravenswood Ave., Dept. 359

**AERO PRODUCTS**  
INCORPORATED

Chicago, Illinois,  
U. S. A.

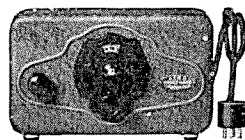

## "Aero-Call" Factory-Built Short-Wave Converter

No short-wave converter on the market is comparable with the new 1929 "Aero-Call." Its advent sounds a new era in short-wave converts. Many factory-built items of this character now being sold are giving trouble particularly on the A.C. models, because there has been found no general adaptation of converters to the A.C. filter on the broadcast sets. The new "Aero-Call" Converters eliminate all these difficulties.

Model A for A.C. Sets.....\$25.00  
Model D for D.C. Sets.....\$25.00

## New 1929 Receiving Coils

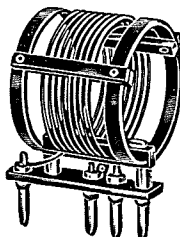

Designed for the new amateur 20, 40 and 80 meter bands, for use with .00003 condenser, including plug-in base with new design adjustable space-wound primary. Complete

Kit L. W. T. 13, 3 coils \$12.50.  
Single coils — 8.2 to 12.6 meters; 19.4 to 21.5 meters; 40.0 to 45.0 meters; 75.0 to 86.0 meters, \$4.00 each. L. W. T. 100-P Plug-in base, \$3.00; .00003 Condenser, \$1.50. This condenser to be slanted with a .00008 Fixed Condenser.

## New 1929 Transmitting Coils

In accord with 1929 practice, First use of plug-in coils for high power up to 75 amperes Heavy aluminum carries 500 watts safely. New material space bar superior to glass. Many new features. For use with 450 mmfd

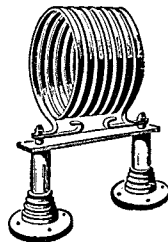

condenser. Kit of 2 coils with plug-in mounts, 9.6 to 27.0 meters \$15.00; 14.2 to 43; also 31.8 to 90.3 meters, \$15.00. Single coils, \$5.50, without Bases. Plug-in mounts only, pair \$3.50. Plugs only, with nuts, pair \$2.00.

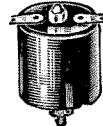

New 1929 Aero Grid Choke No. C-250 A Compact Choke Coil for suppressing high frequency oscillations in transmitting vacuum tubes. Price \$1.50.

Aero Transmitting Choke No. C-248, \$1.50.

Aero Transmitting Choke No. C-249

\$1.50, C-60, \$1.50, C-65, \$1.50



# 9,300 Miles!

The World's Record! Direct two way radio communication between the New York Times Radio Station and Commander Byrd's Airplane flying over the Antarctic.

Every Radio Amateur should know that Burgess Radio Batteries are used in the Antarctic Expedition radio stations.

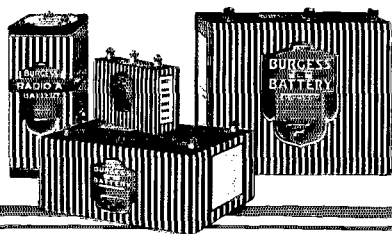

*Ask Any Radio Engineer*

## **BURGESS BATTERY COMPANY**

MADISON,

WISCONSIN