

# QST

DEVOTED ENTIRELY TO

# AMATEUR RADIO

PUBLISHED SINCE 1915 BY THE AMERICAN RADIO RELAY LEAGUE INC.

Designing  
and  
Building

A Modern  
Radio-  
Telephone



APRIL

1929

25¢

The New Fourth Edition of

# The Radio Amateur's Handbook

By HANDY and HULL

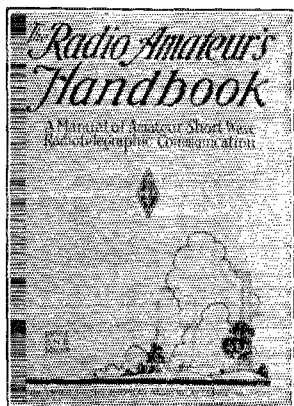

## FOR THOSE WHO DON'T KNOW IT:

The Handbook is a practical manual of amateur radio in all its phases, published by the American Radio Relay League, the amateur's own organization. It starts at the beginning and tells the whole story: What amateur radio is. How to be a radio amateur, How to obtain your licenses. How to build the simple apparatus of a simple station. How to build the best known apparatus for the most modern station. How to operate the station. Enough information to keep you busy and interested for five years.

## FOR THOSE WHO DO KNOW IT:

For years the Handbook has been the practical working guide of successful amateurs the world over. Now it has been completely revised in terms of 1929, by Mr. Handy, the League's Communication Manager, as to all the aspects of operating procedure, and by Mr. Hull, the director of the League's current Technical Development Program, as to all its features of apparatus and technical matters. Everything in it is on a 1929 basis, replacing the 1928 methods which used to be good enough but aren't any more.

## MUCH THAT IS NEW — ALL THAT IS GOOD

*Like QST, "Devoted Entirely to Amateur Radio"*

*Now in its 43d thousand*

*240 pages, 6½ x 9½, 188 illustrations*

In wealth of treatment and profusity of illustration the Handbook is a big book. Printed in usual textbook style it would bulk 500 pages and cost at least \$1. but its publication in the familiar *QST* format makes for handiness and enables its distribution at very modest cost.

ALGERIAN PAPER COVER \$1

STIFF BUCKRAM BINDING \$2

*Postpaid anywhere in the World*

American Radio Relay League, Hartford, Conn., U. S. A.

# RCA

## *announces*

# Radiotron

## UX-865

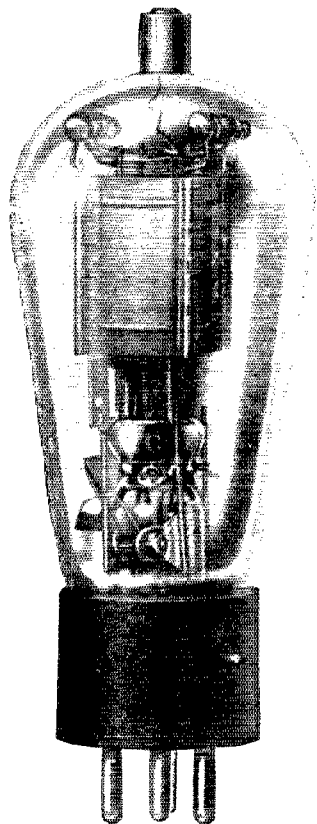

A 7.5 WATT SCREEN-GRID R. F. POWER  
AMPLIFIER OR OSCILLATOR

And now, the newest addition to the *screen-grid* transmitting tube family—  
Radiotron UX-865

In transmitter circuits operating at the higher frequencies, Radiotron UX-865 will prove its effectiveness as a radio frequency power amplifier. Its *screen-grid* eliminates the necessity for neutralization to prevent feedback and oscillation.

Then too, in these days of "staying put" on a definite transmitting frequency, Radiotron UX-865 lends itself admirably for use by the amateur as a crystal-controlled oscillator.

When used in either way, Radiotron UX-865 will give permanent satisfaction to its user.

If your dealer cannot supply you, the nearest RCA DISTRICT OFFICE listed below will be glad to send you Radiotron UX-865 postpaid on receipt of money order and call letters of your station.

Filament } Volts	7.5
Amperes	2.0
Max. Plate Volts.	500
Max. Plate Dissipation (watts)	15
Max. Screen Dissipation (watts)	3
Power Output (watts)	7.5

Average Characteristic Values		
AT	Plate Volts	500
	Grid Volts	0
	Screen Volts	125
	Filament Volts-RMS	7.5
Plate Current (ma.)		21
Plate Resistance (ohms)		200000
Mutual Conductance (ma./v)		0.75
Amplification Factor		150
LIST PRICE		\$22.00

## RADIO CORPORATION OF AMERICA

New York—261-5th Avenue  
San Francisco—235 Montgomery Street

Chicago—100 West Monroe Street  
Dallas—Santa Fe Building, Unit No. 1

Atlanta—101 Marietta Street



FARADON  
EXEMPLIFIES  
EXCELLENCE  
IN  
WORKMANSHIP  
AND  
MATERIALS

WIRELESS  
SPECIALTY APPARATUS  
COMPANY

Jamaica Plain, Boston  
(Est. 1907)  
Manufacturers of

*Faradon*

2690

*Electrostatic Condensers for all Purposes*

Say You Saw It in QST — It Identifies You and Helps QST

# Section Communications Managers of THE COMMUNICATIONS DEPARTMENT, A. R. R. L.

Eastern Pennsylvania	W3QP	<b>ATLANTIC DIVISION</b>	J. B. Morgan, 2nd	431 E. Willow Grove Ave.	Chestnut Hill, Phila.
Maryland-Delaware-District of Columbia	W3AIS		Dr. H. H. Layton	805 Washington St.	Wilmington, Del.
Southern New Jersey	W3CFG		M. J. Levey	Box 49, R. F. D. 1	Cranbury, N. J.
Western New York	W8PJ		C. S. Taylor	598 Masten St.	Buffalo
Western Pennsylvania	W8CEO		A. W. McAuly	309 Third St.	Oakmont
		<b>CENTRAL DIVISION</b>	Fred J. Hinds	3337 Oak Park Blvd.	Berwyn
Illinois	W9APY		D. J. Angus	310 N. Illinois St.	Indianapolis
Indiana	W9CVQ		J. B. Wathen, III	Box 97, R. F. D. 1	Louisville
Kentucky	W9BAZ		Dallas Wise	2187 Falcon Ave.	Detroit
Michigan	W8CAF		H. C. Stork	694 Carpenter St.	Columbus
Ohio	W8BYN		C. N. Crapo	443 Newton Ave.	Milwaukee
Wisconsin	W9YD				
		<b>DAKOTA DIVISION</b>	B. S. Warner	309 4th Ave.	Enderlin
North Dakota	W9DYY		D. M. Pasek	780 Illinois St.	Huron
South Dakota	W9DGR		Carl L. Jabs	1822 James St.	St. Paul
Northern Minnesota	W9BYH		J. C. F. Borshak	130 Warwick St., S. E.	Minneapolis
Southern Minnesota	W9EFK				
		<b>DELTA DIVISION</b>	H. E. Velte	5408 U St.	Little Rock
Arkansas	W5ABI		M. M. Hill		Okdale
Louisiana	W5EB		J. W. Gullett	1708 23rd Ave.	Meridian
Mississippi	W5AKP		Polk Purdue	c/o Radio Station WBAB	Nashville
Tennessee	W4FI				
		<b>HUDSON DIVISION</b>	F. M. Holbrook	2 Livingston Ave.	White Plains
Eastern New York	W2CNS		M. B. Kahn	617 W. 141st St.	N. Y. C
N. Y. C. & Long Island	W2KR		A. G. Wester, Jr.	50 Princeton St.	Maplewood
Northern New Jersey	W2WR				
		<b>MIDWEST DIVISION</b>	H. W. Kerr		Little Sioux
Iowa	W9DZW		J. B. Amis	915 Lincoln Ave.	Topeka
Kansas	W9CEI		L. B. Lazere	8010 Mercier St.	Kansas City
Missouri	W9RR		C. B. Diehl	5605 Cedar St.	Omaha
Nebraska	W9BYG				
		<b>NEW ENGLAND DIVISION</b>	C. A. Weidenhammer	33 Washington Place	Bridgeport
Connecticut	W1ZL		Frederick Best	13 E. Crescent St.	Augusta
Maine	W1BIG		E. L. Battey	39 Royal St.	Wollaston
Eastern Massachusetts	W1JUE		Dr. John A. Tessmer	8 Schaffner St.	Worcester
Western Massachusetts	W1JUM		V. W. Hedge	227 Main St.	Claremont
New Hampshire	W1ATJ		C. N. Kraus	92 Keene St.	Providence
Rhode Island	W1BCR		Clayton Paulette		North Troy
Vermont	W1H				
		<b>NORTHWESTERN DIVISION</b>	W. B. Wilson	U. S. LHT Fern	Ketchikan
Alaska	W7DIN		James L. Young	308 13th Ave. So.	Nampa
Idaho	W7ACN-7JL		O. W. Viers		Red Lodge
Montana	W7AAT-7QT		R. H. Wright	310 Ross St.	Portland
Oregon	W7PP		Otto Johnson	3440 30th Ave. W.	Seattle
Washington	W7FD				
		<b>PACIFIC DIVISION</b>	F. L. Follaway	2714 Manoa Rd.	Honolulu
Hawaii	K6CFG		C. B. Newcombe		Vernon
Nevada	W6UO		D. C. Wallace	209 Pine Ave., Room 110	Long Beach, Calif.
Los Angeles	W6AM		F. J. Quement	1348 Hanchett Ave.	San Jose
Santa Clara Valley	W6NX		J. Walter Frates	368 62nd St.	Oakland
East Bay	W6CZR		C. F. Bane	262 Castro St.	San Francisco
San Francisco	W6WB		C. E. Mason	2530 N. St.	Sacramento
Sacramento Valley	W6CRS		D. B. Lamb	229 W. First St.	Mesa
Arizona	W6AXO		M. I. Felizardo	252 Galicia St.	Manila
Philippines*	K1AU		G. A. Sears	236 Bonair St.	La Jolla
San Diego	W6BQ				
		<b>ROANOKE DIVISION</b>	Enno Schurke	R. F. D. No. 1	Ridgeway
North Carolina	W4ST		J. F. Wohlford	118 Cambridge Ave.	Roanoke
Virginia	W3CA		F. D. Reynolds	Box 1200	Fairmont
West Virginia	W8VZ				
		<b>ROCKY MOUNTAIN DIVISION</b>	C. R. Stedman	1641 Allison St.	Denver
Colorado	W9CAA		Parley N. James	430 "D" St.	Salt Lake City
Utah-Wyoming	W6BAJ				
		<b>SOUTHEASTERN DIVISION</b>	S. J. Bayne	9 Park Ave.	Montgomery
Alabama	W4AAQ		Harvey Charin	6002 Sivanee Ave.	Tampa
Florida	W4AH				
Georgia-So. Carolina-Cuba-Porto Rico-Iste of Pine	W4KU		H. J. Reid	11 Shadowlawn Ave.	Atlanta
		<b>WEST GULF DIVISION</b>	J. H. Robinson, Jr.	522 Cumberland St.	Dallas
Northern Texas	W5AKN		L. M. Edwards	815 S. J. Lincoln St.	Enid
Oklahoma*	W5EJ		R. E. Franklin	1806 Valentine St.	Houston
Southern Texas	W5OX		L. E. Radka		Lucmear
New Mexico	W5IT				
		<b>MARITIME DIVISION</b>	Loyal Reid	Avalon House	St. Johns
Newfoundland	VE8AR		T. B. Lacey	c/o N. B. Power Co	St. John
New Brunswick	VE1E1		A. M. Crowell	69 Dublin St.	Halifax
Nova Scotia	VE1DQ		F. W. Hyndman	25 Fitzroy St.	Charlottetown, P. E. I.
Prince Edward Island	VE1BZ				
		<b>ONTARIO DIVISION</b>	E. C. Thompson	266 Queensdale Ave.	Toronto, 6
Ontario	VE3FC				
		<b>QUEBEC DIVISION</b>	Alex Reid	169 Logan Ave.	St. Lambert
Quebec	VE2BE				
		<b>VANALTA DIVISION</b>	E. J. Taylor	10107-87th Ave.	Edmonton
Alberta	VE4HA		E. S. Brooks	2987 Camosun St.	Vancouver
British Columbia	VE5BJ				
		<b>PRAIRIE DIVISION</b>	H. B. Sinclair	205 Cambridge St.	Princepeg
Manitoba	VE4FV		W. J. Pickering	514 19th St. W.	Prince Albert
Saskatchewan	VE4FC				

\* Temporary officials appointed to act until the membership of the Section concerned choose permanent SCMs by renomination and election.

# *Announcing* ~

## THE TYPE 558-P AMATEUR BAND FREQUENCY METER



*Greater  
Precision  
and  
A New  
Low Price  
\$18*

**Covers all of the amateur bands  
Accuracy of calibration, 0.25%**

Individual calibration supplied for each instrument. Easier to secure a high precision of measurement than with the Type 558 Frequency Meter which it now replaces.

*Bulletin "P" gives the details*

## GENERAL RADIO COMPANY

30 STATE STREET  
CAMBRIDGE  
MASSACHUSETTS

274 BRANNAN STREET  
SAN FRANCISCO  
CALIFORNIA

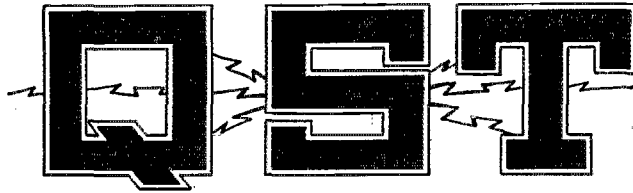

# The Official Organ of the A.R.R.L.

VOLUME XIII

APRIL, 1929

NUMBER 4

Editorials . . . . .	7
Modern Practice in High-Frequency Radiotelephony . . . . . <i>Ross A. Hull</i>	8
The President's Corner . . . . .	22
The Midwest Division Convention . . . . .	22
A General Purpose Audio-Frequency Power Amplifier . . . . . <i>James J. Lamb</i>	23
"Public Interest, Convenience or Necessity" . . . . .	28
Beats . . . . . <i>J. E. Smith</i>	29
Alternating Current Rectification as Applied to Radio — Part I . . . . . <i>R. J. Kryter</i>	33
"Dress" . . . . . <i>C. J. Paldon</i>	38
Notes on Distortion in Audio-Frequency Amplifiers . . . . . <i>J. R. Nelson</i>	40
A New Low-Power Screen-Grid Transmitting Tube . . . . . <i>O. W. Pike and E. E. Spitzer</i>	43
Calibrating the Heterodyne Frequency Meter or Monitor . . . . . <i>George Grammer</i>	46
The Disc Condenser . . . . . <i>Milton Ausman</i>	48
A Simple Home-Made Meter . . . . . <i>Stanton Chapman</i>	49
The Resonance Effect of Receiving Antennas . . . . . <i>Chauncey Coston</i>	51
Experimenters' Section . . . . .	52
I.A.R.U. News . . . . .	56
Calls Heard . . . . .	57
Correspondence . . . . .	58
Financial Statement . . . . .	70
Hamads . . . . .	92

**QST is published monthly by The American Radio Relay League, Inc., at Hartford, Conn., U. S. A. Official Organ of the A.R.R.L. and the International Amateur Radio Union**

**Kenneth B. Warner (Secretary, A.R.R.L.),**  
*Editor-in-Chief and Business Manager*

**F. Cheyney Beckley,**  
*Managing Editor and Advertising Manager*

**Harold P. Westman,**  
*Technical Editor*

**Ross A. Hull,**  
*Associate Technical Editor*

**David H. Houghton,**  
*Circulation Manager*

Subscription rate in United States and Possessions, Canada, and all countries in the American Postal Union, \$2.50 per year, postpaid. Single copies, 25 cents. Foreign countries not in American Postal Union, \$3.00 per year, postpaid. Remittances should be by international postal or express money order or bank draft negotiable in the U. S. and for an equivalent amount in U. S. funds.

Entered as second-class matter May 29, 1919, at the post office at Hartford, Connecticut, under the act of March 3, 1879. Acceptance for mailing at special rate of postage provided for in section 1103, Act of October 3, 1917, authorized September 9, 1922. Additional entry at Concord, N. H., authorized February 21, 1929, under the act of February 28, 1925.

Copyright 1929 by the American Radio Relay League, Inc. Title registered at United States Patent Office.  
Member of the Radio Magazine Publishers' Association.

# The American Radio Relay League

The American Radio Relay League, Inc., is a non-commercial association of radio amateurs, bonded for the promotion of interest in amateur radio communication and experimentation, for the relaying of messages by radio, for the advancement of the radio art and of the public welfare, for the representation of the radio amateur in legislative matters, and for the maintenance of fraternalism and a high standard of conduct.

It is an incorporated association without capital stock, chartered under the laws of Connecticut. Its affairs are governed by a Board of Directors, elected every two years by the general membership. The officers are elected or appointed by the Directors. The League is non-commercial and no one commercially engaged in the manufacture, sale or rental of radio apparatus is eligible to membership on its board.

"Of, by and for the amateur," it numbers within its ranks practically every worth-while amateur in the world and has a history of glorious achievement as the standard-bearer in amateur affairs.

Inquiries regarding membership are solicited. A bona fide interest in amateur radio is the only essential qualification; ownership of a transmitting station and knowledge of the code are not prerequisite. Correspondence should be addressed to the Secretary.

## DIRECTORS

*President*  
**HIRAM PERCY MAXIM**  
 Drawer 2102,  
 Hartford, Conn.

*Vice-President*  
**CHARLES H. STEWART**  
 St. David's, Pa.

*Canadian General Manager*  
**A. H. K. RUSSELL**  
 5 Mail Bldg.,  
 Toronto, Ont.

*Atlantic Division*  
**DR. EUGENE C. WOODRUFF**  
 234 W. Fairmount Ave.,  
 State College, Pa.

*Central Division*  
**CLYDE E. DARR**  
 187 Hill Ave., Highland Park,  
 Detroit, Mich.

*Dakota Division*  
**C. M. JANSKY, JR.**  
 Dept. of Elec. Eng., U. of M.  
 Minneapolis, Minn.

*Delta Division*  
**BENJ. F. PAINTER**  
 424 Hamilton Nat'l Bank Bldg.  
 Chattanooga, Tenn.

*Hudson Division*  
**DR. A. LAFAYETTE WALSH**  
 220 West 42d St.,  
 New York City

*Midwest Division*  
**PORTER H. QUINBY**  
 817 Lauderman Building,  
 St. Louis, Mo.

*New England Division*  
**FREDERICK BEST**  
 13 East Crescent St.,  
 Augusta, Maine

*Northwestern Division*  
**K. W. WEINGARTEN**  
 3219 No. 24th St.,  
 Tacoma, Wash.

*Pacific Division*  
**ALLEN H. BARCOCK**  
 65 Market St.,  
 Southern Pacific Co.,  
 San Francisco

*Roanoke Division*  
**W. TREDWAY GRAVELY**  
 Box 245,  
 Danville, Va.

*Rocky Mountain Division*  
**PAUL M. SEGAL**  
 Box 1771  
 Denver, Colo.

*Southeastern Division*  
**HARRY F. DOBBS**  
 c/o Dobbs & Wey Co.,  
 215 Spring St., N. W.,  
 Atlanta, Ga.

*West Gulf Division*  
**FRANK M. CORLETT**  
 2515 Catherine St.,  
 Dallas, Tex.

## OFFICERS

*President* . . . . . **HIRAM PERCY MAXIM**, Hartford, Conn.  
*Vice-President* . . . . . **CHARLES H. STEWART**, St. David's, Pa.  
*Secretary* . . . . . **KENNETH B. WARNER**, Hartford, Conn.  
*Treasurer* . . . . . **ARTHUR A. HEBERT**, Hartford, Conn.  
*Communications Manager* . . . . . **F. EDWARD HANDY**, Hartford, Conn.



# EDITORIALS

**T**HE annual meeting of the A.R.R.L. Board of Directors occurs in Hartford on May 3d and 4th. This is the meeting where the directors gather in person from all parts of the country (including, of course, the Canadian General Manager) to look into all the ramifications of A.R.R.L. affairs and to make plans and outline policies for the following year.

A.R.R.L. has representative government. These directors have been elected by the membership in each division to represent them in deciding what A.R.R.L. shall do, what it shall not do, what its attitude shall be on important topics, how it shall go about doing the things it undertakes to do. It is worthy of emphasis that the headquarters office of the League does not settle these things; all such functions belong to the Board, the governing body in our A.R.R.L., and through an ensuing year the headquarters office carries on under and is bound by the plans and policies laid down by the Board. Such meetings, then, are of the greatest importance. When your director attends this coming meeting, he is your representative, speaking for all the members in his division. That is the machinery whereby you, an individual member, participate in deciding upon A.R.R.L. activities.

Your director wants to hear from you. Our constitution imposes upon directors the duty of keeping themselves "informed on conditions and activities in their respective divisions, and on the needs and desires of the League members therein, that they may faithfully and intelligently represent them in the Board of Directors." If you have anything on your mind, now is the time to tell your director about it. Have you troubles, are you worried about something in amateur radio, have you a hot suggestion? Write your director about it. The addresses of all the directors appear on page 6 of this issue. Yours will be glad to hear from you, in preparation for the coming meeting.

**T**HE annual Shakespearian radio drama, "To be or not to be," is again on the Congressional boards at Washington as we write, the purpose being to determine whether or

not the Federal Radio Commission shall be continued for another year as the licensing authority. The "be's" seem to have it, the House having acted favorably and the Senate committee reporting favorably, and unless the measure falls by the wayside in the confusion of the last few days of Congress, the Commission will again control our destinies for another year.

This seems a wise provision, for the Commission has much important work in process, work which can be carried on in the Department of Commerce only by duplicating the Commission's whole elaborate structure, an organization of something like seventy people occupying several dozen office rooms.

We amateurs therefore have particular reason to be interested in the President's recent appointments to the Commission in the persons of Arthur Batcheller from the First Zone and Cyril M. Jansky, Jr. from the Fourth Zone, succeeding Commissioners Caldwell and Pickard, who have resigned. The two new commissioners seem to us to be admirably equipped for their task. Their appointment has strengthened the commission and we feel sure must be regarded generally in radio circles as altogether pleasing. Certainly this is true from our viewpoint as amateurs. Both of the new commissioners know us well, Mr. Batcheller has been in the radio inspection service since 1917, for the last nine years being the Supervisor of Radio at New York. Believe us, anybody who has been the 2d District Supervisor since 1920 knows something about amateur radio! Professor Jansky is an associate professor of electrical engineering at the University of Minnesota, the boss at W9XI, a consulting radio engineer of wide experience, and since 1924 the A.R.R.L. Director from our Dakota Division. From which it may be deduced that he too knows his amateur radio. The new commissioners bring to that body professional radio engineering ability and a wealth of practical radio experience, things which the Commission needs and by which it is strengthened henceforth in all it undertakes. It is a good sign. We salute the new commissioners and wish them every success.

E. B. W.

# Modern Practice in High-Frequency Radiotelephony

## A Discussion of Improved Methods Which Virtually Revolutionize Amateur Phone Transmission

By Ross A. Hull\*

*In this, the concluding article in the A.R.R.L. Technical Development Program, amateur phone transmission is taken into the A.R.R.L. Laboratory and given the same sort of (1929) treatment as the Program has previously accorded other sections of amateur activity. The results have been highly gratifying.*

*Amateur phone transmission to-day has progressed but little from the early post-war modulation arrangements, which of high frequencies have inevitably meant poor speech quality and relatively enormous interference, and which have always been wretchedly inefficient as voice transmitters. The application of recent engineering developments in this field, as related in this article, seem to us to justify our use of the word "revolutionize," for they now bring to amateur radio a vastly more efficient phone, one of indescribably better quality, and one in which the interference, peculiarities of this type of transmission are greatly reduced. — EDITOR.*

IT WOULD be futile to attempt to establish that the technique of present-day amateur radiotelephony differs in any important respect from that of 1920. More specifically, it would be useless to attempt to prove any very general improvement in the technique by offering as evidence the present transmissions on, say, the 3500-ke. band where, with a few notable exceptions, amateurs still converse in the same strange language of gargles, gurgles, jangles and wheezes which has been characteristic of amateur phone since the beginning.

This apparent stand-still is made all the more curious by the realization that in commercial technical circles the transmission of voice probably has been given greater attention, and enjoyed greater advances, than has any other branch of radio communication.

The prime purpose of this article is not, therefore, to describe the design and construction of amateur phone transmitters of the type in present general use — subject-matter treated comprehensively in radio literature of the last eight years — but to introduce to the amateur some of the best modern practice reduced to terms of amateur radio.

In a few words, the advances of recent years can be described as a substantial reduction in voice distortion in the transmitter circuits, a similar reduction in the distortion occurring between the transmitter and receiver, and a relatively enormous increase in the range of the transmitter for a given value of carrier. Along with the statement we might recall that the most important weaknesses of the average amateur phone transmitter are: Drastic distortion in the

transmitter circuits; further drastic distortion between the transmitter and receiver, and a poor transmission range for a given value of carrier.

Let us examine the factors which are involved in these weaknesses. Distortion in the transmitter itself may result from incorrect design or adjustment of almost anything in the transmitter. The microphone, the audio-frequency apparatus or that portion of the radio-frequency circuits into which the modulation is introduced usually are guilty. Distortion after leaving the transmitter is, however, quite another story. In amateur work it is probably one of the most common and least recognized troubles. The cause, it would seem, lies in the varying performance, in the upper atmosphere, of different frequencies. The output of a phone transmitter, essentially a rapidly changing cluster of frequencies, is apparently not permitted to travel as a unit. Some of its frequencies are retarded, some advanced and others, perhaps, are attenuated or weakened to a value below audibility. The net result, of course, is distortion of a peculiarly horrible type. This asynchronous or selective fading, as it is termed, is particularly severe on the higher frequencies, and no method of avoiding it entirely has as yet been evolved. Its intensity, however, has been shown to be influenced greatly by the frequency stability of the transmitter, and by certain provisions within the transmitter a highly improved performance has been made possible. The frequency instability which is so concerned in the trouble is not the type of instability which causes the note to waver or creep. It is the rapid fluctuation of frequency accompanying modulation, known in technical circles as "dynamic frequency instability" — the very same animal as the "frequency flutter" about which we have said so

\* Associate Technical Editor, QST. In charge, A.R.R.L. Technical Development Program.

much in these articles. In code work "frequency flutter" results in a poor note and unnecessary interference. In phone work it introduces additional interference also, but a result of greater consequence to the individual behind the signal is that it seriously limits the possibility of producing intelligible speech at the receiving end. Frequency flutter, frequency modulation, dynamic frequency instability — call it what you like — is a most serious problem in high-frequency phone work. Many amateurs have already awakened to the fact and installed crystal-controlled transmitters — the real answer. A great many others, though, will have to make careful consideration of it unless they wish to continue making gargling noises for the next eight or nine years.

The third field of great advance in the commercial world of radio is in the modulation systems, in which

produce some sort of a noise at the receiver (preferable a clear musical noise!), broken up into dots and dashes by a key. The noise need not bear any relation to any noise at the transmitter providing it is keyed on and off in accordance with the telegraph signals. Differing radically from this, we find that the sound produced by the phone transmitter cannot be just any sound. It must be identical with the sound produced in front of the microphone. It must contain the same frequencies at the same amplitudes and sustained for the same duration. It is this that leads us to the statement that a good code transmitter will not necessarily make a good phone transmitter — an obvious sort of statement but one which would seem to be understood by very few amateurs.

To return to the telegraph set, we find that usual practice is to adjust the transmitter for a high value of

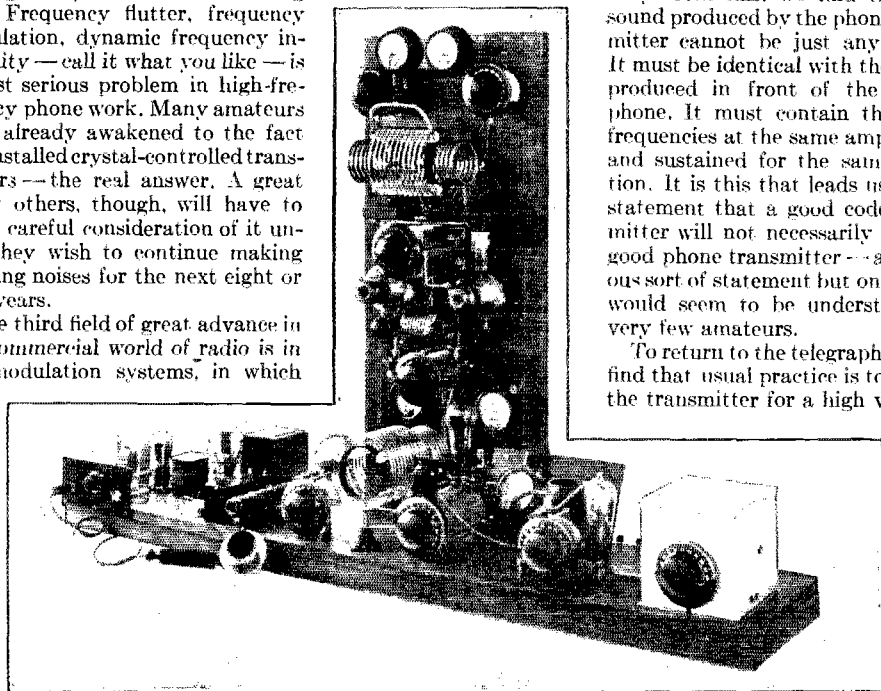

A 1929 TYPE PHONE TRANSMITTER

*Built to illustrate the practical application of most of the ideas discussed in the article, this outfit is much more complex than the average amateur phone is likely to be. Using it as an example, and the text a guide, the amateur should not have difficulty in planning a simple though modern station to suit his own needs.*

modifications have permitted the attainment of 100% modulation without sacrifice of voice quality. This statement does not look as imposing as the substance of it really is. We will have to delve into a few considerations of modulation if we are to appreciate it fully.

#### THE MODULATION PROCESS

All amateurs know that human speech consists of extremely complex combinations and sequences of frequencies lying chiefly between about 200 and 3000 cycles per second. In order to transmit the voice effectively by radio, all of these frequencies must be conveyed in their original form to the receiver, each with the proper amplitude with respect to the others and all of them, as a whole, a replica of the tremendously intricate pattern of frequencies produced in front of the microphone diaphragm by the voice. To transmit a telegraph signal the requirements are absurdly simple in comparison. All that is necessary is to

antenna power when the key is down, so arranging the key that when it is up the antenna power is zero. The idea behind this is to make the key give the greatest possible variation in the output power. Should the key be so arranged that it changed the power (and not the frequency) by only 10% of the maximum value, the effectiveness of the transmitter would be very greatly reduced. In fact it could be said that the power of the transmitter would have to be ten times greater than that of the transmitter keyed to zero in order to give the same result. This same consideration holds good in the case of the phone transmitter. All the antenna power possible will not create a phone signal unless it is varied. And it is the amount of variation that governs the effectiveness of the transmission.

In Fig. 1 is indicated the output of a phone transmitter under three possible conditions. In each case the peak or maximum possible antenna power is considered as being the same. At A the

apparatus is adjusted correctly but the percentage of modulation — the variation of the antenna power — is of the low order usually attained in amateur transmitters. In this case the only portion of the output which is doing any service in creating the phone signal is that between *a* and *b*. The output between *a* and *a* and the possible but unused output between *b* and *c* are entirely

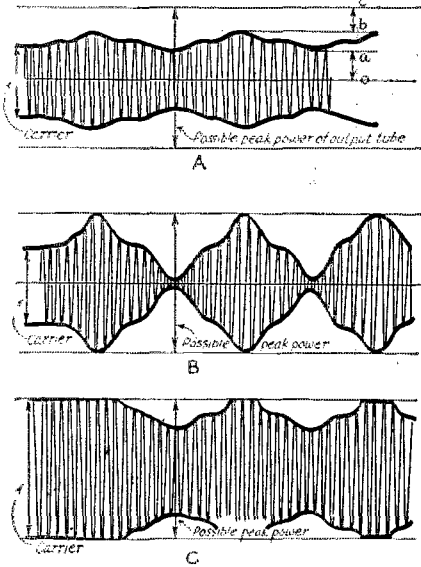

FIG. 1

wasted. In other words a transmitter with an output equal to that fraction between *a* and *b* would, when adjusted to give full variation or modulation of the output, be just as effective. At *B* the output of the transmitter first mentioned is shown to be completely varied (100% modulation). All of the output is being utilized and the signal is therefore the strongest that the output power could possibly produce. In order to obtain the same effectiveness with the 20% variation or modulation indicated at *A* the power of the transmitter would have to be increased five times!

The diagram *C* of the same figure indicates the reason why many amateurs fail to get anything approaching successful operation of their would-be phone transmitters. In this case the transmitter is adjusted to give its full output when the modulation is not being applied. The only possible variation of the carrier is then in a downward direction and since the voice frequencies consist of both "ups" and "downs" the "ups" are lost and only the "downs" register. Under these conditions — we hope to talk more of them later — the effectiveness of the transmitter is quite close to zero.

The system of modulation used in truly modern phone transmitters to permit the 100%

modulation indicated in Fig. 1B comprises the old "constant current" or Heising system with a few simple but extremely important modifications. It seems unlikely that any amateur does not understand the functioning of the Heising system but since that and the new method are so closely related we should, perhaps, touch its high spots.

In Fig. 2A are shown the essentials of the constant-current system — undoubtedly the most generally used system since the year 1921. In it a modulator tube is connected with its plate circuit in parallel with that of the oscillator or amplifier being modulated and both tubes are adjusted to take the same normal plate current. Power to the plates of both tubes is supplied

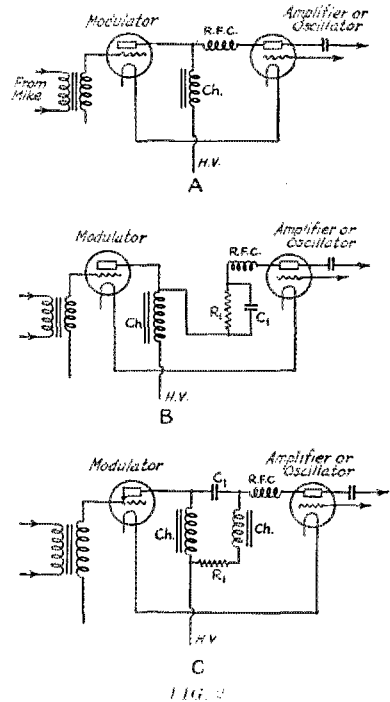
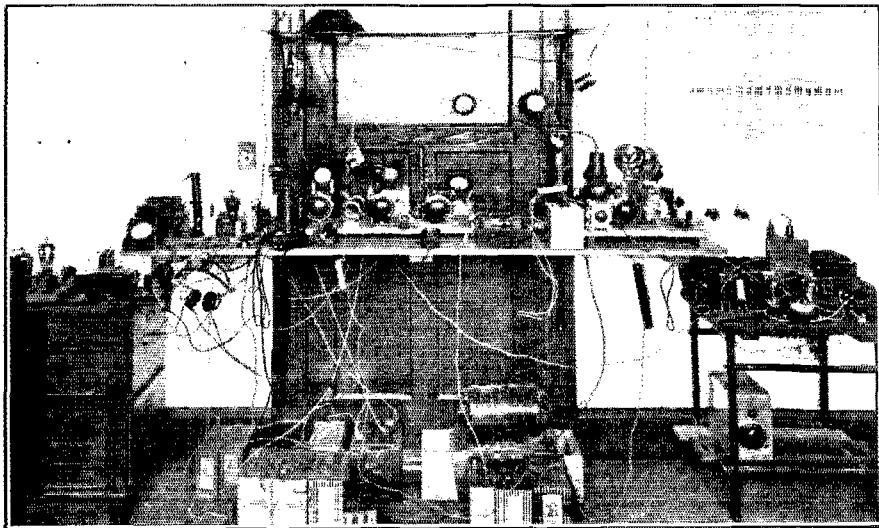

FIG. 2

through the constant-current or speech choke *Ch*. Any variations of the current in the plate supply system at speech frequencies are greatly opposed by the reactance of this choke and consequently any changes in the current through the modulator must be accompanied by an inverse change in current through the oscillator of the same order. The microphone, through a suitable audio-frequency amplifier, serves to vary the potential of the modulator grid and in consequence serves to swing its plate current up and down in accordance with the speech frequencies. Should the modulator current be driven to zero when its grid goes negative, the oscillator current will be forced to double the normal value; and

when the modulator current goes to double the normal value, on the less negative swing in its grid circuit, the oscillator current is reduced to zero. During each half-cycle of this process a voltage is built up in the speech choke equal in value to the normal plate voltage and whenever the oscillator plate current doubles, the voltage on its plate also doubles, the result being that the

that shown in Fig. 2B. In this case the plate voltage is fed directly from the speech choke to the modulator but is dropped in value by the resistor  $R1$  — fitted with a by-pass condenser  $C1$  — before it reaches the oscillator plate. Another practical scheme (used in the transmitter illustrated on these pages) is that shown in Fig. 2C. Two separate speech chokes are employed in



THE 1929 TYPE TRANSMITTER

*As it appeared towards the end of the experimental work involved in its design. With this "hay-wire" equipment, scores of circuit arrangements and tube combinations were put into operation.*

plate power on this tube varies, under such conditions, from zero to four times the normal value. While in practice it is possible to vary the oscillator plate power in this manner, and so obtain 100% modulation, the process requires that the modulator plate current swings from zero to double that of the oscillator. This, in turn, requires that the modulator grid potential be driven down to the point where the plate current cuts off on the negative half-cycle, and far up on the curve on the positive half-cycle — an operating condition which could hardly fail to introduce serious distortion. Practical operation with the system shown in Fig. 2A has therefore been limited to modulation percentages of a relatively low order.

#### MODERN MODULATION METHODS

The keynote of the new method is in the operation of the modulator tube at a higher voltage than the oscillator, by which means 100% modulation can be attained and maintained without distortion of any consequence. In some arrangements a separate plate supply is included in series with the lead from the choke to the modulator. In others a transformer is used to couple the plate circuits of the modulator and oscillator. Possibly the most practical form of the modified system is

this arrangement, the voltage-dropping resistor  $R1$  being included in series with that one which feeds the oscillator. The plates of the oscillator and modulator, as far as the audio-frequency currents are concerned, are connected together by the large condenser  $C1$ .

The effectiveness of the arrangements  $B$  and  $C$  is so much greater than any other methods of modulation at present available to the amateur that we plan to limit our discussion exclusively to them. In comparison, the methods at present generally employed in amateur stations are so pitifully unsatisfactory that we are not able to consider them worthy of mention. If expense is considered in relation to the reading of the antenna ammeter the modern arrangements undoubtedly are costly. If, however, the money spent on the transmitter is considered in relation to the signal produced at the receiver — as it certainly should be — the methods to be discussed will be found very much cheaper.

And now, having skirmished around the three fields in which major refinements have been introduced by more or less recent development, let us examine the amateur transmitter in detail in order to see what these changes look like in actual equipment.

## SUBDIVIDING THE TRANSMITTER

The complete phone transmitter may consist of three separate sections: The apparatus producing the radio-frequency energy to be modulated; the modulator, and an amplifier to amplify the modulated radio-frequency. The last mentioned section is not an essential part, however, and will not be considered at the moment.

The simplest method of producing radio-frequency energy to be modulated is by means of a self-excited oscillator onto which the modulator is

modulation with its accompanying sacrifice in range. For it is only with a low modulation percentage that the plate-voltage fluctuation on the modulated tube can be avoided and it is in this way that the frequency flutter in the self-excited transmitter is reduced.

## EVEN OSCILLATOR-AMPLIFIERS NOT NECESSARILY IDEAL

The obvious move is to turn to the oscillator-amplifier arrangements where the oscillator determining the frequency can be left alone and the modulation applied to the amplifier. The idea is very fine but the unfortunate part of the story is that no self-excited oscillator-amplifier transmitter has yet been built in which changes in the operation of the amplifier did not react on the oscillator to the tune of changed frequency. The frequency of such an oscillator will remain reasonably constant just so long as the load on it, imposed by the amplifier, is constant. Whenever the load varies the frequency will change and the load, when the amplifier is being modulated fully, is changing with a vengeance!

A simple self-excited oscilla-

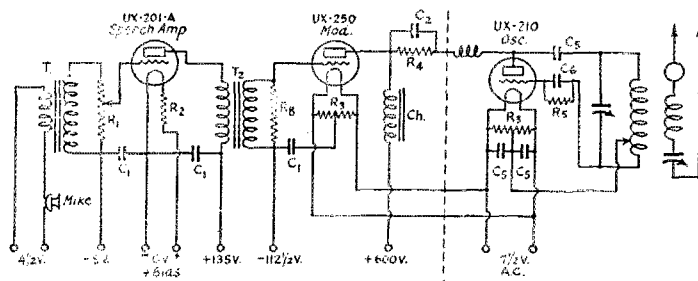

FIG. 3.—SHOWING ONE ARRANGEMENT OF A MODULATED HIGH-C OSCILLATOR

Though such a transmitter can be operated with success at low modulation percentages, it does not compare, in performance, with the transmitters described later at high modulation percentages.

Ch. — 100 ma. choke of 10 henries or more.

R5 — 200,000-ohm gridleak.

All other components correspond with those similarly designated in Fig. 6.

The oscillator plate tank and antenna coils are of the dimensions given in the August, 1928, QST.

connected directly. One arrangement is shown in Fig. 3. The disadvantage of any such transmitter is that its frequency output is not determined alone by the value of  $L$  and  $C$ 's but also by the plate impedance of the tube. As we have said so often before, the plate impedance is varied with any change in plate voltage and a variation of output frequency follows. In the phone transmitter being 100% modulated, the plate voltage on the modulated tube is being driven from zero to twice the normal value, and if this modulated tube is the oscillator it is certain that serious frequency flutter will result. A well-tuned High-C transmitter can withstand relatively large plate voltage "ripples" without a serious corresponding frequency flutter for code work but for phone, where the presence of flutter is so much more serious and where the plate voltage changes are so much more drastic, even the High-C arrangement gets into trouble. A good High-C oscillator, however, can and is being used for amateur phone work with some success. If it is fully modulated, though, there will be appreciable frequency flutter and distortion in transmission will be a common experience. If there are truly successful modulated oscillator transmitters on the air, their ability to avoid distortion troubles in transmission undoubtedly is due to the use of a low percentage of

tor amplifier arrangement can be used for amateur phone, with the one and only amplifier being modulated, but experiment has shown that its performance in regard to frequency flutter is not very much ahead of a good High-C oscillator modulated directly. If the full advantage is to be taken of the oscillator-amplifier system there are two alternatives open. One is to use a "buffer" stage of amplification between the oscillator and the modulated amplifier—a tube biased to operate without any grid current—and the other is to use a crystal oscillator. High-frequency communication engineers who really know what they are talking about will disagree with this. They will insist, as they already have done, that consistently high quality high-frequency speech communication is not possible with any conceivable self-excited oscillator-amplifier transmitter—that it can be accomplished only with a crystal oscillator and then only when the crystal tube is isolated from the modulated amplifier by at least one "buffer" stage. Amateurs, of course, cannot as a rule afford to be such purists on these matters and undoubtedly many of them will do without the crystal or the "buffer" tube, and with their High-C modulated oscillators will at least make fewer and more pleasant gargling noises than they have in the past.

Our recommendations, however, are for the amateur to use a crystal with a "buffer" tube as the first choice; to use a crystal feeding the modulated amplifier as the next alternative; to arrange for a "buffer" stage if a self-excited oscillator must be used; and to install a real High-C oscillator particularly well tuned if funds permit of nothing more elaborate. Being in a frank mood we would suggest, however, that amateurs who have the ambition to attempt 100% modulation but who have not the funds to install a good oscillator-amplifier transmitter, would do themselves

and their fellow amateurs a great favor by concentrating on code transmission until their finances are in better condition. We say this because we have demonstrated to ourselves that the application of 100% modulation to a transmitter of the more elementary form will result only in disappointment and waste of money to the operator, and untold grief to those obliged to listen to him.

A "good" oscillator-amplifier arrangement, in our opinion, consists of a crystal oscillator with a plate supply of its own, feeding the modulated amplifier either through a "buffer" stage or directly. It can consist also of a High-C self-excited oscillator with a plate supply for itself, feeding the modulated amplifier through a "buffer" stage. The transmitter illustrated provides examples of these combinations, and their construction, adjustment and operation are to be detailed later on.

One satisfactory arrangement suited for the modulation of a UX-210 is indicated to the left of the dotted line in Fig. 3. The modulator is a UX-250, a tube highly suited for the work. It is fed with 600 volts of d.c. through the speech choke  $Ch_1$ , and its plate is connected through voltage-drop resistor  $R_1$  and by-pass condenser  $C_1$  to the plate of the tube being modulated. The grid circuit of the modulator tube is fed from the plate circuit of the UX-201-A speech amplifier through a high quality audio-frequency transformer, the secondary of which is preferably

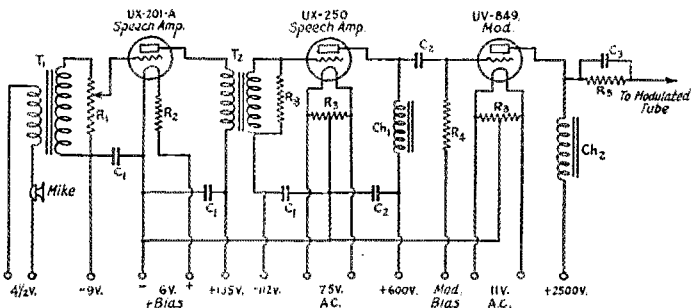
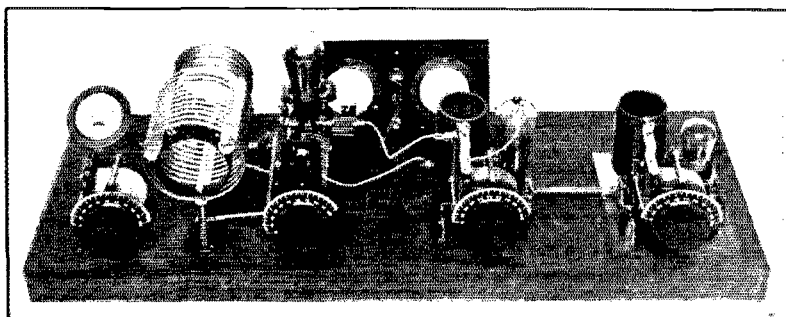

FIG. 4. — THE MODULATION SYSTEM DESIRABLE FOR SATISFACTORY MODULATION OF A UV-204-A

- $Ch_1$  — 10-henry or higher, 50-ma. choke.
- $Ch_2$  — 10-henry or higher, 500-ma. choke.
- $R_4$  — 20,000-ohm grid leak.
- $R_5$  — 5000- to 4000-ohm resistor to carry 200 ma.
- All other apparatus corresponds with that similarly designated in Fig. 6.

shunted by a gridleak-type resistor of about 250,000 ohms. The output of the microphone is fed to the grid circuit of the speech amplifier through a microphone transformer, several modern types of which are now available. The older types of modulation transformers, or Ford coils,



THE OSCILLATOR, "BUFFER" STAGE AND MODULATED AMPLIFIER

Built as a separate section, this unit may be used with the modulator system to provide a low-powered transmitter. Under these conditions the carrier output is  $1\frac{1}{2}$  watts — the peak power output during modulation, 30 watts.

THE MODULATION APPARATUS

The modulator and speech amplifier unit is the essential section of the phone transmitter.

are not satisfactory for this work and if a good modern transformer cannot be bought, an excellent make-shift can be built by removing the primary of a high-quality audio transformer and

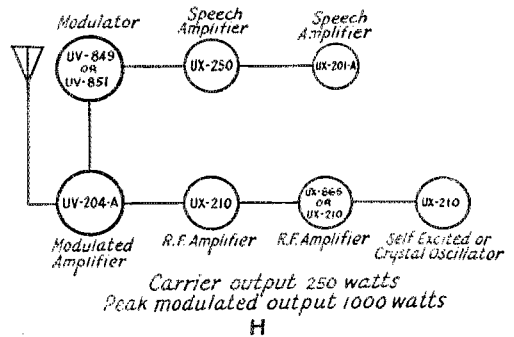
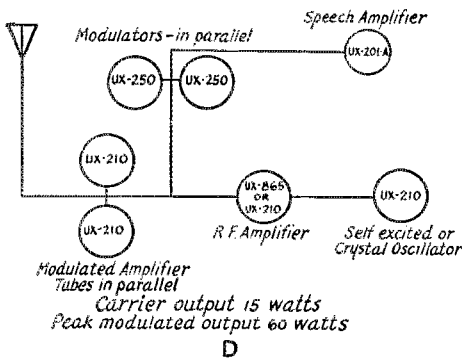
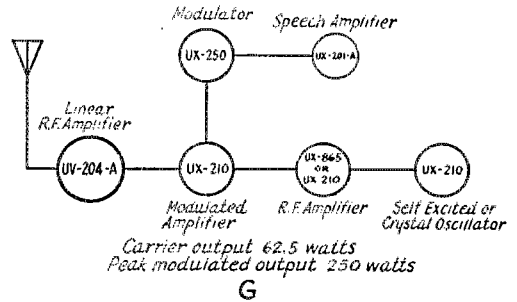
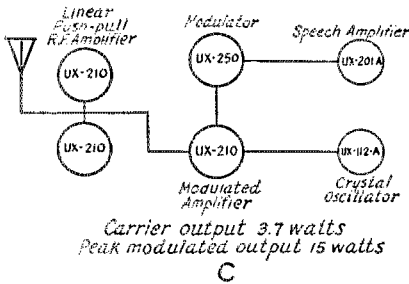
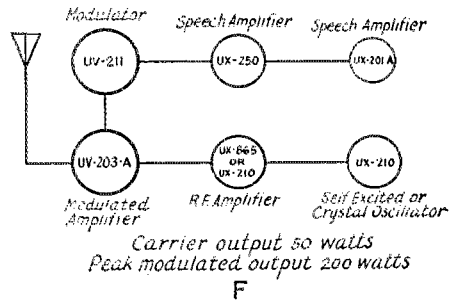
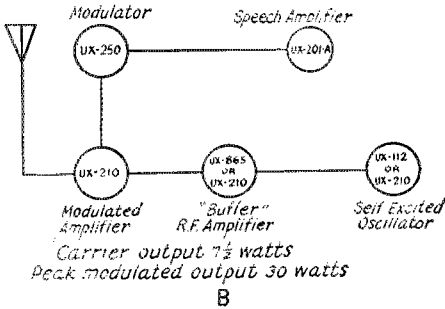
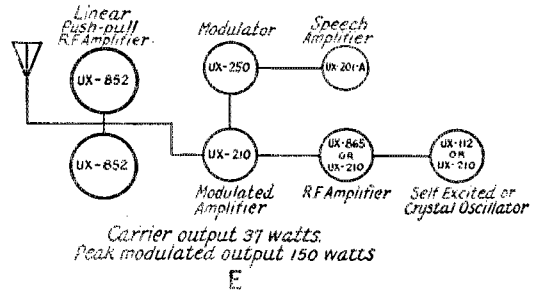
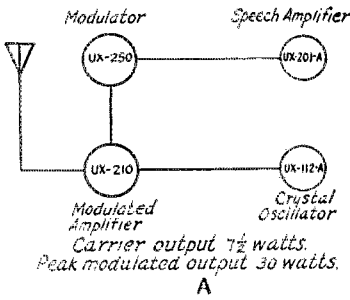

FIG. 5



inserting in its place about 250 turns of 30-gauge wire. The microphone transformer in the transmitter illustrated is of this type. The microphone is, of course, one of the most important units in the whole transmitter. The speech quality is greatly governed and definitely limited by its characteristics. Unfortunately a good double-button microphone is a very expensive item and one which requires much more careful handling than it would ever be likely to get in an amateur station. For the amateur whose aim is to obtain the very best possible voice quality, however, its use is essential. Fortunately, there are many ordinary hand microphones which, though not permitting any very high standard of quality, do provide a high degree of intelligibility. They are really quite satisfactory for the amateur phone transmitter providing they are operated correctly. The usual practice of holding the microphone and yelling directly into it is quite an ab-

erance between it and the modulator to the point where it is only necessary to talk across it and in a low or possibly normal tone of voice. Across the secondary of the microphone transformer is the gain control indicated as *R2*. It consists of a 200,000-ohm potentiometer, the moving contact of which is connected to the speech-amplifier grid. In Fig. 4 is shown one possible arrangement of a modulator suitable for the modulation of tubes of greater rating than the UX-210. For the modulation of a UV-203-A, a UV-211 could be used with some success. For the modulation of a UX-S52 or a UV-204-A, however, the only truly satisfactory tube would be the UV-S49. In either of these circuits the speech choke arrangement shown in Fig. 2C could be incorporated. With a UX-250 modulator it is a particularly effective arrangement since it permits the use of a double "B-eliminator" filter choke—a unit readily available to almost every amateur. The disad-

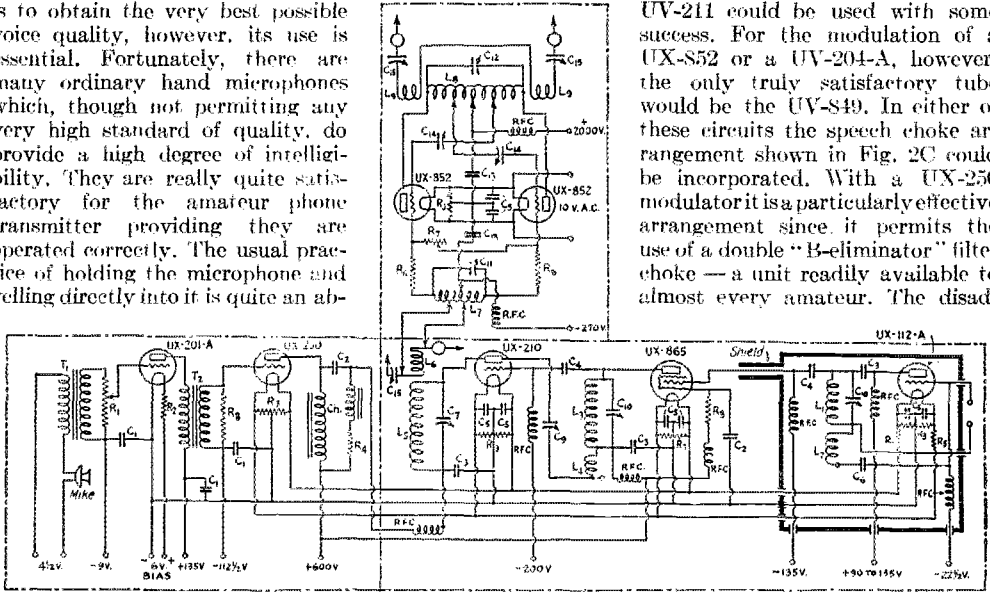

FIG. 6.—THE WIRING OF THE COMPLETE PHONE TRANSMITTER ILLUSTRATED

- C1 — 1- $\mu$ fd. 500-volt Tube condensers.
- C2 — 1- $\mu$ fd. 1000-volt condenser.
- C3 — 1000- $\mu$ fd. 500-volt Sanyama condensers.
- C4 — 20- $\mu$ fd. 500-volt condenser.
- C5 — 2000- $\mu$ fd. 500-volt condensers.
- C6 — 500- $\mu$ fd. 500-volt condenser.
- C7 — 350- $\mu$ fd. Cardwell transmitter-type variable condenser.
- C9 — A 25-plate Pilot midnet condenser with plates double-spaced.
- C10 — 350- $\mu$ fd. Cardwell receiver-type variable condensers.
- C11 — 1000- $\mu$ fd. receiver-type variable condenser.
- C12 — 250- $\mu$ fd. National "treble-speed" transmitting condenser.
- C13 — 1000- $\mu$ fd. Sanyama 500-volt condensers.
- C14 — Cardwell receiver-type variable condensers cut down to 3 plates.
- C15 — 500- $\mu$ fd. receiver-type variable.
- R1 — 200,000-ohm Ward-Leonard potentiometer.
- R2 — 2-ohm Varley fixed resistor.
- R3 — 100-ohm Varley center-tapped resistors.
- R4 — 5000-ohm Ward-Leonard resistors to carry 100 ma.
- R5 — 5-ohm Varley fixed resistors.
- R6 — 100-ohm Varley fixed resistors.
- R7 — 10,000-ohm Ward-Leonard "Adjust."

- L1 — 16 turns of 14 gauge wire on  $\frac{3}{8}$ " diameter tube, as plate coil for crystal operation, 6 turns of same wire coil of self-excited oscillator.
- L2 — 4 turns of same wire. When running as a self-excited oscillator, a 500- $\mu$ fd. Sanyama fixed condenser is shunted across the extremities of L1-L2, i.e., from grid to plate.
- L3 — 39 turns of 14-gauge wire space-wound on  $\frac{3}{8}$ " diameter tubing.
- L4 — 15 turns of 22 gauge d.c. wire on  $\frac{3}{8}$ " diameter tubing mounted inside lower end of L3.
- L5 — B.E.L. 3500-ke. inductance.
- L6 — 6 turns of  $\frac{3}{8}$ " outside-diameter copper tubing, turns  $\frac{1}{2}$ " inside diameter.
- L7 — 10 turns of  $\frac{1}{16}$ " diameter copper tubing, turns  $\frac{3}{4}$ " inside diameter.
- L8 — R.E.L. 2500-ke. inductance.
- L9 — Each 5 turns of  $\frac{1}{16}$ " diameter copper tubing, turns  $\frac{3}{4}$ " inside diameter.
- T1 — High quality audio transformer with new primary of 250 turns of 30-gauge wire. Any modern high-quality microphone transformer undoubtedly would be better.
- T2 — Sanyama audio-frequency transformer.
- Ch. — National type-80 double "B-eliminator" choke.
- R.F.C. — In the lower power stages, Silver-Marshall type 277. In other circuits, Aero type C-248.

surd one. The only sane procedure is to suspend the instrument in a convenient position where it need never be touched, and to adjust the amplifi-

vantage of the single choke of Fig. 2B is that the choke must pass at least 100 ma. whereas the chokes of Fig. 2C need be rated at only half that

figure. There are many more double chokes rated at 50 ma. available than single chokes rated at 100 ma.

#### AMPLIFYING AFTER MODULATION

Let us now consider the third possible section of the phone transmitter—a radio-frequency power-amplifier to amplify the output of the modulated tube. Such amplifiers, as anyone who has tried to operate one will tell you, require very careful handling and are, for the amateur, not always a desirable adjunct. Tubes operated as

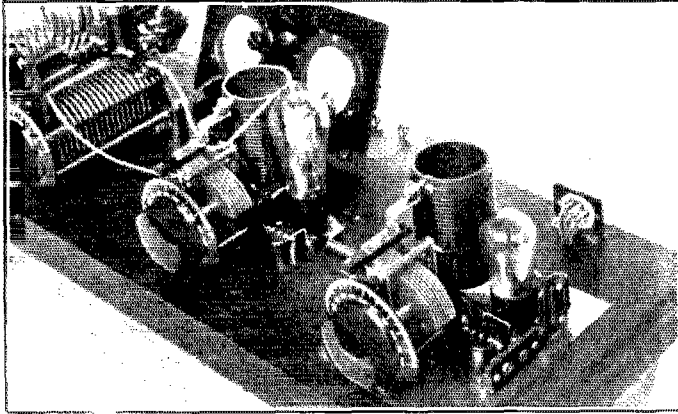

A "CLOSE-UP" OF THE OSCILLATOR AND FIRST AMPLIFIER STAGE

*The oscillator apparatus is mounted on a copper plate over which the shield sits. Crystal operation is made possible by plugging the crystal into the two sockets in the right foreground and changing the coil unit to one consisting of a plate coil only. The coil shown in this view is not the coil described under Fig. 7 but a low-C affair which was afterwards discarded.*

radio-frequency amplifiers after the modulated amplifier must operate over the straight portion of their grid-voltage plate-current characteristic curves in just the same way as do the audio tubes of the broadcast receiver. For this reason they are termed "linear amplifiers." Some idea of the requirements for successful operation of a linear amplifier can be gained by first remembering that the tube exciting it is having its output modulated from zero to four times the normal value and that distortion will result if the output of the linear amplifier cannot go through the same extremes. This means that the excitation of the amplifier must be reduced to the point where its output is one quarter of the possible maximum power, when the system is not being modulated. The antenna current under these conditions will then be half the maximum value. With modulation, the power of the modulated tube goes from zero to four times normal, the excitation of the linear amplifier does the same, the antenna power also. If a single tube or tubes in parallel are used in the linear stage, the bias must be adjusted so that the plate current is the same with and without excitation, which is just another way of saying that

the bias is adjusted so that the tube or tubes operate on the straight portion of their characteristics. When a push-pull linear stage is used, the bias can be increased to the point where the plate current is reduced to zero with no excitation. In all considerations of such amplifiers, however, it is important to remember that the maximum output is limited by the voltage on their plates and that because this is constant, the normal output (when no modulation is taking place) must be reduced to the point where the power is one quarter of the maximum value. *This point, since the antenna power is represented by  $E^2R$ , is that indicated by half the maximum antenna current.*

#### WHERE LINEAR AMPLIFIERS ARE A DISADVANTAGE

The limitations on the use of linear amplifiers can best be explained by referring to the diagrams of Fig. 5. At *A* is shown what is considered the simplest high-quality amateur phone transmitter, consisting of a crystal oscillator exciting a UX-210 modulated amplifier. The carrier output power of this transmitter can be  $7\frac{1}{2}$  watts and, under these conditions, when fully modulated, the output power will vary between zero and 30 watts. At *B* is indicated a somewhat similar transmitter operating with a self-excited oscillator isolated from the modulated amplifier by a "buffer" stage. The carrier and peak power output in this case is the same as at *A*. In diagram *C* a pair of UX-210 tubes have been added as linear amplifiers and, since their output is limited by their fixed plate voltage to 15 watts, the carrier is adjusted to 3.7 watts in order to permit the four-times increase on the modulation peaks. Absurd as it may at first seem, the modulated power output of the transmitter has been cut in half by the addition of the two output amplifier tubes! In order to obtain the same effective power output as the transmitter *A* or *B* four UX-210's would have to be used in the linear amplifier. In diagram *D* the output tubes are two modulated UX-210 amplifiers. In this transmitter the carrier power can be 15 watts and the peak output during modulation 60 watts—a hefty transmitter as amateur phone stations go. If a UX-852 tube were added to this arrangement as a linear amplifier the peak power would then be 75 watts—an increase of just 15 watts. The transmitter indicated at *E* is the apparatus of diagram *B* feeding a linear amplifier consisting of two UX-852

tubes in push-pull. A single UX-210 modulated amplifier serves to excite the UX-852s and the increase in power provided by them is 120 watts — one instance in which the use of a linear amplifier would be justified. This arrangement is exactly that used in the transmitter built to provide examples of the applications of these methods and illustrated on these pages.

It should be pointed out that in no instance are screen-grid tubes specified as linear amplifiers. The types at present available are unsuited for the work.

Arrangement *K* of Fig. 5 is one suited for operation from a plate supply of about 1200 volts. Though the UV-211 is a good modulator tube, its power rating is not sufficiently above that of the UV-203-A to permit satisfactory 100% modulation. The arrangement possibly would not be a very effective one. Diagrams *G* and *H* represent two transmitters in which the output tube is a UV-204-A. At *G* the 250-watt tube is operated as a linear amplifier and without modulation its output is adjusted to 62 watts. The peak power during complete modulation is 250 watts. A UV-849 (a tube designed for use as a modulator) is employed in arrangement *H* to modulate the 250-watter. In this instance the carrier output could be 250 watts and the peak output during modulation not a watt less than 1000. What a snooty amateur phone that would be!

The transmitter illustrated, as we have mentioned at several points, is that designed and built to provide examples of the application of the methods under discussion. It was not designed with the idea that it would ever be duplicated by the amateur. It was arranged and built in its present elaborate form in order to incorporate in the one transmitter as many of the features considered desirable as was possible. A close study of its constructional details together with the diagrams of Fig. 5 should enable the amateur to plan and build a transmitter suited to his own requirements. Then, a study of the tuning methods — to be covered later — should make it at least reasonably possible for him to adjust satisfactorily the transmitter he has built, irrespective of how much it differs from the outfit illustrated.

#### THE COMPLETE OUTFIT DETAILED

The transmitter consists of the three sections mentioned; the oscillator, "buffer" amplifier and

modulated amplifier as one unit; the modulator and speech amplifier as another unit; the push-pull linear amplifier yet another.

The separate illustration of the three-tube radio-frequency unit provides some idea of its lay-out. The close-up gives an impression of the constructional methods used in it. These views may well be studied in conjunction with the circuit diagram of Fig. 6. In the close-up view the oscillator is in the right foreground. It consists of a UX-112 tube arranged in a tuned-plate circuit in such a manner that it can be changed over to crystal-control merely by plugging the crystal into the sockets *X*, *Y* and removing the grid coil *L2*. In the illustration the grid coil can be seen at the bottom of the bakelite tube on which the coils are wound. By turning the coil

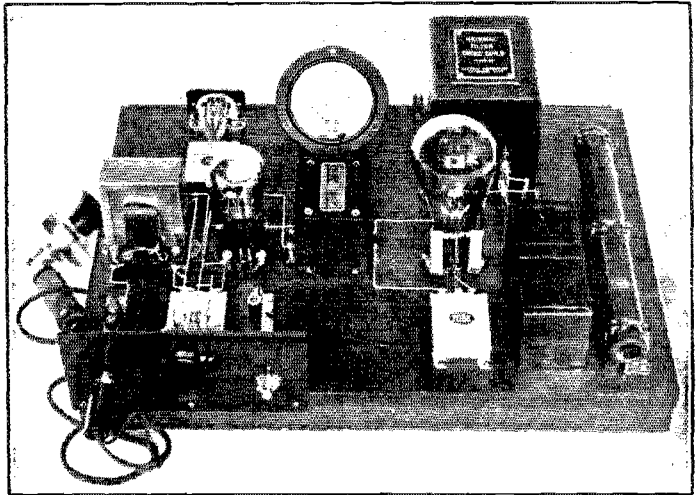

THE MODULATOR AND SPEECH AMPLIFIER UNIT

On the small panel is the microphone jack, the gain control and the microphone switch. Behind it, the microphone transformer and speech amplifier can be seen. The modulator tube with its associate apparatus is at the right.

upside down the plate coil plugs into the same sockets as before but the grid coil extends above it, disconnected. A better scheme is to remove the self-excited coil entirely, replacing *L1* by a separate and larger coil for crystal work. The apparatus of this oscillator unit is mounted on a copper plate over which a shield is fitted. Holes in the side of the shield permit the crystal to be plugged into position from outside. As in the case of other apparatus built under the A.R.R.L. Technical Development Program, the practice has been followed of keeping all radio-frequency leads above the base-board and of permitting no wires to go beneath unless they have first been by-passed above. In addition, the method of mounting units on or from other units has been followed as in previous instances, so permitting the elimination of many wires and the shortening

of others. In this oscillator, for instance, the total length of radio-frequency leads probably does not exceed six inches. The feeder lead to the "buffer" tube is run through a piece of  $\frac{3}{8}$ " copper tube connected to the shield, the idea being to reduce the capacity between the grid and plate circuits external to the screen-grid amplifier to the lowest possible value. The "buffer" tube is a UX-865, ideal for the purpose on account of the possibility of operating it without neutralization. It can be replaced, however, by a neutralized UX-210. In this particular transmitter these first two tubes are operated at the same frequency as the output tubes but if desired they could be operated at half the output frequency, the "buffer" frequency-doubling into the modulated amplifier. The modulated tube, though, should operate at the output frequency since frequency-doubling into a linear amplifier would not be satisfactory. Screen-grid voltage for the UX-865 is obtained from the plate supply through a 25,000-ohm resistor.

The output circuit of the screen-grid amplifier is similar to the usual arrangement, an enamel-wire space-wound inductance  $L5$  being used. The neutralizing coil  $L4$  is wound on a small

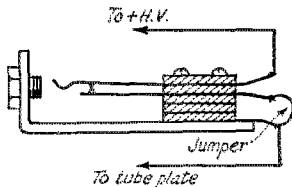

FIG. 7—Showing the connections of the jacks in the tube plate circuit to permit plugging in the milliammeter without breaking the circuit.

piece of tubing inserted in the bottom of the former on which  $L5$  is wound. Since it is not carrying a heavy radio-frequency current it is wound with 22 gauge wire.

The UX-210 modulated amplifier is arranged much as if it were a 50-wattier on account of the high peak voltages which it and its circuits must withstand. The condenser of its tank is of the double-spaced transmitting type and all fixed condensers are of high voltage rating. The neutralizing condenser, to be seen mounted immediately above the plate tank condenser, is a double-spaced midget condenser originally of 23 plates.

The provision of meters for this unit was made with the idea of facilitating the tuning adjustments. A voltmeter is included for the filament circuit, of course, but one plate milliammeter is made to serve for all three tubes by connecting it to a phone plug and arranging a phone jack in the plate circuit of each tube in the manner shown in Fig. 7. By connecting the leaves of the jacks in this way the plate circuit is never opened irre-

spective of the position of the plug. In addition to the plug, a small piece of bakelite rod fitted with a knob is provided. This gadget is inserted in the jack of the UX-210 plate circuit, disconnecting its plate supply for the purpose of neutralizing. The meters, the jacks and this gadget can be seen on the sloping panel at the rear center of the unit.

The bias-battery leads to the three tubes, the plate-supply lead to the oscillator, and its filament supply are connected by means of a battery cable and plug, the socket for which can be seen at the right rear of the base-board in the close-up view. The high-voltage and filament leads to the two amplifiers are connected to Fahnestock clips on the rear edge of the base.

#### THE CONSTRUCTION OF THE MODULATOR

The second unit of the transmitter is the modulator system, illustrated separately. It comprises the microphone transformer, speech amplifier, coupling transformer to the UX-250 modulator, double speech choke, oscillator plate-voltage drop resistor and by-pass condenser, and a milliammeter for the modulator plate circuit. In the case of this unit all battery leads are connected by means of a battery cable and plug. From the general view of the complete transmitter it can be seen that the modulator unit sits end to end with the radio-frequency unit, the parts being disposed just as indicated in the circuit diagram. The audio frequency enters from one end of the affair, the radio frequency from the other; they meet in the middle where modulation is effected, and the result is a phone transmitter of 30 watts peak output with a high standard of performance. When operated in this manner the coil  $L6$  is, of course, the antenna coil, while  $C15$  is the antenna tuning condenser.

The third unit, the vertical section, is the push-pull linear amplifier which can be excited from the modulated output of the UX-210. In the general view it sits immediately behind the modulated UX-210, but there is no particular reason why it should not be mounted on the wall near the antenna leads or in any other convenient place in the station away from the three-tube radio-frequency unit. The same holds good, of course, for the modulator unit. It could be mounted in relation to the rest of the transmitter at any place which would permit the two interconnecting high-voltage leads to be run conveniently.

The two UX-852 tubes of the linear amplifiers are mounted bottom uppermost so that the grid leads are convenient to the output of the modulated tube. The two leads from the "antenna coil" of the UX-210 are clipped across a few turns of the inductance  $L7$  to provide a coupling link, the adjustment of the turns at both ends of this link being used, in addition to adjustment of the coupling of  $L5$  and  $L6$ , in order to provide variation of grid excitation.  $L7$ , together with the large variable condenser  $C11$ , forms a High-C grid

circuit for the linear amplifier tubes. Aside from its use in coupling the UX-210 to the UX-S52s, this circuit serves in reducing the harmonic content of the excitation power and in general improves the operation of the linear amplifier stage. The resistances *R6* in the grid leads have an important function in avoiding parasitic oscillation of the amplifiers, while the resistor *R7* serves an equally important purpose in providing control of the excitation and in reducing distortion in the push-pull stage. These resistors will be given further consideration in discussing adjustment.

The output tank tuning condenser is that mounted between the two tubes. Above it is the tank inductance and the two antenna coils. The inverted U-shape tubing over the inductance is not, as might be supposed, a handle to aid in removing the coil. It is the connecting link between the two sections of antenna coil, these being mounted, incidentally, from the supporting framework of the tank inductance. Since the outer ends of the antenna coils are connected to the condensers by flexible leads, the coils can be rotated through an appreciable arc for the variation of antenna coupling.

The two neutralizing condensers of this unit are mounted at the rear of the panel and are controlled by two extension shafts, the knobs on which can be seen immediately under the plate leads of the UX-S52s. A filament voltmeter, plate milliammeter and two antenna-current meters comprise the meter equipment of this unit.

#### THE TUNING PROCESS

And now we must discuss tuning and adjustment, in the telegraph transmitter an important business but in the phone transmitter a delicate proceeding requiring the most profound attention to detail.

With everything in operating condition the oscillator should first be given consideration. If it is to be run as a self-excited oscillator the grid and plate coils should be proportioned so as to give steady oscillation with about 8 ma. of plate current when operating from a 135-volt plate supply. With either a self-excited or crystal-controlled oscillator this voltage should provide ample output to excite the "buffer" tube, though if a crystal but no "buffer" is used it is certain that a "power" crystal with about 400 volts on the plate of the tube will be necessary for full excitation of the modulated amplifier. The "buffer" stage is, for this reason, serving the added useful purpose of permitting low oscillator power and convenient operation from a separate plate supply. In the case of this particular transmitter the oscillator is driven from the 135-volt receiver "B" battery but there is no reason why a "B-eliminator" (the 135-volt type of which is almost a glut on the market) could not be used with similar satisfaction. When the tube is running as a

self-excited oscillator the "bias" lead is run through a 10,000-ohm gridleak to the negative filament lead. For crystal operation  $22\frac{1}{2}$  volts of bias has been found effective.

In checking the oscillator operation, and for that matter the operation of any section of the transmitter, it is almost essential to use a "tuning

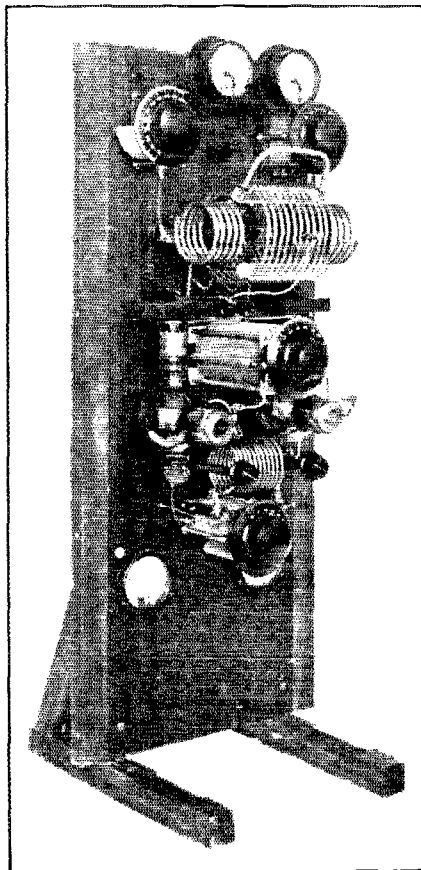

THE SECTION COMPRISING THE OUTPUT LINEAR AMPLIFIER

Two UX-852 tubes in an inverted position are used. The grid circuit equipment is underneath them, the plate and antenna components above. Though arranged to operate behind the two other sections of the transmitter, this unit could be operated in any convenient location in the radio room and fed through a two-wire transmission line.

lamp" consisting of a flash-lamp bulb connected in series with two or three turns of wire. These turns, of course, are coupled loosely to the particular tank coil under examination to determine the presence and approximate amplitude of radio-frequency current in the circuit. The tuning of the oscillator, crystal or self-excited, is greatly facilitated by the use of this lamp.

Once the oscillator has been caused to run

steadily on the required frequency the plate voltage is applied to the plate of the screen-grid "buffer" tube with the grid bias at about 135 volts if the plate voltage is of the order of 600. When the oscillator is switched off the plate current of this tube should be brought approximately to zero by adjustment of the grid bias. When the oscillator is switched on this plate current should rise to about 20 ma. With the bias of the tube adjusted to the point where no plate current flows when there is no grid excitation (termed the "cut-off" point) the tube operates on the lower end of its grid-voltage plate-current curve and is said to be running as a Class B amplifier. With the aid of the tuning lamp it should now be possible to tune the plate tank of the UX-865 without difficulty and proceed to the neutralization of the UX-210. This process is accomplished, as usual, with the plate supply to the UX-210 disconnected. First the tuning lamp is coupled tightly to the UX-210 plate tank and with the neutralizing condenser set at zero the tank tuning condenser is rotated until the tuning lamp lights. The light may light only dimly and it is necessary to search for the resonance spot with considerable care. Once it has been found the neutralizing condenser should be adjusted in steps (the tank condenser being readjusted each time) until the point is found where no radio frequency can be detected by the tuning lamp in the UX-210 plate tank. It is well then to continue the rotation of the neutralizing condenser until the point is reached where current is again detected. In this way it is possible to find a setting for the neutralizing condenser midway between

point (where plate current ceases). This probably will be of the order of 112½ volts. *Now this value of bias should be doubled.* In other words, it should be increased to 225 volts under these conditions. This means that the excitation arriving from the UX-865 will have to swing the grid of the UX-210 112 volts before any plate current flows at all, and much further than that if the plate current is to be driven up to the normal value. In short, the grid of the modulated amplifier must be provided with a relatively terrific sock by the preceding tube—the reason why a "power" crystal is advisable if it is to excite the UX-210 directly. When operating with the bias far beyond the "cut-off" point, the amplifier is said to be running as a Class C amplifier. When so operated the efficiency of the amplifier is very high and the output power varies as the square of the plate voltage within certain limits—the condition necessary for modulation free from distortion.

If the UX-210 is to be used to operate directly into the antenna, attention can now be directed to the modulator section. With 135 volts on the plate of the speech amplifier, satisfactory operation should be obtained with 9 volts of grid bias. If possible a low-reading milliammeter should be connected in its plate circuit, however, to make certain that no plate current fluctuation is caused when the microphone is spoken into. The same should hold good with the modulator. With 600 volts on the plate of this tube the correct bias will be of the order of 112½ volts. Under these conditions the plate current will hold steadily at 50 or 60 ma., when modulation is taking place. Should it fluctuate, further grid bias adjustments should be made.

At this stage the antenna may be connected and the coupling and tuning adjusted to give maximum antenna current. Adjustment of the gain control and talking position is now necessary in order to obtain speech input to the modulator not greater than that necessary to give full modulation on the loudest tones. The correct adjustment is quite difficult to judge but there are three methods of gaining an approximate idea. The first is to hum a constant note near the microphone and adjust the gain control until the antenna current increases by about 25% of its normal value. Complete modulation probably is then taking place. Another check, probably a very approximate one, is to listen to the output of the transmitter with a crystal monitor—a rig which should be available in every amateur phone station. It may consist of nothing more than a hank of, say, twenty turns of wire connected in series with a fixed crystal detector and a pair of head phones. With an assistant talking near the microphone an excellent idea of the voice quality can be obtained by holding the coil of the monitor near an

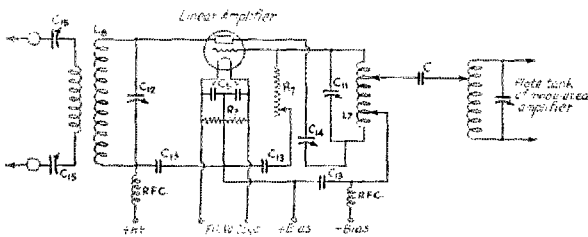

FIG. 8. — A SINGLE-TUBE LINEAR AMPLIFIER

Assuming that the tube is a UX-865 or UT-24-A, the constants of all apparatus will be the same as that similarly designated on Figure 6, with the exception of coupling condenser C. This could be of 250 mufis.

the point where the current went out and the point where it came back. Neutralizing, when one has had a little practice, is surprisingly simple and it is soon found that there is no need to get alarmed about the possibility of self-oscillation even in a transmitter of this type in which there are six circuits all tuned to the same frequency!

#### DRASTIC BIASING

With the oscillator switched off, the bias of the UX-210 should be adjusted to the "cut-off"

antenna lead. Then, the gain control and the talking position can be varied until the point is reached where noticeable distortion can first be detected. The third possible check is to listen to the transmission in an ordinary oscillating monitor in order to observe by just how much the carrier is being backed up by the speech. This probably is the most approximate check of all.

The checking of possible frequency flutter can, however, be made splendidly with the oscillating monitor. With the carrier tuned to zero-beat the quality of the speech should be just as free from distortion as in a non-oscillating receiver. This check also can be made splendidly by an observing station. And, while we're on the subject, try tuning your receiver in an oscillating condition to zero-beat with a few amateur phones. Observe just how scarce are the phones, not crystal-controlled, which are intelligible under these conditions.

#### TUNING A LINEAR STAGE

The adjustment of a linear amplifier may now be considered. The primary adjustment is that of grid bias. With an amplifier of this type it should be adjusted to the point where the plate current is the same irrespective of whether excitation is applied or not. This, however, is presupposing that the excitation has been adjusted, and for this reason the best scheme is probably to adjust the excitation to give the normal plate current of the tube. Then, without paying particular attention to the plate current, the excitation is increased by the means already mentioned until the point is reached where further increase in excitation does not increase the antenna current. Then the excitation should be reduced by decreasing the resistance of  $R7$  until the antenna current is half the maximum value. At this stage slight adjustment of bias may be made to hold the plate current constant with and without grid excitation.

Under these conditions the tube will be operating as a linear amplifier, with its output at one-quarter normal power but ready to be pushed up to full power when the exciting tube is fully modulated.

The adjustment of a push-pull stage differs in that the grid bias is adjusted to the cut-off point when no excitation is applied. Then the excitation is brought to the adjustment where half maximum antenna current is obtained, as before.

It might be mentioned that variation of the coupling of  $L5, L6$  and of the resistor  $R7$  upsets the tuning of both the tanks  $L5-C7$  and  $L7-C11$ . The condensers  $C7$  and  $C11$  therefore require constant readjustment.

Neutralizing of the linear amplifier is carried out in just the same manner as in the case of any other amplifier. In the case of the push-pull stage the two neutralizing condensers are varied together.

Antenna coupling is another important adjustment. Reduction of the coupling below the point of maximum antenna current usually is desirable for phone work.

The transmitter is, of course, an excellent code transmitter when suitably adjusted for that work. When the UX-210 is used as the output tube it is only necessary to provide some good standard keying system to convert it for telegraphing. The linear amplifier, however, when adjusted correctly for phone is not adjusted for the best performance on code. In the case of the push-pull amplifier it is necessary to cut out the resistor  $R7$  in order to get full excitation and maximum antenna current. When a single linear amplifier tube is used it is advisable to increase the bias to somewhere near the cut-off point in addition to increasing the excitation.

#### YES, IT PERFORMS

Perhaps it would be as well to mention that the phone, provided in this article to illustrate the application of the ideas treated, really has worked. It has been on the air only three nights since it came out of the Laboratory — one night with the UX-210 as the output tube, and two nights with the UX-S52s feeding the antenna. Only stations in the Eastern States were heard but all that were called were worked. Reports of the audibility of the signals with the UX-210 output varied from QSA4 to QSA5 and several were to the effect that they were the loudest phone signals on the air. In all cases the voice quality was reported as being excellent. With the linear amplifier in operation the reports were slightly more flattering. At the same time we must mention that we overheard one amateur tell another that he sounded like a broadcasting station. We couldn't help thinking what a horrible broadcasting station that must have been. We knew then that we would have to discount heavily the reports we had been receiving.

We feel that even with all these words this is a pitifully incomplete treatment of the subject and we know that contributors to QST can make almost limitless additions — possibly subtractions. We do feel, however, that somewhere in the treatment lie at least some partial remedies for the unfortunate epidemic of vocal afflictions with which the amateur phone game has for so long been cursed. Here are the key thoughts:

(1) The strength of phone signals is dependent not upon the antenna power of the transmitter but upon the variation of it.

(2) With modern systems this variation can be carried to the 100% mark on the modulation peaks. A relatively enormous gain in the effectiveness of a transmitter is therefore possible without the necessity of power supplies or tubes of higher power rating.

(3) High modulation percentages, however, go hand in hand with drastic voltage variations on

the tube being modulated. This, in turn, spells frequency flutter or frequency modulation unless the tube generating the carrier frequency is well isolated electrically from the tube being modulated.

(4) Some such isolation of the oscillator or the use of crystal-control becomes of the greatest importance, since frequency flutter definitely and greatly increases distortion between the transmitter and receiver, even if the modulation is perfect.

(5) For this reason, with any transmitter in which the oscillator is modulated (and to some extent with transmitters of the oscillator-amplifier type) the speech quality obtained in a monitor in the station is not necessarily similar to the speech quality observed at a distance.

(6) It must be remembered that a good phone transmitter is quite a different animal from the code transmitter. The tubes, their voltages and their circuits all require treatment differing radically from telegraph practice.

(7) The speech quality can be no better than that put out by the microphone. Good microphones are expensive but the cheap ones are often satisfactory providing they are spoken into in the correct manner.

(8) Good amateur phone transmitters may appear expensive. If, however, expense is considered in relation to the signals produced in distant receivers they represent, in comparison with average present-day phones, far greater value for the amateur's money.

## Midwest Division Convention

May 10th-11th at Ames, Iowa

**T**HE Campus Radio Club of Iowa State College is again sponsoring this year's annual convention, and if experience is a good teacher those attending will feel well repaid for making the trip.

*(Continued on page 88)*



## The President's Corner

A WORD FROM  
HIRAM PERCY MAXIM

PRESIDENT OF THE AMERICAN RADIO RELAY LEAGUE AND  
OF THE INTERNATIONAL AMATEUR RADIO UNION

### Being an Amateur

**O**NE of the things that every one of us A.R.R.L. people enjoy is being an amateur. I have pondered often as to the why of this. It is not easy to explain. There may be just a touch of the heroic in it, and every one of us with red blood in him likes the hero business to a certain extent.

We work late into the night, we study and we defy failure, and we spend time and money with no idea whatsoever of gaining any financial reward. In public emergencies we are crazy to sit at our sets day and night on end, dropping our personal affairs entirely. The thought of getting pay for it is abhorrent. Our reward is that kick that comes from successfully achieving an extremely difficult and worth-while result.

I always think of Sir Isaac Newton when I get to mulling over this amateur matter. He was a real one. His job was the chair of mathematics at Cambridge in England. He got paid for that. But when it came to astronomy, optics, acoustics and physics generally, where he profoundly advanced scientific knowledge, he did not get a penny, because he was a dyed-in-the-wool amateur.

Newton completely outstripped his professional contemporaries in solving the great scientific questions of his day. He deduced the law of gravitation and its important sub-laws with real "hay-wire" equipment. He made the professionals follow where he led. He makes me proud of being an amateur.

Does it make you think of those "useless" short waves that were handed out to us amateurs once upon a time?



# A General Purpose Audio-Frequency Power Amplifier

By James J. Lamb\*

**T**HE number of inquiries received by the Technical Information Service requesting design and constructional data on audio-frequency amplifiers of high gain and power output is evidence of a considerable interest in this type of equipment on the part of the amateur fraternity. Motivated by this apparent demand for information on such equipment the amplifier and associated apparatus described herewith have been designed and constructed, the units being so correlated as to be adaptable to a number of uses. The utility ranges from service as the audio-frequency input for a phone transmitter to that of furnishing the musical score for the home or small theatre motion picture. As a matter of humorous interest, the thing may be made to furnish a variety of sound effects as well, since by making the proper misadjustments the amplifier is capable of generating the weirdest of wails; the rattle of machine guns or the roar of almost any type of airplane motor. Although these proper misadjustments cannot be definitely specified it is very probable that the constructor will bump into a sufficient number of them to satisfy the most discriminating lover of racket before he gets everything about the rig properly adjusted. Before going into the details of the design and construction of the amplifier, power supply and phonograph units illustrated, it might be well to consider the features of such equipment necessary for the various purposes to which the devices are intended.

## THE AMPLIFIER

The first consideration is, of course, the amount of undistorted power output required. This consideration must be determined by the amount of coverage necessary in the case of public address or theatre use, the power being specified with relation to the seating capacity of the auditorium.

This method of determining power requirement

\*Technical Information Service, A.R.R.L.

must of necessity be extremely approximate, since there will exist a wide variation in the absorption losses, echo effects and the like with different auditoriums. The following specifications may, however, be taken as of a conservative nature. For home use and small auditoriums

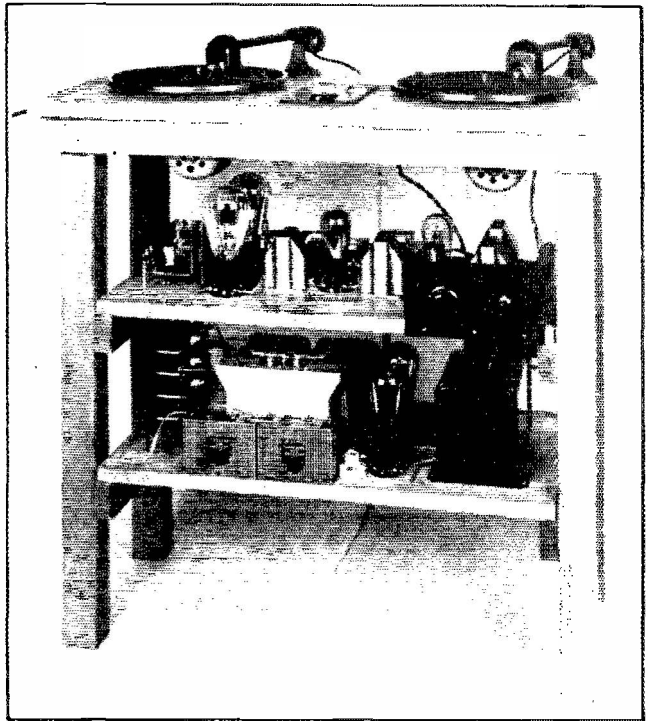

THE COMBINED DOUBLE PHONOGRAPH, AMPLIFIER AND POWER SUPPLY

accommodating audiences of a few hundred, not more than two watts of undistorted output should be required. This degree of output is obtainable with a power stage utilizing two UX-171-A tubes in a push-pull circuit or from one UX-250 tube with 350 volts on its plate. For auditoriums seating up to 1000 persons, four or five watts are ample and this power is obtainable from one UX-250 tube operating with a plate voltage of 450. For auditoriums seating 2000 to 2500 persons ten watts will serve and this order of power may be realized with an output stage utilizing two

UX-250 tubes in a push-pull arrangement, their plate voltage being 450. For outdoor use, the latter combination is capable of delivering intelligible speech to audiences of as high as 10,000.

Having decided upon the power output desirable for the purpose, the next step is to determine the amount of voltage amplification which must

crophone transformer is almost as difficult of specification, since there are microphones and microphones. It may vary from much less to considerably more than the voltage obtainable from the receiving set detector output circuit. With the magnetic phonograph pick-up things are more satisfactory, and the output may be given as 1 to

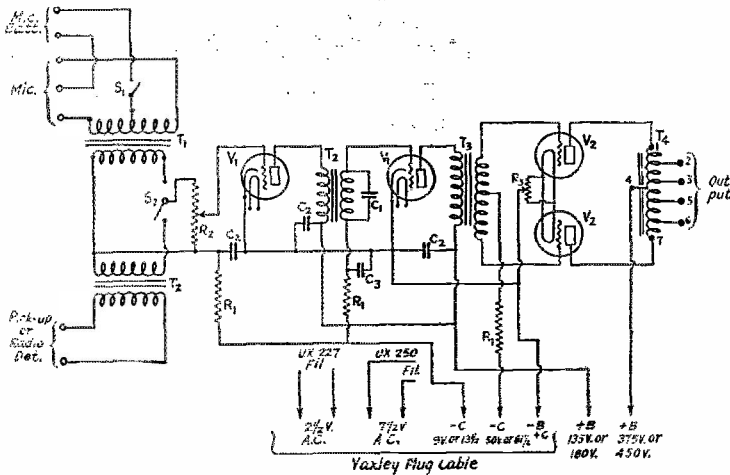

FIG. 1.—THE POWER AMPLIFIER

- T<sub>1</sub>—Samson Microphone Transformer, two-button type.
- T<sub>2</sub>—Samson Symphonic Audio Frequency Transformers.
- T<sub>3</sub>—Samson Push-Pull Input Transformer.
- T<sub>4</sub>—Silver-Marshall Output Choke No. 248.
- T<sub>5</sub>—Lorcham 50,000-ohm receiving type grid leaks.
- T<sub>6</sub>—Giro control, Frost 100,000-ohm potentiometer.
- R<sub>1</sub>—400-ohm Yaxley potentiometer.
- R<sub>2</sub>—100-ohm Yaxley potentiometer.
- R<sub>3</sub>—100-ohm, Sunnino fixed condenser. (See (a.t.))
- R<sub>4</sub>—1-μit, Flechtorn 50-volt filter condensers.
- R<sub>5</sub>—1 ohm as C<sub>2</sub> in parallel.
- V<sub>1</sub>—UY-227 tubes.
- V<sub>2</sub>—UX-250 tubes.
- V<sub>3</sub>—Microphone battery switch, S.P.S.T.
- V<sub>4</sub>—Switch to change input, S.P.D.T.

All transformer and condenser cases connected to negative B and grounded.

precede the power stage in order that it may receive the grid swing necessary to permit realization of the full available power output in its plate circuit. In figuring the voltage amplification required, consideration must be given to the signal voltage which is to be impressed on the amplifier input, and this involves the source of the signal.

Possible signal sources are the detector output of a radio receiver, the secondary of a modulation transformer operating in conjunction with a microphone and the output of an electro-magnetic phonograph pick-up. It is obvious that the voltage realizable at the input of the first amplifier tube from the output of a detector tube will be subject to variation between very wide limits, and any definite voltage must be specified with crossed fingers. Crossing fingers, we hazard 1/4 volt. The voltage across the secondary of a mi-

crophone transformer is almost as difficult of specification, since there are microphones and microphones. It may vary from much less to considerably more than the voltage obtainable from the receiving set detector output circuit. With the magnetic phonograph pick-up things are more satisfactory, and the output may be given as 1 to 1 1/2 volts. Considering 1/4 volt as the signal input voltage applied to the grid circuit of the first amplifier and assuming tubes having an amplification factor of 8, one stage of transformer-coupled amplification should precede the power stage of the two-watt output variety and two stages should precede the power stage in amplifiers of the five- and ten-watt output. In any case the input must be provided with a gain control to limit the input voltage to a point below that where excessive voltage swing reaches the grids and causes distortion.

Tubes of the UY-227 type are most suitable for the voltage amplification stages when a.c. filament supply is to be used, as they operate with a minimum of hum, are non-microphonic and their characteristics are such as to permit their use in conjunction with standard audio frequency transformers. Where d.c. filament

supply is to be used the UX-112-A type of tube is recommended for the voltage amplification stages. In three-stage amplifiers which are to be operated at the "wide open" position it is suggested that the second stage be of the push-pull type as well as the final stage, since the possibility of distortion resulting from overloading of the second stage will thereby be reduced. It must be remembered that while the final push-pull stage may be over-loaded to some extent without the introduction of serious distortion, it cannot correct for distortion introduced in a preceding stage.

With an idea of the power output and gain required in mind, the constructor is ready to proceed with the design of the amplifier. The choice of equipment should not prove at all difficult in view of the fact that there are now available so many high quality types and makes

of components of specified characteristics. This is particularly true of inter-stage coupling devices, those used in the amplifier illustrated being typical. The precautions to be observed in this connection are that the units have a good flat frequency characteristic curve over the musical range of frequencies, that the primary windings have sufficient current carrying capacity to accommodate the plate current being drawn by the tubes and that the cores do not become saturated at this value of current through the primaries. In the case of the plate circuit of a push-pull stage the latter consideration is, of course, eliminated; the current flows through the two sections of the primary winding in opposite directions and the flux due to d.c. plate current is therefore zero — providing the two sections are balanced. Such features as are conducive to the maintenance of high quality of reproduction and to the elimination of objectionable hum should be incorporated, and the location of the various parts with respect to each other should be such as to make the length of connections carrying audio-frequency current short and they should be as widely separated from each other as possible.

The latter is particularly important in the grid and plate circuit wiring. A.c. filament connections should be run as twisted pairs and if possible allow frequency and d.c. power wiring should be cabled.

The amplifier illustrated in the photographs is wired in accordance with the circuit diagram of Fig. 1. It consists of three transformer-coupled stages, the input being either microphone,

form of Frost phone-cord tip jacks, as are also the output and positive high-voltage terminals. These are used solely in the interest of the convenience they lend such an experimental layout and bind-

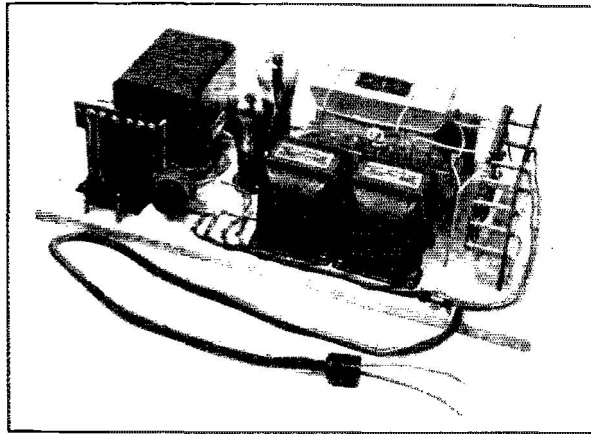

THE POWER SUPPLY

This illustrates the arrangement of the equipment as viewed from the rear. Power and filament transformers are at the extreme left, the rheostat in the 25% heater circuit being beside the filament transformer for these tubes. From left to right, the 2B1 rectifier tubes, filter and panel carrying the voltage-divider resistors are next in order. The Varley cable and positive high-voltage wires are cabled together.

ing posts would serve almost as well. Switch  $S_2$  connects either the microphone transformer secondary or the radio-phonograph input transformer secondary to the grid of the first amplifier, in the up and down positions respectively. Switch  $S_1$  closes the microphone battery circuit and should be closed before  $S_2$  is thrown to the microphone connection as otherwise a considerable jolt will be given the first amplifier tube grid and an objectionable thump in the reproducer will result. The gain control,  $R_2$ , is very effective and volume may be controlled from a whisper to a thunder. The resistors  $R_1$  serve to prevent audio-frequency coupling between the various grid circuits to a considerable degree and also are effective in preventing the flow of excessive grid current in case of improper grid bias adjustment. The capacitances  $C_1$  and  $C_2$  act as by-passes for such audio-frequency current as may tend to flow in these circuits and in the plate return circuits as well.

$C_3$ , connected across the secondary of the second audio-frequency transformer, shunts this grid circuit so as to give a high frequency cut-off and is particularly effective in reducing record

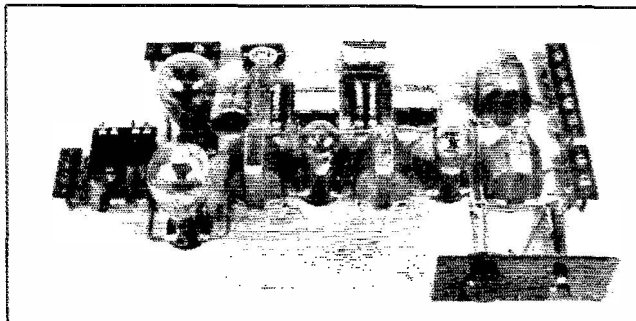

THE POWER AMPLIFIER

The panel at the right carries the gain control and switch used to change over from the audio-frequency transformer immediately behind the panel to the microphone transformer at the back. Inter-stage coupling transformers are located between the tubes and the output terminals are at the left.

detector output of a radio receiver or phonograph pick-up. The various input terminals are in the

grid circuit so as to give a high frequency cut-off and is particularly effective in reducing record

hiss when using phonograph input. Records vary greatly in the amount of surface noise as do microphones in the amount of hiss produced. This by-pass condenser also tends to produce an effect of accentuating the lower frequencies to a pleasing degree, the proper capacity required to give the desired effect being ascertained by trial. In this case, a value of .001 to .002 was found to be most satisfactory, although this value may not be best with a transformer of characteristics at variance with that used in this particular instance. The output device is a

speaker winding or speaker input transformer primary impedance. If more than one speaker is to be used, they should be connected in series or series-parallel and the proper pair of choke output taps should be determined by experiment. If there should be a possibility of persons touching any live part of the output circuit or speaker terminals, it would be advisable to connect a 2- $\mu$ d. condenser in each side of the line, since the high voltage plate potential is applied to the circuit although any two terminals in a pair are at zero potential with respect to each other.

It might be advisable in assembling the amplifier to delay the permanent mounting of transformers  $T_1$  until the unit has been given a test, as there is a possibility that these transformers may pick up some hum from the power supply. In this particular job this was not found necessary, however, although the power supply was mounted directly below the amplifier. In wiring, all transformer cases should be electrically connected to each other and to the negative high voltage which should be grounded. This is very important in the elimination of hum difficulties.

#### THE POWER SUPPLY

Needless to say, the power supply for an amplifier such as that described must be of a husky sort. The total plate current drawn by the tubes is around 125 milliamperes and to this must be added the current flowing through the voltage divider on the filter output, bringing the total current load up to 135 or 140 mills. Allowing for voltage drop in the rectifier tubes and in the filter, the transformer should have a plate supply winding rated at 600 volts at 150 milliamperes or 90 to 100 watts. Three filament windings must also be provided, two capable of handling the UX-251 and UX-250 filaments and one for the 6Y-227 heaters. Most power transformers available incorporate the plate and two 7 $\frac{1}{2}$ -volt windings, and the 2 $\frac{1}{2}$ -volt supply for the 227 tubes may be obtained from a separate transformer designed for that purpose. The latter transformer should be

equipped with a rheostat to accurately adjust the secondary voltage under varying line voltage conditions, as the value of 227 heater voltage is quite important.

The filter chokes should be amply large to

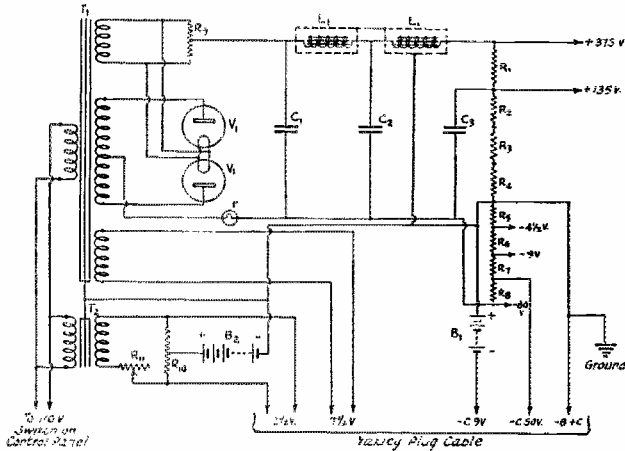

FIG. 2 — THE POWER SUPPLY

$T_1$  — General Radio Co. Type 503-B Power Transformer. Plate winding, 600 volts each side center tap; two 2 $\frac{1}{2}$ -volt filament windings; total power, 200 watts.

$T_2$  — 6Y-227 filament transformer, 2 $\frac{1}{2}$ -volt secondary.

The following resistors are Ward-Leonard Vitahom:

$R_1$  — No. 507-89, 10,000 ohms

$R_2$  — Same as  $R_1$ .

$R_3$  — No. 507-28, 2,700 ohms.

$R_4$  — No. 507-35, 2,000 ohms.

$R_5$  — No. 507-90, 15 ohms.

$R_6$  — No. 507-91, 100 ohms.

$R_7$  — No. 507-92, 500 ohms.

$R_8$  — No. 507-20, 25 ohms.

$R_9$  and  $R_{10}$  — Yacht 200-ohm filament center-tap resistors.

$R_{11}$  — 1-ohm, 2 $\frac{1}{2}$ -amp. first filament rheostat.

The following capacities are incorporated in the Flechtheim Condenser

Packs:

$C_1$  — 1  $\mu$ d., 1,000 volt

$C_2$  — 4  $\mu$ d., 200 volt

$C_3$  — 6  $\mu$ d., 250 volt

$B_1$  — Two 4 $\frac{1}{2}$ -volt C batteries in series.

$B_2$  — Same as  $B_1$ .

Tubes are UX-251.

Cases of transformers, filter chokes and condensers are grounded electrically to reduce hum.

F is a 3.8-volt flash-light bulb.

Silver-Marshall tapped choke of characteristics suited to the plate circuit of the UX-250 tubes. Loud speaker connections should be made to taps 1 and 7, 2 and 6, or 3 and 5; the combination used being dependent on the impedance of the

handle the total output current without saturation or heating, and the filter condensers should be capable of withstanding the full rectifier output peak voltage under no load conditions. Filter units of the ratings specified in the cut label of Fig. 2 should be satisfactory.

Referring to the circuit diagram of Fig. 2, it will be noted that the arrangement is quite usual with but few exceptions. It was found that there was no advantage in using a final filter capacity on the high voltage supply to the UX-250 push-pull stage, and that the capacity available for this purpose could be used to much greater advantage across the plate supply to the 227 plates. It was also found worth while to use battery grid bias on the 227 tubes in place of the resistor bias provided for this purpose as the low end was found to be much better when using battery bias and tendency to motorboat on the part of the amplifier was entirely eliminated. As a matter of fact, the quality in general was found to be considerably augmented by substituting battery bias on the push-pull stage as well, and for best results the use of battery bias is urged. If it is desired to realize the maximum possible output of the amplifier, the plate voltage on the push-pull stage should be raised to the full 450 volts available from the rectifier and filter. This is accomplished by connecting the negative "B," positive "C" and 227 heater center-tap wires to the outside terminal of  $R_3$ , the negative bias for both the 227 and 250 tubes being taken from batteries. The bias batteries may be of the small type 22½-volt units, four being necessary. The battery  $B_2$  consists of two 4½-volt units in series and is effective in reducing hum, since it is connected between the center tap of the 227 heater winding and the cathodes of these tubes, making the cathodes negative with respect to their associated heaters and preventing electron flow from the heaters to the cathodes. The flashlight bulb F, connected in series with the negative output lead of the rectifier, serves as a fuse in protecting the rectifier tubes and transformer winding in case of accidental short circuit of the output or the blowing of a filter condenser. It is also useful in indicating current variation, since it glows at about half or two-thirds full brilliancy under normal rectifier load, and serious variations in current output are readily made visible.

In making adjustments, a high resistance d.c. voltmeter of the multi-range type is particularly useful, and all plate voltages and grid bias voltages should be carefully checked before attempting to put the amplifier and power unit into operation. The filament voltage of the 251, 250 and 227 tubes should be checked with a good a.c. voltmeter, as there are bound to be variations in line voltage — and the transformer secondary voltages are not always as specified, but change under different load conditions. In first placing

the amplifier in operation, it would be advisable to check the plate current of the tubes with a milliammeter, each tube being checked separately. The grid bias voltages and gain control should be adjusted so that none of the plate current readings vary with the input signal, as

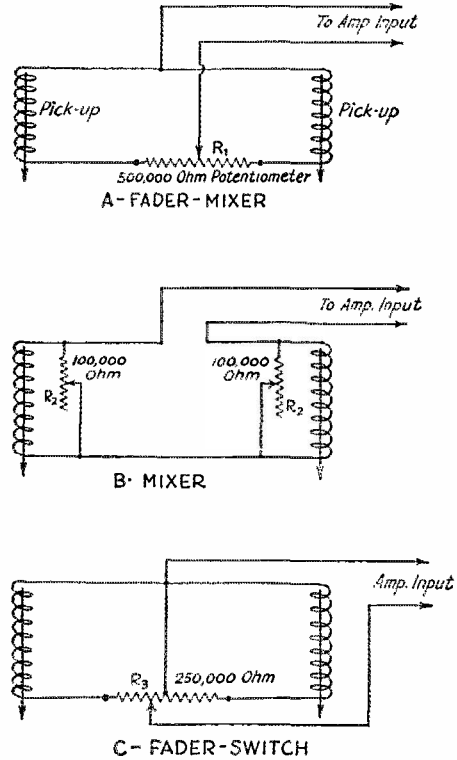

FIG. 3—THREE POSSIBLE FADER ARRANGEMENTS FOR THE PHONOGRAPH CONTROL PANEL

That shown in A is quite workable, but acts as a series resistance and does not entirely eliminate the signal from one pick-up when in the full position for the other. Arrangement B gives a controllable degree of mixing but has bad frequency characteristics when one resistor is not in the full off position. This system also requires that the two resistors be operated simultaneously and is somewhat inconvenient on that account. The circuit diagrammed in Fig. C is probably the most satisfactory, as it operates as a voltage divider, has a good frequency characteristic (comparatively) and entirely eliminates the signal from one pick-up when in the full "on" position for the other. Suggestions for construction of this arrangement are given in the text.

variation in plate current immediately indicates distortion. If the amplifier should show a tendency to motorboat, the capacity of  $C_2$  in the amplifier may be increased to good advantage. However, with proper grid bias and input signal, no such motorboating should occur.

#### THE PHONOGRAPH UNIT

For the furnishing of uninterrupted musical programs, the double turntable and pick-up

arrangement is surprisingly effective. The change-over from one record to the other is accomplished by means of a simple fader, the transition being pleasingly gradual in effect and objectionable gaps between selections are entirely eliminated. The unit consists of two Paerent motor-driven turntables, two Paerent pick-ups and a control panel carrying a 110-volt switch in the supply line to the power amplifier, two similar switches for the turntable motors and the fading control. The fading arrangement used is shown in the circuit diagram A of Fig. 3, and two other possible schemes are shown at B and C. Of the three, C might be considered most effective, as one pick-up is entirely out of circuit when the other is in use. The device consists of a standard potentiometer with a fourth contact made to its exact electrical center. This fourth contact can be most easily arranged on a potentiometer of the wire wound type, such as Electrad or Yaxley. The fader arrangement should not be used as a gain control, but volume should be adjusted by means of the gain control associated with the amplifier.

The phonograph unit is mounted on a board 30 inches long by 15 inches wide and  $\frac{3}{4}$  inch thick. The amplifier and power supply units are mounted on base boards of the same thickness, each being 24 inches long by 12 inches wide. As shown in the photograph of the complete rig, all three units are built into a stand which is 30 inches in height, 28 inches wide and 12 inches deep, outside dimensions. If desired, the stand might be so designed as to also accommodate racks for phonograph records and the cue sheet for motion picture scores.

### “Public Interest, Convenience or Necessity”

THE Federal Radio Commission has decided that it is not necessary for each individual applicant for an amateur station license to struggle with the business of proving that his station will be in the public interest, convenience or necessity. The answer to this question may be omitted.

Recently a new and complex application form was originated by the Commission, known as Form 5-A. Question 12 inquired: “Why will the operation of station be in the public interest, convenience or necessity?” One can picture the average amateur wrestling with this question. The League thought it unnecessary, as the Commission had ruled that the existence of amateurs as a class, under the regulations governing their operation and within the privileges reserved for them, was in the public interest, etc.; and suggested that a normal application from a bona-fide amateur should be so accepted without the neces-

sity of demonstration on the part of the individual applicant.

The Commission has acquiesced. Although amateurs are not excepted from this licensing standard, the Commission feels that proper amateur operation in accordance with regulations satisfied the requirements of law and accordingly on February 9th the Commission took the following action:

“On motion duly made and carried, the Commission directed that answer to the request made of applicants for amateur radio station licenses, application Form 5-A, as to whether the operation of such station is in public interest, convenience or necessity, may be omitted from such applications.” —K. B. W.

### Strays

W70Q is enthusiastic about the idea of making QSL cards from a zinc engraving. His own cards were made from a drawing done in India ink on a sheet of drawing paper about twice the size of the card. No particular artistic ability is necessary to make the drawing, he says, and the zinc plate should not cost more than \$5 or \$6. The printing job from the plate is quite cheap and a new batch of cards can be struck off at any time without the need of type setting.

The peaked audio frequency amplifier in the four-tube “1929” receiver is not satisfactory for phone reception. For this work, as mentioned on page 29 of the February QST, a switch can be provided to cut out the peaked stage. W1CRC proposes an alternative scheme. He has arranged the Ford coil secondary, its tuning condenser, grid condenser and leak on a small “plug-in” base. Also he has arranged an audio transformer on a similar base so that it may be plugged-in in place of the peaked coupling unit. A further alternative would be to arrange a base similar to the peaked unit but fitted with a resistance instead of the Ford coil secondary. Better audio frequency characteristics would then be obtained than with the transformer.

Rain leaked through the lead-in at W8DRU and after cleaning up the mess it was found that the UX-210 showed symptoms of water in the base. W8DRU drilled a hole in the base so that the water could leak out. Unfortunately the water and the vacuum leaked out together.

W2ADZ reminds us of the five comprehensive articles on television which appeared in the October, 1927, issue of the *Bell System Technical Journal*. They should be of great value to television experimenters even though they were printed more than a year ago. This and other issues of the *Journal* can be obtained from the Information Department, American Telephone and Telegraph Co., 195 Broadway, New York City.

# Beats

By J. E. Smith\*

**A**NY FELLOW, as the saying goes, "who knows his beats, knows his vegetables." That may not be a very intellectual manner of speaking, but it is a fact that anyone who has a good knowledge of how beats are produced, controlled and measured, and who is acquainted with the many ways in which beat phenomena can be used, certainly must have a good knowledge of electrical principles.

Everyone knows what beats are. One may not consciously be aware of the fact that he has this knowledge, but, nevertheless, is making use of it every day of his life. Go to your radio receiver and tune in a baritone or a soprano, and listen carefully. Do you notice how the voice wavers as the singer holds a long note? If it does not waver, tune in another station and listen to a better singer.

What does that last sentence mean? Merely, that the quality or timbre of a person's voice, or of an instrument, depends to a great extent upon the number of overtones, as they are called, in the sound produced by the voice or instrument, and when these overtones are generated together they produce what are known as beats. The beats are partial evidence of either many overtones or of strong overtones in the sound. We say *partial* evidence, because the presence of beats does not necessarily mean that the timbre or quality of a sound is good. The beats may result from a mixture of unpleasant tones or dissonances, as they are called.

That the beats have considerable value, however, in connection with the timbre or quality is well recognized: the violinist actually produces artificial beats as he plays, by rocking his finger on the string of the instrument. This makes the active portion of his string longer and shorter by a small amount, and so changes the pitch of the note he is playing by a similar small amount. This is done several times a second, and the ear perceives this variation of the pitch as a slow beat note. In this way the violin or cello, already rich in overtones, are made to sound as if they were still richer in these tones which please the ear.

It is by means of overtones and beats that we are enabled to tell the different musical instruments apart: To go a little further, it is actually by means of these that we are enabled to distinguish the voices of different individuals and to catch the varied and different shades of meaning

in their voices as they speak. Men have voices richer in overtones and beats than women; children have voices with relatively few. That is why they are so shrill. Sopranos have fewer than contraltos. This is because the notes they sing are higher: overtones are pitched higher than the fundamental, and it is clear that there is an upper limit to the capability of the vocal cords for producing high-pitched notes.

Let us find out what a beat is. Suppose we go on a picnic and put up an old-fashioned swing on one of the trees. Our lady friend takes her seat on the swing and we find ourselves assigned to the task of keeping the swing going. We give it a push to

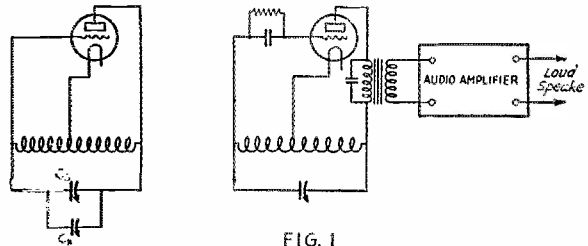

FIG. 1

start it off. When it comes back we give it another push, and soon it is swinging quite high. Now we stop pushing it at each swing, and are content to give it a shove at every other swing. It is clear that each time we push it, it swings harder than those times we do not push it. If the swing is rocking at the rate of 20 swings a minute, we can say there are ten "beats" per minute, or there are ten times per minute during which it swings harder. So, if we pushed it only every fourth time there would be five beats per minute. If we push it every time it swings there would be no beats, for there would be no time when it would swing harder than at other times.

Now we can begin to think of sound waves, for these are caused by the air through which the sound travels swinging back and forth. Suppose we have a certain sound creating vibrations of the air in the room, and that at a given instant and at a certain point the air is moving in a definite direction. Then, if another sound in the room also causes the air at that same point and at that same instant to move in the same direction, the two reinforce each other. At another moment, perhaps, the vibration of the second sound will not be in step with the first and will tend to neutralize the vibration caused by the first sound. This rise and fall in amplitude of the combined waves constitutes the beat in which we are interested.

\* President, National Radio Institute, 16th and U Streets, N. W., Washington, D. C.

The number of beats so created is equal to the difference between the rate of vibration of the two sound waves. That is, if one wave is vibrating at the rate of 1000 times a second and the other at 1100 times a second, there will be 100 beats per second. We shall actually hear a sound which has a pitch corresponding to 100 cycles per second. It will be a rather low-pitched note, but we shall hear it nevertheless. If the frequencies of the two notes differ by only 10 cycles per second we shall distinctly hear ten beats each second, but there

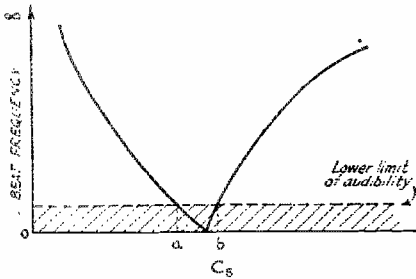

FIG. 2

will not be a definite pitch to the beat note. This is because the beats are so slow that the ear can hear each one separately. When the frequency of the beats gets up to about 25 per second, the ear cannot distinguish each beat separately, but begins to perceive an actual tone.

This should be sufficient to give the novice a fair idea of what beats are. In this article we are more concerned with what we can do with them in electrical and radio circuits, and how we can use them in various ways. Beats can take place in radio circuits as well as in the air, although, of course, they are then caused by the mixing together of two or more radio frequency oscillations in a given circuit.

We are all familiar with the whistling sound which we hear when our radio receiver happens to oscillate and we are trying to tune it to some station. As we turn the dial around we soon begin to hear a high-pitched whistle. Suppose we stop there for a moment and consider what is occurring. Let us assume the receiver to be oscillating at 1,000,000 cycles per second (300 meters). We may also assume the carrier wave of the station to which we are going to tune as being 1,001,000 cycles per second (a trifle less than 300 meters). The difference between the two frequencies is 1000 cycles, which is the pitch of the whistle or note we are hearing.

Let us turn the dial a little more, and tune the oscillating receiver to 1,000,100 cycles per second. The difference is now only 100 cycles so we hear a

rather low note of 100 cycles per second. If we tune the receiver to exactly the same frequency as that of the carrier wave, the difference will be zero, so there will be no beat note at all. This is known as the "zero beat" condition. If we would turn the dial still further, we should find that the beat note would come back again, starting at a low pitch, gradually rising until it passes out of audibility. It makes no difference which wave has the higher and which the lower frequency. The pitch of the beat depends only on the difference between the two.

Let us see how beats may be created in the laboratory or workshop. Take a simple radio frequency oscillator, such as we have shown at the left in Fig. 1. Then take another oscillator, made exactly the same as the first, but this time include a grid leak and grid condenser, so that what we really have is an oscillating detector. This is also shown in Fig. 1. This gives us the same state of affairs which we discussed in the previous paragraphs. The oscillator at the right in Fig. 1 may be considered to be the broadcasting station, and the one on the left is the oscillating receiver. The beat note passes through the a.f. transformer, and may then be amplified and heard coming out of the loudspeaker. We can make the beat note any frequency we want by tuning one oscillator or the other.

One of the simplest applications of the set-up of

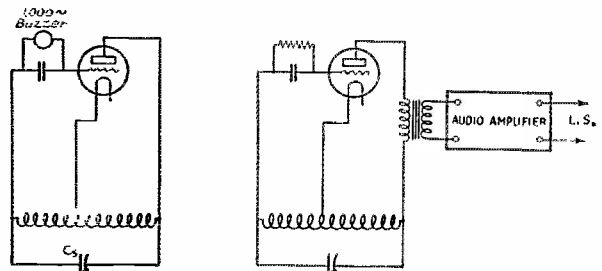

FIG. 3

apparatus is in measuring the capacity of condensers. Suppose the condenser  $C_s$  is a standard condenser — that is, we know its capacity at any setting. Tune the two oscillators so as to obtain the zero beat condition, then connect the unknown condenser  $C_x$  in parallel with  $C_s$  and reduce  $C_s$  until the zero beat is again obtained. The amount by which we had to reduce  $C_s$  is equal to the capacity of the unknown condenser  $C_x$ .

There is a serious difficulty with this method, however, which detracts from its accuracy, and this may be explained with the aid of Fig. 2. Suppose, as we turn  $C_s$  slowly, the beat frequency comes into audibility at a very high frequency, and then becomes of too low a pitch for the ear to perceive as a tone. In other words, the beat fre-



quency passes below audibility. As we continue to rotate  $C_s$ , we shall not be able to hear the beat note again until it rises on the other side of zero beat. In other words, there will be silence between the points  $a$  and  $b$  of Fig. 2. It is clear then that it will be possible to set the condenser  $C_s$  at the exact position which gives the zero beat.

In order to avoid this difficulty we can make use of an idea which is due to Professor Whiddington of the University of Leeds, England. We have an audio frequency note which we can adjust to any frequency we want in the audible range. Let us hear that note against another audible note, in much the same manner as we can make one string of a piano beat with another string, by striking the two strings together.

Let us modulate one or the other of the oscillators shown in Fig. 1 with a constant audio frequency note, say 1000 cycles. This may be very easily done by connecting a 1000-cycle buzzer in the grid circuit as shown in Fig. 3. We shall now hear coming from the loudspeaker two audible notes. One of these notes is the heterodyne resulting from the beating of the two radio frequency oscillations. The other is the 1000-cycle note of the buzzer. As  $C_s$  is rotated then, the heterodyne note will come down from above audibility, as indicated by the arrow in Fig. 4. Let us suppose this heterodyne note gets down to 2500 cycles. We are now hearing two audible notes, one of which is 1000 cycles and the other 2500 cycles. These beat with each other, so that we hear a third note of 1500 cycles. This is called a secondary beat. Suppose the heterodyne note gets

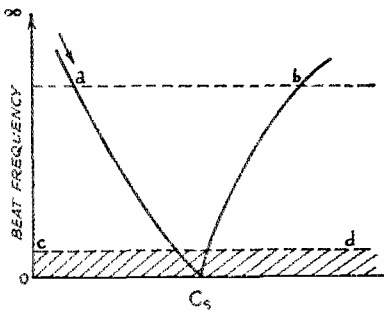

FIG. 4.

down to 1200 cycles. Our secondary beat is now 200 cycles. When the heterodyne note gets to exactly 1000 cycles it has the same frequency as the buzzer, so that we now have a condition of zero secondary beat. This is indicated in Fig. 4 by the point  $a$ .

If we should continue to rotate  $C_s$  we should find our secondary beats would come back again, gradually increasing until they passed out of audibility. The heterodyne note would at the same time decrease until zero beat is obtained below the

line  $cd$  of Fig. 4. Another point of zero secondary beat would be reached at  $b$  (Fig. 4).

In order to visualize how these various frequencies change with the setting of the condenser  $C_s$ , we have spread out enormously the horizontal scale in Fig. 5. In Fig. 5A are shown the radio frequencies of the two oscillators. The oscillating detector is supposed to be fixed or constant, so that

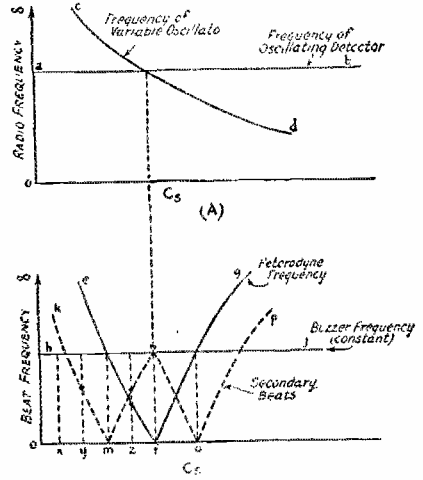

FIG. 5

we represent its frequency by the horizontal line  $ab$ . As we vary  $C_s$  of the oscillator, the frequency of the latter decreases as  $C_s$  is increased. This is indicated by the curve  $cd$ .

The heterodyne note or the beating between these two radio frequencies is indicated by the curve  $efg$  in Fig. 5B. That part which is below audibility is indicated by the shading. The line  $bj$  represents the constant frequency of the buzzer. The secondary beats result from the beating together of the two notes represented by  $efg$  and  $bj$ , and are indicated by the curves  $kmnop$ .

All this may seem rather complicated, but really it is simple. It may be made very clear by cutting Fig. 5B in half, along the line  $ju$ , and considering only one half of it at a time. The action is the same on both sides of the line  $ju$ . Depending on the setting of the condenser  $C_s$ , it is possible to hear one note, or two or three notes simultaneously. For instance, when  $C_s$  is at  $x$  (Fig. 5B) the only note heard is the 1000-cycle note of the buzzer. When set at  $y$  two notes are heard, the 1000-cycle buzzer note and the secondary beat note. When set at  $z$  all three notes are heard, viz., the 1000-cycle buzzer, the heterodyne, and the secondary beat notes. The heterodyne has its zero beat at  $f$ ; zero secondary beat occurs at  $m$  and  $o$ . It is very interesting to hear these various notes travel up and down the scale as the condenser is turned slowly.

In applying the system to measuring capacity of condensers, zero secondary beat is obtained, the unknown condenser is shunted across the standard, and the standard readjusted until zero secondary beat is again obtained.

Another application of the beat phenomena is found in systems which are employed for stand-

to beat any of the harmonics of the one against any of the harmonics of the other. For instance, the fourth harmonic of the tuning fork (4000 cycles) could be made to beat with a sixth harmonic of the generator. Clearly, the generator would have to be set at a frequency of 4000/6 or 667 cycles per second in order to obtain zero beat, and

thus this point on the calibration curve of the generator is obtained. It was possible to use harmonics of the tuning fork and of the generator up to the 10th and in this manner obtain about fifty points on the calibration curve.

There are many other ways in which the beat principles can be utilized, not only in measuring capacities and inductances, but for nearly all kinds of frequency standardization and calibration in systems which require the accurate determination of resonance.

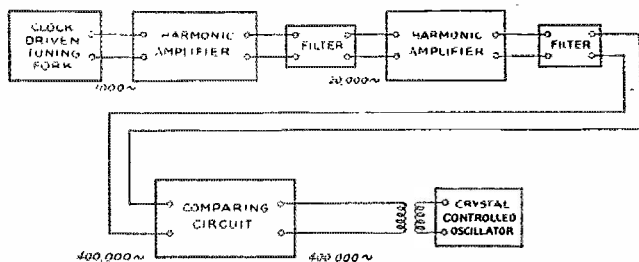

FIG. 6

ardizing frequencies. Some interesting work was recently done along this line by Dr. Jolliffe and Miss Hazen, of the Bureau of Standards.

Referring to Fig. 6, the output of a special precision tuning-fork operated by an astronomical clock was amplified at low frequencies by a harmonic amplifier. This is an ordinary audio frequency amplifier which is adjusted to distort the signal applied to it. In doing this, a large number of harmonics of the signal is created. At the output of this amplifier is connected a filter, which selects, say, the 20th harmonic. There is then impressed on the second harmonic amplifier a frequency which is *exactly* 20 times the original, or 20,000 cycles per second, if we assume the original to be 1000 cycles per second. The 20th harmonic of this may again be selected from the second harmonic amplifier by another filter, furnishing us with a frequency which we know to be *exactly* 400,000 cycles. This is now amplified by an amplifier which does not *distort*.

Suppose now it is desired to compare this frequency with the frequency of a crystal-controlled oscillator, which is supposed to have a frequency of 400,000 cycles. The standard frequency of 400,000 cycles is made to beat with the frequency of the crystal-controlled oscillator, and the beat note which is obtained is clearly the difference between the two frequencies and is the amount by which the crystal-controlled oscillator is in error. This error may be measured in a variety of ways.

Another interesting application of the beat principle was described by S. Harris in the *Proceedings of the I. R. E.* for April, 1926. It was desired to calibrate an ordinary audio-frequency oscillator or generator, and the only standard source of frequency available was a simple 1000-cycle tuning fork. Advantage was taken of the fact that both the generator and the tuning fork were rich in harmonics, and that it was possible

## Strays

Letters to the Technical Information Service still indicate a wide-spread misunderstanding over the terms "microfarad" and "micro-microfarad." The unit of capacity is the farad -- a unit far too large for practical use in radio work. It is replaced by sub-multiples: the microfarad and the micro-microfarad. The microfarad is one millionth of a farad and the micro-microfarad is one millionth of a microfarad. A condenser of .0005 microfarads ( $\mu\text{fd.}$ ) can therefore be said to have a capacity of 500 micro-microfarads ( $\mu\mu\text{fd.}$ ). The conversion of microfarads to micro-microfarads, in other words, is merely a matter of moving the decimal point six places to the right.

W40C has recently been in communication with the Byrd expedition. *The Press of Durham, North Carolina*, thrilled, states, "Whitaker expects to continue his talks with the Byrd operator through the medium of the crackling spark which sends the Morse continental code hurtling across the tremendous space which separates Durham from the polar voyager."

W9FUG suggest that the cover of September 1928 *QST*, together with the A. R. L. emblem, makes a good painting for a slicker!

W5RZ has added a UX-222 to his long-wave honeycomb-coil receiver and finds it highly effective. The existing primary of the receiver serves as the plate coil for the screen-grid tube, a new primary being arranged in the grid circuit of this tube. Shielding undoubtedly would be an advantage but W5RZ's receiver operates splendidly without it.

# Alternating Current Rectification as Applied to Radio

(In two parts—Part 1)

By R. J. Kryter\*

**T**HE ease and economy with which alternating current may be generated and distributed has made it widely available throughout this country. As a result, the majority of the devices and processes using electricity, whether in the factory or in the home, have been adapted to operate on this form of current. The only conspicuous applications of electricity requiring direct current have been in the fields of electric traction, elevator service, and electro-chemical processes. These applications have all been on such a large scale that they justify the special generation of direct current; or the operation of large conversion plants using efficient rotating machinery.

The field of radio communication also requires direct current, but at such a variety of voltages and currents, at such low powers and in so many scattered installations, as to make the above methods of supply impractical. As a result, the rapidly expanding radio art has engendered a sudden demand for cheap, low-power rectifiers, and the entire problem of small-scale alternating current rectification has become a specialized branch of radio technology. The peculiar requirements of radio have revived interest in many methods of rectification which had heretofore been mere laboratory curiosities. Some of these requirements set forth approximately in the order of their importance are as follows:

1. The rectifier must be cheap.
2. It must be reliable.
3. It should have long life.
4. It should require the minimum of attention.
5. It should be compact.
6. It should be silent in operation, cause no radiant electromagnetic disturbance and contain no moving parts.
7. It should be efficient.

The ranges of voltages and currents which these rectifiers must handle are roughly from one to five amperes at two to twelve volts and from twenty to five hundred milliamperes at one hundred to three thousand volts, covering a power range from two watts to one kilowatt.

The various types of rectifiers fulfilling the

\* Research Engineer, Prest-O-Lite Storage Battery Corporation, Indianapolis, Ind.

more important of the above requirements are as follows:

1. Electrolytic.
  - (a) Aluminum.
  - (b) Tantalum.
2. Thermionic.
3. Gas Conduction.
  - (a) Tungar.
  - (b) Mercury Arc.
  - (c) Helium.
4. Dry Contact.
  - (a) Copper Sulfide.
  - (b) Copper Oxide.
5. Vibrating.
6. Rotating.

Of these various types the electrolytic rectifier is the most easily adapted by the experimenter to his special uses; the helium tube is best for small currents at medium voltages; the mercury arc is the most versatile; the Tungar is best for heavy currents at low to medium voltages; the

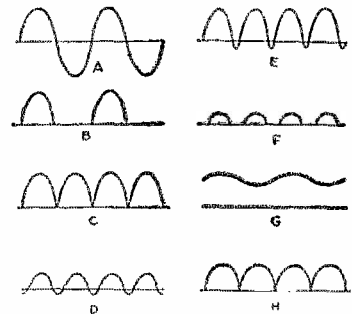
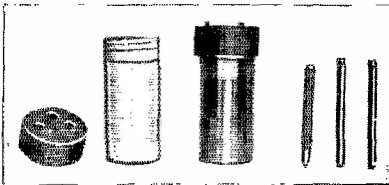

FIG. 1. THE WAVE FORMS OBTAINED FROM VARIOUS RECTIFIER ARRANGEMENTS AND CONDITIONS

thermionic valve is best for moderate currents at high voltages; the dry contact type is best for small currents at low voltages. The vibrating rectifier fails completely to fulfill requirements No. 2, No. 4 and No. 6 and has fortunately become obsolete. The rotating machine usually fails to fulfill items No. 1, No. 4 and No. 5, and never fulfills item No. 6. Its characteristics and application form a special study. Therefore, vibrating rectifiers and rotating machinery will receive no further treatment in this article.

## THE PROBLEM

"Rectification," as defined by Jolley, "should entail the conversion of a current which fluctuates symmetrically about an axis of time into one which fluctuates in any fashion whatsoever unsymmetrically about the same axis." Thus the alternating current sine wave, "A" (Fig. 1) will be rectified if converted into any of the wave-forms "B," "C," "D," "E," "F," "G," and "H." The latter two are spoken of being "complete" rectification, inasmuch as the current is wholly in one direction: the forms "D" and "E" are called "incomplete" because of the presence of a negative wave. Forms "G" and "C" called "perfect" rectification, because the loops of the original sine curve have not been altered in shape. Curve "B" represents half-wave rectification, the original negative loop in "A" being completely suppressed. Curve "C" represents full-wave rectification, the negative loop in "A" being reflected across the time axis into a positive position. Curves "B" and "C," representing perfect rectification, will be obtained only from a rectifier which follows Ohm's law in its "open" direction, possesses neither capacity nor leakage, and works into a pure resistance load.



AN ELECTROLYTIC RECTIFIER BUILT AS DESCRIBED IN THE TEXT, SHOWING THE PROTECTED ALUMINUM ELECTRODE

*Inert electrodes of both graphite and duriron are also shown. The third hole in the cap is for ventilation, an aluminum and one inert electrode being employed.*

## ELECTROLYTIC RECTIFIERS

The electrolytic valve is one of the oldest known devices for rectifying an alternating current. It is simple and inexpensive to construct, the necessary parts usually being found in any experimenter's workshop. It is especially prized by the amateur because it can readily be adapted to a wide variety of conditions. Its operation depends upon the fact that many metals when immersed in suitable solutions offer a much greater resistance to the passage of current in one direction than in the other. This curious behavior is probably due to the fact that the metals in question form on their surfaces a porous oxide film filled with gas. This gas-film permits the passage of electrons from the metal electrode into the solution, but obstructs the passage of the ions from the solution. In other words, current flows freely through the cell only when the

rectifying metal is the negative electrode of the cell.

This valve action is demonstrated by many metals, but is most conspicuous in the cases of aluminum and tantalum. Tantalum, a rare metal closely allied to tungsten, will rectify in almost any electrically conductive solution, while aluminum rectifies only in certain weak electrolytes. Inasmuch as the aluminum rectifier is better known and more widely available, it will be described at greater length.

Aluminum rectifies best in solutions of the complex organic salts of ammonium, sodium, and potassium. Although it will operate in solutions of carbonates, borates, or phosphates, it is at its best in mixtures of citrates, tartrates, oxalates and the like. In general, the heavier and more complex the organic acid with which the ammonium is combined, the better the rectification. Aluminum will not rectify in the presence of strong acids, strong bases, chlorides, sulfates or nitrates. Usually it operates best in a weakly acid solution. Solutions having even a mild alkaline reaction cause rapid disintegration of the aluminum. Although, theoretically the solution should suffer no change during the rectification process other than a loss of water, actually, a progressive decomposition takes place which eventually destroys the electrolyte. As long as the rectifier is not overloaded, this destruction proceeds at a regular pace depending upon the nature of the solution, so that the life of a given solution can be stated in terms of quantity of electricity rectified per unit volume. The life of a simple inorganic solution (such as borax) is very short compared to the life of suitable organic mixtures such as that described below.

The aluminum cell, in common with all other electrolytic rectifiers, displays the phenomenon of "breakdown voltage" much as is done by an insulator. For any given combination of metal and solution there is a certain critical voltage at which the oxide film is disrupted and the valve action is at first seriously unpaired and finally destroyed altogether. This breakdown is accompanied by a sharp rise in the temperature of the solution, pitting of the electrode, disintegration of the electrolyte, and often by visible arcing at the rectifying surface. Furthermore, the aluminum cell does not offer an infinite resistance to the flow of current in the reverse direction but a finite high resistance. In other words, it has a definite leakage. This leakage increases very rapidly with increasing temperature. For this reason it is very important that the temperature of any aluminum rectifier be properly controlled. As the temperature rises, the leakage current increases, and the  $I^2R$  losses of this leakage current further increases the temperature. This causes the leakage current to increase still further, and the cycle repeats until failure of the cell occurs. This vicious circle begins at a certain

critical temperature which is characteristic for any given metal and solution much as in the case of the breakdown voltage. In fact, failures of an electrolytic valve, through exceeding either the breakdown voltage or the critical temperature, produce the same effects and are probably due primarily to the same causes, namely, the speeding up of the negative ions in the solution until their velocity is sufficient to penetrate the oxide-gas dielectric film. This leakage effect produces a wave-form such as shown in "D" of Fig. 1.

Following are two formulas of successful rectifier solutions together with their operating characteristics:

*Solution No. 1*

*Ammonium citrate . . . . .	425 gms.
Citric acid . . . . .	368 gms.
Ammonium phosphate . . . . .	150 gms.
Potassium citrate . . . . .	8 gms.
Distilled water . . . . .	1,000 cc.

*Solution No. 2*

*Citric acid . . . . .	734 gms.
Ammonium phosphate . . . . .	150 gms.
Potassium citrate . . . . .	8 gms.
Distilled water . . . . .	1,200 cc.

The chemicals used must be pure and should be dissolved with the aid of gentle heat. The final solutions should be practically colorless and of a syrupy consistency.

Solution No. 1 has a maximum working voltage of 160 volts (r.m.s.) per cell, a breakdown voltage of 210, a critical temperature of 120° F., and a life of 69 ampere hours per 100 cc. of solution. Solution No. 2 has a maximum working voltage of 130 volts (r.m.s.) per cell, a breakdown voltage of 160, a critical temperature of 110° F. and a life of 91 ampere hours per 100 cc. These solutions darken gradually in use, becoming almost black at the end of their life. A piece of litmus paper may be used to test the condition of the solution. When the solution becomes alkaline, i.e., turns red litmus paper blue, it is exhausted and should be replaced. Both the solutions are non-poisonous and non-corrosive. The only precaution necessary in handling them is to avoid contamination. Evaporation should be offset by the addition of fresh solution or of distilled water; tap-water must not be used. Evaporation can be reduced and the growth of mold prevented by covering the solution with a layer of oil.

The aluminum used in an electrolytic rectifier should be of the highest possible purity, as impurities in the metal cause local actions which corrode it. The only impurity which can be tolerated in any amount is copper. The aluminum may be in any convenient form such as rod, sheet

or wire. The best electrode, however, consists of an aluminum rod, rounded on the end and polished smoothly all over. Sharp corners, edges and rough surfaces tend to concentrate the electrostatic field and break down the film, whereas rounded, polished surfaces maintain a uniform field and a much more homogeneous and tenacious film. The dielectric layer surrounding the aluminum is extremely thin, making the potential gradient very high; therefore the electrode should be shaped the same as it would be to carry high potentials in the open air without corona. A rounded and polished aluminum electrode "forms" much more quickly and maintains its film much better during idle periods than does an ordinary rough irregular surface. If the cell is to remain idle for any length of time, the electrodes should be removed from the solution, washed and dried. The dried film thus obtained is surprisingly permanent.

The inert (positive) electrode for the rectifier may be of graphite, iron, lead, or a non-corrosive alloy, such as "Durion." Piano wire or high carbon drill-rod make excellent inert electrodes.

A convenient rectifier coil consists of a glass bottle 1½" in diameter and 4" high, carrying electrodes ¼" in diameter and filled with about

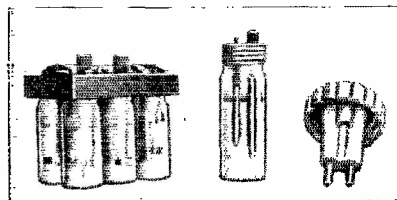

TWO TYPES OF ELECTROLYTIC RECTIFIERS ARE SHOWN ABOVE

To the left is a six-cell unit using tantalum electrodes. The single cell is of the aluminum-lead type. The cap shown illustrates a method which provides protection to both elements allowing only a short length to be exposed to the electrolyte.

90 cc. of solution. Such a cell, if properly ventilated, will continuously rectify 100 milliamperes at the maximum working voltage. If the aluminum electrode be rounded and polished, and protected by a sleeve or rubber tubing so that only the lower inch is exposed to the solution, a new cell should "form" sufficiently for use in one minute and should show a final leakage current of not over 0.1 milliampere at 150 volts d.c.

Since any electrolytic valve functions by virtue of an exceedingly thin dielectric layer interposed between the solution and the active electrode, the valve displays the phenomenon of capacitance inasmuch as it contains two conductors separated by an insulator. In the "closed" valve, some current will flow through this inherent capacity and render the rectification incomplete. This effect is shown in wave form "E" of Fig. 1. For this reason it is desirable to reduce, as far as

\* 1 avoirdupois ounce = 28.3 gms.  
1 apothecary's ounce = 31.1 gms.  
1,000 cc. = 33.8 fluid ounces.

possible, the area of the electrode in order to reduce the internal capacity and thereby produce more perfect rectification. The electrode should be of such a size that the current density will be at least 50 milliamperes per square inch, but not greater than 2500 ma. per sq. in. The higher the current density, the more complete the rectification, but the lower the energy efficiency. Rectification ratios in half-wave circuits as high as 0.62 are obtainable, although the usual values are 0.4 to 0.5. Similarly, although power efficiencies up to 70% are possible, the usual rectifier will have an efficiency of 20% — 40%.

#### ELECTROLYTIC CONDENSERS

The inherent capacitance of an electrolytic valve is made use of in the electrolytic condenser. Such condensers can be designed to give very large capacities in small spaces, and furthermore, are surge-proof and self-healing. In this application, the rectifying metal is the positive electrode, as the condenser operates in the "closed valve" position. An excellent solution for an electrolytic condenser consists of 50% of the above solution No. 1, 25% glycerine and 25% alcohol. The active electrode should be polished aluminum wire wound in coils, and the inert electrode may be a graphite or iron rod, or may be formed by the container itself in case the latter is of iron or tin. Using this construction in the  $1\frac{1}{2} \times 4''$  glass bottle mentioned above, it is possible to build a 30  $\mu$ f. condenser having a working voltage of over 200 volts d.c. When completely formed, the capacity at 150 volts d.c. should be about 0.4 microfarad per square inch of active aluminum surface and the leakage current should not be over 0.05 milliamperes per microfarad. As the forming voltage is increased, the capacity of the cell is reduced and the leakage current increased. In an electrolytic condenser it is essential that the electrode and electrolyte be of high purity, otherwise objectionable leakage currents will occur and the film will not be permanent. The condenser described above will "reform" in twenty to thirty seconds after an idle period of one week.

#### TANTALUM CELL

The tantalum cell, popularized under the name "Balkite," is built around the peculiar properties of the rare metal, tantalum. Since tantalum will rectify in almost any conducting liquid, the electrolytic used is 1.200 sp. gr. sulphuric acid solution since this material is cheap, easily obtained and has a high electrical conductivity. The addition of 1% by weight of ferrous sulphate as a depolarizer increases the output and efficiency of the cell. The tantalum rectifier "forms" instantly, maintains its film almost indefinitely, and shows a negligibly small leakage. Furthermore it is almost unaffected by temperature and will rectify satisfactorily in a boiling solution.

The only drawback to the use of tantalum outside of the difficulty of obtaining the metal lies in its low breakdown voltage. The maximum working voltage is 30 volts per cell and the breakdown voltage is about 45. For this reason it takes six tantalum cells in a "B" socket power device to do the same work that can be done by one aluminum cell. The tantalum cell, however, is rugged, reliable, and has a long life. The small size tantalum trickle chargers have an average useful life of 1000 ampere-hours. Due to the reduced leakage and low internal resistance, the tantalum cell is more efficient than the aluminum cell, an ordinary 3-ampere battery charger having an energy efficiency in the cell itself of about 40%. Tantalum cannot be used for electrolytic condensers because of its high cost.

Ferro-silicon has also been exploited commercially as a rectifier. It operates satisfactorily in sulphuric acid solutions but has the low breakdown voltage of tantalum, combined with the leakage effects of aluminum and consequently is in general inferior to either of the above materials.

#### THERMIONIC RECTIFIERS

Under this heading are considered only those hot-filament rectifiers operating in such a high vacuum that the entire current is carried by an electron stream, as exemplified by the well-known "Kenotron" or "Rectron" tubes. These rectifiers are moderate in price and may be obtained in a variety of sizes; they are suitable for high voltages, are very reliable in operation, and are practically the only devices giving "perfect" rectification. Since they represent the best present answer to the problem of medium-current, high-voltage rectification, their properties will be considered in some detail.

Hot bodies emit from their surfaces small discrete units of negative electricity called "electrons." The rate of emission of electrons from a given surface is dependent upon the temperature and the nature of the surface, the emission increasing rapidly with rising temperature. When a heated filament is placed adjacent to a cold electrode in a highly evacuated vessel, electrons are shot off the filament and impinge upon the cold plate, imparting to the latter a negative charge and leaving the filament positively charged. This charge builds up to the point where the blanket of negative particles around the filament (space-charge) prevents by repulsion any further emission of electrons. If a source of e.m.f. be connected between the filament and plate in such a way as to make the plate positive, then the excess negative charge on the plate will be neutralized and a current will flow in the circuit, this current being carried between the filament and plate solely by the electron stream issuing from the former. If the polarity of the e.m.f. be reversed, that is, if the plate be made negative.

then this additional negative charge assists the space-charge in repelling the electrons shot off from the filament and as a result the flow of current in the circuit stops instantly and completely. Thus in this simple device we have an electrical valve much like an hydraulic check-valve, in that it permits the flow of current in one direction only. Unlike the electrolytic rectifier, this device (as long as it is maintained within normal operating limits) offers a practically infinite resistance in the closed valve direction, i. e., it has no leakage. Furthermore, its internal capacity is so small as to be negligible at commercial frequencies. Under normal conditions its operating characteristics remain remarkably constant during its useful life, independent of temperature, load, or prior treatment.

Just as the behavior of an electrolytic cell is dependent upon the chemical and physical nature of the active electrode, so the behavior of a thermionic tube depends on the chemical and physical nature of the filament surface. The ease with which electrons are emitted from the surface of a substance varies greatly among different materials but is characteristic with any given material. We all know that a relatively high temperature is necessary to evaporate mercury in the open air, whereas water boils with the application of gentle heat and chloroform evaporates freely of its own accord. In the same way, tungsten or platinum must be brought to a bright white heat in order to obtain sufficient electron emission for practical purposes; tungsten containing a small amount of thorium will operate equally well at considerably lower temperatures, whereas alkaline-earth oxides will function at a barely visible red heat. In this way we might classify thermionic valves according to the nature of their active surfaces. The plain tungsten or platinum filament is obsolete; the thoriated tungsten filament (as exemplified by the UX-216-B) has long been in favor but is now being displaced by the more efficient oxide-coated filament such as is used in the UX-281. The oxide-coated filament runs at the lowest temperature of the three and consequently is the most efficient in the sense that a much greater maximum plate current may be obtained from the valve for a given wattage expended in heating the filament. For purposes of interchangeability, the oxide filament of the 281 has been designed for the same current and voltage as the thoriated filament of the 216-B. As a result, at light loads the new tube is no more efficient from the standpoint of filament power than the older tube. However, it is possible to obtain safely much greater rectified currents from the new tube than could be obtained from the old one, and at these heavy loads the filament power becomes a smaller percentage of the total power in the circuit and thereby demonstrates superior efficiency.

The average useful life of an oxide-coated

filament is very great, exceeding that of any other type emitting surface now in use. It is very important, however, that the filament should not be overloaded by applying heating voltages above the rated values as overheating of the filament causes abnormal concentration of the emission on certain active "spots" and quickly exhausts the filament. When such exhaustion of an oxide-coated filament occurs, no restoration is possible, the tube being completely and permanently ruined. With the thoriated tungsten filament, however, the situation is different, inasmuch as an exhausted filament may often be "rejuvenated." In case of the thoriated tungsten filament the majority of the emission is from the traces of thorium present on the surface of the filament wire. This thorium is originally incorporated in the filament, either as a core of thorium oxide in the center of the wire or as a thorium alloy dispersed throughout the wire. In either case a temporary overload will exhaust the surface thorium. More thorium can be brought



THE 281—THERMIONIC RECTIFIER

to the surface from the body of the wire by "cooking" at a voltage slightly higher than normal, applying no voltage to the plate during this process. To rejuvenate the filaments in UX-216-Bs or UX-210s, they should be cooked at 9 volts for 30 minutes and then tested for emission. The "cooking" is continued in 30-minute periods until the emission shows no further improvement. There is no point in "cooking" longer than two hours, as any tube which has not reached an acceptable value after this length of time cannot be reactivated. To test the emission, the filament should be burned at exactly six volts, and 125 volts applied to the plate of a 216-B or 100 volts applied to the plate and grid together of a 210. Normal tubes will show an emission current of 150 milliamperes or more, but the performance of the tube will be satisfactory if the current is greater than 85 milliamperes. A UX-281 should be tested for emission with 7.5 volts on the filament and 150 volts on the plate. The emission should not be less than 200 milliamperes.

To prolong the life of the filament it is generally

(Continued on page 34)

## “Dress”

By C. J. Paddon\*

**D**RESS may convey to one's mind any of a number of impressions. It may, for instance, mean more money spent on the OW or, perhaps, a new pair of pants or even the business of making a straight line out of a company of soldiers. It is also used in engineering to imply those last little touches on a job that make all the difference in the world between a professional-looking, finished-appearing layout and something that just works. “Dress” is the index of the pride and thoroughness of the workman.

It seems to me that “dress” is a quality not usually found in amateur radio stations. The probable reason for this being that the amateur is usually so anxious to try it out once it is working, that the mere question of appearance doesn't seem to be of great importance.



FIG. 1

The type of stitch illustrated here will remain tight even though the pull on the cord running lengthwise is very light.

If the mere looks of a station were the only reason for “dress,” it would be of small importance but there is a great deal more to it than that: How many times has a dangling lead been the cause of a blown tube or meter? How many times has it been necessary to waste an hour or so in getting a haywire layout in shape, when a systematic installation would have speeded things up and allowed the particular job in view to be finished in half the time? How many times have you missed skeds just because the outfit went on the bum and it was impossible to locate the trouble due to the mess of wiring?

All right! That much for destructive criticism; how about something helpful? The simplest use of “dress” is the cabling of all leads carrying low-frequency or direct currents. Suppose, let us say, there are seven leads coming up to the set from a power supply on the floor. Why not take these

seven leads and run them along in a bunch. They can be lashed tightly together with a piece of hard cord using a “whip stitch” as shown in Fig. 1.

There are several manners in which the cord can be looped about the bundle of wires but only one that allows each individual loop to tie itself tightly in place. A careful study of the stitch

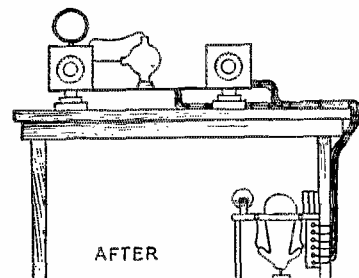
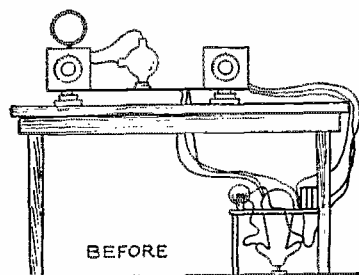

FIG. 2

*Giving some idea of how much water an operating table can be made by running all supply leads in a cable form. The cable should be run down the inside of the table leg to protect it from mechanical injury. For high voltage leads, “Packava” or similarly well-insulated conductor may be obtained. If you are afraid to trust the insulation on the high voltage leads you are now using, it is about time you obtained new wire with sufficient protection against breakdown.*

illustrated in Fig. 1 will show that the cord running lengthwise is passed under the loop which binds the bundle together. Each loop, therefore, locks itself in place and after it is pulled tightly in position, it is difficult to loosen or move it. That portion of the cord running lengthwise does not have to be pulled tightly in order to keep the loops from loosening. This is of extreme importance especially if the stitching is applied to a cable that has several twists or turns in it. Anyone who has tried to sew cable with a slip stitch will appreciate this.

If the cable is one of the more complex affairs

\*Electrical Research Products, 250 West 57th St., Chicago, Ill.



in which the many wires are fanned out to various instruments as it runs along, it would be best to cut the wires somewhat longer than they actually need be and start sewing from one end before cutting and skinning the other terminals to fit. In this way the wires can be fanned out as the position of the various instruments or binding posts demand without any necessity of their

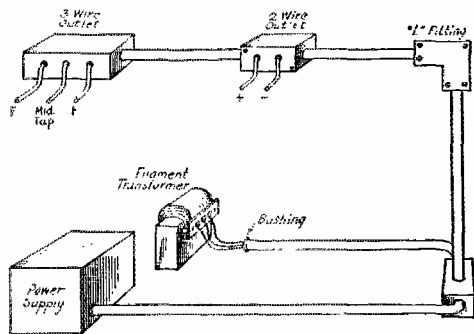

FIG. 3

A general idea of how conduit may be employed. It is particularly advantageous when the power supply is at a distance from the set. All sorts of outlet and switch boxes may be obtained at most any good electrical supply house. Pipe clips may be used to hold the conduit to the wall, floor — or what have you.

being doubled back along the cable or having part of their length which could be included in the cable run along outside of it.

The cable is started by bunching two or more wires together and after the cord is wrapped around the bundle twice, a square or flat knot is tied. From there on, stitching is employed and additional wires are taken into the bundle or fanned out of it as the circumstances may require. A few experiments will show how simple the job actually is. So much for cabling!

The next step in the right direction is to get some of the flexible metallic tubing known as Greenfield and run the wires in it. This tubing should, of course, be grounded because the nearer to ground potential power lines can be brought, the better off you are.

The best possible method would be to run the leads in conduit. This used to require a lot of pipe cutting and threading but, fortunately, there is now available, a line of fittings called "Kondu" that are attached to the pipe and make good contact without the necessity of threading. These fittings are not particularly expensive and the only tools needed are a hack-saw and a wrench. There is an unlimited assortment of tools to choose from and with the amount of ingenuity usually possessed by an amateur, a beautiful finished-looking job can be made.

After the conduit runs are in place they should be suitably grounded and given a good coat of black asphaltum paint which will be dry in an hour or so, leaving a hard glossy finish.

By the use of conduit, we supply ourselves with a shielded power supply line that reduces the fire hazard to nothing, which is a 1000% improvement in looks and which effectively banishes the old dangling lead hazard.

## Alternating Current Rectification as Applied to Radio

(Continued from page 37)

advisable to burn the same at a slightly reduced voltage. It is good practice to use a voltage from 5% to 10% below the rated value. Lower voltages may increase the plate resistance unduly and cause overheating. The practice of underburning is especially valuable in the case of oxide coated filaments, such as used in the UX-281. When burned at rated voltage these filaments have such a great total emission that if short circuited even momentarily, they will destroy themselves. When the filament is underheated, however, the emission is greatly reduced and under proper conditions the saturation current on temporary short circuit is not enough to damage the tube. Such protective underburning of the filament does not materially reduce the output of a tube as a rectifier, but causes the output wave to be flat-topped as shown in "H" of Fig. 1. In the case of UX-281s used on high voltage circuits it is advisable to further protect the tubes by the use of a suitable fuse, otherwise failure of a high-voltage condenser would immediately destroy the tubes. A six-volt dial light is convenient for this purpose; it will usually light to normal brilliancy when carrying the full output of a pair of 281s (150-200 ma.) but will burn out before the current becomes great enough to damage the tubes. A further method of tube protection by judicious design of the filter circuit will be taken up in the latter section on "Filters."

The guaranteed life of the UX-281 rectifier is 1000 hours, but in actual service it will average 3000 hours at full load. The tube was provisionally rated at 750 volts a. c. and 100 ma. output current, although the final rating was reduced to 700 volts a. c. and 85 ma. output. This means that with a single tube in a half-wave circuit (Fig. 2 A), it is possible to obtain 20-100 ma. at 500-700 volts; with two tubes in full wave circuit (Fig. 2 C), it is possible to obtain 150-200 ma. at 600-750 volts; using two tubes in a voltage-doubling circuit (Fig. 2 D), it is possible to obtain 80-100 ma. at 900-1400 volts, and using four tubes in the same circuit (two in parallel in each leg) 100-200 ma. can be obtained at the same voltages.

The voltage which can be applied across a thermionic valve is limited only by the value at which ionization of gas occurs, or arcing across the stem press. In the case of the 216-B, neither

(Continued on page 39)

# Notes on Distortion in Audio Frequency Amplifiers

By J. R. Nelson\*

**T**HE subject of resistance- and impedance-coupled amplifiers has been treated quite extensively. One phase of both resistance- and impedance-coupled amplifiers has been neglected. The stage preceding the power tube is called upon to deliver a large voltage in order to swing the grid of the power tube because there is no step-up ratio in voltage between the plate of the amplifier tube and the grid of the power tube as there is in the case of a transformer-coupled circuit. More distortion may be present in the resistance- or impedance-coupled amplifier than there will be in the transformer-coupled amplifier.

Experience has shown that about 5% of second harmonic voltage is the maximum value that should be present without a noticeable decrease in quality. This value is much greater than the maximum allowable value in some cases of telephone work which is 1.10%. Although 5% seems a rather high value, it may easily be exceeded unless care is taken in design of the amplifier.

The usual method of designing a resistance-coupled amplifier is to determine how much the low-frequency amplification may fall off from the

ification characteristic. For example, assume that the amplification at fifty cycles of a two-stage amplifier is required to be at least 80% of the maximum amplification. When the stage preceding the power tube was designed, it was found

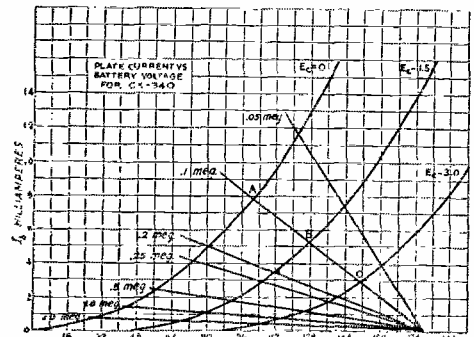

FIG. 2

that the above percentage was 85. The other stage must have its percentage of low frequency amplification to maximum at least 80 divided by 85, or 94%.

This article will develop and discuss the equation of a resistance-coupled amplifier. A method of calculating the input voltage required to give any voltage in the grid circuit of the succeeding tube will also be given. It will also call attention to the method of finding the approximate plate voltage swing for any input voltage for a resistance-coupled amplifier and how this method may be modified for the case of impedance coupling. A method of finding the per cent of second harmonic voltage from direct current readings will also be presented.

Fig. 1 shows the most general case of one stage of a resistance-coupled amplifier. The capacity,  $C_p$ , is the plate-to-filament capacity of the tube plus the wiring capacity.  $R_p$  is the external plate resistance and  $r_p$  is the internal plate resistance of the tube.  $C_c$  is the coupling capacity.  $R_g$  is the external grid resistance and  $r_g$  is the input resistance of the tube.  $C_i$  is the input capacity of the tube and is a function of the tube factors and impedances. It may, however, be taken approximately as the grid-to-plate capacity, plus  $A_v$  times the grid-to-plate capacity; where  $A_v$  is the voltage amplification of the next stage. The voltage  $e_{p1}$  acts as a voltage  $\mu e_i$  in the plate

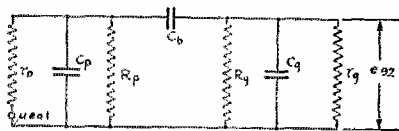

FIG. 1

maximum amplification per stage. The different stages are usually designed alike so the percentage of the low-frequency amplification to maximum amplification, designated here by  $K$ , is  $K$  to the  $n$ th power;  $n$  is the number of stages. For example, if the value of  $K$  for a single stage is 90%, the percentage of low-frequency amplification to the maximum amplification of a two-stage amplifier is 90% squared, or 81%.

The stage preceding the power tube is called upon for a large plate swing so that a more logical method of designing the amplifier is to design this stage so that it will deliver the required voltage with a minimum of distortion. This requires that its grid will not swing positive. The other stage or stages may be designed so that the amplifier will have the correct frequency ampli-

\* Engineering Department, E. T. Cunningham, Inc.

circuit where  $\mu$  is the amplifying factor of the tube. Solving for  $\Delta v$ , we obtain

$$\Delta v = \frac{e_{v2}}{e_{v1}} = \frac{gm}{g_1 \left(1 + \frac{C_v}{C_h}\right) + g_2 \left(1 + \frac{C_p}{C_h}\right) + j \left[ w \left( C_p + C_v + \frac{C_p C_v}{C_h} \right) - \frac{1}{w C_b} g_1 g_2 \right]} \quad (1)$$

Where

$$g_1 = \frac{1}{r_p} + \frac{1}{R_p}$$

$$g_2 = \frac{1}{r_g} + \frac{1}{R_g}$$

$$gm = \frac{\mu}{r_p}$$

The quantities  $C_v/C_b$ ,  $C_p/C_h$  and  $C_p C_v/C_h$  are negligible compared with unity,  $C_p$  and  $C_v$  and may be neglected. Equation 1 then becomes, neglecting the above quantities,

$$\Delta v = \frac{gm}{g_1 + g_2 + j \left[ w(C_p + C_v) - \frac{1}{w C_b} g_1 g_2 \right]} \quad (2)$$

When neglecting the phase angle, the absolute value of Equation 2 is

$$\Delta v = \frac{gm}{(g_1 + g_2)^2 + \left[ w(C_p + C_v) - \frac{g_1 g_2}{w C_b} \right]^2} \quad (3)$$

The real term of Equation 2 does not vary with frequency. The  $j$  term, however, varies with frequency being negative at a low frequency, passes through zero and becomes positive as the frequency is increased. From Equation 3 we can see that it is necessary to make  $C_b$  large if  $K$

frequency limit to the frequencies desired and make our amplification the same at both of these frequencies and greater at any frequency in between. Let  $w_1$  be two  $\pi$  times the low frequency and  $w_2$  be two  $\pi$  times the high frequency. Refer to the  $j$  term of Equation 2. At  $w_1$ , this term will have a certain negative value. If at  $w_2$  we so design the amplifier that this term has the same positive value, the absolute value of Equation 3 will be the same. Assume that  $g_1$  and  $g_2$  are fixed. We may then solve for  $C_b$  to fulfill this condition. Solving for  $C_b$  we obtain

$$C_b = \frac{g_1 g_2}{w_1 w_2 [C_p + C_v]} \quad (4)$$

Equation 3 will have its maximum value when the  $j$  term of Equation 2 is zero. This will occur when

$$w^2 = \frac{g_1 g_2}{C_b (C_p + C_v)} \text{ or } w = \sqrt{\frac{g_1 g_2}{C_b (C_p + C_v)}} \quad (5)$$

Harris\* solved for the approximate equations obtained by neglecting  $C_p$  and  $C_v$  for the value of  $C_b$  required to obtain any value of  $K$ .

$$C_b = \frac{r_p + R_p}{2\pi f_0 [r_g (R_p + r_p) + r_p R_p] \sqrt{\frac{1}{K^2} - 1}} \quad (6)$$

Where  $f_0$  is the low frequency considered.

Fig. 2 shows the family of plate-current plate-voltage curves of the CX-340 tube plotted for different values of grid voltages. If resistance coupling is used, the effective plate voltage is not the same as the "B" voltage because there is some drop in the external plate resistor. Fig. 2 is shown for a 180-volt "B" supply. Load lines are drawn in for different values of external plate resistors. The intersections of these lines give the effective values of plate voltages for the different curves.

The input voltage required for any plate voltage swing may be found approximately from these curves. For example, assume a 0.1-megohm resistor is used. The operating point is 127.5 volts with a grid bias of -1.5 volts. If the plate voltage swing is 26.3 volts we find that an input voltage of 1.5 will give this swing, as the difference between A and B of Fig. 2 is 26.3 volts. To the other side of the bias potential, -3.0 volts, the swing from B to C is only 22.9 volts. The difference between these values is 26.3 minus 22.9, leaving 3.4 volts. This difference is quite large and the amount of distortion would be too high.

Conditions may be improved by using a larger value of resistor. If the same grid bias is used and a 0.5-megohm resistor is substituted for the 0.2-megohm unit, the plate voltage swings, for an

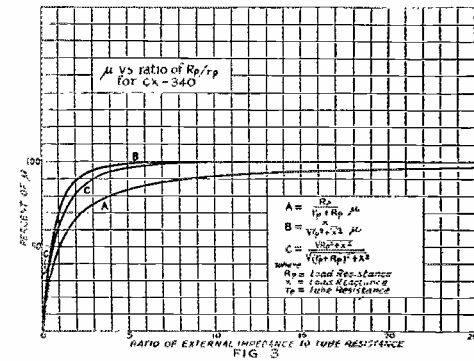

is to be high and to keep  $C_v$  and  $C_p$  small if the high-frequency amplification is to be kept up near the maximum value. The higher our resistances, the more noticeable is the falling off of amplification at both high and low frequencies.

We may, however, set a high- and low-fre-

\* Harris Notes on the Design of Resistance-Capacity Coupled Amplifiers. *Proceedings of the Institute of Radio Engineers*, December, 1926.

input of 1.5 volts with a negative bias of 1.5 volts, will be 34 and 33 volts. This is an improvement over the first case and the distortion would be much less. For an undistorted output the two swings should be equal.

When an impedance is used in the plate circuit, the plate-volts plate-current curve becomes a distorted ellipse instead of a straight line. If there is no distortion, the curve is a true ellipse. If the d.c. resistance is small, the operating point or plate voltage is practically the same voltage as the "B" voltage.

In Fig. 3, the voltage amplification is plotted in terms of per cent of  $\mu$  against the ratio of the external resistance or impedance to the internal resistance of the tube. Three cases are considered: first where the external load is a pure resistance, second when it is a pure reactance and third when it is a combined resistance and reactance. For the last two cases, the phase angles have been neglected. These curves are, however, a comparison of the absolute values of amplification. The curve for an external resistor approaches 100% very slowly.

From these curves we can see that no matter what kind of an external load we have it is possible to obtain the same absolute value of Av. by some external plate resistor. For example, if we have a pure inductive reactance whose value is  $2r_p$ , the amplification would be 80% of  $\mu$ . An external resistor whose value is  $8.2r_p$  would give the same absolute value of amplification.

As any plate load can be replaced with an equivalent  $R_p$ , the curves of Fig. 2 may be used for impedance coupling also. The equivalent value of  $r_p$  is found in Fig. 3. The d.c. operating point is taken as the "B" voltage and a load line of  $R_p$  is drawn through this point. When an input voltage is applied to the grid, the alternating plate current will vary between the plate voltages for  $E_c \pm e_g$ , where  $E_c$  is the d.c. bias and  $e_g$  is the input voltage.

From the example given above and Fig. 3, it can be seen that a small ratio of reactance to  $r_p$  is equivalent to a much larger ratio  $R_p$  to  $r_p$ . If a large plate voltage swing is required, above about 10 volts, impedance coupling should be used in the stage preceding the power tube to keep down the distortion as the larger  $R_p$  is, the less is the distortion.

The required value of  $e_g$  for any given value of  $e_c$  may be calculated from Equation 2. We will assume that Av. has its maximum value so the  $j$  term is zero.

$$\Delta v. \therefore \frac{e_{g1}}{e_{g2}} = \frac{gm}{g_1 + g_2} \tag{7}$$

$$e_{g1} = e_{g2} \frac{gm}{g_1 + g_2} \tag{8}$$

may be left fixed at 2 megohms. The value of  $r_p$  to use in Equation 8 may be found from Fig. 4.

After the value of  $e_{g1}$  is calculated, the distor-

tion should be checked from Fig. 2 by finding the plate voltage swings from  $E_p$  as the grid voltage is varied between  $E_c \pm e_{g1}$ .

When a voltage  $e_c$  is applied to the grid of a tube with an impedance in its plate circuit, the alternating current is

$$i_p = a_1 e_c + a_2 e_c^2 + a_3 e_c^3 \tag{9}$$

In the above "a" stands for an admittance and the subscripts denote the order of the admittance, that is:  $a_2$  is the admittance for  $e_c^2$ .

If we are working the tube as an amplifier on the nearly linear portion of the characteristic

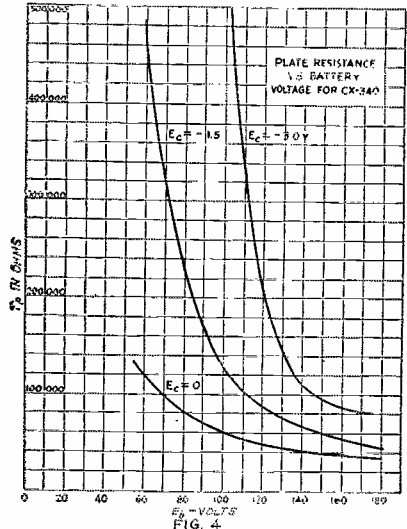

curve the first two terms will represent the plate current to a good approximation.

Let the input voltage be

$$e_c = A \sin t \tag{10}$$

where A is the peak value.

$$e_c^2 = A^2 \tag{11}$$

Equation 9 becomes:

$$a_1 A + a_2 (A^2) + a_3 (A^3) \tag{12}$$

Where  $a_2(A^2)$  denoted the admittance for the second harmonic and  $a_3(A^3)$  the admittance for the direct current.\*

When the u's are evaluated the values are found to be

$$u_1 = \frac{A}{r_p + Z_t} \tag{13}$$

$$u_2(A^2) = \frac{A^2}{r_p + Z_{2,2t}} \tag{14}$$

$$u_3(A^3) = \frac{A^3}{r_p + Z_{3,3t}} \tag{15}$$

(Continued on page 43)

\* The u's may be evaluated by the method given in the article by J. R. Nelson, Detection With the Screen Grid Tube, Proceedings of the Institute of Radio Engineers, June, 1928.

# A New Low-Power Screen-Grid Transmitting Tube

By O. W. Pike and E. E. Spitzer\*

**T**HE UX-865 is a four-element tube of the screen-grid type designed primarily for use as a power amplifier in transmitting circuits. Under this condition, it has a nominal output rating of 7.5 watts and is especially adapted for use on the higher frequencies. The tube is also very useful as a crystal oscillator.

The electrode structure of the tube is built as a single unit, entirely supported from the bottom. The filament is of thoriated tungsten in the shape of a double helix supported from a center rod and

the electrostatic field at the filament. Therefore, there can be practically no feedback through the tube from the plate circuit. In radio-frequency amplifier circuits this eliminates the necessity for neutralization to prevent feedback and oscillation.

The bulb is mounted in a "UX" base. The plate lead is brought out through a cap on top of the bulb instead of through the plate pin in the base; the latter serves as the screen-grid terminal. The control grid and filament are brought out through the usual "UX" base pins.

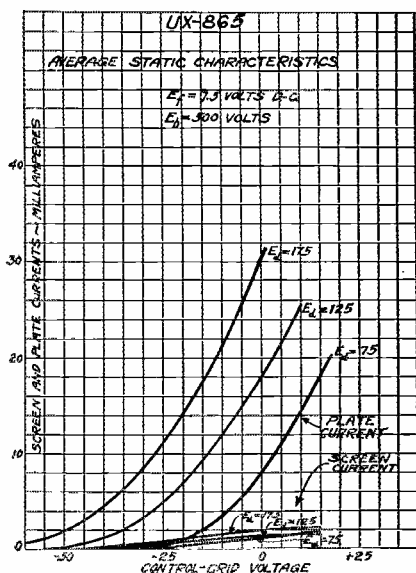

requiring no tension springs. All electrodes are cylindrical. The screen grid consists of a close mesh or winding mounted on side rods extending from a stem collar, and this forms the main supporting structure of the tube. The plate is suspended from this structure by glass beads. It has four fins for heat dissipation.

The function of the screen grid is to provide an electrostatic shield between the plate and the control grid. The voltage of the screen grid is held constant and variations in voltage of the plate have practically no effect on the control grid or on

### TECHNICAL DATA

The technical information on the UX-865, useful to the amateur, may be summarized as follows:

Main use . . . Oscillator or r.f. power amplifier  
Number of electrodes . . . . . 4

Filament:

Volts . . . . . 7.5  
Amperes . . . . . 2.0  
Type . . . . . Thoriated Tungsten

Average characteristic values calculated at:

$E_b = 500$ ,  $E_c = 0$ ,  $E_s = 125$ ,  $E_f = 7.5$  a.c.

$E_b$  = Plate voltage.  
 $E_c$  = Control-grid voltage.  
 $E_s$  = Screen voltage.  
 $E_f$  = Filament voltage.

Plate current . . . . . .021 ampere  
Amplification factor . . . . . 150  
Plate resistance . . . . . 200,000 ohms  
Mutual conductance . . . . . 750 microhms

Approximate direct interelectrode:

Capacities (I.R.F.)  
Plate to grid (filament and screen grounded) . . . . . 05  $\mu$ fd.  
Grid to filament and screen . . . . . 10.  $\mu$ fd.  
Plate to filament and screen . . . . . 7.5  $\mu$ fd.

Maximum overall dimensions:

Length . . . . . 6 1/4"  
Diameter . . . . . 2 3/16"

Base type . . . . . UX and cap

Type of cooling . . . . . Air  
(Oscillator and r.f. power amplifier.)

Maximum operating plate volts:

Modulated d.c. . . . . 500  
Unmodulated d.c. . . . . 500  
a.c. (r.m.s.) . . . . . 500  
Maximum d.c. plate current amperes . . . . . .060  
Maximum plate-dissipation watts . . . . . 15  
Maximum screen-dissipation watts . . . . . 3

\* Both of Research Laboratory, General Electric Co., Schenectady, N. Y.

Nominal screen-grid volts. . . . .	125
Maximum r.f. Grid Amperes. . . . .	5
Operation at Normal; $E_b=500$ , $E_c=(-)75$ , $E_f=125$ , $E_r=7.5$	
Output watts. . . . .	7.5

## USE

When using the tube as an oscillator or radio-frequency amplifier, the plate dissipation should never exceed 15 watts, which produces no color on the plate. Regardless of the actual value of input and output, the efficiency should always be sufficient to limit the plate dissipation, that is, the difference between input and output, to this figure. The d.c. plate current should be held below 60 milliamperes. Without exceeding the dissipation or plate limits, it is possible by careful circuit adjustment to obtain an output of 10 watts of useful power at frequencies up to, and including, the 14,000-ke. amateur band. The 7.5-watt output figure is, therefore, conservative. The maximum plate voltage for modulated or non-modulated oscillator or r.f. power-amplifier service is 500 volts. If, for this service, a self-rectifying circuit is used, the value of a.c. plate voltage should never exceed 500 volts effective.

The screen voltage of approximately one-fourth the plate voltage may be obtained from a separate source or from the plate supply through a series resistance of approximately 20,000 ohms. The latter, or resistance method, is most desirable as it automatically maintains a proper screen-grid current. With the resistance method the filament circuit should not be opened with the plate voltage on, as this will place full plate voltage on the screen. With potentiometer or a separate source of screen voltage, the screen voltage should not be applied without the plate voltage. The screen need never dissipate much energy for proper functioning and no portion of it should be allowed to attain a temperature of more than a cherry red color. In all cases the external impedance between the screen and filament terminals must be kept as low as possible by the use of r.f. by-pass condensers. In any case, the screen dissipation must never exceed 3 watts at any time.

Negative control-grid bias can be obtained from batteries or a gridleak and should have a value of about 75 volts. This value is not critical and can be varied to suit individual conditions. However, the use of less than 75 volts bias results in lower efficiency. A gridleak of 10,000 ohms will give approximately 75 volts bias. This requires a d.c. grid current of 7.4 milliamperes. If less excitation is available, a high-resistance gridleak can be used. The d.c. grid current, incidentally, is a very good indication of the amount of excitation. Grid currents between 5 and 10 milliamperes are sufficient to excite the tube to full output.

If the UX-865 is used as a straight amplifier (no frequency multiplication), the plate and grid circuits should be adequately shielded from each other to reduce any external coupling which may set the tube into oscillation.

When the tube is properly excited and shielded, it is excellently suited for driving the next largest screen-grid tube, the UX-860, or the corresponding three-element tube, the UX-852.

When using the UX-865 as a crystal oscillator, additional feedback external to the tube is generally necessary on account of the low grid-plate capacity. This is best accomplished by means of a small variable condenser connected from plate to control grid. About 10  $\mu\mu$  fd. maximum is sufficient in the 1750- and 3500-ke. amateur bands. It is best to connect a blocking condenser, which is insulated for the peak plate voltage, in series with the variable condenser, so that there is no danger of making a direct metallic connection between the grid and plate. By means of this feedback condenser, it is possible to adjust the load on the crystal very nicely and the danger of cracking the crystal by overloading is greatly lessened.

## CHARACTERISTIC CURVES

The characteristic curves for the UX-865 which are shown here are included for the purpose of supplementing the information given in the preceding description of the tube.

When the tube is used as a radio-frequency power amplifier and, occasionally, for special reasons, as an oscillator, the grid- and plate-voltage swings are

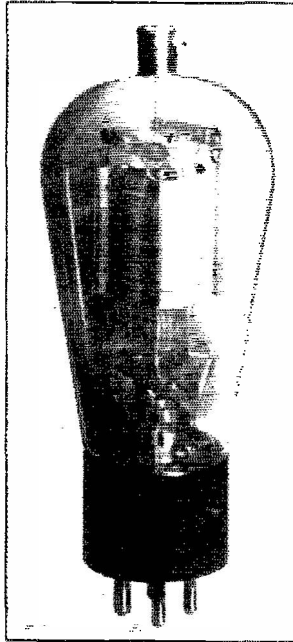

THE UX-865 SCREEN-GRID TUBE

*Though the UX-865 shown above might be expected to resemble the smaller screen-grid tube and the 210, it really has but little in common with them. Unlike the UX-222, the metal cap at the top of the tube does not act as the terminal for the control-grid. It is connected to the plate and insures high insulation against leakage and voltage breakdown. The control-grid connects to the grid terminal of the standard "UX" base and the screen is connected to the regular plate pin.*

*Instead of finding an oval plate as in the 210, the plate of the 865 is round and provided with four fins to aid in the dissipation of heat. The plate is supported at the top by glass leads that are in turn supported by the four rods upon which the screen is wound. These are firmly attached to a clamp that encircles the stem.*

much larger than it is possible to show on a static characteristic curve. Therefore, these curves serve only to illustrate the peculiarities of screen-grid tubes in comparison with three-electrode tubes. In practice, the action of the UX-865 in power circuits is not greatly different from that of similar three-element tubes excepting for the elimination of the feedback capacity.

Fig. 1 shows values of plate current and screen current plotted against plate voltage for several

Equation 13 is the usual amplifier equation and will not be discussed here.  $I^2$  is a function of internal and external impedances and the variations of the tube factors with input voltages. It will not be necessary to use the values of  $I'$  for our purpose, so it will not be given here.

The plate current of frequency  $2f/2\pi$  is given by  $a_{2(c0)}I^2$ . If we multiply this by  $e_s + Z_{s2}i\omega$ , we obtain the second harmonic voltage introduced in the plate circuit. This voltage is

$$E_{(2)} = FA^2 \tag{16}$$

Similarly we find the direct current voltage is

$$E_{(0)} = FA^2 \tag{17}$$

As the second harmonic voltage is equal to the direct current voltage, we may find the second harmonic voltage by finding  $E_{(0)}$  introduced in the plate circuit. To do so it is only necessary to apply a voltage,  $A \sin \omega t$ , to the grid and note the change in direct current. The d.c. voltage introduced in the plate circuit is then  $i_p + \bar{I}$ , where  $\bar{I}$  is the d.c. resistance of the plate load, times the change in direct current.

The voltage of frequency  $f/2\pi$  is  $\mu_1$  and the second harmonic voltage is equal to the d.c. voltage. The per cent distortion is then

$$\% \text{ distortion} = \frac{E_{2f}}{\mu_1 A} \times 100. \tag{18}$$

### Strays

In looking for a suitable form on which to wind a good radio frequency choke W7UJ came across the stand of an old "Kellogg" telephone. It was made of hard rubber, was 1 1/4" by 4 1/2" and held 125 turns of 26 gauge d.c.c. wire. The resulting choke proved thoroughly satisfactory.

"Hey YL, QRA?"  
 "Sa OM QRJ."  
 "Aw cum on LG QRD?"  
 "Say OM QRX or you'll wish you could QTA."  
 "Cum on be a sport QTFU?"  
 "You're gonna have to QRS! QRZ?"  
 "First you'll have to tell me QTS?"  
 "Well OM if you must know your QTFJ is too high, besides I'M QRL anyhow."  
 "Well QRY?"  
 "It's not a matter of QRM OM QRI so please QRT before I SOS and somebody gets QSR. QSE?"

"You don't have to QSH YL I'll QRP."

--- Ed Mace, ex W5EH.

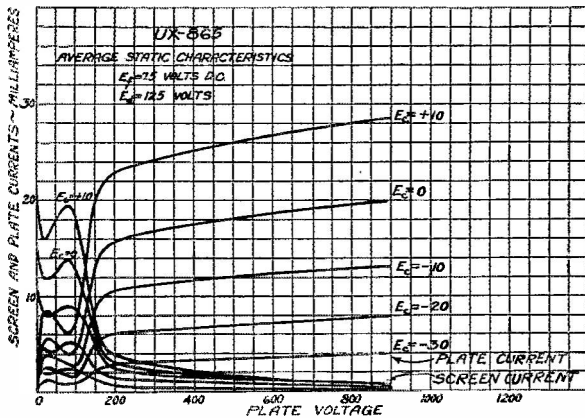

control-grid voltages and at a screen-grid voltage of 125. At the lower plate voltages, the plate current becomes very low due to secondary electron emission from the plate. The screen then draws electrons from both plate and filament, resulting in a screen current peak. As the plate voltage increases (with constant screen voltage) the plate current rises rapidly to its normal value while the screen current drops to a low value which in some cases becomes slightly negative due to secondary emission from the screen-grid. At its normal value, the plate current is practically constant although there is a slight increase because of imperfections in the screening as well as due to the secondary emission current drawn from the screen. In general, the slope of the plate-current curve in this region may be taken as a measure of the screening qualities of the tube.

Fig. 2 gives plate current and screen current plotted against grid voltage for three values of screen voltage and at the normal plate voltage. From these curves the mutual conductance may be calculated as with three-element tubes.

### Notes on Distortion in Audio Frequency Amplifiers

(Continued from page 43)

Where the subscripts for Z, the external impedance, have the same significance as they have for a,

# Calibrating the Heterodyne Frequency Meter or Monitor

By George Grammer\*

**A** FEW months ago there was a message in *QST* from H. P. M.: "If I were asked, 'What is the big outstanding problem in amateur radio today?' my answer would be, 'frequency precision!' Listen in a bit, especially on the old "40" and "20" bands, and then see whether you think the chief was very far wrong.

Naturally, there must be a period of readjustment to 1929 conditions, but in view of the hammering in *QST* on that subject, the only conclusion to be reached is that we were all so busy building those new transmitters and receivers that we neglected the frequency meters.

The object of this article is not to present another brass pounder's idea of how to build a frequency meter, but to point out a few ideas on getting the most out of a good one and to set forth a simple and convenient method of obtaining and keeping that very desirable accuracy of calibration which amateurs regard as practical perfection in frequency precision.

But first of all, let's see what we want our frequency meter to do. We're always being asked, "QRG?", but can we give the other fellow his frequency quickly and accurately? Well, most of us have to reach for the old coil-and-condenser meter, lift the lid on our receiver, jam the meter in among the "works," and then come up for air to read it. Chances are, if we held the meter an inch farther from the tuning coil the reading would have been different. Maybe the next day we're working on a different band and we get the same request. We have to take one coil out, put another in, and go through the same process again. Maybe we missed a point or two on that coil when W9XL was transmitting six months ago, and besides, the meter was dropped a few times since.

What do we want? Why, a meter that we don't have to move when we want to take a reading; one that doesn't require us to shift coils when we go from one band to another; one that we can calibrate once and use for all bands; and above all, one on which we can get a really accurate reading. The answer is simple — a vacuum tube oscillator or heterodyne frequency meter.

Although theoretically, we could use the same oscillator for all the frequency bands assigned to amateurs, practically, we are limited to three. Very well, let's make it cover the three most popular bands; 3500, 7000, and 14,000 kc. In a

pinch perhaps we can use it on 28 mc., but we won't worry about the fellows on that band — they can take care of themselves or they wouldn't be down there.

All right, let's go. We'll build the oscillator to cover the 3500-ke. band with a little overlap at the ends. When we're working on this band we

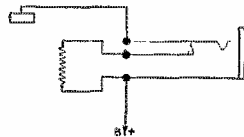

FIGURE 1 — When the phones are removed from the plate circuit of the oscillating tube the resistor takes their place and prevents a change in plate voltage which might cause the frequency of the circuit to shift.

use the fundamental frequency of the oscillator; on the 7000-ke. band, the second harmonic and on the 14,000-ke. band, the fourth harmonic. We find we can pick up the fourth harmonic in our receiver with adequate strength and if we listen closely on 28 mc. we can probably pick up the weak eighth harmonic.

There's been so much good dope in *QST* in the past year on how to go about building such an oscillator-frequency meter that it would be superfluous to give any constructional data here.\* We'll need a pair of phones in the plate circuit, and if we don't want to leave them there permanently we'll have to put in a 2000-ohm resistor to sub for them. The jack arrangement shown in Fig. 1 will take care of this automatically, the resistance being cut out when the phones are plugged in. 22½ volts are plenty for the plate of a 201-A. The same filament battery may be used for both receiver and frequency meter and will usually furnish sufficient coupling between them. Of course, we'll want a vernier dial that can be read accurately. Incidentally, let's put that dial on the condenser so that when the plates are all out the dial will read 100. Then we'll have a scale which will increase as the frequency increases, making it lots easier for us to think in kilocycles.

Now we have our "1929" frequency meter, but we have to calibrate it before it will be much good to us. Where are our "standard" frequencies to come from? To be sure, W9XL broadcasts them, but the next transmission is ten days off, and any-

\* See page 9 of the August, 1928, and page 9 of the October, 1928, issues of *QST*. — EDITOR.



how that's our night with the YL. Well, there are lots of commercial stations above and below our bands but we don't have an up-to-date list of their frequencies,\* and besides we want to get our points inside the amateur bands. Guess the only thing we can do is to go up to the broadcast spectrum. Old stuff, no doubt, but let's do it correctly.

We need an oscillating receiver on the broadcast band from which we can pick up harmonics on our new frequency meter. We hear a loud groan from the chap in the background. "My B.C.L. set is downstairs in the living room and besides it doesn't oscillate."

Take a look at Fig. 2. Then dig that discarded "3-circuit tuner" out of the junk box, together with an old socket and a variable condenser. The fixed condensers and leak will be found in the junk, too. Run the filament and plate wires as shown, to an old tube base. Put a clip on the end of a long lead from the aerial connection on the tuner.

Now we're ready to start to work. We take the detector tube out of our receiver and plug in the "adapter," putting the tube in the latter. Then we put the clip on our antenna lead-in. Don't bother about a ground if one isn't already connected through the filament. We plug the phones into our receiver and hear some music. FB! It works!

Now let's look at the table. Maybe the stations shown under the various frequencies don't come through so well at your location. If not, put in those that do. Starting at the top, we tune in WTAG, 580 kc. Making our adapter oscillate as strongly as possible, we adjust to get zero beat on WTAG.† The oscillations must be strong enough so the sixth harmonic can readily be heard in the frequency meter. Then we listen around the low-frequency end of the band on our frequency meter, find the harmonic, and adjust to zero beat with it. Now we jot down that dial reading as 3480 kc. Some sort of switching arrangement will be convenient to transfer the phone from one set to the other. Now we go back to the broadcast adapter. The next station is WEEL, 590 kc. We tune a little below WTAG and hear a station, but we don't know whether it's WEEL or not, and it's probably too weak to catch the announcement. However, we don't worry, because this station, being next below WTAG, must be on 590 kc., so we proceed as before and jot down the point for 3540 kc. We go down the band in this way, listening to announce-

ments from some stations and "predicting" the others. We must be careful on our "predictions" to be sure we don't skip over some frequencies and throw ourselves out, but this will not happen

<i>Calibration Frequency kc.</i>	<i>4th Harmonic Station</i>	<i>4th Harmonic kc.</i>	<i>5th Harmonic Station</i>	<i>5th Harmonic kc.</i>	<i>6th Harmonic Station</i>	<i>6th Harmonic kc.</i>
3480.....	WLS	870			WTAG	580
3500.....			WLW	700		
3520.....	WQAN	880				
3540.....					WEEL	590
3550.....			WOR	710		
3560.....	WJAR	890				
3600.....	WMAK	900	WGN	720	WCAO	600
3640.....	Canada	910				
3650.....			CNRM	730		
3660.....					WIP	610
3680.....	WWJ	920				
3700.....			WSB	740		
3720.....	WIBG	930			WDAE	620
3750.....			WJR	750		
3760.....	WCSE	940				
3780.....					WOS	630
3800.....	WRC	950	WJZ	760		
3840.....	CKGW	960			WAU	640
3850.....			WBBM	770		
3880.....	WCFL	970				
3900.....			WNC	780	WSM	650
3920.....	KDKA	980				
3950.....			WGY	790		
3960.....	WBZ	990			WEAF	660
4000.....	WOC	1000	WSA	800		
4020.....					WMAQ	670

if a little judgment is exercised. If our broadcast adapter is off by 1 channel (10 kc.), the error will be multiplied by the number of times the harmonic frequency is greater than the fundamental. Thus the error will amount to between 40 and 60 kc. under these conditions and will be readily detected. On some frequencies, for instance 3600 kc., we can check the different harmonics against each other. When we have all the points we can get, we plot them on cross-section paper and find that if we have worked carefully the line of points will be surprisingly uniform. A smooth curve will iron out the "wild" ones.

Now just what degree of precision can we expect from this method? Probably many broadcasters are not keeping on their frequencies as they should, but there is no doubt that those stations on frequencies from 550 to 1000 kc. are being checked pretty closely by the Department of Commerce, since they are on the "preferred" frequencies, and in many cases have exclusive assignments. Broadcasters are required to keep within 500 cycles of their assigned frequency and at 550 kc. this represents a maximum error of .09% while at 1000 kc. it is only .05%. Surely this is good enough for us. If we have done our calibrating with reasonable care we can be sure that our percentage error will not be more than 1/10 of 1%, which means a reading within 3.5 kc. on 3500; 7 kc. on 7000 and 14 kc. on 14,000. It may even be less, as small inaccuracies in the fundamental frequencies will average themselves out if as many points as possible are obtained. As

(Continued on page 48)

\* Those who may be interested in the high frequency assignments will find a complete list of channels above 1500 kc. and the stations to whom they are assigned in the November, 1928, issue of the Proceedings of the Institute of Radio Engineers. Copies may be obtained from the Institute, 33 West 39th Street, New York City for \$1.00 each - Editor.

† The music will be chewed up for all but the point of zero beat at which setting it will be good unless the frequency of the transmitter and receiver do not hold in step. The higher audio frequencies will be clipped, however.

-- EDITOR.

# The Disc Condenser

By Milton A. Ausman\*

**T**HE cost of condensers has at times formed prohibitions in the way of constructing reliable transmitters and it is my purpose to bring out (not originally, however, but more to general use) a cheap, simple, and efficient condenser of the disc type.

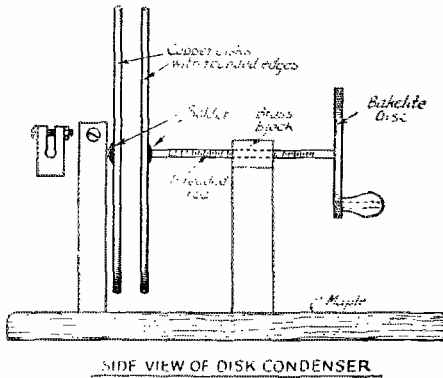

attenuated at the higher frequencies) and the frequency of the voltage across it. The rolled or rounded edges have the effect of reducing corona which in itself causes ionization and results in condenser break-down.

A curve is given showing the approximate breakdown voltage at 60 cycles but it must be understood that at least twice this spacing must be used at radio frequencies and for the very high frequencies, a further increase in the spacing should be made. The curve given is calculated from the formulas of F. W. Peek, Jr., which are given in his paper delivered before the New York Electrical Society, October 26, 1923.

A curve is given for the capacitance of disc condensers of various disc diameters as calculated from the formula:

$$C = \frac{2,248 K a}{d \times 10^9}$$

where:  $C$  = the capacity in microfarads  
 $K$  = the dielectric constant (1 in this case for air)  
 $a$  = area in square inches  
 $d$  = distance between the plates in inches.

There is no use of making either the device or its description complicated. The drawing shows

The breakdown voltage of this condenser is relatively high and depends upon the spacing between plates, the radius of the edges, i.e., the

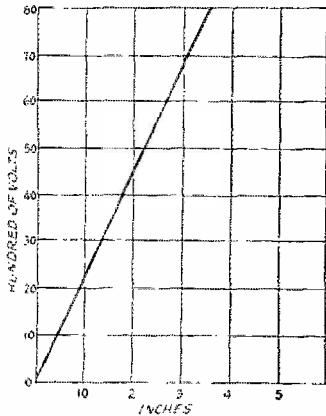

FIG. 1

This shows the breakdown voltage on 60 cycles. This does NOT hold for radio frequencies but the spacing should be about twice that indicated. For the very high frequencies, the spacing should be increased still further.

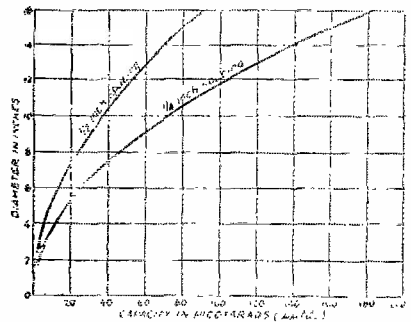

FIG. 2

The capacity of the condenser may be found by means of these curves if the spacing is either  $\frac{1}{2}$  or 1 inch. For other values of spacing, the capacity may be calculated as described in the text.

the details of its construction and its size can readily be varied to suit one's needs.

For those who are not mathematically inclined the simple rule may be given that if we wish to double the capacity we must double the plate area or half the distance between the plates. If we wish to double the breakdown voltage we must

greater the radius of the edges the higher will be the breakdown voltage, this being particularly

\* Engineer, National Radio Tube Company, 342-18th Street, San Francisco, Cal.

(Continued on page 83)

# A Simple Home-Made Meter

By Stanton Chapman\*

**G**OOD electrical meters are always worth their price, but frequently the experimenter cannot have all the meters he would like. Most types of meters are too tricky a job to be attempted at home, but the "hot wire" type is simple, and a good one can be made out of odds and ends found around in the average workshop. Hot-wire meters have disadvantages. They are not very accurate,

right-hand end of this bracket is doubled on itself to make more thickness for the thread of the adjusting screw. This screw should have a fine thread and must be long enough to project through the side of the case. If fine thread taps are not available, a nut may be soldered to the bracket instead of threading the hole. The brackets are fastened to the base by two 6-32 bolts. One bolt in each bracket sticks out at the back and these are the terminals of the meter.

*Bend on dotted lines*

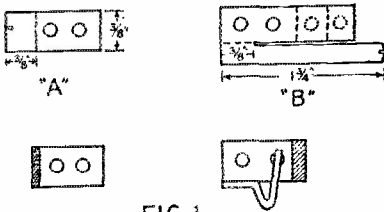

FIG. 1

particularly at the lower end of the scale, unless made with the greatest care and precision. They are easily burned out on an overload, and they must be corrected for variations of temperature. Nevertheless, they have two outstanding advantages for the experimenter; they will measure alternating current and direct current equally well, and they will indicate radio frequency currents with fair accuracy.

The spindle for the pointer movement is part of the clock works. (NOTE: A defunct dollar watch will also provide a spindle and bearings.) Cut away most of the brass frame that supports the wheels, leaving only enough to carry the balance wheel and its bearings. (See Fig. 2.) The hair spring is discarded as it will not be used. The pointer can be a piece of very thin stiff wire, but a carefully selected broom straw makes a very good one. It can be fastened to the balance

The first meter attempted should be of a fair size. A standard four-inch alarm clock will provide a nice glass-fronted case with plenty of room for the "works."

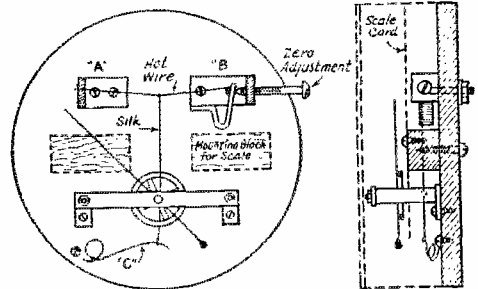

FIG. 3

A disc of radio panel material or hard wood, is cut to fit the clock case and makes a base board upon which to mount the movement.

wheels with thread or sealing wax. A knob of wax on the lower end of the pointer will balance it.

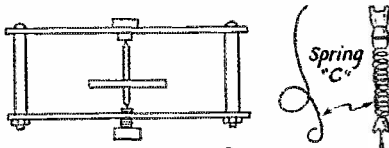

FIG. 2

A small spring is made from thin brass wire. (Fig. 2c.) The little spring on an auto tire valve can be straightened out and re-bent to the shape of the sketch.

If wood is used it must be boiled in wax. This improves its insulating qualities and prevents shrinkage and expansion due to weather changes.

The parts are assembled on the base, and two small wooden blocks are screwed in the position shown in Fig. 3. The card scale is fixed to these by small screws. And now all that is needed to finish the meter is a bit of silk thread and the "hot wire."

Two brackets are cut and filed from 1/16" sheet brass. (See Fig. 1.) Bracket "A" is just a simple angle. Bracket "B" has a tongue that is bent to form a spring to put tension on the wire and to provide the zero adjustment. The

The size of the wire used will determine the range of the meter. Naturally, the smaller the wire, the more sensitive the meter. Small resistance wire can be purchased but excellent wire may be found in a burned-out pocket B-battery tester. Most of the inexpensive voltmeters that read to 50 volts or more are wound with two coils, one on top of the other. The inner winding

\*W4LD, Box 175, Sewanee, Tennessee.

is copper wire, and the outer one resistance wire, usually about No. 40, slightly over three thousandths of an inch in diameter.

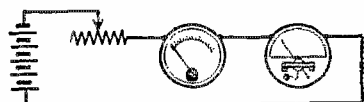

CALIBRATION BY STANDARD AMMETER

FIG. 4

About two inches of this wire is soldered between the brackets, and the silk thread is attached to its center by a small wire hook. The silk is given one turn around the balance wheel spindle, then a loop is tied and hooked over the tension spring. The adjustment of this spring is important. There should be a slight sag in the wire when it is cold, and the tension spring should just take up the slack when it is hot to give a full scale reading. After a few trials this adjustment can easily be found.

With this size of wire the pointer should begin to indicate at about 100 milliamperes and give a full-scale reading of about 400 milliamperes. With a 5-ohm shunt across the terminals it will read from about .5 to 1.5 amperes. (This makes a good antenna meter for a low-power radio transmitter.) With a 1.25-ohm shunt it will read up to 5 amperes. As a voltmeter, it will indicate about 2 volts, and with an 8- to 10-ohm rheostat in series will read 6 volts full scale. This type of voltmeter must not be left in the circuit, as it takes too much current — 0.25 amperes at 6 volts.

If a plate milliammeter for an amateur radio transmitter is desired, smaller wire must be used.

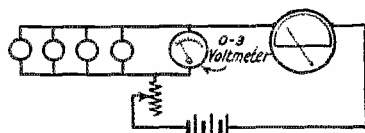

CALIBRATION BY 199 TUBES

FIG. 5

Wire two thousandths of an inch (.002) in diameter will give a reading from about 60 to 250 milliamperes; wire .0015 inch in diameter will work from about 30 to 150 milliamperes. The writer has a home-made meter in use with .00125 diameter wire that reads from 20 to 125 milliamperes.

It must be noticed that the above indicated scale readings are only approximate, and wide variation from these values may be found in some cases. This is because many factors control the actual scale deflection obtained — the tension of the spring, the friction of the bearings, the weight of the pointer, and most important of all, the length and temperature coefficient of the wire. However, after having obtained some wire, a few experiments will soon show what it will do.

If the wire is too large it may easily be reduced in diameter by careful grinding between an oil-stone and a bit of plate glass, using kerosene as a lubricant. A little fine emery powder will speed things up. The .003 wire referred to above can be reduced to .0015 in about ten minutes after a little practice. A machinist's micrometer should be borrowed to test the diameter.

The meter should, of course, be calibrated in a circuit with a standard meter and a variable resistance as shown in Fig. 4, but if no standard is available, rough scale points can be obtained, for a milliammeter, by connecting the meter in the A-battery lead of a radio receiver, using 199 or 299 tubes. (See Fig. 5.) One tube takes 60 milliamperes, two tubes take 120 milliamperes — and so on. Higher readings can be obtained from 201-A tubes, which take 250 milliamperes, or 0.25 amperes each.

In conclusion, note that a hot wire meter *must* be in a case, for even a slight draft will cool the wire and give a low reading.

## Strays

### That Silver Cup

Did you read page 37 of the March issue? If you did, and have failed to send in your Station Description, you are neglecting a chance to gain one of the laurels of Amateur Radio — or else you're ashamed of your station. Do it now!

We said last month that we would publish a picture of the cup in this issue. Unfortunately we were unable to get it in time but will print it next month.

QST is fully indexed — every issue, as soon as published — in a set of cards. These cards bring to your finger tips any article on any subject in QST or in any one of 1,700 other journals in all languages. This is the Engineering Index Service, instituted in January, 1928, which is to be found in the Public Libraries of Newark, Cleveland, Bridgeport, Baltimore, and the John Crerar Library, Chicago.

## Alternating Current Rectification

(Continued from page 47)

of these types of failure occurs until well above the rated voltage. The 281, however, is more likely to contain gas and excessive voltages must be avoided. Even when operating within the normal range a slight blue glow between the filament and plate shows that some ionization is occurring.

The efficiency of the 281 tube when working at full load is of the order of 65%, and the overall efficiency of the rectifier plant, including transformer and filter losses, should be 55%, with a voltage "regulation" on the output of the filter circuit of not more than 1.5 volts per milliamperere change in load.

(To be concluded)

# The Resonance Effect of Receiving Antennas

By Chauncey Coston\*

**O**NE of the most annoying effects a set builder encounters at the higher frequencies is the resonance effect of receiving antennas. This effect, variously called "resonance effect," "damping effect," "energy absorption" or "tuning hole," prevents the oscillation of a regenerative receiver on certain frequencies and does not permit the most efficient operation of the receiver at all frequencies.

No doubt everyone working a receiver has found a certain setting of the secondary condenser or main tuning dial where the set could not be made to oscillate even by increasing the amount of regeneration by an adjustment of the regeneration control dial. Although the regeneration could be increased until the set would howl on each side of the point in question, no oscillations could be obtained at that point. This prevents the reception of c.w. signals and, if the effect comes in the center of an amateur band, it is very troublesome. The resonance effect is further annoying because it does not keep sharply at a definite frequency but depends upon the proximity of the antenna system and the power of the oscillating receiver. The effect is likely to extend over a wide band of frequencies which can be narrowed to some extent by increasing regeneration. However, this brings in another disagreeable element because in most receivers the adjustment of regeneration has an effect upon the tuning of the grid circuit. Any large adjustment of the regeneration will then call for retuning of the grid circuit.

A receiving aerial with its ground connection, lead-in and antenna coupling device (whether inductive or capacitive) forms a system resonating at a definite frequency. My 90-foot grounded aerial with its 15-turn coupling coil has a resonance period at about 2500 kc. (120 meters). It would be less without the loading effect of the coupling coil. This is approximately the fundamental frequency of the antenna system (approximate because of the loading coil, the true fundamental being an unloaded system). That is, this system forms a tuned circuit due to the capacity between the wires and their inductance which resonates at 2500 kc. Now, the effect of a tuned circuit is to absorb energy from any oscillatory system in close proximity. When the tuned circuit is brought too close (tight coupling) to the oscillating circuit, it will tend to absorb more

energy than the oscillator is capable of supplying and the oscillations will be completely damped out. (You are all familiar with the action of a frequency meter in stopping the oscillations of a receiver when tuned to the same frequency and coupled tightly to it.) The absorption or resonance effect at 2500 kc. prevents the receiver from oscillating at that frequency as long as the antenna is coupled tightly enough to the receiver so as to absorb a great deal of energy from it.

However, the effect of the antenna is not limited to 2500 kc. If it were we would say, "Huh! I don't want to hear anything at 2500 kc., let it damp." The effect is obtained at the har-

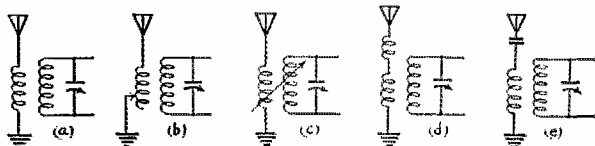

FIG. 1

monics of the system as well as at the fundamental frequency. Under the particular set of conditions existing in my case, instead of following down in regular harmonic relation, absorption is found at only the even harmonics. There is no effect at the odd harmonics.

The effect is so broad at the higher frequencies that the poor receiver refuses to oscillate when coupled at all tightly to the antenna and this is one of the greatest difficulties in operating a receiver above 20,000 kc. It is the main reason for using a short aerial which keeps the absorption points from coming so close together as to blanket the entire range of the receiver.

Having stated the matter in as clear and discouraging manner as possible, let us look around for partial remedies. I say partial because I have not found anything to eliminate the resonance effect, although several semi-remedies are at hand.† In the antenna system shown in Fig. 1a, there are four simple methods of so changing its characteristics as to be of aid in this matter. Of course, one can always do this by changing the length of the aerial, a most excellent method, but who wants to go out and climb thirty or forty feet when there are simpler and quicker methods?

(Continued on page 55)

† The author is not considering the use of a coupling tube as employed in the "1929" receiver shown on page 9 of the November, 1928 issue. Undoubtedly, many will find it undesirable (for financial reasons mostly) to use the untuned r.f. stage and must resort to some of these methods for overcoming their trouble. — Editor.

\* W7ABN, 924 Smith Avenue, Hoquiam, Washington.

## Experimenters' Section Report

**P**ROBABLY one of the chief reasons for the popularity of experimental work is the fact that there are such a large number of diversified paths along which the experimenter may roam. Unlike the traffic handler or DX hound, his objectives are not so well defined, neither do they remain so firmly fixed. One may prospect along a certain trail and find before reaching its end many other by-ways which rival and even excel in their mysteries the original path. The wise experimenter follows along to its ultimate destination the path upon which he has first set his feet and at his journey's end retraces his steps to the intriguing side-way to further prospect its values.

Because of the many and varied problems, we find among those reports on hand for this month no two that deal with subjects closely related. There should be something of interest to most every experimenter. Perhaps we should point out that if you want to see something in a future issue concerning your pet experimental problem, this would be an excellent time to send in a report on it. There is only one more suitable time at which to send in your report — yesterday.

### TO CRYSTAL OR NOT TO CRYSTAL

With the change to the new frequency bands allocated for amateur operation by the I.R.C., many have probably found themselves with crystals suitable for operation in only a small portion of the available territory. One simply hates to give up a crystal-controlled transmitter and go back to the not-so-stable variety particularly after having gone to all the fuss and

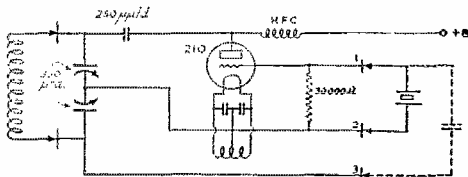

FIG. 1 — The circuit arrangement whereby either a crystal or self-excited oscillator may be used by simply plugging in either the crystal or a panel condenser. No other circuit changes are necessary.

expense of getting a crystal job in good running order. If it is not possible to regrid the crystal for general amateur operation, the next best thing is to use it in those bands for which it is suitable and change over to an oscillator-amplifier arrangement for the other frequencies.

An excellent suggestion along this line is due to John J. Long, jr., W8ABX, of 205 Prospect Street, Canandaigua, N. Y. He recommends the

use of the Colpitts circuit in place of the crystal oscillator. The arrangement is shown in Figure 1 and does not require any complicated switching system or change in the circuit constants when going from one type of oscillator to the other.

A pair of General Radio plugs act as the terminals of the crystal holder which is plugged into a pair of jacks on the transmitter panel. These would be the jacks numbered 1 and 2 on the diagram and they should be mounted along a horizontal line. A Sangamo condenser is equipped with another pair of G.R. plugs and connects between jacks 1 and 3 as shown by the dotted line. The third jack may be mounted directly above the first one so there will be no confusion nor tendency to plug the crystal in the wrong terminals where it may be required to handle a larger amount of power than it is capable of safely taking care of.

Three plug-in coils are employed to cover the 3500-, 7000- and 14,000-ke. bands and if the crystal is in the 1750-ke. band another coil may be constructed to meet these conditions.

If the succeeding amplifier needs to be neutralized, the r.f. feeder to its grid may be taken from plate end of the two plate-tuning condensers and the neutralizing lead may come from the condenser connected to jack No. 3. From that point it connects through the regular neutralizing condenser to the plate of the amplifier tube.

### DESIGN OF INDUCTANCE COILS

Editor, QST:

In connection with the article on the design of Inductance Coils by D. R. Clemons in the February issue of QST, may I add just a few observations to your contributor's remarkably clear and concise exposition.

I should first like to draw your readers' attention to an exceptionally good series of abacs designed to assist constructors in deciding on the form and size of coils for various purposes. The abacs referred to have been appearing in *The Wireless World*\* during the last two months and enable one to calculate the inductance of a coil or, conversely, the size and shape, etc., for a given inductance. Corrections are given for almost every conceivable factor. Obviously, it is almost

\* *The Wireless World and Radio Review*, published by Hiffe & Sons Ltd., Dorset House, Tudor Street, London, E. C. 4, England. Subscription rate to foreign countries other than Canada 19s. 6d. per year. To Canada and England, 17s. 4d. Published weekly. The abacs referred to started in the issue dated July 11, 1928 and cover a great variety of calculations. Those which appeared in the December, 1928 and January, 1929 issues have been devoted to the design of inductance coils. — Editor.

impossible to compute the self capacitance of a coil though, I believe, allowance has been made to compensate for errors due to self capacitance.

As your contributor points out, the parallel resonance effect is often neglected but it is also often over-stressed. It may, I think, be safely assumed that the coil which has the lowest r.f. resistance will also have the lowest self-capacitance. As that statement is a generalization, I hope that none of your readers will take it quite literally as there are obvious exceptions. Nevertheless it is made because the r.f. resistance of a coil at any and all frequencies can be accurately measured with or without its associate components. Incidentally, the factors that contribute to a low r.f. resistance contribute in no small way to the reduction of self-capacitance as can be seen by carefully considering the factors involved.

Obviously, the parallel resonance effect quoted is utilized in the design of wave traps as is mentioned in the article and resistance, both ohmic and r.f. (to differentiate the types) is a primary consideration and, one might add, the deciding

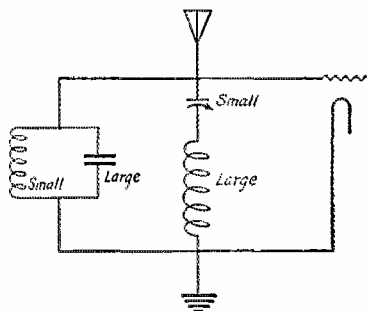

FIG. 2 — The general relationship between the values of the various units for the construction of a successful wave-trap is given above. The trap should be of very low resistance for satisfactory operation.

factor in the efficiency of a wave trap. A little consideration of the principles involved will show the reason for the exceptional inefficiency of so many wave traps on the market. In almost all cases the C:L ratio is far too small. In considering the case of Fig. 2 it follows from the equation:

$$I = V \left( \omega C - \frac{1}{\omega L} \right) \quad (1)$$

that at the resonant frequency  $I = I_1$  and, as both these current components will be 180 degrees out of phase, the power absorbed will, except for the small transient periods referred to, be nil, provided the resistance is nil. It follows, therefore, that the logical way to keep the resistance to its lowest possible value is to employ the largest possible ratio of C:L and the condensers employed should be of the mica variety to keep such losses low. The inductance must also be of low resistance and must be so designed that minute variation is possible.

In most commercial wave traps a not too-efficient inductance is shunted by a small condenser of uncertain efficiency resulting in a woefully bad performance which in turn results in the condemnation of wave traps in general though they can be very efficient if designed on the principle enumerated.

A certain test of the efficiency of the wave trap

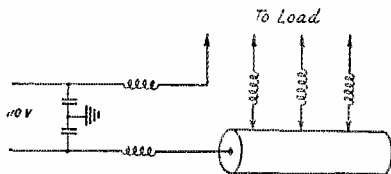

FIG. 3 — The filter arrangement employed to eliminate interference caused by a siren waker. The chokes seem to be responsible for a great deal of the effectiveness of the system.

is to connect and disconnect it while a signal of average intensity is being received. No diminution of the incoming signal will be observed if the trap is functioning correctly. An efficiency of well over 95 per cent is obtainable with a well designed unit. As one approaches the lower frequencies considerable modification is necessary in practice. This has been dealt with in detail in QST at various times.

May I in conclusion point out that a very fertile field for those experimentally inclined lies in the construction and design of astatic and toroidal inductances for the higher frequencies. So far as the writer is aware, no data has been published. However, as they work satisfactorily in the broadcast band and result in simplification of screening and a general reduction in eddy current losses, there appears to be no reason why they should not be employed in high frequency receivers.

Thanking you for your assistance in the past and wishing QST, its Staff and contributors further success, I remain

— John A. MacLaggart,  
H.M.C.S. Stadacona, Halifax, N. S.

-----  
DECIBEL

Edward H. Webber, Jr., W3AAX, of 7226 Hazel Avenue, Bywood, Delaware Co., Penn., writes as follows concerning the decibel.

"In the year 1924, telephone engineers of this country adopted the 'transmission unit,' commonly known as the TU, as a standard in evaluating the losses on various circuits and apparatus. This unit was defined by stating that two amounts of power differ by 1 TU when they are in the ratio of 10:1 and any two amounts of power differ by N TU when they are in the ratio of 10<sup>N</sup>:1. In other words, the number of transmission units in the case of two powers P<sub>1</sub> and P<sub>2</sub> is equal to 10 log<sub>10</sub> P<sub>1</sub>/P<sub>2</sub>.

"Recently, the term 'decibel' was adopted for use instead of the 'transmission unit'. The decibel retains the same value and definition as the TU but is further defined as 1/10th the value of a fundamental unit which is known as the 'bel'. Thus the bel would be defined by stating that two amounts of power differ by one bel when they are in the ratio of 10<sup>1</sup>. The number of bels in the case of two powers, P<sub>1</sub> and P<sub>2</sub> would be equal to log<sub>10</sub> P<sub>1</sub>/P<sub>2</sub>.

"However, this is a relatively large unit and is seldom used so we will consider the decibel which is abbreviated 'db.'

"To further clarify the meaning of this unit let us consider some practical applications. Suppose a

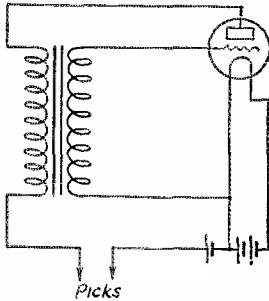

FIG. 4 — The continuity tester. It is superior to the regular phone and battery method in that an open circuit having high capacity will not give a continuous response.

certain amplifier has an input of 10 milliwatts and an output of 40 milliwatts at frequencies for which it is designed. Then, the number of decibels could be found in the following manner:

$$\begin{aligned} \text{Let } x &= \text{the gain in db} \\ x &= 10 \log_{10} 40/10 \\ x &= 10 \log_{10} 4 \\ x &= 10 \times 0.602 \\ x &= 6.0. \end{aligned}$$

This amplifier would be said to have a gain of 6 db.

"Next consider a choke coil which is designed to prevent the passage of all current at certain frequencies. Assume that the power input is 100 milliwatts and the power output is 5 milliwatts at some definite frequency. It is evident that this would be a loss rather than a gain and the most convenient method of solving for losses is to use the larger amount of power as the dividend in the power ratio; thus:

$$\begin{aligned} \text{Let } x &= \text{the loss in db} \\ x &= 10 \log_{10} 100/5 \\ x &= 10 \log_{10} 20 \\ x &= 10 \times 1.301 \\ x &= 13. \end{aligned}$$

This choke would be said to have a 13-db loss at this frequency.

"It is common practice in telephone engineering to plot curves showing the characteristics of

amplifiers, chokes, filters, and other apparatus using the loss or gain in db as ordinates and the frequency as abscissas. The advantage of such a method can readily be understood; such a curve is independent of voltage and current values so long as the rating of the equipment has not been exceeded.

"As yet the decibel, formerly known as the transmission unit, has not been adopted very generally by the amateur. However, it is very probable that in the near future, reference will be made more and more to this unit in various technical articles and the characteristics of our equipment will be shown by curves such as those mentioned. Already, there have been technical articles in *QST* in which the TU was mentioned quite frequently and it is for the purpose of acquainting amateurs with this new unit that this material is being presented."

#### SIGN FLASHER INTERFERENCE

We are indebted to Victor J. Andrew of 4949 Indiana Avenue, Chicago, Ill., for some information on the elimination of interference due to electric light sign flashers. He says:

"I recently worked on a case of electrical interference which yielded beautifully to the proper treatment for quieting it. A flashing sign of nearly a hundred bulbs was completely spoiling broadcast reception in the building on which it was located. The rotating switch system was in the basement. It consisted of two circuits, each of them a constant contact commutator, and four segmented commutators flashing individual circuits. The two units were driven by a motor and the whole assembly was mounted in a metal box. Every time a contact was broken there was a healthy click; these occurred about a dozen times a second.

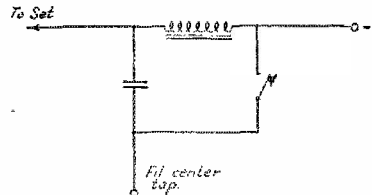

FIG. 5 — Another 'knock' filter that has proven to be successful.

"First, condensers were tried in various places between the 10 leads from the commutator and the ground. A reduction of perhaps 75% was possible although this was by no means satisfactory. Next, a radio-frequency choke was tried and a coil of about 25 turns or more wound around the hand and connected next to the contact arm did wonders. The chokes alone reduced the interference probably 95%.

"The final arrangement shown in Fig. 3 con-



sisted of 10 chokes, one in each switch lead, and necessarily as close as possible to the contact arm. Each choke consisted of 55 turns of No. 16 d.c.c. wire on a  $1\frac{3}{4}$ " tube. The choke was wound in three layers and all were wound on a single tube 28" long. Then, a 1- $\mu$ fd. condenser was connected from the line side of each of the main line chokes to the ground. With this combination of chokes and condensers the interference reduction was practically 100%."

#### CONTINUITY TEST SET

An interesting little test set for checking the continuity of d.c. circuits was suggested by Jack Paddon and is shown in Fig. 4.

It consists primarily of an audio frequency oscillator made up of a 199 tube, an old audio transformer and a three-cell battery such as is used for the obtaining of bias. Filament current is obtained from two cells of the battery and the third cell applies its voltage to the plate of the tube. The plate circuit is completed through the circuit under test. If the circuit is open no oscillations will take place and no sound will be heard in the phones which may be inserted anywhere in the plate circuit. They should preferably be located at the filament end of the circuit as indicated in the diagram. A circuit which may be open which has a high capacity between its disconnected portion will not give a steady signal in the phones although when tested with a pair of phones and battery a perfectly healthy click may be obtained.

#### KEY CLICK FILTER

W9EJG suggests the key click filter shown in Fig. 5 as having been the answer to his particular problem. The choke is of the  $1\frac{1}{2}$  henry variety and the condenser of 1- $\mu$ fd. capacity.

We know from past experience that no one arrangement is suitable for the elimination of clicks in all transmitters. It is for this reason that we have presented so many different arrangements in the past issues of *QST*. The problem seems to resolve itself into a matter of trying all the logical arrangements with the idea of holding on to the system which provides the most satisfactory results. There are, of course, certain definite lines along which one should experiment and a considerable amount of information on the subject is incorporated in the article appearing on page 9 of the February issue of *QST*.

## The Resonance Effect of Receiving Antennas

(Continued from page 51)

The ways discussed are in addition to this. In Fig. 1b, the antenna coupling coil is adjustable

and increasing the number of turns will run the point of resonance up the scale on the tuning condenser dial and decreasing the number of turns will move the point down. Fig. 1c employs variable coupling between the antenna and secondary coil. In this case, decreasing the coupling brings the effect down and at the same time increases regeneration. In 1d, a loading coil is inserted in the antenna circuit which runs the point up to an amount depending upon the size of the coil. Capacitive loading is shown in Fig. 1e (fixed or variable) and this puts the point down. A condenser of more than 100  $\mu$ fd. capacity is not

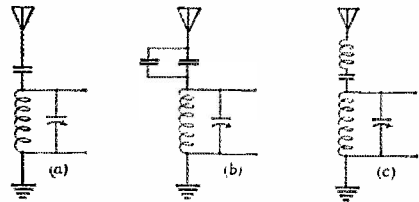

FIG. 2

recommended for use at the higher frequencies, however.

Any of these methods are successful. Fig. 1b, 1d and 1e are fine for operation on amateur bands when it is only necessary to move the resonance points out of the bands. For satisfactory reception and ease of tuning for all frequencies, Fig. 1c is better. A satisfactory way of adjusting the antenna coil coupling was given on page 21 of the June, 1928 issue of *QST* in my article entitled "A Short- and Medium-Wave Receiver."

Everyone does not employ inductive coupling between the antenna and grid circuit and many use a small condenser as shown in Fig. 2a. The coupling condenser usually consists of two metal angles arranged to form a condenser of two plates. One method of varying the point of resonance is to adjust the distance between the plates and thus change the capacity of the condenser. A second method is to shunt the condenser with another small fixed unit which allows the capacity to be increased without so much trouble. This is shown in Fig. 2b. In Fig. 2c, we have a loading coil in series with the antenna as we had in Fig. 1d. The coupling condenser is still necessary. Under normal conditions, the capacity of the coupling condenser should be quite small and as it is increased, the amount to which the antenna affects the ability of the receiver to hold calibration is increased. It is not very desirable, therefore, to increase the capacity of the coupling condenser too much and the use of the loading coil as in 2c will probably be best from this point of view.

**Strays**

Come on, gang! Where are those station descriptions? Let's have real honest-to-goodness competition.



Conducted by A. L. Budlong

**W**ITHIN a short time after this report appears in *QST* the Secretary of the I.A.R.U. will send out a calendar to all existing national sections giving an account of progress of the Union during the past year, matters to be acted upon, etc. One of these latter will be the presentation of petitions from additional societies for admission to the Union. We already have several such petitions. Amateur societies in countries where there are no national sections in existence at the present time who wish to become affiliated with the Union are therefore urged to send in formal petitions immediately, if they wish to be included in this calendar.

#### AUSTRALIA

Although the Wireless Institute of Australia was recognized by the Union as the National Section for that country, many of our readers are probably aware of the fact that for some months past there have been two amateur societies in existence in that country; the W.I.A. and the Australian Radio Transmitters' League, or A.R.T.L.

Both groups covered the Australian amateur field, both have been headed by able men, and both had the interests of the amateur at heart. It was therefore inevitable, after a few incidents concerning government-amateur contact had demonstrated the innumerable disadvantages of this unfortunate situation, that the two societies should take steps to effect an amalgamation. I.A.R.U. Headquarters is happy to announce that the amalgamation has actually taken place, and through the courtesy of *QTC*, the official publication of the A.R.T.L., presents herewith the major details of this step forward.

Before doing this it might be well to outline the scheme of organization heretofore employed by both societies. Australia is about the same size as the United States; the population, however, is considerably less, population centers comparatively far apart, and the number of amateurs much smaller. The country is divided into seven "states."

For these reasons, both the W.I.A. and the A.R.T.L. have consisted of a number of individual

"state organizations," each having its own constitution, articles of incorporation, officers, dues, etc. These several state organizations, or, as they were called, divisions of the Federal organizations, were loosely bound together by a Federal Headquarters, which undertook to coordinate the efforts of the various Division societies, acted as their representative in testifying at government hearings, etc.

The men who met to effect the amalgamation were Howard Love, Stanley Gadsen, and VK3YX, the President, Vice-President and Federal Secretary of the W.I.A., respectively, and Major L. J. Feeaghly, representing the A.R.T.L. The meeting was held in Melbourne.

The first question was that of a name for the new organization. After a considerable discussion it was decided that the name "Wireless Institute of Australia" should stand.

Further deliberations resulted in changes, however. There will continue to be a N.S.W. Division of the W.I.A., a Queensland Division, etc., but from now on each of these divisions will consist of the merged membership of the former W.I.A. and A.R.T.L. organizations in the territories concerned. Not only that, but also in each division there will be new officers elected, new and revamped constitutions adopted, with the combined memberships of both the former organizations meeting to decide and agree upon these points.

The Federal Headquarters, which formerly had but little power in controlling the general policies of divisional branches, will now have considerably more authority. One of the first things FHQ will do is to draft a uniform standard of qualifications for membership.

General government of the Institute will be in the hands of a Board of Directors, consisting of the Federal President, Federal Vice-President, the Federal Secretary, and five Divisional Secretaries (there being division organizations in but five of the seven "states" at the present time.) An "executive committee" known as the Federal Executive Council, and consisting of the Federal President, Vice-President and Secretary will have power to act between meetings of the Board.

(Continued on page 70)

# Calls Heard



*F. Pemberton, 115 Cambridge Road, Wimbledon, London, S.W. 20, England*

7000- and 14,000-ke. bands

wlabv wlabd wlabf wlabp wlabl wlabh wlabz wlabz wlabz  
wlaot wlaop wlaug wlavv wlawu wlabl wbeu wblvy  
wblwp wblum wblux wblvy wloek wloef wloep wloje  
wlojz wlomp wlda wldr wlif wlor wlyr wlyx wlab  
w2abn w2aad w2adk w2aeq w2aeu w2aex w2afe w2afv  
w2afz w2ahi w2aib w2ajl w2akl w2akl w2akm w2anp  
w2aup w2api w2apy w2aqj w2arb w2asx w2atq w2aur  
w2axp w2baa w2bao w2bcm w2bhf w2bto w2by w2bhy  
w2bia w2bif w2biv w2big w2box w2box w2bpg  
w2bpn w2bpq w2odr w2ejx w2erb w2es w2euf w2eug  
w2euz w2evj w2ezr w2djo w2fi w2fn w2fp w2hm w2hy  
w2jz w2rk w2sm w2uk w2uol w2udd w2uod w2uel w2afj  
w2ajh w2ajj w2asx w2avd w2bjm w2bni w2bnu w2bph  
w2bqv w2eog w2ojg w2hg w2im w2ip w2jg w2ot w2ef  
w2afc w2afv w2ag w2ah w2ak w2ale w2dv w2ff w2hr  
w2hy w2ip w2rn w2saj w2bj w2om w2yd w2ae w2bz  
w2euh w2ekz w2eqd w2eqm w2ekl w2sm w2suz w2hek  
w2hdv w2hej w2hqv w2hs w2ht w2hts w2huh w2ebe  
w2ecw w2efl w2eb w2ep w2er w2erx w2erz w2dd  
w2ddz w2deg w2doa w2dsy w2dvz w2dq w2bld w2bpm  
w2che w2erd w2exx w2dce w2dbj w2dgc w2dgg w2ej  
w2ecx w2ehi w2ejo w2elb w2epa w2ftz w2gep w2hm w2j  
w2hr w2br velda veldq veldx veldz veldb veldh veldr  
veldk veldk veldf veldk veldh veldg veldg veldh veldr  
veldk veldk veldf veldk veldh veldg veldg veldh veldr  
klem krlf k4aan em5cx nj-2pa nn-1mic pylah pylaj  
pyllf pylcm pylib pyltd p3ah ce2ar sa-dt9 sa-dt9  
sa-0a3 su-2ak ff-3hvy ik-1lm fo-1sr fq-pm fq-8gom su8an  
z-4k z-4e z-4m z-5c z-5u z-5e ai-2kx ap-9fr au-7a- au-7au  
au-8it au-trk y1lm vk3hq vk5hg qu-1oq haf3a xen-0ep  
xpa-0ja nkf vcb wqj

28,000-kilocycle band

wlhyf wleml wlu w2aol w2alw w2ayr w2jn w8axx w8az nkf g2ex g2od g5ak g6hp g6ll g6vp

*SP3KX cc ET-TPKX, Z. Bressiński, Grottegera 2, Poznań, Poland*

7000- and 14,000-ke bands

wlaak wlabd wlabm wlabk wlabd wlabz wlaep wlafl  
wlafe wlaai wlaie wlaix wlak wladk wlap wlasu wlaqd  
wluqj wlaax wlay wlaze wber wblhn wblke wblbd  
wblna wblsd wblwb wlede wlehe wlemd wlemp wletp  
wlda wleai wlf wlfh wlfm wlfh wlp wll wlmk  
wlmx wlrp wlyr wlom wluo wlyb w2aad w2aau w2abn  
w2abu w2aab w2aad w2afv w2afx w2ags w2agp w2aje  
w2anc w2aui w2api w2aow w2aqj w2atz w2avv w2azu  
w2bhf w2bhk w2blx w2boz w2emq w2eol w2oon w2ert  
w2euz w2evj w2esl w2ey w2dg w2di w2ew w2fb w2ff  
w2fn w2fp w2hvj w2jd w2jt w2ozu w2ot w2peu w2qd  
w2rsk w2tr w2up w2uz w2zx w2as w2ar w3abd w3nce  
w3adm w3adv w3ais w3ant w3asd w3bsd w3bqv w3li  
w3ub w3pt w3rhe w3rpu w3tr w3z w4ab w4aba w4ak  
w4abd w4aj w4ag w4ahy w4apu w4ea w4ei w4ks w4ll  
w4pf w4pk w4sb w4ted w4tk w4r w4wo w5je w5mx  
w5ql w5yq w6avj w7pl w8ae w8ar w8ax w8bi w8boy  
w8euh w8cp w8om w8ddg w8drj w8dvj w8jo w8jq w8ke  
w8kr w8ky w8nu w8rn w9ab w9big w9bqv w9cvi w9exx  
w9ot ag-m2n ag-rb14 ag-rb64 ag-67ra ag-rtr1  
ag-7ab ag-7ae ag-7ao ag-7as ag-7kad ai-2bw ai-2kx ag-1hf  
ag-1lm ag-1mdz au-trk au-7as au-7kwd au-8aa ar-8mo

ar-8opq as-1ag as-1ap as-rb14 as-1ra as-15ra as-52ra  
fi-1fw fm-8dot fm-8ev fm-8eko fm-8rit fm-8ru fm-8cp  
fm-8cid fq-0cu fq-0cy fr-earb k4ak velbr v4br vello  
nj-2pa nn-1mic nn-7mic nq-7ex nr-1as nr-2as nr-8eq  
nt-4rd nr-1r5 z2ab z2ai z2ga z2go z3ar z4am klem  
sa-de8 sa-fe6 sa-fi2 sb-1aa sb-1ah sb-1ak sb-1bc sb-1bs  
sb-1bu sb-1el sb-2ab sb-2ah sb-2ar sb-2ax sb-4cs se-1a  
se-2ab se-2as se-3ab se-1ei su-1cy su-8an ve2bg ystun

*guPP, M. W. Pilpel, 51 Purley Ave., London, N.W. 2, England*

wlaaw wlaed wlafl wlaek wlaie wloep wlatm wlvx  
wlabl wbea wblke wblkr wblvy wloep wlopp wloq  
wliu wlkw wle wlo wloq wlvh wlx w2abe w2ad  
w2ali w2apy w2asx w2ayv w2ayw w2ax w2boz w2bre  
w2bro w2crb w2evj w2eug w2ej w2fx w2mb w2ot w2oy  
w2r w2up w2uol w2uel w2vj w2vz w2vni w2vps w2vd  
w2ad w2avf w2bhx w2bnu w2bi w2bge w2ce w2p w2pi  
w2q w2r w2ex w2hqv w2hs w2ht w2k w2ky w2lc w2lx  
w2sdh w2sdl w2su w2sv w2suz w2bl w2bx w2br  
w2hek w2hjq w2hqv w2hy w2yq w2drj w2dsy w2kr  
w2lt w2uk w2vx w2w w2asx w2rd w2ej w2jyp w2q  
klaf k4aan kd5v kr5 velda ve3he

*Olto Rogue, F Joesunger, Bergen, Norway*

(Heard in the South Atlantic Ocean)

wlabl wlaiz w2aqj w2biv w2bpg w2l w2lp w2gt w2jz w2nu w2zv w3bsx w8am w8er w8ej w8nd w8mp w9etz w9j w9z z4m ve2ax

*C. Conte, 21 Allee du Rocher, Clichy-sous Bois, (S. et O) France*

wlabd wlaed wlad wlaeh wlaif wlaie wlamd wlaux  
wlaqo wlaug wlaaf wlauf wlatv wlawd wlaax wlabl  
wbe wbea wbeb wlefi wlehg wlekn wlemp wlenz  
wlepi wlg wlk wln wlmk wly wlyp wlyr wlyz  
wlp wlv wly wlyz w2af w2ato w2agy w2alu w2aiw w2apd  
w2apy w2atq w2azu w2baz w2bcm w2beo w2bda w2bhy  
w2bjg w2bjj w2blx w2bnx w2boz w2brv w2ced w2edr  
w2ejx w2eug w2eva w2dr w2ew w2hc w2kr w2ov w2rs  
w2rv w2se w2sf w2uk w2uz w2vc w2vy w2uel w2vj  
w2je w2jx w2ah w2apn w2atk w2sd w2adv w2biv  
w2bnu w2bph w2bqv w2ckl w2ee w2ez w2ga w2gt w2pi  
w2ql w2r w2ag w2ai w2aq w2ea w2ff w2hz w2ll w2pan  
w2rb w2rn w2su w2sv w2vm w2vd w2ain w2bbe w2box  
w2je w2jd w2ke w2af w2ake w2akk w2ad w2ax w2ay  
w2axa w2axz w2av w2hd w2hzh w2hp w2hb w2ht  
w2bww w2er w2et w2ez w2ep w2er w2es w2eb  
w2ev w2dkx w2dme w2dnl w2dno w2dnp w2do w2du  
w2nu w2pk w2ap w2ax w2ar w2bd w2be w2qe w2m  
w2eph w2hvj w2dkg w2dvs w2ejo w2fs w2gp w2my  
w2y w2ae ardi ve2au ve2hd ve2ea velda rair5 unlic  
nn7nic v8rg tigo

*Maurice N. Driscoll, 1121 Sixth Ave., Antigo, Wisconsin*

ve5aw xaf x23a 61x nq2ay nq2se nq5ay nq5fl em5ni  
nj2pa nr4e ar2fe unlic nn7nic sb1em sb2ak sb2ay se2ab  
nr15 se2ea k6ekx y1nm o2no o2av o2aj o2hg z1aj  
z1ax z1z1 z1ac z1ar z1em z1ar z1ai z1as

(Continued on page 78)

# Correspondence

The Publishers of QST assume no responsibility for statements made herein by correspondents



## An Old Stove League?

238 So. Jefferson St.,  
Peoria, Ill.

Editor, *QST*:

Here I am, musing over the old days that once were ours; when a thousand miles with old rotary meant a feather in our hat, and a note with its characteristic whine spoke more than the call letter. Yes, the old call book, published by some enterprising ham club over in Nebraska, had more appropriated call letters than issued ones. And this pile of letters and cards which I have just found in the bottom of the trunk all date back to the first year of *QST*, 1915. What history is contained in them! Some day I shall weave a story around them, an individual one.

And here is the Station Appointment issued by the American Radio Relay League, Inc., and bearing the number 35 in the upper left-hand corner. Our first secretary, C. D. Tuska, and our own Hiram Percy Maxim's own handwriting appear. And when I look it over, framed as it first was received and hung above the old outfit, I cannot help but be reminded of the years that have elapsed, the wonderful progress that has been made, and the loyalty with which amateur radio enthusiasts have kept the League in motion.

Right here I wish to make a suggestion. Why not form a list of the first 100 or 200 station owners with A.R.R.L. appointments, organize an Old Stove League, and have some fun. Personally I would be very much interested to know where many old timers have fallen by the wayside. No doubt we could get the Old Man and his wife into the ring, together with a goodly number of others. Although many years have passed, we would all like to be kids again in thought. If Headquarters has a list, let them publish it in *QST*. Who were the first 100? I think A.R.R.L. is old enough by now to begin talking about a little history. What do you say?

— E. G. Stoltzhauser.

## Tall Order

2522 Highland Ave.,  
McKeesport, Penn.

Editor, *QST*:

Amongst the various excellent articles in *QST* I have never seen one entitled, "How to read *QST*." Such an article would certainly be hailed with approbation. For instance, when I receive my copy, I have a hard time of it. You

see, I try to read the whole darn magazine all at once. I unwittingly pay you the sincerest of compliments.

Thank you for much real pleasure and many constructive ideas.

— A. W. Drieling, M.D., W8CGV.

## Lost Cards

1814 Elm St., Rockford, Ill.

Editor, *QST*:

I have been busy lately helping the Post Office here get rid of some QSL cards which are piling up for Rockford amateurs. When a card comes addressed to some amateur giving just the call letters and the city it is very hard for the postal officials to locate the address, and many cards, in consequence, land in the dead-letter office.

I made up a list of all Rockford amateurs with calls, names and addresses and sent this list to the postmaster here who seemed pleased to have such a service rendered. Last month it was possible, by this arrangement, to deliver 14 would-be "Dead-Letter Office" cards to Rockford amateurs.

It would be a very good idea if some amateur made up such a list for his own town for the Post Office people. In the larger cities amateurs could get together and buy the Post Office an up-to-date call book. In this way, the Why-didn't-I-get-my-card complaints could certainly be reduced.

— D. G. Bartolot, W9BXB.

## Phones Out of Bounds

Navy Department,  
Bureau of Engineering,  
Washington, D. C.

Editor, *QST*:

This letter is not a yelp from a crank but is a plea from one amateur to others for fair play and legal operation of phones within the phone bands.

It is granted that phones are not the only offenders; columns of admonitions and denunciations have been written concerning out-of-the-amateur-band operation of amateur stations, and nearly all responsible stations have responded — some after complaints from Commercial and Governmental organizations. On the other hand, however, Commercial and Governmental organizations do not concern themselves with what

# COMING!

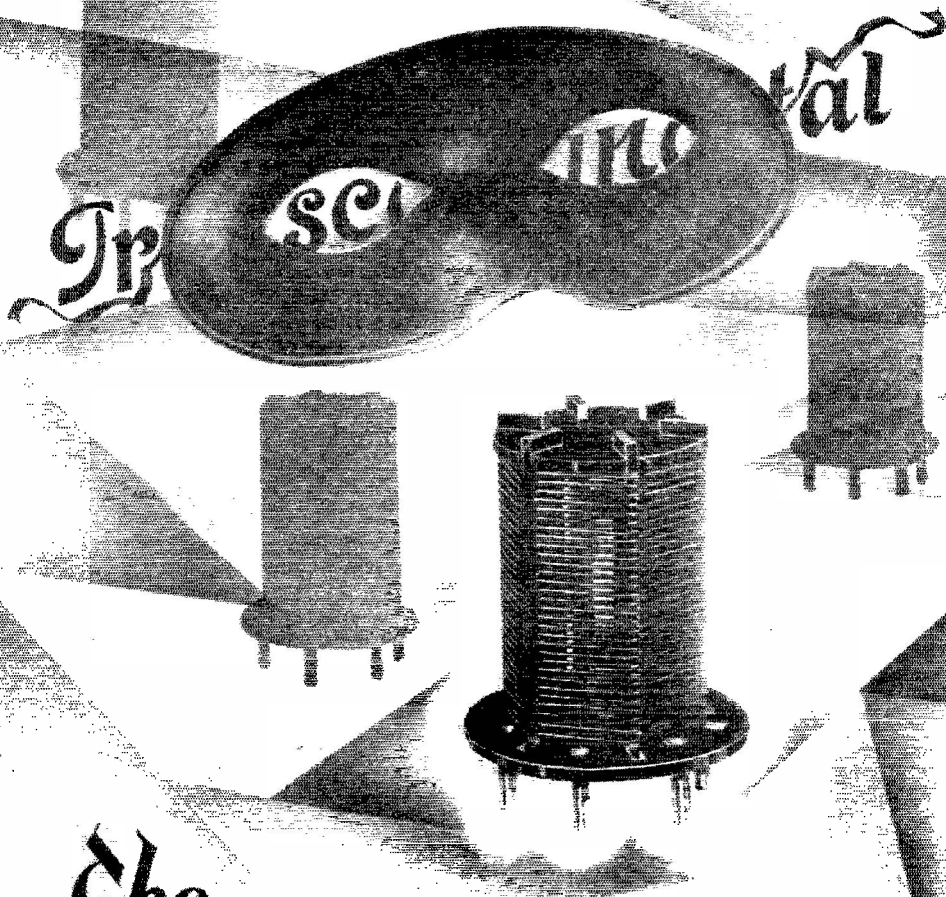

*The*

## **MOST EFFICIENT SHORT WAVE COIL EVER MADE!**

*See this page next month  
for full details ~*



## Individual Instruction Cards for Testing Factory-Built Radio Sets

An Added Service of the  
**WESTON MODEL 537**  
A.C. and D.C. Radio Set Tester

These Instruction Cards, by covering the specific testing requirements of individual receivers, make the Model 537 a still more useful test set for the service man.

They save the service man's time by giving a complete outline of procedure for testing the principal makes of factory-built sets and, in addition, give the socket voltages and tube plate current for every stage throughout the set, as well as the comparative grid test on the various tubes.

The Model 537 is designed to meet the service requirements of every type and kind of radio receiver. Its use, however, is reduced to still greater simplicity when testing any particular make of set in conjunction with its individual instruction card.

Write to us and we will be pleased to acquaint you with full particulars. Or, better still, address your inquiry to your radio jobber, supply house or our nearest representative—and ask for a demonstration.

**WESTON ELECTRICAL INSTRUMENT  
CORPORATION**  
602 Frelinghuysen Avenue Newark, N. J.

**Weston**  
PIONEERS  
SINCE 1888  
**INSTRUMENTS**

goes on within the amateur bands except insofar as the District Inspector can be prevailed upon to check up on these conditions. For this reason, the phone enthusiasts do not limit their operation to the 3500-3550 band (source of greatest QRM), but slide up as far as 3650 kc., and in one case 3852 kc.

These frequency checks were made by means of a precision heterodyne frequency meter originally calibrated from the temperature-controlled crystal-oscillator standard at the Washington Navy Yard and checked regularly by means of standard frequency transmissions from W9XL (Lor' bless 'em) and from WWV (whose only frequency useful to the amateurs is 4000 kc. — why not more?).

Our own Headquarters' Station WIMK handles many important traffic schedules on a frequency of 3575 kc., one of which is with W3HL and consists of traffic from the yacht *Carnegie* to their Headquarters, the Department of Terrestrial Magnetism in Washington. There is always phone QRM on WIMK's frequency, occasionally so bad as to make contact nearly impossible.

A list of some of these off-band phones has been prepared and courteous cards sent to the owners advising them of their QRM. Some stations couldn't be identified because of their poor modulation and hence this general appeal is made to all phone operators, for fair play and coöperation with the rest of us.

— *Edw. N. Dingley, Jr., W3HL.*

## Professor Jansky's Appointment

130 Warwick St., S. E.,  
Minneapolis, Minn.

Editor, *QST*:

It was with the greatest of pleasure that I heard of Prof. C. M. Jansky, Jr., being appointed to the Federal Radio Commission. He is an amateur at heart as he has clearly shown by his constant interest and constructive activity in League affairs.

We of the Dakota Division are very proud that our Director has been selected and are positive that the Amateur will always have a watchful Representative among the United States' highest Radio Authority as long as Professor Jansky is a member.

Wishing him all success in his new work.

— *J. C. Pchoushek, W9EPK,*  
*SCM So. Minn.*

## An Amateur-Broadcast Link

Campbell, Minn.

Editor, *QST*:

In the past few years that I have been a reader of *QST* I have not yet run across any article explaining an incident similar to that I had the honor to experience last winter.

# The trend is toward ALUMINUM

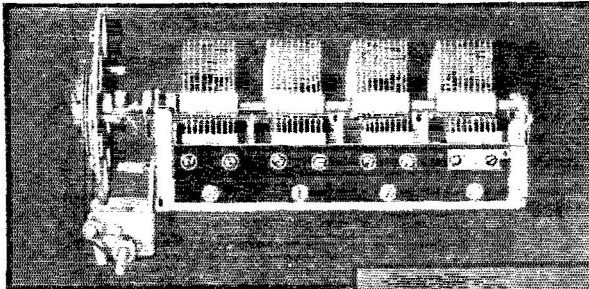

The latest Grigsby-Crummey condenser (at left). Grigsby-Crummey has always used Alcoa Radio Sheet for its variable condensers.

Alcoa Radio Sheet was first developed for Atwater Kent. The latest Atwater Kent condenser assembly is illustrated below.

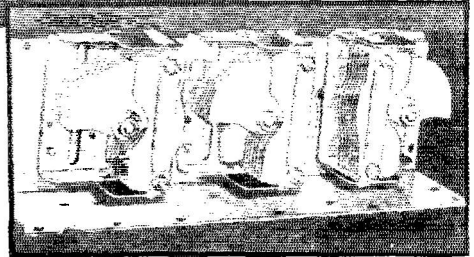

**A**FTER more than two years of testing by the technical staff of Aluminum Company of America, and by the designing engineers of the leading manufacturers of receiving sets, nine manufacturers have adopted Alcoa Radio Sheet for their condenser blades.

In 1928 radio manufacturers used almost three times as much Alcoa Radio Sheet as was used in 1927, and more than six times as much as in 1926. In 1929 more than 6,000,000 single condenser units will be made of Alcoa Radio Sheet.

This wide and rapidly growing use of Alcoa Radio Sheet is due to its extreme accuracy of gauge, high electrical conductivity, unique freedom from vibrating, its lightness and its workability.

Paralleling the increased use of Alcoa

Radio Sheet are large increases in the use of aluminum for shielding, aluminum foil for fixed condensers, and aluminum die castings for loud speaker housings, chasses and condenser frames.

We will be glad to send you, on request, a copy of the booklet, "Aluminum for Radio."

Aluminum Company of America  
2439 Oliver Building Pittsburgh, Pa.  
Offices in 18 Principal American Cities

Alcoa Radio Sheet, the exclusive product of Aluminum Company of America, is manufactured to limits of tolerance and uniformity hitherto unattainable. Its maximum total variation within a single sheet

is .0005 inch. Its sheet to sheet tolerance is  $\pm .001$  inch. It is patent leveled, highly polished, and accurately sheared. We will be glad to quote on finished blades of high accuracy made from Alcoa Radio Sheet.

## ALUMINUM

*The mark of quality in Radio*

Say You Saw It in QST — It Identifies You and Helps QST

# NATIONAL RECTOBULB TYPE R-3

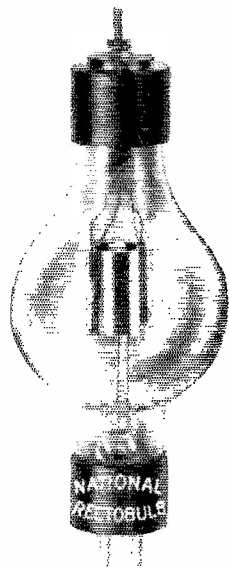

A Mercury Vapor Rectifier which will replace the standard rectifier tubes.

Normal Rating 250 mls  
Normal Voltage 3000 volts  
Filament volts.....10  
Filament amps.....1.7

Oxide coated Cathode of large size furnishes ample emission and long life.

Plate connection at top and standard UX socket at bottom.

Overall height 7 1/2 inches  
Diameter of bulb 3 inches

Cy Barker at W9EGH reports "nothing short of Marvelous" on Discarding his Mercury Arc and installing Rectobulbs.

We are making prompt deliveries and prepay charges if cash accompanies Order.

**Price \$10 each**

We repair 203A tubes at \$19  
204 tubes at \$50  
204A tubes at \$75

We 211 tubes at \$16.50

All repairs fully guaranteed

**National Radio Tube Co.**  
3420 18th Street  
San Francisco California

One evening I converted my short-wave Reinartz receiver into a B.C.L. set by means of placing a 23-plate variable condenser across the regular 5-plate tuning condenser.

I listened to several stations and finally hit upon WJAZ, Chicago; at the time broadcasting a special feature to MacMillan in the Arctic and asking listeners to send in requests to the Arctic Skeeters Club. As some of the announcements came into the head-phones at W9ABV I struck upon the idea of sending in requests by short wave if I could only get some fellow in Chicago.

I removed the 23 plate condensers and looked all over the 80-meter band for some fellow in Chicago calling CQ but none was heard. I called, "CQ Chicago" and "QST" to that city in attempt to attract the attention of some one there and finally on the sixth or seventh attempt I was very much pleased to hear W9ASE calling me. Wow!! You beginners talk about the thrill of the first QSO. I'll bet my best 50 watter that I got more kick out of hearing W9ASE call me than the first ten QSOs the beginner has. He was in Chicago. It meant success if he had the necessary telephone.

I asked if he would QSP a message to WJAZ at once via telephone, to which he answered in the affirmative. I gave him the message and in answering he said that he would return to the air in about 20 minutes.

Cautiously, I tuned back to WJAZ. The announcer was saying, "We have a special announcement to make. It is the first of its kind that has ever come to the studio of WJAZ. We are in receipt of a short-wave message from 9ABV at Campbell, Minn., sent to another short-wave station here in Chicago by the call of 9ASE who telephoned it to us. He wants to join the Arctic Skeeters Club, so Mr. Wells will proceed in the initiation."

The 20 minutes soon lapsed and I returned to 80 meters to hear W9ASE calling me. We soon retained our QSO and had a great conflag about the stunt.

— Howard W. Carlson, W9ABV.

(Schnell at 1BHW tried the same stunt successfully several years ago by getting into communication with a Chicago amateur and through him a Chicago broadcasting station. Guests were in the house at the time and they are said to have been "popeyed" when the announcement was made from the broadcasting station. — EDITOR.)

## Criticism Criticised

Aun Arbor, Mich.

Editor, QST:

Although the majority of us who have enjoyed QST for some years are at times dissatisfied with the contents of one or two issues, it hardly seems possible that anyone who has benefited to the slightest degree from it would write such a letter as was printed in the February, 1929, issue, page 58.



# your money's worth ... in musical performance



The Finest Receivers Are Thordarson Equipped

**T**ONE Fidelity . . . the master salesman of radio . . . is the constant companion of the Thordarson equipped receiver. A snap of the switch . . . a turn of the dial . . . and his message begins. He collects no commissions . . . has no expense account, yet works unceasingly, delivering his message of quality reproduction to everyone within earshot. Without his effortless activity the set manufacturer's days are numbered, for the public will accept no substitute for Tone Fidelity.

It is significant that the manufacturers of the world's finest radio receivers almost universally have selected Thordarson power supply and audio transformers to carry this message of tonal purity into millions of homes.

Whether you are engaged in building, selling or buying radio receivers, remember this: Thordarson power supply and audio equipment spells quality reproduction.

**THORDARSON ELECTRIC  
MANUFACTURING CO.**

TRANSFORMER SPECIALISTS SINCE 1893

Huron, Kingsbury  
and Larrabee Sts., Chicago



**PHILCO**  
neutrodyne-plus

EQUIPPED  
WITH

**THORDARSON**  
RADIO  
TRANSFORMERS

S U P R E M E I N M U S I C A L P E R F O R M A N C E

# Cunningham RADIO TUBES

Always keep  
a spare tube  
with your  
radio

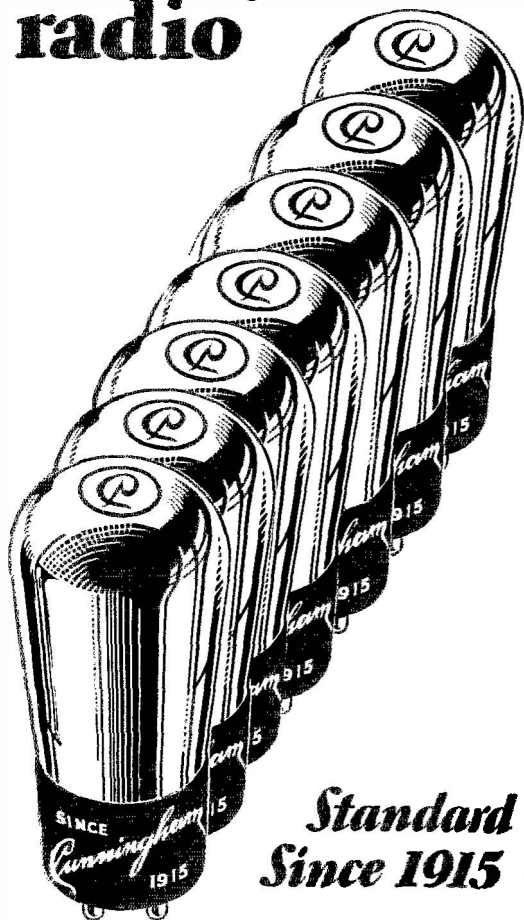

Standard  
Since 1915

E. T. CUNNINGHAM, Inc.  
New York / Chicago / San Francisco

Mr. W. J. Burton evidently requested his secretary to put his file at the end of the letter to give the impression that his criticisms, good or bad, would be of great value and have considerable influence on brass-pounders as a whole.

In spite of this fact, I cannot believe that the average grown-up person could possibly appreciate any sort of criticism from such an individual. Please continue *QST* as it is and don't under any circumstances consider that Mr. Burton's ideas represent a fraction of one per cent of the readers.

— O. Del. Underwood.

## Beginners' Difficulties

125 Union Ave.  
New York, N. Y.

Editor, *QST*:

I read L. O. Weaver's letter in the December issue of *QST* concerning the necessity for impressing the need of the new 1929 developments on the amateur. I want to bring to your attention a different angle of the situation.

A pretty good number of the present amateurs are comparative newcomers. They often know very little of the science of radio. Because of this, these fellows can't make head or tail of an article in *QST*. On such, it would do no good to impose the need for the new 1929 improvements.

You old-timers who have grown up with the game from the time of the spark-coil, don't appreciate the difficulty of acquiring the knowledge necessary to make a real amateur. There are two types of books open to the would-be amateur — the engineering text, and those books that "simplify, popularize, etc., radio" so many of which were run off a few years ago. Both of these types are unsuitable, the one because it takes too much knowledge for granted, and the other, too little. The handbook does come somewhere in between.

In the future, with more new developments, it seems to me that this gap between the old-timer and the newcomer is bound to increase. What are you going to do about it? I am not an amateur but I have been trying to be one so I think I know whereof I speak.

— S. Schuffe.

## Low Conduct

Onionsburg, Pa.

Editor, *QST*:

The conduct of some amateurs is very strange indeed. Recently I worked a "0" on my low-powered rig and was anxious to have a card from him. I asked him whether or not his address was correct in the call book and was pleased when he told me that it was.

In reply to my card I received a letter from a technician in a broadcasting station (to whom the call really belonged) saying that he had not been on the air for over a year. He also stated that he had a card from a "0" who had "worked"

# Hams!

# turn your Radio Knowledge into "Extra Money" with a

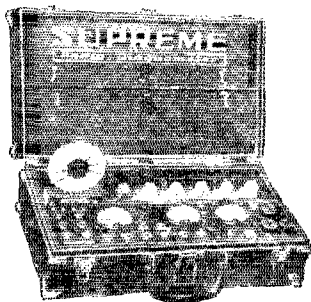

Model 400A

Patents applied for

## SUPREME Radio Diagonometer

Three Weston Meters and SUPREME engineering, combined with the finest of materials and workmanship, insure absolute accuracy. A Voltmeter of three scales 0-10/100-600, 1000 ohms per volt; a Milliammeter of 125 mills and 2½ amps; and an A.C. Voltmeter, three large scales of 0-3/15/150, are built into the SUPREME test panel and are housed in bakelite cases.

All instruments are manufactured for 110 volts and 50-60 cycles. Instruments other frequencies can be furnished special at slight increase in price.

### Prices and Terms

Under our time payment plan, the Model 400A SUPREME Diagonometer can be bought for \$38.50 cash and 10 trade acceptances (installment notes) for \$10 each, due monthly. Cash price, if preferred, \$124.65. All prices net. No dealers' discounts.

### Send No Money

Thousands of owners attest to the superiority of the SUPREME. PROVE its value to you by using it six days in actual service work. We let you be the sole judge. Sign and fill in the six-day trial request and mail today.

### 6-Day Trial

Date.....

Supreme Instruments Corporation,  
319 Supreme Building,  
Greenwood, Mississippi.

Please ship me one Model 400A SUPREME  
DIAGONOMETER.

Upon delivery of the instrument, I will deposit with the express agent either the cash price of \$124.65 or \$38.50 cash and 10 trade acceptances (installment notes) for \$10.00 each, due monthly, at my option, subject to the following conditions:

It is agreed that the deposit made with the express agent shall be retained by him for six days. If, within that time, after testing the instrument, I am not entirely satisfied, I have the privilege of returning the instrument to the express agent in good condition, with the seal unbroken (see note below) and adapters and parts intact. Upon such return, and upon the payment of return express charges, the deposit I have made with the express agent will be promptly returned to me.

Signed.....

Firm Name.....

Address.....

City.....State.....

Please send three or more trade references, including at least one bank, with this coupon.

NOTE: The seal on the panel of the instrument covers the master screw in the assembly. It is never necessary to disturb this, and it does not in any way prevent or restrict the use of the instrument. Factory guarantee ceases with disturbance of seal.

EVERY community has its servicemen, but YOU, equipped with your complete knowledge of radio, and a SUPREME Diagonometer, can give a service that the ordinary serviceman cannot.

You undoubtedly know the SUPREME. The performance of this remarkable Portable Radio Testing Laboratory has attracted the attention and admiration of the entire radio industry. It has changed the standards of radio service. It has eliminated all guess-work. With a SUPREME Diagonometer you can solve any radio problem that may come before you. It tells quickly, accurately, and scientifically the exact working condition of any radio receiver or radio part.

SUPREME Service League members everywhere are making big profits. Join the League. With a SUPREME Diagonometer you can earn the extra money you need to buy that 500 Watter or other equipment you have always wanted but could not afford.

The SUPREME comes in a brass-bound carrying case 18x10½x7 in. It weighs only 25 pounds. The case contains ample and handy compartments for carrying all necessary tools and accessories, including a swinging tube shelf which affords absolute protection for extra tubes.

Here are a few of the tests you can make with a SUPREME:

It has the only tube tester giving oscillation tests from raw A.C., or from radio sockets. Tests all tubes 1½ to 15 volts, including screen grid and heater types. Reads direct output of rectifier tubes. Permits complete and comprehensive analyzing from radio socket of all type A.C. or D.C. radios with Master plunger selector system. Voltage readings with and without load. Gives independent cathode readings.

The modulated tube Radiator takes place of broadcast stations for testing — is a driver for neutralizing and oscillator for synchronizing, giving meter dip and speaker click at resonance. Has heavy duty rejuvenator. Bridges open stages of audio — alters outputs — tests fixed condensers and contains stage of audio — fixed capacities — 500,000 ohm variable resistance and 30 ohm rheostat. Besides regular tests, all apparatus is accessible through pin-jacks. Instrument lifts out of case.



Radio owners recognize this emblem as the sign of efficient radio service.

## Fixed and Adjustable Resistors for all Radio Circuits



### Bradleyunit-B

**R**ADIO manufacturers, set builders and experimenters demand reliable resistors for grid leaks and plate coupling resistors. For such applications Bradleyunit-B has demonstrated its superiority under all tests, because:

- 1—Resistance values are constant irrespective of voltage drop across resistors. Distortion is thus avoided
- 2—Absolutely noiseless
- 3—No aging after long use
- 4—Adequate current capacity
- 5—Rugged, solid-molded construction
- 6—Easily soldered

Use the Bradleyunit-B in your Radio Circuits



### Radiostat

This remarkable graphite compression rheostat, and other types of Allen-Bradley graphite disc rheostats provide stepless, velvet-smooth control for transmitters, scanning disc motors and other apparatus requiring a variable resistance.

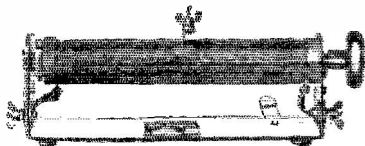

### Laboratory Rheostat

Type E-2910 — for general laboratory service. Capacity 200 watts. Maximum current 40 amperes. A handy rheostat for any laboratory.

Write for Bulletins!

ALLEN-BRADLEY CO., 275 Greenfield Ave., Milwaukee, Wis.

## Allen-Bradley Resistors

him the same day. The business of getting a license in this country is simple enough. Surely the amateur has no justification in stooping to such wretched thieving of other fellows' calls.

— Frank Lucas, W3CRA.

## The 1929 Receiver

Pennsylvania Power & Light Co.,  
Transmission Dept., Pottsville, Pa.

Editor, QST:

I have been interested in the comments on the short-wave sets Mr. Hull described in November, QST.

I put together the four-tube outfit, having become disgusted with half a dozen other short wave sets I had built before, and though it is not operating perfectly as yet, I am ironing out the wrinkles one by one and she works better every day.

W6HMI, who says that aluminum for the panel is the bunk evidently doesn't know how to handle the stuff. I inquired and found that the Aluminum Co. of America will gladly furnish aluminum plate from 1/16" up in thickness, any size desired, and reasonable. A piece 7" by 12" and 1/4" thick costs only 75 cents although one must buy two pieces since their minimum charge is one dollar. If this thickness is used (1/4") a very soft plate is sufficient for mounting and will dress and drill as easily as a piece of yellow pine. I was in too much of a hurry for a panel and before I wrote the Aluminum Company I bought a thin corky tray and cut it into two pieces 7" by 12" and tried to cement them together. Aluminum solder is absolutely necessary and can be secured from the above mentioned company. On the other hand, aluminum makes the nicest job in appearance, is as cheap as composition or rubber, and is a good shield, some form of which is necessary in the panel.

A handy mounting for the Ford coil secondary is to saw off the hollow part of an old tube socket and fasten the coil on top by running a piece of bus bar, soldered into two of the prongs, up through the hole from which the core was removed, to a flat piece placed across the top of the coil end, fastening the two pieces with a bolt. The other two prongs will make connections through the same hole to the coil ends which should be covered with tape after the connections are made. A tube shield will fit nicely over the whole thing if such is necessary. The scheme is handy and amounts to a plug-in coil, the ordinary UX socket being used.

Now about screen-grid tubes: I will be laughed at of course, but it can't be helped. At first I had the control grids connected to the regular socket post and the screen grid to the top post of the tube, and of course it worked as a space charge amplifier, but *how!* I bet I'm not the only one to do this.\*

\* By no means the only one! Scores of competent amateurs throughout the country have slipped in the same way. — EDITOR.

# The Jewell Trio in New Bakelite Cases at No Extra Cost!

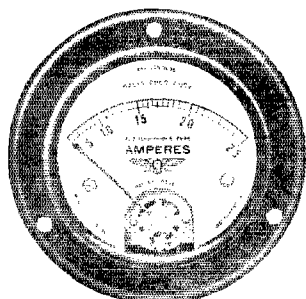

Pattern 68  
Radio Frequency

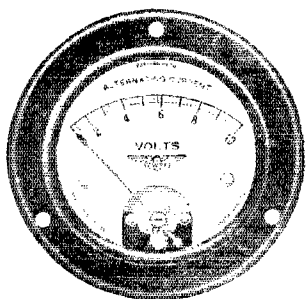

Pattern 78  
Alternating Current

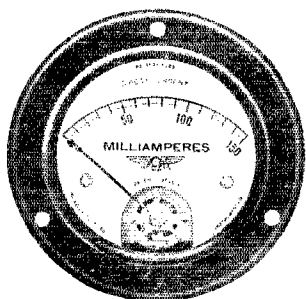

Pattern 88  
Direct Current

IN the new Jewell Patterns No. 68, 78, and 88 radio amateurs will find their old friends, the Jewell Trio, in new bakelite cases, *at no extra cost!* The movements are improved models of the same old standard units that have enabled radio experimenters to bring in long distance records since the very inception of radio.

The bakelite cases provide high insulation and a permanent high finish—there is no enamel to wear off, as is true with metal cases.

## An Improved Movement

A narrower, lighter pointer is used, doubling the speed of action. Damping is increased and quicker action, as well as more accurate readings, are possible. These uniform size instruments in bakelite cases represent the very latest and best in miniature radio instruments.

*Use the New Jewell Trio in your 1929 transmitter. Write for descriptive literature*

**JEWELL ELECTRICAL INSTRUMENT CO.**  
1650 Walnut Street      Chicago, Illinois

29 YEARS MAKING GOOD INSTRUMENTS

# JEWELL

# Radio Instruments

Say You Saw It in *QST* — It Identifies You and Helps *QST*

# Built to meet your own specifications!

Exactly the resistor you want — built to meet your own requirements — with samples on their way to you within 72 hours after we receive your specifications.

Our new Sample Department was planned for just such rush jobs. We even forward samples by air mail, if you prefer.

Tell us about the resistor you want. We'll be glad to make up samples for you.

We also carry a wide range of types and sizes in stock. Send for our catalog.

HARDWICK, HINDLE, Inc.

SALES DEPT.  
122 Greenwich  
St., New York



FACTORY  
215 Emmet St.  
Newark, N. J.

## RESISTORS

Another thing: I was almost ready to turn on the set when I realized that the two resistors on the panel were mounted on metal and had to be insulated from it; very evident, but to the Ham who has been working with rubber panel all his life, not so hard to miss.

Don't expect the coils (grid and tickler) to cover the exact band as laid out in *QST*, on first trial. They *will* vary, and half a turn makes a big difference. Space a turn or two if the band isn't covered. The tickler turns are ditto: Use as few as are necessary to give feedback for half way spacing of the detector plate voltage resistor, and space them in order to get to the bottom of the band.

I found that 45 volts on the screen grids gave better results than higher voltages, especially on the cheaper types of tube if used. The cheap tubes, however, were merely found satisfactory.

I am still battling with several things in my own set and possibly some of the rest may be able to help me. For one thing, a three-foot antenna gives as much volume as one forty feet long and sixty feet high; absolutely no difference. It hurts my feelings that such should be so.

Two things yet to mention. Be sure the tickler coil is not reversed. The set may oscillate even with the tickler reversed but won't work properly. W6HM says it is shocking to use the fingers in changing condensers; He's right and no questions asked. Use a screw driver across plates first.

— W. L. May, W3YQ, #33PV, now W8WF.

Radio Corporation of America,  
233 Broadway, New York.

Editor, *QST*:

In choosing the UX (or Navy type) socket for use with rectifier Radiotron UX-866, the amateur should be very careful to select one making very good filament contact and capable of carrying five amperes continuously. Unless this precaution is followed, poor contact at the filament prongs will cause not only overheating of the prongs and socket, but also high internal tube drop with consequent injury to the Radiotron. We are having this information incorporated in the instruction booklet for this tube, but some booklets without it may be packed with the first tubes sent out.

On page 3 of the instruction booklet we recommend that a filament voltmeter should be connected directly across the terminals of the filament at the socket. This is entirely satisfactory but in doing so the amateur should not forget that when the tube is rectifying, the filament is at a high positive potential. He should therefore take special precautions not to come in contact with the filament voltmeter.

At the bottom of page 3 we recommend the use of a time delay relay in the plate circuit where the inverse peak voltage exceeds 2100 volts. While this is the ideal condition for automatic control, we realize that many amateurs may not or can not afford to use one of these



## Everybody Demands Power

— and after you have heard the best you will insist upon Tone Value too.

### For Use with UX 250 Tubes

- No. 7508 — Transformer for full wave rectification using 2 UX 251 tubes to supply B and C power to receiver and power for 2 UX 250 tubes . . . . . \$12.50
- No. 8529 — Transformer similar to No. 7508 with the addition of a low voltage secondary, one for 220 tubes and the other for 227 tubes so that you can build a power amplifier for either radio receiver or phonograph pickup . . . . . \$17.50
- No. 6551 — Double choke, for use with above transformers . . . . . \$15.00
- No. D-600 — Power Amplifier Condenser Unit . . . \$16.50
- No. D-307 — A Condenser Block, used in connection with D-600 . . . . . \$10.00
- No. 1177 — Straight Power Amplifier Output Transformer . . . . . \$12.00
- No. 1176 — Same as No. 1177 but of Push-Pull type. \$12.00

Please Mail Items Checked C.A.D.  
Send Detailed Information

(Name)

(P. O. address)

(City and state)

**Dongan Electric Manufacturing Co.**

2999-3001 Franklin St., Detroit, Mich.

"TRANSFORMERS of MERIT for FIFTEEN YEARS"

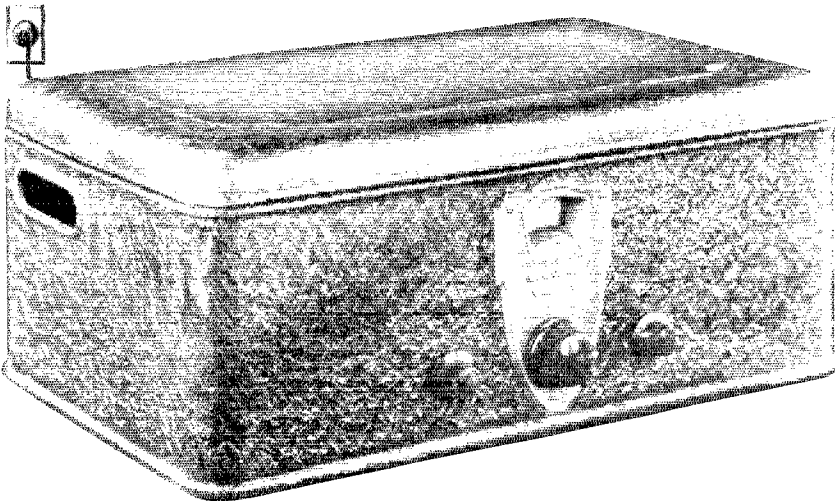

**THE  
CROSLLEY  
AC LINE  
for 1929!**

Thru the use of the superior Mershon condenser Crosley has developed electric light socket operation to a high degree of excellence and presents the trade with a line of AC sets for 1929 that set entirely new standards of radio performance!

**AC Electric 7-tube  
Gembox operating  
dynamic power speaker**

This amazing receiver contains the latest and best radio refinements — new neutrodyne circuit — 3 stages of radio amplification — detector — 2 stages of audio — 171-A power tubes in last audio stage — full voltage on plates of output tube — power supply self-contained — illuminated dial — beautiful case — black cracked finish highlighted with white gold. Price without tubes \$65

# CROSLLEY

ANNOUNCES THE GREATEST RADIO VALUE EVER OFFERED!

**The AC Electric 7-tube GEMBOX (Without Tubes) \$65**

New Full Neutrodyne circuit — New Chassis — New High voltage power output tube — New Volume control of exceptional smoothness — New Switch on front of case — 3 New Added stages of radio frequency amplification — New 3 tuning condensers — New Elimination of regeneration in the detector tube

— combined with these modern, superior Crosley features so essential to complete radio satisfaction —

Proven Illuminated dial  
Proven Self contained power supply

Proven Mershon condenser  
Proven AC Electric socket operation

- 3 radio amplification tubes
- 1 detector tube
- 2 audio tubes
- 1 rectifier tube

## RADIO

THE CROSLLEY RADIO CORPORATION  
Department 18, Cincinnati, Ohio

Power Crosley, Jr. Pres.

Owners of WLW — the Nation's Station

**Crosley 8-tube AC  
Electric Showbox**

This remarkable set unusually selective, contains 3 stages of radio amplification, detector, 3 stages of audio with two 171-A power tubes in the last stage, rectifier tube — 8 tubes. There is a full 180 volts on the plates of the last tubes which insures clear, rich volume of reproduction. The set is sharp, sensitive, powerful. Case is finished in black cracked effect highlighted with white gold. Price without tubes \$80

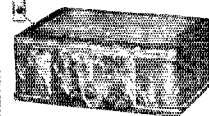

**Crosley 8-tube AC  
Electric Jewelbox with  
tuned antenna circuit  
and power detector**

A new powerful receiver employing a tuned antenna circuit, power detector tubes and use UV 227 tubes in all circuits except last audio stage and rectifier. This set contains a new and improved audio system with push-pull amplification and two 171-A power tubes in the last stage. This set is truly called "The World's Finest Receiver." Its selectivity and sensitivity are amazing. Combined with the dynamic Crosley DYNACONE performance is assured equal to the best radio reception money can buy. The case is finished in black and highlighted with white gold. All the improved Crosley features such as illuminated dial, Mershon Condenser, complete shielding, self-contained power supply and are incorporated in this wonderful value. Price without tubes \$105 Montana, Wyoming, Colorado, New Mexico and West price slightly higher.

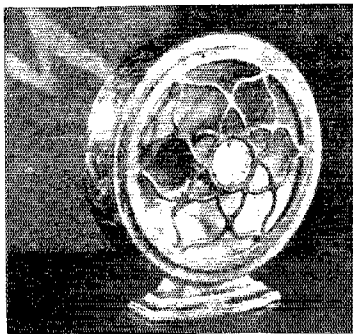

**The Crosley Dynamic DYNACONE** — A power speaker of entirely different principle of operation producing all tones over the entire scale in true relation to each other — \$25

**The 7-tube  
AC GEMCHEST**

A cabinet of Chinese Chipendale design with new 7-tube GEMBOX and Dynacone built in — operation in 3 colors, Red — green or black with metal trimmings — \$94

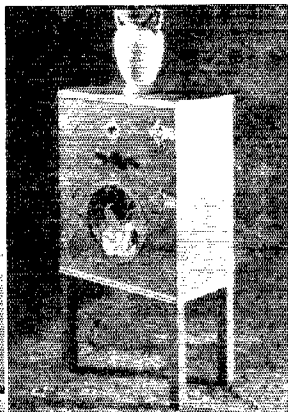
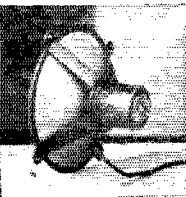

**The Crosley DYNACONE** — Crosley cabinets equipped with Crosley DYNACONES offer amazing value to the trade.

Say You Saw It in QST — It Identifies You and Helps QST

All the latest data in advanced radio science

See it For 10 Days FREE

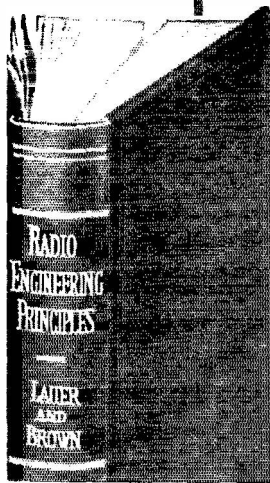

Four Good Reasons Why You Will Want to Examine this New Second Edition of

## Lauer & Brown's RADIO ENGINEERING PRINCIPLES

301 pages, 6x9, 227 Illustrations  
\$3.50 net, postpaid

1. The book covers in detail the science and practice surrounding the 3-electrode vacuum tube;
  2. It gives the principles involved in the functioning of all forms of radio apparatus;
  3. In the development of principles, the electron theory is made use of;
  4. Mechanical analyses are avoided—Mathematics is used only to indicate applications in problems of design.
- This standard manual gives the latest and best basic data on all phases.

### Some of the Topics

- radio-telegraphic transmitting circuits;
- ferro-magnetic or dielectric modulation methods;
- mathematical theory of the balanced modulator;
- piezo-electric oscillators and resonators;
- etc., etc., etc.

devices. It is not absolutely necessary of course, for the amateur can accomplish the same thing by always applying the filament voltage thirty seconds before he closes the plate voltage switch.

— C. D. Mitchell, Radiotron Division.

## Financial Statement

BY order of the Board of Directors the following statement of the income and disbursements of the American Radio Relay League for the fourth quarter of 1928 is published for the information of the membership.

K. B. WARNER, Secretary.

### STATEMENT OF REVENUE AND EXPENSES FOR THE THREE MONTHS ENDED DECEMBER 31, 1928

REVENUE	
Advertising sales, <i>QST</i> .....	\$18,988 53
Newspaper sales .....	14,272 08
Handbook sales .....	2,786 81
Dues and subscriptions .....	10,487 46
Back numbers, etc. ....	715 41
Emblems .....	227 70
Interest earned .....	325 15
Cash discounts earned .....	282 29
Bad debts recovered .....	4 15
	\$48,089 58
Deduct:	
Returns and allowances .....	\$5,269 93
Provision for new stand returns ..	1,131 26
Discount 2% for cash .....	301 61
Exchange and collection charges ..	6 37
	6,709 17
Net revenue .....	\$41,380 41
EXPENSES	
Publication expenses, <i>QST</i> .....	\$14,012 16
Publication expenses, Handbook ..	1,189 19
Salaries and commissions .....	15,576 58
Forwarding expenses .....	613 13
Telephone, telegraph and postage ..	1,466 44
Office supplies and general expenses ..	2,323 42
Rent, light and heat .....	900 71
Traveling expenses .....	1,444 64
Depreciation of furniture and equipment .....	523 45
Communications Department field expenses .....	77 04
Headquarters Station expenses .....	15 57
	\$3,122 30
Total expenses .....	\$3,122 30
Net gain from operations .....	\$3,258 08

### MCGRAW-HILL FREE EXAMINATION COUPON

McGraw-Hill Book Co., Inc.,  
120 Seventh Avenue,  
New York, N. Y.

You may send me Lauer and Brown's RADIO ENGINEERING PRINCIPLES—New Second Edition, \$3.50 net, postpaid. I will either return the book, postage prepaid, in 10 days, or remit for it at that time.

Name .....

Street No. ....

City .....

State .....

Name of Employer .....

Official Position .....

(Books sent on approval in the U. S. and Canada only.)  
*QST*, 3-1-29

## RADIO IN BRASIL

When in Brasil, apply to M. BARROS & CIA for anything you need in connection with radio.

### M. BARROS & CIA

70 sob. Rua S. José 70 sob.,  
Postal Box 89

Rio de Janeiro

Telegraph address, Radioparte, Rio de Janeiro

Branch: Avenida S. João 4, S. Paulo, Brasil

## I.A.R.U. News

(Continued from page 73)

As noted, the secretary of each Divisional organization will constitute the director for his division. These secretaries will vote on which division will be the Headquarters Division, and the Secretary of that division so elected will automatically become the Federal Secretary. It is intended to rotate the headquarters among the divisions, from time to time.

I.A.R.U. Headquarters congratulates Australian amateurs on this progressive step. Unity of effort is absolutely essential to the life of ama-



# Showing 75 Watt MOPA Xmitter Kit & Power Unit Using New UX866 Tube

## CAT 172 REDESIGNED TO EMPLOY THE NEW RECTIFIER

REL's new power unit has been redesigned to employ the new UX-866 rectifier tube, thereby effecting a startling improvement.

The unit is conservatively rated at the following figures:—

- Direct current ( ) 2000 volts at
- Plate Supply ( ) 3000 watts (150 mils)
- Alternating current ( ) 10 volts at 80 watts (8 amperes)
- Filament Supply ( ) Accurately center tapped.

Designed to operate from 110 volt, 60 cycle single phase alternating current power supply, it comprises separate plate and filament transformer with voltage regulating switches—complete filter system—overall dimensions 20" x 9½" front x 13" deep. Price, completely built and tested \$85.00, but does not include UX-866 tube.

## WRITE TODAY! FREE

Booklet showing our complete line of transmitters and receivers specially designed to operate under 1929 regulations sent promptly on request.

### AND FOR 50c

the now famous REL loose leaf handbook will be sent to you. This book is the biggest bargain yet.

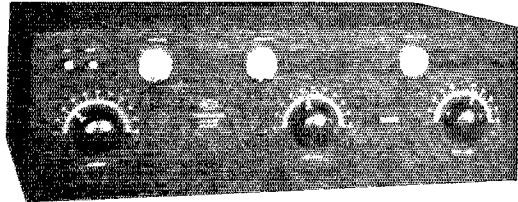

## 1929 MODEL ALL METAL ENCLOSED AMATEUR XMITTER, DESIGNED ALONG COMMERCIAL LINES

REL offers to the more advanced and modern amateurs their Cat. #222, 75 watt, Master Oscillator Power Amplifier Kits. These are specially designed to conform with all of the rigid 1929 requirements. Adapted to the three most popular new bands—14,000—7,000—3500 KC. Complete wide spread tuning in each band is offered.

Constant stable signals which do not swing or vary.

Power may be obtained from any available source, or else if AC is available REL suggests their Cat. #172 power unit, which now employs the new RCA UX-866 tube.

The Power necessary to operate the Cat. #222 transmitter is 2000 volts DC plate supply and 10 volts AC or DC filament supply.

Such features as the following place this kit in a class of its own; metal enclosed case affords complete shielding—Master oscillator circuit in separate shielded compartment—three special new type REL master oscillator plug-in coils. Each one correct for each band. These coils require no tapping or shifting of contacts—master oscillator circuit becomes one dial control

affording great simplicity. Master oscillator circuit uses UX-210 tube which operates directly from the same power supply as the power amplifier tube. Plate and filament resistances supplied so that voltages are reduced to correct amount. — Power amplifier uses UX-852 tube (UX-860 screen grid tube can be used with very slight circuit changes). Standard REL flatwise wound on glass inductances supplied for Power amplifier circuit. — Purchaser has option of either the type "S" or type "L" units. Type "S" are mainly adapted for the 14,000 and 7000 KC bands, while the type "L" are adapted for the 7000 and 3500 KC operation. — Large Cat. #149 tuning condensers used. — With very slight changes set can be adapted for telephone purposes employing the one-hundred percent system of modulation. — Overall dimensions 9" x 18" front x 16" deep. Kit price \$130.00.

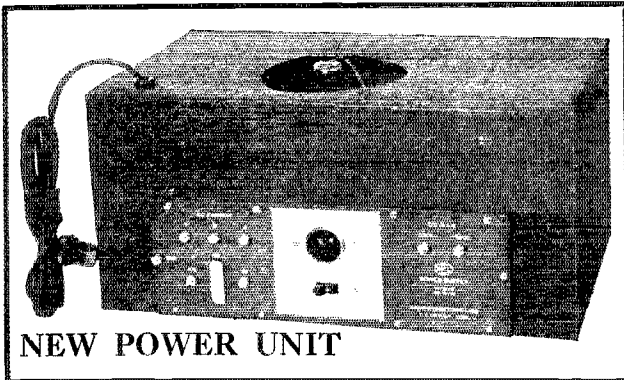

**PIERCE AIRO** Cardwell **Composites**  
 Dubilier THE HOME WIRE CO.  
 PYREXON  
 Raytheon  
 Weston  
 FARRAND  
 Knapp

AD. AURIEMA, Inc.  
 Manufacturer's Export Manager  
 116 Broad Street, New York, N. Y.

Scientifically equipped to economically export dependable receiving and transmitting radio apparatus

teur radio anywhere, and there can be no doubt but that untold benefits to citizen radio in Australia will result from the merger. Congratulations, OMs!

Coincident with the news of the merger, we are happy to learn also of the successful conclusion of negotiations between the W.I.A. and the Australian Department of Defence on a plan of Army-Navy-amateur cooperation, very similar in most ways to our own Army-Amateur Net and Navy Radio Reserve in this country. Again, we are indebted to QTC for the information.

Two very great benefits result from this plan. First, amateurs will be permitted to handle traffic in connection with the Defence tests. The second, and even more important, is that only through the Reserve will Australian amateurs have access to the valuable 75 to 85-meter band. This band is denied to amateurs normally, both in England and Australia - a most unfortunate thing from the American point of view. It is splendid to note that it is now possible for Australian amateurs to enjoy the benefits of this most advantageous and valuable territory.

**BELGIUM**

By Paul de Neek, President Réseau Belge.

Work with NEB4WK, our sailing training ship, *L'Arctur*, has proved to be most successful. Every day communication has been realized, during the 28 days that took the vessel from Antwerp to Martinique. Signals were always of good strength, and with a real crystal-like tone.

Best contact with NEB4WK was maintained by EB4FT, who "clicked" no less than 72 times. Others who did good work with the ship were (WX, 4BC and 4AR.

With the new regulations in force, good contact is possible with W bands, but work with other Europeans is still somewhat difficult owing to the fact that on this side we have not yet eliminated the bad QRM between phone and key bands on the 40-meter band.

A splendid QSO was maintained between EB4EA at Antwerp and FBHYO, on the Ile of Reunion, east of Madagascar.

We hope to start in soon on the 28,000-ke. band, and shall be glad to try contacts on this band with all amateurs in the world who are testing on this very interesting wave.

**DENMARK**

By Helmer Petersen, Secretary E.D.R.

Conditions are pretty good now - better than this time last year. A lot of amateurs seem to be off-wave, however; at least, as far as Europeans are concerned. On the other hand, the new prefixes seem to have been adopted by practically all amateurs on the continent, with the exception of a few French and all the Russian amateurs.

On 40 practically all the Scandinavian and Central European countries may be heard during the day; QSOs are easily established. Early in the

**Potter  
 Dynamic Speaker  
 Filter**

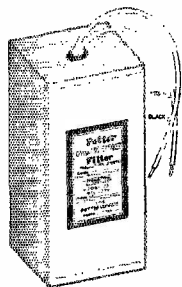

REDUCE the hum in A.C. operated dynamic speakers using low voltage rectifier.

The installation of a Potter Dynamic Speaker Filter is easily made by connecting the two leads provided across the field of the speaker

List Price \$4.75

**Potter Filter Blocks**

- T-2900 Condenser Block for the single 250 type tube amplifier. . . . . \$20.00
- T-2950 Condenser for the push-pull 250 type tube amplifier. . . . . \$22.50

**The Potter Co.**

North Chicago, Illinois  
 A National Organization at Your Service

# Yours FREE!

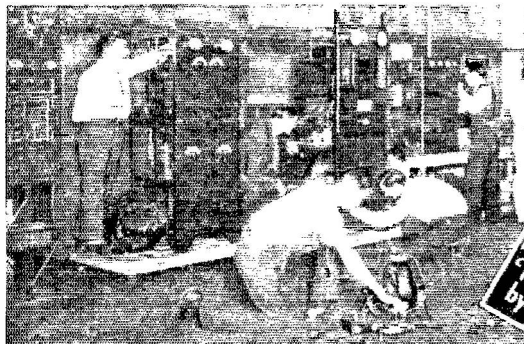

## The Short-Cut to **BIG MONEY** in **RADIO**

**“W**ORTH over \$5,000 to me!” “Never so thrilled in my life!” “Never dreamed Radio was so easy to master!”

So scores of men write of this wonder-book which tells how to achieve brilliant success in Radio. Send for your copy—it's Free!

### Glorious New Opportunities

Radio needs you! Over 30,000,000 sets need servicing. Over 2,000 ships carry radio apparatus. There are 50,000 radio dealers, 4,000 radio manufacturers, scores of broadcasting stations. And now Television, transatlantic Radio Telephony, and Photoradiograms open up brilliant new possibilities! The Free book tells all about them. It tells also how you can make your spare time prepare you for success through a revolutionary new method of training.

### Learn at Home with This Big Laboratory Outfit

You get the “how” as well as the “why” of Radio with this fine training. Only an hour a day—in spare time—is all you need to devour! As part of your course, you receive absolutely free of extra charge—a magnificent outlay of apparatus. With this outfit you learn to build fine sets and solve every problem in repair work. That is why our graduates

have the confidence and ability to command big pay. That's why they're in big demand everywhere!

### Training Sponsored by Radio Corporation of America

Our graduates enjoy greater success because they've posted right up-to-the-minute in everything Radio. Radio's greatest achievements originate in the gigantic laboratories of the Radio Corporation of America. This great Radio organization stands back of every lesson in the RIA course.

### Money Back if Not Satisfied

The course prepares you for success in all phases of Radio—manufacturing, servicing, selling, shore and shore broadcasting, radio operating and many others. Includes Television, Photoradiograms, and radio equipment. A signed agreement assures you of complete satisfaction upon completion of the course—or it won't cost you a single penny!

Send for this Free book now—Why wait years for success that can be yours in only 9 months? Read this Free book. It gives you the real dope about Radio and tells you all about the famous course that has enabled us to place thousands of our students in fine positions, usually from 3 to 10 days after graduation! Mail coupon now. Radio Institute of America, Dept. ST-4, 326 Broadway, New York.

RADIO INSTITUTE OF AMERICA  
Dept. ST-4, 326 Broadway, New York

Gentlemen: Please send me your big FREE 50-page book which tells about the great opportunities in Radio and about your famous laboratory-method of guaranteed radio instruction at home.

Name .....

Address .....

**LASTS TWICE  
AS LONG  
AS  
OTHER TUBES**



**ARCTURUS**  
BLUE A-C LONG-LIFE TUBES

ARCTURUS RADIO TUBE CO.

Newark, N. J.

## Dress Up the Outfit

### FIL VOLTAGE

Escutcheons like above machine engraved on Bakelite. All desired markings for Transmitters, Receivers and B. C. station apparatus.

### GAIN CONTROL

Price thirty-five cents each; 3 for \$1.00—7 for \$2.00—10 for \$2.50. Send stamp for list of markings or tell us what you want. We have them.

**CLARKE LABORATORIES**  
DANVILLE VA

evenings this band is very quiet, although occasional weak signals come through from Asia and southern Europe. As the evening advances, European signals increase in strength, and about midnight it is easy to obtain QSOs, French stations coming through QSA5 at 2021 GMT.

About midnight, the W stations commence to appear, and they are often heard until late morning. As late as 1030 GMT several W stations have been heard with very good strength, but I suppose these stations are using a comparatively large output.

The 32-meter band was formerly very much used by many continental countries for European work, but there is not much to be heard there now. Nor are the few signals there very good, with the exception of the Danish Expedition ship *Dana*, which is at present located near New Zealand. The call is OXQ, and it may be heard frequently here QSA4. QSO has been established by OZ7BL using but 12 watts DC input. FB OM!

On 20 meters there is not very much doing. Sunday afternoons some activity is noted, but mostly from North and South American amateurs, with only a little sprinkling of European stations.

Danish hams are becoming more and more interested in the 10-meter band, and intend to conduct some tests in this territory in the near future.

ENGLAND

By the R.S.G.B.

Nothing outstanding can be reported for this month. Conditions on the 7000-ke. band appeared to be very similar to those which have been noted during the corresponding period in past years. During the day local conditions were rather good, but after dark contacts under 600 miles were rare, although it was again noted that southern European signals were by far the most consistent at night. Except on very few occasions, German, Danish and Czechoslovakian signals were audible after 1800 GMT.

For the great part of the month North American signals were received from 2100 GMT on, but it was only rarely that British stations were able to effect QSO. This was probably due in some measure to the fact that the average British station uses considerably lower power than the local Europeans, with the result that our signals become badly jammed. On one or two evenings, Australian stations have been received on this band.

Conditions on 20 meters are still very bad, and for the most part of the month the only contacts which have been made have been with European stations. There have been no outstanding achievements on the 28-mc. band, and to date no British station has effected a contact with any of the European countries. Confirmation has now come to hand that G6LL was heard in South Africa on the same day (October 21) that he established the pioneer QSO between England and America.

In order to further investigate the problems

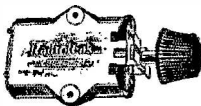

\$4 Bradleystat No. E-210, Special \$1.60

General Radio Type 285



**Audio Transformer**

Ideal for high and even amplification.

Type 285-H — 6 to 1  
Type 285-D — 3 to 1

List \$6.00  
Now only \$2.95



S. J. Mesco Telegraph Key, \$1.45  
Signal Buzzer Set International Code on Baseboard, \$2.45

Television disks as specified in QST special, \$1.95

## THORDARSON TRANSFORMER

R-195 Raytheon B-H eliminator transformer, designed as power supply for B-Battery eliminators using the Raytheon B-H tube. Has 2 secondary voltages—low 225 volts either side of centre tap—high 285 volts either side of centre. Transformer will carry the maximum current consumption of the Raytheon tube without overheating.

Listed at \$7.00  
While they last only \$2.95

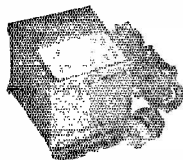

R-197 Thordarson Transformer, 220 volts each side of centre tap; 5 volt filament centre tap.

List \$7. While they last at \$2.95

## ACME TRANSFORMER

Listed at \$5.00. The universal transformer for Super Het, 30 K. C. Limited quantity at \$1.10.

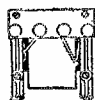

## Photo Electric Cell



The well known K. H., the most sensitive tube for this purpose—4½ inches high. Lasts a lifetime with ordinary care.

Never sold for less than \$15. Now Special \$12

Gross Short Wave Plug in Coils  
16 to 26 meter }  
25 to 48 " } \$6.50 for Set  
47 to 110 " }

# LEEDS

The Home of RADIO—  
45 VESEY STREET  
NEW YORK

New York's Headquarters for Transmitting Apparatus

When in Town Visit Our Store

### SPECIALS

- Belden braid 1½" wide; ideal for shielded grid tubes, etc. \$6.06
- Patent Deluxe No. 124 Phonovox—The electrical pickup; List \$13.50, Special 7.50
- General Radio 243D .001 cond. plain or with vernier 1.75
- Two-inch space wound Ham inductance No. 16 d.s.c. 35c
- Green. Special price per set
- Heath condenser double spaced for transmitting .00025 cap. 2.95
- Honeycomb Coils unmounted, all sizes in stock ¼ price.
- \$5 Signal Corps adjustable arm micro-transmitter for panel mounting 2.45
- R.E.L. Transmitting Inductances, per set 8.80
- Kristol 50 Henry choke 2.75
- No. 12 Enamelled copper wire, any length, ft. .01
- No. 10 Enamelled copper wire, any length, ft. .01½
- 6-pin Bakelite Panel 10 x 14 x ¼ 1.50
- Baldwin phones type C, pair 4.95

Pyrax Low-loss V.T. sockets, each 39c.

R.C.A. V.T. socket; porcelain base, metal top 50c

### General Radio .3 mfd Condenser

\$1. List. Tested at 500 v. D. Ideal for filament By Pass



30c

## ACME VARIABLE A. F. RATIO

TRANSFORMER



Recommended for short wave C.W. reception exclusively. Has sharp peak—gives excellent results. List \$2.75  
price, \$7.00 each. Special

## General Radio—200 watt Full Wave TRANSFORMER

Type 565-B. Secondary voltages 1200 volts (with centre tap) 2-7½ volt filament carrying 7½ Amp. each. Maximum current 200 M.A. Price.

\$13.50

**Resistor**— Vitreous Enamelled 200 watt—20,000 ohm, centre tapped, 8½" long, 1" diameter \$3.75

**Resistor**— Vitreous Enamelled 100 watt—20,000 ohm. \$2.45

MAIL ORDERS FILLED SAME DAY  
10% Must Accompany All Orders

PLEASE PRINT YOUR NAME AND ADDRESS PLAINLY to AVOID DELAY

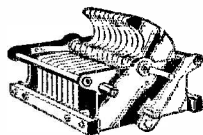

Cardwell condensers, double spaced for transmitting, .00025 cap. \$4.45

## Everything in Cardwell

- Acme
- Thordarson
- Jewell
- Flechtheim
- Signal
- Bradley
- In Stock



We carry the largest stock of GENERAL RADIO PARTS in the country

## Ward Leonard Resistance

\$4.75 list — 6½ inches long — 800-1000-1200-3000-6000-8000-11000 ohms; can be used for 2.50 watt tubes or less, \$1.45.



## NEON GLOW LAMPS

Made by General Electric Co. type G-10, standard base 10L uses, as illustrated in QST May issue page 17. Price only .65c

## RADIO FOUNDATION TRANSFORMER



Will carry 6 or 7-327 A.C. tubes (topped at 2½-3-3½ volts. List \$6.00. Special \$2.25

## Television Lamp

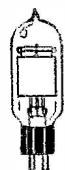

The large K. H. lamp 4½ inches high—contains 1½-inch plate—carrying 5 to 50 M. A. Special . . . . . \$5.50

FROST-RADIO FROST-RADIO FROST-RADIO FROST-RADIO FROST-

# FROST-RADIO MICROPHONES

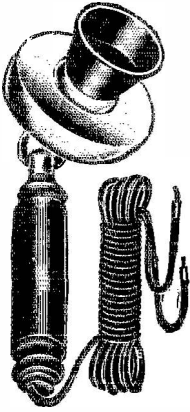

Built of finest quality materials so as to deliver 100% satisfaction for ham use. Solid back, carbon button type. Have unusually sensitive microphones which reproduce all audible frequencies with great fidelity and truthness of tone. Supplied complete with superior quality tinsel cords.

- No. 155 Hand Microphone . . . . . \$6.00
- No. 159 Desk Microphone . . . . . \$8.75
- No. 157 Pony Arm Microphone for wall or panel mounting . . . . . \$4.50

HERBERT H. FROST, INC.,  
Elkhart, Indiana  
Chicago San Francisco

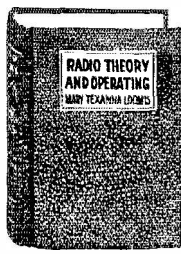

- TELEVISION  
RADIO CONSTRUCTION  
RADIO REPAIRING  
RADIO SERVICING  
MARINE RADIO OPERATING  
RADIO COMPASS WORK  
LAND RADIO OPERATING  
BROADCASTING  
AIRWAYS COMMUNICATIONS  
RADIO ACCOUNTING  
MESSAGE FORMS  
1929 RADIO LAWS  
JUNIOR ENGINEERING

The above subjects and many others thoroughly covered in the best radio text and reference book ever produced.

## "RADIO THEORY AND OPERATING"

992 Pages 300 Illustrations

By Mary Texanna Loomis, President, and Lecturer on Radio, Loomis Radio College, Member Institute of Radio Engineers.

Fourth Edition—Thoroughly Revised  
Used by all the Government radio schools, nearly all the radio schools in U. S. and Canada and over 200 universities, colleges and high schools.

Flexible binding — Price \$3.50  
For sale by practically all bookdealers this and foreign countries. Or sent, postage paid, on receipt check or money order.

LOOMIS PUBLISHING COMPANY  
Dept. 5 Washington, D. C.

which are known to be at present unsolved, the Contact Bureau of the R.S.G.B. proposes to hold a series of special tests for a period of two weeks beginning 0000 GMT March 9th, and concluding at 2400 GMT March 24th. Full particulars of these tests are contained in the letter which the Hon. Manager (Mr. T. P. Allen, G1GYW) of the Bureau is sending to the Headquarters of all the well-known amateur societies.

(See the Communications Department of this issue of QST for full particulars — A. L. B.)

### GERMANY

By E. Reiffen, Secretary, D.A.S.D.

Although considerable interest has been aroused on 28-mc. work, there is nothing very definite in the way of results to report at this time. We hope to have some, however, for the next report.

On 20 meters DX conditions have not improved as compared with the previous month.

On 40, daylight QSO's with all European stations are very easy, but the coming of evening brings a noticeable decrease in the number of signals heard. Contacts with the United States are nicely possible from 2400 middle European time, and the W's are usually heard well on into the early morning hours.

4DBA had several very good QSO's with the United States in the afternoon with an input of 120 watts.

4CB is again in the ether with his 200-watt set, and will make long-distance QSO's on 20 meters.

4ACX is working on the 40- and 20-meter bands.

4BY had the first QSO from Germany with our Doctor Lamm, who is now in the United States temporarily, and who was handling the key at WSADM. The input was 8 watts crystal control. 4BY has been in touch with W 6th and 7th district stations, and also with Uruguayan stations. FB OM!

Is anybody working the ZLs whom we used to hear so well on 30 meters in 1928? We think 20 is the best for them, but would be glad to hear from anyone who is carrying on successful communication with these hams.

The D.A.S.D. would be very glad to have lists of D stations heard in foreign countries, in order to publish them in its magazine "CQ." Such lists should be sent to the D.A.S.D., 19 Blumenthalstrasse, Berlin W. 57, Germany.

### BYRD OPERATORS GET RECEPTION FROM NEW ZEALAND GANG

Through the courtesy of *Break-In*, the fine monthly magazine issued by the N.Z.A.R.T., the New Zealand amateur organization, we reprint here in part a most interesting account of a reception and dinner (or "beano," it seems — Hil) accorded the operators accompanying the Byrd Antarctic Expedition. It was certainly a splendid set on the part of the ZL gang, and, since most of the Byrd op's are hams, and one of them is a

# SM

## 1930 Reception Will Be Different!

### Try It NOW and See—in the New S-M 720AC All-Electric Screen-Grid Six

A SCREEN-GRID tube with A. C. heater-type filament, nearly twice as good as the wonderful UX222—and the 22 in S-M 1929 sets is enabling S-M setbuilders to get station after station never heard with common factory-built sets. . . . A power tube with more than sufficient undistorted output capacity to fill the best dynamic speaker—yet without the high plate voltage required for the 250. . . Every refinement of precision manufacture as built into the tremendously successful 720 (D.C.) Screen-Grid Six—plus improvements which make the new 720AC All-Electric a set capable of far better reception, both as to distance range and selectivity, and tone quality as well, than even the original, never-yet-equalled, 720. . . Be the first on the ground with it! Get your order in at once to your S-M jobber or dealer.

Used with the new S-M 669 power supply, the 720AC is a complete all-electric receiver designed especially to bring out the extreme possibilities of these new tubes. Price, completely WIRED in 700 two tone shielding cabinet, less tubes and power unit, \$117.00. Component parts total \$78.50; cabinet \$9.25 additional. S-M 669 Power Unit, WIRED, \$57.50.

S-M 720 receivers can be changed over at slight cost to the 720AC circuit.)

**Tubes Required**  
 3 UY224 (C324)  
 (The new A.C. screen-grid tube.)  
 2 UY227 (C327)  
 (The present popular heater tube.)  
 1 UX245 (CX345)  
 (Super-power moderate voltage output tube.)

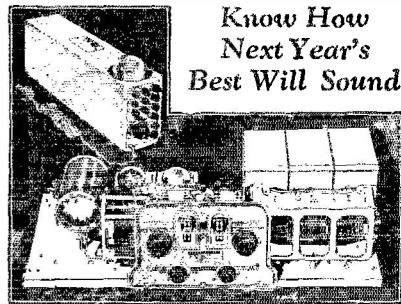

Know How  
Next Year's  
Best Will Sound

### S-M Audios — Positively Guaranteed Superior

That same unchangeable purity and fidelity of tone, which has established S-M supremacy even more firmly this year than ever before, can be built into any receiver or amplifier by using the new S-M Clough-system audio transformers. Guaranteed absolutely and unconditionally to surpass, in their uniform amplification of all notes from 5000 down to 40 cycles, any other transformers obtainable on the American market at any price, these unique instruments make use of a principle totally different from anything used in standard transformer construction—built-in resonance to even out the amplification curve in the critical range which ordinary transformers weaken—and a circuit which keeps D.C. plate current entirely out of the transformer winding and thereby avoids the common injurious effect of hysteretic distortion. Amplification obtainable—running as high as 4 1/2 to 1—is far higher than with

any standard transformers of comparable tone quality.

S-M Clough system audios are now obtainable in a complete line, for both single and push-pull amplification, as follows:

- 255 and 256, for standard use in first and second stage respectively. Each.....\$6
- 225 and 226, similar to 255 and 256, but larger and slightly more perfect in both frequency characteristic and amplification ratio. Each.....\$9
- 257 Push-Pull Input Transformer, to operate from one amplifier tube into two 171A, 210, or 250 tubes. Each..\$7
- 227 Push-Pull Interstage Transformer, to feed from two 112A, 226, 227 or 171A, 210 or 250 tubes. Each.....\$8
- 258 Tapped Output Impedance, to feed from two 171A tubes into any standard speakers. Each.....\$5

248 Universal Output Choke to feed out of two 210 or 250 tubes into one to six or more standard speakers; provided with several impedance-matching taps. It will handle over 20 watts without core saturation. Open-mounted. Each.....\$7  
 228 (248 in case like 227). Each.....\$6

#### For the New Tubes: S-M 335 Power Transformer

This is the transformer used in the new S-M 669 power unit. It contains one 105 to 120 volt primary; one 5 volt, 2 ampere, rectifier filament winding; two 2.5 volt, 6 ampere, filament windings. Plate voltage with one '80 tube, 300 volts at 100 ma. Provided with iron end terminal mountings, or (335U) in open mounting; either type \$15.00.



The Radiobuilder, a monthly publication telling the very latest developments of the S-M laboratories, is too valuable for any setbuilder to be without. Send the coupon for free sample copy, or to enter your subscription if you want it regularly.

Ask about our  
Authorized  
Service Station  
Appointment!

SILVER-MARSHALL, Inc., 858 W. JACKSON BLVD., CHICAGO, - - U. S. A.

Silver-Marshall Inc.  
858 W. Jackson Blvd., Chicago, U. S. A.  
 . . . Send your complete catalog, with sample copy of the Radiobuilder.  
 . . . For enclosed 10c, send five selected Data Sheets, including No. 10 on the 720 AC.

Name.....  
 Address.....



## False Economy Is Costly

Nothing is likely to prove as costly as a cheaply made, over-rated condenser or resistor.

Whether you are a manufacturer, professional set builder or experimenter, you cannot afford the high cost of a cheap condenser or resistor.

Aerovox condensers and resistors are conservatively rated and thoroughly tested. They are not the most expensive, nor the cheapest, but they are the best that can be had at any price.

A COMPLETE CATALOG with illustrations and detailed descriptions may be obtained free of charge on request.



This is a monthly publication which will keep you abreast of the latest developments in radio. Free on request.



## ACME WIRE PRODUCTS

Coils — Magnet Wire Wound  
Magnet Wire All Insulations  
Varnished Insulations  
Parvoit Filter and By Pass Condensers

All products made to Recognized Commercial Standards including those of:

National Electric Mfrs. Assn.  
Radio Manufacturers Assn.

American Society for Testing Materials

For 25 years manufacturers and suppliers to the largest and most discriminating users.

## THE ACME WIRE CO.

NEW HAVEN, CONN.

Branch Offices:

New York Cleveland  
52 Vanderbilt Ave. Guardian Bldg.

Chicago

842 N. Michigan Ave.

former member of *QST* staff, the affair had a decidedly amateur hue. The account follows:

"The five radio operators from the Byrd expedition were the guests of honour of the Otago branch at a dinner and beano held when the Expedition put into New Zealand.

"Our guests were Lt. Hansen, Lt. Berkner and Carl Petersen, of WFBT, and Howard Mason and Mr. Grenlie, of WFAT.

"Lt. Hansen gave a very interesting description of the radio equipment of the expedition. All the dog-sled excursions will be equipped with portable crystal-control transmitters having power ranges of 5 to 50 watts. The radio so far has been working perfectly, and splendid contacts made with stations (both amateur and commercial) in all parts of the world.

"Mr. Howard Mason, formerly Associate Technical editor of *QST*, in reply to a toast of the A.R.R.L., gave us some interesting glimpses of Headquarters.

"Lt. Berkner, toasting the N.Z.A.R.T., said that the present gathering of hams made them all feel very much at home — amateurs are the same the world over — a spirit of comradeship and good-feeling dominating any gathering where amateurs were present. They had made many friends that night and hoped to meet more of our fellows over the air.

"Musical items were contributed by LAC, 4BD, 4BC and Messrs. Bert Isaacs and G. Lister, on the piano and sax respectively.

"The party broke up a little after midnight after lakas had been given in true style, and 'Auld Lang Syne' sung to the echo."

## Calls Heard

(Continued from page 57)

L. Boyé, Rue du Pousel a Toulouse, France

w1mk w1kk w1aba w1bob w1eb w1erj w1hdt w1i w1ladh w1lchz w1hjd w1rp w1enz w1ab w1ejd w1evj w1mh w1erw w1avl w1ja w1uy w1wu w1enp w1bx w1bal w1emp w1bes w1no w1epi w1ang w1w w1ng w1kh w1kn w1che w1aor w1nr w1yb w1anz w1biv w1asw w1box w1ax w1bnu w1abn w1aja w1apd w1aer w1awx w1aed w1ayp w1aeg w1hn w1bw w1aeb w1aib w1bnx w1bwe w1ak w1blg w1aje w1erb w1evj w1afo w1rk w1aw w1ov w1kj w1akg w1bhy w1aed w1agl w1bui w1aep w1bem w1abe w1boz w1uk w1edr w1ry w1kj w1buy w1akd w1ajj w1llg w1ark w1bdr w1ajj w1ke w1ags w1bph w1gw w1ajh w1ayd w1ael w1ber w1aib w1aja w1bwt w1ajj w1awx w1aob w1aip w1ekl w1ld w1uo w1aje w1aas w1bbl w1lmo w1ahl w1aba w1ar w1ei w1ef w1tk w1pa w1ll w1ll w1js w1kn w1eu w1ab w1ag w1ge w1ele w1epk w1dy w1dlo w1bcu w1asv w1brj w1sfb w1dkf w1schb w1del w1bgo w1dyz w1onu w1epj w1wk w1pk w1eib w1udm w1bol w1bke w1bhp w1agv w1bts w1bto w1erj w1ejo w1bpd w1eex w1ema w1erd w1emv w1ebg w1elbr

G6YL, Miss B. Dunn, Acton House, Felton, Northumberland, England

w1aed w1ack w1anz w1bal w1che w1gw w1mk w1mv w1xy w1si w1aem w1blx w1c w1jd w1zg w1ags w1bnu w1pf w1ta w1amy w1axa w1bz w1bcu w1bcu w1cu w1ek ne8az w1laf k1em k1rd py2aj ac1pp ag7as ag7aw ag7ao ag7kad ag7kag ap9irg atrk xw7eff y12ua z1zaw z1dru z2s az4a z4e st5f flb fm8ev fm8ek fm8kk fm8rt fntm2 octu fq8hpg fxfel8orm freara frearb fn1j fn1j fzo fzol gdzp gok kofd kuk lsd oceb oiqa oca tha vis vte



# *Selected and Ordered* BY THE HEADQUARTERS OF THE **BYRD EXPEDITION**

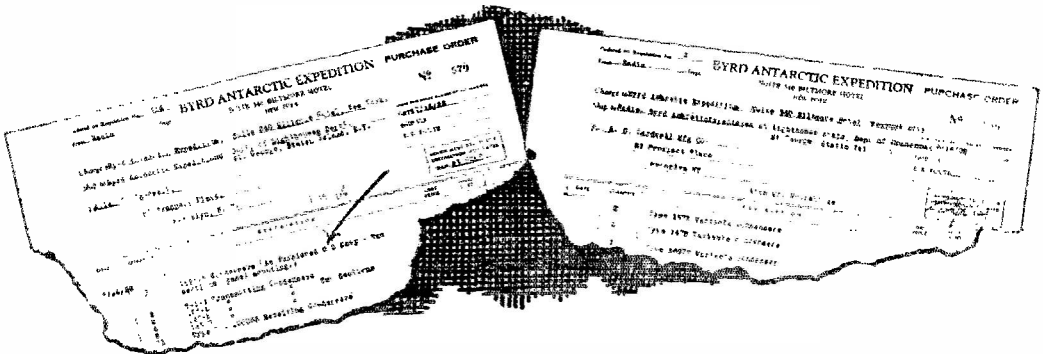

We are authorized to state, without qualification, that *all* transmitting equipment *built* by the Byrd Expedition constructors is equipped with Cardwell condensers. Keeping BYRD in touch with the world, this equipment is daily transmitting thousands of words to the New York Times (WHD), also CARDWELL equipped, and in constant touch with the expedition.



## **CHOSEN BECAUSE THEY ARE CARDWELL CONDENSERS**

**AND KNOWN TO HAVE A HABIT OF COMING THROUGH**

Transmitting Condensers For Powers up to 50 K.W. and More (Fixed and Variable) Receiving Condensers in all Standard Capacities

**AS SIMPLE, RUGGED AND STRONG As condensers can be made**

*Send for literature*

# **The Allen D. Cardwell Mfg. Corp.**

81 Prospect Street, Brooklyn N. Y.

**IF YOUR DEALER DOES NOT STOCK. SEND DIRECT**





# VOLUME CONTROLS

## Electrically—Mechanically

### SMOOTH

#### Standard Centralab Radiohm

0-2000 ohms to  
0-500,000 ohms, \$2.00

Mechanical and electrical construction to conform to present-day high standards is a most important factor in insuring excellence in performance.

Centralab volume controls by virtue of the exclusive rocking disc contact insure long life and quiet, smooth performance so essential in tempering radio reception to the exact tone desired.

The rocking-disc eliminates wear on the resistance material, allowing this important controlling element to remain constant at all times. This constancy of resistance is the determining factor of smooth and gradual control and insures a gradation of intensity from a whisper to maximum.

Fundamental circuits with recommended resistance tapers for smooth volume control are contained in a booklet, "Volume Controls and Voltage Controls — Their Use" — Write for it.

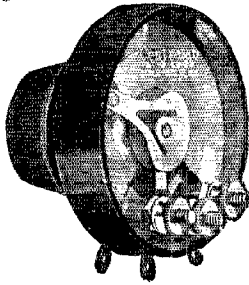

**CENTRAL RADIO LABORATORIES**  
18 KEEFE AVENUE :: MILWAUKEE, WIS.

## THE AIRGAP Socket

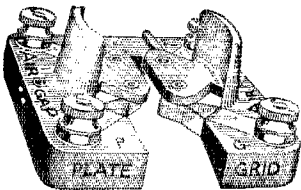

**SPECIFIED IN  
QST  
TRANS-  
MITTERS  
AND  
RECEIVERS**

**LOWER LOSSES! BETTER CONTACT!**  
HEAVY PRONGS CARRY HEAVY CURRENT

At all good dealers, Price 50c.

**TRANSCONTINENTAL COIL, Inc.**  
**GOHAM ENGINEERING & SALES CO.**  
National Sales Representative  
50 Church St., New York City

- Enclosed 8 \_\_\_\_\_ send \_\_\_\_\_ Airgap Sockets  
 Send Literature

My Dealer is \_\_\_\_\_

Name \_\_\_\_\_

Street \_\_\_\_\_

City \_\_\_\_\_ State \_\_\_\_\_

## More Profits To Set Builders

Sports, baseball games, big National events will boost radio business this year. Set builders will reap a rich harvest. BARAWIK sockets will make you money. Everything in A-G-C sets, short wave, television, parts, supplies. World's largest radio stocks on hand. Orders shipped same day. Lowest rock bottom wholesale prices.

Write for Free Radio Catalog and Ham Papers  
**BARAWIK CO.**  
214 Canal St.,  
CHICAGO, U. S. A.



wldar w9ege w9akl w9enr w9eny w9etd w9mtw ar8ufm  
et2aa eefri ed7nu eJ7dd emsnvd fm8kk fm8rit foler  
haf3a hb9y k1af k1em ialg nj2pa oh2nqz oh2nm oh3nh  
oh5nl oh7ub oh7nl ok1fm oz1a oz2a oz2b oz2j oz5a oz7ah  
oz7g oz7sch oz7r pk4az py11b pyle sm4zf sm7wm sm7zy  
sp8ev sp8kx sp8zz spwi su6sw su8au uo1h uo2w velap  
velar velco ve1dq veloj velkx ve2ax ve2hb ve2be ve2ca  
ve3es ve3hb ve3fr ve4ek ve4ff ve4fk vk2dy vk3bq vk3pm  
vk7ch vo8rg y1tae u11lm u14m z50c z50e kbi ktn lse nkf  
ogra onva pjz plf plj pmb rert wfat

**Miles W. Weeks, 40 Norfolk Road, Brookline, Mass.**  
7000-kilocycle band

w6ad w6aer w6ahp w6ano w6ap w6apd w6ax w6ayl w6bec  
w6bdx w6bgh w6cha w6chy w6eui w6evn w6exu w6ezm  
w6ezo w6dea w6dfu w6dmf w6daj w6dqy w6dsj w6dtd  
w6ech w6eco w6efc w6efr w6ehe w6ehv w6eif w6emg  
w6cpz w6ya w7acy w7adb w7ams w7ll w7gl w7sg w7si  
w7w au7kad em-200 em-5il em-5ni ei-1ae ei-1bd ei-1bn  
ei-1by ei-1bx ei-1by ei-1en d-4dkf d-4au ei-4bd eb-4bn  
eb-4de eb-4di eb-4ew eb-4fe eb-4fp eb-4hp eb-4jj eb-4ka  
eb-4kd ee-ear0 ee-ear57 ee-ear62 ee-ear86 ef-8ap ef-8aq  
ef-8ax ef-8br ef-8co ef-8dm ef-8ef ef-8eo ef-8fd ef-8gd  
ef-8gd ef-8g ef-8j ef-8ko ef-8po ef-8rhj ef-8rlj ef-8wz  
ef-8wsm ef-8xh fm-tun2 fm-8ru g5by g5jo ileh iflu j7es  
k4aan ne-8azw ok-aa2 pa-0ga pa-0gw pa-0wim sp-3ar  
uo-1h ve-4cb ve-4dj ve-4gz ve-4j ve-4jg vk-2ac vk-2yy  
vk-5hg vk-7lj vp xv7z xmoi ys-lmu zl-2bi zl-2go

14,000-kilocycle band

w6bes w6dk w7aj w7al ei-laa ex-3ar ef-8er g5by g5bz  
g5ml g5yq gi2m ne-8ae on-4fp py-1ld rxw su-lna ve-the  
ve-3aw x9a z5-4m

**W. A. C. B. K. N. Cusey, 722 No. 74th St., Seattle, Wash.**

wlaep wlab wlanz wlapq wlaze wlbw wloep wlda  
wlms wlyb w2aed w2ah w2dl w2arb w2aso w2avb  
w2biy w2blj w2box w2cix w2lx w2q w2gy w2xas w2xy  
w3adi w3adm w3aw w3bhx w3cm w3cy w3gw w3zd  
w4act w4ag w4abi w4ecq w4efb w4ege w4any w4ayy  
w5bbe w5bex w5j w5om w5g w5gc w5aim w5apa w5bez  
w6bto w6bwo w6bby w6chy w6cui w6cwj w6czk w6dcr  
w6dex w6dqg w6dx w6k w6ks w6tz w6tw w6dya  
w6zdz w6zby w6zez w6egq w6eop w6eek w6gn w6ny  
w6x w7aay w7ab w7aev w7aoy w7a w7g w7id w7af  
w7i w8adm w8ady w8aue w8aur w8ap w8sk w8sur  
w8awi w8by w8bd w8cew w8efr w8eh w8ep w8etx  
w8eyq w8dhb w8dox w8f w8cp w8af w8ahx w8ahz  
w8ap w8anz w8al w8vl w8bey w8bhc w8bhx w8bu  
w8bd w8bkd w8bml w8bpm w8bpx w8cau w8cc w8che  
w8cki w8emp w8esj w8esr w8em w8ell w8exx w8eyc w8dhe  
w8def w8dkm w8dku w8dqg w8dqj w8ej w8elt w8ehi  
w8ejo w8eny w8er w8erb w8eta w8eyu w8eve w8ewe  
w8exy w8exw w8fww w8hly w8is w8ion w8iqw w8lq  
w8ltz w8lzp w8gez w8gl w8hm w8mt w8mz w8uv w8ya  
w8zh ve2ea ve3es ve4c ve4ek ve4ex ve4dk ve4eo ve4ff  
ve4hm ve4go ve4gz ve4gx ve4m ve4mw kcb k6dp k7ar  
k7mu py11b py2aj ce1ab ce1ar em2jt foa4o s5uz t8gou  
sp1st g2ao g5by g5bz g5ml g5mu g6hp su1ev

**W8CHP, Joe Krantz, Malden, W. V.**  
14,000-kilocycle band

w6bkt w6bws w6bz w6by w6de w6eqe w6gm w6sk  
w6ql w7abg w7aes w7aj w7aay w7agb ve4ep ve4gm ve4mo  
ve5bl ve5ex su1ey k4wu

7000-kilocycle band

et1by eb4de ef8z ee4ew ve1br ve4ft ve4nn

**W1MS, C. H. Horton, 173 N. Adams St., Manchester, N. H.**

eb4di f8et f8eo f8hp f8k f8pas f8wb g5by g5bz g5ml  
g6hp g6ta oh2nm pa1jag ve3aq ve3dae ve3es ve4gq ve4jd  
ve4fv ve4hr ve4ep vo8rg

**W3MP, W. N. Dittmann, Chambersburg, Penna.**  
w8dnd w8ap w8evy w8ai w8gd w8wli w8ep w8hw  
w8dfb w3oo w3eo w3evn w3wb w3ap w3be w3it w8hf  
w8dw w8oj w8kx w8yy w8ey w8aev w8asb w8eko w2brd  
w8exj w8rd w8ade w8pk w2g w2bec w3blq w4by w8ms  
w5ag w2iu w3aoy





**WRITE TODAY**  
**FOR YOUR COPY OF CIRCULAR 507**  
*New Prices and New Products*

**VITROHM RESISTORS AND  
RHEOSTATS FOR RADIO**

**Ward Leonard Electric Company**

37-41 South Street

Mount Vernon, N. Y.



FOR EVERY RADIO NEED, in brushed brass or Bakelite. Fit standard electrical switch or outlet box. Single plates and in gang in many combinations.

- No. 135 — For Loud Speaker.....\$1.00
- No. 136 — For Aerial and Ground..... 1.00
- No. 137 — For Battery Connections..... 2.50
- No. 138 — For A C Connections..... 1.00

**YAXLEY MFG. CO.**  
9 So. Clinton St.,

Dept. S,

Chicago, Ill.

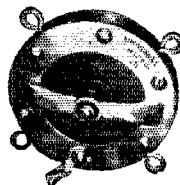

**MICROPHONES**

**2-Button Type**

- For Public Address, \$25  
etc., list.....
- Standard Broadcast \$75  
Model, list.....

Condenser Models for Film and Record Work, list \$250.00, \$300.00

Also Desk and Floor Stands, Covers, Cords, etc. Miniature Microphone, Paper Weight, Radiator Ornament. Die Cast, Bronze finish, prepaid on receipt of \$1.00

**EXPERT MICROPHONE REPAIRS**

*Dealers everywhere*

**UNIVERSAL MICROPHONE CO., Inglewood, Calif.**

**QST OSCILLATING CRYSTALS**

**CONSTANT TEMPERATURE CRYSTAL EQUIPMENT**

**Attention Owners of Broadcasting Stations:**

We are now in a position to supply you with Thermostatically Controlled Heater units for accommodating two crystals (one as a spare) with instantaneous change-over, said unit maintaining a guaranteed constant temperature to ONE TENTH OF ONE DEGREE CENTIGRADE. This unit operates automatically and is easily adjusted to your operating temperature. More details sent upon request.

**Delivery ten days after receipt of order. Price \$400.00**

*For prices of grinding crystals in the Broadcast and Amateur bands, see February or March QST.*

**SCIENTIFIC RADIO SERVICE — "The Crystal Equipment Specialists"**

P. O. Box 86

Dept. D

Mount Rainier, Maryland



It  
Teaches  
the  
Code!

Learn

## Telegraphy with TELEPLEX

**T**ELEPLEX is the practical code instructor. Works like a phonograph. Waxed tape records sound signals like a real operator. Complete code instructions furnished with every Teleplex. Sends messages, radiograms, etc., — regular code traffic like an expert operator. Used by all leading schools. Endorsed by U. S. Navy. Guaranteed to teach you the code or it costs nothing. Soeely, simple, clear. Ideal for advanced students or beginners.

### FREE 10 DAYS TRIAL!

So sure are we that you will be absolutely satisfied with your purchase, that we will let you try it in your own home ON 10 DAYS FREE TRIAL! You are the sole judge. Where can you match that astounding offer? **ACT TODAY!** Write for full facts about Teleplex. No obligation.

TELEPLEX CO., Dept. D12, 76 Cortlandt St., New York, N. Y.

w3ol w3ot w3pf w3qt w3ql w3sz w3zz w3afz w3ark w3ia  
w3agz w3bu w3bn w3gn w3oe w3ap w3be w3ey  
w3dy w3fe w3ie w3ja w3ll w3ey w3va w3wv w3yx w3afz  
w3df w3ahq w3azc w3afe w3ay w3at w3eb w3fl w3iz  
w3je w3ms w3mx w3oc w3oz w3ra w3uj w3uz w3ura  
w3ain w3app w3acc w3agy w3ayo w3age w3ayl w3ake  
w3agz w3azr w3bdg w3bhz w3hez w3hek w3imi w3kfr  
w3nte w3awy w3ap w3ij w3iz w3aur w3awp w3anz  
w3bhi w3bpc w3btz w3bzs w3bys w3bqk w3bwk w3bhy  
w3czm w3cix w3eyz w3elyk w3dow w3dvi w3iza w3dzy  
w3dpy w3dee w3dst w3ded w3dhw w3djq w3edd w3efa  
w3eme w3egk w3bz w3pl w3sg w3aed w3aju w3aul w3acy  
w3zjr w3bx w3ev w3ky w3rl w3wh w3xap w3ahi w3arq  
w3wv w3awz w3bcu w3bk w3bh w3bt w3bs w3ca  
w3dkp w3dpa w3dnm w3zcc w3ec w3ev w3dw w3lk w3mp  
w3um w3ur w3op w3px w3ya w3ay w3ru w3are w3ban  
w3bre w3bly w3bwt w3bqe w3emv w3ewt w3etw w3eyn  
w3eyz w3egc w3eya w3end w3eyv w3djq w3dow w3duz  
w3dty w3dgg w3dez w3dzl w3dsl w3dvw w3dgc w3dek  
w3die w3drw w3dpg w3dmr w3erh w3eny w3etd w3ema  
w3ejo w3ekn w3eaw w3fmu w3ftr w3fey w3fon w3isl w3isw  
w3jdy w3jex w3hjl w3lex m3inc m3ini cm5ll cm5ni  
cm2ay cm4q idv5 xlxl v4gd vclbr yslaa nkf kflf

## Strays

The new Q Code, printed on card, makes a fine addition to the station wallpaper at the present time when so much confusion exists over the amended abbreviations. The new list, styled "Form 772a" can be obtained on application to the Department of Commerce, Radio Division. "Form 773" available from the same source is a splendid printing of the International Morse Code and the conventional signals.

A high resistance medium preferable to that suggested by WIAD on page 45 of the January 1929 QST, says A. A. Kopf of Canal Zone, is "Enameline" stove polish — 10 cents for a great many ohms in the making. The material is said to be excellent for making high resistances or for repairing or amending resistors such as those used for regeneration control.

One satisfactory connection for the resistance volume control of the usual short-wave receiver is across the tickler coil. Bissey, ex QCFX finds that a variable resistor while noisy when connected in series with the plate supply is absolutely quiet in operation when shunted across the tickler. And while we're on the subject, it is a fine scheme to connect the resistor, not as a series resistor but as a potentiometer for plate circuit operation. For this connection the end terminals of the resistance go across 45 volts of the "B" battery, the variable contact being connected through to the detector. The usual 1ufd. by-pass condenser is used between the moving contact and the negative "B" terminal.

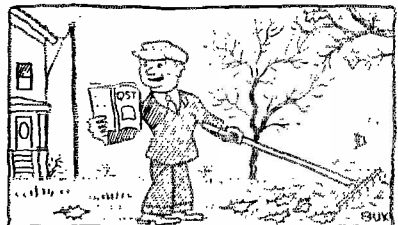

## BECOME A RADIO OPERATOR

See the World. Earn a Good Income,  
Duties Light and Fascinating

### LEARN IN THE SECOND PORT U.S.A.

Radio Inspector located here. New Orleans supplies operators for the various Gulf ports. Most logical location in the U. S. A. to come to for training.

Nearly 100% of radio operators graduating on the Gulf during the past six years trained by Mr. Clemmons, Superintendent of Instruction.

All expenses placed to date. Start training now for Spring and summer terms.

Member of the A.R.R.L. - Call "W5GR."  
Day and Night Classes - Enroll any time.  
Write for circular.

## GULF RADIO SCHOOL

844 Howard Ave. New Orleans, La.

## NEED "MIKES"?

Let us prove that ours  
is all you can expect.

Numerous users insist it is  
superior to all others. A Standard  
Instrument in all respects.

Price, less stand, \$67.50

Desk Stand, as shown, 6.00

Adjustable Floor  
Stand, 12.00

Microphone  
Transformer, 10.00

F. F. JOHNSON CO.

Waseca Minnesota





# Synchronous Motors for Television

In addition to building reliable and satisfactory motor generators, "Esco" has had many years of experience in building *electric motors* for a great variety of applications.

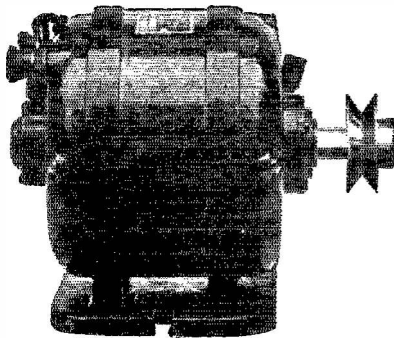

*Synchronous motors*, small, compact, reliable self starting are now offered for *Television* equipment. They require no direct current for excitation, are quiet running and fully guaranteed.

Other types of motors suitable for Television may also be supplied.

Write us about your requirements.

## ELECTRIC SPECIALTY CO.

25 South St.

Trade "ESCO" Mark

Stamford, Conn.

### P-A HORNS

93" long — 66" of cast aluminum, large end fibre, 31" dia. Can use large end for dynamic cones. \$65.00.

Two-button broadcast microphones, standard type, precision made, Quality second to none. \$50.00. Guaranteed — Trial allowed.

**E. E. PATTEN**

5606 42nd Ave., S. W.

Seattle, Wash.

## SET Builders

Barawik, the first and oldest radio specialty house, offers you unusual service this year. Bigger stocks, quicker shipments, lower prices. Deal with an old established, reliable house. Get honest goods, honest service, honest prices. Barawik service makes you more money. Send now for this new catalog showing lowest wholesale prices on sets, parts, short wave, etc.

**BARAWIK CO., CHICAGO, U. S. A.**



### QUARTZ OSCILLATING CRYSTALS

Scientifically Prepared for Maximum Power and Unconditionally Guaranteed 1 in. sections of your approximate specified frequency, supplied at the following prices:

75-100 meters	\$15.00
100-200 meters	10.00
200-600 meters	15.00
1 in. Tested blanks, 200-400, 400-600 meters	5.00
Dustproof Bakelite mounts	3.00

Sections of any practicable dimensions made to order Prompt Delivery

**J. T. Rooney, B. Sc., 4 Calumet Bldg., Buffalo, New York**  
"Ten years' crystallographic experience"

### MORE POWER PER STAGE

*Sharper Tuning and No Oscillation Difficulties*

Radio Science proves neutralization the only satisfactory method of controlling oscillation in tuned radio frequency circuits, thus increasing actual power per stage of amplification from 25% to 300%

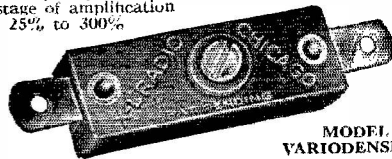

MODEL "N"  
VARIODENSIFIER

Apply the Neurodyne principle to your set by the simple installation of X-L Variodensifiers. The result is an amazing increase in the efficiency and power of the receiver.

Model "N" has Variable capacity, adjustable from 1.8 to 20 micro-micro farads, the price each \$1.00.

Model "G" with grid clips made in three variable capacity ranges. Price, each, \$1.50. New Bakelite insulated X-L Push-Post the most perfect binding post made. Plain or all standard markings. Price each 15 cents.

Write for free book of circuit diagrams showing use of X-L Units.



X-L Push  
Post

**X-L RADIO LABORATORIES**  
Dept. D 1224 Belmont Avenue, Chicago, Ill.

### DON'T FOOL YOURSELF

Unless yours is one of those toy transmitters there's just one rectifier that will stand up and take anything you can slam into or drag out of it — and that's the **MERCURY ARC**. You don't need two tubes, or four, just one. Full wave, not even a split second's wait to throw on the high voltage. No peaks to worry over — 8000 volts 10,000 mils won't ding it. Filters to XTAL purity. Lasts indefinitely. No filament. **That's an ARC.**

RECTIFIER ENGINEERING SERVICE

4837 Rockwood Rd., Radio W8ML, Cleveland, Ohio

# AMATEURS!!!

## use OCTOCOILS

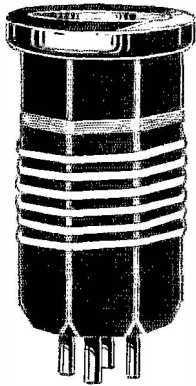

### Get Louder Signals

Set of four Octocoils with midret variable condenser covers 10, 20, 40 and 80 meter wavebands with proper selectivity. Space-Wound on distinctively colored bakelite molded forms with Nos. 12, 14 and 16 bare copper wire. Tests prove no increased losses over airwound coils and OCTOCOILS are much more rugged.

**LIST PRICE \$4.00**  
Per Set of Four Coils  
**\$5.00 with midret condenser.**  
Order Now - Send No Money

Shortwave and Television Laboratory, Inc.  
104 Brookline Avenue, Boston, Mass.

Send me C. O. D. \_\_\_\_\_ set(s) OCTOCOILS with midret tuning condenser to cover the amateur bands at \$5.00 per set.

I understand these are unconditionally guaranteed.

Name \_\_\_\_\_

Address \_\_\_\_\_

## Radio Operators

### Raise Your Speed 50 to 100% in Short Time

Write at once for information about **The Candler System Course in High-Speed Telegraphing and Self-Mastery.** This is the **ST-7 H.M.** that developed McElroy, the world's champion operator, and thousands of other **speedy** radio and Morse operators. Takes the kinks out of **soft** arms. Strengthens weak arms. Relieves "glass" arm. Restores the grip. Prevents fatigue, cramps, paralysis and kindred ills. Develops speed, accuracy and endurance that mean **BIGGER PAY**, often **DOUBLE** speed of slow operators. Makes fast operators **FASTER**. Quick results. Satisfaction guaranteed. Write now!

THE CANDLER SYSTEM CO., Dept. RL  
6343 S. Kedzie Ave. CHICAGO, ILL.

## Massachusetts Radio and Telegraph School

18 Boylston Street, Boston

Send for Catalogue

Tel. Hancock 5184 *Established 1905*

## TRANSFORMERS

Guaranteed - Mounted - Complete

250 watt 550 - 700 each side	\$10.50
500 watt 1000 - 1500 each side	14.50
700 watt 2000 - 2500 each side	21.00

Chokes, Polyphase and Special Transformers  
Sold \$7.00 for h.v. winding

**9CES FRANK GREBEN**

1927 So. Prairie Street, Pilsen Sta. Chicago, Ill.

WIANH has solved the problems usual in any household where any attempt at simultaneous amateur transmission and broadcast reception is made. For reception he runs the broadcast antenna first through the primary of his short-wave receiver, then through the broadcast receiver and thence to ground. Both receivers can be operated at the same time. The transmitter problem has been solved by installing a "1929 type" Hartley. It is operated 15 feet from the broadcast receiver without causing any interference.

And still they come! Amateurs through the country are still building the four-tube "1929" receiver, they are still connecting the screen grids of the UX-222s where the control grids should be, and they are still writing Headquarters to say that they cannot get the results claimed for the outfit. Control grids, as it says quite definitely on the instruction leaflets that come with the tubes, come out at the top of the tubes. Screen grids, on the other hand, are connected to the "G" pin on the tube base. Receivers employing these tubes do not work well when the connections to these grids are bottom side up.

### The Disc Condenser

*(Continued from page 18)*

double the spacing and if at the same time we wish to retain our original capacity we must also double the plate area. In this manner any condenser may be made to suit one's needs by multiplying or dividing by a suitable factor as the above example does.

If you have difficulty I will be glad to calculate an approximate condenser for your needs but I implore you to please try your own ingenuity first.

### Midwest Div. Convention

*(Continued from page 22)*

The convention committee under the direction of Prof. D. C. Faber and Section Manager H. W. Kerr has prepared a wonderful program. Lectures on timely subjects will be given by prominent speakers. A representative from the Radio Supervisor's Office will be present to conduct examinations and also to discuss rules and regulations. A.R.R.L. is sending L. R. Huber, Asst. to Communications Manager (one of our own boys), and if at all possible, Treasurer-Fieldman A. A. Herbert. It is also expected that Director Quinby, who will be returning from the Annual Meeting of the Board of Directors, will attend and be prepared to give a complete report.

Special request is made of all Iowa Amateurs to send their address on a post-card to H. W. Kerr, SCM, Little Sioux, Iowa, for programs and particulars. Prof. D. C. Faber, Iowa State College, Ames, Iowa, will be glad to get a line from those who intend being present.

*Don't forget the dates, fellows: May 10th and 11th.*

# The A.R.R.L. Diamond Is the Emblem of a Real Amateur!



The League Emblem comes in four different forms. Its use by Members is endorsed and encouraged by the League. Every Member should be proud to display the insignia of his organization in every possible way.

**THE PERSONAL EMBLEM.** A handsome creation in extra-heavy rolled gold and black enamel.  $\frac{1}{2}$ " high, supplied in lapel button or pin-back style. There are still a few fellows who are hiding their light under a bushel. Wear your emblem, OM, and take your proper place in the radio fraternity. Either style emblem, \$1.00, postpaid.

**THE AUTOMOBILE EMBLEM.** Introduced last spring, already more than 800 cars are proudly displaying the mark of the "Radio Roll-Royce."  $5 \times 2\frac{1}{2}$ ", heavily enameled in gold and black on sheet metal, holes top and bottom, 50c each, postpaid.

**THE EMBLEM CUT.** A mounted printing electrotype, the same size as the lapel button, for use by Members in any type of printed matter, letterheads, cards, etc. \$1.00 each, postpaid.

**THE "JUMBO" EMBLEM.** You've taken care of your-self, your car and your printing. How about the shack wall or that 100-footer? Think of the attention this big gold-and-black enamel metal emblem will get!  $19 \times 8\frac{1}{4}$ ", same style as Automobile Emblem. \$1.25 each, postpaid.

*Mail your order and remittance NOW to*

**The American Radio Relay League, Hartford, Conn.**



## ALWAYS UP-TO-DATE

Issued quarterly, March, June, September and December. Single copies U. S. and Canada \$1.00 - Foreign \$1.10. Yearly subscription \$3.25 - Foreign \$3.50.

Amateur and Commercial Stations from 83 different countries.

**Radio Amateur Call Book**  
508 So. Dearborn St., Chicago, Ill., U.S.A.

### Send for Western Radio New 1929 Catalog

**LATEST and FINEST, nationally known A.C. sets, consoles, cabinets, speakers and accessories at LOWEST PRICES.** Catalog sent FREE on request.

**WESTERN RADIO MFG. CO.,**  
128 W. Lake Street, Dept. RQ-4 Chicago

*Do you know that the 1929 Handy and Hull Handbook is available in bound form — \$2.00 per copy, postpaid?*

*When ordered, a copy of this new edition book at your present cost, and decrease if you want the 1929 copy in more permanent form.*

## For a Steady Signal—

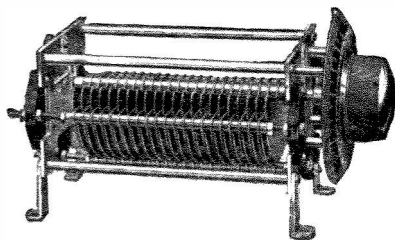

National Transmitting Condensers are designed in accordance with latest practice for securing steady transmitted frequencies.

Furnished in capacities ranging up to .00023 mfd. — 6000 volts; and .00045 mfd. — 3000 volts.

Condensers can now be furnished with either hard rubber or crolite insulation.

*Send for Bulletin L-1-Q*

## NATIONAL

TRANSMITTING CONDENSERS

National Co., Inc. W. A. Ready, Pres. Malden, Mass.

Martin's Latest and Greatest Bug  
**The GREAT NEW VIBROPLEX**

Reg. Trade Marks: Vibronex, Bug, Lightning Bug



**No. 6**

A smooth, easy-working bug — any operator can handle. Not too fast, not too slow — but just right.

Japanned Base \$17  
 Nickel-Plated \$19

**Famous Improved Vibroplex**

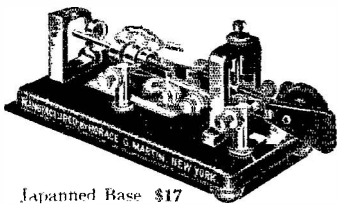

Used by tens of thousands of operators because of its ease and perfection of sending.

Japanned Base \$17  
 Nickel-Plated \$19

**Special Radio Bug**

Equipped with Extra Large, Heavy, Specially Constructed Contact Points for direct use without relay ..... **\$25**

Remit by Money Order or registered mail

**THE VIBROPLEX CO., Inc.**

825 Broadway, New York City  
 Cable Address: "VIBROPLEX" New York

**Calibrating the Heterodyne Frequency Meter**

(Continued from page 47)

a final test, we can see just how close we come to W9XL on his next transmission. We shouldn't be more than a hairline away from him.

Now we're all set to give a chap his QRG with some confidence. We listen in on 7000 kc. and note what a nice whistle we get from the second harmonic of our oscillator. Of course, to get the frequency we multiply the 3500-ke. reading by 2. For 14,000 kc. we would multiply by 4. In fact, it's a good idea to put all three scales on our chart. To measure the frequency of an incoming signal we tune it in with our receiver a little below the os-

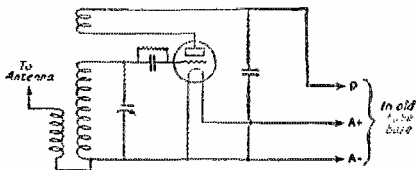

FIGURE 2 — The "adapter" circuit which covers the broadcast spectrum and plugs in to the regular high frequency detector circuit. The harmonics of this oscillator are used for calibrating the heterodyne frequency meter.

cillating point, just as we used to in the old spark days, and use our frequency-meter-oscillator as a separate heterodyne, adjusting it to zero beat with the signal. If we want to know our own QRX, we put the phones in the frequency meter, start the transmitter, tune ourselves in, and read the frequency for the band we're using at the time. We may have trouble doing this on 3500 kc. if the oscillator is not shielded, though.

The question of permanence and stability may arise in the minds of some. No matter how careful we are to build an oscillator that will "stay put," we still have to contend with that familiar phenomenon which causes us so much grief in our transmitters — variation of tube capacity. The difference between the capacity of the tube when it is warm and when it is cold may cause a variation of 10 kc. or more on the 7000-ke. band. While this is not terribly serious, it does raise the percentage error beyond 1/10 of 1%. We could ignore this effect if it were not for the fact that a receiving tube on low plate voltage takes quite a while to warm up — sometimes almost an hour.

Any change in the fixed capacity across the variable condenser (wiring, tube capacity, etc.) merely results in shifting the calibration curve up and down the chart since the same total capacity across the inductance will give the same frequency. Consequently, if we know one frequency which we can always check, we can very easily determine the amount to add or subtract to our dial readings to obtain the correct frequency. This is strictly true only if our condenser is straight-line capacity but is close enough for the others if we do not work too near the ends of the scale. Right here is where our familiar "marker"

**P A C E N T**

**Duo Lateral COILS**

The complete line of all standard turn ratios preferred by leading laboratories and engineers.

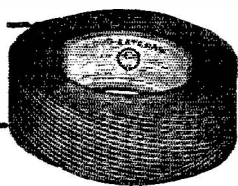

Write for information and prices

**PACENT ELECTRIC CO., Inc.**  
 91-7th Avenue New York City

**RADIO OPERATORS WANTED**

THE EASTERN RADIO INSTITUTE can train you quickly and thoroughly because:  
 MODERN AND EFFICIENT METHODS  
 THOROUGH INSTRUCTION under staff of LICENSED COMMERCIAL OPERATORS  
 MODERN APPARATUS including SHORT WAVE TRANSMITTER  
 SIXTEEN years a RADIO SCHOOL  
 THE OLDEST, LARGEST and MOST SUCCESSFUL school in New England, RECOMMENDED BY THE A. R. R. C.

Day or Evening Classes Start Every Monday  
 SPECIAL CODE CLASSES

Write for Illustrated Prospectus

**EASTERN RADIO INSTITUTE**  
 899 BOYLSTON STREET BOSTON, MASS.

stations become useful to us. For instance, right after we have calibrated our meter we measure the frequency of WIZ. Suppose the reading is 20 degrees on our dial. At another time we find WIZ is tuned in at  $18\frac{1}{2}$  degrees. Obviously, then, we should add  $1\frac{1}{2}$  degrees to all our dial readings to get the correct frequency. This may be an unnecessary refinement to some of us, however, as the error from this source should not raise the total error beyond  $\frac{1}{4}$  of 1%, providing our meter is properly constructed and we were within  $1/10$  of 1% originally, so we are still well within the limits allowed O.F.S. However, if the dial readings of a few "marker" stations are noted when the meter is first calibrated, the curve can be readily checked at any time, and if any appreciable difference appears, a new curve should be determined.

It will be noted that the table has been made up for the frequencies which fall within the 3500-ke. band, with only a few points outside. This chart can be readily extended if it is desired to cover more territory by filling in the missing broadcast frequencies, i.e., 500-570 ke., 680-690 ke., and 810-860 ke., remembering that to obtain the proper frequencies we multiply the first column by  $\frac{1}{4}$ , the second 5, and the third by 6. A meter calibrated with the points in the table would give the following coverage:

Harmonic	From	To
1	3,480 ke.	4,020 ke.
2	6,960	8,040
3	10,440	12,060
4	13,920	16,080

A more complete coverage could be obtained if thought desirable by making the frequency meter cover from 3300 to 4950 ke. (60-90m.):

Harmonic	From	To
1	3,300	4,950
2	6,600	9,900
3	9,900	14,850
4	13,200	19,800

The only blank space with the latter range would be between 4950 ke. and 6600 ke. This "widening" process should not be carried too far, as duplication of frequencies on different harmonics is likely to become confusing. The latter range should be helpful to those of us who are interested in high frequency broadcasting, expeditions, etc.

At any rate, considering the ease with which we can measure frequencies if we only take the time, there is no excuse for off-wave operation by any of us in 1929.

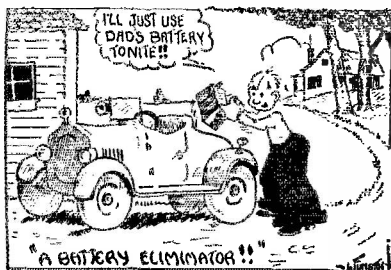

# Are We Right?

You should have at least two of them — one for your complete 1928 file of copies, and one for each 1929 issue as published.

KEEP THEM AS A UNIT IN A

## QST Binder

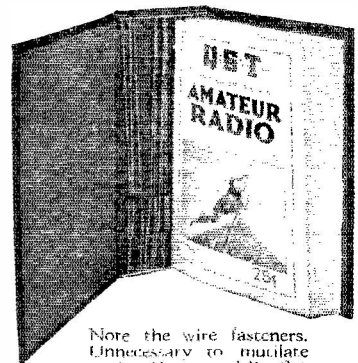

Note the wire fasteners. Unnecessary to mutilate copies. Opens and lies flat in any position.

One-fifty each  
postpaid

A binder will keep your QSTs always together and protect them for future use. And it's a good-looking binder, too.

QST

1711 Park St. Hartford, Conn.

# HAM-ADS

(1) Advertising shall pertain to radio and shall be of nature of interest to radio amateurs or experimenters in their pursuit of the art.

(2) No display of any character will be accepted, nor can any special typographical arrangement, such as all or part capital letters be used which would tend to make one advertisement stand out from the others.

(3) The Ham-Ad rate is 15c per word, except as noted in paragraph (6) below.

(4) Remittance in full must accompany copy. No cash or contract discount or agency commission will be allowed.

(5) Closing date for Ham-Ads is the 25th of the second month preceding publication date.

(6) A special rate of 7c per word will apply to advertising which, in our judgment, is obviously non-commercial in nature and is placed and signed by a member of the American Radio Relay League. Thus, advertising of bona fide surplus equipment owned, used and for sale by an individual or apparatus offered for exchange or advertising inquiring for special equipment, if by a member of the American Radio Relay League takes the 7c rate. An attempt to deal in apparatus in quantity for profit, even if by an individual, is commercial and takes the 15c rate. Provisions of paragraphs (1), (2), (4) and (5) apply to all advertising in this column regardless of which rate may apply.

**PLATE POWER** for your set, the very heart of its performance. For quietness DX ability, life-long permanence, absolute dependability, lowest ultimate cost, no other plate source even approaches the achievement of an Edison steel-alkaline storage B battery. Built painstakingly; every joint pure nickel, upset electrolytically welded. Genuine Edison Electrolyte. Our list describes complete batteries, construction parts, enameled aerial wire, silicon steel. Available immediately, filament and plate transformers for the new 866 rectifier, complete plate power units. Rectifier Engineering Service, radio W8ML, 4837 Rockwood Road, Cleveland, Ohio.

**IMAGINE** an organization with over 4,000 clients scattered throughout the world, all radiowise dealers, builders, experimenters, hams. Over \$50,000 stock of high grade receiving and transmitting parts only, no sets. Spend \$5,000 yearly on our own experimenting. Carry nothing until it passes our tests. We bring prepaid over four pounds catalog, circuits, data, etc. Weekly data (more than all radio magazines together)—20 weeks—\$1.00, 52 weeks—\$2.50. Sample "Over The Soldering Iron," 32 page experimenters' magazine—25c. Full trade discounts to licensed hams and radiowise builders. We carry approved items advertised in radio. Kladag Radio Laboratories, Established 1920, Kent, Ohio.

**SPECIAL** made rectifier aluminum with small percentage copper, stand more amperage, last longer, square foot \$1.25. Lead \$1.00. Elements, holes punched with bolts and nuts, new kind 1" x 4" 15c, 1" x 6" 17c, pair prepaid. Best Silicon steel 014" cut to order 25-35c lb. Postage extra. Geo. Schulz, Calmer, Mich.

**ENSALL** Radio Laboratory receivers and Transmitters are of the most modern designs and are supplied to meet any particular requirements of the radio art. Transmitter designs for radio-phonograph or C. W. Our long experience in the designing of special apparatus is your guarantee of quality and efficient apparatus. We also build to order any items desired. Literature on any apparatus forwarded on request. Ensall Radio Laboratory, 1208 Grandview Ave., Warren, Ohio.

**SELL**—receivers, Silver-Marshall 731 with tubes \$25.00, Dec. 1927 QST screen grid \$25.00, motor-generator, 400v 110v—\$60. \$20.00, Vibroplex \$12.00, W9CTW

**WANTED**—Navy receiver, better SE143 or SE1220, SE1420, IP800, also audion box SE1071, James Thompson, 30 Tenbroeck Place, Albany, N. Y.

**COMMUNICATORS**, Teleplexes, transmitters, receivers, Vibroplex meters, 50 watters, "S" tubes, motor generators, dynamotors, converters. Bought, sold, traded. Ryan Radio Company, Hannibal, Mo.

**Ex-Navy** equipment of excellent construction, ball bearing and new. General Electric 24 1500 volt, 233 ampere \$25.00. Shaft extension \$1.00, 21 750 volt, 23 amperes with filter \$27.50. Shafts \$3.00. Crocker-Wheeler 24 1500 volt 450 watt 6500 RPM \$55.00. Holtzer-Crabot 12 500 volts 35 watt \$20. 1/2 KW 500 cycle with covers \$15. 400 cycle 200 watts \$22.50. With complete aircraft transmitter \$30. Westinghouse 6 15 volt 500 watts with propeller \$15.00, 27.5-33.0 volt .08 ampere \$15.00. Two machines for 700 volts spring suspended \$28.00. Following possibly slightly used, guaranteed, GE 12 350 volt, 143 ampere \$18. Westinghouse 10/530 watt \$18. With meter, panel, W.B. Filter, etc. new \$30. Literature and fotos. Shipments anywhere. Henry Koziele, 501 East 84th Street, New York.

**SELLING** out—shortwave receiver, transmitting parts and tubes, power amplifier, portable phonograph and electrical pick-up. Priced to sell. Write for list, W9CKU.

**FOR sale**—20 watt transmitter complete, mounted on 24 x 24 inch panel. Separate power and filament transformers; filters; Jewell radiation, meter, milliammeter, filament voltmeter. All highest grade R.C.A. and Acme parts. Cost over \$300. Will sell cheap. A real bargain. H. V. Houyoux, Franklin, N. J. Ex-3NJ.

**WANTED**: 50, 75, 250 watt tubes, state condition and price. Also any other apparatus new or used. Will buy for cash all surplus or obsolete stock. Will exchange or trade apparatus. What do you need? Warren Waterman, 125 Madison Avenue, Albany, New York.

**SELLING** out—TP414 modulation transformer, \$4.00, two new Tube 2 mid. 1300v working voltage filter condensers \$4.25 each, five 6X210 tubes, \$4.25 each, new, one RCA UX250, \$6.00, 1 model B3 new 2 button microphone \$30.00 (cost \$45.00), one Federal double coil modulation choke, \$9.00 rated about 350 MA, Corona portable typewriter, \$15.00. Ed. Keers, 2300 E. Washington St., Joliet, Ill.

**EVERYTHING** in stock. Write your needs. Anything built to order, rock bottom prices. Give us a try. W8GIE, Finch Laboratories, 100 Grove St., Syracuse, N. Y.

**SELL**—complete fifteen-watt transmitter and receiver, fifty dollars cash. Photo on request, Carl Leidholdt, Chippewa Falls, Wis.

**QSTs to 1925**. Offers? Also parts. W9AUS.

**DUBILIER** .004 transmitting condensers wanted. Radio, 150 West 22nd St., New York.

**AUDIO** transformers repaired, \$1.00, push-pull \$1.50, guaranteed. Andover Radio Lab., Andover, Ill.

**WANTED**—condensers, high voltage transmitting, .004-.002. Quenched gap units, all sizes. Receivers, SE1420, 1220, 143, 1375, IP501, 500, CGR-1A. State full particulars and price. Manhattan Electrical Bargain House, 105 Fulton St., New York City.

**TELEVISION**. Insuline Corporation outfit, complete with AC and DC motor, Universal disc, television tube, all mounted on heavy brass stand, two CX340 tubes, and Insuline Corp. amplifier. First \$45 takes it. Also one Parmeter shortwave receiver with tubes, \$12.00. Above items guaranteed perfect. West Side Service Station, W2ARS, Pleasantville, N. Y.

**FOR sale**—shortwave receiver and transmitter Ernest Thornhill, Muncie, Indiana.

I want a used EV204A. Must be in good condition and reasonable in price. Write me what you have. W6NSW, D. C. Mast, Bisbee, Arizona.

**SYNCHRONOUS** rectifier or motor, \$10. H. George, Pike St., Dunkirk, N. Y.

**SELL**—Aero 7 B transmitter, complete 3 meters, tube rectifier supply, Pilot 2 step receiver, tubes for both, \$95, W9EXA.

**SELL**—two Amrad Mershon condensers, \$8.00; microphone transformer, \$4.00; choke coil 1", Henry, \$3.00; radio frequency choke coil, \$2.00; magnetic modulator, \$3.00; 2-5 watt tubes, \$5.00; Murdock antenna switch, \$2.00. Raymond Fiedler, 127 Lexington St., Lawrence, Mass.

**BARGAIN**—Complete 15 watt metered transmitter for sale with receiver, both in good condition. Station W9DFK and W9FXS. Write for details. First \$45.00 takes complete outfit, wavemeter and all. G. E. Webster, radio station KSAC, Manhattan, Kansas.

**WANTED**—navy standard receiver SE143, SE1220, SE1420, IP500 or IP501, State price, condition. Trautwein, 15 Albany St., New York.

**SAY** OMs, why not give your guy wires a treat by putting in W2BIR's hook and eye steel screw hot galvanized turnbuckles: 1/2" screw 30c each, 5/16" 35c, 3/8" 45c, 7/16" 55c, 1/2" 65c. Postpaid east Mississippi. W2BIR, D. Troy, 233 Prospect St., Nutley, N. J.

**SELL** UV204A—new \$80.00, UV203A slightly used \$17. UX860 slightly used \$24. Guaranteed good condition. 00045 national transmitting condenser \$5, W5A D.

**FOR quick sale**: two Grebe CR18 sets. All coils. Perfect condition, \$40.00 each. H. B. Stover, 453 S. Park Ave., Don du Lac, Wis.

**PLATE** transformers 250 watt, 1000-750-500 each side. From factory, unmounted, 18 lbs. \$8.75. Adjustable core chokes, 100 MA \$5.00, 250 MA \$6.75. Write for complete lists, Radio Parts Sales Company, Orange, N. J.

**SELL**—210 combined tone CW transmitter, Jewell meters, tube rectifier, speech amplifier, and complete shortwave receiver included, five hundred mile fone world wide code 860. One slightly used \$52, \$19. W2E12D, \$50. Harry E. Smith, Skowhegan, Maine.

**BARGAIN**, 50 watt transmitter. With mercury arc. Receiver and parts. H. P. Brewer, Oskaloosa, Ia.

**HAMS**: Get our Samples and Prices on Printed Call Cards made to order as YOU want them. W9APV HINDS, 19 S. Wells St., Chicago, Ill.

**FOR sale**—General Electric 24 1500 volt dynamotor capable of supplying plate current to two 60 watters L. C. Sigmont, School of Engineering, Milwaukee, Wis. W9EMT.

SELLING out — list, W9FEW, Creston, Iowa.

TRADE — Esco M. G. 1000V 110V 60 cycle 200 watt needs some repair, for UX852 in A1 shape. C melody stage model Conn. saxophone new, with case, for UX204A slightly used. Sax cost \$175. W9A1D, Covington, Ky.

3000 Volt 6000 Watt double commutator motorgenerator, 10 Hp. 3-phase drive \$685.00 complete. 500 Cycle 1 kw. ball-bearing motorgenerator, 110V. DC drive \$225.00. 250 Cycle 1 1/2 kw. ball-bearing motorgenerator 110V. DC drive \$225.00. 2-5 Rotary Spark Gap 110V. DC drive \$45.00. 1000 Volt 200 Watt Esco 1-phase drive \$75.00. 750 Volt 300 Watt new General Electric motorgenerators \$55.00; 200 Watt \$42.50. 400 Volt 100 Watt generators \$8.50; 1/2 Hp. 3450 speed motors \$8.50; repulsion induction motors \$10.50; 1/2 Hp. \$16.50. Converters 32V. DC to 110V. AC, \$35.00. new. Large stock plate and filament generators. Queen City Electric, 1734 Grand Ave., Chicago.

FOR sale — Grebe CR18, guaranteed good as new. Price \$62.50. Ted Veiringer, Clearfield, Pa.

CHOKE supplies: — 30H, 100MA — \$1.75. 50H, 150MA Dudlo-wound — \$2.40. 30H, 400MA — \$3.75. Double-coil 30H, 100MA — \$1.95. Pure rectifier elements. Low Copper-content aluminum. Cut and drilled, complete. Per pair: 1x4 — 8c, 1x5 — 9 1/2c, 1x6 — 11c. Extra Heavy: 1x4 — 12c, 1x5 — 13 1/2c, 1x6 — 15c. One inch wide lead strip — 9c per foot. Aluminum — 10c. 1/4" Heavy copper-tubing inductance: 3" diameter — 10c per turn. 4" — 15c. Special manufacturer's type 2 Mfd., 400 Volt (Working) Filter condensers — 47c. 7 1/2V-215V transformers — \$1.65. Accurate wavemeters. 15-200 Mcs. \$5.00, \$8.00. Send for "Specs". William Harrison, 35 Ft. Washington Ave., New York City.

PARTS for that transmitter or receiver? QSL cards? Write for catalog. Koehler Electric, 9032 Windom Ave., St. Louis, Mo. W9BEU.

PANEL engraving — finest workmanship on radio laboratory apparatus. Request price list. A. L. Woody, 19 S. Wells St., Chicago.

WANTED, one Amrad 1000 volt S tube, anyone having one to sell, please communicate with G. E. Flye, Northeast Harbor, Me.

ARRL sweater emblems should be worn by all League members. They are yellow and black 5" x 8" diamond, felt letters and embroidered symbol. Only \$1.00. Money order or currency only accepted. Eric Robinson, 135 Jefferson Road, Webster Groves, Mo.

W9DGC selling out. Two transmitters, five receivers. Other parts. Real bargains. Send for list. Edwin L. Robb, Decker, Ind. NEW Thordarson transformer, 1500-2000 each side center, \$18 prepaid. Jack Cunningham, Rousseville, Pa.

PUSH-PULL, tuned-grid tuned-plate transmitter, page 13, December QST. For two UX210 or UX250 tubes. 110-volt 60 cycle UX281 tube filtered plate supply. Complete except tubes. \$65.00. Hal S. Justice, W478, Canton, North Carolina.

CRYSTALS: Carefully selected for maximum output. Your complete satisfaction guaranteed. \$5 meter band, \$17.50. Blanks \$4.00. W9DRD, Hollister, Edwardsville, Kansas.

WAGG selling out — 1929 MOPA, 750 volt d.c. powerjack, screen grid receiver, \$75.00. Individual parts cost more. First money order takes it. W. M. Hicks, Oxford, N. C.

WANT 3 phase mercury arc. Sell 1250v batteries. List. Grote Reber, Wharton, Ill.

USED parts bought, sold, exchanged. List, W9CKA, Corwith, Iowa.

TRADE radio parts, supplies, magazines, electrical books for guns. Eaton's, Olney, Texas.

GENERATORS: 1000 volt, 5 ampere Esco with 110-220V motor run less than 20 hours, \$75. 1000 volt, 4 ampere Esco generator, \$25. 1800 volt d.c. Jewell meter \$17.50. 5 ampere thermocouple Jewell meter, \$7.50. 15 volt a.c. Jewell meter, \$4.50. Thordarson 12 volt filament transformer \$7.50. 110 volt Bradlevstat \$6.00. RCA inductance, .002 Paradon condensers, and other surplus after changing over to storage batteries. Above prepaid. Cash with order. W9BSP, M. H. Ensor, Olathe, Kansas.

FOR sale — SA factory wired two tube 731 Round the World. With 4 short wave plug-ins and XY coils for broadcast. First offer \$30 takes it. All in perfect condition. E. A. Schwarze, Brownton, Minn.

QSL cards, cartoons, stationery, message blanks. H. M. Seiden, Cranestville, Pa.

QSL cards, two colors, new Q signals, \$1.00 per hundred. Free samples. W8DTY, 257 Parker Ave., Buffalo, N. Y.

FOR sale — complete low power phone transmitter, also used transmitter parts at half cost. Write for list. W9AEO.

FOR sale — W3AAJ transmitter, d.c. note — lots dx. Also RCA 104 speaker. Write W3AAJ.

MOTOR generator bargains, 750 Volt, 200 Watt, two commutator new General Electric motor generators direct connected to 110 Volt, 60 Cycle, 3500 R.P.M. single phase A.C.

motors each \$45.00. 350 Volt, 150 Watt new General Electric motor generators direct connected to 110 Volt, 60 Cycle, 3500 R.P.M. single phase A.C. motors, with field resistance, each \$27.50. New 1/2 HP, General Electric and Westinghouse 110 Volt, 1750 R.P.M., A.C. motors \$8.75 each. New television variable speed motors for 110 Volt Alternating Current \$7.00 each. A limited number of each of the above items. Also many others to 3000 volts all sizes. Write us your needs. Electrical Surplus Company, 1911 Chicago Ave., Chicago, Ill.

TRANSFORMERS — 100 Watt, 110 Volt, 60 Cycle, 750 Vols each side center, 7 1/2 Volt Filament winding. Will operate one or two 210 Tubes, \$7.25. We will build that "Hard to Find" Transformer, Choke or Coil to Your Specifications. Scott Coil & Transformer Co., New Albany, Mississippi.

SOLD on trial, guaranteed crystals complete with holder; \$4 meter \$15; 42 meter \$22; 160 meter \$12. The new 3000 v. Rectohub \$10 prepaid; new FBI's 95c; 99.6% aluminum 70c a sq. ft.; Sangamo 5000 v. .002 cond. \$1.40. Jewell, Thordarson, Leach, REL, Ward Leonard, Signal 25% off. Fleishheim and Tobe 35%. I buy, sell and trade — Henry's Radio Shop, W9ARA, Butler, Mo.

SELL or trade, 84 meter power crystal, sync, new 6FX fifty, new Leach relay, REL 210 transmitter, new REL wavemeter, complete SA1L mercury are outfit, other apparatus. Want transmitting tubes, transformers, and condensers. W9ARA, Butler, Mo.

SELL: Thordarson 80 watt filament transformer \$5; Radiotron UV203 only slightly used \$12.50; RCA 50 watt sockets \$1. Jewell type 64 0-5 \$8; type 54 0-500 \$4; type 74 0-15 \$4. Acme double 1 1/2 heavy choke \$4. A. R. Celeke, Jackson, Mo.

SELL 1000 watt transformers, guaranteed. Made by G. E. 1100-2300-4400 each side center tap. Used by Cornell and broadcast stations. Will run 861, F. G. Dawson, 5740 Woodrow Ave., Detroit, Mich.

TRADE 1000v Esco M.G. (needs some repairs) for a good 852. Have a new stage model C melody saxophone, cost \$175. Will trade for UX204A in A1 shape. W9A1D, Covington, Ky.

SELLING out — UX852 new with REL socket, \$27.50. UX203A excellent condition, \$18.00, 500 watt Acme plate transformer 3000 and 2000 volt center tapped, \$15.00, 300 watt Acme filament transformer 10 and 12 volt, \$9.50, 150 watt Acme filament transformer 7.5, 10 and 12 volt, \$6.00, grid circuit driver with Weston model 301 five millimeter covers from 8 to 170 meters, \$28.50, .0005, 3000 volt variable condenser \$9.75, .00011, 3000 volt Cardwell condenser two for \$3.00. Ward Leonard UX852, 200 watt 15,000 ohm leak tapped a 5000 and 10,000, \$5.50, Weston 476, 15 volt A.C. meter \$5.95 heavy Clapp Eastman key, \$1.75, Leach PR9, 250 watt relay \$8.50, George W. Ferguson, W1BFA.

SELL transmitter with UX250 eighteen dollars. Wave meter etc. Want 200 watt 500 or 900 cycle generator, mercury arc. W9EHR.

REL inductances, singles \$6, doubles \$11. Tubes UX852, \$32. N250, \$6. N210, \$5. National transmitting condensers .0011 \$10, .00015, \$8, .00023, \$10, .00045, \$14. Wavemeters, \$20. Plate transformer 1500 and 2000 volts, \$30. Filament 12 volt \$12. Peerless dynamic speakers \$50. Utah \$30. C. Hollis, 1622 Mary's, Sharpsburg, Pa.

## Q R A SECTION

50c straight with copy in following address form only:

W8FC — W. Knight Hamilton, 26 Bay Street, Potsdam, N. Y.

### WIMK

A. R. R. L. Headquarters  
R. B. Parmenter, Chief Op. "rp."

The following calls and personal sines belong to members of the A. R. R. L. Headquarters gang:

- W1AL H. P. Westman "ws."
- W1BDI F. E. Handy "fh."
- W1BHW-W1EHL K. B. Warner "kb."
- W1BMM-W1EL G. D. Meserve "dm."
- W1BUD A. L. Budlong "bud."
- W1CFI-W1SZ J. J. Lamb "jm."
- W1ES A. A. Hebert "ah."
- W1KP F. C. Beekley "beek."
- W1PX C. G. Kenelick "ck."
- W1SZ-W1BIZ C. C. Rudimon "rod."
- L. R. Huber "oh."
- R. A. Hull "rah."







# SPECIALS IN R.C.A. PRODUCTS



LIST  
\$10.00

## P. T. 537 FILAMENT RHEOSTATS

Rated to carry 15 amps.

An absolute necessity for the control of U.V. 203, 203A, 204, 204A and U.V. 881 Transmuting Tubes and 217, 217A, 217C and U.V. 16S1 Rectifying Tubes.

Special **\$3.75 ea.**

## ROTARY GRID CHOPPER WHEEL

MODEL P.X. 1638

and Contact Brush Model P.T. 1642

For use with C.W. Vacuum Tube Transmitters. Gives 100 per cent modulation since oscillation can be completely started and stopped at audio frequencies. The note obtained can be varied to any desired pitch by changing the driving motor speed.

Complete with shaft bushing for 5-16" or 1/4" motor shaft. When ordering mention size wanted.

Special **\$1.25 ea.**



LIST  
\$7.45

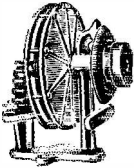

LIST  
\$8.75

## VARIABLE MICA CONDENSER

MODEL U.C. 1819

Capacity .0001 to .005 Mfd.

A Mica condenser which may be varied continuously from a minimum to a maximum value. Its capacity curve is a straight line. It has a very low electric loss. Used as a grid, antenna, or secondary tuning condenser.

Special **\$1.75 ea.**

## PORCELAIN LOW-LOSS SOCKETS

MODEL U.R. 542

For use with U.V. 202, 216 and U.X. 210 and 250 tubes

On account of its low specific inductive capacity and its high insulating qualities, these sockets are excellent for Short Wave work and especially adapted to the above tubes.

Special **50c ea.**

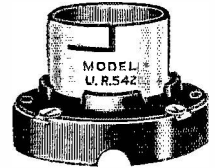

LIST  
\$1.00

# Dubilier High-Voltage Filter Condensers

(Newest Types, Nos. 902 and 903)

These Dubilier Filter Condensers are tested from 3 to 5 times their rated value, thus assuring a sturdy, scientifically designed product, far exceeding the average Filter Condensers now being used. Widely separated soldering lugs are provided to insure long leakage path and to facilitate neat wiring. Each condenser brand new and packed in individual carton.

## TYPE No. 902

Rated D.C. Working Voltage 400 V.

Capacity: 1 Mfd.

List Price \$2.50 ea. SPECIAL **75c ea.**

Capacity: 2 Mfd.

List Price \$3.50 ea. SPECIAL **\$1.05 ea.**

Capacity: 4 Mfd.

List Price \$5.50 ea. SPECIAL **\$1.65 ea.**



## TYPE No. 903

Rated D.C. Working Voltage 600 V.

Capacity: 1 Mfd.

List Price \$3.00 ea. SPECIAL **90c ea.**

Capacity: 2 Mfd.

List Price \$3.50 ea. SPECIAL **\$1.65 ea.**

Capacity: 4 Mfd.

List Price \$9.50 ea. SPECIAL **\$2.85 ea.**

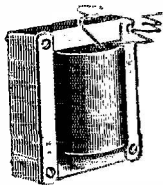

## FILTER CHOKES

20 HENRIES

250 MILLS

Just what you want for obtaining a pure D. C. note for your Transmitter. Also can be used in "A" or "B" Eliminators.

Weight 5 pounds. Wiring heavily insulated. New and packed in individual cartons.

SPECIAL **\$2.50 ea.**

## LAST MINUTE SPECIALS

R.C.A. Uni-Rectron Power Amplifiers — Model A. P. 945 List \$88.50 ea. ....	SPECIAL \$19.75 ea.
E210 BRADLEYSTATS, list \$4.00, line for A.C. Line Voltage Control .....	1.60 ea.
Genuine Black Bakelite Panels 38" x 43", 3-16" thick, Reg. Price \$79 .....	8.75 ea.
U. S. ARMY Aeroplane Spark Transmitters, Gov. cost \$47 ea. ....	4.75 ea.
G. E. Kenotron Rectifying Tubes (Type T.B.1.) .....	1.25 ea.
Gold Kenonode Unpowered, Automatic Radio "A" Power (60 volt), list \$39.50 .....	13.75 ea.
G. E. A. T. 14 — 5 watt Transmuting Tubes (A good power amplifying tube) .....	1.50 ea.
Western Electric Type AA Filters .....	2.50 ea.

AMERICAN SALES CO., 19-21 Warren Street, New York City

Whatever you want to know about RADIO—principles, methods, apparatus—you will find instantly in

# THE RADIO MANUAL

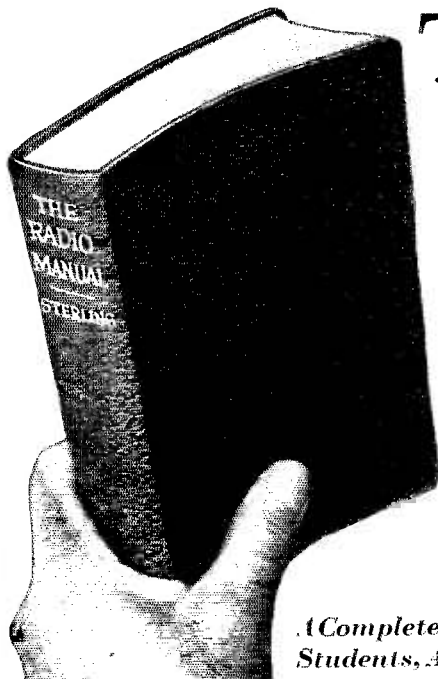

By G. E. STERLING, Radio Inspector and Examining Officer, Radio Division, U. S. Dept. of Commerce

Edited by ROBERT S. KRUSE, for five years Technical Editor of QST.

The new procedure adopted by the International Radio Telegraphic Convention was effective January 1st, 1929. THE RADIO MANUAL records it completely. Department of Commerce examinations for operator licenses were changed the first of the year. Only THE RADIO MANUAL presents all the material to meet the requirements of the questions. Progress has been steadily made in perfecting radio theory and practise. THE RADIO MANUAL, since it is the most up-to-date volume on radio, is the surest source of complete and accurate information on all points.

*A Complete Handbook of Principles, Methods, Apparatus for Students, Amateur and Commercial Operators, Inspectors*

## Complete Preparation for Government License. 16 Chapters Covering

1. Elementary Electricity and Magnetism
2. Motors and Generators
3. Storage Batteries and Charging Circuits
4. Theory and Application of the Vacuum Tube
5. Fundamental Circuits Employed in Vacuum Tube Transmitters
6. Modulating Systems Employed in Radio Broadcasting
7. Wavemeters, Piezo-Electric Oscillators, Wave Traps and Field Strength Measuring Apparatus
8. Marine Vacuum Tube Transmitters including detailed description of Model FT-362b
9. Radio Broadcasting Equipment including, for the first time in any text book, the complete equipment of Western Electric 5 Kilowatt broadcasting Transmitter used in over 75% of American broadcasting stations
10. Arc Transmitters including description of Federal Marine 2 Kilowatt Arc Transmitter Type AM 4151; also models "K" and "Q"
11. Spark Transmitters including description of Navy Standard 2 Kilowatt Transmitter
12. Commercial Radio Receivers and Associated Apparatus including, for first time in any text book description and circuit diagram of Western Electric Super-heterodyne Receiver Type 6004C
13. Marine and Aircraft Radio Beacons and Direction Finders
14. The Development of Amateur Short Wave Apparatus. Complete details of construction, operation and licenses
15. Radio Laws and Regulations of the U. S. and International Radio Telegraph Convention. Quotations of all important sections
16. Handling and Abstracting Traffic

## Examine It Free

Never before has so complete a treatment of radio theory and operation been compressed into a single volume. Here is information that otherwise you could secure only by consulting many different books. And every detail is vouched for by authorities of the first rank. The Manual is profusely illustrated with photographs and diagrams. There are 700 pages, bound in flexible fabricoid that is extremely durable. The immediate demand for so valuable a handbook has already nearly exhausted the second large edition. To be sure of receiving your copy without delay, order at once. The volume will be sent for free examination. Pay or return in 10 days.

### Order On This Coupon

D. VAN NOSTRAND CO. INC.,  
8 Warren St., New York City

Send me THE RADIO MANUAL for examination. Within ten days after receipt I will either return the volume or send you \$6.00 — The price in full.

Name.....

QST4-29

St. and Number.....

City and State.....

# AERO COIL

You have been waiting for it!

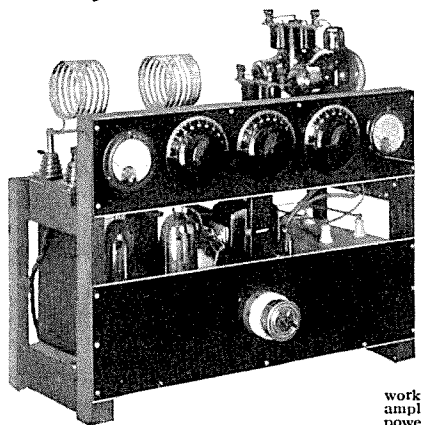

## Aero Kit No. 52 NEW HIGH-POWER XMITTER AND 150-Watt Amplifier OPERATION ON 10-20-40-80-100M. Bands

works with a high degree of efficiency as an amplifier. With two screen grid UX-860 power tubes in this arrangement, it requires no neutralizing. Hook this unit on your present oscillator, converting it into a 1929 job, with ample power for ham use. Power supply delivers 2000 volts at 250 M.A. Employs two of the R.C.A.'s newest rectifiers, UX-866. Due to the construction of the UX-866, unusually high voltage may be applied safely to them.

Kit No. 52 — including the power supply, but not including tubes. List Price. . . . . \$259.00

852 tubes, less power supply and tubes. List Price. . . . . \$114.00

The first high-power amplifier to use the UX-860 screen grid tubes. 1929 In Every Detail. 150 Watts of Pure D. C. Signals with a Stability Which Has Caused Favorable Remarks Everywhere. Flexibility that Fills Every Ham Need. You can use either two UX-852 tubes when using this new Aero Kit No. 52 as a single unit for a transmitter; or two UX-860 (screen grid) tubes, employed when using with Aero Kit No. 55; or as a 150-watt amplifier in any master oscillator combination. For those desiring a master oscillator system, this unit

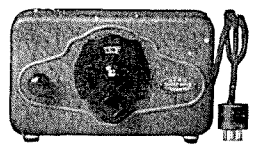

### "Aero-Call" Factory-Built Short-Wave Converter

No short-wave converter on the market is comparable with the new 1929 "Aero-Call." Its advent sounds a new era in short-wave converts. Many factory-built items of this character now being sold are giving trouble particularly on the A.C. model, because there has been found no general adaptation of converters to the A.C. filter on the broadcast sets. The new "Aero-Call" Converters eliminate all these difficulties.

**Model A:** One of the outstanding troubles on Short-Wave A.C. Converters is motorboating. This is caused by the fact that the converter is plugged into a set with an efficient A.C. filter for the broadcast receiver, but when the converter is plugged into it, the A.C. filter systems in the broadcast set is inefficient for the oscillating circuit in the short-wave converter.

This trouble is overcome in the New "Aero-Call" Factory-Built Short-Wave Converter by an auxiliary filter system which is operated from a small dial on the back of A.C. Converter. The broadcast set is knob until proper adjustment is secured and leave it at that adjustment.

**Model D:** In order to open up the region of short waves for those already possessing a battery-operated radio set, we have developed a highly efficient unit which can convert or adapt your present D.C. receiver for operation on the low waves by simply removing the detector tube and plugging in the socket a tube base connected to the Converter by means of a cable, thus completely connecting this unit to your present radio set and power supply in one operation.

**Model A and Model D Converters** are in small metal cabinets — 5½ inches high, 9 inches long and 2¼ inches wide. The metal cabinets, as well as acting as a shield, become an object of beauty. They are beautiful golden brown, crackle-finish. Ship, wt., about 3 lbs.

Model A for A.C. Sets. . . . \$25.00  
Model D for D.C. Sets. . . . \$25.00



**New 1929 Aero Grid Choke No. C-250**  
A Compact Choke Coil for suppressing high frequency oscillations in transmitting vacuum tubes. Price \$2.00

### Aero Transmitting Choke No. C-248

For transmitter circuits where the short current compact never exceeds 100 millihenries, a maximum impedance is desirable, as it presents a high and uniform choking action over the regular amateur wave lengths. For intermittent service, such as C. W. transmitters, it can be safely used up to 200 millihenries. Price \$1.50

**Aero Transmitting Choke No. C-249**  
\$1.50, C-60, \$1.50, C-65, \$1.50

### New 1929 Receiving Coils

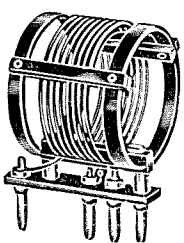

Designed for the new amateur 20, 40 and 80 meter bands, for use with .00003 condenser, including plug-in base with new design adjustable space-wound primary. Complete Kit L. W. T. 13, 3 coils, \$12.50. Single coils — 8.2 to 12.6 meters; 19.4 to 21.5 meters; 40.0 to 45.0 meters; 75.0 to 86.0 meters. \$4.00 each. L. W. T. 100. P. Plug-in base, \$3.00; .00003 Condenser, \$1.50.

\$1.50. This condenser to be shunted with a .00008 Fixed Condenser.

### New 1929 Transmitting Coils

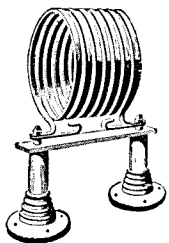

In accord with 1929 practice. First use of plug-in coils for high power up to 15 amperes. Heavy aluminum carries 500 watts safely. New material space bar superior to glass. Many new features. For use with 440-mmf. condenser. Kit of 2 coils with plug-in mounts, 9.6 to 27.0 meters, \$15.00; 14.2 to 43; also 31.8 to 90.3 meters, \$15.00. Single coils, \$5.50, without Bases. Plug-in mountings only, pair \$3.50; Plugs only, with nuts, pair \$2.00.

## New Aero 1929 Listening Monitor Now a real necessity for every "Ham" Are You Working in the Dark?

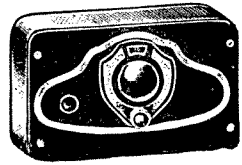

The Aero Listening Monitor Box virtually turns a flood-light on your transmitter that you might accurately know your station and not be a cripple depending on the reports of fellow hams. Is your note pure D.C.? Do you think it is or do you K.N.T. from your own observation? BE WISE! BE SURE! and BE SAFE! Secure an Aero Monitor and be able to check your own note. Take a tip from Q.S.T. and don't drive your Lizzie by Watching the Ammeter, but know the road and keep the supervisor away from your shack.

The Aero Listening Monitor is a completely shielded unit, including filament and B supply and operates with a UX-199 type of tube. It is contained in a golden-brown metal cabinet, 9 inches long by 5½ inches high, by 2¼ inches deep, crackle finish. It employs a stable circuit and delivers a signal intensity of about R-4 or 5. The battery supply is thoroughly shielded from the R.F.; hence no trouble from this source, thereby giving the operator the opportunity to secure a reliable piece of apparatus which also incorporates automatic filament control. Shp. wt., about 2½ lbs.

List Price — Model M-29 — Including Dry Batteries but No Tube. . . . . \$15.00  
Send for new Short-wave supplement showing new 1929 products. It is free to QST readers

4611 E. Ravenswood Ave., Dept. 349 **AERO PRODUCTS** Chicago, Illinois, U. S. A. INCORPORATED

# BURGESS BATTERIES

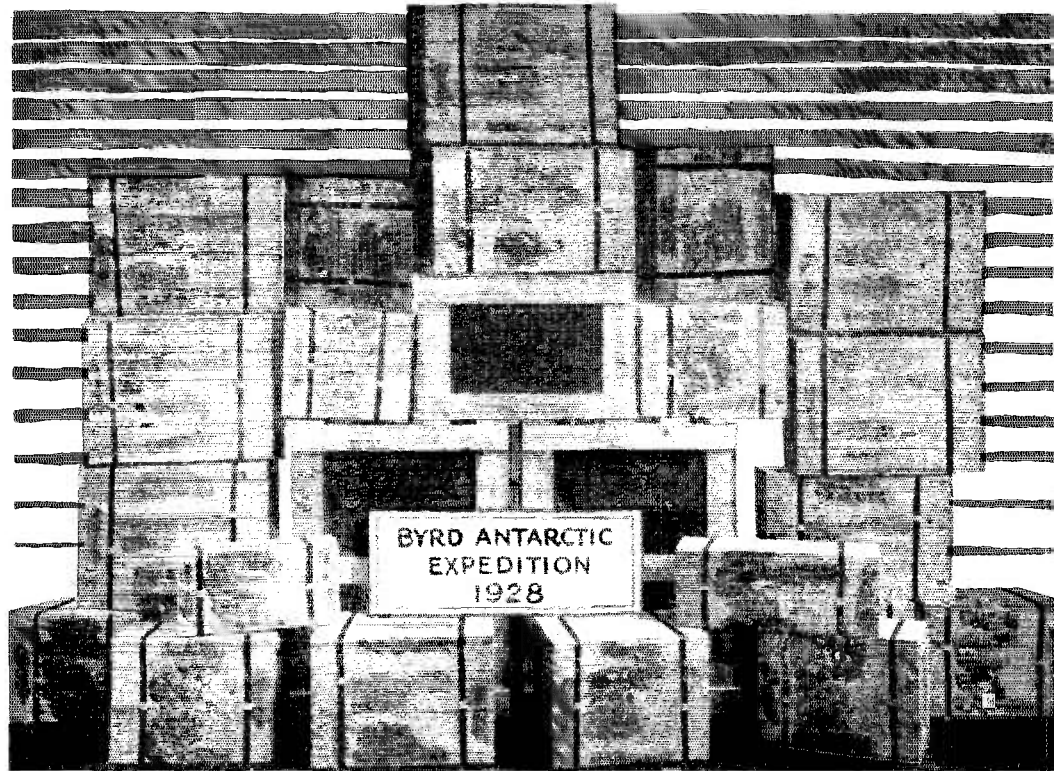

*with Commander Byrd's antarctic expedition*  
*"Ask any Radio Engineer"*



## BURGESS BATTERY COMPANY

MADISON,

WISCONSIN

# The Communications Department

F. E. Handy, Communications Manager  
L. R. Huber, Asst. to Coms. Mgr.  
1711 Park St., Hartford, Conn.

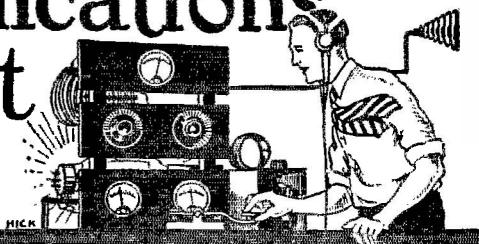

## The New Reporting Dates

As announced last month, a change in the "message month" was made effective March 15. Each reporting month of activity now runs from the 16th of one month to the 15th of the next month inclusive, reports becoming due to S.C.M.s from all who report on the 16th of the month.

Don't forget—report on all communication work accomplished (March 16 to April 15 inclusive) promptly on APRIL SIXTEENTH, and report on the 16th of each month thereafter if you reside in the continental United States. The address of the Section Manager is given on page three of each issue of *QST*. Closing dates in Canada, Hawaiian and Philippine Islands and Alaska are being arranged by the Canadian General Manager and the Section Managers of those Sections concerned. Write them if in doubt. The S.C.M.s welcome reports from all amateur stations on the air in their territory, regardless of whether or not the station has received appointments of any kind. Of course it is understood that those stations holding C.D. appointments are required to report regularly to hold their positions.

A few reports were omitted this month due to the fact that they failed to come through in time from the Section Managers concerned and therefore did not meet our new date of closing these forms—this in spite of the fact that a special bulletin explaining the circumstances and asking cooperation in the emergency had been mailed to every C.D. official. We are glad to receive so many of the reports as did come through on schedule and hope to see every Section represented 100% in next *QST*. Be sure that every individual report is mailed to the Section Manager on time.

## Expeditions

WALTER A. KNIGHT of W1CNA just set forth on a three or four months' trip as radio operator on the Yacht *Pearl*, WPCR. The trip should be interesting as the real object is to hunt for a "Dream Island" somewhere in Pacific waters. Newport News, Miami, Havana, Kingston, Colon, through the canal to the Mexican west coast and a visit to sunny California are all included in the program. Unfortunately most of the two-way work will be connected on the regular ship-shore communication channels. Plenty of receiving equipment has been taken along, for long wave, broadcast and high frequency reception. Knight expects to make a study of signals in the 7000 kc. band and will be glad to listen for any of the gang.

## WSBS

THE Yacht *Carnegie* of the Department of Research in Terrestrial Magnetism, Carnegie Institute of Washington, is nearing Papeete as we write this report. The monthly radio report dated February 27 came forward via both W9BCA and W6CIS to W1MK.

Things are going fine this month except for occasional freak radio weather in the U. S. A. Signals here have been simply great in comparison with the dead periods of the months just previous. However, we have had some interference trouble since the first of the year.

Tell the gang to lay off sitting on the key during rush hours. We now have schedules with W1MK, W1XV, W1SZ, W9BCA, W9DFV, W6AII, W6BPC, W6CIS.

QST FOR APRIL, 1929

nj2PA and KDV5. Other stations worked recently are W3OP, W6CHA, WS4JN, W9MIL, W9CIV, and W6CII.

W9CKQ tried a 14 mc. test with me but I was unable to hear him. 14 mc. signals not being very good as a rule. We have about 1600 miles to go to Tahiti and hope to stop for a day at the island of Amanu on the way. We expect to reach Tahiti in about two weeks. Now having hot clear tropical weather. Everything connected with the expedition is going fine. Many thanks to W1MK and all the other stations that are so willing to help us out. See you next month. 73.—L. A. Jones, Radio Operator, Yacht *Carnegie*, WSBS."

W1XV established contact with WSBS upon leaving Callao, Peru, bound for Tahiti. Regular schedules are maintained Sunday, Monday, Wednesday, and Friday at 8:30 p.m. EST (0130 GCT of the following date). WSBS is still in daylight at this hour and reports signal strength equal on W1XV's 7 and 14 mc. transmissions. His 9045 kc. frequency is usually QSA3 and increasing to QSA5 as the evening advances. Inasmuch as a great deal of the traffic is bound for Washington, W1XV keeps regular schedules with W3GT in Washington the following mornings at 1400 GCT. W1MK-WSBS traffic is regularly forwarded to Washington W3FIL on the early evenings of the day following WSBS schedules.

## WFAT—WFBT

During the month of February W1XV has maintained regular schedules with the S.S. *Eleonor Bolina* while on their second trip to and from the ice barrier. The *Bolina*, WFAT, is usually easily readable on its 8809 kc. frequency until 1230 GCT. WFAT is now making the third and last trip (for this season) to the ice barrier. W1XV used the 7 mc. band exclusively for this communication, scheduled for 1145 GCT.

W9BEZ handled some Byrd traffic with WFBT February 17, relaying the New York bound messages via Ohio W8CPQ. W9EGU reports consistent contacts with the S.S. *City of New York*, although these have not been a daily occurrence. He learns from operator Mason that the land base station now in process of construction will be a duplicate of the WFAT transmitter. Messages have been handled consistently for the expedition. In addition to the limited time spent in operating due to work on the base station, schedules are being cut down somewhat to save gas for the planes. No other reports on Byrd contact were received this month. We note in the Daily Colonist of Victoria, B. C., that VE5CO had a splendid contact with WFAT during the month, however.

TEST USDA and CQ USDA are the general calls of inquiry used by the stations of the Department of Agriculture Net, which has been organized by the A.R.R.L. This net functions once each month among twenty and odd cities all over the United States. Since there are not a great number of USDA stations, and since the traffic work among them takes up all of one evening with no time to spare, everyone is urged to refrain from answering the calls of TEST USDA and CQ USDA unless there is urgent need for contact. Thanks, OM.

WEM operates on 7400 kc. instead of 7300 kc., as many amateurs suppose. There is no marker station at 7300 kc., and therefore it is necessary for each of us to be extra careful about slipping above (in kilocycles) the limit of the band. DHE (Nauen, Germany) on 7322 kc. more nearly marks the boundary off amateur territory. Watch your frequency!

# Improving Your Operating Methods

By E. A. Hubbell \*

Last month we invited contributions on every phase of amateur communication activity, suggesting a wide variety of subjects on which articles would be welcomed. The article presented herewith is the first to receive favorable consideration in connection with our offer (page 62, March QST) and is unquestionably the prize-winning article for this month. In addition to these articles receiving a good position in QST, the author whose article appears to have the greatest value of those sent in for consideration each month, has his choice of (1) a copy of the Radio Amateur's Handbook bound in algerian, (2) six pads of A.R.R.L. message blanks, or (3) 500 A.R.R.L. log sheets. Our offer is good throughout the remainder of 1929.

Mr. Hubbell discusses present-day operating conditions in our 3500 and 7000 kc. bands and suggests the use of up-to-date intelligent methods of operation to increase the amount of satisfactory communication possible and consequently the enjoyment in general amateur work. We hope you will study it and adopt the understandable time-saving practices he recommends. In all classes of operating work, universal understanding of abbreviations and systematic procedure is necessary to secure superlative results. — EDITOR.

**D**UE to the changes in Q signals, the large number of new hams, a mixture of commercial operators, and the lack of using a good book on standardized amateur procedure, the average ham QSO is a hash of old and new Q signals, individual preferences in the matter of abbreviations, and half-understood commercial methods. Yes, it's really as bad as that, considering the average ham. It may not be his fault, if he has read the ham's Bible for a couple of years, invested his dollar in the Handbook and listened intelligently, yet, with the example set by many inexperienced operators, he may easily establish habits making a QSO a puzzle, rather than a friendly contact for a good chat.

This system is not at all in line with the 1929 idea of efficiency. Why should we have to receive with a copy of the last Q signals at our elbow, instead of memorizing the bunch and forgetting the old ones? Simply because many amateurs refuse to use the new Q signals. Laziness, perhaps, accounts for it, but mostly a general inertia of all of us, making any change lengthy. I know of one case where an active amateur, operating on 3500 kc. refuses to recognize the new Q code. He will get over it in time, no doubt, but meanwhile his attitude doesn't make a QSO any more enjoyable.

This poor spirit just takes up a little more precious time, and indeed, most of our QRM is not so much due to the number of stations on the air, as it is to the amount of time each one takes to put his ideas across. The way to help this is to follow standard procedure, making it unnecessary to explain over and over again what should have been understood the first time. For instance, if all CQs could be cut down to the three and three rule (Call CQ three times, sign three times and repeat three times) the QRM would be much lessened — and QSOs would be easy and more numerous. Let's get together on a general plan for amateur contacts, message handling etc., based on the Rules and Regulations.

We think of commercial procedure as being a good way out. However, commercial procedure is adopted for different conditions than amateur work. We must adopt A.R.R.L. procedure for message handling. The ordinary amateur who perhaps handles an average of one message a day needs no especial speed so will use the following procedure:

"HR MSG FM ROCKFORD ILL W9ERU MR 151 FEB 25 TO RADIO W9ARE OWEN WIS=HEAR FROM W9DND THAT YOU HAVE AN RCA UV204A FOR SALE STOP KINDLY GIVE INFORMATION ON CONDITION AND PRICE STOP REPLY VIA W9DND W9DLQ W9DLD W9ERU SCHEDULE ROUTE STOP MY 73= SIG

GENE W9ERU AR"

The italicized abbreviations are not always spelled out in the original message but should always be required of the sender by the originating operator. It is best to spell out the punctuation, as "PERIOD", "QUESTION", etc. Quotation marks are put in by the use of "QUOTE" and "UNQUOTE".

Now for the speedy boys. These are the traffic stations

\*A.R.R.L. Official Observer, W9ERU, 227 North Fourth Street, Rockford, Illinois.

who handle six and more messages in fifteen minute schedule periods. The form is a bit shorter than the above, since a number of abbreviations are left out. Here is the above message in the shorter form.

"DE ROCKFORD ILL W9ERU 151 FEB 25 RADIO W9ARE OWEN WIS=HEAR FROM W9DND THAT YOU HAVE AN RCA UV204A FOR SALE STOP KINDLY GIVE INFORMATION ON CONDITION AND PRICE STOP REPLY VIA W9DND W9DLQ W9DLD W9ERU SCHEDULE ROUTE STOP MY 73=GENE W9ERU AR."

You will note that we have eliminated the "HR MSG FM", "NR", "TO", and "SIG". "DE" is a bit shorter than "FM" and the omissions make a saving of ten characters, altogether. Not a great deal, but helpful when handling numerous short messages.

But the way that saves the most time is sending in strings, that is, five or more messages at a time, getting the OK after the five have been sent, not after each individual message. Here break-in is the only system to use, since, if receiving conditions make it impossible to copy after the five have been started, all the sending will have been in vain. Break-in should not be used if one or two messages are being made in the text of each message, since each break consumes time, throws both the receiving and the sending operators off their stride. Save the one or two messages until the end of the message, or string, then ask for them all at once. Thus, in the above message we will suppose that the initials "RCA" were missed, also the word "INFORMATION." In asking for a fill, in case this message were one of five, we would use the following procedure:

"W9DLQ DE W9DLQ 1517 WB UV204A ES 7WA GIVE K."

In practice this varies slightly but the above makes a snappy way of getting a fill, between good operators. In acknowledging a message "NR" "151 R" is enough for anyone. If the other operator misses, "QSL?" will set him right.

Sometimes we want to make sure the other fellow will get an unusual word or initial in the text OK, without having to repeat it later, so we repeat while sending the first time. Send the unusual word, then the error signal, repeat the word, and continue. I do not regard this as really the best practice. The error signal is "I?" usually shortened to simply "I" (---). For a repeat sign "RPT" is snappy and to the point, and hardly can be misunderstood. A number of stations use merely "I?" for a repeat sign. That is, "I?". This is not long, and is understood by the majority of stations. "7WA", "7WB", "7AB", "7TXX", "7SIG" and "7ADR" are sufficiently short to satisfy anyone.

One of the worst faults in amateur operating is in the method of calling CQ. We hear an open send CQ for ten, fifteen, twenty and more times without a sign of a station call. Just about the time the ops gets ready to sleep, we tune him out — and he wonders why he doesn't QSO anyone. The ARRL "3 and 3" rule is the best. However, calling five times, repeating the call signal three times and the whole thing three to five times, is not bad. No more than five CQs ought ever to be sent without signing at least twice.

Directional CQs follow the same general rules, though they can be a bit longer, as may be necessary. Answers to

CQs may be made by calling ten times, signing twice, calling ten, signing three times, and listening for about 30 seconds. Then call a little more, and QUIT.

Calling a station after hearing him sign "SK" is a good way of QSO, since most stations will dial around a bit after finishing a QSO. Always cover the dish thoroughly after signing, since some one may be calling you.

Among the new abbreviations given us is "CL". This means, when added to the end of a transmission, "I AM CLOSING MY STATION AND LEAVING IMMEDIATELY, DO NOT CALL ME". It will be noticed that when W1MK sends the official Broadcast on both bands, and intends to continue work on 3500 kc. that "CL 7000 KC" will be sent. This indicates that no calls on 7000 kc. will be answered, as no one will be listening at W1MK on that band.

Signal reports should be given by the QSA system. The old R system is OUT. Don't give a fellow a QSA5 report merely because the cans chatter on your head when he presses the key. QRM is getting so bad on 3500 and 7000 kc. that many very loud sigs are entirely drowned at times. When a signal cannot be read, it is *not* QSA5 even though it is louder than all other signals. I don't mean to figure out the other fellow's report, then cut off a notch, but I do mean to take into account receiving conditions as well as actual signal strength. This cheats the DX merchant out of his choicest pleasure, getting a report on how loud he was in Abyssinia, or somewhere in XX DX-land. However, the QSA system is sure the berries for the traffic handler, since he immediately knows how *capable* he is.

All amateur stations should have a call book. A good cheap one is the government issue, which can be purchased for a quarter. But sometimes a station is *not* listed in the call book, or an operator wants to know if the QRA is correct as given, that is, as to the city. So he asks "QRAR?". "IS YOUR CALL BOOK ADDRESS CORRECT?". In answer the other fellow should come back with the same abbreviation, "QRAR". I have noticed a very general failing among some hams, in that, when asked "QRA?" they come back with "MY CALL BOOK ADDRESS IS CORRECT". Now in the first place, if we want to know whether the call book address is correct, it should be asked for by "QRAR?". Next, it is always a good idea to give your city and state, to make sure the other fellow knows for sure what your QRA is, and finally, some amateurs don't have a call book.

In signing off, the usual amateur way is to give a long string of CUAGN, 73, GN, etc., then to give the other fellow's call once, de, their own call once and then SK followed by personal sine, and perhaps another GN. The correct way, as given by Government and A.R.R.L. practice, is to finish what you have to say completely, then to give the SK followed by your own call sent once, *not* giving the other fellow's call at all, and adding no more than your personal sine at the end of your own call. It may seem hard at first, but it is a time saver, and the correct procedure. Also, *don't* sign off with SK, come back with more dope on your transmitter, WX, or what have you, and then sign off again. An acknowledgment of what the other fellow said after you signed can be given by "RSK" which is sufficient to let the other fellow know you got him OK.

An ex-commercial operator, who has not been listening on the air for about four years, but who still can read code pretty fair, was at W9ERU one evening, listening to the amateurs. As each successive station was tuned in, I could see him get more and more disgusted. When he came over early in the evening he was very enthusiastic about coming back on the air. When he left, he didn't think he wanted to after all. His only reason was the number of poor operators on the air, in fact, he said he heard but a couple all evening long who sounded other than "lids". That was stretching it a bit, but the average 7000 kc. amateur is not so good as he ought to be, we can all admit, although the standard has been improving during recent months. Among the 3500 kc. traffic handlers a much larger number of good ops is found, due mostly to more experience.

If just a little time is spent learning some correct procedure, this amateur game can be improved one hundred per cent. Don't be careless, don't be sloppy in your operating. Make your procedure for message handling crisp, snappy and always in accordance with the best known methods and standard practices. If you are in doubt on any points of procedure, write the A.R.R.L. for information. Get into the game, fellows, and strive to make your operation an object of admiration.

## Helping the Air Mail

W2ANV, W8DQP, and VE2BB keep regular early morning schedules for the purpose of reporting weather conditions along the Albany-to-Montreal air lane. This weather reporting system, instigated by Supt. Ambrose of the Albany Airport, has been proving itself of great value to the fliers. The data received by amateur radio has been found to be of greater accuracy than that obtained from government reports. W2ANV says: "Mr. Ambrose took my report from VE2BB one morning and made the trip to Montreal with air mail just to check it against the official government report, as they differed greatly. Later he called me up and said that our radio report was entirely correct."

This is mighty good work on the part of W2ANV, W8DQP, and VE2BB, but the most interesting aspect of it is that it can be applied over the whole country if there are enough wide-awake and enthusiastic amateurs. Right now W2ANV is looking for more reporting stations along the Albany-to-Montreal route. Any amateurs in this general locality should, if interested, get in touch with W2ANV in Albany or Mr. Ambrose, who may be addressed at the Albany Airport.

Similar reporting systems are planned for the air lane along the Hudson River to New York City, and on the route from Albany to Cleveland, via Herkimer, Syracuse, Rochester, Buffalo, and Erie, Pa.

### VOLUNTEERS WANTED

The 1715 kc. band is becoming more popular every month. We now have several volunteer code practice stations in operation. With the increasing number of beginners, however, still more volunteer stations are needed.

Radiophone stations are preferred, as it is possible thus to instruct more efficiently through the microphone than only with a key. If you have a 1750 kc. radiophone transmitter and care to engage in this most worth-while work, please drop us a line, giving data on your exact frequency, hours of schedule, etc. We have some mimeographed material that is designed to be of use in putting the code practice on the air.

Won't you help us, OMI?

### BEGINNERS ATTENTION

Schedules that have appeared in the past few issues of *QST* will be an index to the stations in the 1715 kc. (175m.) band who are transmitting code practice. Beginners are urged to get a receiving set in order to listen to these stations. Constructional details appeared in the October, 1928, issue of *QST* (page 46). In addition to what has appeared in *QST* it is suggested that the *Getting Started* chapter of the *Radio Amateur's Handbook* be referred to as a guide in the work of becoming a full-fledged amateur.

Listeners who make use of code practice transmission should never fail to send a card to the volunteer in order to let him know that his work is being utilized and appreciated. The following schedules in the 1715 kc. band are now in effect:

W7QV-W7GZ, Spokane, Washington, will transmit on 1750 kc. on Mondays and Wednesdays from 7:00 to 8:00 p.m. P.S.T., and on Sundays from 10:30 a.m. to 11:00 a.m., and from 2:30 p.m. to 3:00 p.m. The transmitter is a 100-watt m.o.p.a. operating in the 1750 kc. region, with plate current supplied by storage batteries. A three-stage amplifier and a magnetic microphone are employed. Schedules will be increased in number if reports are received.

W9DHC, Dakota City, Nebraska, will transmit on Sundays, Mondays, and Saturdays from 10:30 p.m. to 11:00 p.m., on a frequency of 1818 kc. (165 meters). W9DHC's transmissions are sponsored by the Tri-State Amateur Radio Club. Above schedules are in C.S.T.

WRVA, Richmond, Virginia (Edgeworth Tobacco Station), broadcasts the regular A.R.R.L. code lessons each Monday at 7:15 p.m. on a frequency of 1110 kc. (270.1 meters.)

Station KFWC, in Pomona, California, advises us that the regular A.R.R.L. code lessons will be broadcast

## ELECTION NOTICES

*For all A.R.R.L. Members residing in the Sections listed below:*  
(The list gives the Sections, closing date for receipt of nominating petitions for Section Manager, the name of the present incumbent and the date of expiration of his term of office.) This notice supersedes previous notices.

In cases where no valid nominating petitions have been received from A.R.R.L. members residing in the different Sections in response to our previous notices, the closing dates for receipt of nominating petitions are set ahead to the dates given herewith. In the absence of nominating petitions from Members of a Section, the present incumbent continues to hold his official position and carry on the work of the Section subject, of course, to the filing of proper nominating petitions and the holding of an election by ballot or as may be necessary. Petitions must be in Hartford on or before noon of the dates specified, all of which are 1929.

Section	Closing date	Present SCM	Present term of office ends
Western N. Y.	May 15	C. S. Taylor	July 1, 1928
Nevada	May 15	C. B. Newcombe	Sept. 15, 1928
Philippines	June 15	M. L. Felizardo	Jan. 3, 1929
Virginia	May 15	J. F. Wohlford	Dec. 2, 1928
Arizona	May 15	D. B. Balm	Jan. 3, 1929
Guam (Cuba-P.R.)		(acting)	
Isle of Pines	May 15	H. L. Reid	Aug. 2, 1928
Sacramento Valley	Apr. 8	C. F. Mason	May 6, 1929
San Diego	May 15	G. A. Sears	Feb. 2, 1929
Los Angeles	Apr. 8	D. C. Wallace	Apr. 27, 1929
Oregon	Apr. 8	R. H. Wright	June 2, 1929
Maine	Apr. 15	Fred Best	Aug. 8, 1930
Oklahoma	Mar. 15	Glenn Morgan (resigned)	Aug. 24, 1930

Due to the pending resignation of Mr. Fred Best, WIBIG in the Maine Section of the New England Division, and of Mr. Glenn Morgan, W5AMO, in the Oklahoma Section of the West Gulf Division, effective at once, nominating petitions are hereby solicited for the office of Section Communications Manager and the closing dates for receipt of nominations at A.R.R.L. Headquarters in Hartford are herewith specified as noon April 15, 1929, and March 15, 1929, respectively

### Canada

Nominating petitions for Section Managers in Canada should be addressed to Canadian General Manager, A. H. K. Russell, VE9AL, 5 Mail Building, Toronto, Ont., Canada. To be valid, petitions must be filed with him on or before the closing dates named.

British Columbia	May 15, '29	F. S. Brooks	Dec. 2, '28
Saskatchewan	May 15, '29	W. J. Pickering	Dec. 2, '28

*To all A.R.R.L. Members residing in the Sections listed:*

1. You are hereby notified that an election for an A.R.R.L. Section Communications Manager, for the next two year term of office is about to be held in each of these Sections in accordance with the provisions of By-laws, 5, 6, 7 and 8.

2. The elections will take place in the different Sections immediately after the closing date for receipt of nominating petitions as given opposite the different Sections. The Ballots mailed from Headquarters will list the names of all eligible candidates nominated for the position by A.R.R.L. members residing in the Sections concerned.

3. Nominating petitions from the Sections named are hereby solicited. Five or more A.R.R.L. members residing in any Section have the privilege of nominating any member of the League in their Section as candidate for Section Manager. The following form for nomination is suggested.

(Place and date)

Communications Manager, A.R.R.L.  
1711 Park-St., Hartford, Conn.

We, the undersigned members of the A.R.R.L. residing in the ..... Section of the ..... Division hereby nominate ..... as candidate for Section Communications Manager for this Section for the next two-year term of office.

(Five or more signatures of A.R.R.L. members are required.)

The candidate and five or more signers must be League members in good standing or the petition will be thrown out as invalid. The complete name, address, and station call of the candidate should be included. All such petitions must be

filed at the headquarters office of the League in Hartford, Conn., by noon of the closing date given for receipt of nominating petitions. There is no limit on the number of petitions that may be filed, but no member shall sign more than one such petition.

4. Members are urged to take initiative immediately, filing petitions for the officials of each Section listed above. This is your opportunity to put the man of your choice in office to carry on the work of the organization in your Section.

- F. E. Hamby, Communication Manager.

## ELECTION RESULTS

In the Florida Section of the Southeastern Division, Mr. Harvey Chafin, W4AIL, 6002 Suwanee Ave., Tampa, Fla. and Mr. J. E. Collins, W4MS, 1115 E. Lloyd St., Pensacola, Fla., were nominated. Election results: Mr. Chafin, 21; Mr. Collins, 19. Mr. Chafin, therefore, has been declared elected, his term of office beginning March 2, 1929.

## 28 m.c.

The biggest news of the month! VT2KT, Bombay, India (F. Rodman, c/o Lloyds Bank, Hornby Rd.) was in successful two-way communication with G5ML, Warwickshire, Great Britain (F. W. Miles, Coventry) using 28,000 kc. between 1115 and 1140 GMT on February 24. Some fading was present at the end of this contact. Communication was reestablished at 1217, remaining good for the next half hour. News of this achievement reaches us by radio through W8AXA who took the report direct from G5VL on 14,000 kc.

There are many countries in which the amateurs are now interested and working on 28 m.c. G2NMI, Finland, reports that he has heard Europeans but no U. S. A. stations on that frequency. Z84M has been testing with W8AXA but has heard little outside of automobile ignition systems so far. Hats are off to the Englishmen as being the foremost 28 m.c. workers at this writing. We look forward with great interest to the outcome of the 28 m.c. tests announced in these columns last month. The result of further tests being conducted by VT2KT and G5ML will also be enlightening.

Mr. Rodman of G2FN-VT2KT sent us an interesting log of his reception of American stations at London in early December. He used a 27-foot horizontal antenna at the time:

"Dec. 2, weather dull and foggy, conditions fair but slight fading on all signals, strength below November average. Between 1330 and 1425 GMT logged, W1XAM, W1AEP, W2ACN, W2JN, 1520 to 1700 GMT logged W1AQD, W2WS, W2TP, W2BVG, W2CJV, W2RB, W5WZ; Dec. 9, weather clear, frost, slight ground fog, fading bad, few stations but good strength. Logged W2JN, W2CMZ, W8AUR 1405-1420 GMT and W1CMF, W2BG, W2RB 1530 to 1625 GMT; Dec. 16, weather overcast, damp, cold south wind, conditions good, little fading, strength above average. Logged W1CMF, W2JN, W2BG, W4NH, W8ZG 1420 to 1445 GMT and W1CMF, W2BJV, W2BG, W2ACN, W5WZ, W6UF 1530 to 1650 GMT; Dec. 23, weather clear, mild, north wind, slight ground fog, fading and conditions bad, few stations audible. Logged W1CMF, W2BC, W2BJV, W2JN, W8ZG 1350 to 1440 GMT. No stations heard 1600 to 1700 GMT; Dec. 24, weather overcast with drizzle. W2JN heard at 1440 GMT; Dec. 25, slightly cloudy, ground fog, fading bad, W2JN heard 1430 GMT and W8ZG at 1550 GMT. Dec. 30, cold, foggy and damp, few stations audible, fading bad, 1355 to 1455 GMT W2JN, W2AYR, W2RVG, W4NH heard, 1600 to 1630 nil." (These reports of stations heard across the water on 28 m.c. remind us in some respects of those first, early, transatlantic tests just when we were getting to know 3000 kc. or 100-meters. We hope this log will give some of the 28 m.c. gang the same thrill it gives us in preparing copy as we think about it! The growing number of stations being heard everywhere on 28 m.c. is mighty encouraging. Let's make increasing use of this band which is one of our largest from the standpoint of kilocycle width. — F.E.H.)

The XC Relay Chain is now going full blast. Starting at Pittsfield, Mass., with W1BKJ, it runs through W8DSP, W8JA, W9DLD, W9EJQ, W9DKM, and W6CPC at Pasadena, Calif. Fine work!

W3BNU kept a nightly schedule during late January with a ship bound for Rio and signing XC7Z.



# High Grade Stations—1929

## Signals

**E**ACH month Section Managers and Route Managers report the outstanding stations which they consider the "best" ones operating in each band.

Really good signals with the requisite sharpness, steadiness, and clarity of tone which constitute our present-day standards of perfection are not too numerous if we may judge from all reports. To "make" our list it is necessary that the signals be heard *several different times* and if possible reported from *more than one source* as proof of the consistency of the station and its regular use of a good signal. Of course stations with perfectly good signals must do a certain amount of operating to be heard and reported. Our list thus credits both *outstandingly good* signals and consistency or reliability. No stations with choppers or uncalled for broadness can qualify, and the attention of observers has been called to this fact so that even the prettiest of signals will not be reported if guilty of being broad and inconsiderate of others.

Stations listed in our reports consistently month after month should be well satisfied with their performance and of good reason. Our column will grow, too, especially if you help your SCM and RM in deciding on their recommendations to *QST* by submitting small lists of the *outstandingly good* signals and reliable consistent operators that you hear. Other stations not in our present list will no doubt be able to qualify shortly. Separate reports from each Section in the U. S. A. and Canada will place more emphasis on good station PERFORMANCE . . . less emphasis on a small DX record accomplished perhaps with brute power and wobbly signals. Since our reports will come from all over the country they are equally fair to all station owners. This month we are changing our lists to identify the Section from which the stations were reported, thus giving the stations listed and idea of where they have been heard consistently. The future of our column depends both on your cooperation in submitting accurate reports and on our new space requirements for this portion of *QST*. Comments on how you would prefer to see the reports modified to do the greatest good would be appreciated. Separate lists should be turned in for each different amateur band. Detailed lists from different Sections follow:

SAN FRANCISCO: (7000 kc.) W1AXX, W1MK, W6CZM, W6DPF, W6UF.  
 WESTERN PENNA.: (3500 kc.) W1MK, W2AG, W3HL, W8ARX, W8CMP, W9CLO, W9CYQ, W9DSC, W9DXZ.  
 EAST BAY: (7000 kc.) W9AZR.  
 ILLINOIS: (7000 kc.) W8CAU, W9BJL, W9FQ, W5FB.  
 WISCONSIN: (3500 kc.) W1MK, W8CAU, W8ZZ, W9CYQ, W9DLQ. (7000 kc.) W1RBZ, W2BIF, W3QL, W4SP, W8CBC. (14,000 kc.) W1BSM.

SOUTHERN NEW JERSEY: (Outstanding signals)  
 W1MK, W8ARX, W2AG, W3ZF, W1CGR, W8AHC, W1ACH, W8XE, W3BWJ. (Well operated stations)  
 W3ARC, W8CTQ, W1MK, W1BG, W1ATJ, W1PE, W1ACH, W2BME, W2AG, W3AKB, W3AFF, W3ZF, W8ARX, W8AHC.  
 SOUTHERN MINN.: W9EGU, W9COS.  
 SAN DIEGO: W3ZF, W8BAS, W8DAQ, W9DXZ, W6EAF, W6EJQ.

LOUISIANA: W5RD, W5EB.  
 ARIZONA: (Really outstanding) VE5CJ, W5AHL, W6UF. (Other line signals) W1SZ, W5AYL, W5JA, W5ZA, W6AGR, W6ASM, W6BCS, W6BVS, W6BVX, W6BYS, W6CJP, W6DGY, W6HS, W6KD, W7AAT, W9BPM, W9BPQ, W9ZD, XC5.

MICHIGAN: (Rated in order in each band) 3500 kc.: W9DXZ, W8AKV, W9DLD, W8ARX, W2AG, W1MK, W8XE, W8CAU, W8BGY, W8DSF, W9ASX, W8BRD, W9BPW, W8CEP, 7000 kc.: W2UK, W2BRB, W9CRD, W9DXL, W9FDJ, W9ACO, W9FBX, W9FZQ, W9EHN, W8BRD, W9BMZ, W9EPQ, W8CNU, W8CAU, 14,000 kc.: W2BOA, W2AQL, W2AUN, W2ACN, W2CUZ, W2AG, W3BQV, W6DZD, W2ADL, W3AHH, W9DEF, W8BV.  
 COLORADO: W9DGW.

W8DII drops us a line to say that he thinks the new abbreviation, MK, which was described in February *QST*, is FB. Are YOU using it in traffic work? If not, OM, better look on page II of the C. D. section of *QST* for February.

### BRASS POUNDERS' LEAGUE

Call	Orig.	Del.	Rel.	Total
K1HR	390	346	478	1214
W6EOF	161	169	561	891
W6EEO	62	185	506	753
W6CGM	5	6	736	745
W6SR	5	54	673	732
W3ZF	70	114	536	720
W9ELX	95	51	494	641
W1MK	78	134	377	589
W9EGU	21	13	470	504
W9DXZ	29	112	357	498
W9DLD	17	49	376	442
W1CO	14	21	404	439
W8DED	99	23	306	433
W6AJM	31	13	386	430
W5AOY	221	31	142	394
W6AD	68	161	161	390
W1CGX	40	15	330	385
W8DYH	77	104	202	383
W9EJQ	31	38	310	379
W6AKW	13	11	350	374
W9ER	139	36	181	356
W9EKW	77	43	221	341
W5OM	18	24	282	324
W6UJ	72	131	116	319
W6ALX	12	15	282	309
W6BO	15	8	276	299
W8CNO	41	20	220	287
W6BZR	7	23	252	282
W6ZBJ	7	262	6	275
W6DWI	12	16	240	268
W9FLG	54	52	151	257
W8RN	46	37	172	255
W5EP	65	17	160	242
W1ATJ	13	32	190	235
W9CET	59	48	127	234
W3GT	37	146	42	225
W9DGW	6	7	211	224
W5WF	49	43	120	220
W1LM	27	26	166	219
W8ACZ	13	2	192	217
W1ACH	56	58	97	211
W8CUG	3	14	187	204
W9ARX	59	31	114	204
W9COS	60	86	32	178
W3ANS	10	147	17	174
W3AKB	8	144	20	172
W8BCM	22	63	64	159
W6CZO	33	68	28	129
W8OA	70	55	4	129
W6CZO	33	68	28	129
W8DSP	34	51	42	127
W3BWT	15	59	51	125
W3ALF	20	66	38	124
W6RJ	48	51	22	121
W8CWO	22	89	6	117
W6BYZ	37	74	6	117
VE2AC	27	64	8	109
W8CFR	41	53	4	98
W8CWF	12	66	2	80
W8DHT	14	52	10	76

A large number of reliable routes are in operation, and because of this fact an increasingly large amount of traffic, even from distant points is being successfully relayed to destination, saving the delays and trouble incidental to mail deliveries in the past.

The several amateur stations responsible for the best traffic work — the ones that are "setting the pace" in worthwhile traffic handling — are listed right up near the top of our B.P.L., the figures giving the exact standing of each station accurately.

All these stations appearing in the Brass Pounders' League are noted for their consistent schedule-keeping and dependable message-handling work in amateur radio. Special credit should be given to the following stations (in the order listed) responsible for over one hundred deliveries in the message month: K1HR, W6ZBJ, W6EEO, W6EOF, W6AD, W3ANS, W3GT, W3AKB, W1MK, W6UJ, W3ZF, W9DXZ, W8DYH. Deliveries count! A total of 200 or more bona fide messages handled and counted in accordance with A.R.R.L. practice, or just 50 or more deliveries will put you in line for a place in the B.P.L. Why not make more schedules with the reliable stations you hear and take steps to handle the traffic that will qualify you for B.P.L. membership also!

The Golden Gate Relay Chain is a budding W3ZF stunt. The stations now in the system include W9BOB, W1SJ, W8BEN, W9ACU, W9DZN, W9DQN, and W9GAG. Come on, fellows, let's see you give W3ZF and his bunch some competition!!

# OFFICIAL BROADCASTING STATIONS

(Local Standard Time)

CALL	FREQUENCY (K.C.)	SCHEDULES	CALL	FREQUENCY (K.C.)	SCHEDULES
W1AJC	7110	Tues., Thurs., Sat., 6:00 p.m.	W7DD	7030	Sun., Wed., Fri., 5:00 and 11:00 p.m.
W1ANH	3970	Tues., Thurs., Sat., 7:00 p.m.; Fri., 10:20 p.m.	W7FL	7142.8	Mon., Wed., Fri., 7:00 p.m.
W1ANI	3600	Mon., Tues., Wed., Fri., 7:00 p.m.	W7FL	3571.4	Tues., Thurs., 12 midnight
W1AQL	3750	Mon., Wed., Fri., 7:00 p.m.	W7FI	14,285.7	Sun., 2:30 p.m.
W1ATJ	3950	Mon., Wed., Fri., 6:30 p.m.	W7HP	-	Sun., Tues., Fri., 12 noon
W1ATR	3980	Sun., Tues., Fri., 7:30 p.m.	W7IZ	7300	Sun. and Thurs., 9:00 p.m.
W1BEP	3500	Mon., Wed., Fri., 6:45 and 10:30 p.m.	W8AGQ	7260	Sun., 1:00 p.m.
W1CDX	7300	Sat., 4:00 p.m.			Daily except Sat. and Sun., 11:30 a.m. and every two weeks on Fri.
W1CDX	3600	Tues., Thurs., Sat., 7:15 p.m.	W8AHK	7200	Wed., Sat., 7:00 p.m.
W2AXT	7265	Mon., Tues., Thurs., 6:45 p.m.	W8AVK	3714	Sun., Tues., Thurs., Sat., 7:00 p.m.; also Sat. and Sun., 1:00 p.m., 14 m.e.
W2AXT	3562	Sun., 10:00 a.m.; Fri., 6:45 p.m.	W8RMJ	3665	Sun., Mon., Thurs., 10:30 p.m.
W2BBS	14,000	Sun., 10:00 a.m.	W8BWP	7170	Daily except Wed., 5:30 p.m.
W2PT	3876	Mon., 10:30 p.m.	W8CEO	3725	Mon., Wed., Fri., 7:00 p.m.
W2PR	14,285	Sun., Wed., 12 noon; Mon., Fri., 7:00 p.m.	W8CMB	3820	Mon., Tues., Wed., Thurs., Sat., 7:00 p.m.
W2ZA	7140	Sun., Thurs., 1:00 a.m.	W8CNT	7200	Daily except Sat. and Sun., 7:15 a.m.
W3ARC	3900	Mon., Wed., Fri., 7:30 p.m.	W8CNZ	7275	Mon., Wed., Fri., 9:00 p.m.
W3BWJ	3845	Sun., Tues., Thurs., 10:30 p.m.; daily at 7:00 p.m.	W8DED	3798	Sun., 6:00 p.m.; Tues., Thurs., 8:00 p.m.
W3CFG	3885	Daily at 6:45 p.m. and 10:00 p.m., and alternately every two weeks at 1:00 a.m.	W8DME	3965	Mon., Fri., 7:00 p.m.
W3SJ	7228	Daily at 7:00 p.m.	W8GI	3615	Tues., Thurs., Sat., 7:00 p.m.
W4AHR	7050	Sun., 8:00 a.m.; Wed., 7:00 p.m.	W8PT	7058	Mon., Wed., Fri., Sat., 5:30 p.m.
W4MS	7300	Sun., Sat., 12 noon; Mon., Wed., Fri., 5:00 p.m.	W9AGL	3770	Tues., Thurs., 7:00 p.m.
W4OO	3614	Mon., Wed., 6:30 p.m.	W9BAN	7175	Mon., Wed., Fri., 11:30 p.m.
W4RN	7250	Fri., Sat., 10:45 p.m.; daily at 6:00 p.m.	W9BEU	7142	Daily at 9:00 p.m.
W5AZD	7200	Mon., 12 noon and 10:00 p.m.; Thurs., 12 noon; Fri., 7:00 and 10:00 p.m.	W9BEU	3580	Daily at 9:30 p.m.
W5ABK	7300	Daily except Saturday and Sunday	W9BHF	3740	Sun., 8:30 p.m.
W6AMI	7228	Tues., Thurs., 7:00 p.m.	W9BHF	7228	Thurs., 8:30 p.m.
W6ASMI	7190	Mon., Wed., Fri., 7:00 p.m.	W9BHF	14,635	Tues., 8:30 p.m.
W6AXE	7081	Mon., Tues., Thurs., 10:00 and 11:30 p.m.; Wed., Fri., 11:30 p.m.	W9BJA	3660	Sun., 7:30 p.m.; Mon., Wed., Sat., 8:00 p.m.
W6BJX	7143	Mon., Thurs., 7:00 p.m.	W9BJA	7140	Mon., Thurs., Sat., 3:30 p.m.
W6RRO	7100	Mon., Wed., Fri., 7:30 a.m.	W9BKJ	3930	Tues., Thurs., Sat., 7:00 p.m.
W6RWS	14,285	Daily except Sunday at 5:00 p.m.	W9CJQ	3820	Mon. and Fri., 7:30 p.m.
W6RSD	7300	Mon., Wed., Fri., 7:00 p.m.	W9CNL	7050	Tues., Wed., Thurs., 10:30 p.m.
W6RZR	3550	Sat., 6 p.m.	W9DAE	3610	Sat., 10:30 p.m.
W6RZR	7193	Wed., 6 p.m.	W9DBJ	7000	Tues., Fri., 6:15 p.m.
W6RZR	14,285	Mon., 6 p.m.	W9DEJ	14,000	Sun., 2:30 p.m.
K6CFQ	7120	Mon., Wed., and Fri., 5:00 p.m.	W9DHP	15,000	Mon., Wed., Sat., 7:30 a.m.
W6CLS	7160	Tues., Sat., 7:00 p.m.	W9DQN	7250	Mon., Wed., Fri., 12:30 a.m. and p.m.
W6CLS	14,355	Tues., Sat., 10:30 p.m.	W9DUD	7000, 14,000 & 1715	Sun., 10:00 a.m.; Mon., Fri., 7:00 p.m.; Tues., 7:00 a.m.
W6DHM	3500	Mon., Wed., Fri., 7:15 p.m.	W9DXZ	3560	Mon., 7:30 and 11:45 p.m.; Wed., Fri., 7:30 p.m.
W6DHR	7140	Daily except Sat. and Sun., 5:00 p.m.	W9EHN	3798	Mon., Tues., Thurs., Fri., Sat., 7:15 p.m.
W6DNV	7200	Mon., Wed., Fri., 5:00 and 7:30 p.m.	W9ERU	3895	Mon., Wed., Fri., 7:00 p.m.
W6HS-6DKK	7000	Sat., 10:30 p.m.; also several times on Sun. on 7000 and 14,000 kc.	W9KZ	7300	Sun., Tues., and Sat., 7:30 and 10:30 p.m.
W6EDK	7250	Daily except Sundays at 8:00 p.m.	W9ZD	7300	Tues., Fri., 9:05 p.m.
W6EUD	7153	Mon., Thurs., 8:00 p.m.; Tues., Wed., Fri., 6:00 p.m.; also on Sat. and Sun., 10:00 a.m. and 10:00 p.m.	WRJN	1370 (voice)	Mon., Wed., Fri., 1:00 and 7:00 p.m.
W6ZZA-6MA	7200	Wed., Thurs., 6:30 a.m.			
W7AAT	7040	Daily except Sunday, 4:30 p.m.			
W7AAW	7182	Mon., Wed., Fri., 2:30 p.m.			
W7DD	3515	Sun., Wed., 7:00 and 11:00 p.m.			

OFFICIAL AND SPECIAL BROADCASTS are sent simultaneously on 3575 kc and 7150 kc from A.R.R.L. Headquarters Station W1AMK at the following times:

8:00 p.m. Sun., Mon., Tues., Thurs., Fri  
10:00 p.m. Mon., Fri.  
12:00 p.m. (midnight) Sun., Tues., Thurs.

# DIVISIONAL REPORTS

## ATLANTIC DIVISION

**WESTERN PENNSYLVANIA** — SCM, A. W. McAuly, W8CEO — W8CUG, with 204 msgs, has the best report. Perhaps a couple of reports were lost in the mail. W8CFR is still busy with Brazilian traffic. W8GT burned out his screen-grid tubes in his "bear-cat" receiver, W8DKQ, a new ORS, is coming along fine. W8CEO is building a new "bear-cat" receiver, W8DHW is building a 56 mc transmitter. He wants a 56 mc. sked. W8AGO is building Xtal control. W8DVZ is on 14 mc. W9AQG is still busy with DX traffic. They were (80) WFBT at the South Pole and also took ten messages from S.S. *Lempira*, in dock at Puerto Cortes, Spanish Honduras. They have their 250 watter going again. W8APQ says the high C circuit is the mosquito's eye teeth. W8DKS is having transmitter trouble. Stick with 'er. OM, W8CQN is leaving Altoona and will be in the first district. W8AJU has come to life with a nice Xtal controlled transmitter. W8AYH waits an ORS. He has been reporting faithfully. W9ARC is so busy with club work that he has forgotten how the old transmitter is hooked up. W8DRF finally got his ORS certificate. It was lost in the mail. W8CMP reports seven messages handled. He claims a place at the top of the Director's BPL list. How about it, Mr. Handy? (Yep, he makes it, all right, but how about W8ZZ, W1BG and W3BZ?) W8DUT is hunting RCT. (RM. That is time well spent. W8APJ is a new call in Erie. W8BTD has had his call changed to W8VJ. W8DOB is rebuilding his transmitter, W8REN made a trip to Chicago. W8CRA was QSO ZL2BG. He is wondering if that call is "hoot-leg." The AFA is planning a big party for Doctor Woodruff and A. A. Hebert at the April meeting. A big feed will be laid and it will have all the earmarks of a little convention. They are trying to make some arrangements with the Radio Supervisor whereby they can handle complaints of interference. With its membership nearing the 100 mark, it is becoming one of the most powerful clubs in the country. Any amateur within motoring distance of Pittsburgh should join. Several official broadcast stations have been appointed and it should be easy for anyone in this section to copy at least one station any night. Anyone wanting schedules is referred to W8GI of Ellwood City.

Traffic: W8CFR 98, W8ARC 2, W8CUG 204, W8GI 70, W8DVZ 22, W8DKQ 83, W8APQ 5, W8CEO 50, W8CQN 5, W8DHW 34, W8AYH 3, W8AGO 28, W8DUT 19, W8BWA 27, W8CRA 6, W8AQG 18, W8CMP 7, W8BNR 18, W8AJU 5, W8DKS 5.

**SOUTHERN NEW JERSEY** — SCM, M. J. Lotysh, W3CFG — First place goes to W3CFG, second to W3ARC who has a very nice total and is doing consistent work. He is now an OBS and O-O. W3BWJ has a better total than usual so guess he had more spare time. He is an OBS also. W3CO is sending code practice for local hams. W3SJ is still waiting for a barge. Hope you get something good, Jim. W3KJ sends in a rejuvenated total. Hi! W3AOC suffered when the gang put W3DH back into service. W3BO apparently had little time this month. W3ATJ's dad broke his leg so Allen has to run store and won't be on much. Too bad all around, OM. W3ARR eliminated his key clicks. W3BEI can't understand why an ORS must handle traffic. The certificate isn't for wall decoration. Take notice of the new reporting date fellows and please be on deck. Keep up the good work!

Traffic: W3CFG 86, W3ARC 79, W3BWJ 39, W3CO 35, W3SJ 26, W3ARR 18, W3KJ 12, W3OH 8, W3BO 6, W3ARR 2, W3ATJ 11.

**EASTERN PENNSYLVANIA** — SCM, J. B. Morgan 2nd, W3QP — There seems to be no limit to the volume of traffic that can be handled by W3ZF. The Twentieth Century Limited route is carrying a lot of trans-continental and trans-Pacific traffic which is proving how valuable such a route can be. W8WJ has been off the air on account of sickness in his family but will be back soon. The Boys from Scranton, W8DHT, W8AWO and W8CWO are keeping their tubes hot and their keys limber, even though station-moving and rebuilding is the order of the day. W3AKB says it is her own fault that she didn't make the R.P.L. — we suspect a premature case of spring fever! Through fair means or foul W3CDS has lost the nice pile of skeds he worked so hard to get. ARO, Ob. We have four new possibilities for ORS appointment this month: W3MC, who has been recently licensed; W3ANS, who used to be the course of the Philadelphia R.C.L.'s; W3NF, who attends

Lafayette and is a well-known traffic man in the District; and lastly, W3BNF, a reformed DX hound of the most dangerous species! As we have said before and will probably say often again, *SKEDS* are the basis of operation for all ORS. Our District led the whole U. S. A. last month. Oms, and I certainly want to thank you for the good support and say "DON'T WEAKEN". Congrats!

Traffic: W3ZF 720, W3ANS 174, W3AKB 172, W8CWO 117, W8DHT 76, W3BNF 54, W8AWO 47, W3CDS 47, W3NF 28, W3QP 8, W3MC 2, W8WJ 0.

**MARYLAND-DELAWARE-DISTRICT OF COLUMBIA** — SCM, H. H. Layton, W3AIS — I wish to take this opportunity to congratulate the men of this Section for the splendid work they did during the Governor's President Relay. I knew you could do it. EB, OM's. Maryland: W3TR will be off the air until April first as he is very busy studying for a Commission in the Navy. W3APX is well located and going strong on weekends. W3RC is also studying for promotion. W3AEI had the misfortune of blowing two tubes. His call has been changed to W3NH.

Delaware: W3ALQ is working phone and CW on 3530 kc, W3WJ has moved to Lyndalia where USNR headquarters is located. W3AJH blew his 50 watter. W3AIS manages to get one night a week in for brass pounding.

District of Col.: W3ASO will be re-instated as ORS. W3ALF seems to have no trouble in moving traffic. Skeds do the trick. W3GT reports all traffic comes from P. I. and yacht W8BS and China. Will take anything for the far east, delivery same day. FB. W3BWT has 7240 kc, set working again. Getting same results as previously. Putting in large tube rectifier in auxiliary to mercury arc.

Traffic: Md. W3APX 134, W3MH 11. Del.: W3ALQ 5, W3WJ 1, W3AJH 8, W3AIS 6. D. C.: W3ASO 17, W3ALF 124, W3GT 225, W3BWT 125.

**WESTERN NEW YORK** — SCM, C. S. Taylor, W8PJ — Due to speeding up printing at Headquarters, hams in Western New York will get their reports in to the SCM not later than the 15th of each month hereafter. By doing so, your copy of *QST* will go to you a week or so earlier each month. All ORS holding certificates with E. B. Duvall's signature, kindly return same to SCM for replacement as the re-numbering of Western N. Y. must be changed. All stations holding ORS and not active, kindly return same for cancellation. There are about 80 ORS in this district and 40 of them are actually working wonders in traffic, DX, etc. Spring housecleaning time has come so check yourself on the ORS. Get after more traffic and make Western N. Y. what it should be.

W8AHC is working hard to push things through. W8ALL has been working Ireland and Porto Rico. W8AK is a new ham with ambitions. W8AKZ works New Zealand, South America, etc. W8ALX makes the BPL in traffic. W8AVR and W8AOT are now WACO bird men but their sets are still going strong. W8AVR has Pilot license now. W8AVS is getting more traffic through. W8BBP puts over banquet of Mohawk Valley Brass Pounders' League in great style. W8HCM makes the BPL again this month. W8BFF has two transmitters in operation. W8BGN is now back in operation after a long silence. W8BJO blew up his power supply. W8BUP is handling traffic now. W8FC is back with us again. W8CMW wants to know what is the matter with the Buffalo, N. Y. stations. W8AYB, W8ADE, W8QB, W8CPC, W8CHG, W8TH are active. W8PJ is on when possible. W8CPC is handling more traffic. W8CSW has a fine schedule report and good traffic this month. W8CVJ has done some fine DX with his UX-210. W8CYG has a whale of a traffic total this month, and has many schedules. W8DDL has a 7½ watt fone set going. W8DHI has a fine traffic total. W8DME states that the Finger Lakes Radio Society will hold the next New York Convention at Auburn, Aug. 9, 10 and 11. He has been busy with schedules and shows a good traffic report. W8DNE has a little traffic report this month compared to his past efforts. W8DQP keeps a schedule with W2ANV, getting check on weather conditions, reporting it to local weather man who informs air mail service fliers every morning. W8DSP bumps into the BPL again with a good total. W8OA has several schedules and makes the BPL.

Traffic: W8AHC 27, W8ALL 4, W8AK 6, W8AKZ 4, W8ARX 108, W8AVS 17, W8BBP 32, W8BCM 159, W8BFG 4, W8BGN 7, W8BUP 6, W8CFV 15, W8CMW

17. W8PCO 54, W8QWV 62, W8CJV 33, W8CYJ 14, W8DDL 65, W8DII 80, W8DME 34, W8DNE 11, W8DQP 45, W8DSP 127, W8QA 129.

CENTRAL DIVISION

ILLINOIS — SCM, F. J. Hinds, W9APY — W9EZQ has a new 852 and is looking for a mercury arc tube. W9AD likes crystal 3500 kc. traffic work. W9BRX sez the mercury arc is working nicely and it the best type of rectifier yet. W9AP works traffic in all directions without schedules. FB, OM. W9BLI wants our state to pick up in traffic. (So do we all, OT.) W9AYB is operating at W9CAR. W9CUB is rebuilding for ALL waves. W9KA is knocking off some DX along with his traffic. W9CZL, W9FI and W9FCW are looking for good schedules. W9FI is using rectobulbs and is breaking in a new ham. W9FDY is back with us again with a fifty. W9DJ is going out for lone work. W9AWX is now using a 50 with 500 volts. W9FDJ is QSA 5 with BCL'S. Hi, Worked WXM 700 miles East of Newfoundland. W9FJO is getting some of the new 866 rectifiers. Reports DX with Australia best yet. W9GJ heard only three amateurs outside the band last month — very good work, gang. W9EFG is now rebuilt with an 852 and is getting some 866 tubes. W9CNY is planning some 1750 kc. phone work. W9EAJ tried 14,000 kc. for the first time (his month — likes it so well, he is quitting 7000 and 3500. W9AVL is making up a 100 watt phone set for 1750 kc. FB, OM. A new Scotch coil receiver has just been completed by W9AFX. (Hw?) W9FWX is trying to get out on 14 mc. W9FMR is moving QRA's. Our high traffic man this month is W9DZX who is Route Manager of Illinois. Congrats, OM. W9BLE has a new MOPA with perfect performance. FB. The new screen-grid receiver at W9BZO is burning out tubes as fast as they are put in. Hi, Something wrong, OT. W9EYA pushes out with his Hartley on 7000 kc. W9AHL of Cicero has a new MOPA. W9CKZ was forced to lag a bit in traffic while rebuilding the outfit. Will be on with a bang shortly. W9ERU has many reliable schedules. This is what we all need to get the traffic running smoothly. W9FFQ tried 14 mc. and likes it. Hi, W9BOL has a low power 250 working. W9DSS works once in a while and we hope to have him pounding steadily soon. W9ERU installed a transmitter in the Shrine Temple at Rockford and handled big totals of traffic for a Boy Scout Merit Badge Exposition. Great work, OT. He had troubles but worked a number of good QSO's.

Traffic: W9DXZ 498, W9ERU 356, W9BZO 153, W9RXB 105, W9BLL 95, W9EJO 74. W9GI 63, W9AD 58, W9APY 58, W9FCW 54, W9EQZ 48. W9BLE 39, W9AP 37, W9EAJ 33, W9CKZ 32, W9CZL 32, W9BSB 24, W9AFX 20, W9DKK 20, W9AHL 18, W9EFG 16, W9FDJ 15, W9FI 14, W9FO 13, W9FDQ 12, W9ME 12, W9ACU 11, W9BRX 11, W9CUB 11, W9DOX 11, W9KB 10, W9AVL 8, W9ATK 6, W9KA 6, W9CNY 5, W9EYA 5, W9FWX 5, W9FDY 4, W9DJ 3, W9NV 1.

INDIANA — SCM, D. J. Angus, W9CYQ — W9EKW handled a fine bunch of messages. W9EXW is working for an ORS and handling plenty of traffic. W9FBV inactive until his attic gets warmer. W9DBJ putting in crystal control. W9BZZ has moved to another location in Richmond but will be going soon. W9BKJ is putting in a couple of 866s as soon as his plate transformer is finished. W9EF sez that dx conditions are getting better as he worked 5 continents consecutively. W9ELX has the high traffic mark for the state of Indiana and is hoping to improve even this month's traffic. W9FQ is beginning to run his traffic totals up. He has moved to Dodge's telegraph school and is now known as W9RW. W9EPB is our first report from Elkhart for a long time. W9AJH is a new station at South Bend. W9AIN, our former traffic record-breaker, is still off the air due to work. Hopes to be going again soon, though. W9FRR and W9FRB are two new stations at Bloomfield. W9FYB is on with a 7½ watt at Bloomington again. W9GIO is a new station at Muncie. The Bloomington High School has a code class of 22 going big. The Indianapolis Radio Club and W9CUD are assisting the Police Department install a transmitter and receivers in squad wagons for emergency calling purposes. Club carrying a full program now.

Traffic: W9ELX 641, W9ASX 204, W9DSC 52, W9GBF 25, W9EF 52, W9BKJ 42, W9BZZ 4, W9CLO 11, W9EMR 5, W9CFO 17, W9DBJ 10, W9FCG 14, W9FXW 22, W9FI 113, W9CYQ 17, W9EKW 341.

KENTUCKY — SCM, J. B. Wathen, 111, W9BAZ — Whoopee! W9OX gets first round in the "Fight for the Pint." He craves red likker. W9JL whose total was split, came a close second. U of K has promised them a 1000

watter. All aboard for Mars! W9BGA received another country to his string. W9EYW's screen-grid receiver is the berries. Page Mr. Hull. W9CEE reports via W. H. That's real spirit. Thanks, OM. W9ENR has a DX list for February like the roll-call of the League of Nations. W9ETD has a new receiver and promises to lead the B.P. next month. GA, OM. Won't hurt my feelings. W9AID ports another tone. The BCL's get a big kick out of it. And how! W9EZY is promoting a KY. network for his traffic. Good idea. W9BXK works A. A. on the side. W9DDH blew everything in sight and still turned in a nice total. Can't keep a good man down. W9FKM is adding screen-grid tube to his receiver. W9CKT has applied for an ORS tag. Welcome to our midst. W9BWJ is rebuilding entirely. W9BAZ sez they ought to put overalls on the gridsleaks. W9BAZ took a trip to see some of the gang, but couldn't find them. Too many YL's. Who is going to take the lead next month? Don't let W9OX get it so easily. He who hesitates is long gone.

Traffic: W9JL 117, W9OX 75, W9DDH 44, W9EYW 29, W9BAN 28, W9EZY 28, W9BXK 23, W9BAZ 17, W9BGA 17, W9ENR 14, W9ETD 14, W9AID 5, W9ARI 5, W9FKM 5.

MICHIGAN — SCM, Dallas Wise, W8CEP — W9RTQ will be on with a new transmitter using a 75 watt. W8BRN says he will be up on 3500 kc. soon. W8DSE reports for the first time since 1925. Glad to have you back on the job again, OM. W8JD a newcomer in Lincoln Park reports for the first time. W8BAX burned up his transmitter but is on again with a 210 and AC. W8AAH has several schedules and is making things hum up in Traverse City. W8ACB is rebuilding the outfit while waiting for another 210 to grow up. W8CU has been playing with a "push-pull" transmitter. W8ZF is having trouble getting enough "ops" to run the station. W8DCW has been experimenting with low power outfit. W8AUB passed the Amateur Extra First exam O. K. and also reports several of the fellows in Grand Rapids have new tickets due to the RI's visit. W8CAT is building a new transmitter for 3500 kc. band. W8CKZ can't keep track of his report cards but gets there just the same. W8DSE was QSO quite a few of the fellows on QSO party night. W8BV has been doing some good DX work lately and hopes to have an 852 soon. W8AAF wants to know where the next Michigan Ham Convention is going to be held. What do you say fellows? W8DED is keeping a regular flock of schedules and his traffic totals sure show it. W8UYH and W8DED have the Michigan Express Route working in fine shape and traffic sure moves when it hits Southern Michigan. W8CVN. W8AHM, W8CGM, W8DPS, W8DVC, W8AJG reported via radio thru W8DED and W8DYH.

Traffic: W9CE 13, W9RTQ 32, W8BRN 9, W8DSE 75, W8CFM 15, W8JD 5, W8BAX 13, W8AAH 14, W8CU 2, W8ZF 13, W8DCW 1, W8AUB 14, W8CAT 8, W8CKZ 12, W8DSE 62, W8BV 7, W8AAF 7, W8DED 43, W8DYH 38, W8CVN 1, W8AHM 7, W8CGM 14, W8DPS 21, W8DVC 16, W8AJG 39, W8CEP 14.

WISCONSIN — SCM, Clarence N. Crapo, W9VD — W9DLI reports a total of 442 which is higher than last month due to splendid cooperation and lots of hard work. W9DLI keeps things humming with schedules on both 7000 and 3500 kc. W9EBO reports plenty of activity at his station. W9BPW going good with low power and sends code drill every Sunday at 1 PM on 80. W9DEK keeping three schedules and will have Xtal going soon. W9DTK says his new shield grid-receiver going fine. W9FHU reports plenty of activity at Mosinee, mostly shoveling snow. W9DND building push pull TPTG with Rectobulbs and 20V211s. W9BZW says traffic kind of scarce up in Darlington. W9DJK reported via radio. W9DVI has been off the air several days this month and has arranged one more schedule. W9ESM working tone successfully on 85 meters. W9LV not on the air regularly. W9EEF thinks are about dead as ever at Racine. W9EZF has been on the air only a few days. W9BQO too busy reading meters at the local electric plant. W9VD handling a few more msgs and new CC panel nearly finished. W9ARE says his 204A going strong and worked Japan this month. W9OT is doing nicely and has nothing to kick about. W9SO operating mostly on 80 at present, sez last month's report was made out but mislaid. W9AZN reports that the Lacrosse Club going fine and getting good publicity for the Amateurs.

Traffic: W9DLI 442, W9DLQ 110, W9EBO 87, W9BPW 92, W9DEK 67, W9DTK 44, W9FHU 43, W9DND 27, W9BZW 20, W9DJK 18, W9CVI 15, W9ESM 12, W9LV 11, W9EEF 7, W9EZF 4, W9BQO 3, W9VD 24, W9ARE 106, W9OT 26, W9SO 15, W9AZN 1.

OHIO — SCM, H. C. Storck, W8BYN — The SCM has been threatening dire results for non-report and non-support for some time, and the ax has fallen. Thirty cancellations go into effect immediately, for the good of OHIO and the League. Our percentage should go up at once, and if you faithful ones keep doing your bit, OHIO will soon be up with the rest again. It is the SCM's ambition to have more reporting traffic than there are ORS. Dead timber was cut down ruthlessly and you who suffered have no one to get sore at and blame except yourselves. By the time you see this in print, you will have been notified as to the plan, new plan, of reporting. Remember that the new reporting date is the 16th of each month. The SCM has followed a policy of waiting until the last moment for late reports, and including them, but late reports will not be tolerated any more, and you will know where to kick if your report, no matter how good, doesn't get into QST.

The reports this month were very good as a whole. The only two made the BPL. Don't know what on earth happened to W8JA lately, and he even failed to report up to the present time. W8CNO leads Ohio this time with 287, which is certainly F's and makes her dream come true. She complains that it's harder to get a message into Cleveland than to fly to the moon. Wish this fellow, W8RN, could stay with us always. When he's home, the fur flies — WHEN HE IS HOME! He turns in 255 this month, and in the next breath tells that he is leaving for Chicago, to take up electrical engineering. Good luck, OM. The SCM has had a little more rum on the air, with W8DDK to help, and takes third prize this month for a change. W8BBR says he is going to quit kicking about conditions in Ciney as it's no use. A good ORS hampered by QRM. It's a shame, W8CRI comes next with 73 and tells us that he will be on with crystal on 3750 and 3530 KC soon. W8CQU turns in a fine total but is in too big a hurry to tell anything else. W8BA has been away from home but turns in a good report for the time he was at the set. W8FDQ has a new operator in Paul Wilkinson as Dave Weisberg is now W8OHL. W8CSS just got married, fellows. W8APB sends in a nice report. W8CWC still sings at WOWO. W8BOR is using two 852x on 7000. W8CMB turns in a good report, and says he is too QRL work to get on much. W8DIE divides his time between his own station and W8DDQ and gets along nicely. W8DDF says the street cars in Ciney are tuned to 3500. W8DSY is working with a crystal transmitter and will have it on the air soon. W8AYO relayed one message direct from New Zealand to Boston. W8DJG just got on the air and worked three new countries the first night. W8DIA is leaving us until the latter part of June. W8CCS will have another 852 soon. W8GZ is still plugging away at 28 meg. W8DJV finally worked Asia. W8AKW is thinking of building a phone set with an 852. W8DHS is still building per 1929. W8OQ has nothing to say. W8BKM announces the arrival of a boy junior op. Congrats OM. W8CNU is still working his set over. W8LI is wanting schedules on 7000 kc. W8PL is putting a station in at his place of business. W8DDK is not on the air weekends. W8DPF expects to be on the air by early summer. W8CFL is very QRL school. W8BBI has moved and is putting up his station again. W8ADH has lost that call and is now W8AJC. W8AMI has been blowing tubes. W8BAU has been rebuilding.

Traffic: W8CNO 287, W8RN 255, W8BYN 114, W8BBR 92, W8CRI 73, W8CQU 60, W8BAC 56, W8DHI 53, W8CSS 53, W8APB 52, W8CWC 49, W8BOR 48, W8CMB 47, W8DDQ 30, W8DDF 15, W8DSY 12, W8AYO 11, W8DJG 9, W8DIA 8, W8CCS 8, W8GZ 8, W8DJV 7, W8AOW 7, W8DHS 5, W8OQ 4, W8BKM 4, W8CNU 3, W8LI 2, W8PL 2, W8DDK 1, W8DPF, W8CFL, W8BBH, W8BEK, W8ADH, W8AMI, W8BAU, reported but no traffic.

#### DAKOTA DIVISION

**S**OUTH Dakota — SCM, Dwight M. Pasek, W9DGR — A good number of stations reported this month, but the traffic was very light. Come on, gang! Pep up a bit and handle that traffic that's going over or around us — we know it's there; and then make some yourselves. W9DWN our RM and "the traffic man" has been off because of the loss of an antenna and the cold wx kept him from getting another up. However, he will be on the air before you read this. W9DB is still working on 30 mc, and with a renewed license will also be on the "high" waves. W9EUI is getting back after his transformer blowout with a new receiver and two new 1929 transmitters (maybe some of the

rest of us better blow our transformers — hi). W9ID spends his spare time lining up the Boy Scouts "in the way they should go" in ham radio, and also operates on 3500. W9EJ is increasing power to a 210 and is on 7000 now. W9DNS is trying hard to keep some skeds with W6BCS (ex9DES). W9FBB is using a 210 in Split Colpitts and is getting very good reports. W9DIY reports a new monitor and an xtal on 3500. W9FKV is buying out W9ETR and expects to have an even better sig on 14,000, 7000 and 3500 kc.

Traffic: W9DGR 21, W9DNS 13, W9DB 11, W9FKV 2. SOUTHERN MINNESOTA — SCM, J. C. Pehoushek, W9EFK — Under the circumstances this report must be in the air mail in less than an hour so I know you fellows will excuse the brevity. One thing only, any ORS who has not reported for three months previous to the time you receive this QST will be cancelled without notice. W9COS leads the section as usual and I would like to see some station TRY and catch him, W9ERT handled a little P. I. traffic. W9BTW says he handled some but school work suffered. W9DLA says 3500 has traffic from every sig. W9AIR finds noon on 7000 with most Minnesota stations on the air making for fine contact. Also reports W9GEL a new ham at Montevideo. W9HHZ finds things OK as usual. W9FCD is still getting crystal reports without one. W9EFK blew the 50 and can't possibly see another in the future. W9DWG has high power now, 300 volts B's on 210 and worked NN and NJ. W9DMA likes 7000 too much so says guess he can stand the QRM if the rest can. W9DBC likes 14,000 but guess the YLs won't allow him to op. W9FYL finds BCL QRM troublesome in his apartment. W9CIX and W9DBW report school QRM very heavy.

Traffic: W9COS 178, W9ERT 51, W9BTW 30, W9ELA 16, W9AIR 21, W9ERT 18, W9BHZ 14, W9FCD 13, W9EFK 12, W9DMA 4, W9DWG 7, W9DBC 3, W9EYL 2. NORTHERN MINNESOTA — SMC, C. L. Jabs, W9BVH — As usual W9EGU stands well in front this month. He turns in a traffic total that is a record for this section and in so doing, wins the crystal oscillator prize without competition. A few daily schedules did it. His WFBT as well as his W6EEO schedule in the P. I. traffic chain, are still going. Cy reports a new 860 and rectobulbs and plans transmitters on 3500 and 14,000 kc. W9EJN is using a 250 watt and a 201A with B eliminator for plate supply. W9CTW called on the SCM and got some dope on crystal control and reports it FB now. W9ERB has a new 852 and will have a couple of 866's soon. W9EHO ground a crystal and says his station will be crystal-controlled from now on. W9BVH is on whenever time and power leaks permit. A shield grid receiver is still in the making. He stopped in and saw W9CTW's station while returning from western Minn., but missed the operator. W9BCT is still QRL hockey and basketball and is trying to locate a Chicago station that can keep a schedule during the day to furnish weather reports to the Universal Airlines. W9EGF is on regularly but finds very little traffic. W9CKI works on 14,000 kc, and also tried 28 and 56 mc, so his message total is low. W9CPO is QRL on mail route so only pounds brass Sundays. W9EHI has gone in for DX on 14 mc, and reports competition from W9DOQ and W9CKI. W9BMR will be back on the air soon. W9ALD is still off due to a blown tube. W9FFU is planning on joining the Army Net now being organized. W9AKM is too busy with BCL sets to be on the air. This report is made a few days early due to change in printing date of QST (see March QST) and all those sending in their reports later than the 26th are too late for the SCM's report. Let's hear from you all promptly on the 16th, hereafter, OMs. A number of ORS were cancelled during the month, leaving room for active stations. Those stations desiring ORS are requested to get in touch with the SCM.

Traffic: W9EGU 504, W9EGN 86, W9CTW 80, W9ERB 55, W9EHO 26, W9BVH 22, W9BCT 9, W9EGF 9, W9CKI 9, W9CPO 9, W9EHI 2.

NORTH DAKOTA — SCM, Bert S. Warner, W9DYV — W9RVP leads this month with a nice total of traffic. W9FCA handles traffic on 1800 kc, but has nothing to report. W9DYA also uses 1800 kc, band to handle traffic on. W9CDO says he is going to have a fifty watt fone going soon. W9DEL is organizing a radio club at the North Dakota state college and says that it will have two transmitters, one on 1800 kc, fone and one on 7000 kc. CW. W9IK is using a three phase rectifier with 750 on each phase.

Traffic: W9RVF 88, W9FCA 11, W9DYA 5, W9CDO 5.

DELTA DIVISION

**MISSISSIPPI**—SCM, J. W. Gullett, W5AKP. There is lots of amateur activity all over the state at this time as some of the old timers are back and we also have some new operators on the air now. It sounds almost like old times. We are glad to welcome everybody and I am going to do my best to make real stations out of all and see that they report every month without fail. I am betting on you, gang. W5QQ of Columbus reports that he is starting over again as he has finished school and is home for good. He reports that he has been handling lots of traffic lately and has applied for an ORS certificate. He is using a UX-250 on 7000 kc. and says that the messages are coming through faster and faster. He is going to build two more transmitters, one for 14 mc. and one for 3500 kc. W5ANR is a new station in Columbus on 7000 kc. using a crystal controlled transmitter. Welcome to our midst. OM, W5AJJ reports that he is still QSO Cuba and says that if any of the gang has messages going that way to let him have them for reliable handling and delivery. He is on 7150 kc. and turns in a nice bunch of messages handled. That's FB. OM, W5AYZ is a new station at Jackson, Miss. We are glad to have you with us, OM, W5FQ is having trouble with his transmitter as his tube wants to quit work right in the middle of a conversation but the SCM has been called in on this case and hopes to have the transmitter going again real soon as these UV-204 tubes are too expensive to throw away until they have drawn their last breath and have hit the long trail for good. W5LY of Drew, Miss., has his transmitter on 1715 kc. and has worked 70 stations since December 16, 1928, with good DX. He has a schedule with W5AAD of Mt. Enterprise, Tex., daily. FB, OM, go to it. W5BBX of Booneville has his transmitter going on 7000 kc. after a lot of trouble with it. Booneville will have two more active amateur stations in the near future and we are glad to see them going on the air, too. W5BDE of Meridian is working zobs of stations on the 7000 kc. band using an indoor antenna and counterpoise and has no trouble working all U. S. districts at will. He gets very strong, steady reports from all stations worked and promises to be a real message handling station. W5AYB is back on the air with us using a UX-852 on 7000 kc. and will be a real traffic handler judging from his past record in this state.

W5AKP has just finished putting up a 7000 kc. antenna and counterpoise and now his receiver refuses to work on the 7000 kc. band after so long a sojourn on the 14,000 kc. band. Hi. But that will be remedied as he is rebuilding same so as to be ready for the GP relay on March 3 and 4. He reports working a few foreign commercial stations on the 14 mc. band within the last two weeks. Gang, look for him on 7000 kc. from now on.

Traffic: W5AJJ 60, W5FQ 30, W5BDE 7, W5AKP 92. **LOUISIANA**—SCM, M. M. Hill, W5EB—Bang! the newly appointed ORS W5WF leads the gang with a total of 220 messages and makes the BPL, FB, OM. How about some more fellows making a few reliable schedules and do the same? W5AYZ and W5ANA have applied for ORS. W5RD reports reception of 28 mc. sigs with minimum QRN except from Fords. Hi! W5BDY blew his power transformer but has a new one and is back on 7000 kc. W5AFE sez he has a new ham W5NR coming out with xmitter. Break him in right and have him report to the SCM. W5NS has his xtal and is going to have the fun of getting it to jazz his 210s. W5AQT has moved to Shreveport and is now on 7000 kc. W5AXA has a bad case of Y latis—seems to be serious. W5FG is on with a 310 on 7230 kc. and wants your N. O. traffic. He receives WFBT and WFAT regularly. W5LV has a portable, W5GT. From what I hear, it fell out of the truck on top of him the other day—wonder why? W5EB will have a 208A on 3500 and an 832 xtal on 7000 in a few days. Conditions in La. have been fine—the QRN that was expected in 1928 is not there. The gang as a whole have cleaned up their notes and steadied their sigs.

Traffic: W5WF 220, W5ER 71, W5LV 56, W5AYZ 52, W5FG 21, W5RD 11, W5AFE 2, W5BDY 2.

**TENNESSEE**—SCM, Polk, Perdue, W4FI—The Nashville gang has finally come to life. We have prospects of an Amateur Radio Club being formed in the near future. W4ZC takes the lead in traffic this month. He is on regularly each evening and wants traffic. W4ACW, our new ORS, shares honors with W4SP for second in traffic. W4SP is on regularly and says the Knoxville gang is getting along nicely. W4AJQ has been appointed ORS and promises to handle lots of traffic. W4FU worked the Hyrd Expedition and got

quite a nice write-up in the local papers. That's nothing unusual for W4FU, Hi.

Traffic: W4ZC 20, W4ACW 16, W4SP 16, W4ABR 7. **ARKANSAS**—SCM, Henry E. Velte, W5AB1—We are glad to note that the traffic totals have taken an upward jump this month. W5EP, who is one of our new ORS, deserves most of the credit for the large total. He made the BPL and we are proud of him. Keep up the good work W5SS reports that he had the bad luck of burning out all his receiving tubes, so will be off the air for a while at least. The R. I. paid Little Rock a visit and several of the gang were down to take the exams. W5FN passed the commercial exams. He has just been appointed a new ORS and has also been named the starting station for the Governor's President Relay. W5RCZ has gone back to his 210 transmitter until he can get a larger rectifier for his 852 tube. W5BDD is getting out FB with a new 50 watter. W5PX is busy most of the time running a broadcast station. It is rumored that the YL has W5ANN off the air. Hi. W5ABI handled a few messages. W5IQ has rebuilt his receiver and says it works FB. W5ARA at Louann has also been appointed a new ORS and promises to be a real traffic handler. W5QV at Johnson is going on fone soon. W5SL, our Route Manager, is still traveling so does not get much time for radio. Well, gang, hereafter our reports will have to be made up and sent in to the SCM on the 15th of each month, as per the announcement in QST. We are glad to see our traffic totals growing but if more of the gang will handle traffic we can have even a larger score. Let's put Arkansas where she belongs, fellows. WE CAN DO IT.

Traffic: W5EP 242, W5AB1 31, W5HN 8.

HUDSON DIVISION

**EASTERN NEW YORK**—SCM, F. M. Holbrook, W2CNS—W2BEE is still keeping schedules with 55X ship, now 5800 miles south. W2ANV has daily schedules with VE2BB and W8DQP for weather reports for Montreal airplane and he wants help from stations at Whitehall or Plattsburgh, also along Hudson to New York, and Herkimer, Syracuse, Rochester, Buffalo, Erie for Cleveland air route. W2AYK keeps the hook clear by operating almost daily. W2BAQ is now using a 210 in place of a 201A with great improvement. W2AXX has pepped up with push pull Hartley. W2AUQ expects to take 1st commercial exam soon. W2ACY reports old Q sigs being used on 600 meters by about half the commercial ops. W2AQL took traffic from F8C1. W2BLN has blown filter condensers. W2BKN is rebuilding and reports W2AHW as a new ham. W2ACD is still looking for 1929 pure D.C. notes. W2JFE is rebuilding his receiver. W2AGR has the call W1BZG while at school in Boston. W2VP is now on the air again.

Traffic: W2HFF 73, W2ANV 43, W2AYK 41, W2BAQ 28, W2AXX 19, W2AUQ 19, W2ACY 15, W2AQT 12, W2BLN 5, W2BKN 3, W2ACD 3.

**NEW YORK CITY AND LONG ISLAND**—SCM, M. B. Kahn, W2KR—The SCM wires Headquarters on the closing date for copy that he has been away and is unable to get the reports in on time. Be sure to have your reports in to him next month on the 16th or 17th so that a good report for your Section will appear in the May issue.

**NORTHERN NEW JERSEY**—SCM, A. G. Wester, W2WR—W2MD handled the greatest amount of traffic this month and goes into the BPL due to good schedules with traffic stations. W2KA resigned as an ORS due to not finding time to operate. W2AVK also resigned as he has moved to NYC where he will resume his duties as ORS under W2ER. W2AOS maintains fine schedules in his Army Amateur network. W2DX and W2CW are quite busy. W2BDF cancelled all skeds as he is rushing WAAM's new 2KW xmitter to get on the air. W2CJX is handling good traffic on 14 mc. W2BY is trying to recruit radio amateurs. W2BIR is putting all effort into a 56 and 28 mc. receiver. W2JX having hard job collecting traffic on 3500 kc. W2AFC been stepping out to the West Coast regularly and is now trying a 160 meter fone. W2BMO is back on the air again in Irvington. W2BAI just finished a 222 receiver which works very FB. W2GV having trouble with key thumps in neighbor BCL set. W2WW is putting out a very good fone which brings in letters from BCL's. W2ANG is building an 852 push-pull xmitter and will be heard shortly. W2CP been busy with a movie-tone installation but will make the BPL next month.

Traffic: W2AGS 24, W2CW 7, W2DX 0, W2KA 1, W2BDF 21, W2MD 115, W2CJX 52, W2BY 2, W2JX1, W2AFC 5.

MIDWEST DIVISION

**KANSAS** — J. H. Amis, W9CET — As usual the RM W9FLG makes the BPL. Here is one of the most reliable stations in the section and gives the rest of the gang something to shoot at. W9CET with xtal control also makes the BPL but fails to turn in a larger total than the RM. W9LN received his ORS appointment and takes 3rd place in traffic. W9ERO wants an ORS and is on 3500 kc. with a 210. W9EFT, our radio parson is on 3500 kc. with fone and says it's FB. W9BHR, our technical advisor, has a push-pull rig going using UN250 and says it's the best yet. W9CKV has lots of grief, two tubes go soft, MOPA transmitter in the junk heap and is bothering the BCT's with a 210 Hartley now. Tuff. OB. W9CFN is very busy with college how so is on very little but says it won't last long. W9FLG has reported three times and will receive his ORS appointment as his traffic is very satisfactory. W9FIG wants an ORS. W9BEZ, an ex-commercial, has applied for ORS and has a MOPA going with a 210 and a fifty on 7000 kc. W9FYP and W9FTY have both been rebuilding and haven't been on much. The SCM will be forced to make some cancellations if some of the gang don't start reporting each month as there is no excuse for it. ORS nite is coming along FB, so listen on 3500 kc. each Wednesday nite at 8:00 P.M. CST for RM W9FLG's QST. Any stations desiring reliable skeds will please get in touch with the SCM.

Traffic: W9ERO 20, W9CET 234, W9FTY 35, W9FLG 145, W9FYP 12, W9LN 185, W9ESL 5, W9FLG 257, W9FIG 12, W9BHR 37, W9HL 9, W9CKV 11, W9CFN 14, W9BEZ.

**NEBRASKA** — SCM, C. E. Diehl, W9BYG — W9ANZ is doing fine and says traffic is improved. W9FAM has repaired and is at it again. W9DNC has the usual fine total. W9DI blames the fact that school keeps him busy. W9BOQ has a new xmitter and is open for business. W9BLW is doing fine. W9CHB does well for the higher waves. W9BES is still pretty busy with work so he can't be on very much. W9CDB is also on higher waves for a change. W9BQR is pretty well tied up with work and sickness in family. W9FFW hasn't time for traffic with a rush of work on his hands. W9DVR is very busy observing. W9BYG is on 14 mc. now.

Traffic: W9ANZ 17, W9FAM 58, W9DNC 26, W9DI 24, W9BLW 6, W9CHB 12, W9BBS 4, W9CDB 2, W9DVR 14, W9FJD 8.

**IOWA** — SCM, H. W. Kerr, W9DZW — The Midwest Division Convention for Iowa will be held at Ames, May 10, and 11th, and all Iowa amateurs are urged to drop the SCM a card at once that their name may be on the mailing list for programs. The Campus Radio Club at the Iowa State College is active with 23 members and the College station will be on the air soon as proper license is received with Phil Kenke, of WOI, faculty advisor com. to the Club in charge — station xtal control working on 3847.8 kc. Our new RM, W9EJQ, tops the traffic list for the month. Did you read his suggestion about "MK" in last QST? You should, if you haven't. W9DGW cancels skeds to go on his job out of town. The Mrs. at W9BCA is in the hospital and the OM doesn't make the BPL, first time in months. He has our wishes for his OW's recovery. W9EFH is working on the 3500 kc band with a FB sig. W9FYC sends in his first report. Thanks. W9GNR is another first reporter — he is joining the Boy Scouts Radio Club, wants skeds. W9FA was worked recently and says 73 Ole Gang. W9CK putting xtal control for 7000-3500 bands. W9BLJ is now using four 201A tubes with 500 volts on plate and keeps 'em cool. Thanks for report. W9EDW reports weather no good and changed QRA so traffic not so heavy. W9BKV is working for M. P. By, care SCM Diehl, Omaha. W9EFD and W9EQG were recent visitors at W9DZW. As we close the report, W9YL, the Iowa State College Station, is heard on the air. Reports should be early hereafter — month closes the 16th now. All traffic reports will be appreciated by the SCM and RM's.

Traffic: W9EJQ 379, W9DGW 224, W9EDW 179, W9DZW 171, W9BCA 95, W9EQG 76, W9BLJ 55, W9FIW 53, W9EFD 49, W9FK 32, W9FZO 31, W9BCY 30, W9EHN 20, W9DPL 7, W9EIF 5, W9FYC 4, W9GDR 2.

NEW ENGLAND DIVISION

**NEW HAMPSHIRE** — SCM, V. W. Hodge, W1ATJ — This is one of the best traffic months we have had. Many new stations are breaking in and they need your help in getting started. Key clicks have held

up some of the gang but most of the trouble has been cleared up. W1MS is DXing on 14 mc. W1AUF has been having trouble with his transmitter stopping for no good reason! W1AUY is an ORS now. W1BFT has a new MOPA using an 852 in last stage, 1929 style. W1AEF handled a bunch in spite of illness. W1IP is still working for the BPL, and says he will make it next month sure! W1AVJ sent in a good total in spite of QRM from his printing business. W1ANS is pounding them out as usual. W1COW at Exeter Academy has a new 1929 transmitter using an 852 and rectobulbs. The following stations have been reported as being on the air: W1BLP, Concord; W1CDD, Meredith; W1ANP, Gorham; W1ASK, Nashua. Help them out with traffic, gang. W1LX, Laconia Radio Club, is active on 3500 kc., with Xtal. W1BST was too busy to handle very many. W1MB of Lebanon enlisted in the Naval Reserve and is making a 2 months cruise in southern waters. W1UN is on with a nice 100 sign 1. Let's have your reports in by the 16th. OM's.

Traffic: W1ATJ 235, W1IP 120, W1AVJ 49, W1AEF 34, W1AUE 24, W1COW 24, W1ANS 19, W1BST 18, W1MB 14, W1LX 7, W1AUY 5, W1BFT 2.

**WESTERN MASSACHUSETTS** — SCM, Dr. J. A. Tessmer, W1UM — The Worcester gang will be sorry to hear that W1AJK, the newly elected president of the Worcester Radio Association has had to resign, due to business activities in Boston. W1AMZ was home for mid-year vacation and managed to be on the air during his visit home. W1AZD, Berkshire brass pounders, has reorganized and the local paper has donated club rooms to "make whoopee" with the coils and brass. Any of the local hams are invited. Just drop them a line when. W1RKM says soup rectifier froze and he feels all broke up after the jars. Hi! But you'll bear him with his new tube rectifier. W1BNI, says his "S" tubes are starting on their fifth year of service and is moving himself and everything to a new location — is on 7200 kc. from 2 to 5:30 daily and all day Sunday. W1MP is on 3800 kc. and reports very busy as commander of Unit 1, Section 7, U.S.N.R. W1BIX is a new ham and the Worcester gang present their compliments and would like to meet him at headquarters, 274 Main Street, some Thursday evening. W1EO is on 14 mc. and 3500 kc. W1BKG has handed in a fine bunch of messages this month. W1UM's telephone is Park 3310, should information respecting A.R.R.L. be wanted. The Worcester Radio Association had their annual meeting. W1AJK, A. E. Linell, was elected president with Charles A. O'Malley, W1ANI, secretary, 41 Oak Avenue. What do you know? — W1ASU had a brand-new junior operator. Congratulations, old man, and more power to you! The Springfield Radio Club certainly are to be commended for the very fine preparation they are making for the Massachusetts Convention.

W1BGM has been bitten by the fone bug and has joined the Army Net. W1ADO is trying fone on 3500 kc. W1FG complains of the storage battery going bad, only having had it six years. W1ASU kept schedule with SDKN Swedish S. S. Kiruna every night for a week from Boston out 2500 miles when Northern Lights spoiled the QSO's. W1ANI is busily active in U.S.N.R. drills.

Traffic: W1AJK 4, W1AMZ 8, W1AZD 43, W1BKM 14, W1BNI 12, W1NP 9, W1EO 17, W1BKG \* 62, W1UM 11, W1ASU 21, W1GR 8, W1BZJ 7, W1BGM 51, W1FG 2, W1ADO 8, W1ANI 36.

**VERMONT** — SCM, C. A. Paulette, W1IT — We have an extra station reporting this month so that is a help.

All please take notice of the fine total our new CRM W1CGX piles up this month. He says he is having BCT, QRM so is off for quiet hours.

W1AOC reports he is still XX QRI and has not much time for ttc. W1BJP is QRI in an orchestra and not much time for hamming, but he has rebuilt his transmitter. W1BCK has gone to Ft. Benning, Georgia, but he is reporting from there.

Thanks a lot W1EZ for the report this month, and if the radio wx conditions ever clear up so I can even hear NAA or WIR, I will keep a sharp lookout for you and try for a QSO.

Traffic: W1CGX 335, W1IT 136, W1AOC 69, W1BJP 17, W1BCK 10 and W1EZ 3.

**EASTERN MASSACHUSETTS** — SCM, E. L. Battery, W1UE — W1CQ beats all comers this month with 439 messages handled! That reminds us of the reports W1FL used to turn in! Very FB! W1LUM and W1ACH have their usual high totals and make the BPL with W1CQ. Even

\* Non ORS.

though several O.R.S. were cancelled last month, we have not yet a percentage of 100 or all stations reporting. Why keep your O.R.S., OM, if you can't appreciate the meaning of it? The Eastern Massachusetts Amateur Radio Association held a Ham-fest on the evening of February 20th. There were about 50 in attendance, among whom were K4GF of Florida hurricane fame, W1BIG S.C.M. of Maine, W3GS, a fifth district ham and many others. Interesting talks were given by Mr. Browning of Browning-Drake and Dr. Kennelley, who was one of the first to bring forth the Heavy-side Layer theory. As the old saying goes: "A good time was had by all." The E.M.A.R.A. is our radio club—meetings are held first and third Wednesdays of each month in Milfin Hall, Cambridge. Come one—come all and get acquainted! WIBIX has moved to Worcester. WICRA is getting up a ham orchestra to play at the Springfield convention and wants a good pianist—one at a time, please. Hi! W1UE is now keeping schedule with W1CQ. The 3500-ke. band on new receiver at W1ACH is covered by 135 degrees on dial—broad enuff! W1RY received report from England that his 14-mc. harmonic was heard on ten meters over there. W1AZE has new National Kit which works great. WIAPK seems very busy at WLEX—hope he doesn't turn into a BCL broadcaster. Hi! WIACA has new high "C" circuit working FB and his sigs sound better now. W1AAW has new receiver built and has only a promise of more work to offer this month. Go to it, OM. WIWV worked a rare one when he hooked SP-3AR in Poland—he also worked VE-5AW in the Yukon. He is using the Push-Pull circuit and urges everyone to try it if the 7000-ke. racket is to be stilled. DX still haunts W1KEL. W1KY discovered that her unsteady sigs were caused by a BCL antenna rubbing on hers, so the interfering antenna comes down and goes boom. Hi! Hi!

W1BW of Williston works everything he hears on 14 mc. and is pioneering on 28. W1BBT reports rectifier trouble—what's wrong, OM? W1AGP is building crystal outfit and has his eye on an O.R.S. appointment. W1AHV suggests that the gang use the service message more—that's a very good idea! Ex-1BAT makes his return signing W1ALY. He is going right in for traffic work and is a prospective O.R.S. W1AOT sends in another report with advice that he will soon junk the AC note—hurray! First report comes in from W1WJ. He is doing some FB relay work—he, as did W1KH, a couple months ago, foned message from F8BTR to destination and sent answer back in very quick time. Remember the New England Convention to be held in Springfield, April 19-20. Hope to see you all there.

Traffic: W1CQ 439, W1LM 219, W1ACH 211, W1CRA 130, W1KY 87, W1AZE 60, W1ARS 54, W1WU 54, W1UE 43, W1KH 32, W1AOT 32, W1ALY 32, W1ACA 26, W1AGP 22, W1RY 8, W1BBT 5, WIAPK 2, W1WV 1. RHODE ISLAND—SCM, C. N. Kraus, W1BCR—BY RADIO DIRECT FROM W1BCR via W1MK—W1BCR worked WFRT and WFAT with an 852 on 7280 ke. W1CPEH is kicking out FB with his B batteries. W1MO is rebuilding and expects to be on soon. W1BLS says his remote control works #B. W1RLY is using low power and finds traffic scarce on 14 mc. W1AVE has been working fine DX on 14 mc. W1CQ and W1CRN are newcomers and we wish them luck. W1AFS is on 7135 ke. with half-wave RAC. On the whole there seems to be plenty of traffic in the 7000-ke. band. W1BCR got the Governor's President message off to W1MK. The following stations are on 56 mc.—W1BCR W1CPEH, W1CRN, W1CQG. It is expected that W1AMW and W1AFS will also work on 56 mc. as well as a gang of new hams who have not received their calls yet.

Traffic: W1BCR 114, W1CPH 10, W1AAL 10, W1MO 6, W1BLS 4, W1BLV 2.

#### NORTHWESTERN DIVISION

IDAHO—SCM, James I. Young, W7ACN-7JL—W7IY has a new G. R. frequency meter. He is trying fone on 3500 ke. W7YA is active on the USDA Net. W7ADC reports new transmitter. W7ACD is active with schedules. W7ABB is on 3500 with a good total. W7ACN is busy with photography and school. W7HE had excellent luck late nights with his 210. W7II is doing fine for a beginner. W7AIW says 7000 ke. is all wet. He works Chile and Hawaii on 14 mc. W7AOC is on 7000 ke. some. W7ALC and W7GU are busy with BCL service work. W7AFK bought power supply from W7HE. W7ALW is ready for his ORS now. W7ACP is going fine. W7ACD, W7ABB, W7YA each report two schedules daily.

Traffic: W7ABB 91, W7YA 44, W7ACD 36, W7ADC 20, MONTANA—SCM, O. W. Viers, W7AAT—W7HP

is the star traffic station this month. FB, OB, W7EL comes in second and sent his report via telegraph. W7FL has asked for membership in the I.R.E. and U.S.N.R. Best of luck to you, Jeff. W7DD is now working on three bands and doing his usual share of experimenting. W7AAW is busy on the jury now but will get going better in a week or so. W7DJ and W7PB are new stations in Hardin so give them a call, gang. W7AEM also of Hardin is having lots of trouble in more than one way and the station is still silent after the recent death of his mother. W7ANT and W7AHN both of Great Falls are putting out a mean signal on the upper end of the 7000 ke. band. W7AAT has been silent for a few weeks, but will be going strong on 7040 ke. again soon and will also have a new 75 watt transmitter on 3520 ke. At present all ORS are reporting on time so let's keep the ball rolling at the same pace from now on.

Traffic: W7HP 115, W7EL 99, W7AAT 80, W7FL 37, W7DD 25, W7AAW 20.

OREGON—SCM, R. H. Wright, W7PP—W7GG is back on the air after a long silence. W7ABH will be on as soon as the ship he is on hits port again. W7PL is all for High C now that he has tried it. W7UN and W7PG works skeds every night. ExW7ABY is back on the air under the new call W7ZB. W7MV has been using MUPA and says that with the exception of being hard to neutralize, it is FB—the set is completely shielded with aluminum. W7ST, ex-SCM of Idaho, is now an Oregon traffic man using a 210 in the Hartley circuit. W7AAR is rebuilding but holds a tri-weekly sked east. W7RL, W7BO and W7DP are all using High C. W7MQ is on consistently. W7KR is working on 28 mc. W7AEC is on occasionally using a 50 watt bottle. He is leaving for Alaska soon. W7AMQ was the station selected in this state to procure and relay the message for the Governor's President Relay. W7AJW, the Rose City Amateur Radio Club, now has its mercury arc outfit going. The general opinion of the amateurs in Portland is that DX and traffic is greatly improving in spite of the fact that spring is almost here with its QLN, vacations, etc.

Traffic: W7PP 77, W7UN 68, W7PL 34, W7MV 32, W7WR 30, W7AMQ 23, W7GQ 18, W7PE 13, W7AAR 11, W7ACG 7, W7ST 6, W7ALK 5, W7AIG 5.

#### PACIFIC DIVISION

LOS ANGELES—SCM, D. C. Wallace, W6AM—Five stations make the BPL this month—W6AKW, W6UJ, W6BZR, W6ZBJ and W6CZO. W6AKW reports W1BDI his East Coast P. I. pick up station and their "Little Three Route" K1AF—W6AKW—W1BDI—is a fast one. P. I. to Hartford in same day. W6UJ had big month again, plenty of traffic with W6EOF for Standard Air Lines, a new line to Phoenix and El Paso. No special DX or records, but good skeds brought lots of good traffic. He is still going good on fast, sure delivery of traffic to Los Angeles. W6BZR did some emergency work for Standard Air Lines. DX has been fairly good but nothing to write about. He flew over the shack about 2000 feet and his 50-foot sticks certainly looked small to him. W6ZBJ tells us that W6CMIY, now working for United Artists on Photophone, reports arrival of a YJ Jr. op on the 9th. W6CZO would like several reliable skeds east of here, Arizona, New Mexico or Utah. W6AVJ sends in his first report since long, long ago and says he has put in Rectobulbs. W6DKV has been elected president of the Foothill High Frequency Club. He is rebuilding his transmitter for crystal control and then hopes to be an Official Frequency Station. W6DJI is keeping some good schedules on the 3500 ke. band and sends in a fine total. W6AM was QSO Byrd when Bernker's neighbor Palmer was at W6AM. W6DLI now had dual transmitter with 30 seconds to QSY on 3500 ke. or 7000 ke. 50 watts on 7000 ke. is 7½ on 3500 ke. He says it seems funny to QSO N. J. on 50 watt set QSA4 and step right out with little one on 3500 ke. and get QSA5 from same place. 3500 ke. seems to be FB. W6EGH moved from Blythe to Los Angeles. W6AEC just finished a new UX222 RF receiver. He is going to make crystal control now. W6BVM went down to 14,000 ke. the middle of February and its FB. W6AGR blew one 281. He helped W6AM at the key of W6HM get QSO W6MA. W6AWQ is open for sked with Los Angeles for Monday, Wednesday and Friday. W6QL reports 14,000 ke. is getting into good form. He is hearing ZL and ZS stations with good readability now. W6FT reports conditions terrible for traffic handling. He says "something will have to be done." W6AKD has been trying out some new 6EX Rectobulbs. W6HS has USDA network skeds the last Saturday of each month, and handles several messages on each test. He ex-



peets heavy traffic with Berkeley zone. W6HS is doing some good work calling every operator's attention to the fact that we want their traffic reports every month, even though they are not ORS. W6DSG has been very busy handling traffic. W6MA and W6ZZA have now had 30 QSO's without a miss from coast to coast and border to border on 7200 kc. W6EPN sends in his first report, a good one. W6AWY couldn't get 852 to perking OK so has laid it aside and is using 210 until he gets more equipment for high power. W6DZI has made quite a few off-wave stations QSY into band lately. W6EKC just finished his 1929 receiver which is FB. W6ANM has been very busy checking up on off-wave stations but he comes to the A. R. R. C. meetings on Wednesday nights. W6DHM hit a streak of hard luck and is down but not out — yet. W6CUH has new QRH, reground crystal and finally has transmitter going right and from now on will be on the air plenty, he says. W6EKE just built a new TPTG high C push-pull with 210's and most of his reports are xtal DC. Got R4 and QSA3 from NJ2PA at sun-up on February 11. Power supply is from Thordarson 1/2 wv. 210 pack

W6LPH sends in a good report via W6HS. W6EFA has been very busy with school and lost time from sickness, but handled some traffic just the same. W6BRO is on the air again with his new transmitter. He says that if he were to quote what some of the operators report his signals as, it would sound like boasting. He is beginning work on his new receiver now. W6EAF rebuilt everything twice. W6ZZA is now arranged for two CX310 tubes. Receiver and transmitter still less than a cubic foot. W6AXE has asked with W7AKJ on Thursday evenings. W6BTA has been rebuilding. Also is working as Associated Editor the Oscillator. W6BJX is busy working to make the banquet on March 29th a success. Heard W6BT QSA4. W6DLK saw W6DNH at the sanatorium and he is coming along fine. Says hello to the gang. W6CRC is at present remodelling station and will be on soon.

Forty-eight stations reported by the 27th this month with 43 reporting traffic. Next month will be a short one as the reports are to be mailed on the 15th instead of the 25th.

W6COT is trying to arrange a sked with Dallas. W6ALR is starting a radio club and boosting the A. R. R. L. in Fresno. W6EEB migrated to 3500 kc. reporting that he can't do anything through 7000 kc. din. W6DEG is keeping skeds. W6OF has to walk ten miles on snowshoes to get his mail. W6APW is trying to find power leaks. W6CHA reports formation of a west coast experimenters' club. The Elks Club has invited the Amateur Radio Research Club to have a station at their National Convention in Los Angeles in July. Bert Sandham, an old navy op, is now on the air as a new ham.

Mr. James M. Chapple, Supervisor of Radio at the Los Angeles branch, was guest of honor at the meeting of the Short Wave Club of Pasadena. Ex9BCJ is second operator at W6FT and is going to Phoenix, where he will erect a ham station. He has applied for a 6 call. W6ELZ is running the code class for Radio Doings on 85 meters on Monday 7:30 to 8, and Thursday 7:30 to 8.

The Jerec Club of Los Angeles send us their publication twice a month and report the meetings and trips they take.

Traffic: W6AKW 374, W6UJ 319, W6BZR 282, W6ZBJ 275, W6CZO 129, W6AVI 139, W6DKV 131, W6DIJ 70, W6AM 69, W6DLI 43, W6EGH 42, W6AEC 41, W6BVM 34, W6AGR 29, W6AWQ 39, W6QLZ 29, W6FT 25, W6AKD 22, W6HS 19, W6DSG 18, W6ESA 32, W6MA 18, W6EPN 17, W6AWY 13, W6DZI 13, W6EKS 12, W6ASM 12, W6DHM 10, W6CIH 10, W6EKE 10, W6EPH 8, W6EFA 8, W6RKO 4, W6EAF 3, W6ZZA 2, W6AXE 2, W6BTA 1, W6COT 21, W6ALR 20, W6EEB 7, W6OF 30, W6APW 15, W6CHA 73.

ARIZONA — SCM, D. B. Lamb, W6ANO — The SCM has gone on a vacation with no date set for his return. Things in Arizona seem to be picking up very well lately with most of the ORS reporting good activity. We had a meeting of the majority of the gang at W6BWS's house a few weeks ago and organized the Arizona Radio Club with the following officers: W6BWS, president; W6DIB, vice-president; W6CDU, secretary-treasurer. DX is fine and it may be of interest to note that at W6EOF last night, we were QSO ZS2B who is exFOA50, I believe he said. We were the second six over this year. W6GHM was the first across: Dale Hammersly ex9EH was at the key. W6EOP is using a W6EX 250 watter, and is certainly pushing the traffic along. W6DTU is getting out very well on 14,000 kc. and has worked Minnesota with his 201A and 110 volts AC.

W6CDY is busy with college and YLs. All his traffic is handled on schedules. He is still using a "fifty" and motor generator plate supply. W6BJF has been doing all his work on 3500 kc, and reports working a couple of Canadians often. He keeps schedules and is very consistent. W6EAA has installed two UX2s1 tubes for his rectifier. He is on both 3500 and 7000 kc, and getting out OK. QRM from school is keeping him off the air. W6CRA is teaching school but finds time to pound brass on 7000 and 14,000 kc. with a 210. W6BWS is using a TPTG with every connection of quarter inch copper tubing. His DX is fine, but he is too busy with college to work much of it. W6EFC, a non-ORS has the right stuff and is doing good work on 7000 and 14,000 kc. band and has acquired a pair of 216 rectifiers. W6EOP is an old timer with a new call. He is doing wonderful traffic and DX work with the help of Charles C. Messman, ex9BCJ. The gang on the east coast should remember W6EOP as exWSABE and exW4PY. W6CCD has departed for transpacific brass-pounding and will be on commercial frequencies soon. W6DGY is now on the air with a UX171 in a split Hartley. He uses a Zepp feed to his antenna and E-eliminators plate supply. W6CDU has at last received his new Ford and is QLL chasing the YLs.

Traffic: W6EOP 891, W6EAA 29, W6CDY 44, W6CRA 4, W6CDU 8, W6BJF 93, W6DTU 29, W6BWS 51.

SACRAMENTO VALLEY — SCM, C. F. Mason, W6CBS — W6ETA has a new transmitter on the air now with a temporary antenna of the counter-poise type but expects to have a Zepp soon. W6CIH is handling lots of traffic now and is also working DX. W6DZY has a case on Canadians. W6ETA gets a thrill out of traffic handling. She has sent and received some messages. W6BYB is on the air with an 852 now and is doing some very good work. W6FSZ is on the air now with RAC from slop. W6AXM has a 210 now and is putting 1500 volts on the plate. W6EOU has a 250. W6EMX is planning on putting in a 250. W6AXI puts out a healthy six. W6ELC has a new slop rectifier which works much better.

Traffic: W6APA 77, W6EEO 753, W6DON 167.

SAN FRANCISCO — SCM, Clayton Bane, W6WB — THIS REPORT BY RADIO FROM W6WB DIRECT TO WIMK. W6AD makes the BPL this month and leads the Section. FB, OB, W6PW is still trying MOPA circuits. W6DPF and W6CZM both have beautiful 1929 notes. W6WN is practically through rebuilding. W6CIS and W6UF are both new stations added to our Section. Glad to have you both. W6DYB has been trying 14,000 kc. and finds this band fairly good. W6AC has also been successful on the same band and reports communication with England FB and easy on that frequency. W6BMU is using MOPA arrangement and says it is excellent. W6DZZ has been sick but managed to squeeze a little traffic through. W6KJ is still busy with his new op. Hi. The SCM is going to be QRL with a new girl op, too. Everyone enjoyed the quarterly A. R. R. L. meeting at San Jose. The next one is to be held by the East Bay section. A number of ORS have been cancelled and others will suffer the same fate if additional reports are missed next month. W6CIS is running schedules with WSBS and WIMK and is a new ORS. W6IIF and W6CKV are in together and using a crystal rig and putting out a beautiful signal. W6BGI is still patiently crving 28 mc. with the SCM but with slight success. Our traffic this month is much better and it is hoped that there will be a further increase next month. W6CLS is now back on the air again after a long absence. A new club has been formed recently which will help materially in putting the Section on the map.

Traffic: W6AD 390, W6DYB 31, W6CIS 15, W6AC 20, W6DZZ 15, W6KJ 3, W6BMU 59, W6PW 40, W6WN 9.

SANTA CLARA VALLEY — SCM, F. J. Quement, W6NX — W6AMM makes the BPL this month on deliveries alone. Bruce is keeping a dandy schedule with K3AA in the Philippines. W6JU is looking hard for a Honolulu schedule. W6RYH is contemplating installing a crystal-control transmitter in the bright future. W6BAX expects to develop his master oscillator — power amplifier on 14 mc. to a great degree of efficiency. W6AME has moved to a new location. W6BMW is waiting for some brand new 866 type tubes. W6AZS is another of the boys on 14 mc.

Traffic: W6AMM 178, W6JU 47, W6BYH 16, W6BAX 8, W6AME 13, W6NX 9.

HAWAII — SCM, F. L. Fullaway, K6CFQ — BY RADIO FROM K6CFQ via W6BLU — There are many new stations on the air that are not reporting. Please report every month, fellows. They are not due the first of every

month. The Army is starting a Net in Hawaii and the SCM has been named the radio aide to L. T. Barton, comdr-in-charge the net operations. W7FS and W6FA have been in town. W7ES is op. on the *Vigilant*. KGALM handled the most traffic and he is applying for an ORS ticket. K6AFF is a new ORS but an old timer and an ex-ORS. K6EST a new ham on Maui reports for the first time. That boy sure can copy. The SCM sent him a message that was one-half hour long and he copied it straight at about 30 per. K6DPG is on 14 mc. steadily now. K6DJU has a 201A xmitter and receiver in a cabinet and is QSO the states regularly. K6DQN reports for the first time. He has a new receiver. Let's hear from you fellows that have not reported yet.

**PHILIPPINES** — Acting SCM, M. I. Felizardo, KIAU — Schedules from K1HR are kept with the following: acWVN (Tientsin, China) at 5:30 p.m. daily; acSZW (Shanghai Observatory, China) 6:00 p.m. daily; om1TB (Sumay, Guam) 7:30 p.m. daily; K1RC (Radio School, Cavite), 8:00 p.m. daily; W6EEO (Williams, Calif.) 9:30 p.m. daily. Traffic is handled thru K1HR to the following destinations: W K VK AC and locals. Transmitter frequency is 7010 kc.

Traffic: K1HR 1214.

**SAN DIEGO** — SCM, G. A. Sears, W6BQ — THIS REPORT BY RADIO FROM W6BQ VIA WBAS. W6AJM leads with five skeds daily. W6BQ is waiting a successor as SCM. W6BAM reports 14 mc. improving. W6BYZ and W6EC has split schedule. W6ACJ sends in a good report for a new ORS. W6BGL is QRL good total. W6EOP is a new ORS keeping daily skeds. W6EPZ will have some skeds soon. W6BCS was QSO 15 countries this month. W6EC is on 28 and 14 mc. W6EGJ was reported QSA6 in New Zealand on 3750 kc. W6BVX is looking for skeds. W6ERT helps BCL QRM. W6BAS has plenty FB xtals. W6ENK and W6DNS are QRL school.

Traffic: W6AJM 430, W6BQ 299, W6BAM 126, W6BYZ 117, W6ACJ 79, W6BGL 75, W6EOP 72, W6EPZ 66, W6DNS 39, W6BCS 32, W6BQW 21, W6EC 21, W6EJQ 16, W6BVX 14, W6ERT 8, W6QY 8, W6CTP 4, W6BAS 1.

**EAST BAY** — SCM, J. Walter Frates, W6CZR — W6CGM, the old Philippine Island traffic man, got back into the running again and made the first place in the section this month with a great volume of traffic, mostly from KIAF. Houston of W6SR ran him a close second, doing a nice assist by taking the Philippine Island stuff from W6CGM and relaying it on to eastern and Pacific coast points. W6CGM is using the old UX-852 in an ultraodion circuit, and W6SR has a UX-210 working in a High G Hartley which gets out in FB fashion. W6ALX, who has recently installed himself in a new shack constructed for radio purposes only, has been burning up the air during the daylight hours and took third place. All of the work of the three major traffic men in the section was done on the new 7000 kc. band so conditions are not as bad as some of us have painted them. W6DWI dropped down to the 12,000 kc. section and was elated to find that traffic was as good there as on 7000. He kept his large totals of the past two months up by a number of skeds, the main one being with a Chilean amateur. W6RJ is coming back into his old position as a traffic man after shifting to the 3500 kc. channel. He is maintaining six schedules and in addition kept W6MI in touch with his OW while in Marshfield, Ore. W7AEC has been paying him a visit and may settle in Oakland. FB, W6EBA is back on the air after settling in his new QRA. He has been maintaining a sked with W6ACI. W6ASJ has been kept so busy in his normal occupation that he has forgotten where he lives but nevertheless managed to rap out some traffic so that his total wasn't bare. HI, W6LP is back on the air again with a 50 wattler in a High G Hartley with which he is doing FB work after blowing another 50 which he was using in a self rect. job. W6BZU at Concord continues to relay north and south from his vantage point beyond the Contra Costa Hills. W6EDK is contemplating the installation of crystal control after getting the crystal of KRE, local BC station. W6EIB at Vallejo is contemplating the installation of a tube rectifier, but declares that the old slop is hard to beat. Smith, W6BI has been doing some traffic work with K7AER in addition to the great deal of work he does for the Naval Reserve. W6BPC has a sked running with W8BS twice weekly on 7260 kc. and all traffic for the yacht should be routed through him. He has also been QSO with WFAT of the Byrd Expedition. W6DDQ has been so busy he says that he hasn't had an opportunity to run up any traffic. W6BUX has been off the air awaiting the arrival of a new 50 but is very enthusiastic about the new mercury

XIV

vapor rectalbulbs. W6EDR, the juvenile sheik, has been letting a YL interfere with his interest in radio again. HI W6BMS says he is getting 5 watts out of a UX-112 on 7300 kc. W6EY is back on the air again after putting in all the stuff recommended by HQ for the new year, but says he has not done much traffic yet. W6HI expects to be in QSO with K7AER again soon. W6EER at Antioch with a UX-210 was QSO with WFBT at Bay of Whales and QSR'd a msg for Washington, D. C. FB, W6GT is on the air again and is beginning to perk under the fingers of W6DUR, W6LP and W6CZR. It is the work of W6CUG, W6PU is still working east coast on 14 mc. W6IT is temporarily off the air but is carrying on with his OG work.

Traffic: W6CGM 745, W6SR 732, W6ALX 309, W6DWI 268, W6RJ 121, W6EDK 55, W6EBA 52, W6ASJ 52, W6LP 45, W6BZU 39, W6EIB 33, W6BI 26, W6BPC 18, W6DDQ 6, W6BUX 5, W6EDR 4, W6CZR 4.

## ROANOKE DIVISION

**VIRGINIA** — SCM, J. F. Wohlford, W3CA — W3AAJ has dismantled his station, but will operate W3WS. This is in connection with his work at WRVA. W3WS will be MOPA. W3ALS reaches out for DX — working on 7400 kc. He maintains several schedules. W3IE, not having television, escaped with his life. Gave his 882 to a station that he was QSO with, for the YL there, and the bird came back and wanted to know if he meant his wife. BEWARE. W3HY claims to have been locked out of the shack and examinations got him all wet, but he worked some DX all right. W3BZ has schedules with W8ZZ and W8CWP working 3500 kc. and good power supply. It is rumored that W3BDZ and W3CKL will attend the Charlotte Convention. Recently a radio club has been organized in Richmond and promises to be a good one. The membership at the start runs around twenty members including one YL. More about it later. Would like more ORS to report monthly. We *must* have reports. We are changing the reporting dates effective with this report. Please close your reports on the 15th of each month and mail to me on the 16th. My report must be mailed on the 20th to Hartford. W3ZA had trouble with his MG and was off the air with phone for several weeks, took advantage of the lay-off and moved station into better quarters. Anyone wanting to chew the rag by phone, call on him.

Traffic: W3AAJ 53, W3ALS 29, W3IE 2, W3HY 3, W3BZ 1.

**WEST VIRGINIA** — SCM, F. D. Reynolds, W8VZ — W8ACZ leads this month with 217 messages and W8CJQ pulls in second with 109. FB. We need more of this to put the section on the map; let's compare next month with this one and then think how many more messages you could have handled. That's the only thing that will ever get us any place. W8DPO reports working AA4FN and Z84M and also managed to handle a few messages. W8OK and W8HD say they are preparing for A-A tests to be held in March. Hoffman reports several weeks' illness. Surely sorry, OAL, hope you're OK now. W8BSZ has gone and got married. Good luck to you, OM, W8EP is working 1715 kc phone. W8DKH is a school teacher.

Traffic: W8ACZ 217, W8CJQ 109, W8APN 60, W8DPO 32.

## ROCKY MOUNTAIN DIVISION

**COLORADO** — SCM, C. R. Stedman, W9CAA — All stations please note the new reporting date. W9DKM got the Governor's message from Colorado at the last minute after much trouble. W9FXP is on regularly. W9EOD is on 150 meters phone, also 28 mc. W9CAA is the same but also on 14,000 and 7000 kc. W9DQV has a new transmitter. W9CND has applied for ORS. W9BQC finished rebuilding and is on with a 250. W9CSR is on 14,000, 7000 and 3500 kc. W9CDE has two schedules. W9EAM is on 7000 and 3500 kc. and says the USDA is fine. W9DQJ the same. W9CCM has a new soup rectifier. W9GEE is on 14 mc. with 30CW. W9GGW reports several new prospective hams. W9DQD has been sick. W9EUR has a DC note on 7000 kc.

Traffic: W9CAA 41, W9EAM 72, W9CDE 10, W9CSR 4, W9DQV 25.

**UTAH-WYOMING** — SCM, Parley N. James, W6BAJ — The section seems to be growing and several new ORS appointments will be made. W6DYE takes the honors this month and says his new MOPA set is in. W6BTX and W6EIW had to quit because of a very bad power leak. W6DZX has a lot of YL qrm. W6BUV comes through with a report

and is building a 250 watt set. W6EKF is still working out to the Atlantic Coast with a lone 201a. W6BAJ was on when school qrm not too bad. W6AYL gets on when not busy at KRP. W6AKM is back on the air once again and is also ZL and MH. W6DXM was made ORS. He is building a 1929 TPTG set. W6RV is building up a new power supply, but no traffic this month.

Traffic: W6DYE 115, W6BTRX and W6EJW 73, W6AYL 33, W6DZX 32, W6BUV 20, W6EKF 16, W6BAJ 14, W6AKM 7, W6DXM 2.

### SOUTHEASTERN DIVISION

**ALABAMA** — SCM, S. J. Rayne, W4AAQ — Please take note of the fact that reports should be mailed on the sixteenth of each month in the future. W4JY is handling several schedules and lots of traffic is being moved there. W4AHZ is also doing nice work in Birmingham. W4AAH has been working hard this month and activity there has dropped off. W4AJY has been appointed Route Manager and all Official Relay Stations should cooperate with him in handling state traffic through schedules. W4TI keeps two reliable schedules north. W4IA uses one on 3500 kc. and is handling some traffic also. W4UV is perking well on 14 mc. and handles DX traffic with a UX210 and 400 volts "B" batteries for power. W4AHR has four schedules and is on consistently. W4AHP has recently moved up to 3500 kc. for night work and sez it is fine business. W4AIR will also work in the 3500 kc. band part time in the future. W4AKB blew his 210 but has another on the way. W4AAQ is holding up his end of the rope. W4OA is having trouble with modulation in his 3500 kc. fifty watt tone but gets out in fine shape with 7000 kc. CW. W4KS is a new one in our midst. Welcome, OMI.

Traffic: W4AYU 116, W4AHR 42, W4AAQ 38, W4TI 25, W4AHP 14, W4UV 14, W4AIR 11, W4IA 8.

**FLORIDA** — Acting SCM, E. M. Winter, W4HY — W4AGY intercepted a message from EB4WX for the Belgian training ship "L'Avenir" at Tampa and by quick relay had it delivered the next morning. (That's real work, OMI-SCM.) W4AGY has built a monitor and frequency meter and says fb. WRAL is off temporarily on account of blown power transformer. W4AJD and W4FH are still working on W4AJY's 852 outfit, testing, etc. Look out when they do get started. W4QV is a new station at Miami, getting out fb. W4AFP and W4AKW are busy rebuilding. W4AGY says any traffic for the East Coast of South Florida will make good time if given to W4ACC at Tampa, with whom W4AGY keeps daily schedule. W4OB is back on the air now and will be on regularly. He used to be one of our best traffic hams. Why not start it up again, OB? W4AFU sent in a fine traffic report. W4AIH has seven schedules. His traffic total indicates he kept most of them, too. W4ACC has six schedules. His traffic total seems to indicate he kept some more than he did not report. (This is the best traffic report we have had for a long time.) The South Florida Fair at Tampa helped some, didn't it? — SCM. And he promises a better report next month! W4PAW, portable call of W4AII, handled South Florida Fair traffic also. W4BL only handled 29 messages. He says swimming is fine (in February. You hams up North better come down here next winter — SCM), and he is too lazy to do the hard boiled owl act any more. Hl. W4TK is on regularly again now, handling some traffic. Hear him calling "CQ-DX." Shows he still has plenty of confidence in spite of the now famous Washington Conference! W4MS has three new hams on the way. Says the gang still calls his OW "OB". Whatsa matter, gang, can't you doff your key to the lady? He went down to 14 mc. and contacted 17 stations without a break. Threatens to put a 50-watt set down there permanently, and keep the 250-watt set on 7000 kc. and 3500 kc. bands. W4OO will be on 7000 and 14,000 meters pretty regularly now. Says the rest of the St. Petersburg hams are off the air, temporarily only we hope. W4KC is now on 14,000 and 3500 kc. Looks out of his shack window and gets a fine view of Bok's Singing Tower every morning. That's what we call inspiration of the best kind.

W4HY is turning over the reins to a new Scotian Communications Manager, Mr. Harvey Chafin, 4AII, 6002 Suwanee Avenue, Tampa, Florida. He takes this opportunity of thanking those who have so generously contributed their ideas and time to helping keep Florida on the map in QST. While I relinquish these pleasant duties with sincere regret, it is my earnest desire to keep in touch with the gang as much as possible. Support your new S.C.M., fellows.

QST FOR APRIL, 1929

Remember, we will represent Florida to the best of my ability. 73.

Traffic: W4ACC 155, W4AII 60, W4MS 46, W4AGY 45, W4AFU 35, W4BL 29, W4HY 13, W4PAW 11, W4KC 8, W4TK 8, W4OB 1, W4OO 1.

W4AFW handled quite a few this month. W4OC handled 60 foreign messages. W4ATO is a new ham in Maine, having moved from Quincy, Mass.

Traffic: W4AFW 26, W4OC 63, W4ATO 80.

### WEST GULF DIVISION

**SOUTHERN TEXAS** — SCM, Robert E. Franklin, W5OX — W5AQY takes the lead again this month and makes the BPL. He keeps a nice sked line-up and has worked numerous foreigners this month. W5LP has just purchased a higher voltage transformer for the 852 and says reports are much better now. W5ABQ sends in a nice report with a promise of a better one next time. He also has a phone going on the 3500 kc. band. W5JC has been keeping a sked with W1MK, W5UC and W5LN both have phones going on the 1750 kc. band. W5BBC and W5BAD are keeping skeds. W5VY of Austin handled the Governor's President message from our Honorable Governor. W5PO is busy rewinding a generator field for W5OX. W5OX is back on again with a 1929 type transmitter and hopes to be on pretty regularly from now on.

Traffic: W5AQY 394, W5LP 11, W5ABQ 20.

**NORTHERN TEXAS** — SCM, J. H. Robinson, W5AKN — Several of the fellows didn't get their reports in time to reach QST for this issue. Did you note the new reporting dates in the March issue? It certainly gives me much pleasure to receive applications for various appointments, especially when the questionnaire papers come back answered as if the sender gave them some thought. Well gang, this month's message report made your SCM smile and feel darn good — just look at the figures at the bottom and who the operators were that did this good work. W5BAD got his grand total in the 3500 kc. band. He says there is a lack of stations in the 5th district to bundle the traffic on this frequency. W5OE says QRM from frigidares and HCl fans keeps him off the air but keeps a sked with W4AKE. W5BBF says all his skeds went hay wire but turned in an excellent report. W5AKN finally got the new receiver as per November QST working OK, but not until after he had made tube base coils. The set was built just as shown in the three-tube hook-up in November QST. W5RAM shoots trouble for the local power and light company and has lots of interesting tales to tell about the local hams. W5JD is trying to find enough parts to build a four-tube receiver as per November QST. W5AAR handled some traffic at W5DF's this month.

Traffic: W5BAD 94, W5BBF 89, W5AAE 54, W5OE 35, W5HY 24, W5ATZ 7, W5RAM 6, W5AKN 3, W5JD 1, W5DF 4.

### MARITIME DIVISION

**NOVA SCOTIA** — SCM, A. M. Crowell, VE1DQ — VE1AC is the ham set the D F station on an island off Cape Breton. Their only contact with the outside world during the winter is through amateur radio mainly via VE1BI and VE1BH. VE1BR is also heard on but not much luck connecting with the Halifax gang lately. VE1AV is now using a five watt set and puts out a mean signal on 3500 kc. VE1BV is laid up with the flu, right in the midst of rebuilding. Hope you get on soon again, OB. VE1AW is on with fone. VE1BN works 'em all on 3500 kc. VE1BE is putting out a fine signal on 3500 kc. with his 852. VE1C has at last persuaded his xmitter to perk on 14,000 kc. again after a period of silence on that band. VE1DQ has left town for a short time and is temporarily off the air but watch the smoke when he gets going again. All Nova Scotia stations requested to report by the 16th of the month to the SCM. He is no mind-reader and needs the cooperation of the gang in this regard. Send in yours on time for next month's report.

### VANALTA DIVISION

**BRITISH COLUMBIA** — SCM, E. S. Brooks, VE5BJ — Say, fellows, why not assist the SCM by sending a few reports on your activities? VE5AL reports nothing very startling this month. Keeps sked with VE5BR where most of his traffic totals originate. Tests carried out on 14,000 kc. but has very little spare time to pound brass. VE5BR sends in a fair traffic total. VE5AJ is progressing slowly.

Traffic: VE5BR 31, VE5AL 28.

ALBERTA — SCM, E. J. Taylor, VE4HA — The gang in the south of the province sure is going fine. The hamfest held in Calgary, February 2nd, was a huge success with twenty in attendance. Lt. Jackson gave a very interesting talk on short wave and its relation to the air service. VE4CC and VE4GX carry the message honors this month with VE4AF close second. VE4GD getting out FB. Thanks for dope. OM, VE4GD says 28 mc. FB, VE4IO on 14 mc. says good DX there. VE4JJ promises good message total for next report. VE4AG and VE4RA only on occasionally. VE4IT has rebuilt. VE4HM pretty busy lately but manages to handle some traffic. VE4HA still with CJCA. VE4BT is still looking for his 210. It went west. VE4GT is on week-ends only. VE4EY is on regularly on 7000 kc., sure has a nice note and gets the traffic, too. VE4EY gave us a nice talk on high C circuits at our hamfest on February 2nd. EX-4HS did likewise on the screen grid tube. VE4HA on 14 mc. most of the time. VE4FF is going strong — gets cards from G and D. Says would like to hear more of them. VE4JF is doing FB at Gadsby. VE4FB is getting out FB. VE4GM works VK. VE4GK, a new ham at Olds, is doing FB. VE4EI is back again. I want to draw your attention to RAC notes. Not much excuse for this, not if you follow the high C in August QST. Our license calls for DC notes so watch your step. The DC note is far easier to get in 1929 than it was in 1928.

Traffic: VE4GX 47, VE4CC 47, VE4AF 38, VE4GD 6, VE4IO 6, VE4JJ 6, VE4EY 12, VE4HM 7, VE4CU 10, VE4TL, VE4FF 7.

#### PRAIRIE DIVISION

NASKATCHEWAN — SCM, V. J. Pickering, VE4FC — VE4CM tops the gang for traffic again this time. He is also operating Army station 7C10 on 8570 kc. VE4IH has increased his power to 800 volts on his 210 and says it worked good first time. VE4GR reports that his 50 wattier died a natural death and a 5 wattier is taking up the work. He has ditched his syno as the neighbors didn't like it. That he has been heard three times in England is VE4FK's report.

QSA3-4 and with 100% readability. VE4BG wants to hear more of the gang on fone as he has only seven stations to work with. VE4FC is on at last, 3.5 and 7 mos. and broke into the traffic news. Will Skaife of Regina (call not known) reports things going good since he changed his location. VE4BG says Regina is wide awake with 6 stations on the air. Why not let the SCM know of your doings by sending in a report once a month?

Traffic: VE4CM 59, VE4GR 19, VE4IH 16, VE4FK 10, VE4BG 3, VE4FC 1.

MANITOBA — SCM, D. B. Sinclair, VE4FV — VE4MO has at last received his official license and is now proudly signing VE4IC. He is still using his 201A on 14 mc. and having considerable success but is installing a 210 soon. The lure of the transmitter was too strong for VE4DP and he is now on the air again with a 201A in a real 1929 TPTG outfit. He is now living in an apartment and keeps his power low to avoid key clicks. Our high traffic man for the month was VE4AR of Boissevain who seems to be putting out a mean sock on 7 and 14 mc. He recently received an "R7" report from ZL. VE4HR has succumbed to 7 mc. QRM and is now heard regularly on 14 mc. with a nice DC note. VE4FN is still very active and is a good traffic man. He has had some trouble with a paralyzed 210 but is going fine now. VE4HV has broken into the trouble ranks at last and says his MOPA is moping OK. The club station, VE4HX, is putting out a real signal on 7 and 14 mc. Reports will be welcome and promptly QSL'd. All reports should be sent care of VE4FV. Loud cheers are heard from the general direction of VE4DJ who has cleared up all key clicks and now gets pure DC crystal control reports. VE4EK has installed a new tube rectifier and is also getting a pure DC note. VE4DK has a bad attack of the blues as he cannot seem to clear up his BCL troubles. He says his only solution is to QRP to a 201A. VE4JB says "No traffic, no time" but seems to spend the odd moment on the air. He at last managed to get going on 14 mc. VE4BT is away at school but has his 201A portable transmitter with him and is arranging schedules with the local boys. VE4DB blew up sundry UX222's, 201A's, etc., and says he will not be back on the air until he can replace them. VE4FV has been on 14 mc. since January 1st and is pretty disgusted with conditions. He has had no DX all month but is building a 96 jar chemical rectifier which he hopes will improve his note some. VE4GQ and VE4DI are the only two locals working on 3.5 mc. They are both interested in phone and VE4GQ bought another 50 the other day to install for a 100%

modulating system at La CRY. The WRTA staged a successful banquet on February 15th with an attendance of 20. Many competitions were held including QRM competition, liars' contest, code sending, home-constructed apparatus, etc. The prize-winners were VE4DB, VE4DP, VE4HR, VE4FV and VE4DU, VE4DU and VE4GG are still threatening to come back on the air again and we await developments. VE4ES is said to be active.

Traffic: VE4HR 4, VE4DK 3, VE4EK 10, VE4DJ 8, VE4HV 5, VE4FN 12, VE4IC 1, VE4AR 23, VE4FV 4.

#### ONTARIO DIVISION

ONTARIO — SCM, F. C. Thompson, VE3FC — This report came via radio through W2CUS, Southern Ontario: VE3CB and VE3DG are the only stations in this district that reported this time. The former is active on all of the popular frequencies, and besides working some nice DX, handled some traffic. VE3DG is now active on 7000, 14,000, and 3500 kc. and intends to remain so and he wants schedules with a Toronto station on the 3500 kc. band.

Central Ontario: VE3BC is our traffic star as usual and this time he has no competition to speak of. His work is mostly on 7000 kc. on schedules several times a week. He reports no luck on 3500 kc. so far. VE3BP gets on the air nearly every morning on 7000 kc. but he reports that traffic for him is light, but as long as the 210 stays amongst us, he has hopes. VE3BO worked ZL2GO of Wellington, N. Z., on 14,400 kc. and that in the middle of a Saturday afternoon, on Feb. 23rd to be exact, FB very, say wa. A single 210 did it and it never was done before from Toronto as far as we know. VE3BO also handles traffic on the above frequency. VE3BL is having troubles with the 500 watt lantern, so is putting the 210 back on the air. His work of late has been in the mornings. VE3AL is in Bermuda. VE3FC works 3792 kcs. after midnight nearly every night. VE3FT is now away from home, but is putting a portable on the air to carry on with while away. VE3CT is also away from home but he has no portable. His return home is indefinite as to date.

Traffic: VE3BC 26, VE3ET 6, VE3CB 4, VE3BP 3, VE3BO 2, VE3FC 7.

#### QUEBEC DIVISION

QUEBEC — SCM, Alex Reid, VE2BE — Since the last report, two ham fests have been held. Twenty-two attended the one held at station VE2BE and the rag-chewing contest was a great success. The great event of the season was held at station VE2AD on Feb. 23rd, twenty-five being present. Four reels of moving pictures taken at last summer's picnic were shown and greatly enjoyed by all present. So many requests were received from VE2HV, VE2CG and VE2BG that Mr. Royer was compelled to repeat the reel, "The Girl from France," four times. If VE2HV ever gets a call to Hollywood, John Barrymore had better watch his step. It was decided at the meeting to hold a banquet at the Queen's Hotel on April 6th.

The 1929 reports using screened grid tubes are getting very popular in this division. VE2AP, VE2AX, VE2CA and VE2BE are using them at present and many more in the making. VE2AP has moved his station from the top floor to the basement and has completely rebuilt both transmitter and receiver. VE2BB is waiting for a transformer, when it arrives he will be on with an 852. VE2AC, our star traffic man, also our RM, enters the BPL with a high total of 109. Very fine work. Alphy, keep it up. VE2BH was QSO South Africa twice within a week on 14,000 kc. VE2AU is rebuilding and expects to be on again shortly. VE2BG is now using 14,000 kc. permanently for spring and summer work. VE2CX is now using fone. VE2CA and VE2BE are pounding away at DX. All second district amateurs are requested to use the lower end of our 75 meter band for Wednesday evening prayer meetings. VE2AC has received his new power equipment and from now on will be using an 852.

Traffic: VE2AC 109, VE2BB 14, VE2BG 9, VE2BE 19, VE2AL 13, VE2AP 7, VE2AM 5.

#### LATE AND ADDITIONAL REPORTS

W6EEO keeps daily schedules with W9EGU, W6AJM and KHHR, W9HZZ moved and has a FB radio room, W9CMIQ is in the Fada Radio business. W9EKW is the big traffic man in Richmond, W9CMIQ-W9EKW are going in for Army-Amateur stuff. W9DZL is on 7000- and 3500-kc. band.

Traffic: W6EEO 753, W9EEY 35, W9DZL 46.



# A radio-wise market demands TONE!

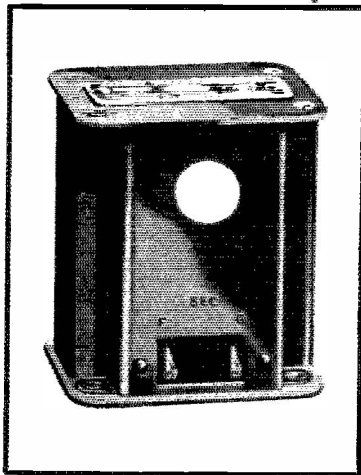

Tone—of musical quality—is now the foremost requirement of the radio market. Receiver manufacturers must *know* what will happen in the “audio end” when a full orchestra crashes through with a crescendo.

True tone, of course, depends upon transformers—and the only way to be sure of the tone quality is to be sure of the transformers you use. All transformers look pretty much alike, but builders and manufacturers know that performance tells another story.

There is something more to a good transformer than windings, a core and a coat of enamel. Transformer building is a science and only specialists of wide experience should attempt it.

Sangamo — with 30 years' experience in manufacturing electrical precision instruments, has unsurpassed facilities for producing audio frequency transformers that are a guaranty of the most satisfactory amplification over the entire musical frequency scale.

*Transformers that match the tubes and speakers with which they work—the Sangamo Audio Line includes specially designed equipment to exactly match specific types of tubes and speakers.*

## SANGAMO ELECTRIC CO.

SPRINGFIELD, ILLINOIS, U. S. A.

Sangamo Electric Co. of Canada, Ltd., 183 George St., Toronto

*For 30 years preeminent manufacturers of electrical precision instruments*

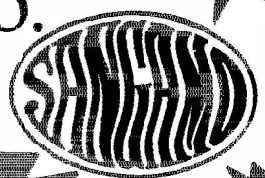

# To manufacturers with an eye to the service problem

*"The standard line of Sangamo Fixed  
Condensers leaves the factory tested  
to maximum variation of 10%!"*

Sangamo standards of precision carried  
into the manufacture of Fixed Condens-

ers, have made it possible for manufac-  
turers to eliminate much of the trouble  
ordinarily caused by the imperfect  
operation of condensers. The internal  
loss is low and insulation nearly infinite  
in Sangamo Condensers. They are accu-  
rate and they *stay* accurate.

## The Sangamo Type "A" Condenser

Every sound characteristic is affected by  
the quality of the fixed condensers in a  
set. Sangamo builds accurate mica con-  
densers, molded within an overall enclo-  
sure of genuine bakelite with only the  
terminals brought outside. Moisture,  
heat, shocks or jars will not alter their  
characteristics nor affect operation after  
the set leaves the factory.

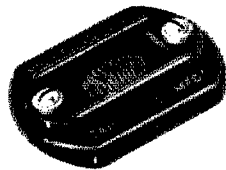

Sangamo Type "A" Condenser—solidly  
molded in bakelite and immune to ther-  
mal or atmospheric changes.

## The Sangamo "Illini" Condenser

This new condenser is of the same qual-  
ity as the standard Sangamo Fixed Con-  
denser—but is of a size and shape that  
more readily adapts itself to factory pro-  
duction. The greater convenience of con-  
necting lugs which may be bent to any  
position without danger to the condenser  
can readily be appreciated.



The new Sangamo "Illini" Condenser—  
for manufacturers' use only.

All prices on request

Pin this to your letterhead and mail.

- SANGAMO ELECTRIC CO., Springfield, Ill., U. S. A.  
Dept. 4421(Sangamo Electric Co. of Canada, Ltd., Toronto)
- (For manufacturers) Please send engineering data on  
your transformers and condensers.
  - (For dealers) Please send data on Sangamo Condens-  
ers.
  - (For set builders) Please send circulars describing your