

QST

DEVOTED ENTIRELY TO

AMATEUR RADIO

PUBLISHED SINCE 1915 BY THE AMERICAN RADIO RELAY LEAGUE INC.

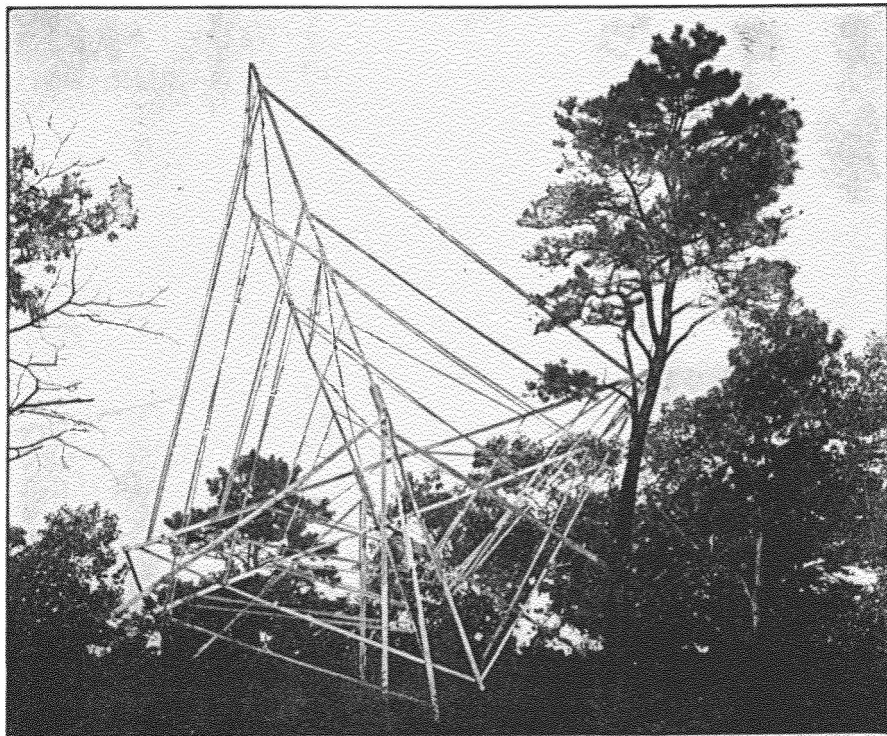

EXPLORING THE MYSTERIES OF HIGH-ANGLE RADIATION
Experimental Antenna at ICCZ—In This Issue

OCTOBER

1928

25¢

Power Transformers

and Chokes

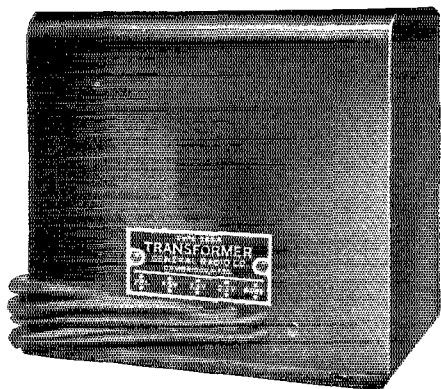

TYPE 565-A TRANSFORMER

PRICE
\$13.50

The Type 565-A Half-Wave Transformer is rated at 200-watts. The primary is designed for 110-120 volts, 50-60 cycle AC. Secondaries of 600 volts for plate, $7\frac{1}{2}$ volts rectifier tube filament, $7\frac{1}{2}$ volts power tube filament, and $2\frac{1}{2}$ volts are provided.

The General Radio Company is prepared to supply the amateur complete equipment for the construction of heavy duty power supply units. This line consists of large and medium size power transformers, chokes, voltage dividers and miscellaneous small parts such as sockets and rheostats.



Bulletin No. 930

On Request



GENERAL

30 STATE ST.
CAMBRIDGE, MASS.

RADIO

274 BRANNAN ST.
SAN FRANCISCO, CAL.

COMPANY

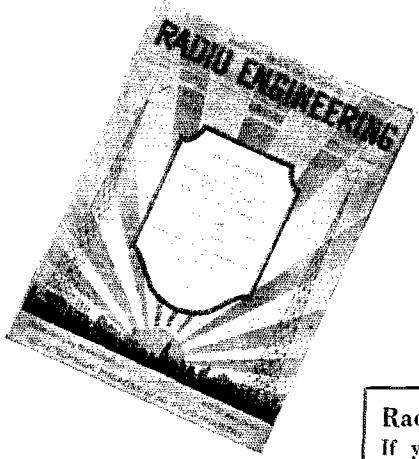

Editor
M. L. Muhleman

Managing Editor
G. C. B. Rowe

Associate Editors
John F. Rider
Austin C. Lescarbours

Radio Engineering is NOT sold on newsstands. If you are not already a subscriber use coupon below.

An interesting section which appears each month in Radio Engineering is that headed "CONSTRUCTIONAL DEVELOPMENTS." It contains technical reviews, prepared by the designers of the apparatus or recognized engineers—not assembly articles—just schematic, parts list, photographs and a few hundred words of technical description. In the last issue, are the following:

We also publish
"Aviation Engineering"

•

Subscription Rates the same as Radio Engineering

- The Hammarlund-Roberts "Hi-Q29". *By H. M. Kelley.*
- The S-M 720 "Screen-Grid Six". *By McMurdo Silver.*
- The Skyscraper. *By Clifford Denton.*
- The Metropolitan Screen-Grid 5. *By M. Seidman.*
- Transmitter Construction Hints for 1929. *By Frank A. Gunther.*
- The Elements of Television Reception. *By D. E. Reptogle.*
- The R-P-L A.C. Receiver. *By F. A. Jewell.*
- A 250 Power Amplifier Combination. *By William H. Fortington.*
- The Aero "Metropolitan" Four. *By Bert E. Smith.*
- "Halldorson Shield Grid 56 Receiver."
- The Screen-Grid Four. *By Robert Frank Goodwin.*
- A New High Quality Resistance-Push-Pull Audio Amplifier. *By Joseph Morgan.*

FOR YOUR CONVENIENCE IF YOU ARE INTERESTED

RADIO ENGINEERING MAGAZINE, Inc.
 52 Vanderbilt Avenue, New York, N. Y.

Enclosed find { \$2.00 for 1 year / \$3.00 for 2 years } subscription to Radio Engineering.

Enclosed find twenty cents (20c) for which send sample copy of Radio Engineering.

Name _____
 Address _____
 City _____ State _____

PLEASE PRINT NAME AND ADDRESS

Please Check Your Classification

- Manufacturer
- Dealer or Distributor
- Engineer
- Professional Builder
- Service Man
- Technician

Anything Else _____

Distance Range—The Keynote of This Remarkable D. X. Receiver

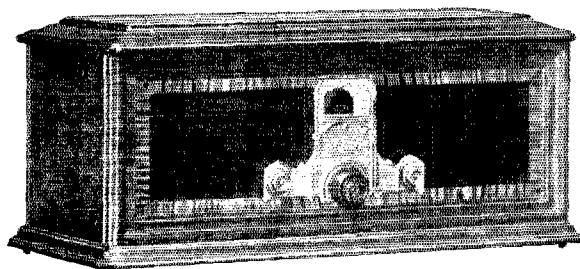

THE Federal F11 has demonstrated, beyond question, its supremacy as a distance getter. Operating at Buffalo, N. Y., it has verified reception on the broadcast band from JOAK Tokyo, Japan, 2LO London, England, PWX Havana, Cuba, and practically every distant station in this country.

Antenna-ground operation with four stages of tuned radio frequency, detector, and two stages of amplification combined with precise engineering, makes possible this phenomenal performance. Delicate hair-line tuning with a single dial, extreme sensitivity to weak signals, full shielding of each unit, including the individual tubes and a sturdy, precisely constructed all-metal chassis further distinguish this outstanding receiver.

Remarkable Federal Feats

A Federal Radio that was caught in the recent St. Francis flood in California lay under four feet of mud and water for two days. When it was salvaged, it operated perfectly without repairs or cleaning.

This model, in beautiful mahogany cabinet, may be had for either battery or light-socket operation. It is priced remarkably low considering the rigid engineering standards that have been maintained in its manufacture—for battery operation \$250, for light-socket operation with Federal's power tube coupler, 60 cycle \$360—25 cycle \$380. These prices do not include tubes and are slightly higher west of Rockies.

Ask the designated Federal retailer in your community to demonstrate this remarkable receiver or write direct for complete specifications.

FEDERAL RADIO CORPORATION, BUFFALO, N. Y.
OPERATING BROADCAST STATION WGR AT BUFFALO
Federal Ortho-sonic Radio, Ltd., Bridgeburg, Ont.

Federal ORTHO-SONIC* Radio

Licensed under patents owned and/or controlled by Radio Corporation of America, and in Canada by Canadian Radio Patents, Ltd.

* Federal's fundamental exclusive development making possible Ortho-sonic reproduction is patented under U. S. Letters Patent No. 1,888,476

See You Saw It In Q S T — It Identifies You and Helps Q S T

Section Communications Managers of THE COMMUNICATIONS DEPARTMENT, A. R. R. L.

Eastern Pennsylvania 3QP
Maryland-Delaware-District of Columbia 3AHS
Southern New Jersey 3CFG
Western New York 3PJ
Western Pennsylvania 3CEO

Illinois 9APY
Indiana 9CYO
Kentucky 9BAZ
Michigan 8CEP
Ohio 8RYN
Wisconsin 9VD

North Dakota 9DYM
South Dakota 9DGR
North Minnesota 9EGU
South Minnesota 9BYA

Arkansas* 5ARI
Louisiana 5UK
Mississippi 5AKP
Tennessee 4FI

Eastern New York 2ONS
N. Y. C. & Long Island 2KR
North New Jersey 2WB

Iowa 9DZW
Kansas 9CET
Missouri 9RB
Nebraska 9BYG

Connecticut 1ZL
Maine 1RIG
Eastern Massachusetts 1UD
Western Massachusetts 1UM
New Hampshire 1ATJ
Rhode Island
Vermont 1IT

Alaska WWDN
Idaho 7ACN-7JL
Montana 7AAT-7QT
Oregon 7PT
Washington 7FD

Hawaii 6CFQ
Nevada 6HO
Los Angeles 6AM
Santa Clara Valley 6NX
East Bay 6CZR
San Francisco 6VR
Sacramento Valley 6ORS
Arizona 6ANK
Philippines* 6PIAT
San Diego 6RQ

North Carolina 4SI
Virginia 3CA
West Virginia 3HD

Colorado 9CAA
Utah-Wyoming 6BAJ

Alabama 4AHO
Florida 4FK
Georgia-South Carolina-Cuba-Porto Rico-Isle of 4KU

Northern Texas 5AKN
Oklahoma 5AMO
Southern Texas 5OX
New Mexico 5TT

Newfoundland 3AB
New Brunswick 1ET
Nova Scotia 1DD
Prince Edward Island 1BZ

Ontario 9BJ

Quebec 2BE

Alberta 4HA
British Columbia 5BT

Manitoba 4FV
Saskatchewan 1FO

ATLANTIC DIVISION

J. B. Morgan, 2nd 431 E. Willow Grove Ave. Chestnut Hill, Phila.
Dr. H. H. Layton 803 Washington St. Wilmington, Del
M. J. Lorysh Box 49, RFD 1 Cranbury, N. J.
C. S. Taylor 598 Mason St. Buffalo
A. W. McAulry 599 Third St. Oakmont

CENTRAL DIVISION

Fred J. Hinds 3537 Oak Park Blvd. Berwyn
D. J. Angus 310 N. Illinois St. Indianapolis
J. B. Wathen 111, Box 97, R. F. D. 1 Louisville
Dallas Wise 9187 Falcon Ave. Detroit
H. C. Storck 694 Carpenter St. Columbus
C. N. Crapo 443 Newton Ave. Milwaukee

DAKOTA DIVISION

B. S. Warner 309 4th Ave. Enderlin
D. M. Fasek 730 Illinois St. Huron
C. L. Barker 5538 Third Ave. So. Hennig
D. P. Cottam Minneapolis

DELTA DIVISION

H. E. Vette 5408 U St. Little Rock
C. A. Freitag 129 Camp St. New Orleans
J. W. Gullett 1708 23rd Ave. Meridian
Folk Purdue 76 Radio Station WBAV Nashville

HUDSON DIVISION

F. M. Holbrook 2 Livingston Ave. White Plains
M. B. Kahn 617 W. 141st St. N. Y. C.
A. G. Wester, Jr. 59 Princeton St. Maplewood

MIDWEST DIVISION

H. W. Kerr Little Stou
J. H. Amis 915 Lincoln Ave. Tonka
L. B. Laizure 8019 Merrier St. Kansas City
C. B. Dehl 5665 Cedar St. Omaha

NEW ENGLAND DIVISION

C. A. Weldenhammer 33 Washington Place Bridgeport
Frederick Best 13 E. Crescent St. Augusta
E. L. Battey 39 Royal St. Wollaston
Dr. John A. Tessmer, 8 Schaffner St. Worcester
V. W. Hodges 227 Main St. Claremont
Clayton Pan'ette North Troy

NORTHWESTERN DIVISION

W. B. Wilson U. S. LBT Fern Ketchikan
James L. Young 503 13th Ave. So. Nampa
O. W. Viers Red Lodge
R. H. Wright 310 Ross St. Portland
Otto Johnson 4540 39th Ave. W. Seattle

PACIFIC DIVISION

F. L. Pullaway 2714 Manoa Rd. Honolulu
C. B. Newcombe Yerington
D. C. Wallace 109 W. Third St. Long Beach Calif.
F. J. Quement 232 Hanchett Ave. San Jose
J. Walter Prates 368 62nd St. Oakland
J. W. Patterson 400 Oeravia St. Apt. 29 San Francisco
C. P. Mason 2530 N. St. Sacramento
H. B. Lamb 229 W. First St. Mesa
Jose E. Jimenez 835 San Fernando St. Manila
G. A. Sears 236 Bonair St. La Jolla

ROANOKE DIVISION

Enno Schuelke R. F. D. - No. 1 Ridgeway
J. F. Wohlford 118 Cambridge Ave. Roanoke
C. S. Hoffman 126 Chantal Court Wheeling

ROCKY MOUNTAIN DIVISION

C. R. Steelman 1811 Athlon St. Denver
Parley N. James 430 "D" St. Salt Lake City

SOUTHEASTERN DIVISION

A. D. Trum 217 Catoma St. Montgomery
C. E. Ffoulkes 502 Spearing St. Jacksonville
Pine 11 Shadowlawn Ave. Atlanta
H. L. Reid

WEST GULF DIVISION

J. H. Robinson, Jr. 522 Cumberland St. Dallas
Glenn Morgan 763 Asp Ave. Norman
K. E. Franklin 1896 Valentina St. Houston
L. E. Radka Tucumcari

MARITIME DIVISION

Loyal Reid Avalon House St. John
T. B. Lacey 270 N. B. Power Co. St. John
W. C. Borrett 14 Sinclair St. Dartmouth
F. W. Hyndman 25 Fitzroy St. Charlottetown, P. E. I.

ONTARIO DIVISION

W. Y. Sloan 167 Close Ave. Toronto

QUEBEC DIVISION

Alex Reid 169 Logan Ave. St. Lambert

VANALTA DIVISION

E. J. Taylor 10107-87th Ave. Edmonton
E. S. Brooks 679 Forestry Dept. Radio Court House, Vancouver

PRAIRIE DIVISION

D. B. Sinclair 205 Cambridge St. Winnipeg
W. J. Pickering 514 19th St. W. Prince Albert

*Temporary officials appointed to act until the membership of the Section concerned choose permanent SCMs by renomination and election.

SERVICE

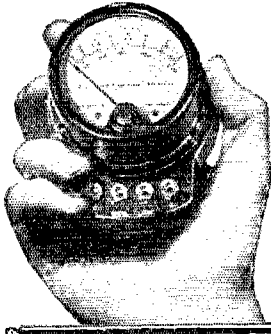

**Model
528**

Model 528 3 Range A. C. Voltmeter—150/8/4 volts. This compact little instrument (shown in hand above) is designed for line supply and filament voltage tests of A. C. receivers. A handy kit instrument, exceptionally accurate, light and durable. Contained in mottled red and black bakelite case.



**Model
537**

Model 533 Counter Tube Checker—Operates direct from an A. C. light socket or any other A. C. 60 cycle 90 to 130 volt source of supply. Requires no batteries. Will test every type of tube—A. C. or D. C.—having filament voltages of 1.5, 2.5, 3.3, 5 or 7.5 volts, including rectifying type tubes. Proper voltage regulation is quickly obtained by means of the voltage adjusting dial and the voltage indicator.

If you are interested in commercial servicing of radio receivers, you should investigate the unusual merits of the following Weston instruments—each one a testing authority in its specific field.

Model 537 A. C.—D. C. Set Tester: This is a complete servicing outfit that will quickly diagnose the trouble in any type of radio receiver set made—without the need for any additional equipment. It is provided with two 3- $\frac{1}{4}$ " diam. Weston instruments:—An A. C. 3-range voltmeter for measurements between 0 and 150 volts; a D. C. volt-milliammeter, 0 to 600 volts in four voltage ranges; and 0 to 150 milliamperes, in two current ranges—*equivalent to nine instruments.*

Filament, grid, plate and cathode voltages determined under actual operating conditions either with or without the tubes in the sockets and with normal voltages applied. General continuity tests and location of distortion in the audio system, due to tube overloading, are within the scope of the tester. A complete receiver installation, including power supply, can be tested in 15 minutes. Used for the determination of "shorts" between grid and plate, filament circuit continuity, filament current requirements, plate current drain, and general operating efficiency. It also serves as a rapid tube tester. Dimensions—9 inches square x 4" high. Weight—6 $\frac{1}{2}$ pounds.

This Weston Set Tester for dealer or serviceman makes radio servicing a most profitable enterprise. Also an ideal unit for those whose experimental or operating interests demand a comprehensive and compact testing equipment. Also note the special services offered in the following new Weston instruments. For complete description and test characteristics of all instruments designed by Weston for radio service, write for your copy of Circular J— just off the press.

WESTON ELECTRICAL INSTRUMENT CORPORATION

602 Frelinghuysen Ave.

Newark, N. J.



Model 533

WESTON RADIO INSTRUMENTS



QST



The Official Organ of the A.R.R.L.

VOLUME XII

OCTOBER 1928

NUMBER 10

Editorials	7
Kansas Midwest Division Convention	8
Amateur Television Waves	8
The Frequency Measurement Problem <i>Ross A. Hull</i>	9
The Central Division Convention	19
A Superheterodyne for High Frequencies <i>E. J. Gluck</i>	20
Receiver Characteristics and Their Measurements <i>V. D. Landon</i>	23
The Rocky Mountain Division Convention	30
High Angle Radiation <i>Paul S. Hendricks</i>	31
Election Notices	32
A Portable Crystal Controlled Transmitter <i>D. J. Angus</i>	33
Picking the Right Filter Condenser <i>Bert E. Smith</i>	37
1929 Abbreviations	41
The Duriron-Duralumin Electrolytic Rectifier <i>Norman F. Woldman</i>	45
Visual Radio and Its Possibilities <i>Milton A. Ausman</i>	48
What Length Antenna <i>James J. Lamb</i>	49
Calls Heard	50
I. A. R. U. News	51
Correspondence	52
Transmitting Hints	82

QST is published monthly by The American Radio Relay League, Inc., at Hartford, Conn., U. S. A.
Official Organ of the A.R.R.L. and the International Amateur Radio Union

Kenneth B. Warner (Secretary, A.R.R.L.),
Editor-in-Chief and Business Manager

F. Cheyney Beekley,
Managing Editor and Advertising Manager

Harold P. Westman,
Technical Editor

Ross A. Hull,
Associate Technical Editor

David H. Houghton,
Circulation Manager

Subscription rate in United States and Possessions, Canada, and all countries in the American Postal Union, \$2.50 per year, postpaid. Single copies, 25 cents. Foreign countries not in American Postal Union, \$3.00 per year, postpaid. Remittances should be by international postal or express money order or bank draft negotiable in the U. S. and for an equivalent amount in U. S. funds. Entered as second-class matter May 29, 1919, at the post office at Hartford, Connecticut, under the act of March 3, 1879. Acceptance for mailing at special rate of postage provided for in section 1103, Act of October 3, 1917, authorized September 9, 1922. Additional entry as second-class matter, acceptable at special rate of postage provided for above, at Springfield, Mass., authorized September 17, 1924.

Copyright 1928 by the American Radio Relay League, Inc. Title registered at United States Patent Office.
Member of the Radio Magazine Publishers' Association.

The American Radio Relay League

The American Radio Relay League, Inc., is a non-commercial association of radio amateurs, bonded for the promotion of interest in amateur radio communication and experimentation, for the relaying of messages by radio, for the advancement of the radio art and of the public welfare, for the representation of the radio amateur in legislative matters, and for the maintenance of fraternalism and a high standard of conduct.

It is an incorporated association without capital stock, chartered under the laws of Connecticut. Its affairs are governed by a Board of Directors, elected every two years by the general membership. The officers are elected or appointed by the Directors. The League is non-commercial and no one commercially engaged in the manufacture, sale or rental of radio apparatus is eligible to membership on its board.

"Of, by and for the amateur", it numbers within its ranks practically every worth-while amateur in the world and has a history of glorious achievement as the standard-bearer in amateur affairs.

Inquiries regarding membership are solicited. A bona fide interest in amateur radio is the only essential qualification; ownership of a transmitting station and knowledge of the code are not prerequisites. Correspondence should be addressed to the Secretary.

DIRECTORS

- | | | |
|---|---|---|
| <i>President</i>
HIRAM PERCY MAXIM
Drawer 2102,
Hartford, Conn. | <i>Dakota Division</i>
C. M. JANSKY, JR.
Dept. of Elec. Eng., U. of Minn.,
Minneapolis, Minn. | <i>Pacific Division</i>
ALLEN H. BARCOCK
65 Market St.,
Southern Pacific Co.,
San Francisco |
| <i>Vice-President</i>
CHARLES H. STEWART
St. David's, Pa. | <i>Delta Division</i>
BENJ. F. PAINTER
424 Hamilton Nat'l Bank Bldg.,
Chattanooga, Tenn. | <i>Roanoke Division</i>
W. TREDWAY GRAVELY
Box 246,
Danville, Va. |
| <i>Canadian General Manager</i>
A. H. K. RUSSELL
5 Mail Bldg.,
Toronto, Ont. | <i>Hudson Division</i>
DR. LAWRENCE J. DUNN
480 East 19th St.,
Brooklyn, N. Y. | <i>Rocky Mountain Division</i>
PAUL M. SEGAL
Box 1971
Denver, Colo. |
| <i>Atlantic Division</i>
DR. EUGENE C. WOODRUFF
234 W. Fairmount Ave.,
State College, Pa. | <i>Midwest Division</i>
PORTER H. QUINBY
817 Lauderman Building,
St. Louis, Mo. | <i>Southeastern Division</i>
HARRY F. DOBBS
c/o Dobbs & Wey Co.,
245 Spring St., N. W.,
Atlanta, Ga. |
| <i>Central Division</i>
CLYDE E. DARR
187 Hill Ave., Highland Park,
Detroit, Mich. | <i>New England Division</i>
DR. ELLIOTT A. WHITE
Dartmouth College,
Hanover, N. H. | <i>West Gulf Division</i>
FRANK M. CORLETT
2515 Catherine St.,
Dallas, Tex. |
| | <i>Northwestern Division</i>
K. W. WEINGARTEN
3219 No. 24th St.,
Tacoma, Wash. | |

OFFICERS

- | | |
|---|---|
| <i>President</i> | HIRAM PERCY MAXIM, Hartford, Conn. |
| <i>Vice-President</i> | CHAS. H. STEWART, St. David's, Pa. |
| <i>Secretary</i> | KENNETH B. WARNER, Hartford, Conn. |
| <i>Treasurer</i> | ARTHUR A. HEBERT, Hartford, Conn. |
| <i>Communications Manager</i> | F. EDWARD HANDY, Hartford, Conn. |

ADDRESS ALL GENERAL CORRESPONDENCE TO THE EXECUTIVE HEADQUARTERS AT HARTFORD, CONN.

EDITORIALS

THE press in late August has been filled with reports of the purportedly false radio messages from the Rockford-Sweden fliers and the loud utterances of a gentleman prominent in aeronautics that he will seek a resolution demanding the cancelling of the 20,000 amateur station licenses in this country to protect the families of aviators from the cruel hoaxes of amateurs.

The distress signals and messages indeed seem to have been false, and their transmission fills every normal person with a feeling of righteous indignation. Only a person of dwarfed and twisted mind and heart could conceive and execute such an act. Whoever he is, wherever he is, he should be brought to justice and given the ample penalties provided by law for this offense.

But we are equally indignant that this matter should so freely have been attributed to an amateur, a thought apparently first planted in the public mind by a spokesman of America's largest radio communication company. What reason is there for thinking that such a thing was done by an amateur more than by any other class of operator? In these days of round-the-world signals on any power, where is there more reason for thinking that a United States amateur is any more responsible than a person of any other country?

We find it impossible to conceive that this act was done by an amateur operator. No licensed amateur in his right mind, knowing the heavy penalties provided, would do such a thing. Would an amateur who has spent years in obtaining proficiency in communicating, spent his money to build a station with no hope of monetary return, obtained his licenses under oath, be likely to violate that oath, commit a crime, jeopardize his station and his freedom and the repute of his whole fraternity? There are many thousands of persons in the world, many classes of radio operators and stations, from whom those signals might have come. They may, indeed, have been transmitted by some interest seeking to discredit amateur radio, to bring dishonor upon us and to discredit the remarkable accomplishments of amateur radio in maintaining contact with distant expeditions. To accuse amateur radio of this offense, without the slightest justification, is a rank injustice to the body which has contributed tirelessly of its energy and time in maintaining contacts with modern man's more spectacular adventures, not the

east of which contacts have been in the field of aviation.

Aviation apparently has much to learn about what amateur radio has done and can do for the man who flies. The amateur's history of accomplishment is replete with stories of his aid to air enterprise, as any file of QST's will show. Frequently the radio equipment of just such flights as this has been designed, built and installed and tested by amateurs, who then were the chief contact with the plane when it made its flight. We amateurs have often shouldered faults that should have rested upon others—the power company, poor receivers, even Old Mother Nature herself. Are we now to be blamed for all the false aviation messages that happen? What about these bottle messages, washed up on many a beach, a last message from lost fliers? Did we perpetrate these "heartless hoaxes" too?

It seems established that false signals were sent. Because we amateurs have been the chief sufferers from that occurrence, we are the worst enemy the sender of those messages has, whoever he may be. We want to find him if we can, whoever he is, wherever he is, and see that he gets what is coming to him. If he should turn out to be an amateur, and a member of this League, we would feel ashamed but it would make no difference. Certainly we don't want any such person in amateur radio. The A.R.R.L. therefore is searching for this offender, and offers a reward of \$500 for information which will lead to his conviction. Any person having the slightest inkling of the identity of the hoaxer will confer a favor upon the League by communicating with the Secretary. If it is an amateur operator, no honest and sincere amateur should have the slightest repugnance in exposing him, for he has done a dastardly thing and should be put where he will not cause further trouble. Whether he is a member of our organization or not, we want his scalp as quickly as we can get it—this year, next year, ten years from now.

EFFECTIVE October 1st the calls of all United States amateur stations are changed to begin with the letter "W" in the case of mainland stations and with the letter "K" in the case of stations in Hawaii, Porto Rico, Alaska and the Virgin Islands. Canadian amateur calls already have been changed to begin with the letters "VF".

The question now arises as to what we ought to do about intermediates. We are supposed to use the old standard intermediate "de" when our calls are changed. This will be very satisfactory between United States stations, between Canadian stations, and between a United States and a Canadian station. Anything additional would be superfluous. But what of the other countries where amateur calls have not yet been changed?—what should they do when working each other, and what should we do when working them? Our I.A.R.U. international intermediates have worked most splendidly for us when we had no other designation of nationality, but their use in connection with "de" and a call that of itself indicates nationality would be a ghastly combination. Can you imagine "5BY egnc de VE9AL"?!

We have given this subject considerable thought at Headquarters and believe we have a satisfactory solution. We are supposed to use "de" from now on in this country, and in but a few weeks, or a few months at most, the calls in other countries will be changed to demand the use of "de". It seems quite in order, then, that all of us should adopt a new plan in which the intermediate is "de". This will be possible if we regard the I.A.R.U. intermediate as a *prefix* instead of an intermediate. Then when the prefix is officially changed by the government concerned, the transition will be very easy. Consider England, for

example. We call them "EG" stations now, and we thing, for instance, of "eg5BY". What will be a more natural form of calling, from now on, than to say "eg5BY de VE9AL"? Then if England officially changes all amateur calls to begin with the letter "G", as is probable, it will be simply a matter of saying "G5BY de VE9AL".

We have been reluctant to propose a change in our I.A.R.U. intermediates which uses them other than as *intermediates*, but considering that these are times of change and that we are on our way towards the universal use of "de", it seems justifiable. We have in mind too that there will be some localities where the government will be very late in acting, or where perhaps there is no government control, and there our I.A.R.U. two-letter designations can continue to be used as the initial letters of calls, providing us automatically with a system to care for such contingencies. It also will be pleasant to have with us, for years to come, some little reminder of a system which has worked so sweetly for us as these old intermediates.

So that's the dope, fellows: "de" for an intermediate, official prefixes where they are assigned by governments, the old I.A.R.U. letters as a *prefix* until the governments act (or forever, if they don't act).

There! That's one more little 1929 problem solved. Wottalife we amateurs lead!

K. B. W.

Kansas Midwest Division Convention

October 12-13, Topeka, Kansas.

THE Kansas section of the Midwest Division is not going to be left behind this year insofar as a convention is concerned. The Kaw Valley Radio Club is sponsoring the event which will take place at Topeka, Kansas, on October 12th-13th, and it has the full approval of Director Quinby, who will be our guest of honor.

The meetings will take place at the Chamber of Commerce and the Banquet at the Hotel Jayhawk, and the best part of it all is that it is going to cost just \$2.50.

We also intend to have plenty of amusement and good talks on pertinent radio matters. J. E. Deines, 9CV, 940 Brooks St.,

Topeka, Kans., asks that you write him and just say: "I'll be there, O.M." That's all.

Amateur Television Waves

THE Federal Radio Commission on August 3d authorized the use, by amateurs, of television and picture transmission apparatus in the bands 1715 to 2000 kc. (150-175 meters) and 56,000 to 60,000 kc. (the 5-meter band), as forecast in our last issue.

All the amateur bands are open to telegraphy. Telephony is permitted in the bands described above and also from 3500 to 3550 kc. (84.5 to 85.7 meters). No provision has heretofore existed for amateur television and picture transmissions. Amateurs may now engage therein, without further authority, in the frequency ranges stated.

The Frequency Measurement Problem

Applications of the Monitor in Transmitter Setting and Signal Checking

By Ross A. Hull*

In view of the present off-band operation, it is not surprising that amateurs have been wondering how it will be possible for them to stay within the relatively narrow confines of the 1929 bands and to know definitely and at all times that the frequency of their transmitters is legal. As the fourth phase of the work of the A.R.R.L. Technical Development Program this problem has been given detailed examination. In this article the difficulties are discussed and some thoroughly practical solutions presented.

—Editor

IF the amateur is to operate his station satisfactorily in the coming year it is quite certain that he will have to add to his accomplishments the ability to determine definitely and at all times whether his transmitter is emitting a sufficiently constant and narrow band of frequencies and whether the frequencies are within the limits of the band. To transmit a signal which clutters up ten kilocycles of a 1929 band, the amateur will have to be insufferably inconsiderate. He will be scorned. To transmit a signal outside the band he will have to be dismally ill-advised. He will be pitied, for he will be doomed to extinction. Nothing is more evident than the necessity for the universal adoption of some method of checking the character of the signal and its frequency at all times. It is fortunate, then, that this undoubted universal necessity can be covered by the addition to the station equipment of a simple monitor—an inexpensive oscillator fitted with plug-in coils to cover the bands in which the transmitter is to be operated. So simple is the apparatus and so effective is it in checking the signal in character and frequency that we have failed to find any good reason why every sincere amateur should not make it his duty to place one in operation before the new year

rolls around. From which the mature *QST* reader will deduce that the writer is prepared to reiterate his plea for the general adoption of monitoring until such time as the typewriter gives out, and that the machine is standing the strain well.

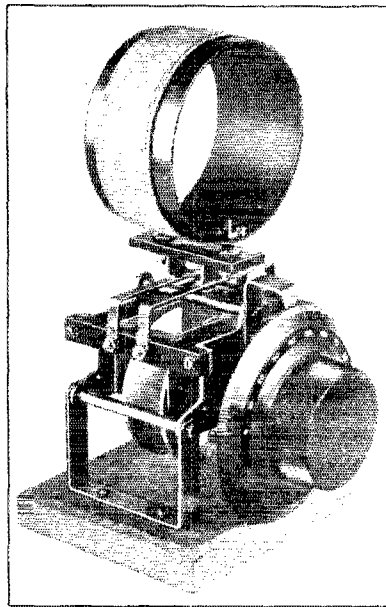

FIG. 1. THE "SERIES-GAP" FREQUENCY METER

FREQUENCY MEASUREMENT

It may seem strange that we should suddenly divert the discussion to the fields of frequency measurement, but we shall see, as the story develops, that monitoring and frequency measurement are very closely related. We hope to clear the air a little on the subject of frequency measurement in general in order to present more satisfactorily our ideas concerning the application of the "monitor box" in this work.

The frequency meter (or more correctly, wave meter) of the present day which has served to keep most of our stations within the limits of the bands, consists of a fixed inductance and a variable condenser so proportioned as to permit tuning over the bands, and calibrated more or less accurately. The meters have been inexpensive to buy, simple to construct, but, in the latter case, difficult to calibrate. No particular demands have been made on the accuracy of the instruments, since the bands were wide and off-wave operation was not a particularly serious offense. Plate milliammeters have been dipped, flash lamp bulbs

*Associate Technical Editor, *QST*. In charge A.R.R.L. Technical Development Program.

lighted or neon tubes glowed throughout the world of amateur radio with fairly complete satisfaction. Our objectives in the laboratory work on this subject were to make a thorough practical study of these methods, to determine just how far short

sequently in the calibration of the meter. The reason for this is that the capacity of such a condenser is inversely proportional to the product of the dielectric thicknesses. Referring to Fig. 2A, and assuming that the three plates represented comprise the variable condenser, the capacity of the condenser is proportional to $\frac{1}{d_1 d_2}$. It can be

seen that if d_1 and d_2 are each equal to 3 units of thickness, the capacity of the condenser will not be the same as when the rotor is displaced to the point where d_1 is 2 units and d_2 is 4 units.

THE "SERIES-GAP" CONDENSER

The condenser illustrated in Figure 1, based on principles expounded by the English experimenter W. H. F. Griffiths¹, is so arranged as to overcome this disadvantage

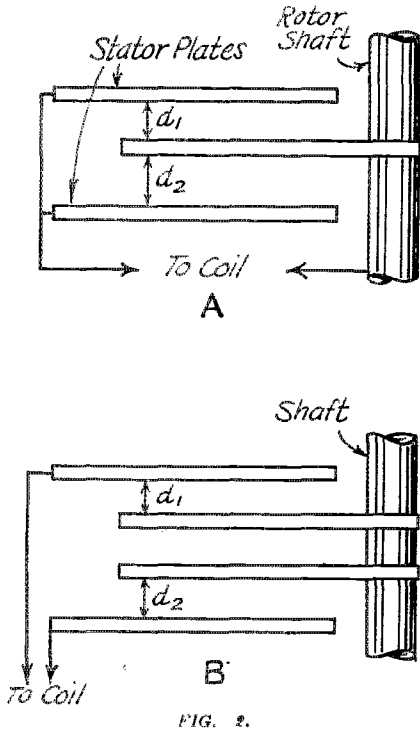

FIG. 2.

of 1929 requirements they fell, and to evolve if possible, modified but equally simple methods which would serve with complete satisfaction in the new year.

It became obvious at once that this year's meters will be unsuited primarily on account of the way in which the bands will be crowded into narrow segments of the dial, and that even if the capacity range of the condenser is decreased, full dial coverage can not be expected. Nevertheless a meter was built with a single low capacity range condenser in order to see just how open the scales could be for the various bands and how it would work out in practice. The meter is that illustrated in Fig. 1 and, since its condenser embodies a somewhat radical arrangement, we will treat it in some detail.

One disadvantage of the standard type of variable condenser when used in a frequency meter is that any longitudinal displacement of the rotor unit (in the direction of the rotor shaft) results in a change in the capacity range of the condenser, and con-

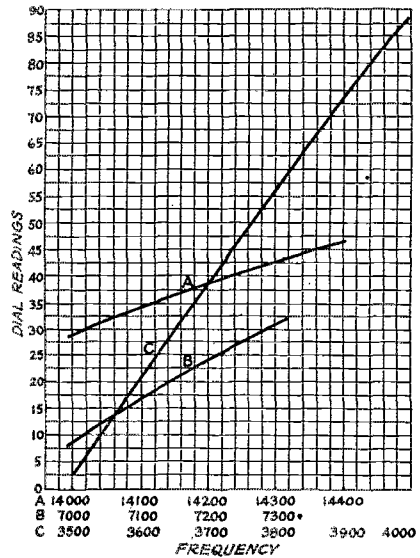

FIG. 3. CALIBRATION CURVES OF THE METER SHOWN IN FIG. 1.

Showing how a single capacity range variable condenser has the disadvantage of cramping the higher frequency bands on small segments of the dial in this case the 3500 kc. band occupies 85 degrees, the 7000 kc. band 33 degrees, and the 14000 kc. band 17 degrees.

by placing the dielectric gaps between the rotor and stator plates in series. The arrangement is that shown in Figure 2B and unlike the standard type of condenser it can be shown that its capacity is inversely proportional to the sum (not the product)

1. The Accuracy and Calibration Performance of Variable Air Condensers for Precision Wavemeters—W. H. F. Griffiths, A. M., I. E. E., Mem. I. R. E. (Experimental Wireless and the Wireless Engineer, January, 1924.)

of the two dielectric thicknesses. Since the capacity is proportional to $\frac{1}{d_1+d_2}$ and since d_1+d_2 is a constant, the change in capacity due to displacement of the rotor is avoided. In fact the rotor could be so far displaced as to place one rotor plate in contact with its adjacent stator without seriously impairing the calibration of the condenser, since in that case the capacity would be proportional to $\frac{1}{d_1}$ and d_1 would still be equal to the sum of d_1 and d_2 for any other setting. The condenser, which has been styled the "series-gap" condenser, was therefore considered promising for an amateur frequency meter, particularly as the arrangement could be provided cheaply by modification of existing standard condensers. For this particular meter a 500- μ fd. Cardwell taper-plate condenser was chosen

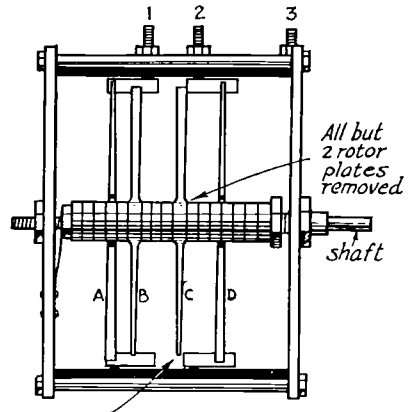

Stator mounting cut away to insulate the two remaining stator plates

FIG. 5. DETAILS OF THE THREE-CAPACITY-RANGE CONDENSER

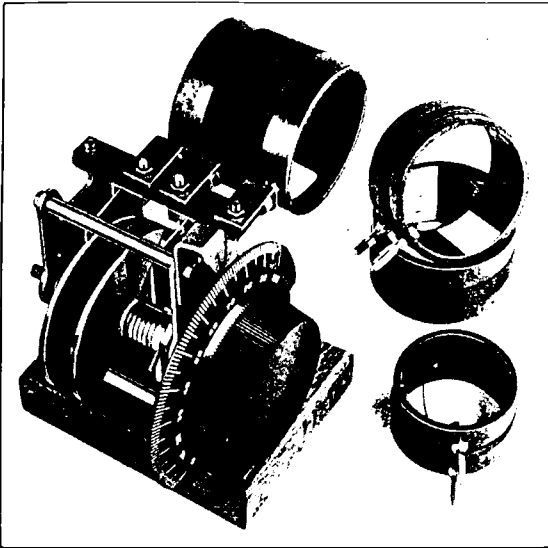

FIG. 4. A FREQUENCY METER HAVING ALMOST FULL SCALE COVERAGE FOR EACH BAND

The variable condenser, modified as shown in Fig 5 has three capacity ranges. The pins on the coils are arranged to fit into two of the three sockets so that the capacity range utilized is suited for the frequency band for which the coil was wound. The coils used in this particular frequency meter were:

Band	Turns	Diameter of Turns	Length of Winding
3,500 kc.	44	2 1/2"	1 1/16"
7,000 kc.	20	2 1/2"	7/16"
14,000 kc.	10	2 1/2"	7/32"
28,000 kc.	5	2"	1/8"

In all coils 24 gauge double silk wire was used. It must be understood that these coils will not necessarily serve for any other condenser. The dimensions are presented as a rough guide only.

on account of its suitability for conversion and because the heavy plates would be less

susceptible to bending and consequent disturbing of the calibration. The alterations consisted in removing all except two rotor plates (spacing them with washers from an ordinary type Cardwell) and in removing all except the two outer fixed plates which were separated by cutting away slices of the metal stator supports with a hack saw.

When a suitable spacing of the rotor plates had been obtained to give a full scale coverage on the 3,500 kc. ("80 meter") band the coils were wound and the instrument calibrated. The curves obtained for three bands are those shown in Fig. 3 and it can be seen that whereas readings could be obtained without difficulty on the 3,500 kc. curve and the cramped dial coverage on the other bands introduced difficulties.

SPREADING OUT ALL BANDS

In order to attempt to overcome these difficulties the meter illustrated in Fig. 4 was built. The condenser, which embodies the result of much mental gyration, is shown more clearly in Fig. 5. It is operated as a "series-gap" condenser for the 28,000 kc. and 14,000 kc. bands and as a standard type of condenser on the three lower frequency bands. For the two high frequency bands the inductance is plugged into the sockets 1 and 2 so utilizing a condenser of the type shown in Fig. 2B. The 7,000 kc. inductance is plugged into the sockets 2 and 3 so connecting it across the capacity given by the plates C and D. For the 3,500 and 1,715

kc. bands the coil goes into sockets 1 and 3 in which case the larger capacity between plates A and B comes into service. In practice, the scheme works out beautifully in providing open scales on all bands, as can be seen from the curves of Fig. 6. The mechanical arrangement of the condenser is similar to that illustrated in Fig. 1 with the

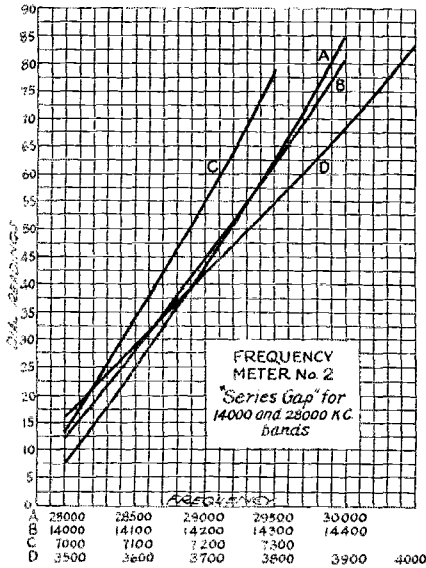

FIG. 6. CALIBRATION CURVES FOR THE METER SHOWN IN FIGS. 4 AND 5

It can be seen that each band occupies almost the whole dial.

difference that the three sockets are provided. Fortunately the location of these sockets is such that the separation between them is progressively greater as the capacity range increases, conveniently allowing wider coils where they are desirable for the lower frequency bands.

In the adjustment of the condenser the spacing of rotor plates B and C is varied by inserting or removing washers until satisfactory coverage is obtained on the 14,000 kc. band. Then the shaft is moved longitudinally (or the plates moved on the shaft) until the capacities given by plates CD and AB are suited for the 7,000 and 3,500 kc. bands respectively. This adjustment of the rotor is greatly simplified by the fact that, in accordance with the "series-gap" idea, it does not affect the capacity range obtained from the terminals 1 and 2 for 14,000 and 28,000 kc. work. The adjustment of the particular condenser described is such that the plates B and C are separated by four washers taken from a standard Cardwell condenser. The approximate separation of plates A and B, measured at the shaft, is $\frac{1}{4}$ " while plates C

and D are separated by $\frac{3}{8}$ ". This adjustment will not necessarily be satisfactory in a similar meter provided with coils of different distributed capacity but these figures will serve as a guide.

AN ALTERNATIVE METHOD

At this stage a third experimental meter was built, the scheme used to spread the dial readings being that of using fixed condensers across the higher frequency coils, so making the capacity of the variable condenser a progressively smaller percentage of the total capacity across the coil. This meter is illustrated in Fig. 7, its curves for four frequency bands being given in Fig. 8. The variable condenser was evolved from a 500- μ fd. Cardwell taper-plate, one stator and one rotor being left to do the work. Adjustment of its capacity range was simplified greatly by the fact that the single rotor plate could be moved towards or from the stator plate by adjustment of the shaft bearings once its approximate position had been set by the disposition of spacer washers on both sides of it. In the particular meter illustrated a spacing of $\frac{1}{16}$ ", measured at the shaft, was found desirable, though this dimension will not necessarily serve when coils of slightly dissimilar construction are used. The coils, described under the photograph, are so proportioned that the pins are spaced the same distance as the terminals of the Sangamo "loading" condensers used. In this way it is possible to screw the pins through the former and into the condensers, making a neat and inconspicuous mounting for them.

The fact that the frequency bands are spread so well across the dial makes the adjustment of the coil size quite a delicate proposition, and for this reason it is not possible to specify dimensions that will hold good in all cases. In building a similar meter it will be advisable to start off with a turn or so more than the number mentioned, giving the coil a light coat of Duco lacquer before its adjustment is completed. In the case of the high frequency band coils it can be expected that the adjustment must be carried to within half a turn or so if the band is to be located symmetrically across the dial.

OTHER TUNING SYSTEMS

By the time that these meters and other less satisfactory ones had been built we had become profoundly interested in the problem of building tuning circuits that would permit each of the various bands of odd widths to be spread across the dial. In our present meters and receivers on existent bands no difficulties are involved since each higher frequency band is twice the width in kilocycles of the band which preceded it. A tuning condenser which tunes any one band across most of its dial gives approximately the same open scale on all

other bands. In the case of the new bands this is not so for the bands are of dizzy widths having no such harmonic relation. A tuning condenser with a certain capacity range suited for one band will not be satisfactory for all others. We realized the inevitable importance of the problem of open scales on all bands in work on receivers yet to be done and could see that some of the gadgets evolved for frequency meter work might well be applied successfully in receivers. The arrangement illustrated in Fig. 4, for instance, in some slightly modified form might well be successful. We could see, however, that the scheme shown

unsatisfactory for frequency meter work (on account of possible inaccuracies in resetting of the rotor plate) is undoubtedly one complete answer to the receiver problem. This condenser was evolved from a 500- μ fd. National "Equitone" by removing all except one stator and one rotor plate and by mounting the latter on a sleeve or collar (cut from the old shaft of the same condenser). In this collar was mounted a set-screw to clamp the rotor on the shaft at predetermined positions. These positions were decided upon by setting the condenser at zero and winding a coil to tune to a frequency slightly above the edge of the band for this capacity. Then the condenser was turned to maximum and the rotor moved back and forth along the shaft until the circuit tuned to a frequency a little below the other edge of the band. As the position was determined for each band a countersink or conical impression was drilled in the shaft to take the set screw. In practice the scheme worked splendidly. When the coil in the receiver is changed the set screw on the rotor is released and the rotor plate slipped to the proper position, the set-screw then being given its half turn to hold the setting. The process is found to be thoroughly natural and straight forward and the time required to change from band to band, in addition to that necessary for coil changing, would not permit the blinking of two eyelids. But we must dismiss that side issue for the present.

THE METERS IN OPERATION

By this time we had obtained what we considered accurate calibration of the meters using, for the work, a number of crystals of established accuracy, wave meters of repute, and the received signals of commercial crystal controlled transmitters of known frequency. Weaknesses were found in our curves at many places but in general they were considered to be at least as accurate as the average amateur would get them. The problem was now to examine the degree of accuracy with which the frequency of a transmitter could be set or measured by them. And in this work there were some surprises in store for us.

The scheme employed for our examination involved setting a transmitter to zero beat with a crystal of known frequency and maintaining it in that condition while its frequency was measured by all the methods within the reach of the amateur. When

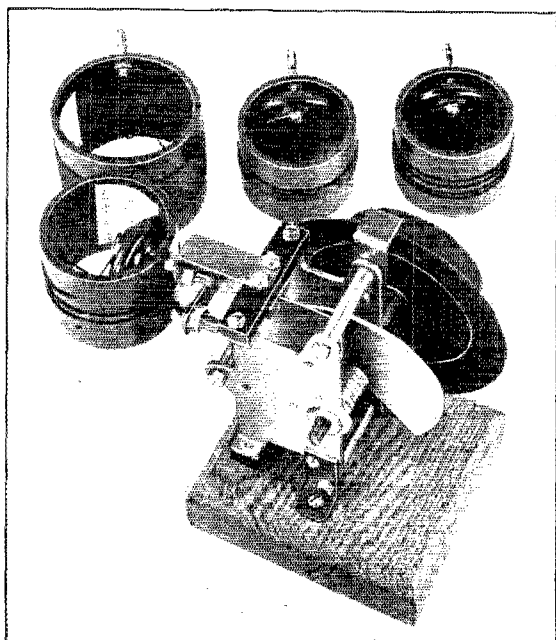

FIG. 7. A METER USING FIXED CAPACITIES ACROSS THE 7000, 14,000 AND 28,000 KC. BAND COILS TO SPREAD THOSE BANDS ACROSS THE DIAL.

The coils used with this meter are as follow:

Band	Turns	Dia. of Turns	Length of Winding	Fixed Shunt of Winding Capacity
3,500 kc.	40	2 1/2"	1"	none
7,000 kc.	9	2"	5 1/16"	100 μ fd
14,000 kc.	4	2"	1 1/2"	50 μ fd
28,000 kc.	2	2"	3 1/16"	50 μ fd

With the exception of the 3,500 kc. coil, which is wound with 21 gauge wire, 20 gauge double silk covered wire is used. These dimensions should serve as a rough guide but it is possible that may have to be varied considerably if a tuning condenser of slightly different capacity range is used.

in Fig. 7 would not be as promising since the inductance-capacity ratio goes down in jumps as the frequency is increased, and the receiver effectiveness is therefore impaired by a loss of detector grid voltage. On the other hand, the arrangement illustrated in Fig. 9, which was considered

possible, curves were plotted from the readings of the indicating device, as the frequency meter was tuned through resonance, in order to avoid any error resulting from

of coupling which undoubtedly have been and still are used by many amateurs. At the same time it should be noted that the frequency indicated in curve A—which is probably the most accurate of the group—is 35 kc. above that of the transmitter and that the indication of curve E is 70 kc. or about one per cent above the correct value.

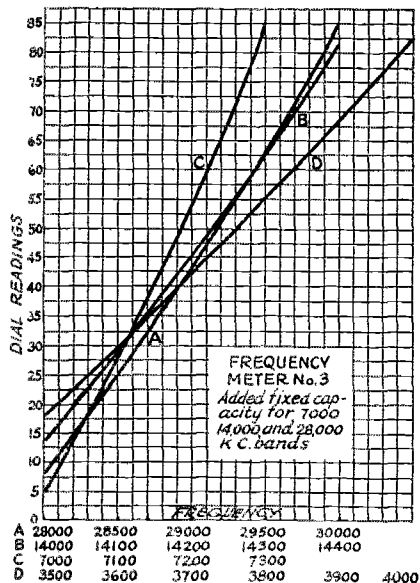

FIG. 8. CALIBRATION CURVES OF THE METER SHOWN IN FIG. 7

the more usual visual or aural estimation of the maximum or minimum readings of the indicator. At the same time, however, visual or aural estimations were made in order to check them with the actual maxima or minima indicated on the curves.

The results of the first run are shown in Fig. 10. The transmitter (an oscillator-amplifier) was first set to zero beat with the harmonic of crystal falling at 7,080 kc. Then an attempt was made to measure its frequency by the much used method of coupling the frequency meter to the plate coil and tuning the former until the plate milliammeter of the transmitter showed a deflection. In these runs readings of the plate current were taken for each setting of the frequency meter dial, the readings being afterwards plotted against the dial readings and the indicated frequency. The curves shown in Fig. 10 are for different values of coupling between the meter inductance and the plate coil of the transmitter, A being that of the minimum coupling attempted and E that of the maximum. It can be seen at once that the various peaks do not by any means coincide. The frequency indicated by curve E, in fact, differs from that of curve A by about 35 kc. or almost one half of one per cent, and yet both of them were taken with values

FURTHER SERIOUS ERRORS

When many similar families of curves had been taken under these conditions the transmitter was changed over to self-excitation and again adjusted to zero beat with the same crystal. With the same frequency meter and the same plate current deflection method the curves shown in Fig. 11 were taken. From curve A—for which the minimum coupling was used—the indicated frequency is of the order of 7,055 kc. differing by about .35 per cent from the transmitter, while in curve C, taken with a higher value of coupling the reading is 7,075 kc. which, through a combination of errors, is strangely close to the actual value. Curve D, taken with much greater coupling, is included to show the double humped curve ob-

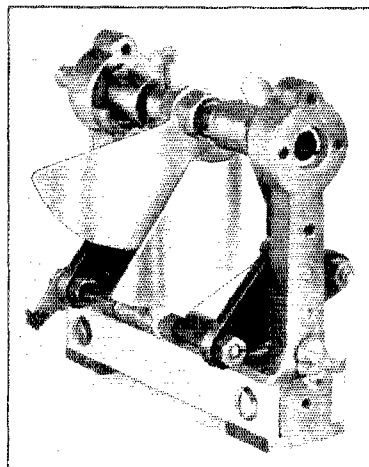

FIG. 9. A VARIABLE RANGE VARIABLE CONDENSER

The rotor plate, being mounted on a collar provided with a set-screw, can be moved to predetermined positions, so giving a number of different capacity ranges. It is one satisfactory solution to the problem of providing full-scale coverage on all bands in the receiver.

tained with excessive coupling and the consequent possibility of making a serious error by taking a reading at either peak. So far, with the same frequency meter, measuring a transmitter output of constant frequency, we had obtained readings differing by 100 kc. or one third of the width of the entire band!

At this time the frequency meter was fitted up with a three-turn pick-up coil con-

nected to a crystal rectifier and a milliammeter reading to 1.5 m.a. in the manner shown in Fig. 12. This device² provided an extremely sensitive indicating system, permitting much looser coupling between the frequency meter and the transmitter. After the calibration of the frequency meter had been checked the curves shown in Fig. 13 were taken with the transmitter still zero beating with the same crystal. In these curves the maxima appeared at points ranging from 7120 to 7160 kc. showing a variation of 40 kc. (about .5 per cent) and a maximum deviation from the transmitted frequency of 80 kc. or more than one per cent.

With the determination to find some means of making accurate use of the frequency meter calibration we again set the transmitter to zero beat with the crystal and, with the same frequency meter, proceeded to take readings by the method described by Aiken³. The scheme required the setting of a separate oscillator to zero beat with the transmitter, with the frequency meter coupled to the separate oscillator, but open circuited. It then required the tuning of the meter, and the consequent "pulling" of the oscillator, until the beat note had climbed from zero, fallen to zero

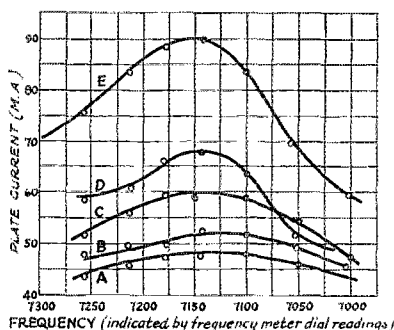

FIG. 10. THE FREQUENCY OF AN OSCILLATOR-AMPLIFIER AS INDICATED BY THE PLATE CURRENT DEFLECTION METHOD

A, B, C, D and E are curves of plate currents vs. indicated frequency taken with various values of coupling between the frequency meter inductance and the transmitter plate coil. The indicated frequency is seen to be higher as the coupling is reduced.

and again climbed. At the center of the zero beat area between the two peaks the reading was to be found. Some results obtained with this method with various values of coupling between the meter and oscil-

lator are shown in Fig. 14, the zero beat areas being shown by the horizontal lines with the approximate position of the peaks on each side. In this case the maximum variation in the indicated frequencies is about 75 kc. or about 1.06 per cent of the higher value. The reading as shown in curve A—obtained with the minimum coupling—is seen to be 7060, or about .28 per cent off the correct value. The reading G, however, is in error to the extent of 1.34

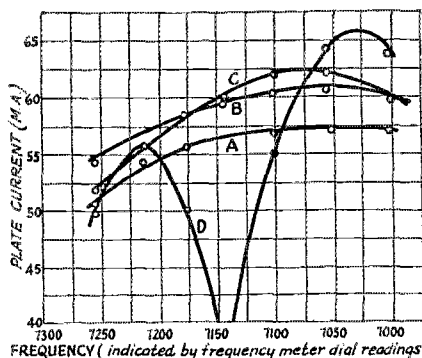

FIG. 11. CURVES SIMILAR TO THOSE OF FIG. 10 TAKEN WITH A SELF-EXCITED TRANSMITTER

Though the transmitter was adjusted to zero beat with the same crystal to which the oscillator-amplifier was adjusted, the indicated frequency is here seen to differ considerably.

per cent, and is, as it happens, well outside the band.

MORE EVIDENCE

A great many similar curves were taken with other indicating devices, including a vacuum tube voltmeter coupled to the frequency meter inductance, but they made us no less horrified at the errors which can be made with the frequency measurement

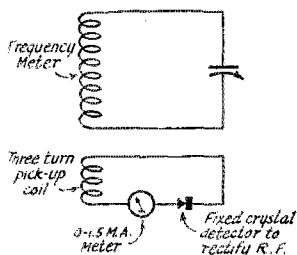

FIG. 12

2. An Improved Type of Wave Meter Resonance Indicator—Morris S. Strock, (Scientific Papers of the Bureau of Standards, No. 502)

3. A Precision Method for the Measurement of High Frequency.—Charles Bayne Aiken, (Proceedings of the Institute of Radio Engineers, February, 1928).

methods which are in such general use. We had endeavored to do the work with care—in just the way that the average sincere amateur would do it—and yet with the same meter, measuring a transmitter of constant

frequency, it could be considered as being on various frequencies between 7160 and 6985 kc.—values differing by 175 kc. or about 2.46 per cent of the actual frequency.

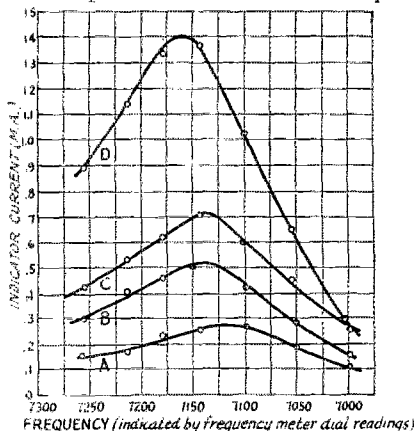

FIG. 13. CURVES TAKEN WITH THE INDICATING DEVICE SHOWN IN FIG. 12. Showing that the indicated frequency was still dependent upon the coupling between the frequency meter and the transmitter.

It could, if measured under different conditions and by different methods, be considered as well above the center of the band or 15 kc. below the bottom! And from our experiences we know that even this degree of "accuracy" will not be approached if the peaks are estimated instead of read from a complete resonance curve. It would seem quite certain that our existing meters, even though they may have been quite accurately calibrated, have given the same inaccuracies all along because they were not employed for taking a measurement under exactly the same conditions in which they were calibrated. It is just that the past practice of cramping several hundred kilocycles into a degree of the dial has failed to make the errors apparent.

Of course, we fully appreciate the fact that these figures may represent extreme variations of conditions which would rarely be found in average amateur work, but, on the other hand, we truly believe that the examples are sufficiently "true to life" to justify our decision that the amateur will have to realize fully the serious limitations of the conventional home built and calibrated frequency meter if he hopes to judge with its aid even whether he is within the limits of the band in which he is working. The fact that the error will not be of serious proportions if the meter is always used under the conditions in which it is calibrated makes us favor greatly the idea⁴ of using the meter coupled permanently to an oscillator, calibrated in that position, and

4. Director Woodruff, SCMP has, for some time, used and recommended a somewhat similar scheme.

read in the Aiken manner described before.

The wiring of such an arrangement is shown in Fig. 15. The frequency meter proper, which could be made similar to one of the meters described, is housed in one compartment of a shield which also houses a monitor. The coupling between the meter and the oscillator is made through a very small adjustable condenser which can be built in the manner of the condensers which have been so generally used to couple our antennae to our receivers. Before calibration this condenser is set permanently at some value which will permit the meter to exert sufficient "pull" on the oscillator. The calibration could well be accomplished by receiving the standard frequency transmissions and the signals of commercial stations of known frequency, setting the oscillator to zero beat with the receiver and the signal, and then finding the two peaks and the zero beat area on the frequency meter dial in the Aiken manner.

As a modification of this scheme ICEI has suggested that it may be possible to measure the frequency of the transmitter with greater accuracy and less equipment by providing the monitor with a frequency meter in the compartment adjoining it which tunes only over a band of frequencies from, say, 3,430 to 4,000 kc. Then, if the transmitter is on the 7,000 kc. band, it can be caused to beat with the second harmonic of the monitor, the position of the beat on 3500 kc. band being measured and the indicated frequency being multiplied by two to give the frequency of the transmitter. Similarly, if the transmitter is on the 14,000 kc. band it could beat with the fourth harmonic of the monitor, the location of the

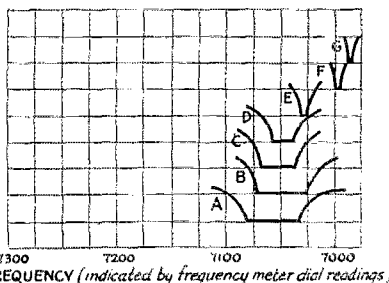

FIG. 14. SHOWING THE ZERO BEAT AREAS OBTAINED WITH THE AIKEN METHOD DESCRIBED IN THE TEXT

Though the transmitter was still at zero beat with the same crystal the frequency, indicated on the same meter used to obtain the previous curves, did not check. In addition it still varied as the coupling between the frequency meter and the oscillator was varied.

beat again being found on the 3500 kc. band and the indicated frequency multiplied by four to give the transmitter frequency.

THE MONITOR AS A FREQUENCY INDICATOR

For the average amateur, however, who has not resolved to set his transmitter on say 7,123 or 14,021 kc., but who is merely determined to be within the band and perhaps near the bottom, top or center, there is a beautifully simple method which involves the use of nothing more than the simple monitor box which we claim is so essential for the work of transmitter tuning. In this scheme the receiver is first switched on to locate the commercial signals of known frequency which undoubtedly will make the edges of the amateur band. When this has been done the receiver is tuned to the point within the limits set by these commercial "markers" at which the transmitter is to be located, and the monitor is then tuned to zero beat with the receiver. The setting of the transmitter to this frequency at this time is merely a matter of tuning it to zero beat with the monitor. In this manner the transmitter can be put definitely within the required section of the band and, if the monitor was built with care and calibrated with the receiver against stations of known frequency at the ends and within the band, there would seem to be no reason why the frequency setting could not be made with precision. Possibly it would be necessary to check the calibration of the monitor from time to time, to guard against variations due to the decay of batteries, but this would involve nothing more than beating it, in con-

from the transmitter is nothing more than a heavy rumble across the entire dial. In some cases, where the receiver and its batteries are completely shielded, the receiver can replace the monitor, but even then the antenna lead would have to be

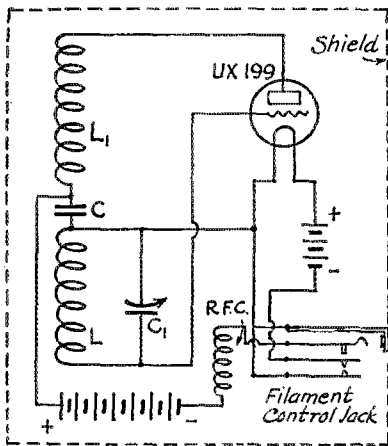

FIG. 16. SHOWING THE CONNECTIONS OF THE MONITORS ILLUSTRATED

- C—1,000 μ fd by-pass condenser.
- C1—Tuning condenser—see text.
- L, L1—Dimensions given under photographs of each Monitor.
- R.F.C.—Receiver type radio frequency choke. 150 turns of 32 gauge wire on $\frac{1}{2}$ " diameter dowel would serve.

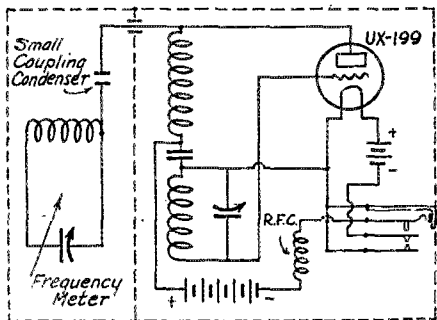

FIG. 15. THE WIRING OF THE COMBINED MONITOR-FREQUENCY METER

junction with the receiver, with a few of the known frequency stations. Conversely, any setting of the transmitter can be found on the monitor, and with the transmitter switched off, the frequency can be located on the receiver and its approximate frequency determined by its relation to known points on the receiver dial. It might be explained that the usual receiver cannot be used for this work without the aid of a monitor since the pick-up of the battery leads and external wiring, even when the tuner is shielded, is so great that the signal

removed when the transmitter is checked, so disturbing any settings made from known frequency signals received.

If there is a crystal within the station, the harmonics of which fall within the limits of the bands in which it is desired to work, it can be used with a UX-201A and 45 volts of "B" battery to provide the "last word" in monitors. With this scheme (suggested by Mr. Alfred Crossley of the Naval Research Laboratory) once can avoid the complications of crystal-controlling the transmitter, still maintaining an almost perfect check on its frequency.

Without doubt there are many other possible methods of setting the transmitted frequency within the band or measuring it accurately. We realize, full well, that with all our discussion we have but skimmed the surface of the field. One thing is certain, however—that the monitor, apart from being of great service in tuning the transmitter for a minimum of interference, is one complete, inexpensive and practical solution for the problem of keeping our transmitters within the limits of our own private territory.

MONITOR CONSTRUCTION

As we have said, the monitor need not be an elaborate or costly affair. Just how crude it can be is shown in the illustrations of the two examples on these pages—examples provided not to show the acme of monitor perfection but to demonstrate that a thoroughly practical affair involves no more constructional work than would occupy a Saturday afternoon.

The chief requirements of the monitor are that it should oscillate steadily over the bands on which the station is to be active; that the bands be at least fairly well spread over the dial so that tuning will not be excessively critical; and that the shielding be sufficiently complete, and the pick-up of the telephone cords sufficiently nullified, to permit the monitor to sit near the trans-

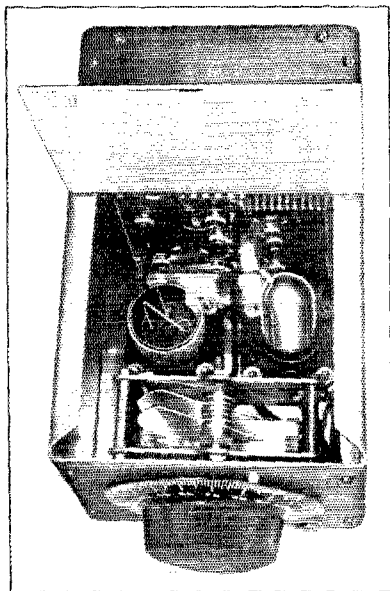

FIG. 17. ONE POSSIBLE ARRANGEMENT OF THE MONITOR

In this case a "C" battery is used for filament supply, so permitting a compact lay-out. With a three plate treble spaced tuning condenser and coils wound on tube bases the number of turns used was as follows:

Band	Grid Turns	Plate Turns	Wire
3,500 kc.	43	18	30 gauge
7,000 kc.	19	13	28 gauge
14,000 kc.	7	7	26 gauge
28,000 kc.	3	3	30 gauge

mitter, and to beat with its fundamental frequency without producing more than an R4 or R5 signal. The monitors illustrated fulfill these requirements.

The circuit used in both of them is given in Fig. 16. In it a UX-199 tube is connected in a split-coil series-feed Hartley

circuit, the filament being supplied from a 3-volt dry battery source and the plate from a small 22½-volt unit. The monitor shown in Fig. 17 is built in an aluminum shield. This shield is built up of 1/16" thick aluminum, the bottom and front being of one piece folded, the sides and back of another piece folded and the top of two pieces, one of them hinged to provide an opening to change the coils, tube or batteries. The apparatus was assembled on the piece constituting the front and bottom and, when the oscillator was in running condition, the sides, back and top were fixed in place with small machine screws.

The tuning condenser for this monitor was built from an eleven plate Cardwell condenser, plates being removed until one stator and two rotor plates were left. The rotor plates were treble-spaced in order to give just sufficient capacity range to bring the 3,500 kc. band within the limits of the dial. No arrangement was made to reduce the capacity range of the condenser for the 7,000 kc. or higher frequency bands and tuning on these bands is therefore rather critical. The coils, wound on tube bases, are described under the photograph. To reduce the effect of the pick-up from the phone cords a receiver type, radio frequency choke is inserted in one of the phone leads at the point shown on the circuit diagram. Without this choke the monitoring of the transmitter during adjustment is made difficult by the fact that the tuning of the monitor and the strength of signal produced by it vary greatly in accordance with any movement of the operator's body in the vicinity of the transmitter.

The monitor illustrated in Fig. 18 employs the same circuit as the smaller one but is fitted with large size dry cells for filament supply in order to make practical the continuous monitoring of all transmissions. It varies from that shown in Fig. 17 also in the arrangement of the tuning system. The main tuning condenser is a small vernier type with all but four plates removed. Its capacity is such that the 3,500 kc. band occupies almost the whole dial. On the 7,000 kc. and higher frequency bands the eleven plate vernier, mounted above it, and connected in parallel with it, is set at a predetermined value which reduces the effective capacity range of the main condenser to the point where the band occupies most of the dial. In order to do this, in this particular monitor, about half of the capacity of the larger condenser is added for the 7,000 kc. band and almost all of it for the 14,000 and 28,000 kc. bands. Either 22½ or 45 volts can be used on the plate, though the latter value was found desirable in order to give satisfactory oscillation on the 28,000 kc. band. The shield for this monitor is a Loose-Wiles biscuit tin measuring 8½"×9"×5½"—a size which

just leaves reasonable breathing space after the larger batteries and the two tuning condensers have been installed. As can be seen from the photograph the apparatus, with the exception of the variable condensers, is mounted on a wooden base $\frac{3}{4}$ " thick. When the leads to the condensers have been removed this base slides out of the shield, so facilitating the changing of batteries or the tube.

INSTALLATION AND ADJUSTMENT

In operation, if the transmitter is on the same side of the room as the receiver, or is mounted near to it, the monitor can well

throw switch which connects the phone either to the receiver or monitor. The flipping of this switch can be done rapidly as a "change-over" to transmitting is made and the signal can be heard when transmitting much as it will be at the receiving end. In this way the usual pounding in the phones is replaced by a pleasant (we hope) R5 or R6 signal, so making for snappier and more readable sending. What is more important, however, is that the arrangement provides a continuous story of the transmitted signal. Not only will the location of the signal in the band be at all times apparent, but its character, be it splendid or hideous, will be exposed as a ceaseless stimulant for the pride or conscience of its owner.

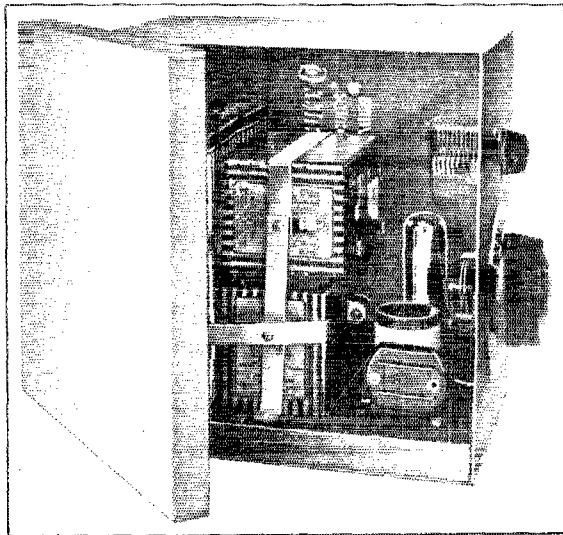

FIG. 18. AN ALTERNATIVE ARRANGEMENT SUITED FOR CONTINUOUS MONITORING OF THE TRANSMITTER

The use of two large dry cells for filament supply makes the monitor more bulky but permits it to give months of service without attention. Using a main tuning condenser of about 15µfd. and an additional 75µfd. condenser, adjustable to spread out the higher frequency bands in the manner described in the text, suitable coils were found to be:

Band	Grid	Turns	Plate	Turns	Wire	Added Shunt Capacity
3,500 kc.	40	15	30	none		
7,000 kc.	12	15	26	approx.		35µfd.
14,000 kc.	5	7	20	approx.		75µfd.
23,000 kc.	3	3	20	approx.		50µfd.

In this monitor also the coils are wound on tube bases.

sit on the table alongside the receiver where the phones can be plugged into it without any inconvenience. Adjustment of the amount of pick-up can be made when the most desirable placing of the instrument has been decided upon. The adjustment can be made effectively by varying the opening of the lid.

One scheme which we recommend very highly is the fitting of the receiver with a Yaxley or similar, small, double-pole double-

throw switch which connects the phone either to the receiver or monitor. The flipping of this switch can be done rapidly as a "change-over" to transmitting is made and the signal can be heard when transmitting much as it will be at the receiving end. In this way the usual pounding in the phones is replaced by a pleasant (we hope) R5 or R6 signal, so making for snappier and more readable sending. What is more important, however, is that the arrangement provides a continuous story of the transmitted signal. Not only will the location of the signal in the band be at all times apparent, but its character, be it splendid or hideous, will be exposed as a ceaseless stimulant for the pride or conscience of its owner.

fact that most ham stations in Columbus have that type of antenna speaks well for the research work done and results obtained. Communications Manager Handy had his hands full with so many meetings to cover and as usual was equal to the task. What Ed. does not know about radio isn't worth knowing; as evinced by the number of little groups that corralled him and plied him

(Continued on Page 40)

The Central Division Convention

THE Ohio Section convention held at Columbus on August 17-18-19, was a "whiz bang" and Storck, Windom and Gibb, the committee, covered themselves with glory.

Starting early Friday, delegates began to arrive from all over the state. Our log also shows hams from West Virginia and Pennsylvania, and we were glad to see some of the Chicago fellows present. By Saturday noon the registration exceeded the estimated attendance.

The committee seems to have been most fortunate in obtaining well known speakers. Our old friend, R. S. Kruse, formerly Technical Editor, QST, was in fine metal and in his inimitable way talked most interestingly on our amateur radio problems. L. C. Young, of NKF, presented a paper on "High Frequency Radio Wave Propagation" and with the showing of slides gave us a good picture of the interesting experimental work they do at Doc. Taylor's laboratory. L. G. Windom, 8GZ, was perfectly at home on the platform when he gave the paper prepared by J. F. Byrne on Hertzian Antennas and Feeder Systems in which he collaborated. The

A Superheterodyne for High Frequencies

By E. J. Gluck*

IT has been stated in *QST* that most of the broadcast stations are run by amateurs and this is to back it up. WBT at Charlotte, N. C. is such a station and so it became necessary to have a high frequency set next to the 1000-watt Western Electric broadcast transmitter and that resulted in problems.

Just considering one side of the case; we had to have a receiver that would "crawl under" a rather high noise level as well as being selective enough to work without a back ground of musical accompaniment. It is very annoying to try and make a "CQ" keep step with the latest dance number as a back-ground. So, many were the spools of wire and quarts of dope and yards of

shaft made of the fibre tune of a telephone fuse, the kind the telephone company uses at the lightning arrestor block in residences. A National Velvet Vernier dial turns the whole works. It might be remarked that this size condenser spreads the 7,000 and 14,000 kc. bands over the dial very nicely. As for the 28,000 kc. band, don't ask too many questions as it is probably too large. We may have more on that later as 28,000 kc. is our weakness now.

Now for the coils used. The 14,000 and 28,000 kc. coils are wound on celluloid and the 7,000 kc. coil is wound on a thin bakelite tube. Celluloid would probably be just as good but we happened to wind this coil on a thin bakelite tube. The tickler coils are

wound between the last two turns at the filament end of the secondary coil. Some may not approve of its being so closely coupled to the secondary but as the adjustment for oscillation is set once and then left alone, all the tuning being accomplished by means of the tuning condenser, the tuning effect of the oscillation control does not enter into the picture to any great extent. This type of winding makes a more compact coil.

While a small grid condenser was found to give somewhat better results as far as signal strength was concerned,

difficulty was had in making the circuit oscillate strongly over the whole of the 14,000 and 28,000 kc. bands. By increasing the size of the grid condenser this trouble was cleared up and its effects on the lower frequencies were not damaging enough to warrant the use of either plug-in condensers or a variable one. The value of the grid leak was not very critical and a 10-megohm unit was employed.

Feed-back is controlled by means of a 100,000-ohm Centralab variable resistor that is shunted by a 1-microfarad condenser which absorbs the clicks and noises that would be present when adjusting it.

The input transformer to the single stage of intermediate frequency amplification employing a screen-grid tube is an R. C. A. UV-1716 transformer with the small lamin-

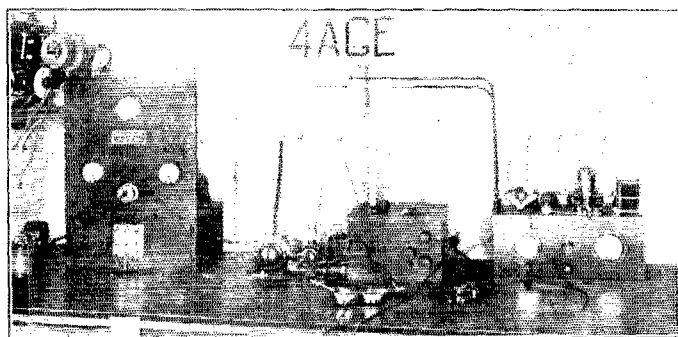

THE RECEIVER IS IN THE CENTER, THE BOX CONTAINING THE "SUPER" PORTION TAKING UP ABOUT AS MUCH TABLE SPACE AS DOES THE REGENERATIVE DETECTOR-ONE STEP

To the right is the 28,000 kc. transmitter and to the left is the power unit.

panel consumed in the search. The result is the receiver to be described, which fills the bill nicely, both from an operating standpoint and also from that of cost and simplicity.

The circuit is of a superheterodyne with an autodyne first and second detector. The intermediate stage is built in one compartment of the home-made copper box, and the second detector and audio stage in the other. Some may want to use this unit on their present short wave set but for the benefit of those who may care to have the details of our first detector (or regenerative short wave receiver which it is) we will go into it here.

The tuning condenser is a 15- μ fd., General Radio midget and is mounted 7" to the rear of the panel being operated by an extension

*4CQ-4AGE Engineer, WBT, Charlotte, N. C.

ated iron core removed and the secondary tuned with a 100 microfarad variable condenser. A 1-microfarad condenser connected between the rotor plates of this condenser and the low potential side of the secondary coil is to allow the rotor plate to be grounded and the low side of the secondary to be brought to the battery side of the rheostat which is not grounded, thus securing the necessary grid bias for the screen-grid tube.

The input transformer, tuning condenser for it and the screen-grid tube are mounted in the compartment to the left. A 1000-turn honeycomb coil shunted by a variable or semi-variable condenser (XL Variodenser or similar) with a maximum of about .0001 μ f. is connected in the plate circuit of the screen grid tube. The coil and condenser are placed in the larger compartment of the copper box. A 250-turn honeycomb coil is employed as a tickler coil so that the second detector will oscillate and thus give an audio frequency beat note.

For the benefit of those who cannot secure an R.C.A. UV-1716 transformer to be used as the input transformer, one may be constructed from the following data. The form to hold the winding is either of paraffin impregnated wood or of bakelite. It should be about $\frac{3}{4}$ " in diameter and a winding groove $\frac{3}{4}$ " wide and $\frac{7}{8}$ " deep is cut. The secondary is wound first and consists of 1000 turns of No. 28 d.c.c. wire. A couple of layers of paper are wound over this and then the primary of 250 turns of the same wire is put on. This secondary will tune to about 30 kc. when shunted by about .0015 μ f. This intermediate frequency has proven to be quite satisfactory and while a lower frequency seems to give a little better signal strength, the amount of noise is increased. A higher intermediate frequency will give reduced signals because of the necessity of greater detuning of the oscillating detector in order that the oscillation frequency and signal frequency have a greater frequency difference. 30 kilocycles has been found to

give satisfactory operation. The by-pass condenser across the phones and B battery in the plate circuit of the second detector is shown as being .0005 μ f. When using such a low intermediate frequency, this may be found to be too small and a thin high-pitched squeal will be heard as a signal is tuned in. By increasing the value of this condenser to about .001 or .002 μ f. the trouble can usually be corrected.

In this particular case, a single stage of audio frequency amplification is used, employing a "distortion type" transformer. It was found that a .00025- μ f. condenser shunted across its primary so tuned the circuit as to discriminate against a large amount of the extraneous noises. It is

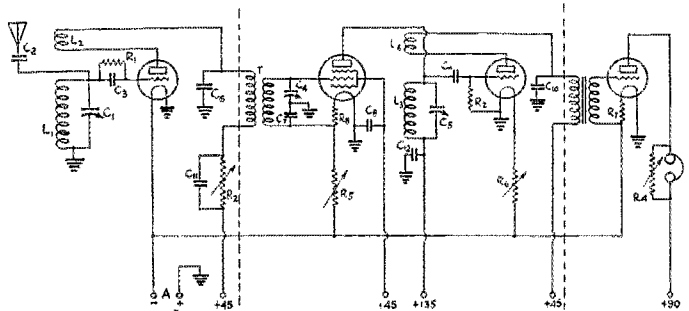

FIG. 1. THIS SHOWS THE SCHEMATIC CIRCUIT ARRANGEMENT

The equipment between the two dotted lines constitutes the intermediate frequency amplifier and the second detector. The other two tubes and their associate circuits comprise the normal autodyne detector and audio amplifier. If the primaries of the input transformer and the audio transformer are terminated with plugs and there are jacks inserted in the plate circuits of both the first and second detectors, the "super" portion may be plugged in or out as desired.

L1 is the grid coil and L2 the tickler coil for the autodyne first detector and the sizes are given herewith. The tickler coils are wound between the last two secondary turns except for the 7,000 kc. coil where it is close wound $\frac{1}{4}$ " from filament end of the secondary.

Band (kcs.)	Secondary Coil			Size	d.c.c.	Tickler	
	Diameter	Turns	Spacing			Turns	Size
23,000	1 3/8"	3	one diameter	18	d.c.c.	2	32 s.c.c.
14,000	1 7/8"	6	one diameter	18	d.c.c.	4	32 s.c.c.
7,000	1 3/8"	18	close wound	24	d.c.c.	3	32 s.c.c.
3,500	1 3/8"	33	close wound	24	d.c.c.	18	32 s.c.c.

- C1—15 μ fds.
- C2—Two, 1" square plates with adjustable spacing.
- C3—250 μ fds.
- C4, C5—100 μ fds.
- C6—500 μ fds.
- C7, C8, C11 and C12—1. μ f.
- C9—2,000 μ fds.
- C10—500 to 2,000 μ fds.
- L3—1000-turn honeycomb coil.
- L4—250-turn honeycomb coil.
- R1, R2—10 megohms.
- R3—0 to 100,000 ohms.
- R4—0 to 50,000 ohms.
- R5—20 ohms.
- R6, R7—30 ohms.
- R8—10 ohms.
- T—Input transformer described in text.

realized that there is much difference of opinion concerning the characteristics of the audio system and the individual operator should pick out that particular system which gives him the greatest pleasure.

Now for cranking the thing up. The first detector is set so that it oscillates over the entire tuning range and the second detector is adjusted to a point just below oscillation. The first detector tuning dial is now turned

until a good strong signal with plenty of modulation is tuned in. Then the two condensers tuning the input transformer and the plate circuit of the screen-grid tube are adjusted. A convenient method is to set the plate tuning condenser at about half its capacity and then adjust the input transformer condenser for maximum signal. It would be best to try reversing the con-

obtained. The same harmonic was then tuned in on the super arrangement and a good R8 or R9 signal resulted.

It is possible to work without any background while WBT is operating in the next room on 1000 watts. Our location here is such that the noise level is always high and with the super it rose to such a value that signals were apparently weaker proportionally than on the regular set. Several methods of band-pass filters were tried without much success. Finally we figured that the noise level was reaching such a stage that more or less paralyzation of the ear occurred and the signals, even though stronger, were not registering on the ear as being louder. With this idea in mind we connected a 50,000-ohm variable resistance in shunt of the phones and found that by adjusting this a point could be reached where the signals stood out over the noise better than they did with the detector—one step arrangement. Well, anyway, it works and this super doesn't know the difference between 7, 14 and 28,000 kcs.

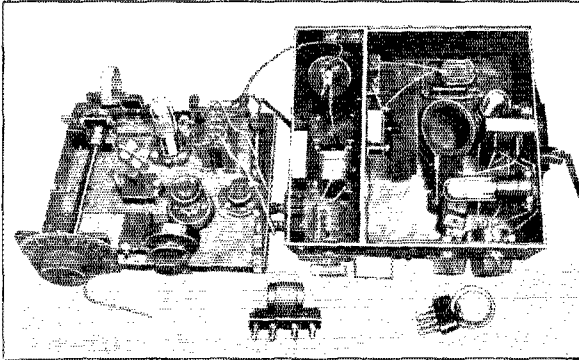

TO THE LEFT IS THE OLD DETECTOR AND ONE STAGE AFFAIR. THE DETECTOR PORTION OF WHICH IS NOW BEING USED AS THE FIRST DETECTOR

The tuning condenser may be seen in the upper left hand corner of the board with the tuning coil mounted just above it. The resistor for controlling regeneration is mounted at the front of the baseboard next to the dial that operates the tuning condenser. The copper box at the right contains the intermediate frequency amplifier, second detector and audio amplifier. The intermediate frequency amplifier input transformer, its tuning condenser, the screen-grid tube and the necessary bypass condensers are located in the narrow section to the left. The larger section holds the coil and condenser in the plate circuit of the screen-grid tube as well as the detector and audio circuits. The detector tube is mounted on the base while the audio amplifying transformer and tube are mounted on the side wall of the box.

nections to the transformer for when they are properly poled, maximum signals will be obtained. After these adjustments have been made, they are left alone and the set becomes a single control affair by simply using the tuning control of the first detector. For c.w. signals, the second detector is set oscillating by adjusting the tickler coil while for phone reception, the circuit is adjusted to give maximum regeneration without oscillating. This condition is not as difficult to maintain as is the usual case where the tuning of the circuit is altered.

The set is not particularly good for high frequency broadcast reception because it chops off everything but the middle register.

The screen-grid tube is capable of rather remarkable amplification as evidenced by the following experiment. We tuned in the seventh harmonic of our quartz crystal frequency standard on our old regenerative detector, one step. This set had been giving good results and about an R3 signal was

Strays

The trickle charger makes a splendid tube "pepper up", says Herbert Hunt. The dud tube is first "flashed" across the secondary of the charger transformer for one minute and is then aged across the output of the rectifier for ten minutes.

West Gulf Division Convention

WE are ready for you, fellows. The second annual West Gulf Division convention will be held under the auspices of the Dallas Radio Research Society at the Hilton Hotel, in Dallas, Texas, on October 19th and 20th, and a cordial invitation is extended to all amateurs to visit us during the two days of our activities. As our convention takes place during the last two days of the big Texas State Fair, amateurs all over the Southwest will have the benefit of very low railroad fare.

Our guest of honor will be K. B. Warner, Secretary-Editor, and as this will be the first time that Mr. Warner will be amongst us it is our desire to give him the biggest reception possible. We want you all to show up.

If you want any further information write to: Holmes Green, 5AQ, c/o W. A. Green Company, Dallas, Tex.

Receiver Characteristics and Their Measurements

By V. D. Landon*

A CERTAIN recent book called *Your Money's Worth* points out some of the fallacies of high pressure salesmanship, and the degree to which advertising has devoted itself to superlative adjectives rather than concrete facts regarding the product to be sold. Much radio advertising has been no exception to this rule in that a good deal of advertised data bears little resemblance to actual performance.

Nevertheless, a radio set is not a thing of mystery. Any property of a receiver that you may speak of is capable of direct measurement. A specification can be written covering receiver performance thoroughly. In fact such specifications are in use today. The Radio Corporation of America buys its radio sets from the manufacturing companies to specification, and any receivers not meeting the specifications in any particular are rejected and returned for repair.

This is a highly desirable condition and should be extended to the industry as a whole. The unfit would then be automatically eliminated and the manufacturer would benefit by increased sales and lower sales cost. The consumer would benefit by lower prices. This paper shows how the data for such a specification is obtained.

Receiver performance is a thing which cannot be measured quantitatively until certain arbitrary definitions and assumptions are made to give a meaning to the results obtained. Anyone can compare two receivers at a given location and make a definite statement as to which is the better. But if receivers are to be measured at different locations with different apparatus, it is necessary to be able to give a quantitative evaluation to each characteristic in order to make valid comparisons. To do this it is necessary to invent appropriate means and methods of measurement and to arbitrarily define the units in which measurements are expressed.

It was for this purpose that the Institute of Radio Engineers appointed a sub-committee on the standardization of receiving set tests. This committee has outlined these tests in a preliminary manner, but has not yet issued its report. Hence the

tests and methods of measurement outlined below may be changed before the report is issued.

The Radio Corporation and its associated companies, General Electric and Westinghouse, have set up an inter-company committee on this work also. This committee keeps in line with the agreements of the I. R. E. committee and at the same time has made a good start toward practical standardization. Every month a special receiver is circulated to each of these companies and measured. These measurements are then compared. Although agree-

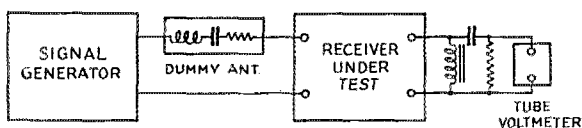

FIG 1

ment was not very good at first, it has become progressively better. Fairly good agreement is now obtained on all measured values. The three most important characteristics to be measured are sensitivity, selectivity and fidelity.

The following does not contain the exact wording of the definitions and test outlines as agreed on, but gives an idea of how tests are conducted and what the apparatus is like. In making measurements of any kind a radio frequency carrier is employed which is modulated 30% at an audio frequency. For all except fidelity measurements, the audio frequency used is 400 cycles. This value of 30% modulation at 400 was chosen as representing approximately the average condition in the average transmission.

SENSITIVITY MEASUREMENTS

In making a sensitivity measurement, the strength of the signal is varied until what is called "Standard Output" is obtained in the output circuit of the receiver. That is, one twentieth of a watt in a suitable resistor, the value of which is equivalent to the plate circuit impedance of the output tube. This value corresponds to a moderately strong loud speaker signal.

The first figure shows the arrangement of the apparatus. The output of the signal generator is applied to the radio set through a dummy antenna whose constants are standardized and are approximately those of an average antenna. The values

* In charge of radio measurements and radio frequency development at the East Pittsburgh laboratory of the Westinghouse Electric and Manufacturing Company.

chosen are 200 micro-microfarads, 20 micro henries and 25 ohms connected in series. The audio output of the receiver is measured by means of a tube voltmeter connected across the resistor. The choke and condenser are used to prevent direct current from flowing in the resistor.

It is a fact that the voltage induced in an

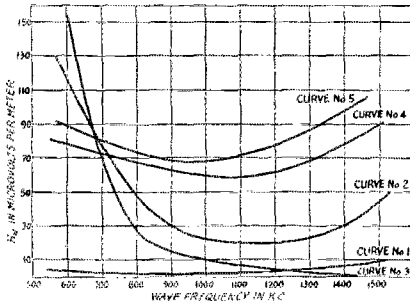

FIG. 2 SENSITIVITY

antenna is proportional to the field strength of the incoming signal. This voltage is also proportional to the effective height of the antenna. Hence, a convenient unit for measuring field strength is volts-per-meter or microvolts-per-meter for weak signals. This means the voltage induced in the antenna per meter effective height of the antenna.

Sensitivity is measured in terms of the weakest field strength which will cause the receiver to produce standard output. An effective height of four meters is assumed as characteristic of an average antenna. Hence, in practice the voltage applied to the dummy antenna is divided by four. The result is called the Normal Radio Field Intensity and is a measure of the sensitivity.

A curious feature is the fact that a smaller number means a greater sensitivity. Hence, sensitivity is defined as the reciprocal of the Normal Radio Field Intensity. However, this reciprocal is never taken. It is customary to speak of a receiver as having a sensitivity of fifty microvolts per meter. What is really meant is a sensitivity to give standard output with an input corresponding to a Normal Radio Field Intensity of 50 microvolts per meter. Twenty-five microvolts per meter means twice as sensitive a set as fifty microvolts per meter.

The second figure shows several typical sensitivity curves. The data for each of these curves are only taken at a few frequencies and then the smooth curve is filled in. The abscissa is the frequency to which the receiver is tuned at the moment. The ordinate is the field strength required to give standard output. Curve No. 1 denotes extremely good sensitivity, since a very

weak signal is sufficient to give loud speaker output. It will be noticed that some receivers are very sensitive at some frequencies and almost worthless at others.

It is an experimental fact that a sensitivity of about twenty microvolts per meter is all that can be used with comfort on an average night with a fairly good antenna. The only advantage obtainable through greater sensitivity is that a smaller antenna may be used. Signals below the level mentioned are usually unusable because of non-descript interference.

However, sensitivities of one or two microvolts per meter are sometimes usable on a very small indoor antenna. Hence, it is necessary to be able to measure such sensitivities. This means the production and measurement of a voltage as small as 8 microvolts at radio frequencies. The difficulties involved in generating and measuring such small voltages will be described later.

SELECTIVITY MEASUREMENTS

Selectivity is not as tangible a quality as sensitivity. It is difficult to rate the selectivity numerically, so it has become standard practice to draw a complete resonance curve to show this characteristic of the receiver. Such curves must be taken at several points to give a complete idea of the selectivity. It is standard practice to take these curves at 600, 1000 and 1400 kilocycles.

A sample curve is shown in Fig. 3. Here plotted in terms of output-versus-frequency with an input of fixed amplitude and variable frequency. This gives a curve with a peak at resonance and sloping sides.

The curves as taken now are just the inverse of this, giving a depression at resonance. This is obtained by varying the amplitude of the input in such a way that as the frequency is varied the output remains constant. The input required is then plotted against the frequency.

A sample curve is shown in Fig. 3. Here the resonant frequency is 1000 kc. Of course, stronger inputs are required for frequencies off resonance. The shape of the curve is a measure of the ability of the receiver to select a desired station without interference from others. To compare the curves of two different receivers, it is almost a necessity to plot the curves on the same sheet of paper. Even then they are not directly comparable until the ordinates of the two curves at resonance are made to coincide. It has been suggested that this be done by adjusting the sensitivity (by means of the volume control) to some standard value such as 100 microvolts per meter before the data for the curve are taken. Another method is to use a multiplier on the ordinates of each curve to bring the

resonance point to the bottom of the paper. Either method will result in curves which may be plotted on the same sheet of paper and made directly comparable.

It is often very desirable to be able to communicate information regarding the selectivity of a receiver by wire or by letter without sending an actual resonance curve. For this reason, it is becoming more and more common to speak of the width of the curve at certain points. The points usually chosen are those at ten, one hundred and one thousand times the value required for resonance. Thus, the width of this curve at 10 times normal input is 56 kc.; at 100 times 140 kc.; and at 1000 times 301 kc. This information tells practically the whole story and is easily sent by letter or wire.

Fig. 4 shows another curve that is sometimes used to illustrate certain points in regard to selectivity. In this curve the ordinate is the width of the resonance curve for 10 times normal resonance input. The abscissa is the frequency of resonance for the point in question. This graph gives a picture of how the selectivity varies with frequency. It will be seen that in the cases

of stations. A flattening of the curve such as in Curve 2 improves both these conditions. The value at 10 times the resonance value should not be less than 20 or sideband attenuation will result.

Modern receiver design is almost always a compromise between selectivity and fidel-

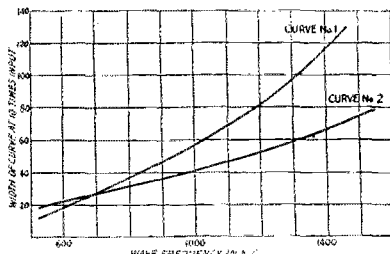

FIG. 4 COMPARISON OF SELECTIVITY CURVES

ity. Most receivers tune so sharply as to harm fidelity appreciably over most of the tuning range.

FIDELITY

Fidelity is another characteristic which requires a complete curve for proper expression. Fidelity means the ability to reproduce accurately the audio frequencies which are transmitted as modulations of the carrier. To take the data for this curve the signal strength is kept constant at normal and the percent modulation is held constant at 30% while the modulating frequency is varied over the audio frequency range. The output of the receiver at the varying audio frequency is measured and plotted in percent of that obtained at 400 cycles.

Some typical curves are shown in Fig. 5. As will be seen, the abscissa is the audio frequency being transmitted and the ordinate is the output corresponding to that frequency.

The range of audibility extends to about 17 thousand cycles for the average individual but it is generally agreed that frequencies above five thousand cycles are relatively unimportant. It can be seen however that most receivers do not pass five thousand cycles very perfectly. Fortunately it is difficult for an untrained ear to detect a lack of these high frequencies if other frequencies are intact. However, a curve as bad as that of number 1 would be noticeable even to a non-technical listener.

More serious is a lack of low frequencies as shown in number 2. This takes the naturalness out of the human voice though speech is still intelligible. The familiar cracked voice of the telephone is an illustration of this. Of course a lack of low frequencies is caused by a poor audio amplifier.

Occasionally a curve of the type of num-

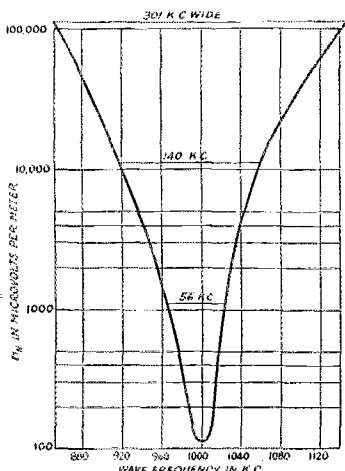

FIG. 3

illustrated it is necessary to detune from a strong local only a small amount at low frequencies but it is necessary to detune a relatively large amount if the local station is on a high frequency. Curve 1 indicates that the receiver is so sharp as to attenuate sidebands and decrease fidelity badly at 600 kc. while at the other end of the scale it is so broad as to prevent proper separation

1. This corresponds to the 56-ke. point of Fig. 2.

ber 3 is found, where a strong peak is found in some part of the frequency range. This is usually due to regeneration in the audio amplifier. It is very objectionable in a listening test, being best described as a hanging-on or a ringing out when certain notes are sounded. Curve 4 is a good average curve of a practical receiver.

Figure 5-A shows some more fidelity curves, which were all taken on the same receiver. The curves were taken at the three standard test frequencies 600, 1000 and 1400 kc. and show very clearly the

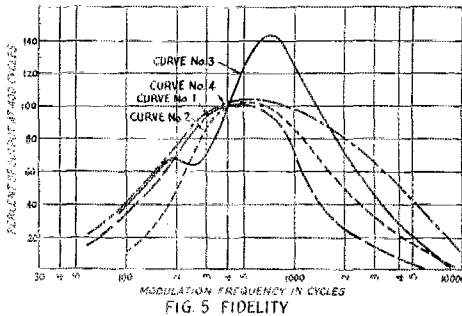

FIG. 5 FIDELITY

effect on the fidelity of the increased selectivity at low carrier frequencies.

MEASUREMENT APPARATUS

As pointed out before, it is impossible to make direct measurements on such very small voltages as are used for the radio frequency input to a receiver. To get a rough idea of how very small an amount of power is involved, it may be compared to the power in a loud speaker. A loud speaker operated at moderate volume takes very little power itself. For instance, it would take the power of 1000 loud speakers all operating in unison to equal the power consumption of a single 50-watt electric light. Nevertheless, the power required to operate a single speaker is enormous compared to the power required on the input to the receiver. In fact the energy consumed in one loud speaker for one minute of time is sufficient if in the form of radio frequency signals across their input circuits to run every radio receiver in the country for several hours.

It is foolish to try to make a direct measurement on such quantities. It is possible to make indirect measurement by the use of calibrated amplifiers but such things are not very accurate or dependable. The practical solution of the problem is to measure the signal at high intensity and then attenuate it by known ratios until the desired value is obtained. For this purpose a special attenuator has been made as shown in Fig. 6.

ATTENUATOR

Different manufacturers have different types of attenuators. The one shown here is that used by Westinghouse at East Pittsburgh. As seen from the figure the attenuator is of the resistance ladder type. The impedance from any step to ground is ten ohms, and the ratio from one step to the next is 10 to 1, so that with 100 milliamperes input current, there is one volt on the first step, one tenth volt on the second, one hundredth on the third, and one thousandth on the fourth.

A capacity attenuator of variable ratio is plugged in on any desired step of the resistance ladder and this further attenuates the voltage which is then applied to the radio set through the dummy antenna. The scale of the variable capacity is calibrated directly in ratio. Hence, the number representing the applied voltage is read directly from this scale. The step of the resistance ladder simply changes the decimal point. Of course careful shielding of the entire attenuator system is necessary. The resistance ladder is wound non-inductively on a long narrow card and inserted in a grounded brass pipe. The capacity attenuator is mounted in a brass box.

The values of the capacity attenuator were so chosen that it pulls down the voltage across the resistance attenuator by a negligibly small amount. To do this it is only

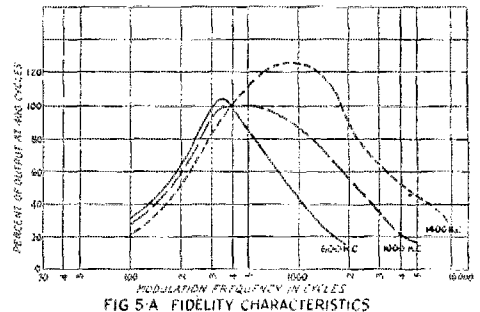

FIG 5-A FIDELITY CHARACTERISTICS

necessary to keep the reactance of the two condensers in series at least ten times the value of the resistance which it parallels, as this will only produce one-half of one percent error². This means that this reactance must be over 100 ohms. The lowest reactance occurs at the high frequency end of the scale with the variable condenser at maximum. Here the reactance is about 300 ohms so that it pulls down the voltage by only an extremely small amount.

² In such a circuit the line current is not the arithmetical sum of the currents in the branch circuits due to their being out of phase. The branch currents should be added vectorially and in many cases as in this one, the line current will be less than the arithmetical sum of the branch circuits currents.

The resistors for this resistance ladder were all simply calculated and the values measured with direct current applied. However, it is impossible to make a strictly non-inductive resistance. Hence, the accuracy of the ratios at high frequencies was subject to doubt until proven. This was done by checking the resistance ratio against the capacitance ratio and both against a current ratio obtained from an accurate thermocouple meter. In all cases a close check was observed over the entire broadcast range.

It was found, however, that for much higher frequencies the inductance of the resistors begins to make itself felt. This begins to make an error of a percent or so at about 80 meters. Of course, for shorter waves the error increases rapidly. Hence, a different arrangement is necessary for short waves. This will be described later.

The three related companies, Radio Corp. of America, General Electric Co. and the Westinghouse Elec. & Mfg. Co., have been cooperating in standardizing measurements with such measuring equipment as this. A receiver is circulated to each of four laboratories of these companies in turn once a month and the measurements made by the different companies are compared. At the last meeting the greatest deviation from the average sensitivity curve was 10%. This is considered very good in view of the fact that the set itself changes that much from day to day especially if the humidity varies.

R. F. OSCILLATOR

All measurements are made inside a shielded booth. This is simply a frame work of two by fours with copper mesh inside and out making two complete cages one inside the other. The oscillator is mounted on the outside on the wall of the booth. All controls extend into the booth and can be operated by one man. The meters are read through the copper screen. A sensitivity curve on a receiver can be run in about one minute after the receiver has been set up.

The oscillator circuit is illustrated in Fig. 7. It will be seen that neither the grid nor the plate circuits are a part of the tuned circuit except through inductive coupling. Also the grid and plate turns are rather low to limit the production of harmonics. Oscillation at the high resonant frequency of the grid and plate circuits is prevented by the use of the grid resistor as shown. This has but little effect at the relatively low frequencies of the broadcast band because less current flows in the grid-filament capacity. The condenser C4 and the inductance L1 may seem superfluous at first glance but it is through their use that constant output is obtained. If they are omitted the current drops off rapidly at the high frequency end of the scale. This is due to the increasing reactance of the main tuning reactor L4 at

high frequencies. To maintain the same current in the coil at all frequencies would mean that the voltage across the tuned circuit would be directly proportional to the frequency. The voltage across the coil does rise with frequency but not rapidly enough. Hence, the current drops off with frequency. The circuit L1-C4 acts like a current trans-

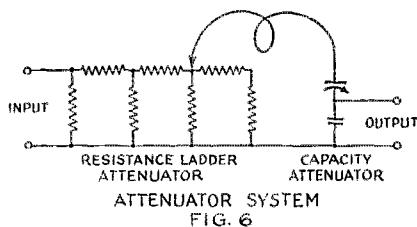

former whose ratio increases as its resonant frequency is approached. Hence, the drooping current at the high frequencies is brought back to normal.

An advantage of the system described over some of the others, is that it uses a very simple rugged current meter and the same value of current is used at all times. Some schemes require the use of large variations in current and this means a whole series of expensive thermo-couple meters.

The taking of selectivity curves is especially easy with this apparatus since the oscillator output is practically constant as the tuning is varied. Thus, it is only necessary to move a step on the resistance attenuator and detune the oscillator the required amount each side of resonance. The width of the curve at 10, 100 or 1000 times normal input is then read from the oscillator calibration. Frequency differences can be read quite accurately as the oscillator tuning condenser is driven by a worm gear of such a ratio that one scale division is about one kilocycle.

BEAT FREQUENCY OSCILLATOR

To take a fidelity curve it is necessary to be able to modulate the signal at a frequency which may be varied from 30 cycles to about 10,000 cycles.

The required audio frequency voltage is obtained from a beat frequency oscillator. The principle is to obtain a beat note between two r.f. oscillators, amplify the resulting audio frequency voltage and use it to modulate the radio frequency oscillator. The apparatus is worked out so that the audio frequency may be varied from 30 to 10,000 cycles by turning a tuning control 180°.

Fig. 8 shows the circuit of the beat frequency oscillator. A socket power unit supplying A and B power to all tubes is employed but is not shown on the diagram.

The two UX-226 tubes are the two r.f. oscillators. The UY-227 detects the beat note between the two frequencies and the resulting audio frequency is amplified by two stages of audio employing choke coil coupling. The chokes L6 and the condensers C4 and C5 are to filter out the r.f. components of the current.

The output circuit is formed by two UX-171 tubes in parallel for the purpose of obtaining a low output impedance and good

volume control setting-versus-sensitivity may be taken. This tells if there is sufficient range of control and whether or not adjustment is unduly critical. The effect of the volume control on selectivity and fidelity may also be investigated.

The possibilities are not confined to overall performance either. Measurements may be made on any portion of a receiver that is desired. This is of great importance to design engineers. For instance, if the overall fidelity curve is bad, a curve may be taken of the audio amplifier alone and then of the radio amplifier and detector alone, to see which portion of the apparatus is at fault.

MEASUREMENT APPARATUS FOR OTHER FREQUENCIES

Similar apparatus has also been designed and built for use in other frequency bands. One oscillator just completed covers the range of 600 to 20 kc. employing plug-in oscillator coils with about a three-to-one frequency range for each coil. The general circuit arrangement of this oscillator follows the one already described and hence needs no further explanation.

When an attempt was made to make such measurements at frequencies very much higher than the broadcast band, it was found that these circuit arrangements became impractical.

The greatest difficulty comes in the attenuator. If an attenuator is to have a constant ratio at different frequencies, it is necessary that it be made up of impedances which have the same ratio to each other at all frequencies, within the allowable limits of error. This means that if resistance is used, the series inductance must be so small that the

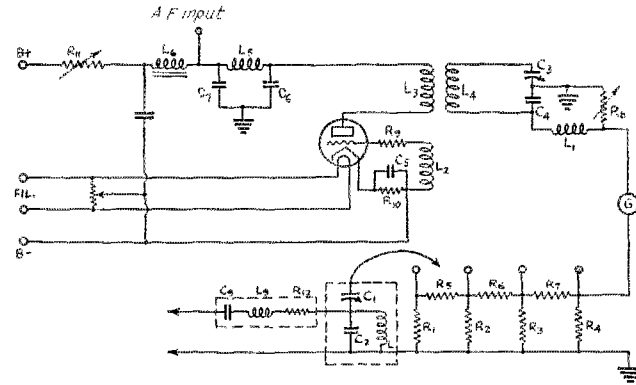

FIG. 7. THE RADIO FREQUENCY OSCILLATOR, ATTENUATOR AND DUMMY ANTENNA SYSTEM

Power supply for the oscillator is obtained from a standard socket power unit.

- C1.—550 μ fds.
- C2.—2400 μ fds.
- C3.—550 μ fds.
- C4.—1200 μ fds.
- C5.—1 μ f.
- C6, C7.—250 μ fds.
- C8.—2 μ fds.
- C9.—200 μ fds.
- L1.—50 millihenries
- L2.—20 turns of No. 30 enameled wire on $\frac{3}{8}$ inch form.
- L3.—30 turns of No. 30 enameled wire on 1 $\frac{1}{8}$ inch form.
- L4.—50 turns of No. 30 enameled wire on 1 $\frac{9}{16}$ inch form.
- L5.—30 turns of No. 30 enameled wire on 1 $\frac{1}{2}$ inch form.
- L6.—50 millihenries.
- L7.—20 μ h.
- R1, R4.—11 ohms.
- R2, R3.—12.2 ohms.
- R5, R6, R7.—29 ohms.
- R8.—10 ohms.
- R9.—2500 ohms.
- R10.—1500 ohms (for obtaining bias).
- R11.—Rheostat of 2000 ohms to control plate voltage.
- R12.—25 ohms.
- G.—Weston thermo-galvanometer (115 mils full scale.)

regulation under load. The output is applied to the B supply of the r.f. oscillator in the signal generator so as to modulate its output 30%.

OTHER TESTS

The above description is rather sketchy but should give some idea of the possibilities opened up to a designer of receivers, when such apparatus is made available.

The three tests described are the most important but there are many others that may be made to advantage. A curve of

effect of its reactance may be neglected over the working range. No matter how small this inductance may be, if it exists at all it will cause trouble if the frequency is raised far enough, because the reactance increases directly with the frequency. Inductance changes the impedance only about $\frac{1}{2}\%$ when its reactance is 10% of the resistance. A further increase however causes a fairly rapid change in impedance. The same sort of thing occurs if some shunt capacity is present around the resistor. That is, the capacity

decreases the total impedance by less than 1/2 of one percent, if its reactance is more than 10 times the value of the resistance. If the reactance becomes much less than that the impedance varies considerably.

If, on the other hand, a combination of capacities is used for an attenuator the inductive reactance of the leads of these ca-

shown in Fig. 9. The amount of error is reduced by reducing the number of elements in the attenuator where error might occur. This means measuring the signal at a much lower level using a more expensive meter of about one and a half milliamperes full scale deflection. As will be seen from the figure the IR drop across

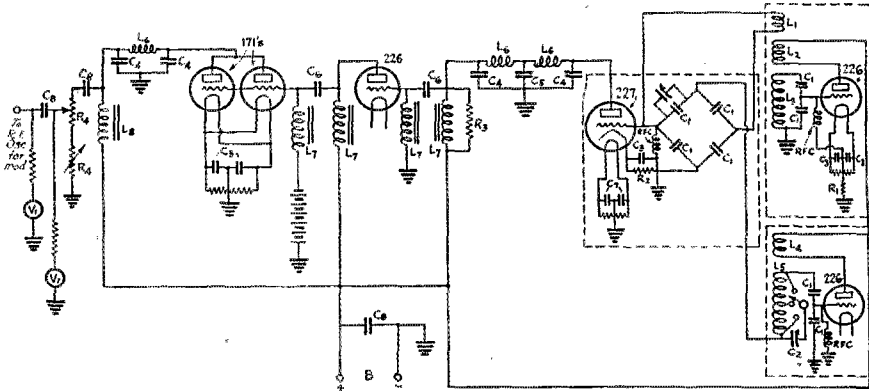

FIG. 8. BEAT FREQUENCY OSCILLATOR USED TO OBTAIN AUDIO FREQUENCIES BETWEEN 30 and 10,000 CYCLES

The two radio frequency oscillators are at the right and are coupled to the grid circuit of the detector tube through a capacity bridge arrangement that effectively prevents the output of one r.f. oscillator from dragging the other into step with it at the lower beat frequencies. A small variable condenser is connected across the smallest capacity to obtain a balance. Power is supplied from a standard socket power unit not shown, the three UX-226 tube filaments being connected in parallel. The 227 and 171 filaments are lighted from separate filament windings on the transformer.

C1.—1000 μfds.

C2.—350 μfds.

C3.—2 μfds.

C4.—250 μfds.

C5.—500 μfds.

C6.—.05 μfds.

C7.—5 μfds.

C8.—20 μfds.

L1.—95 turns of No. 25 enameled wire on a 2 inch form.

L2, L4.—55 turns of No. 25 enameled wire on a 2 inch form.

L3, L5.—190 turns of No. 25 enameled wire on a 2 inch form.

L6.—50 millihenries.

L7.—General Radio impedance coupler type 373.

L8.—30 henries.

R1.—500 ohms for obtaining bias.

R2.—4000 ohms for obtaining bias.

R3.—10,000 ohms.

R4.—2000 ohms.

V1.—d.c. voltmeter with resistor to measure plate voltage of the r.f. oscillator tube. This is not a definite part of the beat frequency oscillator but is mounted with it for convenience.

V2.—Thermal voltmeter employed to measure the output voltage of the system.

pacitors subtracts directly from the reactance of the condensers. It may be possible, however, to build a capacity attenuator of such a nature that the condenser plates are their own leads inside the attenuator, thus eliminating errors due to inductance almost completely.

Sufficient work has not been done to determine what type will be the best, or if any type will prove to be accurate at the very high frequencies.

A method which has been tried out is

a single resistor is fed to the capacity attenuator. The necessity for more attenuation is eliminated by the use of the more sensitive meter. One trouble is that flexibility of output is lost, the total range of output voltage being only about 60 to 1 as against 40,000 to 1 for the broadcast frequency attenuators. The equipment is fairly satisfactory for simple sensitivity measurements but has inadequate control of output for single stage work.

With this circuit at its best, however, very

serious errors are undoubtedly introduced when operated at 15 or 30 thousand kilocycles. The sources of error are as follows:

1. The current in the meter differs from the current in the resistor due to capacity currents.
2. The resistor is slightly inductive.
3. The inductance of the condenser leads reduces the capacity reactance and changes the ratio.

It has been suggested that a resistance ladder attenuator will be accurate even though somewhat inductive, provided the inductance is distributed in the various legs

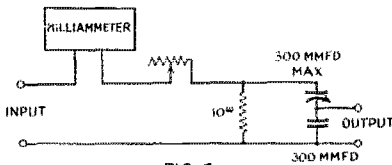

FIG. 9

in the same ratio as the resistance. This condition is quite difficult to obtain and eliminates but one of the sources of error. A great deal of work will be necessary before equipment can be developed for very high frequencies which has the flexibility and accuracy of the broadcast frequency equipment.

Of course, at present nothing has been done by way of standardization of the constants of the dummy antenna or of the assumed effective height at any other than broadcast frequencies. Furthermore, it may be difficult to obtain an agreement since there are such wide variations in the antennas used at present. All that can be done at present is to specify the overall amplification and the conditions of test. This may not be comparable to someone else's results under different test conditions, but at least, it may be duplicated by anyone who does use the same method of test.

Admitting the difficulties, nevertheless it certainly is time for the amateurs of the country to begin to rate their receivers in an accurate standardized way. Relative merit ought to be a matter of established fact instead of a matter of argument.

All that is required is a shielded booth, a modulated oscillator, a few meters and the patience necessary to build and calibrate an attenuator. The result will be positive knowledge where guesswork was before. Of course it will be best to start with the lowest frequency amateur band and include the others, one at a time, only after some experience has been gained.

The Rocky Mountain Division Convention

ANY of you ever see Glen Glascock in action? Well, you should have been at Pueblo, Colorado, during the two days of the convention, August 24th and 25th, held under the auspices of the San Isabel Radio Club and the able leadership of its Chairman, 9ENM.

Those who know Director Segal, can understand why everything ran according to the program. (Guess Paul threatened to prosecute some one if they didn't. Ed.) In the first place we are proud to say that we had the largest registration of any previous convention held in the division and when the chairman called the convention to order the stage was all set for attentive listening-in to the speakers. Mr. Louis A. Deesz, of the Colorado Fuel & Iron Co. gave a very enjoyable and useful talk on the "Electron Theory" and was followed by that well known Denver Ham, Glen W. Earnhart, 9CHV, who explained the many kinds of power supply in use. It was a good practical talk. After the electronic explosions and power supply fluctuations the whole assembly proceeded to the beautiful San Isabel National Forest where a real weenie fry was enjoyed by every one. The evening was spent at the local amusement park.

Saturday morning found everybody ready to visit the enormous plant of the Colorado Fuel & Iron Co. just outside of the city, and it proved most interesting. After a stag lunch the afternoon session started with the Traffic Meeting where L. R. Huber, Asst. to the Communications Manager, from Hartford, got his opportunity to tell us something about our 1929 problems. Good talks were given by M. O. Davis, 9CDE, Director Segal and C. R. Stedman, 9CAA, who acted as chairman of the meeting.

The Banquet, with Director Segal as Toastmaster, was most enjoyable and A. R. R. L. Representative Huber made the principal speech. The manufacturers again showed their cooperation by donation of valuable prizes which enabled us to close the convention in due form, meaning the proper distribution to winners of contests, thereby concluding the 3rd Annual convention of the Rocky Mountain Division.

—K. H. S. 9CAW.

Strays

Amateur Intermediates

Be sure to see the important announcement about new calls, intermediates and methods of calling, in this month's Editorial.

High Angle Radiation

The Experimental 28,000 kc (10 Meter) Beam Antenna at 1CCZ

By Paul S. Hendricks*

AS A contribution to the investigation of the possibilities of the 28,000 kc. band being undertaken by the A.R.R.L. Technical Development Program, Mr. E. C. Crossett, at whose summer home on Cape Cod 1CCZ is located, provided the experimental beam antenna illustrated. The antenna was built primarily to permit variable high angle radiation in somewhat the same manner as that described by Meissner¹. Meissner's experiments with a beam antenna on 27,270 kc. (11 meters) consisted in changing the angle of radiation in a vertical plane in order to

it was planned to endeavor to find the beam angle which would permit satisfactory contact with Australia—a distance over which one might expect 28,000 kc. to exhibit some

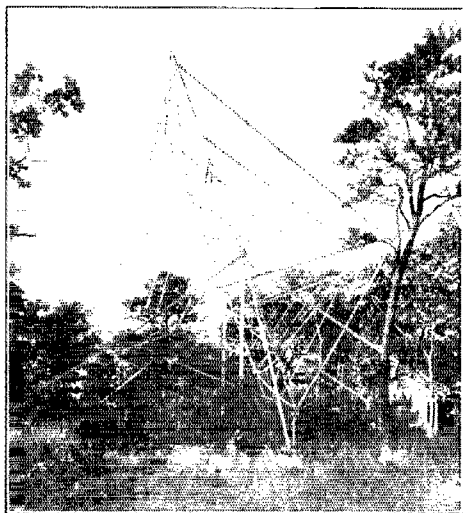

THE BEAM ANTENNA AND OPERATING SHACK AT 1CCZ

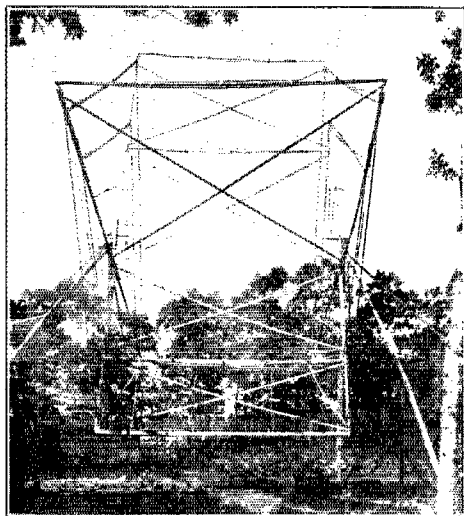

AN END VIEW OF 1CCZ'S 28000 KC. ANTENNA SYSTEM

of its useful characteristics. It was also planned to determine the possibilities, if any, of what has been jocularly referred to as the "Warner Splatter System".

The antenna system consists of a fundamental antenna, fed in the "Zeppelin" fashion, operating in conjunction with three reflector wires and two director wires arranged in the manner suggested by Uda² and Yagi³. The placing and dimensions of these wires is shown in Figure 1. The system is seen to be both complex and cumbersome and not particularly suited for the average amateur. The idea, however was not to attempt to build a truly practical antenna for general amateur work on 28,000 kc. but to put up a system strictly in

determine the particular angle at which the 11-meter signals could be heard best at Rio de Janeiro (the transmitter being at Nauen, Germany). Contrary to computations and theories, the 27,270 kc. frequency was found to be highly effective in daylight between these two points providing the angle of the beam was adjusted to approximately 38 degrees or 80 degrees from the horizontal. With a simple vertical antenna in place of the beam, signals were rarely heard and then only at very low signal strengths. In the experiments undertaken at 1CCZ (in progress at the time of writing)

1. *Directional Radiation With Horizontal Antennas*, by A. Meissner, Proceedings of the Institute of Radio Engineers, November, 1927.

2. *High Angle Radiation of Short Electric Waves*, by S. Uda, Proceedings of the Institute of Radio Engineers, May, 1927.

3. *Beam Transmission of Ultra Short Waves*, by Hidetsuga Yagi, Proceedings of the Institute of Radio Engineers, June, 1928.

*Wianno, Mass. Member Experimenters' Section A. R. R. L.

accordance with the present understanding of the requirements. In this way, it was hoped, the work of developing a practical antenna would be, to some extent, facilitated.

The antenna system is arranged on a line running from Cape Cod 14 degrees north of west, which corresponds to the Great Circle to eastern Australia. In the plane of this Great Circle the system can be rotated from horizontal on the one side to horizontal on the other by means of ropes. In this way the beam can be directed at any angle above the earth's surface.

The transmitter used to excite the antenna employs a UX-204-A supplied with 2000 volts from a full-wave tube rectifier. At present the transmitter is self-excited but it is probable that crystal-control will be incorporated in the near future.

During the month of September the transmitter will be operated on schedule with

Constitution. Your attention is invited to Sec. 1 of Article IV of the Constitution, providing for the government of A.R.R.L. affairs by a Board of Directors; Sec. 2 of Article IV, defining their eligibility; and By-Laws, 14, 15, 16 and 17, providing for their nomination and election.

2. The election will take place during the month of November, 1928, on ballots which will be mailed from Headquarters in the first week of that month. The ballots for each Division will list the names of all eligible candidates nominated for the position by A.R.R.L. members residing in that Division.

3. Nominating petitions are hereby solicited. Ten or more A.R.R.L. members living in any Division have the privilege of nominating any member of the League in their Division as a candidate for Director. The following form for nomination is suggested:

(Place und date)

Executive Committee,
A.R.R.L. Headquarters,
Hartford, Conn.

Gentlemen:

We, the undersigned members of the A.R.R.L. residing in the Division, hereby nominate of as a candidate for Director from this Division for 1929-1930.
(Signatures)

The signers must be League members in good standing. The nominee must be a League member in good standing and must be without commercial radio connections. His complete name and address should be given. All such petitions must be filed at the headquarters office of the League in Hartford, Conn., by noon of the first day of November, 1928. There is no limit on the number of petitions that may be filed, but no member shall append his signature to more than one such petition.

4. Present Directors from these Divisions are as follows: Central, Mr. Clyde E. Darr, Detroit; Hudson, Dr. Lawrence J. Dunn, Brooklyn; New England, Dr. Elliott A. White, Hanover, N. H.; Northwestern, Mr. Karl W. Weingarten, Tacoma; Roanoke, Mr. W. Tredway Gravelly, Danville, Va.; Rocky Mountain, Mr. Paul M. Segal, Denver; West Gulf, Mr. Frank M. Corlett, Dallas.

5. This is your opportunity to put the man of your choice in office as the representative of your Division. Members are urged to take the initiative and file nominating petitions immediately.

For the Board of Directors:

K. B. WARNER, Secretary.
Hartford, Conn., 1 September, 1928.

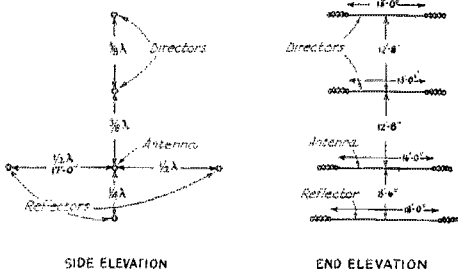

FIG. 1. SHOWING THE ARRANGEMENT AND DIMENSIONS OF THE WIRES

The dimensions given are those employed at ICCZ. They were computed for a frequency of 28,826 kc. (10.4 meters).

listeners in Australia and elsewhere but since these transmissions must terminate by the end of the month their inclusion would not be justified. At this time the organization of the schedules has only just been completed, but during the first two transmissions no reports from Australia were received. The signals however, were reported R6 by 7ACS at Tacoma, Wash.

ELECTION NOTICES

To All A.R.R.L. Members Residing in the Central, Hudson, New England, Northwestern (including Territory of Alaska), Roanoke, Rocky Mountain and West Gulf Divisions:

1. You are hereby notified that an election for an A.R.R.L. Director, for the term 1929-1930, is about to be held in each of the above Divisions, in accordance with the

A Portable Crystal-Controlled Transmitter

By D. J. Angus*

IF YOU knew that owning a crystal controlled transmitter didn't require a bulging pocketbook or any unusual skill in radio engineering, you probably would already have one in operation. It requires neither, and when the narrowing of the amateur bands makes it much more important for you to put out a steady signal, held accurately to one frequency, and having a note that is easily copied, you will probably take the leap.

There seems to be a mistaken impression, among those who have not used crystal control, that it is expensive, complicated and difficult to maintain in adjustment. The writer was one of these skeptics until he had by actual tests proven to himself that such was not the case. I believe that all

the wavelength of a self-excited transmitter have practically no effect on it. The accurately maintained frequency enables one to adjust the antenna system for maximum

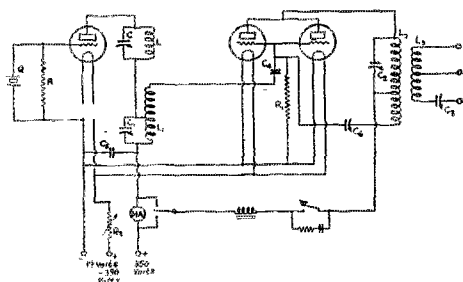

- C₁, C₂ and C₃—500 μfd. variable condensers.
C₄ and C₆—100 μfd. variable condensers.
C₅—100 μfd. fixed condenser.
C₇—1 μfd.
L₁—17 turns No. 18 d.c.c. wire on 2.5 inch form.
L₂—16 turns No. 18 d.c.c. wire on 2.5 inch form tapped at center.
L₃—10 turns No. 15 d.c.c. wire on 2.5 inch form tapped at seventh turn.
L₄—18 turns No. 15 d.c.c. tapped four turns from end and wound on same form and separated by about 1/2-inch from L₂.
R—500,000 ohms.
R₁—Variable resistor, Bradley 'E'
The dimensions of the key-thump filter are not given as they may vary with different installations.*

wide-awake operators should take advantage of crystal control, especially those trying to maintain schedules and handle traffic.

The additional expense for crystal control should be limited to the cost of the crystal, one or two UX-210 tubes and the grid leaks and meters. Practically all of the remaining apparatus can be found in the scrap pile of the average amateur station.

The crystal controlled transmitter is extremely reliable since antenna changes which ordinarily would detune or change

radiation much more easily than when using a self-excited set, since the antenna adjustments do not appreciably change the frequency or other characteristics of the transmitter.

The advantages of crystal control show up especially well in stations handling traffic and maintaining schedules since the stations with whom they are working always find them in the same place with the same note, and receivers can be accurately adjusted to the tone which comes through QRM and QRN best.

At Indianapolis, stations 9CLO and 9CYQ (the writer's station) each have an extra crystal ground to the wavelength of the crystal the other station normally uses. If either operator is out of town and cannot meet his schedules, the remaining station substitutes the extra crystal and takes over the schedules without any prearrangement with the stations being worked.

To be reliable, a crystal controlled set must be controlled by a good crystal. Weak crystals have done as much as any other one thing to discourage the use of crystal

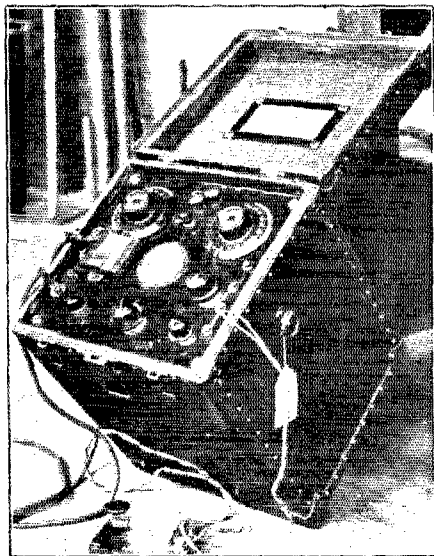

ALL READY TO GO!

*9CYQ, 810 Illinois St., Indianapolis, Ind.

control. When purchasing a crystal, the first thing to do is to be sure it is sufficiently live to make a satisfactory controlling element for the set. When placed in the circuit shown herein it should start oscillating

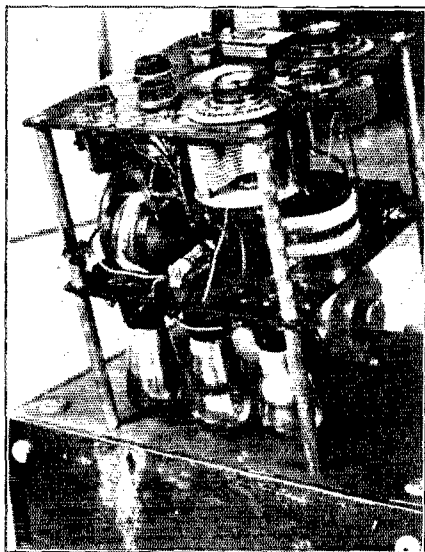

THE ONLY TWO SURFACES ONE IS SURE OF IN THIS SET ARE THE TOP AND BOTTOM; THE OTHERS MAY BE FRONT, BACK OR SIDE ALL DEPENDING UPON YOUR OPINIONS

This view shows the arrangement of tubes. The crystal tube is at the left and above it is L1 and C1. The long small diameter coil draped near L1 is not a choke but some resistance wire in series with the filament rheostat.

as soon as the plate tank circuit is brought nearly in tune with the natural period of the crystal. It should not need to be encouraged by a jar or by the use of a series inductance.

Some users of crystals advocate laying the plate of the crystal holder directly on the crystal, whereas others advocate a very slight separation, amounting to between .0005 inches and .002 inches. Both methods apparently work satisfactorily and since they do, it goes to prove that the plates between which the crystal is located need not be ground exactly flat. Plates that were rather rough showed practically the same output as plates that were perfectly smooth.¹ The plates should fully cover the crystal, because if the crystal extends beyond the holder, and is being worked to its

1. If the crystal is not of the very "live" type, it may not show the same disregard as to the surface of the plates. It would probably be better to make the plates reasonably smooth as this is not damaging under any conditions and may be quite helpful under some.—Tech. Ed.

maximum output, there is danger of cracking the crystal at the edge of the crystal holder plate. The plate should be made of any material which does not oxidize easily. German silver seems to be preferable, although copper or brass or any other similar alloy apparently works about as well. The main advantages of nickel and German silver are that they do not oxidize appreciably. If the crystal holder is built dust tight, the crystal does not need any attention after its initial cleaning and installation.

Before putting a crystal in service, it should be cleaned with alcohol, benzine, or carbon tetrachloride to thoroughly free it from grease, and then should only be handled by the edges, as there is sufficient grease and moisture on one's fingers to prevent the crystal from operating properly if it is handled by the face.

A very satisfactory tube to be used with the crystal is a UX-210, since it is not easily damaged by the crystal failing to oscillate or by the abuse that it gets when tuning the transmitter. It oscillates very freely when used with the crystal and makes an extremely stable combination for controlling an amplifier.

In order that a set will operate smoothly, there must be ample crystal controlled voltage for the grid of the last amplifier. One UX-210 tube, crystal controlled, will furnish sufficient energy to excite the grid of either one or two UX-210 tubes operating in parallel. One UX-210 acting as an amplifier will furnish a useful output of over 20 watts, and two of them in parallel will furnish a useful output of over 40 watts provided the supply voltage is over 500 volts. One UX-210, crystal controlled, will also furnish ample excitation for a 50-watt tube when used on voltages up to 1000. Plenty of grid excitation is required so as to be reasonably sure that the excitation due to the crystal is large compared to that due to accidental feed back. Under these conditions, neutralization should not be difficult.

When operating on a wavelength one half that of the crystal, the doubling should be handled by means of two tank circuits in the plate circuit of the crystal controlled tube, one tank circuit tuned to the wavelength of the crystal, and the other one tuned to one-half the wavelength of the crystal.

If it is necessary to double twice, as when operating on 7000 kc. (40 meters) with a 1750 kc. (160-meter) crystal, the frequency should be doubled as outlined above, and fed into an intermediate amplifier also provided with two tank circuits, one tuned to 3500 kc. (80 meters) and the 7000 kc. (40-meter) energy being tapped off from the 7000 kc. (40-meter) tank circuit to feed

either an intermediate amplifier or the final stage, depending on the output required.

The intermediate amplifier should be a UX-210 tube neutralized to prevent it from oscillating independently. This neutralization is not critical when there is ample grid excitation available from the crystal controlled tube.

With the exception of the tank circuit and the neutralizing condenser of the last amplifier, ordinary receiving condensers and coils can be used since the voltages and currents to be handled are relatively small. If the amplifier plate voltage does not exceed 600 volts, receiving condensers can be used in the final amplifier, but if the voltage does exceed 600 volts, it is better to use double-spaced condensers and coils wound of No. 14 wire, or larger. The coils making up the tank circuit for the crystal controlled tube and intermediate amplifier can be wound of bell wire on ordinary fiber or bakelite tubes, such as used in receiving sets.

As to circuits to be employed, one has the choice of doubling the frequency in the crystal controlled tube or in the amplifier following this tube; also one has the choice between using batteries for the grid bias or grid leaks.

In general, doubling the frequency in the tank circuits of the crystal controlled tube will be the most satisfactory since it is not necessary to take any special precaution to prevent radio frequency feeding back into the crystal circuit, with resulting damage to the crystal. The output, when doubling in the crystal controlled tube, seems to be as great as the output when doubling in the intermediate amplifier, and saves one tube.

Regarding the relative merits of bias batteries or grid leaks, our tests show absolutely no difference in total output, provided a good crystal is being used, and there is a question whether there will be any difference even with a poor crystal. Sets using bias batteries can go out of oscillation without the plate current rising to dangerous values. This is a factor if the set is a large one and the plate power available is sufficient to immediately destroy the amplifier tubes. Damage can be prevented by not accurately neutralizing the amplifier stages so that they will go into oscillation if the crystal controlled frequency fails.

There is one advantage that goes with the use of grid leaks and that is that radio frequency chokes are not necessary in the grid circuit. These chokes, when used, are likely to couple with other tuned circuits in the set, causing erratic behavior of the set, the cause of which is difficult to locate. There is no advantage in using radio frequency chokes in series with the grid leaks.

Series feed on all the tubes is to be pre-

ferred since it does away with the necessity of radio frequency chokes which would tend to link with stray fields and cause trouble. Parallel feed requires the use of radio frequency chokes in the plate leads, which experience has taught is a disadvantage.

If the coils making up the various tuned circuits of the set are placed so that their axes are at right angles to one another, and at least four inches apart, there apparently is no necessity for shielding any part of the set. An inspection of the accompanying cuts shows how closely the apparatus can be bunched together without affecting its operation.

The crystal tube circuit need not be neutralized, but each amplifier stage should be neutralized independently by means of a few extra turns on the plate tank circuit, connected through a neutralizing condenser to the grid of the tube. Occasionally, there will be an installation where the output of the last stage finds its way back to the input of the first amplifier stage, causing the amplifiers to oscillate regardless of the position of the neutralizing condensers. This can be corrected by reversing the polarity of the coupling coils feeding the grid of the first amplifier or that of the first or second amplifier in case two stages are used. Inductive coupling between stages is to be preferred since the accidental radio frequency feed back can be made either to assist or oppose the amplifying system simply by reversing the connections to the grid coil of the inter-stage coupler.

Keying can be satisfactorily handled by keying the plate circuit of the last amplifier stage, through a key-thump filter.

As an illustration of how small and compact a crystal controlled set can be built, the photos show a portable set complete in every detail, including dynamotor for operating it, occupying a space of 10 x 10 x 12 inches. It will be noted that no shielding whatever has been used.

Referring to Fig. 1, Q is a crystal holder containing a crystal ground to 1791 kc. (167.5 meters). This crystal is connected between the filament and grid of a UX-210. A 500,000-ohm grid leak is connected between the grid and filament as shown.

The plate of the tube is connected to coils L and condenser C, making up the 1800 kc. (160 meters approximately) tank circuit. The coil is made up of seventeen turns of double cotton covered No. 18 wire and the condenser is an ordinary .0005- μ fd. receiving condenser, single spaced. The 1800-kc. (160-meter tank circuit is connected in series with a 3600-kc. (80-meter) tank circuit, made up of L1 and C1, eight turns of the coil being connected across the condenser, the remaining eight turns acting as a radio frequency transformer to feed the grid of the succeeding tube. The coil con-

sists of sixteen turns total, wound on a 2½-inch bakelite form. The condenser is .0001- μ fd. receiver neutralizing condenser, single spaced.

The filaments are connected across the input terminals of the dynamotor through filament rheostat R2, in order to cut the 12-volt input down to seven and one-half volts for the filament of the UX-210 tubes.

The 3600-kc. (80-meter) crystal tank circuit coil L1 feeds the grids of 2 UX-210 tubes connected in parallel through a .0001- μ fd. fixed condenser, C4.

A small coupling condenser is an advantage here as it makes the set easier to neutralize. If it were inductively coupled, a larger size condenser would be preferable as C4.

A 10,000-ohm grid leak, R1, is connected between grids and filaments of the amplifier tubes. This grid leak should be the large size Bradley "E" or a resistance hav-

2:1 step-up arrangement of coil L1 tends to more nearly match the input impedance of the grids with the tank circuit of the crystal controlled tube.

The amplifier tubes are connected into a tank circuit made up of coil L2 and condenser C2. L2 consists of ten turns of No. 16 double cotton covered copper wire, wound on a 2½-inch form and tapped three turns from the end, seven turns being connected across the tuning condenser and three turns connected through the neutralizing condenser C6 to the grids of the amplifier tubes. The neutralizing condenser is a single spaced .0001 μ fd. receiving condenser. Tuning condenser C2 is a .0005 μ fd. single spaced receiving condenser.

In order to check the operation of the set, the milliammeter and a single-pole, double-throw switch are installed in such a manner that the instrument is always in circuit with the plate of the crystal controlled tube. By throwing the switch to the upper point, the milliammeter will record the total input to the set, which includes the amplifier.

The plate energy is furnished by a 12-volt dynamotor having an output of approximately 350 volts. The key is connected in series with the plate circuit of the amplifier tubes. Wound on the same tube with coils L2 is the output coil L3 made up of thirteen turns of No. 16 cotton covered wire closely spaced and tapped four turns from one end. L3 is separated from L2 by about ½ inch. The antenna tuning condenser C3, consisting of a .0005 μ fd. receiving condenser is connected in series with the nine turn end of L3. The other two ends are brought out to separate binding posts, making possible a variation in the number of turns connected to the antenna, in order to better match the antenna input impedance to that of the set, since this is a portable set, and may be called to work on various kinds of antennas.

With a total input of 12 volts and 13 amperes (156 watts), this set is capable of delivering twenty-one watts into a dummy antenna. Its field performance has been the same as would be expected from any set capable of delivering that much energy to the antenna. The wiring looks rather crude, but is due to the fact that flexible wire was used in order that vibration due to transportation would not break the wires off the various instrument terminals.

Where the space is available it is preferable to use inductive coupling between the 3600 kc. (80-meter) tank circuit of the crystal controlled tube and the amplifier. This enables one to reverse the connections of the grid feed coil of the coupler in case it is impossible to neutralize the amplifier due to feed back from the antenna system. L1

(Continued on Page 78)

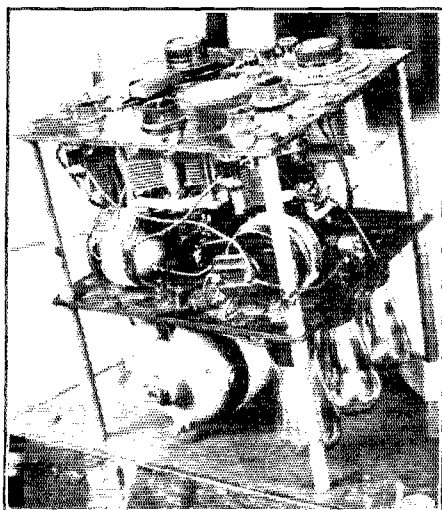

THE CRYSTAL HOLDER CONTAINING THE CRYSTAL MAY BE SEEN ON THE PANEL HELD IN PLACE BY THE CLIP WHICH ALSO MAKES CONTACT TO THE UPPER PLATE

The three condensers directly above the dynamotor are, from left to right, C6 C and C1. The other variable towards the rear is C3.

ing an equivalent radiating capacity. The 500,000-ohm grid leak across the crystal can be any of the small resistance units put out by various manufacturers for use in receiving sets and "B" substitutes.

The 3600-kc. (80-meter) tank circuit coil L1 is constructed to step up the voltage fed to the grids of the amplifiers in order that the maximum possible voltage will be available to control the grids of these tubes. The input impedance of the grids of the amplifier tubes is relatively high, and the

Picking the Right Filter Condenser

By Bert E. Smith*

WITH the advent of the new regulations soon to be in force in amateur bands, most of the good ops are beginning to think about their power supply. The day of putting 60 cycles on the plate of the oscillator tube is certainly past. Two or three such stations would use up almost all of one of the new bands, and a really smooth d.c. input is going to be highly desirable for amateur operation.

All of which brings us to experience with filters in the past, and from the standpoint of the pocket-book, to filter condensers. Many a time have we decided to have some nice smooth d.c. and gone forth to purchase many microfarads which were installed in the set with great joy, and, after some time only a few hours of use, passed out accompanied with great lamentation. Inasmuch as we amateurs know everything in the world, we usually heaped maledictions on the head of the manufacturer who supplied the filter condensers.

And why not? Perhaps we have a transformer supply which is turning out fifteen hundred volts on each side of the center tap. Such transformers have usually been used in connection with a couple of 217 rectifiers which are notorious for having plenty of voltage drop. More than likely, too, we were using at least one choke and certainly the voltage goes down in that. So we always thought if we had a 1750-volt-break-down condenser, it should certainly be plenty, for we only had 1500 volts to start with and it certainly must get smaller every time it passes through a resistance.

As a matter of fact, however, if the transmitter is one of the usual amateur types with the key located somewhere between the output terminals of the filter and the antenna, the condenser had a perfect right to blow up because the actual voltage across it was plenty much higher than the 1750-volt rating of the condenser. It will reach and sometimes exceed, 2100 volts.

This seemingly inexplicable difference is caused by the not-often-thought-of difference in nomenclature between a.c. and d.c. ratings. If we have 1500 volts of smooth d.c. we have just 1500 volts—no more, no less. But when we have a transformer rated at 1500 volts, when viewed from one terminal, the other terminal varies from zero to approximately 2115 volts positive, then falls to zero again and rises once more to 2115 volts but this time negative in

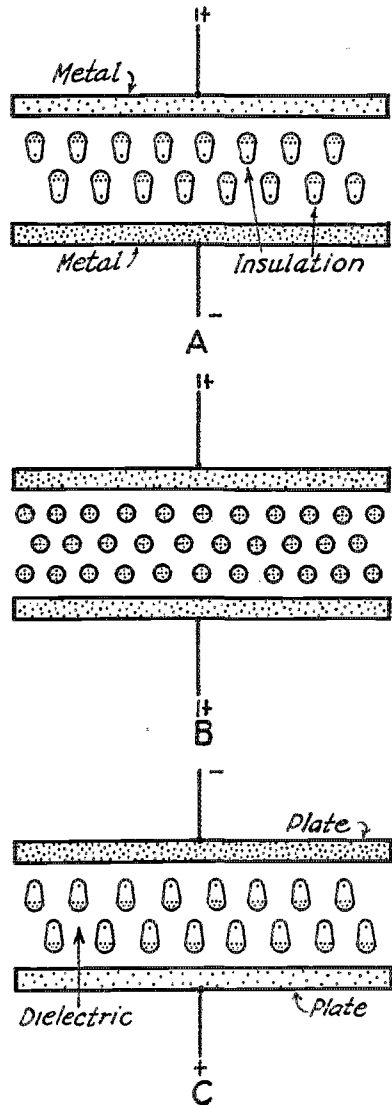

FIG. 1.
 A. Negative charge on the lower plate or foil.
 B. No charge.
 C. Positive charge on the upper plate or foil.

respect to the first terminal. It again drops to zero and repeats this same round of events known as a cycle as long as the transformer is across the line. Each pulse from zero to maximum and back to zero

*Aero Products, Inc., 1772 Wilson Ave., Chicago, Ill.

is an alternation and because we have this peak voltage for but a short period of time in respect to the amount of time taken by the alternation, we cannot expect it to do the amount of work that would be done by a voltage of this value that is constantly impressed across the load. Now we are usually interested in the amount of work that we can get out of a machine and in order to put the a.c. machine on a par with the d.c. one we apply a "correction factor" to equalize matters. In order to arrive at the voltage which will be effective in doing work (r.m.s.) we multiply the peak voltage by .707, or if we want to find the peak voltage from the effective voltage, we can multiply the effective voltage by 1.41. This assumes a pure sine wave-form.

Now, supposing that we take the output of this 1500-volt transformer giving an alternating current which has 2100-volt peaks and put it through a rectifier. If the rectifier is perfect (and few of them are, most of them play tricks that make conditions even worse) we will have a voltage wave from the rectifier that is the same as the a.c. except that we have reversed the polarity of every other alternation making one side of the line positive in respect to the other at all times. That is, to start with, we have peaks from 2100 plus to 2100 minus—sixty of each per second (60 cycles). Having rectified it by a full-wave rectifier, we now have voltages running from zero to 2100 volts plus, one hundred and twenty times per second, and what we hope to do with our filter is to make an arrangement which will store up energy during the period when the voltage is above the average so that it may be used to operate the set when the voltage is below the average.

When we open the key, we allow the condenser to receive energy without being required to supply any to the load. The voltage builds up until it reaches the maximum value at the peak which we have just found in this case to be at least 2100 volts. If the drain we are putting on the system is smaller than the average current carrying capacity of the rectifier tube and transformer, the voltage may never go down as low as the "1500" with which we started, all of which, however, is only one small part of the story.

There is another factor which enters into the life of filter condensers or for that matter any condensers. *The percentage of alternating current mixed with the d.c. input to the filter* has a very important effect on the life of the condensers.

This applies particularly to the first condenser of the filter. Much can be said of the rating of paper condensers without adding a great deal to the world's store of knowledge. Some paper condensers (al-

most all originally and a few even yet) are rated by "flash test." That is, there is only one voltage marked on the condenser label and it indicates that the condenser has been tested by applying the named voltage, d.c., across the terminals for a few seconds. Others are rated according to the "d.c. working voltage" which indicates that they can be worked continuously at that potential. This rating, however, if the manufacturer wants to stand upon technicalities, is meaningless for, as will be explained a little later in this article, the pure d.c. working voltage of a condenser is practically the same as the "flash test" voltage.

The d.c. voltage which is applied to the first capacitor in an ordinary garden variety of filter is something else again. It is correct to term it d.c.¹ as it never reverses polarity, but since the voltage may vary all the way from zero to 1.4 times the rated transformer output in the case of a rectifier device or between varying other values in the case of the d.c. generator having either a large or small amount of ripple, we frequently have all the characteristics of the most virulent a.c. These characteristics must be considered in their effect on the capacitor. As we have explained in the case of a 2000-volt transformer, the rectified voltages at the input of the filter may vary from zero to more than 2800 volts. In the case of a d.c. generator supplying 2000 volts, we will have voltages sent to the filter, sometimes between 1500 to 2500 volts and sometimes with not as large a variation. Rectifiers have different characteristics but in all of them we must not forget that the very fact that we need a filter to supply smooth d.c. is indicative of the fact that we have a large a.c. component superimposed upon a given d.c. voltage which can be roughly estimated as the equivalent of the r.m.s. value of the transformer output or the d.c. rating of the generator.

The plates merely act as terminals for applying charges to the dielectric material and it is in the dielectric material that mechanical distortion of the atomic structure is responsible for our capacitative action. All materials are composed of molecules which are made up of atoms of basic materials which are known as elements. These atoms once again are composed of electrons, revolving about the central proton in established circular orbits just as if each atom were a miniature solar system. In any such material we also have free electrons, not connected to any atom, mov-

1. The *Standard Handbook for Electrical Engineers* defines "d.c." as a "practically non-pulsating" unidirectional current. It is therefore probably preferable to refer to the output of a rectifier as "unidirectional" or "pulsating" and hardly correct to call it d.c.—Editor.

ing around more or less in the same manner as comets in our own great universe. When a material is known as a conductor it is indicative of the fact that there are a large number of these free electrons roaming about the interior structure of the material, occasionally breaking their way into one of the small solar systems and usually in such cases bumping one of the planets or electrons free to wander around until it in turn strikes another planet and knocks another electron loose. Each of these free electrons carries a small charge and if a sufficiently large number of them are free to move, the material will be a conductor of electricity. On the other hand, in some materials, there are almost no free atoms and therefore the electrons are each bound tightly to their own orbit. These materials are known as insulators.

We can look then at Figure B which is a conventionalized sketch of a condenser having no charge. The plates contain their normal number of free electrons represented by small dots and the dielectric material has all its atoms in a regular form with the electrons revolving in their circular orbits.

If, however, we introduce an excessive number of electrons into either plate, this condition is changed. Depending upon the strength of the charge, the greater number of electrons upon the negative plate increases their repulsive effect on the electrons in the dielectric material. On the other side, the positive plate due to its having less than the proper number of electrons has an attraction for the electrons in the dielectric and therefore the orbit of the dielectric electrons are distorted, causing them to assume more or less the condition shown in A.

If the charge is removed and a charge of equal but opposite potential is applied, the atomic structure will pass through normal (B) to exactly the opposite, now reaching the position shown in C. If the polarity charge is rapidly reversed, there will be a steady motion, first to one side and then to the other, resulting in appreciable friction. This friction has a normal result in that it generates heat, the quantity of course depending upon the extent of motion and the rate of reversal. That is to say, more volts, more motion, more heat, and also, more speed (cycles per second) faster motion, more heat. If there is sufficient heat generated it will melt the impregnating material, weakening the dielectric structure mechanically and perhaps causing the condenser to break down because the insulation becomes thinner at the point of softening, increasing the strain per unit of thickness, which again results in further melting; the vicious cycle continuing until a few electrons break through the weakened material.

Besides the action just described, the heat tends to speed up the electrons in their orbit, lessening the cohesiveness of the atomic structure and increasing the probability that some will escape to the positive electrode.

Of course, in a condenser used to filter

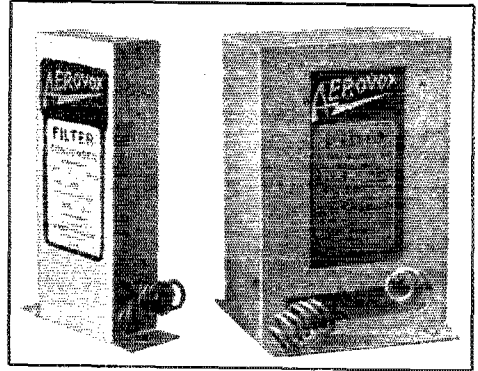

FIG. 2. THE BIG DIFFERENCE "1000-VOLT TEST" AND "WORKING VOLTAGE 1000"

Both condensers have a capacity of 2 μ fd. The type at the left is tested at 1000 volts d.c. but its working voltage is 300 d.c. The condenser at the right has a working voltage rating of 1000 d.c. being tested at 3000. In both cases the a.c. working voltage would of course need to be chosen below the d.c. working voltage (about $\frac{1}{2}$) because of the effects explained in the text.

a fluctuating d.c., there is never a complete reversal, but the change in condition from that sketched in A to that of B and back will have just as much destructive effect as though a complete reversal with approximately half the voltage were to take place. An example would be that to filter the fluctuating direct current resulting from rectifying 2000 volts, r.m.s., of alternating current, the condenser should be capable of continuous operation on alternating current, having an e.m.f. of at least half the peak voltage, or say 1500 volts a.c. in addition to its other requirements. But to return for a moment to the consideration of the reactions in the dielectric. Some dielectrics are far better than others, in that their electrons are more restricted as to their orbits; they move less, and the friction and increase of electronic speed is less. In others, the electrons are very tightly bound at normal temperatures, but will not stand the generation of any heat whatever. For example, when air is the dielectric employed, its characteristics under a single charge and under continuous operation are practically identical. No appreciable heating takes place and such a condenser will operate continuously on any type of alternating current, regardless of frequency or wave form at its flash test.

Mica is the nearest approach in normal

usage. The losses (dissipated as heat) are comparatively small and we can say that at frequencies of 5000 cycles or less, a mica condenser will operate continuously at 75% of its flash test voltage.

It is for this reason that blocking condensers and other condensers which carry either audio frequency or radio frequency are invariably built with mica dielectric as the comparatively high frequency at which they were used would cause paper condensers even of the best construction to disintegrate very rapidly. Even mica is far inferior to a condenser with an air dielectric when used at radio frequencies, but unfortunately in order to procure the necessary capacity, it becomes an impossibility to build an air condenser of the requisite insulation and capacity into the small amount of space available in most transmitters. Where space permits their usage, air dielectric condensers are by far the most preferable for this use. After them, well-built mica condensers are the most desirable and paper condensers should never be used for frequencies in excess of 500 cycles, unless there is a tremendous variance between their rating and the voltage which will be encountered.

Next in line is pure linen content paper, used in the best of present day filter condensers. For 120-cycle operation, as in the ordinary full-wave power supply use, a condenser properly constructed with linen paper dielectric can be depended on for continuous a.c. operation (the preference of a.c. over d.c. working voltage ratings has already been brought out) at one-sixth of the d.c. "flash test" voltage.

Another commonly employed filter condenser dielectric is wood pulp content paper used in most European condensers because of its cheapness. The losses in this type of dielectric are comparatively very large, and it cannot be depended upon to stand up for any length of time at 120 cycles a.c. operating voltage higher than one-tenth at most one eighth of its "flash test."

It is unfortunate that the purchaser cannot inspect the interior of a fixed condenser as easily as he can determine the construction of a variable unit, but if the test voltage is shown, he can be guided to some extent. Until, however, it becomes the practice of fixed condenser makers to abide by some standards as to construction and ratings, he must depend on buying from reliable firms who are willing to guarantee their product and give pitiless publicity to their manufacturing methods.

The Central Division Convention

(Continued from Page 19)

with questions. That made it easy for Treasurer Hebert as all he did was to ham-fest around asking numerous questions and in that manner learn many things pertain-

ing to the welfare of the Division. As principal speaker at the Banquet his address was a comparison of amateur radio as it was in 1918 and at present.

There were Army and Navy meetings showing what the reserve units are doing. R.H.G. Mathews, old 9ZN, also Lt-Commander of Communication Reserve, U.S.N.R., was happy because he succeeded in enrolling a goodly number of the radio amateurs present. Matty is doing great work for the Naval Reserve.

We were all happily surprised to see Fred Schnell, formerly Traffic Manager, and now with Burgess Laboratory. While Fred was put down on the program to talk on "Sense & Nonsense" we can all vouch that there was plenty of good sense in what he said and very little nonsense. It's fine of him to still keep up his amateur interest.

Director Darr acted as Toastmaster and he is getting better and better every time. It was good to see him "hamfesting" with 8CNO and 8ADU—yes, they were YL's of the convention and real hams they are, too. This reporter got his "inning" on the last day though when he was privileged to visit the "shacks" of both and believe it fellows they have real ham outfits.

Quite a large number of the members took advantage of the Radio Inspector's presence by taking the examination for operator's license. The cooperation of the Radio Supervisor's office is appreciated. After the distribution of some of the best prizes seen, the Saturday evening program closed with a sketch entitled "Sinnygooffer Jamboree" by Professor Taurenwerfer. Some stunt!

Sunday was devoted to visiting ham-stations and bidding each other good bye, with a heart full of appreciation for the Committee.

A. A. H.

Strays

The erection of the 23,000 kc. (10-meter) beam antenna at 1CCZ has given the natives of Wianno, Mass. (where the station is located) one of the biggest thrills they have had for years. One village rumor has it that the affair is a private Ferris Wheel but this is flatly contradicted by some inhabitants, who insist that it is to be the new Dirigible for a trans-atlantic flight. "Dear me, that is a wonderful ship," one lady remarked on catching a glimpse of it through the trees, "but how will you ever get it down to the water when it's finished?"

For 1929

In the wiring diagram of the Oscillator-Amplifier transmitter given on page 11 of the September QST the grid leak for the oscillator tube is missing. It is, of course, just as essential in this oscillator as in any other Hartley and should be of 10,000 ohms connected across the grid condenser C8.

1929 Abbreviations

THE 1929 Washington Convention contains a large number of new abbreviations and changes in procedure which take effect January 1, 1929. These apply to all classes of stations and so must be employed by amateurs in lieu of all previously-existing sets of abbreviations and methods of procedure.

NEW REGULATIONS FOR USE OF CQ

Article 10 of the Regulations relates to the use of the signal CQ. Although designed exclusively for use in the mobile service, its terms apply very well to our amateur needs.

CQ is still a signal of inquiry, used when desiring to enter into communication with whatever stations may be within the range of transmission, but when so used the transmission is now to be concluded by the letter K (general call with request for reply).

The signal QST, used as a preface to broadcasts, is now abandoned, and the call CQ *not* followed by the letter K (general call without request for reply) is to be employed for broadcasts of information intended to be read by anyone who can receive them.

NEW AUDIBILITY SCALE

The old scale used to express the strength of signals, running from R1 to R9, is abandoned,

and in its place a simpler and more practicable scale running from 1 to 5 is adopted. This is not used in connection with the letter R but with the abbreviation QSA, the new meaning for which should be seen under the Q Code. Thus one might say "QSA 3", the exact and literal meaning of which is "The strength of your signals is fairly good; readable, but with difficulty". The scale:

- 1—Hardly perceptible; unreadable.
- 2—Weak; readable now and then.
- 3—Fairly good; readable, but with difficulty.
- 4—Good; readable.
- 5—Very good; perfectly readable.

Q CODE

We have a new Q Code. It is much longer and more complete than the previous code. In many cases it assigns utterly different meanings to familiar abbreviations. The old code must be forgotten and the new one learned. Here are the new meanings, effective January 1st. It is of course understood that an abbreviation takes the form of the appropriate question when it is followed by a question mark.

<i>Abbreviation</i>	<i>Question</i>	<i>Answer</i>
QRA	What is the name of your station?	The name of my station is
QRB	At what approximate distance are you from my station?	The approximate distance between our stations is nautical miles (or kilometers).
QRC	By what private company (or government administration) are the accounts for charges of your station liquidated?	The accounts for charges of my station are liquidated by the private company (or by the government administration of).
QRD	Where are you going?	I am going to
QRE	What is the nationality of your station?	The nationality of my station is
QRF	Where do you come from?	I come from
QRG	Will you indicate to me my exact wave length in meters (or frequency in kilocycles)?	Your exact wave length is meters (or kilocycles).
QRH	What is your exact wave length in meters (frequency in kilocycles)?	My exact wave length is meters (frequency kilocycles).
QRI	Is my tone bad?	Your tone is bad.
QRJ	Are you receiving me badly? Are my signals weak?	I can not receive you. Your signals are too weak.
QRK	Are you receiving me well? Are my signals good?	I receive you well. Your signals are good.
QRL	Are you busy?	I am busy. Or, (I am busy with). Please do not interfere.
QRM	Are you being interfered with?	I am being interfered with.
QRN	Are you troubled by atmospheric?	I am troubled by atmospheric.
QRO	Must I increase power?	Increase power.
QRP	Must I decrease power?	Decrease power.
QRQ	Must I send faster?	Send faster (..... words per minute).

Abbreviation	Question	Answer
QRS	Must I send more slowly?	Send more slowly (..... words per minute).
QRT	Must I stop sending?	Stop sending.
QRU	Have you anything for me?	I have nothing for you.
QRV	Must I send a series of V's?	Send a series of V's.
QRW	Must I advise that you are calling him?	Please advise that I am calling him.
QRX	Must I wait? When will you call me again?	Wait until I have finished communicating with I will call you immediately (or at o'clock).
QRY	Which is my turn?	Your turn is No. (or according to any other indication):
QRZ	By whom am I being called?	You are being called by
QSA	What is the strength of my signals (1 to 5)?	The strength of your signals is (1 to 5).
QSB	Does the strength of my signals vary?	The strength of your signals varies.
QSC	Do my signals disappear entirely at intervals?	Your signals disappear entirely at intervals.
QSD	Is my keying bad?	Your keying is bad. Your signals are unreadable.
QSE	Are my signals distinct?	Your signals run together.
QSF	Is my automatic transmission good?	Your automatic transmission fades out.
QSG	Must I transmit the telegrams by a series of 5, 10 (or according to any other indication)?	Transmit the telegrams by a series of 5, 10 (or according to any other indication):
QSH	Must I send one telegram at a time, repeating it twice?	Transmit one telegram at a time, repeating it twice.
QSI	Must I send the telegrams in alternate order without repetition?	Send the telegrams in alternate order without repetition.
QSJ	What is the charge to be collected per word for including your internal telegraph charge?	The charge to be collected per word for is francs, including my internal telegraph charge.
QSK	Must I suspend traffic? At what time will you call me again?	Suspend traffic. I will call you again at (o'clock).
QSL	Can you give me acknowledgment of receipt?	I give you acknowledgment of receipt.
QSM	Have you received my acknowledgment of receipt?	I have not received your acknowledgment of receipt.
QSN	Can you receive me now? Must I continue to listen?	I can not receive you now. Continue to listen.
QSO	Can you communicate with directly (or through the intermediary of)?	I can communicate with directly (or through the intermediary of).
QSP	Will you relay to free of charge?	I will relay to free of charge.
QSQ	Must I send each word or group once only?	Send each word or group once only.
QSR	Has the distress call received from been attended to?	The distress call received from has been attended to by
QSU	Must I send on meters (or kilocycles) waves of type A1, A2, A3, or B?*	Send on meters (or on kilocycles), waves of Type A1, A2, A3 or B.* I am listening for you.
QSV	Must I shift to the wave of meters (or of kilocycles), for the balance of our communications, and continue after having sent several V's?	Shift to wave of meters (or of kilocycles) for the balance of our communications and continue after having sent several V's.
QSW	Will you send on meters (or on kilocycles) waves of Type A1, A2, A3 or B?*	I will send on meters (or kilocycles) waves of Type A1, A2, A3 or B.* Continue to listen.
QSX	Does my wave length (frequency) vary?	Your wave length (frequency) varies.
QSY	Must I send on the wave of meters (or kilocycles) without changing the type of wave?	Send on the wave of meters (or kilocycles) without changing the type of wave.
QSZ	Must I send each word or group twice.	Send each word or group twice.

Abbreviation	Question	Answer
QTA	Must I cancel telegram No. . . . as if it had not been sent?	Cancel telegram No. . . . as if it had not been sent.
QTB	Do you agree with my word count?	I do not agree with your word count; I shall repeat the first letter of each word and the first figure of each number.
QTC	How many telegrams have you to send?	I have . . . telegrams for you or for . . .
QTD	Is the word-count which I am confirming to you accepted?	The word count which you confirm to me is accepted.
QTE	What is my true bearing? (or) What is my true bearing relative to?	Your true bearing is . . degrees (or) Your true bearing relative to . . . is . . . degrees at . . . (o'clock).
QTF	Will you give me the position of my station based on the bearings taken by the radiocompass stations which you control?	The position of your station based on the bearings taken by the radiocompass stations which I control is . . . latitude longitude.
QTG	Will you transmit your call signal for one minute on a wave length of . . . meters (or . . . kilocycles) in order that I may take your radiocompass bearing?	I am sending my call signal for one minute on the wave length of . . . meters (or . . . kilocycles) in order that you may take my radiocompass bearing.
QTH	What is your position in latitude and longitude (or according to any other indication)?	My position is . . . latitude . . . longitude (or according to any other indication).
QTI	What is your true course?	My true course is . . . degrees.
QTI	What is your speed?	My speed is . . . knots, or . . . kilometers per hour.
QTK	What is the true bearing of . . . relative to you?	The true bearing of . . . relative to me is . . . degrees at . . . (o'clock).
QTL	Send radio signals to enable me to determine my bearing with respect to the radio beacon.	I am sending radio signals to permit you to determine your bearing with respect to the radio beacon.
QTM	Send radio signals and submarine sound signals to enable me to determine my bearing and my distance.	I am sending radio signals and submarine sound signals to permit you to determine your bearing and your distance.
QTN	Can you take the bearing of my station (or of . . .) relative to you?	I can not take the bearing of your station (or of . . .) relative to my station.
QTP	Are you going to enter the dock (or the port)?	I am going to enter the dock (or the port).
QTR	What is th exact time?	The exact time is . . .
QTS	What is the true bearing of your station relative to me?	The true bearing of my station relative to you is . . . at . . . (o'clock).
QTU	What are the hours during which your station is open?	My station is open from . . . to . . .

* Waves are classified as follows in Art. 4, General Regulations. A1: unmodulated continuous waves, varied by telegraphic keying. A2: continuous waves modulated at audible frequency, with which is combined telegraphic keying. A3: continuous waves modulated by speech or by music. B: damped waves.—Editor.

MISCELLANEOUS ABBREVIATIONS

The following miscellaneous abbreviations now have universal agreement and should no longer be employed in other than the meanings

specified, nor should other than the specified abbreviation be employed to convey any meaning listed in this table.

Abbreviation	Meaning
C.	Yes.
N.	No.
P.	Announcement of private telegram in the mobile service (to be used as a prefix).
W.	Word or words.
AA.	"All after" (to be used after a question mark to request a repetition).
AB.	"All before" (to be used after a question mark to request a repetition).
AL.	"All that has just been sent" (to be used after a question mark to request a repetition).
BN.	"All between" (to be used after a question mark to request a repetition).
BQ.	Announcement of reply to a request for rectification.
CL.	"I am closing my station."

Abbreviation	
CS.....	Call signal (to be used to ask repetition of a call signal).
DB.....	"I can not give you a bearing, you are not in the calibrated sector of this station."
DC.....	"The minimum of your signal is suitable for the bearing."
DF.....	Your bearing at (o'clock) was degrees, in the doubtful sector of this station, with a possible error of two degrees.
DG.....	Please advise me if you note an error in the bearing given.
DI.....	Bearing doubtful in consequence of the bad quality of your signals.
DJ.....	Bearing doubtful because of interference.
DL.....	Your bearing at (o'clock) was degrees in the doubtful sector of this station.
DO.....	Bearing doubtful. Ask for another bearing later, or at (o'clock).
DP.....	Beyond 50 miles, possible error of bearing can attain two degrees.
DS.....	Adjust your transmitter, the minimum of your signal is too broad.
DT.....	I can not furnish you with a bearing; the minimum of your signal is too broad.
DY.....	This station is bilateral, what is your approximate direction in degrees relative to this station?
DZ.....	Your bearing is reciprocal (to be used only by the central station of a group of radio-compass stations when it is addressed to other stations of the same group).
ER.....	"Here" (to be used before the name of the mobile station in the sending of route indications).
GA.....	"Resume sending" (to be used more especially in the fixed service).
JM.....	"If I may send, make a series of dashes. To stop my transmission, make a series of dots" (Not to be used on 600 meters (500 kilocycles).
MN.....	Minute or minutes (to be used to indicate the duration of a wait).
NW.....	"I resume transmission" (to be used more especially in the fixed service).
OK.....	"We are in agreement."
RQ.....	Announcement of a request for rectification.
SA.....	Announcement of the name of an aircraft station (to be used in the sending of indications of passage).
SF.....	Announcement of the name of an aeronautic station.
SN.....	Announcement of the name of a coast station.
SS.....	Announcement of the name of a ship station (to be used in the transmission of indications of passage).
TR.....	Announcement of the request or of the sending of indications concerning a mobile station.
UA.....	"Are we in agreement?"
WA.....	"Word after" (to be used after a question mark to request a repetition).
WB.....	"Word before" (to be used after a question mark to request a repetition).
XS.....	Atmospherics.
YS.....	"See your service advice."
ABV.....	"Shorten the traffic by using the International Abbreviations."
	or
	"Repeat (or I repeat) the figures in abbreviation form."
ADR.....	Address (to be used after a question mark to request a repetition).
CFM.....	"Confirm" or "I confirm."
COL.....	"Collate" or "I collate."
ITP.....	"The punctuation counts."
MSG.....	Announcement of telegram concerning ship service only (to be used as a prefix).
PBL.....	Preamble (to be used after a question to request a repetition).
REF.....	"Referring to" or "Refer to"
RPT.....	"Repeat" or "I repeat" (to be used to ask or to give repetition of all or part of the traffic by making the corresponding indication after the abbreviation).
SIG.....	Signature (to be used after a question mark to request a repetition).
SVC.....	Announcement of service telegram concerning private traffic (to be used as a prefix).
TFC.....	Traffic.
TXT.....	Text (to be used after a question mark to request a repetition).

Strays

In his story of the radio contact with the "Southern Cross" which appeared in the August *QST*, J. Walter Frates, 6CZR stated that a seventh district amateur was responsible for getting a Nicaraguan station off the plane's wave. He would like it to be known, however, that this statement was the result of a misunderstanding. The man who ac-

tually did the job was Dr. John W. Waters, 6EC, who asked nn-1NIC to QSY as he was on KHAB's wave.

There is not doubt about the fact that High-C circuits are the gnat's knees, but why carry the idea to extremes? In Fig. 8 page 15 of the August *QST*, C5 could surely be less than 2000 Fd.—T. J. McLeod.

The Duriron-Duralumin Electrolytic Rectifier

By Norman E. Woldman, Ph.D.*

IN practically all electrolytic cells used at present to rectify alternating current, the operative electrode consists of aluminum or tantalum while the auxiliary electrode is usually lead. The aluminum cell is well known and has been used for years, while the tantalum cell is a newer development and quite superior to the old aluminum cells in many respects.

Where only a small load is required, the aluminum rectifier is efficient. But for higher loads where a rate of several amperes is required the tantalum rectifier is better adapted. It has the advantage over the aluminum rectifier in being more resistant to the corrosive action of the electrolyte, and consequently has a longer life. Because of its high resistance to corrosive action it permits the use of higher current densities.

Certain metals when used as an electrode in an electrolytic cell containing a suitable electrolyte offer a high resistance to the flow of current from electrode to electrolyte, but little resistance to the current flowing in the opposite direction, namely, from electrolyte to electrode. The direction of current is here used in the ordinary sense, that is, opposite to the flow of electrons. Such a metal acts as a check valve in an alternating current circuit. An electrolytic rectifier consists essentially of a "valve" metal as an electrode, a suitable electrolyte and an auxiliary electrode which will permit the current to flow readily in either direction.

A considerable number of metals possess this valve effect, among them being, aluminum, tantalum, bismuth, magnesium, vanadium, columbium and a few others, but only two of them have been successfully used in practice as electrolytic valve electrodes, namely, aluminum and tantalum.

A new operative electrode possessing this valve effect has been found which is capable of withstanding higher loads than pure aluminum. This metal, known commercially as Duralumin, is a copper-aluminum alloy which has been specially heat-treated and aged. It has the following composition: 94.66% aluminum, 3.93% copper, 0.56% manganese, 0.50% magnesium, 0.33% silicon, and 0.02% carbon.

Duralumin anodes, as aluminum and tantalum anodes, in a suitable electrolyte become coated with a film having remarkable

electrical properties. Films formed in this manner are characterized by the influence of impressed potentials on their electrical resistance. This resistance characteristic imparts to the film the capability of conducting current more freely in one direction than in another; of breaking down as an insulation between the metallic electrode and the solution when voltages above the critical value are applied; and, in combination with its dielectric property and the thinness of the film, of holding a substantial charge of electricity at potentials below the breakdown voltage¹.

When a valve electrode acts as cathode the full current passes with applied voltage.

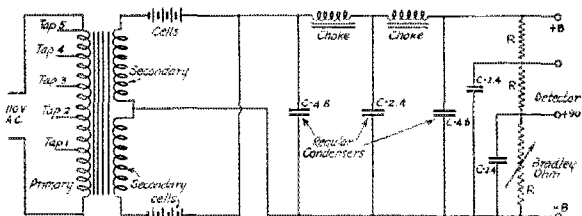

WIRING DIAGRAM FOR "B"-BATTERY ELIMINATOR
FIG. 1

But when it acts as anode a feeble current will pass, negligible in strength if the impressed voltage is below the breakdown voltage of the oxide film. As the potential is increased this "leakage current" will increase at a rate greater than proportionate to the voltage. As the maximum or breakdown potentials are approached it will be observed, if the room is darkened, that the anode begins to glow uniformly over the surface with a pale light and with further increases in voltage sparks begin to scintillate over the entire electrode surface. The current through the cells (leakage current) becomes appreciable under this condition and increases more rapidly until slightly above the sparking potential the cells act virtually as a short circuit. Upon reduction of the voltage, however, the insulating properties of the film are restored, and the current leakage decreases with decreasing potential. Duralumin electrodes

1. H.D. Hoiler & J.P. Schrodet, Bureau of Standards, Tech. Paper No. 265.
2. H.O. Siegmund, J. Am. Electrochem. Soc., April 1928.
3. J. Slepion, J. Am. Electrochem. Soc., Sept. 1927.

*Asst. Prof. of Metallurgy and Chemistry, U. S. Naval Academy, Postgraduate School.

(Continued on Page 80)

Getting Started on 160 Meters

By Harold P. Westman, Technical Editor

MANY old timers in this radio game of ours look with scorn upon the efforts of the newer men because they feel that it is so much easier now-a-days for the neophyte to obtain his first license than it was ten years or so ago. In many respects they are justified in their belief that the road to your first "ticket" does more closely resemble the primrose path than it did when they travelled it.

Ten years ago, the number of periodicals available and suitable for consumption by the radio amateur could be counted on the fingers of one hand while today there is hardly a newspaper in the United States that does not carry its regular radio page every day and many that issue a special supplement of considerable size once a week. In addition to these there are a goodly number of monthly magazines to say nothing about myriad text books that have been written for the man who is getting started and whose knowledge of electricity is negligible. All in all, the afore-mentioned old timers have something on their side when they think it is now a less painful process to obtain that coveted first class amateur radio license.

Unfortunately, obtaining your license does not finish the story by any means. This should be considered as the "commencement" preceding your actual start in amateur radio. From then on you are pretty much on your own hook and this knowledge indicated by your license must be examined and polished to suit conditions as you find them in actual practice. In a great number of cases, this period is by far the more trying of the two and many of those who do not continue in this particular pursuit of happiness drop out because of an inability to surmount its difficulties or because the return on their investment seems so paltry. After all, six months' or a year's study plus an investment of one or two hundred dollars plus two or three months of vain calling and patient listening does seem to be an exorbitant price to pay for a small handful of erratic, incomplete QSO's!

There are several very definite reasons why the new man's advent upon the air is

not more successful. In the first place, he has been attracted to radio because some one told him or he read that it would be possible, with a low powered transmitter employing a receiving tube, to get in communication with similar stations located thousands of miles away. Such stories are usually told in that matter-of-fact fashion that leads one to believe that they are common occurrences and that such communications may be had with the greatest of ease. It will be pointed out that a license will be necessary and will require a few month's study and code work. The man naturally assumes this to be the greatest

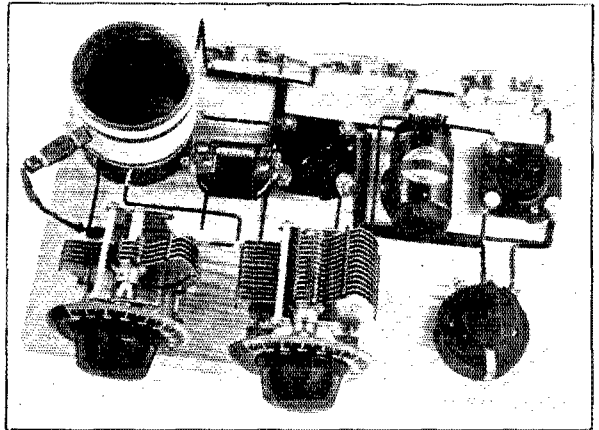

THE COMPLETED RECEIVER

difficulty involved and sets it up as the highest goal to be reached. Little wonder that he is disappointed when he actually gets on the air with his poorly adjusted transmitter and ineffective antenna system. What the author left out of his article was that a larger transmitter had previously been employed at the station which allowed the antenna system to be adjusted to give maximum radiation at the particular frequency desired, that it was necessary to pick a part of the band which was comparatively free from interference and that a time should be picked at which but few other stations were being operated so that this weak signal would be heard by the distant receiving operator. One must then realize that a considerable amount of skill may be required upon the part of both operators and that if the transmitted signal is

not steady and the keying excellent, the other operator may not bother with it at all but run his receiver dial to a signal more to his own liking.

In the second place, a man who enters amateur radio for the DX that may be

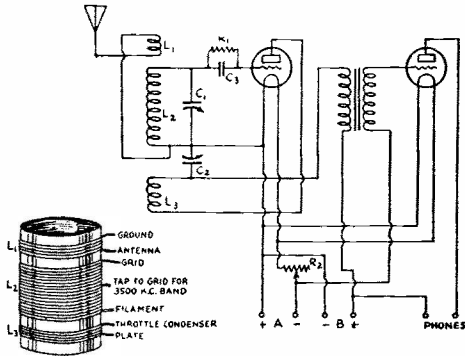

FIG. 1. IN ADDITION TO THE CIRCUIT DIAGRAM THE MANNER IN WHICH THE WINDINGS ON THE COIL FORM ARE DISTRIBUTED IS ALSO INDICATED

All coils are wound in the same direction being of No. 26 d.c.c. wire and the windings are spaced 1/4" from each other.

- L1—10 turns.
- L2—38 turns with tap 15 turns from the filament end.
- L3—7 turns.
- C1—140 µfds. variable.
- C2—350 µfds. variable.
- C3—150 µfds. fixed.
- R1—5 megs.
- R2—6 ohms for '01-A tubes or 20 ohms for '99s.

gotten out of it will hear, long before he obtains his license, that the best band for DX is the 7000-kc. (40-meter) one. He, therefore, assumes that that band offers the greatest inducement and builds his equipment accordingly. In doing so he overlooks some extremely important factors which he bumps his head into at a later date.

To begin with, every other beginner has chosen that band for the same reason that he did. What is more important is that only too many of the advanced men have done the same thing years before and are already firmly entrenched therein. Their signals have become familiar to foreign operators, their "fists" are easily copied, friendships and schedules have been established and it is only logical that the foreign amateur will answer their more consistent signals in preference to the swinging, poorly-keyed signals of the inexperienced man. Why shouldn't he? An amateur athlete with but a few weeks training would not consider entering the Olympic tournaments but the amateur radio operator takes his faith in hand and runs in to the battle without a thought of defeat. Small wonder that he recoils with a wounded, startled look on his face!

Ten years ago when a new man came on the air, conditions were quite different. To begin with, the world might have been DX crazy but it wasn't the same kind of DX. Where we now speak of thousands of miles, the conversation of that day dealt chiefly with hundreds of miles. 220 meters was the "band" and the new man usually started in with a spark coil, the maximum range of which was considered to be but a few miles. The result was that the man was satisfied to work stations around the "block" and spent his time "rag chewing" with these local stations giving but little thought to signals from out of the state because they were quite obviously out of the reach of his transmitter. The effect was that in a few months the man became a pretty decent operator. A QSO might last a half an hour or it might keep going for a couple of hours with the assistance of some of the other locals. Three, four or five cornered conversations were not unusual and were lots of fun. Some times you only discovered how many interested listeners there were by the number of different HI's that followed a "wise crack"!

Those of you who have but recently been granted your licenses are missing something very worthwhile when you are unable to indulge in this sort of "community" life. Your experience on the 7000-kc. band consists of listening for some signal that has travelled at least a thousand miles (else it won't be DX) ascertaining the call (these being repeated many times offer little in the way of code practise) and then frantically replying to it only to have the station answer someone else or, worse, start over again on another elongated CQ. When you are tired of answering CQ's, you try sending a few yourself, the results as far as contacts are concerned being about the same. When contact with another is finally achieved, one usually does nothing other than swap signal reports and 73's.

Many of you already realize these things but don't know what to do about it while others feel that there is something wrong but have been unable to analyze the problem effectively enough to determine just where the shoe does pinch. Many plans have been suggested to alleviate this trouble and the one that seems to offer the greatest possibility for success is to encourage the formation of groups of beginners who will work among themselves. In other words, we will endeavor to duplicate conditions as they were ten years ago. It is quite obvious that the only present amateur band that offers itself for such operation is the 1750-kc. (160-meter) band. It is not overly populated; is to a large extent free from the vagaries of 7000- and 14000-kc. transmis-

(Continued on Page 58)

Visual Radio and Its Possibilities

By Milton A. Ausman*

MEDICAL science tells us that about ninety per cent of the nervous energy expended in any individual goes out through the eyes. That they are a much more efficient apparatus than the ear is obviously true. Light deals with short wavelengths impressed on a more mobile matter and it is thus that it is more efficient than sound. Since our seeing powers are more efficient and there are more brain cells devoted to them and their connection with reaction is more direct it is quite logical that code could be read easier through the medium of light.¹

The old blinker lamp was a good example but its filament had considerable lag and took some time cooling off and warming up and thus it did not respond to the dots and dashes if they were sent with any speed. This eliminated the ordinary lamp from the race even more than the fact that it was quite difficult to couple it to a receiver so that signals could be read. The Moore lamp would respond to any frequency of signal but it also was difficult to couple, the coupling having to be done through a relay. Some months ago I thought of the Pallophotophone which was developed, I believe, by Huxley in the General Electric laboratories. The device in question manipulated a beam of light through the action of a magnetic flux on an armature to which was coupled a very tiny mirror. The beam of light fell upon a light sensitive film and it was in this manner that the music or code was recorded. To reproduce the signal or music a beam of light was passed through the film on a photo electric cell of the potassium type. The output of the cell was fed into the grid circuit of a vacuum tube and thus it could be amplified to any intensity.

It was this machine that brought the mirror idea in mind. In order to actuate the mirror which was fastened on to the extension bar of a cone speaker unit, two stages of amplification were used. Several stations were tuned in up in the vicinity of 16,000 meters and the path of the light beam recorded on ground glass. The source of light was the reflector and bulb of a thousand foot flashlight. A circular disc of conner was placed over the lens and a hole drilled about the size of the end of a piece of bus bar wire in it to give a beam of light. This beam was concentrated on the mirror. As a result when the signal came in the beam

of light chased prettily up and down the ground glass. The mirror consisted of the tiniest piece possible of an automobile reflector that would just take the whole of the beam of light at six inches. A small telescope was used to watch the mirror and a tiny hole was put in a shield in front of the telescope so that when the signal came in, the entire field of the telescope became light and when the signal discontinued the field became very nearly dark. The entire experiment was done in the dark and a board covered with black felt was used between the apparatus proper and the observer.

This concludes the work as far as it has gone but it by no means exhausts the possibilities of the apparatus. A vertical slit might be used with the colors of the rainbow in the glass and color music thus enjoyed. It may make it possible for the deaf to enjoy amateur radio, any one who can tell the difference between light and dark can read the code and greater speeds may be possible with this machine than with the usual headsets. It may be possible to record music on small portable motion picture cameras, to be reproduced as mentioned in the description of the Pallophotophone in the fore part of this article. Apparatus used in this experiment on the optical end was obtained from Bausch & Lomb, Rochester, New York. A Penn Speaker unit was used to actuate the mirror which was obtained from a piece of reflector off a very complicated machine known as a Ford. The parts are cheap, substitutions and revisions are possible and the possibilities unlimited.

 **Strays**

Capt. S. C. Hooper, U.S.N., until recently acting as Technical Advisor to the Federal Radio Commission, has relinquished those duties upon taking office as the Director of Naval Communications, as mentioned in our last issue. He has been succeeded as Chief Technical Advisor to the Commission by Dr. J. H. Dellinger, chief of the radio laboratory of the Bureau of Standards. Associated with Dr. Dellinger as a Technical Advisor is Lt. Commander T. A. M. Craven, U.S.N., whose valiant efforts on behalf of amateur radio at the "tea-cupping" sessions of the International Radiotelegraphic Conference were described in detail in our January issue.

*Engineer, National Radio Tube Co., 3420 18th St., San Francisco, Cal.

1. This assumes that the highest speed desired does not cause the phenomenon of persistence of vision.

What Length Antenna?

James J. Lamb*

IN AN article entitled "The Zepp" which appeared in September QST, it was recommended that the antenna be made exactly a half of the desired fundamental wavelength long and later shortened until its fundamental was that required. In following this procedure on a number of Zepp installations having fundamental antennas of from 10 to 80 meters, it became apparent that there was a very fixed and definite ratio of antenna length to fundamental wavelength. This held true irrespective of whether the antenna was vertical or horizontal, within a quarter wavelength of ground or high above ground, operated on its fundamental or on its harmonics. The method of checking the fundamental wavelength was that described in the above mentioned article, although an additional check by the method of inserting a thermo-couple ammeter at the center of the antenna was tried in one case. Sadly enough, the latter highly recommended method proved far less accurate than the use of meters in the feeders, the point of maximum antenna current being difficult to determine due to the fact that there was no detectable change in the reading of the meter over a considerable frequency and wavelength range¹, while the difference in current as indicated by meters in the feeders was immediately apparent upon a comparatively slight change in the supplied frequency.

Data on a considerable number of Zepp antennas were collected. A table of representative installations is shown in Figure 1. The important item in this table is the length-in-feet to fundamental-wavelength-in-meters ratio, the average being 1.558 or practically 1.56. This means that:

Length of antenna in feet = Fundamental in meters × 1.56.

It is notable that the antennas had fundamentals in the 23,000 kc., 7,000 kc. and 3,500 kc. bands, and were of horizontal, vertical

and bent types, the feeders being of widely varying lengths.

Not satisfied with our own determination of this important ratio, we went hunting for corroboration or denial from more authoritative sources.

As an American authority we found C. R. Englund² backing us up with the results of a series of experiments on horizontal Hertz antennas having fundamental wavelengths

LOCATION	TYPE ANT.	FUND. W.L. METERS	LENGTH FEET	RATIO
WIC CZ	HORIZ.	10.4	16	1.54
WICEI	HORIZ.	37.8	59	1.56
WIBHW	HORIZ.	41.0	64	1.56
WISZ	VERT.	10.3	16	1.56
W9CEI	BENT.	76.0	120	1.57
Average				1.558

FIG. 1
RELATION BETWEEN ANTENNA LENGTH AND FUNDAMENTAL WAVELENGTH OF A REPRESENTATIVE GROUP OF ZEPPELIN ANTENNAS

ranging from 5.36 to 6.34 meters. The results of these experiments showed that the natural wavelength of the antenna was 2.1 times the length in meters. Reducing this to our length-in-feet to wavelength-in-meters ratio, we come out with 1.56. So far, so good.

Going a little further afield, the experiments of Wilmotte³ of the B. B. C. in England gave us additional satisfaction. Working with the Marconi (grounded) type of fundamental antenna, he found the natural wavelength to be 4.2 times the actual length in meters, which reduced to terms of the ungrounded Hertz and the length-in-feet to wavelength-in-meters ratio again gives 1.56. While this finding is but an incident of his experiment, it is important to us. No less important is his proof that the voltage and current distribution in the antenna is practically sinusoidal under all conditions, whether the antenna be operated on its fundamental or harmonics. He also found that an insulated, grounded or tuned conductor placed near the antenna had negligible effect on the current distribution. His work was conducted on wavelengths ranging from 15 to 800 meters.

Going still further in point of both distance and time we found Abraham⁴ in Germany to precede Wilmotte in agreement with our ratio. There appears to be no reason why this 1.56 ratio should not be ap-

(Continued on Page 76)

*1SZ-1CEL Technical Information Service and Experimenters Section, A. R. R. L.

1—The resistance of the antenna itself is large compared to that of the non-radiating feeders, the meters in the feeder system giving a sharper indication of resonance.—Author.

2—The Natural Period of Linear Conductors, C. R. Englund, Bell System Technical Journal, July, 1928.

3—Distribution of Current in a Transmitting Antenna, Raymond W. Wilmotte, B. A., Proceedings of the Wireless Section, Institution of Electrical Engineers, (British), June, 1928.

4—Abraham, Ann. der Phys., 66, 485, 1898. Ann. 2, 32, 1900. Jahr. d. D. T. u. T., 14, 146, 1919.

Calls Heard



F. Pemberton, 115 Cambridge Road, Wimbledon, London, S. W., 20, England

wlaff wlbtt wlij w2agl w2ajh w2aon w2api w2ass
w2ate w2atq w2aub w2axf w2bad w2bek w2ber w2bgr
w2bkn w2bkz w2bsc w2ers w2dp w2fs w2ps w2wa
w4km w5aci w5adi w5aej w5aim w5alq w5alz w5oat
w5aq w5ara w5at w5aut w5ayb w5bag w5bam w5bf
w5bj w5he w5ie w5jx w5kg w5mq w5nj w5oa w5pt
w5yb w5zav w6agr w6ahs w6ajm w6alw w6avp w6ayi
w6azs w6bqv w6bjb w6bjh w6bq w6bsn w6byv w6bfz
w6eel w6che w6cub w6cwl w6cxi w6cyx w6czc w6dbo
w6dch w6dic w6ddy w6dev w6dhw w6dhs w6dlw
w6dom w6dor w6dri w6ec w6ih w6jn w6uf w6vz
w7aax w7acy w7afu w7afq w7ago w7akj w7ef w7fe
w7fs w7mo w7mv w7mx w7vq w7wv w7dii w8ez
w9aas w9aci w9agv w9ahq w9ahz w9aio w9ake w9anb
w9ara w9avp w9avn w9avl w9baf w9bam w9bbi
w9beu w9bez w9bgq w9bib w9bmm w9bmx w9hov
w9hpl w9bce w9brc w9btw w9cch w9cfn w9cgl w9che
w9cjh w9cnd w9cer w9cuh w9cud w9cwn w9cya w9cye
w9dbj w9dec w9del w9dhh w9des w9dfi w9dha w9dk w9dnd
w9dce w9daz w9del w9dey w9ef w9efk w9efz w9ekm
w9ekw w9elt w9eep w9erh w9eta w9etd w9eul w9ewg
w9gyu w9ez w9fbv w9fbw w9fdj w9fwe w9foe w9fij
w9hm w9lo w9lc w9mh w9mx w9nu w9xl ac-2al af-kol
as-1ra as-38ra awv fb-3hl fq-pm fq-8hpq fo-99a fo-1sr
veidq ve2al ve-2am ve2bb ve3ap ve3be ve3cl ve3fe ve3ae
ve4dq ve4fv ve4ha ve4av ve5bn ne-8ae ne-8rg nm-1z
nn-1nic nn-2nic k4agf nw-2ac nq-5cx nq-5fl oa-2iy
oa-2re oa-2sh oa-2yi oa-sbk oa-3ac oa-3gr oa-3hl
oa-8tm oa-wxo oa-5em oa-5dx oa-5hg oa-7os oz-2bz
oz-2bp oz-2bx oz-3at oz-3aw oz-3az oz-4ae oz-4am
zed-oij xem-shm.

sb-2IG, Livio G. Moreira-6 Rua Paula Gemes, Curitiba, (20-meter band)

wlaaw wialb wlaqd wlaze wlbux wibvy wlll wikh
wlom wisz w2aca w2aeb w2ari w2ash w2atr w2avb
w2bbx w2bcw w2cey w2ank w3kd w3qv w3wm w4ab
w4aao w4ar w5rg w5awd w6br w6dr w6csj w8agq
w8bnl w8br w8ced w8cfr w8cjm w8clt w8ctn w8rd
w9auu w9ark w9bce w9dbw w9ef w9etk w9fhy ve2br
efleo ef-3hw ef-3jr ef-3orm ef-rrr ef-8rpu eg-6by
eg-6mu ek-5ml eg-2kf em-smte es-2nad sc-2ab sc-3ac
sc-8cj.

ECRP19, A. Weirauck, Mestec, Kralove, Czechoslovakia
wlaze wlbux wlcw wlez w2bke w2cew w2cxi
w2qd w3ael w3aob w4aba w4adb xn-7eef ve1br ve1ak
sa-de8 sa-ca2 sa-dq4 sa-em8 sb-1ah sb-1ar sb-law
sb-1be sb-1bo sb-1cj sb-1ld sb-1ls sb-2qa sc-2ab su-1ci
su-2ak fm-8dot.

(20-meter band)

wlawe wlbjc wlbux wibvy wiry k4agf sb-1ca sb-2ig sc-3ac.

oz-2GO, Harold G. Fownes, 110 Riddiford St., Wellington, New Zealand

k7aer k7aeb k7ady k7alq k7hl k7mm k7nr k7te k7to
ve2hb ve3gg ve4aj ve4bg ve4ha ve5gt ve5cj ve5cg
nn-1nic nq-5cx nr-2ags ea-eh ea-ch ea-rr eb-4ft ec-1fm
ec-lrv ed-7jo ef-8gc ef-8ol ef-8ba eg-5bn ei-1ch ei-1bd
ei-1fb ei-1bs ei-1gc ei-1qw ei-1po ei-1gk ej-700 ej-7ff
em-smzy et-par eu-88ra eu-49ra fb-8m fm-ear88 fe-lac
sa-d83 sa-d17 sb-1bo sb-1ld sb-2ia sb-5fy sc-2as sc-3cj
sc-7aa se-1em su-1cg su-1oa su-2ak su-2ht ag-67ra
aj-2ax aj-2by aq-lac ac-8rb au-48ra au-88ra op-1po
op-1ah op-1dr w6cfq k6dju k6dlr k6db k6ka

S.S. Lake Fairport, KOGP at Ponce, Porto Rico by ex-5SR eu5PG

wlaev wlkad wlabl wlamu wlians wliar wliaw
wlbqs wigh wims w2aeb w2anh w2atq w2avp w2ay
w2azu w2bhr w2bkw w2bxr w2bw w2cf w2cxl w2ds

w2fc w2gk w2jc w2mq w2rs w2uo w2vz w2xs w3aa
w3aba w3afa w3afx w3anh w3ard w3apq w3ark w3au
w3auv w3auw w3ayz w3ce w3cf w3ekl w3eay w4abw
w4abz w4acm w4acv w4aee w4aee w4ami w4aw w4bnq
w4bu w4ck w4fx w4gn w4hh w4hz w4jac w4pac w4pd
w4qb w4sq w4we w4zx w5abi w5acl w5afe w5aga
w5ain w5azu w5bah w5bb w5bcz w5cy w5di w5gr
w4lo w6ql w6rg w6uk w6vq w6vy w6yb w6awa w6azm
w6bt w6cqh w6dea w6dco w6du w6gu w6hm w6ju w6li
w6wk w7afu w7ar w7ds w7eg w7fe w7gp w7iu w7mx
w7nr w8air w8ajv w8am w8apn w8as w8aze w8axs
w8aze w8bbs w8ic w8bdm w8bqa w8cau w8cem w8ees
w8ecw w8ckh w8dme w8dpa w8dmm w8dwe w8li w8pk
w8pu w9afx w9ajp w9avz w9axu w9bde w9bir w9hmm
w9hpq w9bhr w9chi w9erd w9dea w9dng w9dzc w9dte
w9dwe w9el w9eez w9fees w9ef w9xi ve2bw ve3go ve9al
nm-8ag nm-9a k4aan k4sa nq-2la nq-2pt nq-2ro nq-3jt
nq-5by nq-5cx.

oa-2RX, H. C. St. John, Rockdale, N. S. W., Australia

wlbux wlpd w2bfv w2edm w3bjm w4agr w4cu
w5afx w5bhc w5bh w6hax w6hjh w6hq w6cj w6cu
w6cyx w6dho w6dev w6dhs w6dom w6dor w6ih w6ay
w6vz w7abg w7acb w7afu w7fo w7gv w7os w8ahe w8af
w8avp w8azg w8bzl w8cbd w8ced w8dtn w9adn.

ed-7XX, H. Glistrup, Copenhagen, Denmark (30 to 40-meter band)

wladm wlafe wlae wlfm wlike w2api w2bix w2bjz
w2ctf w2cxl w2fk w2gv w2jd w2oi w2ow w2wi w3aaj
w3ac w3anh w3br w3bv w3abl w3agr w3aq w3nu w3brh
sc-1aj sc-1aw sc-1bo sc-1cj sc-1el sc-2ag sc-2ah sc-2aj
sc-2az sc-1aa sc-4nu su-1cg fg-ocya xed-oic.

(20-meter band)

wlaff wlabl wibvy wicje w2aca w2aer w2avb w2bb w2bfq w9auu.

ef-RO91, C. Conte, 24 Allee du Rocher, Clichy-sous-Bois, (S.I.e.t-o) France

wlabd wlaek wladm wlahx wlaek wlaue wlepc
wlkb wlyb wlsi w2amt w2aaj w2api w2apq w2azs
w2bfq w2beo w2bhr w2bls w2bno w2bse w2bxu w2chu
w2cuq w2dl w2dq w2gc w2hr w2jd w2kr w2mb w2ms
w2ps w2wi w2ja w3anh w3arx w3af w3aws w3bm
w3buw w3chk w3ej w3cgl w3dgt w3dh w3dlp w3ez
w3na w3sn w3sz w4abw w4abz w4ada w4aft w4aq
w4ej w4dp w4ei w4ky w4lu w4lp w4oo w4pd w4px
w4sq w4to w5kh w5vx w5ayl w5av w5az w5fe w5vq
w8aff w8adm w8adq w8aft w8bjb w8bal w8brh w8bth
w8btr w8box w8cke w8ces w8dnu w8dsy w8hd w8li
w8orm w8bre w8cia w8ck w8cl w9ex w9sj w9ms
w9xi k4agf k4sa ve2ca.

en-OQQ Java Sea, Dutch East Indies

w5af w6bvr w6egm w6erx w6caj w6cuh w6ezr
w6dkx w6dmq w9auu w9fhp xnu-6clv xnu-7eff k6dvq
op-1ad op-1cm op-1hr op-1mc op-1pw oa-2ac oa-2kb
oa-2ns oa-2tm oa-2yi oa-3ip oa-5bv oa-5dr oa-5hg
oa-5ia oa-5wh oa-5xg od-nkl od-1bh eb-4au eb-4jt
ef-8br ef-8hg ef-8lx ef-8orm eg-5vl ei-1dy es-7dj
bf-8aa fk-4ms fo-4de fo-4sb fo-4tq fo-4ra ac-1ax
ac-1pa ac-1cz ac-8na ac-9aa aj-law aj-2by aj-2nk
am-8ab.

W2BOG, D. W. Morris, 7389 Amboy Road, Totten-ville, N. Y.

eh14au eb-4fp eb-4ft ef-8br ef-8gdb ef-8gdd ef-8wb
ei-1gc ek-4au ek-4yt en-ovn ep-3co fz-amig ve1ce
ve2bb ve2br ve3ar ve3ay ve3bc ve3ce ve3rt ve3fe ve4ht
ve4bu ve4dj ve5ad ve5ay ve5dt ve5go ve9ai ve9ap ve9aq
nj-2pa nm-1n nm-9a nn-1nic nn-7nic nq-2iq nq-2jt

(Continued on Page 60)



I.A.R.U. NEWS

Conducted by A. L. Budlong

THERE seems to be a little misunderstanding among some of the national sections of the I.A.R.U. as to the real purpose of this department in *QST*. Perhaps the attitude can best be shown by the question of the secretary of one of the national sections who wrote us this month asking, "Will it be all right for me to send in a monthly report of amateur activity in this country, and if so, will it be published in *QST*?"

Our answer was that it certainly would be acceptable to have regular reports and that if they kept to a reasonable length, they would be published; if too long, a little cutting might have to be done.

The editor of this department wishes to call to the attention of all national sections of the Union and of the presidents and secretaries of these sections that this department of *QST* is first and foremost a forum for the member-societies of the Union. Since the creation of the I.A.R.U. this has been its principal object. This department represents the only means that member-societies of the Union have for placing information of interest where all the other members of the Union will see it.

It is most important, then, that first and foremost we have reports here from the various National Sections. Their reports are the ones that have first call on space here. Due in part, perhaps, to a misunderstanding of the real purpose of the department, and due also to inertia or lack of interest on the part of the officials of some national sections, we have not been able to carry regular monthly reports from each national section. A few national sections do see to it that duly authorized reports are sent in; for other countries where there are national sections we have to depend on reports of interested individuals who many times have no official connection with the national section.

It is earnestly urged upon each national section to get an authorized report to Union Headquarters each month. If the presidents or secretaries of the national sections wish

to write up these reports, fine and good. If they do not care to do so, then let them designate some individual to supply such an official report. England, South Africa, Germany and Australia now have such "official correspondents"; we urge every other national section to take similar action.

For the information of the official correspondents already created, and also for those who may come into existence in the near future, the editor wishes to remark that all reports should, so far as possible, contain news of the activities and actions of the *national sections* rather than of individuals.

AUSTRALIA

Of particular interest in the following report is the information regarding the prospects for the formation of an amateur De-

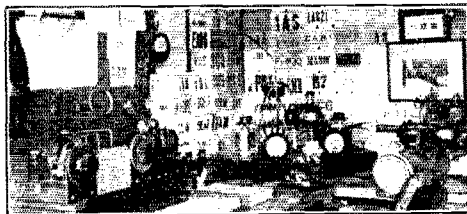

THE ABOVE TRANSMITTER IS THAT OF SYDNEY STRONG, AT GISBORNE, N. Z., OZ8AC

The transmitter in the center is a series-feed Hartley using a UX852 tube, and 240 watts input, operating on the third harmonic on 32 meters and the fifth harmonic for 19 meters. The standby 80-meter set uses a Phillips Z3 tube. Among the trophies on the wall can be seen a presentation photo from CB3 for the first international DX work; also a "clock" below the transmitting lead-in presented by the Radio Society of France for a 24-hour test on 20 meters back in 1927.

A relay of a message from Paris to Shanghai and getting the answer back to Paris under 10 minutes constitutes one of ZAC's chief traffic records.

fence Auxiliary Force. The Wireless Institute of Australia (National Section I.A.R.U.) is to be congratulated for its enterprise in this direction.

"Amateur radio in this country is experiencing a revival after one of those slack

(Continued on Page 66)

Correspondence

The Publishers of QST assume no responsibility for statements made herein by correspondents.



Boycotting "Bootlegs"

Nichols, Iowa.

Editor, QST:

Having been in the game for the past five years as a transmitting amateur and watching quite closely during that time the operation of illegal stations on the air I believe it is time for licensed operators to help keep those fellows from using the air. With the wave band jumper (of which we have far too many) and the "bootlegger" this combination may have a very unpleasant effect upon the amateurs of the U.S.A., at this critical time in radio affairs.

The natural remedy for the "bootlegger" is for the licensed stations to refuse to QSO them and they will die a natural death or become a licensed station; but as long as the fellows do QSO with them, this will just add to the number of them on the air.

One evening recently I called CQ on the 40 meter band and got an answer from nu"8XX" which I supposed to be a special licensed station as his signals were R-8, very steady, and with a good R.A.C. tone. When he came back, after I answered his reply, and told me he was using a "bootleg" call and his QRA was Ohio, I became very much disgusted and listened to him only until he told me "G.A." when I immediately turned the dial and listened for a legal station to call. Evidently he thought I had lost him but this was not the case. I have made it a rule at my station never to QSO unlicensed stations and never to answer their calls if I know it before hand.

I hope the party using "8XX" will read this communication, take it to heart and become a real amateur. I have had several calls from "bootleg" station but have never QSO'ed them and believe we should all do this in order to discourage them.

Thomas S. Wildman, nu9DIB.

Let's Run Them Down

Penna. State College,
State College, Pa.

Editor, QST:

After the Atlantic Division Convention of the League held here June 14, 15 and 16, station 8XE suffered a loss due to a robbery of about \$1000 worth of radio equipment. This consisted of four Western Electric type 212-D, one Western Electric 211-D, two Western Electric type 205-D, two West-

ern Electric 102-D tubes and four UV204-A R. C. A. tubes, serial numbers 13597, 13598, 13345, and 16618.

We believe that the robbery took place about 2.30 AM, Sunday, June 17, 1928. At 7.00 AM one of the operators, upon entering the station, found the rear window open and three W. E. 212-D tubes in their original cartons inside under the open window. We believe these tubes were left because a fire broke out in town about 2.30 AM and the fire siren no doubt scared away the intruders.

We earnestly hope and believe that no amateur would lower himself in the eyes of fellow amateurs to do a trick such as this. Being an amateur in the large amateur fraternity of the United States I am calling on all amateurs to cooperate and assist in every way possible to have the above-mentioned property returned.

This robbery places 8XE in rather bad shape because all tubes including spares for experimental work were stolen. This year's budget will not permit the purchase of new equipment.

If any one has information concerning these tubes, kindly communicate with the undersigned.

*Gilbert L. Crossley,
Instructor Radio
Engineering.*

A W. A. C. Problem

Patton, Calif.

Editor, QST:

Silence has been maintained here until the strain is about 10 amps in the feed line of my very best Zepp. antenna, but we must get the A.R.R.L. WAC Club out of the rumpus.

Let us take this insignificant little "one in thousands" stations for a fair example. Lots of midnight oil has been consumed with two things in mind: Traffic and DX. Don't fool yourself that the DX man has no traffic. He has and it is often important at that. We get the contact and the traffic but where in thunder does that card go from that fellow over there. The message may be delivered but what of the card? Getting down to brass tacks, how many NU 8's and 9's have been QSO with AJ or AC? And it is the same story with the 6's and 7's and their European contact. It is most certainly not a daily occurrence.

TAPERING CHARGERS

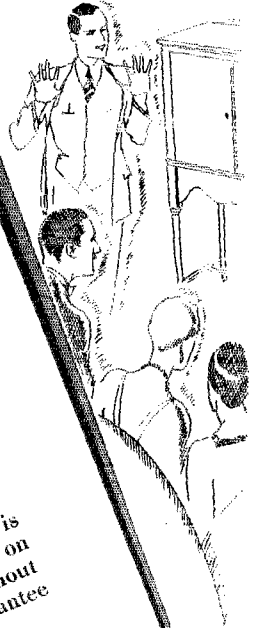
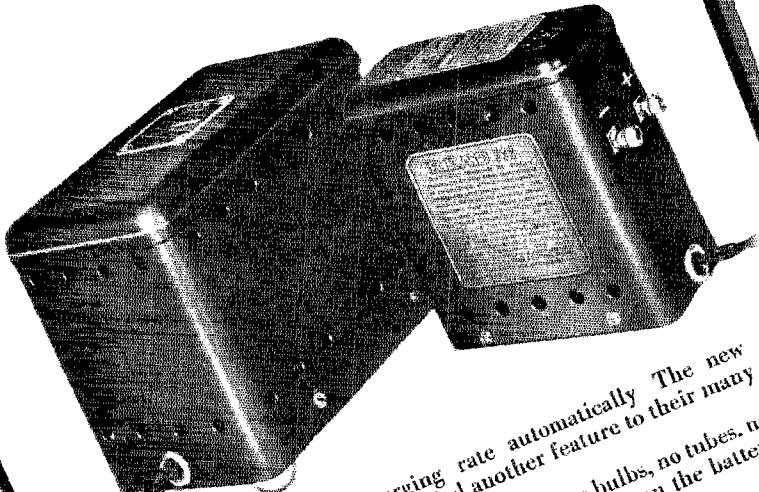

TAPERING the charging rate automatically. The new Elkon Chargers have added another feature to their many advantages:—
 Dry—no acids, no water, no corrosion, no bulbs, no tubes, no noise, no moving parts, high charging rate when the battery is low, low charging rate when the battery is high.
 The Tapering Charger, 1 Ampere, maximum charging rate is the ideal power supply for the storage battery. Leave it on all the time, without interfering with reception and without injuring the battery. Long life. Instructions and Guarantee printed on container.
 The 3 Ampere Tapering Charger is ideal for the rapid charging of either radio or automobile batteries. Has all the advantages of the smaller charger.
 No attention needed—just plug them in and forget them. Elkon Rectifiers are self-healing! They are not affected by accidental overloading or line surges!

ELKON Replacement Rectifiers

This exclusive feature of the Elkon Rectifiers is saving customers millions of dollars! After a long time—5000 hours for battery chargers—a year or so for "A" Eliminators, renewing the rectifier will prove to be an economy. The old rectifier may be shipped out and the new one put in—only a minute required—and the unit is as good as new.
 If you have a power unit using a dry rectifier, ask your dealer about the Elkon Replacement Units. Reputable Elkon is the only unit authorized by Fairsteel to replace the acid jars in the Balkite power units.

ELKON, INC
 Division of
P. R. Mallory & Co., Inc.
 PORT CHESTER, N. Y.

Row upon Row of Elkon Rectifiers measured under the mechanical eyes of skilled workers

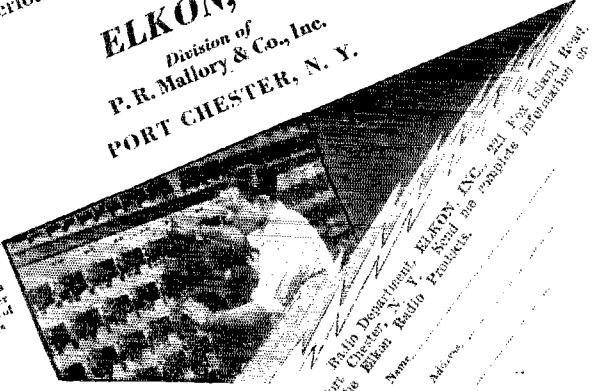

Write, Directly to: **ELKON, INC.** 221 Park Avenue, Room 1404, Port Chester, N. Y. Send me your name and address for a free Elkon Radio Products literature.

Name: _____
 Address: _____



Look for 'the



on top of all

Cunningham RADIO TUBES

WHEN you look inside of your radio, be sure you see the monogram "C" smiling up at you on the top of each radio tube.

Thirteen years of experience and tireless research combined with a guarantee against mechanical and electrical defect stand behind this simple monogram.

Cunningham Tube quality has resulted in national leadership and public approval, two assets we zealously guard and is your assurance of faultless modern reception.

*Never use old tubes with new ones—
use new tubes throughout*

E. T. CUNNINGHAM, INC.
New York Chicago San Francisco

Manufactured and sold under rights, patents
and inventions owned and/or controlled by
Radio Corporation of America.

Cunningham RADIO TUBES

I can truthfully assert that one EF station stands between the gratification of the desire of five sixth district stations in this immediate vicinity of getting that coveted WAC certificate. So this plea is not a self-centered affair as this is the expression of those five and I know not how many more.

I have, in my own case, the verification of other very reliable amateurs who listened to both sides of the QSO. But after having sent two well meant letters and cards I still have no reply from the French Amateur. I am then, not eligible for WAC although the cards from the other five continents are available in numbers.

There is then some inequality for the requirements. It would be a pleasure to have opinions as to the possibilities of rectification of the present situation. Otherwise we will have to take the WAC off the high pedestal where it now enjoys such high distinction.

As a suggestion it might be well to mention the rare possibility of a number of us unfortunates getting a charter of one of Uncle Sam's First Line Cruisers. Perhaps we could actually frighten some of these chaps into putting out a little piece of paper known as a QSL card. How about it?

—J. R. Wells, nu6QL-6AG

1929

Oakland, Cal.

Editor, *QST*:

The amateur is well aware of the fact that our bands have suffered mutilation at the hands of the International Radiotelegraph Conference of 1927. But there is no need to go around moaning about it, gang—the outlook is brighter after you have studied the situation from different angles. The new bands are——“a sheep in wolf's clothing!”

An old proverb says that, “You can lead a horse to water but you can't make him drink.” Weren't the amateurs pushed down below 200 meters where the most important channels are now located. Did we drink? I hope to shout! The amateur guzzled in such delicious gulps that the commercial interests awakened to the fact that the water wasn't poison; but that it was an excellent remedy for a multitude of existing ailments.

Someone in the peanut gallery has a question. “Why is the new band like a sheep in wolf's clothing?” I'm glad that someone is interested in what I'm trying to put over.

In the August *QST*, the transmitter of 1929 holds the spotlight. Disappointed, weren't you? . . . Simple, inexpensive and efficient . . . the new era will demand just that! Expected to see a flock of trick doodads tacked on here and there? Big surprise, wasn't it?

After squinting at the transmitter from numerous angles we find that all the superfluous bric-a-bracs had been hacked away.



In the Sets Designed by Leading Engineers

Faradon Capacitors are specified as standard equipment where electrostatic condenser long life and durability is essential.

We will be pleased to cooperate with you on your condenser problems. Faradon engineers gladly supply data on special capacitor problems not covered by our more than 200 types of Faradon units ready for prompt delivery.

WIRELESS SPECIALTY APPARATUS CO.
JAMAICA PLAIN BOSTON, MASS., U.S.A.

Established 1907

Faradon

Electrostatic Condensers for All Purposes

NATIONAL RECTOBULBS

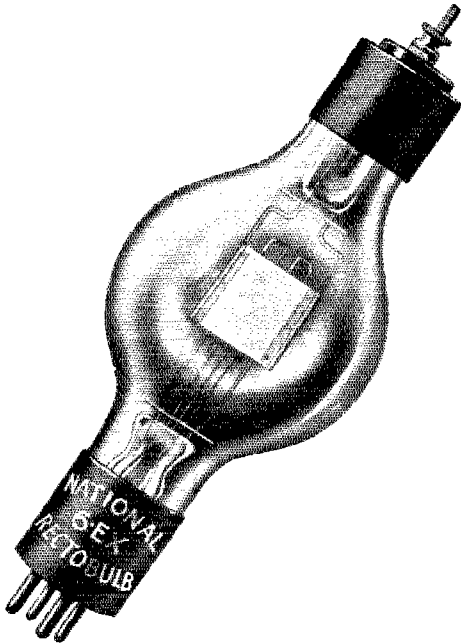

Their popularity grows steadily—an unailing source of smooth Plate Voltage. A Pair of Rectobulbs in full wave, will deliver a distinctive note, which may easily be filtered to DC—the drop at full load of 250 Mils. is only 200 Volts—therefore, it will pay you to adopt Rectobulbs for your Station. **Price \$15.00 each**

We make a guaranteed Rebuild on

UV-204A—Thoriated	\$75.00 ea.
UV-203A—Thoriated	\$19.00 ea.
UV-204—Tungsten	\$50.00 ea.
WE-212—Oxide	\$40.00 ea.
WE-211—Oxide	\$16.50 ea.

We have discontinued the Type 213

We purchase BO tubes of types as listed above

No charge for crates when cash accompanies order.

NATIONAL RADIO TUBE CO.,
(6Ex). 3420 18th St., San Francisco, Cal.
(A Ham Institution)

the adjustments simplified and the wiring conspicuous by its absence. Rigid and strong mechanically as well as it is electrically.

The result is a steady wave, readable signals and more miles to the watt.

The receiver will undoubtedly follow along the same lines. After all, gang, aren't these vital points the goal that we are striving for?

"Necessity is the mother of invention." If so, the new band will make us work out our little problems of making the "ham" game a finer and more interesting hobby . . . yes it will be a "sheep in wolf's clothing!"

Sometime in the near future an amateur will pick his "old junk" out of the scrap box and extending it at arms length, gazing intently for a few minutes, then murmur slowly with a 60 cycle note something like this "Alas! Poor Yorick, I thought I knew him well."

—Edward Burke, Jr., 6DUR

QSO?

Chicago, Ill.

Editor, QST:

Someone, after listening in on the "ham" bands, described Amateur Radio as a realm in which everybody was calling somebody but nobody got to work anybody.

If there are any discouraged "hams" who have come to think of this as a true picture, let them take hear and ponder upon the fact that even the commercial brass pounder has his trouble.

Here is an example—it really happened.

Ship Station called Coastal Station, and added, "Rush message, QRL."

Coastal Station answered and waited.

No Reply.

Coastal station answered again and waited. No reply.

Five minutes later, the Ship Station again called Coastal Station, and appended, "Rush Msg QRL."

Coastal Station answered. No reply. Answered again, repeating ship's call letters about ten times. No answer.

Coastal station then called another ship, and asked him to QSO.

Second ship called, but could not raise the first op.

Ten minutes later the first ship called again, with: "Rush msg. QRL."

Both ship and shore stations tried to QSO but could not be heard by the first ship station.

Coastal station then commented to the assisting ship, "His hay wire set has an open circuit and he can't find it."

About fifteen minutes later, the assisting ship called the Coastal Station. "Did U get WXYZ?"

Coastal Station "No".

Ship Station: "I can just make out his lights."

Coastal Station: "Any chance you can blink him?"

Commander Byrd's Equipment Is Insulated With Formica



Both sending and receiving sets used by the Byrd Antarctic Expedition are built on a foundation of Formica Panels, Tubing and Rod.

For fifteen years Formica has been regarded by American radio men as a dependable, high-quality, uniform insulating material for all radio purposes.

Ask for it when buying insulation.



THE FORMICA INSULATION COMPANY

4620 SPRING GROVE AVENUE
CINCINNATI, OHIO

Any jobber or dealer
can get Formica pan-
els for you.

FORMICA

Formica has a Com-
plete Insulating Service
for Manufacturers.

Get into the COMMERCIAL RADIO FIELD where the MONEY IS

We've had hundreds tell us that they knew radio backwards and forwards. Yet they enrolled in our courses. And a few weeks after they started to learn radio the RIGHT way these same men told us that they never realized how much they had been missing right along.

Maybe you too have sufficient radio knowledge to build a few radio circuits. That isn't enough to make a real commercial success. What you really need is a course that takes you from the first elements of radio right through the most complex stages and gives you the practical knowledge you need for commercial work.

RADIO INSTITUTE SPONSORED BY RCA, G-E AND WESTINGHOUSE

The Radio Institute of America is the world's oldest radio school, giving the finest and most comprehensive instruction obtainable. Our graduates are making real money—we'll send you copies of some of the letters they write us about their successes.

STUDY AT HOME

Another feature of this course is that you can study at home—when you please and as long as you please. No need to give up your present employment. No time lost traveling back and forth to classes. Our new booklet tells how others—just like yourself—have won success in radio, and how you too can make this profession of fascinating brain-work your life career. You owe it to yourself to read this book through. If you will clip and mail the coupon, we'll send the book to you.



RADIO INSTITUTE OF AMERICA Dept. D-10
326 Broadway, New York City

Please send me your booklet.

Name

Address

Ship Station: "No".

About an hour later, the first ship called the Coastal Station again. "TR msg."

Ship then called another boat, which answered, but operator couldn't hear him.

But four hours later, first ship called another, and asked him to QRK.

Second ship complied, and the first operator then said, "Tu OK now."

He then called the Coastal Station, which replied.

Ship gave him position report and routine message.

Coastal Station: "R Where is that rush msg?"

Ship Station: "I don't think it would do any good to send it now. Sender says it wouldn't be any good now."

—H. A. Fanckboner

Getting Started on 160 Meters

(Continued from Page 47)

sion; is excellent for local work (no skip distance) and the adjustment of equipment for transmission at these lower frequencies is materially simpler than at the higher frequencies. To offset these advantages, we find that the transmission over long distances requires considerably more power than would be needed on some of the higher frequencies and that there is more difficulty involved in obtaining enough space in which to erect the more efficient types of antenna systems. Both these factors tend to reduce the maximum range of transmission for a given amount of power. However, the range of a station as far as making successful QSO's are concerned is also dependent upon the amount of interference which must be overcome and there is decidedly less of this in the 1750-ke. band than in any others now commonly used. That should help considerably as most new operators find difficulty in working through strong interfering signals.

In order to aid those who are interested in getting together on the 1750-ke. band, the Communications Department is collecting schedules and making arrangements for the holding of a series of parties for the newer men. Information concerning these will appear from time to time in that special section of *QST* devoted to the C.D. A bulletin listing code-practise schedules, other beginners, 160-meter stations, etc. is also available to anyone from the C.D. on request. Send a postal for it. Herewith follows the description of a simple, effective and cheap receiver that will cover the 1750-ke. band and may also be used for the 3500-ke. band.

The circuit diagram appears in Fig. 1. A detector and one stage of audio amplification is employed. The grid coil is wound on a piece of cardboard mail tubing about 2 1/2" in diameter, and consists of 38 turns of No. 26 d.c.c. wire close wound. A tap is taken out at the 15th turn from the filament end so that the 3500-ke. band may be covered.

SM

CHANGE BANDS AS QUICKLY AS CHANGING A TUBE

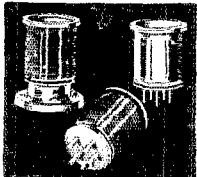

New S-M 131 Plug-In Coils (used in the 730) wound on moulded bakelite, fit any 5-prong tube socket. Four coils cover the band from 17.4 to 204 meters (ham bands at centers of .00014 mfd. tuning scale.) Price \$1.25 each wound, or 50c blank.

Your television experiments and short wave reception—do you *depend* on a receiver which is itself of “experimental” construction and requires excessive attention to insure reliability and time to change wave lengths? If you own an S-M “Round-the-World” Receiver, in its neat aluminum shielding cabinet, with its screen grid r.f. stage and quick-action plug-in coils, you can rest assured your reception—whether code, voice, or pictures—interstate or international—will be top-notch *all the time*.

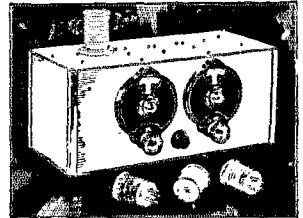

Complete Kit

Everything necessary to build the complete four tube r.f. regenerative (non-radiating) short-wave set, including aluminum cabinet and two S-M Clough audio transformers. 730 Complete Kit.....\$51.00

Adapter Kit

Complete with aluminum cabinet, less the two audio stages. Used with an adapter plug, it converts any broadcast receiver for short-wave use. Ideal for Television. 731 Adapter Kit.....\$36.00

Essential Kit

Contains the two tuning and tickler condensers, four wound plug-in coils, coil socket, and three r.f. chokes, with full instructions for building a 1, 2, 3, or 4 tube set. 732 Essential Kit.....\$16.50

720 Screen Grid Six The Year's Biggest Value

This is the set that S-M gets squarely behind and tells you it's the biggest value in broadcast-band receivers to be found today. A man-sized recommendation!

Successor to the famous Shielded Grid Six that took the country by storm, the 720 is the kind of a set you can build in an evening, on its pierced metal chassis. When it's finished and you put it on the air—then the real surprise begins. Distant stations will come in, one after another, with local

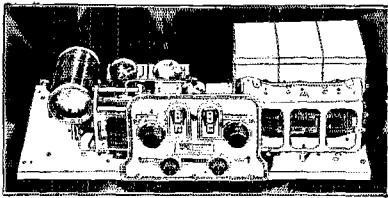

volume, and positive 10 kc. selectivity. As to tone, the 720's superiority is insured by the new 255 and 256 audios, as described at the right.

Look at the 720's features as you see them in the picture, and remember that S-M backs it to the limit—assures you that you can't get more actual radio elsewhere at twice the cost. Then note the price: Custom-built complete in a beautiful two-tone brown metal shielding cabinet, \$102.00. Complete kit only \$72.50, with the same cabinet \$9.25 additional. Better order now—such values spell scarcity!

Are you receiving the “The Radiobuilder” regularly? Every month it gives you all the earliest S-M news, operating hints and kinks. To S-M Authorized Service Stations, it comes free of charge, with all new constructional Data Sheets. If you build professionally, write us about the Service Station franchises.

SILVER-MARSHALL, Inc., 858 W. JACKSON BLVD. CHICAGO, ILL. U. S. A.

Audio Transformers Just Two Years in Advance

Radically new in principle, these transformers are the first to give freedom from the hysteretic distortion found in all other types. They combine decided advances in both tone and volume, as will be seen below. E is the two-stage curve for the large size transformers (S-M 225, 1st stage, and 226, 2d stage, \$9.00 each); D is that of the smaller ones (S-M 255 and 256, \$6.00 each). Note the marked advantage over A, B, and C—all standard eight and ten dollar transformers under equal conditions.

And you can have this finer performance in any set at less than average transformer costs!

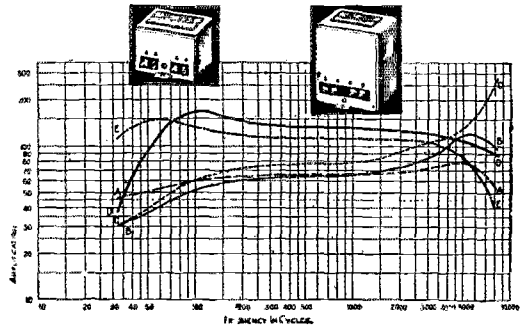

The S-M catalog describes all these products, as well as A and B Power Supplies, Power Amplifiers, Modulation Transformers, etc.

Silver-Marshall, Inc.,
858 W. Jackson Blvd., Chicago, U. S. A.

....Send your complete catalog, with sample copy of the Radiobuilder.

....For enclosed 10c, send five sample S-M Data Sheets.

Name.....

Address.....

Special Offer on Radio Broadcast

containing first 8 articles
by Robert S. Kruse



ROBERT S. KRUSE, formerly Technical Editor of QST and now a regular contributor to *Radio Broadcast* has written a series of exclusive articles on the transmission and reception of telegraph and radiophone signals on short wave. The first article appeared in the August 1928 issue.



We are making a special offer on the next eight issues of *Radio Broadcast* for only \$2.00. This offer gives you *Radio Broadcast* at 25c per copy instead of 35c.

Enclose coupon below with \$2.00 and receive the next eight issues of *Radio Broadcast* containing articles by Mr. Kruse.



Radio Broadcast
Garden City, N. Y.

RADIO BROADCAST
GARDEN CITY, N. Y.

Enclosed is \$2.00 for the next 8 issues of *Radio Broadcast* containing articles by Mr. Kruse.

Name _____
Address _____

A quarter inch below the secondary winding is the tickler coil consisting of 7 turns and the same distance above the secondary is the antenna coupling coil of 10 turns. The same size of wire is used for all windings. It is not necessary that the form on which the coil is wound be of the precise size mentioned. If a form you have is not this size, use it anyway, remembering that if its diameter is larger, fewer turns will be needed while if it is smaller, it will be necessary to increase the number. Wind the antenna coil first as its number of turns has nothing to do with the tuning range. Next wind the number of secondary turns that seems about right and below it put the tickler winding. If there are sufficient tickler turns, the circuit will oscillate when the feedback condenser is rotated toward maximum capacity. To check for oscillation, touch the coil end of the grid condenser with the finger. If a click is heard as the condenser is touched and also when the finger is removed, the circuit is oscillating. The circuit will usually oscillate more readily when the secondary condenser is near minimum. If the circuit does not oscillate, add more tickler turns after checking over the connections to see that they are properly made. If too many tickler turns are used, an audio howl will be heard when the feedback condenser is advanced towards maximum. Adjust the number of tickler turns so that about half the capacity is in the circuit when oscillation commences. After the circuit is in oscillation, you can listen in for signals. To check the frequency (wavelength) range listen for some of the high frequency (low wave) broadcast stations. You should hear a few of them with the tuning condenser near maximum capacity. If you can pick them up as low as 40 or 50 degrees, it indicates that the wavelength range is too high and some secondary turns must be removed. If you can't hear any broadcast signals, the range is too low and more turns should be added. A tap taken out about 2/5 of the way from the filament end of the winding will allow the 3500-kc. band to be covered. A clip allows the tuning condenser to be connected across the entire coil or across the smaller section of it.

Either '99 or '01-A type tubes may be used. If the dry battery type are employed, a 20-ohm rheostat will be needed whereas a 6-ohm one will be suitable for the quarter ampere tubes.

Calls Heard

(Continued from Page 50)

oa-4yn oa-5by oa-6em oa-6dx oa-6hg oa-6rj oa-6ag
oa-6mu oa-6sa oa-7ch oa-7cw oa-7dx oa-7lj k6akg
nq-5ay nq-5cx nq-5fl nq-5ry nr-2ags ns-1fnn oa-2ac
oa-2aw oa-2bc oa-2hc oa-2hm oa-2ij oa-2kb oa-2no
oa-2rb oa-2rc oa-2rz oa-2tm oa-2xr oa-2yi oa-3bd
oa-3bm oa-3bq oa-3cp oa-3dc oa-3gt oa-3jk oa-3lg
oa-3ls oa-3pm oa-3vp oa-3xf oa-3xx oa-4lj oa-4nw
k6avi k6boe k6bqh k6cfq k6dki k6dpg k6dsd k6dv
k6dvg k6dwz k6kq oo-1aj oz-2ba oz-3aj oz-3ar oz-4am
oz-4ay sa-ca2 sb-1ah sb-1sj sb-1bm sb-1ld sb-2bg
sc-2ab sc-3ac se-2ah se-2ea su-1cd su-2ak su-2bt.

New Heights of Stromberg-Carlson Quality.....

THAT fidelity of tone which musical critics have always applauded in Stromberg-Carlson Receivers is more marked than ever in this new instrument.

The No. 636 Stromberg-Carlson is entirely self-contained all operating power coming direct from the house lighting circuit without batteries or liquids. Employs balanced circuit (Hazeltine patents), with scientific total shielding. All operating parts including power equipment are combined in one unit on rigid steel base.

There is but one tuning dial (illuminated) marked in wave length meters as well as divisional scale. A handy jack facilitates playing records electrically through the audio system of the Receiver.

The Cabinet is among the finest ever produced in the radio industry. It is low, perfect in proportion with beautifully grained panel construction and will win a place in any room for decorative value alone.

STROMBERG-CARLSON
TELEPHONE MFG. CO.
ROCHESTER, N. Y.

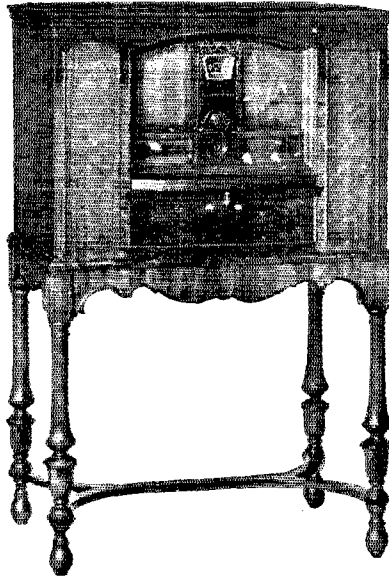
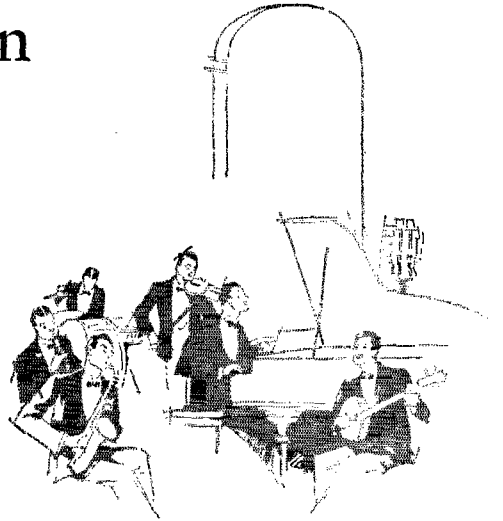

No. 636 Stromberg-Carlson Art Console

Uses 5 UY-227 A. C.,
one UX-171-A Output,
and one UX-280 R. C. A.
Tubes. PRICE, less Tubes
and Cone Speaker, East
of Rockies . . . \$245.00

*Other Stromberg-Carlson
Models available for A. C.
or D. C. current areas, as
well as models operated by
batteries.*

Stromberg-Carlson

MAKERS OF VOICE TRANSMISSION AND VOICE RECEPTION APPARATUS FOR MORE THAN 30 YEARS

Hear these prominent men on Radio Subjects that interest you

THRU the RADIO-TRICIAN PROGRAM
OVER the RED NETWORK

UNDER THE AUSPICES OF THE NATIONAL RADIO
INSTITUTE



S. L. "ROXY" ROTHAFEL

The Future of
Radio Broadcasting

Tuesday, Oct. 2, 8:00 to 8:30



DR. J. H. DELLINGER

What the U. S. Government
is Doing to Advance Radio

Tuesday Oct. 9, 8:00 to 8:30



J. E. SMITH

The Man Power and
Mechanism Back of Radio

Tuesday Oct. 16, 8:00 to 8:30



DR. C. FRANCIS JENKINS

Modern Development in
Television and Radio-Vision

Tuesday Oct. 23, 8:00 to 8:30

Over These Stations

WEAF
WTIC
WJAR
WTAG
WCBS
WIC
WGY
WGR
WCAE
WWJ

WSAI
KSD
WOC
WHO
WOW
WDAP
WPI
WTAM
KYW

The Radio-Trician program advertised above is sponsored by the National Radio Institute, pioneer and largest home-study Radio school in the world. They have a valuable book, "Rich Rewards in Radio" describing the many jobs in Radio and how you can become a Radio expert through spare time study at home. You are welcome to a copy. Just clip and mail the coupon.

Get this book NOW~it explains what Radio offers YOU

National Radio Institute Dept. 22R2
Washington, D. C.

Gentlemen: Send me your book. I understand this request does not obligate me in the least.

Name.....Age.....

Address.....

City.....State.....

S. S. Dromore Castle, New York City to Cape Town, South Africa, Operator Clyde Townsend, care the Union-Castle Mail Steamship Co., 25 Broadway New York City

(1000 miles S. E. New York)

wiabd wlabx wlabd wlags wlajd wlakd wlang wlapk wlawm wlawx wlbca wlbkn wlvbr wliamx wlcpt wlexw wiga wlim wlmk wlmx wlnq wlsi wlttd wlium wlvrr wlvrs w2adl w2aeu w2afo w2agp w2aib w2aaj w2aon w2asb w2asz w2baa w2bey w2bdq w2bek w2bfh w2bfg w2bhf w2bhr w2bjg w2bke w2ble w2bne w2cau w2cin w2com w2exl w2eyx w2eo w2fc w2ik w2il w2jd w2kc w2kp w2mg w2qa w2ty w3aaj w3aii w3ajh w3anh w3ann w3aob w3ard w3arx w3auv w3bel w3bfu w3bgt w3bq w3cs w3ii w3mk w3mq w3mq w3sh w3ua w3ac w4aar w4ahe w4ahl w4aj w4ea w4jk w4pd w4ud w4vl w4wo w5ain w5an w5apo w5aqe w5aqt w5av w5jc w5kh w5rg w5uk w5wo w5ec w7tu w7vq w8agq w8agy w8ahm w8aht w8air w8axq w8bbg w8bbj w8bbs w8bhi w8bjo w8blk w8blp w8bn w8brn w8brf w8brh w8bth w8buf w8cyl w8ciq w8crr w8cns w8cnt w8czz w8ess w8cto w8cyp w8dbf w8dnf w8dp w8dqz w8dsn w8dsy w8dvl w8dwc w8dww w8dwa w8dxr w8krm w8mq w8mz w8acs w8ain w8arm w8avl w8dbj w8brk w8bki w8bsh w8brk w8cpl w8nea w8dvr w8nxx w8dzi w8dzz w8eaj w8egt w8eho w8elh w8aru w8aru w8ena w8fgp w8fhy w8fpp w8fqm w8fs w8gv w8sj w8zk en-7om ek-4yt.

(1000-2000 miles S. E. New York)

wiaak wlaal wlahm wlaek wlafl wlaic wliaks wliams wlap wlaqe wlauk wibbl wlbca wlicz wlecl wlich wldu wlmx wlrp wlvf w2aac w2alo w2api w2atz w2bb w2bf w2bgz w2bhr w2bid w2bql w2bs w2bsj w2cin w2euf w2exl w2dr w2hc w2ja w2jr w2je w2po w2sf w2am w2xy w2aat w2awb w2bmi w2bph w2cjp w3co w3ec w3sh w3us w3zm w3abl w4abi w4aci w4bn w4ib w4ll w4oc w5tk w6cc w8adp w8aff w8agk w8agy w8ax w8bpd w8by w8cau w8cud w8dht w8dkr w8dkx w8dps w8dwc w8dyu w8li w8tn w8uj w8auh w8ayx w8bkg w8caf w8cpl w8cmz w8dwi w8egp w8eey w8eny w8eth w8fes w8flb ea-cm ea-es ea-kl eb-4bh eb-4dv eb-4el eb-4fg eb-4ly eb-4om eb-4roo eb-car28 eb-8arx eb-8gdb eb-8jfv eb-8br eb-2av eb-2bi eb-2xy eb-5bw eb-5wp eb-1eq eb-1mg eb-4ac eb-hau eb-4cb eb-4yt eb-0fp eb-0ga eb-0ncj eb-p63 eb-1ag eb-1br eb-1ca eb-1cp eb-93ra eb-h8 gi-6ky gw-14b velbr ve3ay.

(2000-3000 miles S. E. New York)

wiafb wiale wlbch wlebh wlecp wlcio wlfp wlim wlmk wlmz wiqb wlrp wlvh wlzr w2acb w2anh w2ans w2arq w2ase w2atz w2ann w2bda w2bmi w2cm w2cuf w2cug w2exl w2fk w2fn w2ih w2jd w2rs w2qs w3ael w3age w3any w3auw w3avd w3bfu w3bvl w3gt w3kj w3mk w3rs w3sn w3sz w3td w4aa w4aba w4aci w4adg w4ea w4afx w4ahk w4ahy w4ahz w4dz w4fx w4ie w4nf w4tl w4va w4vl w5ag w5ary w5as w5ayl w5gf w5pt w5qi w6ads w6ax w6dbb w8agq w8aht w8apm w8awy w8bbg w8bum w8hxd w8hy w8bc w8cau w8ent w8ert w8eth w8ezd w8dds w8dne w8dhm w8drs w8dsa w8duw w8dzz w8eg w8fdk w8li w8mz w8ahy w8bhx w8bjz w8bmk w8btb w8cms w8cmz w8cya w8elh w8enk w8evn w8fj w8fs w8ux eb-4xs eb-4wg eb-4om eb-4ly eb-car35 eb-car42 eb-8ic eb-8pac eb-8vu eb-8wm eb-2bi eb-2cx eb-2mf eb-2sc eb-4cb eb-0fp eb-0x eb-1ag eb-1ca eb-1ch eb-1yt eb-2hd eb-nag eb-tvac eb-94ra eb-hb (a-oyca velbr ve3sb nq-5fc nq-5fl nz-rfz sb-lah sb-lar sb-law sb-2al sb-5af sb-7ab ve3ay.

(3000-4000 miles S. E. New York)

wiaed wlaek wlaic wlaoi wlibux wlapd wiah wikh wliom wlrp wlvh w2aba w2aih w2anh w2and w2ate w2exp w2bda w2bg w2bhv w2arm w2arp w2bjp w2bjj w2blx w2bne w2box w2bxc w2com w2cuf w2eap w2ch w2fa w2fc w2fn w2fw w2gv w2hc w2is w2nf w2qs w2tr w3acv w3akw w3ami w3anh w3any w3aua w3ck w3ckl w3im w3mk w3rb w3sn w3vg w4aa w4abw w4abz w4acn w4acv w4ahk w4any w4and w4arh w4cb w4co w4ea w4fe w4jm w4hf w4oc w4pd w4qg w4sh w4to w4vc w4wg w4afx w5ain w5arw w5ayg w5jd w5pt w5qr w8abw w8agq w8aig w8arl w8bgw w8bjb w8bpl w8bq w8bth w8bum w8bvy w8cfn w4ent w5dds w8dfb w8dhe w8dnu w8dpo w8dra w8drs w8dww w8eq w8du w9aat w9bhi w9bi w9bsa w9dcb w9dzz w9ah w9fax w9ll w9ms w9mz w9xl w9zk ea-cm ea-2yd ed-oda eded-7ly eb-8gdb eb-8mop eb-8wb eb-4ar eb-4ac eb-4dba eb-4qb eb-4yt eb-1ca eb-1cp eb-1pn eb-1ms ea-2nag ve2bb nk-u7ax nm-xc5i nm-xc6g nq-2ro nq-5fc sa-de8

A NEW NOTE IN AUDIO AMPLIFICATION

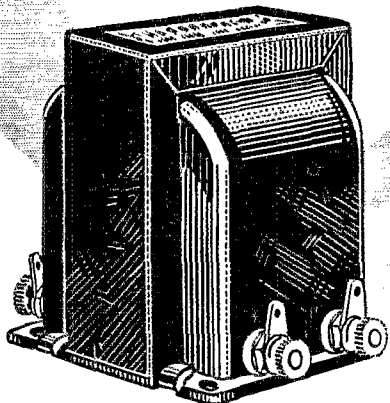

THORDARSON R-300 AUDIO TRANSFORMER

SUPREME in musical performance, the new Thordarson R-300 Audio Transformer brings a greater realism to radio reproduction. Introducing a new core material, "DX-Metal" (a product of the Thordarson Laboratory), the amplification range has been extended still further into the lower register, so that even the deepest tones now may be reproduced with amazing fidelity.

The amplification curve of this transformer is practically a straight line from 30 cycles to 8,000 cycles. A high frequency cut-off is provided at 8,000 cycles to confine the amplification to useful frequencies only, and to eliminate undesirable scratch that may reach the audio transformer.

When you hear the R-300 you will appreciate the popularity of Thordarson transformers among the leading receiving set manufacturers. The R-300 retails for \$8.00.

THORDARSON ELECTRIC MANUFACTURING CO.
Transformer Specialists Since 1895
WORLD'S OLDEST AND LARGEST EXCLUSIVE TRANSFORMER MAKERS
Huron and Kingsbury Streets — Chicago, Ill. U.S.A.

Power Supply Transformers

These transformers supply full wave rectifiers using two UX-281 tubes, for power amplifiers using either 210 or 250 types power amplifying tubes as follows: T-2098 for two 210 power tubes, \$20.00; T-2900 for single 250 power tube, \$20.00; T-2950 for two 250 tubes, \$29.50.



Double Choke Units

Consist of two 30 henry chokes in one case. T-2099 for use with power supply transformer T-2098, \$14; T-3099 for use with transformer T-2900, \$16; T-3100 for use with transformer T-2950, \$18.



Power Compacts

A very efficient and compact form of power supply unit. Power transformer and filter chokes all in one case. Type R-171 for Raytheon rectifier and 171 type power tube, \$15.00; Type R-210 for UX-281 rectifier and 210 power tube, \$20.00; Type R-280 for UX-280 rectifier and 171 power tube, \$17.00.

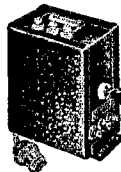

Speaker Coupling Transformers

A complete line of transformers to couple either single or push-pull 171, 210 or 250 power tubes into either high impedance or dynamic speakers. Prices from \$6.00 to \$12.00.



Screen Grid Audio Coupler

The Thordarson Z-Coupler T-2909 is a special impedance unit designed to couple a screen grid tube in the audio amplifier into a power tube. Produces excellent base note reproduction and amplification vastly in excess of ordinary systems. Price, \$12.00.

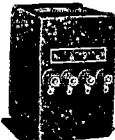

THORDARSON ELECTRIC MFG. CO.
500 W. Huron St., Chicago, Ill. 3893-F

Gentlemen: Please send me your constructional booklets on your power amplifiers. I am especially interested in amplifiers using.....tubes.

Name.....

Street and No.....

Town.....State.....

How's Your Library?

You will be constantly referring to the series of articles by Ross Hull on the work of the A.R.R.L. Technical Development Program. There will be a textbook for 1929 construction and operation. These issues, along with the others, should be preserved in a

QST Binder



Note the wire fasteners. Unnecessary to mutilate copies. Opens and lies flat in any position.

One-fifty each
postpaid

A binder will keep your QSTs always together and protect them for future use. And it's a good-looking binder, too.

QST

1711 Park St., Hartford, Conn.

sa-dqh sa-ens sb-laa sb-lah sb-laj sb-lar sb-law sb-lbg sb-lbo sb-lbs sb-lcg sb-lcj sb-lid sb-2ad sb-2af sb-2aj sb-5af sb-9aa sc-1ai sc-2ab sm-uk so-laa su-luo.

(4000-5000 miles S. E. New York)

wibbl wibgq wicnz wleh winx wiom w2aih w2arz w2cbg w2euf w2cxl w2gv w2lx w2ts w5aef w5anh w5aqz w5aua w5cgl w5ec w5iabz w5aen w5aev w5acz w5ahy w5ahz w5aq w5bh w5ch w5co w5es w5dv w5ea w5gh w5ng w5oc w5pf w5qb w5qr w5tk w5vc w5ad w5afx w5lf w5pt w5to w5uf w5yb w5adb w5bec w5bpl w5cxi w5dpo w5duw w5gq w5hd w5fbv ea-jh eb-4pf ec-2ai ed-7lk ed-oxz ee-ear86 ef-8psc eg-2vq ei-lbw ei-leq ei-lgc ei-lxs ek-4dba ek-4ig ek-4qa en-ofp ep-lae eu-16ra fq-ocya fq-pm velbr nj-2pa nm-xc51 nm-xc69 nz-fr5 sa-de8 sa-dlg sb-lac sb-lca sb-lid sb-lin sb-2ab sb-2af sb-2aj sb-2ay wn-2bg sb-2ca sb-3qa sb-5af sb-6qa sb-2ak.

(6000-6000 miles S. E. New York)

wiads w1ajc w1mk w1mx w1om w1rp w2alo w2apy w2ava w2bge w2box w2bsd w2cxl w2ja w2jd w2qd w2vc w2xm w3aa w3af w3au w3aua w3ca w3cgl w3ec w3en w3ah w3au w3abl w3ac w3aev w3ad w3aeb w3aef w3af w3aj w3al w3au w3pf w3qb w3qr w3to w3apx w3tc w3ql w3dhi w3dds w3dhw w3dln w3dme w3dnf w3rd w3dvw w3hht w3bir w3dlm w3eln w3flh w3mj w3ux ea-jh ea-eam aen-laa eb-4au ee-ear31 ef-8psc eg-5dh eg-6by ek-4aub ep-4bh ew-hb fo-a7q fo-a9a fq-ocya sa-de8 sa-de8 sb-2ae sb-2bg sb-lbo sb-lcg sb-lcl sb-lid.

(6000 miles North Capetown, 7133)

w1ajc w1aka w1bke w1caa w1cdp w1kb w1kl w1mk w1mx w2aeu w2ass w2bjg w2cxl w3vg w4aba w4abt w4dp w4pf w4us w6bg w6cwy w6dbd w6dpg w6sw w6hpl w6cxp w8ha w8fhy w9us eb-4co ee-ear1 eg-5uw en-ofp fo-a4e fo-a6r fq-ocya sa-de8 sa-lc6 sb-2ai sb-lcj sc-2ac sc-3ac su-2ak su-1ev.

Alan G. Brown, 3 Manqarra Road, Canterbury E. 7, Victoria, Australia

(20- and 40-meter band)

w1aao w1ags w1aaf w1bki w1bux w1cki wide w1ga w1mx w1vw w2aeb w2ag w2axn w2ctq w2cxl w2np w2tp w2uo w2wi w3afj w3em w3hh w3ku w3lw w3tu w3vg w3abl w3aef w3cj w3dj w3km w3pd w3to w5aav w5aca w5ain w5anh w5aot w5atm w5bg w5bdg w5bf w5bj w5ek w5mb w5nw w5rg w5uk w5zzk w6aae w6abg w6akd w6akn w6alg w6amm w6oav w6aup w6aai w6awi w6avu w6avz w6azs w6ben w6bgp w6bgh w6bmo w6bec w6bpo w6bvm w6bvt w6bvq w6bvz w6bxz w6byz w6bze w6bzp w6ccl w6cfn w6egr w6eis w6elo w6crx w6csb w6caj w6cuh w6cvb w6czk w6daz w6dbm w6dch w6lev w6nec w6dev w6dkx w6djz w6dmg w6dnn w6dow w6dpy w6dq w6dqj w6ddt w6dtp w6duu w6dvx w6dwi w6dye w6dzd w6dzj w6dzl w6ea w6eah w6eba w6ebr w6ecg w6eb w6ec w6eed w6gn w6hj w6jn w6ju w6ly w6mw w6uc w6wn w6zzd w7ac w7aen w7agh w7ajn w7ih w7iz w7it w7sm w7tu w7ts w7vf w7vy w8acm w8avp w8bcv w8bhv w8bhz w8bqr w8che w8dbi w8dkx w8dnn w8dpo w8air w8aju w8ama w8apw w8arm w8ase w8bfy w8bre w8bsb w8bny w8cjh w8cht w8cph w8erd w8erj w8enr w8exx w8dca w8dkm w8dga w8dr w8eap w8eez w8enn w8erh w8erm w8etd w8ez w8fhy w8twh w8fpx w8hq w8ju w8kb w8ln w8pv w8nu k7abe k7abz k7als k7ac k7to ve3fc ve4cu ve4fv ve4gt ve4ad ve5bn ve5co ve5co nn-lnis no-5by nz-fr5 ac-1ba ac-1bx ac-1el ac-1lf ac-1pp ac-2ab ac-2al ac-2ar ac-2aw ac-2ax ac-2ek ac-2ff ac-3ma ac-6ab ac-8ag ac-8el ac-8fl ac-8rj ac-8to ac-aa ac-a6l ac-1bk ac-1hh ac-4hh ai-2bz ai-2kw ai-2kt aj-law aj-lsm aj-lsk aj-2by aj-2dk aj-3bq aj-3vw aj-4ak aj-4bk aj-4dx aj-4zz aj-7cb aj-7mf aj-jkv aj-jpb ac-aj-jxix aj-xcx ak-laa am-3ab ag-ilm as-ra03 as-ra19 as-35ra ea-jh eb-4ar eb-4au eb-4az eb-4di eb-4dj eb-4ft eb-4rj eb-4rk eb-4rs ec-1ab ed-7dy ee-ear28 ee-ear65 ee-ear73 ef-8bc ef-8br ef-8fc ef-8fd ef-8fr ef-8ga ef-8grg ef-8gyd ef-8hip ef-8hpg ef-8hx ef-8ix ef-8jd ef-8ku ef-8lx ef-8orm ef-8ps ef-8vu ef-8wt ef-8zz eg-2ca eg-2cx eg-2hh eg-2kf eg-3lz eg-2nh ef-2od eg-5br eg-5by eg-5hr eg-5hs eg-5ma eg-5ml eg-5mq eg-5qv eg-5sw eg-5ur eg-5vl eg-6rw eg-6vj eg-6vp eg-6wy gw-18b ei-las ei-lbs ei-lfp ei-lgw ei-lpo ek-4aci ek-4aki ek-4db ek-4ka ek-4ua ek-4uh ek-4vr em-smtc em-smua em-smuk em-smum en-0rz ep-lae ep-lbx ep-3am xep-1ma es-lco es-2nag es-2nm ew-lca kf3ms fm-8as fm-8mb fq-pm fq-ocya fo-a6g fo-a9a sb-lbo sb-leh sb-2ay sc-2as su-lca su-2bt od-ljr od-lwa k6akg k6bxt k6cfq k6ch k6daq k6kx oo-bam op-lad op-lax op-lcm op-lew op-ldr op-lhr op-llg op-lpw op-9pb xnu-md.

(Continued on Page 89)

The Guiding Hand

Hour after hour a graceful monoplane throbs across a vast ocean, searching a path from continent to continent through fog and storm. Like a mighty helping hand rising from the depths, radio points the way and keeps a wondering world informed.



THE tiny wires which constitute the radio apparatus are the unseen nerves which are sustaining the navigator of the air on his trackless route. They must respond instantly to every command. Without the radio apparatus, which is an essential part of every long distance plane, the conquest of the air would be impossible.

Dependable magnet wire and coils are indispensable—for one failure—one short circuit—might mean disaster.

Dudlo takes pride in its belief that in making copper wire products which stand the severest tests, it is contributing to man's triumph over the elements.

DUDLO

DUDLO MANUFACTURING COMPANY, FORT WAYNE, INDIANA

Division of the General Cable Corporation

56 Earl Street 105 W. Adams St. 4143 Bingham Ave. 274 Brannan St.
NEWARK, N. J. CHICAGO, ILL. ST. LOUIS, MO. SAN FRANCISCO, CALIF.

Allen-Bradley Resistors

for
**Experimental Work
in Television**



Bradleyunit-B

IF you are doing experimental work in television, use Allen-Bradley resistors, both fixed and variable. Bradleyunit-B is the ideal fixed resistor for resistance-coupled amplifiers as plate-coupling resistors and grid leaks because:

1. Resistance values are constant irrespective of voltage drop across resistors. Distortion is thus avoided.
2. Absolutely noiseless.
3. No aging after long use.
4. Adequate current capacity.
5. Rugged, solid-molded construction.
6. Easily soldered.

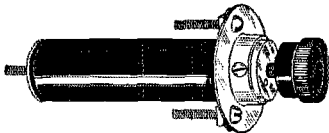

Radiostat

This remarkable graphite compression rheostat, and other types of Allen-Bradley graphite disc rheostats provide stepless, velvet-smooth control for scanning disc motors.

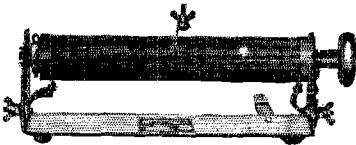

Laboratory Rheostat

Type E-2910 — for general laboratory service. Capacity 200 watts. Maximum current 40 amperes. A handy rheostat for any laboratory.

Write for Bulletins!

ALLEN-BRADLEY CO., 277 Greenfield Ave., Milwaukee, Wis.

Allen-Bradley Resistors

periods from which all amateur movements suffer occasionally. We are fortunate in having the coöperation of wireless interests and a very cordial feeling exists between the Institute and the Post-Master General's Department, which controls radio here, and were able to exert a considerable amount of influence on the delegate to the Washington Conference.

"With the idea of indicating to the Federal Government the tremendous value that amateur radio could be in a time of national emergency, a test was organized a month or two ago which had for its object the delivery to the Chief of the Air Branch of the Defence Force a message which was relayed a distance of 8000 miles. The success of the scheme was greater than we had hoped for and the message was delivered word perfect after passing through eight stations spread throughout all States in a little under two hours. We are hoping that we may now obtain permission to form a Defence Auxiliary Force organized on the lines of that in existence in the United States.

"Further experimental tests are in course of preparation by the Victorian Division with the object of contributing something towards clearing the air when the recommendations of the Washington Conference become effective in 1929. To stimulate interest in the tests two cups are to be awarded. The first will be for work in the 30- and 40-meter bands and will be won by the station which secures the most consistent number of QSO's during the next twelve months. Points will also be allotted for technical details such as the condition of the log book, layout and design of the station and for the amount of amateur made apparatus.

"The second cup will be awarded to the station or operator who can show the greatest development in ten-meter transmission and will run for a period of three months throughout August, September and October.

"At the suggestion of the PMG's Department a comprehensive sorting out was undertaken by the phone transmitters' section and a number of absorption meters made by 3BY and calibrated by 3SW, each meter having a frequency separation of 20 kc. and being checked on a G.R. precision instrument. One of these meters was then allotted to each station applying for one and undertaking not to operate his transmitter before checking up on the official meter.

"The success which the scheme undoubtedly has met with we attribute entirely to the spirit which permeates amateur radio everywhere."

—W. G. Sones, Publicity Officer, W. I. A.

ENGLAND

Before going on to the regular monthly report of Mr. Brian Jay, we want to reprint part of a letter from Mr. H. Bevan Swift, Hon. Sec'y of the R.S.G.B., dealing with the new regulations in Britain.

Radio Operators!

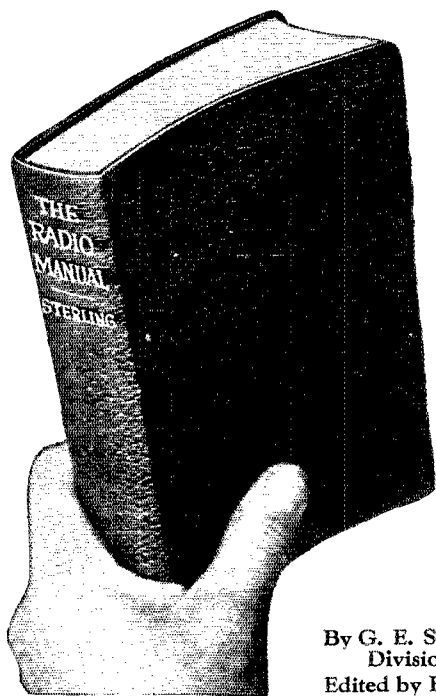

Are you prepared to use the new International "Q" signals which go into effect January 1, 1929? Do you know the correct procedure for obtaining a radio compass bearing as prescribed by the terms of the International Radio Telegraphic Convention, effective January 1, 1929?—the right procedure when distress communications are ended and silence is no longer necessary?—what to do when you hear from a radiotelephone station the spoken expression Mayday?

*These Questions and Thousands More
Are Answered In*

THE RADIO MANUAL

*A Complete Handbook of Principles, Methods,
Apparatus for Students, Amateur and
Commercial Operators, Inspectors*

By G. E. STERLING, Radio Inspector and Examining Officer, Radio Division, U. S. Dept. of Commerce.

Edited by ROBERT S. KRUSE, for five years Technical Editor of QST.

Complete Preparation for Government License. 16 Chapters Covering

- | | | |
|---|--|--|
| <ol style="list-style-type: none"> 1. Elementary Electricity and Magnetism 2. Motors and Generators 3. Storage Batteries and Charging Circuits 4. Theory and Application of the Vacuum Tube 5. Fundamental Circuits Employed in Vacuum Tube Transmitters 6. Modulating Systems Employed in Radio Broadcasting 7. Wavemeters, Piezo-Electric Oscillators, Wave Traps and Field Strength Measuring Apparatus 8. Marine Vacuum Tube Transmitters including detailed description of Model ET-3626 | <ol style="list-style-type: none"> 9. Radio Broadcasting Equipment including, for the first time in any text book, the complete equipment of Western Electric 5 Kilowatt broadcasting Transmitter used in over 75% of American broadcasting stations. 10. Arc Transmitters including description of Federal Marine 2 Kilowatt Arc Transmitter Type AM 4151; also models "K" and "Q" 11. Spark Transmitters including description of Navy Standard 2 Kilowatt Transmitter 12. Commercial Radio Receivers and Associated Apparatus | <ol style="list-style-type: none"> 13. Marine and Aircraft Radio Beacons and Direction Finders. 14. The Development of Amateur Short Wave Apparatus. Complete details of construction, operation and licenses. 15. Radio Laws and Regulations of the U. S. and International Radio Telegraph Convention. Quotations of all important sections 16. Handling and Abstracting Traffic |
|---|--|--|

Examine It Free Special Price Now

"The Radio Manual" is now on the press and will be ready shortly. Over 900 pages bound in flexible Fabrikoid. Regular price after publication will be \$6.00. Orders received now will be accepted at the special advance price of \$4.95. Send no money now. Examine the book first. Pay or return in ten days.

Order On This Coupon

D. VAN NOSTRAND CO., INC., 8 Warren St., N. Y.
Send me as soon as published THE RADIO MANUAL for examination. Within ten days after receipt I will either return the volume or send you \$4.95.—The special advance price.

Name
St. and Number (QST 9-28)
City and State

Pound wise—but Penny foolish!

GETTING the old, familiar adage turned around, but it applies to those radio fans who try to save a few pennies on their condenser blocks. Building a socket-power device is an expensive proposition—and the condensers are the most vital parts in it.



Type PL-574, specially designed for Thordarson R-171 Power Compact, Rathon BH Gas type Rectifier or Elkon EBH Metallic Rectifier.

Price \$16.50

Cheap, under-sized condensers may look pretty in the can—but the huskiness—the factor of safety isn't there.

You can bet on Dubiliers—true, you'll pay more for them—but they'll do more and last longer.

DUBILIER LIGHT SOCKET AERIAL



**Yes sir, it works
on your Set—or
Money Refunded**

No need to be troubled with an outdoor antenna or lightning arrestors any more—simply plug in the Dubilier Light Socket Aerial—clear reception, less static and interference and plenty of volume. No current consumed. All good dealers sell it on a 5 day money-back guarantee. If your dealer is out of stock write to us.

Free Catalog
for radio fans.
simply write

Dubilier

CONDENSER CORPORATION



**4377
Bronx Blvd.
New York**

Reg. U.S. Pat. Off.

"You will no doubt be interested to know that the P.M.G. here has now made his decision regarding the British amateur licenses. The recommendations of this Society have been adopted as the main basis including the prohibition of r.a.c. and i.c.w. All amateurs will have the use of the 20-, 40- and 152-meter bands, while special permits will be issued to skilled amateurs the use of the 5- and 10-meter bands with increased power on the individual recommendation of the Society. The 75- to 85-meter band is being reserved for special experimental work for which application must be made through the R.S.G.B. Considerable freedom is to be permitted in the character of messages, a privilege not hitherto enjoyed in this country, while calibration waves are to be issued by the National Physical Laboratory for the benefit of amateurs."

The R.S.G.B. and British amateurs generally are to be congratulated on this signal success; it represents real progress. And now to the regular report:

"Conditions this month have been rather bad, even the 20-meter band being almost silent, but things seemed to be picked up towards the end of July. 2XV has been very QRW and also suffered from the bad conditions except for a few rare evenings when a few local NU contacts were made on 23 meters, but rapid fading was very prevalent. 5ML reports no DX except R8 reports from local NU districts. He claims first contact with the Canadian 5th district. FB OM. This station was more successful than most and one morning in two hours on 20 was QSO nu-6AJM, 6DLW, 7FE, 7AIJ, and nc-4FV, 4DQ and 5CP. A good two hours' work OM! 5BY says DX is rotten, only R8 from East Coast U.S.A. and R6 from Chile. He asks that if any of the 54 NU 6th and 7th district stations he worked have not received his card will they let him know and he will be pleased to send another. 5BY has confirmation of a QSO with a j-1AW, the first Europe-Japan contact. 5BZ has worked SC three times and 15 NU's in the 1st, 2nd, 3rd and 8th districts. He is ex-eg2BQH and is QRV any of the NU gang he corresponded with under that call. 6CI like most people found conditions bad. He is WAC now with only ten watts input to a fifty watter, with a considerable increase in efficiency resulting. 6DH, Britain's youngest ham, has done no DX but is busy listening on ten meters, having heard nu8ALY and nu2BGC and eu15RA on this wave. ge6WL raised three NU's on 5 watts recently and 5PH also had QSO on this power. 5WK got R5 from sc three times with 10 watts; 2NH is working NU almost nightly but has not had any real DX this month. Most other London hams are not so fortunate. 6QB now has a fifty watter, which he is operating well under its rated power input. (They all do that at first. Hi! —A.L.B.) 6PP had a report of his signals being heard in New Zealand, with only 5 watts.

—K. E. Brian Jay eg-2HJ."

A 1929 CONDENSER FOR TUNING HIGH FREQUENCIES ~ ~ RADICALLY NEW!

Radio Engineering Labs. Special Dispatch—A new variable condenser with outstanding features never before employed in condenser manufacture has now been perfected by REL. These condensers have been expressly designed for High Frequency Receivers and Low Power Transmitters and are being presented at prices which vary but little with those of present type standard makes. Amateurs cannot overlook these incomparable condensers which embody many salient features.

DIE CAST ALUMINUM END SUPPORT

A rigid three cornered die casting is used to support the main parts of the condenser. It is of wide spread design to insure against any panel vibrations which may be transmitted into the condenser proper.

LARGE SINGLE BEARING

(Patent Pending) A very uniquely designed rotor shaft bearing which has conical fittings on either end to insure against side thrust movements of the shaft.

INSULATED STAND OFF BUSHINGS

On each of the three projecting points on the die casting there is mounted an insulated bushing. These condensers may, therefore, be mounted on metal panels without directly grounding either the rotor or stationary plates.

ROTOR TENSION ADJUSTMENT

A large three finger bronze spring is used to control the tension at which the rotor plates are revolved. It assures positive, even action for the complete rotation.

HEAVY BRASS CONDENSER PLATES

Both the stator and rotor plates are stamped of extra hard heavy brass sheets. By using heavy material, vibration between plates is eliminated and, therefore, also reducing microphonic actions. The stator plates are specially shaped so as to give absolute true curves when used in calibrated measuring instruments. Previous, every low capacity condenser usually showed distinct variations at the points where the stator plates supports appeared.

PATENTED ROTARY PLATE CONTACT

This new patented feature will be found only in the new REL condensers. It is the only method of securing absolute positive contact to the rotor plates. Springs, ball bearings, pig tails or any other friction devices allow no comparison with this method. This special contact employs mercury. The rotor shaft continuously revolves in a pool of mercury. By thus gaining a perfect contact, the mechanical friction noises experienced in ultra high frequency receivers can be easily overcome.

The use of these condensers in Amateur Receivers and Low Power Transmitters will be practically obligatory when the new narrow bands become effective, January, 1929. A pamphlet describing their use in various circuits is yours for the asking.

ADJUSTABLE MAXIMUM CAPACITY

The condensers are so designed that they may be adjusted to any small maximum capacity. The single stationary plate may be moved away from the rotor plate so as to cover a very small capacity band. In this manner, the tuning range of a receiver may be designed to cover only the exact frequency desired, another feature never before offered.

STANDARD SHAFT

A standard $\frac{1}{4}$ " diameter shaft takes any present day dial or knob. The condenser is designed for rear panel mounting.

These new REL condensers require a panel space of approximately $4\frac{1}{2}$ x $4\frac{1}{2}$ ", the depth of which varies with the type and capacity of the particular model used.

REL catalog No. 181 is a two-plate variable condenser which is so arranged that the stator plate may be moved away from the rotor plate so that any desired maximum capacity may be obtained. This condenser will lend itself readily to high-frequency receivers, transmitters and measuring devices.

REL catalog No. 187 is a combination semi-fixed tank and condenser. This model is so arranged that a comparatively large semi-variable air spaced condenser is shunted by a continuously variable two plate condenser.

In some receiving and transmitting high frequency circuits, it is always desirable to employ a certain amount of capacity across the inductance. However, it is also desirable to only use a very small portion of that capacity for the actual tuning.

The tank portion of the above condenser may be set at a certain desired capacity and then the variable element can be used to cover only the exact frequency band desired. The single stationary plate may also be shifted similar to the two plate model catalog No. 181.

This is the second announcement of new equipment of vital importance to the amateur under the new narrow-band ruling. The above apparatus is so new that we were not able to have cuts made before going to press. More apparatus now being manufactured will be announced in *QST'S* next issue. For your own sake—Don't Miss Them!

Radio Engineering Laboratories, 100 Wilbur Ave., Long Island City, N. Y.

Are YOU among the 37,500

(The number increases monthly)

who refer daily to a copy of the
Radio Amateur's Handbook
for Guidance and Information?

If Not, get a copy NOW

We believe that The Radio Amateur's Handbook, by F. E. Handy, Communications Manager, A.R.R.L. is the most valuable book which any amateur or experimenter could own. Its chapter headings will give an idea of the thoroughness with which the subject is covered. They are "What is An Amateur?", "Getting Started", "Fundamentals", "How Radio Signals Are Sent and Received", "Building a Station—The Receiver", "The Transmitter", "Power Supply, Keying and Interference Elimination", "Antennas", "The Wavemeter—Radio Measurements", "The A.R.R.L. Communications Department", "Operating a Station", "The Experimenter".

These chapters each occupy from ten to forty pages—indicating that each subject is treated in a thorough manner. In addition there is an appendix containing a fund of useful data. Then there is an index, occupying six pages, by which the valuable information contained in the book is made available. This is a particularly important point and has been compiled and cross-indexed with great care and thought. Altogether the Book contains 256 pages of the most valuable radio information ever found between two covers.

The Radio Amateur's Handbook starts at the beginning and tells what an amateur is, what the League is, what amateur radio is, how to become an amateur, how to learn the code, how to understand what you hear, how to get your licenses, how to build a simple station, how to build a better station, how to operate your station, how the A.R.R.L. works, how to handle traffic, how to conduct experiments and make measurements, and a multitude of other things too numerous to mention.

Anyone who is at all interested in the technical side of radio can ill afford to be without The Radio Amateur's Handbook.

Regular Cover \$1.00

Postpaid Anywhere

Bound in Leather Cloth \$2.00

*If you haven't
a copy of The Radio
Amateur's Handbook you
are missing the greatest value
in radio today.*

DO IT →
NOW

AMERICAN RADIO RELAY LEAGUE,
HARTFORD, CONN.

Dear Sirs:

Enclosed find my \$..... Please send
me postpaid (any where in the world)
my..... copy of the Handbook.

Name

Address

How to be a commercial Radio Operator

A practical book that should enable anyone of average intelligence to pass the Government's theoretical examination given to applicants for a Commercial Radio Operator's License.

NEW!

Nilson and Hornung's PRACTICAL RADIO TELEGRAPHY

380 pages, 5x8, 223 illustrations
\$3.00 net, postpaid

The book covers in detail the theory and practical operation of every type of modern, 1928, commercial arc, spark, and vacuum tube transmitter. It furnishes complete data on commercial vacuum tube receivers. It covers everything from elementary electricity to the practical operation of radio compasses.

Some outstanding points

1. Very little mathematics;
2. Assumes no prior knowledge of electricity;
3. Covers everything in commercial radio in detail;
4. Complete list of self-examination questions;
5. Simple, yet rigidly accurate;
6. Complete wiring diagrams given.

See the book before you purchase. Fill in and mail just this coupon.

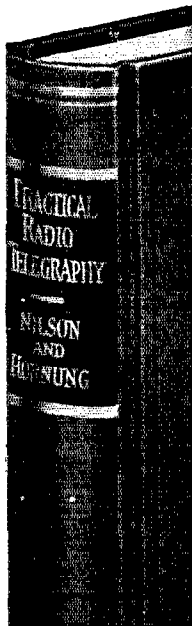

NU, NC, AJ and E friends. We will return in January, 1931. Please direct all letters and reports to the A.R.R.L., at Hartford, Conn., U.S.A. We will get mail each half year.

"As to reception and transmission conditions generally, I will say that South American countries are heard early in the morning, and more loudly now than in the winter. "I shall try to send reports of stations heard and worked from time to time."

—Wladyslaw Grazybowski, care A.R.R.L., Hartford, Conn., U. S. A., until January, 1931.

Stations Working Below 50 Meters

(Concluded from August QST)

- 33. KDO, S.S. *Esparto* (Uni. Fruit)
- 33. OCCO, Conakry, Fr. W. Africa.
- 33. OCDJ, Issy les Moulineaux, France.
- 33. OCTN, Mourillon, Toulon, France.
- 33. VZDK, S.S. *K. Jervis Bay*.
- 33.2 KTF, Midway Island.
- 33.83 PCA, Amsterdam, Holland.
- 33.37 WQC-WEQC, Rocky Point.
- 33.4 KNW, Palo Alto, Calif.
- 33.42 KUN-KEUN, Bolinas, Calif.
- 33.5 AQE, S.S. *Sir James Clark Ross*.
- 33.5 NAJ, Great Lakes, Ill.
- 33.5 WNBT, Elgin, Ill.
- 33.708 VNB, Klipheval, S Africa. (Beam)
- 33.88 KUN- Bolinas, Calif.
- 34. IFC, Royal Cesi School, Rome Italy.
- 34. DCP, S.S. *Cap Polonia*.
- 34. KNW, Palo Alto, Calif.
- 34. LPI, Buenos Aires.
- 34. NAJ, Great Lakes, Ill.
- 34. PCUU, Hague.
- 34. RAV, Tashkent, Turkestan.
- 34. RKY, Moscow, U.S.S.R.
- 34. VNB, Capetown, S. Africa. (Beam)
- 34. XDA, Mexico City, Mex.
- 34.013 GBJ, Bodmin, Eng. (Beam)
- 34.168 GRI, Grimsby, Eng.
- 34.2 HBC, Berne, Switz.
- 34.2 RDI, Petrozavadosk.
- 34.4 KNN, Honolulu, T. H.
- 34.483 VWZ, Kirkee, Bombay, India. (Beam)
- 34.6 VWZ, Kirkee, Bombay, India. (Beam)
- 34.78 Standard Wave for Ships.
- 34.86 KWT, Palo Alto, Calif.
- 35. IPP, Tokyo, Japan.
- 35. 1RG, "Radiogiornale," Lake Como, Italy.
- 35. 2XG, Ocean Beach, N. J.
- 35. 2XI, Schenectady.
- 35. BWW, Gibraltar, N. Front.
- 35. BXW, Sietar, Singapore.
- 35. BKX, Stonecutters Island, Hong Kong.
- 35. BYD, Whitehall, R. C.
- 35. BYC, Horsea.
- 35. BYZ, Rinella, Malta.
- 35. HZE, Matara, Ceylon.
- 35. BZF, Aden, Arabia.
- 35. NPM, Honolulu, T. H.
- 35. OGD, Dakar, Fr. W. Africa.
- 35. VKQ, Garden Island, Sydney, Aust.
- 35. WGY, Schenectady.
- 35. WQO, Rocky Point.
- 35.03 KGDU, S.S. *Four Winds*.
- 35.03 PCMM, Kootwijk, Holland.
- 35.27 WJF, Detroit, Mich.
- 35.3 5DH, Dohie Hill, Eng.
- 35.5 BZC, Portsmouth S.S. *Portsmouth, Eng.*
- 36. 3LO, Melbourne, Aust.
- 36. DS, H.M.S. *Renown*.
- 36. KTA, Guam, P. R.
- 36. LPO, Buenos Aires.
- 36. NPH, Honolulu, T. H.
- 36. QCBR, Rabat, Morocco.
- 36.5 ANF, Tjillin, Java.
- 36.5 FUT, Toulon-Mourillon, France.
- 36.5 SAB, Goteborg.
- 36.52 KGH, Hillsboro, Ore.
- 36.6 2XAP, New York City.

McGRAW-HILL FREE EXAMINATION COUPON

McGraw-Hill Book Co., Inc.,
370 Seventh Avenue,
New York, N. Y.

You may send me *Practical Radio Telegraphy*, Nilson and Hornung. \$3.00 postpaid. I will either return the book, postage prepaid, in 10 days, or remit for it at that time.

Name

St. & No.

City

State

Name of Employer

Official Position

(Books sent on approval in the U.S. and Canada only)
Q. S. T. 10-1-28



ACCURATE!

NOW 1/4 OF 1%
GUARANTEED
ACCURACY

15-110 METERS

The Handy \$15-50
Popular,
Wavemeter...

New Short Wave Coils—Receiver and Transmitting Parts. Piezo Crystals—Special Radio Work.

Fall Bulletins Out—Write for Them
(LIVE DEALERS WRITE FOR FULL INFORMATION)

SEATTLE RADIO LABORATORY

3335 33d Avenue, South
Seattle, Wash.

VITROHM Transmitting Grid Leaks and Rheostats now cover the entire line of transmitting tube circuits. ¶The prices on these amateur products are reduced materially. ¶Your dealer should stock Vitrohm Transmitting Products. ¶If you have difficulty in obtaining them, write us direct.

CATALOGUE NUMBER	PRODUCT	RESISTANCE	DISSIPATION	CURRENT	MAX. TUBE RATING	PRICE
507-2	Grid Leak*	5000 ohms	44 watts	90 m.a.	100 watts	\$2.00
507-3	Grid Leak*	5000 ohms	200 watts	200 m.a.	1000 watts	2.80
507-4	Grid Leak†	50,000 ohms	200 watts	60 m.a.	1000 watts	6.50
507-5	Grid Leak†	20,000 ohms	200 watts	100 m.a.	1000 watts	4.25
507-51	Grid Leak*	10,000 ohms	200 watts	135 m.a.	1000 watts	4.00
507-66	Grid Leak**	15,000 ohms	200 watts	120 m.a.	1000 watts	6.00
507-63	Rheostat†*	50 ohms	50 watts	1 amp.		5.50
507-59	Rheostat**†	20 ohms	80 watts	2 amp.		5.50
507-83	Rheostat**†	12.5 ohms	60 watts	2.2 amp.		5.50

* Center-tapped

† DeForest P or R. C. A. 852 Tube

De Forest H Tube

** Steps at 5M—10M—15M

for R. C. A. 852 or DeForest P Tube

† For Primary Control

*† Filament and Primary Control

Ward Leonard Electric Company

37-41 South Street

Mount Vernon, N. Y.

Build this modern amplifier at low cost!

Now! Sangamo Transformers at a new low price. And push-pull transformers to match new power tubes and dynamic loud speakers.

A small expenditure and you can have one of these modern amplifiers with plenty of capacity to handle the low notes. Nothing equals the full toned beauty of an amplifier built according to the diagram shown at right.

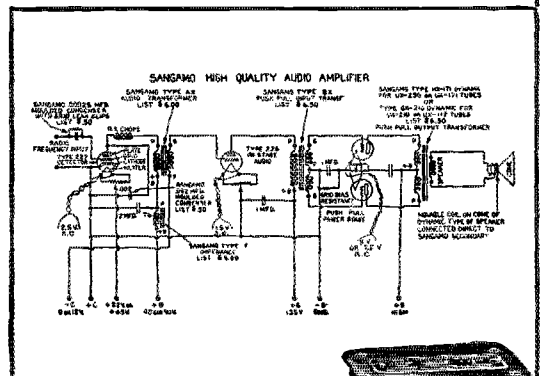

Write for descriptive circulars.

SANGAMO ELECTRIC CO.
Springfield, Illinois

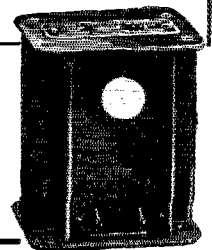



When It Comes To SERVICE

When it comes to service it is quite likely that you will have to look a long time before finding a service instrument that so thoroughly fills the requirements for radio service equipment as does the Jewell Pattern No. 199 A.C.-D.C. Radio Set Analyzer.

This set was designed to take care of the service needs of the many new A.C. operated radio sets as well as those of the battery operated type. Features that have made it a favorite with experienced radio service men are given below.

- Easily portable leather covered case with removable cover.
- Five prong plug with four prong adapter.
- Four reading A.C. voltmeter 0-4-8-16 and 160 volts.
- Six reading D.C. Volt-milliammeter 0-7.5-75-300-600 volts and 0-15-150 milliamperes.
- Accurate tube test.
- Positive, silver contact push button switches for taking readings.
- New cathode voltage test.
- All ranges brought to binding posts for continuity tests.

These features all are described in descriptive circular No. 2002 which tells in detail all about this set analyzer. Write for a copy.

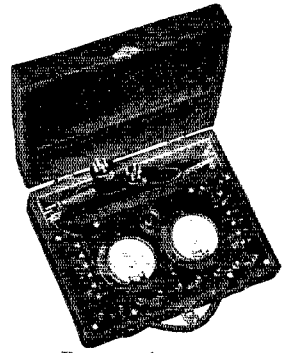

Pattern No. 199

Jewell Electrical Instrument Co.

1650 Walnut St., Chicago

"28 YEARS MAKING GOOD INSTRUMENTS"

You can easily become an **EXPERT**

Radio Operator

Through The Candler System Course of Training in High Speed Telegraphing

Theo. McElroy, World's Champion Radio Operator endorses no other system. He writes: "At the Pageant of Progress, Chicago, I copied 56 words per minute for 5 minutes, establishing a new radio record. I owe my skill, speed and steady nerve to The Candler System." What this system has done for McElroy and over 40,000 others—it will do for you. FREE booklet explains system fully. Send for it TO-DAY. A postcard will do.

The **CANDLER SYSTEM CO.**

Dept. AR 6343 S. Kedzie Ave. Chicago, Ills.

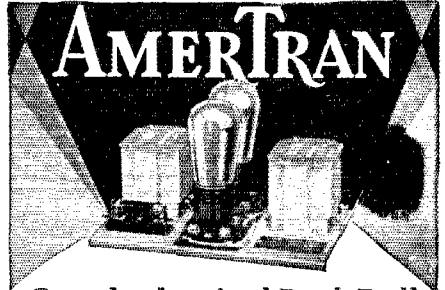

Completely wired Push-Pull
Power Stage

HANDLES ample power to faithfully reproduce full frequency range without tube overloading. Eliminates hum caused by raw AC on filaments of Power Tubes. Increases clarity, reality and volume.

AmerTran gives you a unit in 4 types designed for practically any combination of speakers [including the new dynamic types], and power tubes. For complete information see any authorized AmerTran dealer or write to us direct, mentioning the speaker and tubes you intend using.

Price completely wired and ready to install in set \$36.00 without tubes.

Licensed under Patents owned or controlled by R.C.A. and may be bought with tubes

AMERICAN TRANSFORMER COMPANY

Transformer Builders for more than 28 Years
195 Emmet Street, Newark, N. J.

U.S. GOVERNMENT SURPLUS EQUIPMENT

Army Telegraph and Buzzer sets in portable carrying cases. Consists of key, earphone, high and low pitch buzzers, potentiometer, 3 toggle switches, 3 condensers, etc. \$5.00

½ Kw., 500 cycle Transformers 110 to 12500 volt	5.00
200 watt, 60 cycle Transformers 120 to 2500 volt	7.50
Army Magnetos, pull-cord operated	1.50
Army Telegraph Keys	1.00
Navy Headphones (used)	.50 per pair
400-ohm Sounders (Western Union)	2.00
18 in. Genuine Electrostatic Strain Insulators	.40
7 in. Genuine Electrostatic Strain Insulators	.15
.002 Leyden Jar Condensers, 10,000 volt	2.50
1-2 Kw. 500 cycle Motor Generators 110 DC to 110 AC.	

Largest Assortment of Army and Navy Surplus Wireless and Electrical Equipment—No Catalogs—Millions of Items.
Safe delivery guaranteed.

REMITTANCE MUST ACCOMPANY ORDER.

Manhattan Electrical Bargain House, Incorporated
105 Fulton Street, New York City

Raytheon Kino-Lamp

As Pioneers in TELEVISION

We invite correspondence from amateurs in regard to these new Raytheon Products, which are being used successfully in the Television broadcasting.

Kino-Lamp—the first Television Tube developed to work on all systems.

Foto-Cell—made in both *hard vacuum* and *gas-filled* extra sensitive types.

RAYTHEON MFG. CO.
Kendall Square Building
CAMBRIDGE, MASS.

Raytheon Foto-Cell

- 48.2 KTF, Midway Island.
- 43.33 WPE-WEPE, Rocky Point.
- 43.45 WLK, Wheelwright, Ky.
- 43.45 WLI, Cleveland, Ohio.
- 43.52 KOS, Pampa, Texas.
- 43.6 KTA, Guam.
- 43.74 WOBD, S.S. Radio.
- 44. OCMV, Fr. Nuhtarn Sta. Mont Valerien, Suresne (Seine)
- 44. KTA, Guam.
- 44. WQO, Rocky Point.
- 44. GFA, Air Ministry, London.
- 44. SAA, Karls Krona.
- 44.08 KZA-KZB, Los Angeles.
- 44.08 KOQ, Houston, Texas.
- 44.08 WKI-WAQ, Newark.
- 44.08 SPI, Rio de Janeiro.
- 44.48 WAJ-WEAJ, Rocky Point.
- 44.5 SPI, Rio de Janeiro.
- 44.62 WBO, Dearborn, Mich.
- 44.71 KPZH, Fairbanks, Alaska
- 45. 1CK, Tripoli.
- 45. NPG, San Francisco.
- 45. OCMV, Mont Valerien, France.
- 45. KEG, Vancouver, Wash.
- 45. OCNQ, Nogent-le-Rotrou.
- 45. AIM, Meteorological Hut, Oslo.
- 45. IAX, Rome via Socio 80.
- 45.02 KEU, Los Angeles.
- 45.02 KYU, Wichita Falls, Texas.
- 45.02 WHW, Highland Park, Ill.
- 45.32 KFZG, Pt. Barrow.
- 45.43 KEH, Panhandle City, Texas.
- 45.43 KFE, Ponca City, Okla.
- 45.77 KQS, Lone Pine, Calif.
- 45.77 KQT, Los Angeles.
- 46. PCLL, Kootwijk, Holland. (Hague)
- 46. OAA, The Mossig, Weini Ainlof, 13 Austria.
- 46. OCMY, Mont Valerien.
- 46. KNN, Honolulu.
- 46. BVJ, Dartmouth, England.
- 46.06 KGT, Fresno, Calif.
- 46.06 KGF, Medford, Ore.
- 46.48 WND, Ocean Township, N. J.
- 46.5 TSB, Norwegian SS Helder.
- 46.99 KGH, Hillsboro, Ore.
- 47. POZ, Nauen.
- 47. 1CX, Massawa (Somalie Italienna).
- 47. DNSC, Royal Danish Dockyard, Copenhagen.
- 47. SPI, Rio.
- 47. Dollis Hill, England.
- 47. SUC2, Abu Zabal, Cairo, Egypt.
- 47. 1CX, Massawa.
- 47. KTA, Guam.
- 47. SPM, Helsingfors.
- 47.4 KNN, Honolulu.
- 48. OCTU, Tunis la Casbah.
- 48. OCNQ, Nogent-le-Rotrou.
- 48. KNW, Polo Alto.
- 48.05 KSZ, McConney, Texas.
- 48.05 KYI, Kings Mill, Tex.
- 48.05 KINT, Polo Alto, Calif.
- 49. 1CF, Messina, Sicily.
- 49. WHD, Sharon Pa., Calif.
- 49.15 KNR, Clearwater, Calif.
- 49.5 KVR, Las Vegas, Nev.
- 49.5 Salt Lake City, Utah.
- 49.5 KMW, Bondini, Calif.
- 49.5 TFA, Reykjavik, Iceland.
- 49.5 OCTU, Tunis, Las Casbah, (Tunisie).
- 49.97 KWT, Polo Alto, Calif.

Certain Proof of Resistor Worth

There is no better proof of the real worth of Har-field Resistors, than our records, which show that after two seasons of actual service, Har-field Resistors are being purchased in greater quantities by more manufacturers than ever before. A few of the more prominent we list below.

Stromberg-Carlson Tel. Mfg. Company	Western Union Telegraph Co.
Koister Radio Corporation	A. H. Grebe & Company
American Transformer Co.	Splittdorf Electric Co.
Fansteel Products Co.	Magnavox Corporation
Martin Copeland Co.	Electrical Research Lab's
Zenith Radio Company	Sauson Electric Co.
Crosley Radio Corporation	Philadelphia Storage Battery Company

We shall be glad to design a resistor to meet your specific need, and forward samples for testing with prices. Write to

HARDWICK, FIELD, INC.

SALES OFFICE
122 Greenwich St.
New York



FACTORY
215 Emmet St.
Newark, N. J.

What Length Antenna

(Continued from Page 49)

plicable to not only Zeppelin type antennas but also to all types of voltage and current fed radiators where the antenna itself is not loaded by lumped inductance or capacity. Its universal application certainly simplifies the problem of antenna design for the amateur, at least.

Synchronous Motors for Television

In addition to building reliable and satisfactory motor generators, "Esco" has had many years of experience in building *electric motors* for a great variety of applications.

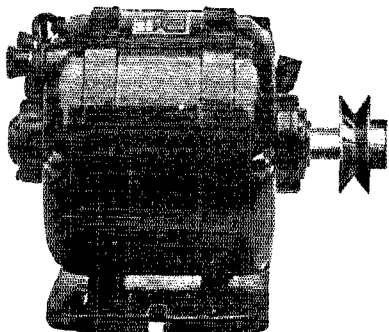

Synchronous motors, small, compact, reliable, self starting are now offered for *Television* equipment. They require no direct current for excitation, are quiet running and fully guaranteed.

Other types of motors suitable for Television may also be supplied.

Write us about your requirements.

ELECTRIC SPECIALTY CO.

225 South St.

Trade "ESCO" Mark

Stamford, Conn

RADIO SCHOOL

Earn \$35 to \$50 Per Week

The rapid expansion of RADIO has created many new positions on land and sea. Enroll now. New term begins September 10th in both day and evening class. Send for free catalogue.

MASS. RADIO SCHOOL

18 Boylston Street, Boston

Tel. Hancock 8184

Established 1905

Send For New Radio Book--It's Free

New book-ups. This book shows how to make short wave receivers and short wave adapters. How to use the new screen grid tube in D. C. and A. C. circuits. How to build power amplifiers, ABC eliminators. Up-to-the minute information on all new radio developments. It's free. Send for copy to-day.

KARAS ELECTRIC COMPANY

4630K1 N. Rockwell Street

Chicago

Name

Street and Number

City and State

4630K1



FANSTEEL

Balkite Radio

IN CABINETS BY

Berkey & Gay

FANSTEEL PRODUCTS COMPANY, Inc.
NORTH CHICAGO, ILLINOIS

A Portable Crystal Transmitter

(Continued from Page 36)

will then consist of 8 turns and the secondary winding should be of 20 turns. Such a transformer is made up with the coils permanently in place, and coupled fairly closely, with a spacing of about $\frac{1}{2}$ or $\frac{1}{4}$ inch between the adjacent ends of the windings.

In order to properly tune and observe the operation of a crystal controlled set, 2 or more milliammeters should preferably be installed, one in the plate circuit of the crystal controlled tube, and the others in the plate circuits of the amplifiers. The milliammeter in the crystal tube circuit need not have a full scale of over 100 mills, but the meter in the amplifier circuit should have a full scale capacity considerably greater than the maximum amount of current that one expects to normally pass through the plates of the amplifier tubes.

In tuning up the crystal controlled set, the antenna should be disconnected and only the crystal tube filament lit. The crystal tube plate voltage can then be applied and the capacity of condenser C increased gradually. The crystal should start oscillating, which is shown by a drop in the milliammeter reading, and as the capacity is made greater, this current will drop still lower, until finally a point is reached where the crystal stops oscillating and the current jumps to the initial value before the crystal started oscillating. The capacity should be adjusted to a point somewhat lower than that at which the crystal stopped oscillating.

A shielded receiver with antenna disconnected should be at hand, and if this receiver is tuned to twice the frequency or the half wave of the crystal, a loud beat note will be heard. Condenser C1 should then be adjusted roughly to the point where this beat note is the loudest. A reduced voltage should be applied to amplifier tubes either by reducing the generator voltage, or by inserting two or three thousand ohms in series with the plate feed. The filament of the amplifier tubes should be lit. Condenser C2 should then be turned until the plate milliammeter reads a minimum. C1 should also be adjusted to still further reduce this minimum, the proper adjustment being secured when an adjustment of either C1 or C2 increases the plate current to the amplifier. If this condition cannot be secured, or if on listening in with the shielded receiver, a number of beat notes are heard, the amplifier is oscillating independently of the crystal. Condenser C6 should then be adjusted until either the numerous beat notes heard in the receiver disappear or the plate current increases considerably, after which the adjustment of C2 and C1 should be repeated. An adjustment can easily be found where there is but one beat note heard in the receiver, which indicates that the amplifier is being controlled by the crystal oscillator.

The antenna should then be connected to the antenna coupling coil and the coupling increased somewhat, which should cause an increase in the plate current to the am-

New Tone Brilliancy

with a Potter Condenser Block in your Power Amplifier. Rich, natural bass tones that possess a real thrill.

No. T2900 where one 250 Type Power Tube is used \$20.00



No. T2950 where two 250 Type Power Tubes are used \$22.50

Highly Efficient—Long Life
The Choice of Leading
Radio Engineers

Ask your dealer for full information

POTTER MFG. CO.
North Chicago, Illinois

REMLER

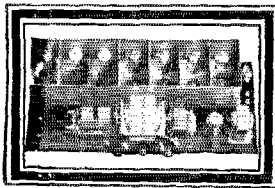

"29"

different

Remler has designed a new circuit. It is different . . . and a long step ahead in radio research. Let us tell you all about it and why it will out perform any factory built receiver. Sign and mail the coupon. We will forward an eight-page, two-color folder and set-builders' bulletin.

Q-10
Remler Division, Gray & Danielson Mfg. Co.
260 First Street, San Francisco, California.

- Gentlemen: Please send me:
 All the "dope" on the "29".
 Bulletin service for professional set builders.

Name

Address

City State

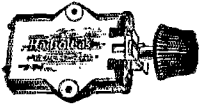

Bradley Leak, absolutely noiseless and stepless, 2000 to 30,000 ohm resistance. List \$5, special \$2.95.

\$4. Bradleystat No. E-210 Specialf.60



Signal Buzzer Set International Code on Baseboard \$2.45
Belden braid 1/4 inch wide, ft. .06

\$7. Acme B-6—"B" eliminator transformer, 235 v. each side of centre tap.2.45

Acme 500 w. plate transformer, 1000-1500-2000 each side of centre tap, 24.00.
Acme B.H-1 transformer, 255-510 each side of centre tap; also 2 hl. windings of 4 v. each side of centre tap, \$10.25.
Acme C.W. 30 Henry choke, \$18 list—150 M. A. single \$14.40; also other sizes at special prices.

Acme C.W. 30 Henry choke, \$18 list—150 M. A. single \$14.40; also other sizes at special prices.

LEEDS

The Home of RADIO
45 VESEY STREET
NEW YORK

New York's Headquarters for Transmitting Apparatus

When in Town Visit Our Store

Full Line of Acme -- Thordarson -- Jewell -- Flechtheim -- General Radio -- Signal -- Bradley

SPECIALS

- Dubilier Mica Condenser .002 cap. 6,000 working volt 1.95
- General Radio 247D .001 cond. plain or with vernier 1.75
- Dubilier cond. 1.7 mfd. 1,000v D.C. test; 650v. working voltage 1.35
- R.C.A.—U.V. 1718 Super Het. transformer .65
- Ward Leonard Resistances; fits standard base receptacles; sizes 300—600—900—1200 and 2000 ohms .95
- \$15. Imported German head sets; very sensitive 3.45
- Honeycomb Coils unmounted, all sizes in stock at 1/4 price.
- \$8 Signal Corp adjustable arm micro-transmitter for panel mounting 2.45
- \$9. Dubilier condenser. 1mfd; 600 v. D. C. working type 2.25
- 903; limited quantity
- R.E.L. Transmitting Inductances, per set, 8.80
- Fristof 50 Henry choke 2.75
- 6.50 Acme .0005 enclosed condenser .95

Neon Glow Lamps, made by General Electric Co., type G.10, standard base. 101 uses, as illustrated in QST May issue page 17 65c

Flechtheim Condensers, all types 35% off list.

Pyrex Low-loss V.T. sockets, each 39c.

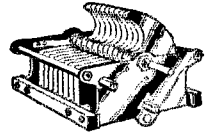

Cardwell condensers, double spaced for transmitting, .00025 cap. 3.45

No. 12 Enameled copper wire, any length, ft.\$1.01

No. 10 Enameled copper wire, any length, ft.011/2

Genuine Bakelite Panel 10x14x1/41.50

Baldwin phones type C, pair 5.95

Myers \$3 4 1/2 volt Det. or Amp tube, complete with mounting clips95



Ward Leonard Resistance \$4.75 list-6 1/2 inch long-800-1000-1200-8000-6000-8000-11000 ohms; can be used for 2-50 watt tubes or less, \$1.45

Television disks as specified in QST special \$1.95.

MAIL ORDERS FILLED SAME DAY
10% Must Accompany All Orders

BECOME A RADIO OPERATOR

See the World. Earn a Good Income.
Duties Light and Fascinating.

LEARN IN THE SECOND PORT U.S.A.

Radio Inspector located here. New Orleans supplies operators for the various Gulf ports. Most logical location in the U.S.A. to come to for training.

Nearly 100% of radio operators graduating on the Gulf during the past six years trained by Mr. Clemmons, Supervisor of Instruction.

Member of the A.R.R.L.—Call "5 G R"
Day and Night Classes—Enroll anytime—Write for circular.

GULF RADIO SCHOOL

344 Howard Ave. New Orleans, La.

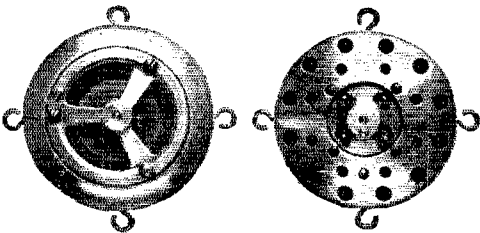

NEW—a low priced two button "mike", similar to cut, priced under \$16.00.

Standard Broadcast Type, ideal for public address, etc., price \$40.00.

Send for further information. A new special bulletin on all short wave equipment is now ready.

E. F. JOHNSON COMPANY Waseca, Minn.

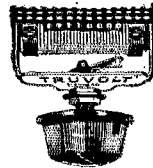

U. S. Pat. 1,676,869
and Pats. Pending

Accurate
and
Durable

TRUVOLT
Reg. U. S. Pat. Off.

All Wire

RESISTANCES

In Truvolt Variable Resistances the unique design permits the winding of a much larger resistance wire in a smaller space. Also the contact arm moves lengthwise over the turns of wire reducing wear to a minimum. Hence much greater current loads may be carried without risk of breakdown. Be sure to use Truvolt Resistances in the Eliminator you build.

Electrad specializes in a full line of controls for all Radio Purposes including Television.

Write for Free Circulars

Dept. T-10, 175 Varick St., New York

ELECTRAD

"The Heavy Duty Giant" POWER RHEOSTAT

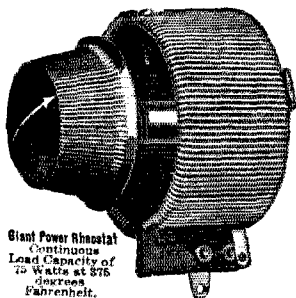

Giant Power Rheostat
Continuous
Load Capacity of
75 Watts at 375
degrees
Fahrenheit.

Centralab offers a variable resistance that is capable of handling the greatest power loads under all conditions and is extremely small in size. The Giant Power Rheostat is constructed completely of metal and asbestos — no fibre to warp or burn out under heavy duty use.

The resistance wire is wound on an asbestos insulated metal core and presents a large area for heat radiation. It will carry a continuous current load through the entire resistance of 75 watts at 375 degrees Fahrenheit.

The mechanical construction is simple but very sturdy, making it an ideal unit for manufacturers. The contact is positive—smooth to the touch and noiseless. This unit is particularly adaptable to primary control of filament transformers for A.C. sets or "A" power supply units to maintain the light socket voltage at a constant average and the secondary output well within rated limits.

The current carrying capacity is so great that it can be used in any radio power circuit without danger of burning out—as the fusion point of the wire is the only limit of capacity.

Made with two and three terminals in resistances from 25 to 8000 ohms. May be had in the 5000 and 8000 ohm size with a fourth terminal for "B" eliminator control.

Priced very low. Wire or write specifications for your needs. Quotations and samples gladly furnished.

CENTRAL RADIO LABORATORIES
18 KEEFE AVE. MILWAUKEE, WISCONSIN

Centralab

plier. The condenser C2 should then be adjusted to the point of minimum current, and the coupling again increased and C2 again adjusted. This should be repeated until the proper plate current is secured, and so that turning C2 in either direction will tend to increase the current. Condenser C1 may then need slight readjusting.

The proper adjustment is that which results in the plate current being a minimum. Full plate voltage may now be applied to the amplifier.

If you already have a good self-excited set built, it is only necessary to construct the crystal controlled element with its two tank circuits and to connect the output of coil L1 to the grid feed of your present set. As an alternative, one can use the transformer coupling referred to previously. The crystal controlled element may be built in a separate box placed alongside the original set. Neutralizing condenser C6 may be connected to one end of the original tank circuit.

After a crystal controlled set has been placed in operation, my experience has been that it requires no further attention whatever, as it will not get out of adjustment due to antenna changes, and if the crystal holder is fairly dust tight, the crystal will not need cleaning for an indefinite period. The set is always ready to go, and the stations with which you are scheduled will always know exactly where to find your signals, and will be able to read through much worse weather conditions than otherwise would be possible.

The Duriron-Duralumin Rectifier

(Continued on Page 45)

properly polarized and immersed in the proper electrolyte can withstand maximum potentials up to 400 volts for limited periods, whereas aluminum electrodes will withstand

LESSEN STATIC TUNE MORE SHARPLY

Bring your set up to maximum sharpness with
X-L Vario Densers

Practically all of the popular high grade circuits now use X-L Products. Endorsed by leading radio engineers, designers and builders and used by members of the league everywhere. Broad and positive capacity range that assures exact oscillation control easily obtained with both Model "N" and Model "G" Vario Densers. Genuine Bakelite casing, dust and moisture proof. All metal parts phosphor bronze nickel plated. Only the best imported India rubber used. Extreme micrometer capacity advance, exceptional accessibility in close quarters.

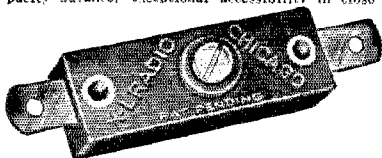

MODEL
"N"
VARIO
DENSER

Model "N" has variable capacity adjustable from 1.8 to 20 micro-microfarads. Price each \$1.00. Model "G" with grid clips made in three variable capacity ranges, viz.—Model G-1 .0002 to .0001 Mfd. Model G-5 .0001 to .0005 Mfd. Model G-10 .0003 to .001 Mfd. Price each \$1.50.

New Bakelite Insulated X-L Push Post

The most perfect binding post made. Push down with thumb, insert wire, remove pressure, wire is held firmly. Plain in all standard makings. Also made in all metal design. Price each 15c. Strip of 7 on black panel with white markings, price \$1.50.

Write for free copy of new book of wiring diagrams showing use of X-L units in all leading circuits.

X-L RADIO LABORATORIES,
Dept. D, 1224 Belmont Ave., Chicago, Illinois



X-L PUSH
POST

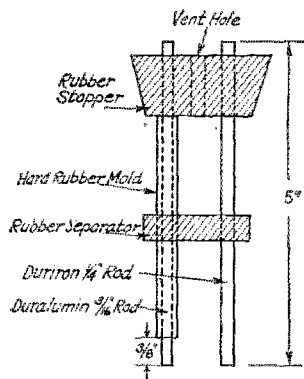

ELECTRODES FOR ELECTROLYTIC CELLS

FIG. 2

maximum potentials up to 300 volts. Sparking at the breakdown point is injurious to the electrode. It causes spots where oxide cannot form.

It is generally understood in the science of chemistry that the purer the metal the more resistant it is to corrosion. But it is a well



A FILTER

—A New Development

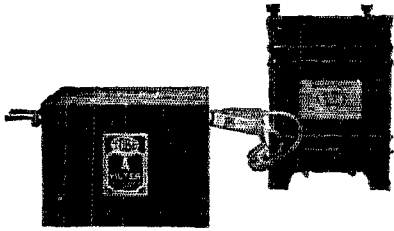

Attach to any good 2 or 5 Amp charger such as Westinghouse, Tungar, Bakelite, Elkton, etc., bulb or electrolytic. —Will make a 4 or 6 volt A-Supply in less than a minutes time. Filter consists of 2 chokes and 8000 microfarads of condensers. The unit is dry, measures but 8 x 4 x 5, thoroughly guaranteed and sold with the understanding that your money will

be refunded if you are not completely pleased with the results.

The TOBE TRANS-A-FORMER has been designed to take the place of a charger, if you are without the standard charger. The TRANS-A-FORMER consists of a 2½ dry rectifier and a step down transformer. The unit is completely wired and fits neatly on top of the A-FILTER—making a complete ALL DRY 6 volt A Eliminator.

A Filter \$18.00

Trans-A-Former \$15.00

Try your dealer; if unable to obtain A Filter send check or money order and we will ship direct.

TOBE DEUTSCHMANN CO.

CANTON, MASSACHUSETTS

DODGE RADIO SHORTKUT

With Appendix and Hints for Better Key Work. Fixes Signals in mind to stick—Kills Hesitation, Cultivates Speed and Good Fist—Produces Results. Slow Hams raise speed to 25 per in few evenings. Previous Failures qualify and pass exam quickly. Beginners master code and pass in ten days.

DODGE HIGH SPEED METHOD

(Intensive Speed Practice)
Quickly puts 25 per Hams in 35-40 per class. Five Hams report made this gain in few evenings. One of them by 75 minutes total practice only.

DODGE MORSE SHORTKUT

Easily mastered by Radio Ops—Kills tendency to mixup or confusion. Either code used as desired.

REPORTS FROM USERS

Tell the complete story—Mailed on request. Radio \$3.50. High Speed \$2.50. Morse \$2.50. Money order. None C. O. D. Foreign add 50 cents. See our Hamad.
C. K. DODGE, MAMARONECK, NEW YORK.

World's Standard Precision Parts In Karas Short Wave Receiver

Enjoy the thrills of hearing stations thousands of miles away. Karas engineers have developed short wave equipment to highest point. Easy to build. Easy to tune with Karas Micrometric dials. 53 to 1 ratio. Uses Karas condensers built like a fine watch. Karas coils and audios—standard of the world. Send to-day for complete information and construction blue print. Free.

KARAS ELECTRIC COMPANY
/ 4030K2 N. Rockwell Street, Chicago

Name

St. and No.

City and State

BUILD A DAVEN TELEVISION RECEIVER

The first complete Kit. Furnished with either T-24, T-36 or T-48 Scanning Disk Motor, Bushing, Rheostat, Daven Television Tube, 3 Complete Stages of Daven Television Amplification and Instructions for Building: Daven Television Receiver, Complete, including Television Tube—\$100.00 Less amplifier Tubes.

DAVEN TELEVISION APPARATUS

Daven Television Scanning Disks	Each	
24 T-24	\$ 5.00
36 T-36	7.50
48 T-48	10.00
Comb. Disc with 24, 36 and 48	
Apertures T-468	13.00
Daven Telev. Amp. T-3	12.50
Daven Spec. Telev. Amp. T-4 for 2	
Hi Mu Tubes and 2 power Tubes	17.50
471, 210, 250 Types	
Daven Telev. Neon Lamp 20 to 80	
Milliamperes Striking Voltage	
100 Plate 1½x1½ each	12.50
Daven Telev. Motor	27.50
Daven Bushing to fit ¼ inch 5-16	
and ⅜ inch Motor Shafts	1.00
Daven bushing for Aperture disc	3.50
Daven Rheostat	3.50
Daven Telev. Photo Elect. Cell 1¼	
inch Bulb	20.00
Daven Telev. Photo Elect Cell 3 inch	
Bulb	37.50
Daven Television Couplers,	
1st Stage No. 421x D-421xx	
2nd Stage No. 422x D-422xx	
3rd Stage No. 423x D-423xx	
x Glostors are used for Grid and Plate resistors	2.15
xx Super Davohms in Plate and Glostors in Grid	4.65
Daven AC 71 for output tubes in series with Tele-	
vision Lamp	3.50
Daven AC 10 (for brighter Illumination)	9.00
Daven Mu 20 Hi Mu Tubes for Amp. Stages	2.25
Daven Mu 6 Power Tube	3.50



THE DAVEN CORPORATION
AMPLIFICATION SPECIALISTS

171 Summit Street

Newark, N. J.



New and Improved Power Amplifier

Transformer

for use with U X
250 Tubes

This newest Dongan Transformer is designed for full wave rectification using two UX 251 tubes to supply B and C power to receiver and power for two UX 250 Tubes. There are two low voltage windings, one for 225 tubes and the other for 227 tubes so that you can build a power amplifier for either the radio receiver or for phonograph pick-up.

With No. 8529 Transformer use one No. 6551 double choke in filter circuit. Approximate D. C. output from filter, 325 V. 130 mils. Secondary voltages 650-650 V, 170 mils. 75V 2 1/2 amp. C. T. 7 1/2V, 2 1/2 amp. C. T. 2 1/2V 1 1/4 A. C. T. 1 1/2V 1.2 A. \$19.50.

Set Manufacturers and Custom Set Builders, you are cordially requested to take advantage of Dongan's very complete engineering facilities. All approved parts are in production now. Prompt attention will be given to any special design in which you are interested.

Dongan Electric Manufacturing Co.

2999-3001 Franklin St., Detroit, Mich.



Become an EXPERT RADIO OPERATOR

-The Quick, Easy Way



The TELEPLEX CODE SENDER teaches you at home in half the usual time. Entirely eliminates hit-or-miss methods. Reproduces actual sending of expert operators. Sends you messages, radiograms, etc.—regular code traffic anywhere, any time, any speed. No experience necessary. Tape records complete course of instructions make everything simple and clear. Set of 6 records supplied at no extra cost. Just what every beginner and advanced student needs for home practice. Used by U. S. Navy and leading Technical and Telegraph Schools. Write for FREE booklet.

TELEPLEX CO., RL, 76 Cortland St., New York, N. Y.

SCIENCE NEWS-LETTER

YOU will enjoy reading this weekly summary of current science. Beginning Sept. 15th the featured series of articles is "How to Make your own Radiovisor" by C. Francis Jenkins. Science News-Letter is thoroughly different, always entertaining and highly instructive. Introductory Offer—\$1 for 13 weeks



SCIENCE SERVICE, 2189 B St., Washington, D. C.

known fact that where the alloying metals form solid solutions or chemical compounds with the base metal, the resultant alloy usually has greater resistance to corrosion than the chemically pure base metal. In Duralumin the copper, magnesium, silicon and iron form chemical compounds with the aluminum, and when properly polarized resist corrosion better than pure aluminum in the electrolyte chosen. The anodically polarized surface offers a more resistant, a more compact and a more stable protective film than aluminum. And this is the primary reason for the superiority of this Duralumin over pure aluminum as a valve electrode in the electrolytic rectifier described below.

Because of the poorly conducting electrolyte and the high resistance of the oxide film, the I²R loss in the aluminum rectifier is considerable. Although the resistance of the oxide film on the Duralumin electrode is as high as on the pure aluminum electrode, the better conducting electrolyte in the Duralumin cell offers a smaller I²R loss than in the aluminum cell. This greater conductivity of the electrolyte is primarily due to the potassium dichromate added. The dichromate also aids in passifying the rectifying electrode, increasing the resistance of the oxide film to corrosion and increasing the breakdown voltage which the film will stand. The dichromate in addition greatly lowers the minimum or breakdown voltage as cathode and this improves the efficiency.

The theory of electrolytic rectification is as follows*: On the anode a solid oxide film is formed which increases in thickness with the passage of the current; at the same time a thin film of gas is formed on the solid film which further increases the resistance of the cell. The action of rectification is attributed, therefore, to the ease with which free electrons, which are present on the surface of the anode can penetrate the oxide and gas layer owing to the high potential gradient, and traverse the electrolyte to the cathode; whereas, the heavier cations are more or less completely held up by the film on account of their greater mass. This results in the production of a high counter e. m. f. or e. m. f. of polarization, which opposes the passage of a reverse current.

Since the amount of rectification* refers to the proportion of alternating current converted into direct current, the most concrete expression for this relation is the ratio of the average value of the current as measured by a permanent magnet type of ammeter to the root mean square value of the current as measured by a hot wire or dynamometer type of ammeter. This ratio is referred to as the degree of rectification and expressed as:

$$\frac{\text{DC}}{\text{AC}} = \frac{\text{average value of current}}{\text{root mean square value of current}}$$

4. Jolley: Alternating Current Rectification.

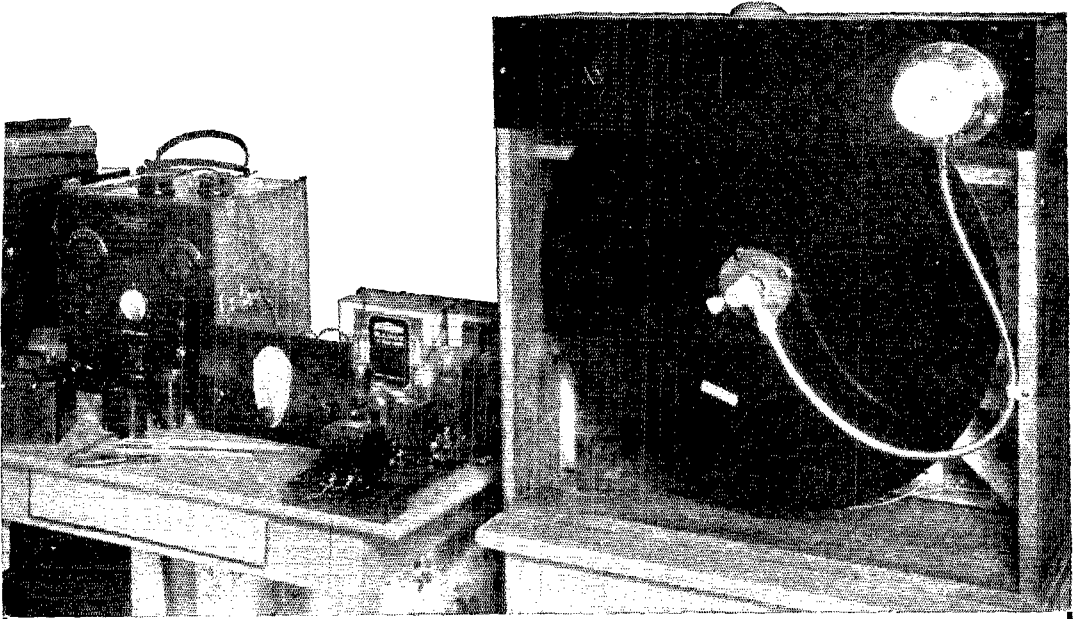

The National Screen Grid Short-Wave Receiver, National Amplifier and National Radial Aperture Scanning Disc, with which *James Millen* of Station 1AXL, Malden, Mass., has been receiving experimental television images from 3KK at Washington, D. C. National Transmitting Condensers and Precision Vernier Dials are also being used by the pioneer television transmitting stations 3KK...WRNY...WLEX and others now under construction.

Write Today for Short-Wave Bulletin 128Q.

NATIONAL CO. INC. W. A. READY, PRES. SHERMAN, ABBOTT & JACKSON, STS. MALDEN, MASS

QUARTZ OSCILLATING CRYSTALS

Unconditionally Guaranteed
1 in. sections ground to 1% of your specified frequency at these prices:

75-100 meters	17.50
100-200 meters	10.00
200-600 meters	15.00
Tested blanks, 2 to 5 mm thick ..	5.00

Sections of any practicable dimensions made to order.
Prompt Delivery

J. T. Rooney, B. Sc., 4 Calumet Bldg., Buffalo, N. Y.
"Ten years crystallographic experience"

ROBERT S. KRUSE

Consultant for Shortwave Devices

103 Meadowbrook Road,
West Hartford, Conn.

Telephone Hartford 45327



UNI-RECTRON POWER AMPLIFIER



(IDEAL FOR USE WITH DYNAMIC SPEAKERS)

As the Uni-Rectron stands it is a super power amplifier, which can be used in connection with any radio set and loud speaker. Binding posts are provided for input to the Uni-Rectron and output to the speaker. Requires no batteries for its operation. It obtains its power from the 110 Volt, 60 Cycle alternating current lighting circuit of your house.

The UX-210 super power amplifying tube and the UX-216B or 231 rectifying tube are used with this amplifier, which cannot overload. From the faintest

MODEL AP-935

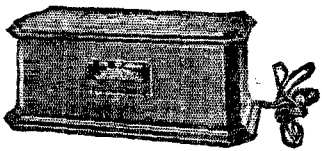

LIST PRICE \$88.50
(without tubes)

Special \$19.75 EA.

whisper to the loudest crash of sound—R.C.A. Uni-Rectron amplifies each note at its true value. High and low notes are all treated alike.

The volume and quality delivered will be a revelation.

Also by removing the input and output transformers it can be used as a source of power for an oscillating or transmitting tube, furnishing power for all circuits, grid, plate and filament and is the cheapest form of Power Supply for Amateur Transmitting purposes ever offered. New.

SEND FOR OUR LIST OF RADIO BARGAINS

AMERICAN SALES CO., 19-21 Warren St., New York City

WIRELESS EGERT

Still serves the Amateur. Buy from the Reliable Dealer. Look at our prices. Sold on Mail Order only.

Acme 200 Watt Transformers,	\$16.75
Thordarson 2098 Transformers,	\$13.95
Flechtheim Condensers,	Less 40%
Hammarlund Short Wave Coils,	\$6.95
Alcoa Shielded Cans 6x5x9,	\$2.25
30 Henry Chokes at 85 mils.,	\$1.69
E 210 Rheostats Bradley,	\$2.85
Edgewire Copper Ribbon, per turn,	10c
Teleplex Practice Set,	\$27.50
Amateur's A.R.R.L. Handbooks,	\$1.00
Citizens' Amateur Call Book,	\$1.00

Anything else in the line of Transmitting Apparatus you may need, we have IN STOCK.

Free Short Wave and Transmitting Catalogue

WIRELESS EGERT,

179 GREENWICH ST.

N. Y. CITY

The simplest ideal case of half-wave rectification is represented by the following equation:

$$\frac{DC}{AC} = \frac{\int_0^{\pi} \frac{I_{max} \sin \theta \cdot d\theta}{2\pi}}{\sqrt{\int_0^{\pi} \frac{I_{max}^2 \sin^2 \theta \cdot d\theta}{2\pi}}} = \frac{2}{\pi} = 0.636$$

The value of 0.636 is, therefore, the maximum degree of half-wave rectification obtainable when the circuit is free from inductance and counter electromotive forces.

By means of the bridge or center-tapped transformer arrangement, it is possible to rectify both halves of the wave. In the case of full-wave rectification when there is no appreciable inductance, capacity or counter e. m. f. the ratio is expressed as follows:

$$\frac{DC}{AC} = \frac{2 \int_0^{\pi} \frac{I_{max} \sin \theta \cdot d\theta}{2\pi}}{\sqrt{2 \int_0^{\pi} \frac{I_{max}^2 \sin^2 \theta \cdot d\theta}{2\pi}}} = \frac{2\sqrt{2}}{\pi} = 0.905$$

The theoretical maximum values of 0.636 and 0.905 may be closely approached.

An electrolytic rectifier designed for use in a "B" battery substitute consists of a battery of eight small electrolytic cells. A transformer, filter system and voltage divider complete the unit, the wiring diagram of which is shown in Figure 1. This gives full wave rectification through four cells on each half of the cycle.

The Duralumin-Duriron electrolytic rectifier consists of a polarized Duralumin electrode (anode) as the check-valve electrode, a Duriron cathode as auxiliary electrode, and an electrolyte consisting of 93 parts by volume of a 20% solution or diammonium hydrogen phosphate, 3 parts of a 10% solution of potassium dichromate and 4 parts of an 8% solution of oxalic acid. Potassium dichromate is here used as a depolarizer to decrease the internal resistance of the cell. The cells are rectangular bottles about 1½ inches by 1 inch by 5 inches high. The electrolyte is covered with a small quantity of light paraffin oil to trap gas bubbles and prevent spraying during the operation of the cells. The Duriron electrode is a non-machinable, brittle iron-silicon alloy containing about 13% silicon, which resists the electrolytic corrosion. There is no crust or precipitate formed on the Duriron electrode after the cells have been in operation many hours as there is on the much used lead electrodes.

The diammonium hydrogen phosphate is the rectifying electrolyte, the potassium dichromate is the depolarizer to decrease the internal resistance of the cell by decreasing

Send For WESTERN RADIO New 1929 Catalog

Dealers and Set Builders

THE NEW 1929 Catalog is crammed full of the FINEST, NEWEST, Nationally known A.C. sets, consoles, cabinets, dynamic speakers, kits, PARTS, eliminators and accessories at LOWEST PRICES. Largest stock of radio parts. Prompt delivery.

Write for our FREE catalog
WESTERN RADIO MFG. CO.,
125 W. Lake St., Dept. 910, Chicago

FREE



"The Big
Friendly
Radio House"

Permanent Insulating Qualities!

UNAFFECTED by smoke, salt fogs and fumes, constant in their electrical and physical characteristics, *PYREX Radio Insulators give *permanent* insulation for all radio work. They represent the true fusion of materials resulting in a homogeneous, non-porous insulator, uniform throughout its structure — high in dielectric strength—low in power loss.

Dust and dirt cannot accumulate on their original diamond hard and

super-smooth surface. There is no "glaze" to check or craze.

Made in several styles and in various sizes: antenna, lead-in, stand-off bus-bar, inductance shapes, bushings, rods and cylinders.

A treatise on the unique chemical, physical and electrical properties of the special glasses from which these high-test insulators are made will be sent on request. Write for "PYREX Industrial Glass Products."

CORNING GLASS WORKS

Industrial and Laboratory Division, Dept. Q-3

CORNING, NEW YORK

*Trade-mark Reg. U.S. Pat. Off.

RADIO IN BRASIL

When in Brasil, apply to M. BARROS & CIA for anything you need in connection with radio.

M. BARROS & CIA

70 sob. Rua S. José 70 sob.
Postal Box 89

Rio de Janeiro

Telegraph address, Radioparte, Rio de Janeiro
Branch: Avenida S. João 4, S. Paulo, Brasil

PACENT DUO-LATERAL COILS

FOR laboratories, experimenters engineers and for special circuits, Pacent Duo-Lateral Coils are the accepted standard.

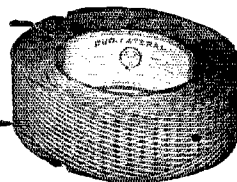

A complete line of all standard turn ratios are always in stock.

Write for information and prices

Pacent Electric Co., Inc.
91 Seventh Avenue, New York

QST Oscillating Crystals—Notice!

The prices quoted in the September QST for grinding POWER CRYSTALS in the various amateur bands are effective up to November first 1928. After that date, our prices will be increased. New prices will be announced in the November issue.

We are compelled to increase the cost of our crystals on account of the higher manufacturing costs in producing high grade crystals which will operate tubes as large as the 50 Watt size. Therefore, now is the time to secure your power crystal for that Winter DX at the present low prices. All our crystals are absolutely guaranteed in every respect. You take no chance in placing your order with us. Immediate delivery.

Present prices for grinding crystals in the Amateur bands are as follows:

1715 to 2000 Kilo-cycle band	\$15.00.
3500 to 4000 Kilo-cycle band	25.00
7000 to 7300 Kilo-cycle band	40.00

Add \$10.00 to the above prices if crystal is to be mounted in an excellent dustproof holder

SCIENTIFIC RADIO SERVICE, The Crystal Specialists

P. O. Box 86

Mount Rainier, Maryland

Short Wave Converter Unit

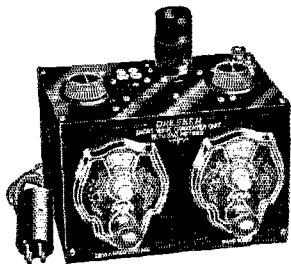

Complete
\$22.50
Special

Some of the best entertainment of the air is broadcast on the short waves by many powerful stations. There is no longer any reason why all should not receive these excellent programs from all over the world. The Dresner Short Wave Converter Unit is completely assembled. It efficiently covers a wave band of 15 to 550 meters, and makes reception easily obtainable for all. Offered at the special price of \$22.50—complete ready to plug into your receiver in a few seconds. If your dealer cannot supply you SEND MONEY ORDER DIRECT and we will ship P. P. prepaid. **GUARANTEED.**

DRESNER RADIO MFG. CORP.
644 Southern Boulevard, New York City

YAXLEY

APPROVED RADIO PRODUCTS

Junior Rheostats

Small in size, but a master instrument. Ask your dealer to show you the exceedingly fine adjustment and velvet smooth action. Diameter, 1 7/16 inches. Up to 400 ohms75c
1000 and 2000 ohms\$1.00
Self-attaching, positive acting switches for Junior Rheostats40c

RESISTANCE UNITS

Here is where you need absolute dependability and you get it with Yaxley Resistance Units. Run true to rating. Convenient screw eye and soldering lug terminals for easy mounting. Filament and grid type; one to 3000 ohms15c to 40c

YAXLEY MFG. CO. Dept. S, 9 So. Clinton St., Chicago

SET Builders

FREE

Barawik, the first and oldest radio specialty house, offers you unusual service this year. Bigger stocks, quicker shipments, lower prices. Deal with an old established, reliable house. Get honest goods honest service, honest prices. Barawik service makes you more money. Send now for our new catalog—showing lowest wholesale prices on sets, parts, short wave, etc.

BARAWIK CO. 1110 CANAL ST., CHICAGO, U. S. A.



Freshman Power Transformers

Complete Power Supply for 210 Transmitter or Power Amplifier. Supplies Plate Voltage of 375 Volts, Filament Voltages of 7 1/2 volts (Center tapped) for 210 and 281 tubes, also "C" Bias for 210. **SPECIAL \$3.00 Ea.**

AMERICAN SALES CO., 19-21 Warren St., N. Y. City

the polarization potential, and the oxalic acid is the stabilizer to prevent the solution around the Duralumin from becoming too alkaline and causing the precipitation of aluminum hydroxide on and around the Duralumin.

The Duralumin electrodes are coated, as shown in Figure 2 with a hard rubber mold to permit an electrical contact point at the upper end and a definite surface area of the Duralumin exposed to the electrolyte at the lower end. The latter surface is 3/8 inch long by 3/16 inch in diameter, giving a total surface area of 0.01 square inches. A greater surface area exposed to the electrolyte lowers the degree of rectification.

The reason for this is that during the period when the Duriyon is anode, no appreciable direct current flows through the oxide film, but the film acts as a dielectric between electrode and electrolyte and the whole combination operates like a condenser. The capacity of this condenser is proportional to the area of the anode in contact with the electrolyte.

By increasing the area of the electrode, therefore, the capacity is increased and an appreciable capacitive current flows during the anodic period, leading the impressed voltage by a quarter of a cycle. Since the capacitive current increases proportionately with the capacity and, therefore, also with the area of the valve electrode and is essentially an alternating current, its average value is zero, but its root mean square value

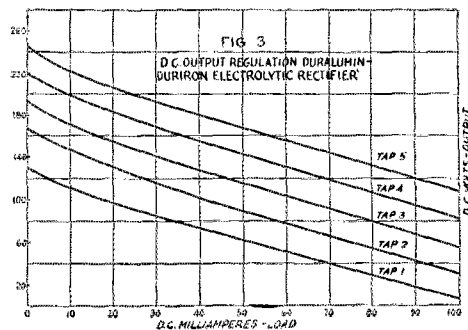

is of course a positive value. The degree of rectification, or ratio DC/AC is therefore reduced by enlarging the exposed area of the electrode, that is, by reducing the current density under given condition.

The transformer of the B substitute constructed has five taps on the primary and a split secondary. The primary is made of 1240 turns of No. 23 black enameled copper wire with taps at 825 turns, 900 turns, 1000 turns and 1100 turns. The secondary consists of 1950 turns of No. 24 black enameled copper wire with a tap at the midpoint, namely, at 975 turns, thus giving a split secondary. The secondary is wound over the primary and the core is of silicon steel laminations.

Two choke coils of similar characteristics and connected in series are used in the filter

To Our Readers who are not A. R. R. L. members

Wouldn't you like to become a member of the American Radio Relay League? We need you in this big organization of radio amateurs, the only amateur association that does things. From your reading of *QST* you have gained a knowledge of the nature of the League and what it does, and you have read its purposes as set forth on page 6 of every issue. We would like to have you become a full-fledged member and add your strength to ours in the things we are undertaking for Amateur Radio. You will have the membership edition of *QST* delivered at your door each month. A convenient application form is printed below—clip it out and mail it today.

A bona fide interest in radio is the only essential qualification for membership.

American Radio Relay League,
Hartford, Conn., U. S. A.

I hereby apply for membership in the American Radio Relay League, and enclose \$2.50 (\$3 in foreign countries) in payment of one year's dues. This entitles me to receive *QST* for the same period. Please begin my subscription with the issue. Mail my Certificate of Membership and send *QST* to the following name and address.

.....

.....

Do you know a friend who is also interested in Amateur Radio, whose name you might give us so we may send him a sample copy of *QST*?

.....

Thanks

YOU'RE LOSING

From a quarter to a third of your output unless your rectifier is a mercury arc. Long life, unlimited power, perfect note. Regulation unmatched. 1929 performance. Read what the gang says, follow 'em—and your rectifier problems are solved.

RECTIFIER ENGINEERING SERVICE
1837 Rockwood Rd. Radio 8ML Cleveland, Ohio

U. S. Navy type CN 239 Receiving Set 1000-10,000 meters, A-1 condition, Maker National Electric Supply Co., complete without tube cabinet for \$35.00. Kolster Decremeter and Wavemeter, Maker N.L. Elec. S. Co., Type CN 12, range 100-3500 meters, complete with graphs, coils, etc., condition O. K. Case 15"x10 1/2"x3", consists of current squared meter, condenser, buzzer, crystal detector and rotary switch, for \$50.00. Largest stock of Government Radio Transmitting and Receiving material in U. S. Send 2c stamp for our new and latest reduced price list. Ship anywhere.

WEIL'S CURIOSITY SHOP,

20 South 2nd St. Philadelphia, Pa.

RADIO OPERATORS WANTED

THE EASTERN RADIO INSTITUTE can train you quickly and thoroughly because:

MODERN AND EFFICIENT METHODS
THOROUGH INSTRUCTION under staff of
LICENSED COMMERCIAL OPERATORS
MODERN APPARATUS including SHORT WAVE
TRANSMITTER

FIFTEEN years a RADIO SCHOOL
THE OLDEST, LARGEST and MOST SUCCESSFUL
school in New England. RECOMMENDED BY THE

A. R. R. L.

Day or Evening Classes Start Every Monday.

SPECIAL CODE CLASSES

Write for Illustrated Prospectus

EASTERN RADIO INSTITUTE

899 BOYLSTON STREET BOSTON, MASS.



FLECHTHEIM SUPERIOR CONDENSERS

Dear OM:

You get a more effective and dependable condenser when you buy a Flechtheim. Regardless of what purpose you may need it, there is one to suit every need—either for the receiver, the power pack or the transmitter. And it costs less—a factor that means a lot to you—in savings. Write for catalog X. Tnx OM es pse QSL.

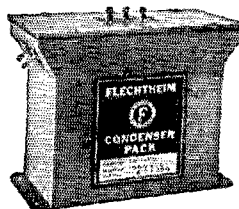

Type FA10—For 210
List Price\$16.50

73's nu 2AFS, Chief Engineer
Complete Line From 250 to 3000 V.D.C.

Type DX25—For 250
List Price\$20.0

A. M. FLECHTHEIM & CO., Inc., Dept. QT, 136 Liberty St., N. Y. C.

Another Home Run!

Here's the Clarostat Speed Control. Just the thing for synchronizing the television scanning disk. Controls any variable speed motor of 1/8th

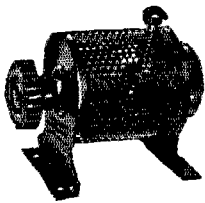

h.p. or less, from standstill to full speed, in several turns of knob. Push-button for quick starts and momentary acceleration. Heavy metal case, properly ventilated. Protected screw terminals. Resistance range of 200-100,000 ohms. 80-watt rating. Ideal for television—but that's only half the story. Can be used in radio and electrical work wherever a variable or fixed heavy-duty resistance is required.

WRITE for literature regarding Clarostat Speed Control, as well as all other Clarostats which have a real place in ham radio. Better still, send a quarter for "The Gateway to Better Radio"—the best investment you can make today!

CLAROSTAT MFG. CO., Inc.

Specialists in Variable Resistors

285-7 North 6th St.,

Brooklyn, N. Y.

CLAROSTAT
REG. U.S. PAT. OFF.

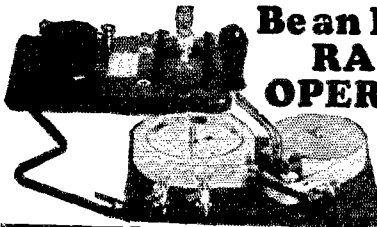

Be an Expert RADIO OPERATOR

Satisfaction Guaranteed
Send Today

MIDGET

TELEPLEX

Just like having an expert operator in your home.

CODE SENDER

Only

\$3.50

Post-paid

Good pay. Travel. Excitement. Adventure. This wonderful instrument will teach you to read the code like an expert in half the usual time. Reproduces actual sending of expert operators. Sends messages, radiograms, newspaper matter, etc.—regular code traffic anywhere, anytime and at any speed. All you have to do is listen. Easy and fascinating. Waxed tape-records carry complete instructions. Just what you need for home practice. Why delay when you can get this simple, practical and efficient codesender with lessons for only \$3.50 or with high-frequency key and buzzer for \$5.50. Postpaid. **TELEPLEX CO., 74-76 Cortlandt St., New York, N. Y.**

TRANSFORMERS

Guaranteed—Mounted—Complete

250 watt 550—700 each side.....	\$10.50
700 watt 1000—1500 each side.....	14.50
700 watt 2000—2500 each side.....	21.00

Also Polyphase and 25-cycle Transformers

Add \$2.00 for fil. winding

GES. F. GREEN

1927 So. Peoria Street, Pilsen Sta., Chicago, Illinois

system. Each coil consists of 450 turns of No. 27 black enameled copper wire wound on a silicon steel laminated open gap core. The core is about 4 1/8 inches long by 2 3/4 inches wide by 7/8 inch thick. Each lamination is 0.017 inches thick. The choke has a resistance of 140 ohms and an inductance of 28 henries. The condenser box is of steel and contains 16.8 microfarads of three-ply mica condensers.

Figure 3 gives the d.c. output regulation data for the unit. This data shows the d.c. voltages obtained on all five taps with loads varying from no load to 100 milliamperes. It will be observed that the maximum d.c. output obtainable is 247 volts at no load. The regulation drops regularly in about 10 volt increments as the load increases by 10 milliampere steps.

On the first tap the voltage drops regularly and smoothly from 131 volts at no load to 8 volts at 100 milliamperes; on the second tap from 167 volts at no load to 32 volts at maximum load; on the third tap from 194 volts to 56 volts; on the fourth tap from 220 volts to 83 volts; and on the fifth tap from 247 volts to 109 volts. With a normal operating load, say 40 milliamperes, the d.c. output obtainable is as high as 181 volts.

The cells operate very smoothly and steadily. There is no aluminum oxide crust formation on the rectifying electrode as can be observed on aluminum units. The oxide film after 1500 hours of continuous operation is very thin and adherent. Gassing is very moderate, increasing with the load. No audible hum is observed save that due to the escaping gasses liberated during electrolysis. At 30 to 40 milliamperes, normal operating load, the temperature of the cells never rises above 40 degrees Centigrade. Due to the very thin oxide film on the Duralumin electrode the I²R loss in each cell is very small, thus causing no high increase in temperature of the cells during operation. This low temperature inhibits the decomposition and break down of the rectifying film and, consequently offers a longer life to the unit.

The work on this rectifier was carried out in the laboratories of The American Bosch Magneto Corporation, Springfield, Mass., and The Postgraduate School of the U. S. Naval Academy, Annapolis, Md.

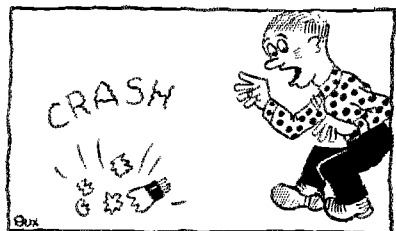

CAN HAPPEN

Calls Heard

(Continued from page 64)

W7MF, Harold DeVos, R. F. D. No. 2, Medford Oregon

(20 and 40 meters)

ac-1pp ac-3gg ac-9aa aj-2by aj-2dk aj-4zz aj-7cb
jix ef-8fd ef-8ix fo-a4a fo-a5o k7aer k7jr k7to nj-2pa
nm-1g nm-1rz nm-9a nm-7nic nq-5fl oa-23h oa-23j
oa-2kj oa-2kl oa-2ns oa-2rb oa-2re oa-2rx oa-2yi
oa-3am oa-3ar oa-3bq oa-3ml oa-3kk oa-4cg
oa-4cm oa-4lj oa-4pn oa-4jr oa-4rj oa5bj oa-5dx
oa-5hg oa-5mb oa-7dx oa-7lj k6adh k6cjl k6dlj k6dbl
k6dcu k6dqn k6dv k6ch k6dv op-1cm op-1cw op-1dr
op-1hr op-1mr op-1pw op-1rc oa-1ar oa-2ab oa-2aw
oa-2ba oa-2bc oa-2bp oa-2ga oa-2gp oa-2xa sb-1aj sc-2ac
se-1em se-2ah.

9BGA, E. J. Raible, 819 Sylvia St., Louisville, Ky.
(20 meters)

eb-4au ee-ear65 ef-8br ef-8cp ef-8ct eg-2ad eg-2od
eg-2lz eg-5ml eg-5wk eg-6bd eg-6by eg-6vp eg-6wy
eg-6yy ep-1aa fq-8hpq na-7mn ne-8ae ne-8fd ne-8wg
nm-227a np-axf nq-2ac nq-2zk nt-2fp ny-1aa
oh-6clj oz-2ac oz-2ae oz-2aw sb-1ah sb-1aw sb-2ab
sb-2aj sb-2al sb-2ig sc-1ai sc-2ah sc-2ac sc-3cj velad
velam velar veldq ve2am ve2ap ve2bb ve3bm ve4di
ve4dk ve4fc ve4ff ve4gd ve4go ve4ie ve5bn ve5cp
ve5ef wnp.

40 meters

fl-1ab nh-up nj-2pa nm-1g nm-9a nn-1nic nn-7nic
nq-2ay nq-2jt nq-2ec nq-5fg nq-5fl nr-oto nt-2fp
nz-fr6 oa-2ac oa-2yi oa-3cp oa-3gr oa-3vp oa-5ax
oa-5bz oa-5mb oa-5wh oa-7bq oa-7hl oh-6qh oh-6dpz
oz-2aw oz-3cd oz-4am sb-2ah se-1em se-2ah se-2ea
se-2jm ve8bv ve8cb ve8va ve8av.

Samuel Gross, 132 S. Carolina Ave.,
Atlantic City, N. J.

w6bv w6by w6gm w6dz w6ix w6ql w6va w6avi
w6ave w6ags w6aub w6amm w6bui w6bck w6bjj
w6bgb w6bqh w6bzs w6ctx w6cuj w6cxo w6ceh
w6cus w6cpq w6cyr w6cui w6cwn w6cja
w6cha w6dbx w6dyl w6dtl w6dyj w6dyh w6dgu w6dfr
w6dgg w6dzu w6dog w6dkx w6dyi w6efc w6eac
w6lev w6efj k6avi k7bf ve5go w7iy w7mo w7ts w7gj
w7aov w7oax w7ai w7mq w7un w7ac w7bf.

W. A. Bousfield, York St., Bellerive, Tasmania

wlaqt wlvw w2bcw w2bfq w2bvg w2exl w2tp w3aql
w3chk w4lu w4to w6awd w6bat w6bbk w6bj w6avj
w6avz w6azy w6bfr w6bq w6cuh w6bvm w6dek
w6dev w6dfs w6dkx w6dow w6dq w6dqg w6vz w7acy
w7aeu w7afo w7aib w7als w7im w7mo w7rz w8acm
w8arg w8aul w8azh w8bc w8cnh w8dix w8dqk w9bal
w9box khab nidk wntb ac-6ab ac-8rj ac-8to ea-jh
eb-4au eb-4di eb-4ft eb-4rk ef-8axq ef-8hf ef-8btr
ef-8fd ef-8hpg ef-8jd ef-8vd ef-8wb ef-8wz eg-2lz
eg-2nh eg-2zc eg-5by eg-5mq eg-5sw eg-5vl eg-6ut
si-1eh ek-4nap ek-4ka ek-4yt ek-4zz em-smut en-ofp
en-oga ep-1bx ew-hb na-7als na-7sc na-2be ne-3be
ne-3es nm-9a ng-2co od-1pk od-1xm k6avi k6doe
k6dey k6dpq k6dwz oa-bam op-1ad op-1cm op-1hr.

G2BOQ, H. E. Bottle, 27 Stormont Rd., London,
S. W. 11

w1aba w1abx w1acm w1adb w1aqp w1aze w1byv
w1cdq w1cj w1cmf w1kl w1kr w1mi w1nf w1zz
w2aca w2api w2apy w2ass w2baz w2bbx w2bcw
w2bkh w2bks w2br w2nm w2qd w3aef w3afj w3anh
w3atq w3bce w3bjm w3car w3vg w3wm w4act w4dt
w4nh w4oc w4wo w4sw w4ad w4scv w4dlw w4dsv
w4dwe w4hx w9atq w9dxi w9emr w9etk xnuizs
nc-2br nc-2ca ve-2ac ve-3es sa-dt3 sb-1ah sb-1aw sb-1bs
sb-2ab sb-2al sb-2ig sb-2ih sb-3g-gmd sb-sql sc-2ab
sc-3ac sc-3cj sg-a7 su-1na su-2bt.

SVGL, S. S. Julla, John Antjaklis, c/o A. R. R. L.
Hartford

w1air w1aj w1by w1cia-w1ekp w1enf w1jm w1mx w1up
w2and w2oab w2aop w2apb w2apd w2apy w2axl
w2bit w2exl w2ezr w2fl w2ja w2mb w2sm w2ty w2uo
w2vn w2xk w3anh w3aua w3ce w3cdn w3ef w3sj
w4el w4ha w5apq w5ayl w5ayo w5bf w5jc w5yw
w6aet w6am w6bck w6bl w6boy w6ppo w6bxa w6chl
w6cmt w6crz w6dfm w6dhl w6drr w6ea w6ec w6fl w6na
w6wsg w7fe w7pp w8air w8apm w8ces w8cc w8cz
w8rb w8xas w9baz w9cb w9ct w9ctg w9czh w9dmj
w9eln w9fdr w9fhy w9hr w9xi.

ef-8amda

w1bw w1mw w1axa w1wk w1cz w1aaw w1atz w1yc
w1ask w1cg w1asl w1by w1cpj w1nj w1rf w1sk
w1td w1blf w1gh w1aj w1lc w1ced w1ry w1br w1dm
w1auc w1bbn w1gw w1il w1bqs w1bby w1chz w1czz
w1kh w1bq w1af w1mo w1rp w1amf w1zl w1rn

Say You Saw It In Q S T — It Identifies You and Helps Q S T

Martin's Latest and Greatest Bug

THE Great New **VIBROPLEX**

Reg. Trade Marks: Vibroplex, Bug, Lightning Bug

No. 6

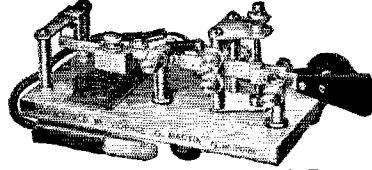

Japanned Base \$17
Nickel-Plated \$19

The smoothest, easiest-working bug on the market. Not too fast, not too slow — but just right. Works where others can't.

Famous Improved Vibroplex

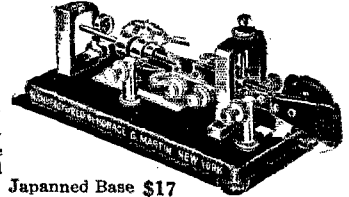

Used by tens of thousands of operators because of its ease and perfection of sending.

Japanned Base \$17
Nickel-Plated \$19

Special Radio Bug

Equipped with Extra Large, Heavy, Specially Constructed Contact Points for direct use without relay

\$25

Be sure you get the Genuine Vibroplex. The Vibroplex Nameplate is your protection. Remit by Money Order or registered mail.

THE VIBROPLEX CO., Inc. 825 Broadway
New York City
Cable Address: "VIBROPLEX" New York

"CHI-RAD"

Complete Stock of

Leach Relays

R. E. L. Products

3000 Volt Rectobulbs

Omnigraphs

Vibroplexes

Send for New 1929 Ham

Book---FREE!

CHICAGO RADIO APPARATUS CO.
415 S. Dearborn St., Chicago



—with Arcturus A-C Long Life Tubes. No. 127 A-C Detector operates in 7 seconds against 30 to 60 seconds for other tubes. For quicker action, better tone, longer life, —put an Arcturus A-C Long Life Tube in every socket.

Detector Power Amplifier
Amplifier Super Power
Shield Grid Rectifier

ARCTURUS RADIO COMPANY
255 Sherman Avenue Newark, N. J.

ARCTURUS

HAVE YOU SEEN IT? 4th Edition "Radio Theory and Operating"

By MARY TEXANNA LOOMIS
1,000 Pages; 800 Illustrations; Price \$3.50, postage paid in this and foreign countries. The best radio text and reference book ever produced. Contains all the latest material, and the new laws and regulations that go into effect Jan'y 1st, 1929. Off press Sept. 1st. Orders filled same day received. Buy it of all leading bookdealers in this and foreign countries. Best seller of the day.

LOOMIS PUBLISHING COMPANY
Dept. 5 Washington, D. C.

More Profits To Set Builders

Elections, football games, big National events will boost radio business this year. Set builders will reap a rich harvest. Barawik service will make you money. Everything in A-C sets, short wave, television, parts, supplies. World's largest radio stock on hand. Orders shipped same day. Lowest rock-bottom wholesale prices.

Write for Free Radio Catalog
BARAWIK CO. 1110A Canal St.,
CHICAGO, U. S. A.



AEROVOX

Makers of high quality resistors and condensers that are Built Better — to endure.
Write for The Research Worker.
A free monthly publication.
AEROVOX WIRELESS CORPORATION
88 Washington Street Brooklyn, N. Y.

wialr wiakm wif wlcx wiapr wicg wiaks wiami
wibqt wiaus wlaxx widl wictp wlabd wicmf wicje
wiadm wimk wled wiahw wiala wlqv wifr wlakm
wirx wicaa wiaaw wiaqt wibr wiaqv wiaab wiaha
wibkq wiaq wibew wimy wibgr wicm wicdi wicmp
wipe wibhm wiaz widi wiafr wlad wiaa wiaay
wiate wlabd wlkw wibke wiaqt wigw wiaja wiaz
wjl wibux wiavc wixr wifn wiajx wija wiry
w1w1 w2pn w2ag w2bc w2cwx w2axl w2ata w2aj
w2bse w2bev w2aao w2avq w2bnc w2bif w2agw
w2ku w2acw w2qu w2ax w2adb w2fc w2wi w2abp
w2bvq w2arm w2bu w2bjm w2bir w2dg w2box w2afi
w2bda w2fz w2bhd w2ft w2ani w2cty w2adl w2bg
w2avb w2baz w2azk w2ake w2chl w2bxr w2ues w2bfq
w2bi w2ty w2afv w2ayk w2bgt w2bzf w2bbx w2bci
w2bow w2aub w2alu w2avb w2dr w2ja w2awu w2ajq
w2cua w2afz w2kx w2agn w2adg w2cua w2tp w2uo
w2aol w2ber w2bgh w2om w2bvq w2bb w2api w2bbh
w2jp w2byw w2hd w2ag w2afz w2aw w2ot w2axz
w2abe w2kaz w2aqk w2aqq w2aop w2cot w2axz
w2ate w2bke w2ama w2fs w2bgt w2aes w2hr w2bme
w2aen w2bhv w2gr w2cgg w2ol w2arp w2eyx w2bad
w2baa w2atq w2ags w2dl w2auv w2sh w2aqm w2ce
w2bqg w2sz w2bt w2dh w2aof w2awf w2aqz w2amx
w2ahl w2cfc w2aio w2adp w2acq w2aib w2bq w2sm
w2cej w2ec w2lz w2gw w2sj w2akv w2wj w2ckj w2apf
w2anb w2ais w2pf w2apx w2bc w2an w2bo w2ceb
w2ag w2oh w2rb w2buw w2hf w2aol w2gfa w2afa
w2ku w2aih w2ais w2cj w2aut w2rk w2gl w2jm
w2ac w2ob w2ka w2ei w2pz w2ta w2apf w2aac w2mi
w2jd w2oc w2aer w2bl w2fu w2ve w2lx w2st w2aef
w2ym w2ox w2bb w2tg w2do w2adg w2kv w2aap
w2ia w2ux w2dr w2am w2dev w2cex w2adh w2ec
w2yb w2amo w2go w2aqe w2yw w2oa w2aff
w2aav w2bj w2uk w2yb w2amg w2kg w2ek
w2beu w2mx w2aly w2p w2awu w2cvo w2brc
w2cqc w2aif w2evs w2dxx w2cxd w2cix w2bbp
w2dh w2bwv w2atv w2on w2pl w2bhv w2xa w2aj
w2bqm w2br w2ajy w2cz w2dce w2it w2dai w2aj
w2dcm w2ahe w2cud w2dod w2dme w2ajy w2erd
w2axa w2dax w2lcm w2air w2dpa w2cke w2cib w2baj
w2li w2cax w2cer w2ced w2cem w2ctx w2drj w2atc
w2bm w2wp w2cae w2aj w2box w2cv w2axz w2aig
w2aoc w2bki w2bn w2cr w2bja w2auc w2cch w2agq
w2cl w2bf w2ag w2ayw w2ola w2bto w2mup w2cqv
w2g w2aok w2kr w2bit w2avp w2dce w2hj w2bpq
w2cis w2bpm w2efo w2dk w2cjq w2enp w2eld w2baz
w2dw w2ou w2bqg w2bqe w2erd w2cuy w2haz w2crz
w2nr w2avz w2bxb w2ez w2bko w2cqv w2ju w2ckm
w2elp w2ahq w2eqk w2tq w2dzt w2dk w2dnn w2bgd
w2fao w2bgm w2cep w2aok w2bk w2bq w2rk w2bwo
w2cia w2ex w2evr w2at w2fs w2ey w2erh w2cl
w2dfx w2des w2eju w2dkk w2ewv w2aof w2cn w2na
w2ejo w2eey w2cet.

WIRY. R. F. Hathaway, 23 West Weir St.,
Taunton, Mass.
(20-meter band)

eb-4au eb-4cb eb-4el eb-4rs ed-7bb ed-7mt ed-7zg
ee-ea6 ee-ear65 ef-8axq ef-8bf ef-8btr ef-8cp ef-8ct
ef-8eo ef-8fc ef-8fd ef-8fr ef-8ft ef-8gyd ef-8he ef-8ho
ef-8il ef-8jr ef-8lc ef-8noy ef-8orm ef-8pam ef-8px
ef-8rrr ef-8xo eg-2ao eg-2ax eg-8ax eg-2bm eg-2cx
eg-2dl eg-2ji eg-2k eg-2ms eg-2nh eg-2nm eg-2p
eg-2oq eg-2ac eg-2vq eg-2vy eg-2xy eg-2zc eg-5ad
eg-5br eg-5by eg-5c eg-5ha eg-5hs eg-5jo eg-5jw
eg-5kl eg-5ku eg-5ls eg-5ma eg-5ml eg-5mq eg-5ms
eg-5ov eg-5sk eg-5us eg-5vl eg-5wq eg-5yk eg-5yx
eg-5yz eg-6by eg-6ci eg-6dr eg-6fa eg-6gz eg-6hp
eg-6ia eg-6jk eg-6l eg-6oh eg-6oo eg-6pi eg-6rb
eg-6rb eg-6rw eg-6sm eg-6ta eg-6tx eg-6uo eg-6ut
eg-6vp eg-6wd eg-6wi eg-6wi eg-6wo eg-6wt eg-6wy
eg-6yk eg-6yq eg-6yv eg-6za ei-1au ei-1cr ei-1dr ei-1dy
ei-1fp ei-1gw ei-1po ei-1td ek-4abn ek-4ab ek-4ay ek-4au
ek-4il ek-4oa ek-4yt em-smuk em-smuv em-smaf
en-obu en-owr en-ozf eo-1ld eo-1zb eo-17c eo-18b
ep-1aa ep-1ae ep-1bc ep-1cg fe-egz fm-3rit fm-tun2
fo-asz fo-aax fo-a7n go-5xq go-6nx gi-2it gi-5mo
gi-6yw ne-8ae ne-8rg ne-8wg nh-ca nj-2pa np-axf
np-4ja np-4sa np-2ac np-2kp nr-2fg ny-5ox oa-1rx
oa-2uk oa-2yi oa-3gr oa-4rb oh-6cfn oh-6clj oz-1fv
oz-2ac oz-2tp oz-3aw sb-1ah sb-1aw sb-1ib sb-2ar
sb-2ax sb-2az sb-2ib sc-3ac su-1bc su-1cd su-1cv
su-2ah.

W4BB, Henry J. Nicks, Jr., 302 Safford Ave., Tarpon
Springs, Fla.
(20-meter band)

k4ja k4sa oa-3gr oa-5by oa-5dx oa-5hg oa-5jj oa-2yj
oa-8kp oa-2uk oz-3az oz-lap oz-1l na-7afu k6avi
k6dey sb-1ar sb-1ib sb-2ar.

(40-meter band)
eg-5hs fm-8ssr fe-suw ear73 eeg-2bqh ac-8ag ac-lax
eb-4xs oz-2fo ef-8btp eg-7cw op-1bq ef-7xx nz-wucg
eg-2cc su-1fb ei-1py ek-40a eg-2bc.

HAM-ADS

EFFECTIVE with this issue of QST the following changes will be made in the rules of this department. The Ham-Ad rate will be 15c per word. The restriction which has limited use of this column to members of the American Radio Relay League will be removed and advertising may be signed either by company name or by an individual. A special rate of 7c per word will apply to advertising which is obviously non-commercial in nature and which is placed and signed by an individual member of the American Radio Relay League. Please read carefully the following conditions under which advertising in these columns will be accepted.

- (1) Advertising shall pertain to radio and shall be of nature of interest to radio amateurs or experimenters in their pursuit of the art.
- (2) No display of any character will be accepted, nor can any special typographical arrangement, such as all or part capital letters, be used which would tend to make one advertisement stand out from the others.
- (3) The Ham-Ad rate is 15c per word, except as noted in paragraph (4) below.
- (4) Remittance in full must accompany copy. No cash or contract discount or agency commission will be allowed.
- (5) Closing date for Ham-Ads is the 25th of the second month preceding publication date.
- (6) A special rate of 7c per word will apply to advertising which, in our judgment, is obviously non-commercial in nature and is placed and signed by a member of the American Radio Relay League. Thus, advertising of bona fide surplus equipment owned, used and for sale by an individual or apparatus offered for exchange or advertising inquiring for special equipment, if by a member of the American Radio Relay League, takes the 7c rate. An attempt to deal in apparatus in quantity for profit, even if by an individual, is commercial and takes the 15c rate. Provisions of paragraphs (1), (2), (4) and (5) apply to all advertising in this column regardless of which rate may apply.

HAWLEY Edison element battery and parts standard for over five years. Look at our patent pending connector—no thin wire to drop off—contains 20 times more metal than regularly used. Heavy shock proof cells, fibre holders, etc. Everything for a rapid-fire "B" supply. Complete assembled 100 volt "B" \$10.00. Knock-down kits at still lower prices. Chargers that will charge in series up to 160 volts \$2.75 to \$4.00. Trickle B Charger for 90 to 150 volt "B" \$3.75. Special transmitter "B" batteries up to 6,000 milli-amp capacity, any voltage. Write for interesting literature, testimonials, etc. B. Hawley Smith, 360 Washington Ave., Danbury, Conn.

PLATE POWER for your set, the very heart of its performance. For quietness, DX ability, life-long performance, absolute dependability, lowest ultimate cost, no other plate source even approaches the achievement of an Edison steel-alkaline storage B battery. Built painstakingly every joint pure nickel, upset-electrically welded. Genuine Edison Electrolyte. Our list describes complete batteries, construction parts, enameled aerial wire, silicon steel. Rectifier engineering service, radio SML, 4837 Rockwood Road, Cleveland, Ohio.

OMNIGRAPHS, Teleplexes, Natrometers, transmitters, receivers, chokes, meters, 50 watters, "3" tubes, motor generators, supersyncs, electric receivers, portable receivers, Vibroplexes, condensers, dynamotors. Bought, sold, exchanged. L. J. Ryan, 9CNS, Hannibal, Mo.

100 volt Edison element kit with instruction, \$5.50; 140 volt, \$7.50; 180 volt, \$9.50. Type A elements with welded connector 3c paid; 5-G 3000 M.A. elements 6c. Prices include separators. Potash-lithium for 5 lbs. Edison solution 85c. Eagle A and B chargers, brand new with bulbs, 2 1/2 ampere, \$6.50; 6 ampere, \$10.00; Western Electric V12 tubes, \$3.00. J. Zied, 834 N. Randolph, Philadelphia, Penn.

SELL 50 watter with power transformer, \$12. 8AVM. We never knew so many five watters could be sold by two small Ham Ads, but we obtained another lucky buy and have genuine, new Navy five watters in original cartons, filament 7.5 volts, plate 750 volts, standard base, and we are passing them on to you for the mere sum of \$1.30 each. Oh you lucky hams! Don't forget we make the worlds finest amateur station emblem \$2.50 each. COD if desired. "For those who want the best" see "Joe" Bush, 178 Berkshire Place, Irvington, N. J.

GIRL hung arms around ham's neck and pleaded him to teach her how to operate the transmitter after she saw it equipped with the original low priced power transformer giving 1500 and 7.5 both center tapped, for two ux210s. Price only \$4.75 each. Shipping weight 10 pounds, please include postage. Of course you want a DC note so we have Dudlo wound 200 milliampere 30 Henry choke coils for only \$2.50 each. New transmitting keys \$2.00, 5000 ohm lavite transmitting grid leaks \$.95. Laboratory television and frequency meter neon tubes \$1.25 each. COD on request. Send for list. E. P. Hufnagel, 879 South 18th St., Newark, N. J.

RECEIVED commercial license. Sell Teleplex seven tapes, audio oscillator, book, \$24; Edison "B" \$3.50; Regent broadcast receiver \$8; ham receiver, cabinet \$9; beautiful 5-50 watt metered transmitter filtered DC supply complete. Photo. 2BJP, Emil Schau, North Avenue, Melrose Terrace, Elizabeth, N. J.

USED generators, good working order, 275 volt, will give up to 500 volts d. c. \$8; 6 volts input, output 400 volts at 200 watts \$15; 6 volt and 600 volt double current General Electric \$18. Used 1/2 k. v. 500 cycle \$15. 200 watt \$10; Kenotrons UV216, \$4.75; Microphones, \$21; 3 coil honey-comb mountings \$1. 500 cycle motor-generator 120 volts d. c. drive. R. Wood, 46-20 102nd St., Corona, N. Y.

TRANSFORMERS—Exchange what you have for what you want, plate and filament supply transformers and filter chokes of all sizes exchanged. Burnt out transformers accepted as part payment on new goods. 25, 40, 50, 60 and 500 cycle plate and filament supply transformers built to your order. Any transformer you want in stock or built to order. Nat G. Scott, New Albany, Miss.

SELL—Aero 40 meter, 7 1/2 watt transmitter, key, transformer, UV201 tube, with meters, and Aero receiver with 2 stage amplifier with tubes, all for \$85. George Ritchey, Box 291, Utica, Ohio.

SELL transmitting parts for 7 1/2 watter, practically new. Price Fish, Oskaloosa, Iowa.

MOTOR generator bargains almost new 750 volt 200 Watt Robbins and Myers, direct connected on iron base to 110 volt, 60 cycle single phase alternating motor \$45.00. 400 volt, 100 watt direct connected to 110 volt, 60 cycle motor \$30.00. Three 400 volt, 100 watt, 3500 Speed Western Electric generator with field resistance each \$9.50. Two 1/3 H.P., 110 volt, 3500 speed alternating current motors with coupling to direct connect to above generators or any machine having a 1/2 inch shaft each \$11.00. Also a few larger generators and motor generators. George H. Harris, 1911 Chicago Ave., Chicago, Ill.

TRANSFORMERS 250-watt, 1000, 750, 500 each side. \$8.00. 325-325 two 7 1/2 \$5.50. Filament heating, \$3.50. Chokes, adjustable core, 250 M.A. \$7.50 160 M. A. \$5.00. 100 M.A. \$2.00. Key click \$3.25. Write for specifications. Radio Parts Co., Orange, N. J.

AERO coils, Thordarson transformers, tubes, meters, etc. Send for list of standard parts. H. A. Carr, 1114 Monroe, Vicksburg, Mississippi.

9ABV selling out. Popular and high quality parts. Write for list. 9ABV, Campbell, Minn.

SELLING out receiver-transmitter parts; 25 cycle transformers. Write William Israel, Barker, N. Y.

BARGAINS for some one. 44 QST magazines, every one perfect, date back to 1924. Make offer. Also lot of spare parts. 3 1/2" O.T.'s edgewound enameled, 9 turns. Few at 50c each, etc. L. Grant, 21 Windsor Road, Somerville, Mass.

TRANSFORMERE 8-volt, \$5.75. 12-volt, \$6.50, new, center tapped, mounted. Also cores, end castings, etc. Send for list. Robert Annis, 524 N. Oriental, Indianapolis, Ind.

GENUINE Cunningham tubes to amateurs. CX210 at \$6.94, CX250 at \$10.34. Postpaid. U. S. Radio Shop, Coolville, Ohio.

SELL—Parts for complete 60-watt phone or 100-watt CW with all tubes and plate supply \$100. Will sell parts separately, write for list. Radiola 25 with loop and tubes \$25. A. R. Ueleke, Jackson, Mo.

NEW Westinghouse 30-volt, 5 ampere generators direct connected to 110-volt, 60 cycle, A.C. motors \$22.50; 50 Western Electric new 1/3 H.P., 110-220-volt, 60 cycle, 1750 speed repulsion induction motors \$16.50 each; also some in new General Electric and Westinghouse, induction type \$10.50 each. 1/4 H.P. size \$8.75 each. Also larger motors at 1/2 price. We have special bargains in new high voltage motor generators. Also a few slightly used, which we have taken in exchange. Write us your needs. Electrical Surplus Company, 1911 Chicago Ave., Chicago, Ill.

12-600-volt 85-watt General Electric dynamotor. Unused. \$20. Hal Justice, X4TS, Canton, North Carolina.

RCA 1368 325 watts, 1100 volts center tap, two 7½-volt center tap, \$12, two CeCo UX250 new \$7 per. Four 1.75 mfd. Dublier working volts 1000 \$1 per. G. E. hotwire amateur 0-2.5 \$3. 50 Henry choke \$1. W. B. Campfield, Staunton, Va.

JEWELL Meters, new, 25% discount. We stock Hammarlund, Ward-Leonard, Acme, Thordarson, Pyrex, National, Cardwell, Baldwin, CeCo, Yaxley, Signal, Bakelite, Samson, Raytheon. RCA, Browning-Drake, Fleron, Ferranti, REL, Aero, Eby, Victoreen, Silver-Marshall, Tyman, Tobe, Shield Grid Tubes, Carter, Bodine, Clorostats, Air Chrome Speakers, Exponential Horns, Abox, Kingston, Marco, Ham Call Books, Keys, ReLays, Buzzers, Exide, Philco, Westinghouse, Fritts, Newcombe-Hawley. Many other lines of Ham and BCL apparatus. Tell us what you want. Discounts to Hams, dealers and custom set builders only. Roy C. Stage, Montgomery & Burt Sts., Syracuse, N. Y.

PURE aluminum and lead rectifier elements holes drilled brass screws and nuts, pair 1"x4" 13c, 1"x6" 15c, 1¼"x6" 17c, 1½"x6" 19c. Sheet aluminum 1/16" \$1.00, lead \$1.00 square foot prepaid, \$1.00 or more. Silicon transformer steel cut to order .014" 10 lb. 25c, 5 lb. 30c, less than 5 lbs. 35c lb. .022" 5c less per lb. Not cut 2-7" wide 15c lb., minimum 10 lb. postage extra. Edgewise wound copper ribbon 7 sizes see January QST. Air pocket and stand off insulators 25c each. 4 for \$1.00. Glazed porcelain 5 and 6¼" long prepaid on 4. Electrolytic condenser parts, \$1.50 prepaid. Geo. Schulz, Calumet, Michigan.

IMAGINE an organization of radio "nuts" with over 3000 clients scattered throughout the world, hundreds of them hams, all of them radiowise—dealers, builders, experimenters. Over \$40,000 stock of high-grade receiving and transmitting parts only, no sets. Spend over \$5,000 yearly on our own experimenting, carrying nothing until it passes our tests. 25c will bring prepaid over four pounds, catalog, circuits, data, etc. Weekly data sheets for experimenters and builders (more reliable data than all radio magazines together)—20 weeks \$1.00, 52 weeks—\$2.50. Full dealer's discounts to licensed hams, and radiowise builders. Fred Luther Kline, Established 1920, Kent, Ohio.

LOUDSPEAKER units rewound and remagnetized, \$1.50 to \$2.50 guaranteed. Quick service. A. B. Clark, Albia, Iowa.

ARRL sweater emblems should be worn by all League members. They are yellow and black 5"x8" diamond, felt letters and embroidered symbol. Only \$1.00. Money order or currency only accepted. Eric Robinson, 135 Jefferson Road, Webster Groves, Mo.

SELL—Two W. E. 50 watters used few hours, \$15.00 each. D. E. Morgan, 1706 Manito St., Muskogee, Okla.

BULLETIN 66-E Lists the Ensall Radio Laboratory receivers, transmitters, wavemeters, etc., Item No. 69 and 68-A type receivers are the most modern types for amateur reception. Four and eight tubes respectively. We also make all types of apparatus for any radio purpose, including inductances, power transformers, rectifier units, filter chokes, high voltage variable condensers, plate reactors, etc. We build to order any apparatus using your parts if desired. Kit and blue print service on any power amateur station. Write for copy of Bulletin 66-E, Ensall Radio Lab., 1208 Grandview Ave., Warren, Ohio, 8BDN.

MASTER radio wavemeters are moving fast! And there's a reason! Only \$5.50 and \$8.50, but worth more. Send for full description. Flechthorn filter condensers. Fully guaranteed. DC working voltages, 650 volt; 1 mfd. \$1.58, 2 mfd. \$2.52, 4 mfd. \$4.10, 1500 volt; 1 mfd. \$2.36, 2 mfd. \$4.26, 4 mfd. \$6.50; 2500 volt; 1 mfd. \$4.26, 2 mfd. \$7.25, 4 mfd. \$12.60 Read-Rite panel meters, 0-10 and 0-15 AC volts \$1.95. Duddo-wound 50 Henry 300 milliamperes chokes \$2.85. Genuine W. E. 50 watters in original cartons \$3.00. Pure rectifier elements. Send for free catalog. "Quick Service." William Harrison, 35 ft. Washington Ave., New York City.

POWER crystals tested 600 volts. New 90 meter band \$15.00, 40 meter band \$22.50, 9DRD, Edwardsville, Kan.

6CYA Gonzales reports: "Had tried many ways and means but could not copy ten per steady. Can now do 25 per consistently. Without Dodge Radio Shortcut would still be in 8-10 per class." Method \$3.50 United States, elsewhere \$4.00. Money order. C. K. Dodge, Mamaroneck, N. Y.

FOR sale—Eleven Jewell 3" meters 0-200 milliamperes two 0-300, two 0-50, at \$3.80 each, three 0-15 volt DC at \$3.80. One RF Thermocouple 0-20 at \$6.00 One Hoyt AC 0-10 volt at \$4.00. Three 204 A tubes perfect condition at \$30.00 each. Ten WE 216 A 5 watters at \$2.80 each. Two 250 tubes at \$7.00 each. Also want first class motor generator 1500 volt and want to trade New Zenith Broadcast set toward it, 3KQ, 25 Sturges St., Binghamton, N. Y.

FOR sale: 1000-volt 250 watt motor-generator, used two hours, cost \$96. Best cash offer takes it. Want Grebe CR18. Kenneth Alley, 628½ N. 4th St., Springfield, Ill.

WANTED—2-203As. One 0-500 milliammeter and any other parts for 50-250 watt set. Bob Thompson, Box 2811, Lowell, Ariz.

SALE—1-204A slightly used, \$50.00; 1 used 204A, \$40.00; 1-204 \$15.00, 2-204A mountings, \$3.00 each; 1-900 watt Thordarson plate transformer, \$18.00. WBRB, Birmingham, Ala.

SELL—UX352, used five hours, perfect condition \$20. YMY, 926 Fifth St., Marshfield, Oregon.

SELLING entire 80 watt station for cash. Receiver and transmitter complete with extra large surplus of high grade parts. Write for complete list. 7QK, Parkdale, Oregon.

THORDARSON mounted 350-550-750 each side; two filament windings \$15; special 650-volt power-filament transformer for 7½ watters \$6.90. Aluminum square foot 85c; lead square foot 85c. Potter 2-mfd tested 1000-volt condensers \$2.19. "Ham-List" 4c. James Radio Curtis, 5AQC, 1109 Eighth Ave., Fort Worth, Tex.

MUELLER 150-watt input tubes \$15. Panel mounted 7½-watt 20-40 meter transmitters \$20. Receiver 20-40-meters \$17.50. Potter 2000-volt tested 1-mfd condensers \$2.50; 2500-volt 1-mfd \$3.25. "Ham-List" 4c. Robert Curtis, 1109 Eighth Ave., Fort Worth, Texas.

FOR sale or trade—Two Bremer Tully factory receiver, one and all electric. Want 204A, 203A, MG. good receiver, or what have you? 9CPI, Grinnell, Iowa.

MODEL 80 five tube Atwater Kent receiver, \$20.00; Radiola 3A with built-in speaker, \$12.50; Majestic Super "B" Eliminator (180v), \$15.00; Valley "P" (90v), \$7.50; New Bodine Loop, \$5.00; Omnigraph with 15 beginner and 15 advanced dials, \$10.00. All in good condition, prepaid. Frank DeLaMater, 311 E. Adams, McAlester, Oklahoma.

SELL—Acme filament transformer 10-12 volts new \$8.50. Thordarson 900-watt 1000-1500 volts each side of center tap, new \$45.00. Grebe CR8 and RQRK good condition \$16.00. 15-600-meter short wave receiver Aero coils and copper cabinet two-step audio \$20.00, 1 need 50 water and that's all. 9DAX, Earlville, Ill.

QSLs 100 two color \$1.00. Government \$1.90. Radiograms, stationery, Samples, 9CKA, Corwith, Iowa.

GENERAL Electric thermometer 0-0.5 amperes, \$7.50; General Radio wavemeter 37½-500 meters, \$8.00. Write for list. Gulian Ellis, 2341 Andrews Ave., New York City.

SELL 500-volt generator \$10.00. Write for list. J. M. Gantt, 24 Capitol Parkway, Montgomery, Ala. 4A1P.

GUARANTEED UX216B, \$3.00, UX210, \$5.00. Swap imported mariner's Sextant, value \$50 for S. W. transmitter or ? Mac-Seaford, N. Y.

QSL cards, new forms, two colors, government cards, \$2.00 per hundred, white \$1.00. Postage 10c. Free samples. 8DTY, 257 Parker Ave., Buffalo, N. Y.

QRRL Better be sure your wavemeter is accurate before next year. We calibrate wavemeters from standard frequency crystal oscillators to highest possible accuracy. Wavemeters constructed. 9BVC, QRH Radio Laboratory, Lutesville, Missouri.

PRECISION short wave 1AVU built apparatus, transmitters, receivers, power-units, oscillators, wavemeters, etc. New precision amateur wavemeter \$9.50 complete 10-100 meters. New 1AVU Silver DX Phantom receiver using UX222, UX210, and UX201 for super DX works. Completely shielded. Precision apparatus built to order. ½ to 5-meter transmitters a specialty. Guaranteed products. 1AVU, H. O. Barschdorf, 171 N. Summer St., Adams, Mass.

METERS: 0-1.5 amp thermocouple Weston new \$10. 0-50V, 0-2A, Jewell 0-200, 0-1000 MA, DC, 0-15V AC, each \$5. 0-1 MA DC, 0-1, 2, 2½, 3 amp thermocouple, each \$5. Roller-Smith 0-150-300 AC DC 5" dia. \$8. 0-1500V 10-1. Condensers: Parvot .5 mfd. 60c. Cardwell 147B \$5. G141 pl. DS, Isolantite, \$2. Karas Orthometric \$2.50 Hammarlund Midgets \$1. Faradon UC490, UC1014, UC1015, UC1803, UC1846, \$1. Transformers:

Q R A SECTION

50c straight with copy in following address form only:

1BML—Curtis G. Docherty, 196 Congress Ave., Providence, R. I.

2AGR—Richard R. Murray, 157 William St., Catskill, N. Y.

W2BPH—Sydney V. Jones, 450 Franklin Ave., Mount Vernon, N. Y.

2BUO—Werner H. Olpe, 14 Brooklyn Ave., Jamaica, Long Island, N. Y.

3GS—Jack Wagenseller, Box 338, Red Hill, Pennsylvania.

9FOF—L. H. Macy, Sully, Iowa.

W9FWX—Arthur L. Hare, 512 Franklin St., Kewanee, Illinois.

The following stations belong to members of the A.R.R.L. Headquarters gang. Mail for them should be addressed care A.R.R.L., Hartford, Conn. When operating 1MK they use personal sines as indicated.

1MK	W1BMM-W1FL	G. D. Meserve "dm"
A.R.R.L. Headquarters	W1CEI-W1SZ	J. J. Lamb
R.B. Parmenter, Chief	"jm"	
Op "rp"	W1BUD	A. L. Budlong
L. R. Huber "ou"	"bud"	
W1AL H. P. Westman	W1ES	A. A. Hebert "ah"
"ws"	W1KP	F. C. Beekley "beek"
W1BDI F. E. Handy "fh"	W1PX	C. G. Keneffick "ck"
W1BHW K. B. Warner	W1SZ	C. C. Rodimon "rod"
"kb"		

UP1656 7.5v \$5. Acme 300w 12v \$10. GR 6.1 audio \$3.90. RCA UV712 \$1.60. Marco Illuminated controls \$1.60. Kennedy Phones \$2.50. Holtzer-Cabot \$1.75. Clarostats \$1. Federal Jacks, Weston plugs 15c. Multiplug Cables \$2.75. Jewell AB Relays \$2.75. Bunnell Relays 150 ohm \$4. 20 ohm \$2. Keys, 1/16" \$1. 1/8" \$1.50. Vibroplexes, \$6. Vibroplex cases \$2. Pyrex 8" \$1. 12" \$2. Standoffs: 3" \$1.75. 7" \$2. REL inductances \$3.75. Pancakes, 7" dia., bakelite form 75c. Radiolaks \$2. RCA leaks, UP1718 \$1. UP1719 75c. RCA 10 amp. theostats \$4. 50w sockets \$1. Raytheon A units \$2. National Raytheon charger \$7. Cabinets 10x24x12, \$10. 7x13x12 \$5. original packing. Telefunken 30 watters \$10. 8 watters \$4. UX216-Bs \$4. Westinghouse dynamotor 12/50v \$25. Crocker-Wheeler 500v generator \$10. Super-synce \$25. Spintite tool kit \$2. Many new, unused. Others guaranteed. Also S/W receivers. Details on request. E. G. Watts, Jr., 12954 Cedar Road, Cleveland, Ohio.

USED vacuum cleaner motor 110-volts A. C. or D. C. Speed can be varied on A. C. with rhostat \$2. F.O.B. Ed. Lear, 1874 Fullerton, Detroit, Mich.

QSL cards. Cartoons. Hams say best made! H. M. Seiden, Cranesville, Pa.

LIKE new 1000-volt, 450-watt Esco ballbearing motor-generator with 10-volt filament supply. 32-volt drive, \$135.00. James Smat, 1734 Grand Ave., Chicago, Ill.

2500-volt 1000-watt motor-generator 110-220-volt. AC drive \$225.00. 1500-volt 500-watt motor-generator 3-phase drive \$125.00. 1000-volt 200-watt motor-generator 110-volt AC drive \$75.00. 750-volt 200-watt motor-generator 110-volt AC drive \$45.00. 300-watt \$65.00. 400-volt generators \$8.50. Couplings \$1.75. 1/2 H.P. 1750 speed motors \$26.50. 1/4 H.P. 3450 speed \$8.50. Also large motors and generators. Queen City Electric Co., 1734 Grand Ave., Chicago, Illinois.

WANTED 204A new or guaranteed perfect. Have Roth Constant Potential charging outfit complete type MBC1. 110-220 single phase cost \$275. Perfect condition for exchange. 2ANS, New Rochelle, N. Y.

MOTORS for television experimenters. 100-volt universal with rheostat. Variable speed from 500 to 5000 revolutions. \$7.50 prepaid. Remittance with order. Samara, 41 South St., New York City.

USED 175-volt DC generators \$8. A-1 order. 6 to 400-volt dynamotors \$15. 200-watt 500 cycle \$10. 1/2 k.w. \$15. R. Wood, 46-20 102nd St., Corona, N. Y.

WANTED to trade transmitting parts for typewriter in good condition. Portable type preferred. 9ARA, Butler, Mo.

SELLING out. What do you need? Everything must go. 9CVY, Butler, Mo.

SELL considerable quantity of transmitting and receiving apparatus that I no longer need. Write for list. 2CUZ.

WHAT have you that you are not using and what do you want to trade for? Lowell Ecker, Sedan, Kansas.

SELL another truck load of G. E. transformers, 1100-2200-4400v each side center tap, 110-220 primary, \$12.00. FOB Detroit, Michigan. F. G. Dawson, 5740 Woodward Ave., Detroit, Michigan.

DEFECTIVE audio transformers reclaimed using factory windings. Original guarantee 90c. Reclaimed transformers for sale. Most makes \$1.00. Inquiries invited. Transformers Reclaiming Service, 9 South Reed Ave., Mobile, Ala.

QSL cards, 500 plain cards, two colors, \$3.50; government cards, two colors, \$1.90 per 100. Printed from your own copy. Send for samples. 9EHI, 513 Sparkman Ave., Duluth, Minn.

POSTPAID and guaranteed brand new. Readrite panel mounting flush type milliameters, 0-300 and 0-400 mils. Either type, \$1.25. Readrite 0-15 A.C. voltmeters, panel mounting flush type, \$5.00. R.E.L. 2000-volt working voltage filter condensers, 1 mfd., \$3.10; 2 mfd., \$5.50. Sangamo .002 mfd. 5000-volt tested condensers, \$2.00. General Electric 5000 ohm heavy duty Gridleaks, \$1.25. G. F. Hall, 585 West Horter St., Philadelphia, Pa.

TRANSFORMERS, CHOKES COILS

*of all descriptions made
to your specifications.*

The crying need of the radio constructor and amateur for *efficient* coils, chokes, and transformers for either transmitter or receiver construction, is filled by the "Most Efficient" Power equipment manufactured by I. R. NELSON CO.

The new and radical core design developed by this company gives the small power transformers and coils all the efficiency inherent in large electrical construction work. Write in your wants. We will be glad to quote you. You will be surprised at the quality received for your investment. Prompt delivery on all orders.

I. R. NELSON COMPANY
Bond Street Newark, N. J.

— LAST MINUTE SPECIALS —

E210 BRADLEYSTATS, list \$4.00	Our Price \$1.60 ea.
Genuine Black Bakelite Panels 38" x 43" 3/16" thick, Reg. Price \$29.00	" 3.75 "
U. S. ARMY Aeroplane Spark Transmitters, Gov. cost \$47 each	" 4.75 "
G. E. Kenotron Rectifying Tubes (type T.B.1)	" 1.25 "
Eby A.C. Adapter Harness with Volume Control. For 6 tube Sets, list \$10.00	" 5.00 "
Gould Kathanode Unipower, Automatic Radio "A" Power (6 volt), list \$39.50	" 13.75 "

AMERICAN SALES CO., 19-21 WARREN ST., NEW YORK CITY

In Stiff Buckram Binding

The Radio Amateur's Handbook

Lies open and flat at any page

The invaluable Handbook with attractive and durable maroon leather cloth covers.

Will Wear Like Iron.

Price \$2 postpaid anywhere

A. R. R. L.,
Hartford, Conn.

Stiff
Binding

Gentlemen:

I've been wanting a better bound copy of the Handbook for a long time. Here are my two dollars.

FOR YOUR CONVENIENCE QST'S INDEX OF ADVERTISERS IN THIS ISSUE

Aero Products, Inc.	3rd cover
Aerovox Wireless Corp.	90
Allen Bradley Company	66
American Sales Company	83, 86, 92
American Transformer Company	75
Arcturus Radio Corporation	90
Aurisma Inc. Ad.	74
A.R.R.L. Binder	94
A.R.R.L. Bound Handbook	94
A.R.R.L. Handbook	71
A.R.R.L. Membership Blank	87
Barawik Company	80, 80
Barvos & Cia., M.	85
Burgess Battery Co.	14th Cover
Candler System Company	75
Cardwell Mfg. Corp., Allen D.	96
Central Radio Labs.	80
Chicago Radio Apparatus Co.	89
Clarostat Mfg. Company	88
Corning Glass Works	85
Crosley Radio Corp.	95
Cunningham, Inc., E. T.	54
Daven Corporation	91, 87
Deutschmann Company, Tube	81
Dodge, C. K.	81
Dongan Electric Mfg. Co.	82
Dresser Radio Mfg. Corp.	88
Duallier Condenser Corp.	68
Dudlo Mfg. Corp.	65
Eastern Radio Institute	87
Electrad, Inc.	79
Electric Specialty Co.	77
Eikon Company	58
Fansteel Products Co.	77
Federal Radio Corporation	2
Flechteim & Company, A. M.	87
Formica Insulation Company	67
Frost, Inc., Herbert H.	70
General Radio Company	2nd cover
Gray & Danielson Mfg. Co.	78
Greben, F.	83
Gulf Radio School	79
Hardwick, Field, Inc.	76
Jewell Electrical Instrument Co.	75
Johnson Co., E. F.	79
Kaus Electric Co.	77, 81
Kruse, Robert S.	85
Leeds Radio Company	79
Loomis Publishing Co.	90
Manhattan Electrical Bargain House, Inc.	75
Massachusetts Radio School	77
McGraw-Hill Book Co.	72
National Company, Inc.	83
National Radio Institute	62
National Radio Tube Company	56
Nelson Company, I. R.	93
Pacont Electric Company	85
Photo Electric Devices, Inc.	70
Potter Manufacturing Company	78
Radio Amateur Call Book	70
Radio Broadcast	80
Radio Engineering	1
Radio Engineering Labs.	69
Radio Institute of America	58
Ravtheon Mfg. Company	76
Rectifier Engineering Service	87
Roney, John T.	89
Saugamo Electric Company	73
Science Service	83
Scientific Radio School	85
Seattle Radio Laboratory	72
Silver-Marshall, Inc.	89
Stromberg-Carlson Telephone Mfg. Co.	61
Teleplex Company	82, 88
Televacal Corporation	74
Thorndara Electric Mfg. Company	63
Van Nostrand Company, Inc., D.	87
Vitroplex Company	89
Ward Leonard Electric Co.	80
Well's Curiosity Shop	34
Western Radio Mfg. Company	80
Western Electrical Instrument Corp.	4
Wireless Egert	84
Wireless Specialty Apparatus Co.	55
X-L Radio Laboratories	84
Yaxley Mfg. Company	86

CROSLEY

DYNACONE



A simple explanation of the new, amazing power dynamic speaker that has swept the radio market at \$25

The dynamic principle of radio speakers means **POWER** combined with the finest attainable **QUALITY**.

Dynamic speakers get their **POWER** by the use of an *electromagnetic field*. Translated from Engineering into English this means that the permanent field

magnet of the average radio speaker is replaced by a powerful electromagnet.

Comparing the possible **POWER** of electromagnets and permanent magnets is like comparing a magneto to a dynamo.

The magneto uses permanent field magnets. It will serve admirably as a shocking machine but cannot light a single lamp bulb. The dynamo uses electro-magnets. Even a moderate sized dynamo will run the lights of an entire village.

Heretofore, the use of

dynamic speakers was limited to a comparative few who could afford them because they required a separate battery to supply the current for their electromagnet coils.

DYNACONE eliminates the battery — and utilizes current direct from the set to operate its field coils.

A continuous direct current is always flowing in the plate circuit of the power output tube of the radio set. Upon this direct current is superimposed the fluctuations of the signal.

It has been customary to keep the direct current out of the loudspeaker because so strong a current would tend to *paralyze* the speaker by pulling its armature over against the field magnet.

To get rid of this strong direct current, a transformer, or a condenser

is used, which allows only the signal fluctuations to

enter the speaker armature. **DYNACONE** uses the latter method for keeping the direct current out of its armature but makes use of this very current, which other speakers throw away, for energizing its field electromagnets.

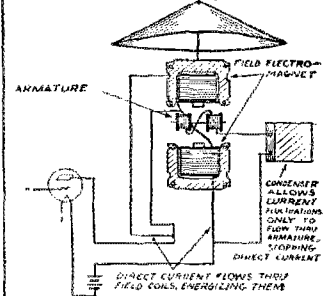

By thus ingeniously utilizing energy heretofore thrown away, **DYNACONE** achieves **POWER** and **QUALITY** only attainable with the dynamic principle, without any special batteries or other apparatus. It is simply connected directly in the output circuit of any set using a 171 type power tube operating at 180 volts on the plate.*

* If the set has an output transformer, this is disconnected by the dealer when **DYNACONE** is installed.

The above description applies to the Type E **DYNACONE**. The Type F **DYNACONE**, which has four connections to the set, takes its direct current from ahead of the output transformer instead of using a condenser to effect its separation from the voice current which actuates the armature.

THE CROSLEY RADIO CORPORATION
DEPARTMENT 18

Cincinnati, Ohio

Powel Crosley, Jr., Pres.

Montana, Wyoming, Colorado, New Mexico and West prices slightly higher



CARDWELL CONDENSERS

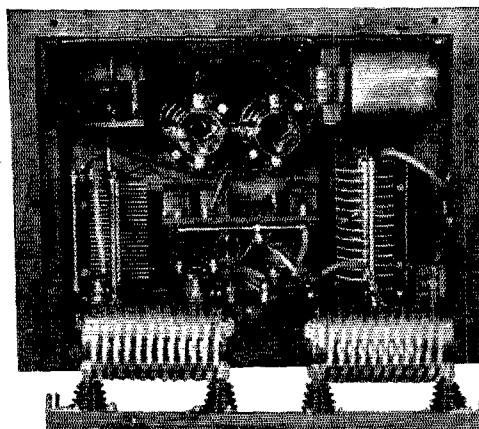

Cardwell Condensers in the transmitter designed and built by Cardwell for the George Dyott Expedition now in Brazil.

A Promise Performed!

ON Land and Sea, in the Air, from Arctic wastes to tropical jungles, the sturdy CARDWELL comes through and generously fulfills our promise of Service and Satisfaction.

Of a design and construction electrically efficient and mechanically sound, pioneered by CARDWELL and since held to first principles because they are *right*, CARDWELL CONDENSERS continue to stand as "The Standard of Comparison."

Three pamphlets describe the sturdy CARDWELL. One of them lists High Voltage Transmitting Condensers, for $\frac{1}{4}$ to 50 KW and more; another, Medium and Low power Transmitting Condensers; and a third, Receiving Condensers, including the rigid Taper Plate, which is unequalled for short waves.

The pamphlets you are interested in are yours for the asking.

"There is a CARDWELL for every tube and purpose."

The Allen D. Cardwell Manufacturing Corp.

81 Prospect Street, Brooklyn, N. Y.



"The Standard of Comparison"



AERO COIL

**SUPER-SENSITIVE
INDUCTANCE UNITS**

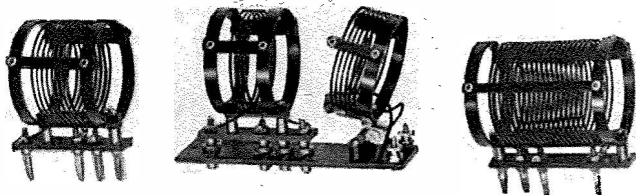

Build your short wave receiver around the famous Aero Interchangeable Short Wave Tuning Coils. During the International Relay Party, the winners of the high places almost all used Aero Coils and thank them for their results. The University of Michigan Greenland Expedition say that Aero Coils saved the lives of some of the party. Where sensitivity is an absolute necessity, there is nothing like an Aero Coil.

95% Air Dielectric

As higher frequencies are used, dielectric material becomes more important. Aero coils are ninety-five percent air dielectric, with less than one-sixth of the losses of celluloid or bakelite. The new two inch diameter coils have already won wide popularity. They provide a much smaller external field, a better shape factor and improved efficiency. The Aero Short Wave Tuner Kit No. LWT 12, illustrated above, consists of three Aero Interchangeable Coils and base mounting with Primary Coil. Price Complete—\$12.50.

Aero Interchangeable Transmitter Kits

Aero Radio Transmitters, built around Aero Interchangeable Transmitter Kits have been the means of introducing thousands of expert amateur operators to the thrills of round-the-world communication.

Aero Coils have given exceptional results and have proven themselves to be the best low-power transmitting coils on the market. Each kit includes all necessary parts for a tuned-plate transmitter, including base with variable antenna coil, plate coil, grid coil and two choke coils. There are Aero Kits for transmitting on 30 Watts, 150 Watts and 500 Watts and from 16.5 meters to 190 meters. 30 Watt Kits are \$12.00 each and 150 Watt Kits are \$15.00 each.

The New Aero Green Book for 1929 is just off the press. Contains data needed by every amateur—wiring diagrams of receivers and transmitters—information about new developments. Send 25c for your copy.

AERO PRODUCTS
INCORPORATED

Dept. 378

4611 E. Ravenswood Ave., Chicago, Ill.



Aero Coil Kit No. LWT-10 For use with Foundation Units containing plug-in mount, or for replacing LWT-125 Coils. Same three coils as in LWT-11 Kit. Kit No. LWT-11 \$10.50

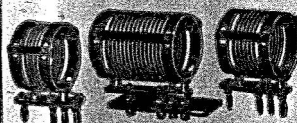

Aero Coil Kit No. LWT-11 contains a plug-in mounting base without primary and three coils for use after a shield grid tube. Range 16.5 to 89.5 meters. Kit No. LWT-11 \$11.50



The range of the LWT-12 Kit can be considerably increased by adding Aero Coil No. INT-4. This coil can be plugged into the LWT-125 mounting base and has a range of from 125 to 275 meters. Coil No. INT-4. \$4.00



The range of the LWT-12 Kit can be still further increased by adding Aero Coil No. INT-5. This coil has a range of from 250 to 550 meters. Coil No. INT-5 \$4.00

Again **BURGESS** *Contributes*

**Type PL 5728 High Potential
Battery [108 volts, taps at 72
and 108 volts]**

In keeping with its policy of assisting in the experimental development of the art of radio, Burgess Battery Company contributes a high potential battery particularly necessary for the successful operation of the receiver used in radiovision, television, and other methods of reception where there is the transference of an image, moving or stationary. In photo electric cell experiments, the PL is indispensable. Also can be used for airplane radio, plate supply.

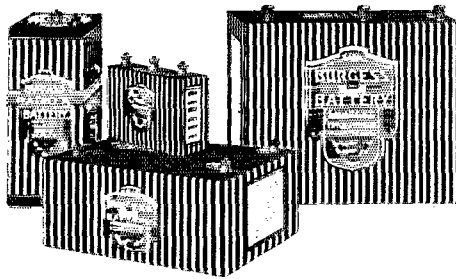
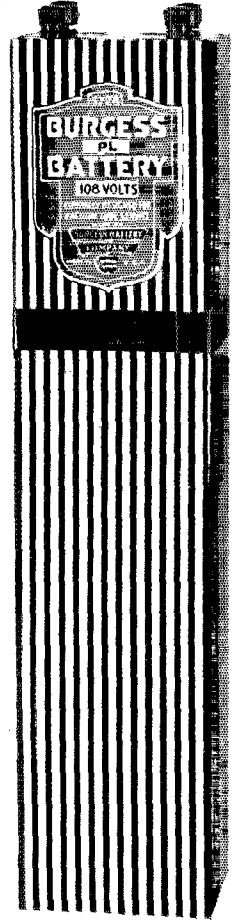
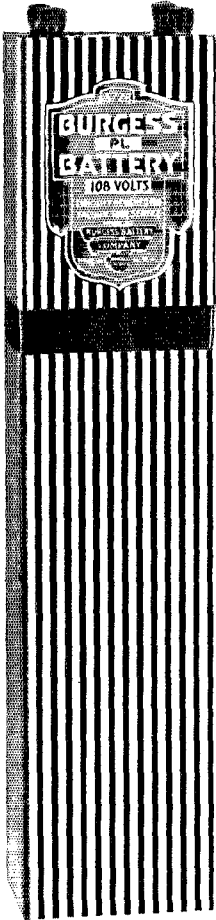

"Ask any Radio Engineer"

BURGESS BATTERY COMPANY
MADISON, WISCONSIN

The Communications Department

F. E. Handy, Communications Manager
1711 Park St., Hartford, Conn.

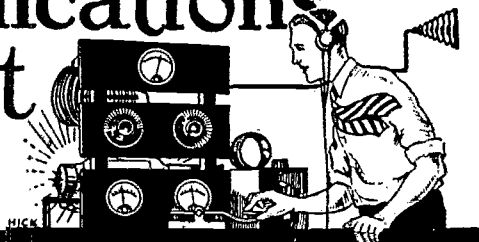

Scandinavian-American Short-Wave-Tests

RADIOLYTTEREN, of Copenhagen, tells us that 35% of the prizes in the Scandinavian-American Short Wave Tests will go to American amateurs—the rest to go to Danish, Norwegian, and Swedish amateurs. Better read that article on page I of last month's CD again, OM. The tests will take place from October 23 to October 30. Radiolytteren is soliciting prizes from some U. S. A. manufacturers to be awarded to U. S. amateurs who take part so there will be prizes as well as plenty of fun. Here is another contest for those who have asked for one more during 1928.

Navy Day Competition

NAVY DAY is Saturday, October 27, 1928! Please mark the date on your calendar. Pin a note in the log or above the operating table—on the station bulletin board if you have one.

A Navy Day program of telegraphic broadcasts to amateurs has been arranged just as last year under the auspices of the Navy League of the United States. To prevent the possibility of overlapping transmissions from different stations, and to insure that everybody has a chance to get the messages, but two transmitting stations have been selected this year. Each of these stations will send the Navy Day broadcasts simultaneously on more than one frequency.

The Navy Day Honor Roll will appear in December QST. Everyone has an equal chance to "make" the Honor Roll. The more of the two messages you can copy and forward to A.R.R.L. Headquarters, the higher your name will be in the list. Just part of one message will put you on the Honor Roll as a participating station, however. There is a good chance that you may be one of the few operators to receive special commendation from the Secretary of the Navy for having submitted the most complete copies of the two messages to the A.R.R.L. If a large number of perfect copies are submitted, legibility and neatness will determine the relative standing of the high operators. Weighted credit will be arranged to favor participants in the west and mid-west, due to the hour of sending these broadcasts.

A good sensitive receiver and an accurate frequency meter will enable you to get all set for the contest in advance. Some individuals will probably get along without the frequency meter. However, it will pay to spend a little time in preparation—in logging both the transmitting stations in advance of the contest to determine which of the several frequencies used will give you the most copiable signals at the time of day at which the broadcasts will be sent. Here is the schedule that will be followed:

Station	Approx. Freq. (ke) W. L. (m)	Starting Time EST&GCT	Message from
N.A.A. Navy Dept., Washington, D.C.	4015 8030 12045 24.9	74.7 37.35 8.00pm	The Secretary of the Navy
WIMK, A.R.R.L., Hartford, Conn	3575 7150	83.9 41.9	Lt. Comdr. Hiram Percy Maxim, U.S.N.R. President, A.R.R.L.

It is requested that care be taken by stations normally using these frequencies to avoid unnecessary interference with these transmissions. Of course there is no excuse for out-of-band operation at any time. Please pass the good word about the schedules around

to other operators, too. It is hoped that as many A.R.R.L. members as possible will take part and notify other operators. Over one hundred made the Honor Roll last year (see Dec. 1927 QST).

Many of us belong to the U.S.N.R., but this is an activity giving us all the opportunity to show an interest and pride in our Navy, whether we happen to belong or not. We can demonstrate our skill in copying and perhaps learn some new facts about the Navy and the Naval Reserve at the same time we have a good time twirling the dials. To some this contest may look "easy" but let us say that to get 100% perfect copy requires an effort and some proficiency.

Copy what you can, OM, and be sure to mail it next morning to A.R.R.L. Headquarters, Attention of the Communications Department. Here's luck to your efforts and vy 73.

About 28-mc. Work

IF signals heard and actual two-way communication over varying distances counts for anything, then we have some results to chronicle in this report. There is such a fine bunch of logs giving information on what happened in the August 28mc. (ten meter) tests and on foreign progress we know scarcely where to begin.

A large amount of experimenting with the new frequency is already reported from Australia, from the Philippines, and from Hawaii. Following the DX reception records that now have been made, we feel sure more two-way 28 mc. (ten meter) communication is coming, and this band will occupy a sphere of its own just as do each of our other bands. As soon as other governments open this band to their amateurs (as they are empowered to do in 1929 by international agreement) more experimenters will join us. From the *T. & R. Bulletin* of the R.S.G.B. we feel sure there will be plenty doing on 28 mc. among the "eg's" in the near future, many of the new regulations going into effect in Great Britain on October 14.

oa3CP of Malvern, Victoria, Australia, sends a radiogram (rec'd via W5QL, W1RY and WIMK) announcing the following times (Greenwich) for Wireless Institute of Australia 28 mc. CQ parties each Sunday: Tasmania (oa7), 0200-0215; St. Houat (oa5), 0215-0230; Victoria (oa3), 0230-0245; Queensland (oa4), 0245-0300. Here's a chance to all who can listen on 28 mc. to take part with the possibility of uncovering some new dope. Through W2CYQ, oa3CP sends word that Victoria stations oa3KS, oa3BQ and oa3CP are on the job on 28 mc. each Sunday between 0100 and 0200 GCT.

oa2HC likewise gives us a message through W1RF reporting that the main 28 mc. stations in Australia are oa6SA, oa7DX, oa3BQ, oa4NW, and oa2HC. "HC" himself is building a "beam" reflector for this work. Just as we are preparing to write this report, word of the latest 28-mc. success comes in a special delivery from W9EF. Mr. Austin, oa6SA of Perth, Australia, on September second established two-way ten-meter communication with oa3BQ, Melbourne, Australia (1500 miles). Both stations used low power and were QSO for about two hours. oa7CW also reports that each week finds new 28 mc. converts and many contacts over distances up to 100 miles. W9FF has three daily schedules with the Aussies and volunteers to QSR any information or messages concerning 28 mc. work. W5QL is also QSO daily and glad to handle any and all "oa" traffic.

W6AMM handled the 28 mc. report from the Philippines. op1DR took part in our August tests, transmitting each date 0100-0200 and 1300-1400 GCT. Escudero is on the air as much as possible in addition to these hours and wishes us all success. Reports on his signals would be appreciated. W6DWI, W1AMG

and W1AUK handled a message from o28AR reporting reception of a ten-meter test at his station. Further details are not available at this writing.

W9EF (Hammond, Ind.) has thus far worked W9EXW, W9BGQ-W9FB, W4JK, W6BZF, W6AM, W6DHS and has been reported by W9CFL, W1CGX, W1BW, W6EB, and W6ZZD in addition. On August 12 excellent contacts were had by this station with W6AM, W9FB, W9EXW and W6DHS. The signal strength on all these contacts was excellent. Although generally the sixes are rarely heard in Hammond before one pm. CST, W6DHS has been worked as early as 9:45 am. The weather and results were poor on August 18 and 26.

W6DZX-W6EPU (Salt Lake City, Utah) logged the following stations. August 18: KESS (Bolinas, Calif.), 8:45 am. MST d.c., R4; W6BTK, 10 am. MST r.a.c., R9; KIO (Kahuku, Hawaii), 10:10 am. d.c., R6; W1XR, 3:35 pm. d.c., R7. August 19: W9COS, 8:25 am. d.c., R7; W9APV, 8:50 am. a.c., R4; W9FNS, 9:20 am. r.a.c., R8. W9EF, 9:47 am. r.a.c., R8; K6CLJ, 1:30 pm. a.c., R4; K6CLJ, 8:15 pm. a.c., R5; W6DYE, 6:45 pm. r.a.c., R5; W8ALU, 6:50 pm. d.c., R6. August 23: W6DYE, 5:30 pm. d.c., R6. In commenting on this most excellent log, Mr. Morgan says, "K6CLJ at Honolulu, Hawaii, is the best DX. The signals were easy to copy, being steady and QRN very light. He was sending 'test 10 m. oh6CLJ'. W1XR-KZET (Houlton, Maine) can be picked up at any time of day, nearly always steady and sending 'V's. W9EF came in very nicely calling CQ. His signals are most easy to copy. W9FNS connected with W9CSB on 28 mc. and had a good QSO at the time I heard him. He next sent CQ. W8ALU at Massillon, Ohio, was heard on a CQ. W9COS CQed and was evidently heard by W9DBA as he called him next. W6BTK, seven blocks away, was heard all afternoon August 18. The signals from W6DYE and the commercials listed may have been harmonics. A 120-meter antenna-c.p. system was used for receiving. Background noise was worse with a ground. It's a pleasure to hear a station without six others on the same wave. QRN is practically nil whereas '40' sounds like a ball park during a home run in the World Series. Results were nil on Aug. 25 and 26. I kept watch during these days but went unwarded. The weather was cloudy; also antenna swings in the wind caused signal swinging. The skip distance is apparently fairly great on 28 mc. as with the exception of the locals, none were nearer than KESS (Bolinas) harmonic. I am going to get a new bottle for the transmitter and stick with the band."

W6AAZ (San Jose, Calif.) has heard five ten-meter stations including W1CCZ. 28 mc. experimentation has also been undertaken by W6KG, and W6NX. W8BDP (Fairmont, W. Va.) has copied W6UF, W5AUZ, W6ANN, W8CSR, and W9DEF, the latter two being harmonics of 14 mc. signals. Two other "fives" were heard but too weak to get the complete call. W1CD was heard and worked early in the season. W8BDP and W8CLQ (15 miles) have attempted two-way work but thus far without success. In the recent tests, W8BDP noticed that few or no stations could be heard, the weather being cloudy—and that the days on which the sun shone brightly also brought notations of 28 mc. signals for the log.

Good reports on the August tests were received from W2AER, W2JN, W2CMU and W2FJ. W2AER used a 7½ watt transmitter. He heard W2JN (35 miles) most consistently, also reporting W2AQB and harmonics of W2CXL and W2APL on higher frequencies than 27,250 kc. (11-m). W2CMU worked W2BVG and W2NM reporting W2VA, W2JN and W2AQB as heard. W2JN was on vacation part of the tests, but had good success Aug. 10, 11, 12 and Aug. 25, 26. W2JN worked W9CSX Aug. 10, 11 from 0815 Greenwich until 0435 (or 12:35 am. EDST). W9CSX was using a 7000 kc. antenna energized at its fourth harmonic by a 7½ watt tube. The signals at W2JN were R6 with some fading, but the 1½-hour contact was maintained without a QTA until the voluntary sign-off. Aug. 11 harmonics of WIK and HJO were copied at 1700 GCT and W9XI at 2215 with an a.c. note and some fading. Aug. 12 W2SY, W2NM and W2AOL were worked at distances of 5, 17 and 22 miles. W2CMU was heard in communication with W2NM. HJO and KMK were also heard. W2AQB worked W2JN August 25 making tests with his parabolic reflector. Complete reversal of the reflector changed signals from R5 to R2. The distance was 12 miles. W2ACN, W2AYR and W2ATH worked W2JN on Aug. 26. W2JN uses exactly 30 mc. and the same antenna previously described in QST. W2FJ announces that test transmissions on 28,600 kc. will be sent daily between 6 and 7 pm. EST. A mechanical

keying device will be used. A completely shielded MOPA circuit with oscillator on 3.83 mc., first multiplier on 10 mc. and the second on 30 mc. is used.

W8CIG tested four different antenna during the tests, working each Sunday. W6AM was heard and almost worked out but for a transmitter break-down. W9CSX (Newcastle, Ind.) heard W2AOL in addition to working W2JN. Some unidentified fifth district stations were also reported as heard by him. W6AM reported communication with W9EF, W6DHS and W6ZZD. Wallace also heard W1XR consistently. W4JK and W3RG both reported 23 mc. signals from W6AM last May 27 when the latter station was testing. The W6AM antenna is seventy feet high and 62 feet long fed in the middle by two 65 foot r.f. feed-lines. W5NW and W5AEK listened on Aug. 11th without much luck and transmitted tests on the following day using the fifth harmonic of a vertical antenna. W6XI and KESS were heard several degrees off 28 mc. On August 19 the second harmonic of W1SZ was successfully copied at W5NW. W6DZL (Burbank, Calif.) heard his first 28 mc. signals on August 12 copying both W9EF and W6AM when these stations were in two-way communication. W5ATZ (Denton, Tex.) at 7:55 pm. CST on August 26 heard W2NM testing on the new band, R3 on detector only. W5ATZ's 28 mc. transmitter will be ready for action soon. W9BGQ (Chicago, Ill.) has been on regularly Sunday afternoons since working W9EF. W2ACN worked W2AQB and W2JN in the tests, copying W2NM, W2TP and W2AYR in addition. He anticipates using 28 mc. for local work, especially phone, and has just completed a neat portable layout.

W2TP heard W7FE R3 at 3:20 pm. EST Sept. 2. Signals were R5 two hours later. W2AS was also heard. W2TP reports the frequency of W7FE 22,560 kc. (13.3 mc.) near WQA 21,200 kc. (14.13 mc.) and KSS, 20,800 kc. (14.4 mc.). W2TP says, "Wish you would tell some of the Western fellows to try and operate on 30 mc.—not 22.5 mc., we know that that works already. I think that they are picking off the third harmonic of 7500 kc. (40 m.) instead of the fourth harmonic. In my last report to QST, I heard W5JT and W6AM and gave their frequency as 26 mc. (13 m.). This should have been nearer 23 mc. (13 m.) to be correct. If these stations continue to send 'test ten meters' on 23 mc. (13 m.) some of the new experimenters will adjust sets near this frequency and before we know it, will be giving false results as far as the real 28-30 mc. band is concerned. I know that W6ANN, W6UF, W5AOT, ef8CT, W2EB, W2JN, W2NM, W2ACN, W2VA and W2AQB are all on the correct and legal frequency. On Sept. 2, I also heard W5BEB and a six at 3:30 pm. on 28 mc. (13 m.) but could not get both calls. W9CET sends the Official Broadcasts on the 28 mc. band."

WNP

"Calls worked from WNP during August twenty meters: w1awe w1awe w1ckb w1cki w1ka w1ry w1sz w1xm w2ar w2bc w2cdm w2cm w2cuq w2vi w3adm w3akw w3aqi w3fr w3hq w3tr w3ra w4act w5es w6am w6cyx w8ao w8alg w8ank w8cug w8dce w8dlld w8dtn w8afa w8as w8bga w8bqg w8cwa w8ebw w9ef w9ef w9ek w9gv w9sbm w4ky en-owin. Forty meters: w1sz w3akm w3akw w5bj en-8ae ne-8fd ve-lcc wgdk. Message total one hundred forty."

"Msg. nr. 1100, Sept. 4, Schooner Bowdoin, WNP, Bras D'or Lakes, Nova Scotia. via 8AGY."

"To A.R.R.L., Hartford, Conn."

"We docked at Sydney, Nova Scotia, yesterday afternoon, after a rather stormy trip south from Labrador. It's our first touch with civilization in nearly fifteen months. Oh, those lacquered white bath tubs filled with hot water at the new Hotel. Oh, those double porterhouse steaks at the Chinaman's restaurant down the street. Oh, those banana royals and what nots at Christy's Sweet Shop."

"Four days hence the Bowdoin will be anchored safely at Wiscasset, Maine, and station WNP will be closed. All members of the Rawson-MacMillan Field Museum Expedition wish to thank all members of the American Radio Relay League for their valued assistance in keeping the expedition in touch with home folks during the past fifteen months."

"This being our last report to QST for the voyage, I wish to add my word of appreciation to amateurs who have helped put over this year of good contact between our expedition and the U.S.A. Many thanks, fellows. Good luck and may we QSO again. Cliff Himoe, opr. WNP."

VOQ

After spending three months among the Aleutian Islands and in the Bering Sea, xneVOQ, the Schooner *Morrissey* was reported to be in the Arctic Ocean about three hundred miles northwest of Point Barrow on Aug. 19, en route Siberia. VOQ works on 9,700 kc. (31 m.) and 7500 kc. (40 m.) with a 500-cycle note. 14 mc. seems of little use. Large quantities of traffic have been handled by VOQ on schedules with K7ABE 11 pm PST daily 7500 kc., VE5GT 2:30 am PST Tues., Thurs., and Sat 9,700 kc. K7HL 9 pm and 11:30 pm PST daily 9,700 kc. Mention should be given W7TX for forwarding some long messages by wire. W6DFW who handled the VOQ traffic as relayed by K7ABE as well as W6CIS who had valuable contact with the East Coast through his W1MK schedule should receive special credit, also. Much general operation has been carried on. Eastern signals were poor at VOQ during July but were fine in August and early September. A reliable east coast schedule would be appreciated as there is much traffic for the east. The best times for attempts at Eastern QSO is between 11 pm and 4 am EST. The above report was received from K7HL via W6CIS and W1MK. W7IM reports working VOQ Aug. 31 and forwarding some traffic by Western Union at VOQ's request. The *Morrissey* was then at Kirkuk, Iraq. VE5GT who kept one of the main schedules, reports that Manley passed some traffic direct to W9DR on several occasions—also, that the further west VOQ was, the better the Eastern signals.

WSBS

S. S. *Carnegie*, WSBS, nr 120 Sept. 9, "All of August spent at sea and still going strong. We expect to arrive at Barbados some time next week. Radio conditions have been excellent in spite of a fair amount of static. Schedules are working out fine. W2AVB has become W2XAU on 9,100 kc. (33 m.) and has handled 50% of our traffic, the other half going through W1MK. W8DME has been worked once a week and many fine contacts have been made with others. All down the middle Atlantic almost to the equator U. S. signals have been pounding in with very consistent signal strength. We are 750 miles East of Barbados now. I am still unable to hear anything on 28 mc. though I hear quite a few on 14 m.c.

"Calls worked during the month are W9CLP, W2AS, W3AGY, W1ASD, W2AVB, W2XAU, W1CEI, W1SZ, W9GX, W2AGS, W9BCA, W8BPL, W1MK, W8DME, W4PF, W4EC, W6EC, W2HC, W2JD, W9AVZ, W4AHL, W2CXL, W3AVD, XBC, NKF, W4PF and W1ASD handled a couple of messages for us. We are just resuming schedule with W1CEI. It's a real pleasure to have such fine contacts. Wish time were available to work dozens of others. The other work of the expedition is going along smoothly. We are enjoying these warm, clear, tropical days and nights but looking forward to the next port. More next month. 73 to the gang.

—L. A. Jones, Radio Opr., Yacht *Carnegie*."

W2AVB-W2XAU, Route Mgr. of Long Island, has kept his schedule with WSBS 100% perfect. Press and baseball scores have been handled often, including messages checking as high as 119 words. LJ's folks have talked with him at the key of WSBS by the hour, also—something that can be done for expeditioners by amateur radio operators that is impossible by any other means! W4ABR reported WSBS as heard when working his schedules on August 12.

GMD, of the Dyott Expedition, is no more. W8CFR reports that it was found that Fawcett (for whom the GMD outfit was searching) had been killed by Indians. The Dyott Expedition lost some of its food in the river, some of their members became sick with beri-beri, and the only choice remaining was to return to civilization. The last QSO was between GMD and sb1AB, after which the radio outfit was thrown into the river in order to lighten the loads. The outfit expects to reach Para down the Xingu river about October 1.

W8CFR and W2TY deserve a great deal of credit for the perseverance with which they stayed with sb1AB and GMD. There was romance in that work, wasn't there, OM's?

The Canadian Government's S. S. *Beothic*, with call letters VYG, is alert for amateur contacts on a frequency of 10,340 kc. (29 m.).

BRASS POUNDERS' LEAGUE

Call	Orig.	Del.	Rel.	Total
op1HR	139	100	598	837
op1CM	145	132	434	711
W6CUH	4	7	616	627
W6AJM	84	32	490	606
W1MK	129	150	275	554
W9PU	45	88	385	518
W8CHC	158	96	234	488
W6AMM	113	308	29	450
W8DHX	97	26	324	447
W3ZF	28	35	326	389
W2BFY	79	94	184	357
W6ZBJ	20	18	306	344
op1DR-1AE	127	141	60	328
W8ARX	30	14	257	301
W6CHA	38	72	174	284
W6CIS	29	54	186	269
W9BCA	13	52	180	245
W9AIN	13	196	28	237
W6CCT	1	35	181	217
W6DOW	15	33	166	214
W8NO	120	92	—	212
W3LC	18	8	182	208
W4ACC	7	9	190	206
W7UN	19	20	166	205
K7HL	17	19	169	205
W9FWG	147	54	—	201
W9XN	136	65	—	201
K7ABE	66	58	64	188
W9ACR	35	150	2	187
W6TP	48	57	79	184
W6UJ	10	54	98	162
W1A00	30	111	13	162
W1BIG	50	63	42	155
W6BZF	49	86	14	149
W9APY	58	65	6	129
K6CFQ	58	50	19	127
W6ALX	22	56	38	116
W6CLQ	26	84	3	113
W6HJ	39	67	2	108
W6BYZ	15	85	6	106
W2KR	10	54	21	85
W2APV	23	58	—	81
W6ABK	3	66	2	71
W9UX	13	55	—	68

Omitted last month: W9AIN: 25, 25, 158, 208.
Again op1HR leads the list, though he had to better last month's record to do it! Special credit goes to W6AMM for the highest number of deliveries. The following stations were responsible for over one hundred deliveries in the message month:

W6AMM, W9AIN, W9ACR, W1MK, op1DR-1AE, op1CM, W1A00, op1HR.

Deliveries count! All stations appearing in the B.P.L. are noted for their consistent schedule-keeping and reliable message-handling work in amateur radio.

A total of 200 or more bona fide messages handled and counted in accordance with A.R.R.L. practice or just 50 or more deliveries will put you in line for a place in the B.P.L. Why not make more schedules with the reliable stations you hear and take steps to handle the traffic that will qualify you for B.P.L. membership also?

TRAFFIC BRIEFS

W2ALU and W2KR are the first to be honored with schedules with WFBE, the supply ship *City of New York* (formerly the *Sampson*). WFBE operates for these schedules on a frequency of 8850 kc. (33.85 meters) with a 500 cycle note. The *City of New York* is now bound for the South Pole via Samoa and New Zealand.

When emergency arises and YOU become a factor in its solution, do not hesitate to wire headquarters, which will act as a clearing house for such situations. This action will help A.R.R.L. to cooperate officially with the government and the press in all such cases.

Europe has been favored with visits from several of the gang on this side of the water. "Among those present" this summer we can mention W6XAC, W1II, W5PM, W2API, and VE4HM.

BEGINNERS

Many beginners have received by this time mimeographed material from headquarters which will enable them to put their receivers on the 1,715- to 2,000-kc. (175- to 180-meter) band. Also, in this issue, there is an article describing a suitable receiver for the 1,750 kc. band and the 3,500 kc. band. For those who have not requested such information, but who nevertheless may be interested in receiving code practice from volunteer transmitters, we are including the list of schedules in *QST*. If you make use of the efforts of any of the following stations, it would be nice to drop a card of appreciation to the volunteer. Here are the schedules:

SUNDAY

WIABO 1880 1:30 pm and 10:30 pm EST
 W1ASD 1710 5:30 to 6 pm EST
 W4— 1880 5 to 7 pm CST
 W5ARP 1820 1-2 pm and 5-6 pm CST
 W5BDT 1770 5:30-6 pm and 8-10 pm CST
 W5RJ 1710 4 to 6 pm CST
 W6BTN 1880 11 pm until midnite PST
 W6EAF 7360 7-7:30 am and pm PST
 W9DZM 1920 2:30-3:30 pm CST
 W9IK 1970 11-11:20 am and 1:40-2 pm CST

MONDAY

W1ASD 1710 5:30-6 pm EST
 W2GL 2000 10:30-11 pm EST
 W4— 1880 5-7 pm CST
 W5ARP 1820 7:15-8 pm CST
 W5BDT 1770 12 noon CST
 W5RJ 1710 6:30-8:30 pm CST
 W6BTN 1880 11 pm to midnite PST
 W6EAF 7360 7-7:30 am and pm PST
 W6YA 1880 7:30-8 pm PST
 W9AWE 1970 10:30 to 11 pm CST
 W9DZM 1920 8-8:30 pm CST
 W9IK 1970 7:40-8 pm CST

TUESDAY

W1ASD 1710 5:30-6 pm EST
 W4— 1880 5-7 pm CST
 W5ARP 1820 9:30-10:30 CST pm
 W6BTN 1770 11 pm to midnite PST
 W6EAF 7360 7-7:30 am and pm PST
 W9BII 1880 7-8 pm CST
 W9EHN 1900 10:30 pm-10:45 pm CST
 W9IK 1970 7:40-8 pm CST

WEDNESDAY

WIABO 1880 Starting 10:30 pm EST
 W1ASD 1710 5:30-6 pm EST
 W2GL 2000 10:30-11 pm EST
 W4— 1880 5-7 pm CST
 W5BDT 1770 12 noon CST
 W5RJ 1710 10:30-11:45 pm CST
 W6BTN 1880 11 pm to midnite PST
 W6EAF 7360 7-7:30 am and pm EST
 W6YA 1750 7:30-8 pm PST
 W9AWE 1980 10:30-11 pm CST
 W9BII 1880 7-8 pm CST
 W9IK 1970 7:40-8 pm CST

THURSDAY

W1ASD 1710 5:30-6 pm EST
 W4— 1880 5-7 pm CST
 W5ARP 1820 7:15-8 pm CST
 W6BTN 1880 11 pm to midnite PST
 W6EAF 7360 7-7:30 am and pm PST
 W9BII 1880 7-8 pm CST
 W9DZM 1920 7:30-8 pm CST
 W9EHN 1900 Starting 10:30 pm CST
 W9IK 1970 7:40-8 pm CST

FRIDAY

W1ASD 1710 5:30-6 pm EST
 W2GL 2000 10:30-11 pm EST
 W4— 1880 5-7 pm CST
 W5ARP 1820 10-11 pm CST
 W5BDT 1770 12 noon CST
 W5RJ 1710 6:30-8:30 pm CST
 W6BTN 1880 11 pm-midnite PST
 W6EAF 7360 7-7:30 am and pm PST
 W9BII 1880 7-8 pm CST
 W9IK 1970 7:40-8 pm CST

SATURDAY

W1ASD 1710 5:30-6 pm EST
 W2GL 2000 10:30-11 pm EST
 W5ARP 1820 9 pm till late hour CST
 W6BTN 1880 11 pm to midnite PST
 W6EAF 7360 7-7:30 am and pm PST
 W9BII 1880 7-8 pm CST
 W9IK 1970 7:40-8 pm and 10:30 to 10:50 pm CST

INVESTMENT

Amid all the lofty ambitions and dreams of radio amateurs, including fifty-watters and crystalline notes, why is it that so few of us aspire to the height of desiring the *best fist* and the *nearest operation* on the air? Fifty-watters cost money, and so do crystalline transmitters; but good operation is within the reach of all. It is the least expensive in money but the most costly in thought and mental preparation. You may hear many and many a "second NAA" on the air, and perhaps each time you can bet your boots that that fellow laid out his cash to get his apparatus. But when you hear the fellow with the steady fist and the well-chosen dots and dashes, you can as safely wager that he has invested a wealth of thought and good intention in his operation.

This gives us two sorts of evaluation for radio stations. In the first instance we may find a heavy investment in tubes and transformers and condensers and other good things that are the delight of every radio amateur. In the second instance we may find that kind of an investment which each of us imagines himself to have—*thought investment*—the only kind of investment which is not subject to overload and super-saturation. Why not start today with a deposit in the Bank of Foresight—five minutes' meditation will start you—so that when dividends are paid in 1929 YOUR account will be one of the fullest?

—L. R. H.

TRAFFIC BRIEFS

New Zealand 2AG tells us that the press in his locality is praising amateur radio because it enabled newspaper sales to take place within one-half an hour after the Tunney-Heeney fight.

KVUA on 8650 kc. is the S. S. *Lake Ormoc* of the Ford Motor Company, and at this time is enjoying a six months' trip up the Amazon River in Brazil to the Ford rubber plantation near Santa Ream, Brazil.

On August 8, 1928, valuable assistance to the Weather Bureau at Tampa, Fla., was rendered by W4MW, W4CV, and W4ABA, U. S. Naval Reservists, by getting reports from Arlington. FB, OMS.

It is interesting (especially to those using low power) to note that W3CKJ used one 210 with a pair of "S" tubes in the International Relay Contest to score his 168 points and win 11th place.

ARMY-AMATEUR NOTES

SECOND CORPS AREA:

All Army-Amateur Radio Nets in the Second Corps Area will resume their weekly Monday schedules starting on October 1.

There is still need for more reliable and active amateur stations for the N. Y., N. J., and Delaware State Army-Amateur Radio Nets. The only requirements are that you be interested enough in the work to keep weekly net schedules on Monday nights and to operate your transmitter within the 4000-3850 band (75-78 meters) in order to work your Net Control Station. Requests for application blanks, information, etc., should be addressed to 1st Lieut. David Talley, 2222 Avenue O, Brooklyn, N. Y.

OFFICIAL BROADCASTING STATIONS

The latest and most important news and developments concerning amateur radio can not always be included in *QST*. Even if important events would always happen just as we go to press, the news would be several weeks old by the time it reached our members. For the dispatch of "hot" news which should be disseminated at once, we have our Official Broadcast Stations, which receive weekly releases from HQ with the dope to be sent. OBS are located over the whole country and send out the Official Broadcast on regular schedules.

The Official Broadcast Stations are instructed to send the OBC slowly so that the average amateur will have no difficulty in copying it. We have heard several times that some OBS are copied for *code practice*.

The operators of Official Broadcasting Stations give their time willingly for *your* benefit, but they have no means of determining how effective their efforts are. It will be a courtesy in return on your part if you will drop a postal card to the station from whom you may receive the Official Broadcast.

The following list of OBS's and the schedules on which they transmit the OBC is up to date:

OFFICIAL BROADCASTING STATIONS

(Local Standard Time)

CALL	FREQUENCY (K.C.)	WAVE-LENGTH (METERS)	SCHEDULES	CALL	FREQUENCY (K.C.)	WAVE-LENGTH (METERS)	SCHEDULES
W1BEP	—	—	SAME AS BEFORE	W6DKV	7,500	40	Mon., Wed., Fri., 6-10:30 p.m.
W1BFZ	3,750	80	Wed., Sat., Sun., 7, 10:30 p.m.	W6DKX	7,750	38.7	Sun., 8:30 a.m.; also daily 10:30 p.m.
W1BIG	4,000	75	Mon., Fri., 7:30 p.m.	W6EDK	—	—	Mon., Wed., Fri., Sat., 1-8 p.m.; Tues., Thurs., 1-7 p.m.
W1BIL	3,800	79	Mon., Fri., 7 p.m.	W6UO	3,800	79.0	Mon., Wed., Fri., 10:30 p.m.
W1CKP	7,500	40	Tues., Sat., 9 p.m.	W7AAT	7,635	39.3	Daily except Sun., 6:30 p.m. and 11 p.m.
W1MK	7,150-3,875	41.93-33.86 (simul.)	Mon., Fri., 8-10 p.m.; Tues., Thurs., Sun., 8 p.m. and midnight	W7DD	7,070	42.4	Tues., Fri., 7 p.m.; Sun., 7-11 p.m.
W1XAM	15,000-7,500	20-40	Fri., Sat., Sun., 7 p.m.	W7DD	3,535	84.8	Tues., Fri., 11 p.m.
W2ALU	7,960	37.7	Thurs., 10 p.m., Sun., 6 p.m.	W7DD	14,140	21.2	Sun., 10 a.m., 1 p.m., 4 p.m.
W2APV	7,940	37.8	Mon., Thurs., 7:30-11 p.m.	W7FL	7,320	41.0	Mon., Wed., Fri., 7 p.m.
W2APV	15,000	20	Sat., Sun., 3 p.m.	W7FL	14,620	20.5	Tues., Thurs., 7 p.m.; Sun., 2:30 p.m., 20.5 m if possible
W2AT	3,870	77.5	Mon., Thurs., Fri., 10:30 p.m.; Sun. daylight	W7IZ	7,700	39	Sun., Thurs., 9 p.m.
W2AXT	7,110	42.2	Mon., Wed., Fri., 5:30 p.m.	W7IZ	30,000	10	Sun., Thurs., 1 p.m.
W2BBX-2FF	3,550-3,890	84.46-77.1	Mon., Fri., 7-10:30 p.m.	W7UQ	7,620	39.4	Mon., Tues., Fri., Sat., 6:45 p.m.
W2CTH	7,890	38	Tues., 7-10:30 p.m.; Thurs., 7 p.m.	W7UQ	14,920	20.1	Mon., Tues., Fri., Sat., 11 p.m.
W2KR	3,530	85 (cc)	Mon., Wed., Sat., 7:15 p.m.	W8AHK	7,700	39	Wed., Sat., 7 p.m.
W2KR	7,760	38.7	Mon., Wed., Sat., 7 p.m.	W8AYK	3,600	83.3	Sun., Mon., Wed., Fri., 7 p.m.
W2PF	3,880	77.4 (cc)	Mon., 10:30 p.m.	W8CEO	3,725	80.5	Mon., Wed., Fri., 7 p.m.
W2ZA	7,320	41	Tues., Thurs., Sun., 1:00 a.m.	W8CMB	3,900	77	Mon., Thurs., 7 p.m.
W2RR	14,620	20.5	Wed., Sat., Sun., 7 p.m.	W8CMB	7,820	38.4	Daily except Mon., 11:45 p.m.
W8ALE	3,840	78	Tues., Sun., 7 p.m.	W8CNT	7,230	41.5	Mon., Tues., Wed., Thurs., Fri., 6 p.m.
W8BSD	3,615	83	Daily 6:30 p.m.	W8DME	7,940	37.8	Fri., 7 p.m.; Sat., 10:30 p.m.
W8BSD	7,900	38	Daily at 1:30 a.m.	W8EQ	7,740	38.8 (cc)	Sat., 7 p.m.
W8CFG	3,750	80	Daily at 1:00 a.m. or 9:00 p.m.	W8PL	7,940	37.81	Mon., Wed., Fri., 5:30 p.m.
W4AIP	7,320	41	Sun., 7 p.m.	W9AAO-CFP	7,960	37.7	Mon., Wed., Fri., 7:30-9:30 p.m.
W4CK	15,210-7,150-3,950	19.7-42-76 (simul.)	Mon., Wed., Sat., 7 p.m.	W9AGL	7,540	39.8 (cc)	Tues., Thurs., 7 p.m.
W4JR	3,562	84.2 (cc)	Mon., Wed., Fri., 7 p.m.	W9BAN	7,180	41.8	Mon., Wed., Fri., 11:30 p.m.
W4OB	7,980	37.6	Thurs., Sat., 7 p.m.	W9BEU	7,170-3,580	41.9-33.8 (simul.)	Tues., 9 p.m.; Thurs., Sat., 9:30-10 p.m.
W4RN	3,940	37.8	Wed., Sat., Sun., 10:30-11:45 p.m.; Daily at 3 p.m. and 7 p.m. on same wave	W9BJA	7,700	39	Mon., Thurs., 9 a.m.
W4SJ	7,500	40	Mon., 1:30-10:30 p.m.; Tues., Thurs., 6 p.m.; Wed., 10:30 p.m.	W9BJA	3,750	80	Wed., Sat., 8 p.m.
W5ACL	15,080	19.9	Tues., Thurs., Sat., 7 p.m.	W9BJW	—	247.8	Mon., Wed., Fri., 1-7:30 p.m.
W5ACY	7,900	38	Mon., Wed., Fri., 5:30 p.m.; Tues., Sat., 11:30 a.m.	W9BKJ	3,820	78.45	Thurs., 7 p.m.
W5AKP	15,000	20	Tues., Thurs., Sun., 7:30 p.m.	W9BKJ	7,640	39.27	Sat., 7 p.m.
W5AGR	7,080	42.3	Thurs., Fri., Sat., 12-12:30 p.m.; Daily except Fri., 5-5:30 p.m.	W9CAT	7,700	39	Daily, 10:30 p.m.
W6AJM	14,140	21.2	Tues., Thurs., Sat., 6:30 p.m.	W9CET	7,475	40.1	Mon., Thurs., 11 p.m.
W6AJM	7,740	38.8	Mon., Wed., Fri., 7 p.m.	W9CET	30,000	10	Sun., 12:30 p.m.
W6ALG	7,600	39.5	Sun., 6-7 p.m.; Sat., 5-6 p.m.	W9CIA	7,980	37.6	Sun., 2:30 p.m.; Tues., 9 p.m.
W6AMM	7,450	40.2	Tues., Thurs., 7 p.m.	W9CN	7,875	38.1	Sun., 3 p.m.; Mon., Wed., Sat., 7:30 p.m.
W6BBJ	3,530	85	Mon., Wed., Fri., 7-10:30 p.m.	W9CPM	7,500	40	Tues., Thurs., Sat., 7 p.m.
W6BJX	7,320	41	Mon., Thurs., 7 p.m.	W9DAE	8,710	81	Fri., Sat., 10:30 p.m.
W6BRO	7,700	39	Mon., Wed., Fri., 7:30 a.m.	W9DHP	15,800	19.6	Mon., Wed., Fri., 7:30 a.m.
W6BWS	7,230	41.5	Mon., Wed., Fri., 5:30 p.m.	W9DQD	7,700	39	Mon., Wed., Fri., 7 p.m.
W6BXD	7,800	38.5	Mon., Wed., Fri., 7 p.m.	W9DQN	7,150	42	Mon., Wed., Fri., 10 p.m.; Tues., Thurs., 7:30 p.m.
W6BYZ	7,575	39.6	Mon., Wed., Fri., 7 p.m.	W9DUD	15,000-7,500-1,500	20-40-200	Sun., 10 a.m.; Mon., Fri., 7 p.m.; Tues., 7:30 a.m.
W6CDU	7,110	42.2	Mon., Wed., Fri., 7 p.m.	W9EGU	7,050	42.6	Mon., Wed., Fri., 7 p.m.
W6CHA	7,500	40	Wed., Fri., Sat., midnight	W9KZ	7,700	39.0	Sun., 2 p.m.; Tues., Sat., 7-10:30 p.m.
W6CLS	14,700-7,460	20.4-40.2	Mon., Wed., Sat., 7 p.m.	W9MN	7,940	37.8	Tues., Thurs., Sat., 10 p.m.
W6CTX	7,500	40	Mon., Wed., 10 p.m.; Fri., 10:30 p.m.; Sat., midnight; Sun., 2 a.m.	W9RR	3,660	82	Daily except Sun. at midnight
				W9ZD	7,300	41.1	Tues., Fri., 9:05 p.m.

WIMK

WIMK operates on frequencies of 3575 kc. and 7150 kc. The chief operator is Robert B. Parmenter, "RP", who keeps the schedules in good working order. Now and then the following signs may be heard: "OU" of Louie Huber (Ass't. C. M.), "FH" of F. E. Handy (C. M.), and "AH" of A. A. Hebert (Treasurer—Fieldman).

In preparing the following description of WIMK's activity, the old familiar "30" and "40" has been displaced by the newer and more descriptive "3500" and "7000". Eastern Standard Time is used throughout.

All the latest OFFICIAL and SPECIAL BROADCASTS are sent simultaneously on 3575 kc. and 7150 kc. from WIMK at the following times (E.S.T.):

- 8:00 p.m.: Sun., Mon., Tues., Thurs., and Fri.
- 10:00 p.m.: Mon. and Fri.
- 12:00 (midnight): Sun., Tues., and Thurs.

PERIODS OF GENERAL OPERATION have been arranged in order that everybody may have a chance to work HQ. Usually these general periods follow one of the Official Broadcasts. They are listed below under 3500 kc. and 7000 kc.:

- 3500—
 - 8:10 p.m.—9:00 p.m. on Sun., Mon., Tues., Thurs., and Fri.
 - 10:00 p.m.—11:00 p.m. on Tues. and Thurs. (no OBC sent preceding these).
 - 12:00—1:00 a.m. (or later) on Sun. night (Monday a.m.).
- 7000—
 - 10:10—11:00 p.m. on Sun., Mon., and Fri.
 - 12:00 p.m.—1:00 a.m. on the following nights (actually the a.m. of the day following). Mon., Tues., Thurs., and Fri. Only on Tues. and Thurs. does the OBC precede.

The following regular schedules are kept with individual member-stations. Traffic to and from HQ will travel quickly through any of the following: (Eastern Standard Time used throughout)

- W1ACH (3500) Sun., 7:45 p.m.; Thurs., 7:30 p.m.
- W1BIG (3500) Mon. and Fri., 7:00 p.m.
- W1BQD (3500) Mon. and Fri., 9:00 p.m.
- W1KY (3500) Mon. and Fri., 7:30 p.m.
- W1UE (3500) Tues., 9:45 p.m.
- W1VB (3500) Tues. and Fri., 7:45 p.m.
- VE2ER (7000) Sun., 9:15 p.m.
- W2BME (3500) Sun., 7:30 p.m. and Thurs., 7:15 p.m.
- W2QP (3500) Mon. and Thurs., 9:45 p.m.
- W2ZF (3500) Mon., Tues., Thurs., and Fri., 11:30 p.m.
- W2ZS (3500) Mon. and Thurs., 7:45 p.m.
- W4IE (3500) Thurs., 11:00 p.m. (W4IE on 7000 kc. band).
- W6BWH (7000) Tues., 12:30 a.m.
- W6EY (7000) Wed., 12:30 a.m.
- W6NX (7000) Mon., 11:45 p.m. (W6BMW sub for W6NX).
- W6OJ (7000) Mon., 1:00 a.m.
- W6ZD (7000) Wed., 1:30 a.m.
- W8AAG (3500) Sun., 11:15 p.m.
- W8AYB (3500) Tues., 11:00 p.m.
- W8BYN (3500) Tues., 11:15 p.m.
- W8DED (3500) Tues. and Thurs., 9:30 p.m.
- W8ZZ (3500) Sun., 11:00 p.m.; Thurs., 9:00 p.m.
- VE9AL (3500) Tues., Fri., 7:15 p.m. (VE9AL on 5720 kc.).
- W9APY (3500) Tues., 9:00 p.m. (W9APY on 7000 kc. band).
- W9BCA (7000) Mon., 11:00 p.m.; Fri., 12:30 a.m. and 11:00 p.m.
- W9OX (3500) Sun. 11:30 p.m.; Thurs., 11:15 p.m.
- WSBS (7000) Sun., Mon., and Fri. at approximately 10:15 p.m. (WSBS on approx. 9050 kc.).

TRAFFIC BRIEFS

WUXTRY!!

The radio club of Liberty, Mo., is offering a 7½ watt tube (we think the filament is OK) to the fellow who sends in the best looking QSL card for their QSL CARD CONTEST. All donations must be in by Jan. 1, 1929, at which time the club members will pass judgment on specimens received. (Some New Year's party, wot?). Interested possessors of the well-known article will kindly submit their entries to the following address: Contest Dep't, c/o W9CKU, S. M. Woodson, Jr., Liberty, Mo.

The following came from W9EF of Hammond, Ind.: "I took a message for Tom Heeney from the Prime Minister of New Zealand through o2ZAC and gave it to W2AJH, who phoned it to Heeney's camp. O'Meara of o2ZAC told me that it was the first message he had ever handled, and that it was sent by special permission of the Prime Minister, the Right Honorable A. J. Coates, M.C.P.V."

W6NT suggests that every general call (that means CQ) should have tacked on to it some indication of where the CQ-er is going to start listening. For example, W6NT would call: CQ CQ CQ de W6NT W6NT W6NT TOP AR. If the operator intended to start at the bottom of the band in listening for replies, his call would end with BOT AR. Perhaps it would be better to save transmission by making the endings simply T and B, followed of course by the "end of call" sign AR.

W9ASX also says that W9EVA claims that static can be so bad that it will have harmonics! Bring the wavemeter, Oscar!!

W7ST wants co-operation from you during October 9 to 12, inclusive, when the Pomona Grange Fair will be held at Boise, Idaho. The operators will be W7ABB, W9BKH, W7ST, and W7AGU. During the day a watch will be kept in the 14 meg. band. Probable QRH in the latter band will be 7140 kc. Schedules are welcome. Anybody interested should drop a card to Harold G. Austin, W7AGU, in care of KFAU, Boise, Idaho.

ELECTION NOTICE

To all A.R.R.L. Members residing in the Sections list below: (The list gives the Sections, closing date for receipt of nominating petitions for Section Manager, the name of the present incumbent and the date of expiration of his term of office.) This notice supersedes previous notices. In a number of cases (*) when no valid nominating petitions have been received from A.R.R.L. Members residing in the different Sections in response to our previous notices, the closing dates for receipt of nominating petitions are set ahead to the dates given herewith. In the absence of nominating petitions from Members of a Section, the present incumbent continues to hold his official position and carry on the work of the Section (†) subject, of course, to the filing of proper nominating petitions and the holding of an election by ballot or as may be necessary.

Section	Closing date for petitions specified of the present year or before noon of the dates	Present SCM	Present terms of office ends (1928)
Western N. Y.†*	Oct. 20	C. S. Taylor, W8PY	July 1
Northern Minnesota*	Oct. 20	C. L. Barker, W9EGU	Oct. 2
Louisiana*	Oct. 20	C. A. Freitag, W5UK	Oct. 2
Rhode Island*	Oct. 20		
Nevada†*	Oct. 20	C. B. Newcomb, W6UO	Sept. 15
West Virginia†*	Oct. 20	C. S. Hoffman, W8ED	Aug. 2
Colorado*	Oct. 20	C. R. Stedman, W9CAA	Oct. 2
Alabama†*	Oct. 20	A. D. Trum, W5AJF	Oct. 2
Ga.-S. C.-Cuba P.R.		H. L. Reid, W4KU	July 1 Aug 2
Isle of Pinest*	Oct. 20		
Philippines*	Nov. 25	Jose E. Jimenez, op1AT	Acting
Southern Minnesota	Oct. 20	D. F. Cottam, W9BYA	Nov. 27
Virginia	Oct. 20	J. F. Wohlford, W3CA	Dec. 2
Arizona	Oct. 20	D. B. Lamb, W6ANG	Dec. 2

Newfoundland and Canada

Nominating petitions for Section Managers in Newfoundland and Canada should be addressed to Canadian General Manager, A. H. Keith Russell, VE9AL, 5 Mail Building, Toronto, Ont., Canada. To be valid, petitions must be filed with him on or before the closing dates named.

Newfoundland†*	Oct. 20	Loyal Reid, VE8AR	July 15
New Brunswick†*	Oct. 20	T. E. Lacey, VE1E1	Aug. 2
Nova Scotia†*	Oct. 20	W. C. Borrett, VE1DD	Aug. 2
P. E. I.†*	Oct. 20	F. W. Hyndman, VE1BZ	Aug. 2
Ontario†*	Oct. 20	W. Y. Sloan, VE9BJ	Oct. 2
British Columbia	Oct. 20	E. S. Brooks, VE2BJ	Dec. 2
Saskatchewan	Oct. 20	W. J. Pickering, VE4FC	Dec. 2

ELECTION RESULTS

Valid petitions nominating a single candidate as Section Manager were filed in a number of Sections on or before the closing dates that had been announced for receipt of such petitions. As provided by our Constitution and By-Laws, when but one candidate is named in one or more valid nominating petitions, this candidate shall be declared elected. Accordingly election certificates have been mailed to the following officials: (These officials will welcome your monthly activity reports.)

Section	Address	2-year Term begins
Quebec	Alex Reid, VE2BE, 169 Logan Ave.	Sept. 15
Arkansas	H. E. Velte, W5ABI, 5408 U. St., Little Rock	Aug. 28
North Carolina	Enno Schuelke, W4SJ, F. F. D. No. 1, Ridgeway	Oct. 2
Tennessee	Polk Purdue, W4FI, Care Radio Station WBAW, Nashville, Tenn.	Oct. 2
Idaho	James L. Young, W7ACN, 303 13th Ave., So. Nampa, Idaho	Oct. 2

In the Utah Wyoming Section of the Rocky Mountain Division, Mr. H. R. Bradford, W6RV, and Mr. Parley N. James, W6BAJ, 430 D. St., Salt Lake City, Utah were nominated. Election results: Mr. Bradford, 11. Mr. James, 19. Mr. James therefore has been declared elected.

In the Oklahoma Section of the West Gulf Division, Mr. L. M. Edwards, W5FJ, and Mr. Glenn Morgan, W5AMO, 763 Asp Ave., Norman, Okla. were nominated. Election results: Mr. Edwards, 12; Mr. Morgan, 20. Mr. Morgan therefore has been declared elected.

In the Kentucky Section of the Central Division, Mr. B. L. Brown, W9FS; Mr. G. W. Mossbarger, W9AUH; and J. B. Wathen III, W9BAZ, Box 97, R. F. D. No. 1, Louisville, Ky. were nominated. Election results: Mr. Mossbarger, 10; Mr. Brown, 15; Mr. Wathen, 16. Mr. Wathen therefore has been declared elected.

DIVISIONAL REPORTS

ATLANTIC DIVISION

EASTERN PENNSYLVANIA—SCM, J. B. Morgan, W3QP—W3ZF continues to be the star performer. He has two ops going now and plans for a mammoth station. W8WJ says traffic looks better. We'll say so, with a total of over 1800 messages for E. Pa. for August. W3AFJ has been off but still reports a few messages. W3QP's traffic is picking up. W3AKB says W3ZF's New York-Chicago traffic keeps her cleaned out of traffic. W8AVK reports improved weather and traffic as does W3ADE. W3CDS has it in for the crowd in general for not making or keeping schedules. W8AVL is going strong with a new rig. W3BFL is back again. He has time to operate once more due to the regular hours necessitated in his business. W8AWO checked up on the gang's language and morals via a S/W receiver he had at camp. W8CWO is covering the state well on the 7000 kc. (40 meter) band. W8DHT is still going strong and applies for ORS. W3AEF is a new reporter this month. Glad to see you, OB, and wish you your share of the fun of being systematic in the old radio hobby.

Traffic: W3ZF 389, W8WJ 77, W3AFJ 10, W3LC 208, W3QP 91, W3AKB 93, W8AVK 94, W3ADE 88, W3CDS 3, W8AVL 6, W3BFL 4, W8CWO 26, W8DHT 125, W3AEF 116.

DELAWARE-MARYLAND-DIST. OF COLUMBIA—SCM, H. H. Layton, W3AIS—It was necessary to cancel a number of ORS certificates last month due to failure to report. However, several new ORS appointments were made last month and applications for appointments are being received daily. Some live wire is needed for RM for our section. Who shall he be?

Delaware: W3ALQ reports weak signals on the 7000 kc. (40 meter) band and traffic NIL. Television results are much better. W3AJH has been devoting all his time to the new YL. W3WJ will soon be on the air. W3AIS had hard luck with his crystal so is on the air with Rac.

Maryland: W3AEI is high traffic man for Md. with W3TR a close second. W3BBW is experimenting with a Hertz antenna on 7500 kc. (40 meters). W3CGC re-

ports he will be on the air again after Sept. 15th. Dist of Columbia: W3GT at Bolling Field continues to be high traffic man for the entire section. W3KA's full QRA is requested by the SCM. W8AHP has applied for an ORS—let's have your report, OM.

Traffic: Del. W3ALQ 2, W3AJH 2, W3AIS 6, Md. W3AEI 9, W3TR 8, W3BBW 1. D. C. W3GT 79.

SOUTHERN NEW JERSEY—SCM, M. J. Lotysh, W3CFG—W3CFG leads the section with no competition in sight as usual. A 90' lattice mast will be doing duty by the time this is in print. W3ARC turned in a fine total to celebrate his ORS appointment, and may he never have a smaller one. W3IV visited Canada and still had time to handle some. He is in line for an ORS. W3AC mostly on 14,000 kc. (20 meter) band with occasional fone on the 3500 kc. (80 meter) band, and handled a few. W8ATJ finally got a 210 so now we will expect better things of him. W3BWJ is rebuilding both transmitters, receiver and antenna. Now is the time to do it, OM. W3ATP turns in his first report and says he isn't going to let the 171's get a chance to cool off next month. HI. W8ZI was at Pine Camp with 112th artillery for 2 weeks so that explains his blank. W3BEI says he gets little time for radio. Hope fall sees an improvement, OM. W3KJ is off the air as usual. Cool weather is coming on now and conditions should improve. Unless they do, and those ORS unlisted this month fail to report next month, there will be some more cancellations. You fellows all have report cards and there is no good reason for not mailing them monthly, explaining your activity, or inactivity.

Traffic: W3CFG 168, W3ARC 60, W3IV 24, W3ATJ 12, W3BWJ 9, W3AC 14, W3ATP 3.

WESTERN PENNSYLVANIA—SCM, A. W. McAuly, W8CEO—The leader in traffic for this month is not yet an ORS but will be one soon. W8CNZ has a regular schedule with nn-INIC. W8CFR reports GMD returning home but off the air on account of trouble with Indians and sickness. W8XE had the misfortune to lose about \$400 worth of apparatus when lightning struck the station. W8DKS is rebuilding. W8ARC is the new secretary of the ATA and has been busy with the duties incidental to the jobs changing hands. W8AGO is on twice a week handling

Army net work with W8SN. W8CES has a grand new transmitter that is doing its stuff and he wants more schedules. W8AKI is getting calibration on a new wavemeter. W8BRM is rebuilding for 1929 operation. W8CEO has changed from 8945 kc. (76 meters) to 8725 kc. (80.5 meters) as the note is improved. There may be some errors in the ORS or other records here so if anyone has any sort of grievance, please write the SCM who will be glad to look the matter up at once. The new officers of the Erie Amateur Radio Club are W8BVB Pres., W8LS, Vice Pres., R. Wagner, Secy-Treas. W8LS is the chief of at W8AMA. W8BEN has a Packard, class, yes, sir! W8VF is in Flint, Mich. The Erie hams are planning a get-together and banquet. W8DRU, the club's secretary is coming down to Carnegie Tech. He expects to have a transmitter with him. W8CAE has left Erie for Cambridge, Mass. W8CZE who attended the radio school in N. Y. C. is at present at home and is attempting to push the ether out of the way with a 250 watt. Let us all get going on fall traffic.

Traffic: W8CNZ 47, W8CFR 37, W8XE 14, W8DKS 5, W8ARC 8, W8AGO 2, W8CES 2, W8AKI 1, W8CEO 28, W8GHC 488, W8AYH 12, W8DNO 76.

WESTERN NEW YORK—SCM, C. S. Taylor, W8PJ—The report this month just doubles last month which shows how quickly Western New York can get going again. W8ABX has overhauled all his apparatus and is ready for the fall season. W8AFG broke his arm but managed to get through quite a number of messages and kept schedules also. W8AHC has also rebuilt the works and is at it again. W8ARX made the BPL this month with over 300 messages. W8BCM started up this month with schedules and traffic. W8BFG has been on vacation so no traffic report this month. W8BIP worked all U. S. districts last month and handled some traffic. W8BMJ has returned from his vacation and now has things going good. W8BQK expects a 2nd dist. call soon so we rekrct to say we have to lose him from our dist. W8BUJ has been sick. W8BUP almost wins the Booby prize with 2 msgs. this month. W8CDB sold his transmitter so no report on traffic until he gets a new one completed. W8CMW works on 3615 kc. (83 meters) and gets fair results. W8CNT states that the Northern Chataqua Radio Club has been formed and W8BOO, W8COM, W8UB, W8DY, W8BPZ, W8BUP, W8BMW, and W8CNT constitute its membership. W8CNT called on the SCM and a good ragchew took place. W8CNX has rebuilt his transmitter and expects to be in operation not later than October. W8DFW is after an ORS and one will be issued him if his reports continue to keep up. W8DHX has handed in his last report under that call. He expects to go to N. J. to live so the 2nd or 3rd dist. will get a good live wire. Good luck, OM. W8DII handled some traffic and kept schedules. W8DME worked WSBS, OZ, SE, SC and is trying to get in touch with VOQ. W8DNE is getting the set in shape for 1929. W8DQP has had quite a bit of trouble with the set so msgs. have not been going so good with him. W8DRJ using a UX210 has put over many messages this month with no schedules. W8TH has handled a few messages for the small amount of time he is able to get on.

Traffic: W8AFG 45, W8AHC 10, W8ARX 301, W8BMC 26, W8BIP 41, W8BMJ 19, W8BQK 8, W8BUJ 3, W8BUP 2, W8CMW 5, W8CNT 54, W8DFW 60, W8DHX 447, W8DII 55, W8DME 12, W8DNE 11, W8DQP 11, W8DRJ 60, W8TH 4.

CENTRAL DIVISION

ILLINOIS—SCM, F. J. Hinds, W9APY—Things look fine this month, fellows. Our traffic is much better in both totals and number of reporting stations and the reports are coming in more promptly. Keep this up and we shall be all set for a REAL season. K6DEY passed through Chicago this month. W9DGA has moved to Pittsburgh on account of business and will "8" there. W9DSU is moving to St. Louis—sorry to lose you, too, OM. W9AFA's traffic was all with WNP—he will meet the boat as it docks at Christmas Cove soon. W9BSH received his commercial ticket and will soon have a 14 mc. (20 meter) and 28 mc. (10 meter) set going. W9DXG has a new "1929" transmitter. W9BNI handled so much Camp Grant traffic he has to rebuild the sets. W9AJM is again with us after a long rest. HI. W9CCR will soon be on with his crystal. W9ACU is now a-la-1929. W9BTX was operator of W9XN and did some

fine work handling new items, stock reports, etc. W9CIA worked Russia as his 53rd country worked. The Fox River Valley Radio League held a very nice hamfest at Aurora. W9PU had a terrible mess when the big mast and antenna system went west but he finally got the zepp going and DX'd again. W9CSB is rebuilding 1929 type of set with a 204A. He will be at W9MI at U. of Ill. this fall. W9AFF has moved and is remodelling for 1765 kc. (170 meter) crystal fone, CW and television. Also will use fone and CW on 3580 kc. (85 meters) with speech amplifier and good modulation. W9BPX received the "commercial". W9GV, W9AAS, and W9CEJ deserve much credit for their efforts trying to locate the Rockford Fliers. W9AVL uses a MOPA on 15,000 kc. (20 meters). W9CKZ handled some nice traffic from Camp Grant via W9BRD and W9DLI. All of W9DKZ's traffic was also with Camp Grant. W9BRN is rebuilding. W9CNY is rebuilding per 1929 specifications. W9FHY is trying a mercury arc. W9FQS trafficked with W9XN mostly this month. W9BOL and W9AQJ are building together in a crystal outfit. W9EBX and W9DLI worked hard on the Rockford-Sweden flight. W9ECC will soon be on the 28 mc. (10 meter) band. W9DOX has been at Camp Grant under W9FWG.

Traffic: W9PU 518, W9FWG 201, W9XN 201, W9APY 129, W9CIA 105, W9DKK 86, W9EJO 68, W9UX 68, W9CKZ 64, W9IV 62, W9AFA 61, W9BNI 55, W9FQS 45, W9AAS 44, W9ASE 44, W9DSU 84, W9CKM 31, W9DXZ 27, W9FHY 22, W9ERU 21, W9DCK 20, W9FCW 19, W9CSB 15, W9CUI 15, W9CNY 18, W9ARM 12, W9AVL 12, W9BSH 12, W9ECC 12, W9CZT 11, W9AFB 9, W9CNB 8, W9CUO 8, W9AMO 6, W9KB 4, W9AAW 3, W9AGG 3, W9AJM 2, W9ACU 1, W9BVP 1, W9CCZ 1, W9EGX 1, W9FO 1.

INDIANA—SCM, D. J. Angus, W9CYQ—W9CVX is putting in crystal control. W9FYB is a new ham at Bloomington. Bloomington has a new radio club with W9ABW president, W9AIN vice-president, W9AYO secretary, and W9TIT treasurer. W9CNC has rebuilt to 1929 specifications and reports much better results. W9AEB is using fone on 3530 kc. (85 meters) now. W9EPR (ex) is waiting for a new license and will then be on the air. W9FQ is on with a new transmitter and a 210. W9EF is going strong on DX. Now lists 34 countries. A USNR unit is being organized at Hammond. W9EVA is testing out antennas for their DX possibilities. W9ESH is off on account of most of his outfit being blown. W9DUZ has a Ford roadster QRM. W9ASX is rebuilding to 1929 specifications. W9FLU died at Indianapolis the fore part of August. South Bend lost an excellent ham and general good fellow by his death. W9ACR handled Camp Knox traffic during CMTC training at Louisville, Ky.

Traffic: W9AIN 237, W9EZ 55, W9CNC 8, W9AEB 8, W9FQ 6, W9ACR 187, W9DSC 14.

KENTUCKY—SCM, D. A. Downard, W9ARU—This, or probably next month, will be the last report to be made by the present SCM. He wishes to take this means of thanking the fellows for the cooperation they have given him and hopes they will give the SCM elect their best. Thanks, fellows! W9BWJ is working on a shielded grid receiver and is looking forward to good results this fall. W9ENR says too much QRM and QRN so he is taking a vacation in the East. W9CRD reports having worked f8HPG on the 7000 kc. (40 meter) band. W9BGA is doing good DX on both the 7000 kc. (40 meter) and 14,000 kc. (20 meter) bands, with one 210. W9EKM reports a lot of good DX on the 14,000 kc. (20 meter) band. 9FBV is QSO OA stations right along. W9MN is also working OZ and OA stations early in the mornings. W9BAN has invested in a new Vibroplex. Hold 'er down, OM. W9DQC and W9DLU are vacationing. W9DDH is having trouble with QRN. HI. W9ARU is working on his outfit having just returned from a week in the Kentucky mountains. W9BXX left his remote control switch turned on and, next morning, ashes. If you'd been using "damped" waves most likely, it would have put itself out, OM. HI.

Traffic: W9BGA 19, W9OX 16, W9CRD 13, W9MN 11, W9BAN 5, W9ENR 3, W9EKM 2.

MICHIGAN—SCM, Dallas Wise, W8CEP—W8CKZ is on 8750 kc. (80 meters) most every night but says there is not much doing just now. W8MS is silent due to blown armatures on the MG. W8BGV now has a 210 working and is handling loads of traffic. W8AAF complains of the BCL harmonics in the 8500 kc. (80 meter) band. W8BRS burned out the bearings on the MG and is rebuilding the outfit. W8DUA uses

DIVISIONAL REPORTS

ATLANTIC DIVISION

SOUTHERN NEW JERSEY—SCM, M. J. Lotysh, 3CFG—3CFG again leads in spite of blowing up his transmitter. A new set is being planned with another 852 and a new plate supply ala 1929. 3ATJ had a chance to be famous. With his shack full of press reporters trying to get out news of Capt. Carranza's death, his lone 201A got cold feet. 3UT requests his ORS to be cancelled. Sorry to lose you, Walt. 3CO also rebuilding for next year. 3BWJ still complains of lack of operating time. 3BEI is off until fall. 3CO's ORS has been reinstated. 3ARN is an up and coming new station. With the next report, good weather will be coming on, so let's get back to work and turn in some real results.

Traffic: 3CFG 24, 3BWJ 6, 3ATJ 7, 3CO 2, 3ARN 3.

WESTERN PENNSYLVANIA—SCM, A. W. McAuly, 8CEO—Please note on page 3 of QST where you are supposed to report, fellows. 8BBL and 8BYS have combined and are now operating under the call of 8DNO. 8CFR reports that GMD has not been heard for three weeks. 8CNZ has moved again. 8BRM is busy with telephone work. 8GI and 8CYP were SCM visitors. 8CEO and 8DHU took a two weeks trip through the south, visiting several hams en route. The SCM would like to hear from a few stations with good wavemeters who would be interested in official observation work. Also those desiring to handle traffic and who do not now have an ORS.

Traffic: 8GI 33, 8CFR 25, 8CYP 21, 8CNZ 20, 8BRM 15, 8CEO 15, 8DNO 35.

EASTERN PENNSYLVANIA—SCM, J. B. Morgan, 3QP—This month's total of traffic is rather good. It is due to the large score run up by 3ZF in his Twentieth Century Limited express message service from N. Y. to Chicago. Try to route your western traffic over this channel, fellows, and watch the speedy work. Connecting channels can be seen by referring to page 49 of the August QST. 8EU will be located in Phila. in a short while and will take a trick at the key at 3ZF, with whom he will be associated. Good luck to you, Maneval. Things are rather slow at 3QP. 3AKB had some QRM in the shape of vacation—the BPL showed it. 8AVK and 8ADE were bothered with hot weather. Who wasn't? 8CDS complains of bad QSR on the part of some of our brethren. 8ADQ rebuilding again and says not to overlook the sign "EB" after his call, in which case the op will be his YL. FB, OL. 8AVL is rebuilding. 8CWO says this may be his last report if his college application is accepted. 8DHT still shooting the traffic. We welcome 8RDG to the ranks of the "Reporters" with a fair total for a starter. 8AWO took a S/W receiver to camp with him to keep his hand in. 8BQ is proud to say he has a new junior YL op. Congrats.

Traffic: 3ZF 433, 3QP 23, 3AKB 37, 8AVK 42, 8ADE 16, 3CDS 1, 8ADQ 28, 8CWO 9, 8DHT 69, 8BDG 15, 8AWO 7.

MARYLAND-DELAWARE—DIST. OF COLUMBIA—SCM, H. H. Layton, 3AIS—L. H. Ryan, 3WJ (Acting SCM)—Dr. Layton, our SCM, has gone on vacation for two weeks to Saginaw, Mich., via car and boat. Let's wish "Doc" a good time. Yes, he took the wife and Jr. op. The seashore and what not will keep 'em from the key, but don't forget, fellows, if you want your reports in this section of QST each month, you've got to send me the info. If you are rebuilding, etc., let us know. Will it be a big report next month—?

Del: 3AIS has been very active with his new crystal control set. 3WJ has been off the air to allow the paper hanger to change the room. 8ALQ reports weak signals.

Md.: 3BBW is rebuilding and teaching the YL the dit dah. 3TR at the Naval Academy writes that he is joining our forces on the air with 75 watts, 2500 volts 25 cycle self rect.

D. of C.: Our old friend 3GT at Bolling Field still has the record on traffic. If you have traffic for the coast and points West, shoot it over to 3GT. 3KA, formerly 4CK of Miami, Fla., has taken up his new residence in Washington. He has applied for an ORS. Welcome, OT.

Traffic: Del: 3AIS 3, 3WJ 1. Md.: 3TR 6, 3BBW 1. D. of C.: 3GT 30, 3KA 12.

WESTERN NEW YORK—SCM, C. S. Taylor, 8PJ—The mid-summer reports this month are fair and much progress has taken place in the Syracuse section. A new club has been formed which will be known as the Syracuse Society of Transmitting Amateurs and solicit the membership of all small town stations around Syracuse. Their object is to give 100% service to the ARRL and their Secretary is H. C. Keffer, 707 Wolf St., Syracuse, N. Y., who awaits your application and membership. 8AHC has worked oa. and oz. 8AIL will be at camp next month. 8AKZ worked 6ZZI but handled no traffic. 8ANX is off for the summer but will be on again about Sept. 8ARX handled 99 msg's. FB, OM. 8BCM has been off the air due to work. 8BFG handles some traffic. 8BMJ expects more traffic in Sept. 8BUM has been off the air due to bad transformer trouble. 8CDB worked all continents and na-7AEB. 8CNT worked 29 stations in six hours one day, but QRN killed good reception. 8CNX is rebuilding very slowly but may be ready by Sept. 8CRF is off until the fall season begins. 8CSW has been at Alfred Univ. for the summer but sneaks over to Cook Academy to get off a few msg's. now and then. 8CVJ will be off the air until Sept. 8CYB put out a few msg's this month. 8DDL says he has an R9 YL now so sigs have changed for a while. 8DHX lost his license and now works 8CIG. 8DII has been changing the transmitter and is going to have 1500 volts DC ready by Sept. 8DME worked Australia and Germany and handled other traffic. 8DNE is at camp but managed to handle traffic from there. 8DQP has been busy getting 8ALQ ready for fall work. 8DSP says things are not very lively at this time. ex8WU is operating a "2" station at Schenectady.

Traffic: 8AHC 8, 8AIL 5, 8ARX 99, 8BFG 8, 8BMJ 18, 8CDB 34, 8CNT 9, 8CVJ 1, 8CYB 20, 8DHX 18, 8DII 21, 8DME 17, 8DNE 25, 8DSP 69, ex8WU 1.

CENTRAL DIVISION

INDIANA—SCM, D. J. Angus, 9CYQ—9AIN leads the section in schedules by virtue of his activity on the "Twentieth Century Limited," N. Y.—Chgo Route. Beginners sit in with him nightly for code practice. 9EZ handled a bunch of msg's with portable stations connected with the Academy. 9EVA handled a stack and says he will build a 1929 xmitter. 9CRV comes next. 9FAP served duty for C.M.T.C. men for a while. 9BYI is the early bird—he arises daily at six for schedules. 9CNC worked OA on 20. 9FB tries 10 meters. 9ASX took a vacation. He reported a dandy hamfest of the South Bend and Elkhart gangs at Lake-of-the-Woods, on July 15. 9DSC and 9DXH bring up the rear.

Traffic: 9EZ 450, 9AIN 208, 9EVA 100, 9CRV 45, 9FAP 38, 9BYI 24, 9CNC 11, 9ASX 6, 9DSC 6, 9DXH 2.

KENTUCKY—SCM, D. A. Downard, 9ARU—9AWN has applied for ORS appt. 9BKK is a new ORS. 9FBU is still handling traffic. 9BGA says 20 meters is the berries. The golf bug hit 9ENR. 9AID got an R-7 report on 20 meters from oz-2AW. 9OX is busy with other work but keeps his skeds—so he says. 9FBV reports a QSL of his sigs from oa-3PJ as R8. We have a new OBS in 9BAN at Henderson. 9BWJ says he has joined the "Experimenters" Section and is going to be an inventor. Hi. 9AZY has a 210 perking on 40 meters. 9MN is putting in a new DC system on his transmitter. 9ATV has a new screened grid receiver that really works plus ultra. 9ARU will be on the air as soon as things start getting cool.

Traffic: 9OX 22, 9ATV 15, 9BAN 10, 9AZY 17, 9AID 11, 9MN 2.

OHIO—SCM, H. C. Storck, 8BYN—Some Ohio ORS are getting good totals for this time of year. 8CMB takes the lead this month with 88 messages. 8DBM follows closely with 74. 8DSY specializes on important traffic. 8DTN handled some traffic for WNP. 8CRI is runner-up for ORS. 8CNO has been having trouble with her set. 8CCS is in the hospital. 8CCS wants dope on VOQ. 8DMX says he can't hear any Ohio stations any more. 8BAC is still working on his new 20 meter outfit. 8AYO is keeping a schedule with se-2EA. 8DJV handled a love letter for 8DLL. Hi. 8DDK is installing xtal control. 8BRR says traffic has disappeared. 8ARW hasn't anything to say. 8BKM is on his honeymoon. 8CFL

business. W9BYA has moved down a flight of stairs and will have to create a new shack.

Traffic: W9DBW 34, W9COS 32, W9ELA 17, W9DOP 12, W9BTW 12, W9DMA 2, W9AIR 2, W9EHO 2, W9DGE 1.

NORTHERN MINNESOTA—SCM, C. L. Barker, W9EGU—W9EGN rates the stars this month, showing the fellows that traffic can be handled in the summer months by just trying. W9EHI reports that W9KV ops WMUO and that W9CKI ops KFML, both on the Great Lakes. He is getting all set for the coming "radio season." W9FTU, a new station at Two Harbors, and an ORS-to-be, is showing up very well, and is putting up a new Zeppelin antenna. W9EGU visited Hoffman, Zurian and Mix at 9EK-9XH while enroute to Springfield, Ill., for a 10 days visit there. W9ABV is now arranging his schedules again, putting in new ones as well as renewing old ones of last year. W9EHO very seldom sends in any news. How come, OM? W9DPB has rebuilt his set for 1929. W9ADS says it's too hot for radio but will be on with a 20SA shortly. W9AKM is rebuilding both transmitter and receiver for fall and winter work. W9BBT lost his tower in a wind but will have it up again real soon. W9BMX just put on a new MOPA and says it's FB, having worked Sweden and Australia the first day on. W9BCT is attending the CMTC at Ft. Snelling. W9BVH is building an operating room. He stopped to visit the SCM but the SCM was gone—no doubt in Springfield. W9CKI is having the time of his life on the SS Pontiac, KFML and will be back on the air at his ham set by Sept. 15th. W9EGF lost his antenna but says it won't be gone long. W9BMR is moving to Wahpeton, N. D. soon as he has employment at the postoffice there. Sorry to lose him from Minnesota and our Northern section.

Traffic: W9EGN 177, W9EHI 14, W9FFU 9, W9ABV 4, W9EHO 4, W9DPB 4, W9ALS 2.

NORTH DAKOTA—SCM, B. S. Warner, W9DYV—Here is a new report from a new SCM. Thanks, gang, for the election support. W9BK is building a new 7½ watt TPTG xmitter. 1929 model for 3750 kc. (80 meters) and has to replace his mast which was lowered by high wind. He keeps skeds with three other stations. FB OM. W9CUT has a portable set going on 7500 kc. (40 meters) and was QSO with 7 districts. W9BJV lost his halvard in a wind storm and was shut down all month but hopes to be going again soon. W9DYV is doing some rebuilding on a TPTG transmitter. W9DYA keeps plugging away but reports no traffic.

Traffic: W9CUT 4, W9DYV 4.

SOUTH DAKOTA—SCM, Dwight Pasek, W9DGR—W9DWN has consented to be RM again so we can count on a snappy traffic leader. Look for him on 40 and 80 and arrange some schedules. Even though you are not an ORS, drop the SCM a line on the 25th and give your station dope and anything that would be of interest in our state bulletin. W9DGR is away on a trip visiting some Canuk stations enroute. W9CKT is back again and fixing up a television layout. W9DNS is hitting the ball and reports that W9DES has moved out to the west coast. Seems like they get all our best ops. W9DB is trying to persuade the set to put out a 1929 sig. W9FOQ worked a bunch of stations but no traffic.

Traffic: W9DWN 162, W9DB 14, W9DGR 6, W9DNS 3.

DELTA DIVISION

ARKANSAS—SCM, H. E. Velte, W5ABI—Hot!!! Boy, we'll say it has been but in spite of the heat, we still have a bunch of active stations. W5HN says that for heat, his shack is next only to a stove. W5BDD is having QRM from BCLs wanting their radios fixed. W5ANN is reported heard by an OA. W5ANB is installing radio sets on airplanes for the Air Squadron. W5ABI has been working. W5AQX on schedule and handling traffic between the Vapor City and Little Rock. W5AQX and W5BCZ reported via radio. We are sure glad to have our former SCM (W5AIP) back with us. He is operator at KTHS now. W5SS is also back with us. He has completed his Aviation Course and says he is glad to be back on the air. W5IQ reports that he is still wanting to test on 28 mc. (10 meters). The SCM had the pleasure of listening to the Acoustic Wave Filter he built as per August QST. It works FB. W5AUI is out of the hospital and has been pounding brass for the Nat'l. Guard encampment. W5ZAA is about ready to shove off. W5BDB wants an ORS appointment. The SCM will be glad to hear from any of the gang and would like to make more ORS appointments. Things are beginning to pick up in

Arkansas and by fall we expect to be sending in much better reports.

Traffic: W5ABI 51, W5AQX 11, W5BCZ 2.
MISSISSIPPI—SCM, J. W. Gullett, W5AKP—Well, gang, I am going to start cleaning up Miss. by canceling all inactive ORS certificates. Watch out W5AYB and W5API—this is your last chance and if you want to keep your certificate, you will have to report every month without fail. If I don't hear from you next report, you will no longer be an ORS. W5BBX is a new 7000 kc. (40 meter) station located in Booneville and promises to be a real good low power station. W5ANP has just completed a 28 mc. (10 meter) transmitter and also 85 mc. (80 meter) layout. W5AJJ says he is dusting cobwebs off the old set and is beginning to take new interest in ham radio. W5FQ is on the verge of rebuilding his big set so that it will comply with the 1929 regulations. W5AKP has just finished rebuilding his power unit and receiver and they are both FB but his B batteries quit on him so he will have to put out a little more cash.

Traffic: W5AKP 50, W5FQ 12, W5ANP 6, W5AJJ 2.

LOUISIANA—SCM, C. A. Freitag, W5UK—W5EB has been visiting in north La. He helped W5BDJ of Monroe get on the air with 7½ watts. It looks like we are going to have a peppy bunch in this section.

HUDSON DIVISION

NORTHERN NEW JERSEY—SCM, A. G. Wester, W2WR—W2AS has been experimenting with fair results on the 28 mc. (10 meter) band. He will leave shortly for Princeton. W2AT handled the most traffic this month and is also getting his fall schedules working. W2CP will be back strong with heavy traffic. W2CW maintains a schedule Wednesday with W1ARE. W2EY is playing with a voltage feed antenna. W2FC installed a shield grid receiver which works FB. W2KA has changed to 7000 kc. (40 meter band). W2ASZ has had fine results this summer with DX. W2JG will be off for a month due to re-installing the transmitter in a new part of the house. W2AGN's YL is vacationing which accounts for his good traffic total. W2AGN is stepping out in all directions with a fifty watt. W2MD is awaiting cooler weather so DX will pick up. W2CTQ put in a new rectifier and mast. W2CJX will return to the air in Sept. sure. W2BY has had an eventful summer paying visits to ham and commercial stations. W2BIR is returning to his summer home Sept. 15. W2AVK QSO'd ek-4AAR in August. W2BAL is experimenting with BCL television. W2AOP will handle traffic again now as his shack is cooling off. W2BDQ, W2WR and a few others plan to welcome ek-4CL when he arrives on the Homeric in New York on Sept. 26. W2CJD is bothered seriously with YLs. W2CKZ sent in his initial report and has hooked with WFBT to handle traffic.

Traffic: W2AT 73, W2CP 1, W2CW 3, W2FC 2, W2ASZ 2, W2AGN 31, W2ANG 16, W2MD 11, W2CTQ 2, W2BY 26, W2AVK 12, W2BAL 3, W2AOP 5, W2CJD 1, W2CKQ 17.

EASTERN NEW YORK—SCM, E. M. Holbrook, W2CNS—Eight stations handled 166 messages. W2APQ made our best quota altho very QRW with YL and a new Ford. W2BKE has left for Atlanta, Ga., to join W4RN and build a super-power station. W2AXX entertained 25 guests this month but does not say whether YLs or OMs. W2MZ at her shack entertained our New Jersey YL, W2BY, with W2RP and W2APQ. W2AUI is coming up to 3750 kc. (80 meters) and wants schedules. W2JE says very few hams on the air in this hot weather. W2CTH has blown a UX210 and UX211 so will be off the air temporarily. W2AY is off rebuilding at old QRA and will have MG set. W2TD will soon be back on the air. W2AUQ who had pre-war spark station W2VP, is opening up with a 7½ watt and says W2CXL pounds in R7-3 at Marlboro and one of best stations to copy in recent QRN. W2SJ makes first report since operating in second district, just across Mohawk from Schenectady. He says most active stations in his vicinity are W2ACY on 15,000 kc. (20 meters) and 2BIA on 7500 kc. (40 meters).

Traffic: W2APQ 79, W2BKE 30, W2AXX 21, W2AYK 10, W2AUO 4, W2JE 3, W2SJ 16, W2CNS 3.

NEW YORK CITY AND LONG ISLAND—SCM, M. B. Kahn, W2KR—Now that all the inactive ORS appointments have been cancelled, the remaining ORS came through with some fine reports this month, and traffic took a big jump and three stations made

the BPL. They are W2BFY, W2KR and W2APV. W2BFY is a non-ORS but will shortly be in line for an appointment if he keeps up the good work. W2AVB, Long Island's RM, deserves special mention for his work in getting the L. I. section organized from practically nothing. They lead all N.Y.C. in traffic. FB. There is plenty of room for the new stations to become ORS and those that have ambitions may send in their traffic reports and applications. Keep up the good work, fellows. Let's show 'em what we really can do.

Manhattan: W2ALU leads in traffic due to his night-ly sked with nz-FR5. W2KR is on 7760 kc. (38.7 meters) with crystal control and on 8530 kc. (85 meters) with fone. Messages from 1qPM relayed on sked through W4OC are given immediate delivery. W2BCB is quite active and has daily sked with W6CJN. W2AFO can be heard on 7980 kc. (37.6 meters) most every night. W2BGO finds it impossible to hook up with West Coast ORS between 2 and 4 am EST. W2CS is flying model airplanes but says DX is good. W2ANX has been away for the summer but will be back again shortly. W2BNL's flivver keeps him busy.

Bronx: W2APV's deliveries enabled him to make the BPL. W2ALL will be going back to college next month but will operate from there. W2BDH came through with his first report. W2CYX has "Ylitis" but promises to get busy next month. W2BBX is having trouble with his usually fine outfit. W2SF foned a message to Governor of N.C. who was in N.Y.C. to see Tunney fight. He is the ham's friend now. W2AET's vacation kept him off the air for a while but he is QRV now.

Brooklyn: W2BDM has been busy getting his new MOPA set ready for 1929. W2PF is busy with ARRL booth at Madison Square Garden for Radio Show to be held Sept. 17-22. W2APD reports after ORS has been cancelled but if activity warrants, renewal can be applied for. W2BRB will be on 28.27 mc. (10.25 meters) crystal controlled and on 8530 kc. (85 meters) with fone.

Long Island: W2BFY leads the whole section in traffic. (Keep up the good work, OM—SCM). W2AVB gets most of his messages from WSBS skeds. W2AEU-ASS is in line for an ORS appointment. W2APL is doing most of his DX on 14,000 kc. (20 meter band). W2AVP is another station whose activity will place him on ORS list.

Staten Island: W2ABO is the only man who seems to be alive on the Island. Where are all the stations from that section?

Traffic: Manhattan: W2ALU 90, W2KR 85, W2BCB 31, W2AFO 25, W2BGO 14, W2CS 14, W2ANX 8, W2BNL 6. Bronx: W2APV 81, W2ALL 53, W2BDH 29, W2CYX 24, W2BBX 19, W2SF 12, W2AET 9. Brooklyn: W2BDM 12, W2PF 9. Staten Island: W2ABO 3. Long Island: W2BFY 357, W2AVB-XAU 93, W2AVP 85, W2AUE-ASS 36, W2APL 10.

MIDWEST DIVISION

IOWA—SCM, H. W. Kerr, W9DZW—Four ORS and 3 non-ORS report with an increase of a 100% over last year. If W9CKQ's report is just a forerunner, we will have to ORS him or the regulars' reputation will be nil. W9BCA continues CAB skeds. W9DEA's QRA is now Sioux City, QRW wholesale hardware. W9DKV's faithful 80 ft. mast was leveled by a storm. W9CUK is at Valp trying for com'l ticket. W9BCL of 'ol Kentuck is residing at Sioux City. W9CZC is QRW golf and training for the dance marathon. W9BCA tops the traffic list and makes the BPL. A hamfest at W9ELW's recently invoked a lot of enthusiasm and more OW's are working the buzzers. The RM is frozen on 8945 kc. (76 meters) again—now let's help the Midwest Division move up from seventh place. W9CZC and W9DZW are planning to drop in on the boys at Sioux City, Shenandoah and Malvern if they can get away.

Traffic: W9BCA 245, W9CKQ 143, W9EHN 67, W9DZW 12, W9EIW 7, W9EJW 2, W9DPL 1.

NEBRASKA—SCM, C. B. Diehl, W9BYG—W9QY is very busy with his harvest and threshing and we will excuse him as we know that this is the only time of the year that the job can be done. W9EEW has started up again and also reports that Mrs. W9EEW is getting along fine now and will soon be herself again after the operation. W9DVR sure does make things sing this time, bully for you, OM, and go to it. W9BOQ is also busy with harvest and threshing. W9CHB hasn't learned yet the Ford and Radio won't mix, but he will know all about it. Hi, W9BYG is busy painting the house, also got a whimper out of the xtal and threw a fit. W9BBS is in the rush season

on the RR and trying to rebuild the receiver. W9CDB will soon be at it again as rebuilding nearly done now. W9BQR works on 14,000 kc. (20 meter) band most of the time and reports good results.

Traffic: W9EEW 11, W9DVR 50, W9CHB 5, W9BBS 3.

KANSAS—SCM, J. H. Amis, W9CET—W9CFN leads the Section with a nice total. W9LN works OA and OZ regularly with 7½ watts but will soon sign a "6." Sorry to lose you, OB. W9CKV and W9HL are QRW due to the hot weather. W9CV and W9BHR are QRW getting ready for the Kansas convention which will be held in Topeka Oct. 12th and 13th. W9CET is going strong with an 852 and mercury arc, also a 222 receiver. W9FLG lost a 210 keeping skeds with CX7. W9DIH is using crystal on the 14,000 kc. (20 meter) and 7000 kc. (40 meter) bands. W9CFN keeps a 3 cornered sked with W9LN and W9BDS. W9DFY handles traffic from WITB and sp-CBI. W9AEK is now a com'l 1st. Your new SCM wishes at this time to assure the gang that he is behind you and expects your support. Let's go, fellows, and put Kansas on the map with large traffic totals. There is room in the section for a few ORS appointments—let's have your applications, fellows.

Traffic: W9CFN 185, W9LN 51, W9CKV 20, W9DFY 31, W9CET 30, W9FLG 6, W9HL 4, W9DIH 9.

MISSOURI—SCM, L. B. Laizure, W9RR—St. Louis amateurs were mostly on vacation this month. W9BEU was off a week visiting around K.C. and W9AOT just returned from a trip west. W9BEQ still is absent somewhere in the northwest according to W9BEU. W9ZK led in traffic with W9BEU short by just one message for second. W9BEU applied for OBS appointment. W9BMU and W9DZN were next highest in traffic figures. W9BMU is cheering up now that he passed the exam OK and is all set for traffic by schedule. W9DZN is using ex-W9DFQ's old 50 watter and says it's FB. W9ZK says he is going in strong for 56 m.c. (5 meter) and 28 m.c. (10 meter) work. W9BUL takes the lead in traffic for the state stations with 45 mgs, followed by W9ECS with 31. W9BUL handled Nat. Guard traffic thru W5AZW during local encampment of the Webb City unit, at Ft. Sill, Okla. W9ECS kicks in with the following: W9FKF, a new ham in Sikeston, is crowing over an 8½ pound boy; W9ASG is installing new chem. rect.; skeds at W9ECS are working FB with W9LN, W9DFY and W9BAZ. W9EPX is a new ORS and is out for traffic with skeds with W9EPY and W9FKZ. W9FNJ sends his first report and is keeping three skeds thru much QRM. W9FNJ lost 3 tubes from receiver when lightning paid his antenna a visit. W9ERM bobs in with some traffic and a QTC regarding Naval Reserve work. W9ARA was on until the 22nd going on a tour of the east. W9ASV was QRT during the month. W9DKG is putting a 250 on 7800 kc. (38.5 m.) right away and has a sked with W9FIO. W9EUB is about QRT rebuilding receiver. W9CDF is monkeying with low power stuff and portables. W9FBF-W9FSI is getting freak reports of DX heard on 7500 kc. (40 meters) when the transmitter is on 1680 kc. (178 meters). W9DAE and W9ASV remembered the SCM with reports even though no traffic was handled. Kansas City stations did not accomplish a great deal this month due to the usual QRM from vacations, etc. W9FTE had good success with his new xtal layout and speared a few messages. W9EWH is another newcomer this season and kept skeds with AM7 at Ft. Dodge, Iowa, during camp. W9DQN handled a few mgs but was mostly QRX with paralyzed 50 watter. W9BSB is still off rebuilding the works. No dope on the other stations was available due to the SCM being too QRW to dig same out.

Traffic: W9ZK 24, W9BMU 12, W9DZN 3, W9BEU 23, W9BUL 45, W9ECS 31, W9BJA 13, W9EUB 1, W9DKG 3, W9ARA 14, W9ERM 14, W9FNJ 17, W9EPX 21, W9FTE 6, W9EWH 18.

NEW ENGLAND DIVISION

CONNECTICUT—SCM, C. A. Weidenhammer, W1ZL—The ORS in Conn. are all lined up ready for the big traffic marathon and they have pledged themselves to break all records. We have several traffic Joie Rays and they will make those who compete with us realize that they have been in a race. W1CTI, W1AOI, and W1BEM have written the SCM to tell of their route plans which should cover Conn. with some "red-hot" traffic avenues. More definite route data will be published next month. W1TD will resume his schedule with

W1BI-W1BQH at Boston when the latter returns to school on Sept. 8. W1VE is dividing his time between the 14,000 kc. (20 meter) and 8500 kc. (80 meter) bands and promises to have a number of schedules next month. W1ASD has a schedule with W1ABX at 6 pm on Monday, Wednesday and Friday. He worked GMD and WSBS. W1AMG was surprised on his birthday with a radio stag party given by W1AUK, W1CVP, W1FT and W1ATN. Needless to say it was a large evening. W1PE reports things very slow on the 8500 kc. (80 meter) band. W1BWM has been doing his good turn daily at a scout camp. W1AOX can hardly wait to make the BPL. Good luck, OM. W1VB is vacationing. W1BHM will start up again in October. W1CTI has moved to 7 Union Ave., South Norwalk. He will be on 13,500 kc. (80 meters) as soon as he gets his new antenna up. W1BM states that he has had his first radio vacation. We have missed him and welcome him back. W1BJK has been busy with the telephone line engineering. W1BNS expects to have a new receiver shortly. W1MK reports that conditions have improved generally. Farmer kept his regular schedule with the *Carnegie* and worked OZ. Our YL operator W1OS, hopes to be active in another month. W1ZL will return from Pennsylvania wilds October 3. W1AFB has been doing his usual splendid DX. He always seems to find time to handle a goodly amount of traffic, too. FB. W1AMC has schedules with W3QP, W1AMZ and W1BBT. He has built a new TP-TG transmitter. The gang welcomes W1BVB, exSCM of Rhode Island, to Conn.

Traffic: W1MK 554, W1AFB 95, W1ASD 30, W1VE 31, W1BNS 5, W1AMC 17, W1TD 14, W1AMG 20, W1PE 14, W1BI-W1BQH 6, W1VB 4.

Maine—SCM, Fred Best, W1BIG—The SCM wants to thank the Maine gang for the splendid support accorded him in the recent election, and promises to put the ARRL over bigger in the coming two years than he did in the past. Nuuf sed! W1BIG, by way of celebration, heads the traffic handlers again this month. W8ZF, W8BJM, and W8EU helped him with some fine traffic, most of which found its way to the Communications Dept. at HQ. HI. W1KQ, with a mighty fine total this month, gives notice that he is on the trail of an ORS. W1CDX, having landed his ORS appointment, is making the ole traffic fly right and left. W1AAV turned in his usual fine total. He says he has built up a 1929 outfit and that practically all reports are now crystal control. W1AUR has a fine outfit going on about 4000 kc. (75 meters). He is interested in the USNR and plans to attend drills with Section One this coming fall and winter. FB. OM. W1ANH, altho busy with his Chevy sales business, found time to handle a grand total and he is setting a good example for other ORS. Mrs. W1AJC sent in her first individual report. Hitherto, she has always reported with the OM. Congratulations on your gaining your ORS appointment. OW. W1AT handled the same total as Mrs. W1AJC but when he gets going, I suppose he shall gain the head of the list once more. W1AQL reports that the Queen City Radio Club is to have its yearly outing soon. Wonder who will win the clam chowder eating championship this year. The SCM is again pulling for W1AQL to win. W1AJC trails the OW. That's tuff, OM, but we know how it is when the OW don't let you get at the set. HI. W1AQD turned in a mighty fine Official Observer report as well as a good traffic total. His work is mighty important and the SCM would like to hear from other hams who are equipped and who will give the time to OO work. W1BAY sends in his final report. He is leaving the state this fall. We sure hate to see you go, Perry OM, for you sure were a livewire. Good luck to you, OM. W1BFZ trails the gang this month. It wasn't always so, though, but when the DX bug gets a traffic man, it usually goes hard with the traffic.

Traffic: W1BIG 155, W1KQ 48, W1CDX 30, W1AAV 25, W1AUR 22, W1ANH 18, Mrs. W1AJC 12, W1AT 12, W1AQL 9, W1AJC 8, W1AQD 8, W1BAY 5, W1BFZ 8.

New Hampshire—SCM, V. W. Hodge, W1ATJ—Cooler weather has increased the traffic total. Many new stations will be on the air soon as N.H. sure ought to have a fine traffic year. W1BFT handled a bunch between toots on the trombone. W1IP has new batts in his transmitter and is all set for traffic. W1JN is back after a nice vacation. W1AUI in Meredith is ready for traffic. W1AUE is doing a lot of DX and handling his share of traffic. 15,000 kc. (20 meters) has claimed W1AEF for a while. W1BLA sent in his first report. He will be at

N.H.U. this fall. The SCM will be glad to hear from any new stations who haven't already reported.

Traffic: W1AUE 75, W1BFT 73, W1IP 53, W1BLA 8, W1AEF 8, W1ATJ 3.

WESTERN MASSACHUSETTS—SCM, J. A. Teasmer, WIUM—The fishing season, YLs and other outdoor sports (hi) have sure put the crimp in the reports this month. W1APL's murder-cycle is still cycling. W1ASU spent the week with W1AOF and says the Berkshires are sure fine business for Ozone, and wants the gang to know that there will be much doing at the club this coming season. W1AJK says that he is out of circulation with the mumps—and how! W1BKQ is accumulating some dust. Too much steam in the rooms. W1BVR will be on approx. 7800 kc. (88-89 meters) during school vacations. W1AMZ has schedules with W1AMC and W8BPH at 7 and 7:30 pm Mon. and Wed. W1AOF QSO'd fq-40C, connecting husband in Africa with his wife in Northfield. W1EL is visiting Worcester again. New QRA is care of Amrad, 205 Colledge Ave., Medford, Mass. W1AWW has been on a fishing trip, taking his portable, W1OF along with him. He reports many successful QSO's and a nice time in general.

Traffic: W1AMZ 68, W1AOF 67, W1APL 6, W1ASU 4, W1AJK 1, W1BKQ 1.

VERMONT—SCM, C. A. Paulette, WIIT—Well, gang, here is the first report that I have the pleasure of giving you. Thanks, Charles OB, for the compliments in the last report and I surely will try to fill the job. W1AOC, our chief RM, takes the cake this month with a total of 162, very good work OB for summertime. W1AJG is to be our Vermont broadcast station for Vermont news only. W1AJG is operating on both 7000 kc. (40 meters) and 8500 kc. (80 meter) bands. W1BCK is the only other man to report this month in this section and he reports that he had his transmitter at Camp Weeks, Fort Ethan, Vt., while National Guard encampment was held there and reports many QSO's. Well, boys, I don't blame you for laying off during the summer but let's get at it soon and show up this old state a little bit this winter. What say?

Traffic: W1AOC 162, W1AJG 3, W1BCK 2.

RHODE ISLAND—W1BDQ has QRM from work. W1CKB cannot seem to get any traffic on 15,000 kc. (20 meters) so will try 7500 kc. (40 meters). W1AWE got back from Canada but his traffic is small. Has QSO'd EM, EN, SB, SC, EG, EF though since he got back. W1MO built a new 15,000 kc. (20 meter) transmitter this month. W7PX was a visitor at his shack, but IMO wasn't at home.

Traffic: W1AWE 5, W1MO 6.

EASTERN MASSACHUSETTS—SCM, E. L. Battery, WIUE—W1ADM, W1AUV, W1CM and W1CWM are on the inactive list for awhile. W1SL is being cancelled for failure to report and W1ON for inactivity. W1BIX, W1AZE, W1CQ and W1BBT are in line for ORS. FB, OMs, but it means real work. W1CRA leads us in traffic this month. W1BVL reports station W1KX operated by Consolidated Lamp Co., Danvers and wants the gang to look for him from there. W1ABZ has been at summer camp in Maine. W1WV has rebuilt per August QST. W1RF is working lots of DX these days. W1KY had a visit from W8ZF and W8EU. Any of the fellows having dope on electrolytic rectifiers should get in touch with W1RY as he wants some. W1AKS and W1VZ keep Chatham on the map. W1ACA is with us again and reports working eg-2BM on 15,000 kc. (20 meters). W1LM says everything flat except USNR. W1NV worked EM and ER on 15,000 kc. (20 meters). A ham-to-be-soon, Fred Black, and W1UE spent two weeks vacation at Ellsworth, Maine and visited W1HB several times. W1PE is to be married very soon. Good luck, OM. W1BDV will be back in Salem after summering at York Beach late in Sept. W1ADM has landed a job with a talking-movie machine company and will travel extensively installing the outfits. Watch for him signing "SX" from some "six" or "seven". HI. W1JM is starting up now with a 210 and Kenotrons. W1APK says very QRW work; he also operates occasionally at W1BIX. W1ACH, W1AAW and W1NK report as usual. W1KH spent two weeks in Maine. W1COZ a new ham, is reported by W1BTT in his town. W1ATO is now located in Quincy and has a FB location. W1RL has been trying to get lined up for Naval Reserve cruise but trouble always arises with the boat. W1SB is rebuilding anticipating a busy winter.

Traffic: W1CRA 62, W1ACH 49, W1BIX 35, W1KY 19, W1LM 18, W1RF 16, W1BDV 15, W1ACA 14, W1RY 10, W1KH 9, W1BBT 8, W1UE 7, W1WV 8, W1NV 4, W1APK 3, W1BVL 2, W1AAW 1.

NORTHWESTERN DIVISION

OREGON—SCM, R. W. Wright, W7PP—W7MF is on the air regularly at Medford and is also holding skeds. W7AIX will be back on the air sometime in September. W7ABE has turned commercial and is now operator on the S.S. *Lakina* (WNB). W7GQ, by holding a sked with 7AY who is in Alaska, keeps the folks at home in communication with him. W7HV has a 1929 transmitter going now and says its FB. W7UN rates the BPL this month and is also high man for this section again. Let's have some real reports next month fellows. Fall is here and with 1929 coming on, surely there is more activity than is apparent from the few reports received.

Traffic: W7UN 205, W7MF 127, W7AJZ 35, W7EH 26, W7GQ 16.

MONTANA—SCM, O. W. Viers, W7AAT—W7DD says he's QRD the N.W. Division Convention and the station will be silent except for the OBS which will be sent on regular schedule time by the second op. W7EL went through the Yellowstone Park and hopes to be on again soon. W7ZU says he has been experimenting with Lecher Wires and standing waves. W7JC the new active Billings station formerly of Portland, Ore., went west, no not out but stopped in on W7ZU, W7EL and some of the gang in the western part of the section. W7HP was inactive from Miles City but handled a few from the SCM's layout while making a short visit. The voice of W7AAT (the little M.G.) will now be heard from W7HP this winter. W7AAW handled a few on 14 mc. (20 meters) and hopes to be on 23 mc. (10 meters) in the near future. W7AAT did a lot of experimenting—not with radio but with the motorcycle he bought from W7FL. W7AHG, one of the three Red Lodge hams will be departing for college this fall but may set up at Bozeman with W7ZU and W7EL. W7AFP hopes to be on full blast soon. Several new prospects have shown up in Red Lodge and near by so this part of the section ought to be voiced on the air quite regularly this coming season. More reports must show up next month or several QSK's will be the result. W7HP has been appointed the new RM for Montana, so give him your cooperation, boys.

Traffic: W7AAW 36, W7DD 24, W7AAT 9.

WASHINGTON—SCM, Otto Johnson, W7FD—All hands attended the annual Northwestern Division Convention at Seattle Aug. 31 and Sept. 1st. Mr. Huber from headquarters made quite a hit with the gang, especially the YL portion. Hi. The trip to NPC at Keyport will probably result in some improved transmitters about the district. W7TX is still the most consistent traffic station. W7LZ is trying out a 250 watt. W7ACS at Tacoma is a new ORS. Many of the gang are returning from Alaska and will be on again shortly. The fall season will bring out many hams with new and better stations.

Traffic: W7TX 54, W7ACS 52, W7ACB 28, W7BR 26, W7ACA 4.

ALASKA—SCM, W. B. Wilson, W7WDN—Alaska is losing many of her amateur stations due to close of fishing activities for the season. K7ABE, K7HL, K7JR and VOQ are still with us, however. Traffic still runs heavy. All VOQ traffic is relayed via ham radio.

Traffic: K7HL 205, K7JR 193, K7ABE 188, VOQ 32.

PACIFIC DIVISION

LOS ANGELES—SCM, D. C. Wallace, W6AM—Five station make the BPL this month. W6CUH's total jumping up to 627 which is FB. W6ZBJ, W6CHA, W6UJ, W6DOW also make the BPL. W6ZBJ handled a lot of traffic for ex W6CLV at sea. W6CHA has been handling messages from K6BQH and his YL. He is now the proud possessor of an 852 jug. W6UJ, one of our newer ORS's, keeps some good skeds. He says W6GEX is organizing a ham club in Monrovia and figures on the El Monte hams joining with them. W6DOW says his sked with op1CM is what helped him to make the BPL. W6CQP sends in a very good report. W6QL just worked ex5MS on 14,000 kc. (20 meter band), his first EG. He handled some traffic from W6AX who says he is having a fine time eating Mr. Dole's pineapples and sends 73 to the gang. W6ABK has just built a 1929 Hi C transmitter and it works good. W6DMG kept no skeds but had a good total nevertheless. W6DXK has been on 15,000 kc. (20 meters) for the past week and handled some traffic on that band.

W6AEC sends in a good report. W6DKV had visitors from Utah, also K6AVL. W6DSG promises that his total will be better from now on. W6AGR is working over a transmitter to 1929 circuit. W6CNJ has been experimenting with low power Hi C circuit and it seems FB. W6BRO will be on the operating staff of the ARRC booth at the Los Angeles Radio Show Beautiful. W6ALR has been busy in radio business building transmitters and BCL sets to order. W6BVM got R7 from FO with 30 watts input. W6GHT received an R8 report from OA while using a single 210. W6AKD has been trying out 23 mc. (10 meter) band. W6BJX reports W6QU is buying up junk to get back on the air. W6COT is planning to overhaul the whole set for 1929. W6AOS is going to be one of our ORS and sends in a good report. W6EEB is rebuilding for 1929. W6ASM has charge of the operators of the ARRL-ARRC booth at the Los Angeles Radio Show station, W6PS. He will be assisted by W6DJY. W6QF furnished the sets. W6CAG is back again with renewed interest and would like some skeds to keep pounding brass. W6DHR is now working in a radio store. W6DEG spent the month rebuilding. W6CZT had a nice ¾ hour chat with sj-5EA which came in fine on the loud speaker. W6CBD is rebuilding receiver shield grid as per "Radio". W6BHR QSO's NZ and Australia. W6BZC will be back on by the time of the Radio Show. W6PY is doing some rebuilding and QRW work. He visited K6CFQ and K6CDU. W6CZU visited W6CQP at Balboa Beach and says he has a real 1929 transmitter with 852 tube. W6BZR is off the air until his 50 gets back from W6EX. W6DGT is getting his set ready for 1929 wave bands. W6AKW is still busy haying but will want skeds soon.

The new Foothill High Frequency Club of Arcadia writes us telling of what the club is doing. They have been challenged to a "miles per watt" contest by the Pasadena Short Wave Club. W6ZZD reports that 14 mc. (20 meter) and 28 mc. (10 meter) sigs have been very scarce the past few weeks. Had one QSO on the latter wave. W6LJ was in charge of the six transmitters and receivers working the NARA National Air Races. There were 2000 planes and \$350,000 spent on this affair. The ARRC supplied the transmitters and receivers and they had special waves and special calls for 10 days. Notices have been mailed out to all the Los Angeles Section announcing the quarterly ARRL Banquet Sept. 12th, 8 pm in the Chamber of Commerce Bldg., Los Angeles. This banquet is being put on by the ARRC of Los Angeles and promises to be a real live meeting. The ARRC has a membership of 82 members and is one of the peppiest clubs in existence. The ARRC is also handling the booth at the Los Angeles Radio Show Beautiful and plan on handling lots of traffic from there. The Associated Radio Amateurs of Long Beach continue with their good meetings on the second and last Monday nights of the month. They usually meet at Washington School, although some of the meetings are at the homes of the various members.

Traffic: W6CUH 627, W6ZBJ 344, W6CHA 284, W6UJ 162, W6DOW 214, W6CQP 77, W6QL 73, W6ABK 71, W6DMG 37, W6DKX 35, W6DKV 29, W6DSG 28, W6AEC 30, W6AGR 22, W6AM 20, W6CNJ 17, W6BRO 15, W6ALR 14, W6BVM 13, W6GHT 13, W6AKD 10, W6BJX 10, W6COT 9, W6AOS 9, W6EEB 7, W6ASM 6, W6CAG 5, W6DHR 5, W6DEG 3, W6DZT 2, W6CBD 2.

EAST BAY—SCM, J. W. Frates, W6CZR—The high traffic totals of the section for the past several months dropped a bit during the past month due to the tremendous amount of work required by the coming Pacific Division Convention in Oakland October 11, 12 and 13 at the Key Route Inn. However, four men made the BPL. W6CCT, one of the RMs of the section, landed at the head of the list after several weeks of strenuous effort. He accomplished the feat in spite of the fact that he is doing quite a bit of experimental work in television. Next month he has a television contest on with W6CTX and a traffic contest on with W6IP, the loser to buy the other a dinner and to receive the SCM's Sockweiler as a consolation prize. W6IP made the BPL and is working on a series of Pacific Coast schedules to be known as the Gold Coast Limited. W6ALX again hit the BPL and is experimenting with a number of transmitters. W6HJ, who also made the BPL, reports traffic not so good. He worked op1HR 18 times and got only three messages. He accords the rag chews championship to K7AER who claims he is the undefeated champion of Alaska. W6CTX is

sponsoring a new traffic organization to be known as the Night Hawks, composed of all traffic men who make a total of over 50 messages a month and is planning to keep W6CCT entertained by sending the "funnies" over the air by television. W6CZR maintained skeds with K6BQH and op1PW as part of a new traffic route that may extend to Rangoon, India. He and K6BQH double up on op1PW, one getting what the other misses. W6ASJ made his debut as a traffic handler this month and has earned the title of the Armenian through his ability to get a perfectly good motor generator for \$1. W6CGM is back on 7500 kc. (40 meters), an 852 and no QRM and is planning to burn up his favorite frequency in that band. He QSR'd a message from WAACE in Florida to K6BQH in 30 minutes. W6BSB has been inviting the entire Pacific Division to the convention by means of his 900 cycle Ultraudion. W6SR has no skeds but craves many. W6EBA also makes his debut as a traffic man but says he is afflicted with a bad power leak and is going on 3400 kc. (80 meters) with fone as soon as he can make his modular modulate. HI. W6COL reports 15,000 kc. (20 meters) is again good for DX and has a 50 watt in the old Hartley going full blast every p.m. W6CLZ announces that he is again QRW with school and will only be on the air on Sundays. W6RJ declares that he has been forced to shut down on account of a bad power leak but hopes he can get relief soon. W6IM is very QRW with work but gets some time to work. W6CTX's outfit. W6EDK is shooting out the League broadcasts by his automatic arrangement as well as those in connection with the convention. W6BZU at Concord set an example for everybody by snatching a few minutes at his transmitter in order not to send his traffic report in bare. W6CDA has an 852 in a Colpitts, but hopes to get xtal control in soon. W6DTM says the 852 went west, the 500 cycle generator was sold and he has come down to earth with the old 210 and slop again. W6IT handled another message but is keeping a sharp lookout on offwave operation as official observer. W6BUX is back at Angwin and, with the aid of W6BJD, is getting good reports with a 210 from Asia, Australia and South Africa. W6CUG and W6PU are planning on a series of 23 mc (10 meter) tests. W6AMI reports working a Danish boat, OZP, off the Mexican coast. W6EDX is one of the new entries into the traffic field. The section monthly dinner meeting was held during the past month at the Florence Cafe with discussion centering around the convention, 23 mc. (10 meter) tests and new traffic routes. The Oakland Radio Club has secured its new caps for the convention, a dark blue overseas cap with gold edging and gold lettering on the side. The Central Calif. Radio Club had reorganized after the summer season and is holding weekly meetings.

Traffic: W6CCT 217, W6IP 184, W6ALX 116, W6HJ 108, W6CTX 78, W6CZR 63, W6ASK 35, W6CGM 29, W6BSB 21, W6EDX 18, W6EDS 13, W6SR 14, W6EBA 13, W6COL 13, W6CLZ 9, W6RJ 6, W6IM 4, W6EDK 4, W6DTM 3, W6BZU 2, W6CDA 2, W6IT 1.

SANTA CLARA VALLEY—SCM, F. J. Quemont, W6NX—W6AMM had his biggest message total this month and although in the middle of summer with QRN at its peak, his signals continue to break through to op-1HR with clocklike regularity. With a grand total of 450, 308 of which were delivered, W6AMM should stand near the top in the BPL this month. Each one of the messages were to and from the Philippines—an 8000 mile jump. W6BWM reports traffic low due to no reliable schedules, his crystal control transmitter is on 7800 kc. (38.5 meters). W6BAX leads the section in low power work. With 15 watts into a 201A, EG, OA and SC were worked. W6ALW lost his aerial this month in a wind storm and next his filter went out. W6NX, W6AAZ and W6KG were on 28 mc. (10 meters) during the month but with very little DX. W6BVY has resumed his sked with op-1AU beginning Oct. 1st and his total should reach about 250 monthly. W6BNH is planning on using 23 mc. (10 meters) soon.

Traffic: W6AMM 450, W6BMW 13, W6BY 17, W6BAX 12, W6ALW 3, W6NX 3.

ARIZONA—SCM, D. B. Lamb, W6ANO—W6BJF makes the BPL with 86 deliveries. His traffic total picked up considerably this month. W6BJF's antenna was wrecked by a high wind storm which hit Phoenix. W6CDU took his outfit to Nat'l. Guard Camp at Fort Huachuca, Ariz. which boosted his traffic total. He

kept schedule with W6BJF during his two weeks stay. The storm also wrecked W6BWS's antenna and rain finished the job. His YL is in Kansas for the summer hence the large traffic total. W6EAA has been having trouble trying to get DC out of the soup. W6AZM says the mercury arc is still going strong. W6ANO's transmitter is working FB. W6BHC reports no more high voltage burns received from his 3000 AC on an 852. W6DIB is still at Marmon Lake on vacation. W6SW went to the coast on a business trip. W6EFC is working for the Coca Cola Soda Co. His transmitter is working FB. W6CAP is on every morning with a good wallop.

Traffic: W6EAA 42, W6BWS 146, W6CDU 148, W6BJF 149, W6BHC 4, W6ANO 41.

SAN DIEGO—SCM, G. A. Sears, W6BQ—W6AJM leads this month again with a fine total. W6BYZ is back on the air again and makes the BPL, with his delivered messages. W6BQ is not on the road so much and will have more time for traffic in the future. W6BAM reports much improved conditions at his station. W6DNS reports a fine QSO with sc-1AI recently. By the way, gang, he has a push pull oscillator that is doubling in output with same input as one tube. W6BZD reports helping W6BZE get started again with a 7½ watt and Zepp. antenna W6FP reports very regularly and will have skeds again when the fishing season is over at Arrowhead Lake. HI. W6BAG is back from his vacation. W6BFE reports static bad at Tustin. W6BGL says will send in his application for ORS soon. He reports regularly and we need an ORS at Escondido. Shoot it along, OM. W6QY sticks tight on 14,120 kc. (21 meters). W6AKQ will be back from his cruise soon and QRV traffic. W6OX is selling out and devoting his time to photography. W6BWI also wants to sell out. W6DOB and our old friend Button were in San Diego recently on leave. W6CEV writes that he is now in Vancouver and will be going to Ketchikan, Alaska soon with the Radiore Company.

Traffic: W6AJM 606, W6BYZ 106, W6BQ 44, W6BAM 31, W6DNS 25, W6BZD 10, W6FP 8, W6BFE 8, W6BAG 6, W6BGL 3.

SACRAMENTO VALLEY—SCM, C. F. Mason, W6CBS—This report by radio via W6CIS and W1MK. The SCM is on vacation and the report is rather slim. The Sacramento Radio Club is operating W6SC at the State Fair Sept. 1st to 8th. Several stations are becoming active as fall is here. W6EET, the high school station, is back on. W6CIS is moving to San Francisco so will be off for a few weeks.

Traffic: W6CIS 15, W6DGG 16, W6DON 5, W6CIS 269.

NEVADA—SCM, C. B. Newcombe, W6UO—The report this month just includes the traffic figures so guess the stations didn't give much account of themselves.

Traffic: W6UO 61, W6CHG 30, W6LB 6.

PHILIPPINES—Acting SCM, J. E. Jimenez, op-1AT—Via Radio—op1HR keeps schedules with ac-8ZW, (Shanghai, China), W6HJ, (Vallejo, Calif.), ac-2AB (Tientsin, China), W6AMM (San Jose, Calif.), op-1RC (Cavite, P. I.), ac-2MO (Hsinho, China) daily. Traffic is handled through op-1HR to NU, OH, AC, AM, OD, AN and locals. op-1CM keeps daily schedules with W6DOW, W6AJM and W7MF. op-1DR and op-1AE test on 28 mc. (10 meters) Saturdays and Sundays. Schedules are kept with op-1AH and op-1HR.

Traffic: op1HR 837, op1CM 711, op1DR-op1AE 328.

HAWAII—SCM, F. L. Fullaway, K6CFQ—This is our poorest month so far, fellows. Very few fellows sent in a report. Let's not let it happen again. We are losing operators very rapidly now. Wier of K5AVL and Hoover of K6DEY have left and Lewellen of K6BOE is leaving. K6DEY is now on KPDT, the SS Calawati. W6AX has been in our midst. He spent several days with Forest K6DTG at Schofield. K6ADH makes the BPL again. Guess he feels lonely as the SCM couldn't keep him company but BPL and bellhopping don't mix. K6CFQ handled 127 messages in a week then went to work so had to QRT. K6DJU hooked VOQ, the Morrissey, in Arctic waters. It was 32 below freezing at VOQ and 83 above at K6DJU. K6DPG put up a new Zepp and sure steps out with it. K6CLJ is starting on 28 mc. (10 meters). He keeps a sked with eg-2NH every day. K6DUC is still in the Army. He says the Colonel liked his good looks and picked him as an orderly.

Traffic: K6ADH 173, K6CFQ 127, K6DJU 75, K6DPG 30, K6LJ 2.

ROANOKE DIVISION

VIRGINIA—SCM, J. F. Wohlford, W3CA—W3EC is leaving for the Philippines, but intends to open up on the other side or consolidate with some ham station over there. (Look up op1CM,—SCM). W3ASC makes application for ORS certificate. Is working on the 14,000 kc. (20 meter) band some now and says it's FB. W3AAJ just returned from a vacation trip, hence report a little short on traffic; however, the old set is getting out. W3ALS is getting out with a 112-A and 135 volts having worked all districts. W3ANV has been off the air on account of sickness and mast blown by wind storm. He reports two new hams in his vicinity—W3AVL and W3BY. W3BEZ is on vacation and business, also built and rebuilt his station. W3CA working TP-TG circuit now but not much time for radio now. W3BDZ mounted a two stage W9DXY short wave receiver in metal cabinet 10 x 10 x 12 inches, including space for the batteries in this cabinet so he can take the junk along on trips in the car.

Traffic: W3EC 41, W3ASC 3, W3AAJ 4, W3ALS 24, W3CA 6.

WEST VIRGINIA—SCM, C. S. Hoffman, W8HD—W8APN, W8CSR and W8VZ went to the Columbus Convention. The car broke down and they had to hike 100 miles to meet the gang. W8CLQ leads again in traffic, keeping five commendable schedules. W8DCM kept a schedule with W8DLF for 22 consecutive nights, besides working eight countries. W8BJB is going to leave us, to be on at W8CAU, U. of Cincinnati. W8ALG reported to be elaborately rebuilding. W8DFO complains about no DX—only a twice-a-week schedule with Hawaii. Hi. Glad to welcome W8NDN into the ranks of ORS. Cancellations of ORS's during the month: W8VJ, W8ADI. The SCM welcomes the gang at Wheeling and hopes many can make the trip up this summer.

Traffic: W8CLQ 113, W8BJB 43, W8DCM 11, W8DFO 24, W8APN 2, W8HD 2.

NORTH CAROLINA—SCM, R. S. Morris, W4JR—W4AEW has applied for ORS appointment. W4TS sold his entire outfit but says he will be on soon with a brand new one. W4OC was visited by W4LU, W4WA and W4WG. W4TO has plenty of traffic as a result of good schedules over the state. W4VH is beginning to recover from his summer slump. W4AHI has been off due to the death of his grandmother. W4UB is a new station at Lexington. W4OH rebuilt his set into a cabinet. W4ADJ says his fingers are beginning to itch for the key again. W4RI is rebuilding. W4JR got a first class commercial ticket as a result of a trip to Atlanta. W4AB has moved to Winston-Salem.

Traffic: W4TO 114, W4OC 37, W4AEW 32, W4VH 19, W4TS 4, W4JR 4.

ROCKY MOUNTAIN DIVISION

COLORADO—SCM, C. R. Stedman, W9CAA—W9ENM and W9CAW have asked that their ORS be cancelled as they are leaving for the east coast the first of Sept. We are surely sorry to lose these two, as they have been two of the most consistent stations in the section. W9CAA has installed a pair of rectobulbs and a new filter will soon go on also. W9CSR is still using 15,000 kc. (20 meters) exclusively but hopes to be on 7500 kc. (40 meters) a little soon. W9CDW won a UX210 at the Rocky Mountain Division convention at Pueblo and will be on with 15 watts from now on. W9CCM is back on the air after a 2 month's vacation and is working them all on 7500 kc. (40 meters). W9DKM is moving and may leave the state to go to Calif. in a few weeks. W9ND is cussing a new power line which has just been run past his window. He will change his QRA shortly and be back on the air. W9BQO can't seem to mx YLs and radio. W9ERN has been spending the summer in Denver but will return to Boulder shortly, taking his station with him. W9DQV has been handling quite a bit of traffic. W9EAM says business and radio don't mix very well if you sell gas, but he is getting away with it. W9DGJ and W9BYC have started work for the phone company. W9FUY at Colorado Springs takes the honors for traffic. W9CDE keeps two schedules going although his time on the air is quite limited. W9ENM is cancelling all of his schedules on account of going to the east coast. Walter Van Arsdale is buying everything in sight and as soon as he gets enough to build a station, will apply for a license. W9DQD has resigned his ORS and OBS and is closing down in Sept. As W9DQD and W9ENM have resigned their places as Official Observers, and official Broadcast Stations

for this section, the SCM would be glad to receive applications for the job. W9CLD has rebuilt his station. W9GJC is putting in crystal.

Traffic: W9FUY 133, W9BQO 6, W9ENM 54, W9CAA 20, W9DQV 27, W9DQD 2, W9CLD 23.

UTAH-WYOMING—SCM, P. N. James, W6BAJ—Most of the activity for the month was by non-ORS. In the near future, inactive ORS will be cancelled and appointments given the active stations. Better report, gang, if you want to keep your certificates. The Salt Lake gang was glad to receive a visit this month from Mr. Huber from HQ. W6DPO, W6DPZ, W6DWD, W6DXE and W6AXA all attended the Rocky Mt. Division Convention at Pueblo. Look at W6DPZ's total this month. Not so bad for a 201A with AC on the air 12 days! W6DPO tried to beat W6DPZ but couldn't find enough traffic on the 7000 kc. (40 meter) band. W6DYE reports keeping a sked with portable W1ZZA for two months. During that time W1ZZA has traveled to the Grand Canyon, Yellowstone Park, Calif. and is now in Minnesota with the sked still going strong. W6RM left for Calif. on the 1st of Sept. where he will attend school. We all want to thank him for the good work he has done as SCM. W6RV has been out of town the last six weeks but is going to be on the air now. W6VBV just came on with a new 852 so we expect to hear something from him next month.

Traffic: W6DPZ 129, W6DPO 89, W6DYE 25, W6BAJ 1.

SOUTHEASTERN DIVISION

FLORIDA—SCM, C. E. Ffoulkes, W4LK—August has been kind of hard with some of the gang. W4MS has his hand in a bandage but manages to work on his new shack. W4ABJ was knocked off his motorcycle and will be in the hospital for 10 weeks. He would appreciate hearing from any of the gang; his QRA is Pensacola Hospital, Pensacola, Fla. W4LK has had an infected right arm along with boils. Tough, OM. Sure glad to see W4ACC doing so well over in Tampa. He is a new ORS, too. Heard from W4AGY, an old timer, who is back on in Miami. W4NE handled a message and saved six months for the sender. Hi. W4HY is on now and then. W4BN handled a few skeds during a recent storm. W4TK can't find any DX lately. W4AAO is rebuilding for the winter. W4BL is still on the Lakes. The SCM will be very glad to hear from any of the new hams in the state, so don't be bashful, gang, but step right up. Hi: There will be quite a bunch of ops in the state this winter from the looks of things now.

Traffic: W4ACC 206, W4AGY 30, W4NE 19, W4HY 6, W4BN 5, W4OB 5, W4TK 3.

GA.-S. C.—CUBA—SCM, H. L. Reid, W4KU—South Caro: W4EI is now on 7195 kc. (41.7 meters) with crystal control and has a beautiful signal. W4AAM has taken on a better half and claims he will do more work now as he can't get out nights. Porto Rico: Sorry, fellows, that your report did not get in last month as the SCM has been laid up in the hospital and is just getting out again. We are counting on you this winter and we are sure you will do the trick. Georgia: W4SI is back from Europe where he had quite a time. The Atlanta gang is glad to have him back as W4SI is a good traffic man. There's not much activity due to vacations and the sort. Cuba:—The SCM would appreciate it if nq-2AY would communicate with him regarding his section line-up.

Traffic: W4EI 14, W4AAM 7, W4KU 1, W4FN 84.

WEST GULF DIVISION

NORTHERN TEXAS—SCM, J. H. Robinson, W5AKN—The SCM attended the Rocky Mountain Convention at Pueblo, Colo., and certainly had a wonderful time, meeting some of the fellows with whom schedules are kept, also L. R. Huber from Headquarters. The SCM won the prize for being the ham coming the farthest to attend the convention. Fellows, don't forget the West Gulf Convention to be held in Dallas early in October. We intend this to rival national conventions. W5ATZ kept schedules with W5AUE, W5AUG and W5LP. W5HY has a good line of schedules and is far ahead of the Dallas gang with his message report. W5BBF is using two 210's that get him good reports. W5BAD is keeping a sked with W5BEC. W5OE is on a vacation. W5NW is still trying 23

me. (10 meter) work. He heard W1SZ on that frequency and keeps a sked with sc-1AL. W5BDL is building a 1929 transmitter and hopes to be an ORS soon. W5APB is using a portable set at Amarilla while waiting for parts for a larger set to arrive. W5AEK is installing a mercury arc rectifier to straighten out the tripples from a 1500 watt plate transformer. W5AAE is working on 1850 kc. (162 meters) keeping skeds with W5AWE and W5BDT. W5AHU has been on vacation, also. Don't forget the West Gulf Convention!

Traffic: W5ATZ 75, W5HY 53, W5BAD 12, W5NW 10, W5BDL 10, W5APB 7, W5AHU 6, W5AEK 4, W5AAE 3, W5AKN 2.

SOUTHERN TEXAS—SCM. R. E. Franklin, W6OX—The SCM wishes to say that he is going to try to be your SCM in the full sense of the word. If he can be of service to you, don't fail to call on him. Come on, fellows, let's make this the liveliest section in the South. There is still some ORS left for live wire stations. Houston is getting back on the map again. They have just organized a new radio club boasting a membership of twenty charter members. Good luck, OMs. The SCM had the pleasure to be present at a meeting of the San Antonio Radio Club while visiting in that city and was gratified to find such fine amateur spirit. W5MS, one of our old timers, has just returned from the sea and promises to be back on the air soon on all waves. W5ZG-W5VY got married recently. Congrats, OM, and may all your troubles be—but why bring that up? W5OX has a WE250 going on 7645 kc. (39.5 meters) and keeping some good skeds. W6KI worked South Africa. FB, OM.
Traffic: W6OX 22.

CANADA

ONTARIO DIVISION

ONTARIO—SCM. W. Y. Sloan, VE9BJ—Southern dist.: London has another new station in VE3HB who has been having a very good time since it was first opened early in July. VE3BV has rebuilt and now announces that he has a 1929 transmitter. VE3IA is also rebuilding. VE3CB says that the weather is not what it used to be. VE3CS is rebuilding that he may do more and better DX if such is possible. VE3AQ is completely overhauling the station. Central Dist: VE3BL has been to Montreal, besides working regularly on 720 kc. (52.5 meters). VE3CL has changed his QRA apparently for the worse as he is now bothered by a very busy BCL. VE3CQ is a new station that seems to be stepping out. VE3BP, VE3AL and VE3CJ are all on vacations. VE3VS has a new transmitter and has done some traffic work. VE3BO is about the busiest in Toronto keeping 3 separate schedules on 5720 kc. (52.5 meters). VE3FC has a car and finds little time for radio. VE3DY uses 5720 kc. (52.5 meters) and 14,000 kc. (20 meters). Northern Dist: VE3HP has been on a vacation but is back and busy again. VE3EH and VE3EF are on whenever possible on 5720 kc. (52.5 meters).

Traffic: VE3VS 20, VE3AL 15, VE3HP 18, VE3BO 18, VE3CJ 8, VE3EH 7, VE3HB 6, VE3BV 3, VE3FC 4, VE3CL 1, VE3DY 1.

VANALTA DIVISION

BRITISH COLUMBIA—SCM. E. S. Brooks, VE5BJ—VE5BR says he is too busy with campus etc. to be on. VE5CT is on occasionally. VE5CO, VE5EK, and VE5HK are silent in Victoria this month. VE5CO wants to know why VE5GO failed to keep schedules and wants a regular station in Vancouver to handle traffic. VE5CO reports visits from W1LZ and W6DCA. Reports have it that VE5AJ is going to work somewhere around Hudson's Bay. VE5CJ is on a visit to the Queen City. The VE9AJ gang are installing the transmitter in their new club house and hope to be on for the fall rush.

The 4th annual ARRL Convention held last month in Vancouver proved a great success and a large number of W7's were in attendance. The SCM had to work and missed the fun. Hi.

Traffic: VE5CO 2.

QUEBEC DIVISION

QUEBEC—SCM. Alex Reid, VE2BE—We are in vacation period and few stations are now heard on their air. We expect a revival in the fall. Some nights eight hams of this division are heard and nearly all are very good on DX. VE2AL is still

very busy with his flying work but is occasionally heard on the 14,000 kc. (20 meter) band. VE2BB is very good on the 7000 kc. (40 meter) band and says BCLs are useless. VE2BG is now and then pounding away on the 14,000 kc. (20 meter) band and seems to be doing fine. VE2AE cannot get out now; he says his condensers will not stand the 1200 he plays with. VE2AQ has gone in the arctic for a long spell. VE2BH is still with the SS Beothic whose call is VYG working on about 10,000 kc. (30 meters). VE2AP has come down onto the 14,000 kc. (20 meter) band and thinks he will like it. VE2AV has also started chasing the ether waves in a plane. VE2CA has done good work on 14,000 kc. (20 meters) and the QRK's he gets are worth having.

PRAIRIE DIVISION

SASKATCHEWAN—SCM. W. J. Pickering, VE4FC—Still another new station on the air VE4BR at North Battleford, who has been on the air for some time with a 210 but hasn't been QSO anyone yet. Will the Sask. gang please listen for him on the 7000 kc. (40 meter) band? VE4GO at Canora has been on since spring with a 201A and is getting good results. VE4BM was QSO eg-2BQH and is getting out fine in his new location, Sinaluta. VE4GR is also kicking out fine now. VE4AO has his set installed at last.

Traffic: VE4BM 2, VE4GR 2.

MANITOBA—SCM. D. B. Sinclair, VE4FV—The gang are now installed in their new club rooms on the roof of the Free Press building and are collecting parts for the club station. The vacation season being over, we welcome back on the air, VE4DU; his sigs are large as life and twice as natural. VE4DJ reports a satisfactory exploration of the 14,000 kc. (20 meter) band. VE4FV expects to get his 852 perking about the time the new regulations come into force. Hi. VE4EK is still bursting ear drums on 14,000 kc. (20 meter) and 7000 kc. (40 meter) band but says he is going to rebuild to a split colpits, for his present set is very efficient at 1700 kc. (28 meters) only. VE4DB is getting out FB on 14,000 kc. (20 meter band), but blew his rectifier the other day so is using AC till pay day. VE4GQ and VE4BT have the DX complex (or bug) and have each worn down their keys pretty well. VE4DK has his new plate glass TPTG perking well on 14,000 kc. (20 meters) and 7000 kc. (40 meters) and would be surprised to hear a report of less than R3. VE4DP divides his time between cursing a bad power lead and listening for the elusive DX. VE4CT is back in town with a brand new job and ambitious that lead us to expect about 150 watts to pound out from QRA very soon. VE4DI has rebuilt TPTG and after some trouble with his milliammeter needle which wanted to become circular, has the rock crusher under control at last. VE4GG sold his transmitter to VE4BT who had seen VE4GG reported from OZ. VE4GG says he is building a bigger and better one now. VE4BU at Pointe du Bois has a new Jr. op at his shack and says now that the excitement is over, he will be back on the air, if he can hear from QRM (local). Very 73 to the Jr., OM. VE4DL also has a new YL Jr. op. Congrats, OM. VE4NR is pounding away as usual on 14,000 kc. (20 meters) and 7000 kc. (40 meters). VE4HF gets on occasionally between his council meetings and wrestlings with his vintage fivver. VE4FN has recovered from the shock of his first DX (Hawaii) and is now looking earnestly for traffic.

Traffic: VE4GQ 7, VE4DL 2, VE4DB 2.

Late and Additional Reports

W6LB had a visit from W6BPR for two weeks. W6BXD says DX is FB with new remote controlled transmitter. W6APW rebuilt his outfit and is going after real DX. W6DPY built a 1929 transmitter and got OA and AJ the first morning. FB, OM. W6EAF has laid the foundation for a new radio room. W6DPK reported no news. W6BZR was off the air for so long, he almost forgot to report. He just got his 50 back from W6EX so ought to be on now. W1NH was very QRW so not much traffic. W1EZ's A batteries left him last month but he will be on with higher power soon. W3ZU has moved to Pittsburgh and will use the call 8ZU from there. W8DSP is experimenting on television and W3XK came through FB.

Traffic: W6LB 6, W6BXD 50, W6APW 33, W6DPY 7, W6EAF 4, W6DPK 4, W1EZ 47, W1NH 27, W8DSP 167.